

USER'S  
HANDBOOK

4920

Alternating Voltage  
Measurement Standard



# USER'S HANDBOOK

for

## THE DATRON 4920 ALTERNATING VOLTAGE MEASUREMENT STANDARD

(for servicing procedures  
refer to the Maintenance Handbook)

850264

Provisional Issue A (March 1991)

For any assistance contact your nearest Datron Sales and Service center.  
Addresses can be found at the back of this handbook.

Due to our policy of continuously updating our products, this handbook may contain minor differences in specification, components and circuit design to the instrument actually supplied. Amendment sheets precisely matched to your instrument serial number are available on request.

© 1991 Datron Instruments

	Page
<b>SECTION 4 USING THE 4920</b>	
Preliminaries	4-1
Safety	4-1
Interconnections - General Guidelines	4-2
Functions	4-4
Measurement of AC Voltage	4-4
mV Function - AC Millivolt Ranges (Option 10)	4-6
AC/DC Function - AC to DC Transfer	4-9
Facilities	4-12
Input Channels A and B	4-12
Digital Filter	4-13
RMS Computation - Low Frequency Limits	4-14
Spot Frequency Operation	4-15
Status Reporting	4-17
Monitoring	4-17
Math	4-19
Direct Action Keys	4-22
Numeric Keyboard Keys	4-23
Test Facilities	4-24
Calibration Operations	4-27
<b>Section 4 Appendices:</b>	
A Error Detection/Error Messages	4-A1
B 4920 Standard Signal-Acquisition Times	4-B1
C 4920 ACV and mV Significant Range Points	4-C1
<b>SECTION 5 SYSTEMS APPLICATION VIA THE IEEE 488 INTERFACE</b>	
Section 5 Contents List	5-0-1
Classified Alphabetical List of IEEE 488.2 Codes used in the 4920	5-0-2
Introduction	5-1
4920 Commands and Queries - Syntax Diagrams	5-28
<b>Section 5 Appendices:</b>	
A IEEE 488.2 Device Documentation Requirements	5-A1
B 4920 Device Settings at Power On	5-B1

**CONTENTS** *(Continued)*

	Page
<b>SECTION 6 SPECIFICATIONS</b>	
Mechanical and Environmental	6-1
Electrical	6-2
Maximum Inputs	6-3
Accuracy Specifications	6-4
ACV Accuracy	6-4
mV Accuracy	6-6
AC/DC Accuracy	6-8
<b>SECTION 7 SPECIFICATION VERIFICATION</b>	
Introduction	7-1
Equipment Requirements	7-1
Preparation	7-2
ACV Performance Verification	7-3
Spot Frequency Verification	7-4
User's Uncertainty Calculations	7-6
Verification Report Sheet	7-7
<b>SECTION 8 ROUTINE CALIBRATION</b>	
Introduction	8-1
Autocal	8-1
The CAL Menu	8-2
Equipment Requirements	8-4
Preparation	8-5
ACV 100mV Calibration	8-6
ACV Calibration	8-7
ACV Spot Calibration	8-8
Calibration at other than Nominal Values	8-10
Setting a New Calibration Due Date	8-10

## SECTION 1

# Introduction and General Description

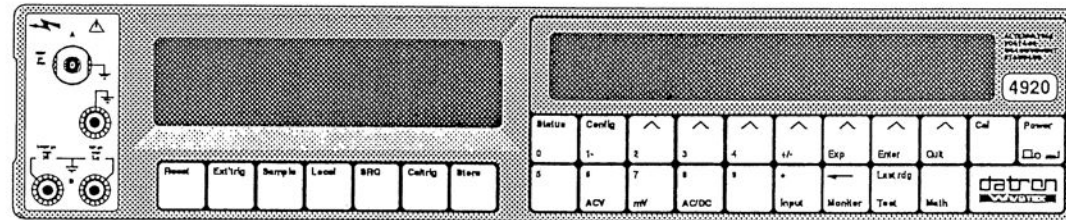

Designed with Standards and Calibration laboratories in mind, the 4920 provides extremely high performance in AC Voltage measurement, combined with ease of use.

## Standard and Optional Measurement Facilities

### Basic Configuration

The 4920 is a high-quality Alternating Voltage Measurement Standard. Its basic configuration offers the following measurement capabilities:

- **High Accuracy mode** - RMS AC Voltage measurement in eight ranges from 90mV to 1100V; 1Hz to 1MHz; 1-year specifications to  $\pm 30$ ppm. Input Impedance  $> 200\Omega/V$ . Display resolution to 100nV maximum.
- **Transfer mode** - Ranges and resolution as ACV. AC/DC or AC/AC transfers performed faster and more easily than with normal thermal transfer devices..
- **Millivolt Ranges (Option 10)** - Measurements from 0.9mV to 110mV in four ranges.
- **Menu Control** - flexible and easy to use.
- **Calibration** - Autocal external calibration.
- **Remote Control** - Fully IEEE-488.2 programmable.

## 'Hard' and 'Soft' Keys - Menus

The use of hard keys (labels printed on the keys themselves) and soft keys (labels appear on the separate menu display) allows programming of the instrument into a wide range of configurations. Pressing the hard key of one of the main functions (ACV, mV option or AC/DC transfer) alters the instrument circuitry to the selected function, at the same time displaying its own menu. Alternatively, once a main function is active, the Config hard key can be used to alter the configuration. Each soft key, marked with an arrowhead (^), is labelled by the legend above it on the display.

The Status hard key allows a check of configured parameters. Once Status is selected, the Config hard key can be used to check or alter the IEEE-488 bus address, to check on the instrument identification, or view significant dates.

The Monitor key permits access to such information as the signal frequency of an AC input signal being measured; and to calculations of the deviation between two measurements.

The menus are arranged in tree structures, leading the user through their branches to an end node, at which the physical circuitry or software selections of the instrument can be changed to suit the required parameters. For ease of use, each track from main function to end node involves the minimum number of user selections.

When the instrument power is switched on, all functions are forced into a safety default state. Once a function is configured to a required state it remains in that state, regardless of subsequent configurations in other functions, until either the state is changed or the instrument power is switched off.

As an easy introduction to the main function keys and their associated menus, users can follow a guided tour through the main tree structures, sequenced in Section 3. The full range of facilities, together with access information, is detailed in Section 4.

## System Use

The 4920 is designed as standard to form part of a remote control system, conforming to IEEE 488.2 Standard Digital Interface. Remote control information is given in Section 5. This fulfils the Device Documentation Requirements of the standard (summary in Section 5 Appendix A).

## Self Test

The Test key displays a menu which provides access to a comprehensive series of self-tests. Among these are:

- An operational selftest;
- A diagnostic selftest;
- A test of the displays;
- A test of the front panel keys;

Details of these selftests can be found in Section 4 of this handbook.

## Calibration

### Autocal

The 4920 is an 'Autocal' instrument, providing full external calibration of all ranges and functions from the front panel; thus making the removal of covers unnecessary.

Periodically, the 4920 is electronically calibrated against traceable external standards, where any differences in the instrument's readings compared to the value of the external calibration sources can be used to derive calibration constants, which are stored by the instrument in non-volatile memory. These external calibration corrections later serve to correct all readings taken by the 4920.

Calibration can also be carried out under remote control via the IEEE 488 interface.

### Calibration Security

A recessed Calibration Enable/Disable switch on the rear panel prevents accidental use of Autocal. For remote operation; in addition to operating the Enable/Disable switch, an 'enable' code is required to gain access to calibration operations.

### Calibration Routines

The Routine Calibration procedures are described in Section 8 of this handbook.

## Message Readout

Generally, the selections offered in the menus reflect the availability of facilities, incompatible combinations being excluded. Nevertheless, the menu display doubles as a message screen, giving a clear readout of information to the user such as unsuitable attempts at configuration, test failures and some other conditions which would need to be reported to a Datron service center.

## Processor

The instrument is internally controlled by a 68000 series microprocessor. It ultimately translates all information, either from the front panel keys or from remote control, according to its program in firmware, into control signals which determine the instrument's operation.

## Computing

As measurements are taken they can be compared with an earlier 'reference', or several measurements can be combined to obtain statistical data. Some of the keys under the Menu display double as a keyboard for setting the bus address, math constants etc.

Full details of the computing facilities are given in Section 4.

### Accessories

The instrument is supplied with the following accessories:

Description	Part Number
Power Connector Cable (L1949)	920012
Power Fuse (230V use) 500mA (L2080A/.500) SLO-BLO	920084
Power Fuse (115V use) 1.0A (L2080/1) SLO-BLO	920116
Hex Key 1.5mm AF (Handle removal)	630284
User's Handbook	850264
User's Quick Reference Guide	850912

### Optional Accessories

The following accessories can be purchased for use with the 4920:

#### Description

Model 1512: High Quality 2/4-Wire AC Lead Kit

Model 1513: General Purpose AC Lead Kit (Dual 4mm Plug)

Model 1514: High Quality 4-Wire DC Lead (Separate 4mm Plugs)

Model 4921: Shunt Adaptor

Description	Part Number
4920 Maintenance Handbook	850265
4920 Reference Handbook	850266

### Additional Documentation

The Maintenance Handbook contains information required to adjust and maintain the 4920, including mechanical data, routine servicing, remedial adjustments, diagnostic guides and circuit descriptions.

The Reference Handbook contains component lists, layout drawings and circuit diagrams.



## Outline of 4920 Applications

### Thermal Transfer Standards - Difficulties

The 4920 has been designed primarily to overcome some of the inefficiencies, costs and complications of calibrating and verifying traceable accuracy of the alternating voltage outputs from AC or multi-function calibrators.

Thermal transfer standards have for many years been the backbone of AC measurement in these and other applications, but their operational requirements are increasingly impeding improvements in productivity. Considerable care is needed due to the electrical and mechanical fragility of thermal elements, and skilled operators are diverted by the tedium of long settling times. Maintenance, support and operating costs of the TTS remain significant overheads, stimulating a search for faster, more rugged and cost-effective alternatives.

At millivolt levels, because of the insensitivity of the TTS, it needs to be supplemented at low frequencies by such devices as the inductive voltage divider (IVD), and at higher frequencies by 'tenth of range' transfer methods, both of which add significant uncertainties to the process.

With the advent of the IEEE 488 and other instrumentation interfaces, measurement and calibration processes are increasingly being programmed for remote and automatic control, to improve their cost-effectiveness. Because of long settling times and the frequency of skilled operator intervention, the TTS is intrinsically unsuitable for automation.

All of these factors motivated the evolution of the 4920 AVMS.

### Anticipated Applications for the 4920

There are six main areas where it is envisaged that the 4920 will operate, while improving on the performance of thermal transfer standards:

- Speed up the operation of high-accuracy AC measurement processes.
- Fully support calibration and verification of the AC voltage functions in Datron's 4200A and 4700 series calibrators.
- In multi-function calibrators, transfer the traceability of their previously-calibrated DC voltage ranges to the calibration of their high-accuracy AC voltage ranges.
- Internally transfer the traceability of its own AC voltage ranges to the measurement of AC millivolts (a stable, but not necessarily accurate, source of 100mV at the measurement frequency is all that is required).
- Perform all its functions within an automated measurement system, under remote control via the IEEE 488.1 interface, conforming to IEEE 488.2 protocols.
- Adapt to AC current measurement between 2.5mA and 20A, using standard current shunts with a rated voltage level of 500mV, such as are presently employed for thermal transfer standards.

The means by which the 4920 carries out its tasks are outlined under 'Principles of Operation' in the following pages.

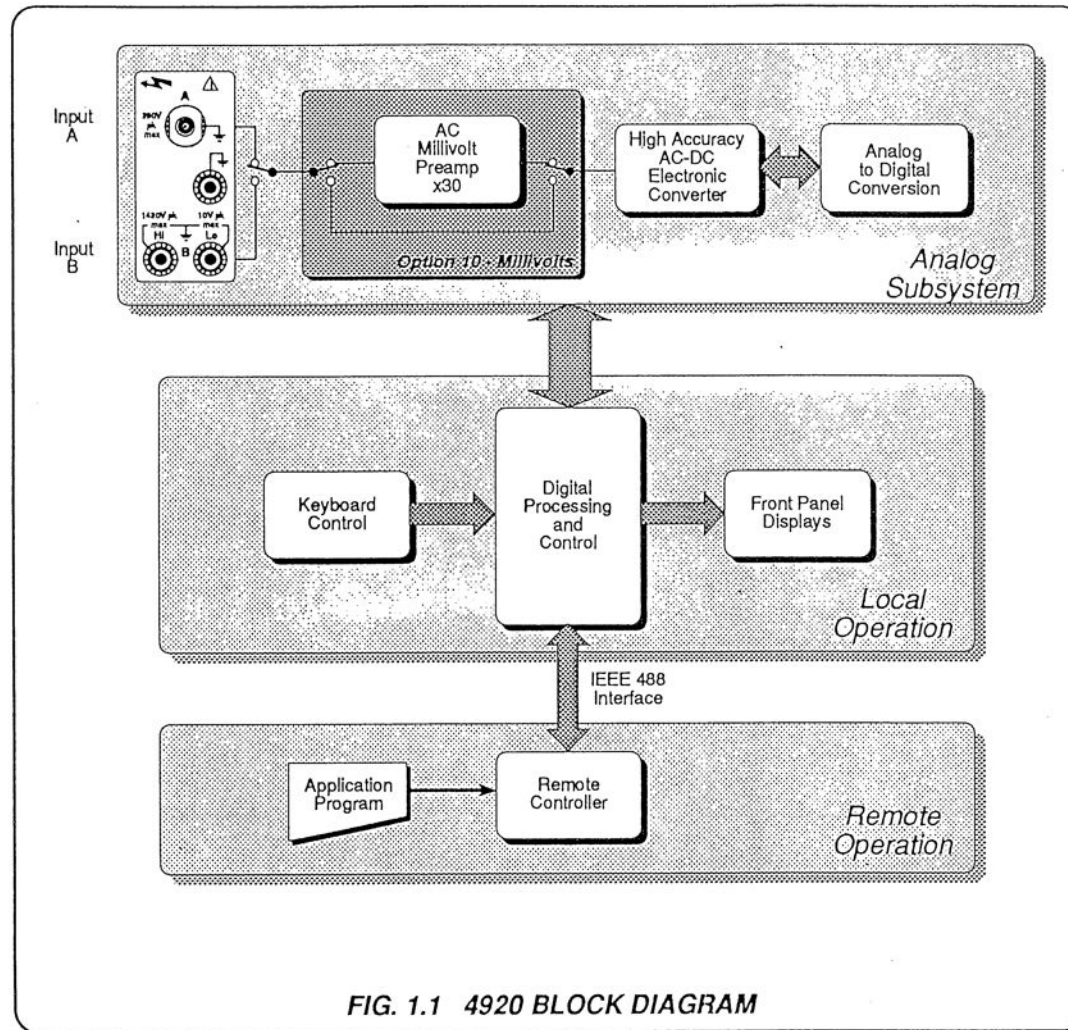

FIG. 1.1 4920 BLOCK DIAGRAM

## Principles of Operation

Figure 1.1 (opposite) shows the instrument's basic measurement functions.

### Basics

#### Precision Design

The 4920 AVMS is designed for calibration and standards laboratory applications, taking full advantage of the inherent qualities of critical accuracy-defining components and advanced measurement techniques to achieve its high performance. It is suited to all applications where a thermal transfer standard would presently be used, with the exception of some highly-developed specialities. It employs a method of calibration which is designed to maintain performance across the entire range of its functions.

#### Three-Reading Measurement Cycle

In all modes, each displayed measurement consists of three separate internal readings in which the RMS value of the input is detected and processed via the A-D and microprocessor system, then fed back to calibrate the measurement process. The final result is transferred to the instrument's microprocessor for calibration, further processing and display.

#### ACV Function

AC voltages input via the front panel are conditioned by a DC-coupled AC preamp, and presented to an electronic RMS detector. The DC 'RMS' level output from the detector acts as reference for the generation of a 'Calculable AC Reference'. This represents the processed RMS value of the applied signal in an AC-AC transfer, during the three-reading measurement cycle mentioned above.

#### Millivolts (mV) - Option 10

An external 100mV signal, at within  $\pm 1\%$  of the frequency of the AC voltage to be measured, is input via the front panel. The 4920 uses this input to characterize the gain of an internal x30 amplifier. This 100mV characterization signal needs to be stable for the duration of the amplifier characterization operation - its absolute value is unimportant. In subsequent use the amplifier is placed in cascade with traceable ACV ranges to measure millivolt inputs from 0.9mV to 110mV.

#### AC/DC Transfer Mode

The RMS value of an AC voltage is compared with the combined RMS value of two DC reference voltages of equal value and opposite polarity.

The DC reference signals are applied in sequence and their individual values are measured and stored. The system digitally computes the RMS of these two stored values to form the 'DCRMS equivalent', which is also stored.

The system then measures the RMS value of the applied AC signal, and digitally computes its deviation from the 'DCRMS equivalent'. The deviation is displayed in ppm on the dot-matrix display.

## ACV Operation

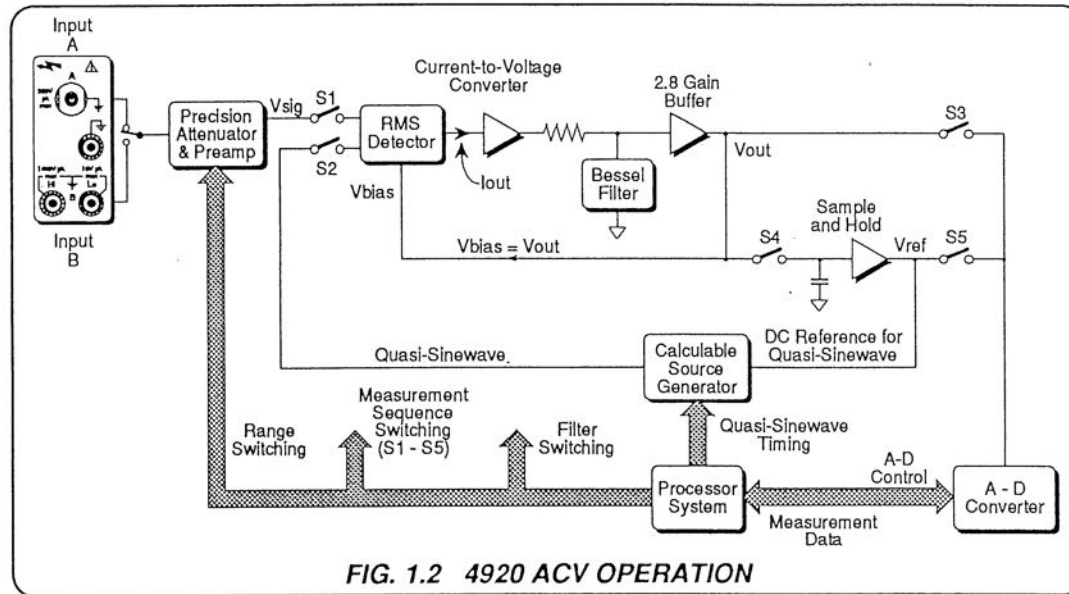

### Attenuators and Preamp

#### Basic Design (Fig. 1.2)

The basic design incorporates a DC-coupled preamplifier, which has relatively high input impedance (124k $\Omega$ /150pF on the 3V to 100V ranges; otherwise 404k $\Omega$ /90pF). The gain-defining resistor chains are guarded, and the remaining time constants are set above 1MHz so that hardware trims are not required.

#### Range Selection

There are three main attenuators:

1. A permanent 1kV/300V attenuator for overload sensing;
2. A 100V/30V/10V/3V attenuator, switched in parallel with the 1kV/300V attenuator;
3. A 1V/300mV attenuator in the unity gain buffer, in series with the 1kV/300V attenuator.

#### Attenuator Elements

The attenuators, which configure the amplifier gain to define the high-accuracy AC Voltage ranges, consist of extremely stable metal foil resistors, packaged in large hermetic-seal cases. Similar types are used in the 1V range protection chain.

To ensure that no spurious leakage currents cause linearity, temperature-coefficient or drift problems in the attenuator chains, the sealed cases form a guard at HF, driven by a capacitor chain. Within the cases of the attenuator elements, the resistor values are split and the junctions guarded to effect a high degree of frequency flatness.

## RMS Converter

### DC Coupled Preamp

In order to minimize the input capacitance to the preamp, reed relays are used to select the signal paths for the various ranges. The preamp bootstraps extensive pcb tracking to guard the attenuators, input tracking and reed relays; it also drives a bootstrap buffer which forces the preamp power supplies to follow the input signal level by reference to bootstrap. The preamp thus sees no change in input signal relative to its supplies, again minimizing its input capacitance and achieving very high common mode rejection.

### Separate PCB

The whole attenuator and preamp circuit is mounted on a separate sub-assembly, fabricated with PTFE board, and mounted above the main High Accuracy ACV printed circuit assembly.

The preamp is run at unity or X3 gain depending on range selection, with corresponding compensation switching. Its output voltage is fed to the RMS Converter on the High Accuracy ACV printed circuit assembly, from which the compensation current for the preamp signal current into the signal ground (0V-4) is derived.

### Protection

The instrument can measure up to 1100VRMS and can withstand a continuous overload of 1100VRMS or 1556V peak. Overload is sensed by a resistor at the low end of the 1000V/300V attenuator; and protection is activated from the HIACC\_AC pcb. Two series resistors, referred to two zener diodes, absorb the overload energy for up to 1 second, by which time the protection system will have disconnected the instrument input from both the 100V/30V/10V attenuator and the preamp input.

### Conversion Process

RMS conversion is based on a modified analog multiplier, consisting of a 'squaring' logarithmic amplifier whose output is buffered into a balanced exponential amplifier.

The DC current output of the squaring circuit 'Iout' is proportional to 'Vin<sup>2</sup>' if a fixed source-current bias is applied to the logging and antilogging elements. The transfer function is

$$I_{out} \propto V_{in}^2 / (R^2 \times I_{bias})$$

where **R** is the common value of balanced source resistors and **I<sub>bias</sub>** is the common source-bias current for the logging and antilogging circuits.

Iout is converted into a DC voltage **Vout** which ultimately becomes the RMS Converter output. However, in order to apply the 'square-root' element of the computation, this voltage is fed back to provide a current bias whose amplitude follows Iout, and this forces Iout to a value proportional to  $\sqrt{(V_{in}^2)}$ .

The transfer function now becomes

$$I_{out} \propto V_{in}^2 / (R^2 \times I_{out})$$

as **R** is constant this leads to  $I_{out}^2 \propto V_{in}^2$ , and to  $I_{out} \propto \sqrt{V_{in}^2}$ . After current-to-voltage conversion and filtering, this gives  $V_{out} \propto \sqrt{V_{in}^2}$  as the DC output voltage fed to the A/D, subject only to calibration.

## Transfer Loop

### Transfer Process (Fig. 1.2)

Three measurements are made to determine the precise RMS value of the signal. The first is an estimate (to about 1%) which is also a function of the gain of the RMS Converter. The other two are used to determine that gain and then apply corrections to the first measurement.

### Calculable Source Generator

The Sample-and-Hold circuit provides a memory of  $V_{out}$ , to be used as reference for the Calculable Source Generator. This in turn constructs a 'quasi-sinewave' whose amplitude and form factor are known, in order to ensure that the transfer is a true AC to AC process.

### Transfer Sequence Switching

Figure 1.2 shows the arrangement of the elements in the loop. The positions of switches S1-S5 are altered by firmware to generate the three-measurement sequence:

### First Measurement (M1):

The uncorrected RMS value of the input signal ( $V_{sig}$ ) is measured directly by the A-D and processor. The DC analog value of  $V_{out}$  ( $V_{ref}$ ) is memorized in the Sample-and-Hold circuit:

- S1 closed drives the RMS Converter from  $V_{sig}$ ;
- S2 open prevents the quasi-sinewave from interfering with the measurement;
- S3 closed the A-D and processor evaluate the first estimate;
- S4 closed  $V_{out}$  is sampled;
- S5 open removes  $V_{ref}$  from the direct measurement of the input.

### Second Measurement (M2):

$V_{ref}$  from the previous measurement (M1) is measured by the A-D and processor. Meanwhile, the quasi-sinewave (resulting from  $V_{ref}$ ) is applied to the RMS converter to allow settling for the next measurement (M3).

- S1 open  $V_{sig}$  is removed;
- S2 closed drives the RMS Converter from the the quasi-sinewave (settling only);
- S3 open removes  $V_{out}$  from the measurement;
- S4 open freezes  $V_{ref}$ ;
- S5 closed the A-D and processor measure  $V_{ref}$ .

**Third Measurement (M3) :**

The quasi-sinewave is measured by the RMS converter, A-D and processor.

- S1 open      Vsig is not applied;
- S2 closed    drives the RMS Converter from  
the the quasi-sinewave for the  
measurement;
- S3 closed    applies Vout for the quasi-  
sinewave to the A-D and  
processor for measurement;
- S4 open      Vref remains frozen;
- S5 open      prevents Vref from interfering  
with the RMS measurement of the  
quasi-sinewave;

**Final RMS Computation**

If the gain of the RMS Detector, Filter and Buffer is G (not precisely known), then:

$$M1 = G.Vsig(RMS);$$

so  $Vsig(RMS) = M1 / G.$

M2 and M3 are combined to determine G very precisely:

$$G = \frac{\text{Transfer Measurement}}{\text{Transfer Reference}} = M3 / M2.$$

This is used to eliminate G:

$$Vsig(RMS) = M1.M2 / M3.$$

## Millivolt (mV) Operation (Option 10)

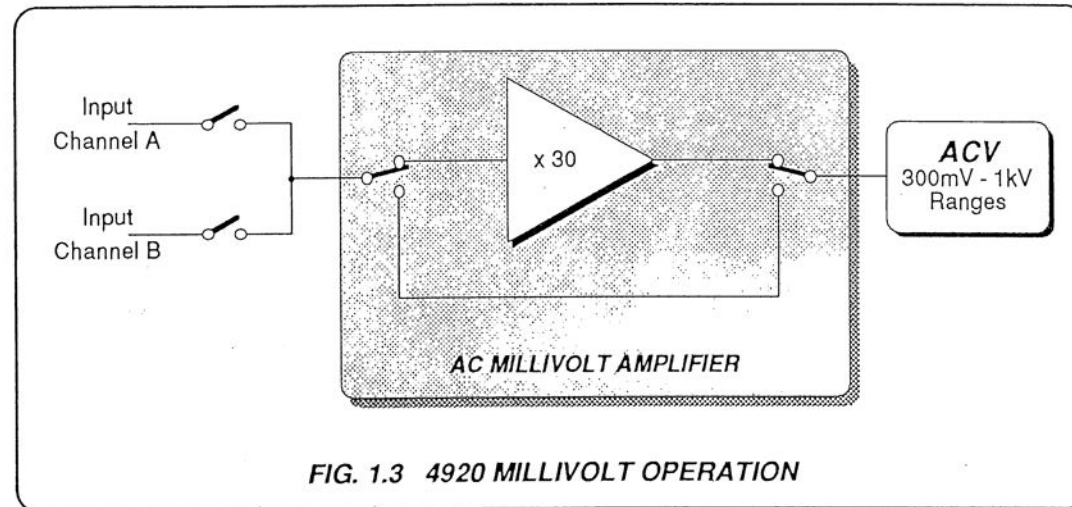

FIG. 1.3 4920 MILLIVOLT OPERATION

### Basic Design

#### Introduction

The 4920 ACV ranges extend from 300mV to 1000V, traceable between 30% and 110% of nominal range values. However, many modern calibrators in use have 10mV and 1mV ranges.

#### Operating Configuration

To permit traceable calibration of these ranges, an optional millivolt facility has been developed for the 4920 (Option 10), which produces the following ranges:

3mV:	0.27mV to 3.3mV
10mV:	0.9mV to 11mV
30mV:	9mV to 33mV
100mV:	27mV to 110mV

Option 10 provides for a x30 amplifier, with bypass switching, between the input terminals and the input attenuator/preamplifier system as represented in Fig. 1.3.



## Measurement Sequence

### X30 Amplifier Gain Characterization

Before operating on the millivolt ranges at power on, a user must input a signal between 95mV and 105mV, within 2% of the frequency to be measured, and initiate a characterization of the amplifier gain. This process takes less than a minute.

The 4920 measures both the input to the amplifier (ACV 300mV range) and its output (ACV 3V range), and automatically computes a correction for the deviation of the gain from x30. This correction is applied to all subsequent readings until the next time the gain is characterized.

### Millivolt Measurements and Traceability

Once the gain value has been stored, the four millivolt ranges provide traceable measurements for signals within 2% of the characterization frequency. To measure at frequencies outside this band, the gain must be re-characterized.

In use, readings are traceable because the gain measurement is derived using traceable ranges of the normal ACV function, and all four millivolt ranges use the amplifier in cascade with ACV traceable ranges as follows:

3mV Range: ACV 300mV range;  
10mV Range: ACV 300mV range;  
30mV Range: ACV 1V range;  
100mV Range: ACV 3V range.

### Implementation of Option 10

When Option 10 is fitted, the Terminal Switch Assembly is replaced by the AC mV Amplifier Assembly. This is connected between the front panel inputs and the AC Preamplifier Assembly, and also carries the input switching.

The x30 Amplifier, on the AC mV Amplifier Assembly, comprises a non-inverting x6 input stage followed by an inverting x5 driver. The whole amplifier is compensated for frequencies up to 1MHz. Input and feedback circuits of the input stage are each protected by a pair of transistors connected as back-to-back diodes.

The amplifier is inserted into the signal path only when a millivolt range is selected, or during its own digitally-controlled gain characterization sequence; at other times it is bypassed.

The amplifier has an input impedance close to 404k $\Omega$ /90pF. The accuracies of the four ranges are given in the millivolt specifications (*Section 6, pages 6-6 and 6-7*).

## Analog to Digital Converter

### Introduction

The instrument's analog-to-digital converter (A-D) takes the form of a highly linear, low noise, fast and flexible multislope integrator. Timing, counting and control are executed by a custom 'Application-Specific Integrated Circuit' (ASIC). A simplified schematic is given as Fig. 1.4. The A-D is involved in every measurement in ACV, mV and AC/DC operation.

### Multislope Operation (Figs. 1.4 and 1.5)

Multislope operation permits the integration capacitor value to be smaller than normally required for a more conventional circuit, greatly reducing problems due to dielectric absorption. Reference switching errors are reduced to a constant value, which are subtracted from the reading by the instrument's microprocessor. A further benefit is that both the signal and the reference may be applied to the integrator simultaneously, greatly reducing the conversion time. A digital autozero system avoids the need for the more common sample-and-hold type of autozero circuit.

The timing and counting considerations with this design of A-D are quite complex. Programmable delay timers, a ramp timer and a counter for the number of completed ramps exercise great control flexibility over its performance. All of these timers and counters are integrated into a custom ASIC which has a 32 bit control register, programmed by the instrument's microprocessor via a special serial interface. The same serial loop is used to transmit the reading from the ASIC to the processor for calibration and display.

**Features**

The result is a compact A-D with the following features:

- Excellent rejection of normal-mode power-line interference (Integration time is fixed at 200ms, an exact multiple of 60Hz and 50Hz line supply periods).
- Excellent linearity of 0.2ppm of full scale.
- Low noise of < 0.05ppm of full scale.

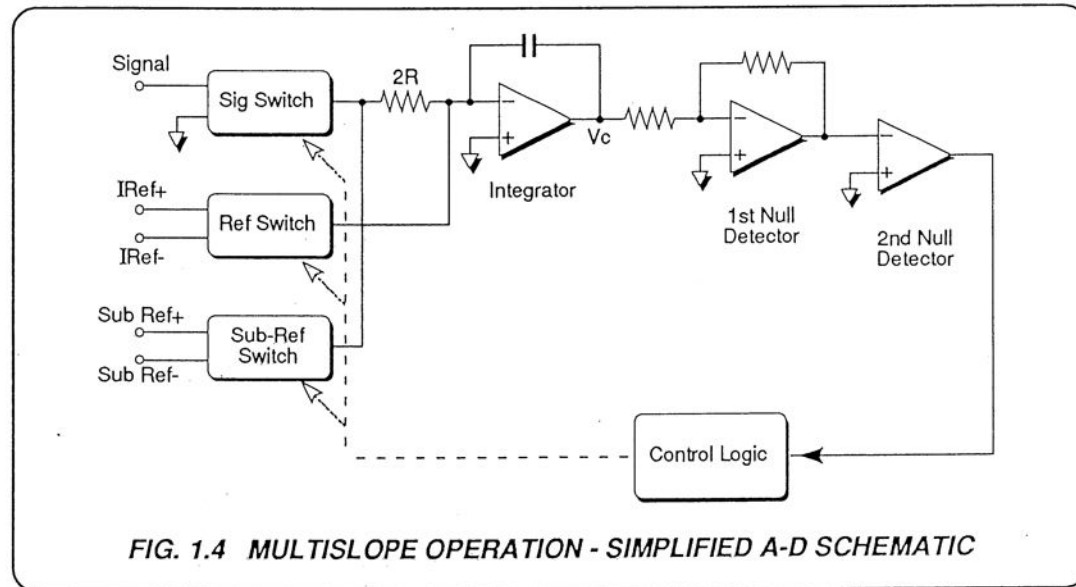

**FIG. 1.4 MULTISLOPE OPERATION - SIMPLIFIED A-D SCHEMATIC**

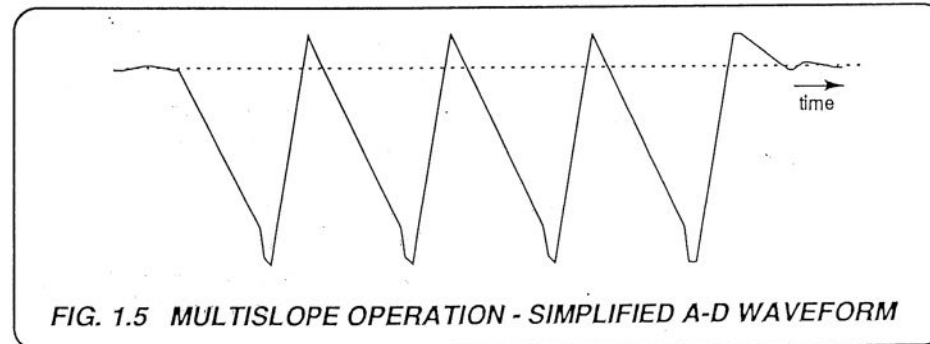

**FIG. 1.5 MULTISLOPE OPERATION - SIMPLIFIED A-D WAVEFORM**

## A-D Master Reference

### Reference Module

The reference used in the analog to digital conversion is derived from a specially conditioned zener reference module. It contains the reference device and its associated buffer circuits, which are all hermetically encapsulated together in order to ensure constant temperature across the module. The module is stable to within  $\pm 4$ ppm per year, produces pk-pk noise less than 0.1ppm, and has a temperature coefficient better than 0.15ppm/ $^{\circ}$ C. This temperature coefficient is held over a temperature span of 0 $^{\circ}$ C to 70 $^{\circ}$ C, and the reference exhibits negligible temperature shock hysteresis.

### Module History

Extensive evaluation of successive reference modules has resulted in a burn-in process which equates to an ageing of 1 year, reducing infant mortalities and improving stability. Following this process, all reference modules are checked over a temperature span of 0 $^{\circ}$ C to 70 $^{\circ}$ C for temperature performance, and then monitored for long term drift over a period of three months minimum.

## SECTION 2

# Installation and Operating Controls

This section contains information and instructions for unpacking and installing the Datron 4920 Alternating Voltage Measurement Standard. It also introduces the layout of controls on the instrument.

### Unpacking and Inspection

Every care is taken in the choice of packing material to ensure that your equipment will reach you in perfect condition.

If the equipment has been subject to excessive handling in transit, the fact will probably be visible as external damage to the shipping carton.

In the event of damage, the shipping container and cushioning material should be kept for the carrier's inspection.

Unpack the equipment and check for external damage to the case, sockets, keys etc. If damage is found notify the carrier and your sales representative immediately.

Standard accessories supplied with the instrument should be as described in Section 1.

### Calibration Enable Switch S2

#### CAUTION

This two-position rear-panel switch protects the instrument calibration memory.

The instrument was initially calibrated at the factory, so the switch should always remain set to DISABLE, until immediate recalibration is intended.

#### For Recalibration:

If the external calibration menu is selected while the key is not in the enabling position, the menu is replaced by the warning message:

**1002: calibration disabled**

## Introduction to the Front Panel

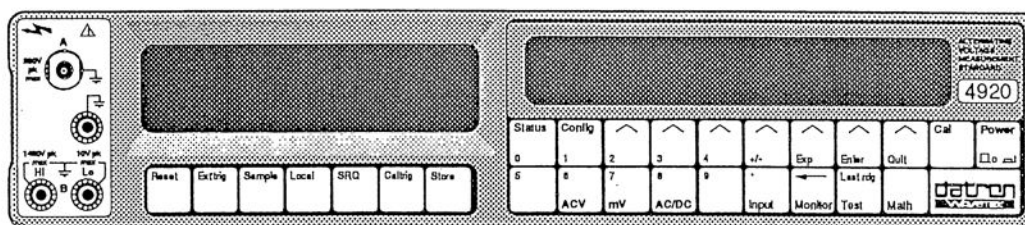

The two displays on the front panel deal with different aspects of operation. We set up the instrument's configuration using menus shown in the right-hand (dot-matrix 'menu') display, then readings appear in the left-hand ('main') display.

Beneath the dot matrix display, all keys other than the Power key are associated with menus. The keys beneath the main display are direct action keys, associated with triggers, remote control, and instrument reset.

### Menu Keys

There are two classes of front panel menu keys, those that lead to an immediate change of instrument state (i.e. the major function keys ACV; mV; AC/DC), and those that do not (Status, Config, Cal, Monitor, Test, Math).

### Numeric Keyboard

Seventeen of the menu and soft function keys also act as a keyboard for entry of parameters such as math constants, bus address, etc. The data entered is purely numeric, and can consist of either a keyboard-entered value or the value of the most recent reading.

### Major Function Keys: ACV, mV, AC/DC

Each of these keys defines a separate measurement state and activates its corresponding menu on the dot matrix display. Changing a selection alters the measurement state.

## Introduction to the Rear Panel

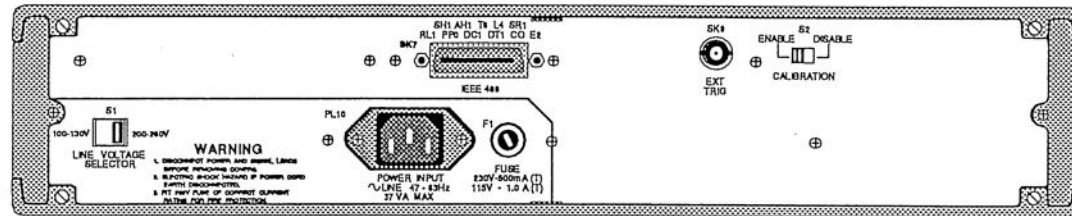

### Mechanical Access

The top or bottom cover is released for removal by undoing two screws visible at the rear. A single screw retains the corner block which covers the handle mechanism on each side panel.

### Labels

The rear panel displays the identification label for the instrument, and a modification label.

### External Connections

Apart from the front input sockets, connections to the internal circuitry enter via the rear panel.

SK7 is the standard IEEE 488 connector. A list of interface function subsets is printed next to the connector.

SK9 provides a coaxial BNC trigger input.

### Fuses

The fuse adjacent to the power input plug protects the power input line.

### Voltage Selector

The recessed power line voltage selector adapts the instrument to either 115V or 230V line inputs.

### Calibration Switch

To calibrate the instrument, special menus are available from the front panel. But to enter these menus it is necessary to set the calibration Switch on the rear panel to ENABLE.

## Preparation for Operation

### DANGER

THIS INSTRUMENT IS CAPABLE OF DELIVERING A LETHAL ELECTRIC SHOCK IF IT IS CONNECTED TO A HIGH VOLTAGE SOURCE. THE INPUT CONNECTORS ARE MARKED WITH THE  SYMBOL TO WARN USERS OF THIS DANGER.

UNDER NO CIRCUMSTANCES SHOULD USERS TOUCH ANY LEADS CONNECTED TO THE INPUT CONNECTORS UNLESS THEY ARE FIRST SATISFIED THAT NO DANGEROUS VOLTAGE IS PRESENT.

### Power Cable

The detachable supply cable comprises two metres of 3-core PVC sheath cable permanently moulded to a fully-shrouded 3-pin cable socket. It fits into a plug (PL10 - incorporates a filter) at the rear of the instrument and should be pushed firmly home. The supply lead should be connected to a grounded outlet ensuring that the Ground lead is connected. Connect Brown lead to Live, Blue lead to Neutral, and Green/Yellow lead to Ground.

### IEEE 488 Bus Connector

This detachable connector comprises two metres of multicore-core PVC sheath cable with standard IEEE-488.1 fittings. It fits into a socket (SK7) at the rear of the instrument. Refer to Section 5 for full details of IEEE-488 operation.



## Fuses

### Power Fuse:

The power fuse F1 is situated next to the power input plug on the rear panel. It should be of the anti-surge type. Its rating is dependent on the supply voltage:

for 100V to 130V - 1.0A SLO-BLO,  
for 200V to 260V - 500mA SLO-BLO.

MAKE SURE THAT ONLY A FUSE WITH THE REQUIRED RATED CURRENT AND OF THE SPECIFIED TYPE IS INSERTED AS REPLACEMENT.

AVOID THE USE OF MENDED FUSES AND DO NOT SHORT-CIRCUIT THE FUSE HOLDERS. SUCH PRACTICES ARE DANGEROUS; AND WILL RENDER THE WARRANTY VOID.

## Line Voltage

### Voltage Selector and Line Fuses - 115V

When shipped, the instrument is packed ready for use with 100V to 130V, 60Hz supplies. The legend '115V' will be visible in the window of the line voltage selector switch (S1) on the rear panel, and the fuse F1 will be rated at 1.0A.

### Changing Supply Voltage to 230V

For 200V to 260V supply; the voltage selector switch S1 must be moved so that '230' is visible in the window, and the fuse rating must be reduced to 500mA.

### Automatic 50-60Hz Operation

The 4920 is capable of operation at any line frequency from 47Hz to 63Hz, so no means of line frequency selection is necessary, or provided.

## Mounting

### Bench Use:

The instrument is fitted with rubber-soled plastic feet and tilt stand. It can be placed flat on a shelf or tilted upwards for ease of viewing.

---

### Rack Mounting - Option 90:

Option 90 permits the instrument to be mounted in a standard 19 inch rack. The method of fitting this option is described below, the locations being shown in the diagram opposite.

N.B. The top or bottom cover should not be removed for this purpose.

### Procedure

1. Remove each of the two rear corner blocks by undoing its single crosspoint screw, and store safely for possible future use.
2. Invert the instrument, and remove each handle as follows (detail 1):
  - a. Pull out the handle until the two 1.5mm socket-headed screws are visible in the handle locking bar.
  - b. Loosen the two locking screws using the 1.5mm hex key provided. Leave the screws in the bar.
  - c. Slide the whole handle assembly to the rear, out of the side extrusion.
3. Fit each front rack mounting ear as follows:
  - a. With its bracket to the front, slide the ear into the side extrusion from the rear.
  - b. Loosely fasten the ear to the extrusion at the front, using the four socket grubscrews provided.
  - c. Assemble the front plate and handle to the front ear as shown in the diagram, and clamp them together using the two counter-sunk screws provided.
  - d. Tighten all six screws.
4. Remove the feet and tilt stand as follows:
  - a. Prize off the rubber pads from the four feet.
  - b. Undo the two securing screws from each foot. This releases the feet, washers and tilt stand so that they can be detached and stored safely for possible future use.
5. Fit the instrument to the rack as follows:
  - a. Attach the two rear ears to the back of the rack, ready to receive the instrument.
  - b. With assistance, slide the instrument into the rack, locating the rear ears in the side extrusions. Push the instrument home, and using screws, cage nuts etc. provided with the rack, secure the instrument by screwing the front ears to the front of the rack.

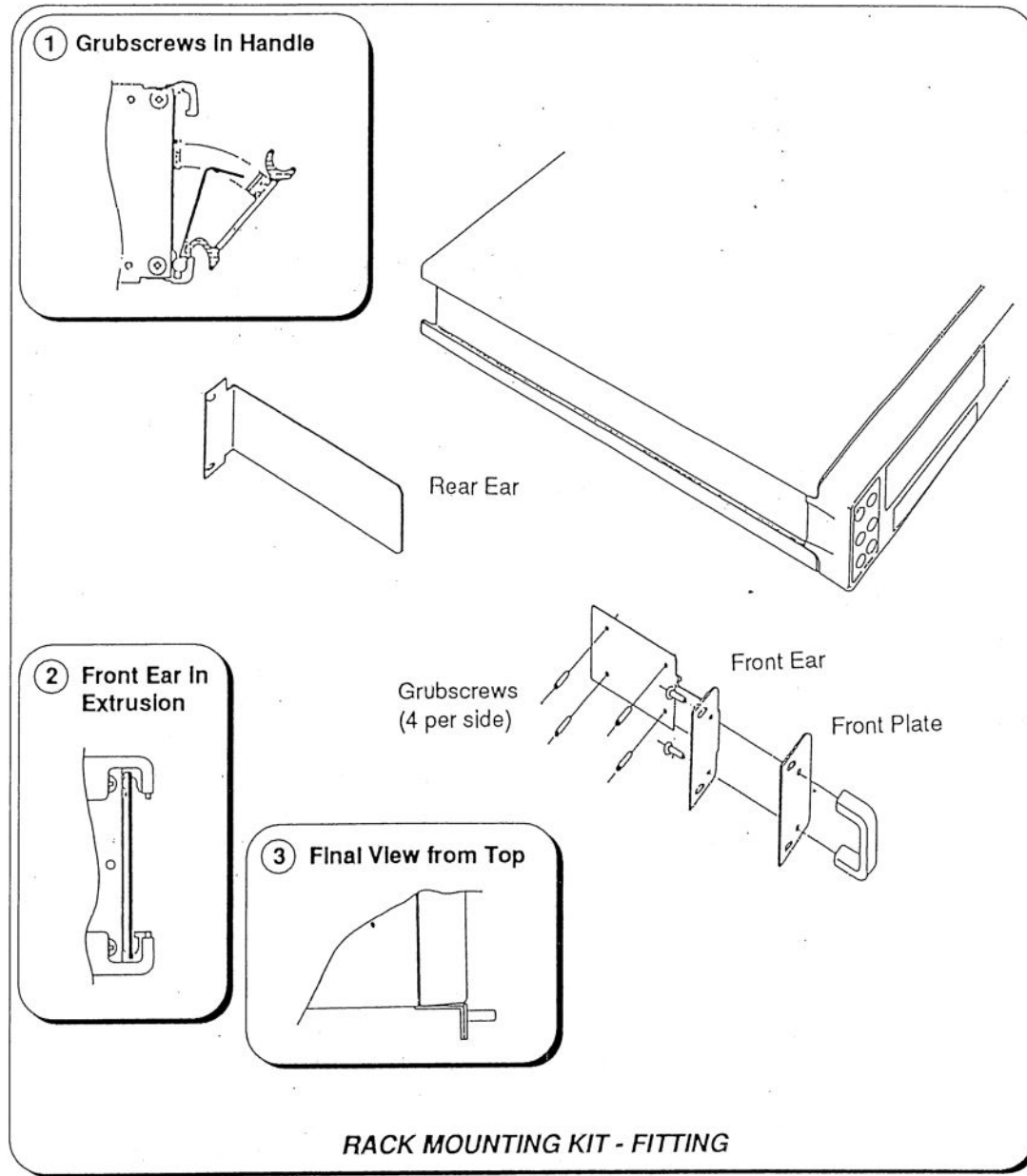

## Mounting (Contd.)

### Rack Slide Kit - Option 95:

Option 95 permits the 4920 to be mounted on slides in a standard 19 inch rack. The instrument can be pulled forward into a position where its rear panel is clear of the rack, to give access to the rear connectors. Cables should not be connected to the instrument until it is mechanically secure in the slides. The method of fitting this option is described below, the locations being shown in the diagram on page 2-11.

**N.B.** Neither top nor bottom cover should be removed for this purpose.

### Procedure

1. Remove each of the two rear corner blocks by undoing its single crosspoint screw, and store safely for possible future use.
2. Invert the instrument, and remove each handle as follows (detail 1):
  - a. Pull out the handle until the two 1.5mm socket-headed screws are visible in the handle locking bar.
  - b. Loosen the two locking screws using the 1.5mm hex key provided. Leave the screws in the bar.
  - c. Slide the whole handle assembly to the rear, out of the side extrusion.
3. Fit each slide mounting bracket (Pt. No. 450659) as follows:
  - a. With its ear to the front, slide the bracket into the side extrusion from the rear.
  - b. Locate and loosely fasten the bracket to the extrusion, using the six socket grubscrews provided.
4. Remove the inner section of each slide (Pt. No. 630353) from the other two sections as follows:
  - a. Lay the slide flat with its inner section uppermost. A rubber grip secured to the outer section at the rear holds the inner section fully home.
  - b. Slide the inner section forward to disengage the rubber grip, then slide fully forward against the release latch.
  - c. When fully extended, invert the slide so that the release latch is visible.
  - d. Press the bevelled side of the release latch, while drawing the inner section out of the middle section.
5. Fit the inner section of each slide to its mounting bracket (Pt. No. 450659) as follows:
  - a. Assemble the slide to the bracket as shown in the diagram (note the position of the release latch), and clamp them together using the three countersunk screws provided.
  - b. Tighten the six grubscrews and the three countersunk screws.
  - c. Fit and secure the front plate and handle to the slider ear, using the two M4 x 12 countersunk screws provided.

## Section 2 - Installation and Operating Controls

6. Remove the feet and tilt stand as follows:
  - a. Prize off the rubber pads from the four feet.
  - b. Undo the two securing screws from each foot. This releases the feet, washers and tilt stand so that they can be detached and stored safely for possible future use.
7. Fit each 10 inch mounting bracket to the correct position on the rack as follows:
  - a. Offer the bracket to the front of the rack as shown in the diagram. Secure the bracket through the rack slots using two slotpan screws, two shakeproof washers, two plain washers and a 2.5 inch nut bar. Slacken the screws slightly to ease final positioning when the instrument is pushed home.
8. Fit each 2 inch mounting bracket to the correct position on the rack as follows:
  - a. Offer the bracket to the rear of the rack as shown in the diagram. Secure the bracket using two slotpan screws, two shakeproof washers, two plain washers and a 2.5 inch nut bar. Slacken the screws slightly to ease final positioning when the instrument is pushed home.
9. The outer section of the slide has two securing holes at the front and two slots at the rear, each within cut-out tongues. The slides are fixed to the adjustment slots in the 10 inch and 2 inch mounting brackets by two slotpan screws through the front holes, and one through one of the rear slots. (The rack depth determines which slide slot is to be used. If the rack is too shallow, the 2 inch bracket can be reversed so that it protrudes rearwards from the rack.)
10. Fit each slide to the correct position on the rack as follows:
  - a. Gain access to the rear slots by sliding the middle section and bearing carriage to the front. The two front holes can be accessed by sliding the middle section and bearing carriage to expose each hole in turn through a rectangular cutout in the middle section.
11. When sliding the instrument into the rack for the first time, the slotpan screws securing the 10 inch and 2 inch mountings should have been slackened. This ensures that there is no lateral stress on the mounting system during the operation. These screws are finally tightened with the instrument sitting in the slides.
  - a. Ensure that the screws securing the 10 inch and 2 inch mountings have been slackened.
  - b. With assistance, locate the slide inner section in the bearing carriage of the middle section, and carefully slide the instrument fully home into the rack. Slide it in and out of the rack several times until it is certain that there is no lateral stress.
  - c. Withdraw the instrument just sufficiently to allow access to the slotpan screws securing the 10 inch and 2 inch mountings. Tighten the screws, and again slide the instrument in and out of the rack to be certain that there is no lateral stress.
12. Using screws, cage nuts etc. provided with the rack, secure the instrument by screwing the mounting bracket ears to the front of the rack.

**Mounting** (Contd.)

**Rack Slide Kit - Option 95 - List of Parts:**

Rack mounting, especially using slides, is complicated by the diversity of rack fittings within the standard 19" concept. Although the Rack Slide Kit contains all the parts necessary to fit the instrument, on its slides, to a standard 19" rack; the assembly would normally be finally secured in position using attachments peculiar to the type and manufacturer of the rack. These final securing parts are not listed below.

The following list of parts is correct at the time of going to press, but our policy of product improvement means that alternative items could be employed for future issues. The current updated parts list is given in the Reference Handbook for the instrument.

Part No.	Description	UM	Quantity
450655-1	Rack Ear, Handle .....	Ea	2
450659-1	Bracket, Slide Mounting .....	Ea	2
450680-3	Rack Mounting, Front Plate .....	Ea	2
611028	Screw, M4 x 8 POSIPAN SZP .....	Ea	6
611058	Screw, M4 x 8 POSICSK SZP .....	Ea	6
611059	Screw, M4 x 12 POSICSK SZP .....	Ea	4
611071	Screw, 10-32 x 1/2 SLOT PAN SZP .....	Ea	8
611116	Screw, M3 x 12 SKT GRUB SZP .....	Ea	12
613013	Washer, M5 SZP .....	Ea	8
613020	Washer, M4 SZP .....	Ea	6
613021	Washer, M4 INT. SHAKP .....	Ea	6
613028	Washer, M5 INT. SHAKP .....	Ea	8
615011	Nut, Full, M4 SZP .....	Ea	6
630181	Bracket, 2", Mounting .....	Ea	2
630182	Bracket, 10", Mounting .....	Ea	2
630183	Nut, 2.5" Bar .....	Ea	4
630353-1	Slid, 24", 3-Section, Pair .....	Ea	1

REMOVE HANDLES 450614 & REAR  
CORNER BLOCKS 450557

THESE TWO PARTS CAN ONLY  
BE ASSEMBLED AFTER 450659  
HAS BEEN SLID INTO POSITION.

POSITION FRONT PLATE TO BE LEVEL  
WITH INSTRUMENT BEZEL THEN TIGHTEN  
GRUB SCREWS!

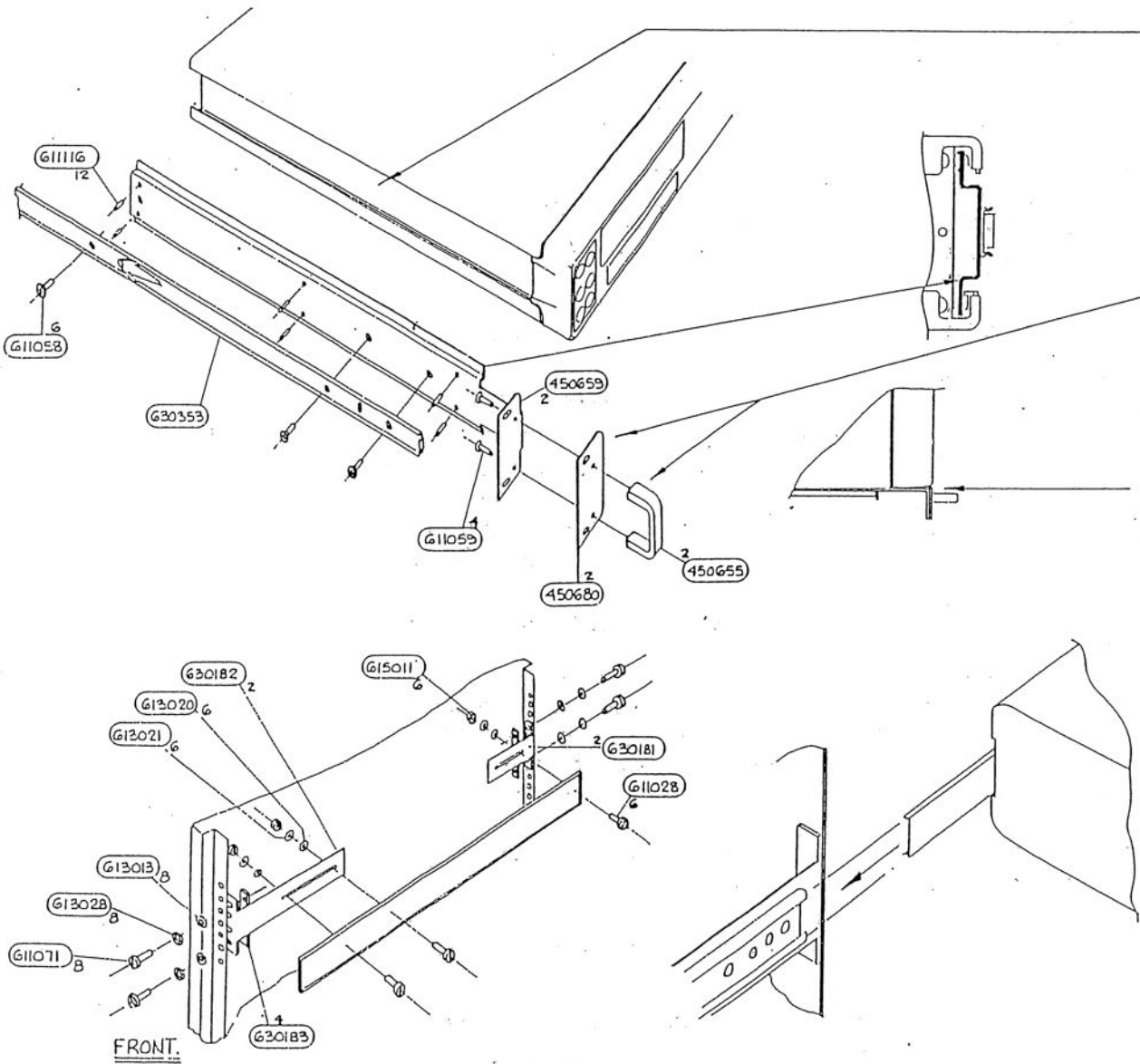

RACK SLIDE KIT - FITTING

## Connectors and Pin Designations

### Inputs

Two input channels are provided:

**Channel A** Precision N-type Co-axial Socket.

**Channel B** Two 4mm Binding Posts.

A third binding post is fitted to the terminal panel for the connection of a lead to Safety Ground.

### SK9 - External Trigger Input

This co-axial BNC socket on the rear panel can be used to trigger a measurement when external triggers are enabled. The single pin is pulled up internally to +5V, and requires a negative-going TTL edge to initiate the reading.

### SK7 - IEEE 488 Input/Output

#### Compatibility

The IEEE input/output is a 24-way Amphenol connector which is directly compatible with the IEEE 488 interface and the IEC 625 Bus.

Note that the Bus Address is set from the front panel (refer to Section 5).

#### Pin Layout

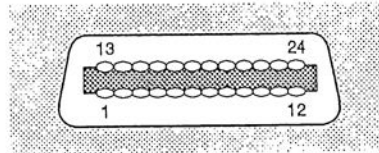

### SK7 Pin Designations

Pin No.	Name	Description
1	DIO 1	Data Input/Output Line 1
2	DIO 2	Data Input/Output Line 2
3	DIO 3	Data Input/Output Line 3
4	DIO 4	Data Input/Output Line 4
5	EOI	End or Identify
6	DAV	Data Valid
7	NRFD	Not Ready For Data
8	NDAC	Not Data Accepted
9	IFC	Interface Clear
10	SRQ	Service Request
11	ATN	Attention
12	SHIELD	Screening on cable (connected to 4920 safety ground)
13	DIO 5	Data Input/Output Line 5
14	DIO 6	Data Input/Output Line 6
15	DIO 7	Data Input/Output Line 7
16	DIO 8	Data Input/Output Line 8
17	REN	Remote Enable
18	GND 6	Gnd wire of DAV twisted pair
19	GND 7	Gnd wire of NRFD twisted pair
20	GND 8	Gnd wire of NDAC twisted pair
21	GND 9	Gnd wire of IFC twisted pair
22	GND 10	Gnd wire of SRQ twisted pair
23	GND 11	Gnd wire of ATN twisted pair
24	GND	4920 Logic Ground (internally connected to Safety Ground)



## SECTION 3 Basic Measurements

This section introduces the basic 'User Interface' of the 4920, describing how to make straightforward measurements without recourse to the more advanced features of the instrument. Descriptions of these other features can be found in Section 4.

### The Measurement Task

With the external circuit properly connected, any measurement requires us to take two actions:

1. Configure the instrument;
2. Trigger the measurement and read the result.

The 4920 allows us to choose from many actions to control these processes. As an introduction, we shall concentrate on the selections for taking basic measurements. These are not complicated - all we need to do is to work through the instrument's selection menus.

### Introduction to the Front Panel

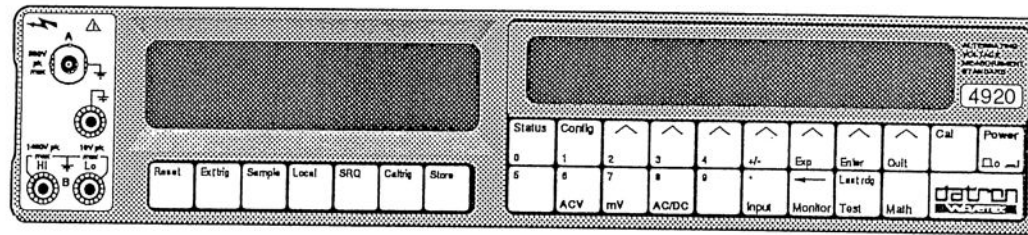

The two displays on the front panel deal with different aspects of operation. Generally, we set up the instrument's configuration using menus shown in the right-hand (dot-matrix) display, then readings appear in the left-hand (main) seven-segment display.

Beneath the dot matrix display, all keys other than the Power key are associated with menus. The keys beneath the main display are direct action keys, associated with triggers, remote control, and instrument reset.

## Menu Keys

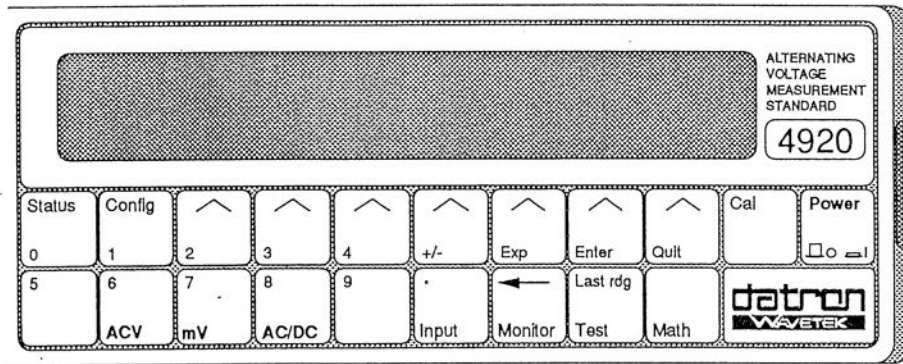

There are two classes of front panel menu keys; those that lead to an immediate change of instrument state (i.e the major function keys **ACV** and **mV**), and those that do not (Status, Config, Cal, Input, Monitor, Test, Math).

The **AC/DC** key activates the AC/DC Transfer mode, which is associated with the ACV function.

As well as the menu selection keys, there are seven soft function selection keys which have different actions depending on the selected menu. An arrowhead printed on each soft key lines up with a label on the display which defines the action of the key.

Also, system messages (all in capitals) may appear, these assist to clarify operation.

The labelled soft keys have actions which fall into the following classes:

- Select another menu.
- Enable or disable a facility (e.g. Range selection). When enabled, the soft key label is underlined by a cursor.
- Trigger a direct action (e.g. 'Oper' in the TEST menu activates an operational selftest).

An error message appears if a selection cannot be executed.

## Numeric Keyboard

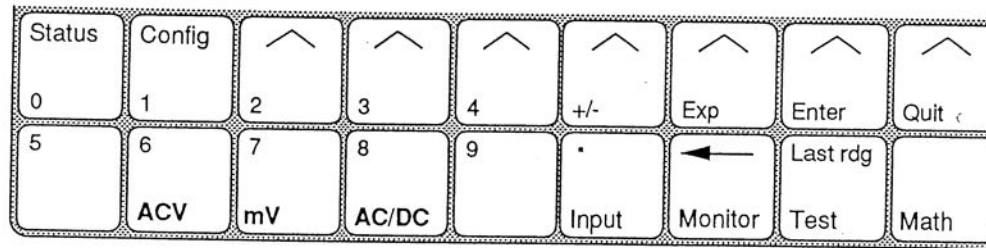

Some menu and soft function keys, shown above, also act as a keyboard for entry of parameters such as math constants, bus address, etc. The data entered is purely numeric, such as a keyboard-entered value or the value of the most recent reading.

### Exit from Menus

We can generally exit from any menu by selecting another menu key. For those menus where the numeric keyboard is active, we can exit by pressing either Enter or Quit. For some menus, a special soft key permits exit by a single keystroke.

## Major Function Keys:

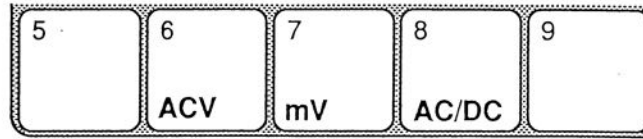

**ACV (AC Voltage)** - specified between 90mV and 1100V RMS in eight ranges; 1Hz to 1MHz at high impedance (subject to V-Hz limit of  $7.5 \times 10^7$ ). Spot-Frequency accuracy enhancement and alternative Digital Filter settings available.

**mV (AC milliVolts)** - specified between 0.9mV and 110mV RMS in four ranges; 10Hz to 1MHz at high impedance. Alternative Digital Filter settings are available.

**AC/DC (Transfer Measurement mode)** - In this mode, the RMS value of an AC voltage is compared with the combined RMS value of two DC reference voltages of equal value and opposite polarity. The voltage ranges and analog processes, used for each individual RMS measurement, are the same as for the ACV function.

The DC reference signals are applied in sequence and their individual RMS values are measured and stored. The system digitally computes the RMS of these two stored values to form the 'DCRMS equivalent', which is also stored.

The system then measures the RMS value of the applied AC signal, and digitally computes its deviation from the 'DCRMS equivalent'. The deviation is displayed in ppm on the dot-matrix display.

Each of these function keys defines separate measurement states and activates its corresponding menu on the display. Changing a function therefore commands changes of measurement state. In general, the instrument remembers the pattern of parameter conditions in each function, so that when it is subsequently reselected, it remains set up as before until we change it or turn off the instrument power.

The three functions have access to an RMS LOW FREQ menu, using the Config key, which can be used to alter the integration parameters of the analog RMS computation.

## Initial State at Power On

To see this condition, ensure that the instrument has been correctly installed in accordance with Section 2.

Operate the **Power** switch on the front panel.

The 4920 forces the following state:

<i>Function</i>	ACV
<i>Range</i>	1kV
<i>Input Channel</i>	Ch B
<i>Spot</i>	Off
<i>Digital Filter</i>	Off
<i>ACV Low Frequency</i>	100Hz
<i>Monitor</i>	Off
<i>Millivolt Option</i>	Off
<i>AC/DC transfer</i>	Off
<i>Math</i>	Off

Observe the **ACV Menu**:

1kV is underlined, showing the active selection. It can be cancelled by any other range selection. Ranges themselves cross-cancel.

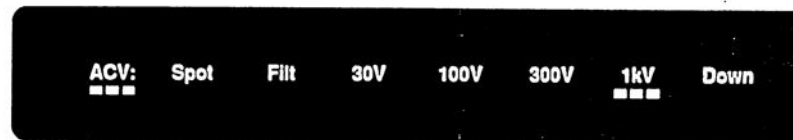

Leave the power switched on.

We have next to distinguish between three main types of action built into the operation of the soft keys. These are defined overleaf, together with the shorthand conventions we use in the quick tour to refer to them.

## Soft Key Conventions

Now look at the soft keys (the ones with the arrowheads) to make some distinctions in a little more detail. Each soft key's action is defined by the legend presented above it on the display. The legends usually define three different types of soft key:

- Choice key*      Chooses one of several possible states. Deselection is by cross-cancelling, i.e. by selecting another state.  
**cursor underline** indicates 'active',  
**no cursor** indicates 'not active'.
- Toggle key*      Activates a particular facility - a second press when its state is active will cancel it.  
**cursor underline** indicates 'active',  
**no cursor** indicates 'not active'.
- Menu key*      Activates another menu - cursor not used. The whole aim of branching via a menu is to gain access to further grouped state keys at an end of the branch.

**N.B.** When introducing soft keys in this text we shall differentiate between the three types (to avoid lengthy paragraphs) as follows:

<i>Choice key</i>	Underlined	e.g. <u>300mV</u>
<i>Toggle key</i>	Underlined italic	e.g. <u>Filt</u>
<i>Menu key</i>	Not underlined	e.g. Filt

Note that this is purely a short method of identifying the type, and bears no relation to its physical appearance on the instrument. Some displays do not relate to soft keys.

## Quick Tour of the Major Function Menus

The following introduction takes the form of a quick tour of the main functions, starting from Power On. To relate the descriptions to the physical appearance, process through the sequence as indicated by the pointer (  ).

### ACV Menu (See the figures on pages 3-2 and 3-5)

This menu defines the following *choice* and menu keys.

**Spot** This calls up the **SPOT** menu for selection of one of up to 100 spot frequencies. A number of these can have been pre-calibrated to provide extra 'spot-corrections' for enhanced accuracy. The **Hz** annunciator on the main display is lit.

*(Refer to Section 4, page 4-15)*

**Filt** **Filt** opens the **DIGITAL FILTER** menu to select one of three 'rolling-average' modes of **4**, **8** or **16** readings or **OFF** (1 reading) Any selection other than OFF lights the Filt annunciator on the main display, and underlines the Filt label on the ACV Menu.

*(Refer to Section 4, page 4-13)*

Low Voltage Ranges:      0.3V    1V      3V      10V    Up

High Voltage Ranges:    30V    100V    300V    1kV    Down

Up                    on the low voltage menu. When pressed selects the high voltage menu.

Down                on the high voltage menu. When pressed selects the low voltage menu.

## ACV Configuration

(RMS Converter Low Frequency Extension)



Press the Config key to see the RMS LOW FREQ menu:

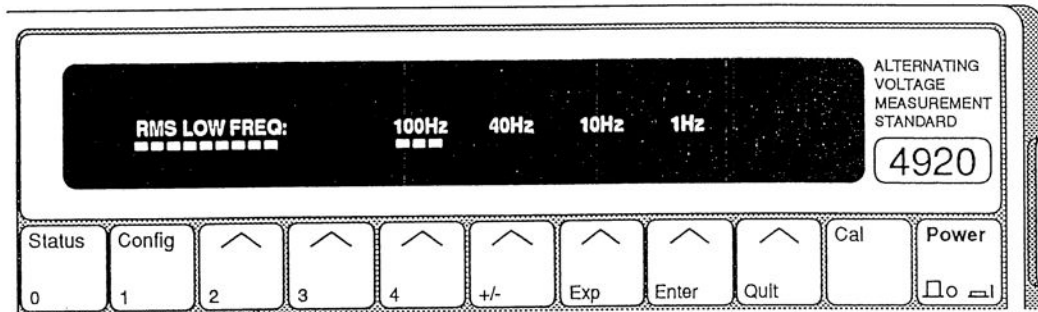

100Hz: RMS converter normal low frequency limit of 100Hz.

40Hz: RMS converter low frequency limit extended to 40Hz.

10Hz: RMS converter low frequency limit extended to 10Hz.

1Hz: RMS converter low frequency limit extended to 1Hz.

At Power On, 100Hz is active.

### Note: Necessary Settling Times

In order to yield a valid signal sample in any form of RMS conversion, a lower input frequency will always require a longer settling time. In the 4920, for each low frequency limit selected in this menu, the internal measurement program will impose the appropriate settling time before initiating an A-D conversion.

For further details refer to *Section 4 page 4-14*.



ACV (AC Voltage) - Movement between Menus

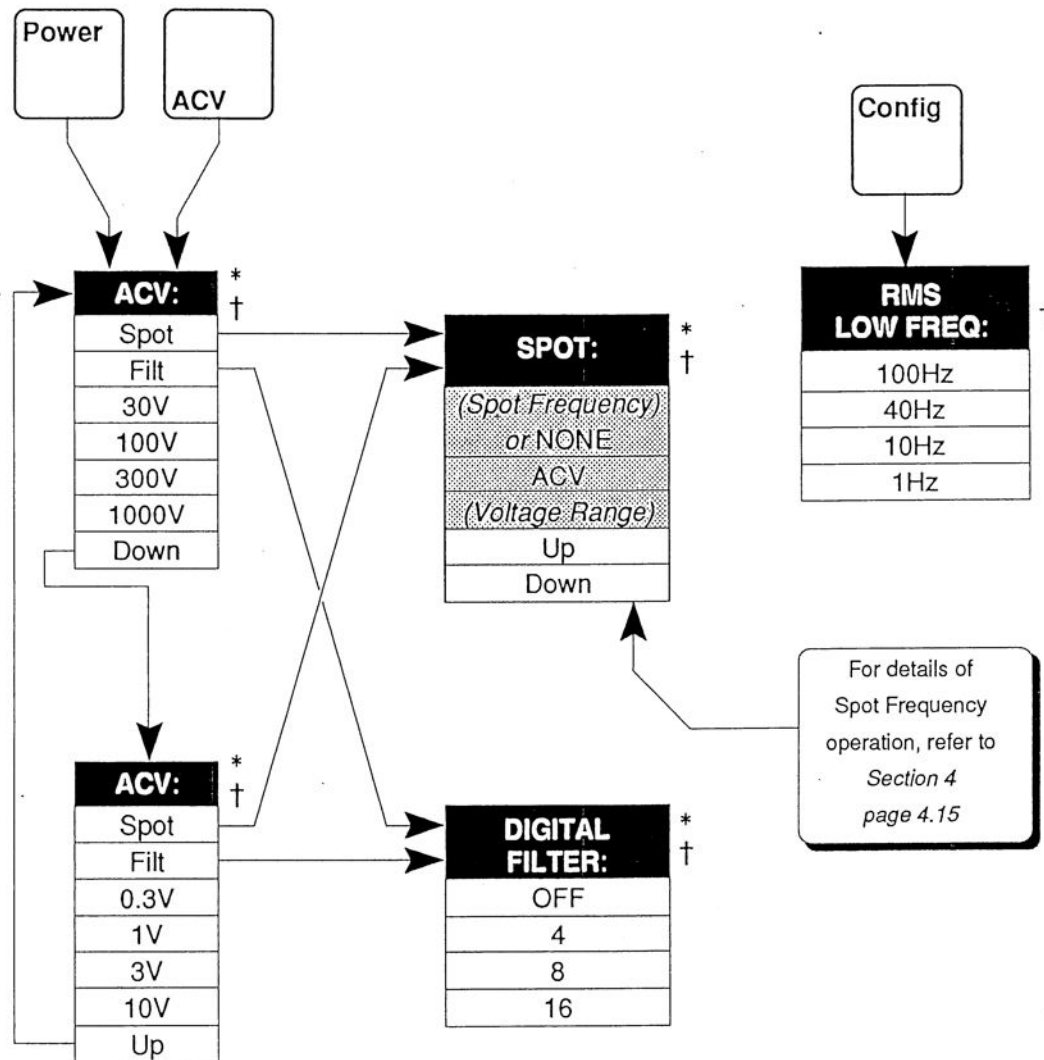

\* Press the Config key to see the ACV Low Frequency selection.  
 † Escape by pressing any front panel Menu key.

## mV Menu (Option 10) - Millivolt Ranges

Operation is described in Section 4 page 4-6



Press the mV key to see the MV menu:

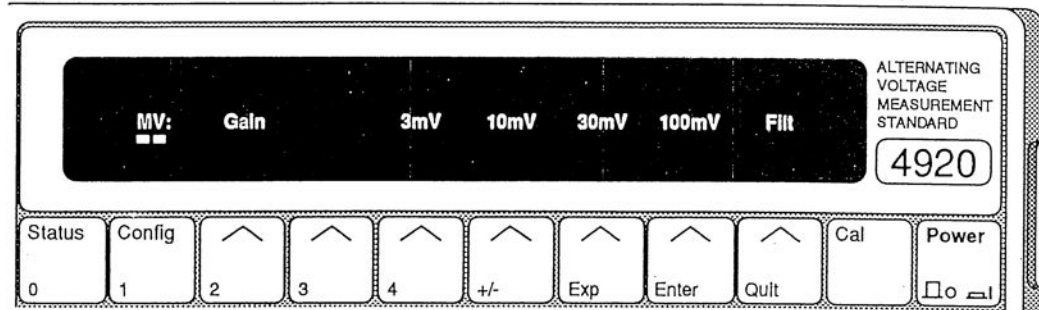

Gain: Characterize the gain of the X30 Amplifier.

3mV: Display reading in the range 0.9mV to 3.3mV.

10mV: Display reading in the range 2.7mV to 11mV.

30mV: Display reading in the range 9mV to 33mV.

100mV: Display reading in the range 27mV to 110mV.

Filt **Filt** opens the **DIGITAL FILTER** menu to select one of three averaging modes or **OFF** (1 reading). Any selection other than OFF lights the Filt annunciator, and underlines the Filt label on the mV Menu.  
(Refer to Section 4, page 4-13)

Readings can be taken only after the gain of the internal X30 amplifier has been determined, and if the frequency of the applied signal is valid (for more details refer to Section 4; page 4-6).

At Power On: 100mV is selected, but the MV menu is inactive.

**mV - Movement between Menus**

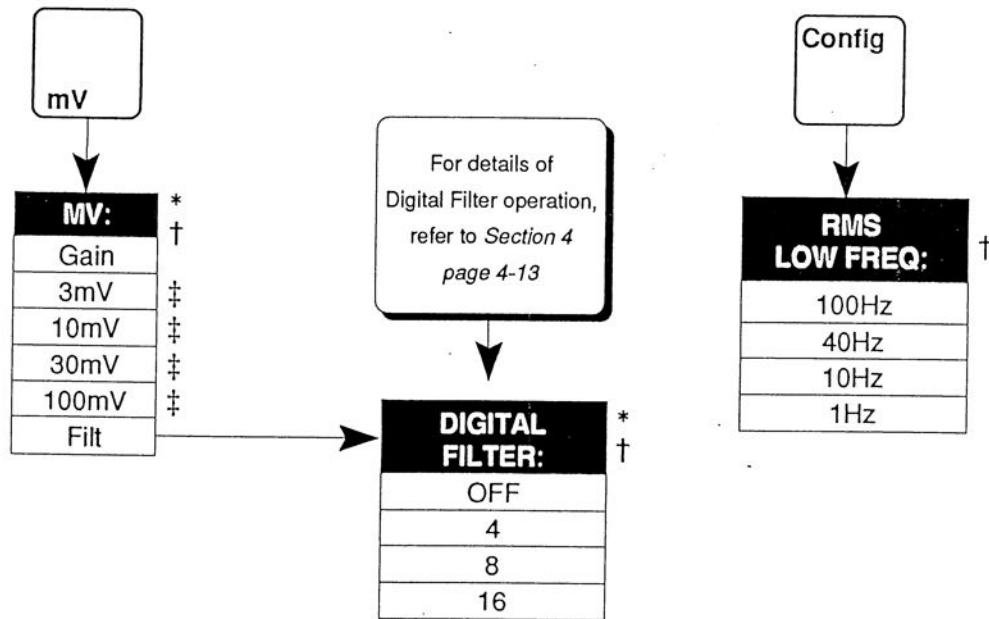

- \* Press the Config key to see the RMS Low Frequency selection.
- † Escape by pressing any front panel Menu key.
- ‡ Selection available only after x30 amplifier gain has been characterized, and within 2% of characterization frequency.

### AC/DC Menu (Transfer Measurement)

Operation is described in Section 4 page 4-9



Press the AC/DC key to see the TFER menu:

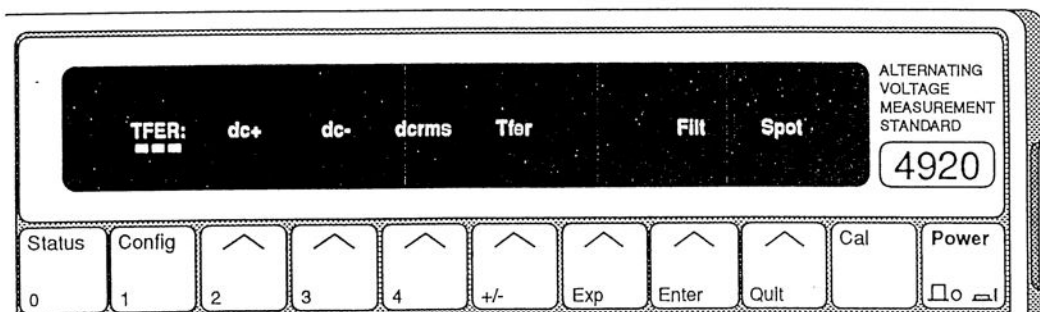

The following soft keys are used in sequence to perform an AC/DC transfer:

- dc+: Reads and displays positive DC signals. Reading must be stored.
- dc-: Reads and displays negative DC signals. Reading must be stored.
- dcrms: Checks stored dc+ and dc- values for consistency. Computes and displays the RMS equivalent. Reading must be stored.
- Tfer: Reads AC signals, computes RMS value and compares with the stored dcrms value. Deviation is displayed as ppm of the stored dcrms value.
- Filt**: **Filt** opens the **DIGITAL FILTER** menu to select one of three averaging modes or **OFF** (1 reading). Any selection other than OFF lights the Filt annunciator, and underlines the Filt label on the TFER Menu. (Refer to Section 4, page 4-13)
- Spot**: This calls up the **SPOT** menu for selection of spot frequencies. The **Hz** annunciator on the main display is lit. (Refer to Section 4, page 4-15)

At Power On, the TFER menu is inactive. For further details of the transfer, refer to Section 4, page 4-9.

AC/DC (AC/DC Transfer) - Movement between Menus

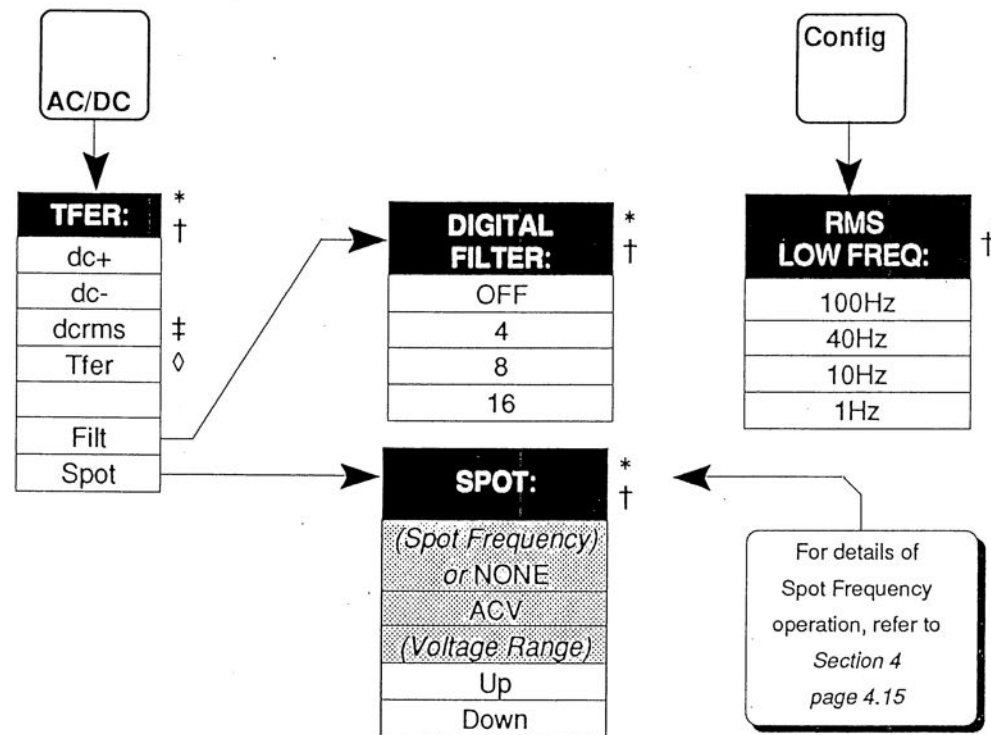

- \* Press the Config key to see the RMS Low Frequency selection.
- † Escape by pressing any front panel Menu key.
- ‡ dcrms selection available only after valid dc positive and negative references have been entered.
- ◊ Tfer selection available only after dcrms value has been calculated.

## 'Input' and 'Status' Keys

So far in this section, we have concentrated on the menus of the keys which select the type of physical quantity to be measured - we call them the Main Function keys. With these, we can configure the functions so that basic measurements conform to our requirements. Obviously the instrument is capable of more sophisticated operation than just taking straightforward measurements.

These are discussed in subsequent sections, but there are two keys which are relevant to basic measurements.

### Input Key

The Input key and its menu permit us to select any one of the two external connections on the front panel. Channel A is a precision N-type connector, and Channel B is a set of three 4mm banana terminal posts.

### Status Key

Using the Status key, we can review the instrument parameters which are currently set up, over and above those indicated by the annunciators on the main display.

In addition, the IEEE 488 bus address can be displayed and changed if required.

## Input Switching

### Input Menu

Operation is described in *Section 4 page 4-12*



Press the Input key to see the INPUT menu:

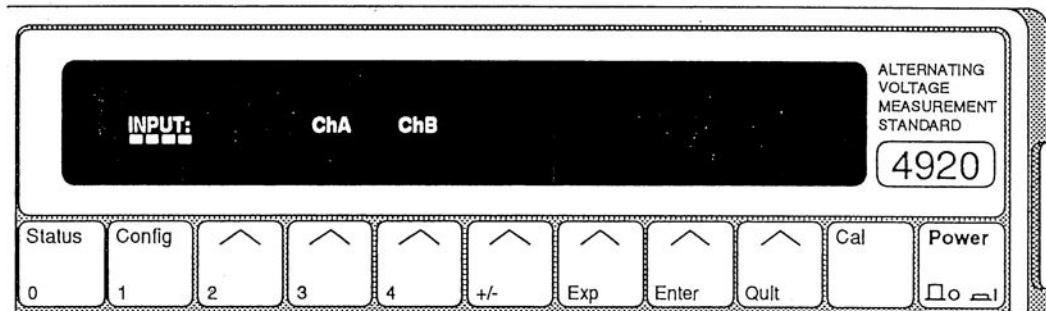

The INPUT menu defines three *choice* keys. The Config key is inactive.

- ChA    Activates Precision N-type Input Channel A only.
- ChB    Activates Terminal Input Channel B only.

It is not possible to select both channels together.  
At power on, Channel B is active.

## Instrument Status Reporting



Press the Status key to see the STATUS report:

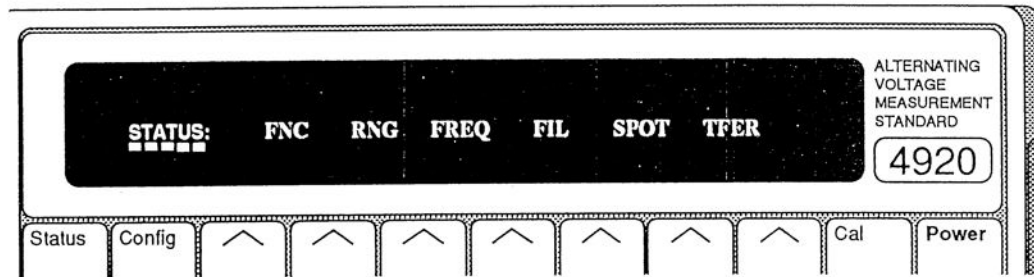

Status is a complete report of the most recent selections made using any of the various menus. It can be used at any time as a fast means of checking that the 4920 selections are suitable for the measurement being made.

The legends shown in the above diagram do **not** actually appear, they only mark the approximate positions for legends which can appear. Each is an abbreviation which merely acts as a key to the list below. The meaning and possible parameters which appear in each position are given in the list:

Abbr.	Meaning	Possible Parameters
FNC:	Function	ACV, mV.
RNG:	Range (ACV) Range (mV)	0.3V, 1V, 3V, 10V, 30V, 100V, 300V, 1kV. 3mV, 10mV, 30mV, 100mV.
FREQ:	Frequency	As measured.
FIL:	Digital Filter	Off, AV4, AV8, AV16.
SPOT:	Spot Frequency	If present, a Spot Frequency is active.
DCPOS; DCNEG; DCRMS; TFER:	AC/DC Transfer	If present, AC/DC Transfer mode is active.



## Status Configuration



Press the Config key to see the STATUS CONFIG menu:

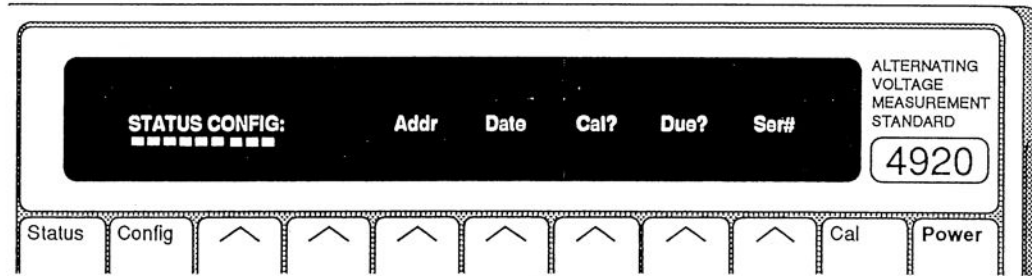

Unlike the STATUS display, this is a menu, defining the following *menu* keys.

- Addr: displays the ADDRESS menu, to review and change the IEEE-488 bus address of the instrument.
- Date: displays the present DATE and TIME.
- Cal?: presents the LAST CAL display, to see the date of the most recent calibration of the instrument and the cal-store code.
- Due?: shows the due date of the next calibration.
- Ser#: presents the SER# and S/W ISS displays, to see the serial number and software issue of the instrument.

## IEEE 488 ADDRESS



In the STATUS CONFIG menu: press the Addr key to see the IEEE 488 ADDRESS:

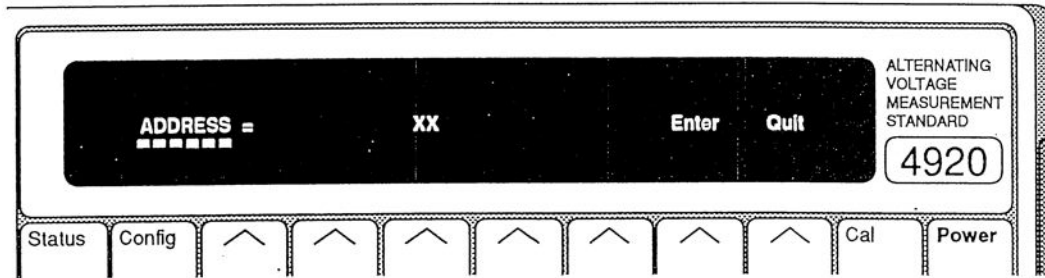

This menu permits entry of a value to be used as an IEEE-488 bus address.

Initially, the menu displays the present address value, and the numeric-keyboard keys are activated. Any valid numeric value (0-30) may be entered.

Pressing Enter stores the new value (or restores the old value if unchanged), but pressing Quit leaves the old value intact.

Either Enter or Quit causes exit back to the STATUS CONFIG menu.



Transfer from the ADDRESS menu back to the STATUS CONFIG menu by pressing the Config key.

## Current Date



In the STATUS CONFIG menu: press the Date key to see the DATE display:

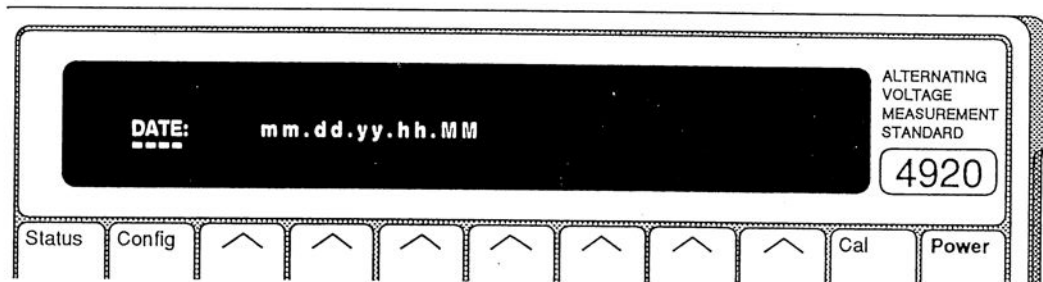

The meaning of this display is self-evident. Leading zeros are used, and the date/time is presented numerically as follows:

m m = month; d d = day; y y = year; h h = hour; M M. = minute.

The display shows the time when the display was called up. The current time cannot be altered except in one of the calibration menus. Time information is not lost when the instrument power is turned off.



Transfer to the STATUS CONFIG menu by pressing the Config key.

### Calibration Dates



In the STATUS CONFIG menu: press the Cal? key to see the LAST CAL and cal-store code displays:

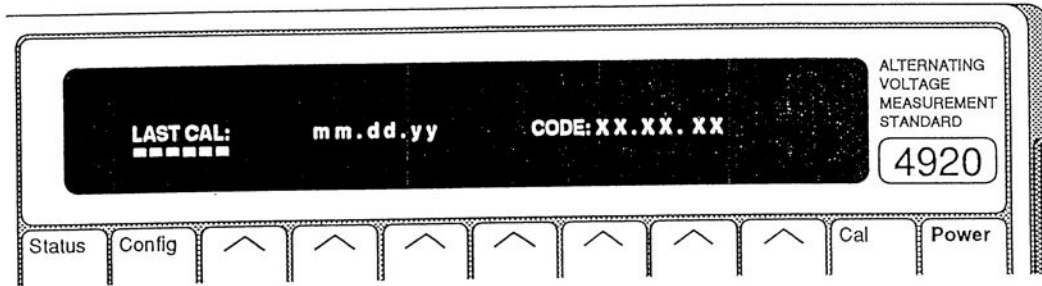

The LAST CAL date is the most-recent date on which the instrument was last exited from Calibration mode. Leading zeros are used, and the date is presented numerically as follows: *mm* = month; *dd* = day; *yy* = year.

The date cannot be altered except in one of the calibration menus. The information is not lost when the instrument power is turned off.

The CODE: display registers the 'Cal-store Code'. This is a 6-ASCII character decode (upper-case alpha and numeric) of a count of the total number of individual times that the cal-store has been written to.

This code is intended to be used to detect whether an unauthorized calibration has been carried out. If the code has changed since the last authorized calibration, this indicates that the calibration store has been written to at on least one occasion. The code is made secure by obscuring the method of incrementation; it will repeat on a cycle of about 200,000 complete calibrations of the instrument.



Transfer to the STATUS CONFIG menu by pressing the Config key.

## Calibration Due Date



In the STATUS CONFIG menu: press the Due? key to see the CAL DUE display:

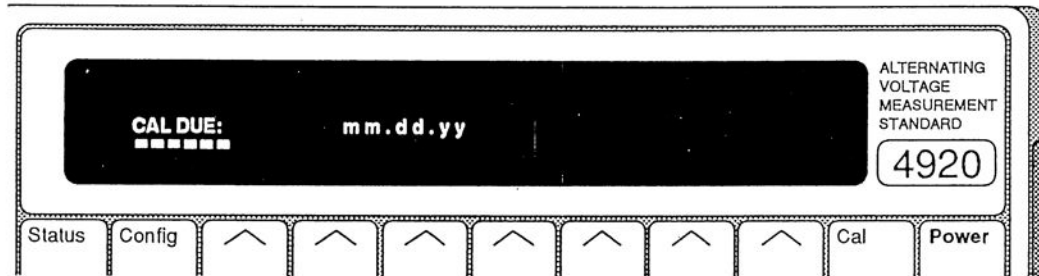

The meaning of this display is self-evident. Leading zeros are used, and the date is presented numerically as follows: m m = month; d d = day; y y = year.

The date cannot be altered except by calculation as a result of entries in calibration menus. The information is not lost when the instrument power is turned off.



Transfer to the STATUS CONFIG menu by pressing the Config key.

## Serial Number and Software Issue



In the STATUS CONFIG menu: press the SER# key to see the SER# and S/W ISS displays:

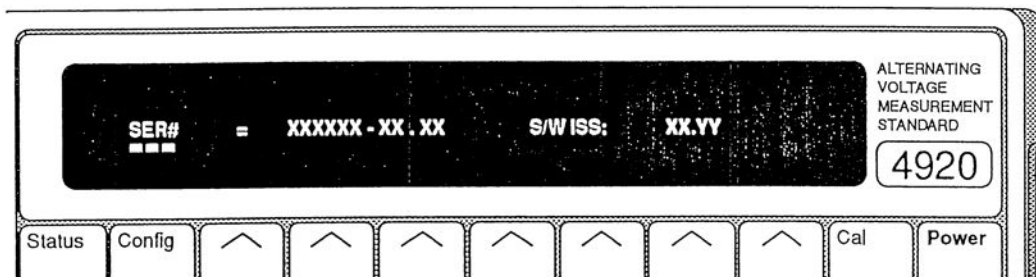

Inspect the instrument serial number and software issue number.

This display is for information only. The serial number cannot be altered except in one of the calibration menus, and this facility is only provided for use during manufacture or when the Digital Assembly is replaced or repaired. Once changed, the new number is not lost when the instrument power is turned off.

The software issue number is embedded in the software itself, and is not user-alterable.

Status Reporting - Movement between Menus

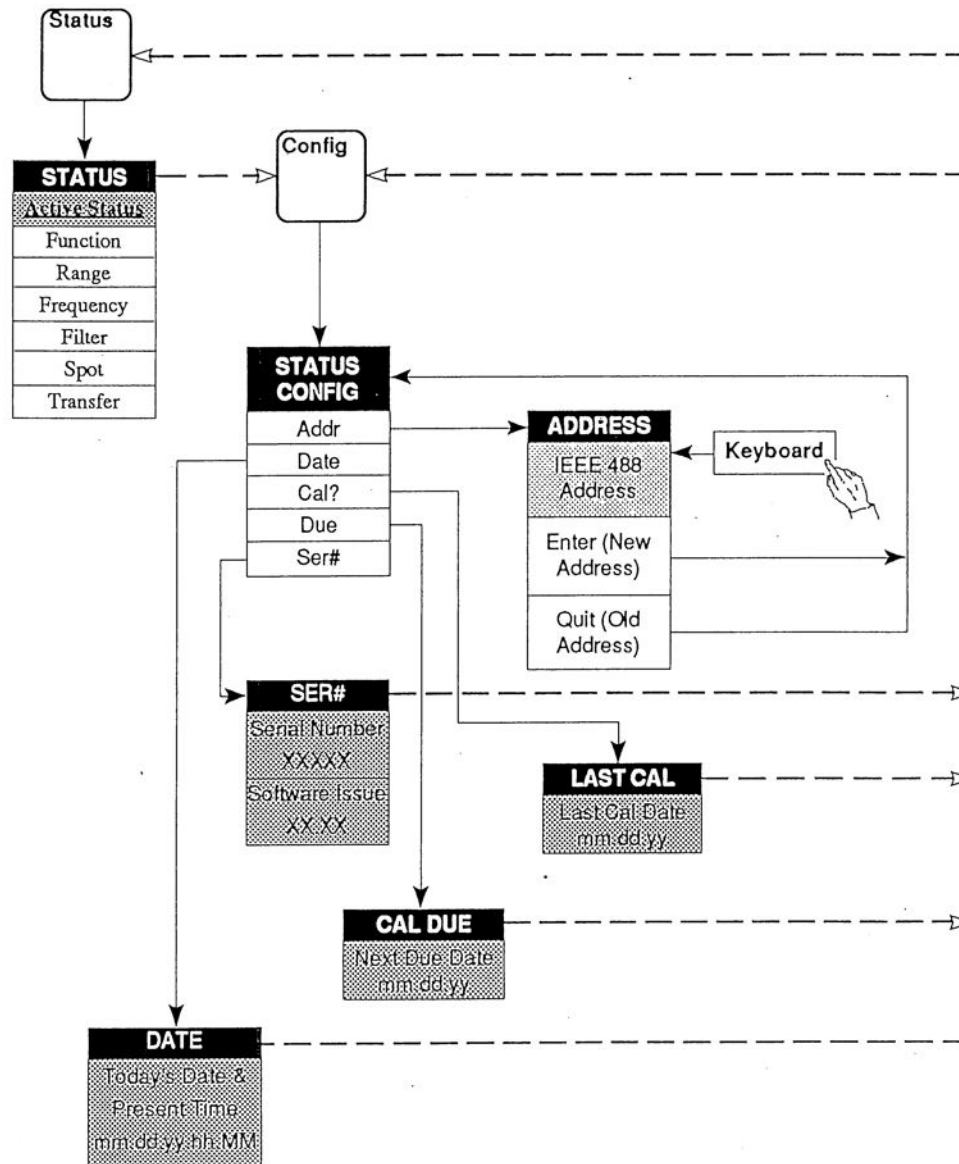

## **Conclusion**

We have now come to the end of our introductory tour of the main menu keys. This is, however, not the end of the instrument's facilities. Now that you are more conversant with the operation of the front panel, it is not necessary to continue in the same sort of programmed way.

You will find that the information in Section 4 is presented in a more concise and accessible form than here in Section 3. Your familiarity with the instrument will allow you to progress rapidly to the facilities you wish to investigate.

Section 4 details the manual selection of instrument functions and facilities;  
Section 5 is devoted to the operation of the instrument via the IEEE 488 Interface.



## SECTION 4 Using the 4920

### Preliminaries

This section details the methods of using the 4920, divided so as to provide an easy reference for particular functions and facilities.

The divisions are as follows:

#### Functions

AC Volts; AC Millivolts; AC/DC Transfer.

#### Facilities

Input channel selection;  
Digital filter - rolling-average window size;  
RMS low frequency limit selection;  
Spot frequency selection and calibration;  
Status reporting;  
Monitoring;  
Math;  
Test;  
Calibration.

The descriptions include: methods of connection, input limits, types of configurations, methods of access to facilities, and calculations available.

Where appropriate, examples of procedures are given in a format similar to that used in Section 3. Although the menus for calibration are shown, all routine calibration should be referred to Section 8.

### Installation

Before using the instrument, it is important that it has been correctly installed as detailed in Section 2.

### Limiting Characteristics

Maximum inputs are detailed in Section 6.

### Safety

The 4920 meets the safety requirements of UL 1244, ANSI C39.5 (Draft 5) and BSI 4743. Protection is provided by a direct connection via the power cable from ground to exposed metal parts and internal ground screens. The power cable line connection must only be inserted in a socket outlet provided with a protective ground contact, and continuity of the ground conductor must be assured between the socket and the instrument.

#### WARNING:

Any interruption of the protective ground conductor inside or outside the instrument, or disconnection of the protective ground terminal may make the apparatus dangerous. Intentional interruption is prohibited. The terminals marked with the  symbol carry the input to the 4920. These terminals and any other connections to the source under test could carry lethal voltages. Under no circumstance should users touch any of the front or rear panel terminals unless they are first satisfied that no dangerous voltage is present.

#### CAUTION:

The  symbol is used to remind users of special precautions detailed in this handbook, and is placed next to terminals that are sensitive to overvoltage conditions.

## Interconnections - General Guidelines

### Importance of Correct Connections

When calibrated, the 4920 is capable of giving highly accurate traceable measurements. To attain this, it is necessary to use the correct connections to any external circuitry or load. A few general guidelines for correct external connection are given in the following paragraphs.

---

#### Sources of Error

##### E-M Interference

Noisy or intense electric, magnetic and electro-magnetic effects in the vicinity can disturb the measurement circuit. Some typical interfering sources are:

- Fluorescent lighting.
- Inadequate screening, filtering or grounding of power lines.
- Transients from local switching.
- Induction and radiation fields of local E-M transmitters.
- Excessive common mode voltages between source and load.

Separation of leads and creation of loops in the circuit can intensify the disturbances.

##### Lead Impedance

The resistance of the connecting leads can drop significant voltages between the source and load, especially at higher frequencies.

#### Avoidance Tactics

##### E-M Interference:

- Choose as "quiet" a site as possible (a screened cage may be necessary if interference is heavy). Suppress as many sources as possible.
- Always keep interconnecting leads as short as possible, especially unscreened lengths.
- Run leads together as twisted pairs in a common screen (or use coax) to reduce loop pick-up area, but beware of leakage problems and excessive capacitance.
- Where both source and load are floating, connect Lo to ground at the source to reduce common mode voltages.

##### Lead Impedance:

- Keep all leads as short as possible.
- Use conductors with a good margin of current-carrying capacity.
- Use Remote Guard or 4-wire connections where necessary.

## Current Shunt Adaptor Model 4921

### Use of 4921

The 4920 Alternating Voltage Measurement Standard is designed for AC Voltage calibration applications where Thermal Transfer Standards (TTSs) are presently used.

For AC Current calibration with TTSs, the user requires sets of current shunts (often the Fluke Models A40 and A40A).

The Datron Model 4921 Current Shunt Adaptor permits the user to retain the use of these shunt sets in conjunction with the 4920 to provide AC Current calibration capability.

Full instructions for use of the adaptor are provided with the 4921 itself; The following paragraphs describe the concepts and connections.

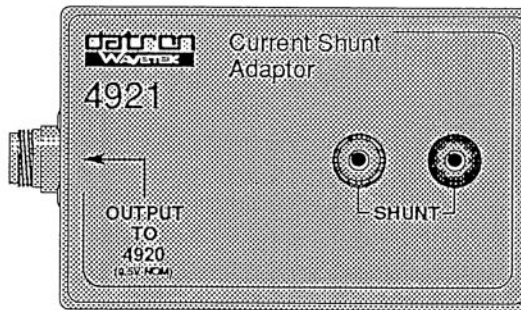

### Connecting Shunts to the 4921

The 4921 Adaptor simulates the  $90\Omega$  input impedance across which the shunts are designed to be connected; and matches to the high input impedance of the 4920.

The Current to be measured by the 4920 is passed through the requisite shunt, whose ends are connected to the SHUNT terminals of the 4921. The output voltage from the 4921 is passed out to the 4920 through the precision N-type coaxial connector on the side of the 4921. (The black 4921 terminal is connected directly to the outer of the N-type connector.)

When used with the A40 and A40A Current shunts, the 4920 is operated in AC/DC Transfer mode to make normal transfer comparisons between the output from a DC Current Calibrator (such as the Datron Model 4808 or 4708) and the AC Current source to be calibrated.

The nominal output voltage from the shunt/4921 combination is 0.5V RMS. The 4920 should therefore be set to its 1V Range with AC/DC Transfer selected.

# Functions

## Measurement of AC Voltage

### Generalized Procedure

#### ACV Key and Menu

A description of the User Interface is given in Section 3 for the main functions. If you are unfamiliar with the front panel controls, you should complete the quick tour which is the subject of Section 3. Specific reference to AC Voltage measurement appears on *Pages 3-7 to 3-9*.

### ACV Menus

#### Range Switching

In order to achieve the high specification of the 4920, the full span of ACV voltage from 90mV to 1100V is divided into eight ranges. As the additional selections of Spot Operation and Digital Filter need to be accessed for each of these ranges, a total of ten selections are required. With seven soft keys available on each menu, four ranges have been assigned to each of two menus, plus a soft key which switches between the two, occupying five of the seven menu choices.

#### Down/Up Soft Key

The 'Down' soft key is used to switch from the high ranges menu (30V, 100V, 300V and 1kV) to the low ranges menu (0.3V, 1V, 3V and 10V), where the same key is reassigned as the 'Up' key for switching back again.

#### Spot and Filt Keys

The remaining two menu choices are assigned to spot frequency operation (Spot key) and digital filtering (Filt key). Their use is described under 'Facilities' on *pages 4-15 and 4-13* respectively.

#### Setup Sequence

##### Input Channel (Refer to page 4-12)

The Power On and Reset default on the INPUT menu is Channel B selected (4mm Terminal Posts). If Channel A is to be used, ensure that it has been selected by first pressing the front-panel Input key, then pressing the soft ChA key.

##### Power On

- The power-on default function is ACV, and the default range (1kV) is selected (underlined) on the ACV menu.



- Choose a range as required, or press the Down key for a lower range.



- Choose a range as required, or press the Up key for a higher range.

## Broadband Frequency Operation

### Frequency Bands

The instrument operates over a frequency spectrum from 1Hz to 1.25MHz, (with appropriate choice of RMS Converter integration times - **ACV Config**). The Specifications for broadband operation are given in Section 6. These show the performance of the analog circuitry in up to seven frequency bands per range between 1Hz and 1MHz. The bands merely provide suitable specification break points; they are not used to allocate correction factors.

### Flatness Corrections

During calibration processes, at internally-measured input frequencies, the 4920 stores correction constants which are unique to each voltage range.

During normal measurement, the 4920 measures the signal frequency. The stored constants are recovered and processed by a proprietary algorithm which describes the flatness profile. The algorithm calculates the correction to be applied at that particular input frequency on the selected range.

### RMS Low Frequency Limits - ACV Config

An essential part of the RMS measurement process is to calculate a mean value using an integrator.

To allow low frequencies enough time for measurement, and for higher frequencies to be measured more quickly, a switched range of integration time constants is often provided, each described by the lowest acceptable frequency.

In the 4920, four switched time constants are available:

100Hz, 40Hz, 10Hz and 1Hz.

They are available in ACV, mV and AC/DC functions, and are described under 'Facilities'. In ACV function they are switched by pressing **Config** when in the **ACV** menu. To meet the instrument specification, the selected ACV Low Frequency must be equal to or lower than the lowest frequency to be measured.

Refer to *Page 4-14*

## Functions (Contd.)

### mV Function - AC Millivolt Ranges (Option 10)

#### General

#### Ranges

In addition to the 0.3V range used for the standard ACV function, Option 10 introduces four further ranges with the following voltage spans:

<b>3mV:</b>	0.9mV to 3.3mV
<b>10mV:</b>	2.7mV to 11mV
<b>30mV:</b>	9mV to 33mV
<b>100mV:</b>	27mV to 110mV

#### X30 Amplifier

A bypassable x30 amplifier is used to perform ratio-metric transfers from traceably-calibrated ranges to millivolt levels; at constant frequency.

#### Gain Determination

The first part of the transfer is to determine the gain of the x30 amplifier. Once this has been done, normal readings can be taken (using the millivolt ranges) for signals whose frequencies lie within  $\pm 2\%$  of that at which the gain was determined.

The gain is evaluated by applying a signal of approx. 100mV to the input of the amplifier, and comparing the amplifier output (x30) with the same signal applied with the amplifier bypassed (x1).

A value close to 100mV is chosen because this is:

- within the traceable span of the 300mV range ( $> 90\text{mV}$ ); and
- when amplified by 30, within the traceable span of the 3V range ( $< 3.3\text{V}$ ).

These are the ranges used for the two measurements.

### mV Key and 'MV' Menu

A description of the User Interface is given in Section 3 for the main functions. If you are unfamiliar with the front panel controls, you should complete the quick tour which starts on *Page 3-1*.

An introduction to Millivolt measurement appears on *Pages 3-10 and 3-11*.

### Filt Key

Digital filtering is available in millivolt ranges using the **Filt** key in the MV menu. Its use is described under 'Facilities' on *page 4.13*. The rolling average window size which is active when mV is selected will remain in force.

### mV Config

Pressing the Config key when in a millivolt range will open the RMS LOW FREQ menu (*refer to page 4-14*). The low frequency limit which is active when mV is selected will remain in force.

### Execution Errors

'NO MV GAIN VALUE' will be generated if the gain was not determined successfully.

CAL mode cannot be entered; an execution error CAL/MV INCOMPATIBLE is generated instead.

### Notes on the Millivolt Function:

#### 1. Effect of Input Impedance:

The input impedance of the 4920 on Millivolt Function is close to  $404\text{k}\Omega/90\text{pF}$ . Most calibrators have relatively high non-active outputs for their millivolt ranges. Typical values are between  $30\Omega$  (including Datron calibrators) and  $50\Omega$ .

Equivalent open-circuit millivolts can be estimated by multiplying the reading by  $(1 + A/B)$ ; where:

A = Output impedance of the source;

B = Input impedance of  $404\text{k}\Omega/90\text{pF}$ ;

at the frequency of the measurement.

#### 2. Spot calibrations are ignored in mV function.

#### 3. AC/DC transfer cannot be used when the millivolt function is active. The action of selecting AC/DC will deselect the millivolt range and destroy the stored (x30 amplifier) gain value.

## mV Function (Contd.)

### Millivolt Measurement Procedure

**N.B. Input Channel** The Power On and Reset default on the INPUT menu is **Channel B** selected (4mm Terminal Posts). If Channel A is to be used, ensure that it has been selected by first pressing the front-panel Input key, then pressing the soft ChA key.

#### X30 Amplifier Gain Measurement

- Enter the MV menu by pressing the mV key.



Apply a stable voltage of between 95mV and 105mV, at within 2% of the frequency to be measured, to the input terminals.

- Press the Gain soft key. The Gain label above the key is underlined.



The 4920 checks the signal level, measures it on the 300mV ACV range and applies it to the x30 amplifier input. Then it measures the amplifier output on the 3V AC range, and calculates the amplifier gain. During the whole of this gain measurement the Busy annunciator lights and remains lit, and the Math annunciator is lit for two shorter periods of time. The Busy light then goes out, and the value of the gain is presented on the main display. The Gain label above the key remains underlined.

Check that the gain presented on the Main display is between 26 and 32. The gain level at 1MHz should lie within  $\pm 5\%$  of that at 1kHz.

- Press the Store key to register this gain value for use in subsequent calculations. The Gain label remains underlined until a millivolt range is selected.



#### Gain Corrections

Having determined the gain of the millivolt amplifier, the necessary correction to account for its deviation from nominal x30 will automatically be applied to all readings taken on the millivolt ranges, provided that they are within 2% of the frequency at which the gain was characterized. The stored values are destroyed when the instrument is Reset or Powered-down, or any ACV calibration is carried out.

#### Millivolt Measurements

The four ranges are now available for use.

- Select the required millivolt range by pressing the appropriate soft key. The underline moves from the Gain label to the selected range.



#### Millivolt Measurement Traceability

The gain value is traceable because it was derived using traceable ranges of the normal ACV function.

In use, readings are traceable because all four millivolt ranges use the amplifier in cascade with ACV traceable ranges as follows:

- 3mV Range:** ACV 300mV range;
- 10mV Range:** ACV 300mV range;
- 30mV Range:** ACV 1V range;
- 100mV Range:** ACV 3V range.



## Functions (Contd.)

### AC/DC Function - AC to DC Transfer

**N.B. Input Channel** The Power On and Reset default on the INPUT menu is Channel B selected (4mm Terminal Posts). If Channel A is to be used, ensure that it has been selected by first pressing the front-panel Input key, then pressing the soft ChA key.

#### General

##### Transfer Mode

The 4920 is capable of making AC/DC (or AC/AC) transfer measurements to very high accuracy, particularly at or near full range. Use of these modes is easier and much faster than conventional thermal transfer devices. It is also very linear and so is capable of indicating AC/DC differences directly, with the sources considerably off null or off balance.

##### Benefits

The AC/DC Transfer mode removes two sources of error - drift in the internal DC reference, input preamplifiers and attenuators with both time and temperature. The reference is typically better than 2ppm per year and the attenuators may contribute up to 10ppm per year. Use of the AC/DC transfer mode gives added confidence where a known DC source is available. A prime application is the calibration of the AC voltage ranges of a multi-function calibrator when its DC voltage ranges have already been calibrated.

##### Measurement of +ve and -ve DC Values

The quality of a thermal transfer element is often interpreted from its DC turnover error: that is its difference in response to identical magnitude positive and negative DC signals.

In electronic devices which employ a high impedance preamplifier, offsets in the input amplifiers and attenuators can cause large turnover errors. The 4920 eliminates the effect of these turnover errors by computing the equivalent RMS value, rather than the arithmetic mean, from the DC positive and negative values of the DC reference source.

##### Positive/Negative DC Reference Inputs - Order of Application

In the Transfer procedure given on *page 4-11*, the positive reference voltage is applied and stored before the negative. This is the natural order because of the positions of the soft keys, but the reverse order works as well, and is just as valid.

## Using AC/DC Transfer Mode

### Transfer Process

Programming AC/DC transfer measurements from the front panel is straightforward, but requires a knowledge of what results are desired.

Once the required range and any digital filtering is programmed (an average of 4 gives excellent results), the positive DC input is applied. When the display has settled, this reading is stored in the DC+ memory. The same process is repeated with the DC- input and the DC- memory. After the two DC values are stored, the DC RMS value is computed and stored as a reference.

When the AC input is applied and transfer mode selected, the data display indicates the difference in ppm between the stored DC RMS reference value and the unknown AC input.

### Transfer Mode and Spot Calibration

Spot Frequencies can be selected and deselected in AC/DC Transfer, as in ACV (*refer to page 4-15*). If a Spot Frequency or Spot Frequency Calibration is already selected when the transfer is invoked, it will remain in force. Note that the DC measurements and RMS calculation are not corrected for spot or flatness, and hence do not change.

### AC/DC Config

Pressing the Config key when in AC/DC Transfer mode will open the RMS LOW FREQ menu (*refer to page 4-14*). Whatever low frequency limit is active when the transfer is invoked will remain in force.

### Input Channel Selection

Two input channels: 'A' and 'B' are provided on the front panel of the 4920.

The most convenient way of connecting AC and DC inputs is for the AC to go to the precision N-type socket of Channel A, and the DC to the terminal posts of Channel B, using the Input facility to select between them. Differences between the input characteristics of the two channels are negligible.

When connected this way, the DC and AC sources are isolated from each other. Using programmable AC and DC sources, this method of connection permits full remote programming of the transfer via the IEEE 488 interface.

### Transfer Mode with other Facilities

The mode selected in the TFER menu remains in force until a primary function key is pressed, when the normal read mode appropriate to that function is forced. This means that the numeric values derived in dc+, dc- and Tfer modes can be digitally filtered, input to math blocks, or monitored.

Stored mV values are destroyed when in AC/DC transfer function. AC/DC transfer cannot be used in mV function; transfer selection or values are destroyed.

### AC/DC Transfer Procedure

1. Press the ACV key and select the desired range.
2. Press the Filt soft key and select the desired averaging mode or 'Off'.
3. Press the AC/DC key to open the TFER menu.



4. Apply the reference source of positive DC Voltage.
5. Press the dc+ soft key.



Wait for the main display reading to settle.

6. Press the Store key.
7. Apply the reference source of negative DC Voltage.
8. Press the dc- soft key.



Wait for the main display reading to settle.

9. Press the Store key.
10. Press the dcrms soft key.



The 4920 checks the stored DC positive and negative values for consistency, then calculates the RMS equivalent.

(If dcrms is selected without both dc+ and dc- values having been stored, the 4920 will generate an execution error, displayed on the menu screen as either NO DC+ VALUE or NO DC- VALUE).

The result is displayed with the symbol  $\pm$ .  
(When calculating the RMS value, if the stored dc+ and dc- values differ by more than 1%, the 4920 will generate a device error, displayed on the menu screen as DCRMS MISMATCH).

11. Press the Store key.



12. Apply the AC Voltage to be measured.
13. Press the Tfer soft key.

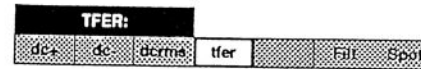

The 4920 reads the AC signal and calculates the deviation of its RMS value from the stored DCRMS equivalent value. The deviation is displayed on the main display as ppm.  
(If Tfer is selected without a dcrms value having been stored, the 4920 generates an execution error on the menu screen as NO DCRMS VALUE)

#### Filt Key

The Filt key is used to access the DIGITAL FILTER menu, in order to select a rolling average for noise reduction during the transfer (refer to page 4-13).

#### Use of AC/DC dc+ Mode for Readings <1Hz

In AC/DC: dc+ and dc-, the signal frequency is not computed. The dc+ mode can therefore be used to measure signals at frequencies below the normal limit of 1Hz without generating an error message. It is, of course, necessary to select 1Hz integration from the RMS LOW FREQ menu.

## Facilities

### Input Channels A and B

#### Front Panel Terminals

Two separate inputs are fitted on the left of the front panel. Channel A is a precision 'N' type coaxial socket, and Channel B consists of three 4mm binding posts. Their functions are as follows:

#### Channel A

<b>Inner</b>	AC Voltage Input - Hi
<b>Max Input</b>	290V peak to meet the IEC348 safety specifications.
<b>Outer</b>	Safety Ground

#### Channel B

<b>HI</b>	AC Voltage Input - Hi
<b>Max Input</b>	1420V peak, 1000V RMS
	AC Current Input - Hi
<b>Lo</b>	AC Voltage Input - Lo
	AC Current Input - Lo
<b>⏏</b>	Safety Ground

#### Input Switching

Either channel can be selected as input to the measurement circuits. Input switching is carried out under front panel or IEEE-488.2 control, with negligible difference errors due to the high input impedance of the measurement channel. Since these switches are programmable, it is possible to perform very efficient AC/DC transfer measurements in an automated system by connecting AC input to channel A and DC to channel B.

Under these conditions, fully automated, multi-range and very high accuracy AC/DC transfer measurements are possible.

#### Channel Selection

Before any measurement can be performed, the correct input channel must be connected to the measurement circuits.

#### Input Key

Press the front panel Input key to open the INPUT menu.

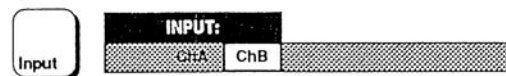

ChA	Precision N-Type
ChB	Hi and Lo terminals

If the channel has not been changed since Power On or Reset, then Channel B will be already selected.

Either: leave Channel B connected or select ChA as required.

Channel A outer is connected to Safety Ground, even when Channel B is connected.

## Digital Filter

### Rolling Average

The 4920 has an averaging mode which combines the results from a series of readings to obtain an average value, thus reducing the effects of random noise. The effect is that of a 'Digital Filter'.

The mode uses a rolling average technique in which the results of the most-recent 4, 8 or 16 readings are combined and displayed as a simple arithmetic mean. A 'window' memory of the requisite size is updated with every trigger by removing the earliest reading and adding the latest as soon as it becomes available. The readings contained in the window are then processed and the new result is displayed. This result remains on the display until the next reading becomes available.

### Digital Filtering In All Functions

ACV, MV and TFER menus each have a Filt softkey, which is used to open the DIGITAL FILTER menu. Any rolling average window selection made in one function is applied when operating subsequently in any other, until the selection is cancelled.

### Selecting the Digital Filter

- Press the Filt key in any of the function menus:



- This opens the DIGITAL FILTER menu. If the facility has not already been selected, the Power-on default Off is underlined, and no window size is underlined:



- To select digital filtering, press either the 4, 8 or 16 key. This also lights the Filt annunciator on the main display and selects the reading window size for the results to be averaged, e.g:



- Exit from the menu by pressing the required function key. When any of the three filters is selected, the selection Filt is underlined.
- To change from one window size to another, merely enter the DIGITAL FILTER menu and press the appropriate key, then exit.
- To deselect digital filtering, enter the DIGITAL FILTER menu and press the Off key, then exit. This also extinguishes the Filt annunciator on the main display.

## Facilities (Contd.)

### RMS Computation - Low Frequency Limits

#### Need for Switched Integration Times

An essential element in the analog RMS measurement process is to calculate a mean value using an integrator circuit. For periodic signals, practical analog methods require the measurement to continue over a number of cycles to avoid run-around due to signal-following. The lower the frequency of the signal, the longer the required measurement time, and the longer the required time constant of the integrating circuit.

To allow low frequencies enough time for measurement, and for higher frequencies to be measured more quickly, a switched range of integration time constants is often provided, each described by the lowest acceptable frequency.

In the 4920, four switched time constants are available:

100Hz, 40Hz, 10Hz and 1Hz.

To meet the instrument specification, the selected RMS Low Frequency must be equal to or lower than the lowest frequency to be measured.

#### Access from Main Function Menus

The integration time constants are switched via the **RMSLOWFREQ** menu. This menu can be accessed when in ACV, mV or AC/DC Transfer; by pressing the front panel **Config** key.

Reasonable readings for signals below 1Hz can be achieved using the DC-coupled 'dc+' mode in the AC/DC function. Refer to *page 4-11*. The RMS low-frequency limit of 1Hz must also be selected using the Config key.

#### Config Key

To Alter the RMS Low-Frequency Limit when in ACV, MV or AC/DC menu:

- Press the **Config** key.



If the frequency has not already been changed since power on, then the default of 100Hz will be active.

- If required, select from 40Hz, 10Hz, 1Hz by pressing the appropriate choice key.

A change from the 100Hz setting will cause the read-rate to slow perceptibly.

Exit back to the ACV, MV or TFER menu by pressing the ACV, mV or AC/DC key respectively.

## Spot Frequency Operation

### Using Spot Frequencies

To pay for the convenience of obtaining a broad frequency range, any measuring instrument must incur errors due to 'flatness' uncertainties.

For applications that require lower measurement uncertainties than those available from 'broadband' operation, the 4920 incorporates a facility for eliminating flatness errors using 'spot' frequency calibration.

A Spot Frequency can be created only by being calibrated. The method is detailed, with other calibration procedures, in Section 8.

Each spot is really a band of frequencies of  $\pm 2\%$  about the calibrated spot frequency. It specifies a span of voltage between 50% and 110% of nominal range and frequency, for which an extra correction is obtained during 'spot calibration', and reapplied when using Spot Frequency mode.

A grand total of up to 100 spots can be allocated, during calibration, to particular ranges and frequencies.

### Calibrated Spot Frequencies

Once in normal operation after a spot has been created, the instrument can be placed into Spot Frequency mode by selecting **Spot** either from an ACV menu, or from the AC/DC TFER menu; then selecting the required spot. An extra correction will be applied for signal frequencies within  $\pm 2\%$  of that spot frequency. An input signal whose frequency does not fall within  $\pm 2\%$  of the spot will elicit an 'Error Hz' message instead of a reading.

### Applying Spot Frequency Corrections

Any spot frequency is valid only for the ACV voltage range in which it was calibrated, and so can be selected only on that range. If a different range is selected when the ACV function is operating at a spot frequency, then Spot mode will be deselected.

The Spot Calibration data itself is a gain correction with respect to readings already corrected for normal AC linearity, gain and flatness. Spot-corrections are therefore applied to a reading *after* these normal corrections and any digital filter corrections have been implemented. Re-calibration of either linearity, gain or flatness will destroy the spot data. The spot will then cease to exist.

Spot frequency mode is not available for use with millivolt ranges, and is cancelled as soon as the mV key is pressed.

### Use of Spot Frequency in Transfer Mode

If the AC/DC key is pressed when the ACV function is operating at a spot frequency, then that particular spot is carried over into the AC/DC Transfer function. It does not become active until the AC signal is selected by pressing the Tfer soft key in the TFER menu. Spot is similarly available as a normal AC reading in Monitor and Math processes. On return to the ACV range where the spot was selected, the same spot frequency will still be active.

### Spot Calibration

When in an ACV range, new spots can be created (and old ones recalibrated) using a calibration menu. This can also be done when AC/DC has been selected, but with dc+, dc-, dcrms and Tfer all deselected.

## Facilities (Contd.)

### Spot Frequency Operation (Contd.)

#### Selecting a Spot Frequency

- Press the Spot key in either of the ACV menus or in the TFER menu. For example:



- The SPOT menu is opened. If no spot frequency is currently selected on the active range, then the word **NONE** appears in the menu. The Hz annunciator on the main display remains unlit.



- If a spot *has* been selected on the range, its frequency will replace the word 'NONE' on the menu display, and the Hz annunciator on the main display remains lit.

For example:



- To select the next-higher frequency spot on the range, press the Up key. If more than one spot has been calibrated, successively pressing the Up key will select them in ascending order of frequency. As each spot is selected, its frequency is displayed. The Hz annunciator remains lit.

#### Spot Frequency Cycling

Once the highest-frequency spot on the range has been reached, the next press on the Up key reverts to NONE again, deselecting Spot mode and putting out the Hz annunciator. The next press on the Up key starts another 'up' cycle.

The Down key cycles through the spots in the same way, but in descending order of frequency.

Up and Down keys can be used in succession to search for a known, required spot. Whenever NONE is displayed, Spot mode is deselected and the Hz annunciator goes out.

Once Spot mode has been set up or deselected as required, revert to the ACV menu by pressing the ACV hard key. If a Spot remains selected, then 'Spot' on the ACV menu will be underlined and the Hz annunciator is lit.

#### Using Spot Frequencies

Once a spot has been selected, a signal at the connected input will be assessed for correct frequency, and if within  $\pm 2\%$  of the spot will be accepted. The measurement will be made with enhanced accuracy as shown in the 'Spot' columns of the ACV or AC/DC specifications in Section 6, pages 6-5 or 6-9 respectively.

For any input signal whose frequency falls above  $+2\%$  of the spot frequency, the message 'Error LF' will appear instead of a reading on the main display. 'Error LF' appears for signals with frequency below  $-2\%$ . The usual meanings of the messages 'Error Ur' and 'Error OL' also apply to these measurements.

#### To Deselect Spot Mode

- Use the Up or Down key in the SPOT menu as above to select NONE, then select the required function. Spot mode is deselected, the label Spot on the ACV or AC/DC function menu loses its underline and the Hz annunciator goes out.



## Facilities (Contd.)

**Status Reporting** This subject is fully described in Section 3, pages 3-14 to 3-20.

### Monitoring

#### Introduction

The measurements taken by the 4920 can be analysed to indicate the signal frequency and deviation from a voltage reference value, using the Monitor facility.

#### Frequency

The instrument continuously measures the input signal frequency. When the LOW FREQ limit of 1Hz is active, the signal is counted during a 2 second gate. For all other measurements, the gate length is 400ms.

The count for each measurement is made available for viewing via the monitor facility.

#### Signal Deviation

When in an ACV or mV range, with the Monitor facility active, a measurement voltage value appearing on the main display can be stored as reference.

When in an AC/DC Transfer mode, a ppm value appearing on the main display can be stored as reference.

Subsequent monitored measurements will be compared against the reference. Each measurement's deviation from the reference value is shown in ppm on the dot-matrix display.

#### Monitor Key (ACV and mV Functions)

- Select the required ACV/mV function and range.
- Select the appropriate input channel and input the required reference ACV signal.
- Press the **Monitor** key.

The FREQ/DEV presentation is displayed:

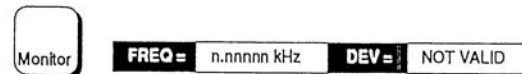

The DEV display shows 'NOT VALID' when a reference value has not been entered.

- Press the Store key to register this reference value for use in subsequent calculations.



After the next A-D conversion, the deviation of the signal voltage from the reference value, in ppm, will replace the NOT VALID display.

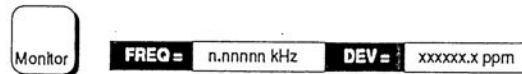

Each subsequent measurement conversion will cause a comparison to be made against the registered reference, updating the displayed deviation.

Deviation is calculated by:

$$\frac{[(\text{Reading} - \text{Reference})]}{(\text{Reference})} \text{ in ppm.}$$

At any time, by pressing the Store key, a reading on the main display can be registered as a new reference.

The stored reference is destroyed whenever the range or function is changed.

# Facilities

## Monitoring (Contd.)

### Monitor Key (AC/DC Transfer Function)

- Select ACV function and the required range.
- Press the **AC/DC** key and perform an AC/DC transfer (*refer to pages 4-9 to 4-11*). When the transfer is complete, the main display will show a deviation in ppm.
- Press the **Monitor** key.  
The **FREQ/DEV** presentation is displayed:

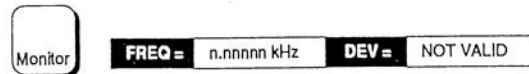

The DEV display shows 'NOT VALID' when a reference value has not been entered.

- Press the **Store** key to register this reference value for use in subsequent calculations.



After the next A-D conversion, the deviation of the signal voltage from the reference value, in ppm, will replace the NOT VALID display.

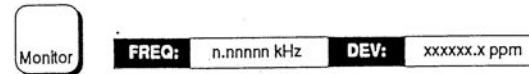

Each subsequent measurement conversion will cause a comparison to be made against the registered reference, updating the displayed deviation.

Deviation is calculated by:

$$\text{(Reading - Reference) in ppm.}$$

At any time, by pressing the **Store** key, a reading on the main display can be registered as a new reference.

The stored reference is destroyed whenever the range or function is changed.

### Validity Messages

The following combinations have the indicated meanings:

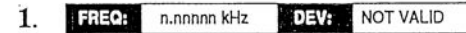

No reference value has been registered.

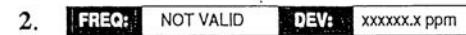

The frequency display is inapplicable.

## Facilities (Contd)

### Math

#### Introduction

This facility is used to record a block of measurements from those being taken by the instrument in ACV, mV or AC/DC functions; then derive their arithmetic mean and standard deviation. The two results are presented on the dot-matrix display.

The Math facility does not initiate measurements; those recorded within a block are triggered by normal means.

The number of measurements to be recorded for processing are set in a BLOCK SIZE menu. The action of pressing the Enter key in this menu starts the block, which ends when the number of measurements specified as block size have been recorded.

#### 'Block Average' Process

A portion of memory is assigned to store block readings. As each subsequent reading becomes available, it is added to the others in the store. When a block of the registered size is complete, the mean and standard deviation of the stored readings is calculated and displayed, and the memory is cleared ready for the next block.

#### Math Menus

A description of the User Interface is given in Section 3 for the main functions.

If you are unfamiliar with the front panel controls, you should complete the quick tour which starts on Page 3-5.

To give an overall view, movement among the MATH group of menus is described by the following diagram:

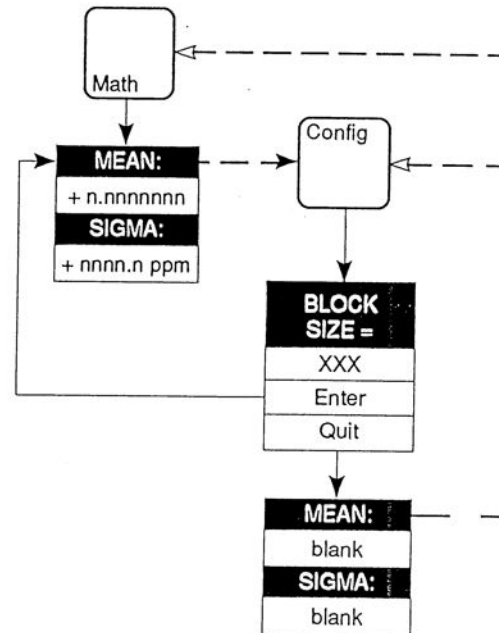

## Enter the Math Menus

### Math Key

- Press the **Math** key to show the MEAN/SIGMA display.

### MEAN/SIGMA Display

This is a display, not a menu, and so no soft keys are defined. Initially:

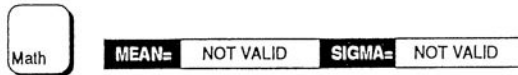

**MEAN** The mean of the block of readings is calculated and displayed. Units are not shown; they are the same as on the main display.

**SIGMA** The Standard Deviation of the block of readings is calculated and displayed. When the main display units are volts, then SIGMA is calculated in ppm of mean. When the main display units are ppm (as in Transfer mode), then SIGMA is calculated in ppm.

Until a block of readings has been started and acquired (via 'Math Config'); both the mean and standard deviation are not available, and NOT VALID is displayed in both areas on the dot-matrix display.

## Start a Block of Readings

### CONFIG Key

- Press the **Config** key in MATH to cause the BLOCK SIZE menu to be displayed.

### BLOCK SIZE Menu

This menu allows the number of readings in the block to be set. Each time the Config key is pressed to enter the menu, the block size always reverts to zero.



The numeric keyboard is activated and two *menu* keys are defined:

- Use the numeric keyboard to register the number of readings in the block; for example:



Either:

- Press the Enter key to start recording the registered block. The dot-matrix display reverts to the MEAN/SIGMA presentation.

or:

- Press the Quit key to revert to the MEAN/SIGMA display, which is presented with both areas blank. Reselect either a main function or press the Config key to reset the block size.

## Results

### MEAN/SIGMA Display

The MEAN and SIGMA areas show NOT VALID until the instrument has completed the number of A-D conversions registered as block size; then the calculated mean and standard deviation values appear against MEAN and SIGMA respectively:

MEAN = + n.nnnnnnnE+XX SIGMA = + nnnn.n ppm

### One-Shot Operation

Because of the possible need for a user to redefine the block size, alter the input, reconfigure the 4920 and decide the timing of the next block, there is no automatic repetition of block recording.

Once the block results are presented, they remain on the display until further user-action takes place.

To record another block, press the Config key and set the required number of readings in the BLOCK SIZE menu, then press ENTER to start recording.

### Validation

Messages are displayed to give information when it is not possible to perform the full analysis:

#### Block Incomplete

MEAN = NOT VALID SIGMA = NOT VALID

Invalid Reading. For example:

MEAN = ERROR OL SIGMA = NOT VALID

Reading Too Noisy, or for a calculated Sigma of 20,000 or more:

MEAN = + n.nnnnnnnE+XX SIGMA = NOT VALID

## Direct Action Keys

These seven keys are located beneath the main display. They allow the operator to act as follows:

### Reset

Provides a quick means of resetting the instrument to the power-up state, when in local operation.

The instrument default states for Power On are given in Appendix B to Section 5. Pressing **Reset** provides the same result, except that any settings directly concerned with remote operation are not altered.

### Ext'trig

Disables internal triggers, and enables the external trigger sources: 'Sample' and SK9. The 'Ext' annunciator on the main display is lit.

Ext'trig can be self-cancelled by a second press, to enable internal triggers. The Ext annunciator is turned off when internal triggers are enabled.

### External Trigger Socket SK9 (Rear Panel)

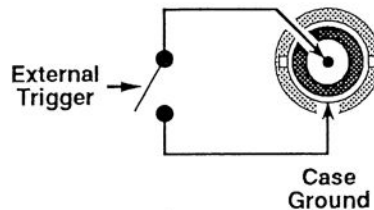

### Sample Key

Triggers a single-shot measurement if the 4920 is in Ext'trig mode. All 'Sample' measurements are subject to the standard acquisition times. These are listed in Appendix B at the end of Section 4.

During the measurement the 'Busy' annunciator on the main display is lit.

### Local

Returns the 4920 to front panel control when operating on the IEEE-488 bus, provided that it is not disabled by remote command. It will cause the Rem annunciator on the main display to turn off.

Local can be disabled by a controller using the LLO (Local Lockout) function.

### SRQ

If set to remote in IEEE 488 system operation, with 'URQ' and 'ESB' bits enabled; this key generates a Service Request (SRQ) on the IEEE 488 bus. It causes the SRQ annunciator on the main display to light, and remain lit until the request is serviced.

SRQ can be disabled via the IEEE 488 bus using the 'Event Status Enable' or 'Service Request Enable' register commands.

For further information refer to Section 5.

### Caltrig

This key is only active when the Cal annunciator is lit in the main display. It is used to trigger all operations selected in the calibration menu, except those concerned with entry of numeric data (in which case the menu contains an 'enter' command).

### Store

In mV and AC/DC functions, also when using the Monitor facility to calculate 'Deviation'; it is necessary to store relevant data, by pressing the Store key, as part of the measurement procedure. For details, refer to the appropriate procedure.

## 'Numeric Keyboard' keys

### Keyboard Facility

#### Numeric Function

Seventeen of the menu keys double as numeric keyboard keys when certain menus appear on the dot-matrix display, and in most cases all other keys are locked out. As well as the numbers 0 to 9, the decimal point and the polarity changeover (+/-) keys, five other functions are represented.

#### Exp

The number appearing on the numeric display to the right of 'E' is a power of ten, by which the number to the left of the E is multiplied. The Exp key is used to enter E into the expression.

Exp can be preceded by a minus sign to indicate fractional powers of ten: to do this press the +/- key before pressing Exp.

#### Enter

After assembling the number within a menu, the Enter key is pressed to confirm that it is to be used. Usually the word Enter also appears in the menu. In some cases the Enter command enables another key, or presents another menu.

#### Quit

For a few menus (associated with 'Math' and 'Cal') the Quit key is provided for convenient exit, without activating any process.

#### ← ('Monitor' key)

Deletes the previous numerical character.

#### Last rdg

When a reading from the main display is required to be incorporated into a process, the Last rdg key can be used to enter the value of the most-recent measurement on to the dot-matrix menu.

## Test Facilities

### Test Menus

A description of the User Interface is given in Section 3 for the main functions.

To give an overall view, movement among the TEST group of menus is described by the following diagram:

If you are unfamiliar with the front panel controls, you should complete the quick tour in Section 3.

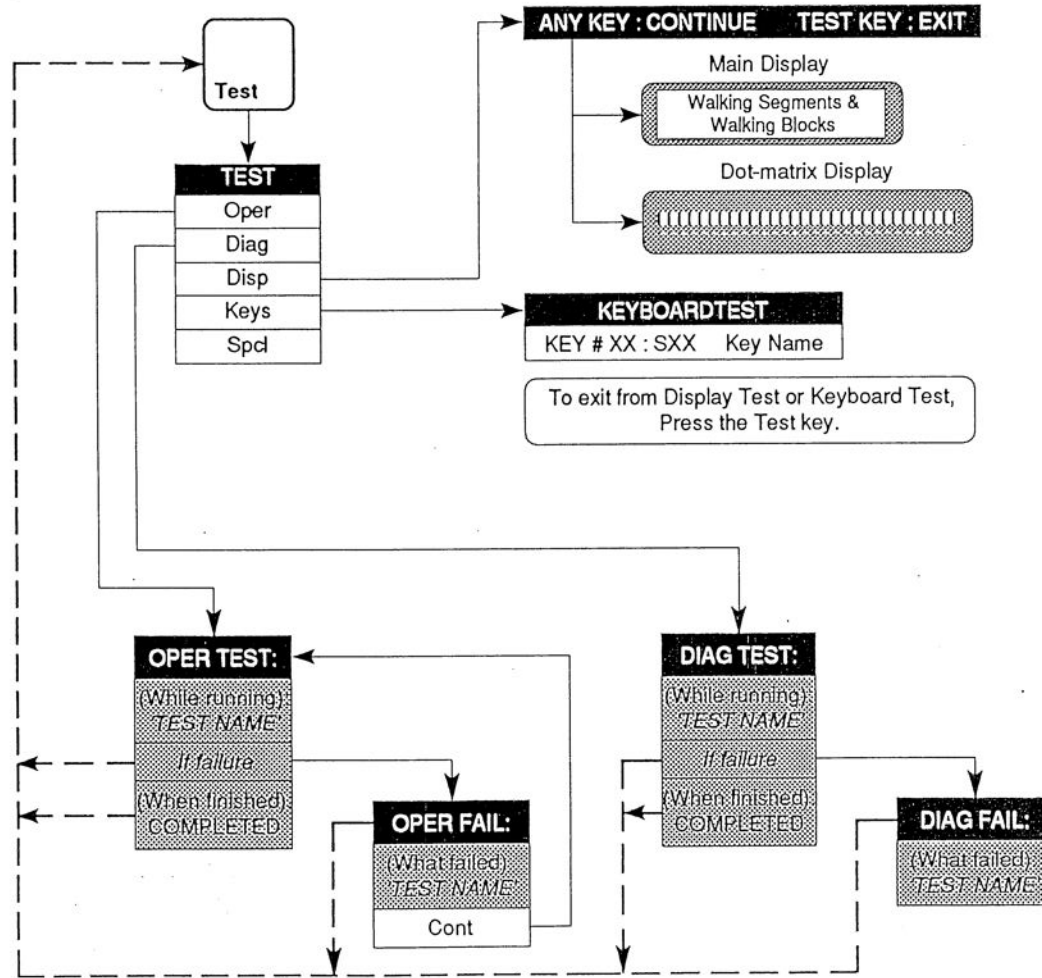



### Test Key

The front panel Test key causes the TEST menu to be displayed. Different types of selftest can be chosen from this menu.

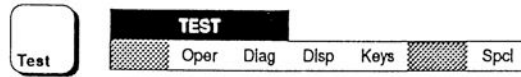

### Caution

Disconnect any signal inputs.

The success of the Operational and Diagnostic Tests can be inhibited by:

- temperature not in the range: 13°C to 33°C;
- more than 1 year since the most-recent external calibration; or
- presence of excessive RFI or power-line noise.

### Oper Key

Oper transfers to the OPER TEST menu, starts an operational test, disabling all menu and direct action keys, signal inputs and normal trigger sources. This test includes a calibration memory check.

### OPER TEST Menu



While operational test is running, the display shows the name of the test currently being performed. Once a failure is noted, the test is halted and transfers to the OPER FAIL menu, showing the test which failed and a key to permit a user to continue the operational test.

### OPER FAIL Menu

When an operational test has failed, the test sequence is stopped, and the OPER FAIL menu is opened.



The name of the failed test appears, and a soft key (Cont) is allocated to allow a user to continue the test after noting the failure.

### Disp Key

A reminder menu appears first, noting the actions of the keys.



Repeatedly pressing any key other than Test increments both displays through a sequence of 'walking strobes', which allow a user to inspect individual segments and complete blocks.

### Keys Key

The Keys soft key presents the KEYBOARD TEST menu.



All keys other than the Test key can be tested by pressing. For each key pressed, the 'Key #' is followed by the key's hexadecimal matrix position, then after a colon an 'S' is followed by the key's switch ident number. The name of the key is given on the right of the display.

### Exit

During 'Disp' or 'Keys' checks, pressing the Test key terminates the sequence.

### Diag Key

Diag transfers to the DIAG TEST menu, starts a diagnostic test, disabling all menu and direct action keys, signal inputs and normal trigger sources. This test includes a calibration memory check.

### DIAG TEST Menu



While diagnostic test is running, the display shows the name of the test currently being performed. Once a failure is noted, the test is halted and transfers to the DIAG FAIL menu, showing the test which failed.

### DIAG FAIL Menu

When an diagnostic test has failed, the test sequence is stopped, and the DIAG FAIL menu is opened.



The name of the failed test appears. No means of continuing the test is provided, as the failure could affect subsequent tests.

### Exit

To exit from Diagnostic Test after a test failure, press any major function key. Pressing the Test key then choosing Diag again will lead to the same failure condition and report.

## Calibration Operations

### Caution

The descriptions in the following pages are intended only as a guide to the operations available to calibrate the instrument. They contain neither examples nor calibration routines, and should NOT be used directly as a basis for calibrating any part of the instrument. Some of the commands, if used unwisely, will obliterate an expensive calibration or recalibration.

For a guide to calibration routines refer to Section 8.

### General Outline of Calibration Operations

The calibration process generally conforms to a set sequence of operation:

1. The rear-panel switch must be set to ENABLE, then calibration is enabled by pressing the Cal key (this may need further parameters to be specified). Optional parameters are available for Spot calibration, and for use when the calibration is to be performed at a non-nominal value.
2. With the appropriate analog input applied, the calibration operation is triggered. The relevant corrections are calculated and stored in non-volatile memory. Subsequently, in normal use; gain and flatness calibrations are applied to correct the pre-selected function and range. Filter and linearity calibrations are carried out on one range and applied to correct all ranges of the pre-selected function.
3. Other operations can be carried out, such as setting the calendar/clock or the calibration interval.
4. When calibration is complete, calibration is finally disabled by setting the rear panel switch to DISABLE.

### CAL Group of Menus - Overall View

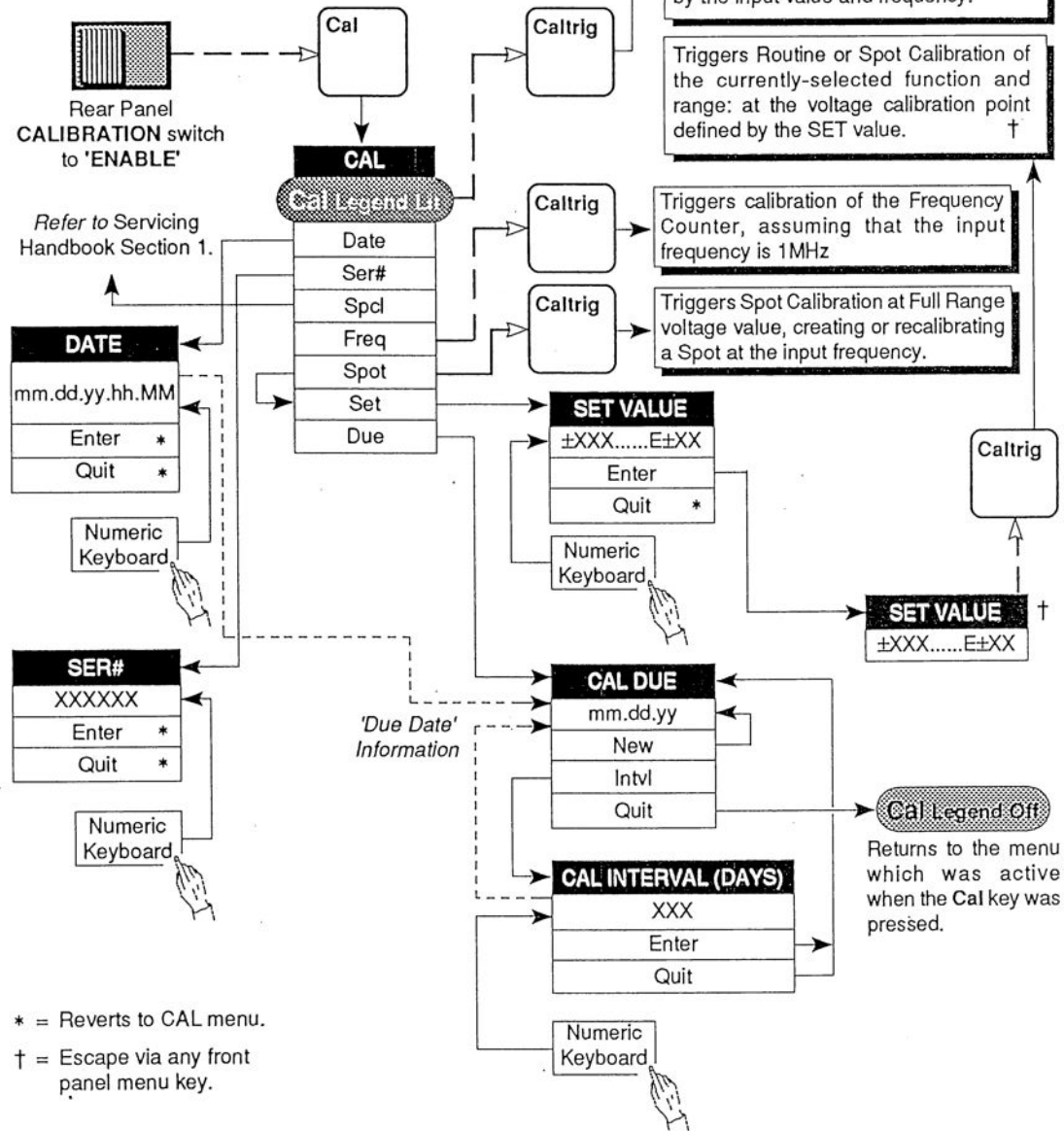

## Calibration Menus

### Front Panel Cal Key

The Cal key on the front panel causes the CAL menu to be displayed in the dot matrix display, so long as the instrument is not already in Cal mode. This menu provides access to the calibration menus, also permitting some other non-volatile memory data to be accessed and changed.

### CAL Group of Menus

A description of the User Interface is given in Section 3 for the main functions.

If you are unfamiliar with the front panel controls, you should complete the quick tour which starts on Page 3-5.

To give an overall view, movement among the CAL group of menus is described by the diagram on the opposite page.

### Access Conditions

Rear panel switch S2 provides access to the CAL menu, and to the non-volatile calibration memory. S2 must be set to 'ENABLE' for calibration.

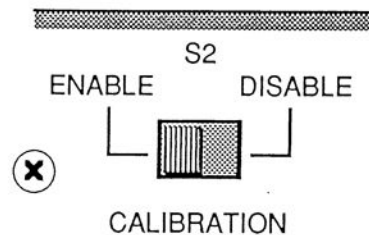

S2 is recessed to avoid inadvertent operation. A paper seal can be placed over the switch to protect calibration.

### CAL Menu

Pressing the Cal key opens the CAL menu. The main group of calibration menus is available.

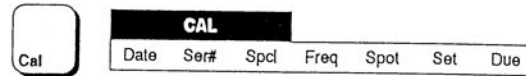

### Caution:

In this and other calibration menus the Caltrig key is enabled, and when pressed alters the calibration memory. To reduce the possibility of inadvertently obliterating the previous calibration, the menu should only be used during a genuine recalibration. Refer to Section 8.

Once the 'Cal' legend is lit, the major function hard keys can be selected and the various ranges calibrated at lower and upper cardinal points, using the Caltrig direct action key.

If Spot calibration is required, and the input value is the Full Range voltage, then the Caltrig key can be used directly to create or recalibrate a Spot at the input frequency.

If the values are not exactly at the cardinal points, then Set in the CAL menu can be used to inform the instrument of the exact value. This facility can also be used with Spot calibration.

This menu defines five *menu* keys, and one *Toggle* key (Spot), all of which are *not selected* at Power On. They are described overleaf.

### Calibration Menus (Contd.)

**Spcl** This key displays the SPCL menu, which accesses five 'special' calibration operations. They can be regarded as 'presets'; being intended for use at manufacture and at times when certain assemblies are repaired. **They are not to be used for routine calibration purposes.**  
**Quit** transfers back to the CAL menu.

**Freq** Selects Frequency Calibration. With an accurate 1MHz signal applied on the 0.3V, 1V, 3V or 10V range, the action of pressing the Caltrig key performs calibration of the internal Frequency Counter.

**Spot** Selects Spot Calibration. With a full range signal applied at the required spot frequency, the action of pressing the Caltrig key creates or recalibrates a spot frequency.  
By pressing Spot followed by Set on the same menu, a particular cal source value can be entered as target value for non-nominal spot calibration. Refer to 'Set' on the next page.

**Date** Opens the DATE menu. This shows the present date in the format:

mm.dd.yy.HH.MM

where the pairs of digits have the meanings:

mm = month

dd = day

yy = year

hh = hour

MM = minute



The date and time can be changed in this menu, by operating the numeric keyboard keys. Pressing any numeric key will cancel the whole date, permitting the present date to be written, in the same format.

**Enter** causes the internal calendar/clock to be reset to the date/time just written.

**Quit** aborts the attempt to reset the calendar/clock, which continues uninterrupted running.

Both Enter and Quit transfer back to the CAL menu.

**Ser#** Opens the SER# = menu. This shows the assigned instrument serial number, and the numeric keyboard is activated. A numeric value can be entered.

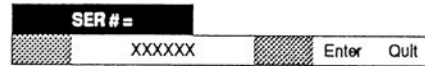

**Enter** writes the new serial number into non-volatile RAM, overwriting the old number.

**Quit** aborts the attempt to reset the serial number. The existing serial number remains stored in non-volatile memory.

Both Enter and Quit transfer back to the CAL menu.

**Set** Opens the SET VALUE = menu. This shows a value of zero, and the numeric keyboard is activated.

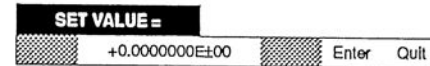

A particular cal source value can be entered as target value for non-nominal wideband or spot calibration.

**Enter** writes the new target value into non-volatile RAM, and generates a new SET VALUE = display. Pressing the Caltrig key performs the 'SET' calibration.

**Quit** aborts the attempt to reset the target value and transfers back to the CAL menu. The newly-written value is destroyed.

**Due** This is intended to be used following a calibration, in order to note the date when the next calibration is due. The new date is calculated from the current date registered by the internal calendar/clock, and calibration-interval information entered via the CAL DUE and CAL INTERVAL menus.

The Due key opens the CAL DUE menu.



This shows the old due date for the next calibration, calculated at the previous calibration.

**New** causes the instrument to calculate the date when the next calibration is due, from the date currently registered by the internal calendar/clock, and calibration-interval information entered via the CAL INTERVAL menu.

The new 'Cal Due' date is presented on the DUE DATE menu instead of the old due date.

**Intvl** Opens the CAL INTERVAL (DAYS) = menu. this displays the currently-registered calibration interval, and the numeric keyboard is activated. A new interval can be written using the numeric keyboard.



**Enter** causes the new interval to be written into non-volatile memory, in place of the old interval.

Enter transfers back to the CAL DUE menu, where the Cal Due date changes to show the effect of the new interval.

**Quit** aborts the attempt to reset the calibration interval. The old interval remains stored in non-volatile memory.

Quit transfers back to the CAL DUE menu. The Cal Due date does not change.

#### CAL DUE Menu - Exit from Calibration mode.

**Quit** from the CAL DUE menu. The Cal legend on the main display is extinguished.

Quit returns either to the menu which was open when the Cal key was pressed; or to a 'neutral' menu, whereupon a main menu key can be pressed to select the next required menu.

#### Calibration Store Code

After performing a calibration and having exited from Calibration mode, it is advisable to enter the STATUS CONFIG menu and select Cal? to observe the Calibration Store Code: 'CODE'.

The code should be recorded, so that on a subsequent occasion, a check can be made to determine whether the calibration store integrity is intact.

Refer to Section 3, Page 3-20.



**Note to users:** For the sake of completeness, this appendix collects together the error codes which might be generated either on the instrument front panel, or via the IEEE 488 system bus.

---

## Error Detection

All errors which cannot be recovered without the user's knowledge, result in some system action to inform the user via a message, and where possible restore the system to an operational condition. Errors are classified by the method with which they are handled. Recoverable errors report the error and then continue. System errors which cannot be recovered cause the system to halt with a message displayed. Restarting the instrument from Power On may clear the error, but generally such messages are caused by hardware or software faults, which require user action.

---

## Error Messages

### Fatal System Errors

For all fatal system errors, the error condition is reported only via the front panel. The processor stops after displaying the message. A user must respond by retrying operation from power on, and initiate repair if the fault persists. The following is a list of error numbers displayed, with their associated fault descriptions:

- 9000 - System Kernel Fault
- 9001 - Run Time System Error
- 9002 - Unexpected Exception
- 9005 - Serial Interface Fault
- 9099 - Undefined Fatal Error

## Recoverable Errors

These consist of **Command Errors**, **Execution Errors** and **Device-Dependent Errors**. Command Errors can only be generated due to incorrect remote programming. Some Execution Errors and all Device-Dependent Errors can all be generated by manual operation as well. Each of the reportable Execution and Device-Dependent Errors are identified by a code number.

### Error Reporting

Whether in response to a bus or a keyboard error, the instrument reports an Execution Error or a Device-Dependent Error to both local and remote operators. It displays the error on the front panel; it also sets the ESR bit, and adds the error to the queue.

A Command Error is related to bus command syntax, and so is not reported via the front panel.

### Command Error (CME)

(Remote operation only)

A Command Error is generated when the remote command does not conform, either to the device command syntax, or to the IEEE 488.2 generic syntax. The CME bit (5) is set *true* in the Standard-defined Event Status Byte, but there is no associated queue.

The error is reported by the mechanisms described in the sub-section of Section 5 which deals with status reporting.

### Execution Errors (EXE)

An Execution Error is generated if a received command cannot be executed due to it being incompatible with the current device state, or because it attempts to command parameters which are out-of-limits.

In remote operation, the EXE bit (4) is set *true* in the Standard-defined Event Status Byte, and the error code number is appended to the Execution Error queue.

The error is reported by the mechanisms described in the sub-section of Section 5 which deals with status reporting, and the queue entries can be read destructively as LIFO by the Common query command \*EXQ?.

The Execution Error numbers are given below, with their associated descriptions.

### List of Execution Errors

- 1000 - No Execution Error
- 1001 - No Test in Cal Mode
- 1002 - Resume test not allowed
- 1003 - Cal Switch disabled
- 1004 - Cal Mode not enabled
- 1005 - Set nominal not allowed
- 1006 - Invalid range/function
- 1007 - Invalid numeric data
- 1008 - No DCPOS Ref value
- 1009 - No DCNEG Ref value
- 1010 - No DCRMS Ref value
- 1011 - No Cal in Millivolt Mode
- 1012 - No Millivolt in Cal Mode
- 1013 - No Millivolt Gain value
- 1014 - mV Option not fitted

**Recoverable Errors (contd)**

**Device-Dependent Errors (DDE)**

A Device-Dependent Error is generated if the device detects an internal operating fault (eg. during self-test). The DDE bit (3) is set *true* in the Standard-defined Event Status Byte, and the error code number is appended to the Device-Dependent Error queue. The code number and description appear on the right-hand display, remaining visible until the next key-press or remote command.

In Remote, the error is reported by the mechanisms described in the sub-section of Section 5 which deals with status reporting, and the queue entries can be read destructively as LIFO by the Common query command \*DDQ?.

Note that error codes beginning 2... can be caused by incorrect operation or instrument failure; error codes beginning 3... are almost certainly due to instrument failure.

**Device-Dependent Error Lists**

Device-dependent errors are associated mainly with test and calibration operations. The error numbers in the following pages are therefore listed in these categories. There is some overlap.

The error list for calibration operations, with their associated descriptions, commences overleaf, followed by the selftest error list.

**Device-Dependent Messages: Normal and Calibration Operations**

**Normal Operation**

- 2000 - No Device Error in List
- 2006 - Invalid Calstore Read
- 2009 - Invalid Serial Data
- 2010 - Corrupt Datarec Value
- 2011 - DCPOS Invalid
- 2012 - DCNEG Invalid
- 2013 - DCPOS/DCNEG Mismatch
- 2015 - Spot Frequency Invalid
- 2016 - mV Gain Error

**Calibration Invalidities**

- 2001 - Invalid Gain Cal
- 2002 - Invalid HF Trim Cal
- 2003 - Invalid Flatness Cal
- 2004 - Invalid Linearity Cal
- 2005 - Invalid Frequency Cal
- 2007 - Invalid Calstore Write
- 2008 - Invalid Cal Arithmetic
- 2014 - Spot Cal Table Full

**Serial Loop Initialization**

- 3028 - Chip Test AC Pre-amp
- 3029 - Chip Test AC RMS Control
- 3030 - Chip Test A-to-D DAC
- 3031 - Chip Test A-to-D Switch
- 3032 - Chip Test A-to-D Tester
- 3033 - Serial Loop Failure

**Calibration Illegalities**

- 3001 - Illegal Cal Exercise
- 3002 - Illegal Special Cal Step
- 3003 - Illegal Cal Update
- 3004 - Illegal Calstore Access
- 3005 - Illegal Calstore Clear
- 3006 - Illegal Calstore Func
- 3007 - Illegal Calstore Range
- 3008 - Illegal Calstore Length
- 3009 - Illegal Clock Destination
- 3010 - Illegal Clock Reading
- 3011 - Illegal Clock Setting
- 3012 - Illegal Clock Access
- 3013 - Illegal Measure Phase
- 3014 - Illegal Scale Index
- 3015 - Illegal Flatness Value
- 3016 - Illegal Linearity Value
- 3017 - Illegal HF Correction
- 3018 - Illegal Gain Correction
- 3024 - Illegal Test Stage
- 3025 - Illegal Test Store
- 3026 - Illegal Test Polarity
- 3027 - Illegal Engine Op-Code
- 3034 - Illegal Operation
- 3035 - Illegal Parameter

**Device-Dependent Messages: Selftest Operations - Error Messages**

Note that errors from 4015 to 4052 may occur if a signal or low impedance is connected to either instrument input when the test is taking place. If this is not the case, then a self-test error implies instrument failure.

**Step Error Message****Preliminary**

4000 Stuck Key.  
4001 Dig Power Supplies  
4002 Battery Voltage

**Memory**

4003 ROM Bitsums.  
4004 RAM Read/Write.  
4005 CAL Integrity.

**Digital Communication**

4006 Serial Loop Config.

**Analog-to-Digital Conversion**

4007 A-to-D Zero.  
4008 A-to-D +15V Supply.  
4009 A-to-D -15V Supply.  
4010 A-to-D Gain.  
4011 A-to-D Linearity +.  
4012 A-to-D Linearity -.  
4013 A-to-D +11V Supply.  
4014 A-to-D -19V Supply.

**High Accuracy ACV Conditioning**

4015 AC Preamp X1 Zero.  
4016 AC Preamp X3 Zero.  
4017 AC 1V Gain, DC Pos.  
4018 AC 1V Gain, DC Neg.  
4019 AC Preamp X3 Gain.  
4020 AC 10V Attenuator.  
4021 AC 100V Attenuator.  
4022 AC 1kV Attenuator.

**Step Error Message****Frequency and Overload**

4023 AC Freq Counter.  
4024 AC Overload Detect.  
4025 AC Overload Switch.

**High Accuracy RMS Conversion**

4026 AC HF Path Detect.  
4027 AC RMS Converter.  
4028 AC RMS Track.  
4029 AC RMS Hold.  
4030 AC Quasi-Sine.  
4031 AC Measurement.  
4032 Not Used.  
4033 AC 10Hz Filter.  
4034 Not Used.  
4035 AC RMS Linearity.  
4053 Cal Validity.

**Other**

4054 Bus Address.

## 4920 Standard Signal-Acquisition Times

The 4920 uses an electronic converter to measure the RMS value of the input signal.

After the reading trigger, with the conditioned input applied to the converter, an optimum settling delay is programmed to allow the converter output to stabilize before the start of the transfer sequence. Users cannot alter this settling time. It is fixed in firmware for each significant filter and range state.

After settling, the signal must remain present for the whole of the electronic transfer cycle.

The total signal acquisition period (which includes both settling and sampling times) is given for Function, Range and RMS Low Frequency selections in the tables below. The signal must remain connected and activated for the periods shown.

### ACV

Range	RMS LF	Acquisition Time
1V-300V	100Hz	? secs
	40Hz	? secs
	10Hz	? secs
	1Hz	? secs
1000V at 1000V levels	100Hz	? secs
	40Hz	? secs
	10Hz	? secs
	1Hz	? secs

### AC/DC

Range	RMS LF	Acquisition Time
1V-300V	100Hz	? secs
	40Hz	? secs
	10Hz	? secs
	1Hz	? secs
1000V at 1000V levels	100Hz	? secs
	40Hz	? secs
	10Hz	? secs
	1Hz	? secs

### AC mV

Range	RMS LF	Acquisition Time
3mV to 100mV	100Hz	? secs
	40Hz	? secs
	10Hz	? secs
	1Hz	? secs

**4920 ACV and mV Significant Range Points**

(including Range selection features)

ACV Range	ACV <i>Nrf</i> selection limits	Range Point	Levels
1000V	300 < <i>Nrf</i>	Upper Limit	1199.5000V
		Nominal	1000.0000V
		Lower Limit	90.0000V
300V	100.0 < <i>Nrf</i> ≤ 300.0	Upper Limit	349.9500V
		Nominal	300.0000V
		Lower Limit	27.0000V
100V	30.0 < <i>Nrf</i> ≤ 100.0	Upper Limit	119.95000V
		Nominal	100.00000V
		Lower Limit	9.00000V
30V	10.0 < <i>Nrf</i> ≤ 30.0	Upper Limit	34.99500V
		Nominal	30.00000V
		Lower Limit	2.70000V
10V	3.0 < <i>Nrf</i> ≤ 10.0	Upper Limit	11.995000V
		Nominal	10.000000V
		Lower Limit	0.900000V
3V	1.0 < <i>Nrf</i> ≤ 3.0	Upper Limit	3.499500V
		Nominal	3.000000V
		Lower Limit	0.270000V
1V	0.3 < <i>Nrf</i> ≤ 1.0	Upper Limit	1.1995000V
		Nominal	1.0000000V
		Lower Limit	.0900000V
300mV	0 < <i>Nrf</i> ≤ 0.3	Upper Limit	.3499500V
		Nominal	.3000000V
		Lower Limit	.0270000V

(mV Range Points - overleaf)

**4920 ACV and mV Significant Range Points (Contd.)**

mV Range	mV <i>Nrf</i> selection limits	Range Point	Levels
3mV	1 < <i>Nrf</i> ≤ 3	Upper Limit	3.599500mV
		Nominal	3.000000mV
		Lower Limit	0.300000mV
10mV	3 < <i>Nrf</i> ≤ 10	Upper Limit	11.995000mV
		Nominal	10.000000mV
		Lower Limit	0.795000mV
30mV	10 < <i>Nrf</i> ≤ 30	Upper Limit	35.995000mV
		Nominal	30.000000mV
		Lower Limit	3.000000mV
100mV	30 < <i>Nrf</i> ≤ 100	Upper Limit	11.995000mV
		Nominal	100.000000mV
		Lower Limit	7.095000mV



**SECTION 5**

**SYSTEMS APPLICATION  
via the IEEE 488 INTERFACE**

X

**Section 5 Contents List**

<b>Alphabetical Index of IEEE 488.2 Codes used in the 4920</b>	5-0-4 to 5-0-6
<b>Introductory Material</b>	
<b>Introduction</b>	
Interface Capability	5-1
Interconnections	5-3
<b>Using the 4920 in a System</b>	
Addressing the 4920	5-4
Remote Operation	5-5
Programming Guidance	5-6
Message Exchange Models	5-12
Service Request	5-16
<b>Retrieval of Device Status Information</b>	
The 4920 Status Reporting Structure	5-17
4920 Status Reporting - Detail (see also pages 5-49 to 5-62)	5-21
<b>4920 Commands and Queries - Syntax Diagrams</b>	
<b>Measurement Definition - Major Functions</b>	
ACV Function	5-28
Option 10 - Millivolts (mV)	5-30
AC/DC Transfer	5-32
<b>Measurement Definition - Parameters</b>	
Trigger Sources	5-34
Signal Input Channels	5-35
Spot Frequency Operation	5-36
RMS Filtering - Low Frequency Limits	5-38
Digital Filtering	5-39
Block Definition	5-40
<b>Measurement Definition - SRQ Generation</b>	
SRQ Origination	5-42
<b>Trigger Reading</b>	
Execute Trigger	5-33
<b>Measurement Results</b>	
Reading and Frequency Recall	5-44
Mean and Standard Deviation Calculation	5-46
Deviation of Present Reading from Stored Reading	5-48

71



<b>Status Data Manipulation</b>		
Status Reporting (see also page 5-17)		5-49
Power On Status Clear		5-56
Clear Status		5-58
Recall Instrument Settings		5-59
<b>Error Reporting</b>		
Error Detection		5-60
Recall Device Errors		5-61
Recall Execution Errors		5-62
<b>General Queries</b>		
Recall Instrument Identification		5-63
Recall Options Fitted		5-64
Recall Today's Date		5-65
Recall Last Calibration Date		5-66
Recall Calibration Store Code		5-67
Recall Calibration Due Date		5-68
Recall Calibration Interval		5-69
Recall Stored Reference Value		5-70
Recall Stored User Data		5-71
<b>Test Operations</b>		
Operational Selftest		5-72
Resume Operational Selftest		5-73
Diagnostic Selftest		5-74
Bus test		5-75
<b>Internal Operations</b>		
Instrument Reset to Default Condition		5-76
Operation Complete		5-77
Wait		5-78
<b>Calibration Commands and Messages</b>		
General Outline		5-79
Enable Calibration		5-80
Trigger Calibration		5-83
Clear Calibration Stores		5-84
Set Date of Last Calibration		5-85
Exit from Calibration		5-85
Set Internal Clock/Calendar		5-86
Set Instrument Serial Number		5-87
Change Instrument Calibration Interval		5-88
Entry of Protected User Data		5-89
Report the Contents of the Calibration Memory		5-91
<b>Appendix A:</b>	IEEE 488.2 Device Documentation Requirements	5-A1
<b>Appendix B:</b>	4920 Device Settings at Power On	5-B1

## Alphabetical Index of IEEE 488.2 Codes used in the 4920

### Common Commands/Querles

Common Command/ Query Header	Description	Page 5-
*CLS	Clears event registers and queues (not O/P queue)	58
*ESE	Enables standard-defined event bits	52 (42)
*ESE?	Returns ESE register mask value	52
*ESR?	Reads Event Status register	53
*IDN?	Reports manufacturer, model, etc.	63
*OPC	Conforms, but not relevant to 4920 application	74
*OPC?	Conforms, but not relevant to 4920 application	74
*OPT?	Recalls option configuration information	64
*PSC	Sets/resets power-on status clear flag	56
*PSC?	Recalls power-on status clear flag	57
*PUD	Allows entry of user data to protected store	89
*PUD?	Recalls user-entered data	71
*RST	Resets instrument to power on condition	76 / App B
*SRE	Enables Service Request Byte bits	54 (42)
*SRE?	Returns Service Request Byte mask value	54
*STB?	Non-destructively reads Service Request Byte	55
*TRG	Causes a single reading to be taken	43
*TST?	Perform Operational Test	72
*WAI	Conforms, but not relevant to 4920 application	78

### Calibration Operations

Device-Dependent Command/Query Header	Description	Page 5-
CAL?	Triggers calibration operation	83
CALINT	Sets calibration interval	88
CALSEAL	Copies current date to 'Last Cal' date	85
CLRMEM	Clears calibration memory	84
DATE	Sets calendar and clock	86
DUMP?	Returns values from calibration memory	90
ENBCAL	Enables calibration	80
EXITCAL	Disables calibration	85
SERIAL	Allows access to change the serial number	87
*PUD	Allows entry of user data to protected store	89

**Normal Operations**

Device-Dependent Command/Query Header	Description	Page 5-
ACV	Selects AC Voltage function	28
AVG	Rolling Average of 4-, 8- or 16-readings window	39
BLOCK	Sets number of readings in Math block	40
BTST?	Tests bus drivers	75
CAL_DUE?	Recalls calibration due date	68
CALINT?	Recalls calibration interval	69
DATE?	Returns date and time	65
DDQ?	Recalls most-recent device error from queue	61
DEV?	Recalls deviation of most-recent reading from stored reference	48
DTST?	Performs diagnostic test	74
EXQ?	Recalls Execution Errors	62
FREQ?	Recalls frequency of most-recent reading	45
INPUT	Selects signal input channel	35
MEAN?	Calculates and returns mean value of block readings	46
MESE	Enables measurement event bits	50 (42)
MESE?	Recalls MESE enable bits	50
MESR?	Reads Measurement Event Status	51
MVAC	Selects Millivolt function (mV)	30
PROG?	Reports programmed state of the instrument	59
RDG?	Recalls most-recent reading	44
REF	Stores current reading as reference in mV Gain, AC/DC or Deviation calculations	41
REF?	Recalls stored reference	70, (41)
RMS	Sets RMS converter integrator time constant	38
RTST?	Resumes operational/diagnostic test	73
SIGMA?	Calculates and returns standard deviation of block readings	47
SPOT	Selects Spot Frequency facility in ACV or AC/DC	37
TFER	Selects AC/DC transfer function	32
TRG_SRCE	Selects trigger source	34

*PTO for other mnemonics*

**Other Mnemonics, their Commands and Functions**

Mnemonic	Command of which the mnemonic is a parameter	Mnemonic Function	Page 5-
ALL	CLRMEM	Clears all non-volatile calibration memory.	84
AV4	AVG	Selects 4-reading Digital Filter.	39
AV8	AVG	Selects 8-reading Digital Filter.	39
AV16	AVG	Selects 16-reading Digital Filter.	39
CH_A	INPUT	Selects Input Channel 'A' (Precision N type).	35
CH_B	INPUT	Selects Input Channel 'B' (4mm Terminal Posts).	35
CLRMEM	ENBCAL	Enables use of CLRMEM command.	80
DCNEG	TFER	Negative DC measurement.	32
DCPOS	TFER	Positive DC measurement.	32
DCRMS	ENBCAL	Enables 'AC/DC Difference' calibration of RMS Converter.	80, 82
DCRMS	TFER	Calculates equivalent RMS value of DC measurements.	32
EXT	TRG_SRCE	Selects external triggers.	34
FILT1HZ	RMS	Selects 1Hz filter.	38
FILT10HZ	ENBCAL	Enables calibration of 10Hz filter.	80
FILT10HZ	RMS	Selects 10Hz filter.	38
FILT40HZ	RMS	Selects 40Hz filter.	38
FILT100HZ	RMS	Selects 100Hz filter.	38
FLAT	CLRMEM	Clears 'Flatness' calibration memory.	84
FLAT	ENBCAL	Enables 'Flatness' calibration.	80, 82
FREQ	ENBCAL	Enables frequency calibration of counter.	80, 82
GAIN	CLRMEM	Clears 'Gain' calibration memory.	84
GAIN	ENBCAL	Enables 'Gain' calibration.	80, 81
GAIN	MVAC	Measures gain of X30 amplifier.	30
INT	TRG_SRCE	Selects Internal Triggers.	34
LINA	CLRMEM	Clears 'Linearity' calibration memory.	84
LINA	ENBCAL	Enables 'Linearity' calibration.	80, 82
OFF	AVG	Deselects AVG operation.	39
OFF	SPOT	Deselects Spot Frequency mode.	37
OFF	TFER	Deselects AC/DC Transfer mode.	32
ON	TFER	Selects AC/DC Transfer mode when DCRMS stored.	32

# SECTION 5 SYSTEMS APPLICATION VIA THE IEEE 488 INTERFACE

## Introduction

This first part of Section 5 gives the information necessary to put the 4920 into operation on the IEEE 488 bus. As some operators will be first-time users of the bus, the text is pitched at an introductory level. For more detailed information, refer to the standard specification, which appears in the publications ANSI/IEEE Std. 488.1-1987 and IEEE Std. 488.2-1988.

## Section Contents

The section is divided so as to group certain types of information together. These divisions are:

**Interface Capability** - IEEE 488.1 subsets which are implemented in the model 4920, satisfying IEEE 488.2.

**Interconnections** - the rear panel IEEE 488 connector and its pin designations.

**Typical System** - a brief view of a typical process using the 4920 to measure the output from a programmable AC voltage source.

**Using the 4920 in a System** - addressing, remote operation and programming guidance - introduction to syntax diagrams.

**Message Exchange** - a simplified model showing how the 4920 deals with incoming and outgoing messages.

**Service Request** - why the 4920 needs the controller's attention and how it gets it.

**Retrieval of Device Status Information** - how the IEEE 488.2 model is adapted to the 4920.

**Programming Messages** - detailed descriptions of both common and device-specific commands and queries.

## Interface Capability

### IEEE Standards 488.1 and 488.2

The 4920 conforms to the Standard Specification IEEE 488.1-1987: 'IEEE Standard Digital Interface for Programmable Instrumentation', and to IEEE 488.2-1988: 'Codes, Formats, Protocols and Common Commands'.

### The 4920 In IEEE 488.2 Terminology

In IEEE 488.2 terminology the 4920 is a **device** containing a **system interface**. It can be connected to a **system** via its **system bus** and set into programmed communication with other bus-connected **devices** under the direction of a **system controller**.

### Programming Options

The instrument can be programmed via the IEEE Interface, to:

- Change its operating state (Function, Range, Filter etc).
- Transmit results of measurements, and its own status data, over the bus.
- Request service from the system controller.

### Capability Codes

To conform to the IEEE 488.1 standard specification, it is not essential for a device to encompass the full range of bus capabilities.

But for IEEE 488.2, the device must conform exactly to a specific subset of IEEE 488.1, with a minimal choice of optional capabilities.

The IEEE 488.1 document describes and codes the standard bus features, for manufacturers to give brief coded descriptions of their own interfaces' overall capability. For IEEE 488.2, this description is required to be part of the device documentation. A code string is often printed on the product itself.

The codes which apply to the 4920 are given in table 5.1, together with short descriptions. They also appear on the rear of the instrument next to the interface connector. These codes conform to the capabilities required by IEEE 488.2.

Appendix C of the IEEE 488.1 document contains a fuller description of each code.

IEEE 488.1 Subset	Interface Function
SH1	Source Handshake Capability
AH1	Acceptor Handshake Capability
T6	Talker (basic talker, serial poll, unaddressed to talk if addressed to listen)
L4	Listener (basic listener, unaddressed to listen if addressed to talk)
SR1	Service Request Capability
RL1	Remote/Local Capability (including Local Lockout)
PP0	No Parallel Poll Capability
DC1	Device Clear Capability
DT1	Device Trigger Capability
C0	No Controller Capability
E2	Open-Collector and Three-State Drivers

**Table 5.1 IEEE Interface Capability**

### Bus Addresses

When an IEEE 488 system comprises several instruments, a unique 'Address' is assigned to each to enable the controller to communicate with them individually.

Only one address is required for the 4920, as the controller adds information to it to define either 'talk' or 'listen'. The method of setting the address,

and the point at which the user-initiated address is recognized by the 4920, is detailed on *page 5-4*.

The 4920 has a single primary address, which can be set by the user to any value within the range from 0 to 30 inclusive. It cannot be made to respond to any address outside this range.

Secondary addressing is not programmed.



## Interconnections

Instruments fitted with an IEEE 488 interface communicate with each other through a standard set of interconnecting cables, as specified in the IEEE 488.1 Standard document.

The interface socket, SK7, is fitted on the rear panel. It accommodates the specified connector, whose pin designations are also standardized as shown in *Fig. 5.1* and *Table 5.2*.

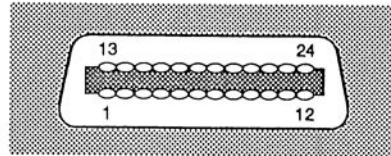

**Fig 5.1 Connector SK7 - Pin Layout**

Pin No.	Name	Description
1	DIO 1	Data Input/Output Line 1
2	DIO 2	Data Input/Output Line 2
3	DIO 3	Data Input/Output Line 3
4	DIO 4	Data Input/Output Line 4
5	EOI	End or Identify
6	DAV	Data Valid
7	NRFD	Not Ready For Data
8	NDAC	Not Data Accepted
9	IFC	Interface Clear
10	SRQ	Service Request
11	ATN	Attention
12	SHIELD	Screening on cable (connected to 4920 safety ground)
13	DIO 5	Data Input/Output Line 5
14	DIO 6	Data Input/Output Line 6
15	DIO 7	Data Input/Output Line 7
16	DIO 8	Data Input/Output Line 8
17	REN	Remote Enable
18	GND 6	Gnd wire of DAV twisted pair
19	GND 7	Gnd wire of NRFD twisted pair
20	GND 8	Gnd wire of NDAC twisted pair
21	GND 9	Gnd wire of IFC twisted pair
22	GND 10	Gnd wire of SRQ twisted pair
23	GND 11	Gnd wire of ATN twisted pair
24	GND	4920 Logic Ground (internally connected to Safety Ground)

**Table 5.2 Socket SK7 - Pin Designations**

# Using the 4920 in a System

## Addressing the 4920

### Address Recognition

With an address selected in the range 0 to 30; control may be manual, or remote as part of a system on the Bus. The address must be the same as that used in the controller program to activate the 4920. The 4920 is always aware of its stored address, responding to Talk or Listen commands from the controller at that address. When the address is changed by the user, the 4920 recognizes its new address and ignores its old address, as soon as it is stored by the user pressing the **Enter** key in the **ADDRESS** menu.

### Setting the Bus Address

The instrument address can only be set manually; using the **ADDRESS** menu, which is accessed via the **STATUS** and **STATUS CONFIG** menus.

To change the address, proceed as follows:

- Press the **Status** key to see the **STATUS** menu:



This menu defines three positions on the dot-matrix display (refer to Section 3 for details). The soft keys are deactivated, and play no part in setting the address.

- Press the **Config** key to see the **STATUS CONFIG** menu:



This menu defines five soft *menu* keys; at present we are interested only in the **Addr** key.

**Addr:** displays the **ADDRESS** menu, to review or change the IEEE-488 bus address of the instrument.

### ADDRESS Menu

- Press the **Addr** soft key to see the **ADDRESS** menu:



This menu permits entry of a value to be used as an IEEE-488 bus address. Initially, the menu displays the present address value (in the position shown above by **XX**), and the numeric-keyboard keys are activated. Any valid numeric value (0-30) may be entered, an invalid address resulting in the display message '1007: data entry error'.

Pressing **Enter** stores the new value (or restores the old value if unchanged), but pressing **Quit** leaves the old value intact. Either **Enter** or **Quit** causes exit back to the **STATUS CONFIG** menu, then press any required function key to escape.

## Remote Operation

### General

When the 4920 is operating under the direction of the controller, the legend *rem* appears on the Main display, and all front panel controls are disabled except Power and Local.

The power-up sequence is performed as for manual operation. The 4920 can be programmed to generate an SRQ at power-up, also preparing a status response for transmission to the controller when interrogated by a subsequent serial poll.

### Transfer to Local Operation (GTL)

The 4920 can be switched into 'Local' operation (by Command GTL), permitting a user to take manual control from the front panel. The system controller regains 'Remote' control by sending the overriding command:

*Listen Address* with *REN* true

The controller addresses the 4920 as a listener with the Remote Enable management line true (Low). This returns the 4920 from local to remote control.

### 'Device Clear'

Either of the commands *DCL* or *SDC* will force the following instrument states:

- all IEEE 488 input and output buffers cleared;
- parser reset to the beginning of a message;
- any device-dependent message bus holdoffs cleared.

These commands **will not**:

- change any settings or stored data within the device except as listed above;
- interrupt analog input;
- interrupt or affect any functions of the device not associated with the IEEE 488 system;
- change the status byte.

### Levels of Reset

Three levels of reset are defined for IEEE 488.2 controllers, a complete system reset being accomplished by resetting at all three levels, in order, to every device. In other circumstances they may be used individually or in combination:

- IFC** Bus initialization;
- DCL** Message exchange initialization;
- \*RST** Device initialization.

The effects of the \*RST command are described on page 5-76.

## Programming Guidance

### Programming Elements

The 4920 operates within the syntax demands of IEEE 488.2. To alter its configuration, elicit information etc., it requires to be sent an address code followed by commands or queries.

The smallest program element capable of activation is called a 'program message unit' (*pmu*), which must conform to a standard structure (detailed later in this section). One *pmu* can be sent on its own, followed by a recognized 'terminator'; in which case it is known as a 'program message'. Several formally-complete *pmus* can be concatenated together, using semi-colons as separators, to form a program message. All program messages must be correctly terminated.

### Activation

The 4920 cannot activate any commands or queries until it receives a message unit separator (;) or a correct message terminator.

The message terminator for the 4920 is the Hex number 0A, characterized in IEEE 488.2 as 'NL'. Alternatively, the 'End or Identify' (EOI) line can be set true with the last byte to be sent; this is represented on the syntax diagram by /<sup>^</sup>END/.

To assist in eliminating incorrect commands or queries, the 4920 checks for errors in the message, and can generate a service request (SRQ) if a syntax error occurs. To ensure that a prohibited state is not set up, it also checks each program message unit for validity. If it finds any errors in this phase, the message unit is ignored.

For Example: Attempting to transfer directly from ACV to mV function, using the *pmu*: MVAC 100, will generate an execution error and the whole message unit will be discarded.

### Conformance to IEEE 488.2

IEEE 488.2 defines sets of Mandatory and Optional Common Commands/Queries along with a standard method of Status Reporting. The 4920 conforms with all Mandatory Commands/Queries but not all the Options, and uses the defined Status Reporting method.

Note: Commands prefaced by asterisk, eg \*TRG, are standard-defined 'Common' commands.

In addition to these Common Commands, the 4920 has a set of Device-Dependent Commands, defined by Datron to program the instrument into its various functions and ranges. IEEE 488.2 defines how these commands should be linked or separated (ie the syntax is defined). These device-dependent commands have been designed to be self-explanatory, while conforming to the standard-defined syntax.

The IEEE 488.2 also requires certain 'Device Documentation' to be supplied by the manufacturer of the device. The necessary data for the 4920 is included within the text of this section, and indexed by Appendix A at the back of the section.

### Command Formation

The following paragraphs describe the types of command that are used to program the 4920.

A command (or 'Program Message Unit') can merely comprise a simple alphabetic code. But if there are alternative ways of programming within a command, this is signified by using a 'Command Program Header', followed by the appropriate 'Program Message Elements'.

An example of a simple command is the query 'FREQ?', which recalls the frequency of the most-recent reading.

An example of a more complex command is:

'MVAC GAIN'

which will program the instrument to Millivolt function, and measure the gain of the X30 amplifier with a 100mV input. In this example, MVAC is the Command Program Header, while GAIN is a Program Message Element.

### 'Forgiving Listening'

IEEE 488.2 closely specifies the format of messages to be transmitted by a conforming 'talker' device. This imposes consistencies which make clear the exact meaning of any message received from the device.

Conversely, a conforming 'listener' device should be able to interpret a variety of received messages, which may have been originated by different types of controller. By limiting the language to the commonly-used ASCII character set, this condition is partly met. But within the ASCII set, the IEEE 488.2 also insists that certain characters be used only as command symbols to separate and specify the elements of concatenated strings, and for no other purpose:

- A succession of Message Units making up a complete Program Message must each be separated by a semi-colon (;).
- A Program Header is separated from its Message Elements by 'white space' - (i.e one or more non-printing ASCII characters in the ranges Hex 00 to 09 and 0B to 20) - denoted here by {phs} - Program Header Separator.
- Successive Message Elements of a Message Unit are each separated by a comma (,).

- In numeric data strings, all variants of a particular family of numeric representations (Nrf) are acceptable.
- No differentiation is made between upper and lower case characters.
- Program Messages may be terminated by a Line Feed - (ie the ASCII character at Hex 0A) - denoted by {NL} (Newline), or by EOI true with the last byte, or both.

An example of a complete Program Message could be:

```
ACV{phs}10;avG{phs}AV16;RmS{phs}Filt10hz;
*TrG{NL}
```

Unfortunately, most of this message appears visually as a cramped string of characters. This can be confusing to read when printed, because of the lack of spaces between the various elements. So IEEE 488.2 also permits optional 'white space' to be inserted within a string to improve its visual intelligibility, providing certain rules are followed:

- The 'white space' characters must be as defined earlier for the Program Header Separator.
- White space can be inserted *before* a Program Message Separator (;).
- White space can be inserted *before and/or after* a Program Message Element Separator (,).
- White space can be inserted *before and/or after* an Exponent Symbol (E) in a numeric string.

These rules are programmed into the 4920, to ensure that it does not reject received commands or data which obey these rules, thus giving it the nature of a 'Forgiving Listener'.

### IEEE 488.2 Syntax Diagrams

To standardize the approach to programming, the IEEE 488.2 Standard has introduced a form of 'Syntax Diagram', in which the possible command formation for particular messages can be given. The IEEE 488.2 syntax has been adhered to, so in the following descriptions of device-dependent commands, we have adopted the standard syntax diagram, with modified style to fit this handbook. A word of explanation about the notation is needed, and the diagrams are defined, although they are virtually self-explanatory.

#### Notation

- Syntactic elements are connected by lines with directional symbols to indicate the flow, which generally proceeds from left to right.
- Repeatable elements have a right-to-left reverse path shown above and around them, which can also contain a separator such as a comma. As far as possible, the commands for the 4920 have been simplified to avoid reverse paths.
- When it is possible to bypass elements, a left-to-right path is shown below and around them.
- When there is a choice of elements, the path branches to the choices.

The example program message:

```
ACV{phs}10;avG{phs}AV16;RmS{phs}Fllt10hz;
*TrG{NL}
```

mentioned earlier, is a syntactic string derived from the ACV, AVG, RMS and \*TRG commands, which appear in the range of diagrams described below. Note that 'phs' means 'program header separator', one or more white-space characters as mentioned earlier.

5-8

### Syntax Diagrams In this Handbook

The following paragraphs describe the syntax diagrams used in this handbook. Some repetition of earlier matter is inevitable, but at this point we are more concerned with the syntax diagrams.

#### Hierarchy of Syntactic Elements

All messages are subject to the protocols of addressing and handshake defined in the IEEE 488.1 Standard document. Within these protocols, messages are characterized by the presence of terminators, each of which seals the set of syntactic elements sent since the previous terminator to form a 'Program Message'.

#### The Program Message

Each Program Message may consist of only one syntactic element plus its terminator, or may be subdivided into many 'Program Message Units', separated by semi-colons (;) which are known as 'Program Message Unit Separators'. Thus the semi-colon cannot be used for any other purpose.

As you can see from the diagram, multiple Program Message Units can be sent if they are separated using semi-colons (shown in the repeat path). The block named 'Program Message Unit' therefore represents **either** repeats of the same unit, **or** a set of different units, **or** a mixture of both. The starting circle is a device used only for the diagram; there is no requirement to use a special character to start a message, providing the previous message was correctly terminated. It is possible to send only the terminator as a complete Program Message (as shown by the forward bypass path), but this feature has little use when programming the 4920.

## Syntax Diagram of a Simple Program Message

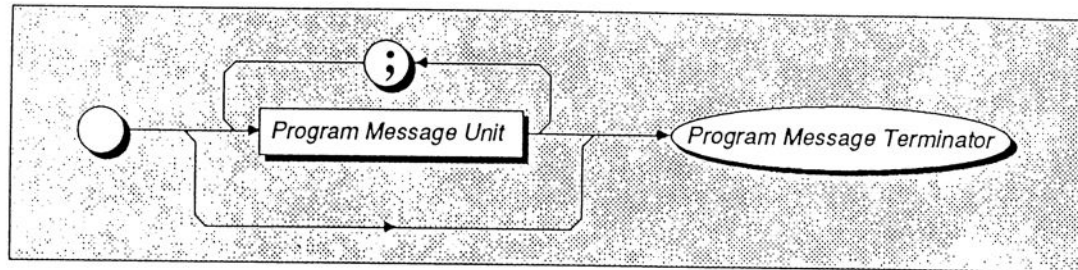
**Character Usage**

Notice that the names of some elements are shown here in italics. This agrees with the convention used on the syntax diagrams in this handbook, which sets 'non-literal' text (names given to particular elements) in italics, whereas 'literal' text (the actual characters to be sent, such as the semi-colon in the diagram) is shown in plain-text capitals.

**Upper/Lower Case Equivalence**

The plain-text capitals are not demanded by the standard, and the 4920 will not differentiate between upper and lower case characters in literal program text. Either or both can be used, mixed upper and lower case if this conveys an advantage.

**Numeric Representation**

Several commands and queries used for the 4920 require transmission and reception of numbers. Decimal formats are generally used.

The IEEE 488.2 document specifies formats which ensure that a device is 'forgiving' when receiving program or query commands, but 'precise' when transmitting responses to queries.

For program data it insists that a device must accept the decimal 'Flexible Numeric Representation (*Nrf*)', which is a flexible version of three numeric representations (*Nr1*, *Nr2* and *Nr3*) defined by ANSI X3.42-1975 [2]. The 4920 complies.

Decimal numeric response data from the 4920 employs either *Nr1* or *Nr3* format, usage depending on the particular response. In this handbook, all syntax diagrams for query messages are accompanied by a paragraph which indicates the response format. Users are left in no doubt as to the construction of the response.

**The Program Message Unit**

Program Message Units (PMUs) can be 'Terminal' or 'Non-terminal'. The final PMU in any Program Message is always Terminal (includes the terminator), whereas all preceding PMUs within

the Program Message are obviously Non-terminal. Most of the commands in this handbook are described in the form of non-terminal message units:

**Non-Terminal Program Message Unit**

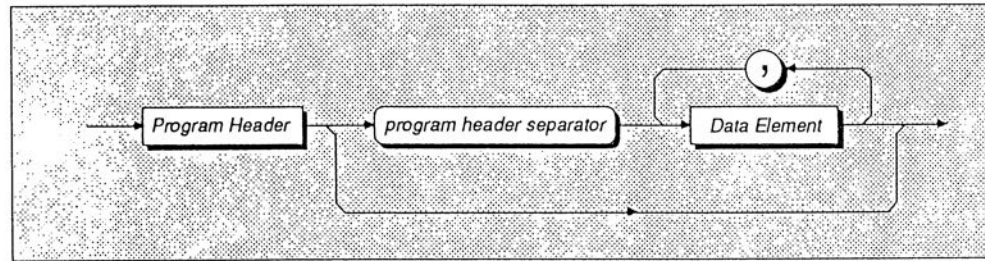

To save space, the name 'program header separator' is abbreviated to 'phs'.

**Use of phs**

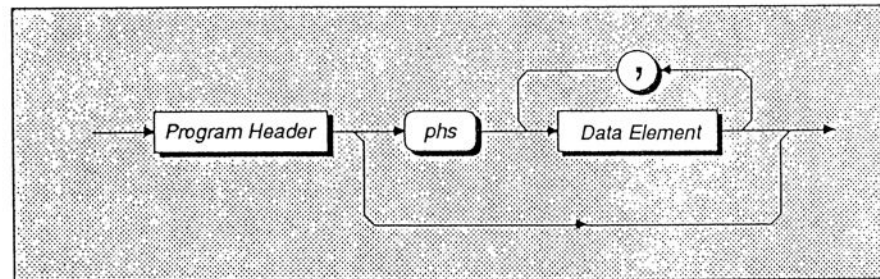

**The Command Program Header**

Several versions are defined by the IEEE 488.2 Standard document. The 'Simple', 'Common' and 'Query' headers are designed into the 4920, but not 'Compound' headers.

The asterisk (Common) and question mark (Query) are defined separately by the standard document, but as they are inseparable from the command, they are shown on the 4920 syntax diagrams in the same block as the program mnemonic (abbreviated

format). For example: the command for Operational Selftest (\*TST?) is shown in abbreviated, rather than full format.

**Common Query - Abbreviated Format .**

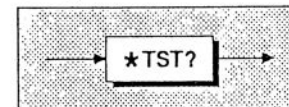



**Program Data Elements**

Four versions of the defined program data elements are employed. They are emphasized in the following syntax diagrams, which are examples from the list of commands available for the 4920:

Character

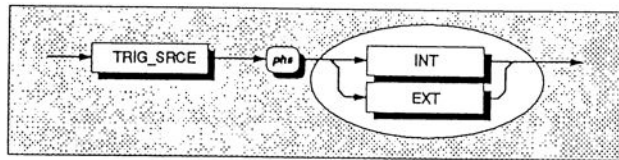

Decimal Numeric



(*Nrf* can be expressed in any of the ways defined by the Standard document)

String

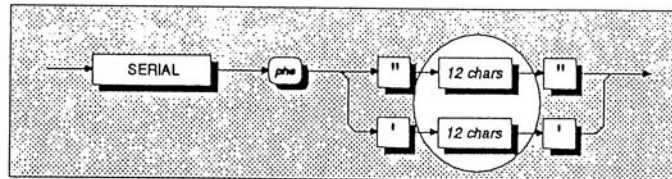

(The string size is defined)

**Arbitrary Block Data Elements**

Both the 'Definite' and 'Indefinite' forms specified in the Standard document are used, as shown in the Syntax diagram below. The *user message* must be limited to a maximum of 63 bytes.

program message must be terminated to inform the instrument that the block is complete.

The definite form can be fitted into a string of message units, but the indefinite form (lower path) has no exit to further message units. In this case the

Note that the slash-delimited /<sup>^</sup>END/ box is not outlined. This is to draw attention to the fact that it is not a data element, but represents the EOI line being set true with the last byte 'NL' to terminate the program message.

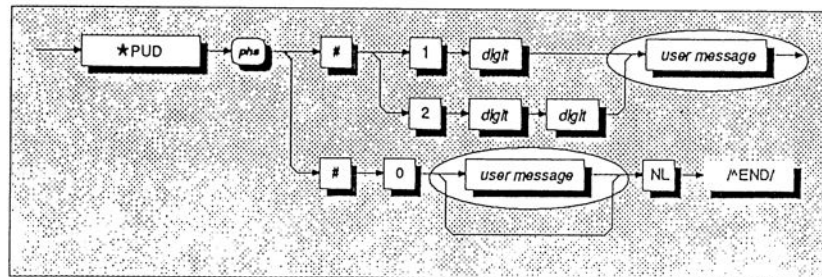

## Message Exchange

### IEEE 488.1 Model

The 4920 conforms to the requirements of the IEEE 488.1 Standard, in respect of the interactions between its device system interface and the system bus. Its conformance is described by the interface

capability codes listed in *Table 5.1* on page 5-2. In addition, the 4920 is adapted to the protocols described by the IEEE 488.2 model, as defined in that standard's specification.

### IEEE 488.2 Model

The IEEE 488.2 Standard document illustrates its Message Exchange Control Interface model at the detail level required by the device designer. Much of the information at this level of interpretation (such as the details of the internal signal paths etc.) is transparent to the application programmer.

However, because each of the types of errors flagged in the Event Status Register are related to a particular stage in the process, a simplified 4920 interface model can provide helpful background. This is shown in *Fig. 5.2* opposite, with brief descriptions of the actions of its functional blocks.

### 4920 Message Exchange Model

**Input/Output Control** transfers messages from the 4920 output queue to the system bus; and conversely from the bus to either the input buffer, or other predetermined destinations within the device interface. Its interaction with the controller, via the system bus, is subject to the IEEE 488.1 management and handshake protocol. It receives

the Status Byte from the status reporting system, as well as the state of the request service bit which it imposes on bit 6 of the Status Byte (ultimately on bus line DIO 7) in the event of a serial poll. Bit 6 reflects the 'Request Service state *true*' condition of the interface.

### Incoming Commands and Queries

The **Input Buffer** is a first in - first out queue, which has a maximum capacity of 128 bytes (characters). Each incoming character in the I/O Control generates an interrupt to the instrument processor which places it in the Input Buffer for examination by the Parser. The characters are removed from the buffer and translated with appropriate levels of syntax checking. If the rate of programming is too fast for the Parser or Execution Control, the buffer will progressively fill up. When the buffer is full, the handshake is held.

The **Parser** checks each incoming character and its message context for correct Standard-defined generic syntax, and correct device-defined syntax. Offending syntax is reported as a **Command Error**, by setting *true* bit 5 (CME) of the Standard-defined Event Status register (refer to the sub-section 'Retrieval of Device Status Information').

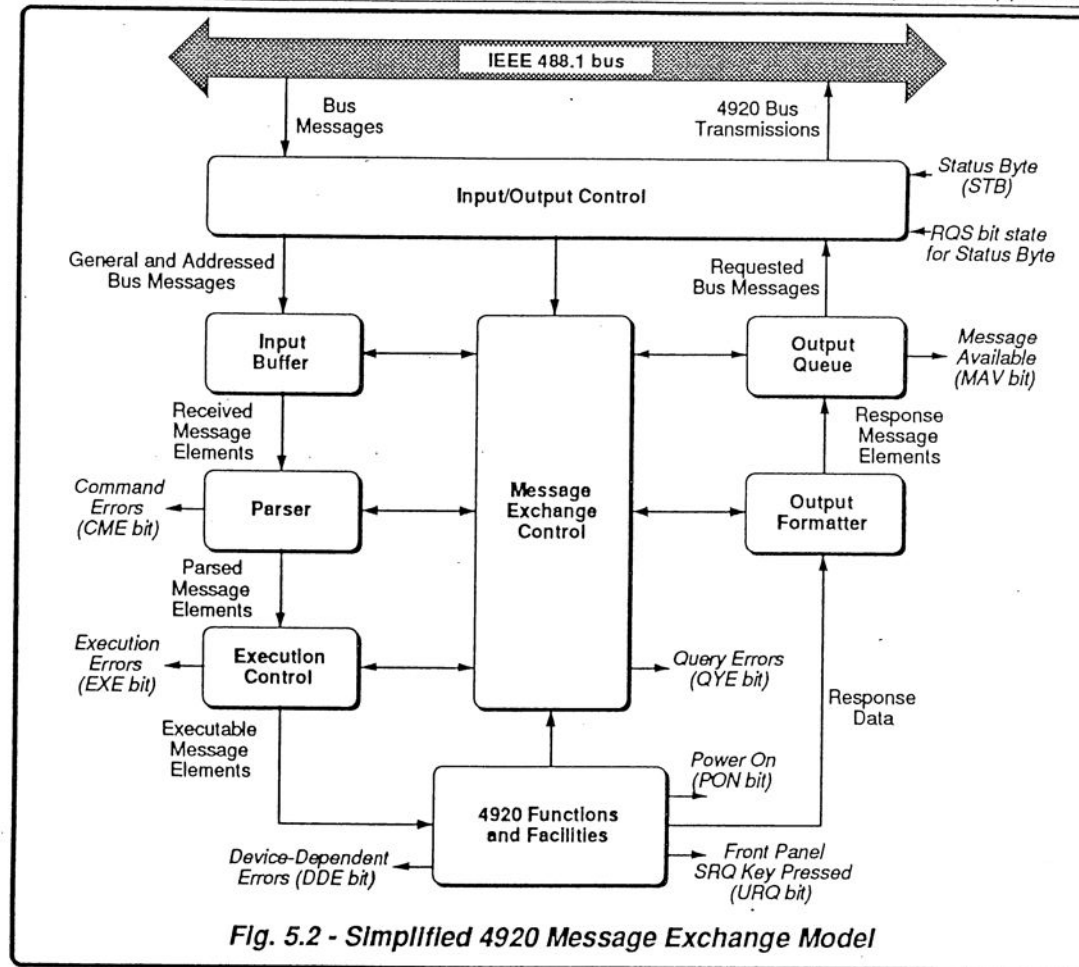

Fig. 5.2 - Simplified 4920 Message Exchange Model

Execution Control receives successfully parsed messages, and assesses whether they can be executed, given the currently-programmed state of the 4920 functions and facilities. If a message is not viable (eg the selftest common query: \*TST? when calibration is successfully enabled); then an Execution Error is reported, by setting true bit 4 (EXE) of the Standard-defined Event Status register, and placing an error description number in

a queue associated with the EXE bit. Viable messages are executed in order; altering the 4920 functions, facilities etc. Execution does not 'overlap' commands; instead, the 4920 Execution Control processes all commands 'Sequentially' (ie. waits for actions resulting from the previous command to complete before executing the next).

### 4920 Functions and Facilities

The 4920 Functions and Facilities block contains all the device-specific functions and features of the 4920, accepting Executable Message Elements from Execution Control and performing the associated operations. It responds to any of the elements which are valid Query Requests (both IEEE 488.2 Common Query Commands and 4920 Device-specific Command Queries) by sending any required Response Data to the Response Formatter (after carrying out the assigned internal operations).

**Device-dependent** errors are detected in this block. Bit 3 (DDE) of the Standard-defined Event Status register is set true when an internal operating fault is detected, for instance during a self test. Each reportable error has a listed number, which is appended to an associated queue as the error occurs.

This block also originates a local power-on message by the action of the 4920 line power being applied. Bit 7 (PON) of the Standard-defined Event Status register is set true when the instrument power transits from off to on (refer to the subsection 'Retrieval of Device Status Information').

The front-panel **SRQ** key allows users to initiate an SRQ (providing the appropriate status register bits are enabled). Bit 6 (URQ) of the Standard-defined Event Status register is set true when the key is pressed, and set to false by reading the Event Status register or if the registers are cleared by \*CLS.

### Trigger Control

Two types of message are used to trigger the 4920 A-D into taking a measurement:

- GET (IEEE 488.1-defined)
- \*TRG (IEEE 488.2-defined)

In the 4920 both GET and \*TRG messages are passed through the Input Buffer, receiving the same treatment as program message units, being parsed and executed as normal.

### Outgoing Responses

The **Response Formatter** derives its information from Response Data (being supplied by the Functions and Facilities block) and valid Query Requests. From these it builds Response Message Elements, which are placed as a Response Message into the Output Queue.

The **Output Queue** acts as a store for outgoing messages until they are read over the system bus by the Controller. For as long as the output queue holds one or more bytes, it reports the fact by setting *true* bit 4 (Message Available - MAV) of the Status Byte register. Bit 4 is set *false* when the output queue is empty (refer to the sub-section 'Retrieval of Device Status Information').

### 'Query Error'

This is an indication that the controller is following an inappropriate message exchange protocol, resulting in the following situations:

- **Interrupted Action.** When the 4920 has not finished outputting its **Response Message** to a **Program Query**, and is interrupted by a new **Program Message**.
- **Unterminated Action.** When the controller attempts to read a **Response Message** from the 4920 without having first sent the complete **Query Message** (including the **Program Message Terminator**) to the instrument.

The Standard document defines the 4920's response, part of which is to set *true* bit 2 (QYE) of the Standard-defined Event Status register.

## Service Request (SRQ)

### IEEE 488.1 Model

The IEEE 488.1 model provides for a separate line (SRQ line) on the system bus, to be set true (Low) by the device to request service of the controller. The model defines the subsequent action by the controller, and in the 4920 the serial poll facility has been incorporated.

The controller polls each device on the system bus in sequence, reading a 'Status Byte' onto DIO lines 8-1, whereby the bit on the DIO 7 line (Request Service bit) indicates whether that device was the originator of the request for service.

### Reasons for Requesting Service

There are two main reasons for the 4920 to request service from the controller:

- When the 4920 message exchange interface discovers a system programming error;
- When the 4920 is programmed to report significant events by SRQ.

The significant events vary between types of devices; thus there is a class of events which are known as 'Device-Specific'. These are determined by the device designer and included in the device operating program.

### IEEE 488.2 Model

The application programmer can enable or disable the event(s) which are required to originate an SRQ at particular stages of the application program. The IEEE 488.2 model incorporates a flexible extended status reporting structure in which the requirements of the device designer and application programmer are both met.

This structure is described in the next sub-section, dealing with 'Retrieval of Device Status Information'. As SRQ provision is integral to the structure, the description of the implementation of SRQ features is covered in that sub-section rather than in this.

## **Retrieval of Device Status Information**

### **Introduction**

For any remotely-operated system, the provision of up-to-date information about the performance of the system is of major importance. This is particularly so in the case of systems which operate under automatic control, as the controller requires the necessary information feedback to enable it to progress the programmed task, and any break in the continuity of the process can have serious results.

When developing an application program, the programmer needs to test and revise it, knowing its effects. Confidence that the program elements are couched in the correct grammar and syntax (and that the program commands and queries are thus being accepted and acted upon), helps to reduce the number of iterations needed to confirm and develop the viability of the whole program. So any assistance which can be given in closing the information loop must benefit both program compilation and subsequent use.

### **The 4920 Status Reporting Structure**

In a closely-specified Standard such as the IEEE 488.2, we should expect to find a well-defined and comprehensive status reporting facility, and this is indeed the case. Not only does the Standard establish regular methods of retrieving the information, but it also provides the means for the device designer to build a status-reporting structure which is pertinent to the nature of the device. Within this structure the application programmer is then given a wide choice to decide on the sort of information required at each stage in the program.

Note: The registers have binary weightings - the numbers in the boxes are bit numbers, not weighted values.

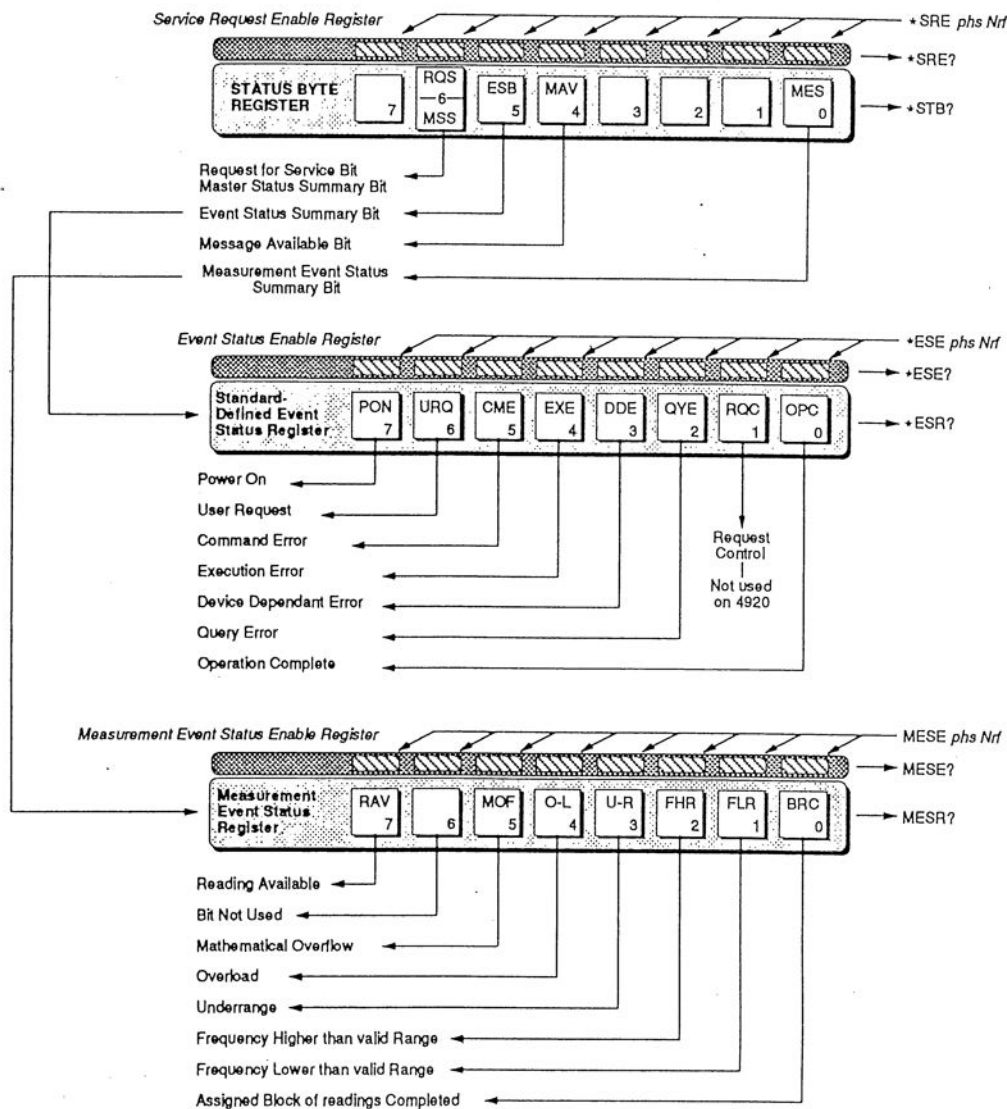

Fig. 5.3 - 4920 Status Reporting Structure



**Standard-Defined and Device-Specific Features**

In the 4920, the structure has been developed into three main registers (Fig. 5.3), as follows:

- **The 'Status Byte Register'**  
contains the 'Status Byte', which summarizes the remainder of the structure. Bits 6-4 are Standard-defined, but bits 3-0 and 7 are provided for the device designer to define.
- **The 'Event Status Register'**  
Defined by the standard, contains the 'Event Status Byte', whose component bits report Standard-defined types of events. This register is summarized by the 'ESB' bit 5 in the Status Byte.
- **The 'Measurement Event Status Register'**  
Up to five Device-Specific Event Status Registers or queues can be defined by the device designer; in this case only one register is defined, for the 'Measurement Event Status Byte', whose component bits are device-specific (ie. to the 4920). It is summarized by the 'MES' bit 0 in the Status Byte.

Although the Event Status Byte bits are defined by the Standard, they are permitted to summarize device-specific events (eg. EXE is associated with a list of execution errors related to the 4920 programmed condition, and DDE is associated with a list of device-dependent errors related to 4920 internal faults). These extensions, with the structures based on bits 3-0 and 7 of the Status Byte, allow the device designer a wide latitude to match status reporting to the requirements of the device.

**Access via the Application Program**

The application designer has access to three enable registers (one for each main register - Fig. 5.3). The application program can enable or disable any individual bit in these registers.

Each bit in the two event status bytes remains in *false* condition unless its assigned event occurs, when its condition changes to *true*. If an event is to be reported, its corresponding bit in the enable byte will already have been set *true* by the application program, using the number *Nrf* (defined as a decimal numeric from 0 to 255 in any common format). Then when this event occurs and changes its event bit from *false* to *true*, the appropriate summary bit in the Status Byte (ESB or MES) is also set *true*. If this summary bit is also enabled, then the 4920 will generate an SRQ by causing the SRQ line on the system bus to be set *true* (low).

Thus the application programmer can decide which assigned events will generate an SRQ, by enabling their event bits and then enabling the appropriate summary bit(s) in the Status Byte. The controller can be programmed to read the Status Byte during a resulting serial poll, and be directed to the appropriate Event Register to discover which event was responsible for originating the SRQ.

The Status Byte is the only one of the six which can be read *bitwise* on to the DIO lines of the system bus, and then only by a serial poll to which special conditions are attached. Each byte can be read by a suitable query (\*STB?, \*ESR? or MESR? for the status and event bytes; \*SRE?, \*ESE?, or MESE? for the enable bytes) and will be presented as an ASCII decimal numeric, which when rounded and expressed in binary, represents the bit pattern in the register. This numeric form is also used to set the enabling registers to the required bit-patterns. The detail of the data in each byte is explained in the following paragraphs, and in the command descriptions.

**Types of Status Information Available**

Three main categories of information are provided for the controller:

**Status Summary Information**

Contained within the 'Status Register', the 'Status Byte' (STB) consists of flag bits which direct the controller's attention to the type of event which has

occurred. Four bits are employed in the 4920; these are described in detail later, but two ('ESB' and 'MES') appear in the following paragraphs.

**Standard-defined events:**

- Power On - the instrument line power has been switched on and the associated operational selftest has been completed successfully.
- User Request - the 'SRQ' key on the front panel has been pressed.
- Command Error - a received bus command does not satisfy the syntax rules programmed into the instrument interface's parser, and so is not recognized as a valid command.
- Execution Error - a received command has been successfully parsed, but it cannot be executed owing to the currently-programmed condition of the instrument.
- Device-Dependent Error - a reportable internal operating fault has been detected. This may be failure of a self-test.
- Query Error - the controller is following an inappropriate message exchange protocol, in attempting to read data from the output queue.
- Request Control - provided for devices which are able to assume the role of controller. This capability is not available in the 4920.
- Operation Complete - initiated by a message from the controller, indicates that the 4920 has completed all selected pending operations.

These events are flagged in the 8-bit latched 'Event Status Register' (ESR), read-accessible to the controller. The user's application program can also access its associated enabling register, to program the events which will be eligible to activate the ESB summary bit in the Status Byte.

**Measurement events:**

- When the instrument has been commanded to take a reading; the reading has been taken and is available to be read.
- Mathematical Overflow
- Overload
- Underrange
- Input frequency higher than the valid range
- Input frequency lower than the valid range
- Assigned block of readings completed

These events are flagged in another 8-bit latched register, called the 'Measurement Event Status Register' (MESR), which is read-accessible to the controller. The user's application program can also access its associated enabling register, to program the events which will be eligible to activate the MES summary bit in the Status Byte.

**A Note about Queues**

Some of the event bits are summaries of queues of events. These are 'historical' (Last In - Last Out) stacks to aid diagnosis of errors, and when the queue stack is full the eldest entries are discarded.

It is good practice to program the application to read the queue as soon as its summary bit is set true, particularly the error bits, otherwise the original cause of the error can be discarded as subsequent dependent errors fill up the stack.

## 4920 Status Reporting - Detail

### IEEE 488.1 Model

Provides for two major forms of status reporting:

- Device-specific commands from the controller, to generate status responses which have been previously programmed into the device to represent specific device conditions.
- Serial-polling of devices on the bus following a Service Request (the device pulling the SRQ line *true*).

The device anticipates that the controller will conduct a serial poll of devices on the bus as a result of the SRQ. So as it issues the SRQ, it sets up a 'Status Byte' for the controller to read.

If the controller is programmed to conduct a serial poll to identify the source of the SRQ, and subsequently read the 'Status Byte', the number represented by the byte can be interpreted as an event message. Such numbers are previously coded into the device's firmware to represent specific device conditions, and application programmers are thus able to program alarms or other actions to occur when such messages are received by the controller.

### IEEE 488.2 Model

This incorporates the two aspects of the IEEE 488.1 model into an extended structure with more definite rules. These rules invoke the use of standard 'Common' messages and provide for device-dependent messages. A feature of the structure is the use of 'Event' registers, each with its own enabling register as illustrated in *Fig. 5.3*.

### 4920 Model Structure

The IEEE 488.2 Standard provides for a more extensive hierarchical structure with the Status Byte at the apex, defining its bits 4, 5 and 6 and their use as summaries of a *Standard*-defined event structure which **must** be included, if the device is to claim conformance with the Standard. The 4920 employs these bits as defined in the Standard.

Bits 0, 1, 2 and 3 and 7 of the Status Byte are made available to the device designer, to act as summaries of *device*-specific events. In the 4920, only bit 0 is necessary in order to summarize its device-specific events.

It must be recognized by the application programmer that whenever the controller reads the Status Byte, it can only receive summaries of types of events, and further query messages are necessary to dig deeper into the detailed information relating to the events themselves.

Thus two further bytes are used to expand on the summaries at bits 0 and 5 of the Status Byte.

**Status Byte Register**

In this structure the Status Byte is held in the 'Status Byte Register'; the bits being allocated as follows:

**Bit 0 (DIO1)** Device-specific Measurement Event Summary Bit (MES)

This summarizes the byte held in a Device-defined 'Measurement Event Status Register' (MESR), whose bits represent reportable conditions in the device. In the 4920 these are overload, math overflow, reading available, underrange, input frequency outside the valid range, and assigned block of readings completed. The MES bit is *true* when the byte in the MESR contains one or more enabled bits which are *true*; or *false* when all the enabled bits in the byte are *false*. The Measurement Event Status Register, its enabling register and byte are described later.

**Bits 1 (DIO2), 2 (DIO3) and 3 (DIO4)** are not used in the 4920 status byte. They are always *false*.

**Bit 4 (DIO5)** IEEE 488.2-defined Message Available Bit (MAV)

The MAV bit helps to synchronize information exchange with the controller. It is *true* when the 4920 message exchange interface is ready to accept a request from the controller to start outputting bytes from the Output Queue; or *false* when the Output Queue is empty.

The common command \*CLS can clear the Output Queue, and the MAV bit 4 of the Status Byte Register; providing it is sent immediately following a 'Program Message Terminator'.

**Bit 5 (DIO6)** IEEE 488.2-defined Standard Event Summary Bit (ESB)

This summarizes the state of the 'Event Status byte', held in the 'Event Status register' (ESR), whose bits represent IEEE 488.2-defined conditions in the device. The ESB bit is *true* when the byte in the ESR contains one or more enabled bits which are *true*; or *false* when all the enabled bits in the byte are *false*. The byte, the Event Status Register and its enabling register are defined by the IEEE 488.1 Standard; they are described later.

**Bit 6 (DIO7)** This bit has a dual purpose:

When the controller is conducting a serial poll (as a result of receiving a Service Request via the SRQ line), the 4920 is placed into 'serial poll active state' and bit 6 is the Request Service Message (RQS bit). If the 4920 had been the device which originated the SRQ, its output control will set the DIO 7 line (bit 6's channel) *true*, but if not, then DIO 7 is set *false*. By reading the Status Byte *bitwise*, the controller identifies the device which originated the SRQ; and in the case of it being the 4920, also receives any enabled summary bits to allow further investigation of the originating event.

If the controller reads the Status Byte using the common query \*STB?, then bit 6 is the Master Status Summary Message (MSS bit), and is set *true* if one of the bits 0 to 4 or bit 5 is *true* (bits 1 to 3 are always *false* in the 4920).

**Bit 7 (DIO8)** is not used in the 4920 status byte. It is always *false*.

**Reading the Status Byte Register**

There are two ways of reading the Status Byte register: by serial poll or by common query \*STB?

**Serial Poll**

When the controller conducts a serial poll, the 4920 is placed into 'serial poll active state' by the IEEE 488.1 command SPE, and is addressed as a talker. The enabled contents of the Status Byte register are transferred in binary form into the 4920 I/O control, which sets the RQS bit 6 *true* if the 4920 had originated the preceding SRQ, or *false* if it had not. The binary values of bits 1, 2, 3 and 7 are always zero. The resulting byte is placed in binary onto the system bus on the corresponding DIO 8-1 lines. When the serial poll is disabled by the command SPD, the 4920 enters 'serial poll inactive state', and the I/O control relinquishes control of RQS bit 6 on the DIO 7 line.

**\*STB?**

The common query: \*STB? reads the binary number in the Status Byte register. The response is in the form of a decimal number which is the sum of the binary weighted values in the enabled bits of the register. In the 4920, the binary-weighted values of bits 1, 2, 3 and 7 are always zero. The query \*STB? is provided mainly for controllers with no serial poll capability, and for those users who are using the device interface for RS232-type communication.

**Service Request Enable Register**

The SRE register is a means for the application program to select those types of events which are to cause the 4920 to originate an SRQ, by enabling individual Status Byte summary bits. The register contains a user-modifiable image of the Status Byte, whereby each *true* bit acts to enable its corresponding bit in the Status Byte.

**Bit Selector: \*SRE *phs Nrf***

The program command: \*SRE *phs Nrf* performs the selection, where *Nrf* is a decimal numeric, which when decoded into binary produces the required bit-pattern in the enabling byte.

**For example:**

If an SRQ is required only when a Standard-defined event occurs and when a message is available in the output queue, then *Nrf* should be set to 48. The binary decode is 00110000 so bit 4 or bit 5, when *true*, will generate an SRQ; but even when bit 0 or bit 6 is *true*, no SRQ will result. The 4920 always sets the Status Byte bits 1, 2, 3 and 7 *false*, so they can never originate an SRQ whether enabled or not.

**Reading the Service Request Enable Register**

The common query: \*SRE? reads the binary number in the SRE register. The response is in the form of a decimal number which is the sum of the binary-weighted values in the register. The binary-weighted values of bits 1, 2, 3 and 7 are always zero.

## IEEE 488.2-defined Event Status Register

The 'Event Status Register' holds the Event Status Byte, consisting of event bits, each of which directs attention to particular information. All bits are 'sticky'; ie. once *true*, cannot return to *false* until the register is cleared. This occurs automatically when it is read by the query: \*ESR?. The common command \*CLS clears the Event Status Register and associated error queues, but not the Event Status Enable Register. The bits are named in mnemonic form as follows:

**Bit 0** Operation Complete (OPC)

This bit is *true* only if \*OPC has been programmed and all selected pending operations are complete. As the 4920 operates in serial mode, its usefulness is limited to registering the completion of long operations, such as self-test.

**Bit 1** Request Control (RQC)

This bit would be *true* if the device was able to assume the role of controller, and was requesting that control be transferred to it from the current controller. This capability is not available in the 4920, so bit 1 is always *false*.

**Bit 2** Query Error (QYE)

QYE *true* indicates that an attempt is being made to read data from the output queue when no output is present or pending, or data in the output queue has been lost. The Standard document defines the conditions under which a query error is generated, as a result of the controller failing to follow the message exchange protocol.

**Bit 3** Device Dependent Error (DDE)

DDE is set *true* when an internal operating fault is detected, for instance during a self test. Each reportable error has been given a listed number,

which is appended to an associated queue as the error occurs. The queue is read destructively as a First In Last Out stack, using the query command DDQ? to obtain a code number. The DDE bit is not a summary of the contents of the queue, but is set or confirmed *true* concurrent with each error as it occurs; and once cleared by \*ESR? will remain *false* until another error occurs. The query DDQ? can be used to read all the errors in the queue until it is empty, when the code number zero will be returned.

The common command \*CLS clears the queue.

**Bit 4** Execution Error (EXE)

An execution error is generated if the received command cannot be executed, owing to the device state or the command parameter being out of bounds. Each reportable execution error has been given a listed number, which is appended to an associated queue as the error occurs. The queue is read destructively as a First In Last Out stack, using the query command EXQ?. The EXE bit is not a summary of the contents of the queue, but is asserted *true* as each error occurs; and once cleared by \*ESR? will remain *false* until another error occurs. The query EXQ? can be used to read all the errors in the queue until it is empty, when the code number zero will be returned.

The common command \*CLS clears the queue.

**Bit 5** Command Error (CME)

CME occurs when a received bus command does not satisfy the IEEE 488.2 generic syntax or the device command syntax programmed into the instrument interface's parser, and so is not recognized as a valid command. Command errors do not have an associated queue.

**Bit 6 User Request (URQ)**

This bit is set *true* by the action of pressing the front panel SRQ key. If the URQ bit and the ESB bit are enabled, an SRQ is generated and the SRQ legend on the main display lights. During a subsequent serial poll the controller reads the Status Byte, the RQS bit in the I/O control is destroyed, and the front panel legend is extinguished. The ESB and URQ bits remain *true*, returning to *false* when the controller destructively reads the Event Status register by \*ESR?, or clears status by \*CLS.

**Bit 7 4920 Power Supply On (PON)**

This bit is set *true* only when the Line Power has just been switched on to the 4920, and the subsequent Operational Selftest has been completed successfully (if unsuccessful, the DDE bit 3 is set *true*, generating an SRQ if its enable bit is also set *true*). Whether this generates an SRQ or not is dependent on the decimal numeric value previously programmed as part of the 'Power On Status Clear' message \*PSC *phs Nrf*. If *Nrf* was 1, the Event Status Enable register would have been cleared at power on, so PON would not generate the ESB bit in the Status Byte register, and no SRQ would occur at power on. For an *Nrf* of zero, and the Event Status Enabling register bit 7 *true*, and the Service Request Enabling register bit 5 *true*; a change from Power Off to Power On generates an SRQ. This is only possible because the enabling register conditions are held in non-volatile memory, and restored at power on.

This facility is included to allow the application program to set up conditions so that a momentary Power Off followed by reversion to Power On (which could upset the 4920 programming) will be reported by SRQ. To achieve this, the Event Status register bit 7 must be set permanently *true* (by

\*ESE *phs Nrf*, where  $Nrf \geq 128$ ); the Status Byte Enable register bit 5 must be set permanently *true* (by command \*SRE *phs Nrf*, where  $Nrf \geq 32$ ); Power On Status Clear must be disabled (by \*PSC *phs Nrf*, where  $Nrf = 0$ ); and the Event Status register must be read destructively immediately following the Power On SRQ (by the common query \*ESR?).

**Standard Event Status Enable Register**

The ESE register is a means for the application program to select, from the positions of the bits in the standard-defined Event Status Byte, those events which when *true* will set the ESB bit *true* in the Status Byte. It contains a user-modifiable image of the standard Event Status Byte, whereby each *true* bit acts to enable its corresponding bit in the standard Event Status Byte.

**Bit Selector: \*ESE *phs Nrf***

The program command: \*ESE *phs Nrf* performs the selection, where *Nrf* is a decimal numeric, which when decoded into binary, produces the required bit-pattern in the enabling byte.

For example:

If the ESB bit is required to be set *true* only when an execution or device-dependent error occurs, then *Nrf* should be set to 24. The binary decode is 00011000 so bit 3 or bit 4, when *true*, will set the ESB bit *true*; but when bits 0-2, or 5-7 are *true*, the ESB bit will remain *false*.

**Reading the Standard Event Enable Register**

The common query: \*ESE? reads the binary number in the ESE register. The response is in the form of a decimal number which is the sum of the binary-weighted values in the register.

**Measurement Event Status Register**

In this structure a 'Measurement Event Status Register' holds the Measurement Event Status Byte, consisting of event bits, specific to the 4920. All bits are 'sticky'; ie. once *true*, can only return to *false* when the register is cleared. This register is automatically cleared when it is read by the query:

MESR?. The common command \*CLS clears the Measurement Event Status Register but not the Measurement Event Status Enable Register.

Each of the bits is named in mnemonic form; they are described below.

**Bit 0** Block of readings completed (BRC)

Using the BLOCK\_nnn command, a number of readings (block) can be assigned for copying to a separate store for the purpose of calculating their mean and standard deviation. By sending the command with a valid 'nnn', the block is started.

Bit 0 is asserted *true* once the instrument has finished copying the block and performing the calculations. The query commands MEAN? and SIGMA? can then be sent to obtain the results.

**Bit 1** Frequency Lower than Valid Range (FLR)

Bit 1 is asserted *true* whenever a signal applied to the active channel has a frequency lower than 1Hz when the 1Hz RMS integration filter (RMS FILT1HZ) is active; and lower than 5Hz for other integration filters. The value recalled by the query: RDG? is  $\pm 200.0000E+33$ .

**Bit 2** Frequency Higher than Valid Range (FHR)

Bit 1 is asserted *true* whenever a signal applied to the active channel has a frequency higher than 1.3MHz. The value recalled by the query: RDG? is  $\pm 200.0000E+33$ .

**Bit 3** Underrange (U-R)

Bit 3 is asserted *true* whenever a signal applied to the active channel has a value less than 2% of the selected range. The value recalled by the query: RDG? is  $\pm 200.0000E+33$ .

**Bit 4** Overload (O-L)

Bit 4 is asserted *true* whenever a signal applied to the active channel has exceeded the selected range. The value recalled by the query: RDG? is  $\pm 200.0000E+33$ .

**Bit 5** Mathematical Overflow (MOF)

Bit 5 is asserted *true* whenever the modulus of the result of an internal math calculation has a value which is too large to be represented.

**Bit 6** Bit 6 is not allocated.

**Bit 7** Reading Available (RAV).

Bit 7 is asserted *true* whenever the result of a reading is available (when the A-D cycle is completed). If command RDG? is sent, the result will be placed in the output queue.



**Measurement Event Status Enable Register**

The application program uses the MESE register to select, from the positions of the bits in the Measurement Event Status Byte, those events which when *true* will assert the MES bit *true* in the Status Byte. It contains a user-modifiable image of the Measurement Event Status Byte, whereby each *true* bit acts to enable its corresponding bit in the Measurement Event Status Byte.

**Bit Selector: MESE *phs Nrf***

The program command: MESE *phs Nrf* performs the selection, where *Nrf* is a decimal numeric, which when decoded into binary, produces the required bit-pattern in the enabling byte.

For example:

If the MES bit is required to be asserted *true* only when the frequency is higher or lower than its valid range, then the value of *Nrf* should be set to 6. The binary decode is 00000110 so bit 1 or bit 2, when *true*, will assert the MES bit *true*; but when bits 0 or 3-7 are *true*, the MES bit will not be asserted.

**Reading the****Measurement Event Status Enable Register**

The device-specific query: MESE? reads the binary number in the MESE register. The response is in the form of a decimal number which is the sum of the binary-weighted values in the register. The binary-weighted value of bit 6 is always zero.

## 4920 COMMANDS AND QUERIES - Syntax Diagrams

### MEASUREMENT DEFINITION - MAJOR FUNCTIONS

#### High Accuracy AC Voltage

The following commands are used to select ACV function along with its associated configuration.

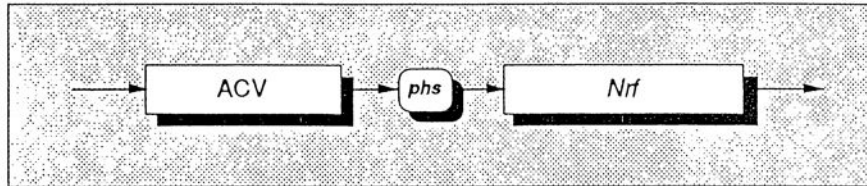

*Nrf* is a decimal numeric value.

It is meant to represent the expected signal amplitude, so that the instrument will go to the most relevant range. For example, an *Nrf* of 6, 10, or even 9.8765, will select the 10V range.

The *Nrf* limits for nominal range selection are shown in the list below, together with the range input limits.

For a full list of significant ACV range points, see *Appendix C to Section 4*.

Note that numbers exceeding the defined data element resolution of 7 digits will be rounded to that resolution.

$0 < Nrf \leq 0.3$	selects the 0.3V range	(0.027V to 0.34995V)
$0.3 < Nrf \leq 1.0$	selects the 1V range	(0.09V to 1.1995V)
$1.0 < Nrf \leq 3.0$	selects the 3V range	(0.27V to 3.4995V)
$3.0 < Nrf \leq 10.0$	selects the 10V range	(0.9V to 11.995V)
$10.0 < Nrf \leq 30.0$	selects the 30V range	(2.7V to 34.995V)
$30.0 < Nrf \leq 100.0$	selects the 100V range	(9V to 119.95V)
$100.0 < Nrf \leq 300.0$	selects the 300V range	(27V to 349.95V)
$300.0 < Nrf$	selects the 1000V range	(90V to 1,199.5V)

**Recall of RMS Value and Frequency**

For each RMS reading trigger, a measurement of signal frequency is also triggered. For recall of these two parameters refer to RDG? and FREQ? commands.

**Range Upper Limit - Error Message:**

If the value of a measured signal exceeds the selected range upper limit, then 'error overload' appears on the front panel. A relevant query command invokes the 'invalid number response', and the appropriate bit is set in the device status registers.

**Range Lower Limit - Error Message:**

If the value of a measured signal is below the selected range lower limit, then 'error underrange' appears on the front panel. A relevant query command invokes the 'invalid number response', and the appropriate bit is set in the device status registers.

**Calculations and Facilities**

When in ACV ranges, the following facilities are available:

AVG; RMS; BLOCK; MEAN?; SIGMA?; DEV?.

**Execution Errors**

None.

**Reversion from Remote to Local**

No Change.

**Exit from ACV Function**

Parameters lost on exit.

**Power On and Reset Conditions**

ACV	Selected active.
Range	1000

**MAJOR FUNCTIONS** (Contd.)**Option 10 - Millivolts (mV)**

The following commands are used to select the millivolt function along with its associated configuration.

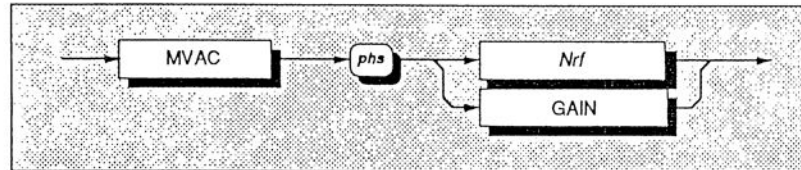

**GAIN** causes the 4920 perform a measurement of the gain of the x30 millivolt amplifier, providing that a stable signal of between 95mV and 105mV is connected to the active input channel.

Before it is possible to select a millivolt range, the gain of the x30 amplifier must have been measured and stored. To store the value use the 'REF' command (page 5-41).

To recall the stored gain value use the 'REF?' query (page 5-41).

The stored gain value is destroyed by:

- Power Off;
- Reset (Front Panel or Remote);
- Any ACV calibration operation.

AC/DC Transfer mode is not available in millivolt function. Selecting millivolts destroys any AC/DC transfer selection and reference value.

Spot frequencies are ignored when in millivolt function.

**Nrf** is a decimal numeric value which is meant to represent the expected signal amplitude, so that the instrument will go to the most relevant range.

If **Nrf** is 2, 3, or even 1.56789, then the 3mV range is automatically selected.

$1.0 < Nrf \leq 3.0$	selects the 3mV range. (0.27mV to 3.3mV)
$3.0 < Nrf \leq 10.0$	selects the 10mV range. (0.9mV to 11mV)
$10.0 < Nrf \leq 30.0$	selects the 30mV range. (9mV to 33mV)
$30.0 < Nrf \leq 100.0$	selects the 100mV range (27mV to 110mV)

Note that numbers exceeding a resolution of 7 digits will be rounded to that resolution.

For a full list of significant mV range points, see Appendix C to Section 4.

Example:

MVAC 100 would select the 100mV range if a gain value for the x30 amplifier has already been stored and the instrument has remained in Millivolt function.

**Frequency Limitation**

Readings are taken normally; specification will be achieved only if the signal frequency is within  $\pm 2\%$  of the frequency of the latest millivolt gain determination.

**Calculations and Facilities**

When in millivolt ranges, the following facilities are available:

AVG; RMS; BLOCK; MEAN?; SIGMA?; DEV?.

**Recall of RMS Value and Frequency**

For each RMS reading trigger, a measurement of signal frequency is also triggered. For recall of these two parameters refer to RDG? and FREQ? commands.

**Execution Errors:**

'NO MV GAIN VALUE': a range has been selected without a valid gain determination.

'NO MILLIVOLT IN CAL MODE': millivolts has been attempted when cal is enabled.

'NO CAL IN MILLIVOLT MODE': Calibration Enable has been attempted when in millivolt function.

**Reversion from Remote to Local**

No Change.

**Exit from mV Function**

Gain value retained except in DEV?, TFER and ENBCAL.

**Power On and Reset Conditions**

x30 amp gain      Undetermined

Range              N/A

mV not active (ACV active).

**MAJOR FUNCTIONS** (Contd.)**AC/DC Transfer**

The **TFER** command is used to select the AC/DC Transfer function along with its associated configuration.

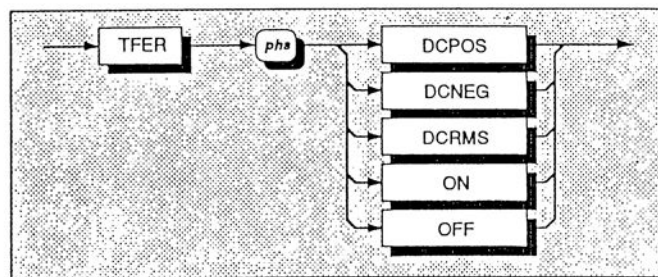

**DCPOS:** The 4920 reads the value of a positive-polarity DC voltage reference input. In order to participate in the transfer, this reading must be stored using the command 'REF' (page 5-41).

**DCNEG:** The 4920 reads the value of a negative-polarity DC voltage reference input. In order to participate in the transfer, this reading must be stored using the command 'REF' (page 5-41).

**DCRMS:** The 4920 calculates the RMS equivalent of the two DCPOS and DCNEG values. This reading must be stored to participate in the transfer, using the command 'REF' (page 5-41).

**ON** causes the 4920 to measure the RMS value of the AC signal connected to the active input channel, providing that a value for DCRMS has been successfully stored. The 4920 then calculates the ppm deviation of this value from the stored DCRMS equivalent.

**OFF** produces direct RMS measurements of the AC input signal, as if the 4920 were in ACV function.

**Loss of DC+, DC- and DCRMS Values**

The stored DC+, DC- and DCRMS value are destroyed by:

- Power Off;
- Reset (Front Panel or Remote);
- Any ACV calibration operation.

**No AC/DC Transfer in Millivolt Function**

AC/DC Transfer mode is not available in millivolt function. Selecting millivolts destroys any AC/DC transfer selection and reference value.

**Calculations and Facilities**

The following calculations and facilities are available when in AC/DC Transfer mode:

Spot Frequencies	SPOT <i>nrf</i>
Digital Filtering	AVG 4/8/16
RMS Low Frequency	RMS FILT...
Set up Math Block	BLOCK nnn
Block Calculations	MEAN? / SIGMA?
Monitoring	REF / REF? / DEV?

**DC Reference Values - Limitations**

If TFER DCRMS is sent when either of the DC+ or DC- references has not been measured and stored, an Execution Error is generated.

If TFER DCRMS is sent when the stored DC+ and DC- references differ by more than 1% of value, a Device-Dependent Error is generated.

If TFER ON is sent when no DCRMS reference has been calculated and stored, an Execution Error is generated.

**Recall of RMS Value and Frequency**

For each RMS reading trigger, a measurement of signal frequency is also triggered. For recall of these two parameters refer to RDG? and FREQ? commands.

**Execution Errors:**

'NO DCPOS VALUE': TFER DCRMS has been sent with no DC+ value stored.

'NO DCNEG VALUE': TFER DCRMS has been sent with no DC- value stored.

'NO DCRMS VALUE': TFER ON has been sent with no DCRMS value stored.

**Device-Dependent Error:**

'DCRMS MISMATCH': TFER DCRMS has been sent when DC+ and DC- stored values differ by more than 1% of value.

**Reversion from Remote to Local**

No Change.

**Exit from AC/DC Transfer Function**

The stored DCRMS value is retained except by selecting:

Power Off; Reset (Front Panel or Remote); Millivolts Function; or any ACV calibration operation.

**Power On and Reset Conditions**

DC+ Value Undetermined

DC- Value Undetermined

DCRMS Value Undetermined

AC/DC Transfer not active (ACV active).

## MEASUREMENT PARAMETERS

### Trigger Source Selector

#### Caution:

The use of internal triggers can produce unexpected results, due to the time required for the A-D conversion, and the A-D triggers being unsynchronized with the IEEE 488 bus operations. Such triggers should be avoided unless they form an essential ingredient of the required measurement.

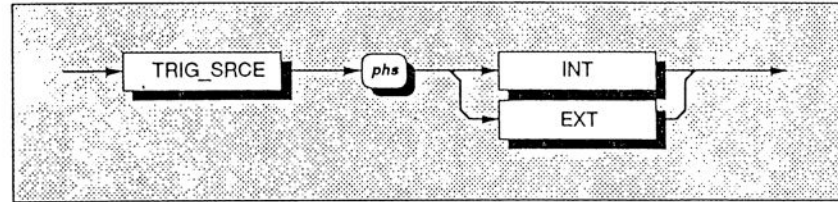

#### TRG\_SRCE INT

generates internal triggers within 0.5 second of completion of the previous reading. External trigger sources are disabled.

#### TRG\_SRCE EXT

disables internal triggers and enables controller-generated external trigger sources. These are:

- IEEE 488.1: GET command.
- IEEE 488.2: \*TRG command.

#### Execution Errors:

None.

#### Reversion from Remote to Local

No Change.

#### Power On and Reset Conditions

The default condition is TRG\_SRCE INT.



### Signal Input Channel Selection

The **INPUT** command is sent with one of two parameters to select the required input channel:

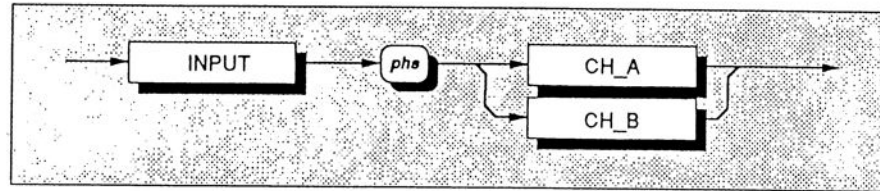

**CH\_A** selects Channel A (Precision 'N')  
**CH\_B** selects Channel B (Terminal Posts)

**Execution Errors:**  
None.

For further details of Channels A and B, refer to Section 4, page 4-12.

**Reversion from Remote to Local**  
No Change.

**Power On and Reset Conditions**  
The default condition is **INPUT CH\_B**.

## MEASUREMENT PARAMETERS (Contd)

### Spot Frequency Operation

#### Using Spot Frequencies

For applications that require lower measurement uncertainties than those available from 'broadband' operation, the 4920 incorporates a facility for eliminating flatness errors using 'spot' frequency calibration.

A Spot Frequency can be created only by being calibrated. The method is detailed, with other calibration procedures, in Section 8.

Each spot is really a band of frequencies of  $\pm 2\%$  about the calibrated spot frequency. It specifies a span of voltage between 50% and 110% of nominal range and frequency, for which an extra correction is obtained during 'spot calibration', and reapplied when using Spot Frequency mode.

A grand total of up to 100 spots can be allocated, during calibration, to particular ranges and frequencies.

#### Calibrated Spot Frequencies

Once in normal remote operation (after a spot has been created) and in either ACV or AC/DC function; Spot Frequency is available. The instrument can be placed into Spot Frequency mode by sending **SPOT *Nrf***, where *Nrf* represents a required spot frequency. *Nrf* is evaluated and the calibration store is searched for spot data within  $\pm 1\%$  of this frequency. If none exists, then an execution error (NO SPOT DATA) is generated. If spot data does exist, then an extra correction will be applied for signal frequencies within  $\pm 2\%$  of the selected spot frequency. An input signal whose frequency does not fall within  $\pm 2\%$  of the spot will elicit the invalid response (200E+33).

#### Applying Spot Frequency Corrections

A spot frequency can be selected only in the ACV range in which it was calibrated (or the same range in AC/DC Transfer). When operating at a spot frequency, then a range change deselects spot.

The Spot Calibration data is a gain correction to readings which are already corrected for normal AC linearity, gain and flatness. Spot corrections are therefore applied to a reading *after* these normal corrections and any digital filter corrections have been implemented. Re-calibration of linearity, gain or flatness destroys the spot data, and the spot then ceases to exist. Spot frequency mode is not available for millivolt ranges, and is cancelled as soon as MVAC is sent.

#### Use of Spot Frequency in Transfer Mode

If the TFER command is sent when ACV function is operating at a spot frequency, then that particular spot is carried over into the AC/DC Transfer function. It does not become active until the TFER ON command is sent to select the AC signal, after the equivalent DC RMS value has been stored (TFER DCRMS;REF).

Spot is similarly available as a normal AC reading in Monitor and Math processes. On return to the ACV range where the spot was selected, the same spot frequency will still be active.

#### Spot Calibration

When in an ACV range (or AC/DC range with dc+, dc-, dcrms and Tfer all deselected), new spots can be created (and old ones recalibrated) using a calibration menu.

## Spot Frequency Selection

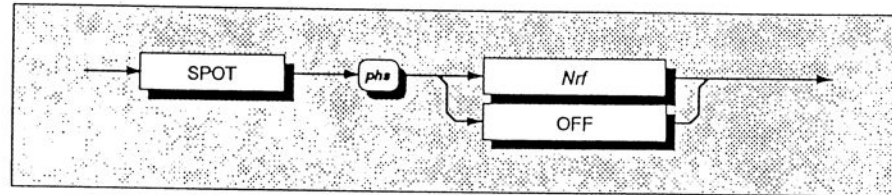

**SPOT OFF** deselects Spot Frequency.

**SPOT *Nrf*** selects a Calibrated Spot Frequency suggested by *Nrf*.

*Nrf* The units used for *Nrf* are Hertz. It is not necessary to send the exact spot frequency value - any number within  $\pm 1\%$  of the exact value will select the spot.

#### Signal Frequency Out-of-Limits

If the signal frequency applied to the instrument is not within  $\pm 2\%$  of the calibrated spot frequency, then the illegal response (200E+33) is given.

**Execution Errors:**  
None.

#### Device-Dependent Errors:

A device-dependent error results when the *Nrf* sent is outside the 1% limit:

'2015 , SPOT FREQUENCY INVALID'

The previous configuration (in broadband or spot) is not changed.

#### Reversion from Remote to Local

No Change.

#### Power On and Reset Conditions

The default condition is SPOT OFF.

**MEASUREMENT PARAMETERS** (Contd)**RMS Computation - Low Frequency Limits**

To allow low frequencies enough time for measurement, and for higher frequencies to be measured more quickly, a switched range of integration time constants is provided, each described by the lowest acceptable frequency.

Four switched time constants are available:

100Hz, 40Hz, 10Hz and 1Hz.

To meet the instrument specification, the selected RMS Low Frequency limit must be equal to or lower than the lowest frequency to be measured.

The **RMS** command is sent with one of four parameters to select the required low frequency limit:

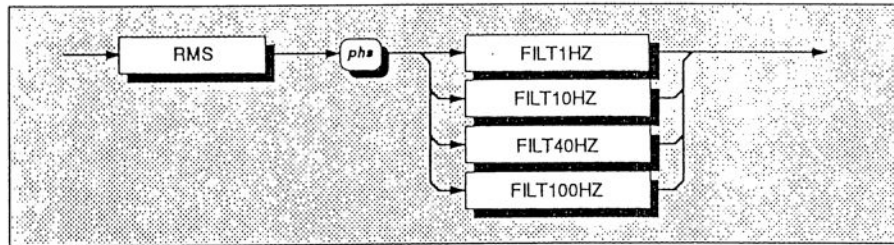

**RMS FILT1HZ** selects an LF limit of 1Hz.  
**RMS FILT10HZ** selects an LF limit of 10Hz.  
**RMS FILT40HZ** selects an LF limit of 40Hz.  
**RMS FILT100HZ** selects an LF limit of 100Hz.

**Execution Errors:**

None.

**Reversion from Remote to Local**

No Change.

**Signal Frequencies < 1Hz**

Reasonable readings for signals below 1Hz can be achieved using the DC-coupled 'dc+' mode in the AC/DC transfer function. Refer to *page 5-32*. The low-frequency limit of 1Hz must also be selected using **RMS FILT1HZ**.

**Power On and Reset Conditions**

The default condition is **RMS FILT100HZ**.

### Digital Filtering

A rolling average computation is used to process successive readings, measuring the arithmetic mean of the most-recent 4, 8 or 16 readings, as selected by the operator (the number of readings is called the 'window size').

As each reading is taken it is placed into one of 4, 8 or 16 stores. The calculated mean goes into a separate store to be updated after each reading.

The **AVG** command is sent with one of four parameters to select the required window size:

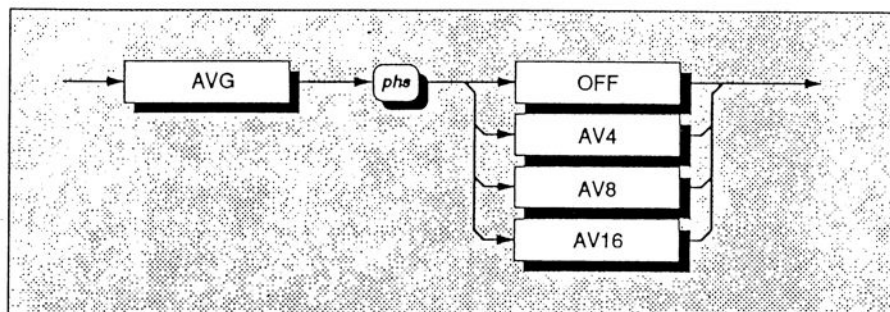

**AVG OFF** cancels averaging.  
**AVG AV4** selects 4 readings.  
**AVG AV8** selects 8 readings.  
**AVG AV16** selects 16 readings.

All the stores are cleared on each command update, then the mean value is updated with every new reading.

As the stores are filling, the processor calculates the average of the readings stored to date, until the selected window size is reached.

Once the stores have filled with the selected number of readings; then as each new reading is added, the earliest reading is discarded, and a new mean is calculated and stored.

#### Availability:

The averaging facility can be used when in **ACV**, **mV** or **AC/DC** Transfer functions.

#### Execution Errors:

None.

#### Illegal Values:

If any reading with an illegal value is encountered (overload etc.), the store is cleared and the invalid response (+200E+33) is returned.

#### Reversion from Remote to Local

No Change.

#### Power On and Reset Conditions

The default condition is **AVG OFF**.

## MEASUREMENT PARAMETERS (Contd)

### Set Block Size and Start the Block of Readings

The measurements taken by the 4920 can be analysed to indicate the **mean** and **standard deviation** of a single block of readings. The number of readings to be taken in the block must first be entered. The action of entering the block size also initiates the first reading in the block.

The normal range of trigger source options is available.

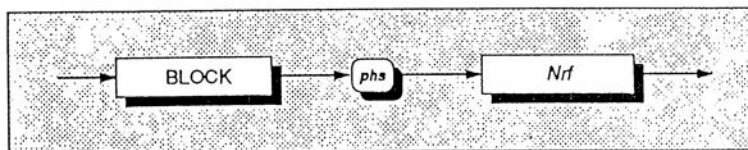

#### BLOCK *Nrf*

The BLOCK command sets the number of readings to be taken and starts the block of readings, so the TRG\_SRCE command must be sent to nominate the trigger source before sending BLOCK.

*Nrf* is a decimal integer whose value is the number of readings to be copied to the block store. This value must lie between 1 and 999 inclusive.

Note: If BLOCK *phs Nrf* is sent when in external trigger mode, then *Nrf* triggers will be required to complete the block of measurements.

#### Response

Calculation of mean and standard deviation proceeds as the readings are copied to the block store. At the completion of the block of measurements, the two results are made available in their respective stores for access by the MEAN? and SIGMA? Query commands.

At the same time, bit 0 of the 4920 Status Byte is set, and an SRQ results, providing that the appropriate bits of the Service Request Enable register (bit 0) and Measurement Event Status Enable register (bit 0) are set.

#### Availability of Results:

The mean and standard deviation results remain accessible in store until they are changed by a subsequent BLOCK command.

The results are cancelled by Power Off, by sending RESET, or by sending a command headed by ACV, MVAC or TFER.

#### Reversion from Remote to Local:

No change

#### Execution Errors:

An Execution Error results when the numeric value of *nnn* is not within the specified limits.

#### Power On and Reset Conditions

All previous results are cleared at Power On and Reset, thus no mean or standard deviation results can exist until a new BLOCK *phs nnn* command has been executed.

**Store Most-Recent Reading as Reference**

Millivolt Gain, AC/DC Transfer and Deviation calculations require a suitable reading to be registered as a reference value. The REF command is used for this purpose.

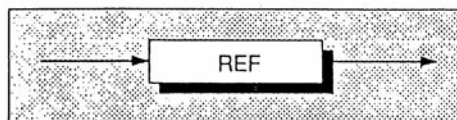

When readings are available, REF is used to store the most-recently converted reading as reference. The reference value is destroyed by change of range.

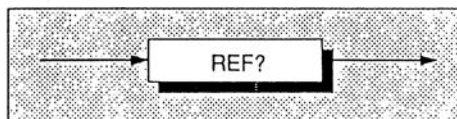
**Recall Stored Reference**

REF? recalls the most recently stored reading.

**Response Format:**

Character position	1	2	3	4	5	6	7	8	9	10	11	12	13	14
	s	n	x	x	x	n	n	n	n	E	sg	p	p	nl

**Where:**

s = + or - or space  
 n = 0 to 9  
 x = either n or decimal point (.)  
 E = ASCII character identifying the exponent  
 sg = + or -  
 p = 0 to 9 (exponent is in engineering units)  
 nl = newline with EOI

**Response Decode:**

If no signal has been stored as reference, the invalid response is given. The returned value represents the applied signal together with any digital filtering selected by use of the AVG command. Overload or underscale is represented by a value of +200E+33.

**Reversion from Remote to Local:**

No change

**Execution Errors:**

None

**Power On and Reset Conditions**

All previous results are cleared at Power On and Reset, thus no reference value can exist until a reading value has been stored.

## MEASUREMENT DEFINITION - SRQ GENERATION

### SRQ Origination

Part of programming a measurement is to decide which (if any) of the predetermined events will be responsible for calling for the attention of the controller. This must be done before triggers are sent, so the means of programming these decisions is mentioned here, although the subject is dealt with thoroughly in other parts of this section.

The three commands which program the instrument's response to events are given below. A more detailed treatment is given elsewhere (*pages 5-16 to 5-27 and 5-49 to 5-55*).

**Measurement Event Enable - MESE *Nrf*** enables the **measurement** event bits which will generate a summary message in the standard defined service request byte. Refer to page 5-49.

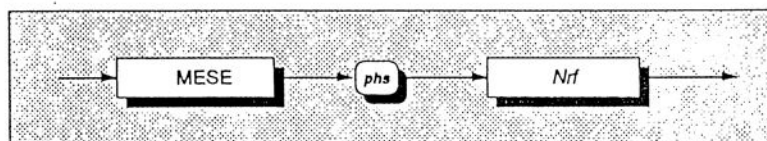

**Event Status Enable - \*ESE *Nrf*** enables the **standard** defined event bits which will generate a summary message in the status byte. Refer to page 5-49.

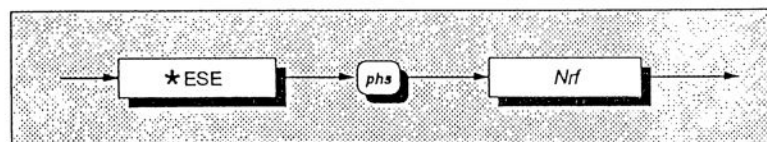

**Service Request Enable - \*SRE *Nrf*** enables the **standard** and **measurement** summary bits in the service request byte, which will generate a service request. Refer to page 5-49.

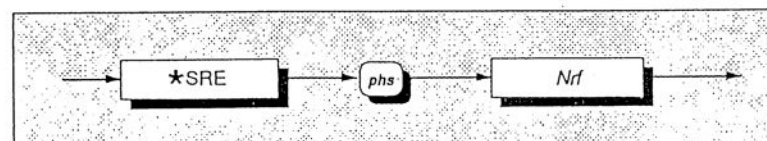



**Execute Trigger**

This command conforms to the IEEE 488.2 standard requirements.

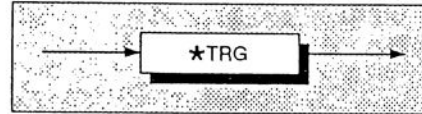

**\*TRG**

is equivalent to a Group Execute Trigger (GET), and will cause a single reading to be taken.

**Reversion from Remote to Local**

Not applicable.

**Execution Errors:**

None

**Power On and Reset Conditions**

Not applicable.

Standard signal acquisition times are given in Section 4, Appendix B; for Function and Filter selections.

## Reading Recall

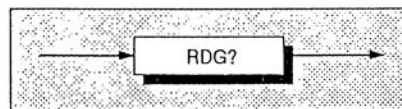

**RDG?** recalls the most recently completed measurement made by the instrument.

### Response Format:

Character position													
1	2	3	4	5	6	7	8	9	10	11	12	13	14
s	n	x	x	x	n	n	n	n	E	sg	p	p	nl

### Where:

s = + or - or space  
 n = 0 to 9  
 x = either n or decimal point (.)  
 E = ASCII character identifying the exponent  
 sg = + or -  
 p = 0 to 9 (exponent is in engineering units)  
 nl = newline with EOI

### Response Decode:

If no signal has been received to generate a conversion of the input signal, then the response to this command will represent the most-recent measurement. If no triggers are available, the invalid response is given. If a trigger has already been received, this query will wait for the completion of the measurement and place its result in the output queue.

### Returned Value:

**Volts** for ACV, TFER DCPOS, DCNEG and DCRMS;  
**ppm** for ACV, TFER ON;  
**mV** for MVAC.

The value represents the applied signal together with any mathematical modifications selected with the Math facility. Overload or underscale is represented by a value of +200E+33 along with a set flag bit in the measurement qualifying byte of the status data.

### Execution Errors:

None

### Power On and Reset Conditions

All previous results are cleared at Power On and Reset, thus an overload response is given until after the first trigger.

### Frequency Readings

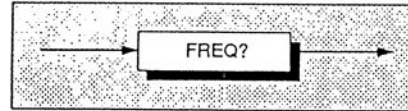

**FREQ?** recalls the frequency associated with the most-recently completed measurement.

#### Response Format:

Character position													
1	2	3	4	5	6	7	8	9	10	11	12	13	14
s	n	x	x	x	n	n	n	n	E	sg	p	p	nl

#### Where:

s = + or - or space  
 n = 0 to 9  
 x = either n or decimal point (.)  
 E = ASCII character identifying the exponent  
 sg = + or -  
 p = 0 to 9 (exponent is in engineering units)  
 nl = newline with EOI

#### Returned Value

The returned value is expressed in **Hz**.  
 A value of +200E+33 is returned if the measurement circuits cannot produce a result.

If no signal has been received to generate a conversion of the input signal, then the response to this command will be the frequency of the most-recent measurement. If no triggers are available, the invalid response is given. If a trigger has already been received, this query will wait for the completion of the measurement and place its result in the output queue.

#### Execution Errors:

None

#### Power On and Reset Conditions

All previous results are cleared at Power On and Reset, thus an invalid response is given until after the first trigger.

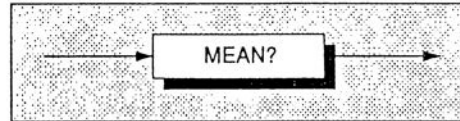
**Recall the Mean of the Assigned Block of Readings**

**MEAN?** recalls the **arithmetic mean** of the block of measurements stored by the BLOCK command. Units: voltage for ACV and mV; ppm for AC/DC Transfer.

**Response Format:**

Character position  
 1 2 3 4 5 6 7 8 9 10 11 12 13 14  
 s n x x x n n n n E sg p p nl

**Where:**

s = + or - or space  
 n = 0 to 9  
 x = either n or decimal point (.)  
 E = ASCII character identifying the exponent  
 sg = + or -  
 p = 0 to 9 (exponent is in engineering units)  
 nl = newline with EOI

**Availability of Results:**

The mean result remains accessible in store until it is changed by a subsequent BLOCK command.

The result is cancelled by Power Off, by sending RESET, or by sending a command headed by ACV, MVAC or TFER.

**Reversion from Remote to Local:**

No change

**Execution Errors:**

While block readings are being acquired (by normal or external triggers) the invalid response (200E+33) is returned to interrogation by MEAN?, and an Execution Error is generated.

**Power On and Reset Conditions:**

All previous results are cleared at Power On and Reset, thus no mean result can exist until a new BLOCK command has been executed. In these conditions the invalid response (200E+33) is returned to interrogation by MEAN?, and an Execution Error is generated.

### Recall the Standard Deviation of the Assigned Block of Readings

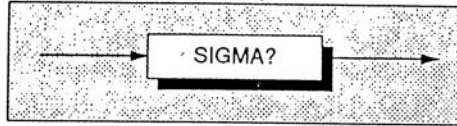

**SIGMA?** recalls the **standard deviation** of the block of measurements stored by the BLOCK command. Units: ppm/mean for ACV and mV; ppm for AC/DC Transfer.

#### Response Format:

Character position

```

1 2 3 4 5 6 7 8 9 10 11 12 13 14
s n x x x n n n n E sg p p nl

```

#### Where:

s = + or - or space  
n = 0 to 9  
x = either n or decimal point (.)  
E = ASCII character identifying the exponent  
sg = + or -  
p = 0 to 9 (exponent is in engineering units)  
nl = newline with EOI

#### Availability of Results:

The standard deviation result remains accessible in store until it is changed by a subsequent BLOCK command.

The result is cancelled by Power Off, by sending RESET, or by sending a command headed by ACV, MVAC or TFER.

#### Reversion from Remote to Local:

No change

#### Execution Errors:

While block readings are being acquired (by normal or external triggers) the invalid response (200E+33) is returned to interrogation by SIGMA?, and an Execution Error is generated.

#### Power On and Reset Conditions:

All previous results are cleared at Power On and Reset, thus no standard deviation result can exist until a new BLOCK command has been executed. In these conditions the invalid response (200E+33) is returned to interrogation by SIGMA?, and an Execution Error is generated.

## Recall the Present Signal Deviation



**DEV?** recalls the deviation, in ppm, between the most recent reading made by the instrument and the reference value stored by the **REF** command.

## Response Format:

Character position													
1	2	3	4	5	6	7	8	9	10	11	12	13	14
s	n	.	n	n	n	n	n	n	E	sg	p	p	nl

## Where:

s = + or - or space  
 n = 0 to 9  
 x = either n or decimal point (.)  
 E = ASCII character identifying the exponent  
 sg = + or -  
 p = 0 to 9 (exponent is in engineering units)  
 nl = newline with EOI

## Response Decode:

If no new signal has been received to generate a conversion of the input signal, then the response will represent the difference between the most-recent reading and the stored reference. If no reference has been stored, the invalid response is given.

## Returned Value:

The value represents the deviation of the applied signal together with any digital filtering selected by the **AVG** command..

## Calculations Employed:

Deviation is calculated as follows:

**ACV** or **mV** functions (voltage reading):  
 $(\text{Reading} - \text{Reference}) + \text{Reference}$

**AC/DC Transfer** function (ppm reading):  
 $\text{Reading} - \text{Reference}$

## Reversion from Remote to Local:

No change

## Execution Errors:

None

## Power On and Reset Conditions

All previous results are cleared at Power On and Reset, thus no reference can exist until a reading value has been stored. In these conditions the invalid response will be given when the instrument is interrogated by **DEV?**.

# Status Reporting

Most of the commands in this sub-section are standard reporting commands defined in the IEEE-488.2 standard. For greater detail, refer to pages 5-16 to 5-27.

## Status Reporting Structure

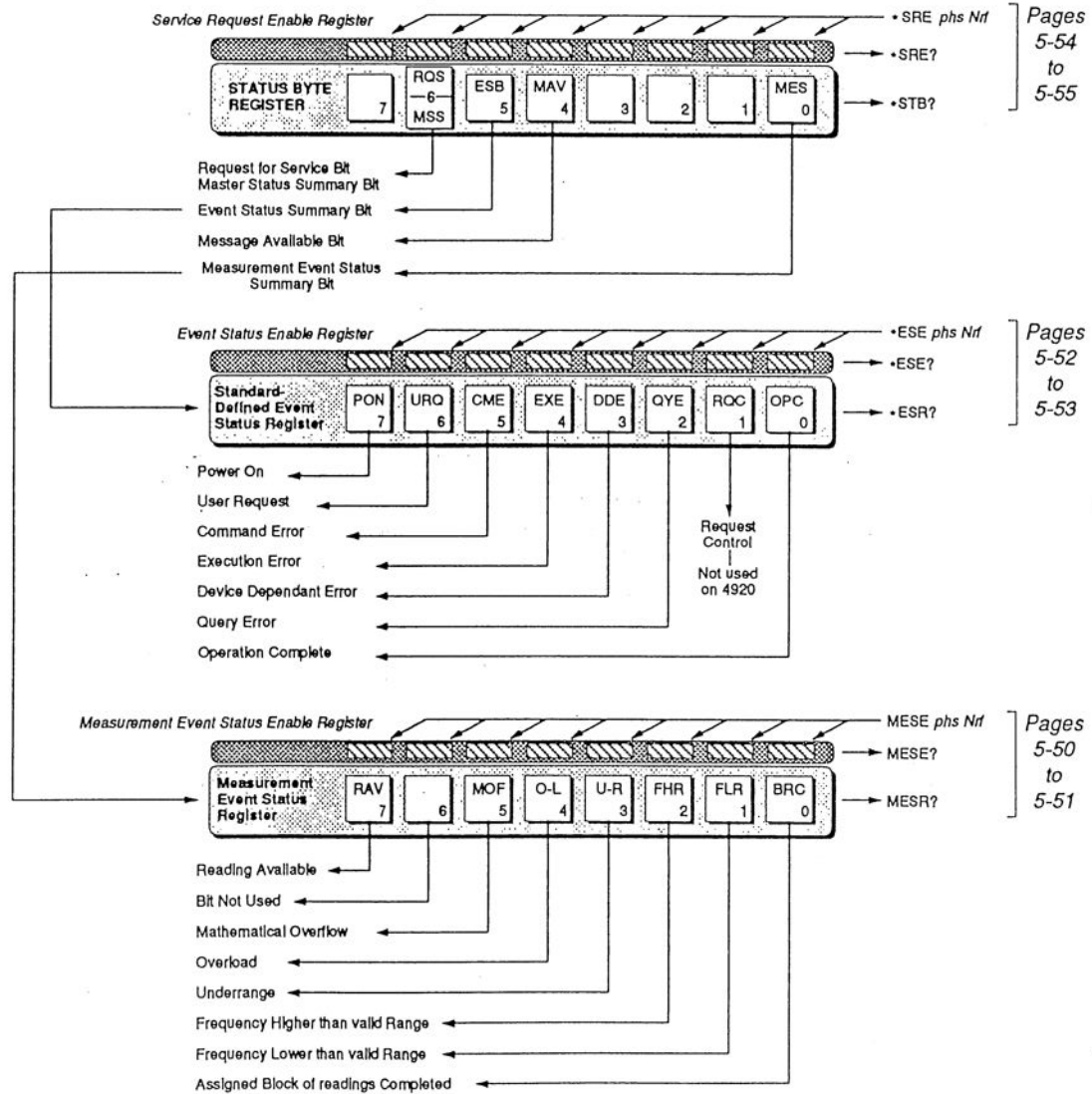

**Measurement Event Enable**

This measurement event status data structure conforms to the IEEE 488.2 standard requirements for this structure.

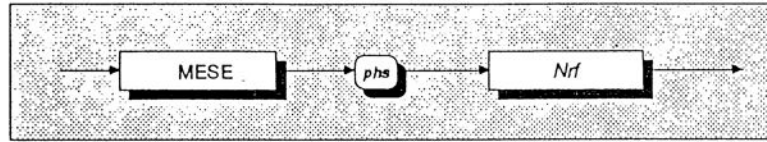

**MESE**

enables the measurement event bits which will generate a summary message in the standard defined service request byte. Refer to page 5-49.

Note that numbers will be rounded to an integer.

**Execution Errors:**

None.

**Nrf** is a Decimal Numeric Data Element representing a value which, when rounded to an integer and expressed in base 2 (binary), enables the appropriate bits in this event enable register.

**Power On and Reset Conditions**

Not applicable.

For example:

- 32 will enable the MOF bit;
- 24 will enable Overload and Underrange.

**Recall Measurement Event Enable**

This measurement event status data structure conforms to the IEEE 488.2 standard requirements for this structure.

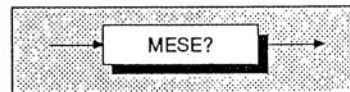

**MESE?**

recalls the measurement status register enable mask. Refer to page 5-49.

**Response Decode:**

The value returned, when converted to base 2 (binary), identifies the enabled bits which will generate a summary message in the service request byte, for this data structure. See the device status reporting model for detail.

**Response Format:**

Character position  
 1 2 3 4  
 n n n nl

**Execution Errors:**

None

**Where:**

- n = 0 to 9
- nl = newline with EOI

**Power On and Reset Conditions**

Cleared (ie. nothing enabled).



**Read Measurement Event Register**

This measurement event status data structure conforms to the IEEE 488.2 standard requirements for this structure.

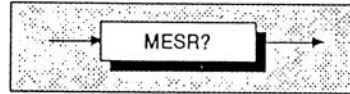

**MESR?**

reads the event register for measurement qualifiers destructively. Refer to *page 5-49*. The register is also cleared by the common command \*CLS.

**Response Format:**

Character position  
 1 2 3 4  
 n n n nl

**Where:**

n = 0 to 9  
 nl = newline with EOI

**Response Decode:**

The value returned, when converted to base 2 (binary), identifies the events that have occurred since the most-recent read or general clear of this register. The detail is contained in the status data structure description.

**Execution Errors:**

None.

**Power On and Reset Conditions**

The register is cleared.

**Event Status Enable**

This event status data structure conforms to the IEEE 488.2 standard requirements for this structure.

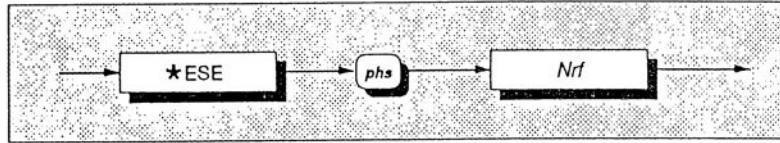

**\*ESE** enables the standard defined event bits which will generate a summary message in the status byte. Refer to page 5-49.

contained in the IEEE 488.2 standard document. Note that numbers **will** be rounded to an integer.

**Nrf** is a Decimal Numeric Data Element representing an integer decimal value equivalent to the Hex value required to enable the appropriate bits in this 8-bit register. The detail definition is

**Execution Errors:**

None.

**Power On and Reset Conditions**

Not applicable.

**Recall Event Status Enable**

This event status data structure conforms to the IEEE 488.2 standard requirements for this structure.



**\*ESE?**

recalls the enable mask for the standard defined events. Refer to page 5-49.

**Response Decode:**

The value returned, when converted to base 2 (binary), identifies the enabled bits which will generate a summary message in the service request byte, for this data structure. The detail definition is contained in the IEEE 488.2 document.

**Response Format:**

Character position  
 1 2 3 4  
 n n n nl

**Where:**

n = 0 to 9  
 nl = newline with EOI

**Execution Errors:**

None

**Power On and Reset Conditions**

The Power On condition depends on the condition stored by the common \*PSC command - if 0 then it is not cleared; if 1 then the register is cleared. Reset has no effect.

**Read Event Status Register**

This event status data structure conforms to the IEEE 488.2 standard requirements for this structure.

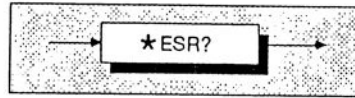
**\*ESR?**

recalls the standard defined events.  
Refer to *page 5-49*.

**Response Format:**

Character position			
1	2	3	4
n	n	n	nl

**Where:**

n = 0 to 9  
nl = newline with EOI

**Response Decode:**

The value returned, when converted to base 2 (binary), identifies the bits as defined in the IEEE 488.2 standard.

**Execution Errors:**

None

**Power On and Reset Conditions**

The Power On condition depends on the condition stored by the common \*PSC command - if 0 then it is not cleared; if 1 then the register is cleared. Reset has no effect.

**Service Request Enable**

This measurement event status data structure conforms to the IEEE 488.2 standard requirements for this structure.

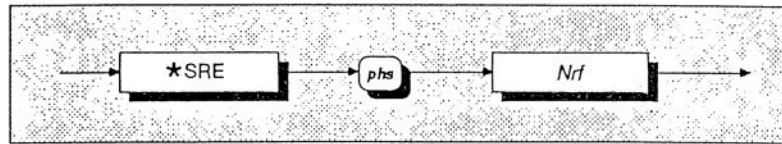

**\*SRE** enables the standard and user-defined summary bits in the service request byte, which will generate a service request. Refer to *page 5-49*.

**Nrf** is a Decimal Numeric Data Element representing an integer decimal value equivalent to the Hex value required to enable the appropriate bits in this 8-bit register. The detail definition is contained in the IEEE 488.2 document. Note that numbers **will** be rounded to an integer.

**Execution Errors:**

None.

**Power On and Reset Conditions**

Not applicable.

**Recall Service Request Enable**

This measurement event status data structure conforms to the IEEE 488.2 standard requirements for this structure.

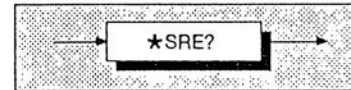

**\*SRE?** recalls the enable mask for the standard defined events. Refer to *page 5-49*.

**Response Decode:**

The value returned, when converted to base 2 (binary), identifies the enabled bits which will generate a service request. The detail is contained in the IEEE 488.2 standard document.

**Response Format:**

Character position  
 1 2 3 4  
 n n n nl

**Execution Errors:**

None.

**Where:**

n = 0 to 9  
 nl = newline with EOI

**Power On and Reset Conditions**

None.

**Read Service Request Register**

This measurement event status data structure conforms to the IEEE 488.2 standard requirements for this structure.

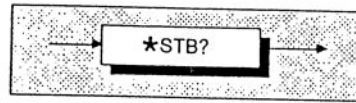

**\*STB?**

recalls the service request register for summary bits. Refer to *page 5-49*.

**Response Format:**

Character position  
 1 2 3 4  
 n n n nl

**Where:**

n = 0 to 9  
 nl = newline with EOI

**Response Decode:**

The value returned, when converted to base 2 (binary), identifies the summary bits for the current status of the data structures involved. For the detail definition see the IEEE 488.2 standard document. There is no method of clearing this byte directly. Its condition relies on the clearing of the overlying status data structure.

**Execution Errors:**

None.

**Power On and Reset Conditions**

Not applicable.

### Power On Status Clear

This common command conforms to the IEEE 488.2 standard requirements.

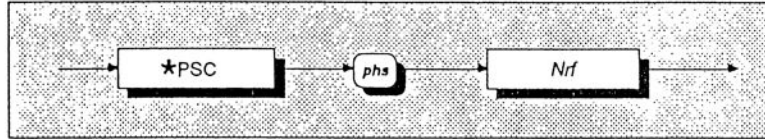

#### \*PSC

sets the flag controlling the clearing of defined registers at Power On.

**Nrf** is a decimal numeric value which, when rounded to an integer value of zero, sets the *power on clear flag false*. This allows the instrument to assert SRQ at power on.

When the value rounds to an integer value other than zero it sets the *power on clear flag true*, which clears the standard *event status enable* and *service request enable* registers so that the instrument will not assert an SRQ on power up.

#### Examples:

\*PSC 0 or \*PSC 0.173 sets the instrument to **assert** an SRQ at Power On.

\*PSC 1 or \*PSC 0.773 sets the instrument to **not assert** an SRQ on Power On.

#### Execution Errors:

None.

#### Power On and Reset Conditions

Not applicable.

**Recall Power On Status Clear Flag**

This common command conforms to the IEEE 488.2 standard requirements. The flag condition is determined by the \*PSC command (opposite page).

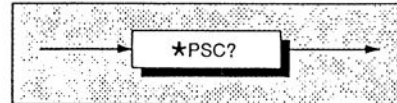
**\*PSC?**

will recall the Power On Status condition.

**Response Format:**

A single ASCII character is returned.

A single query sent as a terminated program message will elicit a single response terminated by:

nl = newline with EOI

If multiple queries are sent as a string of program message units (separated by semi-colons with the string followed by a permitted terminator), then the responses will be sent as a similar string whose sequence corresponds to the sequence of the program queries. The final response in the string will be followed by the terminator:

nl = newline with EOI

**Response Decode:**

The value returned identifies the state of the saved flag:

**Zero** indicates **false**. The instrument is **not** programmed to clear the Standard Event Status Enable Register and Service Request Enable Register at Power On, so the instrument will generate a 'Power On' SRQ.

**One** indicates **true**. The instrument is programmed to clear the Standard Event Status Enable Register and Service Request Enable Register at Power On, so the instrument cannot generate a 'Power On' SRQ.

**Execution Errors:**

None

**Power On and Reset Conditions**

No Change. This data is saved in non-volatile memory at Power Off, for use at Power On.

### Clear Status

This measurement event status data structure conforms to the IEEE 488.2 standard requirements for this structure.

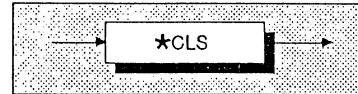

#### \*CLS

clears all the event registers and queues except the output queue. The output queue and MAV bit will be cleared if \*CLS immediately follows a 'Program Message Terminator'; refer to the IEEE 488.2 standard document.

#### Execution Errors:

None.

#### Power On and Reset Conditions

Not applicable.



### Recall Instrument Settings

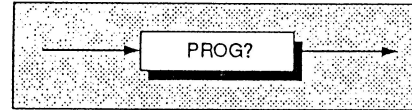

#### PROG?

will recall the instrument's function and range; RMS filter setting, averaging mode and trigger source.

#### IEEE 488.2 String Response Data Syntax:

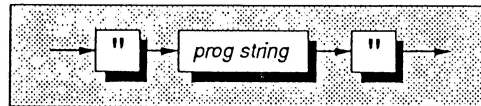

Where *prog string* describes the presently-programmed state of the instrument. It can be defined as a series of character groups representing the program headers and program data elements which would normally be used to set the instrument into its present state.

These groups convey information in the sequence:

" Function (ACV or MVAC),  
 Range,  
 RMS LF (100Hz, 40Hz, 10Hz or 1Hz),  
 Averaging (4, 8, 16 or Off),  
 AC/DC Transfer (On or Off),  
 Trigger Source (Int or Ext)  
 Input Channel (A or B) "

This is illustrated by the following examples:

"ACV 100,RMS FILT1HZ,TFER OFF,AVG OFF,TRG\_SOURCE EXT, INPUT CH\_B"

"MVAC 30,RMS FILT100HZ,TFER OFF,AVG AV8,TRG\_SOURCE INT, INPUT CH\_A"

#### Execution Errors:

None.

#### Power On and Reset Conditions

Not applicable. This query recalls the instrument state at the time of asking.

## Error Reporting

### Error Detection

If an error cannot be recovered transparently, it will result in some system action to inform the user via a message, and where possible restore the system to an operational condition.

Errors are dealt with according to their nature:

Recoverable errors report the error and continue.

System errors which cannot be recovered cause the system to halt with a message displayed. In this case, restarting the system from power on may clear the error, but generally such messages are

---

### Device-Dependent Errors (DDE)

A Device-Dependent Error is generated if the device detects an internal operating fault (eg. during self-test). The DDE bit (3) is set *true* in the Standard-defined Event Status Byte, and the error code number is appended to the Device-Dependent Error queue.

In both Remote and Local operation, a device-dependent error is reported by the mechanisms described in the sub-section which deals with status reporting, and the queue entries can be read destructively as LIFO by the query DDQ?. An error message appears on the Menu display.

The Remote user can ignore the queue, but it is good practice to read the errors as they occur.

The queue cannot be read in local operation, but the local user can continue by pressing any primary menu key. The error is, however, added to the queue so that it can be retrieved in remote operation using DDQ?. When entering remote operation (unless it is intended to investigate errors generated in local) it is therefore advisable to empty old errors from the queue using the common command \*CLS.

The code numbers for device dependent errors, with their associated descriptions, are given in Appendix A to Section 4. Each code number refers to a particular stage in a selftest, indicating failure of an individual test. Section 2 in the Servicing Handbook provides diagnostic information related to the test whose code number has been generated.

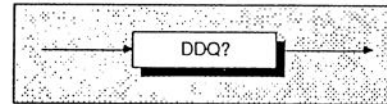
**Recall Device Errors****DDQ?**

recalls the last error from the queue of device dependent errors (e.g errors recorded during a failed operational or diagnosticselftest).

The queue is organized as a last-in - first-out stack, its individual entries being destructively read. If there are no entries in the queue, then use of this command generates a result of  $\emptyset$ .

**Read the Queue until Empty**

It is good practice to read the queue until empty on each occurrence of device-dependent error, to prevent unrelated history of errors being retained.

**Response Format:**

```
Character position
1 2 3 4 5
n n n n nl
```

**Where:**

```
n = 0 to 9
nl = newline with EOI
```

**Response Decode:**

The value returned is a specified integer value indicating the fault. Refer to 'Error Detection' overleaf, and for the meanings of specific codes to Appendix A of Section 4.

**Execution Errors:**

None.

**Reversion from Remote to Local**

Not applicable.

**Power On and Reset Conditions**

Not applicable.

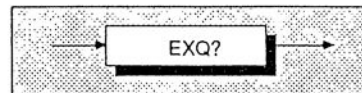
**Error Reporting (Contd.)****Recall Execution Errors****EXQ?**

recalls the last error from the queue of execution errors. An execution error occurs when a command cannot be complied with (e.g calling up a Millivolt range by MVAC *phs Nrf* before the x30 amplifier gain has been measured and stored).

**Response Format:**

Character position			
1	2	3	4
n	n	n	n

**Where:**

n = 0 to 9

A single query sent as a terminated program message will elicit a single response terminated by:

nl = newline with EOI

If multiple queries are sent as a string of program message units (separated by semi-colons with the string followed by a permitted terminator), then the responses will be sent as a similar string whose sequence corresponds to the sequence of the program queries. The final response in the string will be followed by the terminator:

nl = newline with EOI

**Response Decode:**

The value returned is a specified integer value indicating the fault. For details of the number/fault relationship refer to Appendix A to Section 4 of this handbook. Execution Errors are reported in the form required by the IEEE 488.2 standard document.

The execution error queue operates as a last in - first out stack, and individual entries are read destructively. If there are no entries in the queue, then use of this command produces a result of zero.

**Read the Queue until Empty**

It is good practice to read the queue until empty on each occurrence of execution error, to prevent retention of an unrelated history of errors.

**Execution Errors:**

None

**Power On and Reset Conditions**

The queue is cleared.

## General Queries

N.B. Other program queries are listed with their companion program commands (see index)

### I/D (Instrument Identification)

This command conforms to the IEEE 488.2 standard requirements.

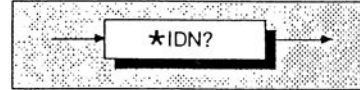

#### \*IDN?

will recall the instrument's manufacturer, model number, serial number and firmware level.

#### Response Format:

Character position															
1	2	3	4	5	6	7	8	9	10	11	12	13	14	15	
W	a	v	e	t	e	k	-	D	a	t	r	o	n	,	
16	17	18	19	21											
4	9	2	0	,											
22	23	24	25	26	27	28	29	30	31	32	33	34			
4	5	6	7	8	9	-	0	1	.	0	9	,			
35	36	37	38	39	40	41	42	43	44	45	46				
4	0	0	9	7	8	/	X	X	.	X	X				

#### Where:

The data contained in the response consists of four comma-separated fields, the last two of which are instrument-dependent. The data element type is defined in the IEEE 488.2 standard specification.

A single query sent as a terminated program message will elicit a single response terminated by:

nl = newline with EOI

If multiple queries are sent as a string of program message units (separated by semi-colons with the string followed by a permitted terminator), then the responses will be returned as a similar string whose sequence corresponds to the sequence of the program queries. The final response in the string will be followed by the terminator:

nl = newline with EOI

#### Response Decode:

The data contained in the four fields is organized as follows:

- First field - manufacturer
- Second field - model
- Third field - serial number - can be altered via a calibration operation - see *page 5-79*.
- Fourth field - part number and issue. revision number (will possibly vary from one instrument to another).

#### Execution Errors:

None.

#### Power On and Reset Conditions

Not applicable.

## General Queries (Contd.)

### Option Configuration

This command conforms to the IEEE 488.2 standard requirements.

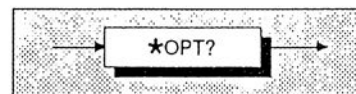

#### \*OPT?

will recall the instrument's option configuration.

#### Response Format:

Character position

1 2 3 4  
x1 , x2 nl

#### Where:

The data in the response consists of comma-separated characters, each being either 1 or 0.

nl = newline with EOI

The data element type is defined in the IEEE 488.2 standard specification.

#### Response Decode:

The character positions represent the following options:

x1 - Millivolt function (Option 10 - mV)  
x2 - not allocated (always 0)

x1 = 1 indicates that the mV option is fitted,  
x1 = 0 indicates that the mV option is not fitted.

#### Execution Errors:

None.

#### Power On and Reset Conditions

Not applicable.

**Recall Today's Date**

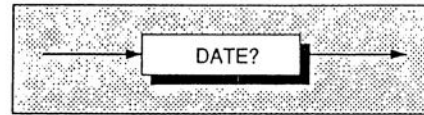

**DATE?**

will return the present date and the time that the query was processed.

**Response Syntax:**

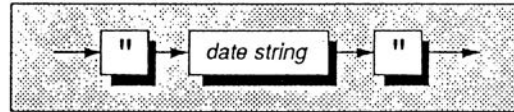

**Response Format:**

	Character position											
	1	2	3	4	5	6	7	8	9	10	11	12
"	m	m	d	d	y	y	h	h	M	M	"	

**Where:**

- m m = two digits representing *month*
- d d = two digits representing *day of month*
- y y = two digits representing *year*
- h h = two digits representing *hour*
- M M = two digits representing *minute*

A single query sent as a terminated program message will elicit a single response terminated by:

nl = newline with EOI

If multiple queries are sent as a string of program message units (separated by semi-colons with the string followed by a permitted terminator), then the responses will be sent as a similar string whose sequence corresponds to the sequence of the program queries. The final response in the string will be followed by the terminator:

nl = newline with EOI

**Response Sources and Decode**

The returned date is derived from the date most-recently entered when in calibration mode: either as a parameter of the DATE command (*page 5-86*), or from the front panel. This is modified by the internal clock to give today's date and time.

**Execution Errors:**

None

**Power On and Reset Conditions**

No Change. Today's date is calculated from data saved in non-volatile memory.

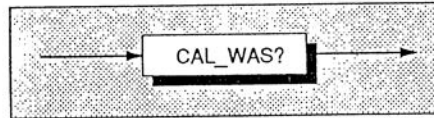
**General Queries** (Contd.)**Query Date of Last Calibration****CAL\_WAS?**

returns the date the date most-recently entered either by use of the command CALSEAL (page 5-85), or when calibration mode was exited from the front panel.

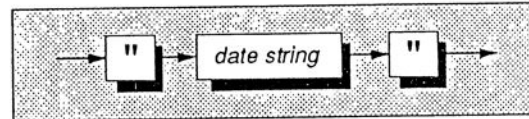
**Response Syntax****Response Format:**

	Character position
1	2 3 4 5 6 7 8
"	m m d d y y "

**Where:**

m m = two digits representing *month*  
 d d = two digits representing *day*  
 y y = two digits representing *year*

**Execution Errors:**

None

**Power On and Reset Conditions**

No Change. The Last Calibration Date is saved in non-volatile memory.

A single query sent as a terminated program message will elicit a single response terminated by:

nl = newline with EOI

If multiple queries are sent as a string of program message units (separated by semi-colons with the string followed by a permitted terminator), then the responses will be sent as a similar string whose sequence corresponds to the sequence of the program queries. The final response in the string will be followed by the terminator:

nl = newline with EOI



**Query Cal-Store Write Count**

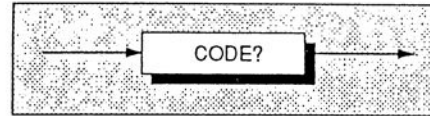

**CODE?**

returns the 'Cal-store Code', which represents the total number of writes to the calibration store.

**Response Syntax**

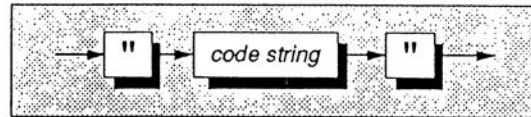

**Response Format:**

	Character position						
1	2	3	4	5	6	7	8
"	α	α	n	n	α	α	"

**Where:**

- α α = two alphabetic characters
- n n = two numeric characters
- α α = two alphabetic characters

The response is a six ASCII-character decode of the total number of times that the calibration store has been written to.

This code is intended to be used to detect whether an unauthorized calibration has been carried out. If the code has changed since the last authorized calibration, this indicates that the calibration store has been written to at on least one occasion. The code is made secure by obscuring the method of incrementation; it will repeat on a cycle of about 200,000 complete calibrations of the instrument.

**Recording the Code**

Effective detection of unauthorized interference with the calibration store is possible only by recording the latest authorized code.

Therefore, as the final action of each authorized calibration, the code should be recorded, so that a comparison can later be made to determine the integrity of the calibration store.

**Execution Errors:**

None

**Power On and Reset Conditions**

No Change. The code is saved in non-volatile memory, and changed only when writing to the cal-store.

**General Queries** (Contd.)**Query Calibration Due Date**

This facility returns the user-recommended date for the next recalibration of the instrument.

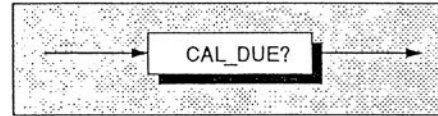

**CAL\_DUE?**

returns the relevant due date, calculated from Last Calibration Date and Calibration Interval.

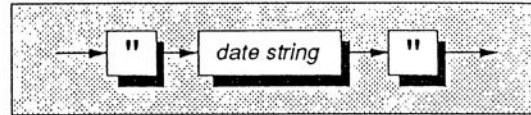
**Response Syntax****Response Format:**

Character position	1	2	3	4	5	6	7	8
	"	m	m	d	d	y	y	"

**Where:**

m m = two digits representing *month*  
 d d = two digits representing *day*  
 y y = two digits representing *year*

A single query sent as a terminated program message will elicit a single response terminated by:

nl = newline with EOI

If multiple queries are sent as a string of program message units (separated by semi-colons with the string followed by a permitted terminator), then the responses will be sent as a similar string whose sequence corresponds to the sequence of the program queries. The final response in the string will be followed by the terminator:

nl = newline with EOI

**Response Sources**

The Last Calibration Date is the date most-recently entered either by use of the command CALSEAL (page 5-85), or when calibration mode was exited from the front panel. The Calibration Interval is the current number of days entered from the front panel, or remotely as a parameter of CALINT (page 5-88).

**Execution Errors:**

None

**Power On and Reset Conditions**

No Change. The due date is calculated from data saved in non-volatile memory.

**Query Calibration Interval**

This facility returns the user-entered time interval between recalibrations of the instrument.

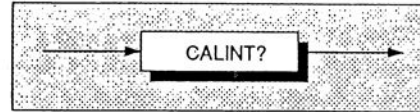
**CALINT?**

returns the instrument's calibration interval; entered previously from the front panel, or remotely as a parameter of CALINT (page 5-88).

**Response Syntax****Response Format:**

Nr1 is an integer.

**Execution Errors:**

None

**Response Source**

The value of Nr1 returned is the current number of days entered from the front panel, or remotely as a parameter of CALINT.

**Power On and Reset Conditions**

No Change. The Calibration Interval is saved in non-volatile memory.

A single query sent as a terminated program message will elicit a single response terminated by:

nl = newline with EOI

If multiple queries are sent as a string of program message units (separated by semi-colons with the string followed by a permitted terminator), then the responses will be sent as a similar string whose sequence corresponds to the sequence of the program queries. The final response in the string will be followed by the terminator:

nl = newline with EOI

## General Queries (Contd.)

### Recall Stored Reference Reading

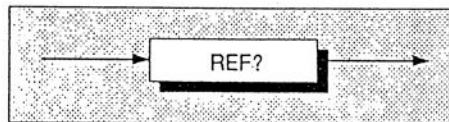

REF? recalls the most recent reading, stored using the REF command (page 5-41).

**Response Format:**

	Character position													
	1	2	3	4	5	6	7	8	9	10	11	12	13	14
	s	n	x	x	x	n	n	n	n	E	sg	p	p	nl

**Where:**

- s = + or - or space
- n = 0 to 9
- x = either n or decimal point (.)
- E = ASCII character identifying the exponent
- sg = + or -
- p = 0 to 9 (exponent is in engineering units)
- nl = newline with EOI

**Reversion from Remote to Local:**

No change

**Execution Errors:**

None

**Power On and Reset Conditions**

All previous results are cleared at Power On and Reset, thus no reference value can exist until a reading value has been stored.

**Response Decode:**

If no signal has been stored as reference, the invalid response is given. The returned value represents the applied signal together with any digital filtering selected by use of the AVG command. Overload or underscale is represented by a value of +200E+33.

**Recall of User Data**

This common command conforms to the IEEE 488.2 standard requirements.

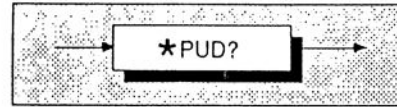

`*PUD?` recalls previously entered user data. Refer to program command `*PUD`, page 5-89.

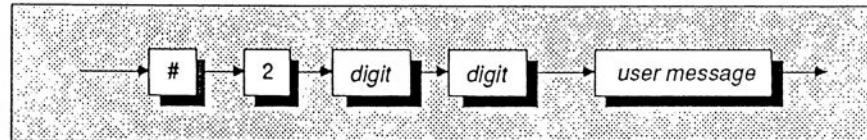
**Response Syntax:**

where:

*digit* = one of the ASCII-coded numerals previously entered,  
*user message* = the saved user message.

**Response Decode:**

The previously-saved message is recalled.

If no message is available, the value of the two digits is 00. The data area contains 63 bytes of data.

A single query sent as a terminated program message will elicit a single response terminated by:

`nl` = newline with EOI

If multiple queries are sent as a string of program message units (separated by semi-colons with the string followed by a permitted terminator), then the responses will be sent as a similar string whose sequence corresponds to the sequence of the program queries. The final response in the string will be followed by the terminator:

`nl` = newline with EOI

**Execution Errors:**

None.

**Power On and Reset Conditions**

Data area remains unchanged.

## Test Operations

### Operational Selftest

This command conforms to the IEEE 488.2 standard requirements.

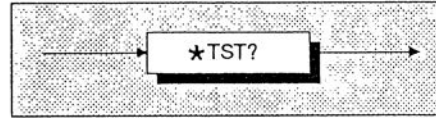

#### \*TST?

executes an operational selftest. A response is generated after the test is completed.

**N.B.** Operational selftest is valid only at temperatures:  $23^{\circ}\text{C} \pm 10^{\circ}\text{C}$ .

#### Response Format:

Character position  
 1 2  
 n nl

#### Where:

n = 0 or 1  
 nl = newline with EOI

#### Response Decode:

The value returned identifies pass or failure of the operational selftest:

**ZERO** indicates operational selftest complete with no errors detected.

**ONE** indicates operational selftest has failed. The errors can be found in the device dependent error queue.

#### Execution Errors:

Operational selftest is not permitted when calibration is successfully enabled.

#### Reversion from Remote to Local

Not applicable.

#### Power On and Reset Conditions

Not applicable.

### Recall Device Errors

**DDQ?** recalls the last error from the queue of device-dependent errors (e.g errors recorded during a failed operational or diagnostic selftest). Refer to *page 5-61*.

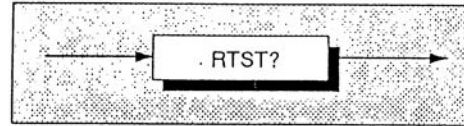
**Resume Selftest****RTST?**

resumes an operational selftest which was interrupted to report a test failure. When the selftest is eventually completed, a response is given.

**Response Format:**

Character position

1 2

n nl

**Where:**

n = 0 or 1

nl = newline with EOI

**Response Decode:**

The value returned identifies pass or failure of the selftest which was resumed:

**ZERO** indicates test complete with no errors detected.

**ONE** indicates the resumed selftest has failed. The errors can be found in the device dependent error queue.

**Execution Errors:**

Operational selftests are not permitted when calibration is successfully enabled.

**Reversion from Remote to Local**

Not applicable.

**Power On and Reset Conditions**

Not applicable.

**Recall Device Errors**

**DDQ?** recalls the last error from the queue of device-dependent errors (e.g errors recorded during a failed operational or diagnostic selftest). Refer to *page 5-61*.

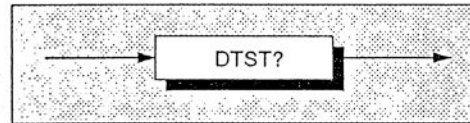
**Diagnostic Selftest****DTST?**

initiates a diagnostic selftest. A response is generated after the test is completed.

**N.B.** Diagnostic selftest is valid only at temperatures:  $23^{\circ}\text{C} \pm 10^{\circ}\text{C}$ .

**Response Format:**

Character position

1 2

n nl

**Where:**

n = 0 or 1

nl = newline with EOI

**Response Decode:**

The value returned identifies pass or failure of the diagnostic test:

**ZERO** indicates test complete with no errors detected.

**ONE** indicates diagnostic selftest has failed. The errors can be found in the device dependent error queue.

**Recall Device Errors**

**DDQ?** recalls the last error from the queue of device-dependent errors (e.g errors recorded during a failed operational or diagnostic selftest). Refer to *page 5-61*.



**Bus Test**

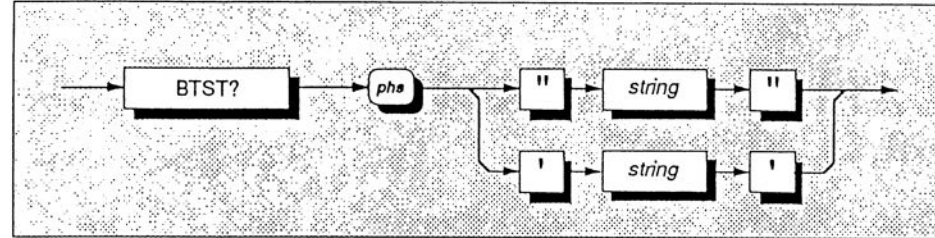

**BTST?**

is used to test the bus drivers. It is a <STRING PROGRAMDATA> element as defined in the standard document. A response is generated when the 4920 is addressed to talk following this command.

*string* is a <string data item>, consisting of up to 128 ASCII characters which must be enclosed in single or double quotes as shown in the syntax diagram. Any embedded quote character in the string, of the same type as the enclosing quotes, must be doubled (repeated) to distinguish it from them. All extra quotes will be stripped from the string upon receipt by the 4920.

**Response Syntax:**

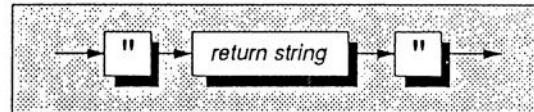

The response is a <STRING REPOSE DATA> element as defined in the standard document.

*return string* is the same as the transmitted *string* data item, stripped of any extra quotes; but as it is to be returned enclosed in double quotes, any embedded double-quote character will be repeated to distinguish it from the enclosing quotes.

**Execution Errors:**

None

**Reversion from Remote to Local**

Not applicable.

**Response Decode:**

After correctly processing embedded quote characters, the returned data can be compared with the transmitted data. The two should be identical.

**Power On and Reset Conditions**

Not applicable.

## Internal Operations Commands

All of the commands under this heading are common commands defined in the IEEE-488.2 standard.

### Reset



#### \*RST

will reset the instrument to a defined condition, stated for each applicable command with the command's description, and listed in Appendix B to this section.

The reset condition is independent of past-use history of the instrument except as noted below:

\*RST does not affect the following:

- the selected address of the instrument;
- calibration data that affect specifications;
- SRQ mask conditions;
- the state of the IEEE 488.1 interface;
- stored math constants.

The action of the front panel Reset key is not equivalent to \*RST, but is a subset of it.

#### Execution Errors:

None.

#### Power On and Reset Conditions

Not applicable.

## Internal Operations Commands (Contd.)

### Operation Complete

This command conforms to the IEEE 488.2 standard requirements.

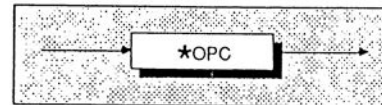

#### \*OPC

is a synchronization command which will generate an operation complete message in the standard Event Status Register when all pending operations are complete.

#### Execution Errors:

None.

#### Power On and Reset Conditions

Not applicable.

### Operation Complete?

This command conforms to the IEEE 488.2 standard requirements.

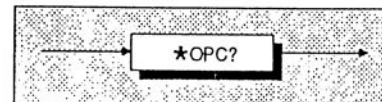

#### Response Format:

Character position

1 2

n nl

#### Where:

n = 1

nl = newline with EOI

#### Response Decode:

The value returned is always 1, which is placed in the output queue when all pending operations are complete.

**Wait**

This command conforms to the IEEE 488.2 standard requirements.

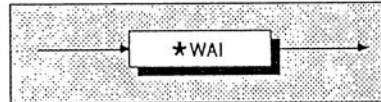
**\*WAI**

prevents the instrument from executing any further commands or queries until the *No Pending Operations Flag* is set true. This is a mandatory command for IEEE-488.2 but has no relevance to this instrument as there are no parallel processes requiring Pending Operation Flags.

**Execution Errors:**

None.

**Power On and Reset Conditions**

Not applicable.

## Calibration Commands and Messages

### Caution

The descriptions in the following pages are intended only as a guide to the messages available to calibrate the instrument. They contain neither examples nor calibration routines, and should NOT be used directly as a basis for calibrating any part of the instrument. Some of the commands, if used unwisely, will obliterate an expensive calibration or recalibration.

For a guide to calibration routines refer to Section 8.

### Calibration Sequences

Remote calibration via the IEEE 488 system bus generally follows similar sequences (and is subject to similar constraints) as for local calibration. But because the remote method does not require a human operator to gain access to a sequence of commands via a single menu screen, it is possible to group commands together within bus message units.

For this reason we should not always expect to find a one-to-one correspondence between the local and remote calibration commands.

### General Outline of Calibration Operations

The calibration process generally conforms to a set sequence of operation:

1. The rear-panel switch must be set to ENABLE, then calibration is enabled using the ENBCAL command, which also requires the type of calibration to be selected (this may need further parameters to be specified).
2. With the appropriate analog input applied, the calibration operation is triggered (usually using the CAL? query). An optional parameter is available for use when the calibration is to be performed at a non-nominal value. Subsequently, in normal use; gain and flatness calibrations are applied to correct the pre-selected function and range. Filter and linearity calibrations are carried out on one range and applied to correct all ranges of the pre-selected function.
3. Other operations can be carried out, such as setting the calendar/clock or the calibration interval.
4. When all calibration operations are complete, the CALSEAL command can be used to record the date of the current calibration. Calibration is then disabled using the EXITCAL command and switching the rear panel switch to DISABLE.

Successive calibration program message units can be sent within a single program message; but as it is normal for calibration operations to be interspersed with other actions to change ranges, inputs etc., it is more usual for each calibration operation to use a terminated program message.

### Enable Calibration

The ENBCAL command allows access to the calibration operations, provided the calibration switch on the instrument rear panel is set to 'ENABLE'. It permits a choice between six types of calibration process, and permits selected areas of non-volatile calibration memory to be cleared.

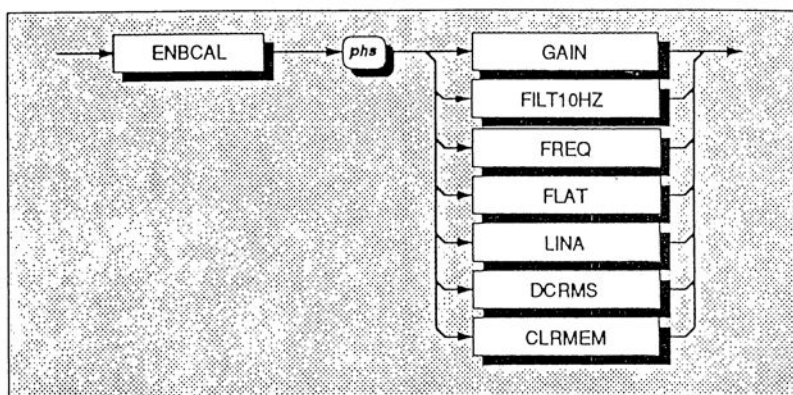

### Effects of Data Elements

#### GAIN

A subsequent CAL? will trigger calibration of the gain of the selected function/range.

#### FILT10HZ

A subsequent CAL? will trigger calibration of the 10Hz filter if the 10V ACV range is selected.

#### FREQ

A subsequent CAL? will trigger calibration of the frequency counter if the 300mV, 1V, 3V or 10V ACV range is selected.

#### FLAT

A subsequent CAL? will trigger calibration of the flatness of the selected function/range.

#### LINA

A subsequent CAL? on the 10V ACV range will trigger calibration of the linearity of all ACV ranges.

#### DCRMS

If in ACV 10V range and TFER DCRMS; a subsequent CAL? triggers calibration of the RMS Converter's AC/DC difference at 10V and 3V.

#### CLRMEM (Caution!)

Enables the use of the CLRMEM program command, which in turn will clear the section of non-volatile calibration memory specified as its parameter. Refer to *page 5-83*.

#### Protected Commands

ENBCAL with any parameter enables the protected commands CALINT, CALSEAL, SERIAL, \*PUD and EXITCAL, provided the rear panel switch is in the enable position.

#### Execution Errors:

An execution error is generated if the rear panel switch is not in the ENABLE position.

#### Power On and Reset Conditions

Calibration disabled.

**ENBCAL Parameters - GAIN, FREQ, FLAT, LINA, DCRMS - Further Details**

**GAIN**

**Calibration Point Targeting** The instrument determines whether it is intended to target an upper or lower calibration point on the active function/range, by measuring the applied input voltage and evaluating the unprocessed reading.

**Nrf:** If the optional *Nrf* is present after CAL?, and is within the *Nrf* limits for the calibration point, then it is used as target for the actual measured value.

**Nrf omitted:** The instrument assumes that nominal is the target for the actual measured value.

**ACV Callbratlon**

Range	Lower Callbratlon Point		Upper Calibration Point	
	Nomlnal	Nrf Limits	Nomlnal	Nrf Limits
0.3V	0.1V	$0.0099V \leq Nrf < 0.15V$	0.3V	$0.15V \leq Nrf < 0.36V$
1V	0.3V	$0.03V \leq Nrf < 0.5V$	1.0V	$0.5V \leq Nrf < 1.2V$
3V	1.0V	$0.099V \leq Nrf < 1.5V$	3.0V	$1.5V \leq Nrf < 3.6V$
10V	3.0V	$0.3V \leq Nrf < 5.0V$	10V	$5.0V \leq Nrf < 12V$
30V	10V	$0.99V \leq Nrf < 15.0V$	30V	$15.0V \leq Nrf < 36V$
100V	30V	$3.0V \leq Nrf < 50.0V$	100V	$50.0V \leq Nrf < 120V$
300V	100V	$9.9V \leq Nrf < 150.0V$	300V	$150.0V \leq Nrf < 360V$
1000V	300V	$30.0V \leq Nrf < 500.0V$	1000V	$500.0V \leq Nrf < 1200V$
Frequency	All Ranges:	Nominal Fc = 1kHz; Frequency Limits are $300Hz < Fc < 3kHz$		

**FREQ**

The frequency counter can be calibrated using the ACV 300mV, 1V, 3V or 10V range.

**Suitable Input Signal Level:** The Lower **GAIN** Calibration Point for the range or greater.

**Nrf.** If the optional *Nrf* is present after CAL?, and is within the *Nrf* frequency limits, then it is used as target calibration frequency.

**NrfOmitted:** If *Nrf* is not present, then the nominal calibration frequency of 1MHz is assumed.

**Nrf and Signal Frequency Limits:**  
 $30\text{kHz} \leq F_c \leq 1.2\text{MHz}$ .

**LINA**

The ACV Linearity can be calibrated using the ACV 1V, 3V or 10V range.

**Suitable Input Signal Level:** The Lower **GAIN** Calibration Point for the range or greater.

**Nrf.** If the optional *Nrf* is present after CAL?, and is within the *Nrf* limits for the upper calibration point, then it is used as target for the actual measured value.

**Nrfomitted:** The instrument assumes that nominal is the target for the actual measured value.

**Frequency Limits:**  $950\text{kHz} \leq F_c \leq 1\text{MHz}$ .

**DCRMS**

The RMS Converter gain and linearity can be calibrated, at 10V and 3V on the 10V range.

**Process:** The AC/DC Transfer must have progressed as far as having used REF to store both DCPOS and DCNEG. Then TFER DCRMS performs the RMS calculation and provides the result. Sending ENBCAL DCRMS enables a subsequent CAL? or CAL? *Nrf* to perform the calibration.

**FLAT**

All ranges can be calibrated for flatness.

**Calibration Point Targeting**

The upper calibration point only is used.

**Nrf.** If the optional *Nrf* is present after CAL?, and is within the **GAIN** *Nrf* limits for the upper calibration point, then it is used as target calibration value.

**NrfOmitted:** If *Nrf* is not present, then the nominal **GAIN** upper calibration point and input limits are assumed.

**Frequency Limits:** Signal frequency  $F_s$  is checked against the following bands of limits before use:

**ACV: 0.3V; 1V; 3V; 10V; 30V & 100V Ranges**

Flatness A:  $9.8\text{kHz} \leq F_s \leq 51\text{kHz}$   
 Flatness B:  $98\text{kHz} \leq F_s \leq 408\text{kHz}$   
 Flatness C:  $490\text{kHz} \leq F_s \leq 765\text{kHz}$   
 Flatness D:  $882\text{kHz} \leq F_s \leq 1020\text{kHz}$

**ACV: 300V & 1000V Ranges**

Flatness A:  $4.9\text{kHz} \leq F_s \leq 15.3\text{kHz}$   
 Flatness B:  $20.4\text{kHz} \leq F_s \leq 40.8\text{kHz}$   
 Flatness C:  $49\text{kHz} \leq F_s \leq 76.5\text{kHz}$   
 Flatness D:  $88.2\text{kHz} \leq F_s \leq 102\text{kHz}$



**Trigger 'Calibration'**

The CAL? command triggers a calibration event. Optional selection of a user-specific non-nominal target value is also available.

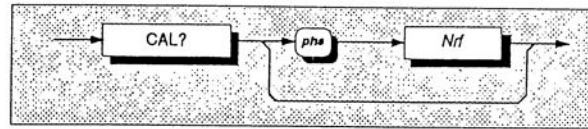
**Calibration Point Targeting**

The instrument determines whether it is intended to target an upper or lower calibration point on the currently active function/range, by measuring the applied input voltage and evaluating the unprocessed reading.

***Nrf***

is a decimal numeric data element representing the user-specific value which is to be assigned as target for the actual measured value. The difference between these two values is used to determine the correction factors.

The *Nrf* value is rounded to 7 digits resolution.

If the *Nrf* data element is included then *phs* is required. The target value must conform to the limits required for the intended calibration point.

***Nrf* omitted**

If the program header separator (*phs*) and *Nrf* are omitted, the instrument assumes that the nominal value is the target for the actual measured value.

**Response Format:**

A single ASCII character is returned.

A single query sent as a terminated program message will elicit a single response terminated by:

nl = newline with EOI

If multiple queries are sent as a string of program message units (each separated by semi-colons, with the string followed by a permitted terminator), then the responses will be sent as a similar string whose sequence corresponds to the sequence of the program queries. The final response in the string will be followed by the terminator:

nl = newline with EOI

**Response Decode:**

The value returned identifies the success or failure of the calibration operation:

**Zero** indicates **complete** with **no error** detected.

**One** indicates **error detected**. The error can be found in the device-dependent error queue.

**Execution Errors**

occur if calibration is not enabled, or if the number used is incompatible with the setting being calibrated.

**Power On and Reset Conditions**

Not applicable.

**Clear Calibration Stores**

To allow the calibration correction memories to be cleared.

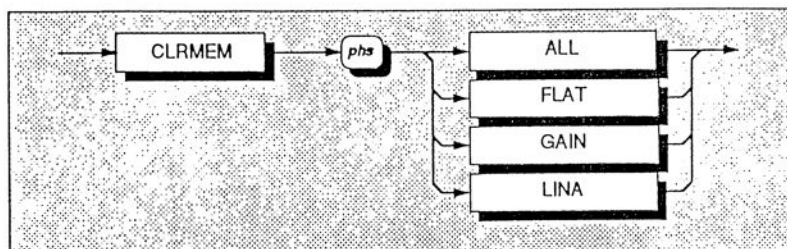
**CLRMEM****Caution!**

This command can **obliterate** the results of an **expensive** original calibration or recalibration!

**Extent of Clear**

The extent of clear is defined by programming the following options:

**ALL** clears all non-volatile calibration memory *except* the data entered using the program headers: SERIAL and \*PUD.

**CALINT:** The calibration interval is reset to 90 days,

**DATE:** The internal calendar/clock is reset to 121281.

**FLAT** Clears the section of non-volatile calibration memory which contains corrections to flatness.

**GAIN** Clears the section of non-volatile calibration memory which contains corrections to range gain.

**LINA** Clears the section of non-volatile calibration memory which contains corrections to ACV linearity.

DCRMS???

5-84

**ROM Checksums**

ROM checksums are recalculated and written to calibration memory when any CLRMEM command is executed.

**Execution Errors**

CLRMEM is executable only when the rear panel calibration switch is in the enabled position *and* calibration has been enabled by the command ENBCAL. Otherwise an Execution Error is returned.

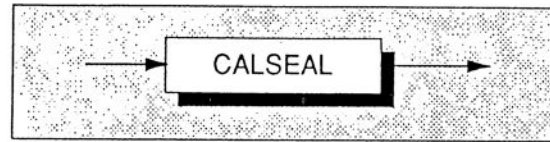
**Set 'Date of Last Calibration'****CALSEAL**

copies today's date to 'Last Cal Date'. This then becomes one of the elements from which the response to the query DUE\_DATE is calculated.

**Execution Errors**

CALSEAL is executable only when the rear panel calibration switch is in the enabled position *and* calibration is enabled by the command ENBCAL. Otherwise an Execution Error is returned.

**Power On and Reset Conditions**

The 'Last Cal Date' is saved in non-volatile memory, so is not destroyed at Power Off.

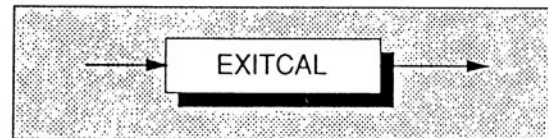
**Exit from Calibration****EXITCAL**

takes the instrument out of calibration mode, thereby disabling the calibration operations which were enabled by the command ENBCAL.

**Execution Errors**

EXITCAL is executable only when the rear panel calibration switch is in the enabled position *and* calibration is enabled by the command ENBCAL. Otherwise an Execution Error is returned.

**Protected Commands**

EXITCAL also disables the protected commands CALINT, CALSEAL, SERIAL, \*PUD, and EXITCAL itself.

**Power On and Reset Conditions**

Not applicable, as calibration is not enabled.

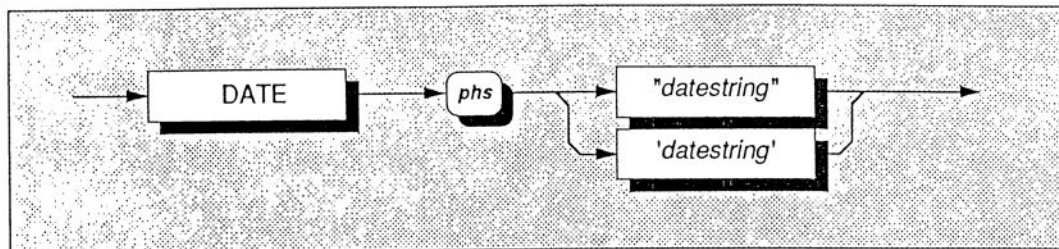

### DATE

allows access to re-set the internal Calendar/Clock to 'Today's Date and Time'.

**datestring** This is a string of ASCII printing characters in the form:

*mmddyymm*

Where:

- mm* = two digits representing *month*  
(01-12)
- dd* = two digits representing *day of month*  
(valid day of specified month and year)
- yy* = two digits representing *year*  
(00-99)
- hh* = two digits representing *hour*  
(00-23)
- MM* = two digits representing *minute*  
(00-59)

Unspecified values of *hhMM* or *MM* will remain unchanged. The datestring is set in quotes so that the specified format can be used for the number itself.

### Query DATE?

At any subsequent time, the query DATE? will return the current 'Today's Date and Time', which is derived by using the internal calendar/clock to project forward from the most-recent registered date: entered either as a parameter of the above command DATE, or entered from the front panel when in calibration mode. Refer to page 5-65.

### Execution Errors

DATE is executable only when the rear panel calibration switch is in the enabled position and calibration has been enabled by the command ENBCAL. Otherwise an Execution Error is returned.

### Power On and Reset Conditions

The date is saved in non-volatile memory, so is not destroyed at Power Off.

**Set Instrument Serial Number**

This number is originally set at manufacture to match the serial number on the rear panel plate. The information is stored in non-volatile RAM and is separately sum-checked against an appropriate individual error message. It can be changed only when in calibration enabled state. User-access has been provided so that an inventory or asset number can be used to replace the manufacturer's serial number.

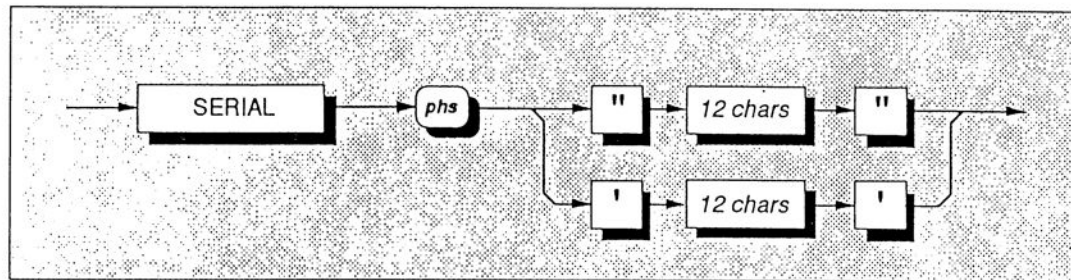

**SERIAL** allows access to change the serial number.

**chars** are ASCII printing characters.

The serial number is set in quotes so that a free format can be used for the number itself.

It can be recalled together with the manufacturer's name, model number and firmware level, using the standard IEEE 488.2 identification query \*IDN? (refer to page 5-63).

**Execution Errors**

SERIAL is executable only when the rear panel calibration switch is in the enabled position *and* calibration has been enabled by the command ENBCAL. Otherwise an Execution Error is returned.

**Power On and Reset Conditions**

The serial number is saved in non-volatile memory, so is not destroyed at Power Off.

## To Change the Instrument's Calibration Interval

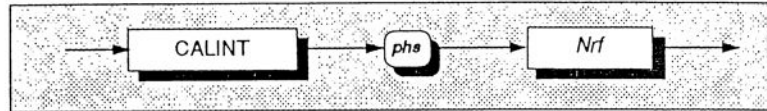

**CALINT** allows the operator to enter the calibration periodicity in days.

***Nrf***

will be rounded to an integer representing the number of days between calibrations. After rounding it must satisfy:  $0 < Nrf < 1000$ .

The integer can be returned using the program query **CALINT?**. It can also be displayed by a front panel user, who can enter a new date only via the (protected) calibration mode menu.

**Calibration Due Date**

The due date can be returned using the program query **CAL\_DUE?** (page 5-68). It is calculated internally; by projecting the calibration interval forward, starting at the date which was most-recently copied to 'Last Cal Date' by the command **CALSEAL** (page 5-85).

**Execution Errors**

**CALINT** is executable only when the rear panel calibration switch is in the enabled position *and* calibration has been enabled by the command **ENBCAL**. Otherwise an Execution Error is returned.

**Power On and Reset Conditions**

The integer is saved in non-volatile memory, so is not destroyed at Power Off.

## Protected User Data

### Entry of User Data

This command conforms to the IEEE 488.2 standard requirements.

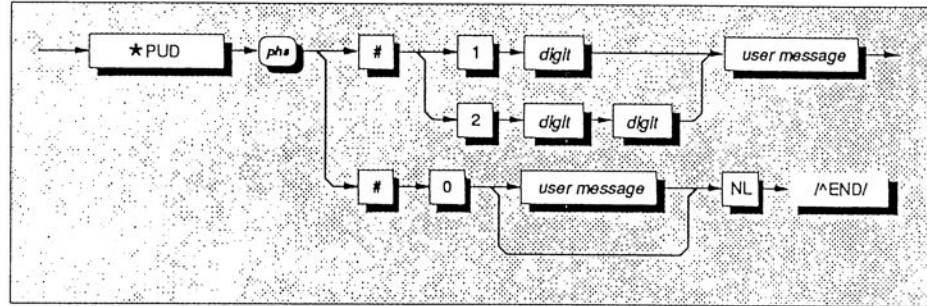

where:

*phs* = Program Header Separator,  
*digit* = one of the ASCII-coded numerals,  
*user message* = any message up to 63 bytes maximum.

### \*PUD

allows a user to enter up to 63 bytes of data into a protected area to identify or characterize the instrument. The two representations above are allowed depending on the message length and the number of 'digits' required to identify this. The instrument must be in calibration mode for this command to execute.

The data can be recalled using the \*PUD? query. Refer to page 5-71.

### Execution Errors

\*PUD is executable only when the rear panel calibration switch is in the enabled position *and* calibration has been enabled by the command ENBCAL. Otherwise an Execution Error is returned.

### Power On and Reset Conditions

Data area remains unchanged.

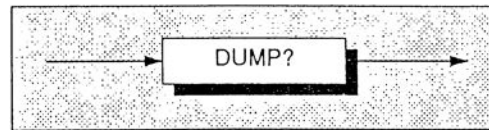
**To Report the Contents of Calibration Memory**

**DUMP?** allows the operator to retrieve data from the calibration memory. This information is related to the currently-selected function and range.

**Response**

Each response consists of an three-digit index number followed by two signed floating point numbers. The index number defines the source of the data in the other two numbers, according to the list opposite.

The index number is reset to zero whenever function is changed remotely, or whenever either function or range is changed locally.

In response to successive DUMP? queries without index reset; the index number is incremented by 1 in each response, and the source of the information is changed as shown in the list opposite.

To return data from a particular source, the DUMP? query must be repeated until the index for that source is reached.

**Response Format:**

Character position

1 2 3 4  
n n n ,

5 6 7 8 9 10 11 12 13 14 15 16 17 18 19  
sg n . n n n n n n n E sg n n ,

20 21 22 23 24 25 26 27 28 29 30 31 32 33  
sg n . n n n n n n n E sg n n

**Where:**

n = 0 to 9

E = ASCII character identifying the exponent

sg = + or -

A single query sent as a terminated program message will elicit a single response terminated by:

nl = newline with EOI

If multiple queries are sent as a string of program message units (separated by semi-colons with the string followed by a permitted terminator), then the

responses will be returned as a similar string whose sequence corresponds to the sequence of the program queries. The final response in the string will be followed by the terminator:

nl = newline with EOI



**Response Decode:**

The data contained in the three fields is organized as in the following list:

**Cal Data for all ACV Ranges**

001 , Lower LF Cal Nominal	, Lower LF Cal Reading	(Volts)	(Volts)
002 , Upper LF Cal Nominal	, Upper LF Cal Reading	(Volts)	(Volts)
003 , HF Cal frequency	, Flatness Error	(Hertz)	(Fraction)
004 , Band A Flatness Cal Frequency	, Flatness Error	(Hertz)	(Fraction)
005 , Band B Flatness Cal Frequency	, Flatness Error	(Hertz)	(Fraction)
006 , Band C Flatness Cal Frequency	, Flatness Error	(Hertz)	(Fraction)
007 , Band D Flatness Cal Frequency	, Flatness Error	(Hertz)	(Fraction)
008 , Lower AC Lin Nominal	, Lower AC Lin Reading	(Volts)	(Volts)
009 , Upper AC Lin Nominal	, Upper AC Lin Reading	(Volts)	(Volts)
010 , Frequency Gain Factor	, 40Hz Filter Error	(Fraction)	(Fraction)
011 , 10Hz Filter Error	, 1Hz Filter Error	(Fraction)	(Fraction)
012 , Lower DCRMS Nominal	, Lower DCRMS Reading	(Fraction)	(Fraction)
013 , Upper DCRMS Nominal	, Upper DCRMS Reading	(Fraction)	(Fraction)

Note that these last six pairs should be range-independent.

Finally, any spot calibrations for the range are dumped, in ascending order of frequency, in the sequence:

Spot Frequency	, Spot Error	(Hertz)	(Fraction)
----------------	--------------	---------	------------

**Errors and Corruptions**

If the index is forced outside its range by excessive repetitions of DUMP?, then the number +2.0000000E+32 is always returned.

If the calstore information is corrupt (i.e. it is a mismatch with its stored complement) then the number -2.0000000E+32 is always returned.

**Execution Errors:**

None.

**Power On and Reset Conditions**

Not applicable.

## IEEE 488.2 Device Documentation Requirements

IEEE 488.2 requires that certain information be supplied to the user about how the device has implemented the standard. The Device Documentation Requirements are detailed in Section 4.9 of the Standard document, on page 32. In this handbook, the required information is already contained within the descriptions of the system, and this appendix provides cross-references to those descriptions in which it is presented. The following paragraphs have the same numbers as the paragraphs of Section 4.9 in the Standard document to which they refer.

1. The list of IEEE 488.1 Interface Functions subsets implemented is given as Table 5.1 (page 5-2). The list is also printed close to the IEEE 488 connector on the rear of the instrument.
2. The instrument address is set manually, and the instrument firmware refuses to set any address outside the range 0-30. It responds instead with a Data Entry Error, displayed on the front panel.
3. The (manual only) method of setting the address is described on page 5-4, including the point in time when the 4920 recognizes a user-initiated address change.
4. Appendix B to Section 5 describes the active and non-active settings at power-on.
5. Message Exchange Options:
  - a. The Input Buffer is a first in - first out queue, which has a maximum capacity of 128 bytes (characters). Each character generates an interrupt to the instrument processor which places it in the Input Buffer for examination by the Parser. The characters are removed from the buffer and then translated with appropriate levels of syntax checking. If the rate of programming is too fast for the Parser or Execution Control, the buffer will progressively fill up. When the buffer is full, the handshake is held.
  - b. No query returns more than one <RESPONSE MESSAGE UNIT>.
  - c. All queries generate a response when parsed.
  - d. No query generates a response when read.
  - e. No commands are coupled.
6. The following functional elements are used in constructing the device-specific commands:
  - Command Program Header
  - Query Program Header
  - Character Program Data
  - Decimal Numeric Program Data.
  - String Program Data (DATE, SERIAL, BTST? and PROG?)
  - Arbitrary Block Program Data (\*PUD)Compound Command Program Headers are not used

## Section 5 - System Operation

---

7. \*PUD blocks are limited to 63 bytes.
8. Expression Program Data elements are not used.
9. The syntax for each command is described in the general list of commands on pages 5-28 to 5-88. This list includes all queries, for which the response syntax is also described.
10. None. All device-to-device message transfer traffic follows the rules for <RESPONSE MESSAGE> elements.
11. The only command which elicits a Block Data response is the query \*PUD?. Its response consists of #, 2, two digits and a data area of 63 bytes; 67 bytes in all.
12. A separate list of every implemented Common Command and Query is given in the alphabetical index at the start of Section 5. They are also described in the general list on pages 5-28 to 5-88.
13. \*CAL? is not implemented.
14. \*DDT is not implemented.
15. Macro commands are not implemented.
16. \*IDN? is described on page 5-63.
17. \*PUD blocks are limited to 63 bytes.
18. Neither \*RDT nor \*RDT? are implemented.
19. The states affected by \*RST are described for each command in the list of commands and queries on pages 5-28 to 5-88. Query Command \*LRN? is not implemented; neither are Commands \*RCL and \*SAV.
20. \*TST? invokes the Operational Selftest. The response to \*TST? is described on page 5-46, with a list of possible errors detailed in Appendix A to Section 4 of this handbook. The Servicing Handbook Section 2 describes the nature of the tests applied and the resulting error codes for both the Operational Selftest, and the Diagnostic Selftest DTST?.
21. The additional status data structures used in the instrument's status reporting are fully described on pages 5-17 to 5-27. Operating instructions for the status reporting facilities are given on pages 5-49 to 5-59.
22. All commands are sequential - overlapped commands are not used.
23. As all commands are sequential, there are no pending parallel operations. The functional criterion which is met, therefore, is merely that the associated operation has been completed.

## 4920 Device Settings at Power On

### Active Function:

Funct.	Range	Dig. Filter	RMS Low Freq
ACV	1kV	AVG_OFF	FILT_100Hz

### Inactive Function:

Funct.	
AC/DC Transfer	TFER_OFF (no stored references)
mV (Option 10)	x30 Amplifier Gain Undetermined

### Analog Connections

Input	INPUT_CHB (Channel B selected - 4mm Terminal Posts)
-------	---

### Analog Processes and Conditioning

Trigger Source	Internal
Voltage Reading	'Overload' given until first trigger processed.
Frequency Reading	'Invalid' given until first trigger processed.

### Post A-D Processes

AVG	OFF
Deviation Readings	Cleared at Power On and Reset, so no reading exists until after the first trigger.

### Math

MEAN and SIGMA unavailable until a reference reading has been stored

### Calibration Processes

Calibration	Disabled
Calibration Corrections	Applied
Calibration Interval	Previous interval preserved
Calibration Due Date	Previous date preserved

### Device Monitoring

Last Reading Value Recall	Invalid until after first trigger
Last Reading Frequency Recall	Invalid until after first trigger
Device I/D (Serial Number)	Previous entry preserved
Protected User Data	Previous entry preserved

Section 5 - System Operation

---

**Status Reporting Conditions**

**Status Byte Register**

Depends on state of \*PSC

**Event Status Register**

Depends on state of \*PSC

**Event Summary Register**

Depends on state of \*PSC

**\*PSC Condition**

Previous state preserved

**Output Queue**

Empty until after first trigger  
or unless error detected

1 2 3 4 5 6 7 8 9 10 11 12 13 14 15 16 17 18 19 20 21 22 23 24 25 26 27 28 29 30 31 32 33 34 35 36 37 38 39 40 41 42 43 44 45 46 47 48 49 50 51 52 53 54 55 56 57 58 59 60 61 62 63 64 65 66 67 68 69 70 71 72 73 74 75 76 77 78 79 80 81 82 83 84 85 86 87 88 89 90 91 92 93 94 95 96 97 98 99 100

## SECTION 6 SPECIFICATIONS

### MECHANICAL AND ENVIRONMENTAL

HEIGHT	88mm (3.5ins).
WIDTH	427mm (16.8ins).
DEPTH	487 max. (19.2ins).
WEIGHT	11.8kg (26 lbs).
RACK MOUNTING	Rack mounting ears to fit standard 19inch rack (ANSI-EIA-310-C). Conversion to accept 0.5inch wide slides, including MATE standard (Drg No. 2806701, Sperry).
RACK MOUNTING DEPTH	467mm (18.4ins).
TEMPERATURE	Non-Operating: -40°C to +70°C. Operating: 0°C to 50°C.

## ELECTRICAL

**POWER SUPPLY** Voltage: single-phase 100V-130V or 200V-260V selectable from rear panel.  
Line Frequency: 47Hz to 63Hz.

**POWER CONSUMPTION** 37 VA maximum.

**INPUT PROTECTION** **ACV & AC/DC** function inputs: 1.1kV rms all ranges.  
mV input: 3V rms. Fuse protected above this level.

**INPUT IMPEDANCE** **ACV, mV** and **AC/DC** function inputs:  
3mV to 1V ranges: 404k $\Omega$  shunted by 90pF  
3V to 100V ranges: 124k $\Omega$  shunted by 150pF  
300V & 1kV ranges: 404k $\Omega$  shunted by 90pF

**INPUT SENSING** True rms, DC and 1Hz to 1.25MHz.

**INPUT VOLT. HERTZ** 7.5x10<sup>7</sup> maximum.

**WARM UP TIME** 90 minutes to full accuracy after power on.

**MEASUREMENT ACCURACY** See accuracy specification tables.

<b>ACQUISITION TIME</b>	<b>RMS LF Mode Selected</b>	<b>Acquisition Time</b>
	100Hz	XX2.5 seconds.
	40Hz	XX4 seconds.
	10Hz	XX8 seconds.
	1Hz	XX35 seconds.

**Note:** For maximum accuracy at 1kV levels on the 1kV range, it is advisable to allow the instrument to settle for a longer period until a stable reading is obtained.

**SAFETY** Designed to UL1244; IEC 348.

**EMI** FCC Rules, Part 15, sub-part J: Limits A and B.  
VDE 0871: Limits A and B.



## Maximum Inputs

### Peak ACV Inputs [1][2]

Ch. A Inner		Ch. A Outer		Ch. B HI		Ch. B Lo		Safety Ground	
290V		1430V		1430V		10V			
290V		10V		1420V		10V			
290V		0V		1420V		10V			
290V		0V		1420V		10V		0V	

Logic Ground

### Peak Millivolt Inputs [1][2]

Ch. A Inner		Ch. A Outer		Ch. B HI		Ch. B Lo		Safety Ground	
290V		1430V		1430V		10V			
290V		10V		1420V		10V			
290V		0V		1420V		10V			
290V		0V		1420V		10V		0V	

Logic Ground

### Peak AC/DC Transfer Inputs [1][2]

Ch. A Inner		Ch. A Outer		Ch. B HI		Ch. B Lo		Safety Ground	
290V		1430V		1430V		10V			
290V		10V		1420V		10V			
290V		0V		1420V		10V			
290V		0V		1420V		10V		0V	

Logic Ground

## Notes to Maximum Input Tables

- [1] Logic Ground and Input Signal Lo (ChA input) are internally connected to Safety Ground.
- [2] Signals at any input during Self Test may affect performance of test.

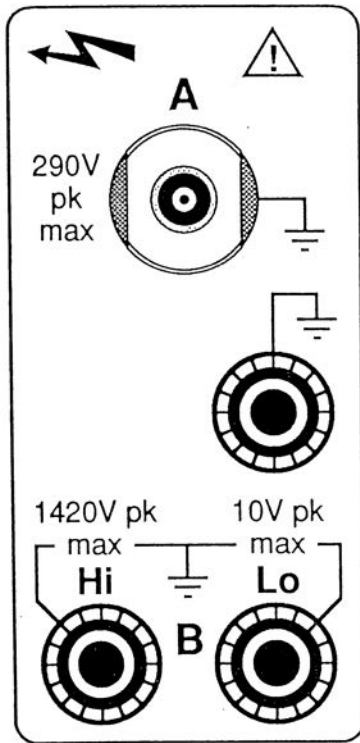

## ACCURACY SPECIFICATIONS

### ACV Accuracy

#### Operational Validity

ACV Operation is valid between 9% and 110% of nominal range, and for frequencies in the range: 1Hz to 1.25MHz.

#### Specification Validity

ACV Specifications are valid between 30% and 110% of nominal range, for available frequencies from 1Hz to 1MHz, subject to a Volt-Hertz limit of  $7.5 \times 10^7$ .

#### Spot Calibration Specification Validity

Spot calibrated mode specifications are valid at up to  $\pm 2\%$  about the spot calibrated frequency and between 50% and 110% of nominal range.

#### Absolute Uncertainty

To calculate the absolute uncertainty in a measurement made with a factory calibrated 4920, combine the 4920 'Performance Relative to Calibration Standards' with the relevant 'Calibration Uncertainty'.

#### Note [1]: Calibration Uncertainties.

The listed 4920 calibration uncertainties are traceable to and include the uncertainties of the US National Institute of Standards and Technology. Individual uncertainty contributions have been combined to give a minimum confidence level of 99%.

Calibration of the 4920 to standards traceable to other National Standards Laboratories will yield different figures for calibration uncertainty, due to the different capabilities of those National Standards laboratories.

For more detailed information on traceability issues in general and the factory calibration of the 4920 in detail, please refer to the applications note entitled "Datron 4920 AVMS - Calibration and Traceability".

AC Voltage

Voltage Range	Frequency (Hz)	Accuracy Relative to Calibration Standards (ppm Reading)								Calibration Uncertainty [1] (±ppm Rdg)
		24 Hour ± 1°C		90 day ± 1°C		1 Year ± 5°C		2 years ± 5°C		
		Broadband	Spot	Broadband	Spot	Broadband	Spot	Broadband	Spot	
300mV	1 - 2	320	230	340	250	360	300	370	330	200
	2 - 10	120	30	140	50	160	100	170	130	200
	10 - 40	15	5	20	10	30	20	35	25	45
	40 - 30k	15	5	20	10	30	20	35	25	13
	30k - 200k	60	15	70	25	80	50	85	65	50
	200k - 500k	225	50	250	75	325	200	350	250	100
500k - 1M	600	150	650	200	850	500	950	600	130	
1V	1 - 2	320	230	340	250	360	300	370	330	180
	2 - 10	120	30	140	50	160	100	170	130	180
	10 - 40	15	5	20	10	30	20	35	25	13
	40 - 30k	15	5	20	10	30	20	35	25	13
	30k - 200k	60	15	70	25	80	50	85	65	40
	200k - 500k	225	50	250	75	325	200	350	250	100
500k - 1M	600	150	650	200	850	500	950	600	130	
3V	1 - 2	320	230	340	250	360	300	370	330	180
	2 - 10	120	30	140	50	160	100	170	130	180
	10 - 40	15	5	20	10	30	20	35	25	13
	40 - 30k	15	5	20	10	30	20	35	25	8
	30k - 200k	60	15	70	25	80	50	85	65	40
	200k - 500k	225	50	250	75	325	200	350	250	100
500k - 1M	600	150	650	200	850	500	950	600	130	
10V	1 - 2	320	230	340	250	360	300	370	330	200
	2 - 10	120	30	140	50	160	100	170	130	200
	10 - 40	15	5	20	10	30	20	35	25	13
	40 - 30k	15	5	20	10	30	20	35	25	8
	30k - 200k	60	15	70	25	80	50	85	65	40
	200k - 500k	225	50	250	75	325	200	350	250	100
500k - 1M	600	150	650	200	850	500	950	600	130	
30V	1 - 2	320	230	340	250	360	300	370	330	200
	2 - 10	120	30	140	50	160	100	170	130	200
	10 - 40	15	5	20	10	30	20	35	25	25
	40 - 30k	15	5	20	10	30	20	35	25	13
	30k - 200k	60	15	70	25	80	50	85	65	40
	200k - 500k	225	50	250	75	325	200	350	250	100
500k - 1M	600	150	650	200	850	500	950	600	130	
100V	1 - 2	320	230	340	250	360	300	370	330	200
	2 - 10	120	30	140	50	160	100	170	130	200
	10 - 40	15	5	20	10	30	20	35	25	25
	40 - 30k	15	5	20	10	30	20	35	25	18
	30k - 200k	60	15	70	25	80	50	85	65	50
300V	1 - 2	330	240	350	260	380	310	400	340	200
	2 - 10	130	40	150	60	180	110	200	140	200
	10 - 40	20	10	25	15	35	25	40	30	35
	40 - 20k	20	10	25	15	35	25	40	30	20
	20k - 100k	65	20	80	30	105	55	120	70	50
1000V	1 - 2	330	240	350	260	380	310	400	340	200
	2 - 10	130	40	150	60	180	110	200	140	200
	10 - 40	20	10	25	15	35	25	40	30	30
	40 - 20k	20	10	25	15	35	25	40	30	30
	20k - 100k	65	20	80	30	105	55	120	70	60

## mV Accuracy

### Measurement Method

The measurement method consists of two steps. In step one, a nominal 100mV signal at the frequency of interest is applied to the input terminals (the absolute value is unimportant) and a sequence of measurements on the higher, traceably calibrated ranges establishes the gain of a bypassable millivolt amplifier.

Within 24 hours,  $\pm 1^\circ\text{C}$  and  $\pm 1\%$  in frequency of this gain measurement, the unknown millivolt level signal may then be measured by amplification and measurement on the calibrated higher ranges.

For more detailed information on this operating mode, refer to the applications note 'Datron 4920 AVMS - Design, Application and Performance'

### Sources of Uncertainty

The following performance specifications include all contributions of error: the performance of the higher voltage ranges of the 4920, the calibration of these ranges, the error in the measurement of the gain of the bypassable millivolt amplifier and the gain stability, temperature stability and linearity of the amplifier.

### Specification Validity

Specifications are valid from 30% to 110% of nominal range.

The 24 hour  $\pm 1^\circ\text{C}$ , 90 day  $\pm 1^\circ\text{C}$ , 1 year  $\pm 5^\circ\text{C}$  and 2 year  $\pm 5^\circ\text{C}$  time and temperature spans refer to the time and temperature change since traceable calibration of the higher voltage ranges of the 4920.

## AC MilliVolts

Voltage Range	Frequency (Hz)	Absolute Accuracy ( $\pm$ ppm Reading)		
		90 day $\pm 1^\circ\text{C}$	1 Year $\pm 5^\circ\text{C}$	2 years $\pm 5^\circ\text{C}$
3mV	10 - 100	1270	1300	1320
	100 - 30k	1100	1130	1150
	30k - 200k	1580	1650	1680
	200k - 500k	2750	3000	3150
	500k - 1M	5400	6100	6450
10mV	10 - 100	390	420	440
	100 - 30k	230	260	270
	30k - 200k	530	600	630
	200k - 500k	1450	1700	1800
	500k - 1M	3500	4100	4500
30mV	10 - 100	310	330	350
	100 - 30k	180	200	210
	30k - 200k	390	430	450
	200k - 500k	1150	1300	1400
	500k - 1M	2700	3100	3400
100mV	10 - 100	235	250	260
	100 - 30k	100	120	130
	30k - 200k	210	230	250
	200k - 500k	620	700	750
	500k - 1M	1600	1850	2000

## AC/DC Transfer Accuracy

### Functional Method

The AC/DC transfer function displays the difference between the unknown AC signal and the average of a positive and negative DC signal in the range 100mV to 1100V, previously stored under front panel or IEEE-488.2 control.

### Operating Validity

This operating mode is valid for any voltage and frequency combination, but yields a significant improvement in measurement uncertainty only for the frequency band from 40Hz to 30kHz.

### Specification Validity

Therefore, specifications for this mode are as the specifications for the ACV Function, with the exceptions shown in the table opposite, and are valid when DC and AC are within 1% of each other and are both within +10% and -30% of nominal full range.

For more detailed information on this operating mode, refer to the applications note "Datron 4920 AVMS - Design, Application and Performance"

### Note [2]: Calibration Uncertainty.

The 4920 calibration uncertainties listed are traceable to and include the uncertainties of the US National Institute of Standards and Technology. The individual uncertainty contributions have been combined to give a minimum confidence level of 99%.

Calibration of the 4920 to standards traceable to other National Standards Laboratories will yield different figures for calibration uncertainty due to the different capabilities of those National Standards laboratories.

The uncertainties listed here define Datron's ability to transfer the national standard of AC/DC difference to the 4920, rather than an absolute AC voltage, hence the difference between these columns of Calibration Uncertainties and those listed in the 'ACV Function' specifications.

To calculate the uncertainty in an AC/DC Transfer measurement, simply combine the Calibration Uncertainty specification to the 4920 accuracy relative to calibration standards AND the traceability of the DC signal used in the Transfer process.

AC/DC Transfer

Voltage Range	Frequency (Hz)	Accuracy Relative to Calibration Standards ( $\pm$ ppm Reading)						Calibration Uncertainty [2] ( $\pm$ ppm Reading)
		90 day $\pm 1^\circ\text{C}$		1 Year $\pm 5^\circ\text{C}$		2 years $\pm 5^\circ\text{C}$		
		Broadband	Spot	Broadband	Spot	Broadband	Spot	
300mV	40 - 30k	17	7	17	7	18	8	12
1V	40 - 30k	17	7	17	7	18	8	12
3V	40 - 30k	17	7	17	7	18	8	7
10V	40 - 30k	17	7	17	7	18	8	7
30V	40 - 30k	17	7	17	7	18	8	12
100V	40 - 30k	17	7	17	7	18	8	17
300V	40 - 20k	22	12	22	12	23	13	19
1000V	40 - 20k	22	12	22	12	23	13	29



## SECTION 7 SPECIFICATION VERIFICATION

### Introduction

This section details the procedures required to check that the 4920 is performing to its accuracy specification. It should be used to verify correct instrument performance when the instrument is first received from the manufacturer, and as a normal part of routine 4920 recalibration.

### Equipment Requirements

Equipment Type	Range	Accuracy [1][2]
DC Voltage Calibrator [3] e.g. Datron Model 4808 (Options 10 & 30) or Datron Model 4708 (Option 10)	Voltage: 100mV to 1000V Resolution: 1ppm	±4ppm
AC Voltage Calibrator/ High Resolution AC Voltage Source [3] e.g. Datron Model 4808 (Options 20 & 30) or Datron Model 4708 (Option 20)	Voltage: 300mV to 1000V Frequency: 10Hz to 1MHz Resolution: 1ppm	1V to 3V: ±210ppm at 10Hz ±100ppm at 1kHz ±5ppm short-term stability
Thermal Voltage Converters e.g. Holt Model 11, and Ballantine Model 1396	Voltage: 300mV to 1000V Frequency: DC to 20MHz	To best uncertainties
DC Nanovoltmeter e.g. EM Model N2a or Keithley Model 181	±100nV to ±10mV	Better than 2% of range
DC nV Source e.g. EM Model S6	10mV	±1ppm short-term stability

- [1] Absolute accuracy (traceable to National Standards, and inclusive of National Standards uncertainties).
- [2] Provides a 95% confidence level of achieving a 4:1 calibration ratio except where 'state-of-the-art' limitations apply.
- [3] This equipment can be part of a single AC/DC unit. e.g. a Datron 4808 multifunction calibrator with Options 10, 20 and 30; or 4708 with Options 10 and 20.

## Preparation

1. Before operating it, familiarize yourself with the performance verification equipment by reading the appropriate operating manuals.  
In particular, note the electrical and mechanical handling procedures required to maintain the calibration of the thermal voltage converters.
2. **Note any safety precautions which are necessary to prevent electrical shock from the equipment.**
3. Set up the equipment in a stable environment at  $23^{\circ}\text{C}\pm 1^{\circ}\text{C}$ , power it on and allow it to stabilize for an appropriate period of time. The 4920 requires a minimum of 90 minutes to warm up after it is powered on.
4. Select the **TEST** menu by pressing the front-panel **Test** key and select the **Oper** (Operational Test) menu option. Allow the operational self-test to run to completion, at which point the 4920 should display the word **COMPLETED**.  
If at any point during the operational self-test the 4920 displays the words **OPER FAIL** (Operational Test Failure) the unit probably has a fault, in which case refer to the 4920 Servicing Handbook before proceeding.

## ACV Performance Verification

For each of the verification point voltages detailed in the ACV Full Range Checks section of the 4920 Verification Report Sheet, carry out the following procedure:

1. Configure a thermal voltage converter for the required verification point voltage.
2. Connect the DC voltage calibrator to the 4920 and thermal voltage converter as shown in Figure 7.1 and select the 4920's ACV function.
3. Set the output of the DC voltage calibrator to the required verification point voltage and turn the output of the calibrator on.
4. Allow the thermal voltage converter to stabilize.
5. Adjust the DC nV source to achieve a null on the DC nanovoltmeter.
6. Reverse the polarity of the DC voltage calibrator output, allow the thermal voltage converter to settle, and note the DC reversal error on the nanovoltmeter. Adjust the nV source until the nanovoltmeter shows half of the DC reversal error.
7. Turn the output of the calibrator off and disconnect it by splitting the two N-series tees.
8. Connect the high resolution AC voltage source in place of the DC voltage calibrator. (Note: if the DC calibrator and AC voltage source are combined into a single unit, the output of this unit can simply be switched from DC to AC.)
9. Set the AC voltage source to the selected verification point voltage and frequency and turn its output on.
10. Increment or decrement the AC source output voltage to achieve a null on the DC nanovoltmeter. Allow the thermal voltage converter to settle, and check and adjust the null. Note the 4920 reading in the '4920 Reading' column of the Verification Report Sheet.
11. Calculate the true value of the AC voltage source from the data recorded on the 4920 Verification Report Sheet, taking into account the AC-DC transfer error of the thermal voltage converter at the selected voltage and frequency.
12. Calculate the Validity Tolerance Limits as indicated on the Verification Report Sheet and check that the value entered in the '4920 Reading' column is within these limits.

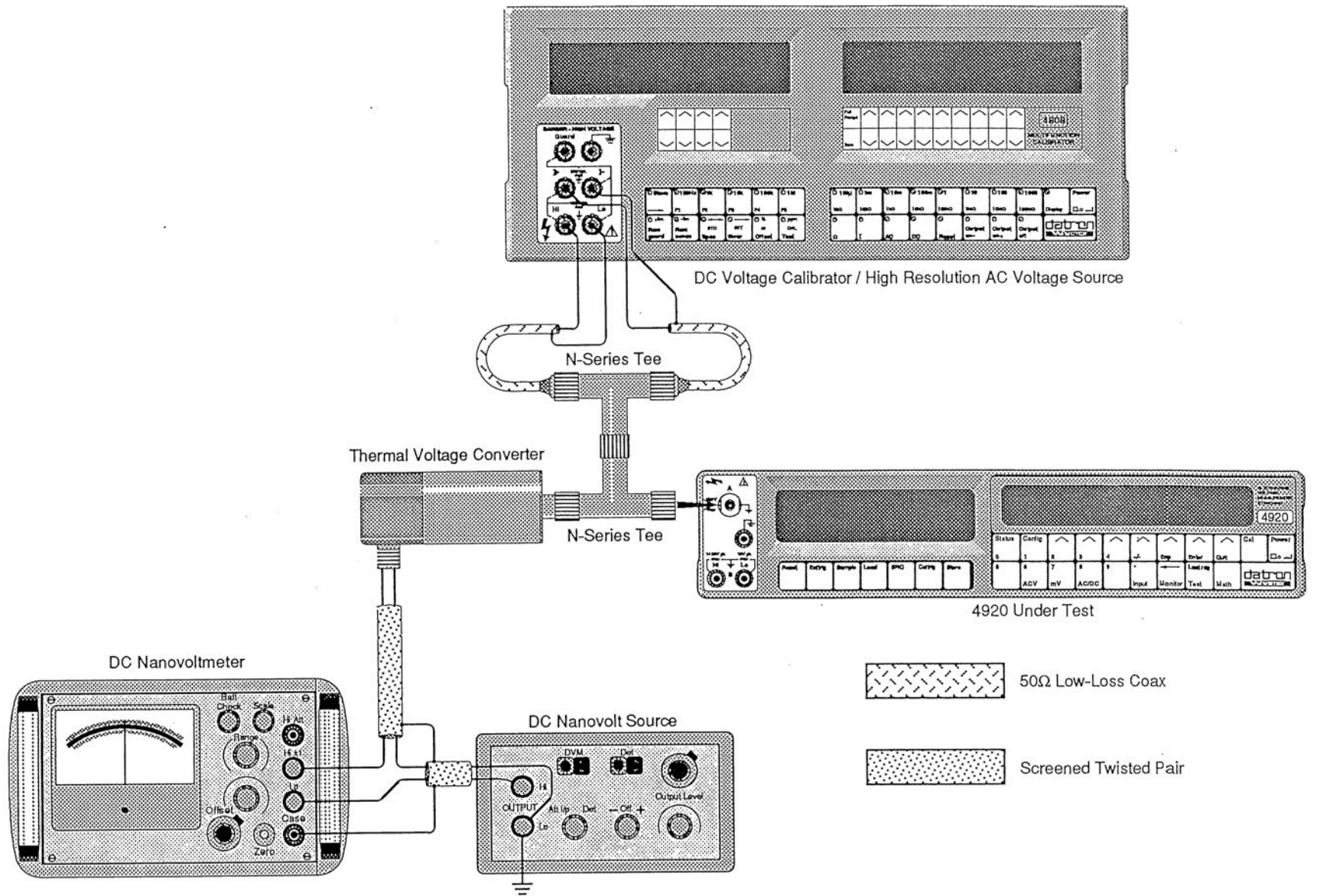

FIG. 7.1 ACV FULL RANGE PERFORMANCE VERIFICATION  
-INTERCONNECTIONS

## Provision of Spot Frequencies

### Spot Frequencies

For applications that require lower measurement uncertainties than those available from 'broadband' operation, the 4920 incorporates a facility for eliminating flatness errors using 'spot' frequency calibration.

A Spot Frequency is created by being calibrated. The method is detailed, with other calibration procedures, in *Section 8*.

Each spot is a band of frequencies of  $\pm 2\%$  about the calibrated spot frequency. It specifies a span of voltage between 50% and 110% of nominal range and frequency, for which an extra correction is obtained during 'spot calibration', and reapplied when using Spot Frequency mode.

A grand total of up to 100 spots can be allocated, during calibration, to particular ranges and frequencies.

For further information about spot frequencies, refer to *Section 4 Pages 4-15 and 4-16*.

### Verifying Spot Frequencies

The Spot Frequency facility is provided for the user's convenience, and it is expected that users will wish to verify the accuracy of spots that they have created. For this purpose a blank report table appears at the rear of this section, which includes space to insert the uncertainties necessary to construct a 'Validity Tolerance'.

As part of the final calibration of the 4920, the manufacturer offers a purchasable service option: to create a standard set of spot frequencies for use when calibrating the AC Voltage ranges of Datron Model 4708 (Multifunction Calibrator) and 1281 (DMM).

As these spots are calibrated at the factory, User's may wish to verify them on receipt of the instrument, and at subsequent intervals. For this purpose a report table for the standard option set of spots is also provided at the rear of this section. A separate procedure for spot frequency verification is given on the opposite page.

## Spot Frequency Verification

For each spot frequency to be verified, carry out the following procedure:

1. Configure a thermal voltage converter for the required verification point voltage.
2. Connect the DC voltage calibrator to the 4920 and thermal voltage converter as shown in Figure 7.1 and select the 4920's ACV function.
3. Set the output of the DC voltage calibrator to the voltage of the required spot and turn the output of the calibrator on.
4. Allow the thermal voltage converter to stabilize.
5. Adjust the DC nV source to achieve a null on the DC nanovoltmeter.
6. Reverse the polarity of the DC voltage calibrator output, allow the thermal voltage converter to settle, and note the DC reversal error on the nanovoltmeter. Adjust the nV source until the nanovoltmeter shows half of the DC reversal error.
7. Turn the output of the calibrator off and disconnect it by splitting the two N-series tees.
8. Connect the high resolution AC voltage source in place of the DC voltage calibrator. (Note: if the DC calibrator and AC voltage source are combined into a single unit, the output of this unit can simply be switched from DC to AC.)
9. Set the AC voltage source to the required spot voltage and frequency and turn its output on.
10. On the 4920, select the required spot (refer to Section 4 Page 4-16).
11. Increment or decrement the AC source output voltage to achieve a null on the DC nanovoltmeter. Allow the thermal voltage converter to settle, and check and adjust the null. Note the 4920 reading in the '4920 Reading' column of the Verification Report Sheet.
12. Calculate the true value of the AC voltage source from the data recorded on the 4920 Spot Verification Report Sheet, taking into account the AC-DC transfer error of the thermal voltage converter at the selected voltage and frequency.
13. Calculate the Validity Tolerance Limits as indicated on the Spot Verification Report Sheet and check that the value entered in the '4920 Reading' column is within these limits.

## User's Uncertainty Calculations

The accuracy and traceability of a user's standards affect the manner in which the performance of the 4920 can be verified. Because users will need to evaluate the effects of the uncertainties associated with their own equipment in conjunction with the 4920's accuracy specifications, calculations for total tolerance limits (Validity Tolerances) are required.

### The 'Validity Tolerance'

It is impossible to verify the specification of an instrument with absolute certainty, even using the original calibration equipment to make the measurements. All measurements carry a degree of uncertainty in themselves, these uncertainties being quantified by the traceability of the measuring equipment to National Standards and the repeatability of the transfers involved.

The performance verification measurements which follow are intended to establish that the instrument performs within its specifications - i.e. that it operates within the tolerance of its accumulated uncertainties. As the measurements taken to verify the instrument's performance have their own accumulated uncertainties, these must be added to those of the instrument in order to set a 'Validity Tolerance'.

The Validity Tolerance for the 4920 is obtained by adding all the intervening uncertainties (from the point at which the performance verification measurement is made, back to and including National Standards uncertainties) to the worst case instrument specification at the verification point voltage and frequency. For the standards equipment used, worst-case tolerances must be assumed. Complete the following tables and calculate the validity tolerance limits using the formulae provided. If any range fails to verify and the instrument is to be returned, please be certain to include a copy of the Verification Report Sheet and give as much detail as possible about the performance verification setup.

# Verification Report Sheet

Model 4920                      Serial Number.....                      Last Calibration Date.....

Current Date.....                      Checked by.....                      Company/Dept.....

Note: It is advisable to make duplicate copies of this report sheets for future use. Check at the values shown in the tables. Contact your Datron Service Centre if the instrument fails to verify and please include a copy of the completed Verification Report Sheet if the instrument is returned.

**IMPORTANT:**

The 4920 accuracy specifications listed in the following tables are absolute accuracies which assume that the 4920 has been traceably calibrated as detailed in Section 8 of the 4920 User's Handbook. If the 4920 has been calibrated against calibration standards which do not have the absolute accuracies detailed in Section 8 of the 4920 User's Handbook then the 4920 accuracy specifications listed in the following tables will not apply.

**Calculation of Validity Tolerances**

Intermediate quantities and final Validity Tolerances should be calculated using the equations shown beneath the column headings in the tables. It should be noted that the references used in these equations — for example (a), (b), (c), (d) etc. — refer only to values within the same table as indicated.



ACV Broadband Full Range Checks

ACV Range	Verification Point		DC Calibrator Output (V) (a)	TVC AC-DC Transfer Error (ppm) (b)	Calculated AC Voltage (V) (c) = (a) x [1 + (b)x10 <sup>-6</sup> ]	Verification Point Uncertainty (±ppm) (d)	4920 90dy Broadband Accuracy (±ppm) (e)	Broadband Accuracy Validity Tolerance Limits		4921 Reading (V)
	Voltage	Frequency						Lower (V) (f) = (c) x {1 - [(d) + (e)]x10 <sup>-6</sup> }	Higher (V) (g) = (c) x {1 + [(d) + (e)]x10 <sup>-6</sup> }	
0.3V	300.0000mV	10Hz					20			
0.3V	300.0000mV	40Hz					20			
0.3V	300.0000mV	30kHz					20			
0.3V	300.0000mV	200kHz					70			
0.3V	300.0000mV	500kHz					250			
0.3V	300.0000mV	1MHz					650			
1V	1.000000V	10Hz					20			
1V	1.000000V	40Hz					20			
1V	1.000000V	30kHz					20			
1V	1.000000V	200kHz					70			
1V	1.000000V	500kHz					250			
1V	1.000000V	1MHz					650			
10V	10.00000V	10Hz					20			
10V	10.00000V	40Hz					20			
10V	10.00000V	30kHz					20			
10V	10.00000V	200kHz					70			
10V	10.00000V	500kHz					250			
10V	10.00000V	1MHz					650			
100V	100.0000V	10Hz					20			
100V	100.0000V	40Hz					20			
100V	100.0000V	30kHz					20			
100V	100.0000V	200kHz					70			
1000V	1000.000V	40Hz					25			
1000V	1000.000V	20kHz					25			
1000V	1000.000V	33kHz					80			

ACV Spot Frequency Checks (Standard Option)

ACV Range	Verification Point		DC Calibrator Output (V) (a)	TVC AC-DC Transfer Error (ppm) (b)	Calculated AC Voltage (V) (c) = (a) x [1 + (b)x10 <sup>-6</sup> ]	Verification Point Uncertainty (±ppm) (d)	4920 90dy Spot Accuracy (±ppm) (e)	Spot Accuracy Validity Tolerance Limits		4920 Reading (V)
	Voltage	Spot Frequency						Lower (V) (f) = (c) x {1 - [(d) + (e)]x10 <sup>-6</sup> }	Higher (V) (g) = (c) x {1 + [(d) + (e)]x10 <sup>-6</sup> }	
0.3V	100.0000mV	1kHz					10			
0.3V	100.0000mV	60kHz					25			
0.3V	100.0000mV	1MHz					200			
1V	1.000000V	1kHz					10			
1V	1.000000V	60kHz					25			
1V	1.000000V	1MHz					200			
10V	10.00000V	1kHz					10			
10V	10.00000V	60kHz					25			
10V	10.00000V	1MHz					200			
100V	100.0000V	1kHz					10			
100V	100.0000V	60kHz					25			
100V	100.0000V	100kHz					25			
1000V	1000.000V	1kHz					15			
1000V	1000.000V	30kHz					30			





## SECTION 8 ROUTINE CALIBRATION

### Introduction

**IMPORTANT:** The following procedures allow the 4920 to be recalibrated to external calibration standards. To verify the 4920's performance to specification without affecting the instrument's calibration memory, refer to Section 7 of this handbook.

In addition to the routine calibration procedures detailed in this section, the 4920 requires several special calibration operations to be performed after it has undergone repair. For details of these special calibration operations refer to Section 1 of the 4920 Servicing Handbook.

### Autocal

The 4920 includes Datron's autocal feature, which allows full control of external calibration either from the unit's front panel controls or via its integral IEEE-488.2 bus interface. The autocal feature eliminates the thermal disturbance which would occur if the instrument's covers had to be removed during calibration, and it greatly speeds up the calibration process.

To perform autocalibration, appropriate calibration voltages are applied to the 4920 for each of its measurement ranges. As each of these calibration voltages is applied to the instrument, a single depression of the front-panel 'Caltrig' key or an appropriate IEEE-488.2 calibration command causes the 4920 to calculate an appropriate digital calibration constant, which is stored in non-volatile memory within the instrument. These calibration constants are subsequently used to correct the output of the 4920's internal A/D converter so that the instrument provides accurate measurements of the input signal.

The 4920 automatically determines whether the applied calibration voltage is at a bottom-of-range or top-of-range calibration point, and whether it is a low-frequency or a high-frequency input.

Provision is also made for the user to enter the true value of the calibration source where this differs from the nominal bottom-of-range or top-of-range value.

Access to the autocal function is protected by a rear-panel slide switch. This switch must be set to the 'Enable' position before the autocal feature can be operated.

It should be noted that it is not always necessary to perform all the calibration procedures detailed in this section. Because each of the 4920's measurement ranges can be calibrated separately, without affecting the measurement performance of other ranges, partial recalibration of the 4920 can be carried out if required.

The ACV input calibration procedures detailed in this section use AC-DC Thermal Transfer Techniques to traceably refer the 4920 measurement performance to DC calibration sources. If it is required to automate the calibration process, or to calibrate large numbers of 4920s, it may be better to characterize the performance of a suitable AC voltage calibrator and to then use this calibrator as a direct calibration source for the 4920.

## The CAL Menu

Pressing the front-panel Cal key, with the rear-panel CALIBRATION switch set to the ENABLE position, opens the CAL menu as illustrated opposite.

The CAL menu provides the following functions:-

### Date

The **Date** menu option allows display and modification of the current date.

### Ser#

The **Ser#** (Serial Number) menu option allows the instrument serial number to be displayed and, if necessary, modified.

### Spcl

The **Spcl** (Special Calibration) menu option allows various special calibration operations to be performed. These calibration operations need only be performed when the instrument is set up immediately after manufacture or repair. For more information on special calibration operations refer to the 4920 Servicing Handbook.

### Freq

Selects Frequency Calibration. With an accurate 1MHz signal applied on the 0.3V, 1V, 3V or 10V range, the action of pressing the Caltrig key performs calibration of the internal Frequency Counter.

### Spot

Selects Spot Calibration. With a nominal full range signal applied at the required frequency, the action of pressing the Caltrig key creates or recalibrates a spot frequency. The Set facility can be employed to permit a non-nominal target value between 50% and 110% FR to be used.

### Set

The **Set** menu option allows the operator to enter the known value of a calibration input where this differs from the nominal bottom-of-range or top-of-range value. The set function must be used immediately prior to use of the Caltrig key.

### Due

The **Due** menu option allows the due date for instrument recalibration to be displayed and, if necessary, modified.

For more information on the use of the CAL menu options refer to Section 4 of this handbook.

### CAUTION:

While the CAL menu or any of its menu options is displayed, the Caltrig key is enabled, and when pressed alters the contents of the calibration memory. To avoid the risk of inadvertently overwriting previous calibration data, the Caltrig key should only be used for genuine calibration operations.

### CAL Group of Menus - Overall View

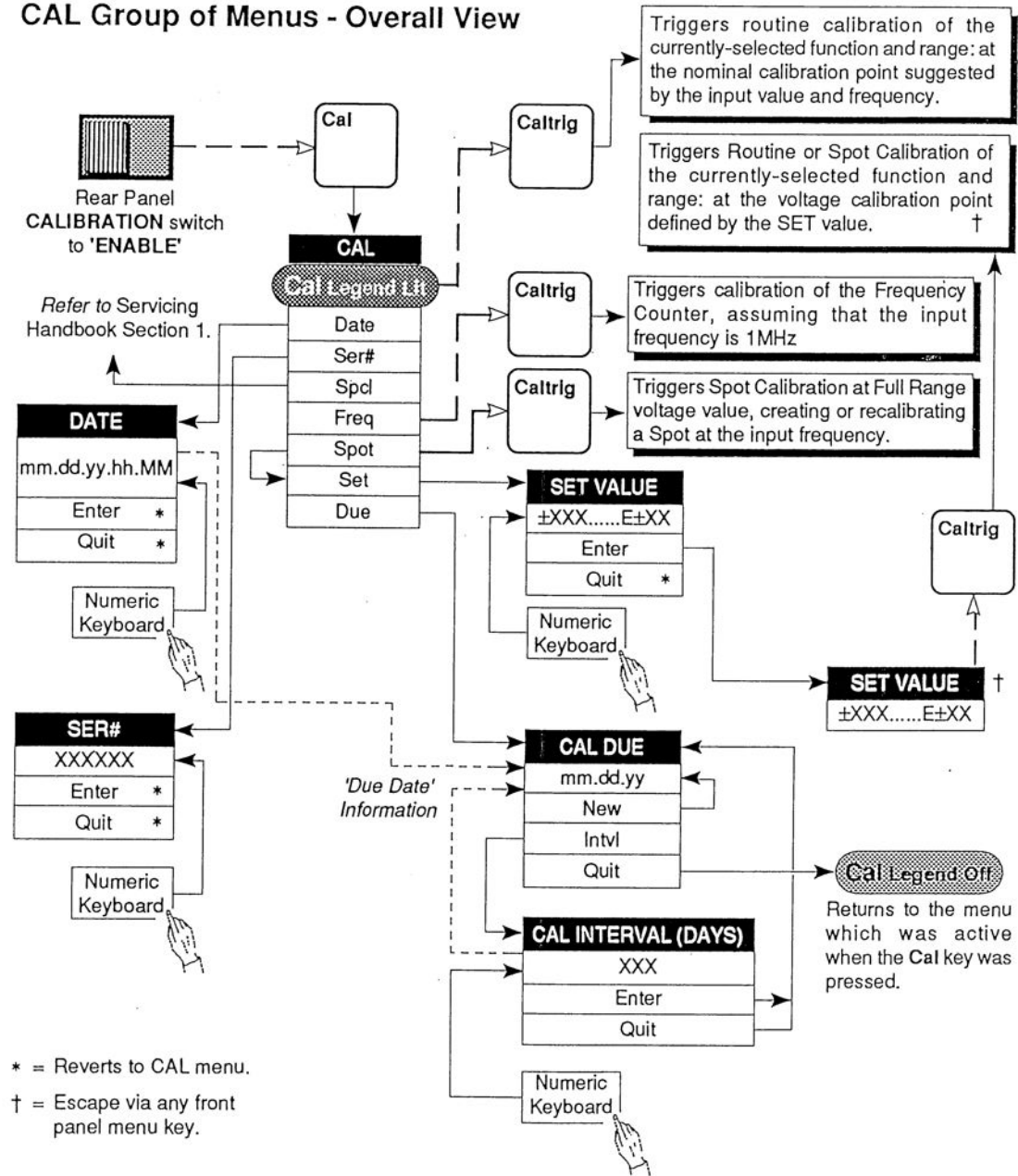

## Equipment Requirements

Equipment Type	Range	Accuracy [1][2]
<b>DC Voltage Calibrator/ High Resolution DC Voltage Source</b> [3] e.g. Datron Model 4808 (Options 10 & 30) or Datron Model 4708 (Option 10)	Voltage: 100mV to 1000V Resolution: 1ppm	±4ppm
<b>AC Voltage Calibrator/ High Resolution AC Voltage Source</b> [3] e.g. Datron Model 4808 (Options 20 & 30) or Datron Model 4708 (Option 20)	Voltage: 100mV to 1000V Frequency: 10Hz to 1MHz Resolution: 1ppm	100mV: ±200ppm at 1kHz 1V to 3V: ±100ppm at 1kHz ±5ppm short-term stability
<b>Thermal Voltage Converters</b> e.g. Holt Model 11, Ballantine 440-Series and Ballantine 1396	Voltage: 100mV to 1000V Frequency: DC to 1MHz	To best uncertainties
<b>DC Voltmeter</b> e.g. Datron Model 1281	Voltage: 100mV Resolution: 1ppm	±12ppm
<b>DC Nanovoltmeter</b> e.g. EM Model N2a or Keithley Model 181	±100nV to ±10mV	Better than 2% of range
<b>DC nV Source</b> e.g. EM Model S6	10mV	±1ppm short-term stability

- [1] Absolute accuracy (traceable to National Standards, and inclusive of National Standards uncertainties).
- [2] Provides a 95% confidence level of achieving a 4:1 calibration ratio except where 'state-of-the-art' limitations apply.
- [3] This equipment can be part of a single AC/DC unit. e.g. a Datron 4708 multifunction calibrator with Options 10 and 20.



## Preparation

1. Before operating any of the calibration equipment, familiarize yourself with the equipment by reading the appropriate operating manuals. In particular, note the electrical and mechanical handling procedures required to maintain the calibration of the thermal voltage converters.
2. **Note any safety precautions which are necessary to prevent electrical shock from the equipment.**
3. Set up the equipment in a stable environment at  $23^{\circ}\text{C}\pm 1^{\circ}\text{C}$ , power it on and allow it to stabilize for an appropriate period of time. The 4920 should be allowed to stabilize for a minimum of 90 mins. after it is powered on.
4. Select the **TEST** menu by pressing the front-panel **Test** key and select the **Oper** (Operational Test) menu option. Allow the operational self-test to run to completion, at which point the 4920 should display the word **COMPLETED**. If at any point during the operational self-test the 4920 displays the words **OPER FAIL** (Operational Test Failure) the unit probably has a fault, in which case refer to the 4920 Servicing Handbook before proceeding.
5. Set the rear-panel **CALIBRATION** switch to the **ENABLE** position.
6. Press the front-panel **Cal** key to display the **CAL** menu.

## ACV 100mV Calibration

For the ACV 100mV calibration point carry out the following procedure:

1. Configure a Selby micropotentiometer for 100mV.
2. Connect the high resolution DC voltage source (DC calibrator) into the calibration setup as shown in Figure 8.1. On a Datron DC calibrator set 100mV on the 1V output range to ensure that an active (low impedance) DC source is used. Select the 4920's ACV 0.3V range.
3. Turn the output of the DC voltage source on and increment its output from zero until the DC voltmeter indicates a reading of 100.0000mV. Allow the Selby micropotentiometer to settle and, if necessary, readjust the DC source to achieve a DC voltmeter reading of 100.0000mV.
4. Adjust the DC nV source to achieve a null on the DC nanovoltmeter.
5. Reverse the output polarity of the DC voltage source and allow the Selby micropotentiometer to settle.
6. Note the new reading on the DC voltmeter, the new reading on the DC nanovoltmeter, and the output voltage of the DC voltage source.
7. Turn the output of the DC voltage source off and disconnect the DC voltage source and the DC voltmeter from the calibration setup.
8. Connect the high resolution AC voltage source (AC calibrator) in place of the DC voltage source. On a Datron AC calibrator select the 1V output range to ensure that an active (low impedance) AC source is used. (Note: if the DC voltage source and the AC voltage source are combined into a single unit, the output of this unit can simply be switched from DC to AC.)
9. Set the output of the AC voltage source to the same value as the DC source output noted in step 6, and a frequency of 1kHz. Turn its output on and increment or decrement the output to achieve a DC nanovoltmeter reading of half the DC nanovoltmeter reading noted in step 6. Allow the Selby micropotentiometer to settle and, if necessary, adjust the output of the AC voltage source to achieve the required reading on the DC nanovoltmeter.
10. Calculate the arithmetic mean of 100mV and the DC voltmeter reading noted in step 6, and then increment or decrement this mean as appropriate by the AC-DC difference correction of the Selby micropotentiometer at 100mV and 1kHz. Select the Set option from the 4920's CAL menu and enter a value which is equal to this incremented or decremented mean.
11. Execute the calibration of the 4920 by pressing the Caltrig front panel key.

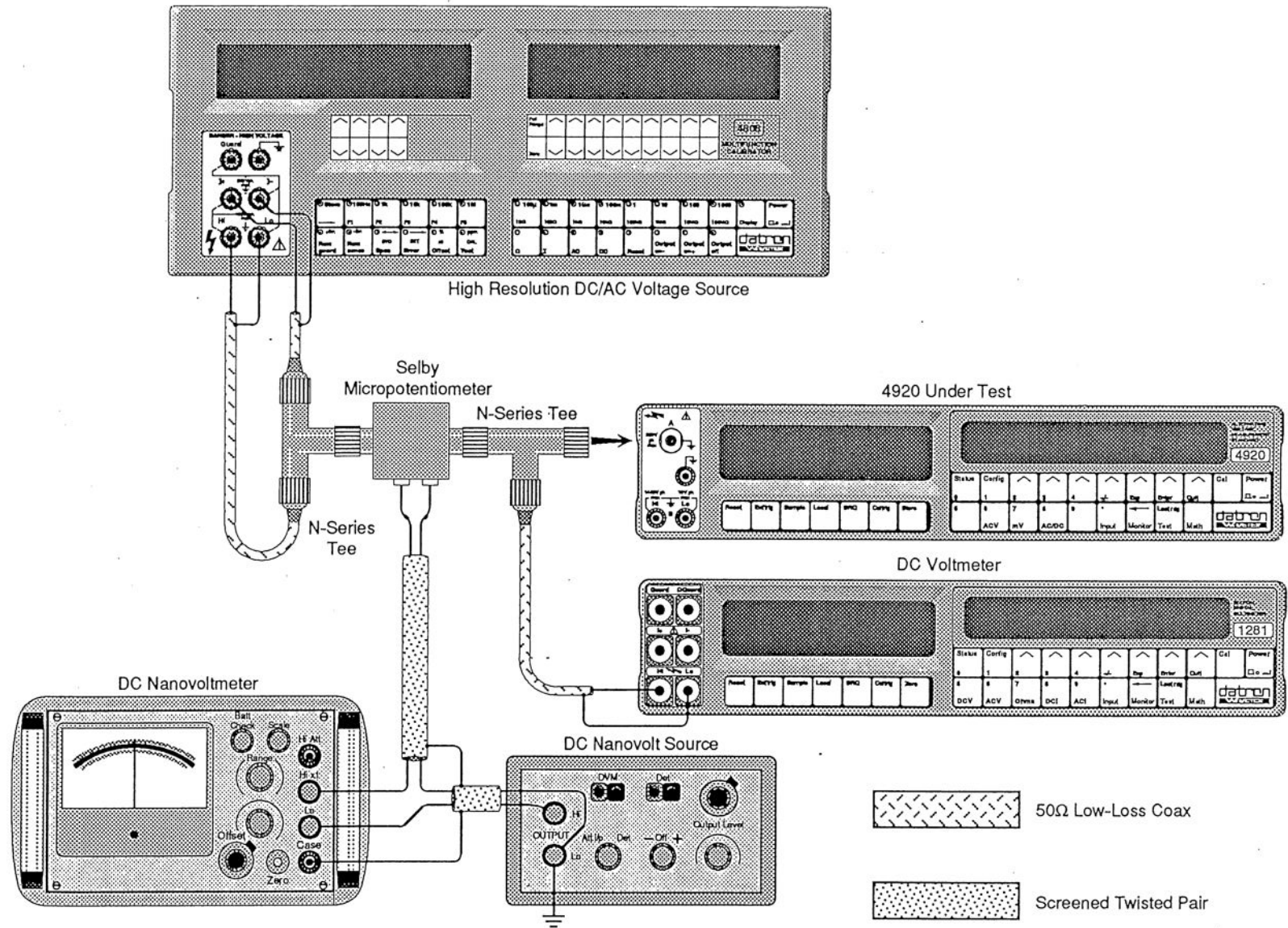

FIG. 8.1 ACV 100mV CALIBRATION - INTERCONNECTIONS

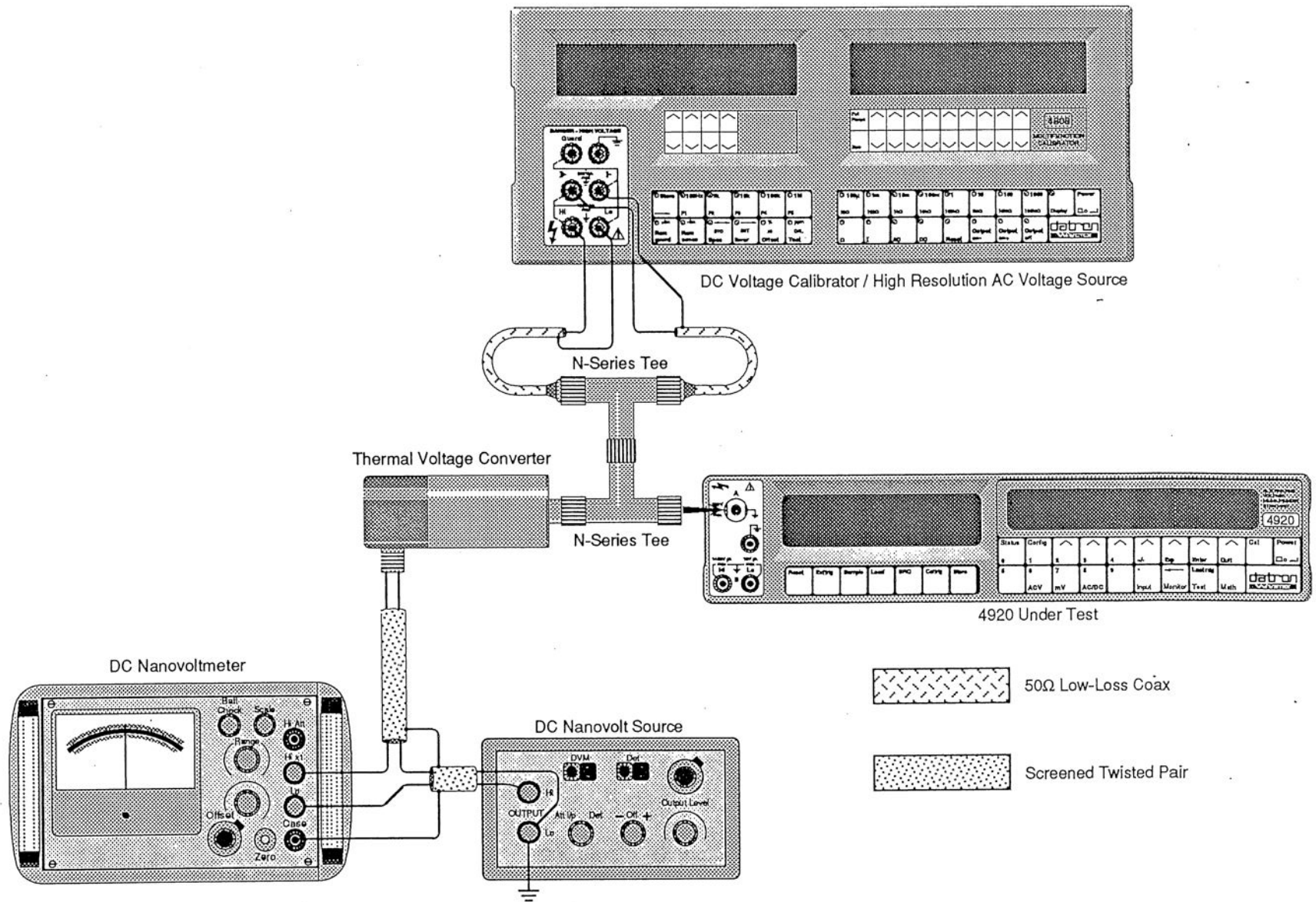

FIG. 8.2 ACV CALIBRATION - INTERCONNECTIONS

## ACV Calibration

For each of the calibration voltages and frequencies detailed in Table 8.1, carry out the following procedure:-

1. Configure a thermal voltage converter for the required calibration voltage.
2. Connect the DC voltage calibrator into the calibration setup as shown in Figure 8.2 and select the 4920's ACV function.
3. Set the output of the DC voltage calibrator to the required calibration voltage and turn the output of the calibrator on.
4. Allow the thermal voltage converter to settle.
5. Adjust the DC nV source to achieve a null on the DC nanovoltmeter.
6. Reverse the polarity of the DC voltage calibrator output, allow the thermal voltage converter to settle, and note the DC reversal error on the nanovoltmeter. Adjust the nV source until the nanovoltmeter shows half of the DC reversal error.
7. Turn the output of the calibrator off and disconnect it by splitting the two precision N-series tees.
8. Connect the AC voltage source in place of the DC voltage calibrator. (Note: if the DC calibrator and AC voltage source are combined into a single unit, the output of this unit can simply be switched from DC to AC.)
9. Set the AC voltage source to the required calibration voltage and frequency and turn its output on.
10. Increment or decrement the AC source output voltage to achieve a null on the DC nanovoltmeter. Allow the thermal voltage converter to settle, and check and adjust the null.
11. Select the Set option from the 4920's CAL menu and enter a value which is equal to the calibration voltage selected from Table 8.1, incremented or decremented as appropriate by the AC-DC difference correction of the thermal voltage converter at the calibration voltage and frequency.
12. Execute the calibration of the 4920 by pressing the Caltrig front panel key.

TABLE 8.1

4920 ACV Range	CALIBRATION	
	Voltage	Frequenc
0.3V	300.0000mV	1kHz
0.3V	300.0000mV	1MHz
1V	0.300000V	1kHz
1V	1.000000V	1kHz
1V	1.000000V	1MHz
3V	1.000000V	1kHz
3V	3.000000V	1kHz
3V	3.000000V	1MHz
10V	3.00000V	1kHz
10V	10.00000V	1kHz
10V	10.00000V	1MHz
30V	10.00000V	1kHz
30V	30.00000V	1kHz
30V	20.00000V	1MHz
100V	30.0000V	1kHz
100V	100.0000V	1kHz
100V	20.0000V	1MHz
300V	100.0000V	1kHz
300V	300.0000V	1kHz
300V	300.0000V	100kHz
1kV	300.000V	1kHz
1kV	1000.000V	1kHz
1kV	700.000V	100kHz

## ACV Spot Calibration

### Introduction

A spot frequency is a single frequency on a particular ACV range, for which an individual calibration has been carried out at a specific value of input voltage.

The calibration is available between 50% and 110% of nominal full range value, obtaining an extra correction which is applied over a small range of input frequencies ( $\pm 2\%$  of the spot frequency) when the spot is selected during subsequent operation.

A 4920 can be furnished with up to 100 such spot frequencies, distributed among all the ACV ranges.

They can be used to improve access to commonly-used calibration points, and enhance the instrument's accuracy at the spots by minimizing the flatness error.

Spot frequency corrections can also be applied in the AC/DC Transfer function.

### Creating Spot Frequencies

New spot frequencies can be created, and old ones recalibrated, using the Spot selection in the CAL menu.

If the Caltrig key is pressed immediately after selecting Spot, the 4920 triggers spot calibration, assuming that the input voltage is at the nominal full range value.

It is possible to trigger a spot frequency calibration at input levels other than full range, by pressing Set immediately after Spot, then using the SET VALUE menu to enter the target calibration value. When triggered, the 4920 then assumes that the input voltage is as defined by the set value, measures the input frequency to determine the spot frequency.

## ACV Spot Calibration Procedure

For each required spot frequency, carry out the following procedure:

1. Configure a thermal voltage converter for the required spot calibration voltage.
2. Connect the DC voltage calibrator into the calibration setup as shown in Figure 8.2. On the 4920, select the ACV function and the range required to be spot-calibrated.
3. Set the output of the DC voltage calibrator to the required spot calibration voltage and turn the output of the calibrator on.
4. Allow the thermal voltage converter to settle.
5. Adjust the DC nV source to achieve a null on the DC nanovoltmeter.
6. Reverse the polarity of the DC voltage calibrator output, allow the thermal voltage converter to settle, and note the DC reversal error on the nanovoltmeter. Adjust the nV source until the nanovoltmeter shows half of the DC reversal error.
7. Turn the output of the calibrator off and disconnect it by splitting the two precision N-series tees.
8. Connect the AC voltage source in place of the DC voltage calibrator. (Note: if the DC calibrator and AC voltage source are combined into a single unit, the output of this unit can simply be switched from DC to AC.)
9. Set the AC voltage source to the required spot calibration voltage and frequency and turn its output on.
10. Increment or decrement the AC source output voltage to achieve a null on the DC nanovoltmeter. Allow the thermal voltage converter to settle, and check and adjust the null.
11. Select the **Spot** option from the 4920's **CAL** menu.
12. Select the **Set** option from the 4920's **CAL** menu and enter a value which is equal to the spot calibration voltage, incremented or decremented as appropriate by the AC-DC difference correction of the thermal voltage converter at the spot calibration voltage and frequency.
13. Execute the spot calibration of the 4920 by pressing the **Caltrig** front panel key.

## Calibration at other than Nominal Values

Calibration can be carried out at voltages close to (but not exactly at) the nominal values detailed in the calibration procedures provided that the **Set** option is selected from the 4920's **CAL** menu, and the known calibration point voltage is input via the 4920's numeric keys and entered with the **Enter** key immediately before pressing the **Caltrig** key.

## Setting a New Calibration Due Date

After completing calibration of the 4920 carry out the following procedure to set the new calibration date:-

1. Select the **Date** menu option from the **CAL** menu. Enter the current date and time using the front-panel numeric keys and the **Enter** key. (Use the **Quit** menu option if the display already shows the correct date and time.)
2. Select the **Due** menu option from the **CAL** menu and then select the **Intvl** (Interval) menu option from the **CAL DUE** menu. Enter the required calibration interval in days using the front-panel numeric keys and the **Enter** key. (Use the **Quit** menu option if the display already shows the correct calibration interval.)
3. Select the **New** menu option from the **CAL DUE** menu. The 4920 should now display a date which is one calibration interval ahead of the current date.
4. Return the rear-panel **CALIBRATION** switch to the **DISABLE** position.
5. Press the Status key, then the Config key to obtain the STATUS CONFIG menu. Select Cal? and observe the LAST CAL menu.  
  
Record the calibration store code registered to the right of the 'CODE' header. This code will be changed in the event of any further 'writes' to the calibration store, and can be used on a subsequent occasion to detect any such unauthorized interference.
6. Carry out the performance verification procedure detailed in section 7 of this handbook.





### Datron Sales and Service Representatives Worldwide

COUNTRY and REPRESENTATIVE	Telephone	Telex	Fax
<b>AUSTRALIA</b>			
Scientific Devices Pty. Ltd 2 Jacks Road, South Oakleigh, Victoria 3167	3 579 3622	AA32742	3 579 0971
<b>AUSTRIA</b>			
Walter Rekirsch Elektronisch Geraete GmbH & Co. Obachgasse 28, A-1220 Wien	222 253626	134759	222 2572 75
<b>BELGIUM</b>			
Air-Parts International B. V. Avenue Huart-Hamoir, 1-Box 34, 1030 Bruxelles	2 241 6460		2 241 8130
<b>BRAZIL</b>			
Sistronics Instrumentacao E Sistemas Ltda Av. Alfredo Egidio de Souza Aranha 75-3 & 4 Andares-Jd. Santo Antonio, CEP 04726 Sao Paulo	11 247558	57155 SNCS	11 5238457
<b>CHINA</b>			
Tianjin Zhong Huan Scientific Instruments Corp. No. 59 Zhao Jia Chang Street, Hong Qiao Section, Tianjin	Tianjin 753732	----	----
<b>DENMARK</b>			
Instrutek A/S, Christiansholmsgade 8700 Horsens	5 611100	61656	5 615 658

*Sales and Service*

<b>COUNTRY and REPRESENTATIVE</b>	<b>Telephone</b>	<b>Telex</b>	<b>Fax</b>
<b>EASTERN EUROPE</b>			
<b>Amtest Associates Ltd</b> Amtest House, 75-79 Guildford Street, Chertsey, Surrey KT16 9AS, England	0932 568355	928855	0932 561919
<b>EGYPT &amp; MIDDLE EAST</b>			
<b>EPIC</b> 20-22 Ashmoun St, PO Box 2682, Horriya, Heliopolis	2 661767 2 669861	23033 CHAKA UN 23315 EPIC UN	2 662839 2 668924
<b>FINLAND</b>			
<b>Profelec OY</b> PO Box 67, 00421 Helsinki 42	0 566 4477	125225 PROFE SF	0 566 2998
<b>FRANCE</b>			
<b>M. B. Electronique</b> 606 Rue Fourny, Zi de Buc, 78530 Buc	1 39 568131	695414	1 39 565344
<b>WEST GERMANY</b>			
<b>WAVETEK Electronics GmbH</b> Freisinger Straße 34, 8045 Ismaning	0 89 96 09 49-0	5 212 996 WVTK D	0 89 96 71 70
<b>GREECE</b>			
<b>American Technical Enterprises SA</b> PO Box 3156 39, Agiou Konstantinou Street, Athens 10210.	5240620 5240740	216046 ATE GR	5249995
<b>HONG KONG</b>			
<b>Eurotherm (Far East) Ltd</b> 18/F., Gee Chang Hong Centre, 65 Wong Chuk Hang Road, Hong Kong	8140311 (Sales) 546391 (Service)	72449 EFELD HX 72449 EFELD HX	8735974 8700497

*Sales and Service*

<b>COUNTRY and REPRESENTATIVE</b>	<b>Telephone</b>	<b>Telex</b>	<b>Fax</b>
<b>INDIA</b>			
<b>Technical Trade Links</b>			
• Deodahar Centre, Gyani Compound, 424 Marol Maroshi Road, Andheri (East), Bombay 400 059	22 6362412	1179261 TTL IN	9122 634 2204
• 413, Pratap Chambers, Gurudwara Road, Karolbaugh, New Delhi - 110 005			
<b>IRELAND</b>			
<b>Euro Electronic Systems</b>			
Unit 1, Sandyford Park, Sandyford Ind. Est., Dublin 18.	01 952326	-----	01 952246
<b>ISRAEL</b>			
<b>DAN-EL Technologies</b>			
Office 60, Pinkas St. Tel-Aviv 62151.	3 453157	342105	3 544 1468
<b>ITALY(1)</b>			
<b>Sistrel SPA</b>			
Via Pellizza da Volpedo 59 20092 Cinisello Balsamo, Milano	02 618 1893	334643	02 618 2440
<b>ITALY(2)</b>			
<b>Sistrel SPA</b>			
Viale Erminio Spalla 41 00142 Roma	06 504 0273	625857	06 504 0067
<b>ITALY(3)</b>			
<b>Sistrel SPA</b>			
Via Cintia Parco S. Paolo 35 80126 Napoli	081 767 9700	----	081 766 1361

*Sales and Service*

<b>COUNTRY and REPRESENTATIVE</b>	<b>Telephone</b>	<b>Telex</b>	<b>Fax</b>
<b>JAPAN</b>			
<b>G &amp; G Japan Inc</b> No. 406, 12-16, 4-Chome, Hongoh, Bunkyo-ku, Tokyo	3 8130971	2722884 ICHAIN J	3 8159216
<b>KOREA</b>			
<b>Sama Electronics Corporation</b> CPO Box 9517, Seoul	2 271 2761	K26375 SAMATR	2 271 2764
<b>MALAYSIA</b>			
<b>TME Systems Pte Ltd</b> 21 Moonstone Lane, No. 06-01, Poh Leng Building, Singapore 1232	298 2608	37545	291 1935
<b>MOROCCO</b>			
<b>Minhol SA</b> 64 Rue El Mortada, Casablanca 02.	254945	24064	254969
<b>NETHERLANDS</b>			
<b>Air Parts International BV</b> PO Box 255, 12 Kalkovenweg, 2400 AG Alphen aan den Rijn	1720 43221	39564	1720 20651
<b>NEW ZEALAND</b>			
<b>G. T. S. Engineering Ltd</b> 5 Porters Avenue, Eden Terrace, PO Box 9613 Newmarket AUCKLAND	9 392 464	----	9 392 968
<b>NORWAY</b>			
<b>Morgenstjerne &amp; Co.</b> Olaf Helsets vei 1, P.O. box 15 - Bogenrud N-0621 Oslo 6	2 289490	71719 MOROF N	2 289494
<b>PORTUGAL</b>			
<b>Decada SA</b> Rua Margarida, Palla. 11, 1495 Alges Lisbon.	1 4103420	24476 ESPEC P	1 4101844