

USER'S HANDBOOK

for

THE DATRON AUTOCAL 1061, 1061A and 1071 DIGITAL VOLTMETERS

(for maintenance procedures
refer to the Calibration and Servicing Handbook)

850040

Issue 11 (MARCH 1988)

For any assistance contact your nearest Datron Sales and Service center.
Addresses can be found at the back of this handbook.

Due to our policy of continuously updating our products, this handbook may contain minor differences in specification, components and circuit design to the instrument actually supplied. Amendment sheets precisely matched to your instrument serial number are available on request.

CONTENTS

Page

SECTION 1 THE 1061/1061A/1071 AUTOCAL INSTRUMENTS	1-1
Standard and optional measurement facilities	1-1
Accessories	1-2
Principles of operation	1-3
SECTION 2 BASIC MEASUREMENT PROCEDURES	2-1
Maximum input voltages	2-1
Safety	2-2
Controls	2-2
DC voltage measurement procedure	2-4
AC voltage measurement procedure	2-5
Current measurement procedure	2-6
Resistance measurement procedure	2-7
Rear input	2-9
6½ digits (1061A only) 7½ digits (1071 only)	2-9
Display messages	2-10
SECTION 3 ADVANCED OPERATIONAL PROCEDURES	3-1
'Manual', external triggers and 'Hold'	3-1
Ratio measurement procedure	3-2
Self test	3-3
Spec mode	3-4
dB measurements (1061/1061A only)	3-5
Average mode measurements (1071 only)	3-6
Computation facility	3-7
Load/reset store	3-7
(A-B)	3-8
÷ C	3-9
Max and Min procedure	3-11
Limits procedure	3-12
SECTION 4 SYSTEMS APPLICATION VIA THE IEEE INTERFACE	4-1
Connecting the 1061/1071 into a system	4-3
Address selection	4-4
Using the 1061/1071 in a system	4-4
Programming instructions	4-5
Control of DVM inputs	4-5
Control of DVM output	4-6
Service request	4-7
Control of computing functions	4-8
Alternative method of programming	4-9
Calibration via the bus	4-9
High speed readings	4-10
Spec readout, test and input zero	4-10
Program string characteristics	4-11
Operational sequence guidelines	4-12

SECTION 5 SYSTEMS APPLICATIONS VIA THE BCD INTERFACE (1061 only)	5-1
DVM control commands	5-1
BCD output interpretation	5-2
SECTION 6 INSTALLATION	6-1
Unpacking and inspection	6-1
Preparation for operation	6-1
Connectors and pin designations	6-2
SECTION 7 SPECIFICATIONS	7-1
General	7-1
1071 specifications	7-2
1061/1061A specifications	7-4
Standard internal delays	7-7
SECTION 8 SPECIFICATION VERIFICATION	8-1
Introduction	8-1
Equipment requirements	8-1
1071 specification verification	8-2
1071 specification verification report sheet	8-5
1061 specification verification	8-6
1061 specification verification report sheet	8-9
1061A specification verification	8-10
1061A specification verification report sheet	8-15

SECTION 1 THE 1061/1061A/1071 AUTOCAL INSTRUMENTS

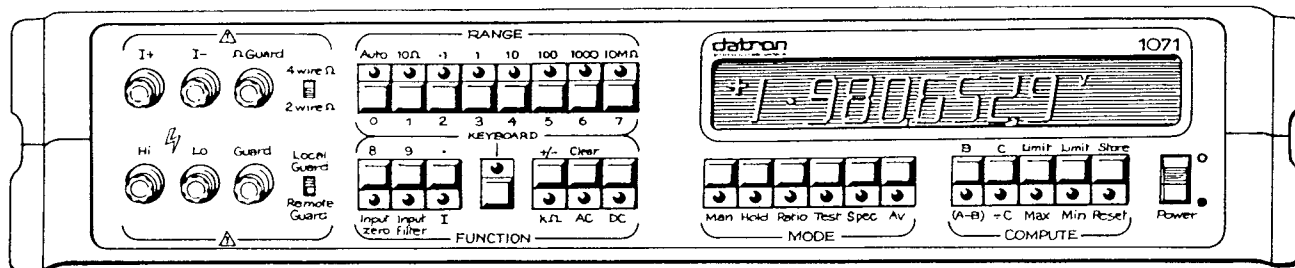

The Datron 1061, 1061A and 1071 AUTOCAL multi-function, microprocessor controlled digital voltmeters (DVM) are high precision measuring instruments featuring exceptionally high stability and systems capability. The basic instrument provides full DC measurement capability, computation facilities, self check routines and calibration memory.

The AUTOCAL 1061 instrument combines high accuracy with short measurement time to maximize usability. A 5½ digit display provides a resolution of one microvolt and an accuracy of 5 ppm.

In the AUTOCAL 1061A, operation of the "Input Filter" key extends the display to 6½ digits to provide extra resolution to 100nV.

NB. Unless otherwise noted, references to "1061" in this Handbook apply also to 1061A instrument.

The AUTOCAL 1071 instrument maximizes accuracy with a 6½ digit display (7½, in the 'averaging' mode for 0.05 ppm resolution).

Standard and optional measurement facilities

In addition to the basic DC voltage measurement function, the instrument performance can be expanded, by the selection of options, to provide further measurements:

- DC current
- Resistance
- True RMS AC voltage
- True RMS AC current
- DC coupled true RMS AC voltage
- DC coupled true RMS AC current
- Ratio

In addition, the standard 1061 and 1061A instruments provide a dB measurement.

The full range of options is as follows:

- Option 10: True RMS AC converter (DC plus 45Hz to 1MHz)
- Option 12: High Performance true RMS AC voltage converter (1061A only)
- Option 20: 4-wire resistance measurement converter
- Option 30: DC and true RMS AC current converter (in conjunction with option 10 only)
- Option 40: Rear input / ratio input
- Option 41: Selectable rear input
- Option 50: IEEE 488 standard digital interface
- Option 51: BCD interface (1061 only)
- Option 52: External trigger
- Option 70: Analog output
- Option 80: 115V 60Hz line operation
- Option 81: 115V 50Hz line operation
- Option 82: 115V 400Hz line operation
- Option 90: Rack mounting kit

Calibration

The AUTOCAL instruments have been designed to make the removal of the covers for calibration unnecessary, as full calibration of all ranges and functions can be carried out from the front panel.

The procedure for calibrating the instrument is contained in the Calibration and Servicing Handbook.

Accidental or unauthorised use of the calibration routine is prevented by a key operated switch on the instrument rear panel.

Message read-out

The measurement display doubles as a message display, providing a clear read-out of 15 different messages. Full details of the meanings of these displays can be found in sections 2 and 3.

Self test

Pressing the 'Test' key starts a self test procedure, during which a sequential routine:

- checks, in turn, all the display segments, characters and legends
- verifies the correct functioning of individual measuring circuits
- checks the non-volatile calibration memory

On completion of the test, the instrument returns to the last selected function and range to provide rapid return to measurement. In the event of the self test failing, an error message is displayed.

Computing

The range and function selection keys double as a keyboard for the input of data so that measurements can be compared with previously recorded data or manually input data for display of:

- measurement offset
- percentage deviation
- maximum and minimum value storage
- the exceeding of limits (upper and lower)

Full details of these facilities are given in section 3.

Systems use

The AUTOCAL 1061 and 1071 instruments can form part of a system by means of the IEEE 488 standard digital interface option. The details for the connections of the instrument to the system and programming details for the controlling machine can be found in section 4.

In addition, the 1061 voltmeter can be connected, using the BCD interface option, for remote operation by a controlling machine. In this mode, ranges and functions are remotely controllable and the measurement data is output in a binary-coded-decimal form. Details of this interface are given in section 5.

Accessories

The instrument is supplied with the following accessories:

Description	Part Number
Power cable	920012
Hexagon key 2mm A/F	630101
Hexagon key 2.5mm A/F	630109
Set of calibration keys	700068
User's Handbook (1061, 1061A and 1071)	850040
Calibration and Servicing Handbook (1061 and 1061A)	850045
Calibration and Servicing Handbook (1071)	850046
Power fuse (230 V)	920024
or Power fuse (115 V)	920084
Current fuse	920071

In addition, the following accessories are available for use with the 1061/1071 instruments:

Description	Part Number
HVP high voltage probe	400335
RMK rack mounting kit (option 90)	440063
1501 de luxe lead kit	440070
1M Ω 'Lin' calibration source	400391
10M Ω 'Ib' calibration source	400392

Additional documentation

The Calibration and Servicing Handbook contains information required to adjust and service the DVM. It contains detailed description of the circuits, trouble shooting diagrams, calibration procedures, parts lists and circuit diagrams.

Principles of operation

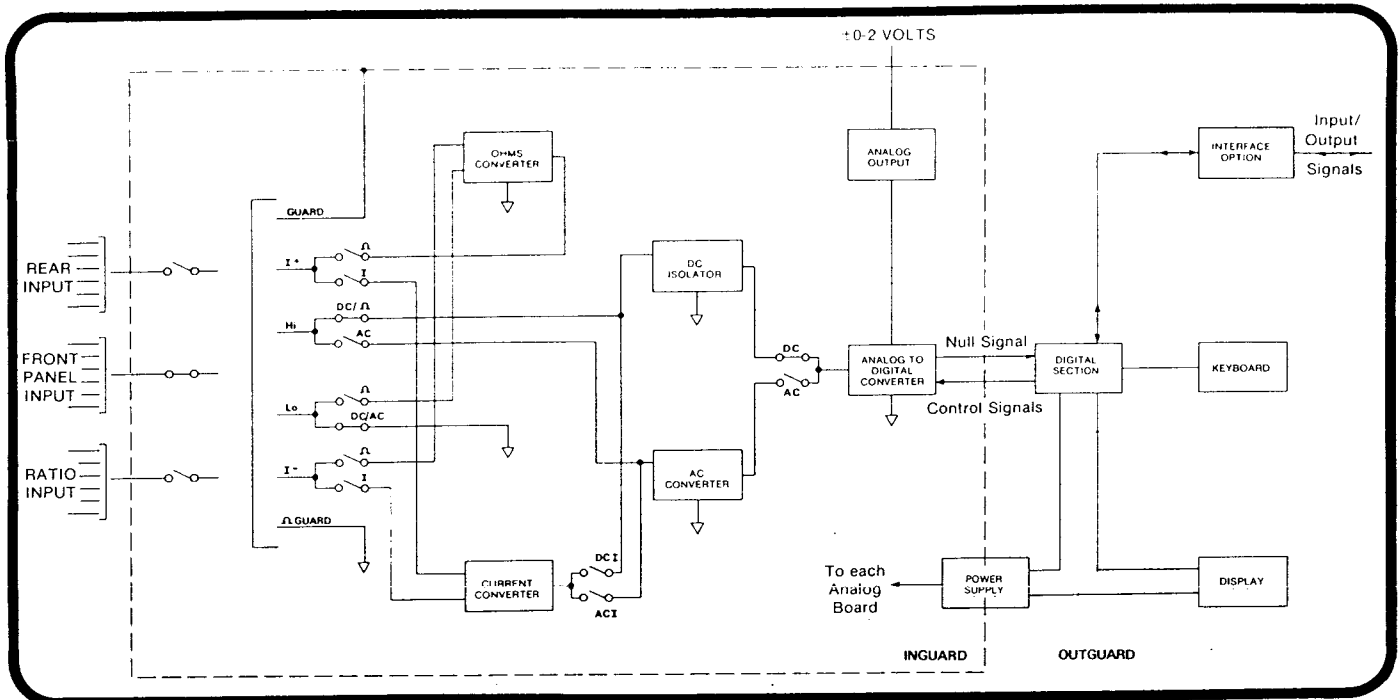

Fig 1.1 DVM simplified block diagram

Figure 1.1 shows how the DVM achieves its basic measurement functions, its advanced measurement and computing functions and the interfacing with other equipment in systems applications.

Voltage measurement

The instrument comprises a fully floating isolation amplifier with electronically switched gain ranges providing a full range output which is applied to the analog to digital converter. AC voltage measurement is achieved using a True RMS AC converter which converts AC signals to DC and applies the DC voltage to the analog to digital converter.

Resistance measurement

Resistance measurement is achieved by passing the current from an internal precision current source through the unknown resistance and sensing the voltage developed across the resistance.

Current measurement

For current measurement, switched precision shunts are fitted internally. The unknown current is passed through these and the resulting voltage sensed.

Analog to digital conversion

The signal from the DC isolator or AC converter is applied to the input of a high gain integration amplifier. The integration capacitor starts charging from a zero state at a rate proportional to the magnitude of the incoming signal. The integration period is approximately 20mS (1061) or 160mS (1071).

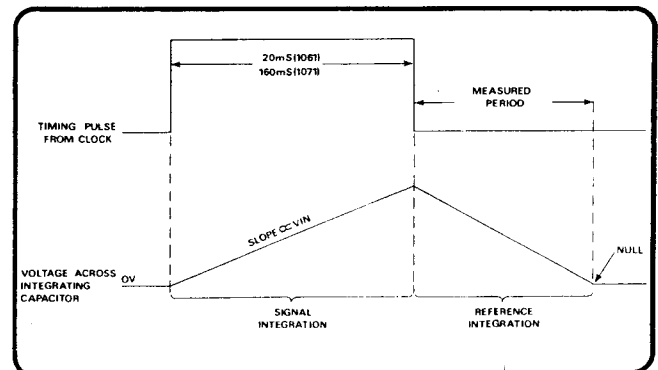

Fig 1.2 Simplified measurement cycle

At the end of this period, a reference signal of opposite polarity to the input signal is applied and the time taken for the capacitor to discharge to zero volts is measured (null detection), providing an accurate computation of the input signal magnitude.

Processor

The internal control of the instrument is performed by a microprocessor (6800 series) using 12k bytes of program memory. The microprocessor translates range and function information from the front panel keys (or remote source) into commands for the analog sections, generates triggers to control the analog to digital conversion and organises the mode and compute facilities.

Autocalibration

With the calibration enable switch on the rear panel turned to the 'CAL' position, the calibration procedure (see Calibration and Servicing Handbook) can take place, during which measurements of zero, linearity, gain, input bias current and high frequency gain of the instrument are taken and the results stored in a non-volatile memory. These values are then used as a reference for future measurements when the instrument is in the normal 'RUN' mode.

Specification readout

A table of the instrument's measurement specification is held internally, in a read-only memory. When the 'Spec' key is depressed, the maximum specified limits of uncertainty for the selected measurement will be displayed according to the measurement and range selected and the position of the calibration interval switch on the rear panel.

Ratio

Ratio measurements can be made between two signals applied at the rear input and ratio input sockets on the rear panel.

Analog output

An analog output scaled to be 1V for any full range signal input is generated to allow the instrument to drive equipment (X-Y plotters, chart recorders, etc.) that require an input proportional to the measured quantity.

SECTION 2 BASIC MEASUREMENT PROCEDURES

Preliminaries

Before using the instrument it is important that it has been correctly installed as detailed in section 6.

Maximum input voltages

The following tables give the maximum input voltages to the DVM (front panel) for each of the operating ranges.

For rear panel and ratio inputs, maximum inputs indicated at 1000 or 650V RMS must be reduced to 250V RMS.

The  symbol is used to remind the user of special precautions detailed in this Handbook and is placed adjacent to terminals and switches that are sensitive to overvoltage conditions.

DC & AC Voltage						
Hi	Lo	I ⁺	I ⁻	GUARD	Ω's GUARD	SAFETY GROUND
1,000V	250V [d]	1,000V				
1,000V	250V [d]	1,000V				
1,000V	250V [a]	1,000V	250V	GUARD		
1,000V	0V	1,000V	250V	250V [a]	Ω's GUARD	
1,000V	650V	1,000V	650V	650V [e]	650V	SAFETY GROUND
1,000V	650V	1,000V	650V	650V [e]	650V	0V [c]

DIG
COMMON

Table 2.1 Maximum RMS input voltages [b]

DC & AC Current						
HI	Lo	I ⁺	I ⁻	GUARD	Ω's GUARD	SAFETY GROUND
250V	250V [d]	250V				
250V	250V [d]	2.0 amps				
250V	250V [a]	250V	250V	GUARD		
250V	2.0 amps	50V	0V	250V [a]	Ω's GUARD	
1,000V	650V	1,000V	650V	650V [e]	650V	SAFETY GROUND
1,000V	650V	1,000V	650V	650V [e]	650V	0V [c]

DIG
COMMON

Table 2.2 Maximum RMS input voltages [b]

NOTES:

- With the local guard/remote guard switch set to 'Local Guard', this value reduces to 0V, i.e. the terminals are internally linked.
- Values specified assume peak voltage \leq RMS voltage $\times \sqrt{2}$. Also, maximum inputs of 1000 or 650V RMS reduce to 250V RMS for rear and ratio inputs.

Maximum permissible voltage between front and rear inputs is equal to the maximum input at the front input (not switched) or 250V RMS (switched).

- The digital common conductor for the remote interface is internally grounded.
- When the 2-wire Ω / 4-wire Ω switch is set to '2-wire Ω ', the 'I⁺' terminal is internally linked to the 'Hi' terminal and the 'I⁻' terminal is internally linked to the 'Lo' terminal.
- Maximum slew-rate of 'Guard' with respect to ground or digital common \leq 50V/ μ S (5×10^6 volt Hz) for normal operation (accuracy is degraded as volt Hz product increases).
- Maximum slew-rate of any terminal to ground should be \leq 1kV/ μ S (10^6 volt Hz) or the instrument may revert to the 'power up' condition (i.e. select DC 1000V range).

Resistance						
Hi	Lo	I ⁺	I ⁻	GUARD	Ω's GUARD	SAFETY GROUND
250V	250V [d]	250V				
250V	250V [d]	250V				
250V	250V	250V	250V	GUARD		
250V	250V	250V	250V	250V [a]	Ω's GUARD	
1,000V	650V	1,000V	650V	650V [e]	650V	SAFETY GROUND
1,000V	650V	1,000V	650V	650V [e]	650V	0V [c]

DIG
COMMON

Table 2.3 Maximum RMS input voltages [b]

Safety

The 1061 and 1071 voltmeters are designed to be Class 1 equipment as defined in IEC Publication 348 and UL 1244 concerning safety requirements. Protection is assured by a direct connection via the power cable from ground to exposed metal parts and

WARNING:

ANY INTERRUPTION OF THE PROTECTIVE GROUND CONDUCTOR INSIDE OR OUTSIDE THE INSTRUMENT OR DISCONNECTION OF THE PROTECTIVE GROUND TERMINAL MAY MAKE THE APPARATUS DANGEROUS. INTENTIONAL INTERRUPTION IS PROHIBITED. THE TERMINALS MARKED WITH THE ⚡ SYMBOL CARRY THE POTENTIAL OF THE

internal ground screens.

The line connection must only be inserted in a socket outlet provided with a protective earth contact and continuity of the ground conductor must be assured between the socket and the instrument.

SOURCE UNDER TEST. THESE TERMINALS AND ANY OTHER CONNECTIONS TO THE SOURCE COULD CARRY LETHAL VOLTAGES. AT NO TIME SHOULD THESE CONDUCTORS BE TOUCHED DURING A TEST OF HIGH VOLTAGES. IF DIFFICULTY IS FOUND WITH THE TEST, ENSURE THAT THE SOURCE IS RENDERED SAFE BEFORE ATTEMPTING TO IMPROVE CONNECTIONS.

Controls

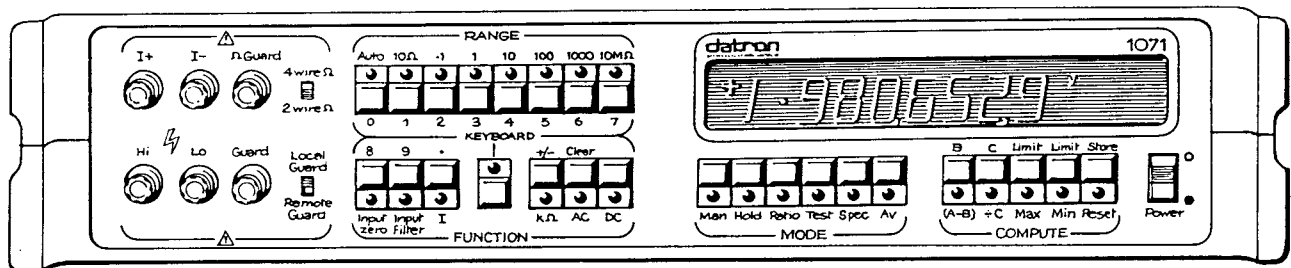

Fig 2.1 Front panel

Line on/off ('Power') switch

When set to the off position, this switch isolates the instrument from the line supply. When switched to the on position, the instrument powers up and automatically selects its DC 1000V range.

After 1/2 hour, the instrument is near its full specification, but should be left on for 2 hours before use if full accuracy is required.

Function keys

The four keys - 'I', 'kΩ', 'AC' and 'DC' - provide the means to select the mode of operation of the instrument and contain LED indicators that light to show the selected function, i.e. if the indicators in the 'I' and 'DC' keys are lit, the instrument is set to measure DC currents.

'Input zero'. This facility is available on all DC voltage and Ohms ranges, by manual or systems operation.

When the 'Input Zero' key is pressed, the DVM:

- accepts the measured input as a zero offset for the range selected, providing it does not exceed approx 1.5% of full range.
- stores the offset value in non-volatile memory.
- compensates ALL SUBSEQUENT READINGS taken on that range by the stored offset value, until the user redefines the input zero.

If the measured input offset exceeds 1.5% of full range from the calibrated DVM zero, no offset is stored and the Err 4 message is displayed.

A separate zero offset correction is stored for each range. When the DVM is in 'Auto' during the Input Zero routine, all ranges are zeroed automatically in ascending order.

CAUTION

The stored offset correction is applied to all readings, so that the correct procedure is to re-zero the DVM whenever the input zero condition is changed. Failure to observe this procedure will cause an incorrect zero compensation to be applied.

'Input filter' key. The 'Input filter' key is pressed to increase the series mode AC noise rejection in measurement of DC volts or resistance and to extend the frequency response of the instrument to make possible AC measurements as low as 40 Hz.

On the 1061A and 1071 models only, selection of 'Input filter' extends the DC Voltage and Resistance displays by an extra digit:

- i.e. 1061A is extended to 6½ digits.
- 1071 is extended to 7½ digits.

Range select keys

The instrument range of inputs in each function is as follows:

1061

- 1 μ V - 1,000V DC
- 1 μ V - 1,000V true RMS AC
- 1nA - 2A DC
- 1nA - 2A true RMS AC
- 0.1m Ω - 20M Ω

1071

- 10nV - 1,000V DC
- 1 μ V - 1,000V true RMS AC
- 1nA - 2A DC
- 1nA - 2A true RMS AC
- 1 $\mu\Omega$ - 20M Ω

Autorange ('Auto') key. This key commands the instrument to select the optimum ranges for the measurement, saving the operator this task and introducing very little delay.

Mode and compute keys

The function of these keys is given in Section 3.

4 wire/2 wire switch

During resistance measurements, this switch should be set to match the connection arrangement.

Local/remote guard switch

Selection of 'Local Guard' connects the front panel 'Guard' internally to the front panel 'Lo' terminal for voltage measurements, to the front panel ' Ω Guard' terminal for resistance measurement and to the front panel 'I-' terminal for current measurement. Selection of 'Remote Guard' isolates the 'Guard' terminal from all others and enables a remote connection to be made from the internal guard screens to the source of any common mode voltage.

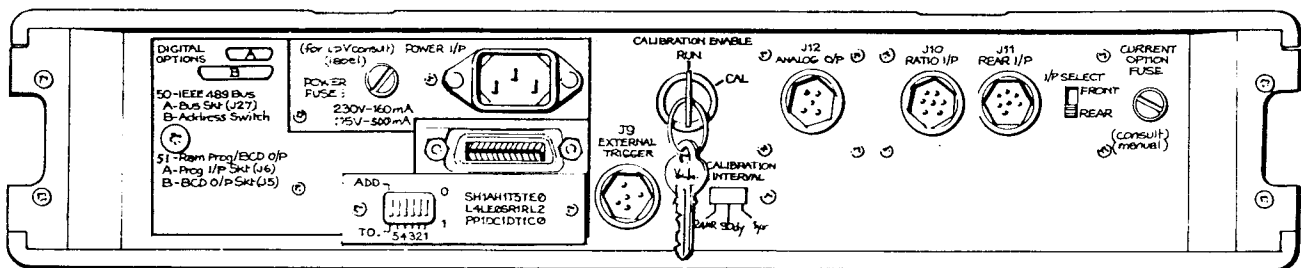

Fig 2.2 Rear panel

Calibration enable keyswitch

The calibration procedure is detailed in the Calibration and Servicing Handbook. The calibration switch is of the locking type to avoid accidental or unauthorised initiation of the calibration procedure.

Calibration interval switch

The calibration interval switch should be set to

correspond with the intervals that elapse between re-calibrations of the DVM. The setting of the switch determines the selection of uncertainty values displayed when the 'Spec' key is pressed (see Section 3 - Spec mode).

I/P select switch

The I/P select switch is used to select the rear measurement input plug in favour of the front panel terminals.

DC voltage measurement procedure

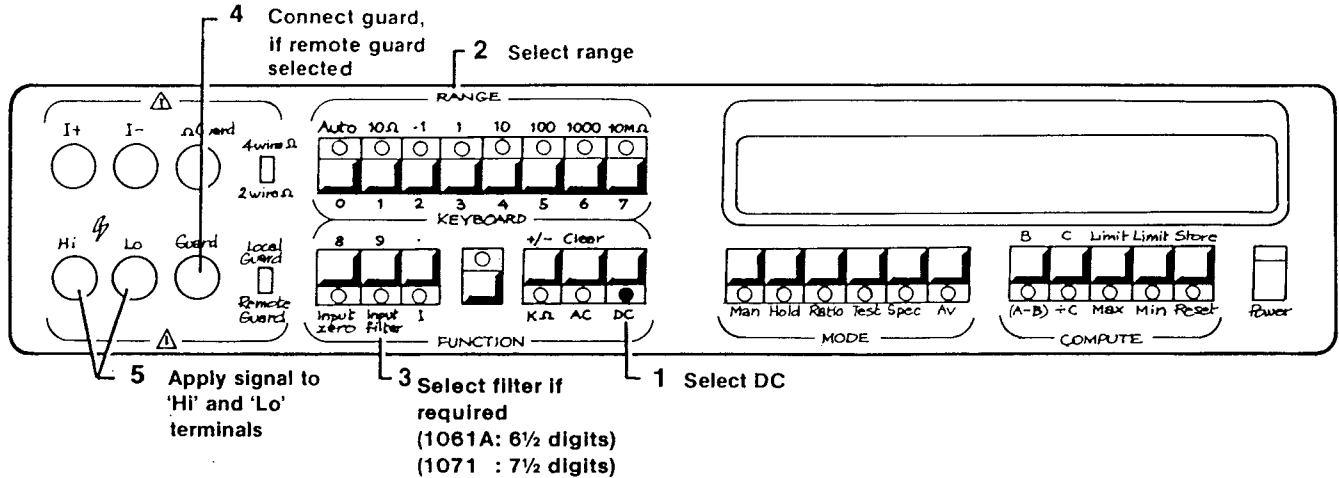

Simple lead connection

For the majority of applications the simple lead connection shown below with 'Local Guard' selected will be adequate. The disadvantage of this simple arrangement is that the connecting leads form a loop. If a stray alternating magnetic field, e.g. from the line transformer of a neighbouring instrument, passes through the loop it will behave as a single turn secondary winding inducing unwanted AC voltages into the measuring circuit. Use of a twisted pair will reduce the loop area as adjacent twists will automatically cancel any induced voltages. If problems with stray pick-up are encountered, it is recommended that a screened twisted pair cable be used with the screen connected to the 'Lo' or 'Guard' terminal.

flowing in the measuring circuits, are minimised by providing a separate common mode current path as shown in the examples below.

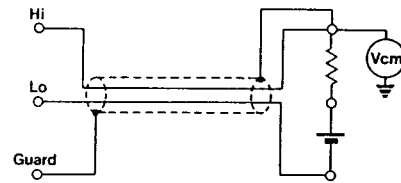
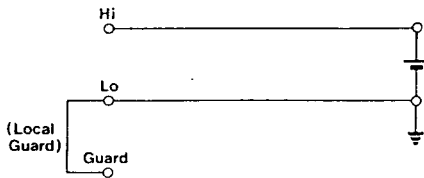

Use of remote guard connection

The 'Guard' terminal should be used with 'Remote Guard' selected when the source to be measured presents an unbalanced impedance to the measuring terminals and common mode voltages are present. Regardless of how the 'Hi' and 'Lo' terminals are connected, the 'Guard' terminal should refer to the source of common mode voltage. This will ensure that errors, caused by common mode currents

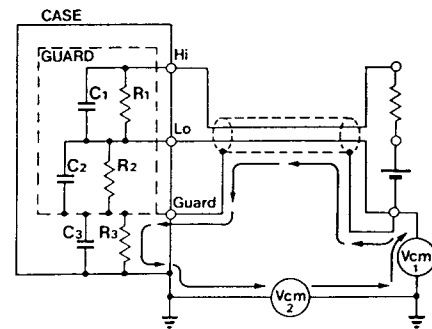

- R1, C1 = Input impedance
- R2, C2 = Input to guard leakage impedance
- R3, C3 = Guard to case leakage impedance
- Vcm1, Vcm2 = Common mode voltages

AC voltage measurement procedure

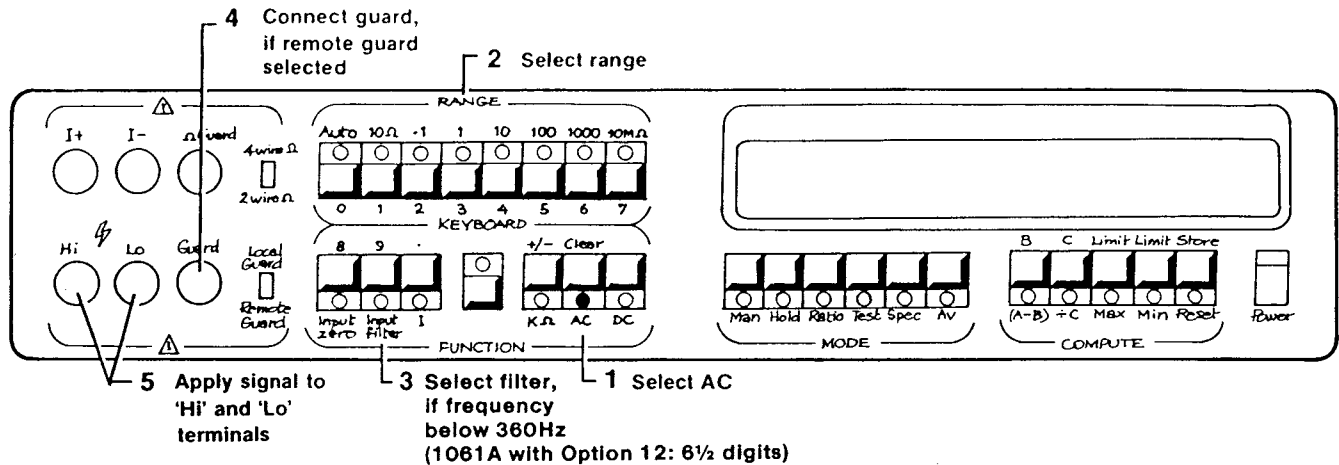

DC coupled AC voltage measurement procedure

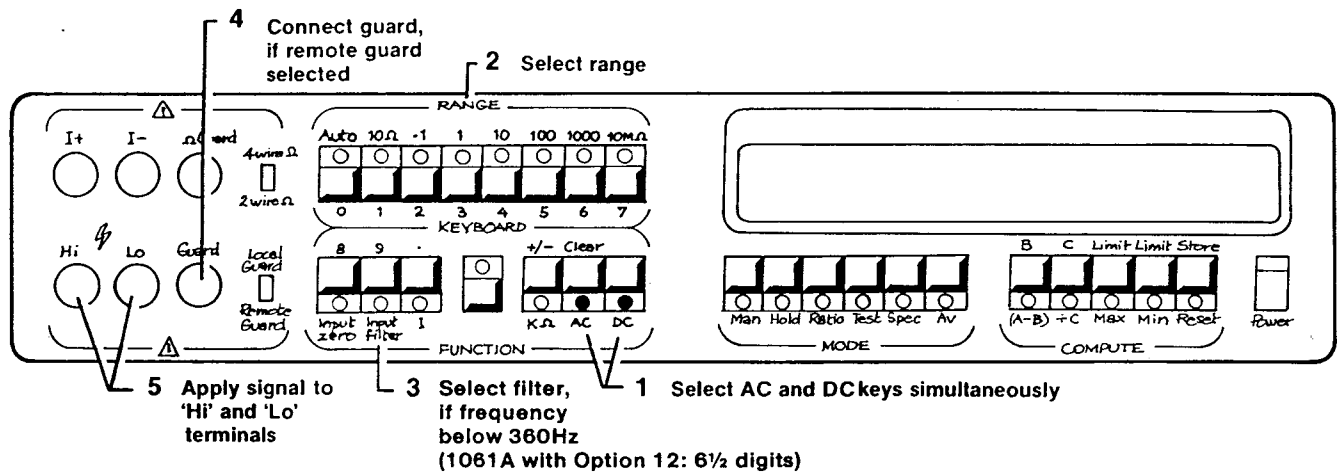

AC voltage measurement

Whereas for DC voltage measurement the resistance of the connection lead is generally unimportant so long as it is small compared with the input impedance of the measuring device, with AC voltage measurement the capacitance may give rise to an appreciable shunting effect causing source loading as well as voltage drop in the leads. The approximate 'Hi' to 'Lo' capacitance of the leads in the Datron lead kit are, low thermal emf lead with spade terminals:— 65pF, other leads:— 160pF. In extreme cases, use of separate leads will give lower capacitance (dependent upon spacing but typically 4pF) but will be liable to corrupt the

measurement by adding induced signals. The table below gives the approximate impedances at different frequencies.

FREQUENCY	LEAD CAPACITANCE		
	4pF	65pF	160pF
100Hz	400MΩ	20MΩ	10MΩ
1kHz	40MΩ	2MΩ	1MΩ
10kHz	4MΩ	200kΩ	100kΩ
100kHz	400kΩ	20kΩ	10kΩ
1MHz	40kΩ	2kΩ	1kΩ

Table 2.4 Connection lead capacitance

DC current measurement procedure

(in conjunction with option 10 only)

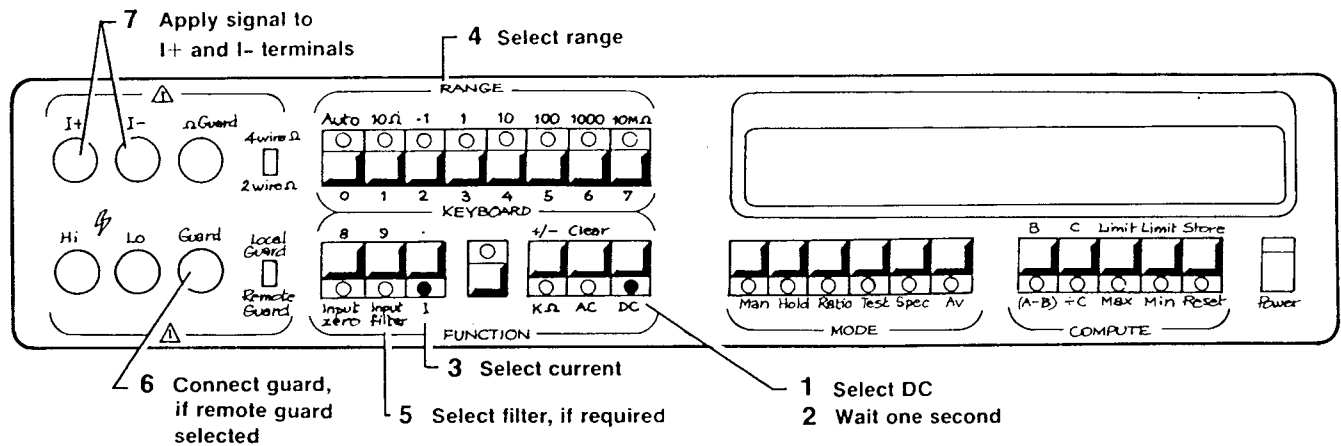

AC & DC coupled AC current measurement procedure

(in conjunction with option 10 only)

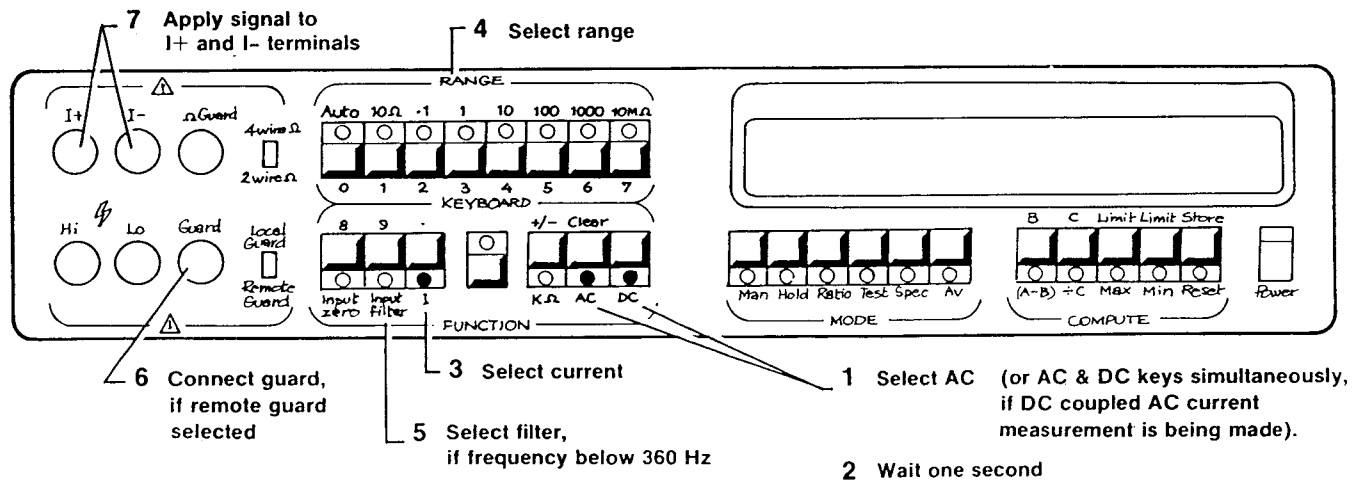

Current measurement

Similar connection considerations are required for current measurement as for voltage measurement. Use screened twisted pair cable to reduce induced voltages and connect 'Guard' to the source of

common mode voltage to provide a separate common mode current path. When making AC current measurements pay particular attention to the lead impedance, especially at high frequencies on the lower current ranges.

Resistance measurement procedure

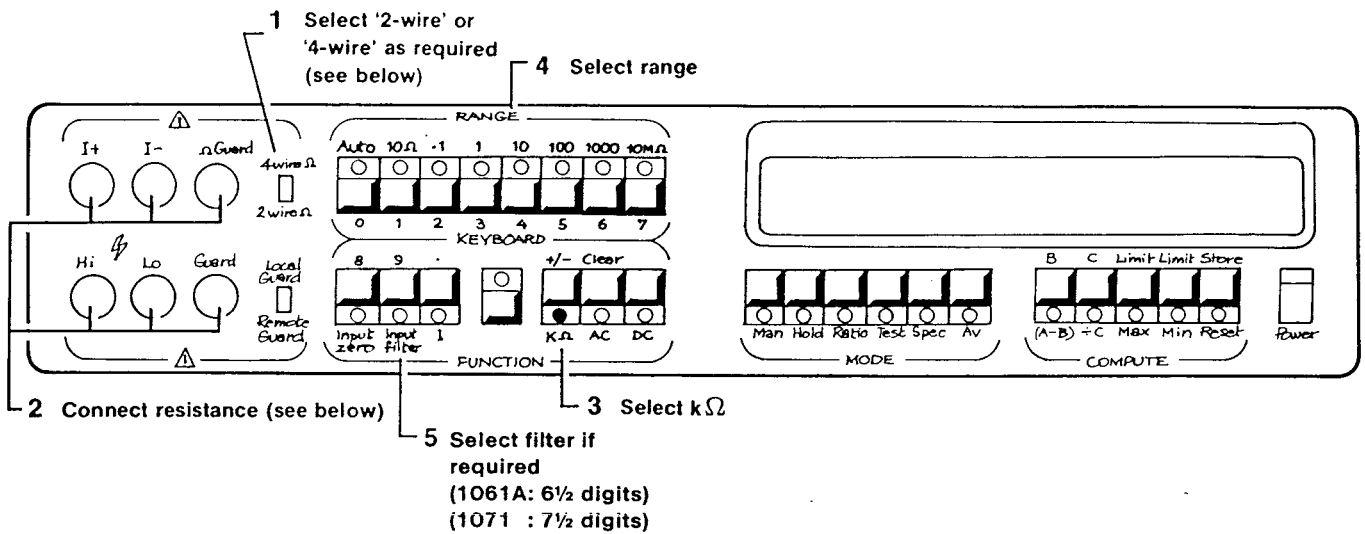

2-wire measurements

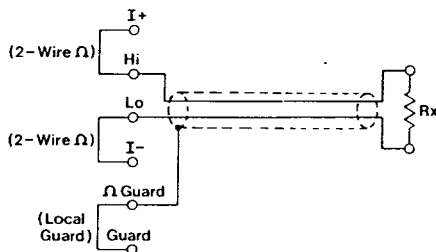

For the majority of applications, the simple 2-wire arrangement will be adequate. However, the value displayed will include the resistance of the connecting leads.

Use a screened twisted pair cable to reduce induced voltages, particularly where R_x is high.

4-wire measurements

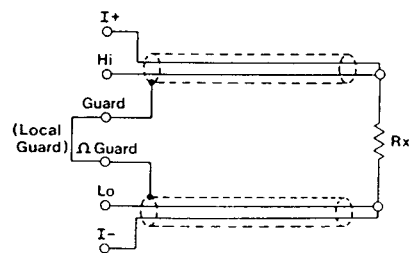

With a 4-wire connection the lead resistances have negligible effect and only the value of R_x is displayed. The 4-wire connection, as shown above using two screened twisted pair cables, is also suitable for measuring high resistances with long cables since the effects of leakage and capacitance between leads is eliminated. When making very high resistance measurements the ' Ω Guard' terminal should also be connected to a guard screen wrapped around the resistor, or the case it is mounted in, to reduce any errors due to noise.

True 4-wire zero

For accurate measurements of Ohms it is ESSENTIAL that a correctly connected zero source is used when operating 'Input zero' before making a series of resistance measurements.

Two arrangements are shown below, depending upon the resistance to be measured, which ensure that thermal emf effects are eliminated.

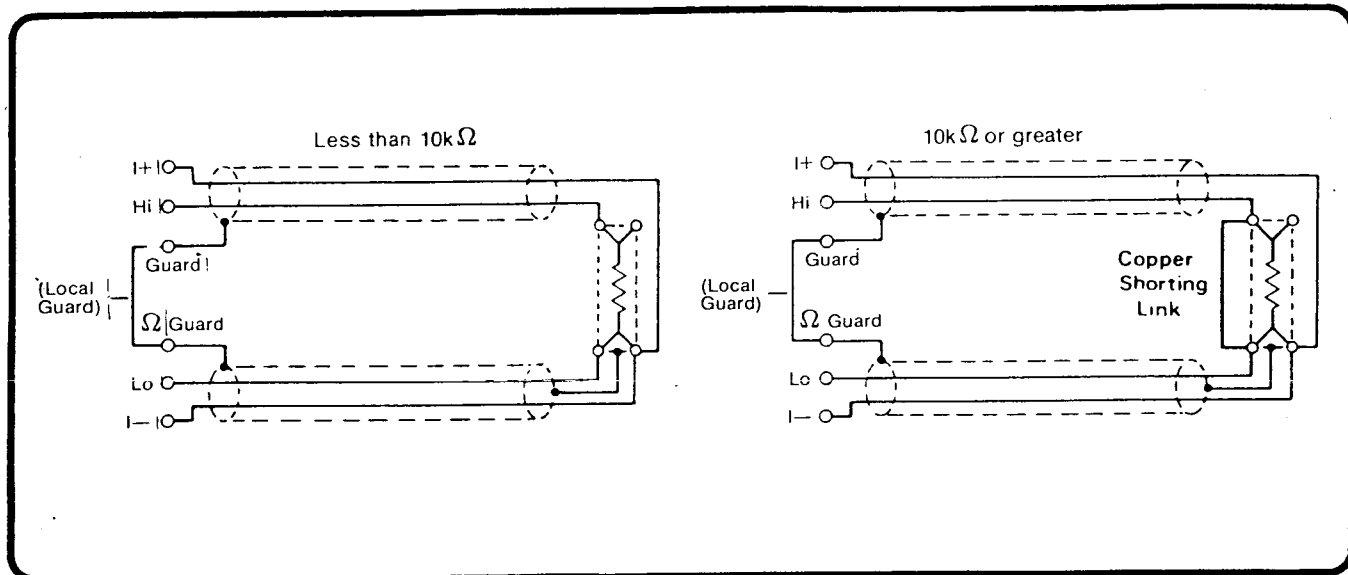

Fig. 2.1 Zero resistance source connections

'In-circuit' measurements

'Ω Guard' can be used to make 'in-circuit' resistance measurements by guarding out parallel resistance paths so that only the value of R_x will be displayed.

Similarly, 'Ω Guard' can be used to reduce the settling time if R_x is shunted by any capacitance and a suitable tapping point is available.

Providing that R_a and R_b are no less than 250Ω ($1.5k\Omega$ on $1000k\Omega$ or $10M\Omega$ Ranges), and the Ω Guard resistance (R_g) is less than 5Ω ; the actual value R_x can be calculated from the displayed value R_d by:

$$R_x = R_d \times (1 + E).$$

Deviation fraction 'E' can be found within 1% by the simplified formula:

$$E = \frac{(R_d \cdot R_g)}{(R_a \cdot R_b)}$$

(Where R_g is the Ω Guard lead-resistance from the junction of R_a and R_b , + 0.25Ω .)

Example:

If $R_d = 100\Omega$, $R_g = 1\Omega$, $R_a = R_b = 10k\Omega$, then the value of E is given by:

$$E = \frac{100 \times 1}{10k \times 10k} = 10^{-6} \text{ (1ppm of reading);}$$

The value of R_x is thus given by:

$$\begin{aligned} R_x &= 100 \cdot (1 + 10^{-6}) \text{ Ohms,} \\ &= 100.0001 \text{ Ohms} \end{aligned}$$

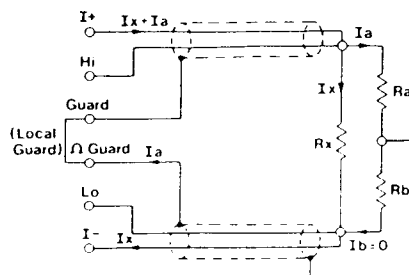

Rear input

The measurement source may be connected to the 'REAR I/P' plug instead of the front panel terminals when the 'I/P SELECT' rear panel switch is set to the 'REAR' position.

For all rear panel inputs, the maximum limit is 250 V RMS.

When using the rear panel input plug the front panel switches '4-wire Ω / 2-wire Ω ' and 'Local Guard / Remote Guard' are inoperative. Therefore to effect local guarding, a connection should always be made between 'Guard' (pin H) and 'Ohms Guard' (pin A). For 2-wire resistance measurement external connections must be made from 'Hi' to 'I+' and from 'Lo' to 'I-'.

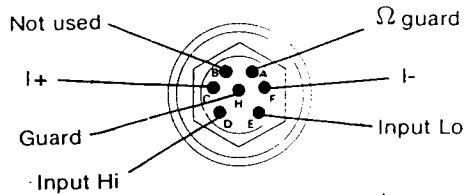

Fig. 2.2 Rear input 7 pin plug

Thermal EMF

Thermal emfs are significant in DC voltage, current and resistance measurements, especially when measuring low voltages or large currents. These unpredictable thermal emf errors arise when dissimilar metal junctions are at different temperatures. To minimise thermal emf errors use the same material throughout the measuring circuit, particularly avoid the use of steel probes, nickel plated terminals and tinned copper wire. The table below shows thermal emfs relative to hard drawn copper at 23°C.

MATERIAL	EMF $\mu\text{V}/^\circ\text{C}$
SILVER	+0.03
GOLD	+0.01
TIN	-3
LEAD	-3
NICKEL	-22

If dissimilar metal junctions are used ensure that they are offset by other junctions of the same material at the same temperature and allow for thermal emfs by making the measurement twice with reversed polarities.

A lead with gold plated copper terminals is provided in the Datron lead kit for making low thermal emf connections.

6½ Digits (1061A only) 7½ Digits (1071 only)

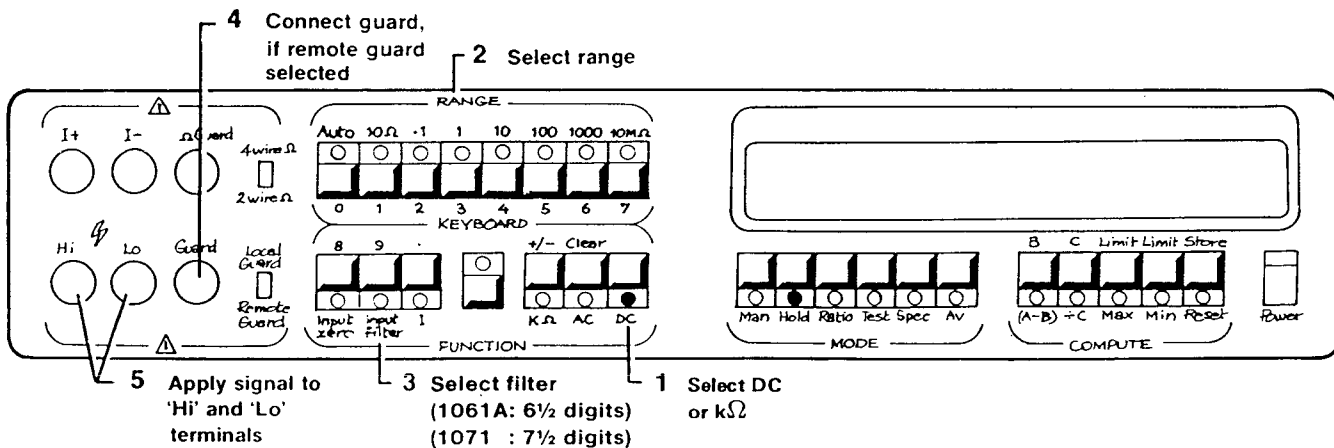

On the 1061A and 1071 models only, selection of 'Input filter' extends the DC Voltage and Resistance displays by an extra digit:

- i.e. 1061A is extended to 6½ digits.
- 1071 is extended to 7½ digits.

If option 12 is fitted in 1061A, then 'Input Filter' also

selects 6½ digits for 'AC' and 'DC Coupled AC' functions.

De-selection of this feature is achieved by re-pressing the 'Input filter' key.

Refer also to 'Average Mode measurements' in Section 3.

Display messages

Alpha numeric messages will appear on the display when an input, computational or memory error occurs. A message will also appear when a limit is transgressed and during the self test routine.

Message	Cause	Correction
Error OL	Overload 199999(9)	Reduce input signal or up range
Error 1	Arithmetic Overflow	Adjust C store, rear input or ratio input signal
Error 2	Invalid Data Entry/Recall	Adjust Data value/Recall
Error 3	Uncertainty > 100% or unspecified	
Error 4	Input Zero or calibration input error	Adjust applied input and repress key.
Error 5	DC Self Test failure	} Refer to Calibration & Servicing Handbook
Error 6	kΩ Self Test failure	
Error 7	AC Self Test failure	
Error 8	I Self Test failure	
Error 9	Arithmetic Underflow	Adjust C store, rear input or ratio input signal
IP-O	Input Zero memory error	Repeat input zero procedure
FAIL	Calibration memory error	Refer to Calibration & Servicing Handbook
Hi Lt	Hi Limit transgressed	
Lo Lt	Lo Limit transgressed	
Hi Lo Lt	Hi and Lo Limit transgressed	Amend limit values
PASS & Legend*	Self Test pass message	

SECTION 3 ADVANCED OPERATIONAL PROCEDURES

The procedures for exercising the features that supplement the basic measurement functions of the 1061, 1061A and 1071 AUTOCAL instruments are detailed in this section.

'Manual', external triggers and 'Hold'

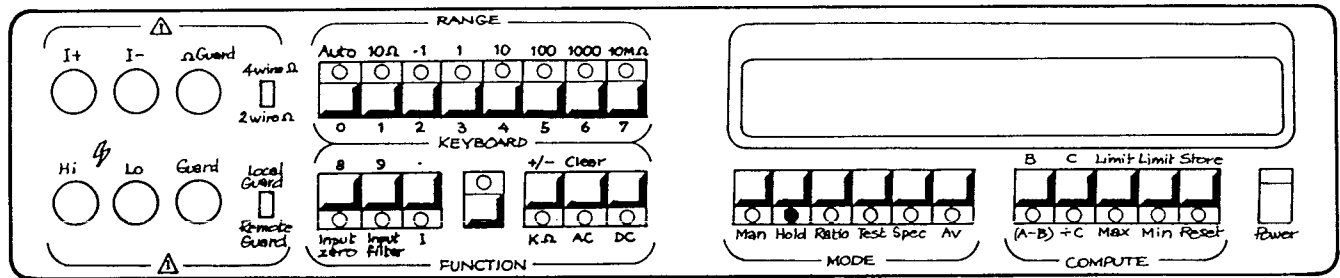

When the instrument is under local control, readings are taken at a rate in accordance with its internal read rate specification. When the 'Hold' key is pressed the reading in progress is completed and displayed, but no further readings are taken.

In this condition, pressing the 'Man' key causes one reading to be taken and displayed (i.e. a single shot operation).

If 'Hold' and 'Auto' are both selected, when 'Man' is depressed, the instrument will change range as required before a reading is taken and held.

The DVM measurement cycle can be triggered externally, after the internal trigger has been disabled by pressing the 'Hold' key. The trigger occurs on a high to low edge. The external trigger connector is on the rear panel, connection arrangement is shown in Fig. 3.1.

Pressing 'Hold' again returns the instrument to its free running condition.

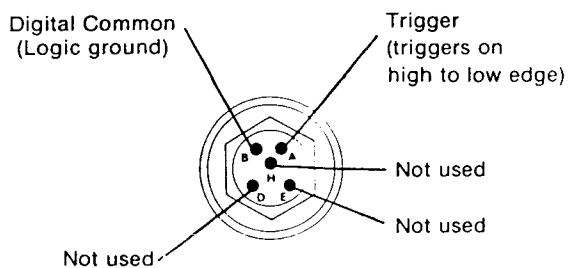
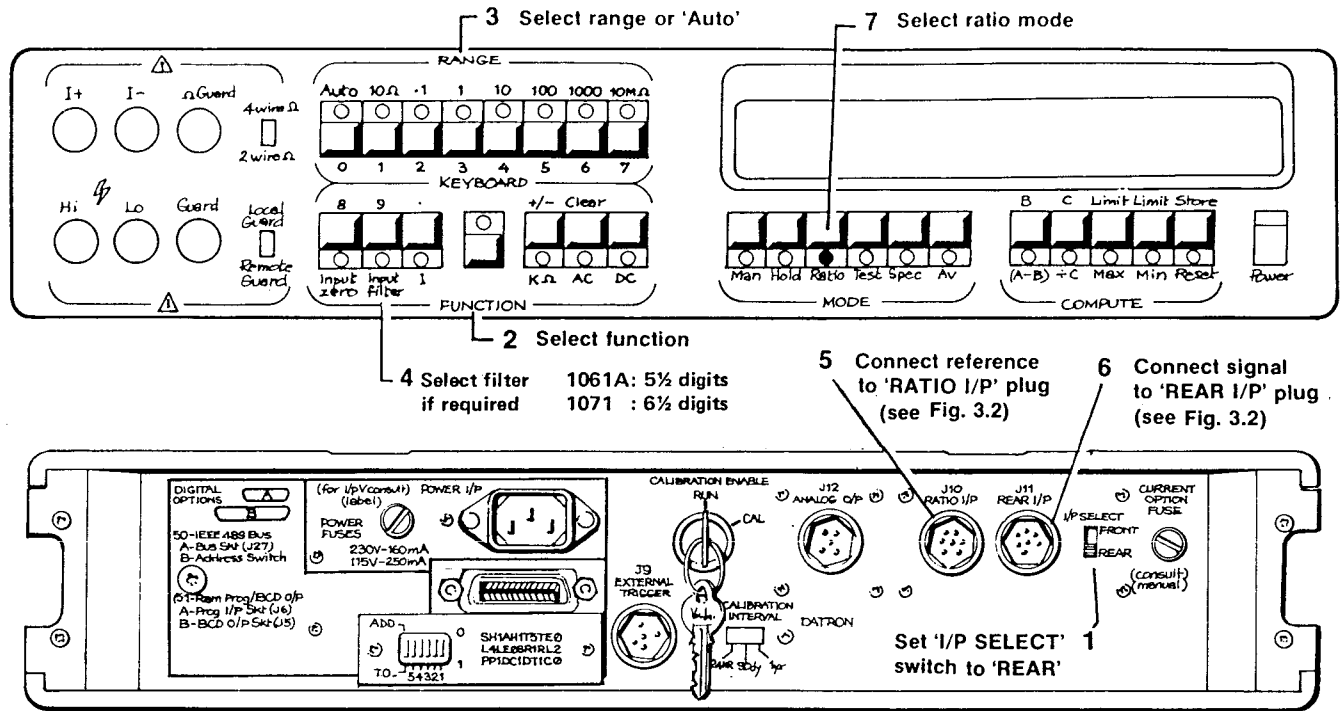

Fig 3.1 External trigger 5-pin plug

Ratio measurement procedure



The ratio of any two similar function inputs can be displayed by following the procedure shown above. If 'Auto' is selected the two inputs may be of widely different magnitude, although maximum permissible input voltages are limited to 250V RMS when using the rear input plugs.

The display will show a value equal to:

$$\frac{\text{rear input}}{\text{ratio input}} \times 100\%$$

An Error 1 indicates an arithmetic overflow
Error 9 indicates an arithmetic underflow

In either case, the rear or ratio input signal should be adjusted until a valid ratio reading is obtained.

Deselection of this mode is made by repressing the 'Ratio' key.

Example of ratio measurements

The instrument's AC converter is a true RMS DC coupled unit, making it possible to perform AC:DC ratio measurements. When used in this way, with an AC source compared with an accurate DC source, the instrument operates as an automatic AC/DC transfer standard with a typical transfer accuracy of 0.01% at low frequency.

Transfer standard measurements should be made

with the instrument set to take DC coupled AC measurements (see section 2). Connect the AC source to the rear input plug and the DC source to the ratio input plug, a displayed reading of 100% indicates an equalized state.

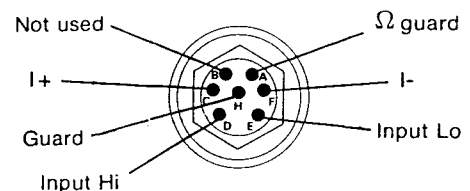

Fig 3.2 Rear and ratio inputs 7-pin plugs

Ratio in Average Modes

'Input Filter'. The associated rolling average is not available in 'Ratio'.

1071 Continuous 'Av'. The 1071 first measures the two inputs and computes the ratio normally. This ratio is averaged with all its predecessors, and only the new average is displayed.

1071 Block 'Av'. The 1071 takes a full block of 'Ratio Input' measurements and stores their average. It then takes a full block of 'Rear Input' measurements and stores their average.

The ratio: $\frac{\text{Rear Input Average}}{\text{Ratio Input Average}} \times 100\%$
is computed and displayed.

Self test

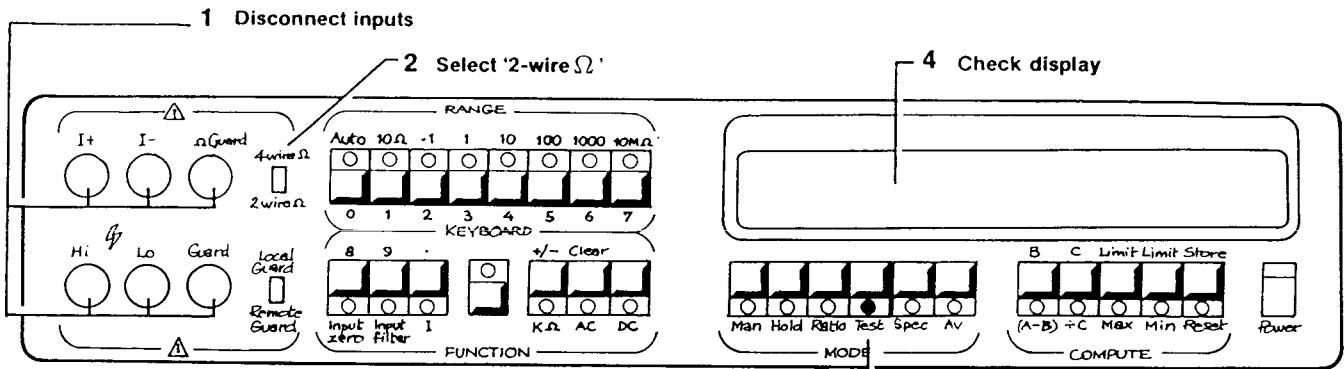

Pressing the 'Test' key starts a self test routine. The self test is a part visual, part internal check of the proper operation of the instrument. A visual check is made of the display by the operator and internal checks are executed to verify that the circuits are functioning correctly. Self Test does not check the full measurement accuracy of the instrument.

ALL MEASUREMENT INPUTS SHOULD BE LEFT OPEN CIRCUIT.

'2 wire Ω' should be selected.

Switching to Self Test automatically selects 'Front input' if option 40 or 41 is fitted.

Self test sequence

The routine after pressing 'Test' is as follows:-

1. Turns off all key LEDs except 'Test'.
2. Display cleared.

Visual check sequence

3. All commas displayed (1071 only).

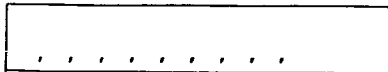

4. Seven segment digits and legends illuminated 'bar' by 'bar'.

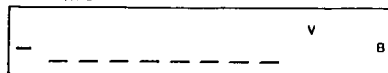

5. All decimal points displayed.

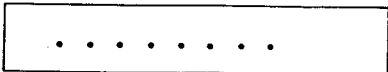

6. Polarity signs and overrange digit displayed.

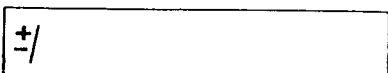

7. Seven segment digits displayed digit by digit.

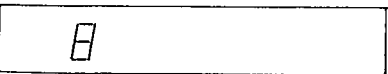

8. First then second block of legends displayed.

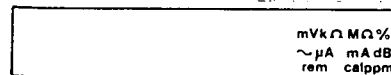

9. Display cleared.

Internal check sequence

- | | |
|---|---------------------------|
| | <u>PASS indication:</u> |
| 10. Check Ratio. | Adds % legend to display. |
| 11. Check DC volts.
If the following options are not fitted, the routine passes on to the next step. | Adds V legend. |
| 12. Check Ohms. | Adds Ω legend. |
| 13. Check AC volts. | Adds ~ legend. |
| 14. Check I. | Adds A legend. |
| 15. A check is made of the non-volatile memory (i.e. the calibration and input zero memory). | PASS |

When the test routine is completed successfully, the instrument will retain the 'PASS' indication. Pressing 'Hold' will return the instrument to the last selected range and function but all mode and compute functions are cancelled.

When the 'Test' routine finds an error in the internal checks, an Error message will be held on the display. To clear this state and continue with the self test routine, press 'Man'. Refer to Calibration and Servicing Handbook for fault finding procedure.

- An Error 5 indicates DC failure
- Error 6 indicates $k\Omega$ failure
- Error 7 indicates AC failure
- Error 8 indicates I failure
- FAIL indicates Calibration memory error.

Spec mode

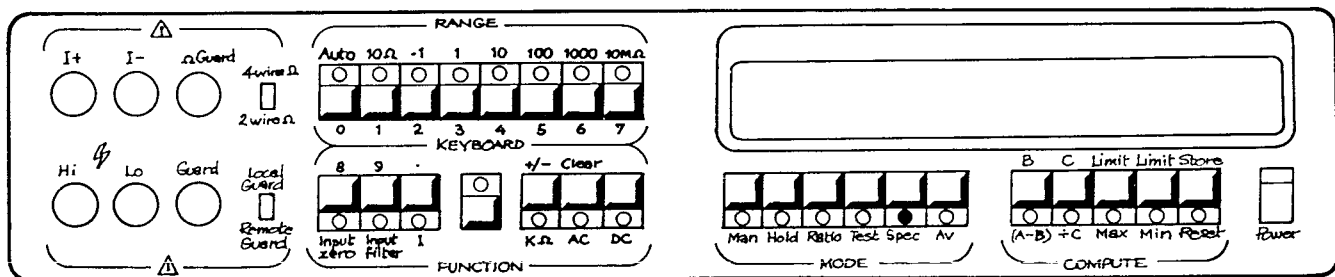

Depressing the 'Spec' key causes the instrument to compute and display an uncertainty value that relates to the last measurement made. The instrument contains a table of the measurement specification for every function and range, and the maximum limits of uncertainty for the last displayed measurement is displayed as a fraction of that measurement.

This uncertainty value is only available for the measurement itself, not for the computed value of the reading (see 'Computation Facility'). Nor is it available for Average Mode readings (1071 only - see Average Mode) or when in Superfast mode (1061/ 1061A only - see Sections 4 & 5).

The uncertainty value of dB measurements can be displayed. In this case, it is expressed in dBs.

The uncertainty is calculated according to the setting of the calibration interval switch on the rear panel so that the instrument's specification is examined in the area that corresponds to the chosen re-calibration interval.

The display is preceded by a +/- indication and is in ppm or %, depending on magnitude. Very large errors, such as near zero readings, are displayed as a message (Error 3).

Depressing the 'Spec' key again, returns the instrument to normal operation.

dB measurements (1061/1061A only)

The dB mode is selected by depressing the 'dB' key.

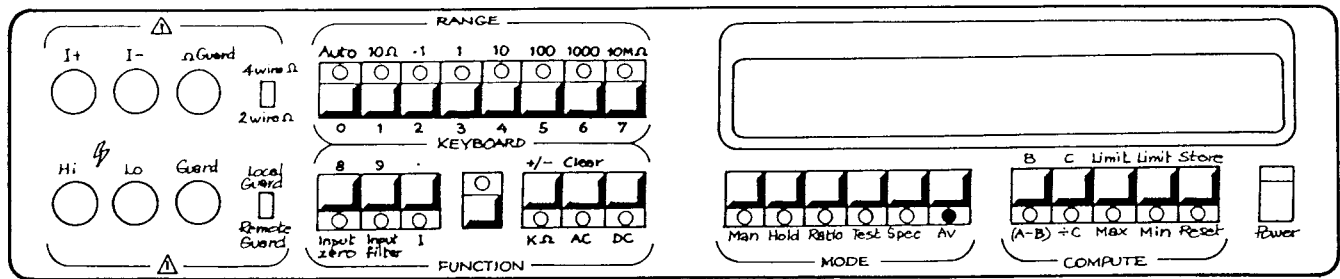

Selection of 'dB' causes the readings to be expressed in terms of decibels relative to unity (1V, 1kΩ or 1mA).

Selection of 'dB' and 'Ratio' displays readings of ratio in decibels relative to the reference signal connected to the 'Ratio I/P' plug.

$$\text{Display is } 20 \log \left(\frac{|x|}{y} \right)$$

Where x = measured or computed value
and y = 1V, 1kΩ, 1mA or the ratio reference input.

In addition, a dB readout can be displayed of the input signal in relation to any value, divided by 100, stored in the ÷ C store (see Computation Facility). This facility is accessible by depressing both the 'dB' and '÷ C' keys.

If the dB measurement function is combined with the (A-B) function, the subtraction A-B is performed before the conversion to dB is made.

De-selection of this mode is made by re-pressing the 'dB' key.

dB measurement example

To plot the frequency response of an amplifier.

The gain of an amplifier and the phase relationship between its input and output signals is dependent upon the frequency of those signals. A convenient way of representing the frequency response of an amplifier is to plot the magnitude of the voltage gain of the amplifier in dB's against frequency.

$$\text{Voltage gain} = 20 \log_{10} \frac{V_{out}}{V_{in}}$$

The ratio V_{out}/V_{in} may be measured using 'Ratio' mode (V_{in} as rear reference input and V_{out} as rear input) or measuring V_{in} , storing $V_{in}/100$ in store C (see Computation Facility) and then selecting ÷ C when measuring V_{out} . To express this gain in decibels, the dB key is selected.

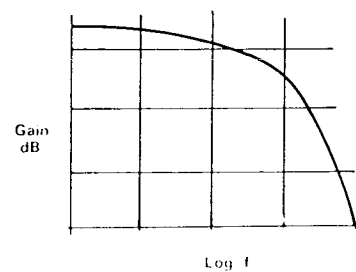

Average mode measurements (1071 only)

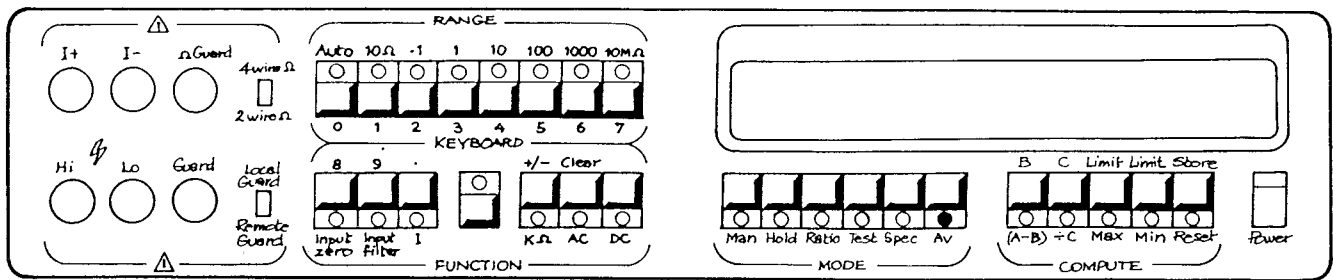

Pressing the 'Av' key activates one of two averaging modes: 'Continuous' or 'Block'.

With DC or kΩ functions set, selection of 'Av' extends the display to 7½ digits giving greater resolution. It can also be selected for other functions, but without increasing the display resolution.

Interlocks in Averaging Modes

Setting 'Av' deselects auto-ranging, so overscale readings cause an error indication (Error OL). Conversely, setting 'Auto' deselects 'Av'.

When 'Input Filter' is selected in combination with 'Av', 'Ratio' or 'Remote'; the analog input filter is connected in circuit, but the high resolution 'Rolling Average' mode associated with the input filter key is not selected.

Rolling, Continuous, and Block Average modes cannot be selected in 'Cal' mode. Entry into 'Cal' mode deselects any average mode set.

Choice between 'Block Size' and 'Continuous'.

A 'Block' is a set of consecutive measurements, whose mean value is calculated and displayed by the instrument. A user can preselect how many measurements will constitute a block, by entering a number (called the 'Block Size') via the front panel keyboard. The number is stored in an internal memory, but it also has a second use; to determine which of the two averaging modes will be activated by pressing 'Av':

- Block Size = 0: Continuous Average Mode
- Block Size ≥ 1: Block Average Mode

When the 1071 is powered on; the block size is initialized to '0', with Average OFF. Subsequent selection of 'Av' will thus activate 'Continuous' mode.

Access to Block Size memory.

A user gains access to the block size memory to inspect or adjust the stored number, by using the front panel 'Keyboard' mode.

To inspect the block size:

- Press 'KEYBOARD' - 1071 enters 'Keyboard' mode.
- Display = '+0'
- Press 'Av'
- Either 'Cont' or a number appears on the display.

If 'Cont' is displayed, the 1071 is set for Continuous mode. Otherwise, the displayed number is the block size in Block mode.

To set the block size:

- Press 'KEYBOARD' - 1071 enters 'keyboard' mode.
- Display = '+0'.
- Enter block size required
- Display = Value entered (in range 0 to 19999)
- Press 'Store'
- Store LED lights green.
- Press 'Av'
- Block size is set in memory, and the 1071 reverts to its previous operation.

N.B. By entering a value of 0. Continuous mode is set; any other value sets Block mode.

Description of Averaging Modes

'Input Filter'

A 'Rolling Average' mode is automatically set by this selection, (or by the IEEE 488 bus command A2). Up to the 15th measurement, the displayed reading is the arithmetic mean of all measurements since pressing the key. On the 16th and subsequent measurements in DC or $k\Omega$ function, the resolution is increased to 7½ digits, and the reading is the arithmetic mean of the 16 most-recent measurements. The extra digit accommodates an improvement in true accuracy due to a graduated jitter technique used internally.

In the following formulae:

i is an integer: the number of measurements taken since pressing 'Input Filter'.

R_i is the value of the reading displayed after the 'i'th measurement, and

x_n is the value of the 'n'th measurement.

$$\text{For cases when } i < 16: R_i = \frac{1}{i} \sum_{n=1}^i x_n$$

$$\text{For cases when } i > 15: R_i = \frac{1}{16} \sum_{n=i-15}^i x_n$$

Continuous Average Mode.

This mode is selected by pressing 'Av' when the block size is zero (It is available by IEEE 488 bus command A1, which clears the block size memory to zero). The displayed reading is the arithmetic mean of all readings taken since the 'Av' key was pressed. After the first measurement in DC or $k\Omega$ function, the display resolution is increased to 7½ digits.

$$\text{i.e. each displayed value } R_i = \frac{1}{i} \sum_{n=1}^i x_n$$

Where: i = number of measurements taken since pressing the 'Av' key, and
 x_n = value of the 'n'th measurement.

The 'Average' memory has a capacity of 222 readings leading to overflow after approximately 24 days at 2 readings per second. The memory is reset whenever the Average mode is selected, or at a Range or Function change.

Block Average Mode

This mode is selected by pressing 'Av' when the block size is non-zero (Its IEEE 488 bus command is A3, which also sets the block size to '1' if its value was '0').

A 'Block' is a preset number of measurements, taken at maximum internal read-rate on receipt of a block trigger. Minimum block size is 1 measurement, maximum is 19999.

After taking the block of measurements, the instrument displays a single reading (with extra digit if appropriate), which is the arithmetic mean of all measurements in the block.

$$\text{i.e. each displayed value } R_k = \frac{1}{k} \sum_{n=1}^k x_n$$

Where: k = number of measurements taken in the block (Block Size), and
 x_n = value of the 'n'th measurement in the block.

While the block average is being displayed; if the instrument is retriggered, externally triggered or manually triggered, it takes a further block of measurements and changes the display to the new average when completed. A 'single shot' block can be activated using 'Hold' and 'Man' keys, or by use of an external trigger.

N.B. If a block size of 1 is set, the average value is that of a single reading. The extra digit therefore has no significance.

Computation facility

Four compute stores exist labelled B, C and Limits which can be loaded with any number from the display. This means that either a previous reading or a manually entered display using the 'Keyboard' feature can be used. These stores can then be used in a variety of ways to usefully extend the measurement capability of the instrument.

Entry of constants

The secondary use of the range and function keys as a keyboard is achieved by pressing the 'KEYBOARD' key. The display clears, apart from a '0' as the least significant digit. Digits and decimal points are then entered from the keyboard. The sign of the value keyed may be changed at any time by pressing the '+/-' key.

If an error is made, the entire display can be cleared by pressing the 'Clear' key.

Recall Store

The number in any of the four computational stores may be displayed at any time by pressing the 'KEYBOARD' key, followed by the appropriate 'COMPUTE' key. Pressing 'KEYBOARD' again returns the instrument to the previous setting.

The units of the recalled number are dependent upon the function selected and legend displayed as shown below.

FUNCTION	LEGEND	UNITS
V	NONE	V
	m	mV
	k	kV
k Ω	NONE	k Ω
	m	Ω
	k	M Ω
I	NONE	mA
	m	μ A
	k	A

e.g. with 'k Ω ' selected 2.5 recalled indicates a stored value of 2.5k Ω and 2.5k recalled indicates a stored value of 2.5M Ω .

Load/reset store

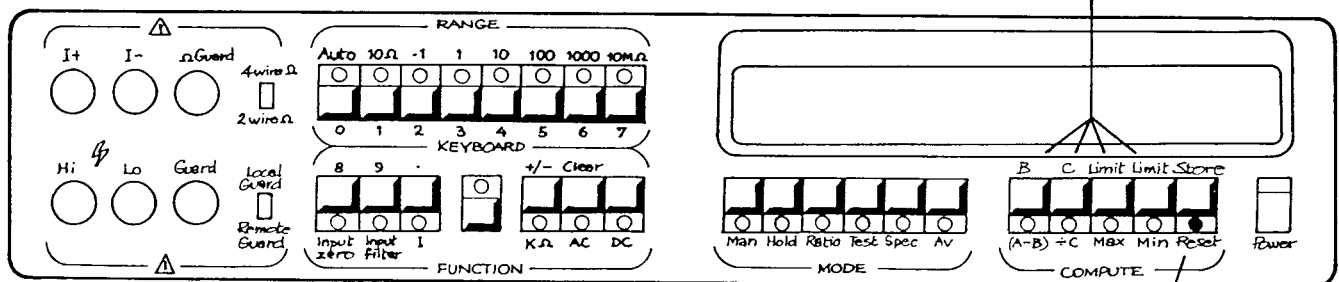

In order to load a compute store with the displayed number, press the 'Reset (Store)' key followed by the required store location ('B', 'C' Limit (max)' or 'Limit (min)'). The number is then loaded, extinguishing the 'Reset (Store)' LED and returning the instrument to its original setting.

The stored number assumes the units displayed for the range being used i.e. 2.5 entered on the '10k Ω ' range results in a stored value of 2.5k Ω and 2.5 entered on the '10M Ω ' range results in a stored value of 2.5M Ω .

(A-B)

Pressing the (A-B) key gives measurements a constant offset, B, to be subtracted from the true reading, A. The offset must lie in the range.

$$1061 \quad 10^{-5} \leq |B| < 2 \times 10^{+5}$$

$$1071 \quad 10^{-7} \leq |B| < 2 \times 10^{+7}$$

The (A-B) LED is lit to show that the instrument is operating in this mode. Repeating (A-B) returns the instrument to normal operation, with stored value in B for later use.

(A-B) may be used in conjunction with \div C, Ratio, dB and Average mode.

(A-B) procedure 1: Subtracting an offset from each reading

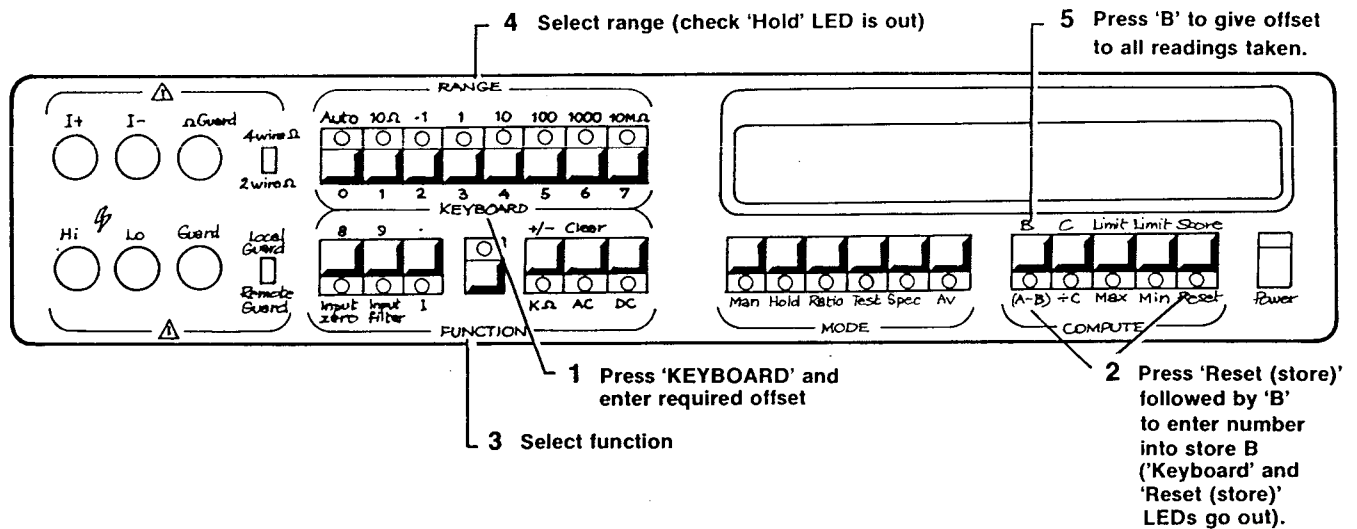

(A-B) procedure 2: Finding the difference between two readings

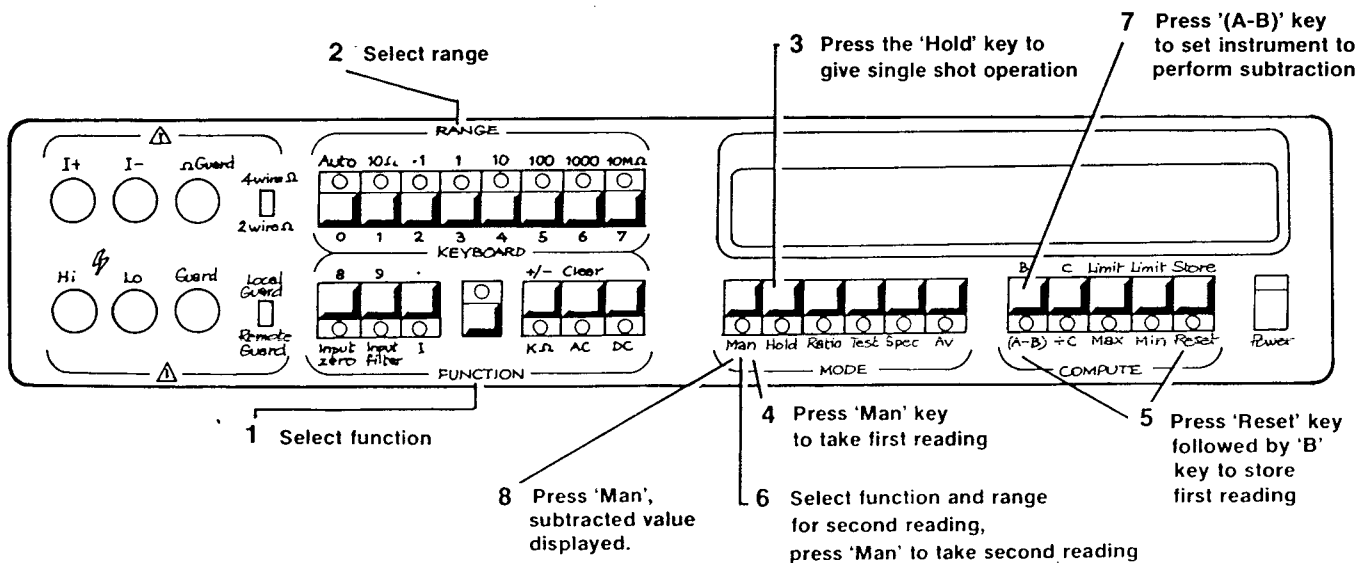

÷ C

Selection of ÷ C allows measured readings to be divided by a constant C x 100%. The constant must lie in the range

$$1061 \quad 10^{-5} \leq |C| < 2 \times 10^{+5}$$

$$1071 \quad 10^{-7} \leq |C| < 2 \times 10^{+7}$$

(To multiply the measured reading by a constant, enter its reciprocal multiplied by 100 into Store C).

The ÷ C key LED lit indicates that the instrument is operating in this mode. Repeating ÷ C returns the instrument to normal operation, with the stored value in C for later use.

÷ C may be used in conjunction with (A-B), Ratio and Average mode.

A display of:

Error 1 indicates an arithmetic overflow.

Error 9 indicates an arithmetic underflow

In either case the value in the C store should be adjusted.

÷ C Procedure: Continuously halve all measurements.

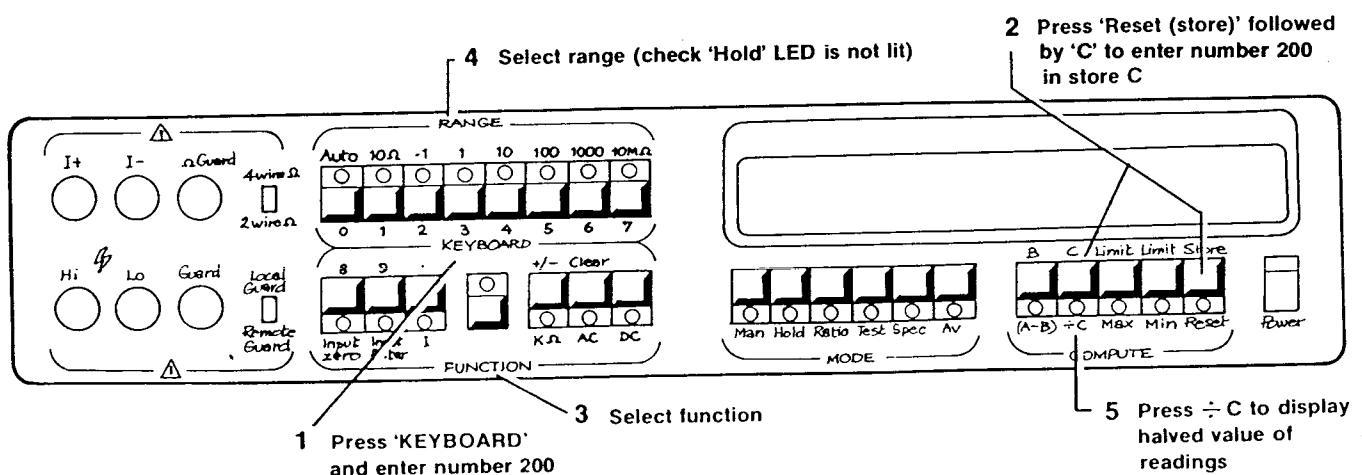

Examples of measurement using (A-B) and \div C

To remove the zero offset of a pressure transducer.

Most pressure transducers have a standard offset of a few volts at 'zero' pressure. This offset may be removed from subsequent readings by storing the constant in store 'B' and placing the instrument into '(A-B)' compute mode.

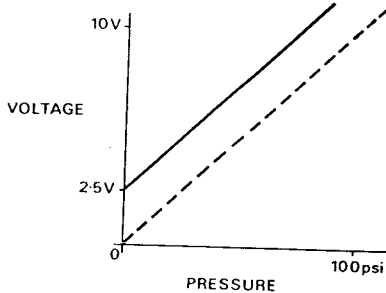

To compute the current flowing through a known resistance.

Using the simple formula $I = V/R$ the value of I may be obtained by measuring the voltage developed across the resistance. The value of R , say $1k\Omega$, is placed into store 'C' and the instrument used in the \div C compute mode. The displayed reading then indicates the current in milliamps.

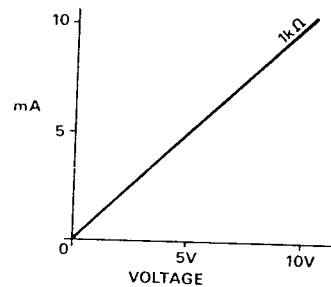

To check a particular component is within its stated tolerance.

Suppose we have a batch of $39k\Omega \pm 5\%$ resistors and we wish to know each resistor's percentage deviation from nominal. The equation

$$\frac{A-N}{N} \times 100$$

gives the percentage deviation from nominal, requiring the entry of the nominal value into both B and C stores. Selecting '(A-B)' and \div C compute modes gives a direct read-out of percentage deviation.

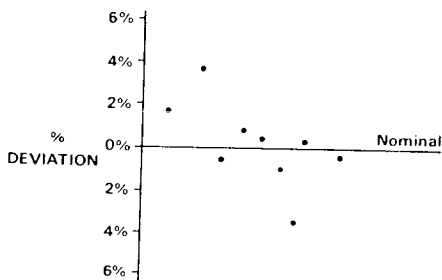

To measure a resistance greater than $20M\Omega$

By connecting a $10M\Omega$ resistor in parallel with R_x and using the '(A-B)' and \div C compute modes large resistances can be measured and displayed.

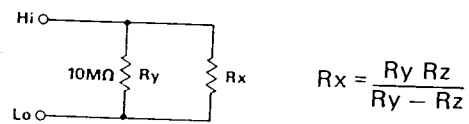

Where $R_z = R_x$ in parallel with R_y .

Measure R_y and store in store 'B'. Select '(A-B)' and measure R_z (display reads $R_z - R_y$).

Store $-10 (R_z - R_y)$ in store 'C', using the 'Keyboard' mode and select \div C.

The display now reads R_x in $M\Omega$ (% legend displayed) and the accuracy of the reading approximates to the accuracy of the DVM when measuring a value equal to R_z . Use short screened leads to reduce any errors due to noise.

Max and min

Selection of 'Max' or 'Min' causes the display to indicate the maximum or minimum reading since the stores were last reset. Each time the measured value is outside the current maximum or minimum, the appropriate store is updated.

The 'Max' and 'Min' stores are reset by pressing 'Reset' twice, changing function or passing into or out of 'Ratio' mode, after which the maximum and minimum displayed values are again retained and updated.

Simultaneous selection of 'Max' and 'Min' gives a maximum-minimum indication, i.e. a peak to peak indication of the readings since the stores were last reset.

NOTE: 'Limit' operation is also cancelled when the stores are reset.

The Max. and min. stores do not record the maximum and minimum values of dB or Average readings.

Max and Min procedure: Displaying the maximum value of a series of inputs.

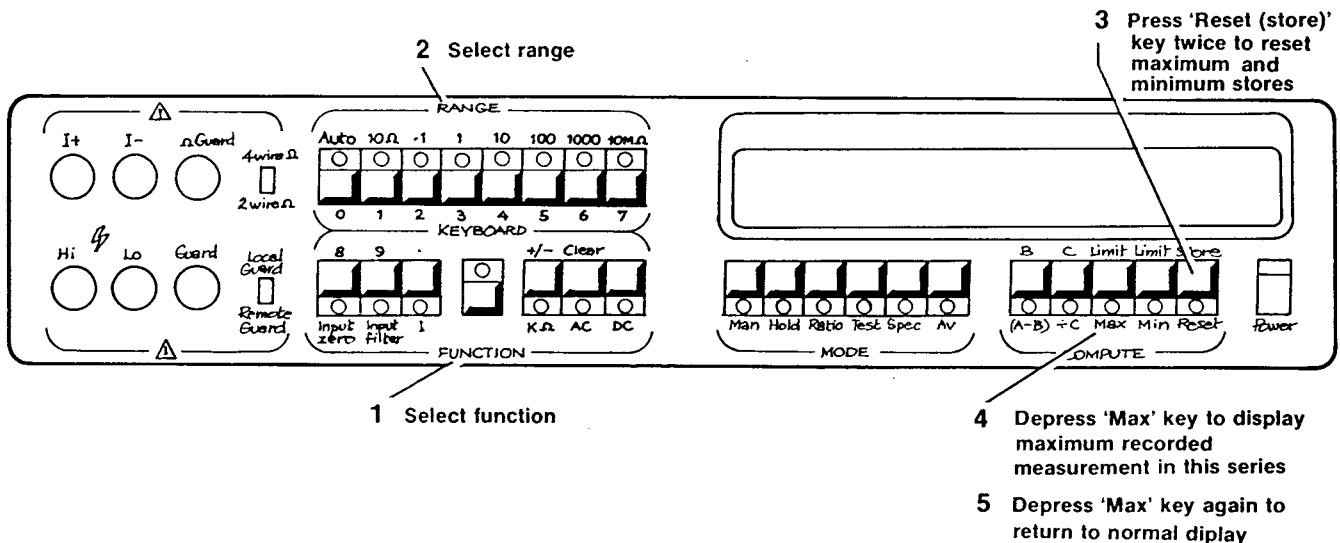

Example of Max and Min measurement

To find the maximum and minimum line supply voltage over 24 hours.

The instrument automatically keeps a record of maximum and minimum readings. Therefore once the DVM has been set to monitor the input voltage (i.e. AC Volts, 1000V range, filter in), the run may be started by clearing the stores (press 'Reset' twice). During the run the instrument can be set to display individual readings, the maximum or the minimum without store corruption.

On completion of the run, selecting 'Max' or 'Min' causes the instrument to display the maximum or minimum readings respectively.

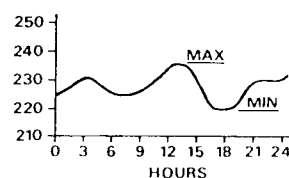

Limits

High and low limit values are placed into the 'Limit' stores so that when these values are transgressed a display message is shown. Limit operation is cancelled (and the limit values lost) by pressing 'Reset' twice, changing function or passing into or out of 'Ratio'.

NOTE: 'Max' and 'Min' stores are also reset when cancelling the 'Limit' operation.

The value of a limit can be entered independently of the range selected, i.e. 100.000 V limit can be entered with 0.1 V range selected.

The display of an out of limit reading is as follows:

Hi Lt - indicates Hi limit transgressed.
 Lo Lt - indicates Lo limit transgressed.
 Err Lt - indicates both Hi and Lo limit transgressed.

Limits procedure: Setting upper and lower limits.

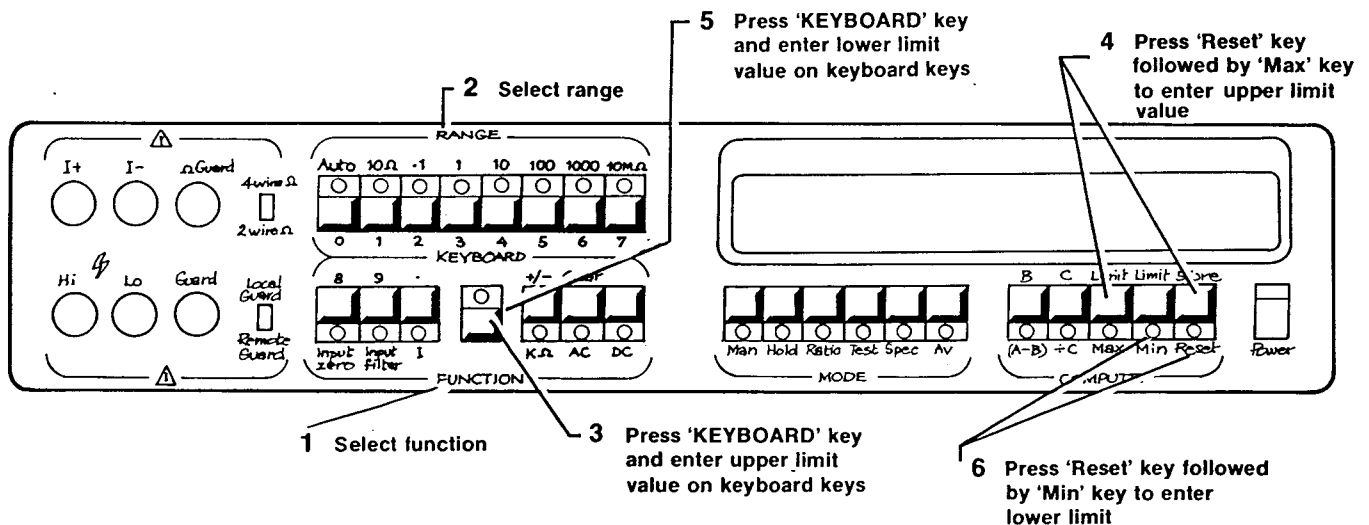

Example of Limit measurement

To use the limit mode for 'in specification' selection.

Consider the fabrication of 39kΩ 5% resistors. To meet the tolerance specification the resistor value must lie in the range 37.05kΩ to 40.95kΩ. The first step is to set the DVM to monitor the resistor value (kΩ, 100kΩ range, 2-wireΩ) then using the keyboard mode, place 37.05 in the min limit and 40.95 in the max. limit ('Keyboard 37.05', 'Reset', 'Min' limit, etc.) The samples may then be measured, the display messages Hi Lt and Lo Lt showing out of tolerance samples.

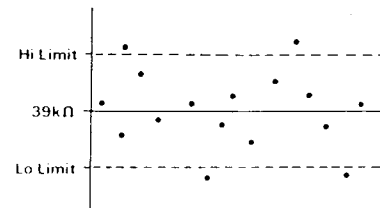

SECTION 4 SYSTEMS APPLICATION VIA THE IEEE INTERFACE

The IEEE interface option allows the 1061 and 1071 instruments to form part of a system, outputting measurement data to other parts of that system. In addition, the DVM can be instructed via the interface so that the instrument's facilities can be selected remotely.

In order that instruments from differing manufacturers can be built into the same system, it is necessary that all interfaces are compatible. To ensure this, the interfaces conform to a standard specification as detailed in the publication ANSI/IEEE Std 488-1978 called 'IEEE Standard Digital Interface for Programmable Instrumentation'.

A typical system is shown in Fig. 4.1. The system is driven by a controlling device able to issue commands (controller), receive data (listener) and output data (talker). The DVM is able to receive programming information (listener) and to output data (talker). A device such as a printer or VDU will simply input data (listener) its output not being into the system, but onto paper or the screen. The signal scanner is also a listener only, receiving only commands. Neither its signal input or output are directly connected to the interface bus.

If a system comprises several instruments, the controller is able to communicate with the instruments individually through the assignment to each of a different 'address'. The controller adds information to the address to define either talk or listen.

In the system example (Fig. 4.1), the sequence of events for the task of selection of one of the input signals, measuring it with the DVM and printing the result is as follows:

1. The controller requires to select a signal and therefore must send instructions to the scanner. The instruction must not be received by the DVM or the printer and so the controller sends the general bus message "unlisten".
2. To enable the scanner to receive its instructions the controller sends the listen address which has been assigned uniquely to this device. It follows this with the instructions required to select a channel. The instructions are passed along the IEEE bus data lines as coded messages (bytes). The code most normally used is ASCII (American Standard Code for Information Interchange).
3. Since the scanner will take a period of time to change channels it sends a message back to the controller via one of the IEEE bus management lines (SRQ) upon completion. Note that the scanner does not have to be addressed as a talker to return information to the controller via the management lines. This is only necessary if the data lines are to be used.
4. The controller does not know which of the devices generated a message on this management line, since all devices are connected to the same line. To determine the originator, the controller will, by sending messages via the interface, ask or 'poll' all the devices either one by one (serial poll) or together (parallel poll).
5. The controller will determine that the scanner is the source and must send instructions to the DVM so that the correct range and function is selected before the measurement is made. Firstly it must ensure the scanner is not listening since any coded messages sent to the DVM (known as "device dependant") could be misinterpreted by the scanner. Sending 'unlisten' followed by the listen address of the DVM and the required programming instructions achieves the desired result.
6. The DVM requires a period of time to take a measurement and prepare data. It generates a message via the same management line (SRQ) to the controller when it is ready.
7. The controller must again determine which of the devices sent the message (service request SRQ) by conducting a poll.
8. With the reading available, the controller activates the printer with its listen address only, and the DVM with its talk address.
9. When the controller signals the beginning of the transfer, using another of the bus management lines, the DVM will send the

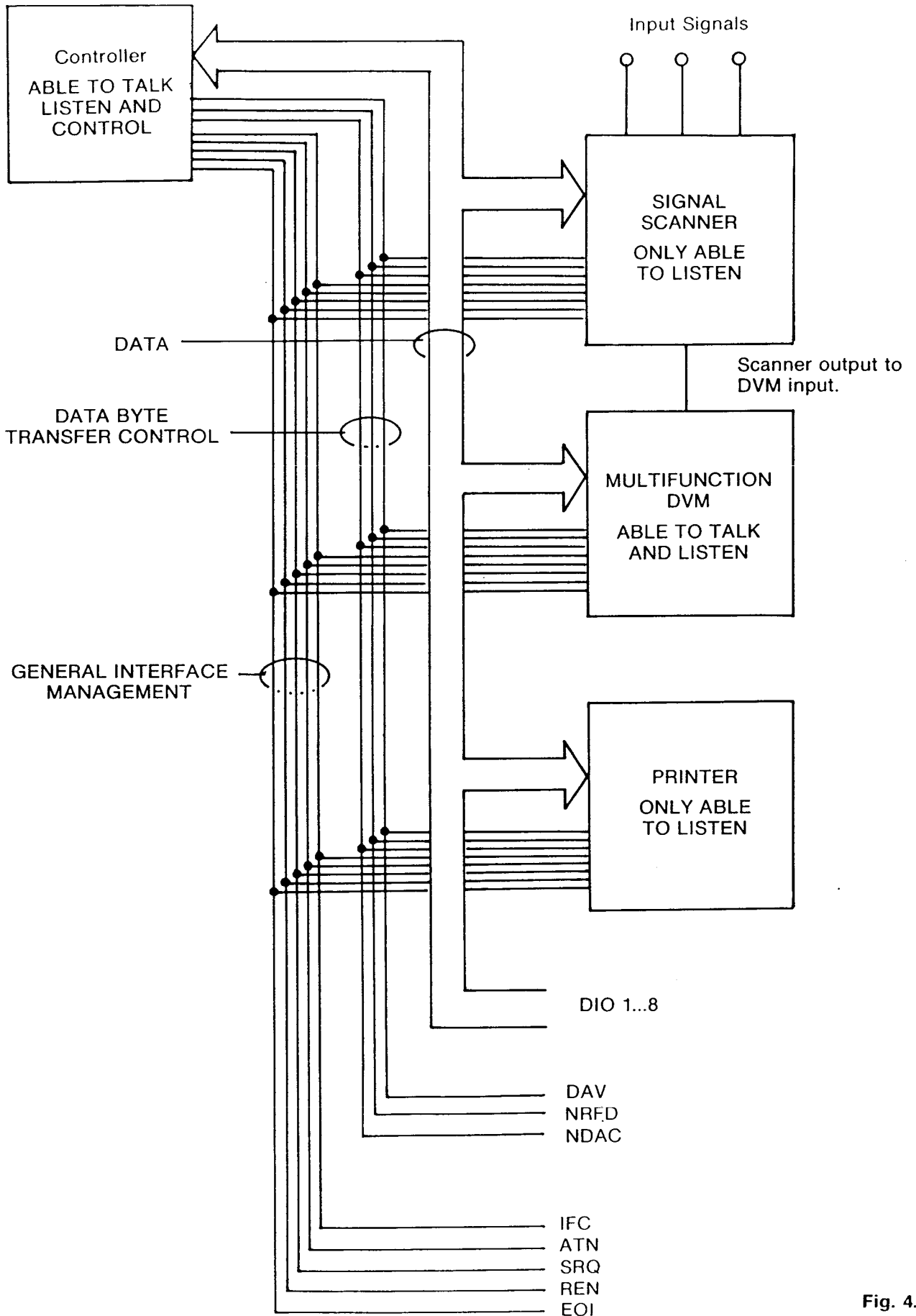

Fig. 4.1

data byte by byte to the printer using the three data byte transfer control lines (handshake lines) to ensure orderly transfer of data between the instruments.

10. Usually the controller is also listening to this data transfer to determine when it is complete. As an aid to the controller and printer, the DVM will send with the last byte to be transferred another message (EOI end or identify) using another of the bus management lines.
11. The sequence is complete and the controller is able to start again using another input signal.

Connecting the 1061/1071 into a system

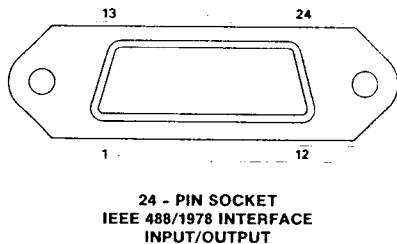

Fig. 4.2

J27 Pin No.	Name	Description
1	DIO 1	Data Input Output Line 1
2	DIO 2	Data Input Output Line 2
3	DIO 3	Data Input Output Line 3
4	DIO 4	Data Input Output Line 4
5	EOI	End or Identify
6	DAV	Data Valid
7	NRFD	Not ready for Data
8	NDAC	Not Data Accepted
9	IFC	Interface Clear
10	SRQ	Service Request
11	ATN	Attention
12	SHIELD	Screening on cable (connected to DVM Safety Ground)
13	DIO 5	Data Input Output Line 5
14	DIO 6	Data Input Output Line 6
15	DIO 7	Data Input Output Line 7
16	DIO 8	Data Input Output Line 8
17	REN	Remote Enable
18	GND 6	Gnd wire of twisted pair with DAV
19	GND 7	Gnd wire of twisted pair with NRFD
20	GND 8	Gnd wire of twisted pair with NDAC
21	GND 9	Gnd wire of twisted pair with IFC
22	GND 10	Gnd wire of twisted pair with SRQ
23	GND 11	Gnd wire of twisted pair with ATN
24	GND	DMM Logic Ground (Internally connected to DVM Safety Ground)

Table 4.1 IEEE 488/1978 Connector - Pin Designations

Interconnections

Instruments fitted with an IEEE interface are connected together to form a system by using an interconnecting cable as specified in the IEEE Standard 488-1978 document. The connector and pin designations are also standardised and shown in Fig. 4.2 and Table 4.1.

Although the interface specification is called a standard, variations in implementation within the specification are permitted. These variations determine the capabilities of the particular interface and a list of abbreviations are defined in the standard document to indicate to a user which interface capabilities have been designed in. These abbreviations appear on the rear of the instrument beneath the interface connector and are shown in the table below. A fuller description of each code appears in appendix C of the IEEE standard.

Code	Interface Function
SH1	Source Handshake Capability
AH1	Acceptor Handshake Capability
T5	Talker (basic talker, serial poll, talk only mode, unaddressed to talk if addressed to listen)
TEØ	No Address Extension Talker Mode
L4	Listener (basic listener, unaddressed to listen if addressed to talk).
LEØ	No Address Extension Listener Mode
SR1	Service Request Capability
RL2	Remote/Local Capability (without Local Lockout)
PP1	Parallel Poll Capability (configured by the controller)
DC1	Device Clear Capability
DT1	Device Trigger Capability
CØ	No Controller Capability

IEEE Interface capability.

Address selection

The instrument address is set manually using a six way miniature switch near the interface connector on the rear panel. Five of the switches are used to set the address, and using a binary code, this enables any address in the range 00 to 30 to be used. e.g. 11010 is address 26.

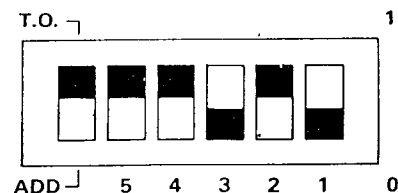
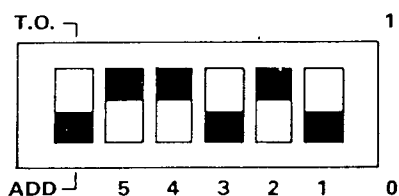

Address Switches					5-bit Decimal Code
A5	A4	A3	A2	A1	
0	0	0	0	0	00
0	0	0	0	1	01
0	0	0	1	0	02
0	0	0	1	1	03
0	0	1	0	0	04
0	0	1	0	1	05
0	0	1	1	0	06
0	0	1	1	1	07
0	1	0	0	0	08
0	1	0	0	1	09
0	1	0	1	0	10
0	1	0	1	1	11
0	1	1	0	0	12
0	1	1	0	1	13
0	1	1	1	0	14
0	1	1	1	1	15
1	0	0	0	0	16
1	0	0	0	1	17
1	0	0	1	0	18
1	0	0	1	1	19
1	0	1	0	0	20
1	0	1	0	1	21
1	0	1	1	0	22
1	0	1	1	1	23
1	1	0	0	0	24
1	1	0	0	1	25
1	1	0	1	0	26
1	1	0	1	1	27
1	1	1	0	0	28
1	1	1	0	1	29
1	1	1	1	0	30

Table 4.2 Address Selection

'Talker only' ('T.O.')

The sixth switch, when set to a "1", causes the DVM to become a 'talker only', meaning it can only output data and not be programmed over the interface. This is particularly useful if, for example, the system consists of only a DVM (the talker) and a printer (the listener), in which case a controller is not required.

Address 31 (Illegal bus address)

If the interface option is fitted, the address selected affects the manner in which the DVM powers up.

With address 31 selected, the DVM assumes the role of bench instrument and powers up to DC, 1000V range and reading at the internally controlled read rate. In addition, a manual calibration is only enabled with Address 31 selected, as explained in the Calibration and Servicing Handbook.

With an address selected in the range 0 to 30, the instrument powers up as a systems instrument in DC, 1000V range but in 'Hold'. Each time power-up occurs in this condition, a message is sent to the system controller to indicate that an instrument power-up has taken place.

Using the 1061/1071 in a system

The DVM can be operated under remote control, when ASCII coded programming instructions are received from a controller, or in local control when the DVM is operated from its front/rear controls. In both cases output of results or parameters is available at both DVM display and via the interface.

When operating in remote the legend 'rem' is displayed and all front panel controls are disabled except 'Power', '2/4-wire Ω', 'Local/Remote Guard' and in certain trigger modes 'Man'.

All the front panel controls (except 'Power', '2/4-wire Ω ' and 'Local/Remote Guard') are programmable via the interface, in addition to 'Front/Rear I/P Select' and 'Run/Cal-Calibration Enable' on the rear panel.

Furthermore, other 61/71 features exist which are only programmable and therefore can only be used if the IEEE interface is fitted. These are known as Superfast, Double trigger ratio, Binary Program, Binary Dump and Delay. These are explained in this section of the handbook under 'Programming Instructions'.

From the example given earlier in this section it may be seen that the DVM requires an address command followed by a series of device dependant messages or commands to change the various range, function and operating modes.

A series of these commands can be sent together as a 'program string'. e.g. R4F3T7 =

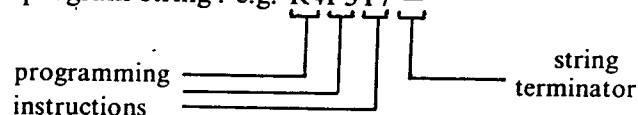

Each string will contain at least one programming instruction, details of which are given later, but before the instrument can take any action on the instructions, it must receive a terminate signal at the end of any string.

The required terminators are:

- i) The ASCII character '='
- or ii) EOI (end or identify) with the last byte of the string.

To assist in obtaining a correct set of programming instructions, the DVM checks for errors in the string, and generates a service request (SRQ) if a syntax error occurs or if an option was called for but not fitted.

The full range of commands for programming the DVM is given in Table 4.3. The precise programming details for each command are given in the next section under PROGRAMMING INSTRUCTIONS.

Programming instructions

Control of DVM inputs

Range. R1 through to R7 configure the instrument to a specific range, while R0 places the instrument in auto-range. Programming R1 or R7 when Ohms is not selected causes the DVM to set itself to R2 and R6 respectively.

Function. F1 through to F7 configure the instrument to the required function. Programming a function which is not fitted will generate an option select error.

Filter. Programming C1 introduces an additional filter into the analog circuitry.

Front/rear input selection. At power up, the DVM selects front or rear input dependent on the position of the rear panel control switch. If this switch is set to rear, selection of front or rear can be accomplished by programming I0 or I1 respectively.

Triggers. A reading may be triggered from one of four sources, (1) internally generated, (2) external (see section 3), (3) front panel manual triggers or (4) a GET (group execute trigger) via the interface. A group execute trigger is a standard bus message which is recognised by the DVM when it has been addressed as a listener. Programming the appropriate trigger code allows one or more of these sources to initiate a measurement cycle. When the DVM is programmed to accept GET, sending the ASCII character @ or J as part of the program string will also trigger the instrument.

The GET command will initiate a measurement cycle if one is not already in progress or will be stored until the current measurement cycle is complete in order to initiate a second cycle. This permits the second cycle to overlap the processing of data from the previous measurement cycle to increase overall instrument read rate.

In the same way, an external trigger received during the processing of data from an earlier measurement cycle will initiate another measurement cycle. External triggers received during the measurement cycle will be ignored.

CONTROL	CODE	DESCRIPTION
Av/dB HIGH RESOLUTION	A0	Normal Mode (1071) Continuous Average (1061 & 1061A) dB Rolling Average: (1061A only) 6½ digits (1071 only) 7½ digits (1071 only) Block Average
	A1	
	A2	
Av	A3	
BINARY PROGRAM	B	
FILTER	C0	Normal mode Filter mode
	C1	
DELAY	DX	Internal delay Programmed delay (*** 0 to 254)
	D***	
SPEC	E0	Normal mode Spec readout mode
	E1	
FUNCTION	F1	k Ω ACV DCV ACI DCI DC + ACV DC + ACI
	F2	
	F3	
	F4	
	F5	
	F6	
	F7	
CALIBRATE	G0	Zero Gain Ib AcHf Lin
	G1	
	G2	
	G3	
	G4	
BINARY DUMP	H	Calls Binary Dump mode
INPUT SELECTION	I0	Front Rear
	I1	
KEYBOARD	K	Calls Keyboard mode
STORE	L0	Clears Limits, Max and Min stores Store B Store C High Limit Low Limit Block Size (A3 Mode)
	L1	
	L2	
	L3	
	L4	
	L5	
MATHS	M0	Normal Mode A-B A/C (A-B)/C
	M1	
	M2	
	M3	
MAX/MIN	N0	Normal Mode Max Min Max-Min
	N1	
	N2	
	N3	
OUTPUT NOTATION	O0	Scientific and range and function Scientific and full status Four byte binary As O2 without EOI
	O1	
	O2	
	O3	
RATIO	P0	Normal Mode Ratio (single trigger) Ratio (double trigger)
	P1	
	P2	
SERVICE REQUEST	Q0	No SRQ generated SRQ when data ready for output SRQ if out of limit or new max/min As Q1 with triggers inhibited until data output As Q2 with triggers inhibited until data output
	Q1	
	Q2	
	Q3	
	Q4	
RANGE	R0	Autorange 10 Ω otherwise 100mV, μ A 100mV, μ A, Ω 1V, mA, k Ω 10V, mA, k Ω 100V, mA, k Ω 1000V, mA, k Ω 10M Ω , otherwise 1000V, mA
	R1	
	R2	
	R3	
	R4	
	R5	
	R6	
	R7	
SUPERFAST	S0	Normal Mode 100 Readings/second (1061) 200 Readings/second
	S1	
	S2	
TRIGGER	T0	Internal External GET or @ GET, @ or external Manual (front panel) External or manual GET, @ or manual GET, @, external or manual
	T1	
	T2	
	T3	
	T4	
	T5	
	T6	
	T7	
@		Immediate trigger
J		
RECALL STORES	V1	Store B Store C High Limit Low Limit Block Size (A3 Mode)
	V2	
	V3	
	V4	
	V5	
ENABLE CAL	W0	Normal mode Cal mode
	W1	
SELF TEST	Y	
INPUT ZERO	Z	

Table 4.3 IEEE Programming Instructions

CONTROL	CODE	DESCRIPTION
Av/dB	A0	Normal Mode
HIGH RESOLUTION	A1	(1071 Continuous Average (1061 & 1061A) dB)
	A2	Rolling Average: (1061A only) 6½ digits (1071 only) 7½ digits (1071 only) Block Average
Av	A3	(1071 only) Block Average
BINARY PROGRAM	B	
FILTER	C0	Normal mode
	C1	Filter mode
DELAY	DX	Internal delay
SPEC	E0	Programmed delay (***)
	E1	(0 to 254)
FUNCTION	F1	Normal mode
	F2	Spec readout mode
	F3	kΩ
	F4	ACV
	F5	DCV
	F6	ACI
	F7	DCI
CALIBRATE	G0	DC + ACV
	G1	DC + ACI
	G2	Zero
	G3	Gain
BINARY DUMP	H	Ib
	I0	AcHf
INPUT SELECTION	I1	Lin
KEYBOARD	K	Calls Binary Dump mode
STORE	L0	Front
	L1	Rear
	L2	Clears Limits, Max and Min stores
	L3	Store B
	L4	Store C
	L5	High Limit Low Limit Block Size (A3 Mode)
MATHS	M0	Normal Mode
	M1	A-B
	M2	A/C
	M3	(A-B)/C
MAX/MIN	N0	Normal Mode
	N1	Max
	N2	Min
	N3	Max-Min
OUTPUT NOTATION	O0	Scientific and range and function
	O1	Scientific and full status
	O2	Four byte binary
	O3	As O2 without EOI
RATIO	P0	Normal Mode
	P1	Ratio (single trigger)
	P2	Ratio (double trigger)
SERVICE REQUEST	Q0	No SRQ generated
	Q1	SRQ when data ready for output
	Q2	SRQ if out of limit or new max/min
	Q3	As Q1 with triggers inhibited until data output
	Q4	As Q2 with triggers inhibited until data output
RANGE	R0	Autorange
	R1	10Ω otherwise 100mV, μA
	R2	100mV, μA, Ω
	R3	1V, mA, kΩ
	R4	10V, mA, kΩ
	R5	100V, mA, kΩ
	R6	1000V, mA, kΩ
	R7	10MΩ, otherwise 1000V, mA
SUPERFAST	S0	Normal Mode
	S1	100 Readings/second (1061)
	S2	200 Readings/second
TRIGGER	T0	Internal
	T1	External
	T2	GET or @
	T3	GET, @ or external
	T4	Manual (front panel)
	T5	External or manual
	T6	GET, @ or manual
	T7	GET, @, external or manual
RECALL STORES	@	Immediate trigger
	J	
	V1	Store B
	V2	Store C
	V3	High Limit
ENABLE CAL	W0	Normal mode
	W1	Cal mode
SELF TEST	Y	
INPUT ZERO	Z	

Table 4.3 IEEE Programming Instructions

Delay. DX inserts the standard internal delay into the digital circuitry to allow for the settling of analog signals and is dependent upon the function/range/filter combination selected.

D*** (D followed by a number in the range 0-254) inserts a programmable delay.

Delay = (***) mS
where *** is in the range 0-254
and N = 10mS (1071) or 5 mS (1061)

Control of DVM output

Output notation. OØ configures the data to be output as an ASCII character string in scientific notation, with range and function data in the following format:

±	1.8888(8)(8)(8)E	±	88	O	CrLf	V	(EOI is also available on the last byte)
#	#	A	#	A			
±DC	4½ digit -	1061	superfast	V =	volts		
~AC	5½ digit -	1061	normal	O =	ohms		
# DC coupled AC	6½ digit -	1061A	hi. res.	A =	amps		
	7½ digit -	1071	normal	DC/Ω			
	7½ digit -	1071	hi. res.	DC/Ω			
	7½ digit -	1071	averaging	DC/Ω			

Programming O1 includes in the output string full instrument status information having the format:

±	1.8888(8)(8)(8)E	±	88	O	R4F3MØNØPØQ1T7CØAØDXWØCrLf
#	#	A	#	A	

(EOI is also available on last byte.)

NOTE: DX will be replaced by D? when using non-standard delays.

Programming O2 or O3, changes the output to four byte binary where the reading is represented as a fraction of full range. Various formats exist to cope with the variable scale lengths and the following equations are provided for translation to decimal numbers assuming the four bytes in order are A B C & D.

1071 Positive readings (A = Ø₁₀ or I₁₀)
 Reading = $+\left(\frac{A}{256} + \frac{B}{65536} + \frac{C}{16777216}\right) \times \text{Full range}$

1071 Negative readings (A = 255₁₀ or 254₁₀)
 Reading = $-\left(\frac{(255-A)}{256} + \frac{(255-B)}{65536} + \frac{(255-C)}{16777216}\right) \times \text{Full Range}$

1061 Positive readings (A = Ø₁₀)
 Reading = $+\left(\frac{B}{32} + \frac{C}{8192} + \frac{D}{2097152}\right) \times \text{Full range}$

1061 Negative readings (A = 255₁₀)
 Reading = $-\left(\frac{(255-B)}{32} + \frac{(255-C)}{8192} + \frac{(256-D)}{2097152}\right) \times \text{Full range}$

1061 Superfast positive readings (B = Ø)
 Reading = $+\left(\frac{C}{64} + \frac{D}{16384}\right) \times \text{Full range}$

1061 Superfast negative readings (B = 255)
 Reading = $-\left(\frac{255-C}{64} + \frac{(256-D)}{16384}\right) \times \text{Full range}$

- NOTE:**
1. Since byte A is not required for data in superfast mode the instrument status byte is substituted.
 2. The most significant byte, i.e. A, is the first byte output.
 3. Only EOI is available as a terminator with the last byte in O2 mode. O3 mode has no terminator.
 4. Autorange is not recommended in binary output modes.

When the output has been read no further output is available until the data from another measurement cycle has been obtained and processed. If an error occurs during a measurement cycle the normal output is replaced by a message, e.g.:

In OØ and O1 an overload would produce 'ERR OL'.

In O2 and O3 two conditions are set up:

- a. bit b8 of the SRQ Instrument Status Byte is set to 1, so that a subsequent serial poll will reveal an invalid measurement to a controller programmed to process SRQs. (In Superfast, byte A contains this information.)
- b. Except in Superfast, all four bytes are set to 255₁₀ (all 1s). This is equivalent to an unlikely (though still valid) near-zero measurement of minus 1 bit. In superfast; bytes B, C and D are each set to 255₁₀.

Thus in O2 or O3, an Error Overload should be detected by examining the instrument status byte.

Service request

A wide variation can occur in the time taken for a measurement cycle, dependant on factors such as the magnitude of the signal. Therefore, when the result is available, a service request (SRQ) is generated by the DVM via the interface. This can act as a flag (or interrupt) to a controller, which is processing other data, signalling that the DVM requires service.

Q1 and Q3 allow an SRQ to be generated on completion of any reading while Q2 and Q4 allow generation of SRQ only when a reading is 'out of limits', or when a new maximum or minimum occurs. Programming Q3 or Q4 inhibits further triggers until the DVM has been serviced. An SRQ will always be generated on power up and when a syntax or option error occurs. Q0 however, will suppress other SRQ's normally generated.

Serial Poll and Status Byte

In a system with various devices, many of them could request service and to determine which of

Status byte	b8	b7	b6	b5	b4	b3	b2	b1
Invalid measurement								
SRQ								
Syntax error								
Option error								
Valid measurement (b8 = 0)								
Normal reading	0	0	0	0				
'Hi' limit transgressed	X	X	X	1				
'Lo' limit transgressed	X	X	1	X				
New maximum	X	1	X	X				
New minimum	1	X	X	X				
	x = 1 or 0							
Invalid measurement (b8 = 1)								
Overload/valid recall	0	0	0	0				
Arithmetic overflow	0	0	0	1				
Invalid data entry/invalid recall	0	0	1	0				
Error readout invalid	0	0	1	1				
Input zero or calibration failure	0	1	0	0				
DC self test failure	0	1	0	1				
Ohms self test failure	0	1	1	0				
AC self test failure	0	1	1	1				
Current self test failure	1	0	0	0				
Arithmetic underflow	1	0	0	1				
Binary dump available	1	0	1	0				
Reference finished (see code P2)	1	0	1	1				
Self test finished memory fail	1	1	0	0				
Self test finished memory pass	1	1	0	1				
Power-up/memory fail	1	1	1	0				
Power-up/memory pass	1	1	1	1				

these devices had initiated a request, either a serial poll or a parallel poll would be undertaken by the controller. During a serial poll each device sends its status byte on command, and the controller checks the request bit, thus determining a requesting device.

The DVM has many reasons for requesting service and with the additional bits available in the status byte this information is transferred at a serial poll.

Parallel poll

The parallel poll capability provided for in the DVM allows a controller with similar capability to more quickly determine which device is requesting service. The controller can, at any time, conduct a parallel poll when all devices, which have been configured to respond, will place on separate bus data lines a positive poll response if the device was requesting service or a negative poll response if the device does not require service. With eight data lines available the controller can simultaneously check eight responses.

Having determined the requesting devices from the parallel poll the controller would normally conduct a serial poll of these devices to determine the reason for the request.

The configuration of a device to respond to a parallel poll consists of determining the DIO line on which the response will occur, and the sense (0 or 1) of the positive poll response. The negative poll response gives the opposite sense. The DVM can only be configured for this response by the controller. The configuration sequence is given later in this section.

The DVM **must** be serviced by either reading the output or by reprogramming to allow the generation of subsequent service requests.

To aid the user in servicing the instrument by reading, a character string is always available for output on generation of an SRQ even if a measurement is not available. This string in O0 and O1 modes is "!\r\n" and in O2 and O3 modes all four bytes contain 255₁₀ (all 1's). These 'null' strings occur with syntax or option programming errors if no measurement is available.

Control of computing functions

Keyboard. The DVM will place itself into keyboard mode on receipt of a K, enabling the entry of math, limit and calibration constants via the bus. The constant may be expressed in numeric or scientific notation as $\pm 1.88888(88)E\pm\emptyset 8$. If a two digit exponent is used the first must be zero.

To exit keyboard mode the constant entered must be placed in an appropriate store or used in calibration.

NOTE: The constant entered is not shown on the front panel display.

Store. L1 through to L4 inform the instrument of the store location for the entered constant or alternatively, if used without keyboard mode, the location for the previous valid reading.

L \emptyset deselects limit operations and resets max/min stores. A new max/min value will be stored on completion of the next valid reading.

Store L5 is only accessible after A3 is programmed (1071 only).

i.e.: A3, L5, N1-----19.999
sets new block size on 1-----19,999

Recall stores. The current contents of the four stores can be displayed on the front panel and output via the bus with the commands V1 through to V4 having the format:

$\pm 1.88888(8)E\pm 88L2CrLf.$
 └───┬───┘
 store location

- NOTE:**
1. The output of the stores is not available in binary output modes.
 2. It is recommended that after the recall of a store value the trigger mode is reprogrammed.
 3. Recall of empty limit stores will result in ERR 2 being output.

1071 only

Recall store V5 recalls block size but does not display block size unless preceded by A3. i.e. A3V5.

Maths mode. Programming M1 to M3 causes the reading to be offset, divided by or both offset and divided by the contents of stores B and C respectively.

M \emptyset places the instrument back to its normal operating mode.

Max/min. The maximum or minimum reading since the stores were last reset is output in place of the current reading when N1 or N2 are programmed. N3 computes the difference between maximum and minimum. N \emptyset places the instrument back to its normal operating mode. Reset of stores occurs automatically on changing function and entry or exit from ratio and programming L \emptyset or superfast mode.

1071 Average Modes. Programming A1 on the 1071 selects Continuous Average mode. A2 selects High Resolution 'Rolling Average' mode without switching in the input filter, and A3 selects Block Average mode. Each of these commands extends the reading to 7½ digits for DC Voltage and Resistance measurement (see Section 3).

dB. On the 1061 and 1061A, A1 selects the dB mode (see Sect. 3). The reading is displayed in terms of dB and the output format is modified to:

$\pm 1.88888E\pm 88DBCrlf$

High Resolution. Functions F1 and F3 (k Ω and DCV), on 1061A only, may be programmed by A2 to select 6½ digit resolution. Unlike manual operation, this is not linked to 'Filter'. See 'Output Notation' for the output string format.

Ratio. Setting the signal input switch on the rear panel to rear input and programming rear input with P1 or P2 configures the DVM into the ratio mode. P1 when next triggered initiates two readings, the first from the ratio (reference) input and the second from the rear (signal) input. P2 requires two triggers, the first to take a reading from the ratio input (an SRQ being generated on completion) and the second, a reading from the rear input. The ratio is then calculated and made available for output as a 'per unit' (p.u.) quantity, the format being:

$\pm 1.88888E\pm 88PUCrlf$

Ratio measurements can also be taken from the front panel terminals by inputting two successive readings the first of which is used as reference. P \emptyset returns the instrument to normal mode.

Alternative method of programming

Binary program. Using only four bytes the majority of instrument functions may be programmed. The first of the group must be an ASCII 'B' followed by three bytes containing programming information in the following format. In this programming mode the terminator must be an EOI as the "=" character is not recognised.

	bit							
	b8	b7	b6	b5	b4	b3	b2	b1
byte 1	output notation		function			range		
byte 2	ratio		service request			Superfast	Av/dB/ Hi Res	
byte 3	filter	trigger			Max/Min		Maths	

Each group of bits is replaced by the binary equivalent of the numeric value used for normal programming. Thus to program DCV (F3) by binary programming, byte 1, bits 6, 5, 4 are 011 respectively.

Example:

To program scientific output notation with full status, DC current, 10mA range, not ratio, generation of SRQ on data ready for output, not superfast, not Av/dB, not filter, internal trigger, and not maths or max/min mode. The normal string to set the instrument to the above status is 01F5R4P0Q1S0A0C0T0M0N0. (This string could be shorter by programming only those controls that need updating.)

The equivalent binary program bytes are:

	bit							
	b8	b7	b6	b5	b4	b3	b2	b1
byte 1	0	1	1	0	1	1	0	0
byte 2	0	0	0	0	1	0	0	0
byte 3	0	0	0	0	0	0	0	0

Note that all groups of bits must be programmed to the desired value irrespective of any necessity for update.

Programming less than three bytes will cause a syntax error.

Binary dump. After being programmed with H the DVM will assemble the current status of the instrument in the identical format to that of binary program. When the controller addresses the DVM to talk, these 3 bytes together with an EOI with the last byte will be output.

NOTE: The three bytes will be overwritten by any commanded reading occurring between the dump command and the output of the result.

Calibration via the bus

The DVM can be calibrated remotely using the programming instructions provided. For full details of procedure see the Calibration and Servicing Handbook.

Invalid use of these instructions will cause the generation of an option error SRQ.

High speed readings

Superfast (1061)

Two superfast modes are available, S1 reducing the full range measurement time to approx 10mS. The data both on display and output is reduced to 4½ digit with all output modes available. In S2 mode each full range measurement takes approx 5mS the display being replaced by the message SF2 and the output available only in binary format (O2 or O3 modes).

Superfast excludes the use of autorange, ratio, dB, maths modes and max-min (N3) mode.

Programming SØ will place the instrument into normal operating mode.

Recommendations for the use of superfast modes

To achieve the high read rates available in superfast (S1 up to 100/110 readings/second, S2 up to 200/220 readings/second at 50/60Hz) and to output these readings over the bus requires some knowledge of the controller's capabilities.

Responding to SRQ's generated by the DVM at the end of each reading and then outputting the reading as an ASCII string can sometimes introduce intolerable delays into the system. For example:- the response to SRQ's in some controllers can be as much as 10 ms and the subsequent output of a 14 byte ASCII string at around 200µs per byte limits the maximum reading speed to 78 readings/second.

This problem can be overcome by a combination of techniques. Firstly, to use a binary output mode, O2 or O3 which reduces the number of bytes output to four. Secondly, many controllers have a fast block transfer mode of operation. In this mode, bytes are continually accepted over the bus as they become available (i.e. as the DVM generates new readings) and are stored in a temporary buffer. When the block transfer is complete, the data may be read out of the buffer and processed as required.

The DVM requires an external trigger of sufficient frequency (approximately 2kHz) to achieve maximum superfast speeds.

Spec readout, test and input zero

Spec. The programming and execution of code E1 causes the instrument to compute the measurement uncertainty of the previous reading. An SRQ is generated (if allowed) with the status byte indicating a normal valid measurement. The output format is:

1.888E±88PUCrLf (where PU = per unit)

The DVM will be held until EØ is programmed or until a GET or manual trigger is received, assuming the correct trigger mode has been programmed.

Spec readout is not available for maths modes or when in binary output mode.

Self test. When the DVM receives a Y command the internal test routine is initiated. The front panel displays are not exercised in this test and only option and calibration memory checks are included. Any error will be reported with the generation of an SRQ together with the appropriate status and an error message made available for output. A GET or manual trigger (regardless of trigger mode programmed) will continue the test after an error situation. Upon completion an appropriate pass or fail status will be generated with an SRQ, and the DVM will return to the previously programmed range and function. Maths modes, max/min, Av/dB and error readout will all be cleared on completion.

Input zero. Z initiates a series of 17 readings at an internal read rate, the first 16 being averaged and the result used as a zero offset. The 17th reading is available for output. If autorange is selected each range is zeroed in turn (lowest to highest). Should the offset be too large, the store is not updated and an SRQ and error status is generated together with an error message for output.

Program string characteristics

If more than 25 bytes have been programmed before receipt of any terminator the execution of the string will commence sequentially until sufficient space is available for further input data.

If an invalid command is sent an SRQ will be generated, the associated status byte containing a syntax or option error. In this case the output available is '!CrLf'.

- NOTE:**
1. For program instruction requiring only one numeral after an alpha character, the last numeral is operated on and a syntax error reported.
e.g. F123 results in F3 (DCV).
 2. For all program strings a finite time is required for execution, e.g. the string "R4F3Q1T7=" will be processed and triggers enabled after approx 15mS from receipt of string terminator.

Bus messages

Remote. The DVM will go into remote when remote enable line (REN) is true and the device receives its listen address. It is possible to send a program string to the DVM when in local which will be acted upon immediately when the DVM goes to remote.

Local. The GTL message returns the DVM to front panel control in the condition in which it was last programmed remotely with the exception of the trigger mode which is forced to T5 and superfast which is cancelled.

Clear. When the instrument receives a clear message (SDC or DCL) it will revert to a predetermined state of DC volts 1000V range and hold.

i.e. A0C0DXE0F3M0N0P0Q0R6S0T5

Operational sequence guidelines

Most interface communication tasks require a sequence of coded messages to be sent over the interface. It is recommended that a careful study of the available controller capabilities is made, many of them assigning one programming instruction to these sequences. Different controllers will not necessarily have identical sequences or program instructions.

It is highly recommended that a sequence which causes the DVM to be addressed as a talker should be terminated with an untalk command.

The following sequences are recommendations only.

Data transfer

UNL	Inhibits all current listeners
LAD ₁	Each address sent enables a specific device to receive future data bytes.
⋮	
LAD _n	More than one address may be sent if multiple listeners desired.
TAD	The address sent enables a specific device to send data.
DAB ₁	Data bytes sent by currently enabled talker to all currently enabled listeners.
⋮	
DAB _n	
UNT	Disables the talker on receipt of last character.

UNL =	unlisten
LAD =	listen address of specific device
TAD =	talk address of specific device
DAB =	data bytes
UNT =	untalk

Parallel poll response

To obtain the parallel poll response, the controller must place the management lines ATN and IDY (attention and identify) true when the predetermined devices will each place their request on a specified data line.

Serial poll

UNL	Prevents other devices listening to status sent.
SPE	Puts interface into serial poll mode during which all devices send status instead of data when addressed.
TAD _n	Enable a specific device to send status. Within this loop devices should be sequentially enabled.
SBN or SBA	Status byte sent by enabled device. If SBN sent, loop should be repeated. If SBA sent, the enabled device is identified as having sent SRQ and will automatically remove it.
SPD	Disables serial poll mode
UNT	Disable last talker.

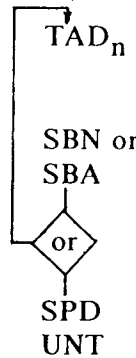

SPE =	serial poll enable
SPD =	serial poll disable
SBN =	status byte negative where bit 7 = 0
SBA =	status byte affirmative where bit 7 = 1.

Parallel poll Configure

LAD	Addresses a particular device for which a parallel response coding is to be assigned.
PPC	Enables the listener to be configured.
PPE	Bit 4 specifies the sense of the poll response. Bits 1 to 3 specify, in binary code, the data line (DIO) on which the poll response is to be given.
UNL	End of configuration routine.

PPC =	parallel poll configure
PPE =	parallel poll enable

NOTE: The PPE command can be disabled by substitution of PPD. All devices can be unconfigured by use of the PPU command.

PPD =	parallel poll disable
PPU =	parallel poll unconfigure

SECTION 5 SYSTEMS APPLICATIONS VIA THE BCD INTERFACE (1061 ONLY)

The BCD interface option allows the instrument to output to and be remotely driven by a remote source. Inputs to the DVM determine its mode of operation and outputs from the DVM signal its operation state as well as carrying the measurements taken, in a binary-coded-decimal (BCD) format.

Interface electrical specification

The interface lines are TTL compatible, having a fan-out of two low power TTL loads and a fan-in of one TTL load. Positive logic is used and the voltage levels are:

Logic 0 \leq 0.4 V

Logic 1 \geq 2.4 V

All inputs are referenced to logic 1 (+5V) via 100k Ω resistors.

DVM control commands

The command signals to determine the operational mode of the DVM are input via the Program Input socket ('Prog I/P Skt') and provide control of the following:

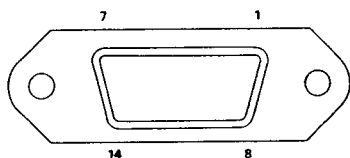

Pin No.	Function	Description
1	INPUT FILTER	1 selects Input Filter
2	DIGITAL COMMON	0 state reference
3	AC	0 selects AC
4	DC	0 selects DC
5	k Ω	0 selects k Ω
6	I	0 selects I
7	RATIO	0 selects Ratio
8	RANGE A	} see range coding table
9	RANGE B	
10	RANGE C	
11	AUTO	1 selects Autorange
12	REMOTE	0 selects Remote
13	not used	
14	not used	

Table 5.1 Prog I/P Skt (J6) Pin designations

Ranges: Auto, 10 Ω , .1, 1, 10, 100, 1000 and 10M Ω .

Functions: DC, AC, k Ω , I and Input Filter.

Modes: Manual, Hold, Delay, Superfast, Ratio, Front Panel Inhibit and Remote.

Details of these commands are given below.

The interconnection details for the programming input socket are given by Table 5.1.

Range

The selection of range is enabled when REMOTE (J6-12) = 0 and is coded as follows:

RANGE	RANGE A (J6-8)	RANGE B (J6-9)	RANGE C (J6-10)
Autorange	0	0	0
10 Ω (100mV, μ A)	1	0	0
100mV, μ A Ω	0	1	0
1V, mA, k Ω	1	1	0
10V, mA, k Ω	0	0	1
100V, mA, k Ω	1	0	1
1000V, mA, k Ω	0	1	1
10M Ω (1000V, mA)	1	1	1

Autorange can also be selected by making AUTO (J6-11) = 1. This will override all other range selections.

Function

The selection of function is enabled when REMOTE (J6-12) = 0 and the permitted combinations are:-

FUNCTION	DC (J6-4)	AC (J6-3)	I (J6-6)	k Ω (J6-5)
DCV	1	1	1	1
DCV	0	1	1	1
ACV	1	0	1	1
DC+ACV	0	0	1	1
DCI	0	1	0	1
ACI	1	0	0	1
DCI+ACI	0	0	0	1
k Ω	1	1	1	0

Input filter can be selected with any of the above combinations by making INPUT FILTER (J6-1) = 1.

Manual

The selection of manual is enabled when $\overline{\text{HOLD}}$ (J5-40) = 0 or 'Hold' is selected on the front panel. A reading will be initiated by making $\overline{\text{MANUAL}}$ (J5-41) = 0, the reading being triggered by the falling edge. When manual is enabled by $\overline{\text{HOLD}}$ (J5-40) = 0 manual commands will be latched and executed when the reading is complete, thus allowing closed loop operation by connecting $\overline{\text{MANUAL}}$ (J5-41) to $\overline{\text{SIGNAL INTEGRATE}}$ (J5-43) and initiating the first reading with a falling edge (See Fig. 5.1 and 5.2) or pressing the front panel 'Man' key.

NOTE: Manual is disabled when print inhibit is selected.

Hold

The DVM can be put into the hold mode by making $\overline{\text{HOLD}}$ (J5-40) = 0. This enables both manual and delay modes, the manual mode being modified as above.

Delay

The selection of delay is enabled when $\overline{\text{HOLD}}$ (J5-40) = 0 and the standard internal delays (see Section 7) will be increased by 15mS when making $\overline{\text{DELAY}}$ (J5-44) = 0.

NOTE: If 'input filter' is selected on the front panel or via the program input socket, $\overline{\text{INPUT FILTER}}$ (J6-1) = 1, the delay will be equal to the standard delay filter out when $\overline{\text{DELAY}} = 1$ and the standard delay filter in when $\overline{\text{DELAY}} = 0$.

Superfast

Making $\overline{\text{SUPERFAST}}$ (J5-23) = 0 places the DVM into the superfast mode, each full range measurement taking approximately 10mS. The 5th digit on the front panel display is blanked and the 5th digit of the BCD output number (J5-19, 20, 21 & 22) is set to 1,1,1,1. The signal integrate pulse is reduced to 2.5mS and the print command pulse to $250\mu\text{S}$.

Read rates up to 100/sec may be achieved by applying a trigger signal to the $\overline{\text{MANUAL}}$ line (J5-41).

NOTE: Superfast mode excludes autorange, ratio, dB, error readout and compute modes, and inhibits all front panel 'RANGE', 'FUNCTION', 'MODE' and 'COMPUTE' keys.

Ratio

Setting the 'I/P SELECT' switch on the rear panel to 'REAR' and making $\overline{\text{RATIO}}$ (J6-7) = 0 configures the DVM into the ratio mode. Successive readings are taken, the first from the ratio (reference) input and the second from the rear (signal) input, the ratio is calculated and the BCD output number gives the 'per unit' quantity.

Print inhibit

Selecting print inhibit, $\overline{\text{PRINT INHIBIT}}$ (J5-42) = 0, puts all BCD outputs in the 'tri-state' (floating) mode and disables the selection of manual.

Front panel inhibit

Operation of all front panel 'MODE' and 'COMPUTE' keys is inhibited and the 'rem' legend displayed when making $\overline{\text{FP INHIBIT}}$ (J5-38) = 0.

Remote

Operation of all front panel 'RANGE' and 'FUNCTION' keys is inhibited, the 'rem' legend displayed, and the programmable ranges and functions enabled by making $\overline{\text{REMOTE}}$ (J5-12) = 0.

BCD output interpretation

The interconnection details for the BCD output socket are given in Table 5.2.

BCD output number

There are 4 lines for each of the 5 digits indicating the BCD equivalent of its value and a single line (J5-18) for the overrange digit. The decimal point can be fixed from the range information.

NOTE: In superfast mode the 5th digit (J5-19, 20, 21 & 22) is set to 1,1,1,1.

Overload, polarity and limit indication

The overload, plus and minus outputs are coded as follows, to indicate reading polarity, overload and limit transgression.

Indication	OVERLOAD (J5-17)	MINUS (J5-26)	PLUS (J5-27)
Unsigned reading	0	1	1
Positive reading	0	1	0
Negative reading	0	0	1
Unsigned overload	1	1	1
Positive overload	1	1	0
Hi limit transgressed			
Negative overload			
Lo limit transgressed	1	0	1

Range

Autorange is indicated when $\overline{\text{AUTO}} \text{ (J5-33)} = 0$.
The specific range indication is as follows:-

Range	RANGE A (J5-34)	RANGE B (J5-35)	RANGE C (J5-36)	mV (J5-32)
10Ω	1	0	0	0
100mV, μA, Ω	0	1	0	0
1V, mA, kΩ	1	1	0	1
10V, mA, kΩ	0	0	1	1
100V, mA, kΩ	1	0	1	1
1000V, mA, kΩ	0	1	1	1
10MΩ	1	1	1	1

Function

When input filter is selected $\overline{\text{INPUT FILTER}} \text{ (J5-31)} = 0$. The other function combinations are indicated as follows:-

Function	DC (J5-29)	AC (J5-30)	I (J5-24)	kΩ (J5-28)
DCV	0	1	1	1
ACV	1	0	1	1
DC+ACV	0	0	1	1
DCI	0	1	0	1
ACI	1	0	0	1
DC+ACI	0	0	0	1
kΩ	1	1	1	0

Ratio

This mode is indicated when $\overline{\text{RATIO}} \text{ (J5-25)} = 0$.

Pin No.	Function	Description
1	2×10^{-4}	BCD Output Number
2	4×10^{-4}	BCD Output Number
3	8×10^{-4}	BCD Output Number
4	1×10^{-4}	BCD Output Number
5	2×10^{-3}	BCD Output Number
6	4×10^{-3}	BCD Output Number
7	8×10^{-3}	BCD Output Number
8	1×10^{-3}	BCD Output Number
9	2×10^{-2}	BCD Output Number
10	4×10^{-2}	BCD Output Number
11	8×10^{-2}	BCD Output Number
12	1×10^{-2}	BCD Output Number
13	2×10^{-1}	BCD Output Number
14	4×10^{-1}	BCD Output Number
15	8×10^{-1}	BCD Output Number
16	1×10^{-1}	BCD Output Number
17	OVERLOAD	1 indicates overload or over/under limit
18	1×10^0	BCD Output Number
19	2×10^{-5}	BCD Output Number
20	4×10^{-5}	BCD Output Number
21	8×10^{-5}	BCD Output Number
22	1×10^{-5}	BCD Output Number
23	SUPERFAST	0 selects Superfast
24	I	0 indicates I
25	RATIO	0 indicates Ratio
26	MINUS	} see polarity coding table
27	PLUS	
28	kΩ	0 indicates kΩ
29	DC	0 indicates DC
30	AC	0 indicates AC
31	INPUT FILTER	0 indicates Input Filter
32	mV	0 indicates mV, Ω, μA
33	AUTO	0 indicates Autorange
34	RANGE A	} see range coding table
35	RANGE B	
36	RANGE C	
37	not used	
38	FP INHIBIT	0 selects FP Inhibit
39	DIGITAL COMMON	0 state reference
40	HOLD	0 selects Hold
41	MANUAL	1 selects Manual
42	PRINT INHIBIT	0 selects Print Inhibit
43	SIGNAL INTEGRATE	1 indicates DVM sampling input signal
44	DELAY	0 selects Delay
45	PRINT COMMAND	1 indicates print command
46	not used	
47	not used	
48	not used	
49	not used	
50	not used	

Table 5.2 BCD O/P Skt (J5) Pin designations

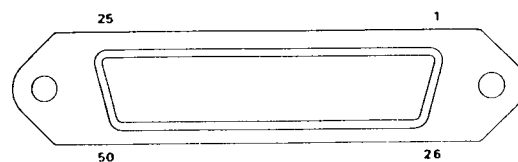

Print command

PRINT COMMAND falls from logic 1 to 0 at the end of each measurement cycle indicating that a new number has been transferred to the storage registers and is available as BCD output information. This line is at logic 0 except for a period of 5mS ($250\mu\text{S}$ in Superfast mode) when the BCD information is being updated and can therefore be used as a data available indication to an external reading device. (See Fig. 5.1 & 5-2).

Signal integrate

The DVM is sampling the input signal when SIGNAL INTEGRATE (J5-43) = 1 and the falling edge indicates that a new input may be applied. (See Fig. 5.1, 5.2 & 5.3).

Closed loop operation

For maximum read-rate it is convenient to use the SIGNAL INTEGRATE line as a trigger by connecting this to the MANUAL line as shown in Fig. 5.2. This means the falling edge of SIGNAL INTEGRATE for the current reading triggers the next reading. In this situation the read-rate obtained depends upon the magnitude of the input. This arrangement requires an additional trigger before the closed loop operation takes place and pressing the front panel 'Man' key is a convenient method of achieving this.

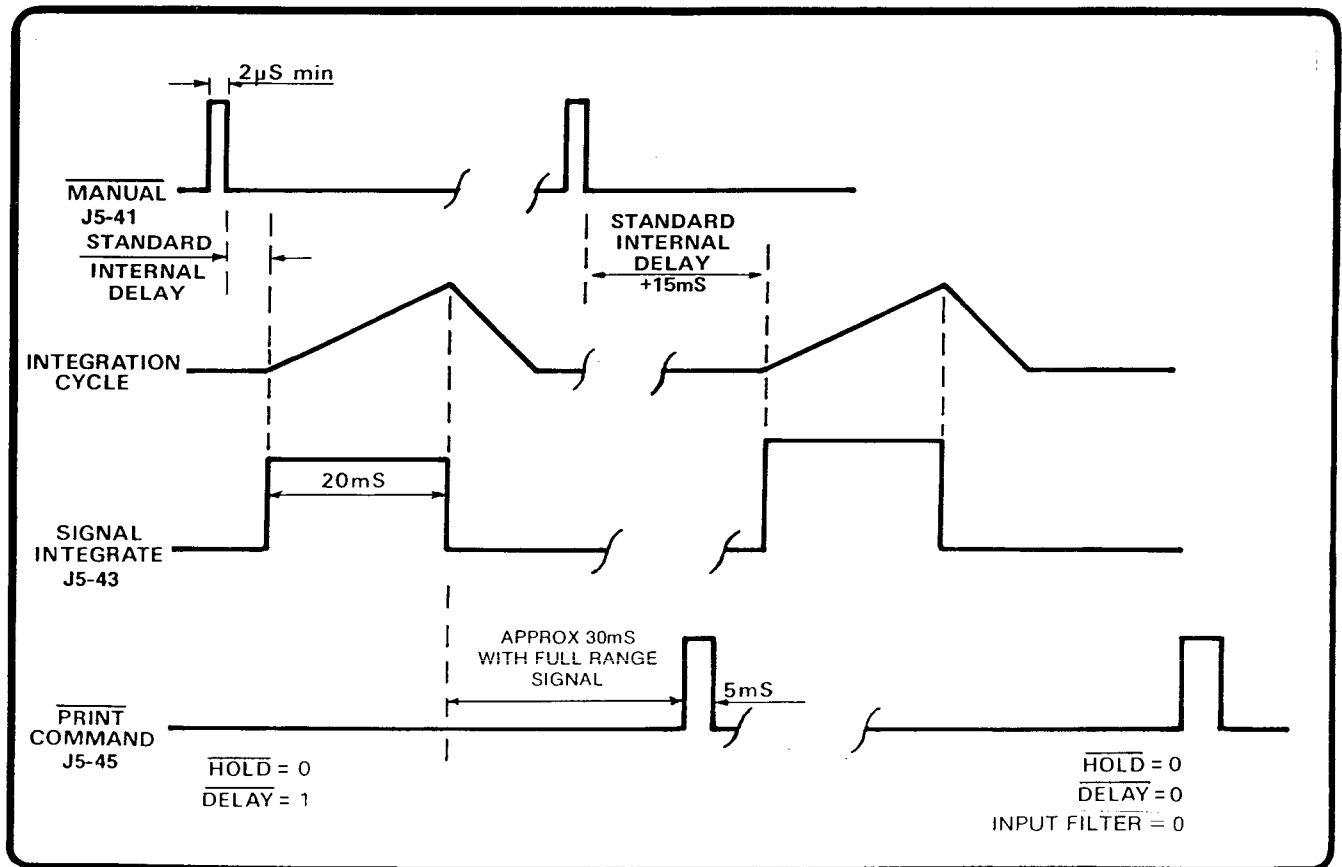

Fig. 5.1 Normal operation timing

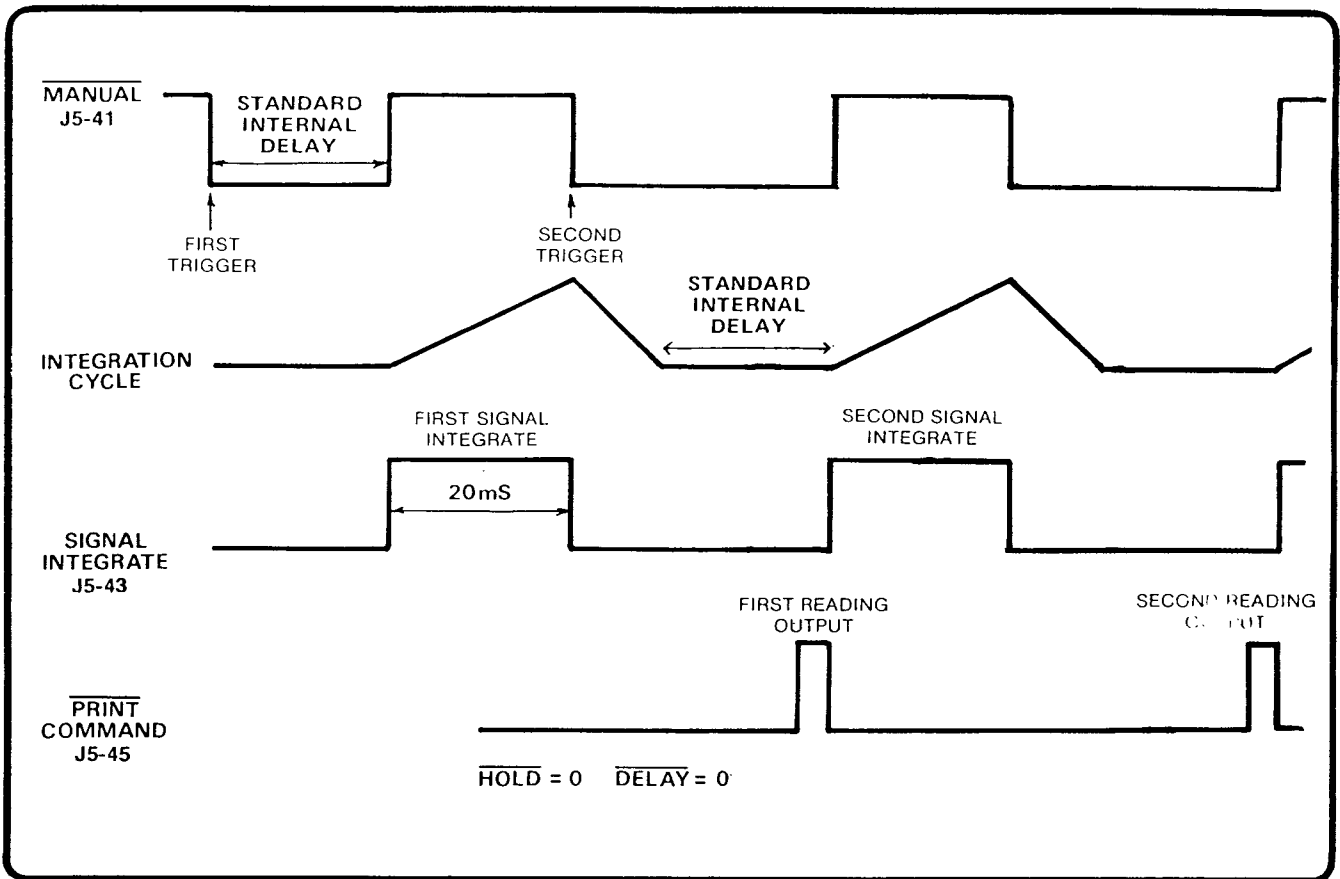

Fig. 5.2 Closed loop operation timing

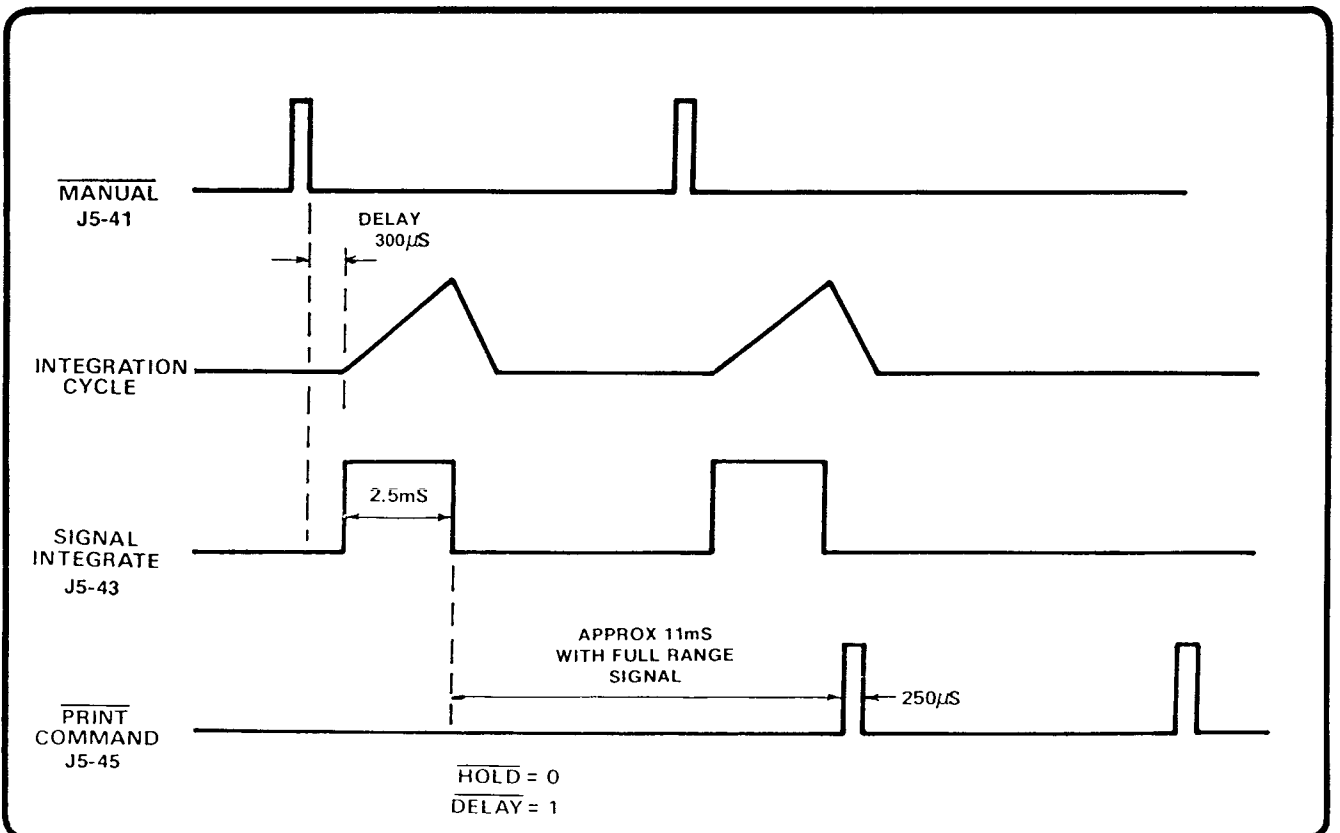

Fig. 5.3 Superfast timing (>100/sec)

SECTION 6 INSTALLATION

This section contains information and instructions for unpacking and installing the Datron 1061, 1061A and 1071 Autocal voltmeter.

Unpacking and inspection

Every care is taken in the choice of packing material to ensure that your equipment will reach you in perfect condition.

If the equipment has been subject to excessive mishandling in transit, the fact will probably be visible as external damage to the shipping carton. In the event of damage, the shipping container and cushioning material should be kept for the carrier's inspection or until the instrument has passed the Specification Verification Tests.

Unpack the equipment and check for external damage to the case, terminals, keys, etc. If damage is found notify the carrier and your sales agent immediately.

Standard accessories supplied with the instrument are as described in Section 1. If input and/or output options are fitted the appropriate plug or socket is attached in its respective place on the rear panel of the instrument.

The rack mounting kit option is packed separately and should be fitted as instructed in "mounting".

Preparation for operation

Power cable

A detachable supply cable, comprising two metres of 3-core PVC sheath cable permanently moulded to a fully-shrouded 3-pin cable socket, fits at the rear of the instrument and should be pushed firmly home. The supply lead should be connected to an earthed outlet ensuring that the earth lead is connected. Connect Brown lead to Live, Blue lead to Neutral and Green/Yellow lead to Earth.

Line voltage

The instrument is packed ready for use with 205V to 255V 50Hz supplies unless Option 80, 81 or 82 is specified at the time of ordering. To change the

supplies and/or line frequency, it is necessary to alter links in the instrument. (Refer to Calibration and Servicing Handbook).

Fuses

Power Fuse:

The power fuse is located on the left-hand side of the back panel adjacent to the power input. The power fuse rating is 160mA for 205V—255V and 500mA for 105V—127V supply voltages. It should be of the anti-surge type.

Current Fuse:

The current fuse is located on the right-hand side of the back panel and is a high breaking capacity, quick acting fuse, rated at 1.6A — recommended type: BESWICK S501.

MAKE SURE THAT ONLY FUSES WITH THE REQUIRED RATED CURRENT AND OF THE SPECIFIED TYPE ARE USED FOR REPLACEMENT. THE USE OF MENDED FUSES AND THE SHORT-CIRCUITING OF FUSE-HOLDERS SHALL BE AVOIDED, AND RENDERS THE WARRANTY VOID.

Mounting

Bench Use:

The instrument is fitted with rubber covered plastic feet and tilt stand. Thus it may be placed flat on the bench or tilted for ease of viewing.

Rack Mounting:

Option 90 permits the instrument to be mounted in a standard 19 inch rack.

The method of fitting this option is described below but on no account should the covers be removed. The handles should be removed, if fitted, by loosening the hexagonal screws of the handle assembly and sliding the assembly to the rear of the instrument until free.

The rack mounting 'ears' may now be fitted by slotting the 'ears' into the guides at each side of the instrument, from the rear. Draw the 'ears' forward until positioned correctly and tighten the hexagonal screws, using the hexagonal key provided. It is recommended that the rear of the instrument is supported in the rack.

Connectors and pin designations

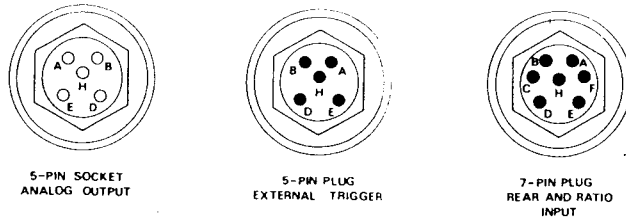

Fig. 6.1 Rear panel connectors - pin layout

Rear input and ratio input (option 40)

J10 and J11 are 7-pin connectors accepting input signals as defined for the front panel terminals. See Tables 2.1 to 2.3 for maximum inputs, Table 6.1 for pin descriptions and Fig. 6.1 for pin layout.

Pin No.	Signal
A	Ω GUARD
B	Not Used
C	I+
D	Input Hi
E	Input Lo
F	I-
H	GUARD

Table 6.1 Ratio & Rear Inputs - pin designations

NOTE: For local guarding, connect pins A and H.

External trigger input (option 52)

J9 is a 5-pin connector used to accept an external trigger source to initiate a DVM measurement cycle. See Table 6.2 for pin descriptions and Fig. 6.1 for pin layout.

Pin No.	Signal
A	Trigger (High to Lo edge τ)
B	Logic Ground
D	Not Used
E	Not Used
H	Not Used

Table 6.2 External Trigger Input - pin designations

Analog output (option 70)

J12 is a 5-pin connector providing a 1V full-range output for any nominal full-range input, with overrange capability to 2V. See Table 6.3 for pin designations and Fig. 6.1 for pin layout.

Pin No.	Signal
A	Output Hi
B	Output Lo
D)
E) Not Used
H)

Table 6.3 Analog Output - pin designations

IEEE input/output (option 50)

The IEEE input/output is a 24-way connector that is directly compatible with the IEEE defined system but requires a connection adaptor for the IEC defined system (D-type Cannon).

Fig. 6.2 gives the pin designations and Table 6.4 the pin layout.

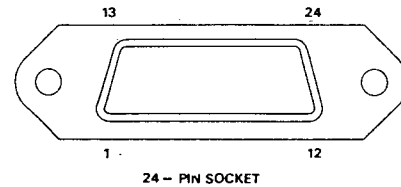

Fig. 6.2 IEEE 488 connector - pin layout

J27 Pin No.	Name	Description
1	DIO 1	Data Input Output Line 1
2	DIO 2	Data Input Output Line 2
3	DIO 3	Data Input Output Line 3
4	DIO 4	Data Input Output Line 4
5	EOI	End or Identify
6	DAV	Data Valid
7	NRF D	Not ready for Data
8	NDAC	Not Data Accepted
9	IFC	Interface Clear
10	SRQ	Service Request
11	ATN	Attention
12	SHIELD	Screening on cable (connected to DVM Safety Ground)
13	DIO 5	Data Input Output Line 5
14	DIO 6	Data Input Output Line 6
15	DIO 7	Data Input Output Line 7
16	DIO 8	Data Input Output Line 8
17	REN	Remote Enable
18	GND 6	Gnd wire of twisted pair with DAV
19	GND 7	Gnd wire of twisted pair with NRF D
20	GND 8	Gnd wire of twisted pair with NDAC
21	GND 9	Gnd wire of twisted pair with IFC
22	GND 10	Gnd wire of twisted pair with SRQ
23	GND 11	Gnd wire of twisted pair with ATN
24	GND	DMM Logic Ground (Internally connected to DVM Safety Ground)

Table 6.4 IEEE 488 connector - pin designations

BCD programming input/BCD output (option 51)

14-way and 50-way 'Micro-Ribbon' connectors carrying TTL logic level signals as designated in Tables 6.5 and 6.6 and Fig. 6.3 gives the pin layouts.

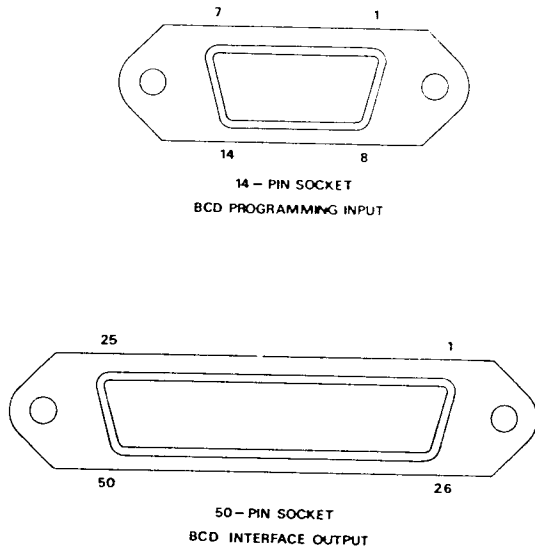

Fig. 6.3

Pin No.	Function	Description
1	INPUT FILTER	1 selects Input Filter
2	DIGITAL COMMON	0 state reference
3	AC	0 selects AC
4	DC	0 selects DC
5	kΩ	0 selects kΩ
6	I	0 selects I
7	RATIO	0 selects Ratio
8	RANGE A	} see range coding Section 5
9	RANGE B	
10	RANGE C	
11	AUTO	1 selects Autorange
12	REMOTE	0 selects Remote
13	not used	
14	not used	

Table 6.5 BCD Remote Programming Input
- pin designations

Pin No.	Function	Description
1	2×10^{-4}	BCD Output Number
2	4×10^{-4}	BCD Output Number
3	8×10^{-4}	BCD Output Number
4	1×10^{-4}	BCD Output Number
5	2×10^{-3}	BCD Output Number
6	4×10^{-3}	BCD Output Number
7	8×10^{-3}	BCD Output Number
8	1×10^{-3}	BCD Output Number
9	2×10^{-2}	BCD Output Number
10	4×10^{-2}	BCD Output Number
11	8×10^{-2}	BCD Output Number
12	1×10^{-2}	BCD Output Number
13	2×10^{-1}	BCD Output Number
14	4×10^{-1}	BCD Output Number
15	8×10^{-1}	BCD Output Number
16	1×10^{-1}	BCD Output Number
17	OVERLOAD	1 indicates overload or over/under limit
18	1×10^0	BCD Output Number
19	2×10^{-5}	BCD Output Number
20	4×10^{-5}	BCD Output Number
21	8×10^{-5}	BCD Output Number
22	1×10^{-5}	BCD Output Number
23	SUPERFAST	0 selects Superfast
24	I	0 indicates I
25	RATIO	0 indicates Ratio
26	MINUS	} see polarity coding Section 5
27	PLUS	
28	kΩ	0 indicates kΩ
29	DC	0 indicates DC
30	AC	0 indicates AC
31	INPUT FILTER	0 indicates Input Filter
32	mV	0 indicates mV, Ω, μA
33	AUTO	0 indicates Autorange
34	RANGE A	} see range coding Section 5
35	RANGE B	
36	RANGE C	
37	not used	
38	FP INHIBIT	0 selects FP Inhibit
39	DIGITAL COMMON	0 state reference
40	HOLD	0 selects Hold
41	MANUAL	1 selects Manual
42	PRINT INHIBIT	0 selects Print Inhibit
43	SIGNAL INTEGRATE	1 indicates DVM sampling input signal
44	DELAY	0 selects Delay
45	PRINT COMMAND	1 indicates print command
46	not used	
47	not used	
48	not used	
49	not used	
50	not used	

Table 6.6 BCD Output connector - pin designations

SECTION 7 SPECIFICATIONS

General

SAFETY

The 1061, 1061A and 1071 have been designed to meet BSI 4743, IEC 348, and UL 1244 specifications.

MAXIMUM INPUTS

See Tables 2.1 to 2.3

CLIMATIC CONDITIONS

Operating Temperature : 0°C to +50°C (except where specified)

Storage Temperature^[1] : -40°C to +70°C

Maximum Relative Humidity : 75% @ 40°C

Warm-up Time : Two hours to meet all specifications

POWER SUPPLY

Voltage : 205-255 or 105-127 Volts

Line Frequency : 50Hz ± 2%, 60Hz ± 2%, or 400Hz ± 2%.

Consumption : Approximately 30VA

Fuses : 160mA or 500mA anti-surge (depends on voltage)

MECHANICAL

Dimensions : Height = 89mm, Width = 455mm, Depth = 420mm

Weight : 10 kg.

OPERATING INDICATIONS

Scale length : 1071 7½ digits maximum, i.e. 19,999,999
1061 5½ digits i.e. 199,999
1061A 6½ digits maximum i.e. 1,999,999

Overload : Error 0L displayed

Indication : Symbols lit on display and illuminated keys

AUTORANGE

Range Up : 200% of nominal range

Range Down : 18.8% of nominal range

DIGITAL ERROR

Computation : + 1 digit (assumes no error in stored value)

Spec read-out : < 1% of displayed error

ANALOG OUTPUT (0 to ±2 Volts)

1 Volt output for full range signal input

Accuracy : ± 1% of Reading ± 2mV

Output Resistance : Approximately 200Ω

RATIO

Type : Computational, same function (True 4-wire and auto-ranging). (AC:DC voltage and current ratios [DC coupled AC])

Accuracy :

$$\pm E_R \pm E_S \pm \infty \left(\left| \frac{\text{Ref. range}}{\text{Ref. reading}} \right| + \left| \frac{\text{Sig range}}{\text{Sig reading}} \right| \right)$$

Where E_R = Net error of reference
 E_S = Net error of signal
 ∞ = 0.000 002 (1071, DCV, kΩ)
 = 0.000 02 (1071 remaining functions)
 = 0.000 02 (1061 same range all functions)
 = 0.000 06 (1061 all functions and 1071 AC: after a range change)

Read rate, with full scale input:

	Function	Filter	Max. Read Rate
1071	DCV or kΩ	out	1 per 5 seconds
		in	1 per 40 seconds
	DCI, ACV } or ACI }	out	1 per second
		in	1 per 2 seconds
1061 } 1061A }	DCV or kΩ	out	7 per second
		in	1 per second
	DCI, ACV } or ACI }	out	1 per second
		in	1 per 2 seconds

[1] Excessive temperature stress may affect calibration stability.

1071 Specifications

DC VOLTAGE

Full Range Count (FR) : $\pm 1,000,000$
Full Scale Count (FS) : $\pm 1,999,999$ on all ranges
except 1000V range
Average Modes Full Scale Count : $\pm 19,999,999$ on
all ranges except 1000V range

ACCURACY (Valid up to 24 hours after 'Input Zero' correction).
24 HOURS ($23^{\circ}\text{C} \pm 1^{\circ}\text{C}$) Relative to calibration standards and at
internal read rate

*0.1V range:	$\pm 4\text{ppm}$ of reading	± 4 digits (40)
1 and 10V range:	$\pm 3\text{ppm}$ of reading	± 2 digits (20)
100 and 1000V range:	$\pm 4\text{ppm}$ of reading	± 2 digits (20)

90 DAYS ($23^{\circ}\text{C} \pm 5^{\circ}\text{C}$)

*0.1V range:	$\pm 20\text{ppm}$ of reading	± 5 digits (50)
1 and 10V range:	$\pm 15\text{ppm}$ of reading	± 3 digits (30)
100 and 1000V range:	$\pm 20\text{ppm}$ of reading	± 3 digits (30)

1 YEAR ($23^{\circ}\text{C} \pm 5^{\circ}\text{C}$)

*0.1V range:	$\pm 30\text{ppm}$ of reading	± 6 digits (60)
1 and 10V range:	$\pm 20\text{ppm}$ of reading	± 4 digits (40)
100 and 1000V range:	$\pm 30\text{ppm}$ of reading	± 4 digits (40)

*Rolling-Average Mode typically twice as good as Normal mode.
Specification applies on illumination of last digit following
selection of Input filter after application of input signal
(approximately 8 seconds).*

TEMPERATURE COEFFICIENT: (10°C to 35°C)
1/10th of 90 DAY specification $\pm 0.3\mu\text{V}/^{\circ}\text{C}$.

READ RATE (with full scale input)
Normal Mode: 2/second
'Input Filter': Updates every 8 seconds (due to digital filtering)
'Continuous' Average Mode: Updates average value at the same
rate as Normal mode.
'Block' Average Mode: Measurement rate ≥ 2 /second, displays
block average until next block completed.

SETTLING TIME (to 10ppm of step size)^[1]
Filter out: $< 50\text{ms}$
Filter in: $< 1\text{sec}$

SERIES MODE REJECTION
Filter out: 66dB @ 50Hz (60Hz) $\pm 0.15\%$
Filter in: add 54dB @ 50Hz increasing at 18dB/octave

COMMON MODE REJECTION
(1k Ω source unbalance)
> 140dB at DC
> 80dB + series mode at 1Hz to 60Hz

AUTORANGE SPEED (No filter)
Typically 300mS per range between top and bottom
ranges.

INPUT RESISTANCE
0.1 to 10 Volt ranges ($< 20\text{volts}$): $> 10,000\text{M}\Omega$
100 and 1000 Volt ranges: $10\text{M}\Omega \pm 0.1\%$.

INPUT CURRENT (1 year)
 $< 50\text{pA}$ drifting at $< 2\text{pA}/^{\circ}\text{C}$.

RESISTANCE

Full Range Count : 1,000,000
Full Scale Count : 1,999,999
Average Modes Full Scale Count : 19,999,999

ACCURACY (Valid up to 24 hours after 'Input Zero' correction).
24 HOURS ($23^{\circ}\text{C} \pm 1^{\circ}\text{C}$) Relative to calibration standards and at
internal read rate

*10 Ω range:	$\pm 10\text{ppm}$ of reading	± 8 digits (80)
0.1k Ω , 1k Ω , 10k Ω ranges:	$\pm 5\text{ppm}$ of reading	± 2 digits (20)
100k Ω range:	$\pm 10\text{ppm}$ of reading	± 2 digits (20)
1000k Ω range:	$\pm 20\text{ppm}$ of reading	± 2 digits (20)
10M Ω range:	$\pm 100\text{ppm}$ of reading	± 2 digits (20)

90 DAYS ($23^{\circ}\text{C} \pm 5^{\circ}\text{C}$)

*10 Ω range:	$\pm 30\text{ppm}$ of reading	± 8 digits (80)
0.1k Ω , 1k Ω , 10k Ω ranges:	$\pm 20\text{ppm}$ of reading	± 4 digits (40)
100k Ω range:	$\pm 30\text{ppm}$ of reading	± 4 digits (40)
1000k Ω range:	$\pm 80\text{ppm}$ of reading	± 4 digits (40)
10M Ω range:	$\pm 240\text{ppm}$ of reading	± 4 digits (40)

1 YEAR ($23^{\circ}\text{C} \pm 5^{\circ}\text{C}$)

*10 Ω range:	$\pm 40\text{ppm}$ of reading	± 10 digits (100)
0.1k Ω , 1k Ω , 10k Ω ranges:	$\pm 30\text{ppm}$ of reading	± 6 digits (60)
100k Ω range:	$\pm 40\text{ppm}$ of reading	± 6 digits (60)
1000k Ω range:	$\pm 120\text{ppm}$ of reading	± 6 digits (60)
10M Ω range:	$\pm 360\text{ppm}$ of reading	± 6 digits (60)

*Rolling-Average Mode typically twice as good as Normal mode.
Specification applies on illumination of last digit following
selection of Input filter after application of input signal
(approximately 8 seconds).*

TEMPERATURE COEFFICIENT (10°C to 35°C)
1/10th of 90 DAY specification $\pm 100\mu\Omega/^{\circ}\text{C}$

READ RATE : As DC Volts

TYPE
True 4-wire with active guard (can be switched to 2-wire on
the front panel).
Measurement technique is independent of the internal
reference voltage.

OPEN CIRCUIT VOLTAGE
 $< 10\text{volts}$ on all ranges

LEAD RESISTANCE
Up to 100 Ω may be tolerated in any or all the leads on any
range. (Rejection of lead resistance is 100dB on any range).

RESPONSE TIME
Depends on external capacitance and guarding/shielding
techniques used.
Generally up to 10k Ω response as DC Volts. Higher resist-
ances take longer to settle. OHMS GUARD may be used to
guard out stray capacitance.

CURRENT THROUGH UNKNOWN ($\pm 0.2\%$)
10 Ω , 0.1k Ω ranges: 10mA
1k Ω range: 1mA
10k Ω range: 100 μA
100k Ω range: 10 μA
1000k Ω range: 1 μA
10M Ω range: 100nA

OHMS GUARD
Drive Capability: I+ or I- to OHMS GUARD,
250 Ω minimum (up to 10 Ω lead resistance)
Guarding Accuracy: See Section 2 - 'Resistance measurement'

*Within 15 minutes of 'Input Zero' correction and 'Input Filter' selected or add 5 μV per year

[1] or < 30 digits or 1ppm of step size (whichever is greater) following a range change

[5] Accuracy figures in brackets refer to 1071 in 'Filter' or 'Av' Mode (7 $\frac{1}{2}$ digits)

1071 Specifications (cont.)

AC VOLTAGE (TRUE RMS — OPTION 10)

Full Range Count : 100,000
 Full Scale Count : 199,999 on all ranges except 1000V range

ACCURACY (Signals $< 2 \times 10^7$ Volt Hz, $> 0.25\%$ Full Scale).

	DC + 45Hz ^[2] to 5kHz	DC + 5kHz to 100kHz
24 HOURS (23°C ± 1°C) Relative to calibration standards.		
0.1V and 1000V ranges:	± 0.04% of reading ± 40 digits	± 0.1% of reading ± 100 digits
1 to 100V ranges:	± 0.02% of reading ± 20 digits	± 0.05% of reading ± 50 digits
90 DAYS (23°C ± 5°C)		
0.1V and 1000V ranges:	± 0.08% of reading ± 40 digits	± 0.2% of reading ± 100 digits
1 to 100V ranges:	± 0.04% of reading ± 20 digits	± 0.1% of reading ± 50 digits
1 YEAR (23°C ± 5°C)		
0.1V and 1000V ranges:	± 0.12% of reading ± 40 digits	± 0.3% of reading ± 100 digits
1 to 100V ranges:	± 0.06% of reading ± 20 digits	± 0.15% of reading ± 50 digits

HF ACCURACY^[3] (1 and 10V ranges)
 Option 10: 100kHz to 1MHz ± 2% of reading ± 2000 digits (typical)

INPUT IMPEDANCE
 1MΩ shunted by 150pF

LF ACCURACY
 Filter out, at line frequency add: ±0.6% of reading
 Filter in, 10Hz: ±2.0% of reading

CONVERSION TYPE
 True RMS AC coupled (measures AC component with up to 1000V DC bias on any range, subject to the constraints of Section 2, Table 2.1).

or
 True RMS DC coupled (measures $\sqrt{AC^2 + DC^2}$)

CREST FACTOR
 7 : 1 typically, at full range

TEMPERATURE COEFFICIENT
 $< 1/10$ th of 90 DAY specification/°C

SETTLING TIME (DC coupled)

(i) To 0.1% of step size
 Filter out < 150 mS
 Filter in < 500 mS

COMMON MODE REJECTION
 1kΩ unbalance > 90 dB @ DC - 60Hz

READ RATE (with full scale input) : 2 readings/second.
 Continuous and Block Average modes : As DC Volts.
 No digital filtering on 'Input filter'.

(ii) From DC bias input (AC coupled) or severe overload:
 Depends on change of DC bias
 (CR time constant 0.22 seconds)

DC CURRENT

(applicable only if Option 12 is not fitted)

Full Range Count : ± 100,000
 Full Scale Count : ± 199,999

ACCURACY

24 HOURS (23°C ± 1°C) Relative to calibration standards.	
0.1 to 100mA ranges:	± 50ppm of reading ± 4 digits
1000mA range:	± 100ppm of reading ± 4 digits
90 DAYS (23°C ± 5°C)	
0.1 to 100mA ranges:	± 100ppm of reading ± 4 digits
1000mA range:	± 200ppm of reading ± 4 digits
1 YEAR (23°C ± 5°C)	
0.1 to 100mA ranges:	± 150ppm of reading ± 4 digits
1000mA range:	± 300ppm of reading ± 4 digits

TEMPERATURE COEFFICIENT
 1/10th of 90 DAY specification/°C

READ RATE : As DC Volts

SETTLING TIME : As DC Volts

SHUNT RESISTANCE

0.1mA range : 1kΩ
 1mA range : 100Ω
 10mA range : 10Ω
 100mA range : 1Ω
 1000mA range : 0.1Ω

Internal lead resistance: $< 20\%$ of shunt resistance + 1Ω.

INPUT PROTECTION

Overloads : < 2 A, internally clamped
 ≥ 2 A, rear panel fuse

AC CURRENT (TRUE RMS)

(in conjunction with option 10 only)

Full Range Count : 100,000
 Full Scale Count : 199,999

ACCURACY DC + 45Hz^[2] to 5kHz
 (Signals $> 0.1\%$ Full Scale).

24 HOURS (23°C ± 1°C) Relative to calibration standards	
0.1 to 1000mA ranges:	± 0.1% ^[4] of reading ± 100 digits
90 DAYS (23°C ± 5°C)	
0.1 to 1000mA ranges:	± 0.2% ^[4] of reading ± 100 digits
1 YEAR (23°C ± 5°C)	
0.1 to 1000mA ranges:	± 0.3% ^[4] of reading ± 100 digits

CREST FACTOR
 3 : 1 typically, at full range

TEMPERATURE COEFFICIENT
 $< 1/10$ th of 90 DAY specification/°C

READ RATE : As AC volts

SETTLING TIME : As AC volts

SHUNT RESISTANCE : As DC current

CONVERSION TYPE

True r.m.s. AC coupled or DC coupled

INPUT PROTECTION

As DC Current but large DC bias may cause protection to operate as the AC coupling is provided after current shunts.

[2] Read 360Hz instead of 45Hz if 'Input Filter' not selected.

[3] Spec read-out invalid above 100kHz.

[4] Typical above 1kHz.

1061 and 1061A [5] Specifications

DC VOLTAGE

Full Range Count (FR) : $\pm 100,000$ (1,000,000)
 Full Scale Count (FS) : $\pm 199,999$ (1,999,999) on all ranges
 except 1000V range
*Superfast Mode Full Scale Count : 19,999 on all ranges
 except 1000V range*

ACCURACY

24 HOURS (23°C \pm 1°C) Relative to calibration standards.
 *0.1V range: ± 10 ppm of reading ± 2 digits (16)
 1 and 10V ranges: ± 5 ppm of reading ± 1 digit (8)
 100 and 1000V ranges: ± 10 ppm of reading ± 1 digit (8)
 90 DAYS (23°C \pm 5°C)
 *0.1V range: ± 30 ppm of reading ± 2 digits (16)
 1 and 10V ranges: ± 20 ppm of reading ± 1 digit (8)
 100 and 1000V ranges: ± 30 ppm of reading ± 1 digit (8)
 1 YEAR (23°C \pm 5°C)
 *0.1V range: ± 45 ppm of reading ± 2 digits (16)
 1 and 10V ranges: ± 30 ppm of reading ± 1 digit (8)
 100 and 1000V ranges: ± 45 ppm of reading ± 1 digit (8)

Superfast Mode (all ranges) : \pm above ppm of reading ± 1 digit

TEMPERATURE COEFFICIENT : (10°C to 35°C)
 1/10th of 90 DAY specification $\pm 0.2\mu\text{V}/^\circ\text{C}$

READ RATE

Normal Mode
 All DC ranges : 3/second (internal trigger) with full scale input
 30/35 per second (external trigger) with full
 range input at 50/60Hz

Superfast Mode

All ranges: 200/second (external trigger) with
 full range input.

SETTLING TIME (to 10 ppm of step size) [1]

Filter out : $< 5\text{mS}$
 Filter in : $< 350\text{mS}$

SERIES MODE REJECTION

Filter out : 66dB @ line frequency
 Filter in : add 34dB @ 50Hz increasing at
 18dB/octave

COMMON MODE REJECTION

1k Ω source unbalance
 $> 140\text{dB}$ at DC
 $> 80\text{dB}$ + series mode at 1Hz to 60Hz

AUTORANGE SPEED (No filter)

Typically 100mS per range between top and bottom
 ranges.

INPUT RESISTANCE

0.1 to 10 Volt ranges (< 20 volts) : $> 10,000 \text{M}\Omega$
 100 and 1000 Volt ranges : $10\text{M}\Omega \pm 0.1\%$.

INPUT CURRENT (1 year)

$< 50\text{pA}$ drifting at $< 2\text{pA}/^\circ\text{C}$.

RESISTANCE

Full Range Count : 100,000 (1,000,000)
 Full Scale Count : 199,999 (1,999,999)
Superfast Mode Full Scale Count : 19,999

ACCURACY

24 HOURS (23°C \pm 1°C)

*10 Ω range: ± 15 ppm of reading ± 2 digits (16)
 0.1k Ω , 1k Ω , 10k Ω ranges: ± 10 ppm of reading ± 1 digit (8)
 100k Ω range: ± 15 ppm of reading ± 1 digit (8)
 1000k Ω range: ± 30 ppm of reading ± 1 digit (8)
 10M Ω range: ± 150 ppm of reading ± 1 digit (8)

90 DAYS (23°C \pm 5°C)

*10 Ω range: ± 40 ppm of reading ± 2 digits (16)
 0.1k Ω , 1k Ω , 10k Ω ranges: ± 30 ppm of reading ± 1 digit (8)
 100k Ω range: ± 40 ppm of reading ± 1 digit (8)
 1000k Ω range: ± 100 ppm of reading ± 1 digit (8)
 10M Ω range: ± 300 ppm of reading ± 1 digit (8)

1 YEAR (23°C \pm 5°C)

*10 Ω range: ± 60 ppm of reading ± 2 digits (16)
 0.1k Ω , 1k Ω , 10k Ω ranges: ± 45 ppm of reading ± 1 digit (8)
 100k Ω range: ± 60 ppm of reading ± 1 digit (8)
 1000k Ω range: ± 200 ppm of reading ± 1 digit (8)
 10M Ω range: ± 500 ppm of reading ± 1 digit (8)

Superfast Mode : As DC Volts

TEMPERATURE COEFFICIENT : (10°C to 35°C)
 1/10th of 90 DAY specification $\pm 100\mu\Omega/^\circ\text{C}$

READ RATE

Normal Mode
 All ranges : As DC Volts.
Superfast Mode : As DC Volts

TYPE

True 4-wire with active guard (can be switched to 2-wire
 on the front panel).
 Measurement technique is independent of the internal
 reference voltage.

OPEN CIRCUIT VOLTAGE

< 10 volts on all ranges

LEAD RESISTANCE

Up to 100 Ω may be tolerated in any or all the leads on
 any range. (Rejection of lead resistance is 100dB on
 any range).

RESPONSE TIME

Depends on external capacitance and guarding/shielding
 techniques used.
 Generally up to 10k Ω response as DC Volts.
 Higher resistances take longer to settle.
 OHMS GUARD may be used to guard out stray capacitance.

CURRENT THROUGH UNKNOWN ($\pm 1\%$)

10 Ω , 0.1k Ω ranges : 10mA
 1k Ω range : 1mA
 10k Ω range : 100 μA
 100k Ω range : 10 μA
 1000k Ω range : 1 μA
 10M Ω range : 100nA

OHMS GUARD

Drive Capability: I+ or I- to OHMS GUARD,
 250 Ω minimum (up to 10 Ω lead resistance)
 Guarding Accuracy : See Section 2 - 'Resistance measurement'.

*Within 15 minutes of 'Input Zero' correction and 'Input Filter' selected or add 5 μV per year
 [1] or < 3 digits or 1ppm of step size (whichever is greater) following a range change
 [5] Count and Accuracy figures in brackets refer to 1061A in 'Filter' Mode (6 $\frac{1}{2}$ digits)
 NOTE: SUPERFAST selected by remote programming only

1061 Specifications (cont.)

AC VOLTAGE (TRUE RMS – OPTION 10)

Full Range Count : 100,000
 Full Scale Count : 199,999 on all ranges except 1000V range

ACCURACY (Signals $< 2 \times 10^7$ Volt Hz, $> 0.25\%$ Full Scale)

	DC + 45Hz ^[2] to 5kHz	DC + 5kHz to 100kHz
24 HOURS (23°C ± 1°C) Relative to calibration standards.		
0.1V and 1000V ranges:	± 0.04% of reading ± 40 digits	± 0.1% of reading ± 100 digits
1 to 100V ranges:	± 0.02% of reading ± 20 digits	± 0.05% of reading ± 50 digits
90 DAYS (23°C ± 5°C)		
0.1V and 1000V ranges:	± 0.08% of reading ± 40 digits	± 0.2% of reading ± 100 digits
1 to 100V ranges:	± 0.04% of reading ± 20 digits	± 0.1% of reading ± 50 digits
1 YEAR (23°C ± 5°C)		
0.1V and 1000V ranges:	± 0.12% of reading ± 40 digits	± 0.3% of reading ± 100 digits
1 to 100V ranges:	± 0.06% of reading ± 20 digits	± 0.15% of reading ± 50 digits

HF ACCURACY^[3] (1 and 10V ranges)
 100kHz to 1MHz ± 2% of reading ± 2000 digits (typical)

INPUT IMPEDANCE
 1MΩ shunted by 150pF

LF ACCURACY
 Filter out, at line frequency add: ±0.6% of reading
 Filter in, 10Hz : ±2.0% of reading

CONVERSION TYPE
 True RMS AC coupled (measures AC component with up to 1000V DC bias on any range, subject to the constraints of Section 2, Table 2.1).

or
 True RMS DC coupled (measures $\sqrt{AC^2 + DC^2}$)

CREST FACTOR
 7 : 1 typically, at full range

SETTLING TIME (DC coupled)
 (i) To 0.1% of step size
 Filter out $< 150\text{ms}$
 Filter in $< 500\text{ms}$

TEMPERATURE COEFFICIENT
 $< 1/10\text{th}$ of 90 DAY specification/°C

COMMON MODE REJECTION
 1kΩ unbalance $> 90\text{dB}$ @ DC – 60Hz

(ii) From DC bias input (AC coupled) or severe overload:
 Depends on change of DC bias
 (CR time constant 0.22 seconds)

READ RATE (with full scale input) : 3 readings/second.

DC CURRENT

(applicable only if option 12 is not fitted)

Full Range Count : ± 100,000
 Full Scale Count : ± 199,999
Superfast Mode Full Scale Count : 19,999

ACCURACY

24 HOURS (23°C ± 1°C) Relative to calibration standards	
0.1 to 100mA ranges:	± 50ppm of reading ± 4 digits
1000mA range:	± 100ppm of reading ± 4 digits
90 DAYS (23°C ± 5°C)	
0.1 to 100mA ranges:	± 100ppm of reading ± 4 digits
1000mA range:	± 200ppm of reading ± 4 digits
1 YEAR (23°C ± 5°C)	
0.1 to 100mA ranges:	± 150ppm of reading ± 4 digits
1000mA range:	± 300ppm of reading ± 4 digits

Superfast Mode : As DC volts.

TEMPERATURE COEFFICIENT
 1/10th of 90 DAY specification/°C

READ RATE : As DC Volts

SETTLING TIME : As DC Volts

SHUNT RESISTANCE

0.1mA range :	1kΩ
1mA range :	100Ω
10mA range :	10Ω
100mA range :	1Ω
1000mA range :	0.1Ω

Internal lead resistance: $< 20\%$ of shunt resistance + 1Ω

INPUT PROTECTION

Overloads : $< 2\text{A}$, internally clamped
 $\geq 2\text{A}$, rear panel fuse

AC CURRENT (TRUE RMS)

(in conjunction with option 10 only)

Full Range Count: 100,000
 Full Scale Count : 199,999

ACCURACY DC + 45Hz^[2] to 5kHz
 (Signals $> 0.1\%$ Full Scale)

24 HOURS (23°C ± 1°C) Relative to calibration standards	
0.1 to 1000mA ranges:	± 0.1% ^[4] of reading ± 100 digits
90 DAYS (23°C ± 5°C)	
0.1 to 1000mA ranges:	± 0.2% ^[4] of reading ± 100 digits
1 YEAR (23°C ± 5°C)	
0.1 to 1000mA ranges:	± 0.3% ^[4] of reading ± 100 digits

CREST FACTOR
 3 : 1 typically, at full range

TEMPERATURE COEFFICIENT
 $< 1/10\text{th}$ of 90 Day specification/°C

READ RATE : As AC volts

SETTLING TIME : As AC volts

SHUNT RESISTANCE : As DC current

CONVERSION TYPE
 True r.m.s. AC coupled or DC coupled

INPUT PROTECTION
 As DC Current but large DC bias may cause protection to operate as the AC coupling is provided after current shunts.

[2] Read 360Hz instead of 45Hz if 'Input Filter' not selected.

[3] Spec read-out invalid above 100kHz.

[4] Typical above 1kHz.

HIGH PERFORMANCE AC VOLTAGE (TRUE RMS – OPTION 12)

Full Range Count: 100,000 (1,000,000)

Full Scale Count: 199,999 (1,999,999) on all ranges except 1000V Range

ACCURACY

(For signals $< 2 \times 10^7$ Volt Hz, $> 0.25\%$ Full Scale)

(\pm % reading \pm digits)

	DC + 45Hz - 2kHz [2] [5]	2kHz - 30kHz [5] [6]	30kHz - 100kHz [5] [6]
24 HOURS (23°C \pm 1°C) Relative to calibration standards			
0.1V & 1000V ranges:	0.02 \pm 15(150)	0.04 \pm 30(300)	0.08 \pm 45(450)
1V to 100V ranges:	0.01 \pm 10(100)	0.02 \pm 20(200)	0.04 \pm 40(400)
90 DAYS (23°C \pm 5°C)			
0.1V & 1000V ranges:	0.04 \pm 15(150)	0.08 \pm 30(300)	0.20 \pm 45(450)
1V to 100V ranges:	0.025 \pm 10(100)	0.05 \pm 20(200)	0.10 \pm 40(400)
1 YEAR (23°C \pm 5°C)			
0.1V & 1000V ranges:	0.05 \pm 15(150)	0.10 \pm 30(300)	0.25 \pm 45(450)
1V to 100V ranges:	0.03 \pm 10(100)	0.06 \pm 20(200)	0.15 \pm 40(400)

LF ACCURACY

Filter out, at line frequency: $\pm 0.6\%$ of reading
Filter in, 10Hz : $\pm 2\%$ of reading

HF ACCURACY: 100kHz - 1MHz [3]

1V & 10V Ranges $2\% \pm 2000(20,000)$

DC COUPLING

Add to main specification $0.01\% \pm 3(30) \pm 10\mu\text{V}$.

CONVERSION TYPE

True RMS AC coupled (measures AC component with up to 1000V DC bias on any range, subject to the constraints of Section 2, Table 2.1).

CREST FACTOR

5 : 1, at full range

or

True RMS DC coupled (measures $\sqrt{\text{AC}^2 + \text{DC}^2}$)

TEMPERATURE COEFFICIENT

$< 1/10\text{th}$ of 90 day specification /°C

COMMON MODE REJECTION

1k Ω source unbalanced: $> 90\text{dB}$ @ DC – 60Hz

SETTLING TIME (DC coupled)

(i) To 0.1% of step size:

Filter out $< 200\text{ms}$

Filter in $< 1.25\text{s}$

(ii) From DC bias input (AC coupled) or severe overload: Depends on DC bias, (CR time constant 0.22 seconds)

INPUT IMPEDANCE

1M Ω shunted by 150pF

READ RATE

With full scale input: 3/s

Notes:

[2] Read 360Hz instead of 45Hz if "Input Filter" not selected

[3] Spec read-out invalid above 30kHz

[5] Count and accuracy figures in brackets refer to 1061A in "Filter" mode (6 $\frac{1}{2}$ digits)

[6] Add 0.01% per 100V above 500V

Standard internal delays

An internal time delay is introduced between receipt of any trigger pulse and the start of a measurement cycle.

It is therefore possible for a user to apply the trigger and signal simultaneously, knowing that the input circuitry will have settled to the new signal level before the measurement cycle begins.

To optimize maximum read-rate with adequate settling time, the size of the internal delay is standardized for various combinations of function and range selection. These variations are shown in the following tables:

1061/1061A		Filter Out (ms)	Filter In (ms)
Function	Range		
DCV	all	5	500
(Option 12) ACV DCV + ACV	all	300	1250
(Option 10) ACV DCV + ACV ACI DCI + ACI	all	225	750
DCI	100 μ A-1mA	5	500
	10mA	10	
	100mA	20	
	1A	25	
k Ω	10 Ω -100k Ω	5	500
	1M Ω	15	600
	10M Ω	150	1250

1071		Filter Out (ms)	Filter In (ms)
Function	Range		
DCV DCI	all	50	1000
ACV DCV + ACV ACI DCI + ACI	all	230	750
k Ω	10 Ω -100k Ω	50	1000
	1M Ω	50	1200
	10M Ω	310	2500

In addition to all the delays shown above, two further delays are imposed:

Range change – 10V-100V : 25ms
Function change : 100ms

SECTION 8 SPECIFICATION VERIFICATION

Introduction

The following section contains procedures to check that the instrument is working within specified accuracies. In addition, a functional check of the COMPUTE and KEYBOARD facilities can be carried out by following the examples of Section 3.

Section 8 is divided into three parts by instrument model, to clarify the variations between the basic 1061, the 1071 (higher display resolution), and the 1061A (requirements for Option 12, and higher resolution on DC Volts, Option 12 AC Volts, and Resistance). Each part contains performance-check procedures, a set of limit tables and a suitable form of report sheet. It is advisable to make duplicate copies of the report sheets for future use.

If the 1061, 1061A or 1071 is found to be out of specification, reference should be made to the Calibration and Servicing Handbook for a routine calibration, or if necessary for technical fault-finding information.

Equipment requirements

- DC Voltage - a DC Voltage source of accuracy at least four times better than the accuracy being verified; from 1mV to 1000V.
Example: Datron Autocal Standard, Model 4000/A.
- AC Voltage - an AC Voltage source of sufficient accuracy; from 1mV to 1000V.
Example: Datron Autocal AC Standard, Model 4200.
- Resistance - a set of standard resistors covering 10Ω to $10M\Omega$. The 10Ω to $10k\Omega$ values should be 4-wire types.
Example: Datron Autocal Standard, Model 4000/A (Option 20).
- DC Current - a current source of accuracy at least four times better than the accuracy being verified; from $100\mu\text{A}$ to 1,000mA.
Example: Datron Autocal Standard, Model 4000/A (Option 20).
- AC Current - a current source of accuracy at least four times better than the accuracy being verified; from $100\mu\text{A}$ to 1,000mA.
Example: Datron Autocal AC Standard Model 4200 (Option 30).

1071 specification verification

1071 DC performance

1. Turn on the instrument to be checked and allow a minimum of 2 hours to warm up in the specified environment.
2. Cancel any 'MODE' or 'COMPUTE' keys, set the Local/Remote Guard switch to 'Local Guard', select front input on rear panel and check that 'cal' is not displayed.
3. Select 'Test' and check that the Self Test routine is passed (see Section 3).
4. Connect DC voltage source and turn down to zero. Allow input to stabilize.
5. Select DC, 'Auto', 'Input filter' and 'Input zero'. When this routine is complete, the 'Input zero' key LED will be extinguished.
6. Select range 10 and apply the input signals between 'Hi' and 'Lo' as listed in Table 8.1 check that the displayed reading is within the limits shown in Table 8.1.
7. Select each range in turn and apply a corresponding full range input signal between 'Hi' and 'Lo'. Check that the displayed reading is within the limits shown in Table 8.2.

NOTE: When checking the .1 and 1 ranges, it will be necessary to turn the source down to zero and allow the thermal emf's to disappear or stabilise (several minutes). Select range and then 'Input zero' to "zero out" any offset. The signal may then be applied.

If changing polarity involves reversing leads, this procedure may need to be repeated as the thermal emf's may have changed.

1071 AC performance

1. Carry out 1071 DC performance checks 1 to 3 if the DC performance has not been verified.
2. Select 'AC', 'Input filter' and each range in turn and apply a corresponding full range input signal between 'Hi' and 'Lo' at the frequencies specified.

Check that the displayed reading is within the limits shown in Table 8.3 (Option 10).

1071 resistance performance

1. Check out 1071 DC performance checks 1 to 3 if the DC performance has not been verified.
2. Connect a true four wire zero as detailed in the section on 'Resistance Measurement'. Select 'k Ω ', 'Input filter' and 'Input zero'.
3. Carry out step 2 for each range in turn and then measure the corresponding full range resistor. Four wire connection is recommended throughout but a two wire arrangement may be used for 1M Ω and above, in which case '2 wire Ω ' should be selected. If high value standards are fitted with a guard terminal, this should be connected to ' Ω guard'. Check that displayed reading is within the limits shown in table 8.4.

1071 DC current performance

1. Carry out 1071 DC performance checks 1 to 3 if the DC performance has not been verified.
2. Open circuit the 'I+' and 'I-' terminals. Select '4 wire Ω ', 'DC', 'I', 'Input filter', 'Auto' and 'Input zero'. When this routine is complete, the 'Input zero' key LED will be extinguished.
3. Remove the link, and connect the output of of the current source to the current input terminals of the instrument. Select each range in turn and apply a corresponding full range input signal. Check that the displayed reading is within the limits shown in Table 8.5.

1071 AC current performance

1. Carry out 1071 DC performance checks 1 to 3 if the DC performance has not been verified.
2. Connect the output of the current source to the current input terminals of the instrument, select each range in turn and apply a corresponding full range input signal at the frequencies specified. Check that the displayed reading is within the limits shown in Table 8.6.

Range	Input Signal	24 HR Test Limits	90 DAY Test Limits	1 YEAR Test limits
10	$\pm 1\text{mV}$.000980 to .001020	.000970 to .001030	.000960 to .001040
10	$\pm 10\text{mV}$.009980 to .010020	.009970 to .010030	.009960 to .010040
10	$\pm 100\text{mV}$.099980 to .100020	.099970 to .100030	.099960 to .100040
10	$\pm 1\text{V}$.999980 to 1.000020	.999950 to 1.000050	.999940 to 1.000060
10	$\pm 10\text{V}$	9.999950 to 10.000050	9.999820 to 10.000180	9.999760 to 10.000240
10	$\pm 19\text{V}$	(1.9 x reading at 10V ± 20 digits)	(1.9 x reading at 10V ± 30 digits)	(1.9 x reading at 10V ± 40 digits)

Table 8.1 1071 DC Linearity Checks ⁽¹⁾

Range	Input Signal	24 HR Test Limits	90 DAY Test Limits	1 YEAR Test Limits
.1	$\pm 100\text{mV}$	99.99920 to 100.00080	99.99750 to 100.00250	99.99640 to 100.00360
1	$\pm 1\text{V}$.9999950 to 1.0000050	.9999820 to 1.0000180	.9999760 to 1.0000240
10	$\pm 10\text{V}$	9.999950 to 10.000050	9.999820 to 10.000180	9.999760 to 10.000240
100	$\pm 100\text{V}$	99.99940 to 100.00060	99.99770 to 100.00230	99.99660 to 100.00340
1000	$\pm 1000\text{V}$	999.9940 to 1000.0060	999.9770 to 1000.0230	999.9660 to 1000.0340

Table 8.2 1071 DC Full Range Checks ⁽¹⁾

Range	Input	Frequency	24 HR Test Limits	90 DAY Test Limits	1 YEAR Test Limits
.1	100mV	500Hz	99.920 to 100.080	99.880 to 100.120	99.840 to 100.160
.1	100mV	40kHz	99.800 to 100.200	99.700 to 100.300	99.600 to 100.400
1	1V	500Hz	.99960 to 1.00040	.99940 to 1.00060	.99920 to 1.00080
1	1V	40kHz	.99900 to 1.00100	.99850 to 1.00150	.99800 to 1.00200
10	10V	500Hz	9.9960 to 10.0040	9.9940 to 10.0060	9.9920 to 10.0080
10	10V	40kHz	9.9900 to 10.0100	9.9850 to 10.0150	9.9800 to 10.0200
100	100V	500Hz	99.960 to 100.040	99.940 to 100.060	99.920 to 100.080
100	100V	40kHz	99.900 to 100.100	99.850 to 100.150	99.800 to 100.200
1000	1000V	500Hz	999.20 to 1000.80	998.80 to 1001.20	998.40 to 1001.60
1000	1000V	20kHz	998.00 to 1002.00	997.00 to 1003.00	996.00 to 1004.00

Table 8.3 1071 AC Full Range Checks (Option 10) ⁽¹⁾

⁽¹⁾ All test limits are relative to the calibration standards.

Range	Resistor Value	24 HR Test Limits	90 DAY Test Limits	1 YEAR Test Limits
10 Ω	10 Ω	9.999820 to 10.000180	9.999620 to 10.000380	9.999500 to 10.000500
.1	100 Ω	99.99930 to 100.00070	99.99760 to 100.00240	99.99640 to 100.00360
1	1k Ω	.9999930 to 1.0000070	.9999760 to 1.0000240	.9999640 to 1.0000360
10	10k Ω	9.999930 to 10.000070	9.999760 to 10.000240	9.999640 to 10.000360
100	100k Ω	99.99880 to 100.00120	99.99660 to 100.00340	99.99540 to 100.00460
1000	1M Ω	999.9780 to 1000.0220	999.9160 to 1000.0840	999.8740 to 1000.1260
10M Ω	10M Ω	9.998980 to 10.001020	9.997560 to 10.002440	9.996340 to 10.003660

Table 8.4 1071 Resistance Full Range Checks^[1]

Range	Input	24 HR Test Limits	90 DAY Test Limits	1 YEAR Test Limits
.1	$\pm 100\mu\text{A}$	99.991 to 100.009	99.986 to 100.014	99.981 to 100.019
1	$\pm 1\text{mA}$.99991 to 1.00009	.99986 to 1.00014	.99981 to 1.00019
10	$\pm 10\text{mA}$	9.9991 to 10.0009	9.9986 to 10.0014	9.9981 to 10.0019
100	$\pm 100\text{mA}$	99.991 to 100.009	99.986 to 100.014	99.981 to 100.019
1000	$\pm 1\text{A}$	999.86 to 1000.14	999.76 to 1000.24	999.66 to 1000.34

Table 8.5 1071 DC Current Full Range Checks^[1]

Range	Input	Frequency	24 HR Test Limits	90 DAY Test Limits	1 YEAR Test Limits
.1	100 μA	500Hz	99.850 to 100.150	99.750 to 100.250	99.650 to 100.350
1	1mA	500Hz	.99850 to 1.00150	.99750 to 1.00250	.99650 to 1.00350
10	10mA	500Hz	9.9850 to 10.0150	9.9750 to 10.0250	9.9650 to 10.0350
100	100mA	500Hz	99.850 to 100.150	99.750 to 100.250	99.650 to 100.350
1000	1A	500Hz	998.50 to 1001.50	997.50 to 1002.50	996.50 to 1003.50

Table 8.6 1071 AC Current Full Range Checks^[1]

[1] All Test Limits are relative to the calibration standards

SPECIFICATION VERIFICATION REPORT SHEET

MODEL 1071

SERIAL NUMBER

DATE.....

TESTED BY.....

1(a) DC VOLTS 10V Range Linearity

Range	Input Signal	Reading	
		+ Polarity	- Polarity
10	1mV		
10	10mV		
10	100mV		
10	1V		
10	10V		
10	19V		

1(b) DC VOLTS Full Ranges

Range	Input Signal	Reading	
		+ Polarity	- Polarity
.1	100mV		
1	1V		
1C	10V		
100	100V		
1000	100mV		

2. AC VOLTS (Option 10) Full Ranges

Range	Input Signal	Reading	
		500Hz	40kHz
.1	100mV		
1	1V		
10	10V		
100	100V		
1000	1000V		

3. RESISTANCE Full Ranges

Range	Resistor Value	Reading
10Ω	10Ω	
.1	100Ω	
1	1kΩ	
10	10kΩ	
100	100kΩ	
1000	1MΩ	
10MΩ	10MΩ	

4. DC CURRENT Full Ranges (Option 30)

Range	Input Signal	Reading	
		+ Polarity	- Polarity
.1	100μA		
1	1mA		
10	10mA		
100	100mA		
1000	1A		

5. AC CURRENT Full Ranges (Options 30 & 10)

Range	Input Signal	Reading (500Hz)
.1	100μA	
1	1mA	
10	10mA	
100	100mA	
1000	1A	

1061 specification verification (For 1061A see page 8-10)

1061 DC performance

1. Turn on the instrument to be checked and allow a minimum of 2 hours to warm up in the specified environment.
2. Cancel any 'MODE' or 'COMPUTE' keys, set the Local/Remote Guard switch to 'Local Guard', select front input on rear panel and check that 'cal' is not displayed.
3. Select 'Test' and check that the Self Test routine is passed (see Section 3).
4. Connect DC Voltage source and turn down to zero. Allow input to stabilise.
5. Select 'DC', 'Auto', 'Input filter' and 'Input zero'. When this routine is complete the 'Input zero' key LED will be extinguished.
6. Select range 10 and apply the input signals between 'Hi' and 'Lo' as listed in Table 8.7. Check that the displayed reading is within the limits shown in Table 8.7.
7. Select each range in turn and apply a corresponding full range input signal between 'Hi' and 'Lo'. Check that the displayed reading is within the limits shown in Table 8.8.

NOTE: When checking the .1 Volt range, it will be necessary to turn the source down to zero and allow the thermal emf's to disappear or stabilise (several minutes). Select .1 range and then 'Input zero' to 'zero out' any offset. The signal may then be applied.

If changing polarity involves reversing leads, this procedure may need to be repeated as the thermal emf's may have changed.

1061 AC performance

1. Carry out 1061 DC performance checks 1 to 3 if the DC performance has not been verified.
2. Select 'AC', 'Input filter' and each range in turn and apply a corresponding full range input signal between 'Hi' and 'Lo' at the frequencies specified. Check that the displayed reading is within the limits shown in Table 8.9 (Option 10).

1061 resistance performance

1. Carry out 1061 DC performance checks 1 to 3 if the DC performance has not been verified.
2. Connect a true four wire zero as detailed in the section on 'Resistance Measurement'. Select 'k Ω ', 'Input filter' and 'Input zero'.
3. Carry out step 2 for each range in turn and then measure the corresponding full range resistor. Four wire connection is recommended throughout but a two wire arrangement may be used for 1M Ω and above, in which case '2 wire Ω ' should be selected. If high value standards are fitted with a guard terminal, this should be connected to ' Ω guard'. Check that displayed reading is within the limits shown in Table 8.10.

1061 DC current performance

1. Carry out 1061 DC performance checks 1 to 3 if the DC performance has not been verified.
2. Open circuit the 'I+' and 'I-' terminals. Select '4 wire Ω ', 'DC', 'I', 'Input filter', 'Auto' and 'Input zero'. When this routine is complete, the 'Input zero' key LED will be extinguished.
3. Remove the link and connect the output of the current source to the current input terminals of the instrument. Select each range in turn and apply a corresponding full range input signal. Check that the displayed reading is within the test limits shown in Table 8.11.

1061 AC current performance

1. Carry out 1061 DC performance checks 1 to 3 if the DC performance has not been verified.
2. Select 'AC', 'I' and 'Input filter'.
3. Connect the output of the current source to the current input terminals of the instrument, select each range in turn and apply a corresponding full range input signal at the frequencies specified. Check that the displayed reading is within the limits shown in Table 8.12.

Range	Input Signal	24 HR Test Limits	90 DAY Test Limits	1 YEAR Test Limits
10	$\pm 1\text{mV}$.0009 to .0011	.0009 to .0011	.0009 to .0011
10	$\pm 10\text{mV}$.0099 to .0101	.0099 to .0101	.0099 to .0101
10	$\pm 100\text{mV}$.0999 to .1001	.0999 to .1001	.0999 to .1001
10	$\pm 1\text{V}$.9999 to 1.0001	.9999 to 1.0001	.9999 to 1.0001
10	$\pm 10\text{V}$	9.9998 to 10.0002	9.9997 to 10.0003	9.9996 to 10.0004
10	$\pm 19\text{V}$	(1.9 x reading at 10V ± 1 digit)	(1.9 x reading at 10V ± 1 digit)	(1.9 x reading at 10V ± 1 digit)

Table 8.7 1061 DC Linearity Checks ⁽¹⁾

Range	Input Signal	24 HR Test Limits	90 DAY Test Limits	1 YEAR Test Limits
.1	$\pm 100\text{mV}$	99.997 to 100.003	99.995 to 100.005	99.993 to 100.007
1	$\pm 1\text{V}$.99998 to 1.00002	.99997 to 1.00003	.99996 to 1.00004
10	$\pm 10\text{V}$	9.9998 to 10.0002	9.9997 to 10.0003	9.9996 to 10.0004
100	$\pm 100\text{V}$	99.998 to 100.002	99.996 to 100.004	99.994 to 100.006
1000	$\pm 1000\text{V}$	999.98 to 1000.02	999.96 to 1000.04	999.94 to 1000.06

Table 8.8 1061 DC Full Range Checks ⁽¹⁾

Range	Input	Frequency	24 HR Test Limits	90 DAY Test Limits	1 YEAR Test Limits
.1	100mV	500Hz	99.920 to 100.080	99.880 to 100.120	99.840 to 100.160
.1	100mV	40kHz	99.800 to 100.200	99.700 to 100.300	99.600 to 100.400
1	1V	500Hz	.99960 to 1.00040	.99940 to 1.00060	.99920 to 1.00080
1	1V	40kHz	.99900 to 1.00100	.99850 to 1.00150	.99800 to 1.00200
10	10V	500Hz	9.9960 to 10.0040	9.9940 to 10.0060	9.9920 to 10.0080
10	10V	40kHz	9.9900 to 10.0100	9.9850 to 10.0150	9.9800 to 10.0200
100	100V	500Hz	99.960 to 100.040	99.940 to 100.060	99.920 to 100.080
100	100V	40kHz	99.900 to 100.100	99.850 to 100.150	99.800 to 100.200
1000	1000V	500Hz	999.20 to 1000.80	998.80 to 1001.20	998.40 to 1001.60
1000	1000V	20kHz	998.00 to 1002.00	997.00 to 1003.00	996.00 to 1004.00

Table 8.9 1061 AC Full Range Checks (Option 10) ⁽¹⁾

⁽¹⁾ All test limits are relative to the calibration standards

Range	Resistor Value	24 HR Test Limits	90 DAY Test Limits	1 YEAR Test Limits
10Ω	10Ω	9.9996 to 10.0004	9.9994 to 10.0006	9.9992 to 10.0008
.1	100Ω	99.998 to 100.002	99.996 to 100.004	99.994 to 100.006
1	1kΩ	.99998 to 1.00002	.99996 to 1.00004	.99994 to 1.00006
10	10kΩ	9.9998 to 10.0002	9.9996 to 10.0004	9.9994 to 10.0006
100	100kΩ	99.997 to 100.003	99.995 to 100.005	99.993 to 100.007
1000	1MΩ	999.96 to 1000.04	999.89 to 1000.11	999.79 to 1000.21
10MΩ	10MΩ	9.9984 to 10.0016	9.9969 to 10.0031	9.9949 to 10.0051

Table 8.10 1061 Resistance Full Range Checks ^[1]

Range	Input	24 HR Test Limits	90 DAY Test Limits	1 YEAR Test Limits
.1	100μA	99.991 to 100.009	99.986 to 100.014	99.981 to 100.019
1	1mA	.99991 to 1.00009	.99986 to,1.00014	.99981 to 1.00019
10	10mA	9.9991 to 10.0009	9.9986 to 10.0014	9.9981 to 10.0019
100	100mA	99.991 to 100.009	99.986 to 100.014	99.981 to 100.019
1000	1A	999.86 to 1000.14	999.76 to 1000.24	999.66 to 1000.34

Table 8.11 1061 DC current Full Range Checks ^[1]

Range	Input	Frequency	24 HR Test Limits	90 DAY Test Limits	1 YEAR Test Limits
.1	100μA	500Hz	99.850 to 100.150	99.750 to 100.250	99.650 to 100.350
1	1mA	500Hz	.99850 to 1.00150	.99750 to 1.00250	.99650 to 1.00350
10	10mA	500Hz	9.9850 to 10.0150	9.9750 to 10.0250	9.9650 to 10.0350
100	100mA	500Hz	99.850 to 100.150	99.750 to 100.250	99.650 to 100.350
1000	1A	500Hz	998.50 to 1001.50	997.50 to 1002.50	996.50 to 1003.50

Table 8.12 1061 AC Current Full Range Checks ^[1]

[1] All test limits are relative to the calibration standards.

SPECIFICATION VERIFICATION REPORT SHEET

MODEL 1061

SERIAL NUMBER

DATE

TESTED BY

1(a) DC VOLTS 10V Range Linearity

Range	Input Signal	Reading	
		+ Polarity	- Polarity
10	1mV		
10	10mV		
10	100mV		
10	1V		
10	10V		
10	19V		

1(b) DC VOLTS Full Ranges

Range	Input Signal	Reading	
		+ Polarity	- Polarity
.1	100mV		
1	1V		
10	10V		
100	100V		
1000	100mV		

2. AC VOLTS (Option 10) Full Ranges

Range	Input Signal	Reading	
		500Hz	40kHz
.1	100mV		
1	1V		
10	10V		
100	100V		
1000	1000V		

3. RESISTANCE Full Ranges

Range	Resistor Value	Reading
10Ω	10Ω	
.1	100Ω	
1	1kΩ	
10	10kΩ	
100	100kΩ	
1000	1MΩ	
10MΩ	10MΩ	

4. DC CURRENT Full Ranges (Option 30)

Range	Input Signal	Reading	
		+ Polarity	- Polarity
.1	100μA		
1	1mA		
10	10mA		
100	100mA		
1000	1A		

5. AC CURRENT Full Ranges (Options 30 & 10)

Range	Input Signal	Reading (500Hz)
.1	100μA	
1	1mA	
10	10mA	
100	100mA	
1000	1A	

1061A specification verification

N.B. As 'Input Filter' is employed in these verifications: DC Voltage, Resistance and AC Voltage (option 12 only) display resolution is expanded to 6½ digits.

1061A DC performance

1. Turn on the instrument to be checked and allow a minimum of 2 hours to warm up in the specified environment.
2. Cancel any 'MODE' or 'COMPUTE' keys, set the Local/Remote Guard switch to 'Local Guard', select front input on rear panel and check that 'cal' is not displayed.
3. Select 'Test' and check that the Self Test routine is passed (see Section 3).
4. Connect DC Voltage source and turn down to zero. Allow input to stabilise.
5. Select 'DC', 'Autocal', 'Input filter' and 'Input zero'. When this routine is complete the 'Input zero' key LED will be extinguished.
6. Select range 10 and apply the input signals between 'Hi' and 'Lo' as listed in Table 8.13. Check that the displayed reading is within the limits shown in Table 8.13.
7. Select each range in turn and apply a corresponding full range input signal between 'Hi' and 'Lo'. Check that the displayed reading is within the limits shown in Table 8.14.

NOTE: When checking the .1 Volt range, it will be necessary to turn the source down to zero and allow the thermal emf's to disappear or stabilise (several minutes). Select .1 range and then 'Input zero' to 'zero out' any offset. The signal may then be applied. If changing polarity involves reversing leads, this procedure may need to be repeated as the thermal emf's may have changed.

1061A AC performance

1. Carry out 1061A DC performance checks 1 to 3 if the DC performance has not been verified.
2. (Option 12 only)
Select range 1 and apply the input signals between 'Hi' and 'Lo' as listed in Table 8.15. Check that the displayed reading is within the limits shown in Table 8.15.
3. Select 'AC', 'Input filter' and each range in turn and apply a corresponding full range input signal between 'Hi' and 'Lo' at the frequencies specified. Check that the displayed reading is within the limits shown in Table 8.16 (Option 12) or Table 8.17 (Option 10).

1061A resistance performance

1. Carry out 1061A DC performance checks 1 to 3 if the DC performance has not been verified.
2. Connect a true four wire zero as detailed in the section on 'Resistance Measurement'. Select 'k Ω ', 'Input filter' and 'Input zero'.
3. Carry out step 2 for each range in turn and then measure the corresponding full range resistor. Four wire connection is recommended throughout but a two wire arrangement may be used for 1M Ω and above, in which case '2 wire Ω ' should be selected. If high value standards are fitted with a guard terminal, this should be connected to ' Ω guard'. Check that displayed reading is within the limits shown in table 8.18.

1061A DC current performance

(Option 30 - Not applicable if option 12 fitted)

1. Carry out 1061A DC performance checks 1 to 3 if the DC performance has not been verified.
2. Open circuit the 'I+' and 'I-' terminals. Select '4 wire Ω ', 'DC', 'I', 'Input filter', 'Auto' and 'Input zero'. When this routine is complete, the 'Input zero' key LED will be extinguished.
3. Remove the link and connect the output of the current source to the current input terminals of the instrument. Select each range in turn and apply a corresponding full range input signal. Check that the displayed reading is within the test limits shown in Table 8.19.

1061A AC current performance

(Option 30 - in conjunction with option 10)

1. Carry out 1061A DC performance checks 1 to 3 if the DC performance has not been verified.
2. Select 'AC', 'I' and 'Input filter'.
3. Connect the output of the current source to the current input terminals of the instrument, select each range in turn and apply a corresponding full range input signal at the frequencies specified. Check that the displayed reading is within the limits shown in Table 8.20.

Range	Input Signal	24 HR Test Limits	90 DAY Test Limits	1 YEAR Test Limits
10	± 1mV	.00092 to .00108	.00092 to .00108	.00092 to .00108
10	± 10mV	.00992 to .01008	.00992 to .01008	.00992 to .01008
10	± 100mV	.09992 to .10008	.09992 to .10008	.09992 to .10008
10	± 1V	.99992 to 1.00008	.99990 to 1.00010	.99989 to 1.00011
10	± 10V	9.99987 to 10.00013	9.99972 to 10.00028	9.99962 to 10.00038
10	± 19V	(1.9 x reading at 10V ± 10 digits)	(1.9 x reading at 10V ± 10 digits)	(1.9 x reading at 10V ± 10 digits)

Table 8.13 1061A DC Linearity Checks ^[1]

Range	Input Signal	24 HR Test Limits	90 DAY Test Limits	1 YEAR Test Limits
.1	± 100mV	99.9974 to 100.0026	99.9964 to 100.0036	99.9954 to 100.0046
1	± 1V	.999987 to 1.000013	.999972 to 1.000028	.999962 to 1.000038
10	± 10V	9.99987 to 10.00013	9.99972 to 10.00028	9.99962 to 10.00038
100	± 100V	99.9982 to 100.0018	99.9962 to 100.0038	99.9947 to 100.0053
1000	± 1000V	999.982 to 1000.018	999.962 to 1000.038	999.947 to 1000.053

Table 8.14 1061A DC Full Range Checks ^[1]

Range	Input Signal	24 HR Test Limits	90 DAY Test Limits	1 YEAR Test Limits
1	1mV	.000900 to .001100	.000900 to .001100	.000900 to .001100
1	1V	.999800 to 1.000200	.999650 to 1.000350	.999600 to 1.000400
1	1.9V	(1.9 x reading at 1V ± 10 digits)	(1.9 x reading at 1V ± 10 digits)	(1.9 x reading at 1V ± 10 digits)

**Table 8.15 1061A AC Linearity Checks at 200Hz ^[1]
(Option 12 Only)**

[1] All test limits are relative to the calibration standards.

Range	Input	Frequency	24 HR Test Limits	90 DAY Test Limits	1 YEAR Test Limits
.1	100mV	200Hz	99.9650 to 100.0350	99.9450 to 100.0550	99.9350 to 100.0650
.1	100mV	3kHz	99.9300 to 100.0700	99.8900 to 100.1100	99.8700 to 100.1300
.1	100mV	20kHz	99.9300 to 100.0700	99.7550 to 100.2450	99.7050 to 100.2950
1	1V	200Hz	.999800 to 1.000200	.999650 to 1.000350	.999600 to 1.000400
1	1V	3kHz	.999600 to 1.000400	.999300 to 1.000700	.999200 to 1.000800
1	1V	30kHz	.999200 to 1.000800	.998600 to 1.001400	.998100 to 1.001900
10	10V	200Hz	9.99800 to 10.00200	9.99650 to 10.00350	9.99600 to 10.00400
10	10V	3kHz	9.99600 to 10.00400	9.99300 to 10.00700	9.99200 to 10.00800
10	10V	30kHz	9.99200 to 10.00800	9.98600 to 10.01400	9.98100 to 10.01900
100	100V	200Hz	99.9800 to 100.0200	99.9650 to 100.0350	99.9600 to 100.0400
100	100V	3kHz	99.9600 to 100.0400	99.9300 to 100.0700	99.9200 to 100.0800
100	100V	30kHz	99.9200 to 100.0800	99.8600 to 100.1400	99.8100 to 100.1900
1000	1000V	200Hz	99.9650 to 100.0350	99.9450 to 100.0550	99.9350 to 100.0650
1000	1000V	3kHz	99.9300 to 100.0700	99.8900 to 100.1100	99.8700 to 100.1300
1000	1000V	20kHz	99.9300 to 100.0700	99.7550 to 100.2450	99.7050 to 100.2950

Table 8.16 1061A AC Full Range Checks (Option 12 only)

Range	Input	Frequency	24 HR Test Limits	90 DAY Test Limits	1 YEAR Test Limits
.1	100mV	500Hz	99.920 to 100.080	99.880 to 100.120	99.840 to 100.160
.1	100mV	40kHz	99.800 to 100.200	99.700 to 100.300	99.600 to 100.400
1	1V	500Hz	.99960 to 1.00040	.99940 to 1.00060	.99920 to 1.00080
1	1V	40kHz	.99900 to 1.00100	.99850 to 1.00150	.99800 to 1.00200
10	10V	500Hz	9.9960 to 10.0040	9.9940 to 10.0060	9.9920 to 10.0080
10	10V	40kHz	9.9900 to 10.0100	9.9850 to 10.0150	9.9800 to 10.0200
100	100V	500Hz	99.960 to 100.040	99.940 to 100.060	99.920 to 100.080
100	100V	40kHz	99.900 to 100.100	99.850 to 100.150	99.800 to 100.200
1000	1000V	500Hz	999.20 to 1000.80	998.80 to 1001.20	998.40 to 1001.60
1000	1000V	20kHz	998.00 to 1002.00	997.00 to 1003.00	996.00 to 1004.00

Table 8.17 1061A AC Full Range Checks (Option 10)^[1]

[1] All test limits are relative to the calibration standards.

Range	Resistor Value	24 HR TEST Limits	90 DAY Test Limits	1 Year Test Limits
10 Ω	10 Ω	9.99969 to 10.00031	9.99944 to 10.00056	9.99924 to 10.00076
.1	100 Ω	99.9982 to 100.0018	99.9962 to 100.0038	99.9947 to 100.0053
1	1k Ω	.999982 to 1.000018	.999962 to 1.000038	.999947 to 1.000053
10	10k Ω	9.99982 to 10.00018	9.99962 to 10.00038	9.99947 to 10.00053
100	100k Ω	99.9977 to 100.0023	99.9952 to 100.0048	99.9932 to 100.0068
1000	1M Ω	999.962 to 1000.038	999.892 to 1000.108	999.792 to 1000.208
10M	10M Ω	9.99842 to 10.00158	9.99692 to 10.00308	9.99492 to 10.00508

Table 8.18 1061A Resistance Full Range Checks^[1]

Range	Input	24 HR Test Limits	90 DAY Test Limits	1 YEAR Test Limits
.1	100 μ A	99.991 to 100.009	99.986 to 100.014	99.981 to 100.019
1	1mA	.99991 to 1.00009	.99986 to 1.00014	.99981 to 1.00019
10	10mA	9.9991 to 10.0009	9.9986 to 10.0014	9.9981 to 10.0019
100	100mA	99.991 to 100.009	99.986 to 100.014	99.981 to 100.019
1000	1A	999.86 to 1000.14	999.76 to 1000.24	999.66 to 1000.34

Table 8.19 1061A DC Current Full Range Checks (Not applicable if Option 12 fitted)^[1]

Range	Input	Frequency	24 HR Test Limits	90 DAY Test Limits	1 YEAR Test Limits
.1	100 μ A	500Hz	99.850 to 100.150	99.750 to 100.250	99.650 to 100.350
1	1mA	500Hz	.99850 to 1.00150	.99750 to 1.00250	.99650 to 1.00350
10	10mA	500Hz	9.9850 to 10.0150	9.9750 to 10.0250	9.9650 to 10.0350
100	100mA	500Hz	99.850 to 100.150	99.750 to 100.250	99.650 to 100.350
1000	1A	500Hz	998.50 to 1001.50	997.50 to 1002.50	996.50 to 1003.50

Table 8.20 1061A AC Current Full Range Checks (In conjunction with Option 10)^[1]

[1] All test limits are relative to the calibration standards.

SPECIFICATION VERIFICATION REPORT SHEET

MODEL 1061A

SERIAL NUMBER

DATE.....

TESTED BY.....

1(a) DC VOLTS 10V Range Linearity

Range	Input Signal	Reading	
		+ Polarity	- Polarity
10	1mV		
10	10mV		
10	100mV		
10	1V		
10	10V		
10	19V		

1(b) DC VOLTS Full Ranges

Range	Input Signal	Reading	
		+ Polarity	- Polarity
.1	100mV		
1	1V		
10	10V		
100	100V		
1000	100mV		

2(a) AC VOLTS (Option 12) 1V Range Linearity at 200Hz

Range	Input Signal	Reading
1	1mV	
1	1V	
1	1.9V	

2(b) AC VOLTS (Option 12) Full Ranges

Range	Input Signal	Reading		
		200Hz	3kHz	20kHz/30kHz
.1	100mV			(20)
1	1V			(30)
10	10V			(30)
100	100V			(30)
1000	1000V			(20)

3. AC VOLTS (Option 10) Full Ranges

Range	Input Signal	Reading	
		500Hz	40kHz
.1	100mV		
1	1V		
10	10V		
100	100V		
1000	1000V		

4. RESISTANCE Full Ranges

Range	Resistor Value	Reading
10Ω	10Ω	
.1	100Ω	
1	1kΩ	
10	10kΩ	
100	100kΩ	
1000	1MΩ	
10MΩ	10MΩ	

5. DC CURRENT Full Ranges (Option 30, No Option 12)

Range	Input Signal	Reading	
		+ Polarity	- Polarity
.1	100μA		
1	1mA		
10	10mA		
100	100mA		
1000	1A		

6. AC CURRENT Full Ranges (Options 30 & 10)

Range	Input Signal	Reading (500Hz)
.1	100μA	
1	1mA	
10	10mA	
100	100mA	
1000	1A	



Datron Sales and Service Representatives Worldwide

COUNTRY and REPRESENTATIVE	Telephone	Telex	Fax
AUSTRALIA Scientific Devices Pty. Ltd 2 Jacks Road, South Oakleigh, Victoria 3167	3 579 3622	AA32742	3 579 0971
AUSTRIA Walter Reklirsch Elektronisch Geraete GmbH & Co. Obachgasse 28, A-1220 Wien	222 253626	134759	222 2572 75
BELGIUM Air-Parts International B. V. Avenue Huart-Hamoir, 1-Box 19, 1030 Bruxelles	2 241 6460	25146 AP1 B	2 241 8130
BRAZIL Comercial Goncalves Rua Deocleciana, 77, Cep 01106 Ponte Pequena, Sao Paulo SP	11 2294044	22104 34272	----
CHINA Tianjin Zhong Huan Scientific Instruments Corp. No. 59 Zhao Jia Chang Street, Hong Qiao Section, Tianjin	Tianjin 251941	----	----
DENMARK Instrutek A/S, Christiansholmegade 8700 Horsens	5 611100	61656	5 615 658
EASTERN EUROPE Amtest Associates Ltd Amtest House, 75-79 Guildford Street, Chertsey, Surrey KT16 9AS, England	0932 568355	928855	0932 561919
EGYPT & MIDDLE EAST EPIC 20-22 Ashmoun St, PO Box 2682, Horriya, Heliopolis	2 661767 2 669861	23033 CHAKA UN 23315 EPIC UN	2 662839 2 668924
FINLAND Profelec OY PO Box 67, 00421 Helsinki 42	0 566 4477	125225 PROFE SF	0 566 2998

COUNTRY and REPRESENTATIVE	Telephone	Telex	Fax
FRANCE			
M. B. Electronique 606 Rue Fourny, Zi de Buc, 78530 Buc	1 39 568131	695414	1 39 565344
WEST GERMANY			
Wavetek Electronics GmbH Hans-Pinsel Strasse 9-10, 8013 Haar bei München	89 461090	841 5211296 WVTKD	89 463223
GREECE			
American Technical Enterprises SA PO Box 3156, 48 Patission Street, Athens 147	1 8219470	216046 ATE GR	----
HONG KONG			
Eurotherm (Far East) Ltd 21/F Kai Tak Commercial Building 317-321 Des Voeux Road C, Hong Kong	5 411268	72449 EFELD HX	5 8151540
INDIA			
Technical Trade Links 42, Navketan Estate, Mahakali Caves Road, Andheri (East), Post Box No. 9447, Bombay 400 093	22 6322412	11 79261 TTL IN	9122 634 2204
IRELAND			
Euro Instruments & Electronics Euro House, Swords Road, Santry, Dublin 9	0001 425 666	318121	0001 425 497
ISRAEL			
Racom Electronics Co. Ltd 7 Kehilat Saloniki St., P. O. Box 21120, Tel-Aviv 61210	3 491922	33808 RACEL IL	3 491 576
ITALY(1)			
Sistrel SPA Via Pellizza da Volpedo 59 20092 Cinisello Balsamo, Milano	02 618 1893	334643	02 618 2440
ITALY(2)			
Sistrel SPA Viale Erminio Spalla 41 00142 Roma	06 504 0273	625857	06 504 0067
ITALY(3)			
Sistrel SPA Via Cintia Parco S. Paolo 35 80126 Napoli	081 767 9700	----	081 766 1361
JAPAN			
G & G Japan Inc No. 406, 12-14, 4-Chome, Hongoh, Bunkyo-ku, Tokyo	3 8130971	2722884 ICHAIN J	3 8159216
KOREA			
Sama Trading Corporation CPO Box 2447, Seoul	2 733 9336	K26375 SAMATR	2 733 8481

COUNTRY and REPRESENTATIVE	Telephone	Telex	Fax
MALAYSIA			
Mecomb Singapore Ltd Sime Darby Centre, 895 Duncarn Road, 04-2 Singapore 2158	469 8833	RS 23178	467 1905
NETHERLANDS			
Air Parts International BV PO Box 255, 12 Kalkovenweg, 2400 AG Alphen aan den Rijn	1720 43221	39564	1720 20651
NEW ZEALAND			
G. T. S. Engineering Ltd 5 Porters Avenue, Eden Terrace, PO Box 9613 Newmarket AUCKLAND	9 392 464	----	9 392 968
NORWAY			
Morgenstjerne & Co. Konghellegaten 3/5, 0569 Oslo 5	2 356110	71 719 MOROF	2 381457
PORTUGAL			
Decada-Espectral Av. Bombeiros Voluntarios, Lote 102b Miraflores/Algee 1495 Lisboa	1 4103420	15515 ESPEC P	1 4101844
SINGAPORE			
Mecomb Singapore Ltd Sime Darby Centre, 895 Duncarn Road, 04-2 Singapore 2158	469 8833	RS 23178	467 1905
SOUTH AFRICA			
Altech Instruments (Pty) Ltd PO Box 39451, Wynberg 2018	11 887 7455	422033	----
SPAIN			
ESSA (Equipos y Systemas SA) C/Apolonio Morales 13-B, Madrid 16	1 458 0150	831 42856	----
SWEDEN			
Ferner Electronics AB Snormakarvagen 35, Box 125, S-16126 Stockholm-Bromma	8 802540	10312 FERNER S	8 250226
SWITZERLAND			
Kontron Electronic AG Bernerstrasse-Stüd 169, 8048 Zurich	1 435 4111	822196 + KOEL CH	1 432 2464
TAIWAN			
Evergo Corporation Room A, 9th Floor, 305 Section, 3 Nan King East Road, P. O. Box 96-546, Taipei	2 7150283/4/5	27027 EVERGOEC	2 7122466

COUNTRY and REPRESENTATIVE	Telephone	Telex	Fax
UNITED KINGDOM			
Datron Instruments Ltd Hurricane Way, Norwich Airport, Norwich, Norfolk NR6 6JB, England	0603 404824	975173	0603 483670
UNITED STATES of AMERICA			
Datron Instruments Inc c/o Wavetek RF Products Inc. 5808 Churchman Bypass, Indianapolis, Indiana 46203	(317) 787 3915	TWX (810) 341 3226	(317) 788 5999
Wavetek Northeast Area Sales 1 Executive Blvd. Suite 206, Suffern New York 10901	(914) 357 5544	-----	(914) 357 5609
Wavetek Western Area Sales 9045 Balboa Avenue, San Diego, California 92123	(619) 565 9234	TWX (910) 335 2007	(619) 565 9558

For customers in countries not listed please contact DATRON INSTRUMENTS in the United Kingdom:

Datron Instruments Ltd Hurricane Way, Norwich Airport, Norwich, Norfolk NR6 6JB, England	0603 404824	975173	0603 483670
--	-------------	--------	-------------