

# **EFRATOM LPRO-101**

Repair reference guide  
By Fred de Vries, PE1FBO, 2008

Revision 2, August 2008, © PE1FBO

# Contents

Brief specs .....	4
Rubidium lamp.....	4
Temperature controlled assemblies.....	5
17 and 14 Volts section .....	6
5 volts filtering.....	7
VCO and input protection diodes.....	8
VCO section (20MHz).....	8
Lamp exciter diagram .....	9
Rb cell connections (SRD and C-field) .....	10
SRD Bias (Step Recovery Diode).....	10
Rb cell connections (Thermistor and Photocell).....	11
C field adjustments .....	12
Possible faults on the unit.....	13
Note on replacement of the Rb cell heater transistors .....	14
Tantalum caps .....	14
Location of R705 and R731 .....	14
Lamp heater diagram sub 1 .....	15
Lamp heater diagram sub 2.....	16
SMD diode reference.....	17
SMD diode reference by SMD code .....	17
SMD transistor reference by SMD code .....	17
SMD IC reference .....	17
Tuning the unit.....	18
Efratom Rubidium synthesizer schema .....	20
Hyperfine resonance frequencies according to NIST.....	20

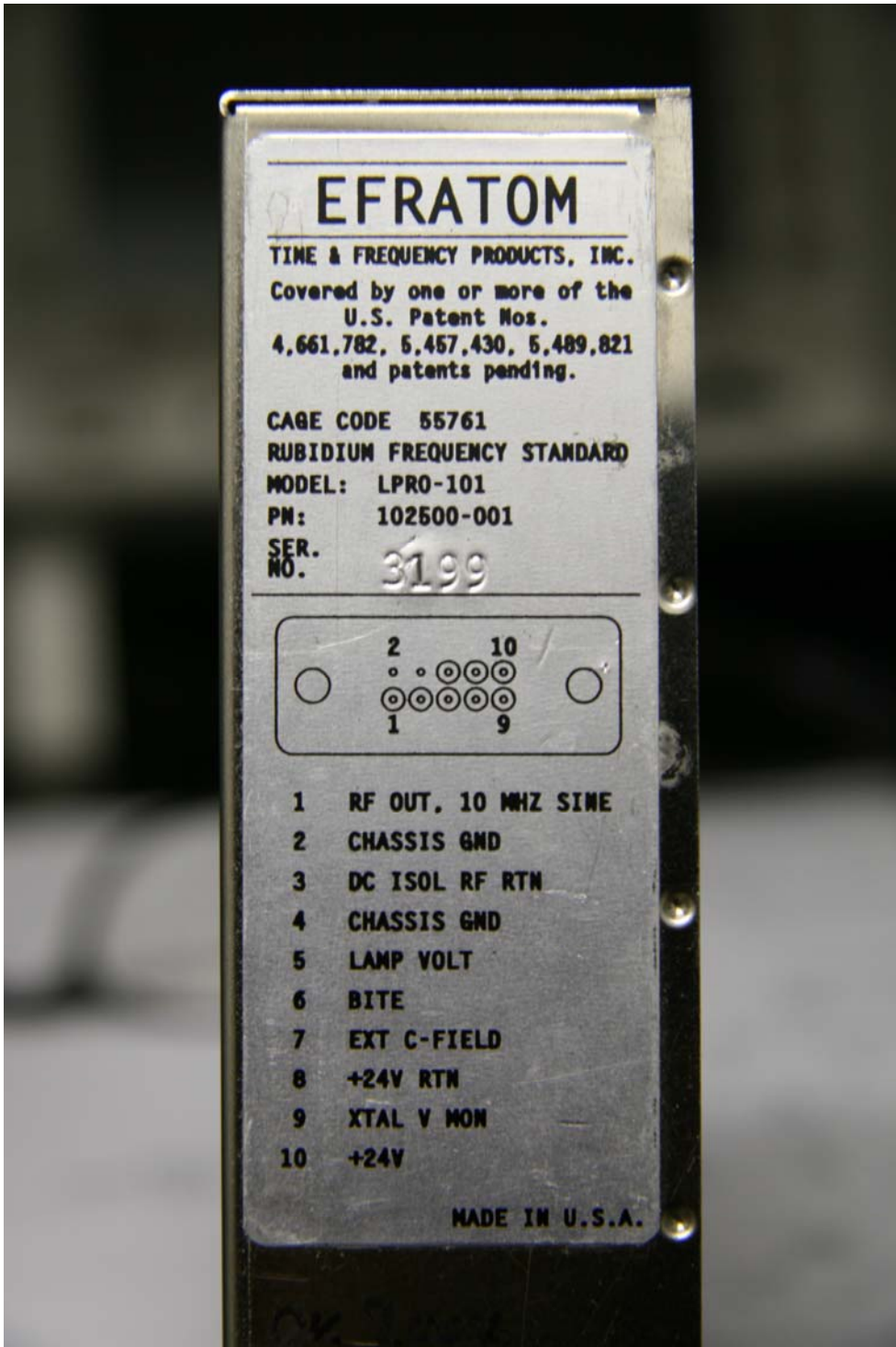

Fig 1, Connections

## Brief specs

Input voltage 24 V DC. (19 .. 32V)

Input current when cold is about 1.25 Amp, when the lamp ignites it becomes 1.19 Amps.

Input current when warm is 0.35 .. 0.45 Amp

Time to lock when cold is 3 to 5 minutes

## Rubidium lamp

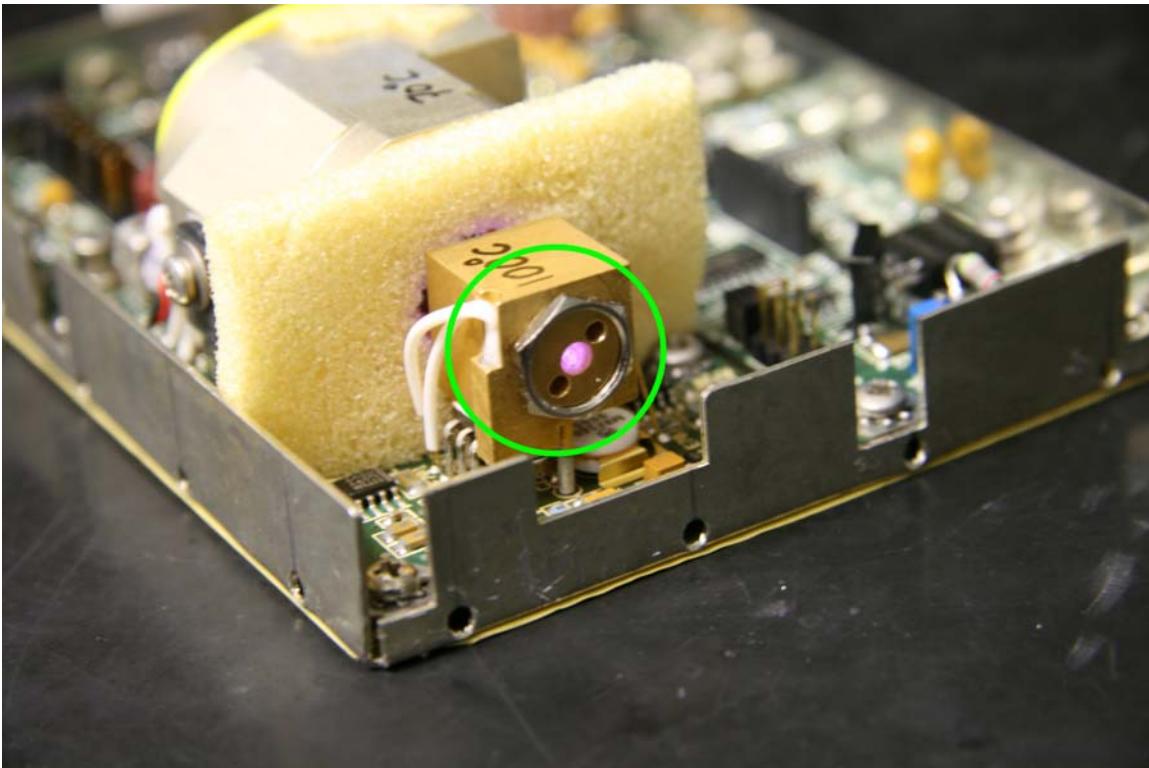

Fig 2, Rubidium lamp

When the rubidium lamp section reaches 40 to 60° Celcius it ignites, you will see the purple light coming from the back of the lamp.

Mind you, that when stray light (50Hz or 60Hz) enters the rubidium cell, the whole unit starts to behave very strange, so be aware of this!

Lamp voltage (pin 5) can be as low as 3 Volts, below 3 volts an atomic lock becomes difficult. Healthy units are ranging from **6 to 9 Volts**.

## Temperature controlled assemblies

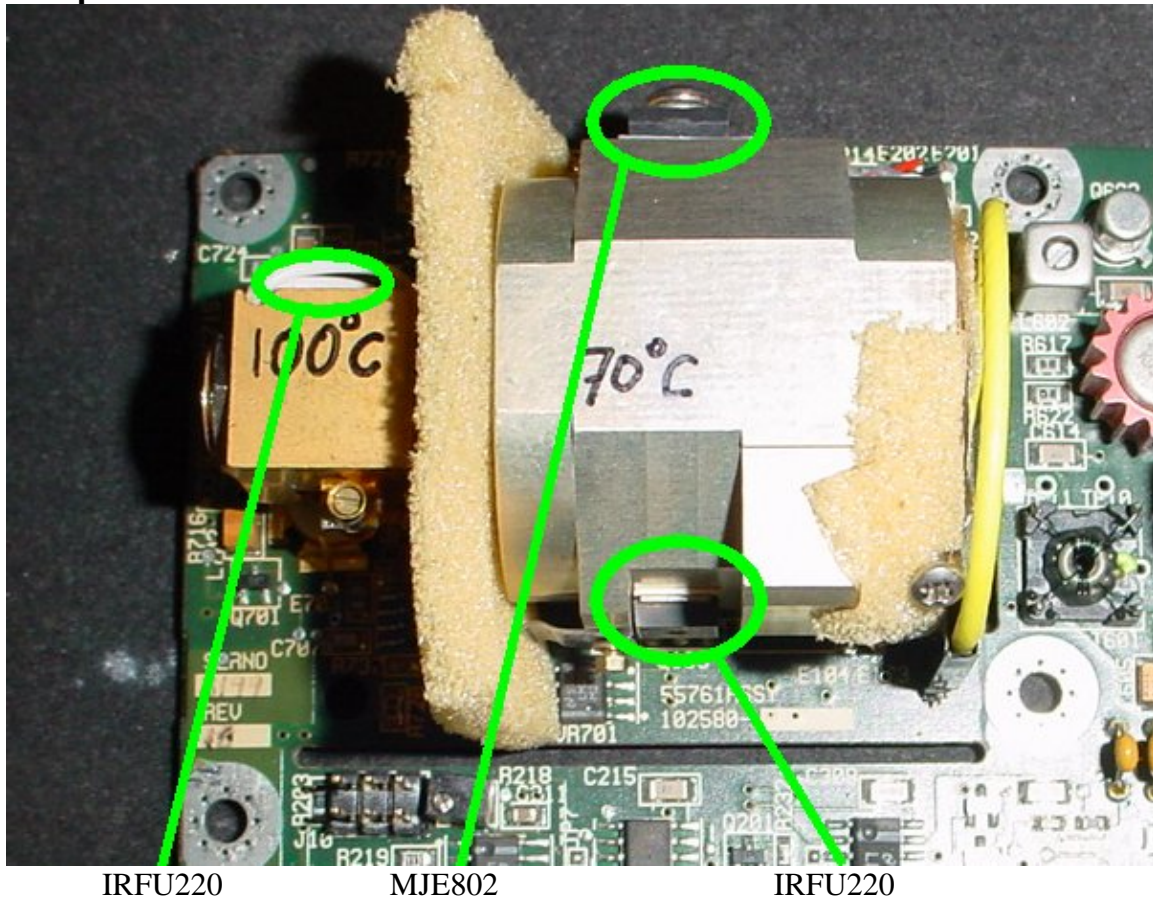

Fig 3, Temperature controlled assembly

The Rubidium lamp housing is about 101° Celcius  
The Rubidium cell is about 71° Celcius

The official temperatures (according to the manual) are 110° C for the lamp, and 79° C for the Rb cell.  
The housing of the heated assemblies measures lower. Both samples had this. It is also depending where you measure the temperature.

**The base plate needs to be mounted on a heat sink to prevent loss of lock and thermal runaway of the internal electronics.**

As a test, you can operate the unit without heat-sink for about half an hour to check if the electronics work reliable at higher ambient temperatures.

The TO202 heater transistor is a MJE802 (NPN darlington, 4A, 40Watt), this can be replaced with an BD679 or BD681.  
The TO251 transistors on the lamp and Rb-cell are IRFU220 MOSFETS, 4.6A/200V, 40 Watt. They can be replaced with an IRFU420 or STD3NB30  
The Rb lamp exciter transistor is an MRF160, it's a MOSFET from Motorola. Ft 500 Mhz, 4W, 28 volts. A possible substitute could be the PD57006 from ST

## 17 and 14 Volts section

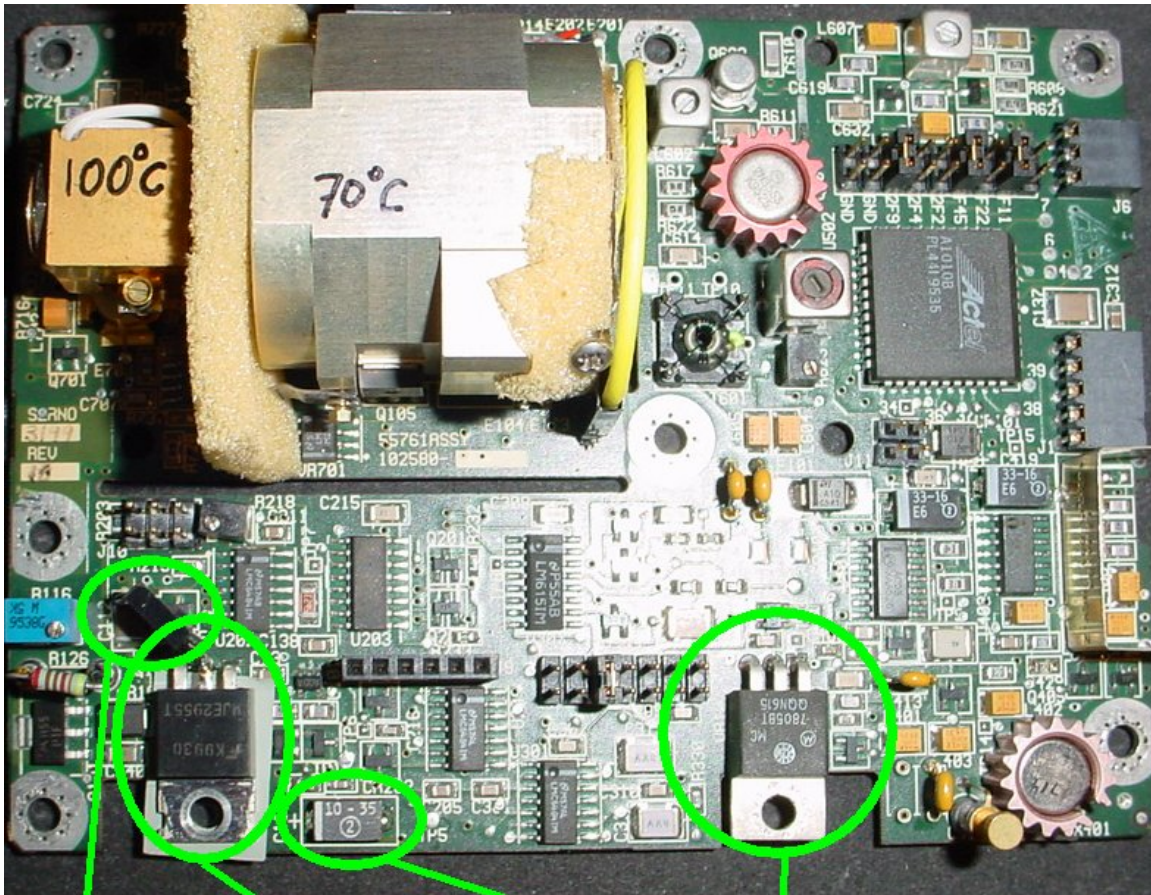

Ceramic C 2N6490 4u7/35V 7805

Fig 4, 17 Volts section and 14 Volts section

Power transistor Q106 is originally a 2N6490, it is a 15Amp, PNP, low hfe type. It can be replaced by an MJE2955T or BD912 if faulty.

**The collector (mounting tab) of Q106 should be at 17.0 Volts (to GND)**  
Q106 is isolated from the chassis.

The additional black capacitor is 1uF/50Volts ceramic. I had to remove the one on the back side, which was suspected to be short at higher temps. There is not enough clearance on the back side of the PCB to have it fitted there.

The capacitor C116 is a tantalum one, 4.7uF/35V

**The positive terminal of this capacitor is about 14.4 Volts (to GND)**

The voltage regulator VR102 is an 7805, it's output is at 5 Volts (to GND)

## 5 volts filtering



Fig 5, 5 Volts filtering

The two SMD tantalum capacitors can be replaced by SMD tantalum ones of a different value.  
The original ones were 68  $\mu$ F/16Volts. The new ones I used are 33 $\mu$ F/16 Volts.

**The positive terminal of C419 is about 4.6 Volts, the other cap's voltage is about 4.4 Volts (to GND)**

Both are used to filter the 5 Volts supply.

## VCO and input protection diodes

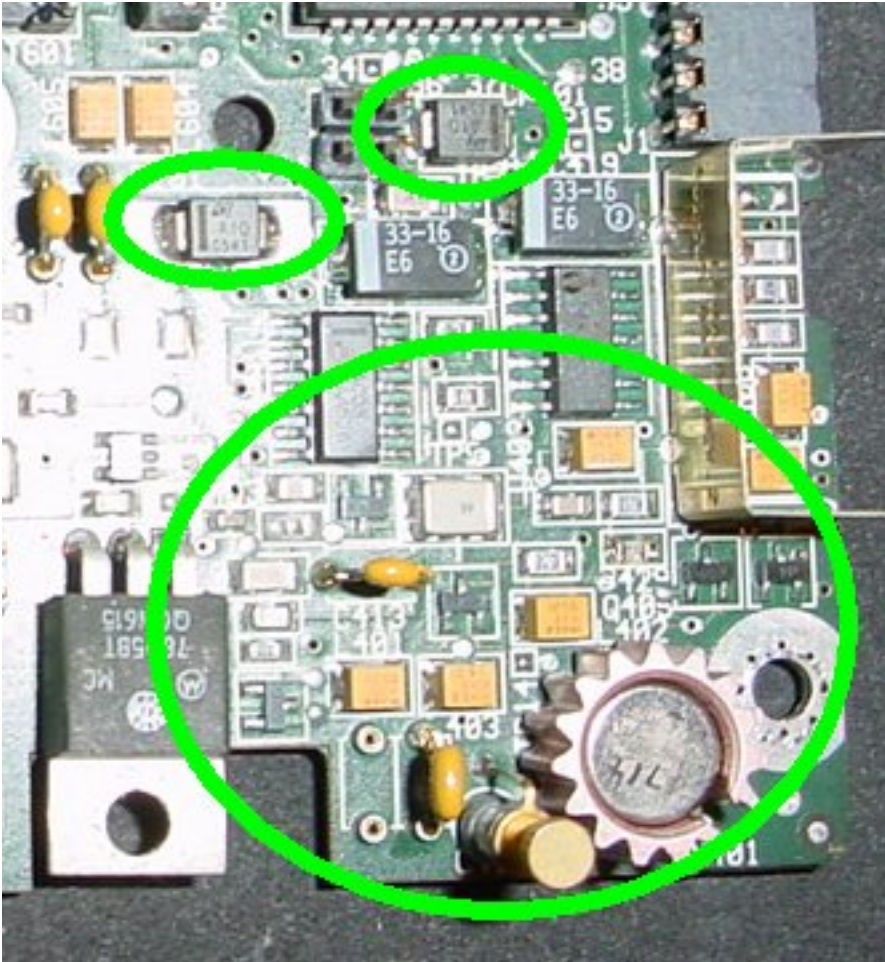

Fig 6, input protection diodes and VCO

Both diodes CR101 and CR 106 (F101) are SMDY02 diodes, with a forward voltage drop of 650 mV.

**Both anodes are connected to the input of 24 Volts, the cathode is 23.35 Volts.**

### VCO section (20MHz)

Oscillator VCO range is rather big +/- 150 Hz for the 10Mhz output.

9.999 850 .. 10.000 180 Hz

Total time for a complete scan takes about 105 seconds. (60s ramp up, 45s ramp down) The internal VCO works on 20MHz.

The 20 MHz crystal is housed in the round package with heat-sink on it.



# Lamp exciter diagram

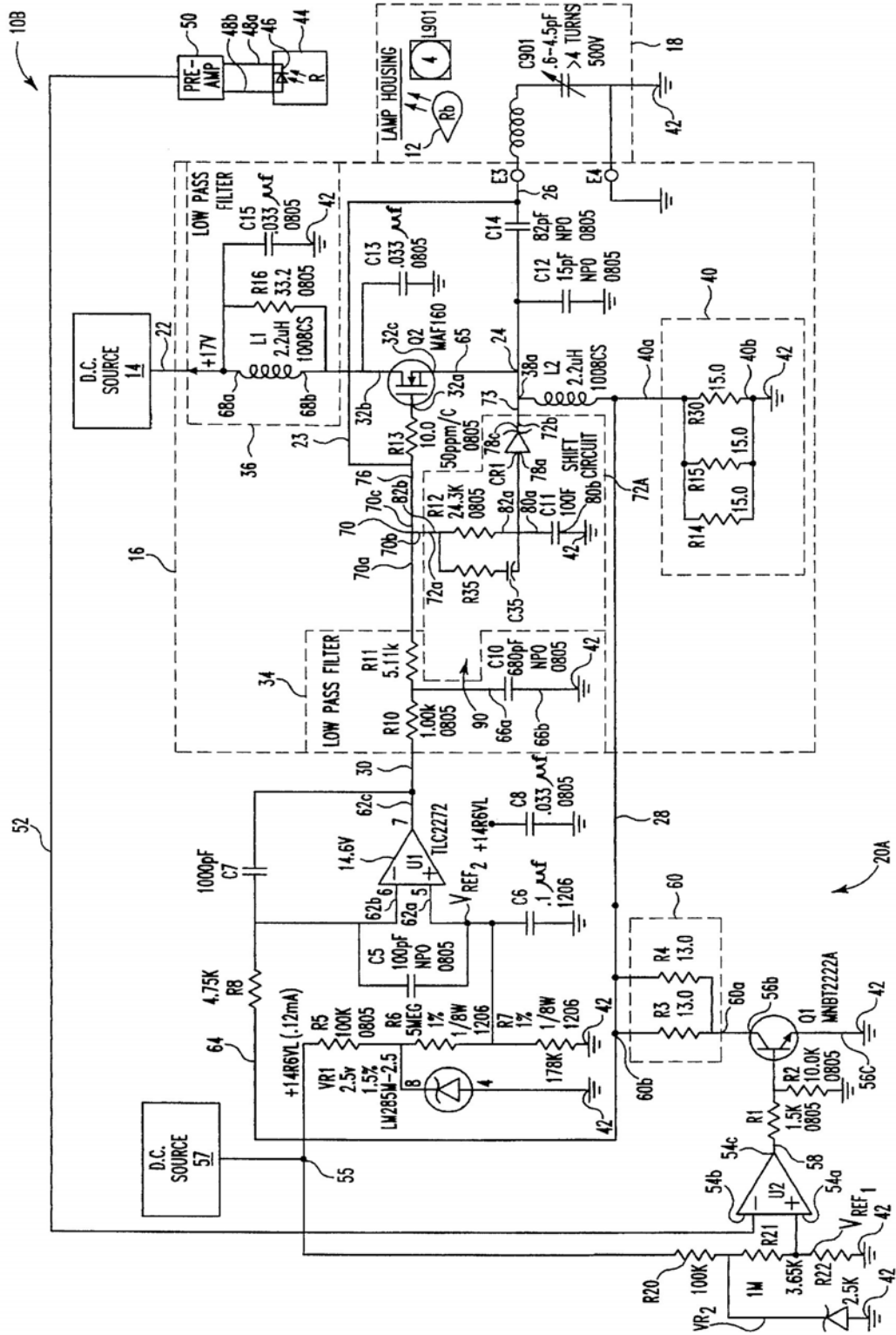
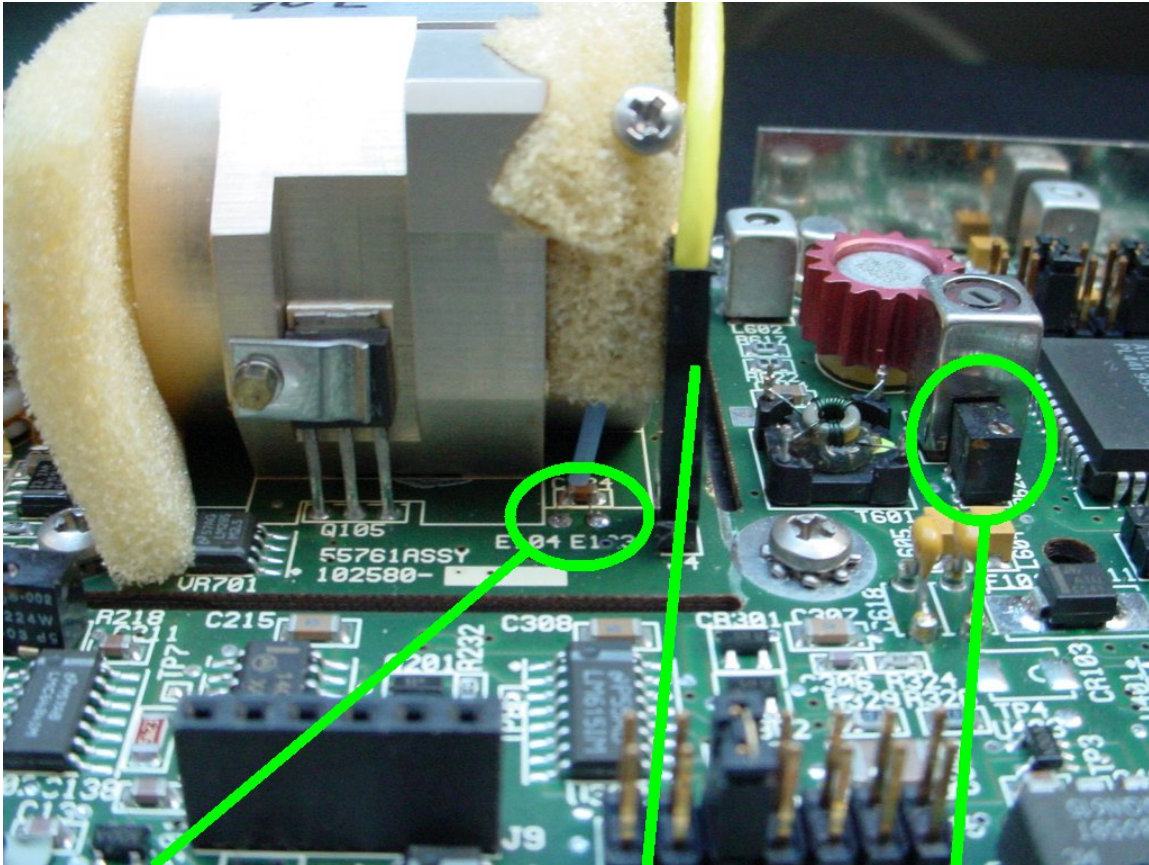

Fig 7, Diagram of Rb lamp exciter

## Rb cell connections (SRD and C-field)



C-field coil connection

RF to cavity

SRD bias pot

**Fig 8, Rb cell connections**

## SRD Bias (Step Recovery Diode)

The SRD bias potentiometer is typical set between 1.5 and 4 kOhms

If you disconnect the yellow coax cable you can measure the SRD forward voltage drop of 0.7 Volts (center to shield).

**Rb cell connections (Thermistor and Photocell)**

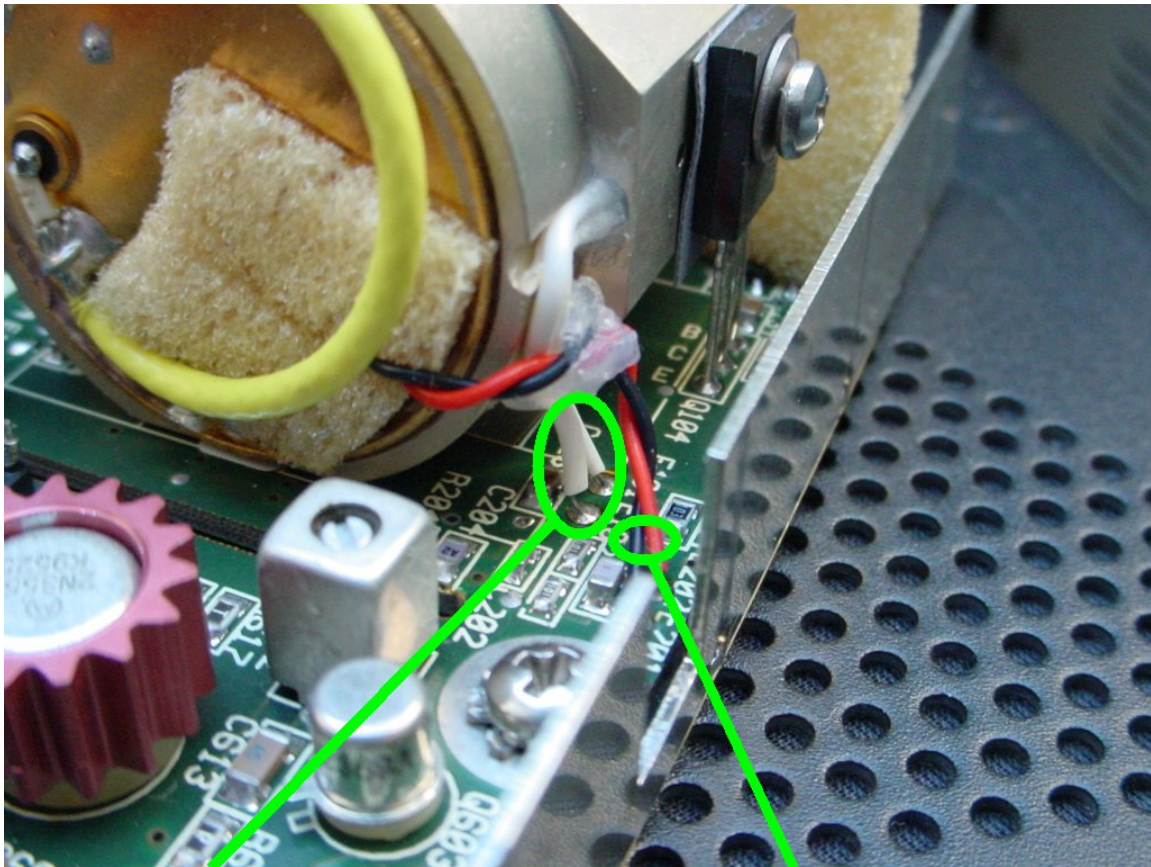

Thermistor connection

Photocell connection

**Fig 9, Rb cell connections**

## C field adjustments

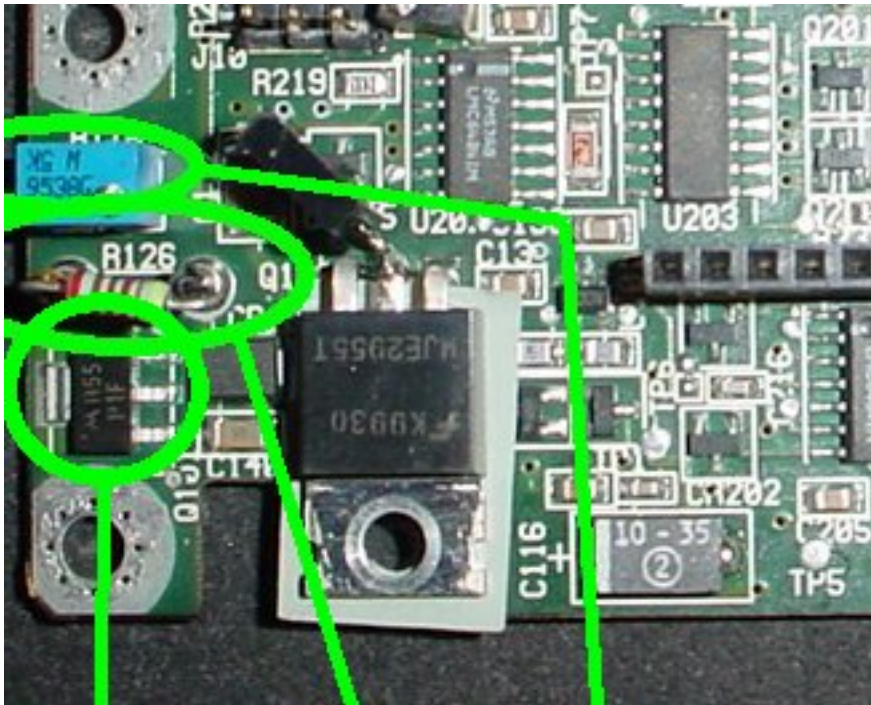

Q10, PZT2222

R126

R116

**Fig 10, C field resistor**

Frequency	Resistor value R126
9.999.999.908	>100k
9.999.999.964	6k2
9.999.999.976	5k2
10.000.000.002	4k2
10.000.000.050	3k2
10.000.000.165	2k2

With increasing current through the C field coil, the frequency increases.

By adapting R126, you can tune the unit with potentiometer R116 to exactly 10 MHz

The C field coil is approx. 18 Ohms

Q10 is a PZT2222A, P1F marking, This is a 2N2222 in SOT223 SMD package.

## **Possible faults on the unit.**

Quote from Antonio, I8IOV

*Before inspecting the lamp, I suggest the following checks:*

- Check that the lamp housing gets VERY hot in about 1 minute (100°C).*
- Check that the physics unit (on the other side of the foam) gets hot too (70°C).*
- Check the presence of the RF field.*

*You could use a counter. Using a link of one turn of wire, check if you can read a frequency of about 70 (or 140, second harmonic) MHz approaching the link to the MRF160 power mosfet (if you read 60 MHz you are picking up the field of the physics unit, not the field for lamp, then orient better the link). If you don't see the signal, check the transistor on board. In one case I've found it shorted. If the transistor seems OK, check resistors in the vicinity, even on the upper side of the board. In one case I've found R705 (bottom, 100K) interrupted. It should read (onboard) about 82K.*

*If the lamp assembly doesn't heat, check R731 (bottom of PCB)*

*In one case I had a faulty lamp. It can be inspected quite easily. Unlock the hexagonal nut and unscrew the lamp, taking note of how much it protruded from the assembly. Don't touch the lamp with fingers. A good lamp has a delicately brownish glass, a lamp which leaked has transparent glass with some small white pigments.*

*If you tried turning the lamp assembly trimmer in order to increase lamp volt, you could have "forced" it causing the rotation of its hot (not ground) lead and possible short on the coil inside the lamp assembly.*

**I would say all 100k resistors of this size on the board are suspect. They are of the 0603 SMD size, and marked with 104 (The smallest parts on the board)**

If there is a problem with the heating of the Rb cell, check if the emitter of the MJE802 is at 12 volts. This is about half the supply voltage, and follows the input voltage. The voltage over the current sense resistors (backside) is about 300mV. This is when the Rb cell is cold. There are 3 1.2Ohm resistors in parallel. Current is 850 mA. Voltage on the gate of the IRFU220 when stabilised is about 4.4 volts, on the source it is 70 mV. Drain voltage is 12 Volts.

If there is a problem with the lamp heater, you could check if the voltage over the 2 Ohms resistor (backside) is about 0.4 Volts, this corresponds to 200mA.

## Note on replacement of the Rb cell heater transistors

Efratom has used a fusing kind of isolation pad to mount both heater transistors. This results in a very low thermal resistance from transistor case to the aluminium base. If you replace the transistors it is important to restore the original low thermal resistance. With an increased thermal resistance, the lock time increases as well and the MTBF of the unit is also negatively affected since the junction temperature of both heater transistors will be higher.

## Tantalum caps

On an old unit, the tantalum caps have possibly a high ESR or are completely open. I would replace them with new ones since the units run at high temperatures and this has an accelerated aging effect on the tantalum caps.

## Location of R705 and R731

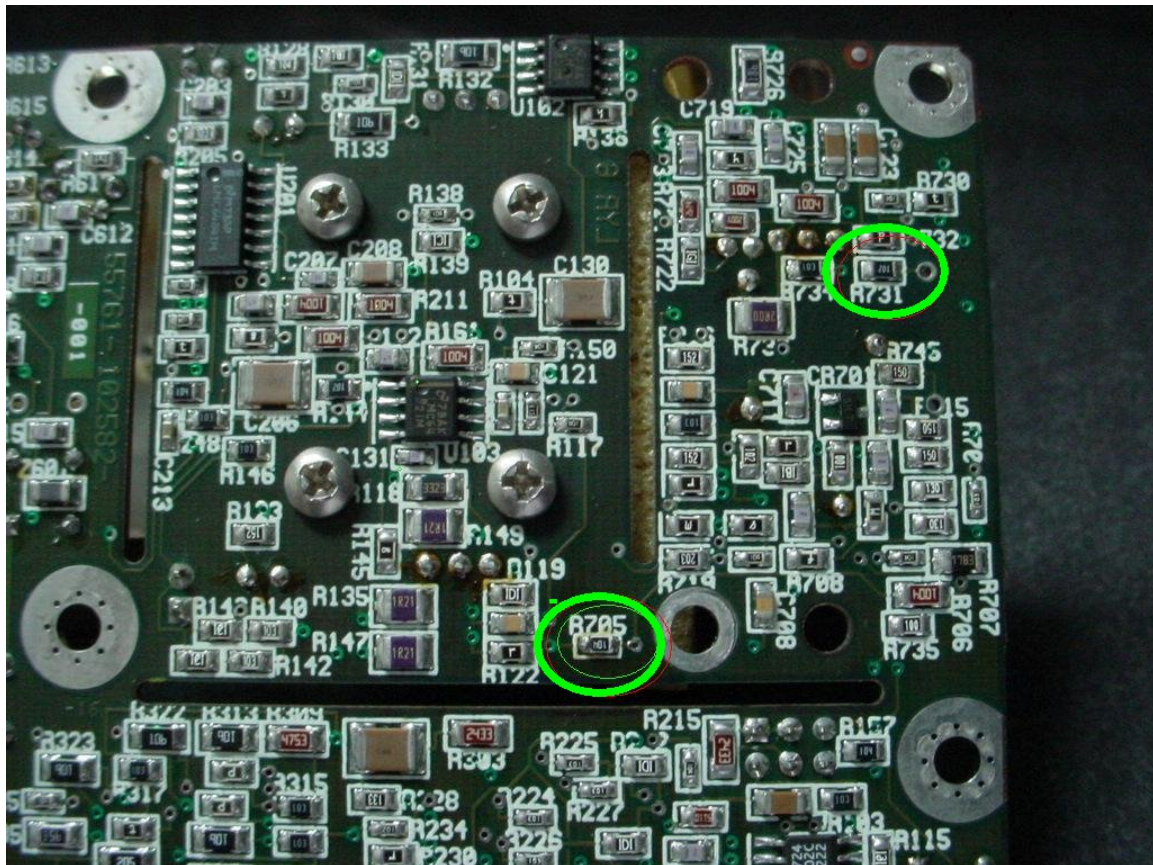

Fig 11, Location of R705, R731

# Lamp heater diagram sub 1

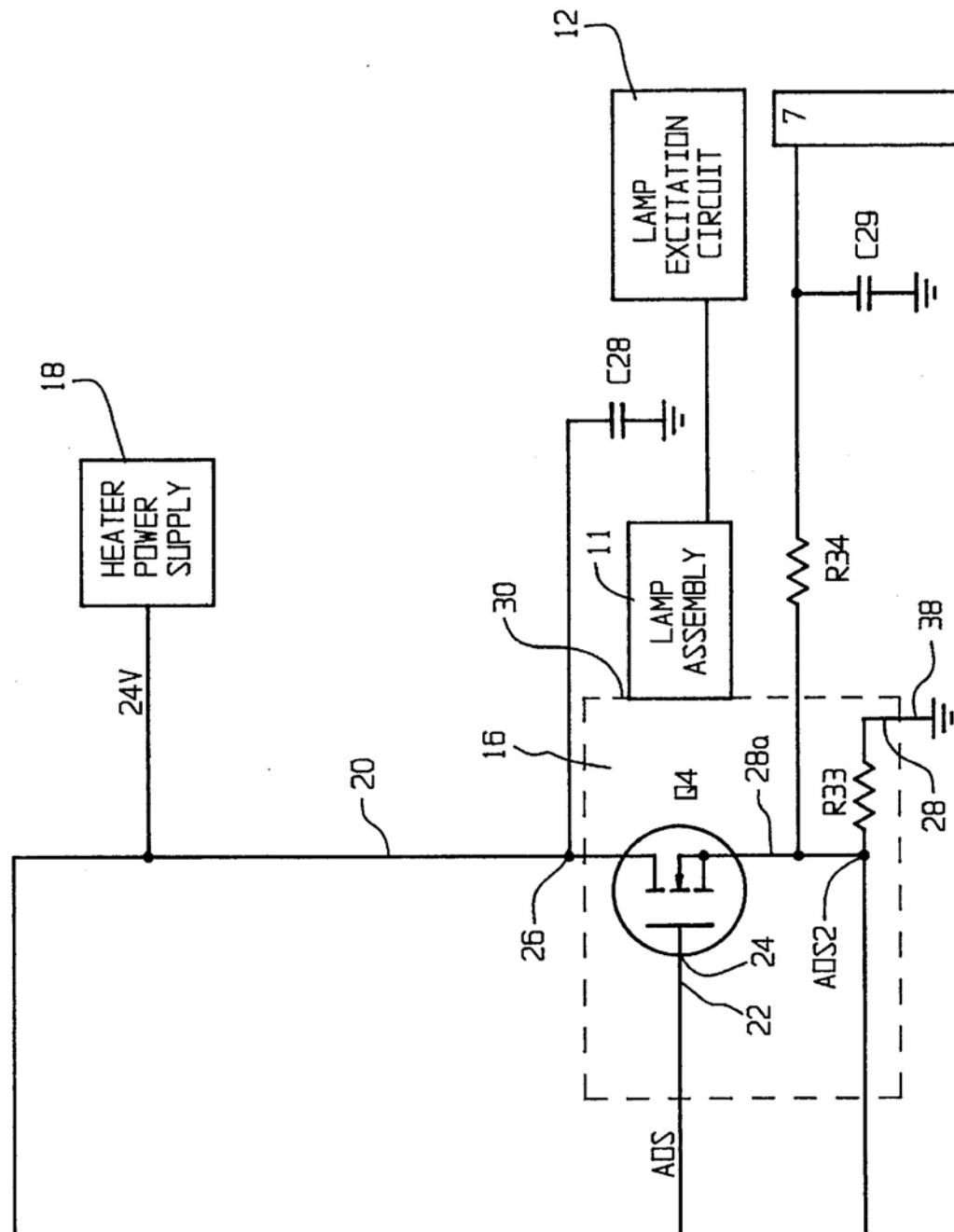

Fig 12, Lamp heater diagram sub 1

# Lamp heater diagram sub 2

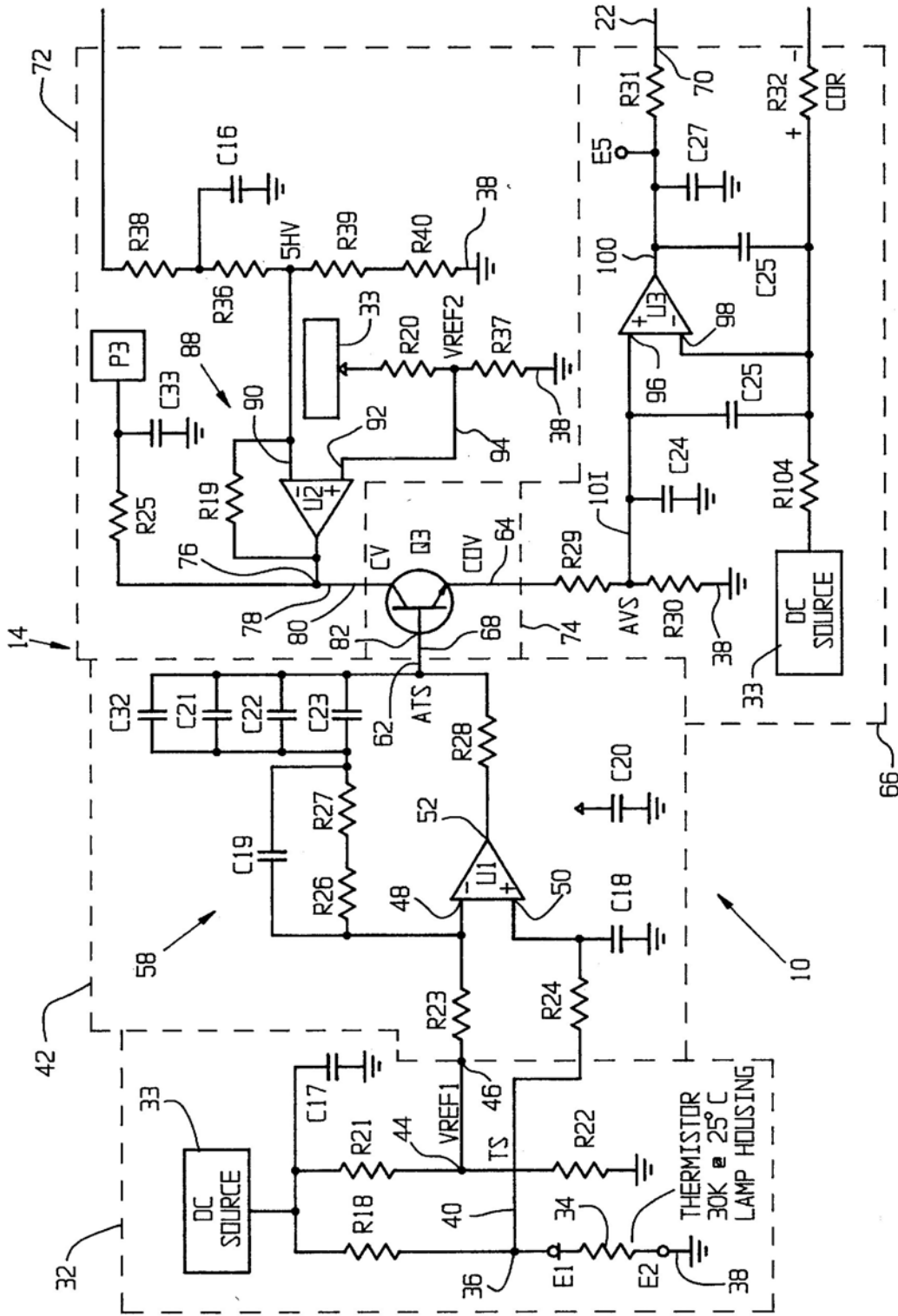

Fig 13, Lamp heater diagram sub 2



### **SMD diode reference**

CR101	SMBYW02-100 (BYW02)
CR106 or F101	SMBYW02-100
CR102	SMD CODE ER10 ??

### **SMD diode reference by SMD code**

5D	MMBD914 (1N914)
----	-----------------

### **SMD transistor reference by SMD code**

1P	MMBT2222 A
P1F	PZT2222 A
1JA	MMBT2369 A

### **SMD IC reference**

U101	LMC7101 AIM5X
U102	LMC6482 IM (TLC272)
U103	LMC6482 IM (TLC272)
U201	LMC6484 IM (TLC274)
U202	LMC6484 IM (TLC274)
U203	MC14053 B
U204	LMC6484 IM (TLC274)
U301	LMC6484 IM (TLC274)
U302	LM615 IM
U401	74AC08
U402	74AC74
U403	LMC7101 AIM5X
U501	MAX709 M
U701	TLC2272
U702	TLC2272
VR101	LP2951 CM
VR103	REF02 C
VR701	LM285

## Tuning the unit

Once you have a locked unit you can tune the SRD bias and the 6.8 GHz cavity. Allow the unit to warm-up for 10 minutes. You can only do this after a lock has been established. If you don't have a lock, you probably make things worse by adjusting the settings on the unit.

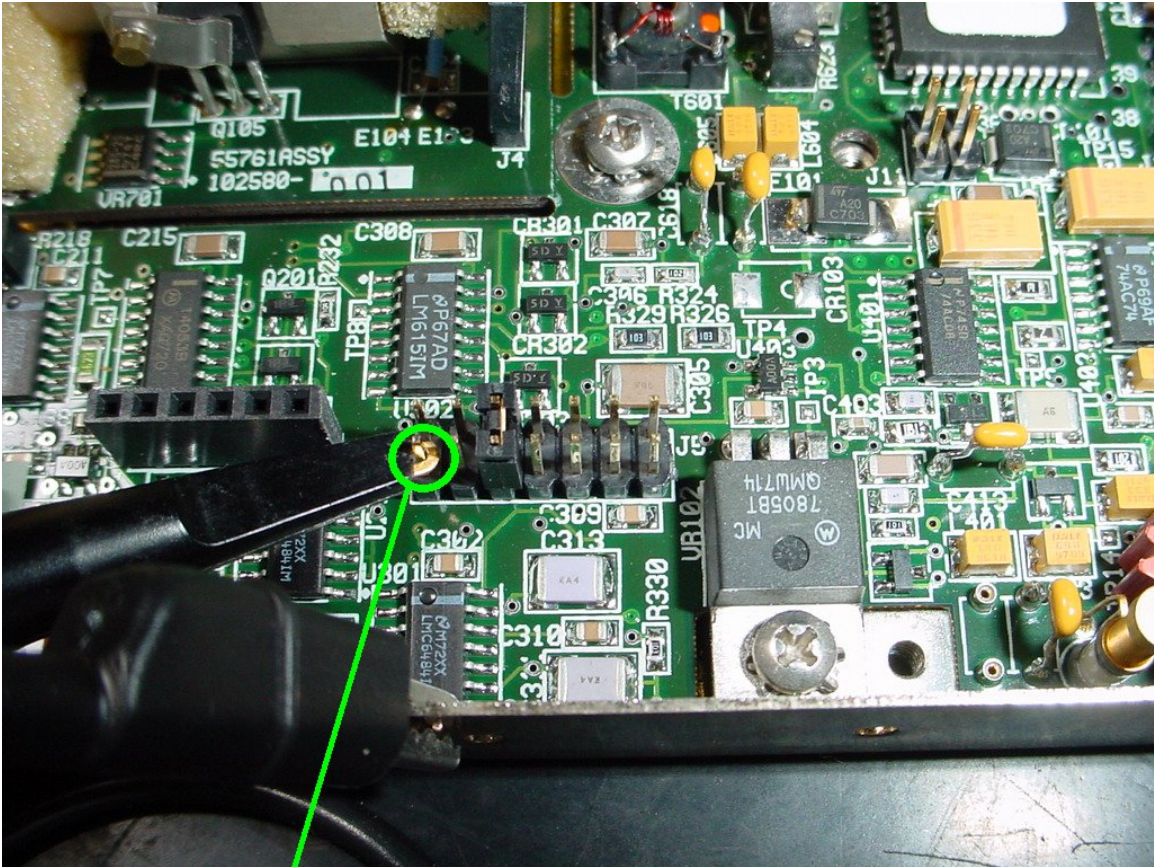

Fig 14, Test point J5, corner pin

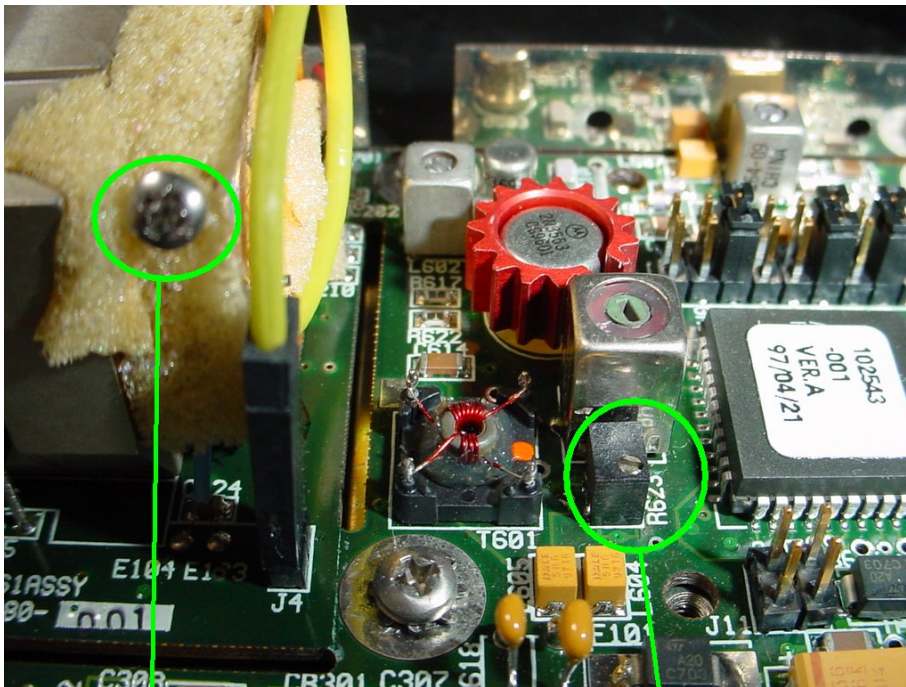

Fig 15, Cavity tuning 6.8 GHz

SRD bias pot

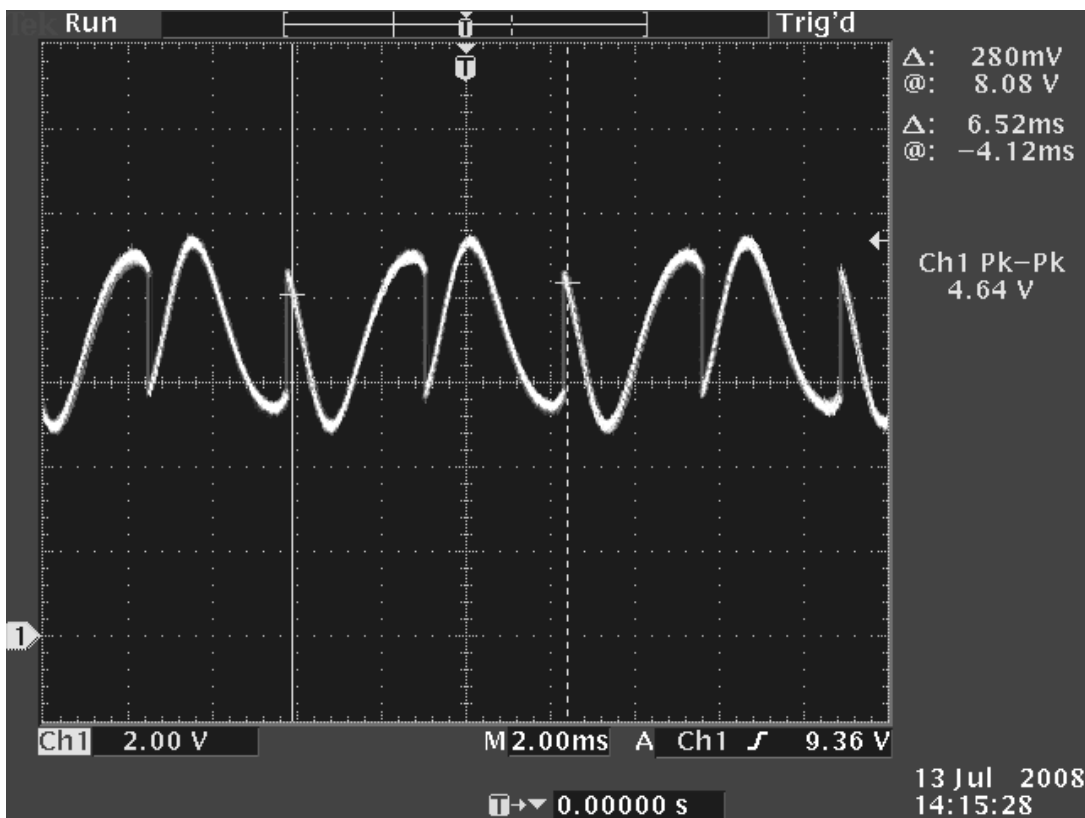

Fig 16, Wave form on J5

Tune both adjustments for maximum Vpp

## Efratom Rubidium synthesizer schema

A part)

$$10 \text{ MHz} * 6 = 60 \text{ MHz}$$

$$114 * 60 \text{ MHz} = 6.840 \text{ GHz}$$

B part)

$$10 \text{ MHz} / 2 = 5 \text{ MHz}$$

$$5 \text{ MHz} / 16 = 0.3125 \text{ MHz}$$

$$5 \text{ MHz XOR } 0.3125 \text{ MHz} = 5.3125 \text{ MHz}$$

A and B are mixed, one of the components is

$$6.840 - 0.0053125 = 6.834 \text{ 687 500 GHz}$$

## Hyperfine resonance frequencies according to NIST

Rubidium = 6.834 682 608 GHz

Hydrogen = 1.420 405 752 GHz

Caesium = 9.192 631 770 GHz

Difference of frequency (NIST measure and Efratom synth.) is due to buffer gas in the Rb cell, that has a positive offset on the resonance frequency