

MODEL 113
LOW NOISE PREAMPLIFIER
INSTRUCTION MANUAL

215291-A-MNL-C

Copyright (C) 1986 - 1990 EG&G INSTRUMENTS CORPORATION

TABLE OF CONTENTS

Section	Page
I CHARACTERISTICS	I-1
1.1 Introduction	I-1
1.2 Specifications	I-1
II INITIAL CHECKS	II-1
2.1 Introduction	II-1
2.2 Equipment Needed	II-1
2.3 Procedure	II-1
III OPERATING INSTRUCTIONS	III-1
3.1 Introduction	III-1
3.2 Noise and Source Resistance	III-1
3.3 Grounding	III-2
3.4 Signal Voltage and Gain	III-2
3.5 Dc Zero Adjustment	III-3
3.6 Overload Fast Recovery	III-3
3.7 Low-Pass/High-Pass Filters	III-3
3.8 Single-Ended/Differential Operation	III-4
3.9 Common-Mode Rejection and Dc Zero Adjustments	III-4
3.10 Maximum Input Signal Consistent with Linear Operation	III-4
3.11 Battery Operation, Test, and Charging	III-5
3.12 Rack Mounting	III-5
3.13 Using a Signal Input Transformer	III-6
3.14 Use of the Model 113 in Bio-Medical Applications	III-12
IV CIRCUIT DESCRIPTION	IV-1
4.1 Block Diagram Discussion	IV-1
4.1A Input Coupling Circuit	IV-1
4.1B Ground-Loop Suppression	IV-1
4.1C Gain Determination	IV-1
4.1D Rolloff Filter Circuit	IV-1
4.1E Overload Fast-Recovery Circuit	IV-2
4.1F Power Supply	IV-2
4.2 Circuit Descriptions	IV-2
4.2A Differential Preamplifier (A1)	IV-2
4.2B Output Amplifier (A2)	IV-3
4.2C Power Supply Circuit	IV-3
4.2D Battery Test Circuit	IV-3
V ALIGNMENT PROCEDURE	V-1
5.1 Introduction	V-1
5.2 Preliminary	V-1
5.3 Equipment Needed	V-1
5.4 A2 FET Gate Source Zero Adj.	V-1
5.5 Common-Mode Rejection Adj.	V-1
5.6 Gain Calibration	V-1
5.7 Low Frequency Rolloff Compensation	V-2
5.8 High Frequency Rolloff Compensation	V-2
5.9 Battery Test Calibrate	V-2
VI TROUBLESHOOTING	VI-1
6.1 Introduction	VI-1
6.2 Procedure	VI-1
6.3 Printed Circuit Soldering	VI-1
VII SCHEMATICS	VII-1

FIGURES

Number	Description	Page
III-1	Typical Noise Figure Contours for the Model 113	III-1
III-2	Typical Recovery Time vs Low Frequency Rolloff	III-3
III-3	LP Filter Normalized Amplitude Transfer Curve	III-4
III-4	HP Filter Normalized Amplitude Transfer Curve	III-4
III-5	LP/HP Filter Normalized Phase Transfer Curve	III-4
III-6	Typical Common Mode Rejection Characteristics	III-4
III-7	Maximum Differential Input to Model 113	III-5
III-8	Modifying the AM-1 Transformer for Use with the Model 113 Preamplifier	III-6
III-9A	Frequency Response of Typical Model AM-1 Transformer	III-6
III-9B	Noise Figure Contours for Typical Model AM-1 Transformer	III-6
III-10	Schematic of Model AM-1 Transformer (Unmodified)	III-7
III-11	Photographs of Model AM-1 Transformer	III-7
III-12A	Frequency Response of Typical Model AM-2 Transformer	III-8
III-12B	Noise Figure Contours for Typical Model AM-2 Transformer	III-8
III-13	Model AM-2 Schematic, Turns Ratio 1:100	III-8
III-14	Photo of Model AM-2	III-9
III-15	Frequency Response of Typical Model 190 Transformer	III-9
III-16	Noise Figure Contours for Typical Model 190-113 System	III-9
III-17	Model 190 Schematic	III-10
III-18	Photograph of Model 190 Transformer	III-10
III-19	B-H Curve & Waveform	III-10
III-20	Degaussing Waveforms	III-11
IV-1	Ground-Loop Current Path	IV-1
VI-1	Solder Removal by Wicking	VI-1

SAFETY NOTICE

(Read Before Operating Instrument)

A. INTRODUCTION

The Model 113 to which this instruction manual applies has been supplied in a safe condition. This manual contains some information and warnings that have to be followed by the user to ensure safe operation and to retain the instrument in a safe condition.

The described apparatus has been designed for indoor use.

B. INSPECTION

Newly received apparatus should be inspected for shipping damage. If any is noted, notify EG&G PARC and file a claim with the carrier. Be sure to save the shipping container for inspection by the carrier.

WARNING!

THE PROTECTIVE GROUNDING COULD BE RENDERED INEFFECTIVE IN DAMAGED APPARATUS. DAMAGED APPARATUS SHOULD NOT BE OPERATED UNTIL ITS SAFETY HAS BEEN VERIFIED BY QUALIFIED SERVICE PERSONNEL. DAMAGED APPARATUS WAITING FOR SAFETY VERIFICATION SHOULD BE TAGGED TO INDICATE TO A POTENTIAL USER THAT IT MAY BE UNSAFE AND THAT IT SHOULD NOT BE OPERATED.

C. SAFETY MECHANISM

As defined in IEC Publication 348 (*Safety Requirements for Electronic Measuring Apparatus*), the Model 113, when operated from the ac line, is Class I apparatus, that is, apparatus that depends on connection to a protective conductor to earth ground for equipment and operator safety. Before any other connection is made to the apparatus, the protective connection is made via the earth ground prong of the power cord plug. The power cord plug shall only be inserted in a socket outlet provided with the required earth ground contact. The protective action must not be negated by the use of an extension cord without a protective conductor, by use of an "adapter" that doesn't maintain earth ground continuity, or by any other means.

WARNING!

ANY INTERRUPTION OF THE PROTECTIVE CONDUCTOR INSIDE OR OUTSIDE THE APPRATUS OR DISCONNECTION OF THE PROTECTIVE EARTH TERMINAL MAY MAKE THE APPARATUS DANGEROUS. INTENTIONAL INTERRUPTION IS PROHIBITED.

The power cord plug provided is of the type illustrated in Figure 1. If the provided plug is not compatible with the available power sockets, the plug or power cord should be replaced with an approved type of compatible design.

WARNING!

IF IT IS NECESSARY TO REPLACE THE POWER CORD OR THE POWER CORD PLUG, THE REPLACEMENT CORD OR PLUG MUST HAVE THE SAME POLARITY AS THE ORIGINAL. OTHERWISE A SAFETY HAZARD FROM ELECTRICAL SHOCK, WHICH COULD RESULT IN INJURY OR DEATH, MIGHT RESULT.

When operated from its internal battery with the line cord disconnected, the Model 113 could be considered Class III apparatus, that is, apparatus in which protection against electric shock relies on supply at safety extra-low voltage (SELV) and in which voltages higher than those of SELV are not generated. When operated battery powered and with the line cord disconnected, the voltage levels inside the Model 113 will not exceed ± 12 V. This does not take into account the possibility of higher voltages being applied via the signal input or output cables.

D. POWER VOLTAGE SELECTION

Before plugging in the power cord, make sure that the instrument is set for operation from the voltage of the ac power supply.

CAUTION!

THE APPRATUS DESCRIBED IN THIS MANUAL MAY BE DAMAGED IF IT IS SET FOR OPERATION FROM 110 V AC AND TURNED ON WITH 220 V AC APPLIED TO THE POWER INPUT CONNECTOR.

The line voltage is selected by means of a rear-panel switch. FOR SAFETY, UNPLUG THE

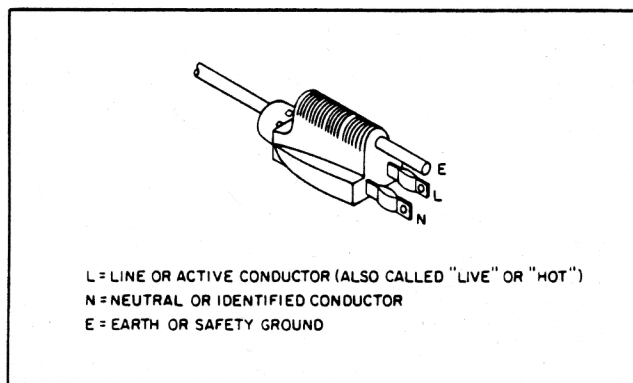

Figure 1. POWER CORD PLUG WITH POLARITY INDICATIONS

POWER CORD WHEN CHANGING THE LINE VOLTAGE SETTING. Depending on the switch position, either "115" or "230" (both are printed on the switch) will be visible to the operator. For operation from a line voltage of nominally 115 V ac, the switch should be set so that "115" shows. For operation from a line voltage of nominally 230 V ac, "230" should show.

E. LINE FUSE

The Model 113 line fuse is located inside the instrument. To check or replace the fuse, it is first necessary to remove the top cover and also the shield mounted on the inside of the rear panel. The fuse should be a slow-blow type rated at either 1/16 A (115 V operation) or 1/32 A (230 V operation). The voltage rating should be 125 V or higher in the case of 115 V operation and 250 V or higher in the case of 230 V operation. Only a BUSS MDL or equivalent fuse should be used.

WARNING!

TO AVOID THE POSSIBILITY OF A SAFETY HAZARD FROM ELECTRICAL SHOCK WHICH COULD RESULT IN INJURY OR DEATH, DISCONNECT THE POWER CORD BEFORE REMOVING OR INSTALLING A FUSE. BECAUSE OF THE POTENTIAL HAZARD, THE FUSE SHOULD BE CHECKED AND/OR CHANGED BY A QUALIFIED SERVICE TECHNICIAN ONLY.

A procedure for gaining access to the fuse follows.

- (1) Remove the top cover. It is secured by a single screw on the bottom surface of the top-cover "lip" at the rear of the instrument. With the screw removed, the cover simply slides back to where it can be freed from the instrument.
- (2) Remove the shield attached to the inside of the rear panel. This shield is secured by a single screw at its center. With the shield removed, the fuse holder, located directly above the Line Voltage Selector switch, becomes accessible.
- (3) After checking and, if appropriate, changing the fuse, remount the shield and top cover before plugging in the line cord and operating the instrument.

F. USE OF THE MODEL 113 IN BIO-MEDICAL APPLICATIONS

In the past few years, safety in bio-medical applications has been a matter of growing concern to both the users and suppliers of electronics equipment. It has long been known that electrical currents passing through the heart can interfere

with normal heart functioning. However, recent research has shown that danger exists at far lower current levels than was previously suspected. As a consequence of this increased awareness, and after a careful analysis of the Model 113 design, EG&G Princeton Applied Research Corporation feels that it *cannot* recommend the Model 113 for use in applications involving human subjects or patients. In certain situations involving specific conditions of grounding, internal component failure, or excessive common-mode input, the high input impedance of the Model 113 could fail and potentially dangerous currents could flow through the subject.

However, the reader should not get the impression that the Model 113 is in any way a dangerous instrument to use in ordinary applications. Those characteristics that necessitate the advisory against the instrument's use in bio-medical applications with humans are common to most other preamplifiers as well. In fact, with its low internal supply voltages, capability for internal battery power with complete independence of the ac line, and extremely high input impedance under normal operating conditions, the Model 113 is probably one of the safest preamplifiers available for general use. For all practical purposes, it can be considered to be completely harmless. The maximum internal supply voltages applied to the amplifiers are only ± 12 V. Even these low voltages can only appear at the input under very specific operating conditions, and then generally for only a few milliseconds. A person inadvertently touching the input under these conditions would, in general, not even be aware that there was any voltage there at all and by no stretch of the imagination could the operator of the instrument be regarded as being in any danger.

The preamplifier can be used in biological applications involving animal subjects. However, if the application is one in which skin resistance is greatly reduced or bypassed, the operator is advised to observe the following recommendations if unnecessary risk to the experimental animal is to be avoided.

- (1) Turn the amplifier power on BEFORE making any connections to the experimental animal.
- (2) Set the Input Coupling switches of the Model 113 to GND before making any connections to the experimental animal. Do not transfer from the GND settings until after the connections are completed.
- (3) Do not turn the power switch on or off while the instrument is connected to the experimental animal.

It may prove helpful to consider the reason for these precautions. By understanding them, the

operator may be better able to safely carry out electrical monitoring of experimental animals, not only where the input amplifier is the Model 113, but where other preamplifiers are used as well.

(1) Turn-On Transients

When the amplifier is first turned on, all circuits do not instantly assume their quiescent operating state. Instead, a finite time is required for the common-mode loop amplifier to set the input stages to their proper operating point. During this interval (which varies from a few milliseconds to a second or more depending on the source impedance), the source-gate junction of one input transistor or the other is forward-biased. In this state, the transistor does not exhibit a high impedance, but instead appears as a low impedance from the input of the instrument to the output of the common-mode amplifier.

(2) Power Transformer

The power transformer in the Model 113 is of very high quality and is unlikely to fail during the life of the instrument. Nevertheless, the possibility of such a failure, however remote, must be considered. Should a short develop, and if the instrument were being used with incomplete or improper ground returns (common in many buildings and installations), a dangerous situation would exist.

(3) Internal Component Failure

The input transistors of the Model 113 are junction-type field-effect transistors. Although they exhibit an extremely high input resistance when properly biased, their resistance can drop to a few ohms if their operating current or bias is out of the normal operating range sufficiently to give a simple forward biased diode junction from the gate to either the source or the drain. There are several possible internal component failures which, though unlikely, could bring about this condition. Should it occur, the input of the amplifier would be connected through a low impedance directly to the instrument's power supply.

(4) Excessive Common-Mode Input

As stated in the specifications, the common-mode input limit of the Model 113 is 1 V rms. Higher levels "turn on" low conduction paths at the input of the preamplifier to protect the input circuits, and thereby lower the input impedance.

Again, it should be emphasized that, even though EG&G Princeton Applied Research Corporation does *not* recommend the Model 113 for use with human subjects, its use in all other applications is recommended without reservation.

G. VENTILATION

With a power consumption of only 5 watts when operated from the ac line, and even less when battery operated, the Model 113 does not have any special ventilation requirements. It can be operated on a bench or in a rack (rack mounting kits can be purchased from the factory), the only constraint being that the ambient temperature be in the range of 15°C to 45°C.

H. DEFECTS AND ABNORMAL STRESSES

Whenever it is likely that the protection provided by the connection to earth ground has been impaired, the apparatus shall be made inoperative and secured against any unintended operation. The protection is likely to be impaired if, for example, the apparatus:

- (1) Shows visible damage,
- (2) Fails to perform the intended measurements,
- (3) Has been subjected to prolonged storage under unfavorable conditions,
- (4) Has been subjected to severe transport stresses.

Such apparatus should not be used until its safety has been verified by qualified service personnel.

SECTION I CHARACTERISTICS

1.1 INTRODUCTION

The Model 113 Low-Noise Preamplifier provides high gain, low noise amplification of wideband signals from dc to 300 kHz. Adjustable high and low frequency rolloffs allow the bandwidth to be reduced. Two inputs, with individual coupling switches, allow either differential or single-ended operation. Calibrated gain is switch selectable from $\times 10$ to $\times 10^4$ in a 1-2-5 sequence, and an uncalibrated gain vernier provides $\times 1$ to $\times 2.5$ range expansion.

The unit may be powered either from the ac line or from its own batteries. The nickel-cadmium batteries recharge automatically during line operation.

Other features include an overload fast-recovery switch, special circuitry that reduces the effects of ground-loop currents, front-panel dc zeroing and common mode rejection screwdriver controls, and battery test provisions.

The Model 113 is well suited for use as a preamplifier for other Princeton Applied Research signal processing instruments.

1.2 SPECIFICATIONS

(1) INPUTS

Two channels, each with a three position switch to provide for ac or dc coupled, single-ended or differential operation. Input connectors are BNC type.

(2) INPUT IMPEDANCE

- (a) Ac coupled: through $0.1 \mu\text{F}$, shunted to ground with 100 megohms and 15 pF in parallel.
- (b) Dc coupled: 1 gigohm, shunted by 15 pF.

(3) MAXIMUM INPUT WITHOUT DAMAGE

- (a) Dc coupled: Common-Mode, $\pm 10 \text{ V}$; Differential, $\pm 7.5 \text{ V}$.
- (b) Ac coupled: coupling capacitors can withstand 200 V. Transients which pass through coupling capacitors cannot exceed dc coupled operation limits.

(4) MAXIMUM INPUT SIGNAL CONSISTENT WITH LINEAR OPERATION (see Subsection 3.10)

- (a) Common mode: 1 V rms.
- (b) Differential mode (gains of 10 to 100): $\pm 500 \text{ mV}$.
- (c) Differential mode (gains of 200 through 10 k): $\pm 50 \text{ mV}$.

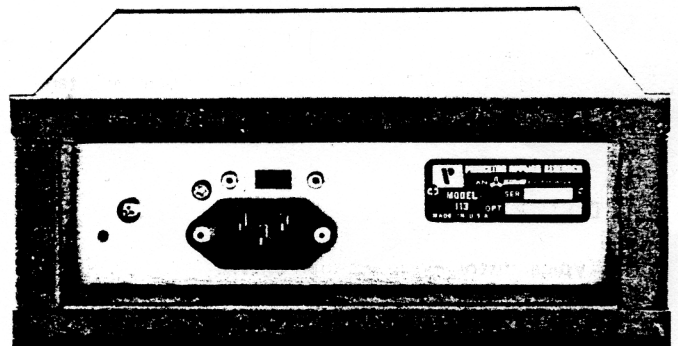
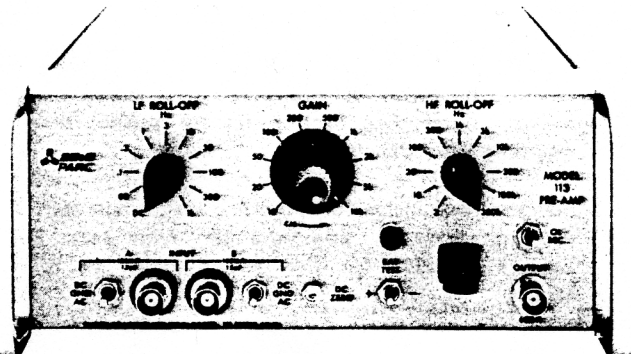

(5) COMMON MODE REJECTION

FREQUENCY	FOR GAIN > 200	FOR GAIN < 200
dc to 100 Hz	120 dB (min)	100 dB (min)
1 kHz	100 dB	80 dB
10 kHz	80 dB	60 dB
100 kHz	60 dB	40 dB

(6) GAIN

x10 to x10⁴ calibrated gain settings. Accuracy of calibrated gains is ±2% when gain vernier is in the calibrate position. Gain vernier provides uncalibrated gain range expansion of up to x2.5 (minimum).

(7) FREQUENCY RESPONSE

Rolloff frequencies are switch selectable. Front panel switch markings indicate 3 dB point of 6 dB/octave rolloff curve. Rolloffs are selectable as follows:

- (a) Low Frequency: dc position and 0.03 Hz to 1 kHz positions in 1-3-10 sequence.
- (b) High Frequency: 3 Hz to 300 kHz in 1-3-10 sequence.

(8) NOISE

At 10 Hz with a 2 megohm source impedance, noise figure is 0.3 dB maximum. At 1 kHz with a 1 megohm source impedance, noise figure is 0.2 dB maximum. See Section III for further discussion and noise figure contours.

(9) DC DRIFT

- (a) Referred to input (dc coupling): maximum 10 $\mu\text{V}/^\circ\text{C}$ or less than 10 $\mu\text{V}/24$ hours at constant ambient temperature. A front panel screwdriver control provides for dc zeroing.
- (b) Referred to output: less than 1 $\text{mV}/^\circ\text{C}$, or less than 1 $\text{mV}/24$ hours at constant ambient temperature.

(10) DISTORTION

Typical distortion is less than 0.01%.

(11) OUTPUT VOLTAGE

10 volts pk-pk ahead of 600 ohms.

(12) OUTPUT IMPEDANCE

600 ohms.

(13) OVERLOAD RECOVERY

Resets immediately with spring-loaded front-panel toggle. See Figure III-2 for characteristic recovery data.

(14) POWER REQUIREMENTS

- (a) Rechargeable nickel-cadmium batteries provide approximately 30 hours operation between charges. A front-panel, three-position, spring-loaded toggle switch and test lamp permit test of each of the two internal batteries.
- (b) Ac line operation: 105-125 V ac or 210-250 V ac, 50-60 Hz, 5 watts. Internal batteries will recharge automatically while unit is connected to ac power line.

(15) DIMENSIONS

8.6" W x 4.1" H x 11.3" D (21.8 cm x 10.4 cm x 28.7 cm).

(16) WEIGHT

4 pounds (1.8 kg).

(17) ACCESSORIES

If the source impedance is less than 100 ohms, best low-noise performance will be obtained if a Model AM-1, AM-2, or 190 input transformer is used. Both the AM-1 and the AM-2 have 1:100 turns ratios. The AM-1 has a 3 dB bandwidth of from 1 kHz to 10 kHz at 10 ohms source impedance, and the AM-2 has a bandwidth of from 1 kHz to 150 kHz with a 1 ohm source. The Model 190 has a 1:10:100 turns ratio. The three dB bandwidth is from 0.25 Hz to 500 Hz with a 1 ohm source. See Section III for further details regarding these transformers.

Flanges are available for mounting on a single unit or two units side by side in a 19" relay rack. See Subsection III-12 for the part numbers of these flanges.

SECTION II

INITIAL CHECKS

2.1 INTRODUCTION

The following procedure is provided to facilitate initial performance checking of the Model 113. In general, the procedure should be performed after inspecting the instrument for shipping damage (any noted to be reported to the carrier and to Princeton Applied Research Corporation), but before using it experimentally. Should any difficulty be encountered in carrying out these checks, contact the factory or one of its representatives.

2.2 EQUIPMENT NEEDED

- (1) General purpose laboratory oscilloscope.
- (2) Signal generator capable of providing a 1 V pk-pk sinewave at 1 Hz, 100 Hz, and 1 kHz.

2.3 PROCEDURE

- (1) Make sure the rear-panel slide switch is in the position indicating the line voltage to be used (115 V ac or 220 V ac).
- (2) Plug the line cord into the rear of the instrument and into the power receptacle.
- (3) Press the power switch so that it remains depressed.
- (4) Push the spring-loaded battery test toggle to the left, then push it to the right. The green indicator should light for both positions.
- (5) Make the following initial control settings:
 - (a) Gain: x10; Cal.: fully counterclockwise (turn until the switch "clicks").

- (b) Coupling: A input AC, B input GND.
- (c) Low Frequency Rolloff control: 1 Hz.
- (d) High Frequency Rolloff control: 1 kHz.
- (6) Connect the oscilloscope to the output BNC jack.
- (7) Set the signal generator to 1 Hz, 1 V pk-pk, and connect it to the A input BNC jack. (Use the oscilloscope to make the signal generator amplitude settings, to obtain consistency between input settings and output readings.)
- (8) Monitor the output; the output level should be 7 V pk-pk.
- (9) Set the signal generator to 100 Hz, 1 V pk-pk. Monitor the output; the output level should be ten times the input level.
- (10) Set the signal generator to 1 kHz, 1 V pk-pk. Monitor the output; the output level should be 7 V pk-pk.
- (11) Press the OVL recovery button; the output should decrease to a low level, typically 50 mV. However, the absolute signal amplitude can vary considerably from unit to unit.
- (12) Return the power switch to the OFF (out) position.

This completes the initial checks. If the instrument performed as indicated, one can be reasonably sure that it is operating properly.

SECTION III OPERATING INSTRUCTIONS

3.1 INTRODUCTION

To obtain optimum performance from the Model 113, care must be exercised in selecting the signal source impedance, in selecting the bandwidth, and in ground loop considerations, all of which are discussed below.

Fundamentally, the instrument is powered as required either from the self-contained batteries or from the ac line, and the signal to be amplified is applied to the input connector(s); the amplified signal is available at the output jack through a resistance of 600 ohms.

NOTE: Before operating from ac line power, make sure the rear-panel switch is in the position indicating the line voltage to be used, and be sure the proper size line fuse is installed (1/16 A for 115 V operation or 1/32 A for 230 V operation). Operating from too high a line voltage will blow the line fuse and possibly damage the power transformer and circuit components.

3.2 NOISE AND SOURCE RESISTANCE

Best amplifier performance is often regarded to be realized under those conditions where it least decreases the overall signal-to-noise ratio. In many instances the thermal noise generated by the signal source resistance is the dominant factor in determining the input signal-to-noise ratio. In this respect, amplifier noise performance can be specified by the amount of noise the amplifier adds to the amplified source thermal noise; expressed in decibels, this is called the "Noise Figure":

(1) Noise Figure =

$$20 \log_{10} \frac{\text{total rms noise voltage at the amplifier output}}{\text{gain} \times \text{source thermal noise voltage (rms)}} \text{ dB}$$

where the Source Thermal Noise = $\sqrt{4KTR\Delta f}$ volts rms = E, and

K = Boltzmann's constant, 1.38×10^{-23} joules/K

T = absolute temperature in kelvins

Δf = equivalent noise bandwidth in Hz

R = source resistance in ohms (differential source resistance for Model 113; if used single-ended, set the coupling selector for the unused input to ground, and regard this part of input resistance to be zero).

The total output noise may be converted to an equivalent input noise by dividing by the amplifier gain. The noise figure, expressed in these terms, becomes:

(2) Noise Figure =

$$20 \log_{10} \frac{\text{total rms noise voltage referred to amp. input}}{\text{source thermal noise voltage (rms)}} \text{ dB}$$

Each amplifier has its own characteristic noise figure, which varies as a function of frequency and source resistance. These figures are obtained experimentally, and plotted graphically. Figure III-1 is a typical set of noise figure contours for the Model 113.

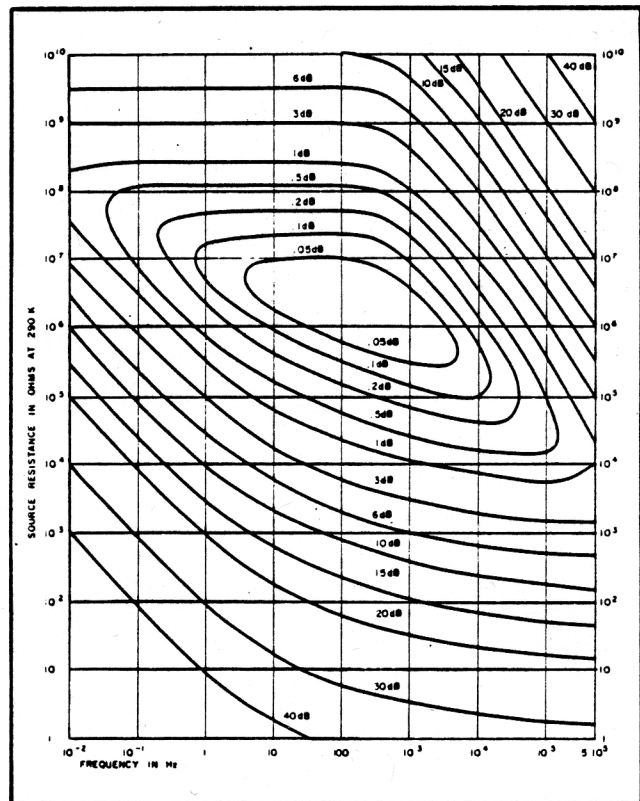

**Figure III-1. TYPICAL NOISE FIGURE CONTOURS
FOR THE MODEL 113**

In using these contours, the total equivalent rms input noise is usually the quantity of interest. This can be obtained from the graph and equation (3):

(3) Total equivalent rms input noise voltage =
source thermal noise x antilog NF/20 volts rms

The equivalent noise bandwidth used in determining the source thermal noise is a function of the external circuitry and/or the amplifier bandwidth. When operating dc coupled (LF rolloff to DC), the equivalent noise bandwidth of the M113 is simply the HF rolloff frequency multiplied by $\pi/2$. If the LF rolloff frequency setting is other than dc, the equivalent noise bandwidth is given by the formula:

$$\text{ENB} = \frac{\pi}{2} \times \frac{f_2^2}{f_1 + f_2}$$

where:

ENB is the equivalent noise bandwidth in Hz,
 f_2 is the setting of the HF Rolloff Control, and
 f_1 is the setting of the LF Rolloff Control.

If the two frequency settings are far apart, the equivalent noise bandwidth to a close approximation is simply $\pi/2$ times the HF rolloff frequency.

Suppose one intended to operate the Model 113 in conjunction with an experiment that presents a source impedance of 50 ohms, and suppose it is known that the information required from the experiment is situated below 1 kHz. Since the source thermal noise contributing to the total noise is dependent on bandwidth, the amplifier bandwidth is minimized by setting the LF rolloff control to dc and the HF rolloff control to 3 kHz. Dc coupling is used. The source thermal noise in this case is:

$$E = \sqrt{4 \times 1.38 \times 10^{-23} \times 2.9 \times 10^2 \times 50 \times 3 \times 10^3 \times 1.57}$$
$$= 6.1 \times 10^{-8} \text{ V rms}$$

From Figure III-1, the noise figure for the Model 113 at a center frequency of 1500 Hz and a source resistance of 50 ohms is 18 dB. Substituting these values into equation (3):

$$\begin{aligned} \text{total equivalent rms input noise} \\ &= 6.1 \times 10^{-8} \times 10^{18/20} \\ &= 0.5 \mu\text{V rms} \end{aligned}$$

Occasionally the dc component is not required, so that the best noise performance can be achieved with the help of an input transformer. This is possible by taking advantage of the property of a transformer to multiply the source resistance by the square of the turns ratio and the voltage by the ratio. With a transformer inserted between the signal source and the amplifier input we can increase the effective source resistance to a value that reduces the noise figure to less than 0.05 dB. From Figure III-1, the source resistance should be about 1 megohm. The transformer turns ratio, for this impedance increase, is $\sqrt{R_2/R_1} = 140$. Thermal source noise at the amplifier input is equal to the noise generated by the 50 ohm source multiplied by the turns ratio. With a noise figure near zero, the total equivalent rms input noise is also equal to the noise generated by the 50 ohm source multiplied by the turns ratio, = 70 $\mu\text{V rms}$. Although the numerical value of equivalent input noise is much larger than before, the signal-to-noise ratio is substantially increased. This can be seen by considering all of the transformed source signal voltage as appearing at the amplifier input terminals, because the Model 113 input resistance is much larger than the 1 megohm presented by the transformer; the signal-to-noise ratio is equal to the maximum possible value: $e_{\text{sig}}/E \times \text{antilog NF}/20 \cong e_{\text{sig}}/E$. In this example the transformer increases the signal-to-noise ratio by a factor of 8.

Princeton Applied Research Corporation manufactures transformers for use in low level, low frequency applications. Characteristics and details regarding the use of some of these transformers are discussed in Subsection 3.11. Because the transformers have so much influence in determining bandwidth, and because of the noise contrib-

uted by the transformers, the results obtained using a transformer hardly resemble the ideal theoretical results as predicted in the example. When using a transformer, it is best to use noise figure contours and amplitude transfer curves obtained empirically for the individual transformer. Subsection 3.11 contains such data for the transformers.

3.3 GROUNDING

The Model 113 is specifically designed to have a high degree of immunity to the effects of ground-loop currents. The signal ground side of the input connectors is connected to chassis ground through a 10 ohm resistor. To maintain ground-loop immunity, avoid shorting the input grounds to chassis ground at the amplifier end of the cables. To further reduce the effects of ground-loop currents, use an input cable that is short and has a high conductivity outer conductor. (For a discussion of the circuit design with respect to grounding considerations, see Section IV).

CAUTION: The power rating of the 10 ohm resistor is $\frac{1}{2}$ watt. Avoid excessive ground-to-ground current to avoid burning out this resistor.

When the signal is applied to the input via a transformer, operate the amplifier single-ended. That is, place one input selector to the ground position, and connect the transformer to the other input (ac couple); connect one transformer lead to the outer shell of the BNC connector and connect the other transformer lead to the center conductor of the connector. Connecting this way avoids the problem of static charge build-up at the inputs due to no ground return.

3.4 SIGNAL VOLTAGE AND GAIN

With the variable gain control in the calibrated position (ccw), the position of the gain selector accurately sets the gain to the indicated level. Intermediate levels of gain may be obtained by use of the uncalibrated variable gain control. If it is desired to accurately set an intermediate level of gain, apply an input signal to the amplifier input and, using an ac voltmeter, proportionally adjust the output signal level to a corresponding value between the levels of the two fixed gain settings bracketing the desired gain.

The maximum output that the amplifier can provide is 10 volts peak-to-peak (through 600 ohms into an open circuit). For maximum input voltages, refer to the specifications and to Subsection 3.10.

3.5 DC ZERO ADJUSTMENT

The dc zero adjustment may need to be touched up as the gain is changed. In particular, if the adjustment is first made when operating at a low gain, followed later by transfer to high-gain operation, it is important that the dc zero be checked, and, if necessary, readjusted as required.

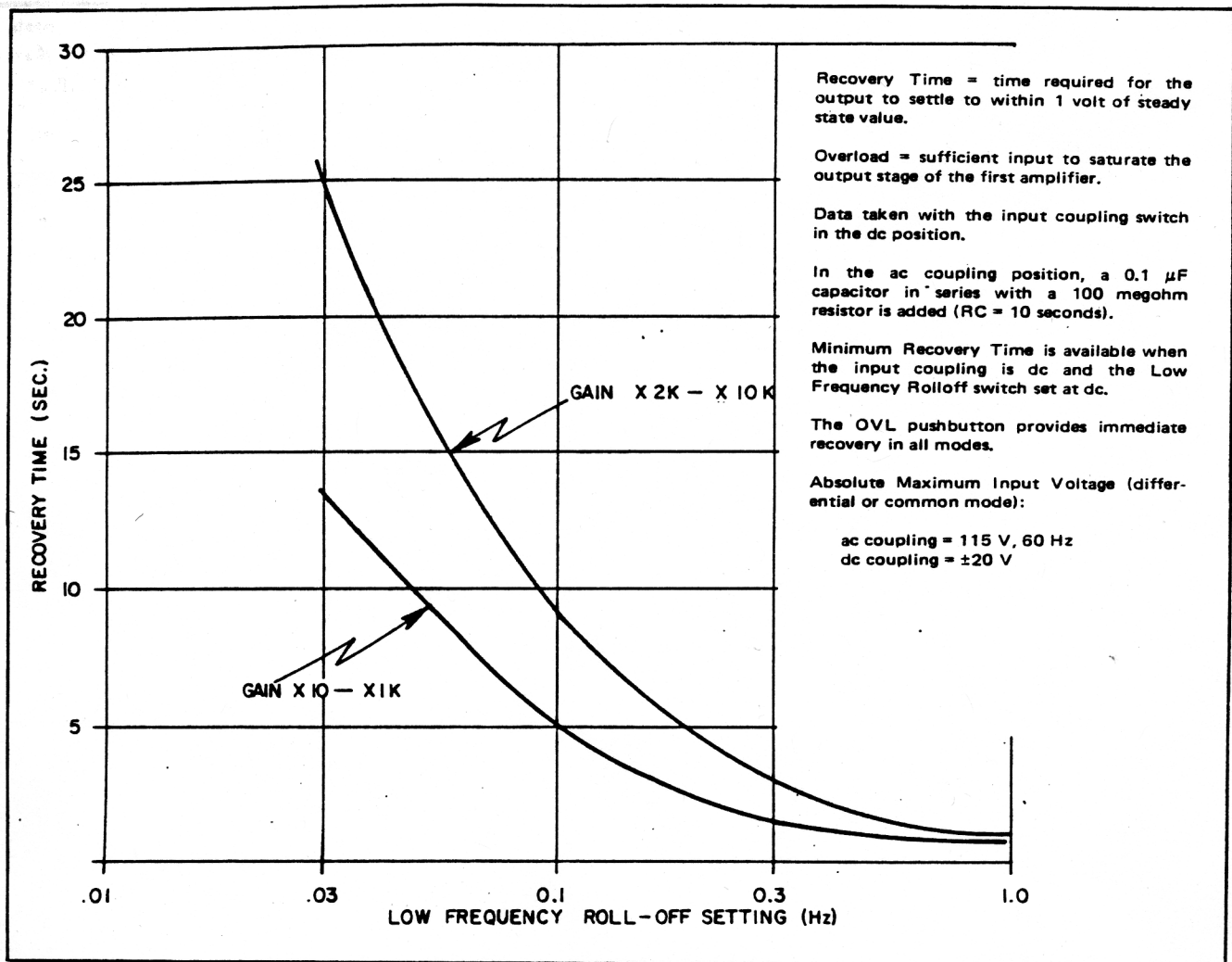

Figure III-2. TYPICAL RECOVERY TIME VS LOW FREQUENCY ROLLOFF

3.6 OVERLOAD FAST RECOVERY

If the input signal exceeds the level indicated in the specifications (Section I), the amplifier will saturate and remain disabled until coupling and filter capacitors discharge (see the recovery time data, Figure III-2). Pressing the spring-loaded overload recovery toggle causes fast discharge of the capacitors so that normal operation can be resumed immediately.

3.7 LOW-PASS/HIGH-PASS FILTERS

Series low-pass and high-pass filters are incorporated to provide bandpass characteristics. Minimizing the bandwidth minimizes the source thermal noise. In addition, the filters can be used to eliminate unwanted signals (such as dc, high frequency, or 60 Hz pickup). The following figures are normalized amplitude and phase transfer characteristics.

If one or both Coupling switches are set to the AC Coupling position, the LF ROLLOFF switch should not be left in the DC position. If it is left in the DC position, output voltage

offsets resulting from the input offset current (100 pA max) may occur. At high gains, the offset could exceed full scale.

3.8 SINGLE-ENDED/DIFFERENTIAL OPERATION

The amplifier may be operated differentially or single-ended. For single-ended operation, simply place the unused input coupling switch to the ground position, and place the signal-input switch to ac or dc coupling as desired.

For differential operation, place both coupling switches in ac or dc positions or one in dc and the other in ac, as appropriate. The output voltage is equal to the gain times the difference of the voltages at the A and B inputs.

Remember that the two signal grounds (tied together internally) are connected to chassis ground through a 10 ohm resistor. For maximum ground-loop rejection, avoid shorting the signal ground to chassis ground.

3.9 DC ZERO ADJUSTMENT

To do zero adjustment, place both coupling switches in the ground position, set the L.F. Rolloff switch to DC, and set the gain switch to the position to be used. Then adjust the front-panel zero potentiometer for 0 V at the output.

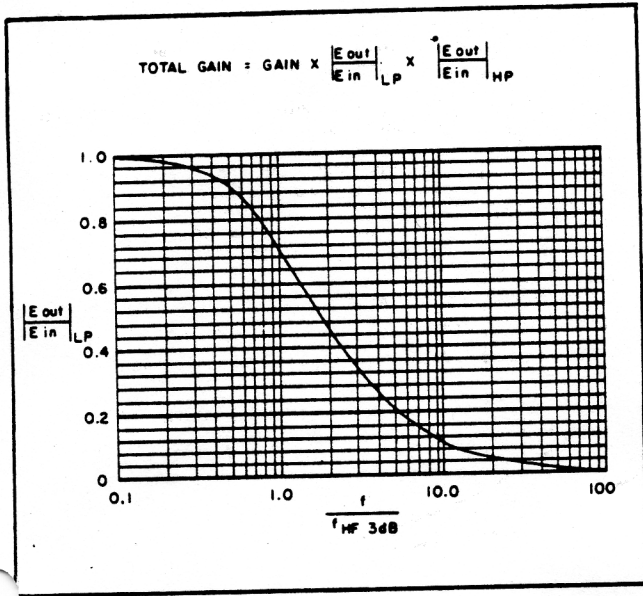

Figure III-3. LP FILTER NORMALIZED AMPLITUDE TRANSFER CURVE

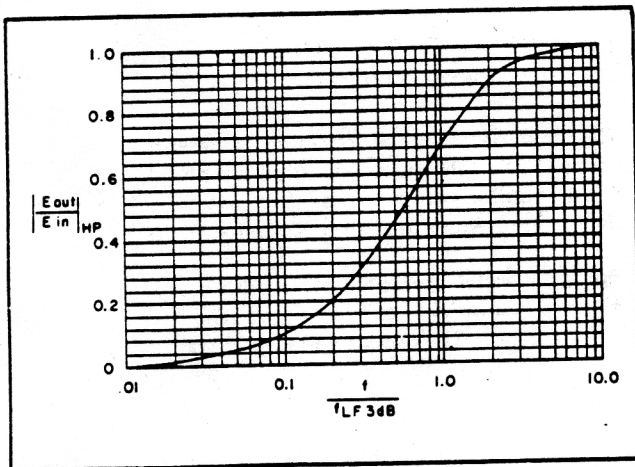

Figure III-4. HP FILTER NORMALIZED AMPLITUDE TRANSFER CURVE

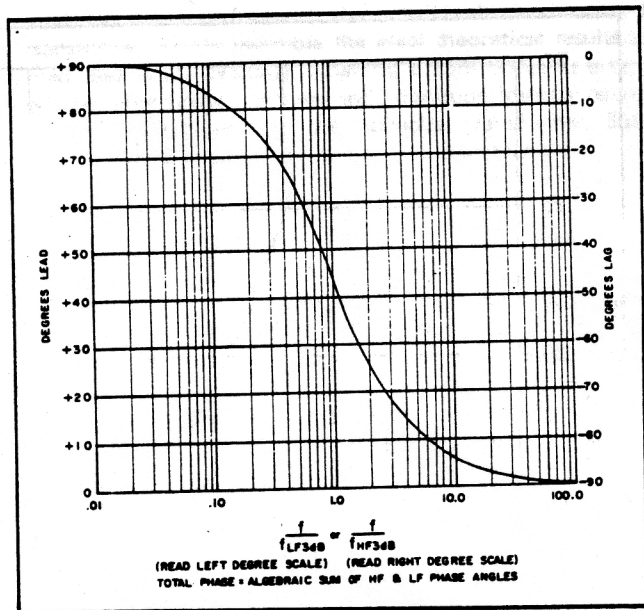

Figure III-5. LP/HP FILTER NORMALIZED PHASE TRANSFER CURVE

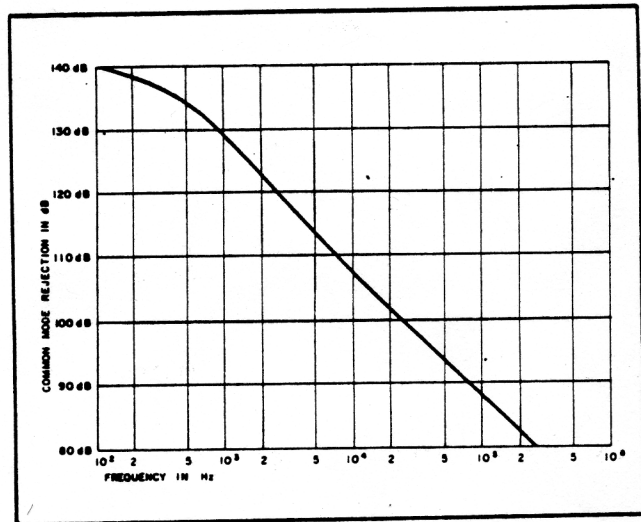

Figure III-6. TYPICAL COMMON MODE REJECTION CHARACTERISTICS

3.10 MAXIMUM INPUT SIGNAL CONSISTENT WITH LINEAR OPERATION

When speaking of the maximum input that can be applied, a distinction must be made between common mode signal, that signal which is common to and identical at both the A and B inputs, and differential signal, that signal which exists between the inputs, that is, that is measured at one input with respect to the other. A perfect amplifier responds not at all to common mode signal, that is, if both the A and B inputs are driven by the same large signal, no trace of that signal should appear at the output. The signal at the output should result from the differential input signal only. Real

amplifiers, including the Model 113, do not exhibit complete immunity to common mode signals. However, as stated in the COMMON MODE REJECTION specification, the immunity, though finite, is very great indeed. This immunity only holds for common mode signals of 1 V rms or less. With higher common mode signals, input circuits become non-linear and a very great degradation in common mode signal rejection occurs. This is the meaning of the Common Mode Maximum Input Signal specification.

To appreciate the meaning of the Differential Mode Maximum Input Signal specifications, it is necessary to distinguish between attenuated differential input signal and unattenuated differential signal. Attenuated input signals are those at a frequency which is attenuated by either the High Pass Filter or the Low Pass Filter. The frequencies affected by these filters depend on the setting of the corresponding front-panel switches. Unattenuated signals are those at a frequency which is unaffected by the filters. The maximum output capability of the Model 113 is 10 V pk-pk. Clearly, for an unattenuated signal, the maximum differential input one can apply is $10/G$ V pk-pk, where G is the selected gain. At frequencies where the filters begin to have some effect, greater differential input signals can be applied. The further one moves into the region of filter influence, going either higher or lower in frequency, the larger the differential input signal can be. However, a limit is reached where any further increase in input signal, regardless of frequency, will cause non-linear operation and performance degradation. This limit, which is a function of the Gain switch setting, is given by the two Differential Mode Maximum input signal specifications. For gains of 10 to 100, the absolute maximum one can apply is 1 V pk-pk. For gains of 200 to 10,000, the absolute maximum differential signal one can apply is 100 mV pk-pk. It should be clear that if the frequency component of interest is not being maximally attenuated by the High Pass or Low Pass Filter, the maximum input will be lower. Figure III-7 illustrates these relationships.

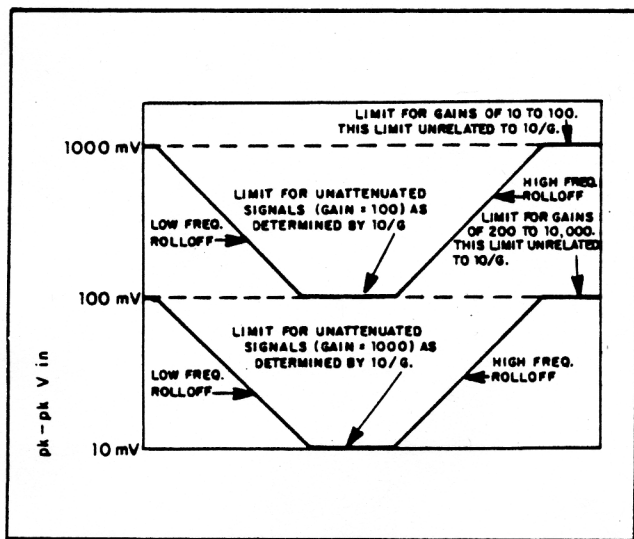

Figure III-7. MAXIMUM DIFFERENTIAL INPUT TO MODEL 113

3.11 BATTERY OPERATION, TEST, AND CHARGING

The Model 113 has rechargeable batteries good for up to 30 hours of operation when fully charged. If they are not fully charged, or if the Model 113 is driving a load having an impedance of less than 10 k Ω , a shorter operating period will result. To operate from battery power, set the Power switch to ON, but do not plug in the line cord. When the period of battery powered operation is completed, be sure to set the switch to OFF to prevent running down the batteries.

To check the batteries, push the spring-loaded test switch to the left and to the right. If the green indicator lights, the corresponding battery is charged. If it remains out, the batteries need charging. Battery charging takes place whenever the Power switch is set to OFF with the line cord plugged in. Beginning from the fully discharged state, it takes anywhere from 24 to 36 hours to fully recharge the batteries. In general, one should follow each period of battery operation with a charging period of equal or greater duration.

NOTE: When the power switch is set to ON with the line cord plugged in, the batteries "trickle charge" at a rate very much lower than that obtained with the switch set to OFF. For this reason, it is better to charge with the switch set to OFF.

The batteries used in the Model 113, should they require replacement, can be ordered from Princeton Applied Research Corporation. The part number is 4000-0016-04, Specification #710311 A.

When the batteries are being recharged (instrument plugged in but with Power switch in OFF position), there is no time limit, that is, there is no possibility of overcharge with subsequent battery damage due to the charging being maintained for too long a time.

3.12 RACK MOUNTING

The Model 113 may be mounted in a standard 19" relay rack, either singly or two units side by side. The following mounting accessories are available from the factory:

Single mounting: Panel, rack mounting, part number 1415-0553-08

Double (side-by-side) mounting:

Coupling, rear, part number 1415-0555-14
Coupling, front, part number 2517-0217-19
Screw, coupling, part number 2517-0218-18

Flanges are required for both types of rack mounting. Most units are shipped with the flanges, but if the unit to be mounted does not have them, order part number 1402-0008-20 (two for each type mounting).

3.13 USING A SIGNAL INPUT TRANSFORMER

How a signal input transformer can improve low-noise performance was discussed in Subsection 3.2. There it was indicated that a transformer often has a bandwidth narrow compared with the amplifier it is being used with, and that the transformer adds its own noise to the total noise. For this reason, it is best to have noise figure contours and amplitude transfer curves for the transformer. Princeton Applied Research Corporation manufactures three magnetically shielded signal transformers that may be used with the Model 113: the Models AM-1, AM-2, and 190. Data for each of these transformers follows.

(1) Model AM-1

A general-purpose frequency response and changeable turns ratio render the AM-1 the most versatile of the three transformers. **NOTE:** The outer connector, as the transformer comes from the factory, is wired for a differential output with separate ground return (see Figure III-8A). When using the transformer with the Model 113, one half of the secondary will be shorted to ground, if the Model 113 is operated single-ended as recommended in Subsection 3.3, unless the output connector is rewired. To use the full 1:100 turns ratio, the center tap wire must be removed from pin 1 (ground), and the wire going to pin 3 removed from pin 3 and reconnected to pin 1, as shown in Figure III-8B.

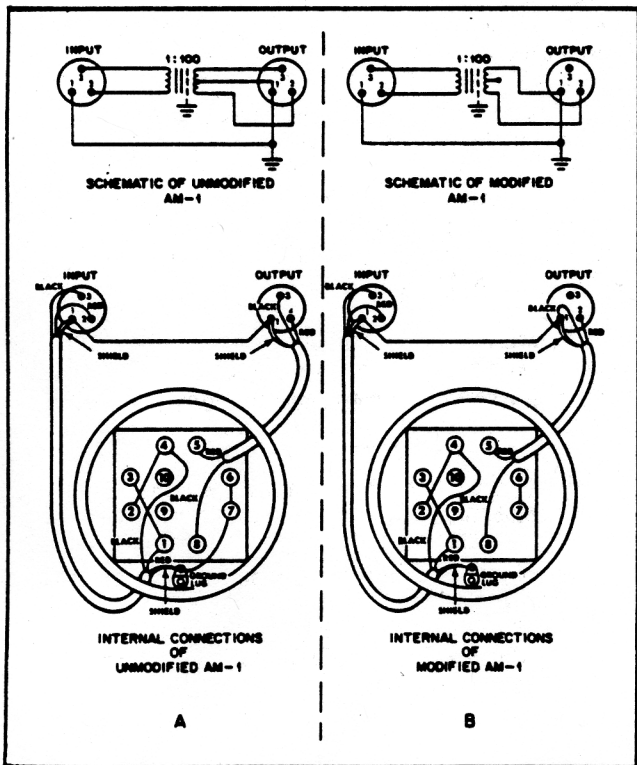

Figure III-8. MODIFYING THE AM-1 TRANSFORMER FOR USE WITH THE MODEL 113 PREAMPLIFIER

Figure III-9A is a family of amplitude transfer curves for a typical Model AM-1 wired for a 1:100 turns ratio, and Figure III-9B is the corresponding family of noise figure contours. In the transformer-amplifier system, the noise figure obtained from III-9B predominates, and, therefore, this noise figure can be regarded as the system overall noise figure. However, the transformer frequency response and the amplifier response set with the rolloff controls must be combined to obtain the system overall response characteristics.

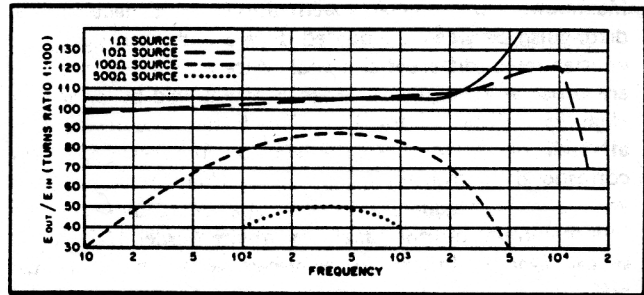

Figure III-9A. FREQUENCY RESPONSE OF TYPICAL MODEL AM-1 TRANSFORMER

From Figure III-9B, for a turns ratio of 1:100, the optimum source resistance is between 10 and 100 ohms. If a source resistance in another range is to be used, the operator may consider changing the turns ratio to shift the lowest noise-figure resistance range to that being used. The source resistance scale of Figure III-9B should be multiplied by the factor $10^4 N^2$, where N is the step-up turns ratio being used. Required wiring and scaling information is given in Figure III-10.

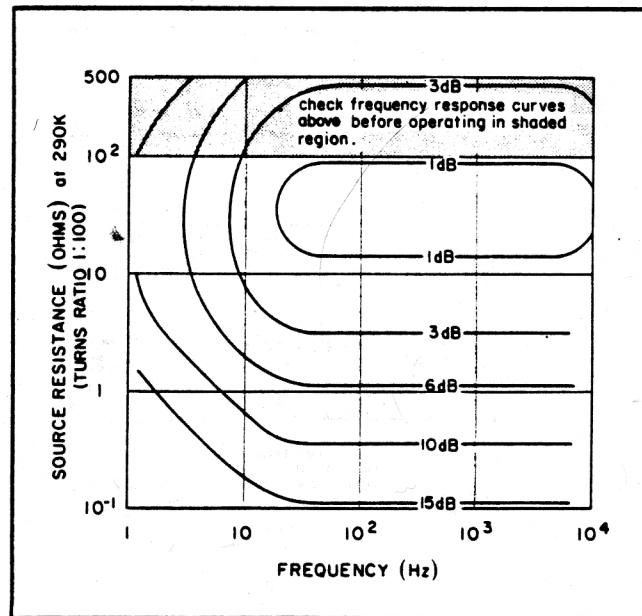

Figure III-9B. NOISE FIGURE CONTOURS FOR TYPICAL MODEL AM-1 TRANSFORMER

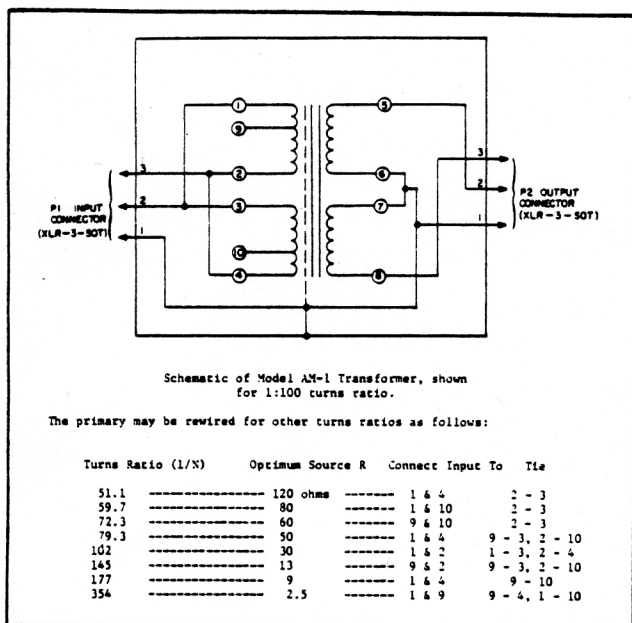

Figure III-10. SCHEMATIC OF MODEL AM-1 TRANSFORMER (UN-MODIFIED)

An output cable, made up with connectors, and an input connector are supplied with each AM-1 manufactured. When ordering the transformer remember to specify which instrument it is to be used with, so that the proper connector can be provided at the amplifier end of the cable. When making up cables for connecting to the input and to the output, use Cannon brand audio connectors type XLR-3-11C or XL-3-11C, or equivalent. Coaxial cable should be used, preferably of short length and of the low-noise variety (Amphenol RG/U type 21-537 or 21-541). Figure III-8B indicates that the center conductor of the output cable should be wired to pin 2 and the shield wired to pin 1. A BNC connector should be installed at the amplifier end of the cable.

Note the resonance peak at the high frequency end of the transformer response curve (Figure III-9A). If the input signal has frequency components in this range the amplifier may be prematurely overloaded by them, particularly at high signal or gain levels. If high frequency signal components cause such problems the operator may consider prefiltering the signal or changing the source impedance to flatten the response curve in this range.

CAUTION: Be careful to avoid applying a signal to the primary such that will cause insulation breakdown of the secondary or damage to the input circuit of the amplifier.

CAUTION: Avoid passing excessive dc current through the primary of this transformer. More than 200 μ A will magnetize the core. Core magnetization will cause the transformer to saturate prematurely for one polarity of ac signal, resulting in distortion of high level signals, and a magnetized transformer is usually

noisy and microphonic, causing low level distortion as well. See paragraph (4) for a discussion of this distortion and a procedure for degaussing the transformer. Do not measure winding resistance with an ohmmeter; ohmmeter current is sufficient to magnetize the core.

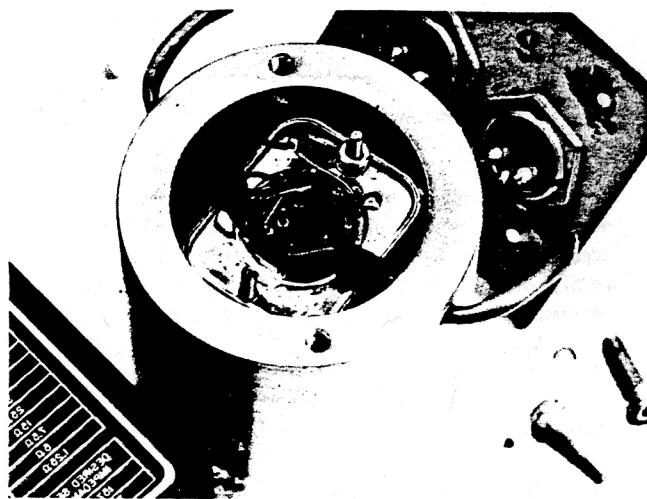
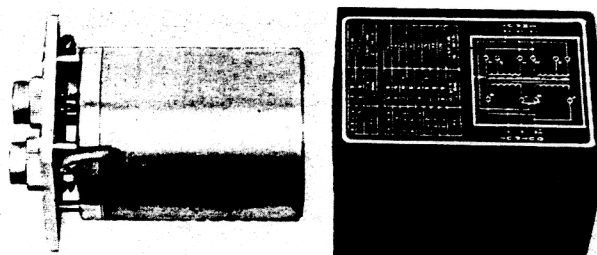
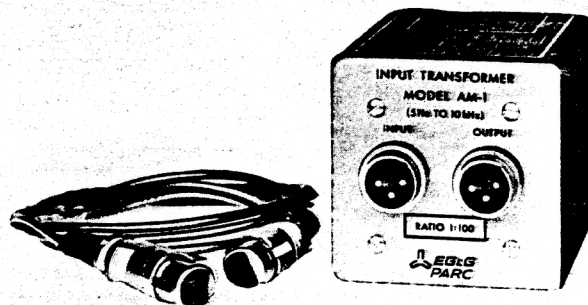

Figure III-11. PHOTOGRAPHS OF MODEL AM-1 TRANSFORMER

(2) Model AM-2

The AM-2 is best for high frequency applications. The turns ratio of this transformer is 1:100. Figure III-12A is a family of amplitude response curves for a typical Model AM-2, and Figure III-12B is the corresponding family of noise figure contours. In the transformer-amplifier system, the noise figure obtained from Figure III-12B predominates, and, therefore, this noise figure can be regarded as the system overall noise figure. However, the transformer frequency response and amplifier frequency response set with the rolloff controls must be combined to obtain the system overall response characteristics.

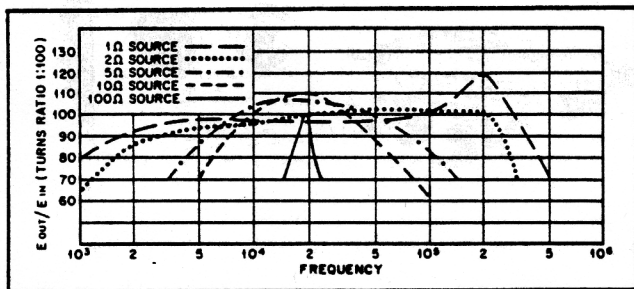

Figure III-12A. FREQUENCY RESPONSE OF TYPICAL MODEL AM-2 TRANSFORMER

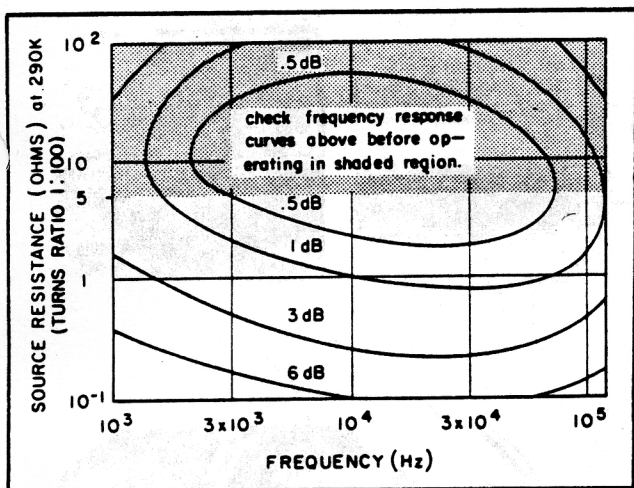

Figure III-12B. NOISE FIGURE CONTOURS FOR TYPICAL MODEL AM-2 TRANSFORMER

An output cable, made up with connectors, and an input connector are supplied with each AM-2 manufactured. When ordering the transformer remember to specify which instrument it is to be used with, so that the proper connector can be provided at the amplifier end of the cable. When making up cables for connecting to the input and to the output, use Cannon brand audio connectors type XLR-3-11C or XL-3-11C, or equivalent. Coaxial cable should be used, preferably of short length and of the low-noise variety (Amphenol RG/U type 21-537 or 21-541). Figure III-13, the schematic, indicates that the center conductor of the output cable should be wired to pin 2 and the shield

wired to pin 3. A BNC connector should be installed at the amplifier end of the cable.

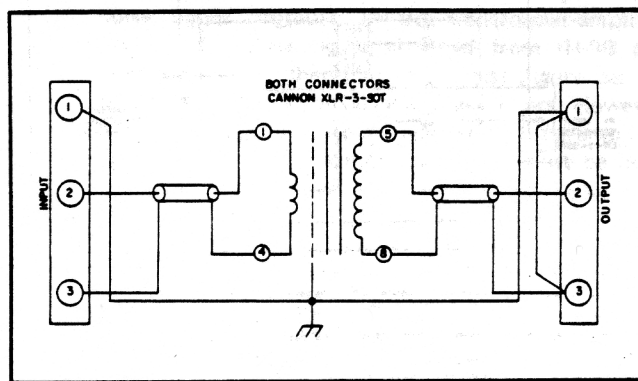

Figure III-13. MODEL AM-2 SCHEMATIC, TURNS RATIO 1:100

CAUTION: Be very careful to avoid applying a signal to the primary such that will cause insulation breakdown of the secondary or damage to the input circuit of the amplifier.

NOTE: Because the Model AM-2 has a ferrite core, core magnetization will not occur as a result of dc current. However, excessive dc current in the primary, along with the ac signal, may result in premature saturation of the core and distortion of the signal.

(3) Model 190

The Model 190 is the best transformer to use at very low frequencies and where good low-noise performance is required at low frequencies. This transformer has two primary windings, P1, with a P1:P3 turns ratio of 1:1000, and P2, with a P2:P3 turns ratio of 1:100. Only one of these primaries should be connected at a time, and the unused winding left open. Figure III-15 is a family of amplitude transfer curves for the Model 190, and Figure III-16 is the corresponding family of noise figure contours. The noise figure contours are transformer-amplifier system contours, so separate noise figures do not have to be combined. However, the transformer frequency response and the amplifier frequency response set with the rolloff controls must be combined to obtain the overall system response characteristics.

Note the resonance peak at the high frequency end of the transformer response curve. If the input signal has frequency components in this range the amplifier may be prematurely overloaded by them, particularly at high signal or gain levels. If high frequency signal components cause such problems the operator may consider prefiltering the signal or changing the source impedance to flatten the response curve in this range.

The secondary winding has a neon lamp connected across it. If too large a signal is applied to the primary,

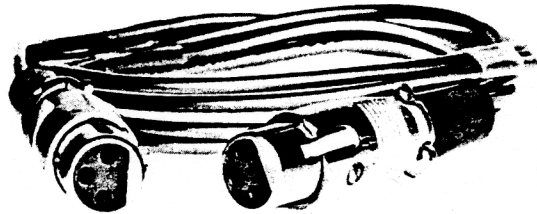
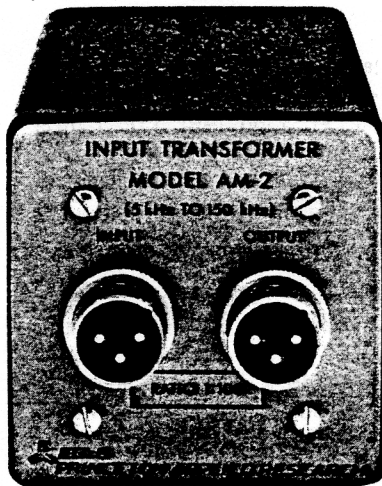

Figure III-14. PHOTO OF MODEL AM-2

the lamp conducts to prevent the voltage induced in the secondary from damaging the transformer or amplifier input circuit.

An output cable, made up with connectors, is supplied with each Model 190 manufactured. When ordering the transformer remember to specify which instrument it is to be used with so that the proper connector can be provided at the amplifier end of the cable. When making up cables for connecting to the input and to the output, use BNC connectors and coaxial cable. The coaxial cable should be short to keep capacitance low, and should be, preferably, low-noise cable (such as Amphenol RG/U type 21-537 or type 21-541).

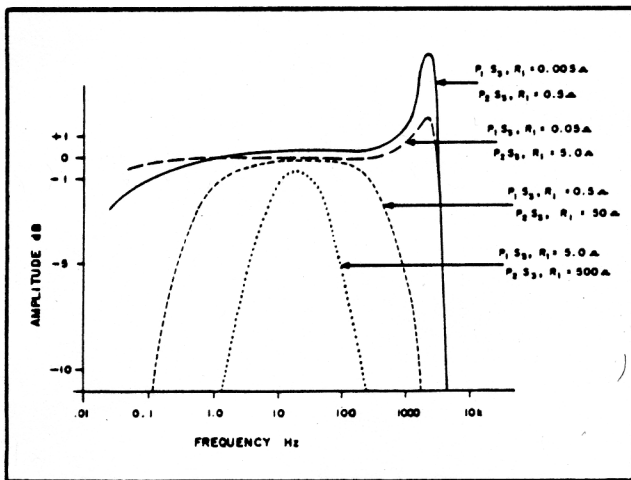

Figure III-15. FREQUENCY RESPONSE OF TYPICAL MODEL 190 TRANSFORMER

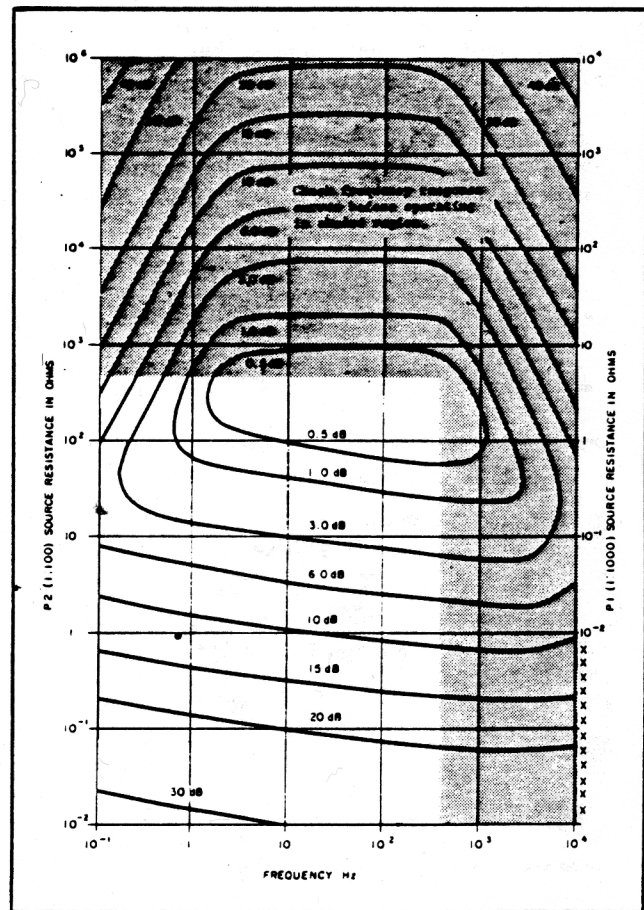

Figure III-16. NOISE FIGURE CONTOURS FOR TYPICAL MODEL 190-113 SYSTEM

The outer shells of the input BNC connectors are floating off ground (see 190 schematic, Figure III-17); to maintain the common-mode rejection properties of the transformer, *do not* connect the input-cable shield to the transformer case ground.

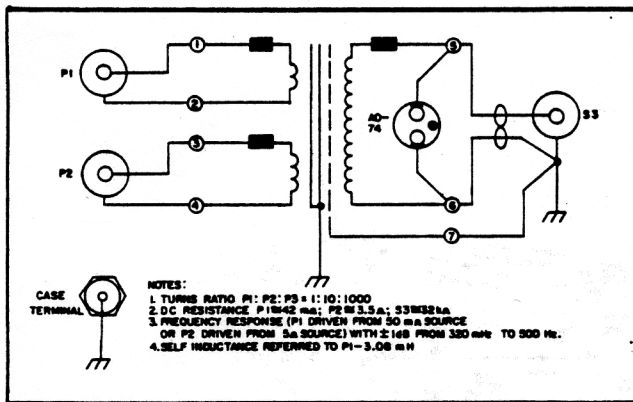

Figure III-17. MODEL 190 SCHEMATIC

CAUTION: Avoid passing excessive dc current through the primary of this transformer. More than 200 μ A will magnetize the core. Core magnetization will cause the transformer to saturate prematurely for one polarity of ac signal, resulting in distortion of high-level signals, and a magnetized transformer is usually noisy and microphonic, causing low level distortion as well. See paragraph (4) for a discussion of this distortion and a procedure for degaussing the transformer. *Do not measure winding resistance with an ohmmeter;* ohmmeter current is sufficient to magnetize the core.

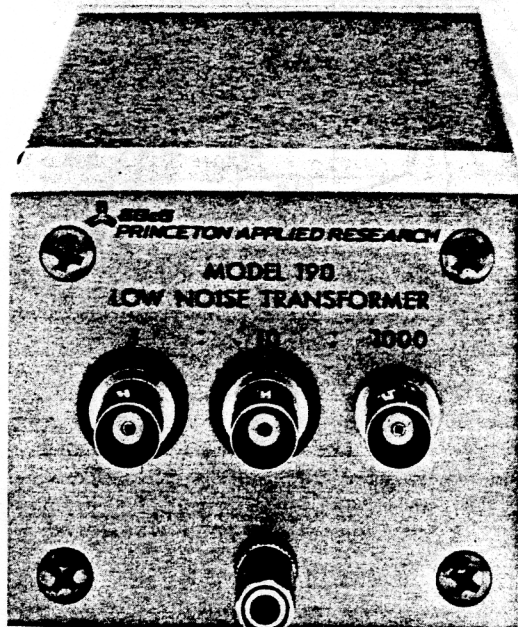

Figure III-18. PHOTOGRAPH OF MODEL 190 TRANSFORMER

(4) Core Magnetization, Corresponding Distortion, and Degaussing

Excessive current through a winding of a transformer will permanently magnetize the core of most transformers. This is true of the Models AM-1 and 190. The Model AM-2 has a ferrite core which virtually will not permanently magnetize. All transformer cores saturate in magnetization ($=B$) after a given winding current has been reached ($\propto H = \text{no. turns} \times i = \text{magnetizing force, where } i = \text{current through winding}$). The voltage induced in the secondary is proportional to dB/dt , so the secondary voltage is distorted on that part of the curve where B is not a linear function of H . A permanently magnetized core saturates at a lower level of H , and thereby reduces the maximum signal current that can be transformed without distortion. Figure III-19 shows a B-H curve and waveforms that graphically illustrate this core saturation and corresponding distortion. Note that the B-H characteristic is actually a loop; curves #1 and #2 of Figure III-19A are only representative "center lines" of the corresponding loops. Actually, the loops are usually "suarish ovals", with different degrees of squareness for different core materials; but the details of the loops are not of interest in this discussion, only the general situation of the loops with respect to saturation.

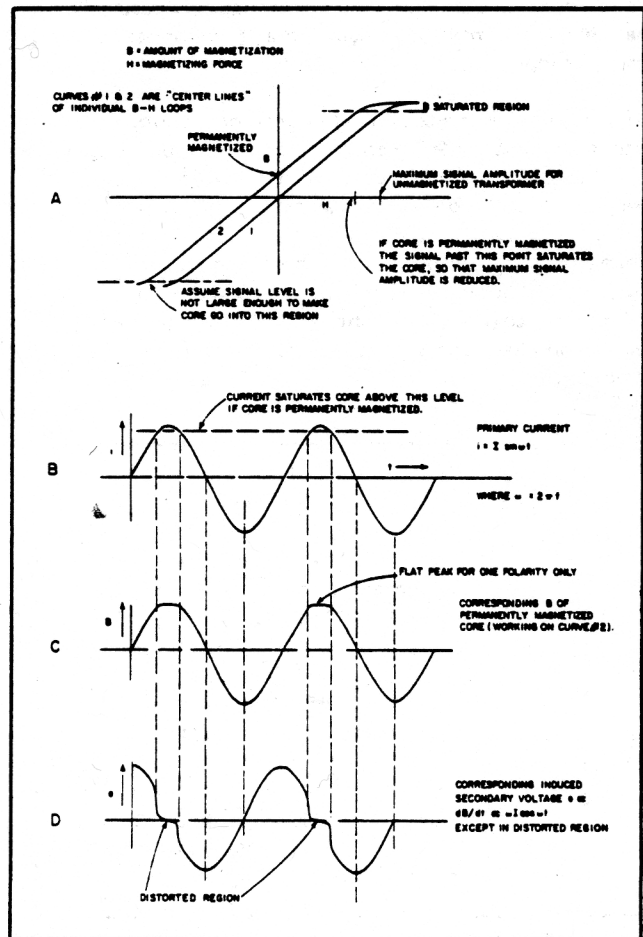

Figure III-19. B-H CURVE & WAVEFORM

A magnetized transformer is usually noisy and microphonic compared to when it is not magnetized. This noise is the most objectional characteristic of a magnetized transformer because it affects low level signals. The distortion of high level signals described here is not usually an operating problem because the signal is seldom so large, but high level distortion is useful in determining the condition of the core and in monitoring the degaussing process.

Notice from Figure III-19A that as long as the core is not magnetized the transformer works on a loop around center-line #1 and the signal can be of maximum amplitude. If the core becomes permanently magnetized, the transformer works on a loop around center-line #2 (or equivalent for opposite polarity), and, if the same maximum signal current is applied, the core becomes saturated at one of the peaks of the signal. B, C, and D of Figure III-19 show a primary signal current, corresponding core magnetization, and corresponding induced secondary voltage for a magnetized-core transformer with large signal input. Notice that the permanently magnetized core saturates

sooner for one polarity of signal and later for the other polarity.

To demagnetize (degauss) the transformer, it is necessary to pass a relatively large ac current through the primary and to very slowly decrease this current. The degaussing current is initially large enough to magnetize the core in the direction of each corresponding polarity excursion of this current, and overrides the initial magnetization. The object of decreasing the current slowly is so that each successive magnetization is slightly less than the preceding one of the opposite polarity. As the current is decreased, the core is less magnetized until it is no longer magnetized at all. Figures III-20A, B, and C illustrate the secondary waveforms as the transformer becomes demagnetized. **IMPORTANT:** Use a LOW FREQUENCY degaussing current, 1 Hz or so, to avoid inducing excessively high voltage in the secondary, and monitor the secondary with a *high impedance* oscilloscope. The Model 190's secondary is protected with a neon lamp, but the Model AM-1 could suffer insulation breakdown if the operator is not careful.

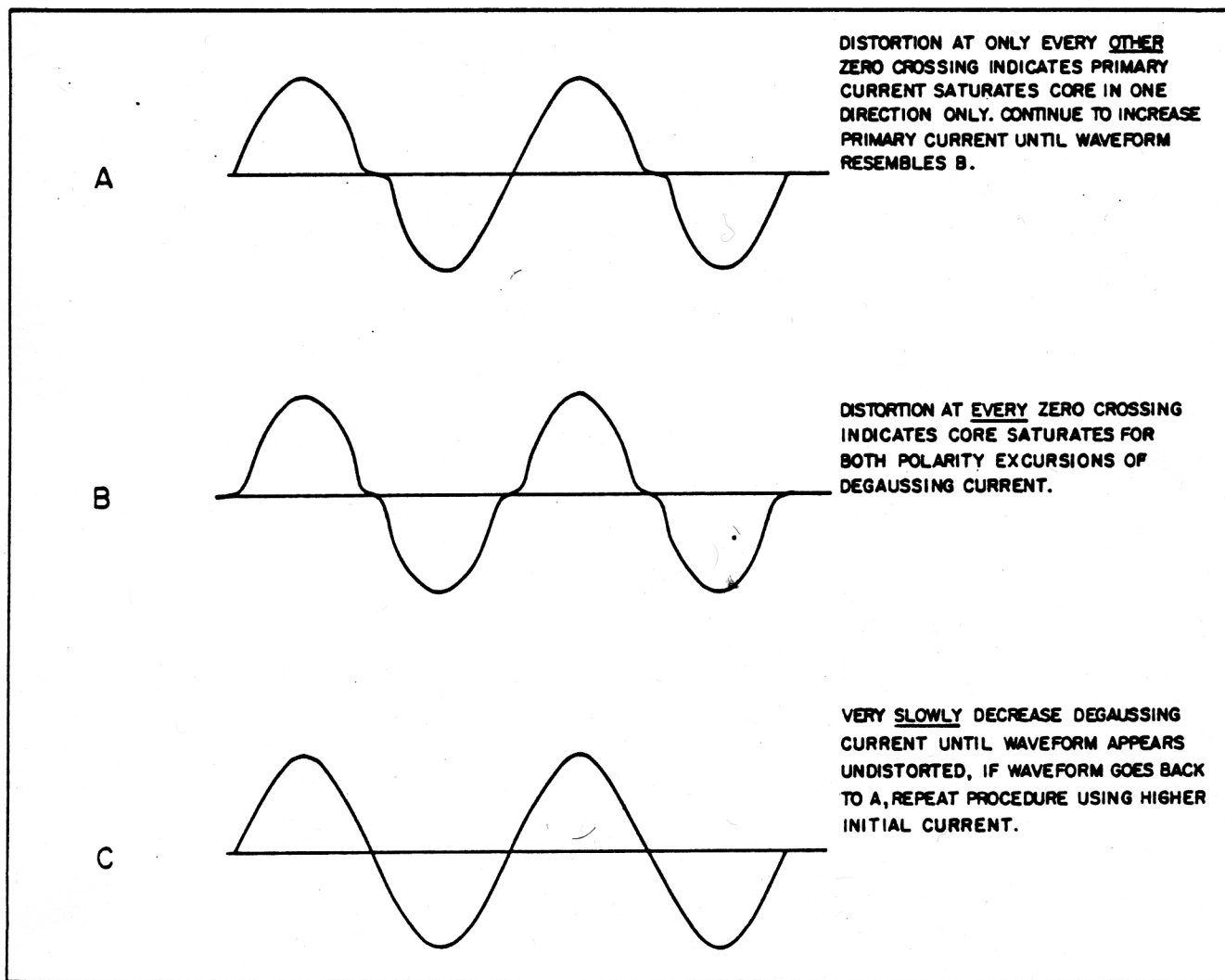

Figure III-20. DEGAUSSING WAVEFORMS

SECTION IV CIRCUIT DESCRIPTION

4.1 BLOCK DIAGRAM DISCUSSION

Refer to the Block and Wiring diagram on page VII-2. Note that the Model 113 is composed, essentially, of two operational amplifiers in tandem, with associated coupling, interstage LP/HP filter circuits, overload recovery circuit, and battery charging and test circuits.

4.1A INPUT COUPLING CIRCUIT

Individual input coupling switches select the inputs directly, through dc blocking capacitors, or select ground, and apply the selected inputs to the corresponding field-effect input transistors of A1. In the ac positions, the 100 megohm bleeders, R4 and R6, keep charge from building up on the capacitors, which would otherwise render the amplifier inoperative by offsetting the input FET's to cutoff. In the dc positions the signals go directly to the FET's, so that no bleeder is needed. (When in a dc position, if the signal source cannot bleed off charge, then the operator should provide an external bleeder.) The ground positions are convenient to use when setting the zero control, and when using the amplifier single-ended the coupling switch for the unused input should be set to the ground position.

4.1B GROUND-LOOP SUPPRESSION

A typical amplifier hook-up consists of a signal source or sources, amplifier, and readout device such as an oscilloscope. This type of hook-up usually has two ground connections between the signal source and amplifier: that which accompanies the power source and mounting rack, and that which accompanies the signal between the source and amplifier; see Figure IV-1. The two ground paths together form a loop that is exposed to varying environmental electric and magnetic fields. These fields, cutting the loop, generate emf's and currents in it. Various other sources of current in the loop may exist, such as current due to battery action at the connectors, etc. A significant

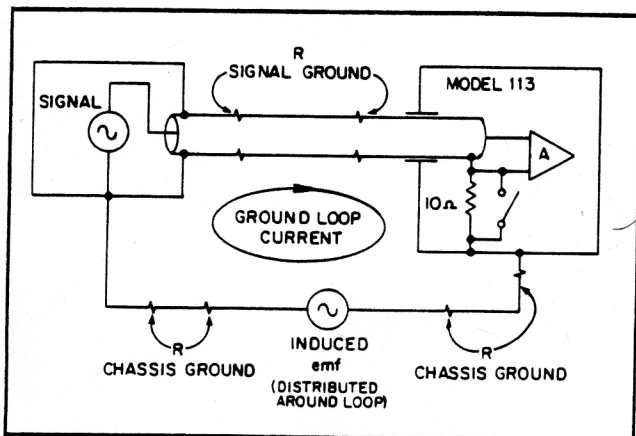

Figure IV-1. GROUND-LOOP CURRENT PATH

part of the ground-loop voltage (V_{gl}) is developed across the signal ground path, especially if the chassis ground is very good (it usually is and should be). This portion of the ground-loop voltage is amplified along with the desired signal, and, at very low signal levels, can cause a great deal of trouble. The Model 113 has provisions for eliminating this ground-loop voltage from the signal being amplified.

For doing this, the signal ground is not connected directly to chassis ground but to a 10 ohm resistor (R7) connected between the insulated outer shells of the input BNC's and chassis ground. Since 10 ohms is very much greater than the signal ground and chassis ground resistances, virtually all of the ground-loop voltage develops across the resistor. The first amplifier stage amplifies, either differentially or single-ended with respect to signal ground, and does not, therefore, amplify these ground-loop voltages. The output signal is referenced to chassis ground, and is free of ground-loop components.

4.1C GAIN DETERMINATION

The gain switch selects either x10 or x100 gain of the first amplifier, either x0.1, x0.2, x0.5, or x1 attenuation of an interstage attenuator, and either x10 or x100 gain of the second amplifier, as required to yield the gain marked at each position of the switch.

For the first four switch positions, the gain of A1 is x10. For the last six gain positions, the D section of the gain switch, S1, connects pins 10 and 12 of the PC board, thereby changing the gain of A1 to x100. How the gain of A1 is determined is explained in the schematic discussion for A1.

The interstage attenuator comprises R12 through R15. The A section of the gain switch selects the required attenuation level. The series attenuator output resistors, R16 through R19, adjust the attenuator output impedance so that the attenuator presents the same impedance to the rolloff circuit for all switch positions.

For all gain-switch positions, the 500 ohm-4.5 kilohm feedback attenuator at the inverting input of A2 makes A2 operate with a gain of at least 10. In the last three positions another 10:1 attenuator, comprising R9 and R10, is switched in by the F section of S1 to increase the gain to x100. The gain vernier, R11, is also in this feedback circuit.

4.1D ROLLOFF FILTER CIRCUIT

The high frequency and low frequency rolloff circuits are simple RC filters connected in tandem. The HF and LF rolloff switches select different capacitors for each rolloff frequency of the corresponding filter. The HF rolloff filter is composed of the series resistance presented by the gain attenuator circuit (15.9 kilohms for all gain switch posi-

tions) and a shunt capacitor selected by the HF rolloff switch. The LF rolloff filter is composed of the series capacitor selected by the LF rolloff switch and the 1.59 megohm shunt resistor at the input to A2. The transfer curves for these filters are given in Section III.

4.1E OVERLOAD FAST-RECOVERY CIRCUIT

The overload recovery button, when pressed, turns on FET's Q105 and Q106 connected between each input of A1 (PC terminals 5 & 6) and ground, and turns on a FET switch connected between the input of A2 and ground. Q105 and Q106 discharge the input capacitors, C1 and C2, and the FET switch between the input of A2 and ground discharges the LP and HP filter capacitors, thereby providing fast overload recovery.

4.1F POWER SUPPLY

Ac line power is stepped down by a transformer, then rectified. The + & - rectifier outputs are shunted with 12 V nickel-cadmium batteries. Batteries across the dc supply outputs provide sufficient regulation so that other regulation is not needed when ac line power is used. If the batteries are in a state of discharge, the transformer-rectifier circuit will automatically charge them while operating from ac. For battery operation, the unit is simply not plugged into the ac receptacle, so that the batteries alone provide power to the dc lines. For convenience in checking the batteries, a test circuit is provided.

4.2 CIRCUIT DESCRIPTIONS

4.2A DIFFERENTIAL PREAMPLIFIER (A1)

Refer to the schematic on page VII-3. This circuit differentially amplifies the input signals at the gates of Q100 A & B. These field-effect transistors are involved in two overlapping modes of operational amplifier feedback that determine gain and prevent amplification of common-mode signals.

Q102 provides constant current to R108, thereby fixing the voltage across R108. R105 and R119 provide an average of the source voltages of Q100 A & B to the base of Q103. Because Q103 and both sections of Q101 are forward biased (so that their emitter junctions have constant 0.6 V across them, approximately), the source-drain voltages of Q100 A & B are held constant at approximately the voltage across R108 (5 V). CR101 and CR107 are input protective diodes reverse biased by the collector voltage of Q104. If either input voltage becomes larger than about -3 V, the corresponding diode will conduct. The current path is through the Q104 collector junction and CR104 to ground. The gate junctions of the input FET's can handle positive input over-voltages without being damaged; they simply become forward biased and conduct.

The drain currents of Q100A & B pass to the collectors of Q101A & Q101B, and are developed as voltages for application to the bases of Q109A and Q109B. Q109A and Q109B are emitter followers which provide drive for Q114A and Q114B. Up to now amplification has been

single-ended for each half of the circuit. But differential signals cause the emitter-coupled pair, Q114A and Q114B, to provide equally and oppositely changing signal currents to their collector circuits, and common-mode signals tend to cause equal changes in the collector currents of Q114A and Q114B. Differential signals cause no change in the emitter currents of Q114A and Q114B but common mode signals do. Therefore the common-mode feedback signal is taken from the emitter resistor R146.

Q116 shifts the Q114A collector voltage level for driving Q117. Q117 inverts the Q114A signal, and helps Q114B drive the complementary output pair Q118 and Q119. Opposing the Q114A and Q114B outputs this way cancels common-mode signals that may remain in this part of the circuit. This is because the common-mode feedback loop, in keeping the voltage across R146 constant, cancels the common-mode signal component that would otherwise appear in the collector currents of Q114A and Q114B. CR108 temperature-compensates the emitter junction of Q113. CR112 and CR113 are forward biased diodes whose constant 0.6 V junction drops keep Q118 and Q119 forward biased. The primary gain-determining feedback is taken from the output through R131, and will be explained below.

Q111A and Q111B compare the common-mode feedback voltage at the base of Q111B to a reference voltage at the base of Q111A, and provide corresponding equal and opposite signal currents to their collector circuits. Q113 inverts the Q111A collector signal to aid Q111B in driving Q107 and Q108. Q107 and Q108 are complementary transistors that drive the junction of R123 and R126, providing balanced feedback to the sources of the input FET's.

The feedback action of an operational amplifier is such as to keep the summing point voltage equal to the reference point voltage. Since feedback is usually taken from the output, this condition, being the only stable condition, is taken advantage of in determining gain. In this circuit, however, we really have two dependent operational amplifier loops that determine gain and provide common-mode rejection.

The first feedback component we will consider is the common-mode feedback from Q107 and Q108. Corresponding currents through R123 and R126 drive the sources of Q100 A & B to counteract the common-mode component of the input signal. In this loop the base of Q111A is the reference point and the base of Q111B is the summing point. The high gain of the loop causes the feedback to the sources to completely counteract the common-mode component of input signal. In doing so it aids the feedback from the output in satisfying the requirements of the gain-determining loop, as will be seen from the following discussion.

The gates of the two input FET's can be considered as the reference points of two separate operational amplifiers, and the sources the corresponding summing points. Both of these operational amplifiers must be satisfied simulta-

neously by the feedback from the output and the feedback from the common-mode circuit. The latter has already been discussed regarding Q111A and Q111B as the operational amplifier inputs for that loop, but it is now apparent that the common-mode loop involves all three operational amplifier inputs. Both feedbacks work together in satisfying the two FET operational amplifier input requirements, and the output loop depends on the common-mode feedback in determining gain.

R131, R126, R123, and R128 (and R106 and R120 in x100 gain mode of A1) comprise the feedback voltage divider that determines gain. Even though connected to the junctions of R126-R131 and R123-R128, the sources of Q100 A & B do not affect the divider ratio because the common mode feedback to the junction of R123 and R126 supplies the source currents. Therefore gain is equal to the ratio of the sum of R131 and R128 to the sum of R123 and R126, as can be seen by stating the equilibrium source-source voltage (across R123 and R126) and determining the output voltage required to force the required current through the divider network to establish this voltage. To see how the common-mode feedback is necessary for the gain-determining feedback's proper operation, aside from providing the source currents to avoid loading of the divider network, set as an example the gate voltage of Q100A at 0 V and the gate voltage of Q100B at +1 V. In this example the source voltage of Q100B must be +1 V and the source voltage of Q100A 0 V (not counting small source-gate drops, which are ignored here). Without the common-mode feedback it would be quite impossible for any value of output voltage to force current through the divider network that can satisfy the loop. However, the common-mode feedback to the junction of R123 and R126, in forcing current through these resistors, allows the gain loop to be satisfied with -10 V at the output.

4.2B OUTPUT AMPLIFIER (A2)

Refer to the schematic on page VII-4. CR200 through CR203 are input protective diodes, biased through R203 and R204. Notice that CR201 and CR203 are forward biased, and their forward bias voltages (about 0.6 V) reverse bias CR200 and CR202. This scheme fixes the maximum input voltage at two diode drops (about 1 V).

Q201 is a field-effect transistor used as a switch for discharging the filter capacitors (see block diagram) when the OVL recovery button is pressed. During normal operation this switch is off and does not load the input signal.

The gates of field-effect transistors Q205 A & B are the reference and summing inputs of the A2 operational amplifier. The first stage of A2, comprising Q202, Q203A, Q203B, Q205 A & B, and Q206, is a differential stage with common-mode rejection. Q206 provides constant current to the common source point of Q205 A & B, and is primarily responsible for the common mode rejection of the first stage. Q202 provides constant current to R213, thereby fixing the voltage across R213 at about 3 V. Q203A and Q203B are forward biased, so that -- because the emitter junction voltage of a forward biased silicon

transistor is constant at about 0.6 V -- the source-drain voltages of Q205 A & B is held constant at approximately the voltage across R213. The differential-signal drain currents of Q205 A & B pass to the collectors of Q203A and Q203B, where they are developed as signal voltages for application to Q207A and Q207B.

Q207A and Q207B are emitter followers which provide drive for Q209 and Q210. Q209 and Q210 are an emitter-coupled pair, which provide equally and oppositely changing signal currents to their collector circuits. Q211 shifts the Q209 collector voltage level for driving Q212. Q212 inverts the Q209 signal for helping Q210 drive the complementary output pair Q213 and Q214. CR204 temperature compensates the emitter junction of Q212. CR205 and CR206 are forward biased diodes whose constant 0.6 V junction drops keep Q213 and Q214 forward biased.

The operational amplifier adjusts its output voltage to whatever value is required to keep the summing point voltage equal to the reference point voltage; therefore the gain of A2 is determined by feedback dividers R216-R217 and R9-R10 (see block diagram discussion, Subsection 4.1).

4.2C POWER SUPPLY CIRCUIT

Refer to the schematic on page VII-5. Ac line power is stepped down by T400, and the low-voltage output of T400 is rectified by CR400 and CR401. S400 selects the transformer's ac line voltage. The + & - rectifier outputs are shunted with 12 V nickel-cadmium batteries. Batteries across the dc supply outputs provide sufficient regulation so that other regulation is not needed. If the batteries are in a state of discharge, the transformer-rectifier circuit will automatically charge them while operating from ac. A Zener-referenced divider circuit, comprising CR300, Q300, and associated resistors, provides several biasing voltages to the amplifier circuits.

4.2D BATTERY TEST CIRCUIT

Q301 and Q302 are a Zener-referenced switch, to which the battery test switch connects one battery at a time, applying the voltages in the same polarity for both batteries. If the batteries are charged sufficiently, Q302 conducts and lights the panel lamp. If a battery is low, the lamp remains off when the switch is pressed in the direction of the corresponding battery. Note that the power switch must be on for this circuit to operate.

SECTION V SAFETY NOTICE

WARNING! POTENTIALLY LETHAL VOLTAGES ARE PRESENT INSIDE THIS APPARATUS. THESE SERVICE INSTRUCTIONS ARE FOR USE BY QUALIFIED PERSONNEL ONLY. TO AVOID ELECTRIC SHOCK, DO NOT PERFORM ANY SERVICING OTHER THAN THAT CONTAINED IN THE OPERATING INSTRUCTIONS UNLESS YOU ARE QUALIFIED TO DO SO. Any adjustment, maintenance and repair of the opened apparatus under voltage shall be avoided as far as possible and, if unavoidable, shall be carried out only by a skilled person who is aware of the hazard involved. When the apparatus is connected to a power source, terminals may be live, and the opening of covers or removal of parts is likely to expose live parts. The apparatus shall be disconnected from all voltage sources before it is opened for any adjustment, maintenance, or repair. Note that capacitors inside the apparatus may still be charged even if the apparatus has been disconnected from all voltage sources. Service personnel are thus advised to wait several minutes after unplugging the instrument before assuming that all capacitors are discharged. If any fuses are replaced, be sure to replace them with fuses of the same current and voltage rating and of the same type. The use of makeshift fuses and the short-circuiting of fuse holders are prohibited.

SECTION V

ALIGNMENT PROCEDURE

5.1 INTRODUCTION

The Model 113 is a stable, reliable instrument which should give trouble-free service. If a component is replaced, however, alignment may be necessary, depending on what circuit the component belongs to. For locating components and testpoints mentioned in this section, refer to the photograph and the circuit-board layout diagram in Section VII.

5.2 PRELIMINARY

Before operating from ac line power, make sure the rear-panel switch is in the position indicating the line voltage to be used, and be sure the proper size line fuse is installed (1/16 A for 115 V operation or 1/32 A for 230 V operation, located on inside rear panel). Then connect the ac line power and energize the instrument.

NOTE: This alignment procedure assumes that no components in the instrument are defective. The technician should make sure of this by making the appropriate voltage and signal checks before and during alignment.

5.3 EQUIPMENT NEEDED

- (1) Sinewave generator, 500 kHz range, low distortion.
- (2) Oscilloscope, 500 kHz frequency response and 1 mV/cm sensitivity.
- (3) Precision rms voltmeter, 0.1% accurate, such as Hewlett-Packard Model 400 EL.
- (4) Dc voltmeter, capable of measuring 0 V to within 1 mV, and capable of measuring 11 V to within 50 mV.
- (5) Variable dc supply, floating output, 12 V max.
- (6) Attenuators, 2000:1 and 10:1, 0.1% accurate.

5.4 A2 FET GATE SOURCE ZERO ADJ.

- (1) Use a short clip-lead to connect the wiper of the HF Rolloff switch to ground; connect at the switch.
- (2) Set the Gain switch to 10^4 .
- (3) Monitor the output BNC with the dc voltmeter.
- (4) Adjust R211 for 0 V (± 2 mV).
- (5) Remove the clip-lead.

5.5 COMMON-MODE REJECTION ADJ.

- (1) Set both input coupling switches to their ground positions.

- (2) Set the LF Rolloff switch to DC.
- (3) Adjust the front panel dc zero control for 0 V dc at the output BNC.
- (4) Monitor the output with the oscilloscope. If oscillation is present, adjust C200 to just beyond the point where oscillation stops.
- (5) Connect a 4 V pk-pk 100 Hz sinewave signal to the A and B inputs (common mode).
- (6) Set both input coupling switches to DC.
- (7) Set the gain switch to 10 k.
- (8) Set the HF Rolloff switch to 1 kHz.
- (9) Adjust R118 (CMR ADJ.) for minimum 100 Hz output, as indicated by the oscilloscope.
- (10) Adjust the signal generator to 2 V pk-pk, 100 kHz.
- (11) Set the HF Rolloff control to 300 kHz.
- (12) Adjust the gain as necessary to obtain a display on the oscilloscope (still connected to the output).
- (13) Adjust C105 and C116 for minimum 100 kHz on oscilloscope.
- (14) Adjust the signal generator to 2 V pk-pk, 300 kHz.
- (15) Set the Model 113 gain to 100.
- (16) Adjust C108 for minimum signal output.
- (17) Repeat steps 10 through 16 several times for optimum common-mode rejection.

5.6 GAIN CALIBRATION

- (1) Connect the 2000:1 attenuator to the output of the signal generator, and connect the output of the attenuator to the Model 113's A input.
- (2) Set the 113's A input coupling switch to DC, the B coupling switch to GND, the HF Rolloff switch to 300 kHz, LF Rolloff switch to DC, and set the Gain switch to 2 k (cal).
- (3) Monitor the output of the signal generator with the precision rms voltmeter; the attenuator must remain connected to the signal generator so that a change of load does not occur that would change the signal amplitude. Adjust the rms voltage to 1 V (exactly) @ 400 Hz.

- (4) Connect the precision rms voltmeter to the 113's output jack.
- (5) Adjust R221 for *exactly* the same reading as set in step (3). **NOTE:** This adjustment trims the gain only in the 2 k, 5 k, and 10 k positions of the Gain switch.

5.7 LOW FREQUENCY ROLLOFF COMPENSATION

- (1) Set the HF Rolloff control to 100 kHz, and set the LF Rolloff to DC.
- (2) Connect the signal generator to the 10:1 attenuator, and connect the attenuator output to the Model 113's A input.
- (3) Set the A coupling switch to DC, the B coupling switch to GND, and the gain switch to 10.
- (4) Monitor the 113's output with the precision rms voltmeter.
- (5) Adjust the signal generator to produce a reading of 1 V rms @ 10 kHz.
- (6) Set the LF Rolloff control to 1 kHz.
- (7) Adjust C200 to obtain exactly the same voltage reading as in step (5) above.

5.8 HIGH FREQUENCY ROLLOFF COMPENSATION

- (1) Connect the 10:1 attenuator to the output of the signal generator, and connect the output of the attenuator to the Model 113's A input.

- (2) Set the 113's A input coupling switch to DC, the B coupling switch to GND, the HF Rolloff switch to 300 kHz, the LF Rolloff switch to DC, and set the Gain switch to 10 (cal).
- (3) Monitor the output of the signal generator with the precision rms voltmeter; the attenuator must remain connected to the signal generator so that a change of load does not occur that would change the signal amplitude. Adjust the rms voltage to 1 V (exactly) @ 300 kHz.
- (4) Connect the precision rms voltmeter to the Model 113's output jack.
- (5) Adjust C26 (on the HF Rolloff switch) to produce a voltmeter reading of 0.707 V rms.

5.9 BATTERY TEST CALIBRATE

- (1) Set the Power switch to OFF (pushbutton OUT) and the BATTERY TEST toggle switch to either "+" or "-". If the BATTERY TEST toggle switch is left in the center (off) position, the external supply will be shorted out.
- (2) Connect the negative terminal of the variable dc supply to the brown lead of the Battery Test lamp.
- (3) Connect the positive lead of the supply to terminal #37 of the PC board.
- (4) Slowly adjust the supply to the point where the lamp comes on.
CAUTION: DO NOT EXCEED 13 V DC.
- (5) If necessary, adjust R309 until the test lamp comes on at 11 V (± 0.1 V) dc. The lamp should not come on below 10.7 V dc.

SECTION VI SAFETY NOTICE

WARNING! POTENTIALLY LETHAL VOLTAGES ARE PRESENT INSIDE THIS APPARATUS. THESE SERVICE INSTRUCTIONS ARE FOR USE BY QUALIFIED PERSONNEL ONLY. TO AVOID ELECTRIC SHOCK, DO NOT PERFORM ANY SERVICING OTHER THAN THAT CONTAINED IN THE OPERATING INSTRUCTIONS UNLESS YOU ARE QUALIFIED TO DO SO. Any adjustment, maintenance and repair of the opened apparatus under voltage shall be avoided as far as possible and, if unavoidable, shall be carried out only by a skilled person who is aware of the hazard involved. When the apparatus is connected to a power source, terminals may be live, and the opening of covers or removal of parts is likely to expose live parts. The apparatus shall be disconnected from all voltage sources before it is opened for any adjustment, maintenance, or repair. Note that capacitors inside the apparatus may still be charged even if the apparatus has been disconnected from all voltage sources. Service personnel are thus advised to wait several minutes after unplugging the instrument before assuming that all capacitors are discharged. If any fuses are replaced, be sure to replace them with fuses of the same current and voltage rating and of the same type. The use of makeshift fuses and the short-circuiting of fuse holders are prohibited.

SECTION VI TROUBLESHOOTING

6.1 INTRODUCTION

Although the Model 113 is a reliable instrument, occasional troubleshooting may be necessary; the procedures outlined in this section will be helpful. Once the problem is isolated to a specific circuit or component, or before attempting any troubleshooting, the user should contact Princeton Applied Research Corporation for advice on the relative merits of repairing the instrument himself, as opposed to returning it to the factory for repair. In any case, if the instrument is still in **WARRANTY**, it is particularly important that an authorized factory representative be contacted prior to attempting a field repair, as failure to do so could invalidate the Warranty.

6.2 PROCEDURE

To speed the troubleshooting process, try to determine any external causes of the trouble, and ascertain the symptoms when the amplifier is properly connected and tested. The set-up and procedure given in Initial Checks, Section II, will be helpful in determining the symptoms. Section IV, the Circuit Description, together with the layout diagrams and schematics (Section VII), should provide sufficient information for isolating the trouble. After checking the power supply voltages, the two amplifier stages may be checked by comparing output signals against input signals. After signal checks isolate the trouble to one of the amplifier stages or to the overload circuit, voltage and resistance checks can then specifically pinpoint the trouble. When doing resistance checks, it is sometimes possible to locate a bad transistor by checking the diode action of the base and collector junctions. While doing voltage checks, it is useful to remember that the base-to-emitter voltage of a forward biased silicon transistor (or diode junction) is roughly 0.6 V, and that the collector voltage of a saturated transistor is less than the base voltage (measured with respect to the emitter).

When troubleshooting and replacement of bad components is completed, it will probably be necessary to adjust some of the amplifier trim-components. Section V, the Alignment Procedure, should be consulted.

6.3 PRINTED CIRCUIT SOLDERING

If any components are removed from a printed-circuit board for inspection or replacement, be especially careful not to damage the foil. To remove components cleanly requires considerable care. Either one of two methods can be used to remove the solder from a pad. One entails the use of a vacuum bulb operated solder remover, and the other the use of a "wick". Both methods give good results. A brief description of each follows.

METHOD #1

Removing solder by means of a solder-remover is a simple process. The required equipment includes a vacuum bulb

operated solder remover (UNGAR type SOLDER-OFF #7805 recommended) and a good soldering iron of moderate power (WALL type 14HDG40120 with type W14KS tip). The solder must be removed from the pad on the side opposite the component. To remove a component, proceed as follows: Heat the pad on the side opposite the component. As soon as the solder flows, use the solder remover to remove the solder from the pad and hole. Take care not to heat any longer than necessary. After the solder has been removed, pull the lead through the hole from the component side of the board, using suitable long-nose pliers. If the lead is not free, continue to apply heat while pulling the lead from the hole. A component with leads which cannot be removed one at a time must have all of its leads free in the holes simultaneously; if it is not possible to free all of the leads in the holes, the component can be removed by applying heat to one of the leads and "rocking" the component to pull the lead through the hole as far as possible, and successively repeating this for each of the unfree leads until the component is free from the board. After the component has been removed, use the solder remover to completely clear all solder from the holes.

METHOD #2

Wicking is a method which uses a length of stranded wire or shielding braid as a wick to draw up the molten solder from the pad. Exceptionally clean work can be achieved by this method. Equipment required includes a good soldering iron (that recommended in Method #1 is excellent), a supply of stranded braid, and some rosin base soldering flux (ALPHA 346-35 or equivalent). Proceed as follows: Dip a few inches of stranded wire or shielding braid into the rosin-base soldering flux. Then place the wire or braid on top of the joint to be unsoldered, allowing some of the flux to flow over the joint. **NOTE:** Under no circumstances use an acid-base flux.

As shown in Figure VI-1, place a hot soldering iron on top of the stranded wire directly above the joint to be unsoldered. Within a few seconds, most of the solder in the joint will melt and flow quickly up the wick, leaving the joint area free of solder.

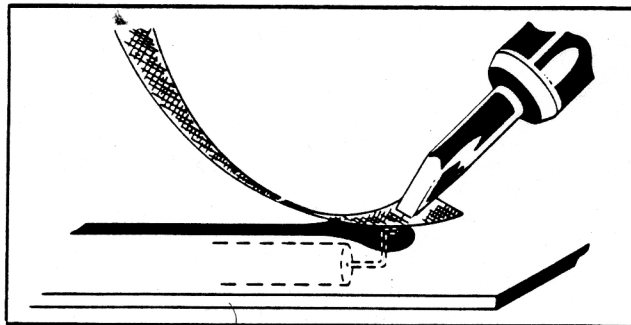

Figure VI-1. SOLDER REMOVAL BY WICKING

Lift the soldering iron and remove the wick before it freezes to the joint. Cut off the "filled" end of the wick (generally about 1/2 inch should be removed).

Inspect the joint. If any solder remains, repeat the procedure as required. Then, while applying heat to keep the solder in the hole molten, pull the lead through the hole. Components with leads which cannot be removed one at a time, such as transistors and trimpotentiometers, can be removed by applying heat to one of the leads and "rocking" the component to pull the lead through the hole as far as possible, and successively repeating this for each of the leads until the component is free from the board. After

the component has been removed, use wicking to completely clear all solder from the holes.

INSTALLING COMPONENTS

In returning the component or its replacement to the board, make sure the leads are bent on the proper centers and that they don't angle in or out. If they do not pass freely through the centers of the holes, they may catch the edge of the foil and lift it. Bend and cut the leads after inserting the component; then solder the leads with a hot iron (no larger than 40 watts) and a good grade of rosin core 60/40 solder. Be sure to apply heat no longer than necessary to achieve a good joint (usually a few seconds).

SECTION VII SCHEMATICS

	Page
Schematics, Table of	VII-1
Components Location Diagram	VII-2
Block and Wiring Diagram (4340-D-SD)	VII-3
Differential Preamplifier Schematic (4332-D-SD, sheet 1)	VII-4
Output Amplifier Schematic (4332-D-SD, sheet 2)	VII-5
Power Supply and Battery Test Circuit (4332-D-SD, sheet 3)	VII-6

TERMINAL #37

1350-0011
270-0005-0E11

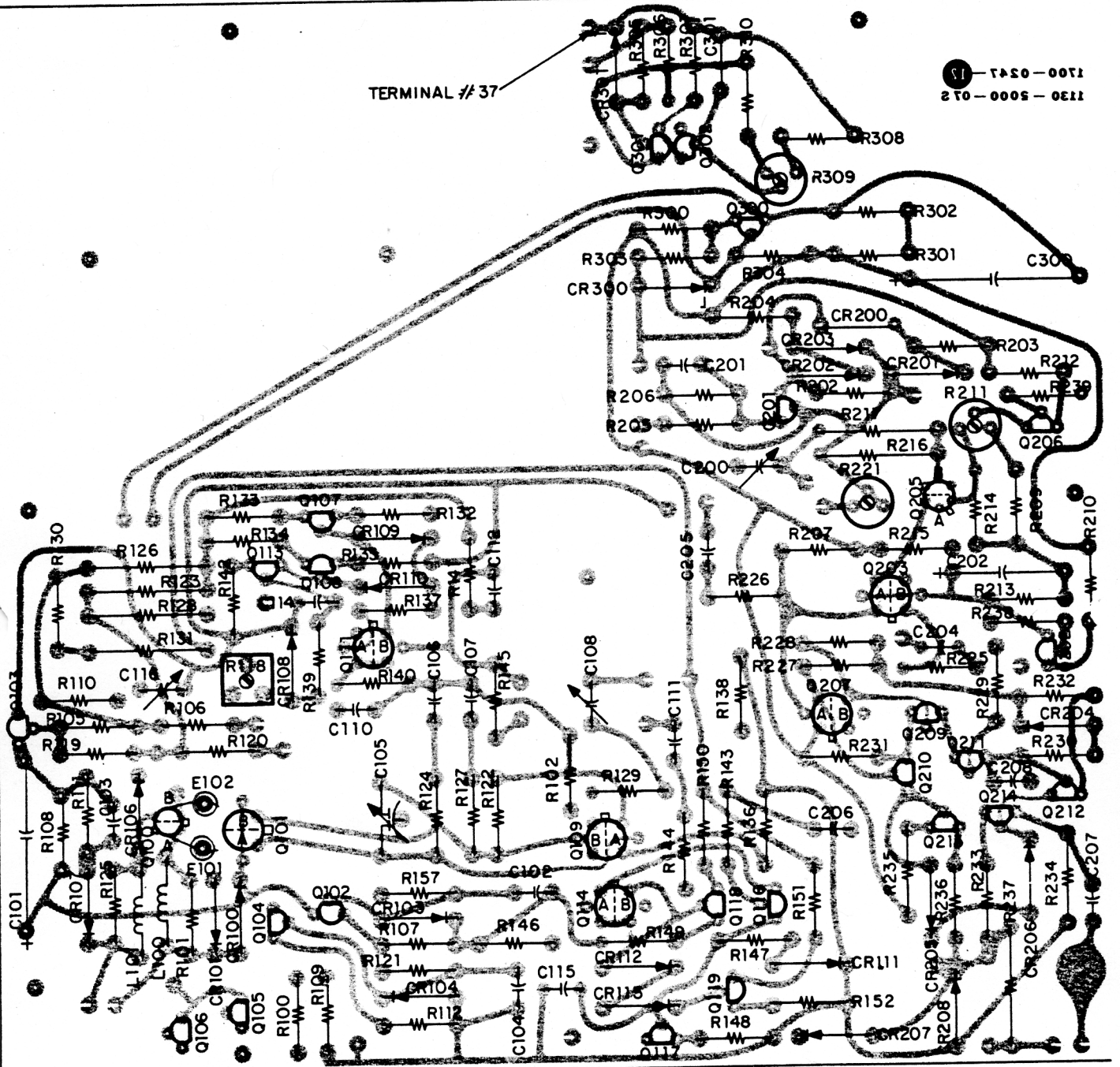

MODEL 113
MAIN BOARD

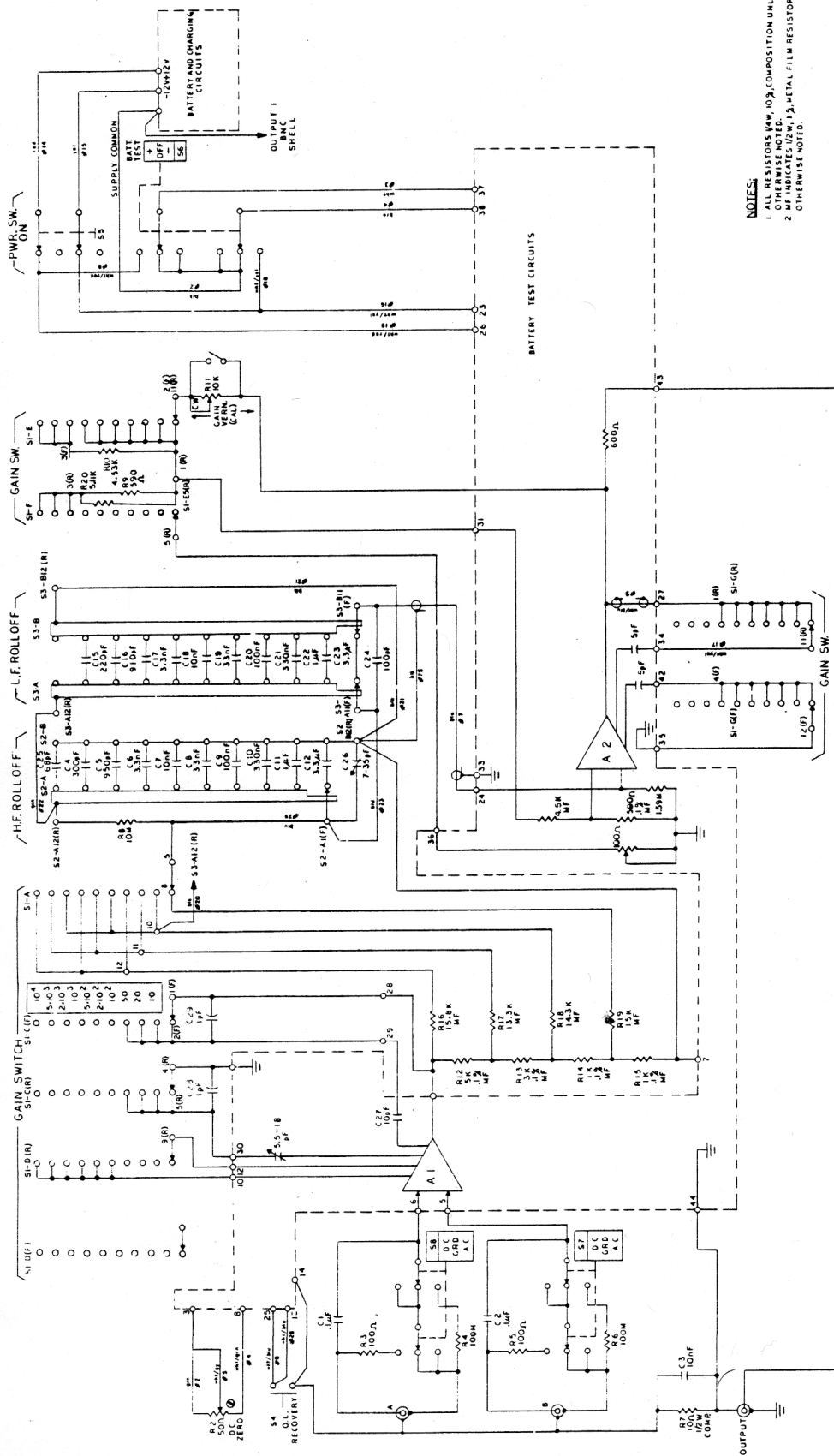

NOTES:
 1 ALL RESISTORS MW 10% COMPOSITION UNLESS OTHERWISE NOTED.
 2 ALL RESISTORS 1/2W, 1% METAL FILM RESISTOR UNLESS OTHERWISE NOTED.

MODEL 113

BLOCK AND WIRING DIAGRAM

A340 D | S D | E

REPRODUCED BY THE PRINCETON APPLIED RESEARCH CORPORATION FOR THE OPERATION AND MAINTENANCE OF THE PRINCETON APPLIED RESEARCH MODEL 113. THIS DOCUMENT IS NOT TO BE USED WITHOUT THE CONSENT OF THE PRINCETON APPLIED RESEARCH CORP.

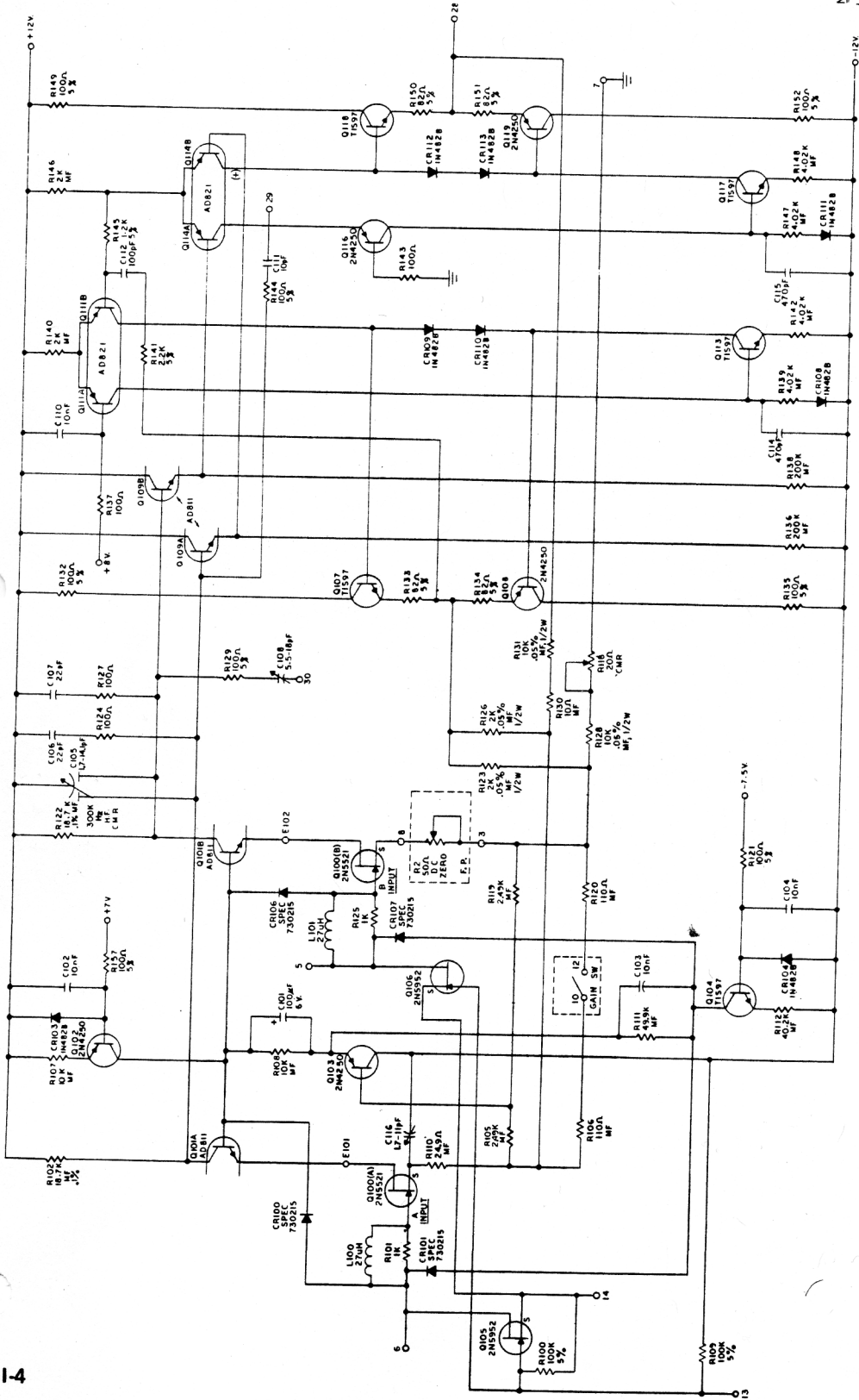

NOTES:

1. ALL RESISTORS (WV, 10%), COMPOSITION UNLESS OTHERWISE NOTED.
 2. MF INDICATES (WV, %) METAL FILM RESISTOR UNLESS OTHERWISE NOTED.

DIFFERENTIAL PREAMPLIFIER
 SUB-ASSEMBLY 1130-2000-075(PARTIAL)

MODEL 113

COPYRIGHT 1962 BY THE PRINCETON APPLIED RESEARCH CORPORATION. THIS DRAWING IS INTENDED FOR THE RESEARCH EQUIPMENT AND IS NOT TO BE REPRODUCED OR REPRODUCED WITHOUT WRITTEN CONSENT OF THE PRINCETON APPLIED RESEARCH CORP.

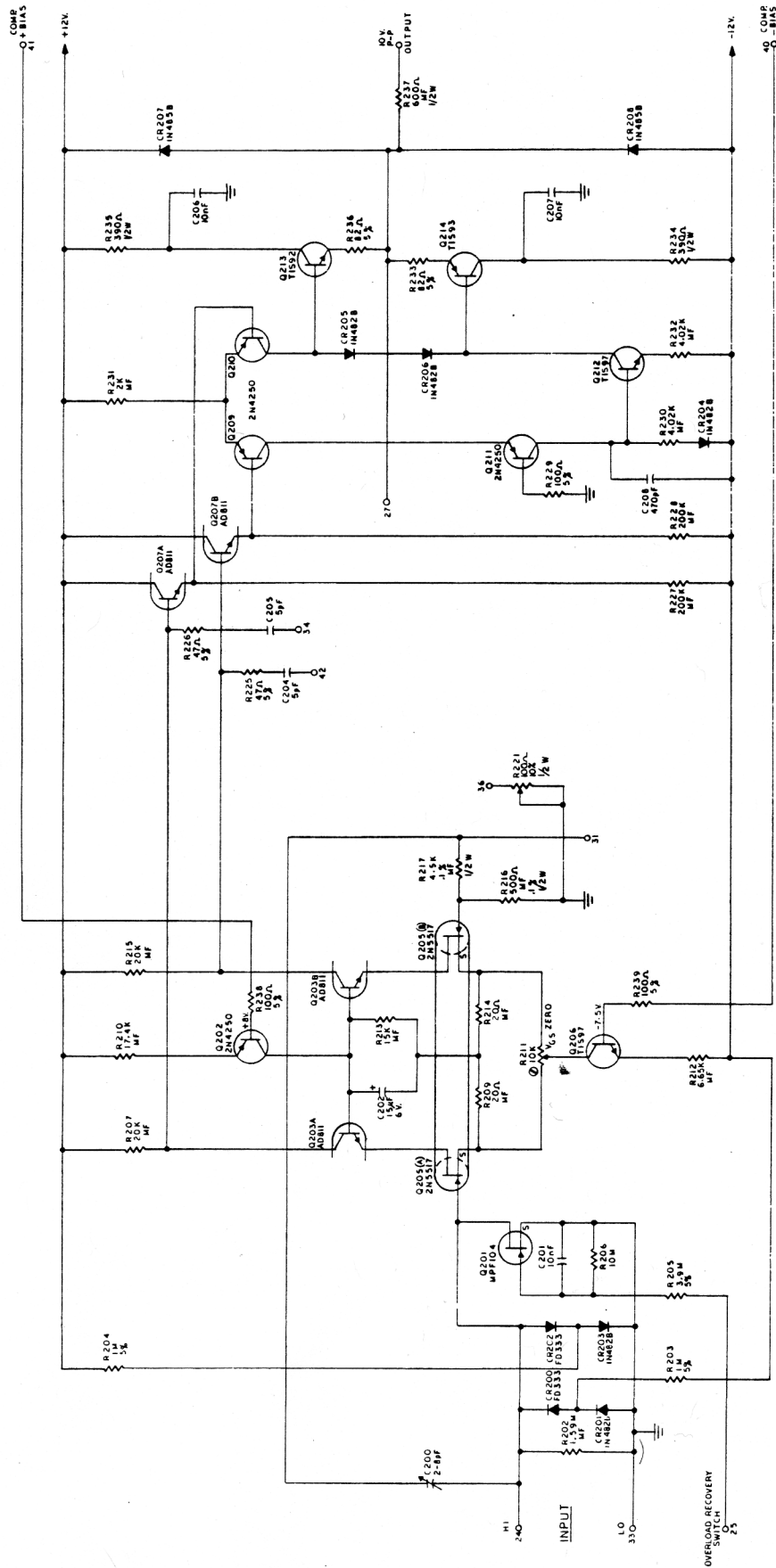

NOTES:
 1 ALL RESISTORS (V.W., I.O.), COMPOSITION UNLESS OTHERWISE NOTED.
 2 MF INDICATES (V.W., I.), METAL FILM RESISTOR UNLESS OTHERWISE NOTED.

MODEL 113

OUTPUT AMPLIFIER A-2
 SUB ASSEMBLY 1150-2000-07 (PARTIAL)

COPYRIGHT BY THE PRINCETON APPLIED RESEARCH CORPORATION. REPRODUCTION OF THIS DOCUMENT FOR OPERATION AND MAINTENANCE OF PRINCETON APPLIED RESEARCH EQUIPMENT IS NOT TO BE USED WITHOUT THE EXPRESS WRITTEN CONSENT OF THE PRINCETON APPLIED RESEARCH CORP.

SHEET 2 OF 3 4332 D 50

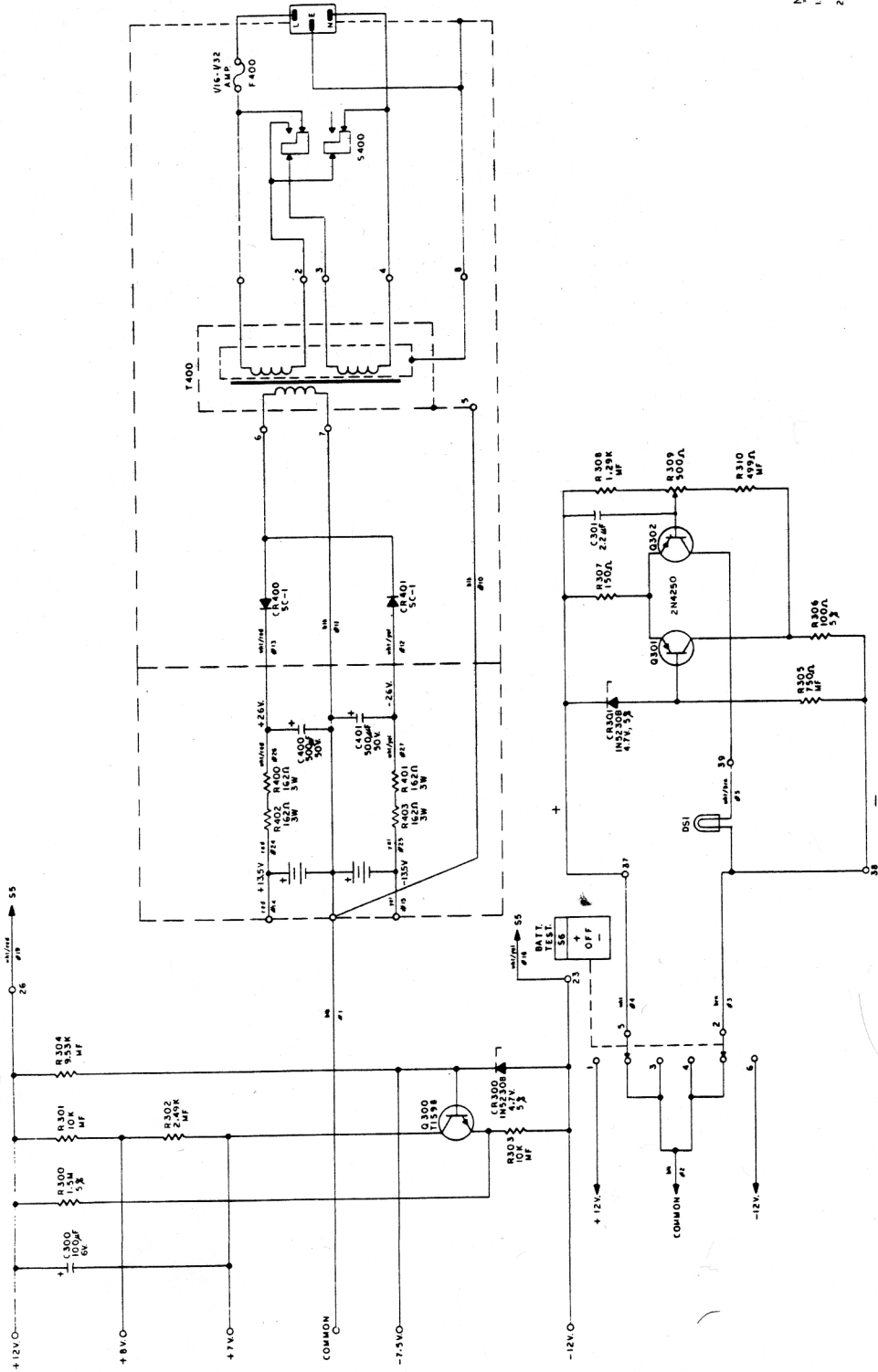

NOTES:

1. CAPACITORS (μF, 10% COMPOSITION UNLESS OTHERWISE NOTED.
2. M IF INDICATES /ΩM, 1% METAL FILM RESISTOR UNLESS OTHERWISE NOTED.

MODEL 113

POWER SUPPLY AND BATTERY TEST CIRCUITS
SUBASSEMBLY *1150-200007 (PARTIAL)

SHEET 3 OF 3 4332 D|S0

COPYRIGHT BY THE PRINCETON APPLIED RESEARCH CORPORATION. THIS DRAWING IS INTENDED FOR THE OPERATION OF THE EQUIPMENT AND IS NOT TO BE USED FOR REPRODUCTION OR REPRODUCTION WITHOUT WRITTEN CONSENT OF THE PRINCETON APPLIED RESEARCH CORP.

APPENDIX A INSTALLATION INSTRUCTIONS FOR DUAL RACK-MOUNTING KIT (1715-0008)

- (1) Set the two Model 113's on a bench side by side.
- (2) Remove the top cover of both units. The cover is secured by a single screw located on the under surface of the lip at the rear of the top cover. This screw is most easily removed by using a long screwdriver (or an extraordinarily short one). Once the screw has been removed, simply slide the cover back to where it can be lifted free of the unit.
- (3) Remove the bottom cover of both units. The bottom cover is held by the screws that secure the two rear rubber feet. When these screws are removed, the feet can be removed and the cover slid back and freed from the unit.
- (4) From the sides that will be adjacent after mounting, remove the side decorative plate (secured by two screws) and the side panel. These will not be replaced. Do not remove the shim plates exposed when the decorative plates are removed.
- (5) Using the two Allen head screws provided, secure the front coupling to one of the units. The shim plate exposed when the decorative strip was removed should be under the coupling.
- (6) As shown in the photograph, install the locking screw in the other instrument, taking care to retain the shim.
- (7) Lock the front of the two units together by sliding the head of the locking screw into the coupling slot.
- (8) Insert the rear mounting flange to secure the rear of the instruments together. The flange is simply pushed into the assembly from the rear.
- (9) Reinstall the bottom and top covers, securing the assembly. The two instruments can now be picked up and handled as a single assembly. This assembly can be mounted in any standard 19" rack. As long as the top and bottom covers of the individual instruments are secure, the two instruments will remain a single assembly. If the covers are removed, the two instruments will separate.

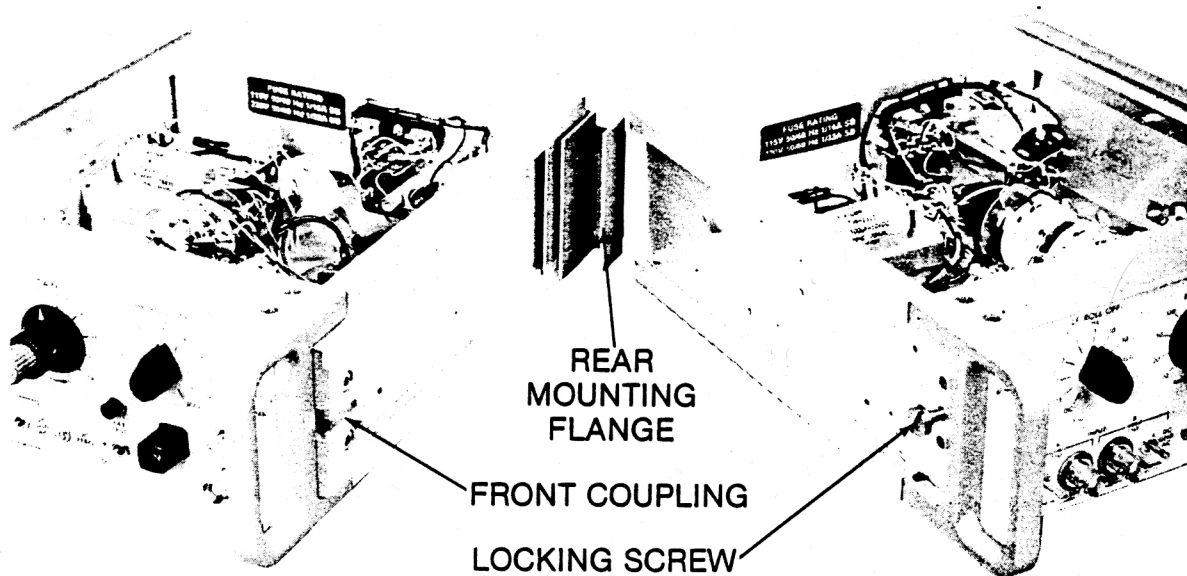

WARRANTY

EG&G Instruments Corporation warrants each instrument of its own manufacture to be free of defects in material and workmanship. Obligations under this Warranty shall be limited to replacing, repairing or giving credit for the purchase price, at our option, of any instrument returned, shipment prepaid, to our Service Department for that purpose within TWO years of delivery to the original purchaser, provided prior authorization for such return has been given by an authorized representative of EG&G Instruments Corporation.

This Warranty shall not apply to any instrument, which our inspection shall disclose to our satisfaction, to have become defective or unworkable due to abuse, mishandling, misuse, accident, alteration, negligence, improper installation, or other causes beyond our control. This Warranty shall not apply to any instrument or component not manufactured by EG&G Instruments Corporation. When products manufactured by others are included in EG&G Instruments Corporation equipment, the original manufacturer's warranty is extended to EG&G Instruments Corporation's customers.

EG&G Instruments Corporation reserves the right to make changes in design at any time without incurring any obligation to install same on units previously purchased.

THERE ARE NO WARRANTIES WHICH EXTEND BEYOND THE DESCRIPTION ON THE FACE HEREOF. THIS WARRANTY IS IN LIEU OF, AND EXCLUDES ANY AND ALL OTHER WARRANTIES OR REPRESENTATIONS, EXPRESSED, IMPLIED OR STATUTORY, INCLUDING MERCHANTABILITY AND FITNESS, AS WELL AS ANY AND ALL OTHER OBLIGATIONS OR LIABILITIES OF EG&G INSTRUMENTS CORPORATION, INCLUDING, BUT NOT LIMITED TO, SPECIAL OR CONSEQUENTIAL DAMAGES. NO PERSON, FIRM OR CORPORATION IS AUTHORIZED TO ASSUME FOR EG&G INSTRUMENTS CORPORATION ANY ADDITIONAL OBLIGATION OR LIABILITY NOT EXPRESSLY PROVIDED FOR HEREIN EXCEPT IN WRITING DULY EXECUTED BY AN OFFICER OF EG&G INSTRUMENTS CORPORATION.

SHOULD YOUR EQUIPMENT REQUIRE SERVICE

- A. Contact the Service Department (609-530-1000) or your local representative to discuss the problem. In many cases it will be possible to expedite servicing by localizing the problem to a particular plug-in circuit board.
- B. If it is necessary to send any equipment back for service, we need the following information.
 1. Model number and serial number.
 2. Your name (instrument user).
 3. Your address.
 4. Address to which the instrument should be returned.
 5. Your telephone number and extension.
 6. Symptoms (in detail, including control settings).
 7. Your purchase order number for repair charges (does not apply to repairs in warranty).
 8. Shipping instructions (if you wish to authorize shipment by any method other than normal surface transportation.)
- C. **U.S. CUSTOMERS** - Ship the equipment being returned to:

EG&G PARC
375 Phillips Blvd.
Trenton, NJ 08618
- D. **CUSTOMERS OUTSIDE OF U.S.A.** - To avoid delay in customs clearance of equipment being returned, please contact the factory or the nearest factory distributor for complete shipping information.
- E. Address correspondence to:

EG&G PARC
P.O. Box 2565
Princeton, New Jersey 08543-2565

Phone: (609) 530-1000
TELEX: 84-3409
FAX: 883-7259