

# MODEL 2100/2110 VideoBridge

## Auto LRC Meter

### Operation Manual

Part Number 46508

March 1981

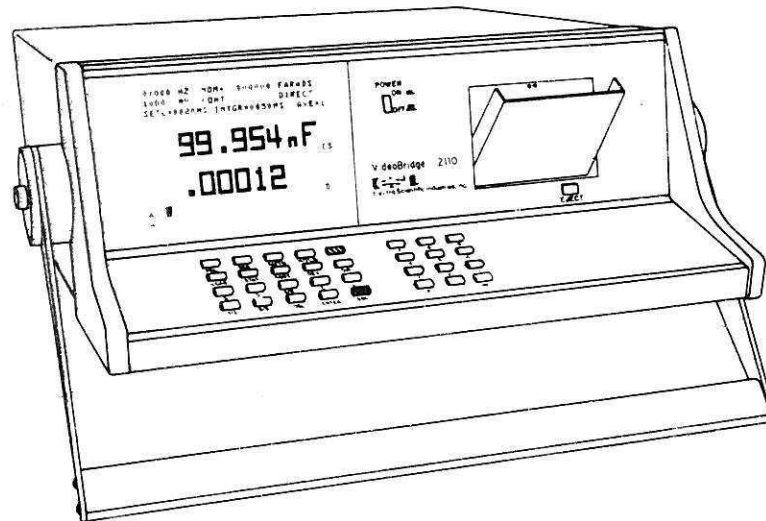

Electro Scientific Industries, Inc.

13900 N.W. Science Park Drive • Portland, Oregon 97229 • Telephone: (503) 641-4141 • Telex: 15-1246

©Copyright 1980 Electro Scientific Industries, Inc.  
All rights reserved • Litho in U.S.A.

ESI<sup>®</sup> Reserves the right to change specifications  
and other product information without notice.

# PROTECT AGAINST ELECTROSTATIC DISCHARGE

In this instrument there are MOS and FET semiconductors, which can be damaged by electrostatic discharge during handling. The following precautionary procedures are recommended to minimize this possibility.



**HANDLE STATIC SENSITIVE DEVICES ONLY AT A GROUNDING, STATIC-FREE WORK STATION**

**HANDLE DEVICES BY THE BODY. DO NOT TOUCH THE DEVICE LEADS.**



**BE SURE YOUR SOLDERING IRON TIP IS GROUNDING AND DO NOT USE SOLDER-SUCKERS THAT ARE NOT ANTI-STATIC PROTECTED**

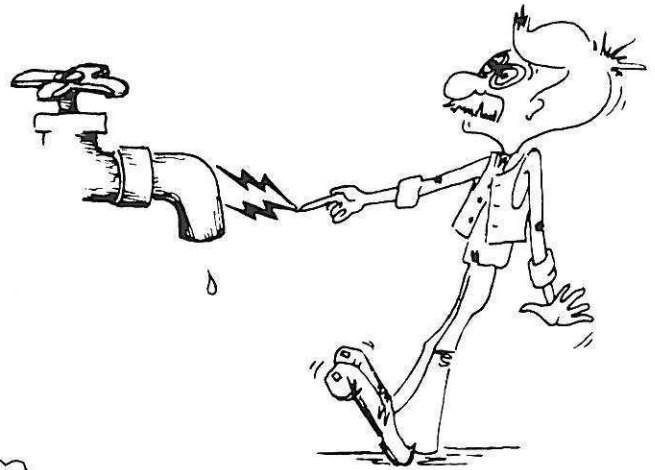

**DISCHARGE PERSONAL STATIC BEFORE HANDLING DEVICES**



**AVOID HANDLING WHENEVER POSSIBLE**



**USE ANTI-STATIC PACKAGING FOR HANDLING AND TRANSPORT**

**KEEP PARTS IN MANUFACTURER'S PROTECTED CONTAINERS**

**DO NOT SLIDE STATIC SENSITIVE DEVICES OVER ANY SURFACE AND AVOID PLASTIC, VINYL AND STYROFOAM IN WORK AREAS**





## TABLE OF CONTENTS

### WARNING

ELECTRICAL SHOCK HAZARD EXISTS WHEN BIAS SUPPLIES ARE CONNECTED TO THIS INSTRUMENT. WHEN EXTERNAL BIAS SUPPLIES ARE ATTACHED. THE BIAS VOLTAGES ARE PRESENT ON THE REAR PANEL BNC CONNECTORS. USE ONLY BIAS VOLTAGES UP TO +50DC WITH EACH BIAS SUPPLY CURRENT LIMITED AT 100MA. DO NOT TOUCH, CONNECT, OR DISCONNECT THE UNKNOWN OR BNC CABLES WHILE BIAS VOLTAGES ARE APPLIED.

## S SAFETY INFORMATION

|     |  |     |
|-----|--|-----|
| S.1 | INTRODUCTION                           | S-1 |
| S.2 | SAFETY TERMS AND MEANINGS              | S-1 |
| S.3 | SAFETY WARNINGS APPEARING IN MANUAL    | S-1 |
| S.4 | WARNING LABELS APPEARING ON INSTRUMENT | S-3 |

## 1 DESCRIPTION

|     |  |      |
|-----|--|------|
| 1.1 | INTRODUCTIONS                              | 1-1  |
| 1.2 | SPECIFICATIONS                             | 1-7  |
|     | 1.2.1 Electrical Specifications            | 1-7  |
|     | 1.2.2 Environmental Specifications         | 1-13 |
|     | 1.2.3 General Specifications               | 1-14 |
| 1.3 | CASSETTE RECORDER SPECIFICATIONS           | 1-15 |
| 1.4 | OPTIONS AND ACCESSORIES                    | 1-15 |
|     | 1.4.1 Accessories (available when ordered) | 1-15 |
|     | 1.4.2 Options (field installable)          | 1-16 |

## 2 OPERATION

|     |  |      |
|-----|--|------|
| 2.1 | FRONT PANEL CONTROLS AND INDICATORS      | 2-1  |
|     | 2.1.1 Keyboard and Key Definitions       | 2-1  |
|     | 2.1.2 CRT Display                        | 2-11 |
|     | 2.1.3 Cassette Tape Loader               | 2-12 |
|     | 2.1.4 Other Front Panel Controls         | 2-12 |
| 2.2 | REAR PANEL                               | 2-13 |
|     | 2.2.1 Rear Panel Controls and Connectors | 2-13 |
| 2.3 | INSTRUMENT SET UP                        | 2-15 |
|     | 2.3.1 Power Requirements                 | 2-15 |
|     | 2.3.2 Applying Power                     | 2-17 |
|     | 2.3.3 Connections to Unknown             | 2-18 |
|     | 2.3.4 Test-Leads vs Test-Fixtures        | 2-19 |
|     | 2.3.5 Zero Calibration                   | 2-19 |
|     | 2.3.6 Input Protection                   | 2-21 |

## TABLE OF CONTENTS (Continued)

|      |   |      |
|------|---|------|
| 2.4  | MEASUREMENT FUNCTIONS                                 | 2-22 |
|      | 2.4.1 Programming Measurement Functions               | 2-23 |
|      | 2.4.2 Exchanging Measurement Displays                 | 2-25 |
|      | 2.4.3 Series and Parallel Equivalent Circuit          | 2-27 |
| 2.5  | TEST SIGNAL   | 2-32 |
|      | 2.5.1 Frequency                                       | 2-32 |
|      | 2.5.2 Signal Levels                                   | 2-35 |
|      | 2.5.3 Measurement Range                               | 2-37 |
|      | 2.5.3.1 Range Hold                                    | 2-40 |
|      | 2.5.4 Continuous and Single Measurements              | 2-41 |
|      | 2.5.5 Delete  | 2-43 |
| 2.6  | DEVIATION MEASUREMENT                                 | 2-44 |
|      | 2.6.1 Deviation Mode                                  | 2-47 |
|      | 2.6.2 Absolute or Percent Deviation                   | 2-48 |
|      | 2.6.3 Exit Deviation Mode                             | 2-49 |
| 2.7  | COMPONENT SORTING                                     | 2-50 |
|      | 2.7.1 Bin Display                                     | 2-51 |
|      | 2.7.2 Programming Limits                              | 2-52 |
|      | 2.7.3 Bin Counters                                    | 2-57 |
|      | 2.7.4 Sort Mode                                       | 2-57 |
|      | 2.7.5 Component Sorting Example                       | 2-60 |
| 2.8  | MEASUREMENT SPEED                                     | 2-63 |
|      | 2.8.1 Programming Integration Time                    | 2-69 |
|      | 2.8.2 Programming Settling Time                       | 2-71 |
|      | 2.8.3 Programming Measurement Speed                   | 2-72 |
|      | 2.8.4 Programming Measurement Averaging               | 2-73 |
| 2.9  | CASSETTE TAPE LOADER                                  | 2-74 |
|      | 2.9.1 Cassette Tape Installation                      | 2-74 |
|      | 2.9.2 Cassette Tape Loader Maintenance                | 2-75 |
|      | 2.9.3 Cassette Tape Formatting                        | 2-76 |
|      | 2.9.4 Cassette Tape Programming                       | 2-77 |
|      | 2.9.4.1 Saving Parameters                             | 2-77 |
|      | 2.9.4.2 Loading Parameter Programs                    | 2-78 |
|      | 2.9.5 Program Write-Protect                           | 2-78 |
|      | 2.9.6 Cassette Care                                   | 2-79 |
| 2.10 | CODE KEY FUNCTION OPERATION                           | 2-80 |
|      | 2.10.1 $\Delta$ Capacitance Measurements with DC Bias | 2-80 |
| 2.11 | ERROR MESSAGES  | 2-82 |

## LIST OF ILLUSTRATIONS

| Fig. No. | Title                              | Page No. |
|----------|------------------------------------|----------|
| S-1      | Warning Label Locations            | S-4      |
| 1-1      | Model 2100/2110 Impedance Formulas | 1-3      |
| 2-1      | Model 2110 Front panel             | 2-1      |
| 2-2      | CRT Display Formats                | 2-11     |

| <u>Fig. No.</u> | <u>Title</u>                                 | <u>Page No.</u> |
|-----------------|--|-----------------|
| 2-3             | Rear Panel                                   | 2-13            |
| 2-4             | Line Voltage Settings                        | 2-15            |
| 2-5             | Power Cord Connectors                        | 2-16            |
| 2-6             | Power ON/OFF                                 | 2-17            |
| 2-7             | Connection to Unknown                        | 2-18            |
| 2-8             | Measurement Display                          | 2-24            |
| 2-9             | Series and Parallel Equivalent Circuit Modes | 2-29            |
| 2-10            | Status Display                               | 2-50            |
| 2-11            | Sorting Mode Preparation Checklist           | 2-58            |
| 2-12            | Measurement Sequence                         | 2-63            |
| 2-13            | Sample Time                                  | 2-64            |
| 2-14            | Cycle Time                                   | 2-65            |
| 2-15            | Measurement Time                             | 2-66            |
| 2-16            | Measurement Averaging                        | 2-66            |
| 2-17            | Cassette Tape Installation                   | 2-75            |
| 2-18            | Cleaning Recording/Playback Heads            | 2-76            |
| 2-19            | Cassette Tape File Areas                     | 2-77            |
| 2-20            | Program Write-Protect Feature                | 2-79            |
| 2-21            | Capacitance Measurements with Bias           | 2-81            |

#### LIST OF TABLES

| <u>Table No.</u> | <u>Title</u>                                | <u>Page No.</u> |
|------------------|---|-----------------|
| 1-1              | Capacitance Measurement Accuracy            | 1-8             |
| 1-2              | Inductance Measurement Accuracy             | 1-9             |
| 1-3              | Resistance/Conductance Measurement Accuracy | 1-10            |
| 1-4              | Impedance Ranges vs Test Signal Level       | 1-11            |
| 2-1              | Inspect Protection Limits                   | 2-21            |
| 2-2              | Measurement Functions                       | 2-22            |
| 2-3              | Test Frequencies                            | 2-33            |
| 2-4              | Test Level vs Impedance                     | 2-35            |
| 2-5              | Model 2100/2110 Impedance Ranging Chart     | 2-38            |
| 2-6              | Reactance Chart                             | 2-39            |
| 2-7              | Integration Time Chart                      | 2-69            |
| 2-8              | Measurement Speeds                          | 2-72            |





## SECTION S

# SAFETY INFORMATION

### S.1 INTRODUCTION

Read and follow the CAUTIONS and WARNINGS in this manual. They are designed to emphasize safety during all phases of operation and maintenance.

### S.2 Safety Terms And Meanings:

**CAUTION** -- Statements identify conditions or practices that could result in damage to the equipment or property.

**WARNING** -- Statements identify conditions or practices that could result in personal injury or loss of life. In addition, damage to the equipment or other property may result.

**DANGER** -- Indicates a personal injury hazard is near the marking.

### S.3 The following WARNINGS appear in this manual:

#### WARNING

ELECTRICAL SHOCK HAZARD EXISTS WHEN BIAS SUPPLIES ARE CONNECTED TO THIS INSTRUMENT. WHEN EXTERNAL BIAS SUPPLIES ARE ATTACHED, THE BIAS VOLTAGES ARE PRESENT ON THE REAR PANEL BNC CONNECTORS. USE ONLY BIAS VOLTAGES UP TO +50VDC WITH EACH BIAS SUPPLY CURRENT LIMITED AT 100mA. DO NOT TOUCH, CONNECT, OR DISCONNECT THE UNKNOWN OR BNC CABLES WHILE BIAS VOLTAGES ARE APPLIED.

#### WARNING

TO PREVENT POSSIBLE ELECTRICAL SHOCK OR DAMAGE TO THE INSTRUMENT, CHECK LOCAL ELECTRICAL STANDARDS BEFORE SELECTING A POWER CORD. THE INFORMATION PRESENTED HERE MAY NOT BE CORRECT FOR ALL LOCATIONS WITHIN THE REFERENCED AREAS.

**WARNING**

TO AVOID PERSONAL INJURY FROM ELECTRIC SHOCK DO NOT REMOVE INSTRUMENT COVERS OR PERFORM ANY MAINTENANCE OTHER THAN DESCRIBED IN THIS MANUAL. INSTALLATION AND MAINTENANCE PROCEDURES DESCRIBED IN THIS MANUAL ARE TO BE PERFORMED BY QUALIFIED SERVICE PERSONNEL ONLY.

**CAUTION**

BECAUSE OF DIFFERING POWER REQUIREMENTS, INSTRUMENTS SHIPPED OUTSIDE THE UNITED STATES MAY REQUIRE A DIFFERENT POWER CORD CONNECTOR. WHEN PLACING A NEW CONNECTOR ON THE POWER CORD, CARE MUST BE TAKEN TO ASSURE THE WIRES ARE CONNECTED PROPERLY. THE GREEN OR GREEN-WITH-YELLOW STRIPE WIRE IS ALWAYS CONNECTED TO EARTH GROUND. THE WHITE OR LIGHT BLUE WIRE IS CONNECTED TO THE NEUTRAL SIDE OF THE POWER LINE. AND, THE BLACK OR BROWN WIRE IS CONNECTED TO THE HIGH SIDE OF THE POWER LINE. FIGURE 2-5 ILLUSTRATES THE AVAILABLE POWER CORDS, WHICH MAY BE USED IN VARIOUS COUNTRIES INCLUDING THE STANDARD POWER CORD FURNISHED WITH THE INSTRUMENT. ELECTRICAL CHARACTERISTICS AND COUNTRIES USING EACH CONNECTOR ARE LISTED IN THE FIGURE.

**CAUTION**

TO AVOID DAMAGE TO CIRCUITRY, TURN POWER OFF WHILE PLUGGING IN OR REMOVING CIRCUIT ASSEMBLIES.



S.4 The following WARNING labels appear on the instrument, see Figure S-1 for their locations.

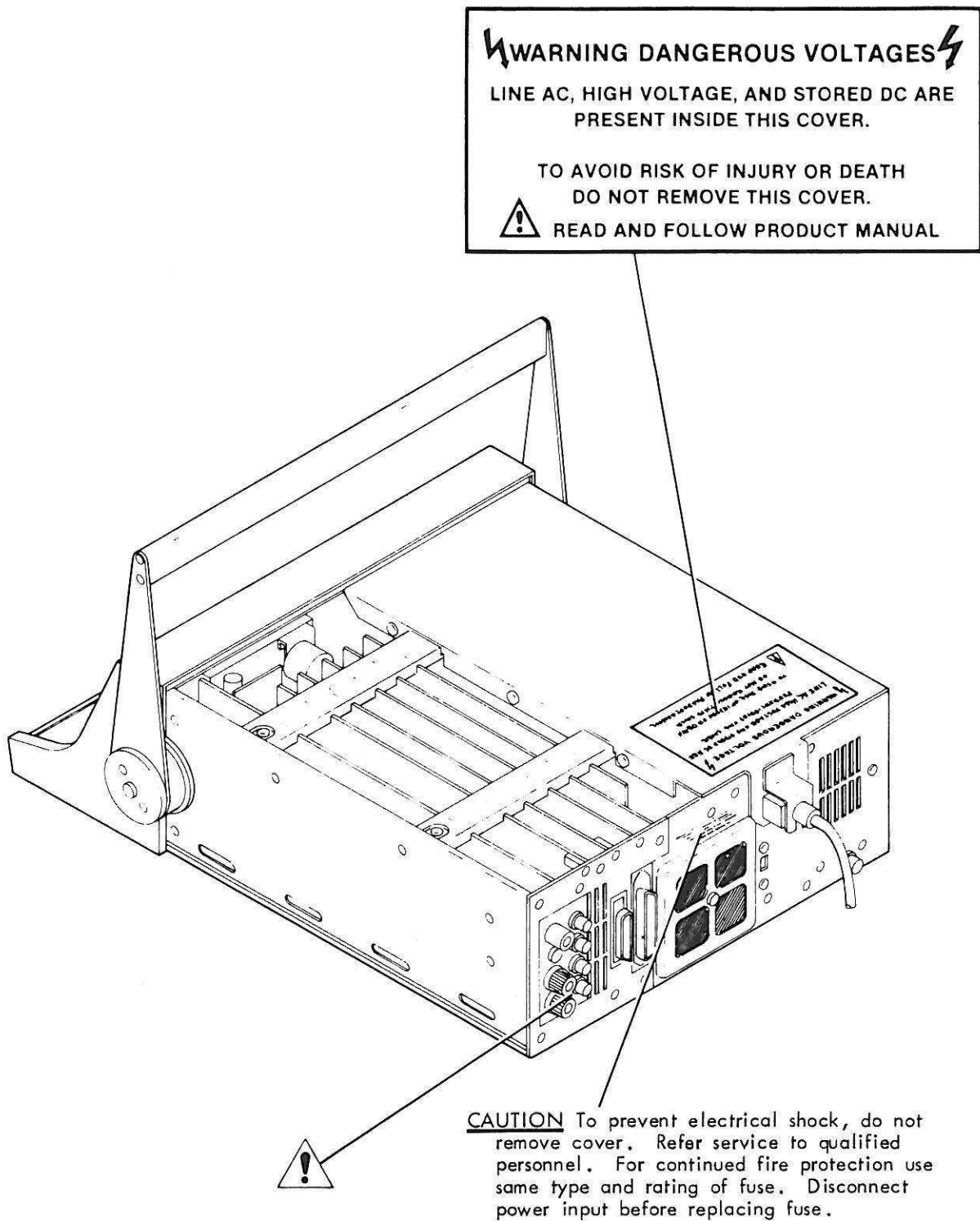

Figure S-1. Warning Label Locations



# SECTION 1

## DESCRIPTION

### 1.1 INTRODUCTION

ESI's Model 2100/2110 Auto LRC Meters are two extremely versatile impedance measuring instruments. They feature variable test frequencies (~3000), programmable test-signal levels, component sorting, and CRT displays. They measure inductors (L), resistors (R), capacitors (C), and display up to 10 impedance characteristics in 26 different combinations. Basic accuracy of 0.05% added to the widest ranges available for passive component measurements make the 2100/2110 the most informative impedance measuring instruments available today.

Mass storage for test parameter setups and measurement results is the feature that set the Model 2110 apart from the Model 2100. The 2110 has a cassette tape loader that uses mini-cassette tapes for storing and reloading test parameter programs.

The 2100/2110 measurement system is basically composed of a frequency selectable, digital sinewave generator, a test-level regulator, precision range resistors, a phase-sensitive voltmeter, and a charge balancing analog-to-digital converter. All measurements, calculations, and displays take place under the watchful eye of the 2100/2110's Z80 micro-computer.

The level regulator's sinewave output is imposed across both the device-under-test and a selected precision, standard range resistor. The resulting voltage-drops are measured in both phase and amplitude by the phase-sensitive voltmeter. The phase-sensitive voltmeter produces four voltage outputs labeled:

- $V_0$  or V unknown  $0^\circ$
- $V_1$  or V unknown  $90^\circ$
- $V_2$  or V standard  $0^\circ$
- $V_3$  or V standard  $90^\circ$

These voltages are serially processed by the A/D converter with resistance (R) and reactance (X), when in the mA mode, or conductance (G) and susceptance (B), when in the mV mode, computed by the Z80 CPU.

mV MODE

$$G_{\text{unknown}} = \frac{V_0 V_2 + V_1 V_3}{(V_0)^2 + (V_1)^2} \times R_{\text{standard}}$$

$$B_{\text{unknown}} = \frac{V_0 V_3 - V_1 V_2}{(V_0)^2 + (V_1)^2} \times R_{\text{standard}}$$

mA MODE

$$R_{\text{unknown}} = \frac{V_0 V_2 + V_1 V_3}{(V_2)^2 + (V_3)^2} \times R_{\text{standard}}$$

$$X_{\text{unknown}} = \frac{V_1 V_2 - V_0 V_3}{(V_2)^2 + (V_3)^2} \times R_{\text{standard}}$$

All other impedance parameters are computed using the results of these measurements, the test frequency, and the formulas in Figure 1-1.

| MILLIAMPERE MODE<br>WITH SHORT CIRCUIT CORRECTION<br>(RANGE 0 → 3) | MILLIVOLT MODE<br>WITH OPEN CIRCUIT CORRECTION<br>(RANGE 4 → 8) |
|--|---|
| $R_s = (R_s)_m - (R_s)_0$  | $G_p = (G_p)_m - (G_p)_0$                                       |
| $X_s = (X_s)_m - (X_s)_0$  | $B_p = (B_p)_m - (B_p)_0$                                       |
| $D = \frac{R_s}{ X_s }$  | $D = \frac{G_p}{ B_p }$   |
| $Q = \frac{ X_s }{R_s}$  | $Q = \frac{ B_p }{G_p}$   |
| $L_s = \frac{X_s}{2\pi f}$   | $L_s = \frac{-B_p}{2\pi f(G_p^2 + B_p^2)}$                      |
| $L_p = \frac{R_s^2 + X_s^2}{2\pi f X_s}$                           | $L_p = \frac{-1}{2\pi f B_p}$                                   |
| $C_s = \frac{-1}{2\pi f X_s}$                                      | $C_s = \frac{G_p^2 + B_p^2}{2\pi f B_p}$                        |
| $C_p = \frac{-X_s}{2\pi f(R_s^2 + X_s^2)}$                         | $C_p = \frac{B_p}{2\pi f}$                                      |
| $B_p = \frac{-X_s}{R_s^2 + X_s^2}$                                 | $X_s = \frac{-B_p}{G_p^2 + B_p^2}$                              |
| $G_p = \frac{R_s}{R_s^2 + X_s^2}$                                  | $R_s = \frac{G_p}{G_p^2 + B_p^2}$                               |
| $ Z  = \sqrt{R_s^2 + X_s^2}$                                       | $ Z  = \frac{1}{\sqrt{G_p^2 + B_p^2}}$                          |
| $ Y  = \frac{1}{\sqrt{R_s^2 + X_s^2}}$                             | $ Y  = \sqrt{G_p^2 + B_p^2}$                                    |

|                           |                        |                 |
|---------------------------|------------------------|-----------------|
| R = Resistance            | p = Parallel measured  | L = Inductance  |
| s = Series Measurement    | X = Reactance          | f = Frequency   |
| m = Measured value        | B = Susceptance        | C = Capacitance |
| 0 = Zero correction value | D = Dissipation factor | Z = Impedance   |
| G = Conductance           | Q = Quality factor     | Y = Admittance  |

Figure 1-1. Model 2100/2110 Impedance Formulas



The 2100/2110 also offers a wide variety of test conditions:  $\approx 3000$  test frequencies (between 20Hz and 20kHz), test signal levels (10mV to 1500mV or 1mA to 100mA), settling times to 1500ms, integration time to 600ms or choose from 3 preset combinations of settling time, integration time, and number of measurements averaged are programmed for FAST, MEDIUM, or SLOW operation, and select up to 20 measurements for averaging.

Special measurement features built into the instruments include: displayed deviations from a nominal value in either absolute or percentage terms; component sorting mode that characterizes components into 10 tolerance categories or as a reject while counting the number of components that fall into each category; and automatic zero calibration for test-lead or test-fixture impedances.

Communication interfacing -- the meaningful transfer of information between instrument and its operator is the reason for the cathode-ray tube (CRT) display. The 5-inch CRT provides two levels of information and two display formats. In the direct display format, the CRT provides large easy-to-read alphanumeric characters to highlight up to 6-digits of measurement information, and small alphanumeric characters to display the settings for frequency, nominal value, measurement mode, test signal level, settling time, integration time, and number of measurements averaged. The versatility of the instrument is again exemplified by the CRT's display of component sorting information. It simultaneously displays + and - limits for all component tolerance bins, and their component counters capable of up to 64000 counts for each bin.



Three, four, five, or six digits of measurement information can be displayed on the CRT. The number of digits displayed is related to the resolution contained in the A/D conversion process. More commonly, the number of digits displayed is a product of integration time and the number of measurements averaged. Three digits are displayed when integration time is 4ms or less. Integration times greater than 4ms display four digits, while MEDium measurement speed (50ms integration time) provides five displayed digits. A full six digits are displayed anytime the product of integration time and measurements averaged is  $\geq 500$ ms (50ms integration time and 10 averages, or 25ms integration time and 20 averages).

The Model 2100/2110 offer maximum flexibility with a wide range of options. All options are field installable and are designed to tailor instrument operation to specific testing requirements. They operate as stand-alone benchtop testers or can be used with auxiliary handling equipment and easily fits into sophisticated automatic testing systems.

(BLANK)

## 1.2 SPECIFICATIONS

### 1.2.1 Electrical Specifications

Measurement Functions:

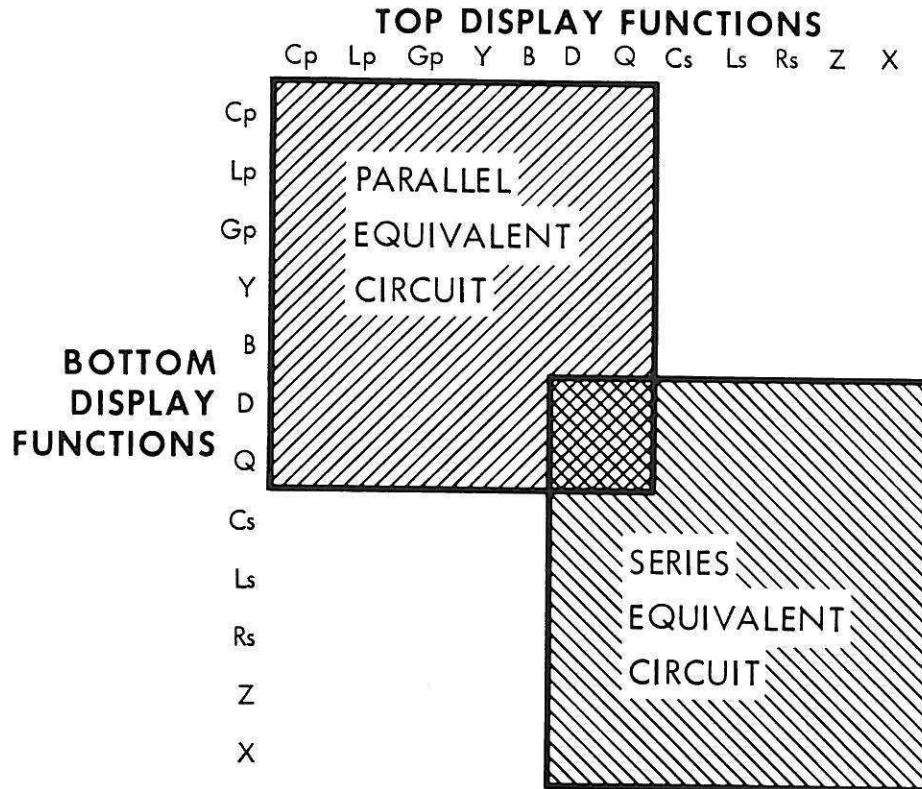

**NOTE:** Any top display can be displayed with any bottom display within the shaded areas.

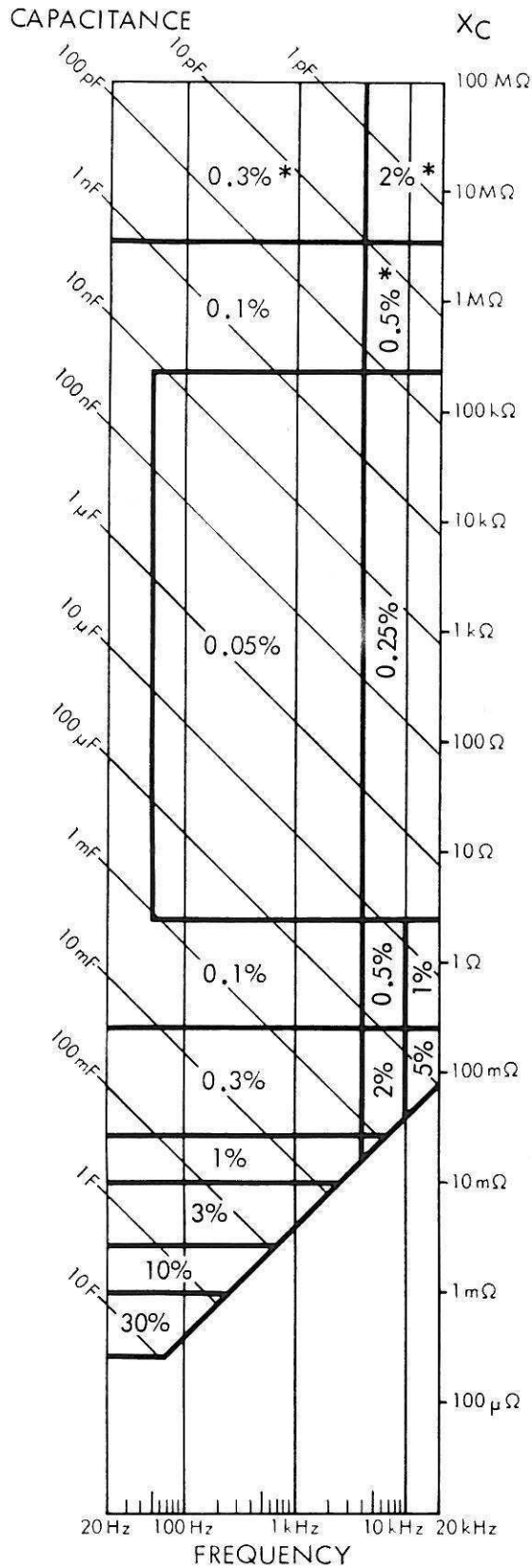

Table 1-1. Capacitance Measurement Accuracy

$$* + \left( \frac{0.01 \text{ pF}}{f(\text{kHz})} + 0.01 \text{ pF} \right)$$

If  $D > 1$ , add  $[0.05\% (1 + 0.3D^2)]$   
to accuracies shown

TEST CONDITIONS:

- Level -1000 mV/100 mA
- Speed -Medium
- Range -Auto
- Bias -Off
- Calibrated -Zero

$$V_{\text{test}} = 800 \text{ mV to } 1500 \text{ mV}$$

$$I_{\text{test}} = 50 \text{ mA to } 100 \text{ mA}$$

For  $V_{\text{test}} < 800 \text{ mV}$  Multiply Basic Accuracy  
by  $\left(1 + \frac{300}{\text{mV}}\right) \left(1 + \frac{\text{kHz}}{10}\right)$

For  $I_{\text{test}} < 50 \text{ mA}$  Multiply Basic Accuracy  
( $Z > 16 \Omega$ ) by  $\left(1 + \frac{300}{\text{mA} \times Z(\Omega)}\right)$

For  $I_{\text{test}} < 50 \text{ mA}$  Multiply Basic Accuracy  
( $Z \leq 16 \Omega$ ) by  $\left(1 + \frac{30}{\text{mA}}\right)$

INDUCTANCE

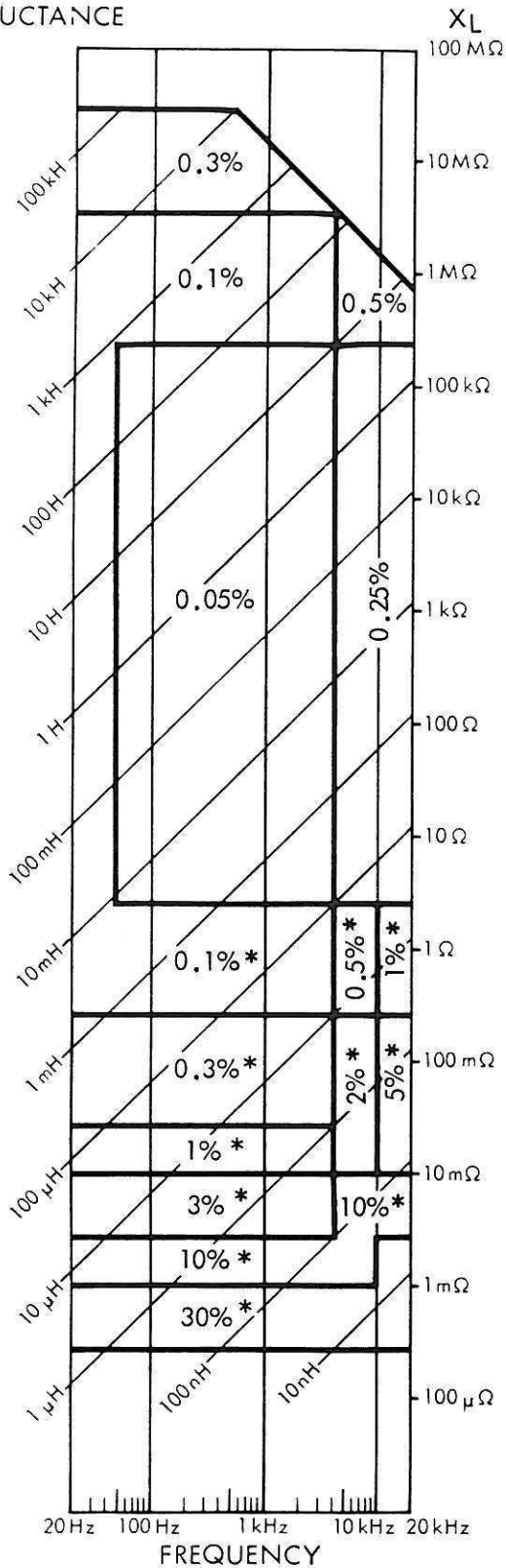

Table 1-2. Inductance Measurement Accuracy

$$* + \left( \frac{0.01 \mu\text{H}}{f(\text{kHz})} + 0.01 \mu\text{H} \right)$$

If  $D > 1$ , add  $[0.1\% (1 + 0.3D^2)]$  to accuracies shown

TEST CONDITIONS:

- Level -1000 mV/100 mA
- Speed -Medium
- Range -Auto
- Bias -Off
- Calibrated -Zero

$$V_{\text{test}} = 800 \text{ mV to } 1500 \text{ mV}$$

$$I_{\text{test}} = 50 \text{ mA to } 100 \text{ mA}$$

For  $V_{\text{test}} < 800 \text{ mV}$  Multiply Basic Accuracy by  $\left(1 + \frac{300}{\text{mV}}\right) \left(1 + \frac{\text{kHz}}{10}\right)$

For  $I_{\text{test}} < 50 \text{ mA}$  Multiply Basic Accuracy ( $Z > 16 \Omega$ ) by  $\left(1 + \frac{300}{\text{mA} \times Z(\Omega)}\right)$

For  $I_{\text{test}} < 50 \text{ mA}$  Multiply Basic Accuracy ( $Z \leq 16 \Omega$ ) by  $\left(1 + \frac{30}{\text{mA}}\right)$



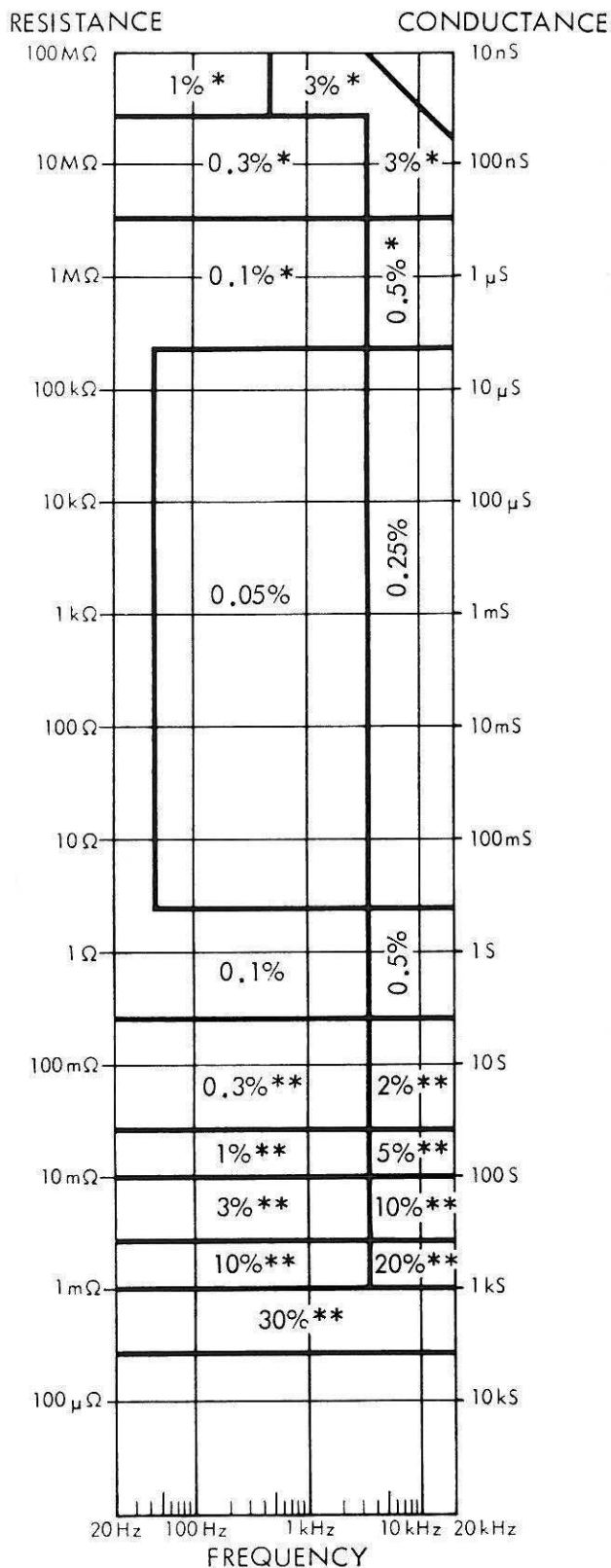

$$* + [0.1 \text{ nS} \times f(\text{kHz}) + 0.5 \text{ nS}]$$

$$** + [0.01 \text{ m}\Omega \times f(\text{kHz}) + 0.1 \text{ m}\Omega]$$

If  $Q > 1$ , add  $[0.1\% (1 + 0.3Q^2)]$   
to accuracies shown

**TEST CONDITIONS:**

- Level -1000 mV/100 mA
- Speed -Medium
- Range -Auto
- Bias -Off
- Calibrated -Zero

$$V_{\text{test}} = 800 \text{ mV to } 1500 \text{ mV}$$

$$I_{\text{test}} = 50 \text{ mA to } 100 \text{ mA}$$

For  $V_{\text{test}} < 800 \text{ mV}$  Multiply Basic Accuracy  
by  $\left(1 + \frac{300}{\text{mV}}\right) \left(1 + \frac{\text{kHz}}{10}\right)$

For  $I_{\text{test}} < 50 \text{ mA}$  Multiply Basic Accuracy  
( $Z > 16\Omega$ ) by  $\left(1 + \frac{300}{\text{mA} \times Z(\Omega)}\right)$

For  $I_{\text{test}} < 50 \text{ mA}$  Multiply Basic Accuracy  
( $Z \leq 16\Omega$ ) by  $\left(1 + \frac{30}{\text{mA}}\right)$

**Table 1-3. Resistance/Conductance Measurement Accuracy**



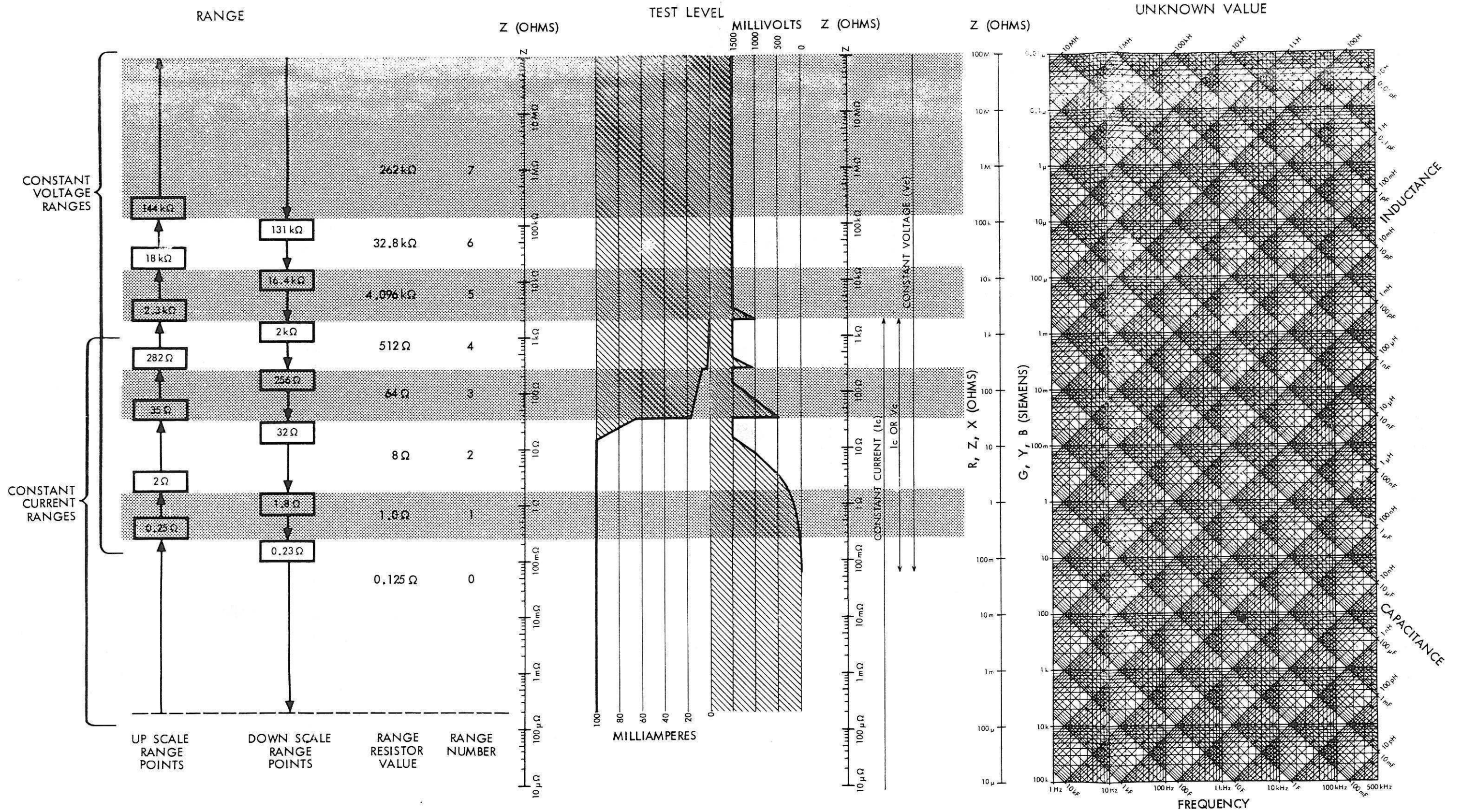

Table 1-4. Impedance Ranges vs. Test Signal Level





### BASIC D ACCURACY

Capacitance:  $\pm 0.00025 (1+D^2) *$   
Inductance:  $\pm 0.00035 (1+D^2) *$

### BASIC Q ACCURACY

All Components  $\pm 0.035 * \left(Q + \frac{1}{Q}\right) \% *$

### \*Correction Factors

For HI Z ( $Z \geq 10M\Omega$ ) add  $\left[0.0005 \left(\frac{Z(M\Omega)}{10M\Omega}\right)\right]$  to basic D or Q accuracy

For LO Z ( $Z \leq 1\Omega$ ) add  $\left[0.0005 \left(\frac{1\Omega}{Z(\Omega)}\right)\right]$  to basic D or Q accuracy

For Frequencies  $> 1000Hz$  multiply basic D or Q accuracy  
by  $\left(1 + \frac{Hz}{3000}\right)$

For Frequencies  $< 200Hz$  multiply basic D or Q accuracy  
by  $\left(1 + \frac{60}{Hz}\right)$

For  $V_{test} < 800mV$  multiply basic D or Q accuracy  
by  $\left(1 + \frac{300}{mV}\right)$

For  $I_{test} \leq 100mA$  multiply basic D or Q accuracy  
by  $\left(1 + \frac{300}{mA \times Z(\Omega)}\right)$

## TEST SIGNALS

Frequency  $\approx 2998$  programmable between 20Hz and 20kHz.

$$f = 60\text{kHz}/N$$

Where: N is an integer  
 $3 \leq N \leq 3000$

Accuracy  $\pm 0.01\%$

## Level Set

Voltage Level 10mV to 1500mV RMS in 10mV steps

Accuracy  $\pm(4\% + 10\text{mV}), Z > 2\Omega$   
 $\pm(4\% + 2\text{mV}), Z < 2\Omega$

Current Level 1mA to 100mA RMS in 1mA steps

Accuracy  $\pm(4\% + 1\text{mA}), Z < 32\Omega$   
 $\pm(4\% + 0.2\text{mA}), Z > 32\Omega$

## MEASUREMENT SPEED

|        | SETL | I.T. | AVG |
|--------|------|------|-----|
| Fast   | 5ms  | 10ms | 1   |
| Medium | 50ms | 50ms | 1   |
| Slow   | 50ms | 50ms | 5   |

OR

Integration time (I.T.)

$n\left(\frac{1}{f}\right)$  Where: n = integer  
 between 1 and 256  
 f = Test Frequency

Settling Time (SETL)

2ms to 1500ms in 1ms steps

Measurement Averaging (AVG)

1 to 20 measurements

## BIAS

Voltage

+50VDC maximum

Fuse

0.5A, 250V, 3AG Fast Blow

## 1.2.2 Environmental Specifications

### HUMIDITY

|           |                          |
|-----------|--------------------------|
| Operating | 20% to 80% Relative      |
| Storage   | 0% to 90% Non-Condensing |

### TEMPERATURE

|           |                                     |
|-----------|-------------------------------------|
| Operating | 10°C to 45°C<br>(50°F to 113°F)     |
| Storage   | -40°C to 71.1°C<br>(-40°F to 160°F) |

## 1.2.3 General Specifications

### POWER REQUIREMENTS

|                   |   |
|-------------------|---|
| Line power        | 115VAC +15% -22% 48/66Hz<br>230VAC + 9% -22% 48/66Hz                                      |
| Powerline Fuse    | 2A, 250V, Slow Blow for 115VAC<br>operation, and 1A, 250V Slow<br>Blow for 230V operation |
| Power Consumption | ≈ 100W  |

### DIMENSIONS

|        |                  |
|--------|------------------|
| Height | 133mm (5.25 in)  |
| Width  | 324mm (12.75 in) |
| Length | 464mm (18.25 in) |
| Weight | 28 lb            |

### 1.3 CASSETTE RECORDER SPECIFICATIONS

Tape Cassette Type: Braemar Computer Devices Type CMC-50 (50 ft. long)

File Storage Information: All displayed measurement parameters, binning limits, and bin counter information.

Storage Capacity: 30 files total (15 files per side)

### 1.4 OPTIONS AND ACCESSORIES

#### 1.4.1 Accessories (available when ordered)

|   | <u>ESI Part No.</u> |
|---|---------------------|
| Model 2003 Sorting Fixture, 4-terminal (requires 4 cables).                               | 32003               |
| Model 2004 Zero Insertion Force Sorting Fixture, 4-Terminal (requires 4 cables).          | 32004               |
| Model 2005 Tweezers, 4-Terminal (for chip capacitors).                                    | 32005               |
| BNC to KELVIN KLIPS <sup>®</sup> cable assembly (comes with all Model 2100's and 2110's). | 47454               |



#### 1.4.2 Options (field installable)

|  | <u>ESI Part No.</u> |
|--|---------------------|
| General Purpose Interface Bus (IEEE-488)                         | 46725               |
| RS232 Interface (2100 only)                                      | TBA                 |
| Handler Interface Options*                                       |                     |
| 1. For interfacing to the Engineered Automation Autosort handler | 47895               |
| 2. For interfacing to the Daymarc Type 147 and 149 handlers.     | 47896               |
| 3. For interfacing to Browne handlers                            | 47897               |

\*Consult factory for interface to specific handlers

## SECTION 2 OPERATION

### 2.1 FRONT PANEL CONTROLS AND INDICATORS

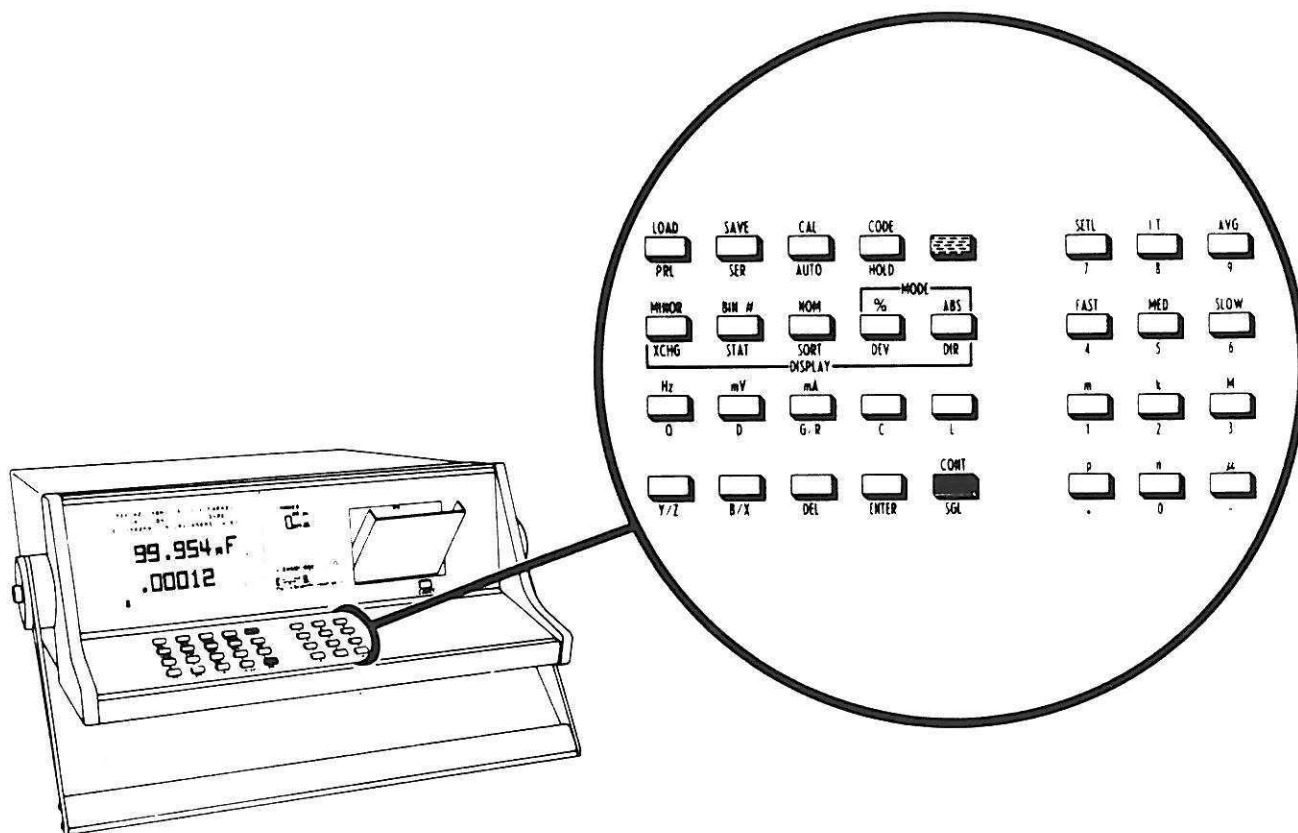

Figure 2-1. Model 2110 Front Panel

#### 2.1.1 Keyboard and Key Definitions

The Model 2100/2110 keyboard has 32 keys to control all instrument operations. Many of the keys have labels for more than one function. The functions labeled in white are selected by pushing the key directly above it. Alternate functions, labeled in yellow, are selected by pushing the yellow key followed by the key directly below the desired function. The following list defines each keyboard function.

## Measurement Controls



Single measurement mode key makes one measurement and holds the displayed result.

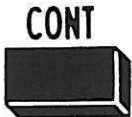

Continuous measurement mode key automatically starts a new measurement as soon as the present measurement is finished. Displayed results are continuously updated at the rate of three per second at medium measurement speed.



Series equivalent circuit key, in conjunction with the measurement function, selects the equivalent circuit element of the unknown component to be measured. Also selects R, Z, and X when using the G/R, Y/Z, and B/X keys.



Parallel equivalent circuit key, in conjunction with the measurement function, selects the equivalent circuit element of the unknown component to be measured. Also selects G, Y, and B when using the G/R, Y/Z, and B/X keys.



Zero correction key. Stores L, R, C, and G zero correction values to compensate for test fixture reactance (L and C) and loss (R and G) components.

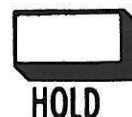

Range Hold key allows rapid checking of many unknowns in the same range.

## Measurement Controls (continued)



Auto key returns unit to autoranging mode. Autoranging is automatically selected when the instrument is first turned on.

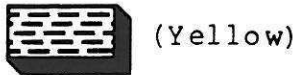

Upper function key selects functions labeled in yellow.

## Display Controls



Exchange key interchanges the top measurement display function with the bottom display function. One exchange takes place for each push of the key.



Status (display) key toggles the display format between direct display format and binning display format. Display format changes once for each push of the key. Also used to escape from sorting mode operation.



Sort key enters the instrument into the component sorting mode. Display indicates BIN number or REJECT for each component measured.



Deviation (display) key enters the deviation measurement mode. After a nominal value is set, the top measurement display will indicate absolute or percent deviation from the nominal value.

## Display Controls (continued)



**Direct (display) key** returns the instrument to normal (direct) display operation after being in sorting or deviation mode.



**Delete key** erases the last digit entered; does not affect previously entered data.

## Impedance Functions

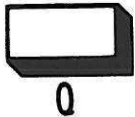

**Quality Factor key** selects the Q measurement function as the bottom display function.

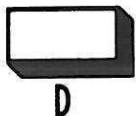

**Dissipation factor key** selects D measurement function as the bottom display function.



**Conductance (G)/Resistance (R) function key** selects S (siemens -- units of conductance) or  $\Omega$  (ohms -- units of resistance) as the bottom display function. G is selected in parallel equivalent circuit mode. R is selected in series equivalent circuit mode.

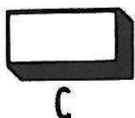

**Capacitance function key** selects F (farads -- units of capacitance) as the top display function.

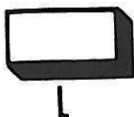

**Inductance function key** selects H (henrys -- units of inductance) as the top display function.



## Impedance Functions (continued)



Admittance (Y)/Impedance (Z) function key selects either S (siemens -- units of admittance) or  $\Omega$  (ohms -- units of impedance) as the top display function. Y is selected in parallel equivalent circuit mode. Z is selected in series equivalent circuit mode.

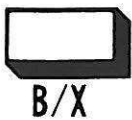

Susceptance (B)/Reactance (X) function key selects either S (siemens -- units of susceptance) or  $\Omega$  (ohms -- units of reactance) as the top display function. B is selected in parallel equivalent circuit mode. X is selected in series equivalent circuit mode.

## Cassette Functions

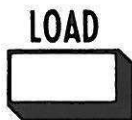

Load function key programs the instrument with measurement parameters stored on the cassette tape.



Save function key stores the instrument's parameters on the cassette tape.

## Deviation and Limits Functions

**BIN #**



Bin number key is used with a numerical argument to identify the bin in which a set of limit values will be entered.

**MINOR**



Minor number key is used to enter a maximum or minimum reject limit for the secondary component when programming limits for the sorting mode. Minimum for Q, maximum for others.



**ENTER**

Enter key is used for spacing device when programming limit values.

**%**



Percent mode key is used with the sorting and deviation modes to define and display percent deviation.

**ABS**



Absolute mode key is used with the sorting and deviation modes to define and display absolute deviation.

**NOM**

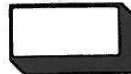

Nominal value key is used to enter a comparison value for deviation measurements. A nominal value set after percent limits are programmed causes the instrument to automatically calculate absolute values for each limit.

## Test Frequency and Level

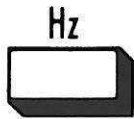

Frequency key enters a desired test frequency in hertz (Hz). Available frequencies are found by  $F = 60\text{kHz}/N$  Where:  $N$  is an integer  $3 \leq N \leq 3000$ .

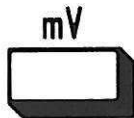

Test voltage level key enters a desired test voltage in 10 millivolt steps. Test voltage levels are available between 10mV and 1500mV.

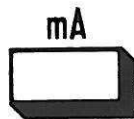

Test current level key enters a desired test current in milliamps. Maximum available test current is 100mA.

## Measurement Time



Settling time key enters a time, in milliseconds. After initiation of a measurement, the instrument waits for the selected time before the actual start of the measurement.

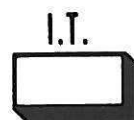

Integration time key enters the number of test frequency cycles during which a measurement is to be made.

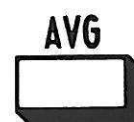

Average measurements key enters the number of measurements to be averaged with the result displayed.

Measurement Time (continued)

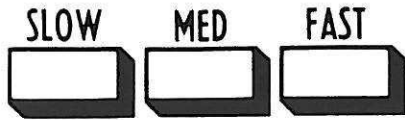

Fast, Medium, Slow keys choose pre-selected values of Settling Time, Integration Time, and average measurements.

|        | SETL | I.T. | AVG |
|--------|------|------|-----|
| Fast   | 5ms  | 10ms | 1   |
| Medium | 50ms | 50ms | 1   |
| Slow   | 50ms | 50ms | 5   |

Numerical and Unit Multiplier Keys

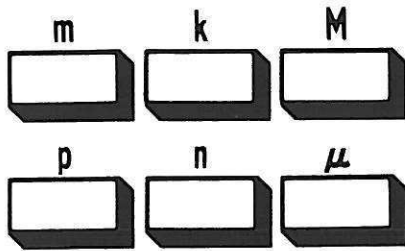

Multiplier prefix keys for the basic units programmed m = milli, k = kilo, M = mega, p = pico, n = nano, and  $\mu$  = micro.

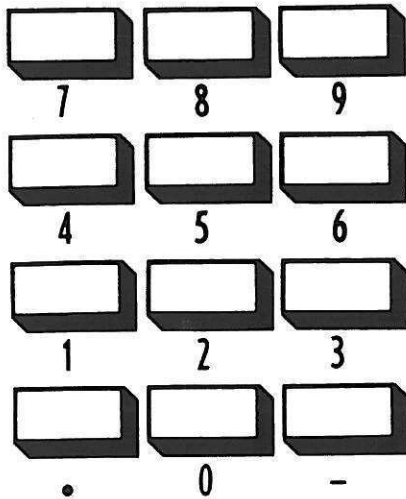

Numerical keys used for keyboard entry of desired numerical data into the instrument.

## Special Functions

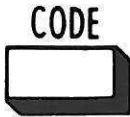

Code key when preceded by a numerical argument allows access to instrument functions not available directly on the keyboard. Following is a list of the functions available with the code key.

| <u>Code No.</u> | <u>Function</u>  | <u>Code No.</u> | <u>Function</u>   |
|-----------------|--|-----------------|---|
| 1               | Bias Voltage ON (capacitor measurements with bias).  | 7               | Software Version. Date and version of instrument software is displayed as an error message.   |
| -1              | Bias Voltage OFF (measurements without bias).  | 8               | Activate Handler Interface option and Lockout the Keyboard. Component sorting begins when the option is activated. To de-activate this option, temporarily ground Pin 21 of the Handler Interface rear panel connector.   |
| 2               | Reset STATUS display. All bin limits and counters are set to zero.   | 9               | Keyboard Lockout. To re-activate VideoBridge keyboard: <ol style="list-style-type: none"> <li>1. Ground pin 21 on Handler Interface.</li> <li>2. Type UNLOCK through the GPIB Interface.</li> <li>3. Type UNLOCK through channel B of the RS-232C Interface.</li> </ol> |
| 3               | "Make Tape" Formats cassette tapes to accept test parameters.  | 10              | Interface output select test code. It displays measurement information on the CRT as well as outputting it through the interface  |
| 4               | Keyboard control transferred from the VideoBridge to an external video-terminal. Control is transferred through channel A of the RS-232C Interface option. To return control to VideoBridge keyboard type KB on the terminal connected to channel A of the RS-232. |                 |   |
| 5               | Direct range setting. (To exit -- depress AUTO).   |                 |   |
| 6               | D correction ON (default mode when instrument is turned ON).   |                 |   |
| -6              | D correction OFF.  |                 |   |



| <u>Code No.</u> | <u>Function</u>  |
|-----------------|--|
| 10<br>(cont)    | option. To select the output option (RS-232C or IEEE-488) Enter:<br><br>1 (space) 10 (space) CODE<br>-- to provide output on serial channel B of the RS-232C<br><br>OR |

| <u>Code No.</u> | <u>Function</u>   |
|-----------------|---|
| 10<br>(cont)    | 2 (space) 10 (space) CODE<br>-- to provide output on IEEE-488<br><br>To deactivate this function push either 1 or 2, depending on the option selected above, then push -10 (space) CODE |

The procedure for programming code key function is:

1. Push the numerical key(s) representing the desired function (from list above).
2. Push the Yellow key.
3. Push the CODE key.

Example: Turn ON Bias

Push: 

To select a range via CODE 5, the number of the desired range must precede the selection of this function. Refer to range chart in Section 1.2 for range information.

Example: Select range 3

Push: 

**NOTE:** These functions may be remotely programmed when the interface options are installed.

## 2.1.2 CRT Display

The 5-inch (diagonal) cathode-ray tube (CRT) presents a simultaneous display of those test parameters and measurement results that are most important to the operator. Model 2100/2110 feature two display formats ... normal (direct) and binning (sorting).

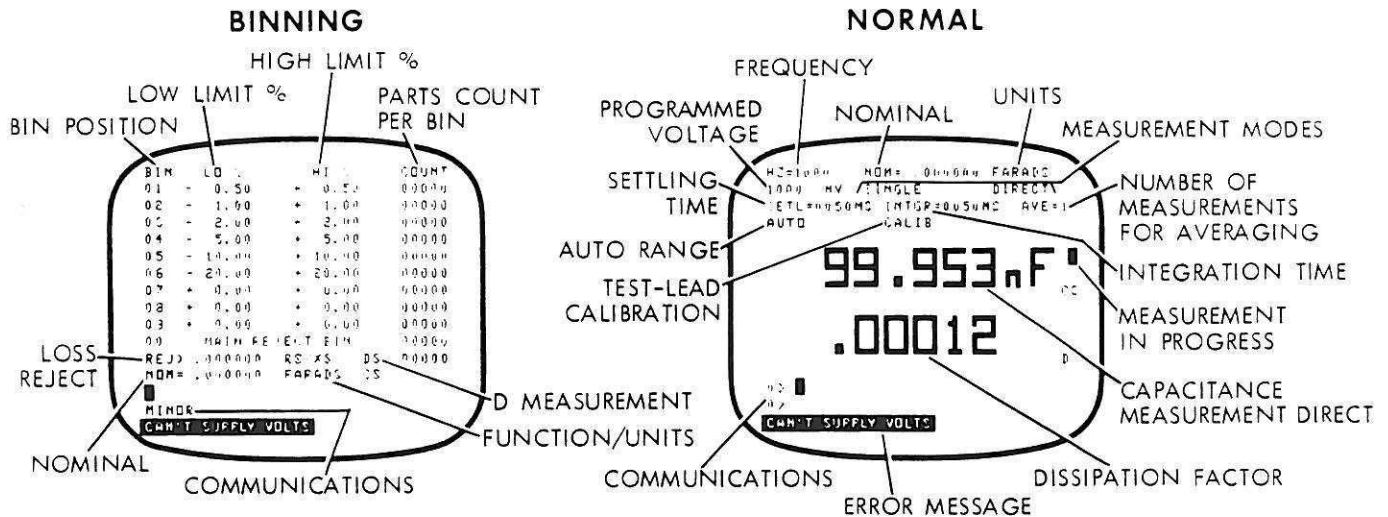

Figure 2-2. CRT Display Formats

Normal display format can be broken-down into three major areas:

- Parameter field (top portion of CRT screen). It contains:
  - Test frequency in hertz (Hz)
  - Nominal value (when programmed)
  - Units of the top measurement display function
  - Test signal level in millivolts (mV) or milliamperes (mA)
  - Measurement mode -- continuous (CONT) or single (SINGLE)
  - Display mode -- Direct, Deviation, or % Deviation
  - Settling time in milliseconds (ms)
  - Integration time in milliseconds (ms)
  - Number of averaged measurements for each display
  - Ranging mode -- Auto or Hold
  - Calibration (CALIB) indicator for test-lead or test fixture zero

2. Measurement display (center portion of CRT screen). It contains:
  - . Two readings
  - . Units multiplier and units for each reading
  - . Function and equivalent circuit mode for each display
  
3. Data entry (bottom portion of CRT screen). It contains:
  - . Data entry lines that echo and display the last keyboard entries.

Binning display format is used when preparing for component sorting operation. It can be divided into two major areas ... sorting limits and reject limit. For a more detailed explanation of the sorting operation and the binning display see Section 2.7.1 in this manual.

### 2.1.3 Cassette Tape Loader

The cassette tape loader is a Model 2110 (optional for 2100) feature that adds to the overall versatility of the instrument. The cassette can be used as a mass storage device for either test parameters or measurement information. It relieves the tedious chore of setting test parameters by storing often used test setups for later retrieval. For a more detailed explanation of the cassette tape loader see Section 2.9 in this manual.

### 2.1.4 Other Front Panel Controls

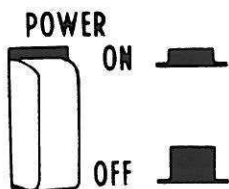

Turns instrument power ON and OFF.

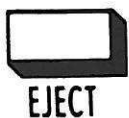

Opens Cassette Tape Loader door for direct access to cassette tapes. (Model 2110 only)



## 2.2 REAR PANEL

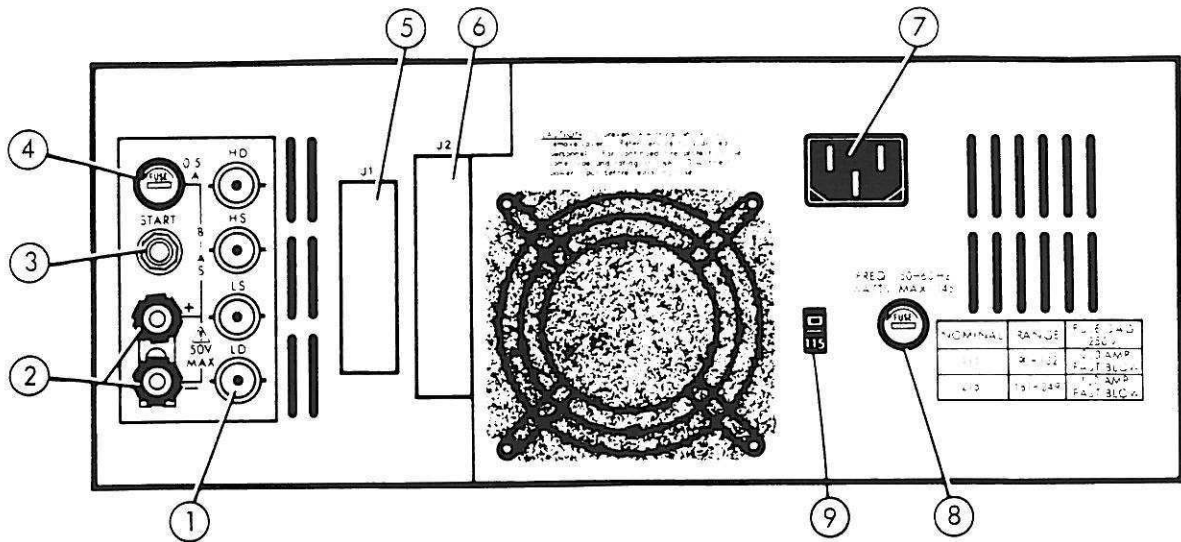

Figure 2-3. Rear Panel

### 2.2.1 Rear Panel Controls and Connectors

① HD, HS, LS, LD

Four BNC style connectors for making passively guarded, four-terminal-connection to the unknown.

#### WARNING

ELECTRICAL SHOCK HAZARD EXISTS WHEN BIAS SUPPLIES ARE CONNECTED TO THIS INSTRUMENT. WHEN EXTERNAL BIAS SUPPLIES ARE ATTACHED, THE BIAS VOLTAGES ARE PRESENT ON THE REAR PANEL BNC CONNECTORS. USE ONLY BIAS VOLTAGES UP TO +50VDC WITH EACH BIAS SUPPLY CURRENT LIMITED AT 100MA. DO NOT TOUCH, CONNECT, OR DISCONNECT THE UNKNOWN OR BNC CABLES WHILE BIAS VOLTAGES ARE APPLIED.

② ⚠ BIAS Terminals

Two banana plug jacks for connection of external power supplies for biasing, up to 50VDC with bias supply current limited at 100mA, the component being tested. Bias supply polarity must match the terminal indicators.

- ③ REMOTE START A miniature phone jack style connector for remotely initiating measurements.
- ④ BIAS FUSE A 0.5A 3AG fuse prevents damage to the instrument if a charged capacitor is connected to the input terminals or if excessive bias current is applied.
- ⑤ J1 An option inputs/outputs connector which allows connection to an interface option. Connector is present only when option is installed.
- ⑥ J2 An option connector; outputs depend on option installed. Connector is present only when option is installed.
- ⑦ LINE POWER CORD A standard 3-wire power cord for connection to 115VAC +15 -22% at 48/66Hz or 230VAC +9% -22% at 48/66Hz. (See Section 2.3.1 before using cord and connectors other than supplied.)
- ⑧ POWER FUSE The line power fuse used is 2A, 250V Slow-Blow for 115V operation and 1A, 250V Slow-Blow for 230V operation.
- ⑨ 115/230 Switch Selects the nominal line voltage.



## 2.3 INSTRUMENT SETUP

### 2.3.1 Power Requirements

The 2100/2110 requires a power source of 115VAC, +15% -22%, at 48/66Hz (230VAC, +9% -22%, at 48/66Hz, optional). Before turning the power ON, make sure the instrument is set to the proper line voltage. The instrument contains a rear panel slide switch to select the nominal line voltage. See Figure 2-4 for proper line voltage settings.

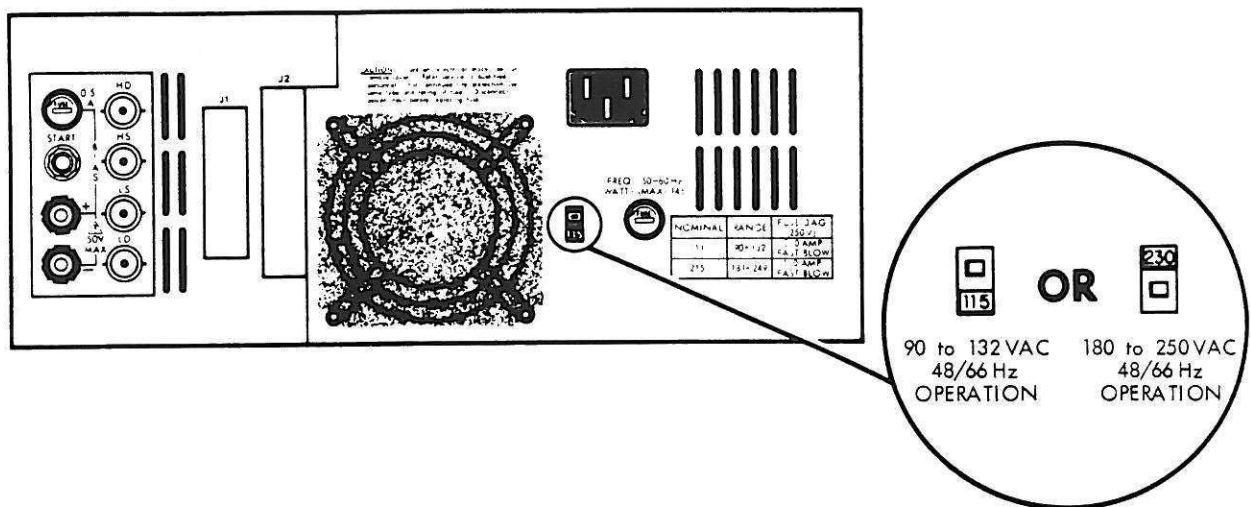

Figure 2-4. Line Voltage Settings



BECAUSE OF DIFFERING POWER REQUIREMENTS, INSTRUMENTS SHIPPED OUTSIDE THE UNITED STATES MAY REQUIRE A DIFFERENT POWER CORD CONNECTOR. WHEN PLACING A NEW CONNECTOR ON THE POWER CORD, CARE MUST BE TAKEN TO ASSURE THE WIRES ARE CONNECTED PROPERLY. THE GREEN OR GREEN WITH YELLOW STRIPE WIRE IS ALWAYS CONNECTED TO EARTH GROUND. THE WHITE OR LIGHT BLUE WIRE IS CONNECTED TO THE NEUTRAL SIDE OF THE POWER LINE. AND, THE BLACK OR BROWN WIRE IS CONNECTED TO THE HIGH SIDE OF THE POWER LINE. FIGURE 2-5 ILLUSTRATES THE AVAILABLE POWER CORDS, WHICH MAY BE USED IN VARIOUS COUNTRIES INCLUDING THE STANDARD POWER CORD FURNISHED WITH THE INSTRUMENT. ELECTRICAL CHARACTERISTICS AND COUNTRIES USING EACH CONNECTOR ARE LISTED IN THE FIGURE.

**WARNING**

TO PREVENT POSSIBLE ELECTRICAL SHOCK OR DAMAGE TO THE INSTRUMENT, CHECK LOCAL ELECTRICAL STANDARDS BEFORE SELECTING A POWER CORD. THE INFORMATION PRESENTED HERE MAY NOT BE CORRECT FOR ALL LOCATIONS WITHIN THE REFERENCED AREAS.

|  |   |
|--|---|
|  <p>-- N WHITE<br/>E GREEN/YELLOW<br/>L BLACK<br/>L BLACK<br/>E GREEN/YELLOW<br/>N WHITE</p>          | <p>FURNISHED FOR COUNTRIES<br/>OTHER THAN LISTED BELOW</p>                                |
|  <p>E GREEN<br/>L RED<br/>N BLACK<br/>L RED<br/>E GREEN<br/>N BLACK</p>                              | <p>250V, 6A<br/>NEW ZEALAND,<br/>AUSTRALIA, ETC.</p>                                      |
|  <p>N LIGHT BLUE<br/>E GREEN/YELLOW<br/>L BROWN<br/>L BROWN<br/>E GREEN/YELLOW<br/>N LIGHT BLUE</p> | <p>250V, 5A<br/>GREAT BRITAIN,<br/>SOUTH AFRICA, INDIA,<br/>RHODESIA, SINGAPORE, ETC.</p> |
|  <p>N LIGHT BLUE<br/>E GREEN/YELLOW<br/>L BROWN<br/>N LIGHT BLUE<br/>E GREEN/YELLOW<br/>L BROWN</p> | <p>250 V, 6A<br/>EAST/WEST EUROPE,<br/>IRAN, ETC.</p>                                     |
| <p>LEGEND E: EARTH OR SAFETY GROUND<br/>L: LINE OF ACTIVE CONDUCTOR<br/>N: NEUTRAL OR IDENTIFIED CONDUCTOR</p>   |   |

Figure 2-5. Power Cord Connectors

### 2.3.2 Applying Power

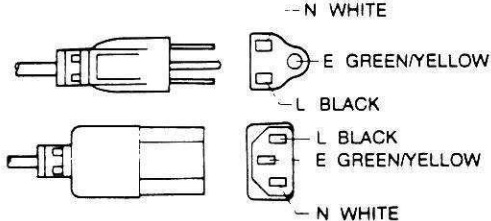
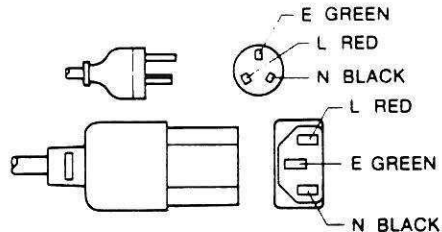
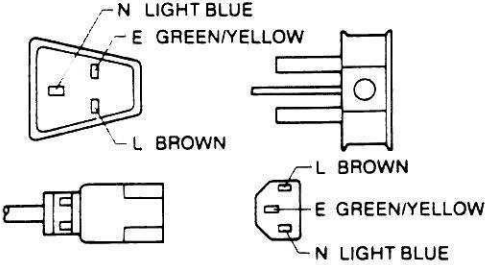
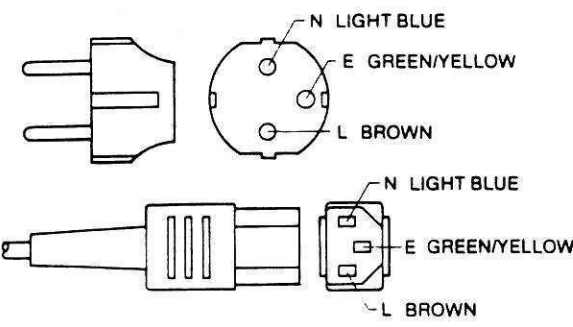
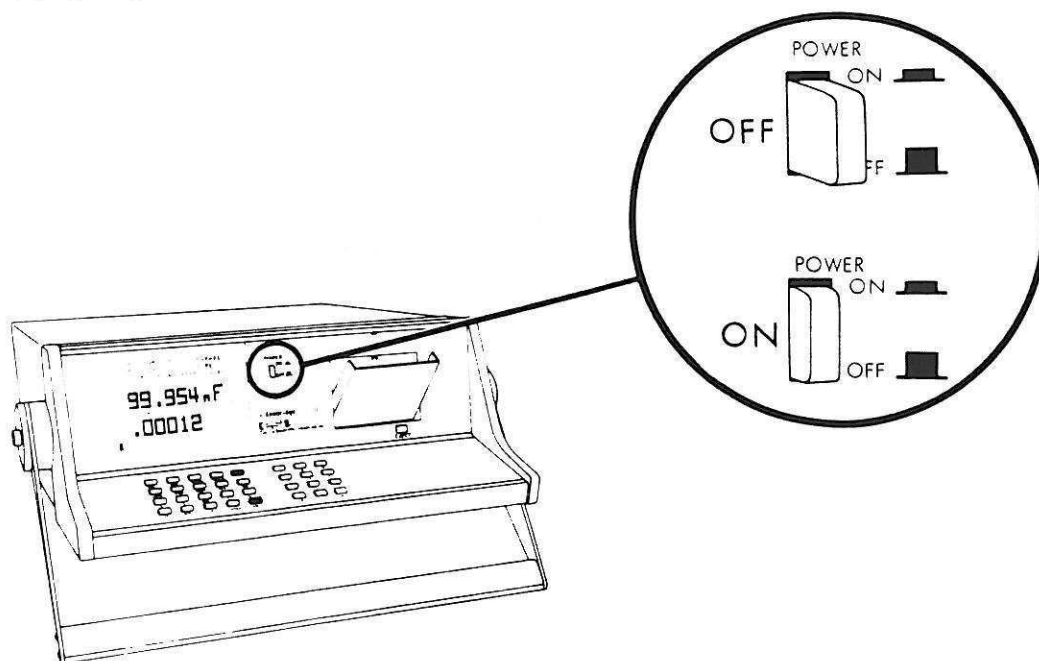

Figure 2-6. Power ON/OFF Switch

A front panel push-ON, push-OFF switch turns power ON and OFF (see Figure 2-6). When power is applied, the CRT display will illuminate in  $\approx 15$  seconds. Instrument warm-up time is  $\approx 5$  minutes. The initial starting condition for all programmable parameters is:

|                                      |            |
|--------------------------------------|------------|
| Display Format                       | Direct     |
| Frequency                            | 1000Hz     |
| Nominal value                        | 0000       |
| Units of the top measurement display | Farads     |
| Test signal level                    | 1000mV RMS |
| Measurement mode                     | Single     |
| Settling time                        | 50ms       |
| Integration time                     | 50ms       |
| Measurements averaged                | 1          |
| Measurement speed                    | Medium     |
| Top Display function                 | Cs         |
| Bottom display function              | D          |
| Binning limits 1 - REJ               | 0000       |
| Limits mode                          | %          |



### 2.3.3 Connections to Unknown

Model 2100/2110 makes four-terminal measurements with passive guarding. It provides separate shielded connection cables for current drive and voltage sense to the high and low side of the unknown. These cables are fully shielded to minimize the effects of stray capacitance. They are labeled HI DRIVE, HI SENSE, LO DRIVE, and LO SENSE. The shields around the HIGH and LOW DRIVE cables are connected to the GUARD point (see Figure 2-7). Drive and sense leads for both HIGH and LOW terminals must be connected together for accurate measurements.

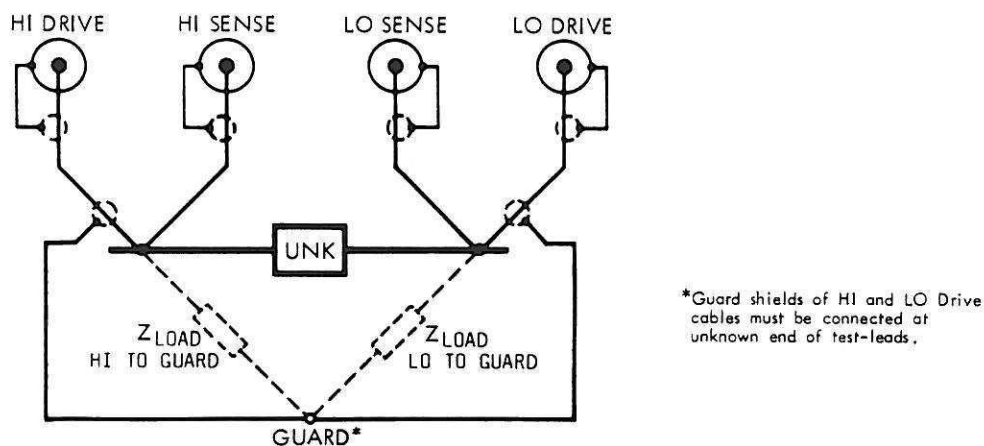

Figure 2-7. Connection to Unknown

Separate drive and sense connections are necessary to prevent lead resistance from becoming a part of the measured unknown. This is especially true for accurate measurements of low impedance unknowns. Separate drive and sense connections can be made to a single lead connected to the unknown if the lead is a small part of the unknown impedance ( $R_{lead} < Z_{unk}/1000$  for  $<0.1\%$  error). With proper connections as shown in Figure 2-7, for most measurements cable lengths up to 5 feet cause no loss of accuracy. Longer cable lengths or special test conditions may result in some accuracy loss. Consult ESI factory for advise on your application.



#### 2.3.4 Test-Leads vs Test-Fixtures

Certain measurement areas are more critical than others and require that a test-fixture be used rather than test-leads. Test-leads, with KELVIN KLIPS, are best used at low frequencies (at or below 1kHz) or for higher frequency measurements where high accuracy is not needed. At higher frequencies (above 1kHz), the need for a test-fixture becomes more and more important because test-lead (Klips) spacing cannot be fixed as in a test-fixture. Changes in test-lead position change stray capacitance and/or inductance making a true zero correction reading in either open-circuit or short-circuit mode difficult to obtain. If higher accuracy, high frequency measurements are needed, then use a test-fixture.

#### 2.3.5 Zero Calibration

Measurement accuracy is enhanced by the 2100/2110's ability to correct for zero-offset errors caused by test-lead and test-fixture impedances (capacitance, inductance, resistance, etc.). These impedances appear in parallel or in series with the unknown component during measurement and add to the measured value. The zero calibration function measures these zero offset errors and stores them in memory. The stored value is automatically subtracted from each measured value.

The 2100/2110 makes two types of zero calibration measurements -- Open-Circuit and Short-Circuit -- that operate as follows:

##### Open-Circuit Calibration

Open-circuit calibration is used when the instrument is in the voltage mode (test signal level is mV). To activate this mode, push the yellow button followed by the CAL button. The display will echo:

OPEN UNKNOWN -- THEN PUSH "SNGL"

With the test-leads in place, but unknown not connected, push the SINGLE button. The zero calibration error will be measured and stored.

**NOTE:** Anytime the measurement frequency or test signal level is changed or re-entered as the same value, the zero calibration value is erased from memory. A new value can be obtained by performing the procedure described above.

### Short-Circuit Calibration

Short-circuit calibration is used when the instrument is in the current mode (test signal level is mA). To activate this mode, push the yellow button followed by the CAL button. The display will echo:

CLOSE UNKNOWN -- THEN PUSH "SNGL"

With the test-leads shorted together, push the SINGLE button. The zero calibration error will be measured and stored.

**NOTE:** Anytime the measurement frequency or test signal level is changed or re-entered as the same value, the zero calibration is erased from memory. A new value can be obtained by performing the procedure described above.

### 2.3.6 Input Protection

The 2100/2110 input terminals have a circuit which prevents damage to the instrument if a charged capacitor is connected to these terminals. Protection limits can be calculated from the equation:

$$V_{MAX} = \sqrt{\frac{2}{C}}$$

where V = capacitor voltage in volts  
C = capacitor value in farads

The protection circuit allows a maximum energy of 1 joule up to a maximum voltage of 1kV. Table 2-1 below gives examples of maximum voltages for various capacitance values.

|      |                |
|------|----------------|
| 1kV  | 0 to 2 $\mu$ F |
| 315V | 20 $\mu$ F     |
| 100V | 200 $\mu$ F    |
| 31V  | 2mF            |
| 10V  | 20mF           |
| 3V   | 200mF          |
| 1V   | 2F             |

Table 2-1. Input Protection Limits

When limits are exceeded, the fuse on the rear panel will burn out and must be replaced with a 0.5A 3AG fuse. To prevent possible damage to the instrument use only the proper replacement fuse.

## 2.4 MEASUREMENT FUNCTIONS

The Model 2100/2110 will measure and display a variety of function combinations. The shaded areas of Table 2-2 shows the functions that can be displayed simultaneously. Either of the two selected functions can be displayed as the top or the bottom function on the CRT screen. For a further explanation of programming measurement functions or exchanging their display positions see Sections 2.4.1 and 2.4.2 respectively, in this manual.

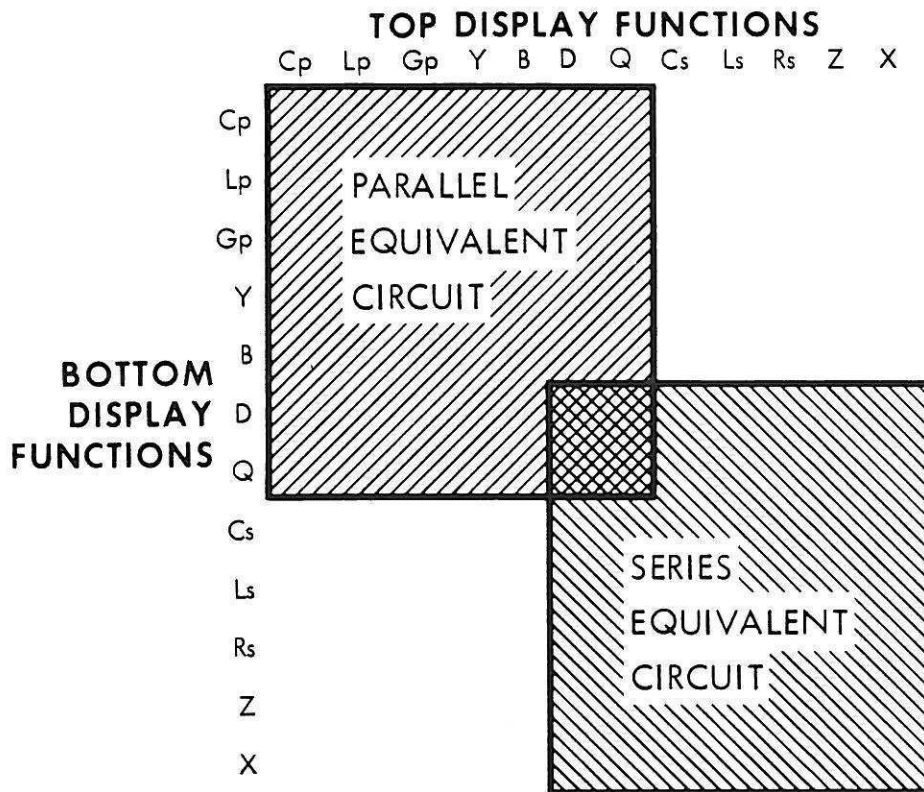

**NOTE:** Any top display can be displayed with any bottom display within the shaded areas.

Table 2-2. Measurement Functions



### 2.4.1 Programming Measurement Functions

Measurement functions available with the Model 2100/2110 are: capacitance (C), inductance (L), resistance (R), dissipation factor (D), quality factor (Q), conductance (G), admittance (Y), impedance (Z), susceptance (B), and reactance (X). They are selected via the front panel keyboard by pressing the pushbutton for the desired function. The selected functions are displayed, one-above-the-other, on the CRT screen. Their position on the screen can be exchanged at any time, i.e. Cs displayed above R can be exchanged to display R over Cs. Because of the versatility involved in displaying and positioning measurement displays and to assure the measurements are displayed as you want them, read the following precautions before programming measurement functions.

1. C, L, Y, Z, B, and X functions always replace the top measurement display on the CRT.
2. G, R, D, and Q functions always replace the bottom measurement display on the CRT.
3. G/R, Y/Z, and B/X functions program in conjunction with the PRL (parallel) and SER (series) keys, i.e. when in the parallel equivalent circuit mode G, Y, and B can be programmed and in the series equivalent circuit mode R, Z, and X can be programmed.
4. Top and bottom measurement displays are exchanged using the XCHG key.

The Model 2100/2110 initially measures series capacitance (Cs) and dissipation factor (D) when power is applied (see Figure 2-8). These measurement functions can be changed at any time by pushing the desired function button.

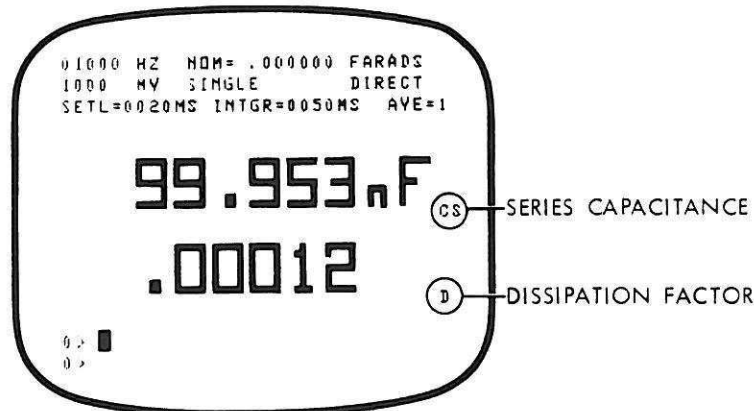

Figure 2-8. Measurement Display

Example: Measure series inductance (Ls) and resistance (Rs).

Push

Display

Comments



L

01000 HZ NOM= .000000 HENRIES  
 1000 MV SINGLE DIRECT  
 SETL=0020MS INTGR=0050MS AVE=1

L key changes Cs to Ls in top display.



G/R

99.443 mH<sub>LS</sub>  
 5.2719 Ω<sub>R</sub>

G/R key changes D to R (series equivalent circuit) in bottom display.







SGL

0 >   
 0 > G/R

Makes one measurement and holds displayed result.





Example: Measure impedance (Z) and quality factor (Q).

| Push   | Display  | Comments   |
|--|--|--|
| <br>Y/Z |  | Y/Z key changes Ls to Zs (series equivalent circuit) in top display. |
| <br>Q   |  | Q key changes R to Q in bottom display.                              |
| <br>SGL |  | Initiate single measurement.   |

#### 2.4.2 Exchanging Measurement Displays





The XCHG key exchanges the position of the two displayed measurements. Using the XCHG key allows two functions that normally program into the top display to be measured and displayed simultaneously.

Example: After turning instrument power ON. Set the instrument to measure and display Ls and Cs.

| Push  | Display   | Comments                                    |
|---|---|---|
|  |  | Exchange key moved Cs to bottom display.    |
|  |   | L key set top display to series inductance. |
|  |   | Initiate single measurement.                |

In the same context, any two functions that normally appear in the bottom measurement display can also be displayed simultaneously.

Example: Set the instrument to measure Rs and Q.

| Push  | Display   | Comments  |
|---|---|---|
|  |  | G/R key changes D to R (series equivalent circuit) in bottom display. |
|  |   | Exchange key moves R to top display.                                  |
|  |   | Q key selects Q in the bottom display.                                |
|  |   | Initiate single measurement.  |



### 2.4.3 Series and Parallel Equivalent Circuit

Capacitors, inductors, and resistors are inherently imperfect impedance components, i.e. they have series and parallel, reactive and resistive elements. The Model 2100/2110 measures the reactive and resistive elements of an impedance component. (The relationship of these reactive and resistive elements is often described in terms of their series or parallel equivalent circuits.) The 2100/2110's PRL (parallel) and SER (series) functions steer the measured reactive and resistive values to an algorithm that calculates values in terms of series or parallel equivalent circuit. Series and parallel equivalent circuit mode measurements will provide differing results. The magnitude of difference depends on the quality of the component being measured. In determining which equivalent circuit mode to use, consider the following factors before making a selection.

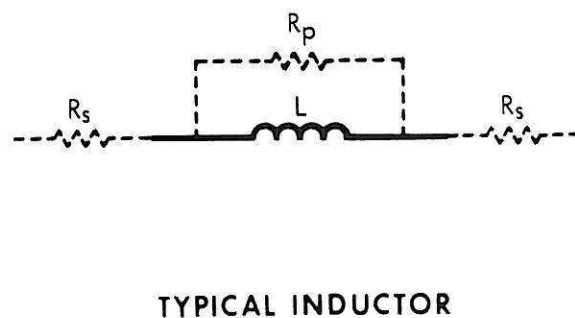
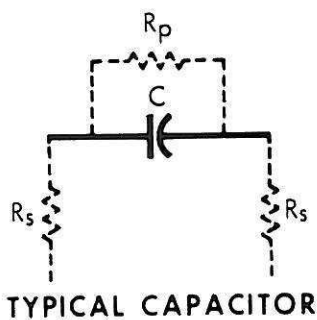

1. What is the actual equivalent circuit of the capacitance being measured? This information should be available from the manufacturer's specifications. If not available, the equivalent circuit can be determined by a comparison of dissipation factor (D) value obtained at another frequency removed from the selected test frequency. If the test frequency goes up and the measured D decreases, then the unknown is most likely a parallel equivalent circuit. Likewise, if the test frequency goes down and the D decreases, the unknown is most likely a series equivalent circuit.

**NOTE:** The dissipation factor (D) of an inductor moves in the opposite direction from the D of a capacitor for a given change in frequency.

2. What is the end use for the component? The equivalent circuit used should provide the information most useful to determining the performance of a component in a particular application. For example, the information necessary for selecting a power supply bypass capacitor is obtained from the series equivalent circuit mode, while the information needed to select a capacitor for a LC resonant circuit is obtained from the parallel equivalent circuit mode.
  
3. Which equivalent circuit is most valuable to me? If no other information is available, the rule-of-thumb for selecting either series or parallel equivalent circuit mode is as follows:

Series equivalent circuit should be used when measuring components with a low impedance (basically large value capacitors, low value inductors) and parallel equivalent circuit for components with a high impedance (basically low value capacitors, high value inductors).

To convert a series equivalent circuit measurement to that of a parallel equivalent circuit use the formula given in Figure 2-9. These formulas consider the effects of dissipation factor (D) with the measured value. (Dissipation factor (D) is always equal for both series and parallel equivalent circuits at a given frequency.)





| CIRCUIT MODE | DISSIPATION FACTOR   | CONVERSION TO OTHER MODES                                     |
|--------------|--|---|
| C            |  $D = \frac{1}{2\pi f C_p R_p} = \frac{1}{Q}$ | $C_s = (1 + D^2) C_p$ $R_s = \frac{D^2}{1 + D^2} R_p$         |
|              |  $D = 2\pi f C_s R_s = \frac{1}{Q}$           | $C_p = \frac{1}{1 + D^2} C_s$ $R_p = \frac{1 + D^2}{D^2} R_s$ |
| L            |  $D = \frac{2\pi f L_p}{R_p} = \frac{1}{Q}$ | $L_s = \frac{1}{1 + D^2} L_p$ $R_s = \frac{D^2}{1 + D^2} R_p$ |
|              |  $D = \frac{R_s}{2\pi f L_s} = \frac{1}{Q}$ | $L_p = (1 + D^2) L_s$ $R_p = \frac{1 + D^2}{D^2} R_s$         |

Figure 2-9.

Series and parallel equivalent circuit modes are selected by pushing either the PRL (parallel) or the SER (series) keys.

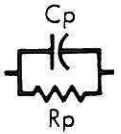
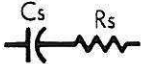
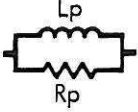
Examples: The 2100/2110 initially measures series capacitance (Cs) and dissipation factor (D) when power is applied. To change to parallel capacitance (Cp) and dissipation factor (D):

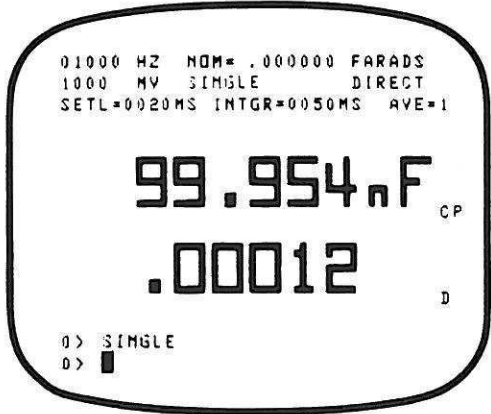
| Push   | Display  | Comments                        |
|--|--|---------------------------------|
| <br>PRL |  <pre> 01000 HZ  NOM= .000000 FARADS 1000 MV  SINGLE      DIRECT SETL=0020MS INTGR=0050MS AVE=1  99.954 nF CP .00012 D  0&gt; SINGLE 0&gt; █           </pre> | Cs is changed to Cp.            |
| <br>SGL |  | Initiates a single measurement. |

Three measurement functions are programmed in conjunction with the SER and PRL keys. They are Y/Z, G/R, and B/X. Admittance Y, conductance G, and susceptance B are all parallel equivalent circuit values. They are automatically replaced by their reciprocal values -- impedance Z, resistance R, and reactance X when the series equivalent circuit (SER key) is programmed.



Example: Change the displayed parameters to display parallel capacitance and conductance, then change the measurement mode to display series capacitance and resistance.

Push

Display

Comments

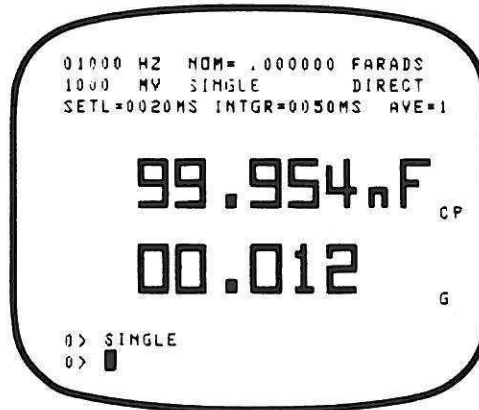

G/R key changes D to G (parallel equivalent circuit) in bottom display

Initiates a single measurement

THEN

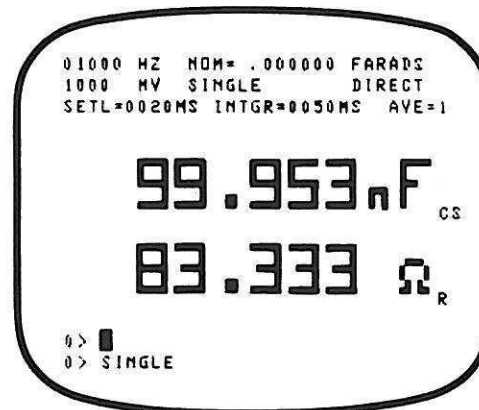

G automatically changes to R in series mode

Initiates a single measurement

## 2.5 TEST SIGNAL



The test signal, applied to the device under test, is a sinusoidal waveform derived from a digital source. It is programmable both in frequency and in magnitude from either the front panel keyboard or remotely via an IEEE-488 or RS-232 interface bus. When power is applied, the instrument's frequency, and voltage level, initialize to 1000Hz, and 1000mV RMS, respectively.

**NOTE:** Because using voltage or current test signals at their low extremes produces a low signal-to-noise ratio, measurement accuracy at these low levels may be seriously derated.

### 2.5.1 Frequency

The Model 2100/2110 has  $\approx 3000$  selectable test frequencies between 20Hz and 20kHz. All frequencies are accurate to within  $\pm 0.01\%$ . When power is applied, the instrument's test frequency initializes to 1000Hz. All frequencies are entered directly in hertz (Hz).

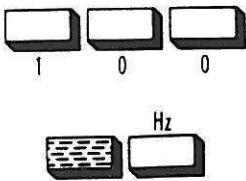
Example: Set the instrument's test frequency to 100Hz.

| Push   | Display   | Comments  |
|--|---|---|
|  |  | To allow the test signal to stabilize after a frequency change, wait 200ms before initiating a measurement. |

The frequency selected is displayed on the CRT (first line -- small letters). The displayed frequency is the nearest available frequency greater than the selected value. Table 2-3 shows some of the commonly used frequencies. The available frequencies not shown in Table 2-2 can be determined using the formula:

$$F = 60\text{kHz}/N$$

Where: N is an integer  $3 \leq N \leq 3000$

| N  | Frequency (Hz) | N   | Frequency (Hz) | N     | Frequency (Hz) | N    | Frequency (Hz) |
|----|----------------|-----|----------------|-------|----------------|------|----------------|
| 3  | 20,000         | 30  | 2,000          | 300   | 200            | 3000 | 20             |
| 4  | 15,000         | 40  | 1,500          | 400   | 150            |      |                |
| 5  | 12,000         | 50  | 1,200          | 500   | 120            |      |                |
| 6  | 10,000         | 60  | 1,000          | 600   | 100            |      |                |
| 8  | 7,500          | 80  | 750            | 800   | 75             |      |                |
| 10 | 6,000          | 100 | 600            | 1,000 | 60             |      |                |
| 12 | 5,000          | 120 | 500            | 1,200 | 50             |      |                |
| 15 | 4,000          | 150 | 400            | 1,500 | 40             |      |                |
| 20 | 3,000          | 200 | 300            | 2,000 | 30             |      |                |
| 25 | 2,400          | 250 | 240            | 2,500 | 24             |      |                |

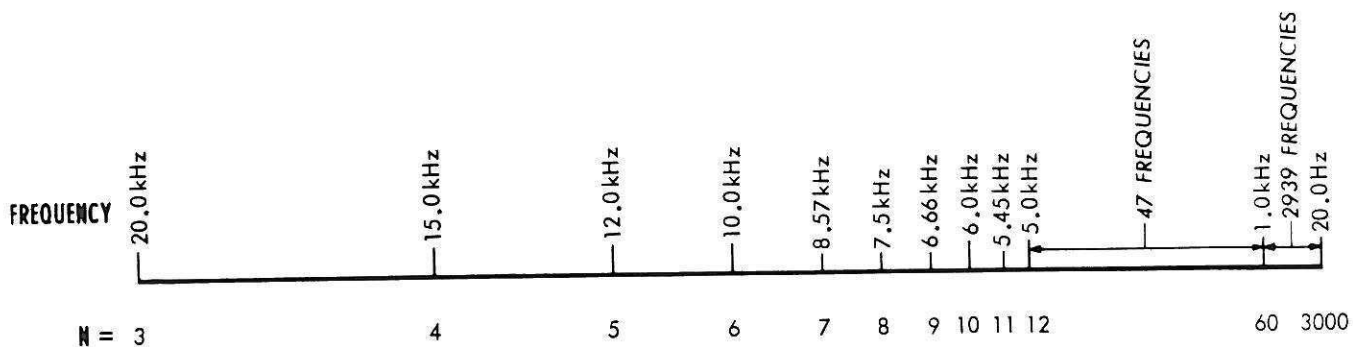
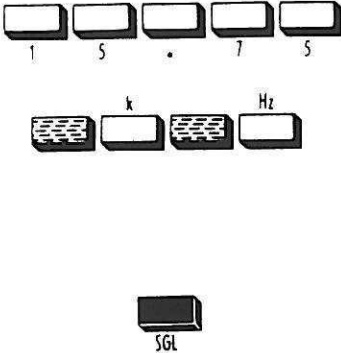



Table 2-3. Test Frequencies

Any frequency entered between two available frequencies will automatically divert to the higher frequency.

Example: Set the test frequency to 15,750Hz.

| Push   | Display   | Comments   |
|--|---|--|
|  <p>1 5 . 7 5<br/>k Hz<br/>SGL</p> |  <pre> 20000 HZ NOM=.000000 FARADS 1000 MV SINGLE DIRECT SETL=0020MS INTGR=0050MS AVE=1  99.951 nF CS .00013 D  0&gt; SGL 0&gt; 15.75 KILO HZ                 </pre> | <p>Frequency (15.75kHz) automatically reverted to the closest but higher frequency (20,000Hz).</p> <p>Initiate a single measurement.</p> |

Notice in the examples above, as numbers are entered, they are echoed on the CRT. When the entry was terminated, by pushing Hz, the 2100/2110 selected the closest, but higher, frequency available.



**NOTE:** To provide greatest measurement accuracy, test-lead or test-fixture calibration must be performed after any frequency change.



## 2.5.2 Signal Levels

The test signal voltage level initializes to 1V RMS when instrument power is applied. The test signal level can be changed at any time to meet testing requirements. Voltage is programmable from 10mV to 1500mV RMS in 10mV steps. Current is programmable from 1mA to 100mA in 1mV steps.

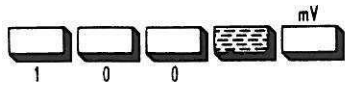
Example: Set the amplitude of the test signal to 100mV RMS.

| Push  | Display   | Comments   |
|---|---|--|
|    |  | To allow the test signal time to stabilize after a signal level change, wait 200ms before initiating a measurement |
|  |   | Initiate a single measurement  |

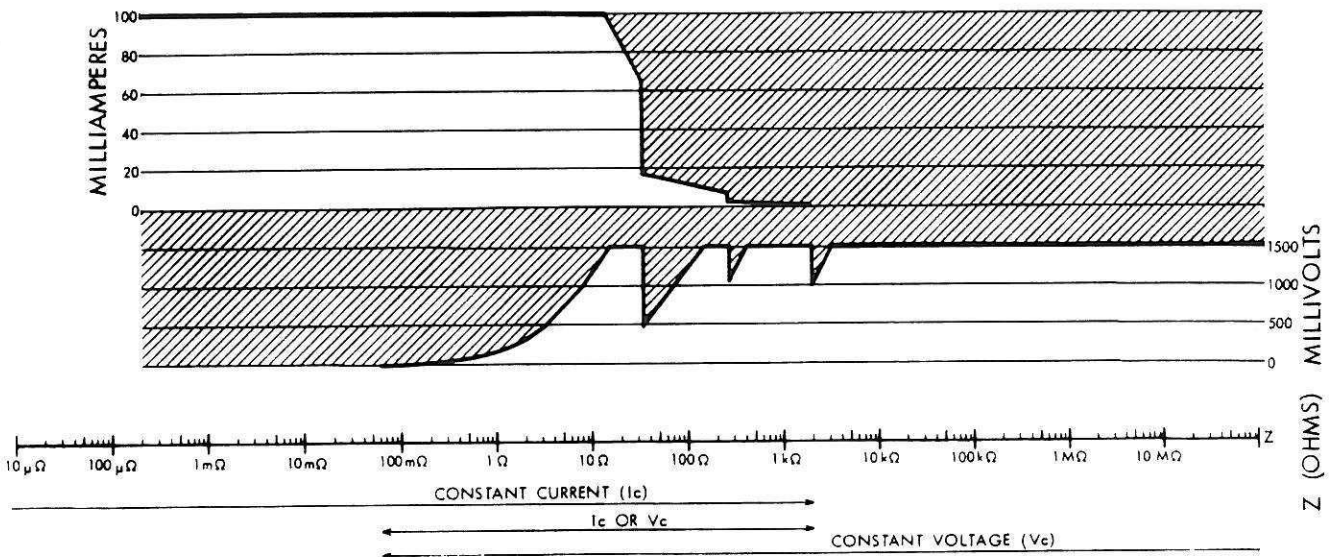

Table 2-4. Test Level vs Impedance

Test currents can be programmed between 5mA and 100mA. For unknown impedances between 0 and 2k $\Omega$ , set the test current directly. For unknown impedances over 2k $\Omega$ , the test current is determined by dividing the voltage level, by the unknown impedance.

For best measurement results, select a test signal level that will provide the best signal-to-noise ratio. High test signal levels are used for general component testing (capacitors, resistors, and certain inductors). Low test signal levels are used for testing devices requiring low operating-signal levels (semiconductor devices, inductors, and non-linear impedance devices).

Table 2-4 shows the 2100/2110's test level limitations compared to the impedance of the component under test. If the impedance of the device falls outside these limits, the following conditions result:

- . At a set voltage level and with an impedance too low to produce the specified voltage drop across the unknown, the instrument will display the error message "Can't supply volts". The instrument will perform the measurement at the highest possible test voltage level. The test signal voltage will not exceed the programmed value.
- . At a set current level and with an impedance too large to allow the instrument to produce this current, the instrument will display the error message "Can't supply amps". The instrument will perform the measurement at the highest possible test current level. The test current will not exceed the programmed value.

To optimize measurement accuracy, care should be taken when selecting test signal levels. Measuring high impedance components at very low test voltages or very low impedances at very low current levels can cause measurements to be erratic due to a poor signal-to-noise ratio. The test level and impedance charts in this manual, and the 2100/2110's capability to measure and display Z, the total impedance of the device under test, can be used as an aid to determining the optimum test signal level.

**NOTE:** To maintain measurement accuracy, test-lead or test-fixture calibration must be performed after any test level change.

### 2.5.3 Measurement Range

The Models 2100/2110 are basically continuously ranging instruments. Ranging is a transparent operation that makes the instrument appear to have only one range throughout its entire impedance measuring capabilities. Actually, ranging is achieved by making an initial measurement before making the actual measurements for display. This initial measurement is made with very short integration times and is completely unaffected by the values programmed for measurement speed or test level. The sole purpose for this measurement is to determine the proper range resistor. This measurement is not displayed. With the proper range resistor selected, the instrument makes a measurement and displays the results. Refer to Table 2-5 for ranging data.



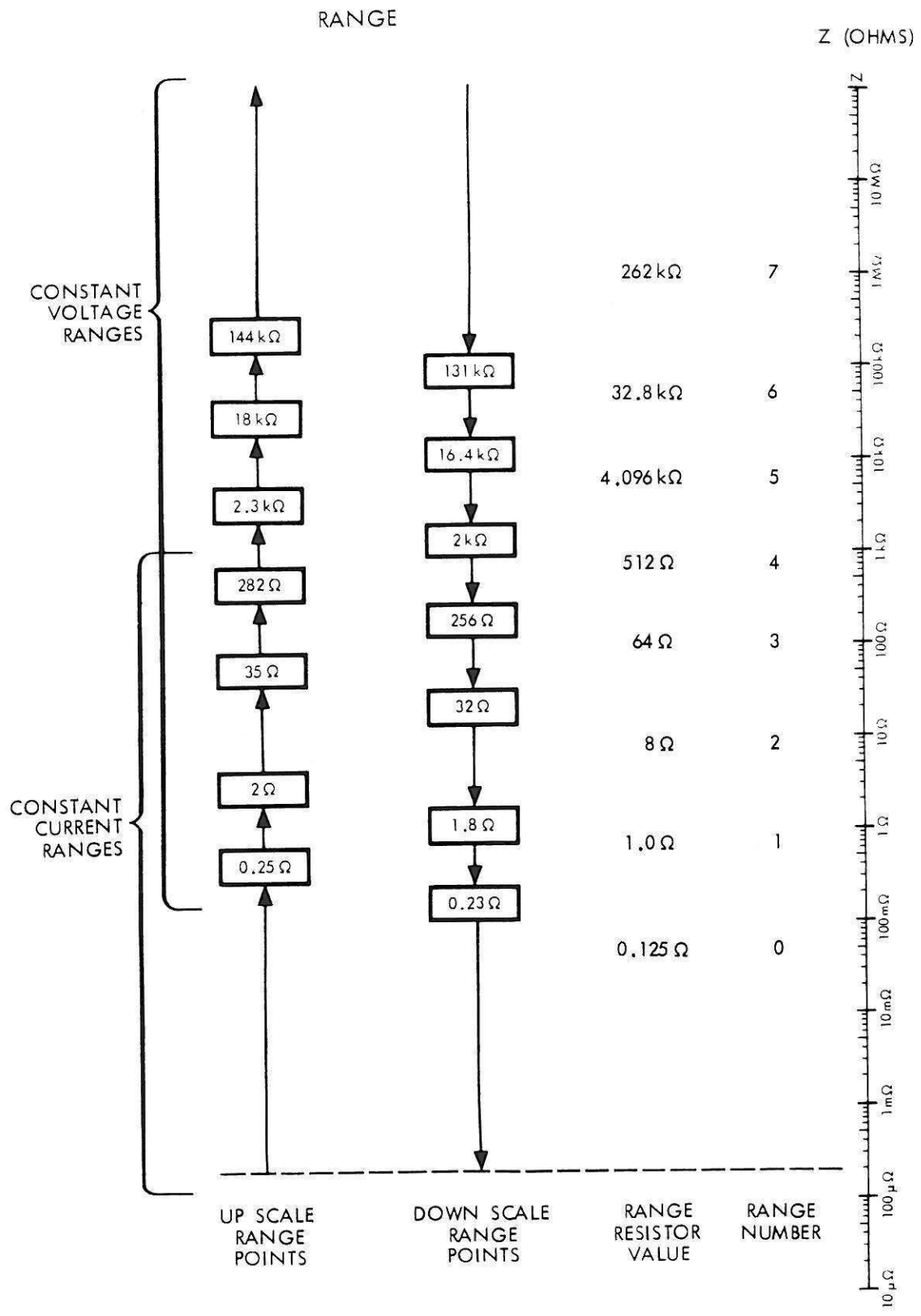

Table 2-5. Model 2100/2110 Impedance Ranging Chart



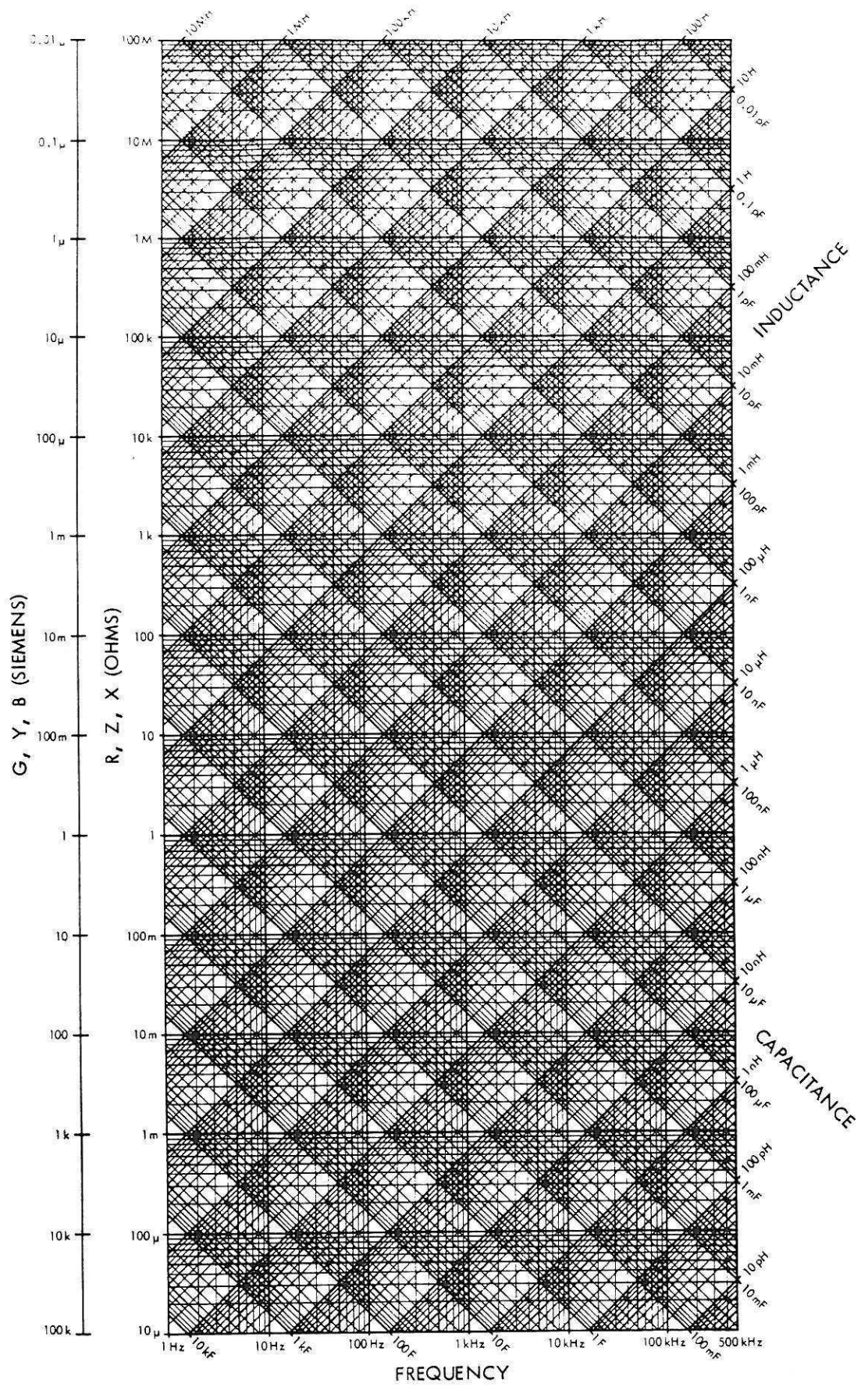

Table 2-6. Reactance Chart



To find the span of capacitance, inductance, or other measurement parameters for a particular impedance range (shown in Table 2-5) at a particular frequency use Table 2-6 as follows:

1. Find the impedance (Z) along the left margin of Table 2-6.
2. Find the operating frequency (Hz) along the bottom margin of Table 2-6.
3. Find the intersection of the horizontal impedance line and the vertical frequency line.
4. Find the closest diagonal line to the intersection.
5. Move down the diagonal line to the right or bottom margin to find the corresponding capacitance value. Move up the diagonal line to the right or top margin to find inductance. Resistance, conductance, admittance, susceptance, and reactance can be found in the two adjacent columns of the left margin.

#### 2.5.3.1 Range Hold

When testing many components of the same value where speed is a prerequisite, the pre-measurement described in Section 2.5.3 can be eliminated by using range HOLD. (The range finding measurement takes a minimum of 60ms. Due to increased integration time, range finding measurements made at frequencies below 500Hz will take longer.)

To initiate range HOLD:

1. Connect a component to the test leads or fixture.
2. Allow one measurement to be made, then push the HOLD button.

Returning to the continuous ranging mode is accomplished by pushing the AUTO button.

#### 2.5.4 Continuous and Single Measurements

In the Continuous mode the instrument makes 1 measurement and calculates the selected display value. Immediately after a measurement is completed a new measurement is initiated. The continuous measurement mode is entered by pushing the yellow key followed by the CONT key. The CRT display is updated once every 300 milliseconds when medium measurement speed is selected.

Single measurement mode is initially selected when instrument power is applied. To perform single measurements, press the SGL button. The instrument will make one measurement and update the display. Single measurements can also be initiated via the rear panel remote start jack. Remote start requires a "de-bounced" switch or relay closure to ground to initiate a single measurement.

Example: Set the instrument to the continuous measurement mode.

Push

Display

Comments

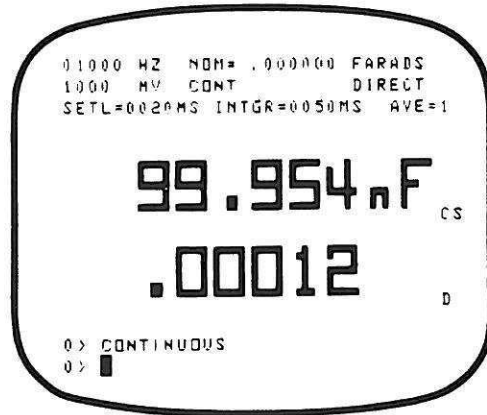

Selects continuous measurement mode.



To return to single measurement mode, push the SGL key.



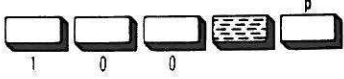
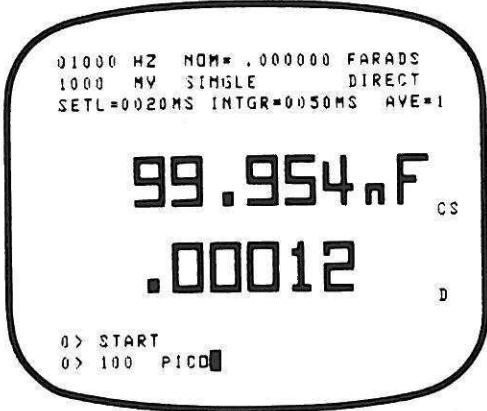

### 2.5.5 DELETE

The DEL key removes the last incorrect entry made while programming data into the 2100/2110.

Example: Set the nominal value to 100 $\mu$ .

| Push  | Display  | Comments   |
|---|--|--|
|    |  | OOPS! Wrong suffix.                                      |
|  | <p>0 &gt; 100 PIC</p> <p>0 &gt; 100 PI</p> <p>0 &gt; 100 P</p> <p>0 &gt; 100</p>   | One character is erased for each push of the delete key. |

Re-enter the correct data.

| Push  | Display  | Comments                     |
|---|--|------------------------------|
|  |  | Correct value is programmed. |

If the entry has been terminated, by pushing the NOM button (in this example), the DEL button will no longer remove the incorrect data. However, the correct data can be reprogrammed as a new entry.

## 2.6 DEVIATION MEASUREMENT

Two types of deviation measurement are possible with the Model 2100/2110; deviation as a percent of nominal or absolute deviation from a nominal in units. Deviation measurements can be made using either autoranging or range hold modes. In the autoranging mode, the 2100/2110 will change ranges to allow percent deviations from -100% to +900% of the preset nominal value, and absolute deviation may vary up to 3 times the nominal value. In the range hold mode, the range of percent and absolute deviations are limited by the measurement ranges' upper and lower boundaries. Deviation calculations require a small amount of time to complete, so measurement speed is decreased slightly.

To make deviation measurements, a nominal value must first be set. A nominal value can be programmed at any time. It is programmed as a number with multiplier and assumes the units in the top measurement display. The nominal value is compared with the measured value only when in the deviation measurement mode. The comparison result is displayed as the top reading on the CRT. In the deviation mode, the instrument's measurement resolution can be determined by using Table 2-7.



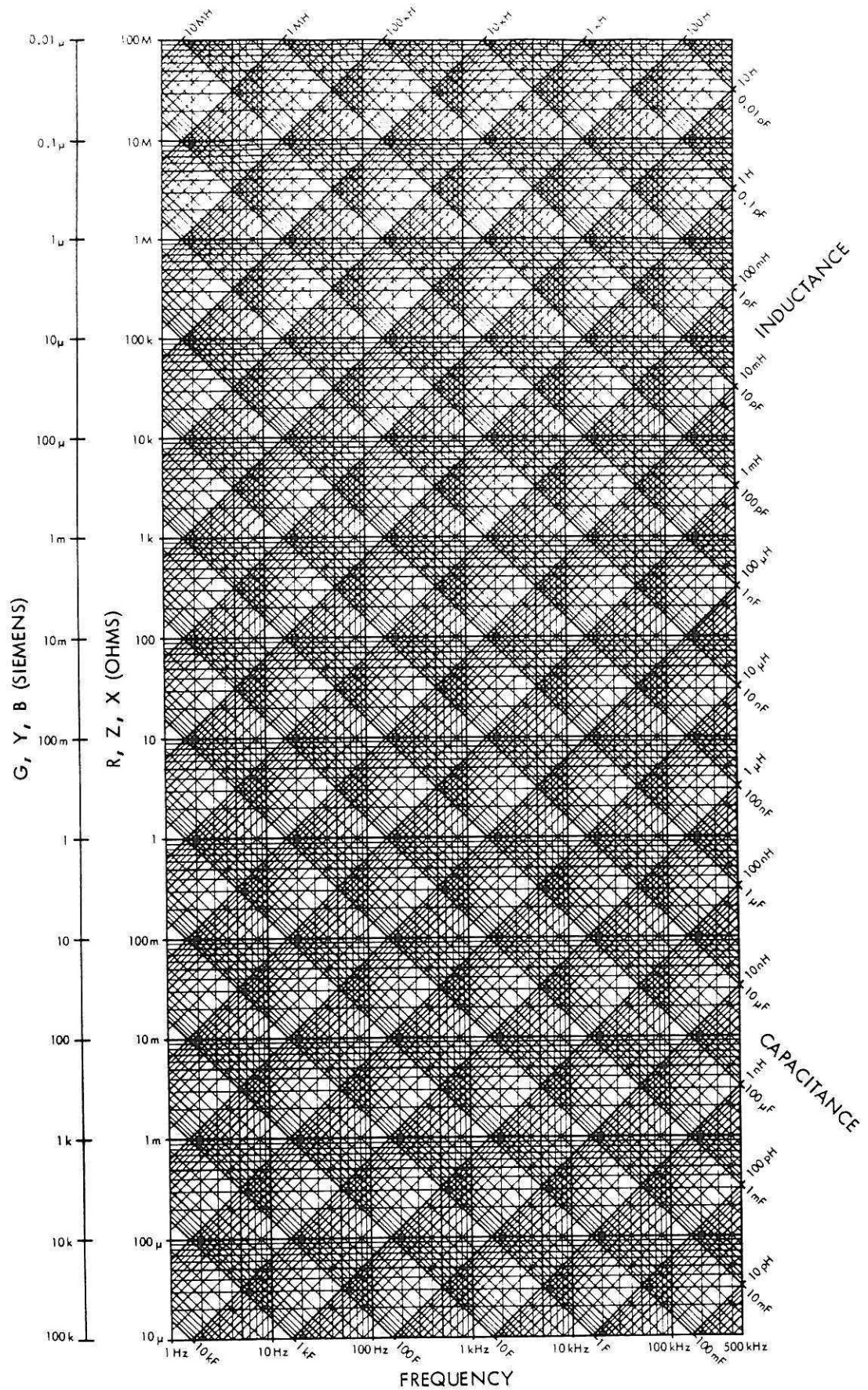

Table 2-7.

To set a nominal value, enter the desired value with multiplier (p,n,u,m,k,M) then push NOM VALUE. The entry takes the same units as selected for the top measurement display.

Example: Set a nominal value of 15.9nF.

| Push | Display | Comments  |
|------|---------|---|
|      |         | <p>Nominal value takes on the units of the top displayed function</p> |
|      |         |   |
|      |         | <p>Initiate a single measurement</p>                                  |

**NOTE:** Only one nominal value can be set. The top measurement display is the result of comparing the measured value against the nominal value only when in the deviation mode.



### 2.6.1 Deviation Mode

The deviation mode (DEV) compares the nominal value against the calculated value selected as the top measurement display. It displays the results, in either absolute or percent deviation, in place of the top display. To enter the deviation mode, push the DEV key.

Example: Make deviation measurements using the nominal value set in the example above.

Push



Display

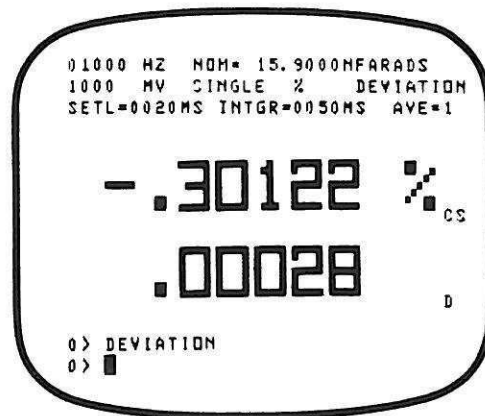

Comments

Enter deviation measurement mode. Deviation is the top displayed value





Initiate a single measurement

## 2.6.2 Absolute or Percent Deviation

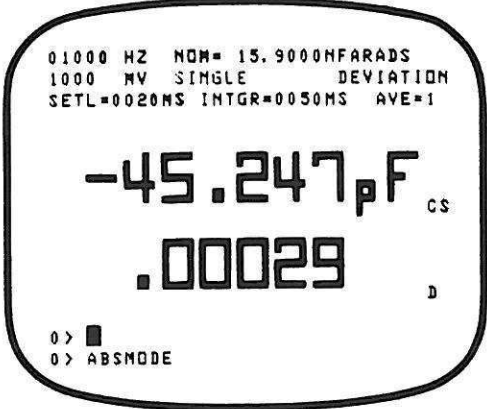

The difference between nominal value and calculated value, of the top reading, can be displayed as either absolute or percent deviation. Percent deviation is initially selected when power is applied. To display absolute deviation, Push ABS.

Example: Continuing with the previous examples, the instrument is displaying percent deviations. Change to display absolute deviation.

| Push   | Display  | Comments                      |
|--|--|-------------------------------|
|   |  | Display absolute deviation    |
|  |  | Initiate a single measurement |

The instrument will remain in the absolute mode until changed by pushing %, or until power is removed or interrupted.

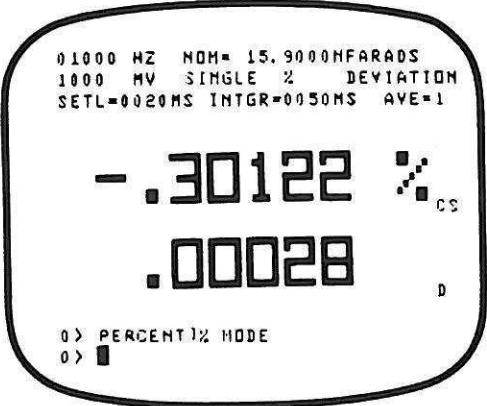

Example: Return to percent deviation mode.

| Push  | Display   | Comments                      |
|---|---|-------------------------------|
|  |  | Display percent deviation     |
|  |   | Initiate a single measurement |

### 2.6.3 Exit Deviation Mode

To exit from the deviation mode, push DIR. The instrument will revert to the direct (normal) display mode. The top measurement reading will again display the calculated value of the device under test.

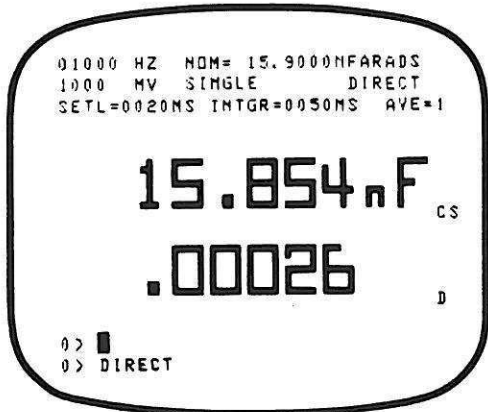
Example: Continuing with the examples above, return to the direct measurement mode.

| Push   | Display   | Comments                      |
|--|---|-------------------------------|
| <br>DIR |  | Exit deviation mode.          |
| <br>SGL |   | Initiate a single measurement |

## 2.7 COMPONENT SORTING

The sorting mode allows the 2100/2110 to characterize components by tolerance. Components are categorized into one of eleven preprogrammed limit bins. There are 10 limit bins, numbered 0 through 9 plus one reject limit, labeled REJ. Limits can be arranged in two methods: 1.) ten bins for the reactive element of the unknown (C,L,Z,Y,B,X) and one reject limit for its loss element (R,G,D,Q); or 2.) ten bins for the loss element of the unknown and one reject limit for its reactance. The choice between these two arrangements is made when the displayed functions are selected. The 10 limit bins sort components according to the measurement function of the top reading on the CRT. The bottom reading is subject to the reject limit (see Figure 2-10).

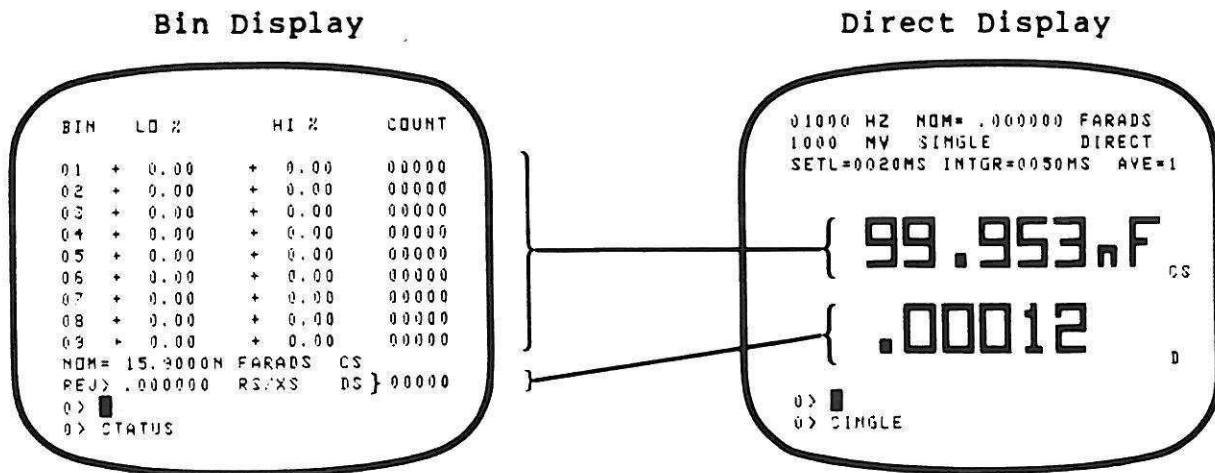

Figure 2-10. STATUS Display

To properly characterize components, the test parameters should be set as close to the component's actual operating condition as possible. Before entering the sorting mode, set the test parameters (functions, frequency, test-signal level, settling time, integration time, etc.) to the optimum conditions for the component to be tested. Refer to Section 2.4 for setting test parameters.



## 2.7.1 Bin Display

The Model 2100/2110 initializes in the DIRECT display format when instrument power is applied. To toggle the display format to the binning display, push the STAT key.

Example:

Push



Display

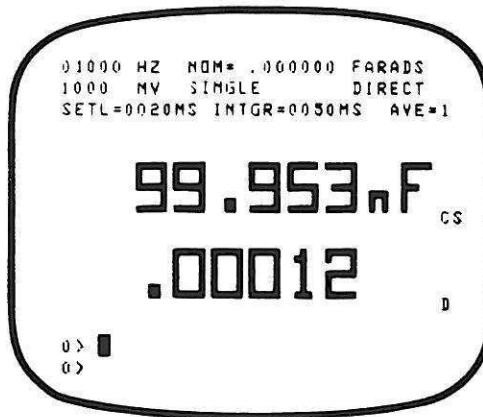

Comments

Direct display format.

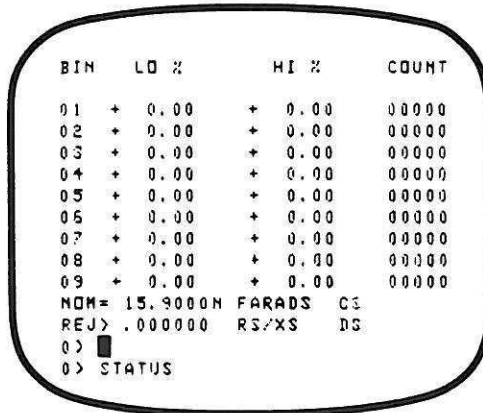

Binning display format.

The binning display consists of ten bins, numbered 0 through 9, and one reject limit. Each bin contains a LO limit value, a HI limit value, and a component counter. (Limits programming and the component counter will be explained in the following paragraphs.) The display also contains the programmed nominal value, units, and function for bins 0 - 9, and the units, component counter, and function for the reject limit. To return to the DIRECT display format, push STAT again.

### 2.7.2 Programming Limits

Limits may be set as absolute units or in percent. When instrument power is applied, the 2100/2110 is in the percent limits mode. Each bin requires a LO and HI limit value. These two values can be programmed in either order - lowest value first or highest value first. (The 2100/2110 automatically arranges the values to display the most negative value first.) The bins may be programmed in any order, however, the span of the limits within each bin must be increasingly larger for each succeeding bin ; i.e. Bin 1 = -1%, 1%; Bin 2 = -2%, 2%; Bin 3 = -5%, 5%; etc. The priority for limits comparison is to compare a measured value first against the minor component limit, then against each individual bin limit from top to bottom on the display. To set values for bins 0 - 9, push numerical and/or multiplier keys representing the first limit value, ENTER key, numerical key representing the second limit value, ENTER key, numerical key representing the bin in which the limit will be entered, and the Yellow key followed by the BIN # key.

Example: Set bin number 2 for limits of  $\pm 1\%$ .

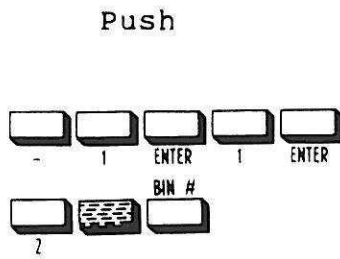

Display

| BIN                     | LO %    | HI %   | COUNT |
|-------------------------|---------|--------|-------|
| 01                      | .00000  | .00000 | 00000 |
| 02                      | -1.0000 | 1.0000 | 00000 |
| 03                      | .00000  | .00000 | 00000 |
| 04                      | .00000  | .00000 | 00000 |
| 05                      | .00000  | .00000 | 00000 |
| 06                      | .00000  | .00000 | 00000 |
| 07                      | .00000  | .00000 | 00000 |
| 08                      | .00000  | .00000 | 00000 |
| 09                      | .00000  | .00000 | 00000 |
| NOM= 00.0000M FARADS CS |         |        |       |
| REJ>.000000 RS/XS DS    |         |        |       |
| 0> █                    |         |        |       |
| 0> 1 -1 2 BIN#          |         |        |       |

Comments

The limit values could have been entered in the reverse order with the same display and sorting results. Before sorting can begin, a nominal value must be set

The preceding example programmed percent limits. There are two methods for programming absolute limit values.

1. Program absolute limits directly. Place the instrument in absolute mode. (push Yellow key, then ABS key) to enter absolute limit values.

Example: Set bin 2 for limits  $9.90\mu\text{F}$  and  $10.1\mu\text{F}$ .

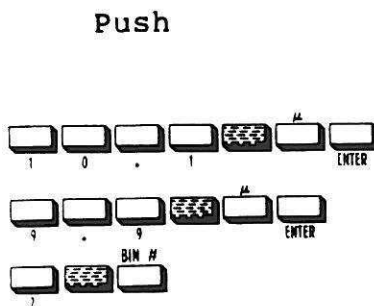

Display

| BIN                     | LO     | HI     | COUNT |
|-------------------------|--------|--------|-------|
| 01                      | .00000 | .00000 | 00000 |
| 02                      | 9.9000 | 10.100 | 00000 |
| 03                      | .00000 | .00000 | 00000 |
| 04                      | .00000 | .00000 | 00000 |
| 05                      | .00000 | .00000 | 00000 |
| 06                      | .00000 | .00000 | 00000 |
| 07                      | .00000 | .00000 | 00000 |
| 08                      | .00000 | .00000 | 00000 |
| 09                      | .00000 | .00000 | 00000 |
| NOM= 00.0000M FARADS CS |        |        |       |
| REJ>.000000 RS/XS DS    |        |        |       |
| 0> █                    |        |        |       |
| 0> 10.1 9.9 2 BIN#      |        |        |       |

Comments

The units for the limits in bins 0-9 are taken from the top measurement display in the direct display format.

2. Program limits as percents, then set a nominal value. The instrument will automatically calculate the absolute value for each limit. Absolute values are displayed by pushing the ABS key.

Example: Program bin 2 for absolute limits of  $\pm 1\%$  ( $9.9\mu\text{F}$  and  $10.1\mu\text{F}$ ).

Push

Display

Comments

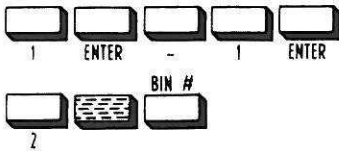

| BIN                     | LO %    | HI %   | COUNT |
|-------------------------|---------|--------|-------|
| 01                      | .00000  | .00000 | 00000 |
| 02                      | -1.0000 | 1.0000 | 00000 |
| 03                      | .00000  | .00000 | 00000 |
| 04                      | .00000  | .00000 | 00000 |
| 05                      | .00000  | .00000 | 00000 |
| 06                      | .00000  | .00000 | 00000 |
| 07                      | .00000  | .00000 | 00000 |
| 08                      | .00000  | .00000 | 00000 |
| 09                      | .00000  | .00000 | 00000 |
| NOM= 15.9000N FARADS CS |         |        |       |
| REJ> .000000 RS/XS DS   |         |        |       |
| 0> █                    |         |        |       |
| 0> 1 -1 2 BIN#          |         |        |       |

Enter percent limits.

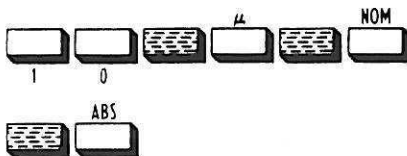

| BIN                     | LO      | HI      | COUNT |
|-------------------------|---------|---------|-------|
| 01                      | 10.000U | 10.000U | 00000 |
| 02                      | 9.9000U | 10.100U | 00000 |
| 03                      | 10.000U | 10.000U | 00000 |
| 04                      | 10.000U | 10.000U | 00000 |
| 05                      | 10.000U | 10.000U | 00000 |
| 06                      | 10.000U | 10.000U | 00000 |
| 07                      | 10.000U | 10.000U | 00000 |
| 08                      | 10.000U | 10.000U | 00000 |
| 09                      | 10.000U | 10.000U | 00000 |
| NOM= 10.0000U FARADS CS |         |         |       |
| REJ> .000000 RS/XS DS   |         |         |       |
| 0> ABSMODE              |         |         |       |
| 0> █                    |         |         |       |

Setting nominal value causes absolute limits to be calculated



Using percent limits allows different value parts to be sorted using the same limit values. While in this mode, the 2110 automatically calculates new absolute values every time the nominal value is changed. Percent limits need not be re-entered when changing nominal value.

Example: Continuing with the above example (absolute limits of  $\pm 1\%$  for  $10\mu\text{F}$  capacitors) change the nominal value to sort  $1\mu\text{F}$  capacitors,  $10\text{nF}$  capacitors, and  $100\text{pF}$  capacitors.

Push



Display

| BIN                     | LO      | HI      | COUNT |
|-------------------------|---------|---------|-------|
| 01                      | 1.0000U | 1.0000U | 00000 |
| 02                      | .99000U | 1.0100U | 00000 |
| 03                      | 1.0000U | 1.0000U | 00000 |
| 04                      | 1.0000U | 1.0000U | 00000 |
| 05                      | 1.0000U | 1.0000U | 00000 |
| 06                      | 1.0000U | 1.0000U | 00000 |
| 07                      | 1.0000U | 1.0000U | 00000 |
| 08                      | 1.0000U | 1.0000U | 00000 |
| 09                      | 1.0000U | 1.0000U | 00000 |
| NOM= 1.00000U FARADS CS |         |         |       |
| REJ> .000000 RS/XS DS   |         |         |       |
| 0> 1 MICRO NOMINAL      |         |         |       |
| 0> █                    |         |         |       |

Comments

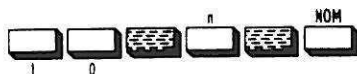

| BIN                     | LO      | HI      | COUNT |
|-------------------------|---------|---------|-------|
| 01                      | 10.000N | 10.000N | 00000 |
| 02                      | 9.9000N | 10.100N | 00000 |
| 03                      | 10.000N | 10.000N | 00000 |
| 04                      | 10.000N | 10.000N | 00000 |
| 05                      | 10.000N | 10.000N | 00000 |
| 06                      | 10.000N | 10.000N | 00000 |
| 07                      | 10.000N | 10.000N | 00000 |
| 08                      | 10.000N | 10.000N | 00000 |
| 09                      | 10.000N | 10.000N | 00000 |
| NOM= 10.0000N FARADS CS |         |         |       |
| REJ> .000000 RS/XS DS   |         |         |       |
| 0> 10 MAND NOMINAL      |         |         |       |
| 0> █                    |         |         |       |

The instrument recalculates the absolute limits for each nominal value.

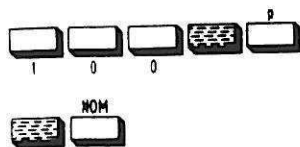

| BIN                     | LO       | HI      | COUNT |
|-------------------------|----------|---------|-------|
| 01                      | .10000N  | .10000N | 00000 |
| 02                      | .99.000P | .10100N | 00000 |
| 03                      | .10000N  | .10000N | 00000 |
| 04                      | .10000N  | .10000N | 00000 |
| 05                      | .10000N  | .10000N | 00000 |
| 06                      | .10000N  | .10000N | 00000 |
| 07                      | .10000N  | .10000N | 00000 |
| 08                      | .10000N  | .10000N | 00000 |
| 09                      | .10000N  | .10000N | 00000 |
| NOM= .100000N FARADS CS |          |         |       |
| REJ> .000000 RS/XS DS   |          |         |       |
| 0> 100 PICO NOMINAL     |          |         |       |
| 0> █                    |          |         |       |

When in the binning display format, re-entering or changing the nominal value will reset all component counters to zero.

The reject (REJ) limit must always be set before entering the sorting mode. It is a limit for the secondary parameter (bottom measurement display when in direct display format). Reject limit is set as an absolute value for both absolute and percent mode. To program the reject limit, push the numerical and/or multiplier keys representing the limit of the secondary parameter, then yellow key and MINOR key.

Example: Set the maximum limit of D (secondary parameter) to 0.005.

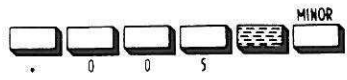
| Push   | Display   | Comments |       |    |       |    |         |         |       |    |         |         |       |    |         |         |       |    |         |         |       |    |         |         |       |    |         |         |       |    |         |         |       |    |         |         |       |    |         |         |       |                         |  |  |  |                      |  |  |  |                |  |  |  |      |  |  |  |  |
|--|---|----------|-------|----|-------|----|---------|---------|-------|----|---------|---------|-------|----|---------|---------|-------|----|---------|---------|-------|----|---------|---------|-------|----|---------|---------|-------|----|---------|---------|-------|----|---------|---------|-------|----|---------|---------|-------|-------------------------|--|--|--|----------------------|--|--|--|----------------|--|--|--|------|--|--|--|--|
|  | <div style="border: 2px solid black; border-radius: 15px; padding: 10px; width: fit-content; margin: auto;"> <table border="0"> <thead> <tr> <th style="text-align: left;">BIN</th> <th style="text-align: left;">LO</th> <th style="text-align: left;">HI</th> <th style="text-align: left;">COUNT</th> </tr> </thead> <tbody> <tr><td>01</td><td>.10000N</td><td>.10000N</td><td>00000</td></tr> <tr><td>02</td><td>99.000P</td><td>.10100N</td><td>00000</td></tr> <tr><td>03</td><td>.10000N</td><td>.10000N</td><td>00000</td></tr> <tr><td>04</td><td>.10000N</td><td>.10000N</td><td>00000</td></tr> <tr><td>05</td><td>.10000N</td><td>.10000N</td><td>00000</td></tr> <tr><td>06</td><td>.10000N</td><td>.10000N</td><td>00000</td></tr> <tr><td>07</td><td>.10000N</td><td>.10000N</td><td>00000</td></tr> <tr><td>08</td><td>.10000N</td><td>.10000N</td><td>00000</td></tr> <tr><td>09</td><td>.10000N</td><td>.10000N</td><td>00000</td></tr> <tr><td colspan="4">NDM= .100000N FARADS CS</td></tr> <tr><td colspan="4">REJ&gt;.005000 RS/XS DC</td></tr> <tr><td colspan="4">0&gt; 0.005 MINOR</td></tr> <tr><td colspan="4">0&gt; █</td></tr> </tbody> </table> </div> | BIN      | LO    | HI | COUNT | 01 | .10000N | .10000N | 00000 | 02 | 99.000P | .10100N | 00000 | 03 | .10000N | .10000N | 00000 | 04 | .10000N | .10000N | 00000 | 05 | .10000N | .10000N | 00000 | 06 | .10000N | .10000N | 00000 | 07 | .10000N | .10000N | 00000 | 08 | .10000N | .10000N | 00000 | 09 | .10000N | .10000N | 00000 | NDM= .100000N FARADS CS |  |  |  | REJ>.005000 RS/XS DC |  |  |  | 0> 0.005 MINOR |  |  |  | 0> █ |  |  |  |  |
| BIN  | LO  | HI       | COUNT |    |       |    |         |         |       |    |         |         |       |    |         |         |       |    |         |         |       |    |         |         |       |    |         |         |       |    |         |         |       |    |         |         |       |    |         |         |       |                         |  |  |  |                      |  |  |  |                |  |  |  |      |  |  |  |  |
| 01   | .10000N   | .10000N  | 00000 |    |       |    |         |         |       |    |         |         |       |    |         |         |       |    |         |         |       |    |         |         |       |    |         |         |       |    |         |         |       |    |         |         |       |    |         |         |       |                         |  |  |  |                      |  |  |  |                |  |  |  |      |  |  |  |  |
| 02   | 99.000P   | .10100N  | 00000 |    |       |    |         |         |       |    |         |         |       |    |         |         |       |    |         |         |       |    |         |         |       |    |         |         |       |    |         |         |       |    |         |         |       |    |         |         |       |                         |  |  |  |                      |  |  |  |                |  |  |  |      |  |  |  |  |
| 03   | .10000N   | .10000N  | 00000 |    |       |    |         |         |       |    |         |         |       |    |         |         |       |    |         |         |       |    |         |         |       |    |         |         |       |    |         |         |       |    |         |         |       |    |         |         |       |                         |  |  |  |                      |  |  |  |                |  |  |  |      |  |  |  |  |
| 04   | .10000N   | .10000N  | 00000 |    |       |    |         |         |       |    |         |         |       |    |         |         |       |    |         |         |       |    |         |         |       |    |         |         |       |    |         |         |       |    |         |         |       |    |         |         |       |                         |  |  |  |                      |  |  |  |                |  |  |  |      |  |  |  |  |
| 05   | .10000N   | .10000N  | 00000 |    |       |    |         |         |       |    |         |         |       |    |         |         |       |    |         |         |       |    |         |         |       |    |         |         |       |    |         |         |       |    |         |         |       |    |         |         |       |                         |  |  |  |                      |  |  |  |                |  |  |  |      |  |  |  |  |
| 06   | .10000N   | .10000N  | 00000 |    |       |    |         |         |       |    |         |         |       |    |         |         |       |    |         |         |       |    |         |         |       |    |         |         |       |    |         |         |       |    |         |         |       |    |         |         |       |                         |  |  |  |                      |  |  |  |                |  |  |  |      |  |  |  |  |
| 07   | .10000N   | .10000N  | 00000 |    |       |    |         |         |       |    |         |         |       |    |         |         |       |    |         |         |       |    |         |         |       |    |         |         |       |    |         |         |       |    |         |         |       |    |         |         |       |                         |  |  |  |                      |  |  |  |                |  |  |  |      |  |  |  |  |
| 08   | .10000N   | .10000N  | 00000 |    |       |    |         |         |       |    |         |         |       |    |         |         |       |    |         |         |       |    |         |         |       |    |         |         |       |    |         |         |       |    |         |         |       |    |         |         |       |                         |  |  |  |                      |  |  |  |                |  |  |  |      |  |  |  |  |
| 09   | .10000N   | .10000N  | 00000 |    |       |    |         |         |       |    |         |         |       |    |         |         |       |    |         |         |       |    |         |         |       |    |         |         |       |    |         |         |       |    |         |         |       |    |         |         |       |                         |  |  |  |                      |  |  |  |                |  |  |  |      |  |  |  |  |
| NDM= .100000N FARADS CS  |   |          |       |    |       |    |         |         |       |    |         |         |       |    |         |         |       |    |         |         |       |    |         |         |       |    |         |         |       |    |         |         |       |    |         |         |       |    |         |         |       |                         |  |  |  |                      |  |  |  |                |  |  |  |      |  |  |  |  |
| REJ>.005000 RS/XS DC   |   |          |       |    |       |    |         |         |       |    |         |         |       |    |         |         |       |    |         |         |       |    |         |         |       |    |         |         |       |    |         |         |       |    |         |         |       |    |         |         |       |                         |  |  |  |                      |  |  |  |                |  |  |  |      |  |  |  |  |
| 0> 0.005 MINOR   |   |          |       |    |       |    |         |         |       |    |         |         |       |    |         |         |       |    |         |         |       |    |         |         |       |    |         |         |       |    |         |         |       |    |         |         |       |    |         |         |       |                         |  |  |  |                      |  |  |  |                |  |  |  |      |  |  |  |  |
| 0> █   |   |          |       |    |       |    |         |         |       |    |         |         |       |    |         |         |       |    |         |         |       |    |         |         |       |    |         |         |       |    |         |         |       |    |         |         |       |    |         |         |       |                         |  |  |  |                      |  |  |  |                |  |  |  |      |  |  |  |  |

### 2.7.3 Bin Counters

Adjacent to each of the bins (0 - 9 and REJ) is a counter. The counter records the number of components that fall within the limits for each bin. During the sorting operation, the counter will record up to 65,225 parts for each bin. To view the counters and to stop the sorting operation, push the STAT key. To restart the sorting operation, push SORT. The bin counters for bins 0-9 are reset to zero by re-entering or changing the nominal value. The counter for the reject bin is reset to zero when the minor (REJ) limit is changed. Counting is only accomplished in the single measurement mode.

**NOTE:** The reject limit is either a maximum or a minimum value depending on the measurement function of the bottom display on the CRT. Maximum or minimum is shown on the CRT as:

Rej > = Maximum Limit (all secondary components except Q)

Rej < = Minimum Limit (Q only)

### 2.7.4 Sort Mode

Component sorting starts when the SORT key is pushed. All test parameters and limit values must be set before entering the sort mode. While in the sort mode, the keyboard is inoperative except for the SINGLE key and the escape key (SORT). Figure 2-11 is a Sorting Mode Preparation Check List.

### TEST PARAMETERS

- Frequency
- Nominal Value (if required)
- Top Display Function
- Bottom Display Function
- Signal Level
- Settling Time
- Integration Time
- Measurements Averaged

### BINNING LIMITS

- Correct Limits Bins 0 - 9
- Correct Reject Limit
- Nominal Value (if required)

Figure 2-11. Sorting Mode Preparation Check List

The sorting display consists of the word BIN and a number. The number represents the bin in which the component value fell. If the component exceeds the REJ limit, the display will read BIN R.

Entering the sort mode sets the instrument to the single measurement mode. Measurements can be initiated by either pushing the SINGLE key or receiving a remote start signal. To enter the sort mode, push SORT.



Example: Continuing with the preceding examples, enter the sorting mode and make several measurements.

Push

Display

Comments



| BIN                     | LD      | HT      | COUNT |
|-------------------------|---------|---------|-------|
| 01                      | .10000M | .10000M | 00000 |
| 02                      | 99.000P | .10100M | 00000 |
| 03                      | .10000M | .10000M | 00000 |
| 04                      | .10000M | .10000M | 00000 |
| 05                      | .10000M | .10000M | 00000 |
| 06                      | .10000M | .10000M | 00000 |
| 07                      | .10000M | .10000M | 00000 |
| 08                      | .10000M | .10000M | 00000 |
| 09                      | .10000M | .10000M | 00000 |
| NOM= .100000M FARADS CS |         |         |       |
| REJ>.005000 RS/XS DC    |         |         |       |
| 0> 0.005 MINOR          |         |         |       |
| 0> █                    |         |         |       |



```

01000 HZ  NOM= 10.0000M FARADS
1000 MV SINGLE          SORT
SETL=0020MS INTGR=0050MS AVE=1

      BIN 2

0> █
0> SINGLE
    
```



To exit the sorting mode, push STAT key. When the STAT key is pushed, sorting stops, turns off bin counters, and the display reverts to the binning display format. All limits and nominal values are left intact. To re-enter the sorting mode, push SORT key.

## 2.7.5 Component Sorting Example

This example is to illustrate the concepts presented in this portion of the manual. It is a typical setup, starting from the instrument power ON condition, for sorting 100nF capacitors into tolerance bands of  $\pm 0.5\%$ ,  $\pm 1\%$ ,  $\pm 2\%$ ,  $\pm 5\%$ ,  $\pm 10\%$ ,  $\pm 20\%$  with a maximum limit on D of 0.005. Other test parameters include: frequency, 10kHz; signal level, 500mVRMS; measurement speed, MED. After all parameters are programmed, the example will look at the limits in absolute units, start the sorting operation, stop sorting to look at the bin counters, and restart the sorting operation. The example will end by exiting the sorting mode to normal measurement operation.

Example:

### Test Parameter Set Up

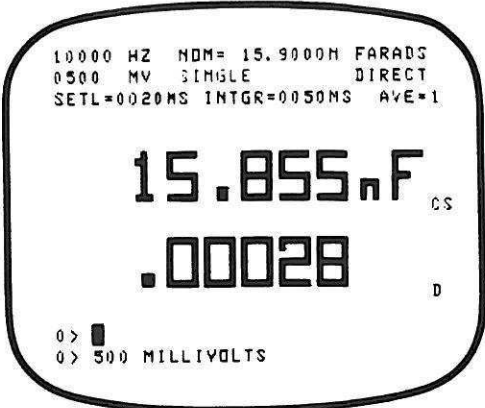
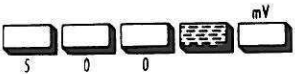
| Push  | Display   | Comments     |
|---|---|--------------|
|   |  | Frequency    |
|  |   | Signal level |

**NOTE:** In this example, the measurement functions Cs and D, settling time, integration time, and measurement averaged did not need programming because the 2100/2110 initialized to these functions when power was applied.

## Limits Set Up

Push

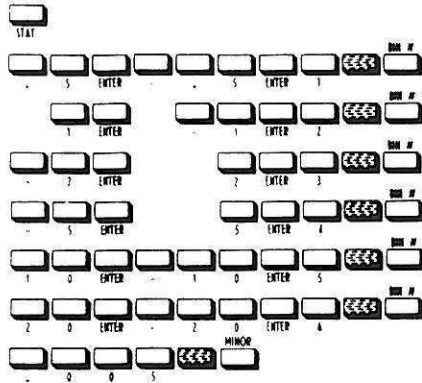

Display

| BIN                    | LO %    | HI %    | COUNT |
|------------------------|---------|---------|-------|
| 01                     | - 0.50  | + 0.50  | 00000 |
| 02                     | - 1.00  | + 1.00  | 00000 |
| 03                     | - 2.00  | + 2.00  | 00000 |
| 04                     | - 5.00  | + 5.00  | 00000 |
| 05                     | - 10.00 | + 10.00 | 00000 |
| 06                     | - 20.00 | + 20.00 | 00000 |
| 07                     | + 0.00  | + 0.00  | 00000 |
| 08                     | + 0.00  | + 0.00  | 00000 |
| 09                     | + 0.00  | + 0.00  | 00004 |
| NOM= .000000 FARADS CS |         |         |       |
| REJ>.000000 RS/XS DS   |         |         |       |
| MINOR                  |         |         |       |

Comments

Limit values must be set in ascending order. They can be entered in either order (HI value first or LO value first) within each bin.

Enter Nominal Value (calculate absolute values)

Push

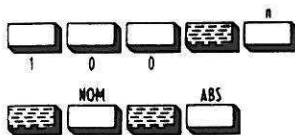

Display

| BIN                     | LO      | HI      | COUNT |
|-------------------------|---------|---------|-------|
| 01                      | 99.500N | .10050U | 00000 |
| 02                      | 99.000N | .10100U | 00000 |
| 03                      | 98.000N | .10200U | 00000 |
| 04                      | 95.000N | .10500U | 00000 |
| 05                      | 90.000N | .11000U | 00000 |
| 06                      | 80.000N | .12000U | 00000 |
| 07                      | .10000U | .10000U | 00000 |
| 08                      | .10000U | .10000U | 00000 |
| 09                      | .10000U | .10000U | 0000+ |
| NOM= .100000U FARADS CS |         |         |       |
| REJ>.000000 RS/XS DS    |         |         |       |
| 0>                      |         |         |       |
| 0> ABSNOE               |         |         |       |

Comments

Set measurement range and calculate absolute values.

View absolute values.

Begin Sorting Operation

Push



Display

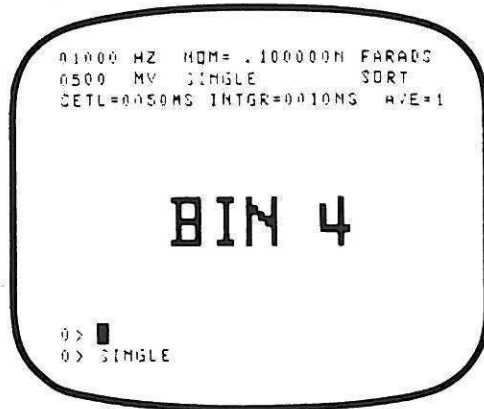

Comments

Components exceeding the reject limit will display BIN R.

View Bin Counters then continue sorting

Push



Display

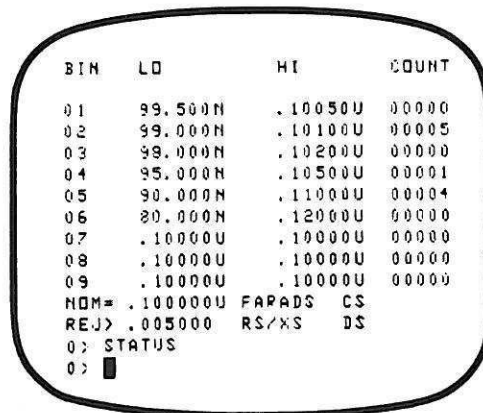

Comments

Escape from sort mode. To clear bin counters, re-enter the nominal value.

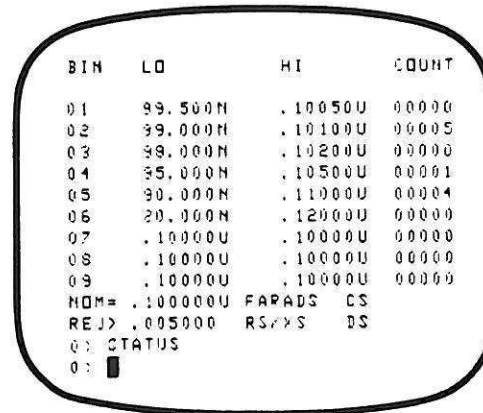

Re-enter sorting mode.



Exit Sorting Mode

Push



Display



Comments

Sorting stops.

Display reverts to direct format.

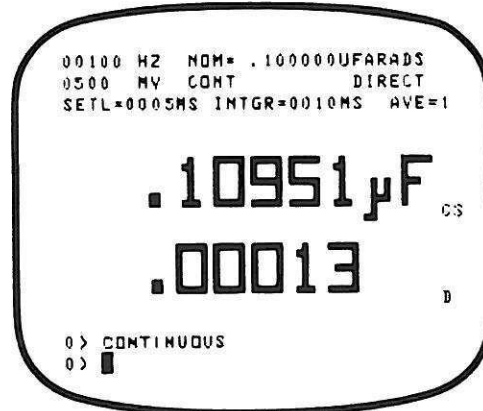

Normal continuous measurements are made and results displayed.

## 2.8 MEASUREMENT SPEED

A measurement sequence for the Model 2100/2110 is illustrated in Figure 2-12. Total measurement time consists of a number of fixed and variable elements. The following paragraphs describe and illustrate each of these elements.

Figure 2-12.  
Measurement Sequence

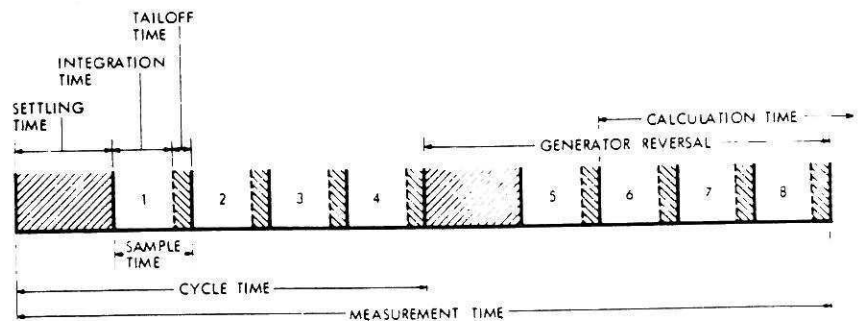

Integration Time is the number of test frequency cycles during which the A/D converter is making the measurement. Integration time can be determined by the formula:

$$n \left( \frac{1}{f} \right) \quad \text{Where: } n = \text{Integer between 1 and 256}$$

$$f = \text{Test Frequency}$$

The limits between which integration time can be programmed are shown by the formula:

$$500\text{ms} \leq n \left( \frac{1}{f} \right) \leq 2\text{ms}$$

Tailoff Time is the fixed portion of measurement time which is set at 4ms. During tailoff time the A/D converter is being brought to zero, and the course and fine counters are accumulating measurement data.

Sample Time is Integration time + Tailoff time (see Figure 2-13).

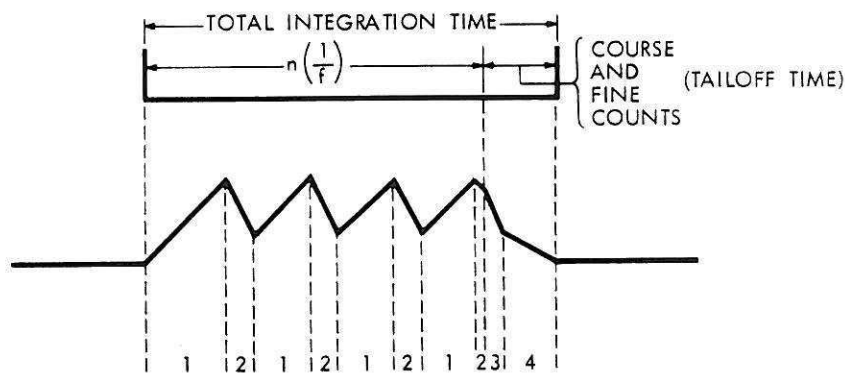

- 1 = Integration on measured signal.
- 2 = Integration on mixture of measured and reference signal. Course counter sums these periods.
- 3 = Integration on reference signal only. Course counter sums this with previous periods.
- 4 = Integration on fine reference. Fine counter monitors this period adding its count to the course counter total 1 course count = 1024 fine counts.

Figure 2-13. Sample Time

Settling Time is the time required for the analog voltage representing the unknown to settle to the desired accuracy. Settling times between 2ms and 1500ms can be programmed in 1ms step. Settling time values are dependent on the type of component being tested and/or requirements of externally connected equipment. Typically, smaller impedances require longer settling times.

Cycle Time is settling time + (4 × Sample time), see Figure 2-14. Cycle time represents the time to acquire the four readings representing:

- 0° voltage unknown
- 90° voltage unknown
- 0° voltage reference
- 90° voltage reference

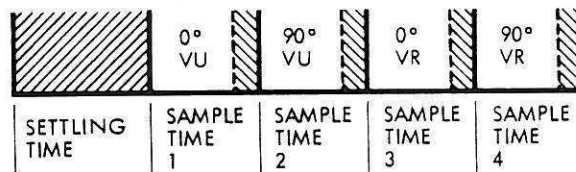
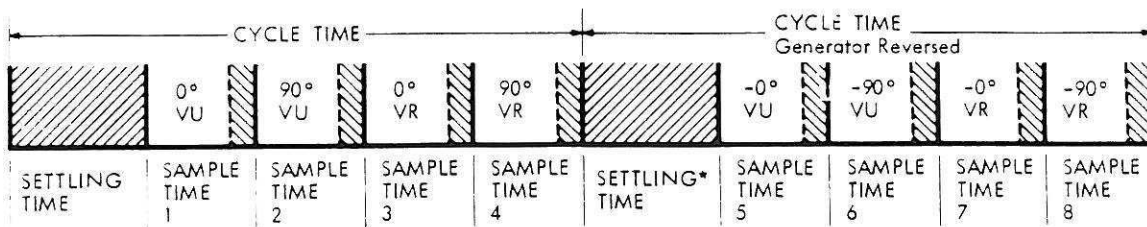

Figure 2-14. Cycle Time

Linelock Time is the average time for the line frequency to reach the zero crossing point with a positive going slope. Linelock time is added to the settling time when the test frequency is between 20Hz and 200Hz.



**Measurement Time** is  $2 \times (\text{Cycle time} + \text{Linelock time})$ , see Figure 2-15. Measurement time is the total time from start to end of a measurement sequence or total measurement time. The second cycle time is made with the generator polarity reversed.



**Figure 2-15. Measurement Time**

**Generator Reversal** is the sinewave generator reversed in polarity after the first cycle time. The second series of measurements are made in the opposite polarity. These two series of measurements are algebraically added, i.e. (1-5) (2-6), (3-7), (4-8), to cancel offset voltages in operational amplifiers and synchronized line related pickup.

**Measurement Averaging** is  $n \times (\text{measurement time})$  Where:  $n$  is an integer between 1 and 20 (see Figure 2-16). Averaging reduces noisy readings by adding a selected number of measurements and dividing by the number of measurement times.

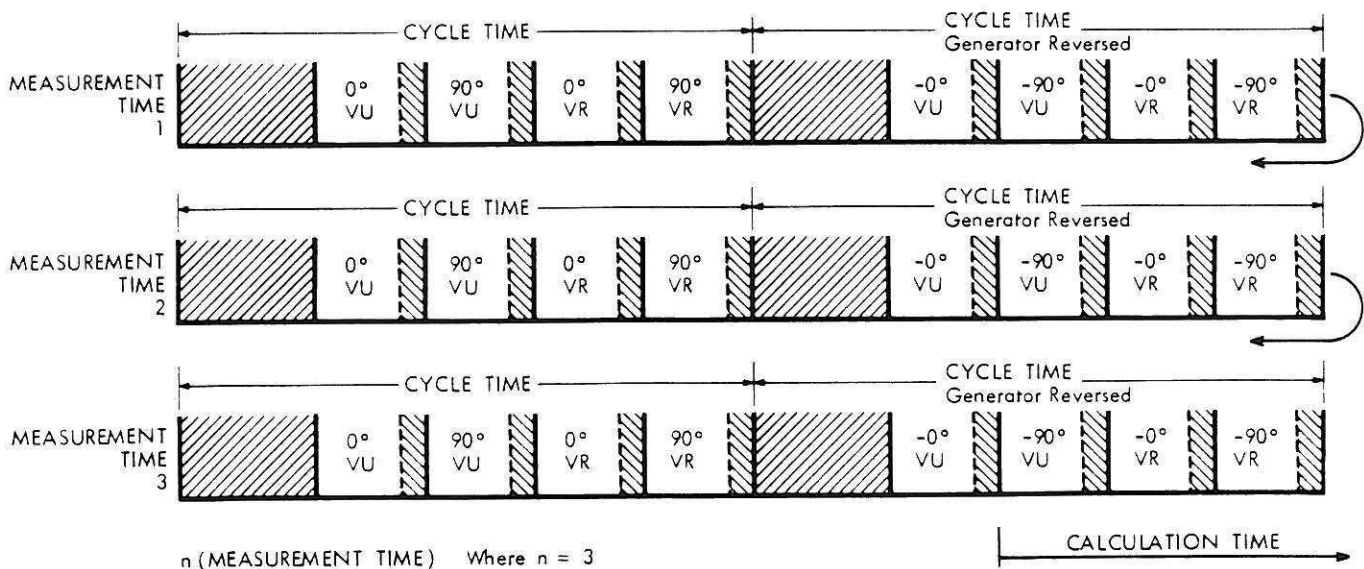

**Figure 2-16. Measurement Averaging**



Calculation Time is the time required to calculate display information from the raw measured data.

Display Time is the time required to display stored information on the CRT.

### Measurement Speed Summary

The preceding paragraphs gave you some insight into the various elements that make up total measurement time. Now, total measurement speed can be found by using the formula:

Measurement Speed = Total Measurement Time + Calculation Time + Display Time

Where:

Total Measurement Time = 8(Sample Time) + 2(Settling Time)  
x Measurements Averaged

Calculation Time = 100ms

Display Time = 300ms Normal display  
50ms Sorting display

Example: Measurement speed for an instrument in initial start-up mode, medium measurement speed selected (SETL = 50ms, I.T. = 50ms, and AVG = 1), normal display mode, and at 1kHz, is calculated as follows:

|                        |     |                                  |
|------------------------|-----|----------------------------------|
| Integration time       | =   | 50ms                             |
| Tailoff time           | = + | <u>3ms</u>                       |
| Sample time (total)    | =   | 53ms                             |
| Settling time          | =   | 50ms                             |
| Linelock time          | =   | <u>0</u> (frequency above 200Hz) |
| Measurement time       | =   | 524ms [8(53) + 2(50)]            |
| Measurements averaged  | =   | <u>1</u>                         |
| Total Measurement time | =   | 524ms                            |
| Calculation time       | =   | 100ms                            |
| Display time           | =   | <u>300ms</u> (Normal display)    |
| Measurement speed      | =   | 924ms                            |

Example: Measurement speed for an instrument in FAST measurement speed mode (SETL 5ms, I.T. 10ms, and AVG 1), sorting mode, and at 1kHz is computed as follows:

|                        |     |                                  |
|------------------------|-----|----------------------------------|
| Integration time       | =   | 10ms                             |
| Tailoff time           | = + | <u>3ms</u>                       |
| Sample time (total)    | =   | 13ms                             |
| Settling time          | =   | 5ms                              |
| Linelock time          | =   | <u>0</u> (frequency above 200Hz) |
| Measurement time       | =   | 114ms [8(13) + 2(5)]             |
| Measurements averaged  | =   | <u>1</u>                         |
| Total Measurement time | =   | 114ms                            |
| Calculation time       | =   | 100ms                            |
| Display time           | =   | <u>50ms</u> (Sorting display)    |
| Measurement speed      | =   | 264ms                            |

### 2.8.1 Programming Integration Time

Integration time is only a small portion of the overall measurement time of the Model 2100/2110. It is the variable portion of sample time (described previously), that is based on a number of cycles of the test frequency. Integration time can be programmed to a maximum of 500ms and to a minimum of 2ms.

As a rule, short integration times are less accurate than longer times and can cause less measurement resolution to be displayed. Any integration time that does not allow the instrument to integrate on a number of complete measurement frequency cycles will automatically be reprogrammed to the next larger integration time that does. When the measurement frequency is decreased below 500Hz, the instrument again automatically updates to the next valid time. Integration times continue to increase with each lower frequency programmed. To find the permissible integration times use the formula:

$$500\text{ms} \leq n \left( \frac{1}{f} \right) \leq 2\text{ms} \quad \text{Where: } n = \text{Integer between 1 and 256} \\ f = \text{Test Frequency}$$

**NOTE:** Three preprogrammed measurement speeds (Fast, Medium, Slow) are available in the Model 2110. Each has preset settling time, integration time, and measurements averaged (see Section 2.8.3).

| <u>Frequency</u> |   | <u>Minimum Integration Time</u> |
|------------------|---|---------------------------------|
| 500Hz            | = | 2ms                             |
| 400Hz            | = | 3ms                             |
| 300Hz            | = | 4ms                             |
| 200Hz            | = | 5ms                             |
| 100Hz            | = | 10ms                            |
| 60Hz             | = | 17ms                            |
| 50Hz             | = | 20ms                            |
| 40Hz             | = | 25ms                            |
| 30Hz             | = | 34ms                            |
| 20Hz             | = | 50ms                            |

To program integration time, push the numerical keys representing the desired integration time in milliseconds, then push the yellow key followed by the I.T. key.

Example: Program integration time based on 10 cycles of the 500Hz test frequency.

$$n\left(\frac{1}{f}\right) = 10 \left(\frac{1}{500}\right) = 10(0.002) = 20\text{ms}$$

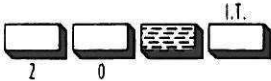
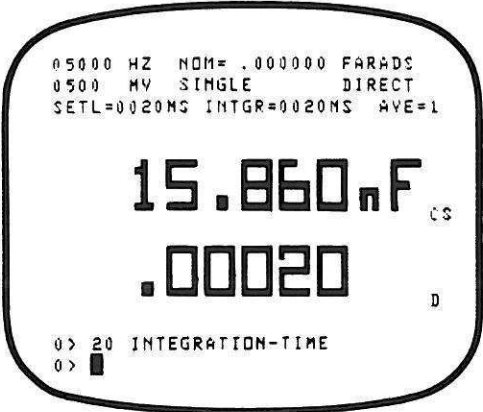
| Push   | Display  | Comments  |
|--|--|---|
|  |  | <p>Integration time is entered in milliseconds.</p> |



## 2.8.2 Programming Settling Time

Settling time, as described above (Section 2.8), is the time required for the analog voltage representing the unknown to settle to stated accuracy. Settling times between 2ms and 1500ms can be programmed in 1ms step. When instrument power is applied, the settling time is at 10ms. To program settling time, push the numerical keys that represent the settling time, in milliseconds, followed by the yellow key and the SETL key.

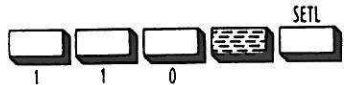
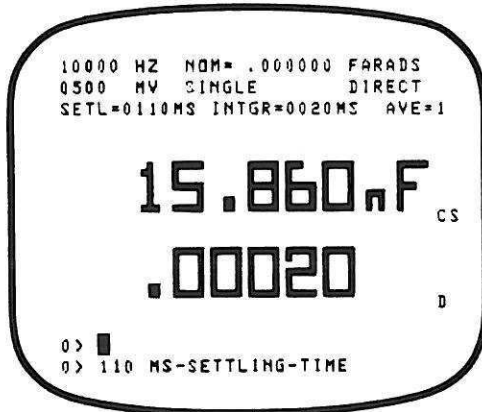

Example: Set settling time to 110 milliseconds.

| Push  | Display   | Comments |
|---|---|----------|
|  |  |          |

### 2.8.3 Programming Measurement Speed

Three pushbuttons are dedicated to programming FAST, MEDIUM, or SLOW measurement speeds. Each speed is fixed in both settling time and integration time (see Table 2-8). Medium speed is the initial speed when instrument power is applied. FAST speed is not available at test frequencies below 200Hz. To program FAST, MED, or SLOW measurement speed, push the yellow key followed by the FAST, MED, or SLOW key.

Example: Set the instrument to SLOW measurement speed.

| Push  | Display  | Comments  |
|---|--|---|
|  |  | <p>Measurement speed is changed from MED to SLOW.</p> |

|        | SETL | I.T. | AVG |
|--------|------|------|-----|
| Fast   | 5ms  | 10ms | 1   |
| Medium | 50ms | 50ms | 1   |
| Slow   | 50ms | 50ms | 5   |

Table 2-8. Measurement Speeds

## 2.8.4 Programming Measurement Averaging

Measurements made where stray fields introduce noise can result in fluctuating readings. The 2100/2110 can reduce these fluctuations by averaging a specified group of measurements. The noise is reduced by approximately the square root of the number of measurements averaged. As shown in Section 2.8, the total measurement time for averaging measurements is equal to:

$$n \times (\text{Sample time})$$

Where:  $n$  = an integer between 1 and 20

To program a selected number of measurements to be averaged, push the numerical keys representing the number of measurements to be averaged followed by the yellow key and the AVG key.

Example: Average 10 measurements and display the results.

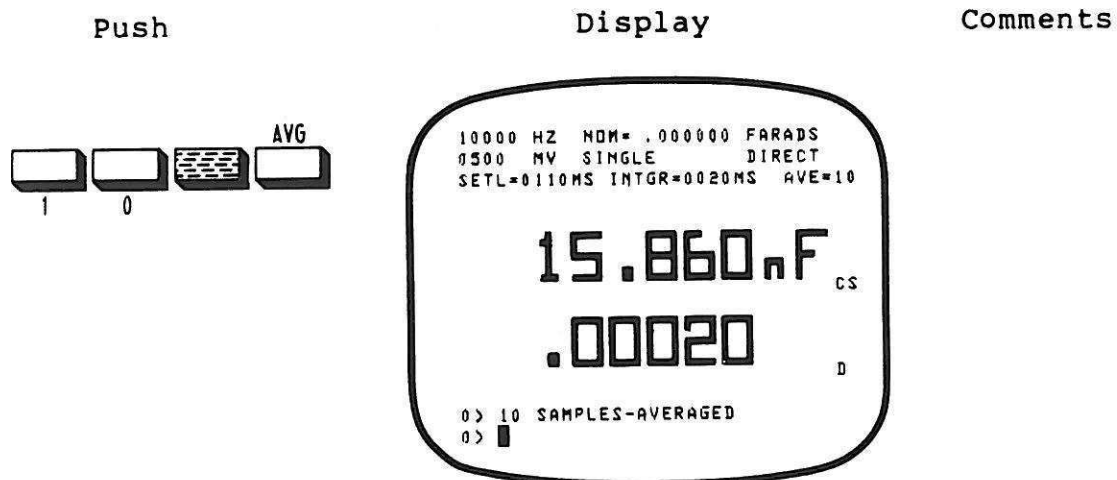

## 2.9 CASSETTE TAPE LOADER

The cassette tape loader is a non-volatile, mass storage unit for measurement application programs. It uses a certified digital mini-cassette recording tape for saving and reloading instrument measurement-parameter setups. All measurement parameters, binning limits, and bin counter information can be saved, then reprogrammed at a later time. The cassette tape loader saves the time required to reload test parameters and limits at the start of a production run or after a power interruption.

### 2.9.1 Cassette Tape Installation

The mini-cassette tape is installed in the 2110's cassette tape loader as shown in Figure 2-17. To install:

- STEP 1. Push the front panel button labeled EJECT. The cassette tape loader door will spring open.
- STEP 2. Remove any cassette tape already in the loader and install the new tape (see Figure 2-17).
- STEP 3. Push the door closed.
- STEP 4. The Model 2110 is ready to save or retrieve parameter programs (see Section 2.9.3.1, 2.9.3.2).



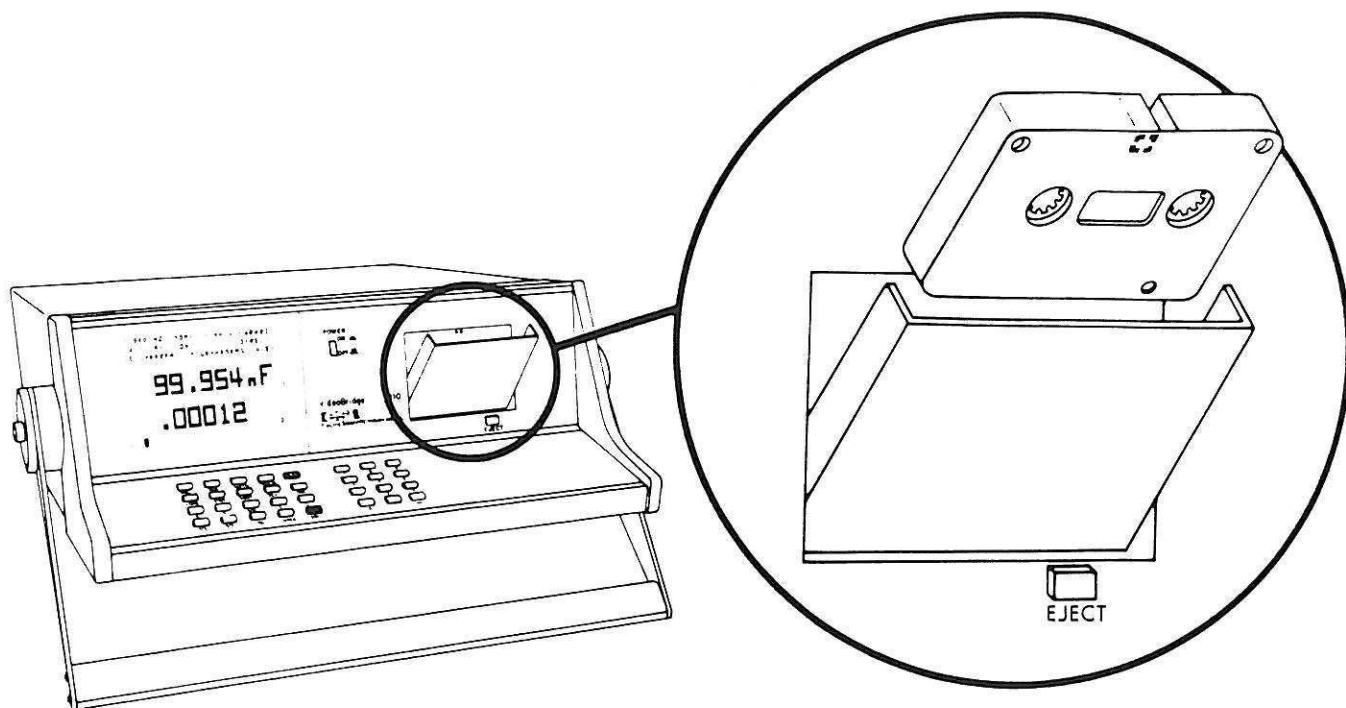

Figure 2-17. Cassette Tape Installation

### 2.9.2 Cassette Tape Loader Maintenance

To assure reliable data storage and playback, the recording and playback heads should be periodically checked and cleaned. The heads should be cleaned using a cotton tipped swab dipped in alcohol (see Figure 2-18). No other preventive maintenance or lubrication is required.

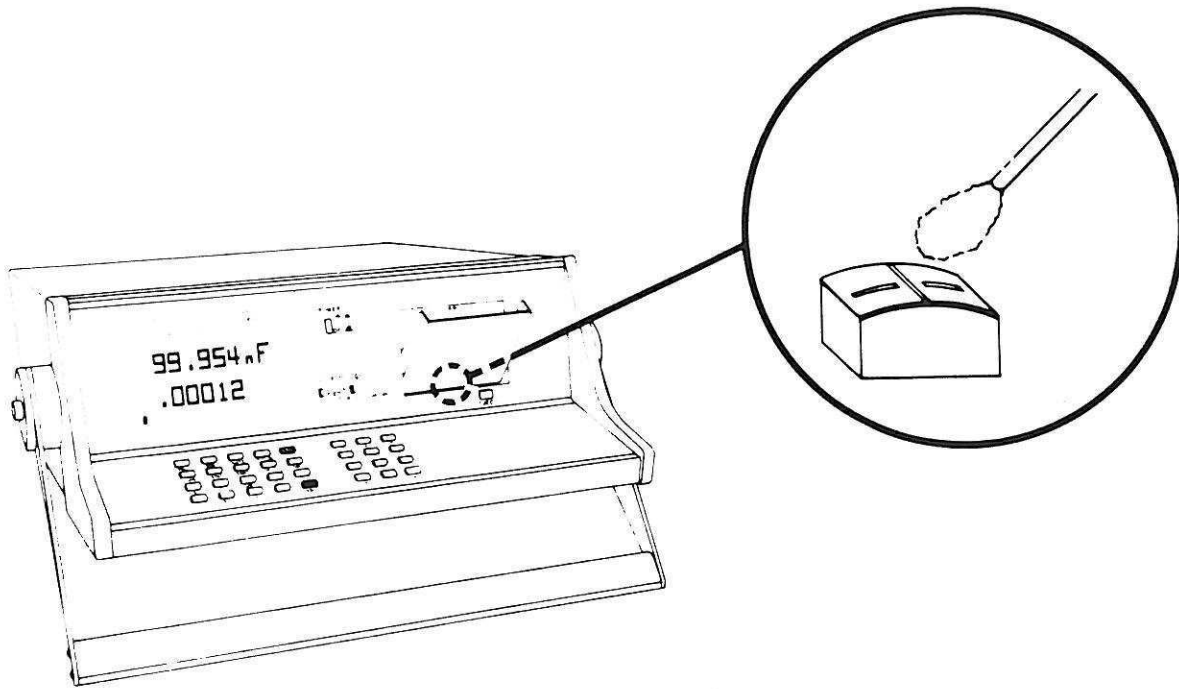

Figure 2-18. Cleaning Recording/Playback Heads

### 2.9.3 Cassette Tape Formatting

Cassette tapes must be formatted before instrument parameters can be stored or retrieved. The formatting sequence sets up 15 blocks, on each side of the tape, in which information can be stored. To format a new tape:

1. Place the new tape in the cassette drive unit.
2. Push 3 (yellow) CODE. The 2110 will echo the message "MAKE TAPE -- SNGL TO START".
3. Push SINGLE. The message will disappear when formatting is complete.

## 2.9.4 Cassette Tape Programming

The mini cassette tape is divided into 15 areas or files, numbered 1-15, as shown in Figure 2-19. Each file will hold one complete instrument setup. Instrument parameters are stored according to the identification number (1-15) assigned to the program when it is stored. Saving and reloading parameter information to/from the cassette tape is described in the following paragraphs.

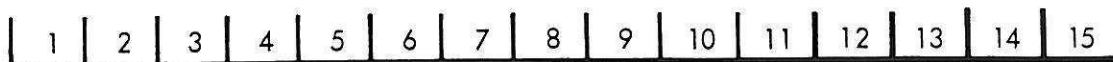
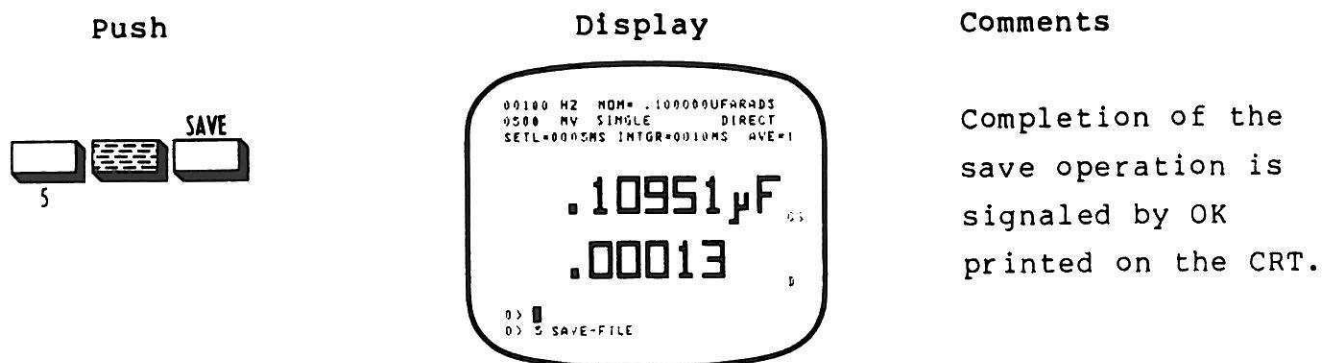

Figure 2-19. Cassette Tape File Areas

### 2.9.4.1 Saving Parameters

Instrument parameters are saved on the cassette tape by pushing the numerical keys (1-15) representing the program identification number followed by the yellow key and the SAVE key.

Example: Using the component sorting example (see Section 2.7.5) set up all test parameters and binning limits. Save this parameter program under the identification number 5.



#### 2.9.4.2 Loading Parameter Programs

Parameter programs saved on the cassette tape can be retrieved at any time. To reprogram the 2100/2110 with a prestored program, push the numerical keys (1-15) representing the identification number of the program followed by the yellow key and LOAD key.

Example: Turn instrument power off then on again. Reload the parameter program saved in the preceding example.

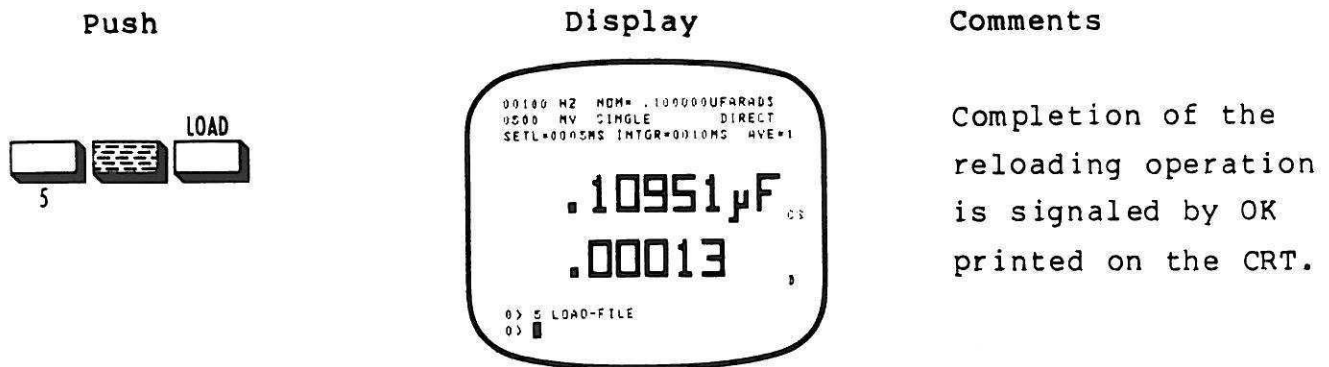

#### 2.9.5 Program Write-Protect

Important parameter programs can be permanently protected from accidental erasure with the cassette write-protect feature. Each cassette module has a cross shaped plug located on the top back of the cassette (see Figure 2-20). To permanently protect recorded programs, punch out the cross shaped plug. With the plug removed, no additional data can be written over the existing programs on that side of the tape.



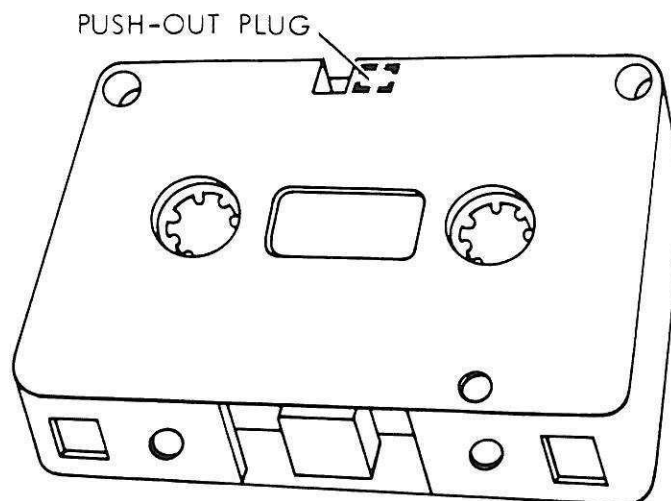

Figure 2-20. Program Write-Protect Feature

Cassette tape modules with the write-protect plug removed can be reprogrammed by placing a piece of cellophane or vinyl tape over the write-protect hole.

#### 2.9.6 Cassette Care

Careful handling procedures will extend the useful life of the mini-cassette tapes used with this instrument. Read the following precautions to extend the life of cassette tapes.

- . Avoid direct sunlight, high temperatures, and moisture.
- . Keep tape surface clean. Touching the tape surface can transfer any dirt from your fingers to recording and playback heads.
- . Prevent tape breakage and stretching by removing any slack in the tape before putting the cassette into the recorder.
- . Do not store cassette tapes on or near magnetic fields or devices. Strong magnetic fields may destroy stored programs.

## 2.10 CODE KEY FUNCTION OPERATION

### 2.10.1 Capacitance Measurements with DC Bias (Codes 1 and -1)

A DC bias of up to 50V can be applied to the rear panel bias terminals (observe polarity). The Bias Voltage is not applied to the unknown until the Bias Key is pushed. Measurements with bias are available for capacitance only. Bias supply must have low ripple with internal current limit of 100mA and its output impedance must be less than 50mΩ. Leakage current through the unknown can be measured by sampling the current from the bias source to the bias terminals with a low impedance ammeter. If the bias source impedance is not low compared to the unknown, a bypass capacitor whose impedance is 1/5 of the unknown at the operating frequency can be connected across the bias source and ammeter (if used).

#### **WARNING**

**ELECTRICAL SHOCK HAZARD EXISTS WHEN A BIAS SUPPLY IS CONNECTED TO THIS INSTRUMENT. WHEN AN EXTERNAL BIAS SUPPLY IS ATTACHED, THE BIAS VOLTAGE IS PRESENT ON THE REAR PANEL BNC CONNECTORS. USE ONLY BIAS VOLTAGES UP TO 50VDC AND BIAS SUPPLIES CURRENT LIMITED AT 100mA. DO NOT TOUCH, CONNECT, OR DISCONNECT THE UNKNOWN COMPONENT OR BNC CABLES WHILE A BIAS VOLTAGE IS APPLIED.**

Use the following procedure when measuring DC-biased capacitors.

- STEP 1. Connect the external biasing supply to the instrument's rear panel bias terminals (observe polarity).
- STEP 2. Turn bias supply on and set to the proper bias setting.
- STEP 3. Connect the unknown capacitor to the test leads. Observe proper polarity connection when testing electrolytic capacitors.

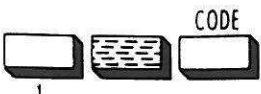
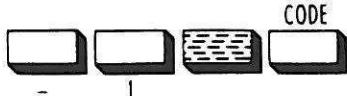
- STEP 4. Turn the bias voltage on. Push 
- STEP 5. Make the measurement.
- STEP 6. Turn the bias voltage off. Push 
- STEP 7. Remove the measured capacitor from the test leads.
- STEP 8. Repeat steps 4 through 7 for each component to be measured.

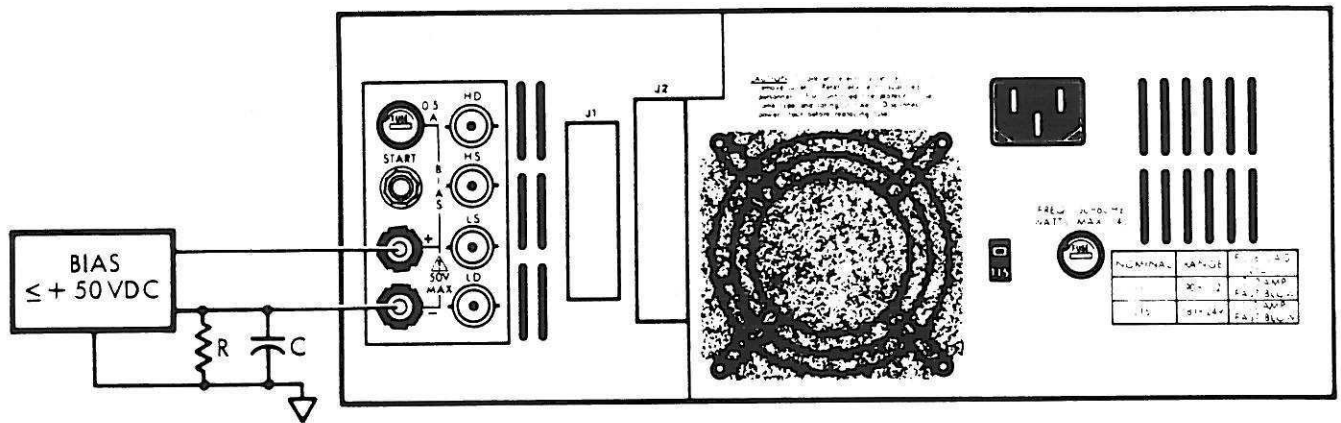

**NOTE:** Bias supply must be floating, i.e. must be isolated from earth ground.

$$R > 100k\Omega$$

$$C < 0.002\mu F$$

Figure 2-21. Capacitance Measurements with Bias



## 2.11 ERROR MESSAGES

If an improper operation is attempted, the 2100/2110 responds by displaying an error message. Error messages are displayed in reverse video (green letters on black background) at the bottom of the CRT screen. All parameters entered prior to the improper operation remain unchanged. Following is a list of error messages that may appear during the programming and operation of this instrument. Included with each error message is a short explanation of probable causes for the message.

### Programming and Operating Related Errors

#### **Input overloaded! Can't measure**

This indicates that the input to the analog circuitry has been overloaded. In this case the sample is discarded and the old reading is left on the screen. Check for an overrange value if on range "HOLD". Reset to "AUTO" range and make another measurement.

#### **Can't supply volts** or **Can't supply amps**

If the impedance of the component in the clips is too high for the current range or too low for the voltage range to supply the level specified on the screen, this message will appear on the bottom line of the display. The instrument will set itself to the highest level possible below the specified maximum level and make a measurement.

#### **Stack empty**

Any of the commands (mostly upper case key strokes) which take numerical arguments will display this message if insufficient numbers precede the word. For instance, programming 2 3 \_\_ Bin# will give a stack empty message because it requires an upper limit, a lower limit, and the number of the bin being programmed. Start again.



## **Undefined**

Occasionally a combination of keys will be pressed which result in the construction of a word which the instrument does not recognize. Pushing a number key and then a key which does not use a number ahead of it will result in something like "ldirect". The instrument will not recognize "ldirect" and the undefined message appears. Start again.

**NOTE:** Undefined errors and stack empty errors will take the machine out of continuous mode and put it into single. This allows the error message to stay on the screen until some action is taken. When the error has been corrected the user must put the unit back into the continuous mode.

## Cassette Tape Related Errors

### **Discard tape**

This error message says that the tape was not able to be formatted (Code 4).

### **Bad read**

When "bad read" appears on the screen try again.

### **Bad write**

When "bad write" appears on the screen try writing into a different block.

### **No tape in place**

This message will appear when there is no cassette tape in the drive unit or when the LOAD or SAVE buttons are pushed on instruments without the cassette option installed.

### **Write Protected**

This message comes onto the screen if a write or format command is tried on a cassette tape that has its write protect tab broken out.

### **Tape Jammed**

When the cassette tape will not move forward or backward, this message appears on the screen. Remove the tape and try again.

## WARRANTY OF TRACEABILITY

The reference standards of measurement of Electro Scientific Industries, Inc., are compared with the U.S. National Standards through frequent tests by the U.S. National Bureau of Standards. The ESI working standards and testing apparatus used are calibrated against the reference standards in a rigorously maintained program of measurement control.

The manufacture and final calibration of all ESI instruments are controlled by the use of ESI reference and working standards and testing apparatus in accordance with established procedures and with documented results. (Reference MIL-C 45662)

Final calibration of this instrument was performed with reference to the mean values of the ESI reference standards or to ratio devices that were verified at the time and place of use.

## DISCLAIMER OF IMPLIED WARRANTIES

THE FOREGOING WARRANTY OF ESI® IS IN LIEU OF ALL OTHER WARRANTIES, EXPRESS OR IMPLIED. ESI SPECIFICALLY DISCLAIMS ANY IMPLIED WARRANTIES OR MERCHANTABILITY OR FITNESS FOR A PARTICULAR PURPOSE. In no event will ESI be liable for special or consequential damages. Purchaser's sole and exclusive remedy in the event any item fails to comply with the foregoing express warranty of ESI shall be to return the item to ESI, shipping charges prepaid, and at the option of ESI obtain a replacement item or a refund of the purchase price.



13900 N.W. Science Park Drive • Portland, Oregon 97229 • Telephone: (503) 641-4141 • Telex: 15-1246





## WARRANTY OF QUALITY

Electro Scientific Industries, Inc., warrants its products to be free from defects in material and workmanship. Rigorous quality control permits the following standard warranties:

1. Two years for components and instruments utilizing passive circuitry. One year on repairs of out-of-warranty items.
2. One year on components and instruments utilizing active circuitry as identified in the price list. Six months on repair of out-of-warranty items.

During the in-warranty periods, we will service or, at our option, replace any device that fails in normal use to meet its published specifications. Batteries, tubes and relays that have given normal service are excepted. Special systems will have warranty periods as listed in their quotation.

## DISCLAIMER OF IMPLIED WARRANTIES

THE FOREGOING WARRANTY OF ESI® IS IN LIEU OF ALL OTHER WARRANTIES, EXPRESS OR IMPLIED. ESI SPECIFICALLY DISCLAIMS ANY IMPLIED WARRANTIES OR MERCHANTABILITY OR FITNESS FOR A PARTICULAR PURPOSE. In no event will ESI be liable for special or consequential damages. Purchaser's sole and exclusive remedy in the event any item fails to comply with the foregoing express warranty of ESI shall be to return the item to ESI, shipping charges prepaid, and at the option of ESI obtain a replacement item or a refund of the purchase price.



13900 NW Science Park Drive • Portland, Oregon 97229 • Telephone: (503) 641-4141 • Telex: 15-1246



- applications data
- technical articles
- engineering bulletins



- |  |  |
|--|--|
| <ul style="list-style-type: none"> <li><input type="checkbox"/> EB10 Effects of Output Loading on Resistive Voltage Dividers, October 1969</li> <li><input type="checkbox"/> EB15 Low Input Resistance Voltage Dividers, February 1970</li> <li><input type="checkbox"/> EB17 Accuracy vs. Frequency of Models 290B and 250DE Universal Impedance Bridges, (revised May 1969)</li> <li><input type="checkbox"/> EB26 International System of Units, August 1969</li> <li><input type="checkbox"/> EB29 DC and Low Frequency AC Ratio Measurements, Dr. Merle L. Morgan, September 1962</li> <li><input type="checkbox"/> EB30 Traceability of Resistance Measurement, Jack Riley, January 1964</li> <li><input type="checkbox"/> EB34 Resistance Transfer Technique, Lawrence H. White, (revised April 1968)</li> <li><input type="checkbox"/> EB35 An Improved Technique for Establishing Resistance Ratios, R. M. Pailthorp and J. C. Riley, November 1962</li> <li><input type="checkbox"/> EB41 Derivation of Electrical Units from Fundamental Standards, R. D. Kuykendall and R. M. Pailthorp, July 1964</li> <li><input type="checkbox"/> EB44 DC measurements Using Ratio Techniques, Jack C. Riley, September 1965</li> <li><input type="checkbox"/> TA2 A Ratio Transformer Bridge for Standardization of Inductors and Capacitors, D. L. Hillhouse and H. W. Kline, August 1960</li> <li><input type="checkbox"/> TA6 The Accuracy of Series and Parallel Connections of Four-Terminal Resistors, Jack C. Riley, April 1965</li> <li><input type="checkbox"/> TA8 AC Measurements Using Ratio Techniques, Jack C. Riley, May 1965</li> <li><input type="checkbox"/> TA14 The Advantages of a Ten Kilohm Transportable Resistance Standard, Robert M. Pailthorp, September 1967</li> </ul> | <ul style="list-style-type: none"> <li><input type="checkbox"/> TA16 Which Bridge for Precise Resistance Measurements? Edward J. Swenson and George D. Vincent, December 1967</li> <li><input type="checkbox"/> TA17 Experimental Verification of the Five Terminal, Ten-Kilohm Resistor as a Device for Dissemination of the Ohm, R. M. Pailthorp and George Vincent, December 1968</li> <li><input type="checkbox"/> TA22A Laser Resistance Trimming from the Measurement Point of View, Arthur G. Albin and Edward J. Swenson, June 1971</li> <li><input type="checkbox"/> TA23 Precision Measurement of Resistor Networks, Robert M. Pailthorp and Jack C. Riley, June 1971</li> <li><input type="checkbox"/> TA24 Predictive Adjustment of Tantalum Film Resistors by Anodization, Donald R. Cutler and Edward J. Swenson, July 1971</li> <li><input type="checkbox"/> TA25 Laser Trimming Analysis Using a Resistive Sheet Analogy, Swenson, Vincent, Riley, December 1972</li> <li><input type="checkbox"/> TA26 The Effects of Laser Trimming on Bixox and 1100 Series Thick Film Composition, N. S. Spann, R. Headley, G. D. Vincent and E. J. Swenson, October 1971</li> <li><input type="checkbox"/> TA27 Laser Trimming Thin Film Precision Resistor Networks with an Automated System, Leonhard Groth, January 1974</li> <li><input type="checkbox"/> TA28 YAG Laser Trimming of Thick Film Resistors, Headley, Popowich, Anders, January 1974</li> <li><input type="checkbox"/> TA31 A Method of Obtaining Optimum Trimming Performance from a Laser System, Paul F. Parks and Thomas W. Richardson, October 1974</li> <li><input type="checkbox"/> TA32 Laser Trimming RC Active Filters, Edward J. Swenson, April 1978</li> <li><input type="checkbox"/> TA33 Reducing Post Trim Drift of Thin Film Resistors By Optimizing YAG Laser Output Characteristics, June 1978</li> </ul> |
|--|--|

