

52120A

Transconductance Amplifier

Users Manual

Table of Contents

Chapter	Title	Page
1	Introduction and Specifications.....	1-1
	Introduction.....	1-3
	How to Contact Fluke.....	1-3
	Safety Information.....	1-4
	Symbols.....	1-5
	Protective Earth (Grounding).....	1-6
	Instruction Manuals.....	1-6
	52120A Getting Started Manual.....	1-6
	52120A Users Manual.....	1-6
	How to Unpack and Examine the Product.....	1-7
	Service Information.....	1-7
	How to Place and Rack Mount the Product.....	1-7
	Cooling Considerations.....	1-7
	How to Connect the Product to Mains Power.....	1-8
	Front-Panel Features.....	1-10
	Rear-Panel Features.....	1-12
	Input and Output Connections.....	1-13
	Input Terminals.....	1-13
	Output Terminals.....	1-14
	Product Connection Cables.....	1-14
	Safe Working Practice.....	1-15
	How to Connect the Product to an External Circuit.....	1-15
	How to Disconnect the Product from an External Circuit.....	1-15
	Accessories.....	1-15
	General Specifications.....	1-16
	Electrical Performance Limits.....	1-16
	Performance Specifications.....	1-17
	Operated within 6105A or 6100B Control Loop, Sine or Harmonic Input (all current ranges).....	1-17
	Coverage factor $k=2.58$ (99 % confidence level).....	1-17
	Coverage factor $k=2.00$ (95 % confidence level).....	1-18
	Operated Stand Alone.....	1-19
	Coverage factor $k=2.58$ (99 % confidence level).....	1-19
	Coverage factor $k=2.00$ (95 % confidence level).....	1-20

	52120A/COIL 3 KA 25-Turn Coil	1-21
	52120A/COIL 6 KA 50-Turn Coil	1-21
2	Front-Panel Operation	2-1
	Introduction.....	2-3
	Notes on Product Use	2-3
	Accuracy.....	2-3
	Potential Measurement Errors	2-4
	Leakage Paths.....	2-4
	Common-Mode Current.....	2-4
	External Voltage Connections.....	2-6
	Load Regulation.....	2-8
	Product Operation Behavior	2-8
	Front-Panel Indicator Colors.....	2-8
	Incompatible Key Selections.....	2-9
	Status Indicators.....	2-9
	Voltage Compliance Indicators	2-10
	Three Red LEDs Together or Product Self-Shutdown.....	2-10
	How to Use the Product.....	2-10
	Current Amplifier Operation	2-10
	Stand-alone Operation	2-10
	How to Setup Multiple Amplifiers	2-12
	Greater than 120 Amps Operation.....	2-12
	Closed-Loop Operation	2-14
	Multi-Phase Current Outputs.....	2-17
	How to Use the Accessory Coils with the Product.....	2-19
	Current/Hz Profile	2-19
	Current Cable Connection	2-19
	Current Clamp Calibration	2-19
	Built-In Fan	2-19
3	Remote Operations	3-1
	Introduction.....	3-3
	IEEE-488.2 Compliance	3-3
	How to Set the Bus Address	3-3
	Power On and *RST Conditions.....	3-4
	SCPI Status Registers	3-4
	Remote Commands.....	3-5
	Supported Common Commands.....	3-6
	Supported SCPI Commands	3-6
	SCPI Command Summary	3-7
	52120A SCPI Command Details	3-8
	6105A SCPI Command Details	3-11
	Calibration and Adjustment Command Extensions.....	3-12
	6105A *OPT? Command	3-12
4	Operator Maintenance	4-1
	Introduction.....	4-3
	How to Replace the Mains Input Fuse.....	4-3
	How to Clean the Air Filter	4-3
	How to Clean the Product.....	4-4
	Replaceable Parts	4-4

5	Calibration.....	5-1
	Introduction.....	5-3
	Calibration Correction Factors	5-3
	Equipment Required	5-3
	Initial Setup and Input Zero Adjustments.....	5-3
	Calibration Verification – Standalone Mode.....	5-5
	Equipment Setup	5-7
	2 Amp Range Verification	5-7
	20 Amp Range Verification	5-9
	120 Amp Range Verification	5-11
	Current Input Burden Resistor Verification	5-13
	Amplitude Specification Limits, Pass/Fail Analysis	5-13
	Calibration Adjustment – Standalone Mode	5-14
	Equipment Set Up	5-14
	How to Correct for Shunt Resistance Error	5-16
	Adjustment Process	5-16
	Adjustments Notes	5-16
	Adjustments	5-16
	Calibration Verification – Closed-Loop with 6100A or 6105A	5-22
	Test Equipment	5-22
	Power Line Frequency Confidence Check.....	5-22
	Phase Angle Accuracy Confidence Check.....	5-23
	Verify Amplitudes at DC and Higher Frequencies	5-23
	Verify Phase Angles at Higher Frequencies	5-26

List of Tables

Table	Title	Page
1-1.	Symbols.....	1-5
1-2.	Standard Equipment.....	1-7
1-3.	Line Power Cord Types Available from Fluke.....	1-9
1-4.	Front-Panel Features.....	1-10
1-5.	Rear-Panel Features.....	1-12
1-6.	Maximum Voltage and Current on Input Terminals.....	1-13
1-7.	Maximum Voltage and Current on Output Terminals.....	1-14
1-8.	Optional Accessories.....	1-15
2-1.	Confidence Probabilities.....	2-3
2-2.	Total Accuracy Calculation.....	2-3
2-3.	Front-Panel Indications.....	2-8
2-4.	Status Indicators.....	2-9
3-1.	Power On and RST Defaults.....	3-4
3-2.	Common Command Summary.....	3-6
3-3.	SCPI Commands.....	3-7
3-4.	6105A SCPI Commands for the 52120A.....	3-8
3-5.	*OPT? Bit Identification.....	3-12
4-1.	Approved Replacement Fuses.....	4-3
4-2.	Replaceable Parts.....	4-4
5-1.	Calibration Equipment.....	5-3
5-2.	Nominal Resistance for A40B Shunts.....	5-6
5-3.	2 Amp Range Verification.....	5-8
5-4.	20 Amp Range Verification Points.....	5-10
5-5.	120 Amp Range Verification Points.....	5-12
5-6.	Burden Resistor Verification Points.....	5-13
5-7.	Product Adjustment Points.....	5-20
5-8.	Test Equipment for Closed-Loop Verification.....	5-22
5-9.	Power Line Frequency Confidence Check Points.....	5-23
5-10.	Phase Angle Accuracy Confidence Check Points.....	5-23
5-11.	Amplitude Verification on 2 Amp Range.....	5-24
5-12.	Amplitude Verification on 20 Amp Range.....	5-25
5-13.	Amplitude Verification on 120 Amp Range.....	5-26
5-14.	Phase Angle Verification on 2 Amp Range.....	5-26
5-15.	Phase Angle Verification on 20 Amp Range.....	5-27
5-16.	Phase Angle Verification on 120 Amp Range.....	5-27

List of Figures

Figure	Title	Page
1-1.	Front-Panel View	1-10
1-2.	Rear-Panel View	1-12
2-1.	Connections for Reduced Common-Mode Interference	2-5
2-2.	Product Connections to a Watthour Meter	2-7
2-3.	Status Indicators	2-9
2-4.	5520A and 52120A Connections	2-11
2-5.	Master to Slave Connections.....	2-13
2-6.	Two Amplifier Outputs Connected in Parallel.....	2-14
2-7.	Feedback Cable Connections	2-15
2-8.	Multiple Amplifier Connections	2-16
2-9.	6105A to 6106A Connections	2-18
3-1.	IEEE Bus Address Switches	3-3
3-2.	SCPI Status Registers.....	3-5
5-1.	Test Equipment Connections	5-4
5-2.	Calibration Adjustment Setup	5-15
5-3.	Calibration Enable Switch.....	5-16

Chapter 1

Introduction and Specifications

Title	Page
Introduction.....	1-3
How to Contact Fluke.....	1-3
Safety Information.....	1-4
Symbols.....	1-5
Protective Earth (Grounding).....	1-6
Instruction Manuals.....	1-6
52120A Getting Started Manual.....	1-6
52120A Users Manual.....	1-6
How to Unpack and Examine the Product.....	1-7
Service Information.....	1-7
How to Place and Rack Mount the Product.....	1-7
Cooling Considerations.....	1-7
How to Connect the Product to Mains Power.....	1-8
Front-Panel Features.....	1-10
Rear-Panel Features.....	1-12
Input and Output Connections.....	1-13
Input Terminals.....	1-13
Output Terminals.....	1-14
Product Connection Cables.....	1-14
Safe Working Practice.....	1-15
How to Connect the Product to an External Circuit.....	1-15
How to Disconnect the Product from an External Circuit.....	1-15
Accessories.....	1-15
General Specifications.....	1-16
Electrical Performance Limits.....	1-16
Performance Specifications.....	1-17
Operated within 6105A or 6100B Control Loop, Sine or Harmonic Input (all current ranges).....	1-17
Coverage factor k=2.58 (99 % confidence level).....	1-17
Coverage factor k=2.00 (95 % confidence level).....	1-18
Operated Stand Alone.....	1-19
Coverage factor k=2.58 (99 % confidence level).....	1-19
Coverage factor k=2.00 (95 % confidence level).....	1-20
52120A/COIL 3 KA 25-Turn Coil.....	1-21
52120A/COIL 6 KA 50-Turn Coil.....	1-21

Introduction

The Fluke 52120A Transconductance Amplifier (the Product) is a precision current amplifier that can:

- Accept full scale dc or ac inputs of 2 volts or 200 mA from any calibrator, signal generator or power supply
- Deliver proportional output current in ranges of 2 A, 20 A or 120 A at frequencies to 10 kHz
- Offer enhanced accuracy to 140 ppm when used in closed-loop mode with a 6105A Electrical Power Standard
- Operate in parallel with one or two other Products to deliver 240 A or 360 A
- Push current with compliance voltage of 4.5 V rms or 6.4 V peak
- Drive inductive loads to 1 mH
- Drive optional current coils to deliver test currents of 3000 A or 6000 A

How to Contact Fluke

To contact Fluke Calibration, call one of the following telephone numbers:

- Technical Support USA: 1-877-355-3225
- Calibration/Repair USA: 1-877-355-3225
- Canada: 1-800-36-FLUKE (1-800-363-5853)
- Europe: +31-40-2675-200
- Japan: +81-3-6714-3114
- Singapore: +65-6799-5566
- China: +86-400-810-3435
- Brazil: +55-11-3759-7600
- Anywhere in the world: +1-425-446-6110

To see product information and download the latest manual supplements, visit Fluke Calibration's website at www.flukecal.com

To register your product, visit <http://flukecal.com/register-product>.

Safety Information

This Product complies with:

- EN/IEC 61010-1:2010
- CAN/CSA C22.2 No. 61010-1-04
- ANSI/UL 61010-1:2004
- EN 61326-1:2006

In this manual, a **Warning** identifies conditions and procedures that are dangerous to the user. A **Caution** identifies conditions and procedures that can cause damage the Product or the equipment under test.

For safe operation of this Product, follow all the warnings and cautions in this manual.

Warning

To prevent possible electrical shock, fire, or personal injury:









- **Read all safety Information before you use the Product.**
- **Never connect line power to a Product input or output connector, other than the mains power receptacle.**
- **Use this Product indoors only.**
- **Do not use the Product around explosive gas, vapor, or in damp or wet environments.**
- **Examine the case before you use the Product. Look for cracks or missing parts. Carefully look at the insulation around the terminals.**
- **Use only the mains power cord and connector approved for the voltage and plug configuration in your country and rated for the Product.**
- **Make sure the ground conductor in the mains power cord is connected to a protective earth ground. Disruption of the protective earth could put voltage on the chassis that could cause death.**
- **Replace the mains power cord if the insulation is damaged or if the insulation shows signs of wear.**
- **Do not use and disable the Product if it is damaged.**
- **Be aware the 52120A binding posts may be connected to supply lethal voltages. If one terminal of a pair is connected, the other may also be at lethal potential.**
- **Do not energize voltage circuits unless the Product cables are either properly connected at both ends or disconnected at both ends.**
- **Use only cables with correct voltage ratings.**
- **Use extreme caution when the current output terminals of the Product are connected to voltage circuits, as lethal voltage may be present.**

- **Do not connect to live output terminals. The Product can supply voltages that can cause death. Standby mode is not sufficient to prevent electrical shock.**
- **Use the Product only as specified, or the protection supplied by the Product can be compromised.**
- **Always ensure the Product is in STBY mode and external circuits are not energized before you make cable connections or disconnecting either end of the cables.**
- **Do not touch voltages >30 V ac rms, 42 V ac peak, or 60 V dc.**
- **Do not use the Product if it operates incorrectly.**
- **Do not use test leads if they are damaged. Examine the test leads for damaged insulation. Do a continuity test on the test leads.**

Symbols

Symbols used in this manual and on the Product are explained in Table 1.

Table 1-1. Symbols

Symbol	Description	Symbol	Description
	Chassis ground		Conforms to relevant North American Safety Standards.
	Conforms to European Union directives.		Protective earth
	Risk of Danger. Important information. See manual.		Hazardous voltage
	Earth ground		Conforms to relevant Australian EMC requirements.
	Do not dispose of this product as unsorted municipal waste. Go to Fluke's website for recycling information.		

Protective Earth (Grounding)

Protection Class 1 – Always operate the Product with an earth/ground connection to the earth ground conductor of the ac supply cable. The earth/ground connects before the ac line and neutral connections when the supply plug is put into the mains socket of the Product. If the last mains connection is made elsewhere, make sure the earth/ground connection is made before ac line and neutral.

Connect an applicable earth/ground to the auxiliary protective terminal on the rear panel if:

- it is possible the earth/ground connection will not connect before the ac line and neutral connections.
- the output terminals are connected to a potentially hazardous live circuit.

Instruction Manuals

The 52120A Manual set supplies complete information for operators. The set includes:

- *52120A Users Manual* on the included CD-ROM (PN 3977736)
- *52120A Getting Started Manual* (PN 3977724)

One of each manual shown above is shipped with the instrument. You can order more copies of the manuals from Fluke. To learn more on how to place an order, refer to the How to Contact Fluke section.

52120A Getting Started Manual

This *52120A Getting Started Manual* contains a brief introduction to the Product. The Getting Started topics are:

- Safety Information
- Instruction manuals and their content
- How to unpack and examine the Product
- How to connect the Product to mains power
- Front and rear panel familiarization
- Maintenance
- General Specifications

52120A Users Manual

The *52120A Users Manual* contains data on how to install the Product and operate it from the front panel keys and in remote configurations. This manual also contains Product specifications and error codes. The Users Manual topics are:

- Installation
- Operating controls and features, including front panel controls
- Remote operation
- Operator maintenance
- Calibration
- Accessories

How to Unpack and Examine the Product

The Product is shipped in a container built to prevent damage during shipping. Examine the Product carefully for damage and immediately report damage to the shipper. Instructions for inspection and claims are included in the shipping container.

When you unpack the Product, make sure all the standard equipment shown in Table 2 was shipped. Also examine the shipping document for more items. Refer to the Accessories chapter in the *52120A Users Manual*. Report all shortages to the place of purchase or to the nearest Fluke Service Center. A performance test is shown in the Maintenance chapter in the *52120A Users Manual*.

If it becomes necessary to ship the Product, use the container and inserts it was initially shipped in, if possible. If it is not available, you can get a transit case from Fluke. This container is applicable for most handling conditions, but gives less shock protection than the initial shipping container.

Table 1-2. Standard Equipment

Item	Model or Part Number
Transconductance Amplifier	52120A
Line Power Cord	Per ship-to location, see Table 1-3.
52120A Getting Started Manual	3977724
52120A Users Manual on CD-ROM	3977736

Service Information

Each Product is warranted to the original purchaser for the period specified in the warranty and starts on the date received. The warranty is found at the front of this manual.

Factory authorized service and technical advice for the Product is available at Fluke Service Centers. A complete list of service centers is available at www.flukecal.com.

Warning

To prevent possible electrical shock, fire, or personal injury, have an approved technician repair the Product.

How to Place and Rack Mount the Product

Always operate the Product in controlled electromagnetic environments such as calibration and measurement laboratories. Where rf transmitters, like mobile telephones are not used.

This Product can be used on a bench-top or in a rack. The rack-mount kit must be ordered separately from Fluke. See the How to Contact Fluke section in this manual.

Note

There must be sufficient space on the sides of the Product for sufficient air flow.

Cooling Considerations

Caution

The Product can overheat and become damaged if the area around the air intake is too small, the intake air is too warm, or the air filter becomes clogged.

To increase the life of the Product:

- Keep the area around the air filter a minimum of 4 inches from nearby walls or rack enclosures.
- Keep the inlet and exhaust perforations on the sides of the Product clear of blockages.
- Keep the air that goes in to the Product between 5 °C and 35 °C.
- Make sure exhaust from a different instrument is not pointed into the fan inlet.
- Clean the air filter at a maximum of 30 day intervals. More frequently if the Product is operated in a dusty environment. See the Maintenance section of this manual for instructions on how to clean the air filter.

How to Connect the Product to Mains Power

⚠⚠ Warning

To prevent possible electrical shock, fire, or personal injury:

- **Use only the mains power cord and connector approved for the voltage and plug configuration in your country and rated for the Product.**
- **Replace the mains power cord if the insulation is damaged or if the insulation shows signs of wear.**
- **Make sure the ground conductor in the mains power cord is connected to a protective earth ground. Disruption of the protective earth could put voltage on the chassis that could cause death.**
- **Do not disconnect or open the protective ground conductor inside or outside the Product. An open ground conductor can make the Product dangerous.**

⚠ Caution

When exposed to low temperatures for an extended time, such as air travel or storage, condensation may form inside the Product. To prevent damage to the Product, let it acclimate to its environment out of its shipping container a minimum of one hour before you connect it to mains power.

The Product automatically senses mains voltage between 100 and 240 volts. No line voltage or fuse selection is necessary. See the Maintenance section to learn how to replace the mains fuse.

Because the Product can pull more current than a standard 10 A IEC connector, the Product has a 16 A power connector on the rear panel. A mains power cord with 16 A capacity is also supplied with the Product. Table 1-3 is a list of power cord types available from Fluke.

Table 1-3. Line Power Cord Types Available from Fluke

Country	Fluke Part Number
UK	1998167
Europe	1998171
Australia, New Zealand	1998198
China	4121791
USA, Japan	1998209
Brazil	3841358
Other (no plug fitted)	1998211

Note

*Typical maximum power requirement of the Product at 115 V is 1500 VA.
 Make sure the mains supply outlet is rated for this load and has a grounded
 three-prong outlet. Make sure the outlet ground connector is connected to
 earth ground.*

If a mains power cord is supplied without a mains connector, use the color codes below when you connect a connector to the power cord.

- Line = Brown
- Neutral = Blue
- Earth = green/yellow

Front-Panel Features

Table 1-4 is a list of front-panel controls and connections shown in Figure 1-1.

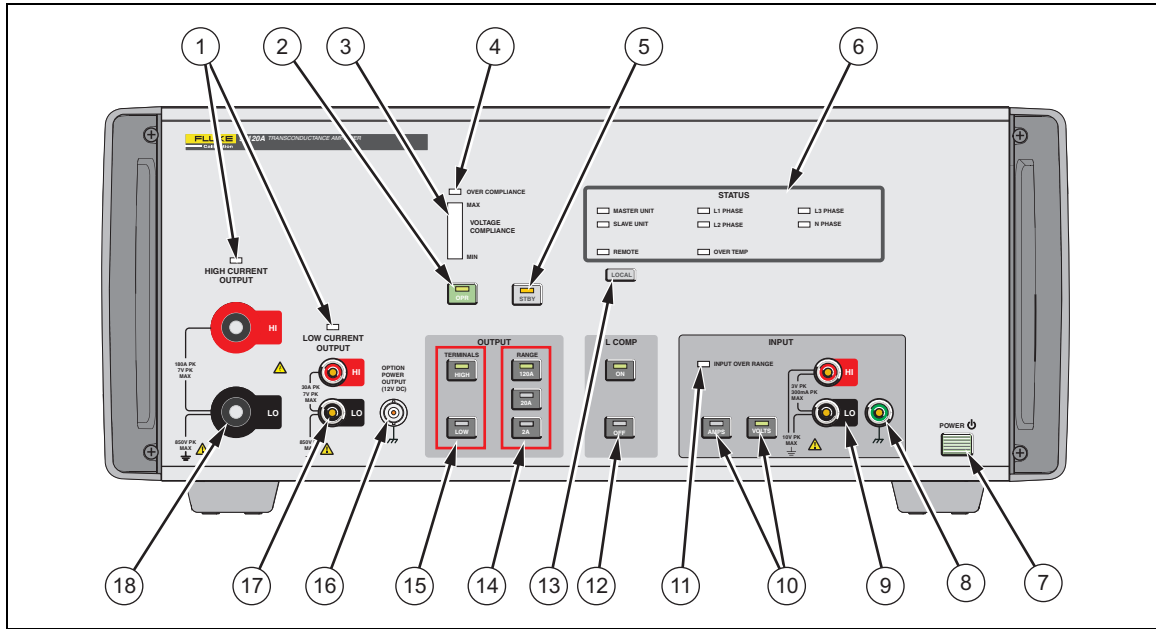

Figure 1-1. Front-Panel View

gpp001.eps

Table 1-4. Front-Panel Features







Item	Description
①	<p>Current Output Indicators</p> <p>Output on indicator. In STBY (standby) mode, these two indicators will be Amber. In OPR (operate) mode, the indicator for the selected terminals will be illuminated green.</p>
②	<p> OPR</p> <p>The OPR (Operate) key places the Product in operate mode. Operate mode is indicated by the lit indicator on the OPR key. The indicator over the set output terminals also shows green.</p>
③	<p>Voltage Compliance Level Indicator</p>
④	<p>Over Compliance Indicator</p> <p>Indicates when the Product senses the voltage developed across the current terminals due to the current through the load impedance has exceeded the specified level. This condition also automatically puts the Product in standby to remove the output current.</p>
⑤	<p> STBY</p> <p>The STBY (Standby) key puts the Product in standby mode. Standby mode is indicated by the lit indicator on the STBY key. The output indicators above the output terminals also shows amber.</p>
⑥	<p>Status Indicators</p> <p>Indicates the status of the different functions of the Product.</p>

Table 1-4. Front-Panel Features (cont.)

Item	Description
⑦	<p>Mains Power Switch</p> <p>The power switch turns the power on and off. The switch is a latching push-push type. When the switch is latched in, power is on.</p> <p style="text-align: center;"><i>Note</i></p> <p style="text-align: center;"><i>The front panel power switch operates electronically and is not an isolation switch. The main power ON/OFF isolation switch is on the rear panel.</i></p>
⑧	<p>Chassis ground connection</p>
⑨	<p>Input Terminals</p> <p>Used to input voltage or current to the Product.</p>
⑩	<p> AMPS VOLTS</p> <p>Sets the INPUT to receive voltage or current.</p>
⑪	<p>INPUT OVER RANGE Indicator</p> <p>Comes on when the input exceeds the limit.</p>
⑫	<p> ON OFF</p> <p>Sets LCOMP on or off. LCOMP ON is used for highly inductive loads. See the Specifications for inductive loading limits.</p>
⑬	<p> LOCAL</p> <p>Sets the Product for local (front panel) control when it is in remote mode.</p>
⑭	<p> 120A 20A 2A</p> <p>Sets the output range to 2, 20, or 120 amps.</p>
⑮	<p> HIGH LOW</p> <p>Puts the output current on the High Current or Low Current output terminals.</p>
⑯	<p>OPTION POWER OUTLET</p> <p>BNC connector that sources 12 V dc to power the cooling fan of a connected accessory such as a 25 turn coil.</p>
⑰	<p>LOW Current Output Terminals</p> <p>Used with 2 A and 20 A output ranges.</p>
⑱	<p>HIGH Current Output Terminals</p> <p>Used with all output ranges.</p>

Rear-Panel Features

Table 1-5 is a list of rear-panel controls and connections shown in Figure 1-2.

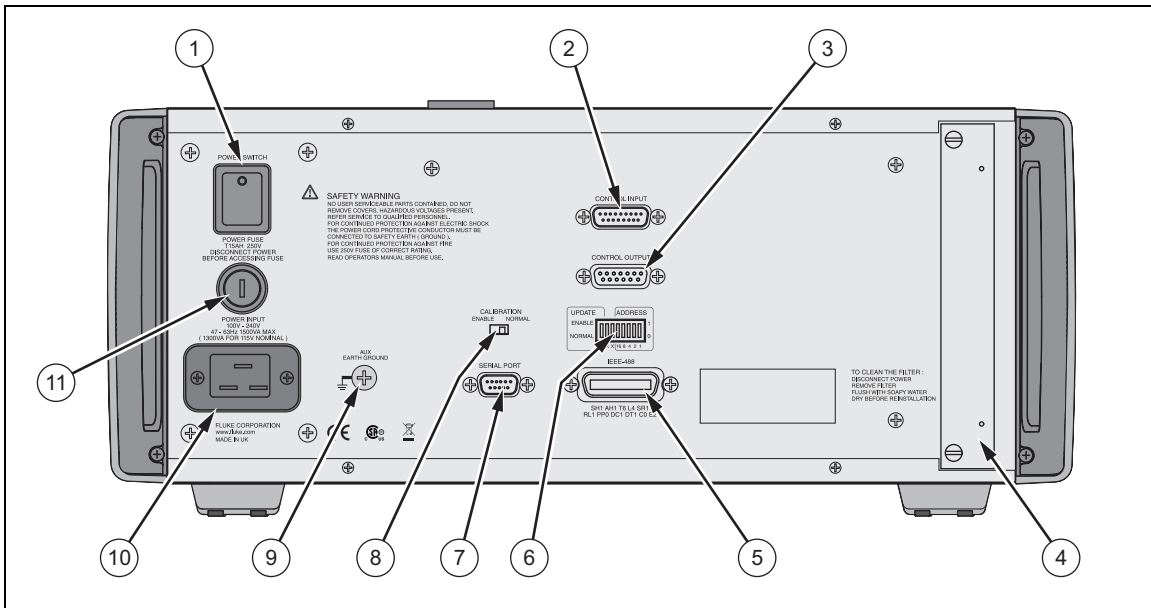

Figure 1-2. Rear-Panel View

gpp002.eps

Table 1-5. Rear-Panel Features

Item	Description
①	Main Power ON/OFF Switch This is the mains isolating switch.
②	Control Input Used to control the Product from a MASTER unit. Either another 52120A or a 6100 series Electrical Power Standard.
③	Control Output Used to control another 52120A (SLAVE) through its control Input. This Product acts as the master.
④	The Air Filter covers the air intake to keep dust and debris out of the chassis.
⑤	The IEEE-488 (GPIB) connector is a standard parallel interface for remote operation of the Product.
⑥	Combined GPIB address switch and firmware UPDATE ENABLE / NORMAL selector.
⑦	Serial Port for firmware upload

Table 1-5. Rear-Panel Features (cont.)

Item	Description
⑧	The CALIBRATION ENABLE / NORMAL switch is used to write enable and disable the nonvolatile memory that stores calibration constants. See the Calibration section of this Manual to learn more about calibration of the Product. Set to NORMAL for normal operation.
⑨	The AUXILIARY PROTECTIVE terminal is internally grounded to the chassis.
⑩	Mains Power Receptacle Grounded three-prong connector that accepts the line power cord.
⑪	Fuse Holder Holds the mains power fuse. See the Maintenance section for the fuse replacement procedure.

Input and Output Connections

⚠ Caution

To prevent damage to the Product, do not connect mains power to any signal input or output terminal.

Input Terminals

The input terminals of the Product are 4 mm binding posts. Table 1-6 shows the maximum voltage and current that can safely be applied to the input terminals.

⚠ Caution

To prevent damage to the Product, do not apply voltage between the HI and LO input terminals when input current is set. This can cause the burden resistor to change its resistance value and invalidate the calibration for current input.

Table 1-6. Maximum Voltage and Current on Input Terminals

Output Current Range	Maximum Voltage Input HI and LO	Maximum Current Input HI to Lo	Maximum Voltage HI or LO to Earth
2 A and 20 A	2 V rms, 3 V pk	200 mA rms	30 V pk
120 A	1.2 V rms, 1.7 V pk	120 mA rms, 170 mA pk	30 V pk

When the input terminals are configured for current input, a precision burden resistor is connected across the HI and LO terminals to make a voltage from the input current.

The green 4 mm binding post is connected to the chassis of the Product. This is a signal connection and must not be used for a protective earth connection.

Output Terminals

There are two sets of output terminals on the Product. They are not referenced to ground. Each of the four terminals can be connected to a signal source with a maximum voltage of 850 V pk (600 V rms). Table 1-7 shows the maximum voltage and current that can be safely applied to the output terminals.

Table 1-7. Maximum Voltage and Current on Output Terminals

Output Current Terminal	Maximum Voltage Input HI and LO	Maximum Current Input HI to Lo	Maximum Voltage HI or LO to Earth
2 A and 20 A	7 V pk	30 A pk	600 Vrms, 850 Vpk
120 A	7 V pk	170 A pk	600 Vrms, 850 Vpk

Warning

To prevent possible electrical shock, fire, or personal injury:

- Use extreme caution around the output terminals. Lethal voltages may be present.
- Make sure the Product is in standby mode and external circuits are not energized before you connect or disconnect cables between the Product and the circuit under test.
- Do not turn on voltage circuits unless the cables between the Product and circuit are connected or disconnected at both ends of the cable.
- Do not connect a connector or terminal, other than the mains input connector to line power.

Product Connection Cables

Five signal cables are shipped with the Product. All are rated for 600 V. Two interchangeable low current cables, with 4 mm plugs, are used on the Product inputs or on the 2A or 20A outputs. Three heavy-duty cables, with 6 mm plugs, are used only on the 120A outputs. The short black cable loops Hi and Lo output terminals for clamp meter tests to a maximum of 120 A. The long red and black cables connect the high current outputs of the Product to the load.

To prevent an accidental disconnect, the heavy-duty cables have snap-in connectors. To operate the snap-in feature, push the connector in to the socket until the rubber insulation touches the Product and you hear a soft click. This locks the connector in the socket. To remove the connector, push in fully, then remove it. To bypass the snap-in mechanism, push the connector fully in to the socket. It is not necessary to push in on the connector to remove it when the snap-in mechanism is bypassed.

Warning

To prevent electrical shock or personal injury, use only cables supplied with the Product to connect the output current terminals to the load. Before you touch an exposed connector, make sure external voltage is isolated.



Safe Working Practice

The high current output LO and low current output LO are electrically connected internally. Similarly, the two output HI terminals are connected internally. If one of the terminals is connected to high voltage, one of the other output terminals will be at the same voltage.

⚠️⚠️ Warning

To prevent electric shock or personal injury, remove all cables from the current terminals that are not used. When you make connections to a circuit that can be energized with voltages, always make the connection at the Product before you connect to the external circuit. Voltage can be present at the loose ends of cables.

How to Connect the Product to an External Circuit

1. Remove power from external circuits.
2. Push  to set the Product to standby.
3. Remove all connections to the terminals of the Product that are not used for the test.
4. Connect the test leads to the HI and LO terminals of the Product.
5. Connect the test leads to the external circuit.
6. Push  to set the Product to operate.

How to Disconnect the Product from an External Circuit

1. Remove power from external circuits.
2. Push  to set the Product to standby.
3. Disconnect the test leads from the external circuit.
4. Disconnect the test leads from the Product.

When you connect a high current cable to a load, make sure the connections are tight. A loose connection can cause voltage over compliance and set the Product into standby (STBY) mode. A loose connection can cause the connection to overheat.

Accessories

Table 1-8 is a list of optional accessories for the Product.

Table 1-8. Optional Accessories

Model	Description	Part Number
52120A/COIL3KA	Coil, 25 Turn, 3000 Amp. For jawed clamp meters.	4044897
52120A/COIL6KA	Coil, 50Turn, 6000 Amp. For Rogowski flexible current probes.	4044904
52120A/COIL12V	Coil, 12V DC Power Supply	4107239
6105A/52120A SVC	Enhance 6105A or 6100B Master Unit for 52120A capability.	4162016
6106A/52120A SVC	Enhance 6106A or 6101B Auxiliary Unit for 52120A capability.	4162025

General Specifications

Line Power

Voltage range	100 V to 240 V
Frequency	47 to 63 Hz
Voltage variations	±10 % about line voltage
Power consumption	<1500 VA
Transient overvoltage	Impulse withstand (overvoltage) Category II of IEC 60364-4-443

Dimensions (HxWxL)

With feet.....	192 mm x 432 mm x 645 mm (7.6 in x 17.0 in x 25.5 in)
Without feet.....	178 mm x 432 mm x 645 mm (7.0 in x 17.0 in x 25.5 in)

Weight 25 kg (54 lb)

Temperature

Operating	5 °C to 35 °C (41 °F to 95 °F)
Calibration (tcal).....	16 °C to 30 °C (61 °F to 86 °F)
Storage	0 °C to 50 °C (32 °F to 122 °F)
Transit.....	-20 °C to +60 °C (-4 °F to +140 °F) <100 hours

Warmup Time Twice the time since last warmed up, to a maximum of 1 hour.

Humidity (non-condensing)

Operating	<80 %, 5 °C to 31 °C (41 °F to 88 °F) ramping linearly down to 50 % at 35 °C (95 °F)
Storage	<95 %, 0 to 50 °C (32 °F to 122 °F)

Altitude

Operating	2,500 m (8,200 ft) maximum
Non-Operating	12,000 m (39,400 ft) maximum

Shock and Vibration MIL-PRF-28800F Class 3

Safety Complies with EN/IEC 61010-1:2010, CAN/CSA C22.2 No. 61010-1-04, ANSI/UL 61010-1:2004

EMC Complies with EN 61326-1:2006, CISPR 11 (EN 55011:2004), FCC rules part 15, sub part B, Class A

Indoor user only Pollution degree 2

Agency Approvals CE, 

Electrical Performance Limits

Voltage compliance developed across inductive loads may prevent range maximum current output being achieved at higher frequencies. The appropriate maximum frequency (F_{max}) for a given load inductance and current is given by:

$$F_{max} = \frac{4.5}{2 \cdot \pi \cdot I \cdot L} \quad \begin{array}{l} I = \text{Current} \\ L = \text{Total} \\ \text{inductance} \end{array}$$

The maximum frequency calculated with this equation is only approximate. Series resistance and parallel capacitance also affect the maximum achievable frequency.

Input common mode rejection 80 dB @ DC decreasing linearly to 40 dB at 10 kHz

Input Impedance

Voltage input	>1 MΩ
Current input	10 Ω

Maximum output compliance voltage 4.5 V rms (6.4 V pk), 6.4 V dc. 120 A range maximum compliance voltage decreases from 4.5 V at 1 kHz to about 3 V at 10 kHz

DC Offset Magnetic remanence that follows abrupt changes in output current level may cause small changes to DC current offset. It is good practice to correct for offsets in DC measurements and techniques such as DC reversal measurement will result in best accuracy.

Operating Limits

	Output Current Range		
	2 A	20 A	120 A
Current Output (Max.)	2 A rms	20 A rms	120 A rms
	Current Input		
Input Current (Max.)	200 mA rms	200 mA rms	120 mA rms
Current gain	10	100	1,000
	Voltage Input		
Input Voltage (Max.)	2 V rms	2 V rms	1.2 V rms
Transconductance	1 Siemen	10 Siemens	100 Siemens

120 A Range Current/Frequency Limits

Frequency	Maximum Output Current	Maximum Current Input	Maximum Voltage Input
DC	±100 A	±100 mA	±1.0 V
<10 Hz	100 A pk (70 A rms)	100 mA pk (70 mA rms)	1.0 V pk (0.7 V rms)
10 Hz to 10 kHz	170 A pk (120 A rms)	170 mA pk (120 mA rms)	1.7 V pk (1.2 V rms)

Note: The 2 A and 20 A ranges operate at full output current from DC to 10 kHz.

Output Isolation

Frequency	Maximum Voltage Signal Applied to any Output Current Terminal with respect to Earth
DC to 850 Hz	600 V rms, 850 V pk, limited 2 A rms, no transient overvoltages
850 Hz to 3 kHz	100 V rms, 142 V pk, limited 2 A rms, no transient overvoltages
3 kHz to 10 kHz	33 V rms, 47 V pk, limited 2 A rms, no transient overvoltages

Performance Specifications

Operated within 6105A or 6100B Control Loop, Sine or Harmonic Input (all current ranges)

The current and phase angle accuracies of the 52120A when controlled by a single 610X, apply to the parallel output of up to three 52120As connected as slaves. See the 610X specifications for interharmonic, fluctuating harmonic, dip and flicker specifications.

Coverage factor $k=2.58$ (99 % confidence level)

Current Accuracy

Frequency	1-year accuracy, t_{cal} ^[1] ±5 °C ±(% of output + % of range)			
	6105B		6100B	
	% of output	% of range	% of output	% of range
DC	0.015	0.010	0.022	0.025
10 Hz to 850 Hz	0.011	0.003	0.018	0.003
850 Hz to 6 kHz	0.052	0.005	0.052	0.005
6 kHz to 9 kHz	See Operated Stand Alone current accuracy table.			

[1] t_{cal} is the temperature at which calibration adjustment took place.
Notes:
Maximum inductance for stability LCOMP OFF is 100 μH. Maximum inductance for stability LCOMP ON is 400 μH for 2 A and 20 A ranges. 100 μH on the 120 A range.

Phase Angle Accuracy

Frequency	Accuracy
10 Hz to 69 Hz	0.006 °
69 Hz to 180 Hz	0.012 °
180 Hz to 450 Hz	0.025 °
450 Hz to 850 Hz	0.045 °
850 Hz to 3 kHz	0.325 °
3 kHz to 6 kHz	0.645 °

Coverage factor $k=2.00$ (95 % confidence level)

Current Accuracy

Frequency	1-year accuracy, t_{cal} ^[1] $\pm 5^\circ\text{C} \pm (\% \text{ of output} + \% \text{ of range})$			
	6105B		6100B	
	% of output	% of range	% of output	% of range
DC	0.012	0.008	0.017	0.019
10 Hz to 850 Hz	0.009	0.002	0.021	0.002
850 Hz to 6 kHz	0.040	0.004	0.040	0.004
6 kHz to 10 kHz	See Operated Stand Alone current accuracy table.			
<p>[1] t_{cal} is the temperature at which calibration adjustment took place. Notes: Maximum inductance for stability LCOMP OFF is 100 μH. Maximum inductance for stability LCOMP ON is 400 μH for 2 A and 20 A ranges. 100 μH on the 120 A range.</p>				

Phase Angle Accuracy

Frequency	Accuracy
10 Hz to 69 Hz	0.005 °
69 Hz to 180 Hz	0.009 °
180 Hz to 450 Hz	0.020 °
450 Hz to 850 Hz	0.035 °
850 Hz to 3 kHz	0.250 °
3 kHz to 6 kHz	0.500 °

Maximum load dependent phase shift..... <0.001 ° @ 60 Hz; increasing linearly to 0.006° @ 6 kHz.

Maximum Distortion and Noise

Frequency	Distortion ^[1]				Noise 16 Hz to 10 MHz
	LCOMP OFF		LCOMP ON		
	dB	Current	dB	Current	
2 Amp Range					
16 Hz to 850 Hz	-76	42 μA	-70	83 μA	-60 dB
850 Hz to 6 kHz	-52	662 μA	-46	1.3 mA	-60 dB
6 kHz to 10 kHz ^[2]	-40	2.6 mA	-35	4.7 mA	-60 dB
20 Amp Range					
16 Hz to 850 Hz	-76	418 μA	-60	2.6 mA	-70 dB
850 Hz to 6 kHz	-52	6.6 mA	-42	20.9 mA	-70 dB
6 kHz to 10 kHz ^[2]	-40	26.4 mA	-35	46.9 mA	-70 dB
120 Amp Range					
16 Hz to 850 Hz	-76	2.5 mA	-60	15.8 mA	-70 dB
850 Hz to 6 kHz	-52	39.7 mA	-42	125.7 mA	-70 dB
6 kHz to 10 kHz ^[2]	-40	158.2 ma	-35	281.3 mA	-70 dB
<p>[1] Use dB or Current. Whichever is larger. [2] Interharmonics only above 6 kHz.</p>					

Operated Stand Alone

The stand-alone specifications are stated for the accuracy of transconductance with a voltage input, or current gain with a current input. These specifications do not include the errors of the instrument that provides the voltage or current signal to the Product input. To get the absolute accuracy of the current output, combine the source and Product specifications with the “root sum of squares” (RSS) method found in the *52120A Users Manual*.

Up to ten 52120As (one master and nine slaves) can be chained together in stand-alone mode. Any additional slave units are ignored by the control system.

Coverage factor k=2.58 (99 % confidence level)

Current Accuracy

Frequency	Accuracy 1-year accuracy, $t_{cal}^{[1]}$ $\pm 5^\circ\text{C} \pm (\% \text{ of output} + \% \text{ of range})$		
	% of Output	% of Range	
		LCOMP OFF ^[2]	LCOMP ON ^[3]
2 Amp Range			
DC	0.010	0.005	0.005
10 Hz to 65 Hz	0.015	0.070	0.300
65 Hz to 300 Hz	0.030	0.070	0.500
300 Hz to 1 kHz	0.100	0.070	3.500
1 kHz to 3 kHz	0.300	0.600	Not Specified
3 kHz to 6 kHz	1.000	1.600	Not Specified
6 kHz to 10 kHz	2.000	4.000	Not Specified
20 Amp Range			
DC	0.010	0.005	0.005
10 Hz to 65 Hz	0.015	0.060	0.300
65 Hz to 300 Hz	0.030	0.060	1.200
300 Hz to 1 kHz	0.100	0.060	6.000
1 kHz to 3 kHz	0.300	0.200	Not Specified
3 kHz to 6 kHz	1.000	0.400	Not Specified
6 kHz to 10 kHz	3.000	0.600	Not Specified
120 Amp Range			
DC	0.010	0.005	0.005
10 Hz to 65 Hz	0.015	0.020	0.500
65 Hz to 300 Hz	0.030	0.030	0.700
300 Hz to 1 kHz	0.100	0.100	3.500
1 kHz to 3 kHz	0.300	0.250	Not Specified
3 kHz to 6 kHz	1.000	0.450	Not Specified
6 kHz to 10 kHz	4.000	0.750	Not Specified
[1] t_{cal} is the temperature at which calibration adjustment took place. [2] Maximum inductance for stability LCOMP OFF is 100 μH . [3] Maximum inductance for stability LCOMP ON is 1 mH.			

Coverage factor $k=2.00$ (95 % confidence level)

Current Accuracy

Frequency	Accuracy 1-year accuracy, t_{cal} ^[1] $\pm 5^\circ\text{C} \pm (\% \text{ of output} + \% \text{ of range})$		
	% of Output	% of Range	
		LCOMP OFF ^[2]	LCOMP ON ^[3]
2 Amp Range			
DC	0.008	0.004	0.004
10 Hz to 65 Hz	0.012	0.054	0.233
65 Hz to 300 Hz	0.023	0.054	0.390
300 Hz to 1 kHz	0.078	0.054	2.720
1 kHz to 3 kHz	0.233	0.465	Not Specified
3 kHz to 6 kHz	0.775	1.240	Not Specified
6 kHz to 10 kHz	1.550	3.100	Not Specified
20 Amp Range			
DC	0.008	0.004	0.004
10 Hz to 65 Hz	0.012	0.047	0.233
65 Hz to 300 Hz	0.023	0.047	1.200
300 Hz to 1 kHz	0.078	0.047	6.000
1 kHz to 3 kHz	0.233	0.155	Not Specified
3 kHz to 6 kHz	0.775	0.310	Not Specified
6 kHz to 10 kHz	2.330	0.470	Not Specified
120 Amp Range			
DC	0.008	0.004	0.004
10 Hz to 65 Hz	0.012	0.016	0.390
65 Hz to 300 Hz	0.023	0.023	0.700
300 Hz to 1 kHz	0.078	0.078	3.500
1 kHz to 3 kHz	0.233	0.194	Not Specified
3 kHz to 6 kHz	0.775	0.349	Not Specified
6 kHz to 10 kHz	3.101	0.581	Not Specified
<p>[1] t_{cal} is the temperature at which calibration adjustment took place.</p> <p>[2] Maximum inductance for stability LCOMP OFF is 100 μH.</p> <p>[3] Maximum inductance for stability LCOMP ON is 1 mH.</p>			

Distortion

Frequency	LCOMP OFF		LCOMP ON	
10 Hz to 65 Hz	-60 dB	0.1 %	-60 dB	0.1 %
65 Hz to 300 Hz	-60 dB	0.1 %	-50 dB	0.3 %
300 Hz to 1 kHz	-54 dB	0.2 %	-50 dB	0.3 %
1 kHz to 3 kHz	-46 dB	0.5 %	Not Specified	
3 kHz to 6 kHz	-46 dB	0.5 %	Not Specified	
6 kHz to 10 kHz	-40 dB	1.0 %	Not Specified	
<p>Note Distortion specifications apply to output at full range measured in a 50 kHz bandwidth.</p>				

52120A/COIL 3 KA 25-Turn Coil

Number of turns 25
Minimum internal jaw dimension to clear wires 26 mm (width) x 36 mm (length)
Maximum input current 120 A continuous with built-in 12 V fan on
Maximum voltage 4.5 V rms

Accuracy

Input Current ^[1]	Frequency	Effective Current Amp-turns	52120A + Coil Accuracy ^[2] ±(% of Amp-turns + % of 52120A range)	
			% of Amp-turns	% of 52120A Range
0 A to 100 A	DC	0 to 2500	0.7 %	0.7 %
0 A to 120 A	10 Hz to 65 Hz	0 to 3000	0.7 %	0.7 %
0 A to 120 A	65 Hz to 300 Hz	0 to 3000	0.7 %	0.7 %
0 A to 40 A	300 Hz to 1 kHz	0 to 1000	0.7 %	0.7 %
0 A to 12 A	1 kHz to 3 kHz	0 to 300	0.8 %	1.0 %
0 A to 3 A	3 kHz to 6 kHz	0 to 100	1.5 %	1.0 %
0 A to 1 A	6 kHz to 10 kHz	0 to 50	5.0 %	1.0 %

[1] The inductance and mutual inductance of the 25 turn coil and clamp that is measured causes a frequency dependent compliance voltage across the coil. The length and configuration of the cables that connect the current to the coil also have an effect. Maximum input current is 120 A input at approximately 100 Hz. Maximum current input decreases to approximately 0.8 A at 10 kHz.
 [2] Includes coil/clamp interaction.

52120A/COIL 6 KA 50-Turn Coil

Number of turns 50
Minimum flexible probe length 500 mm
Maximum input current 120 A continuous with built-in 12 V fan on
Maximum voltage 4.5 V rms

Accuracy

Input Current ^[1]	Frequency	Effective Current Amp-turns	52120A + Coil Accuracy ^[2] ±(% of Amp-turns + % of 52120A range)	
			% of Amp-turns	% of 52120A Range
0 A to 100 A	DC	0 to 5000	0.7 %	0.7 %
0 A to 120 A	10 Hz to 65 Hz	0 to 6000	0.7 %	0.7 %
0 A to 120 A	65 Hz to 300 Hz	0 to 6000	0.7 %	0.7 %
0 A to 120 A	300 Hz to 1 kHz	0 to 6000	0.7 %	0.7 %
0 A to 120 A	1 kHz to 3 kHz	0 to 3500	0.8 %	1.0 %
0 A to 25 A	3 kHz to 6 kHz	0 to 1250	1.5 %	1.0 %
0 A to 13 A	6 kHz to 10 kHz	0 to 600	5.0 %	1.0 %

[1] The inductance and mutual inductance of the 50 turn coil causes a frequency dependent compliance voltage across the coil. Maximum frequency for 120 A input current is approximately 600 Hz. Maximum current input decreases to approximately 13 A at 10 kHz.
 [2] Includes coil/probe interaction.

Note

The specifications for these coils are at 99 % confidence level and are the combined accuracy of the coil and a 52120A. If the coils are used with other current sources the calibration uncertainty of the coils alone is 0.65 % (99 % confidence level) from 0 Hz to 10 kHz.

Chapter 2

Front-Panel Operation

Title	Page
Introduction.....	2-3
Notes on Product Use	2-3
Accuracy.....	2-3
Potential Measurement Errors	2-4
Leakage Paths.....	2-4
Common-Mode Current.....	2-4
External Voltage Connections.....	2-6
Load Regulation.....	2-8
Product Operation Behavior	2-8
Front-Panel Indicator Colors.....	2-8
Incompatible Key Selections.....	2-9
Status Indicators.....	2-9
Voltage Compliance Indictors	2-10
Three Red LEDs Together or Product Self-Shutdown	2-10
How to Use the Product.....	2-10
Current Amplifier Operation	2-10
Stand-alone Operation	2-10
How to Setup Multiple Amplifiers	2-12
Greater than 120 Amps Operation.....	2-12
Closed-Loop Operation	2-14
Multi-Phase Current Outputs.....	2-17
How to Use the Accessory Coils with the Product.....	2-19
Current/Hz Profile	2-19
Current Cable Connection	2-19
Current Clamp Calibration	2-19
Built-In Fan	2-19

Introduction

The Product can be configured to operate in a stand-alone configuration or controlled by an Electrical Power Standard like the Fluke 6100B or 6105A. The inputs of multiple Products can be connected to one power standard. Then the current output from each Product can be connected in parallel to a load. Each Product can be set so that each output has a different ac phase angle.

Notes on Product Use

Accuracy

The specifications in Chapter 1 for stand-alone operation do not include the errors of the instrument that supplies the voltage or current signal to the Product input. To get the absolute accuracy of the current output, use the “root sum of squares” (RSS) procedure. To calculate total accuracy:

First calculate:

$$\sqrt{\text{specA}^2 + \text{specB}^2} = \text{total specification}$$

Multiply the total specification by the coverage factor to get the expanded accuracy at the necessary confidence probability. The most commonly used confidence probabilities for this type of product are shown in Table 2-1.

Table 2-1. Confidence Probabilities

Confidence Probability	Coverage Factor Divisors/Multipliers
95 %	2.00
99 %	2.58
Not Stated	1.73

In this example, the 5720A has an output of 1.2 volts at 20 Hz applied to the Product. The Product is set to the 120 A range with LCOMP off. The Product and 5720A have confidence probability specifications of 99 %. It is not necessary to change them to standard confidence before you calculate the specification with the RSS procedure. For this example, the 5720A has a confidence probability of 95 % and the Product 99 %. Table 2-2 shows how the total accuracy is calculated.

Table 2-2. Total Accuracy Calculation

Calculation Steps	Expanded	Standard
5720A output of 1.2 V at 20 Hz (240 ppm + 40 μV)	0.0273 %	
Divisor to convert to standard confidence	2.00	
5720a standard confidence		0.0137 %
Product output 120 Amp at 20 Hz, LCOMP off	0.0350 %	
Divisor to convert to standard confidence	2.58	
Product standard confidence (0.015 % + 0.020 %)		0.0136 %
Root sum of squares (RSS)		0.0192 %
Multiplier to convert to 99 % confidence	2.58	
Combined accuracy at 99 % confidence	0.0497 %	

Potential Measurement Errors

When you make current measurements, there are some common measurement errors that can have an unwanted effect on the output of the Product.

Leakage Paths

Current leakage paths are a problem with the calibration and measurement of very low currents. This type of error is usually not a problem because of the high current range of the Product. Unless there is very high humidity or equipment insulation is dirty leakage path errors can be ignored.

Common-Mode Current

When referenced to local common or ground, there is a common-mode signal on the two lines of a two-wire cable. These signals on these two lines are in-phase and have equal amplitudes. The current flows through the signal conductors to ground through inter-winding capacitance in transformers. Common-mode current does not flow through a measurement device sense transducer. It does introduce an error if the device and its electronic circuits are not perfectly balanced about earth potential.

Unless measurement devices and sources are fully isolated, common-mode current errors have an effect on all measurements to some degree. A handheld measurement device with no connection to an external power supply or earth is mostly immune to common-mode current. This is because there is nowhere for the common-mode current to flow. Current transformers are also immune to common-mode current. It is always good procedure to attach the output LO connection to a ground to make some reference for guard shields. Thermal sense devices have some immunity to common-mode current. Although the heat source is electrically disconnected from the thermocouple, common-mode current can be found in and around the device through capacitance.

There is a simple check for common-mode interference when the Product is used with a stand-alone measurement device. Connect and then disconnect the output LO terminal to/from the earth terminal of the Product while you monitor the measured value. Change in the measured value is probably caused by common-mode interference.

⚠ Caution

To prevent damage to the Product, do not connect the LO terminal to earth if the output is connected to an external circuit that could be energized.

To decrease the effects of common-mode interference, connect one side of the signal two-wire system to ground. The effectiveness of common-mode chokes increase as the common-mode interference signal frequency increases. Figure 2-1 shows the recommended ground and common mode choke configuration to decrease common-mode interference if it is a problem.

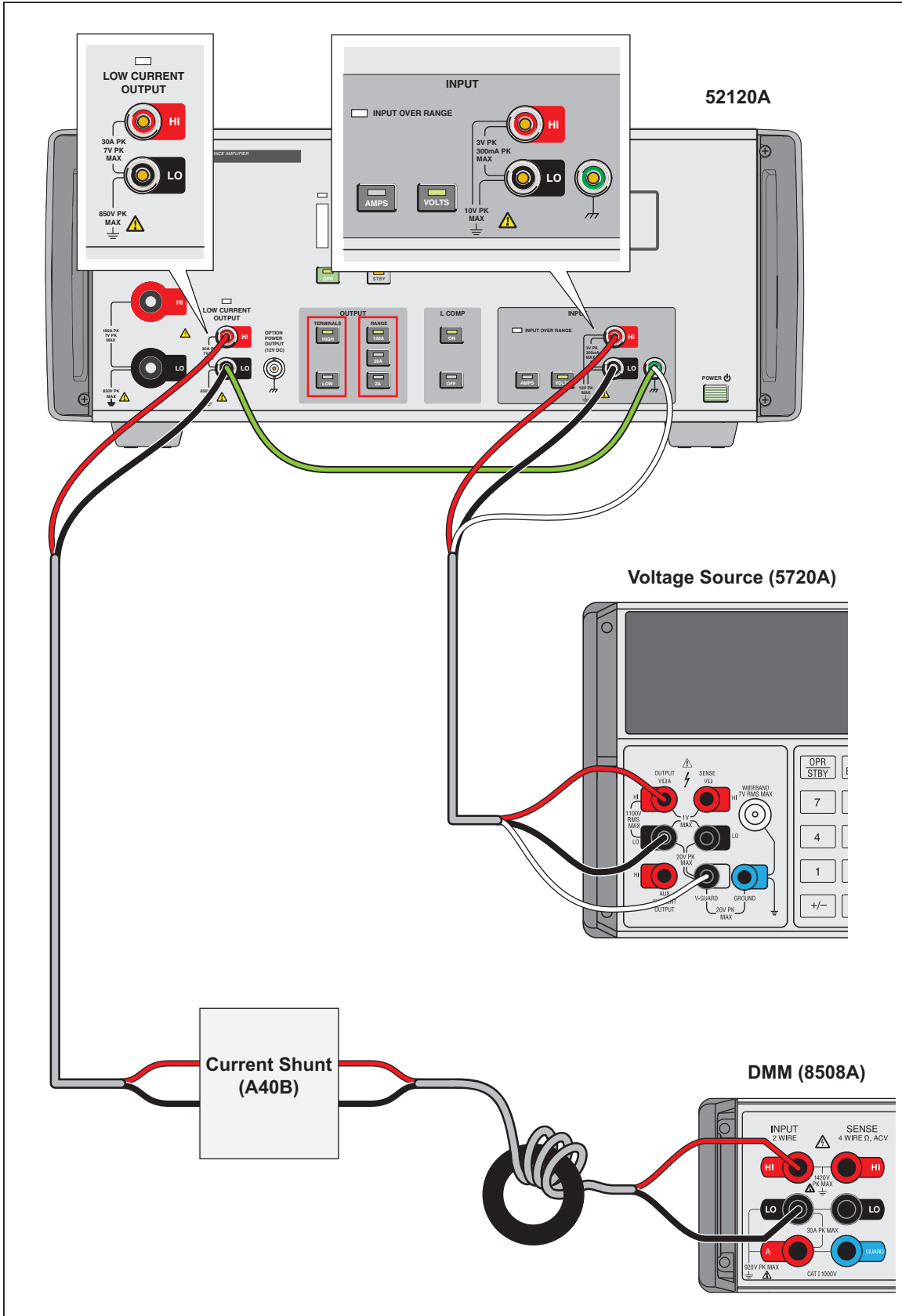

Figure 2-1. Connections for Reduced Common-Mode Interference

gpp005.eps

External Voltage Connections

The Product output is isolated from ground so measurements can be made on external circuits energized to a maximum of 600 V rms. If the Product is to be connected to external hazardous voltage, it is recommended you use the connection and disconnection sequence in the Product Connection Cables section in Chapter 1.

⚠ Caution

To prevent damage to the Product, do not connect the HI and LO terminals to external voltages at the same time.

Only connect the output HI terminal or LO terminal to an external voltage. As the voltage between the HI and LO can be no more than 4.5 volts in normal operation, the HI and LO inputs will be very near the voltage of the external circuit.

When you connect an external voltage to the current output terminals, you cannot connect the output current low connector to ground for common-mode protection.

⚠ Caution

To prevent damage to the Product, do not connect the LO terminal to a terminal that can be at earth potential when an external voltage is connected to the current terminals.

The configuration of the connected equipment can limit the measures you can use to decrease common-mode current errors when external voltage is applied to the current circuit. The best measure is to use equipment that has good common-mode current immunity.

The calibration or type test of single-phase or multi-phase watt-hour meters is one example where common mode voltage can be applied to the output terminals. Figure 2-2 shows a typical connection of the Product to a watt-hour meter where a 6105A supplies the voltage and the Product the current.

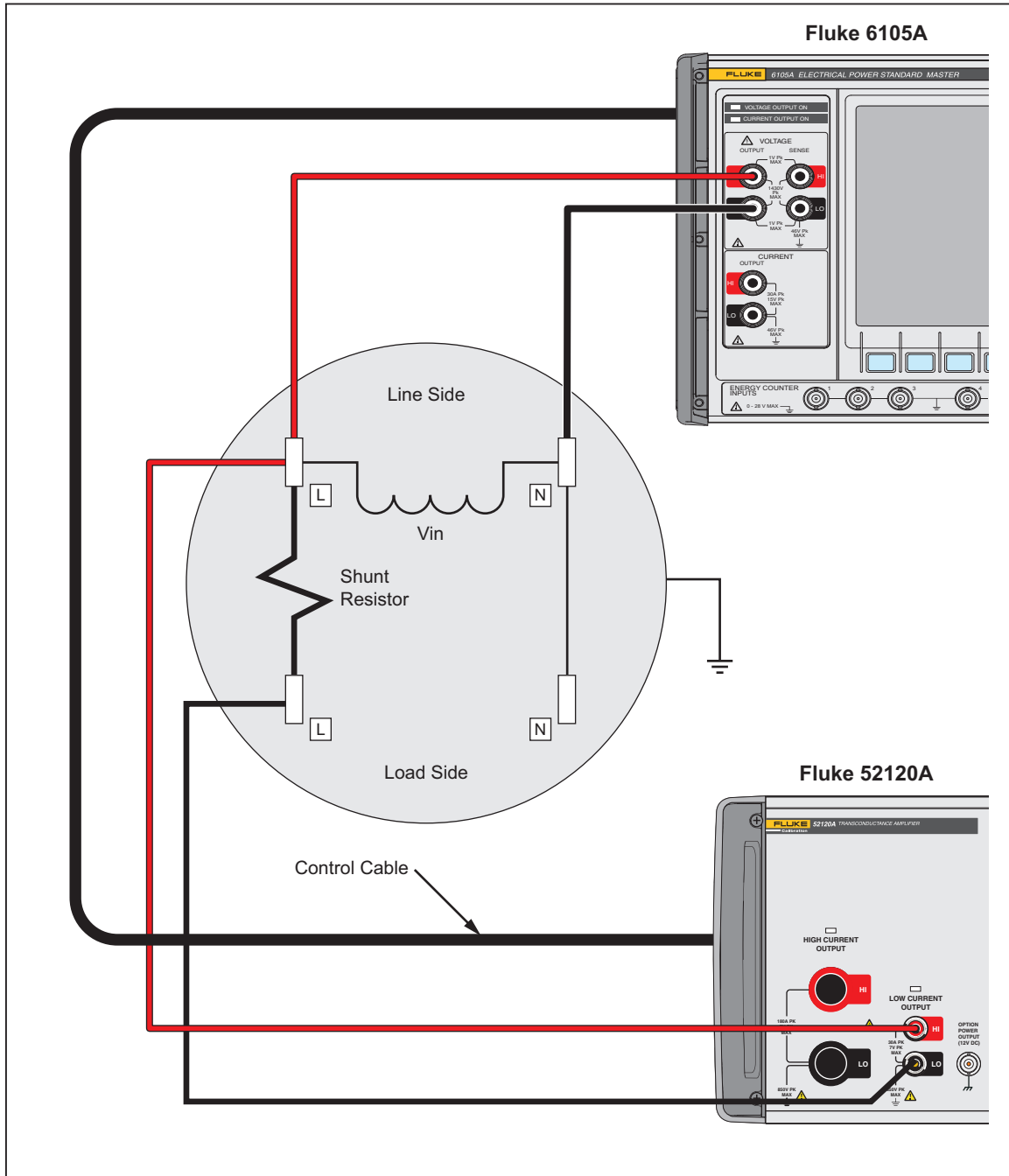

Figure 2-2. Product Connections to a Watthour Meter

gpp012.eps

The capacitance between the measurement circuits and the grounded meter case is too small to pass a common-mode signal of sufficient amplitude to change the measurement.

Devices with their own power supplies which have an isolation input transducer (such as current transformers) are relatively immune to common mode current errors. The path to ground is interrupted by the transducer.

Load Regulation

As with all current sources, the Product has finite output impedance and thus suffers from frequency dependent load regulation errors when in Open Loop mode. The effects of worst case load regulation are included in the Product specification as a percentage of full range. For low impedance loads the load regulation effects are very small and the percent of full range specification adder is pessimistic. A40B shunts are a good example of low impedance loads. The absolute transconductance accuracy performance of the Product is significantly better than specification into such devices if you keep inductive loop impedance to a minimum in long cables.

When you connect the Product to a load, keep the cable length to a practical minimum. Also keep the cables close together to keep loop impedance low. The high current connection cables that shipped with the Product add around 2 μ H to the load impedance if tied together at 150 mm (6 inch) intervals.

For best accuracy, use ac-dc comparison when you calibrate shunts. In this type of measurement, the ac current is compared to a known dc current. Accuracy is supplied by an ac-dc reference instrument such as a thermal voltage convertor. The Fluke 792A or a Fluke 5790A for example. To use this type of measurement, refer to the documentation that comes with the ac-dc reference standard.

The short-link cable that comes with the Product is used when a short loop between the high current HI and LO terminals is necessary. The short loop connector has very low inductance. The low inductance means you can do clamp meter performance tests at higher frequencies than is possible with longer, more inductive cable configurations.

Product Operation Behavior

The Product has internal detectors for Product protection. Equipment connected to the Product receives protection as well. When the Product senses an unexpected condition, the Product goes in to standby (STBY) mode. An interruption of mains power input for three milliseconds or more causes the Product to go to its power up state with the output off. This makes sure the circuits are in a safe condition while internal power supplies are available.

When the Product is in operate (OPR) mode, a change of state such as an error or key push causes the Product to go to standby (STBY) mode.

Front-Panel Indicator Colors

Many of the front-panel keys have indicators embedded in them. The color and condition of these indicators show different conditions. Table 2-3 is a list of the colors used on the front-panel keys.

Table 2-3. Front-Panel Indications

Indicator Color/Condition	Description
Green	Key function is on. When Operate is on, the indicators in the OPR key and the set terminals key show green.
Flashing Green	Shows an incompatible condition has been set. Key(s) that flash green are suggested alternate(s).
Red	Shows an Over Compliance, Over Temperature, or Input Over Range error.
Amber	Product is in standby mode. The STBY key and the set terminals key shows amber in standby mode.
Amber (Error condition)	Over Compliance, Over Temperature, or Input Over Range. A Product in the Master/Slave chain reports an error.

Incompatible Key Selections

There are some key sets and conditions that are mutually exclusive. If the 120 A range is set and you push LOW, the LED in HIGH flashes green to show your choice is incompatible and the HIGH key is compatible. If the low current terminals are set and you push 120A, the LEDs in the 2A and 20A keys flashes green. The 2 A and 20 A ranges are compatible with the low current terminals while the 120 A range is not.

Status Indicators

As shown in Figure 2-3, the Product has eight status indicators. Table 2-4 is a list of these indicators and their description.

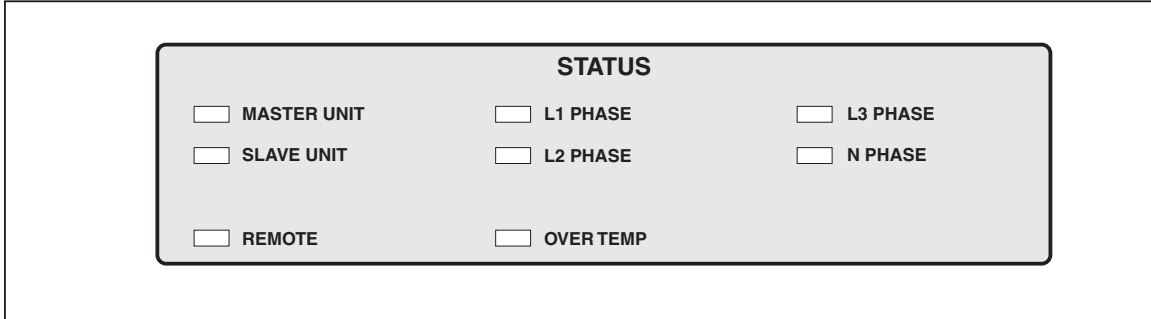

Figure 2-3. Status Indicators

gpp014.eps

Table 2-4. Status Indicators

Indicator	Description
MASTER UNIT	No other Product or the Control Input of a second Product is connected to the control output of this Product. This Product is the master and controls other Products as slaves.
SLAVE UNIT	This Control Input of this Product is connected to the Control Output of a second Product. This Product is a slave to a master Product.
REMOTE	Control of this Product is through the IEEE interface on the rear panel.
L1, L2, L3, N phase	When connected to a 6100B/6105A, one of these indicators shows which phase this Product is connected to.
OVER TEMP (red)	Internal temperature sensors caused the Product to go to the standby mode. Where multiple Products are connected as Master/Slave, the OVER TEMP indicators of those Products that are not over temperature will show amber. You must turn the Product off and on to clear this status.
OVER TEMP (amber)	A Product connected to this Product has had an OVER TEMP condition and caused this Product to go to the standby mode.

Voltage Compliance Indicators

There are two indicators to show the voltage compliance of the Product. The Compliance Voltage Level indicator shows the voltage across the load. The load voltage across the load is in proportion to the current supplied load by the Product. When the voltage on the output terminals of the Product is equal to or more than the specified maximum voltage, the over compliance indicator illuminates red. The Product goes to the standby mode when an over compliance occurs.

Three Red LEDs Together or Product Self-Shutdown

There is an unspecified error when the Over Compliance, Over Temperature, and Input Over range indicators show red at the same time. This can be caused by over temperature or over current in the power supply in the Product. If this condition occurs or the Product turns off unexpectedly, push the rear-panel mains power switch to OFF. Keep the Product turned off for a minimum of 10 minutes. Make sure the ambient temperature is less than 35 °C. Make sure the air inlets and outlets are clear. If necessary, refer to Chapter 4 to clean the air filter. If none of these procedures clear the condition, get in touch with a Fluke Service center representative.

How to Use the Product

One amplifier can source a single-phase ac current waveform to a maximum of 120 amps or 100 amps dc current. The Product can be set to sense a voltage (transconductance amplifier) or current (gain amplifier) on the input and output a current in proportion to the input signal.

Current Amplifier Operation

When you set the Product to current input, a precision resistor is connected across the input terminals. A voltage in proportion to the input current is sensed across the resistor.

If an input overload condition is sensed, the Product changes to standby (STBY) mode. The Product will also change to voltage input as protection for the precision resistor. The current source that supplies the Product input can output more than the voltage compliance limit and turn off. It will be necessary to set the input back to current to operate the Product as a current amplifier.

⚠ Caution

To prevent damage to the Product or voltage source, do not put a voltage between the HI and LO terminals when the input is set to current.

Stand-alone Operation

One example of how to use the Product is to supply a current to verify the performance of a clamp meter. To setup the Product for this performance test:

1. Connect the output of a voltage source, a Fluke 5520A in our example, to the input of the Product. See Figure 2-4.

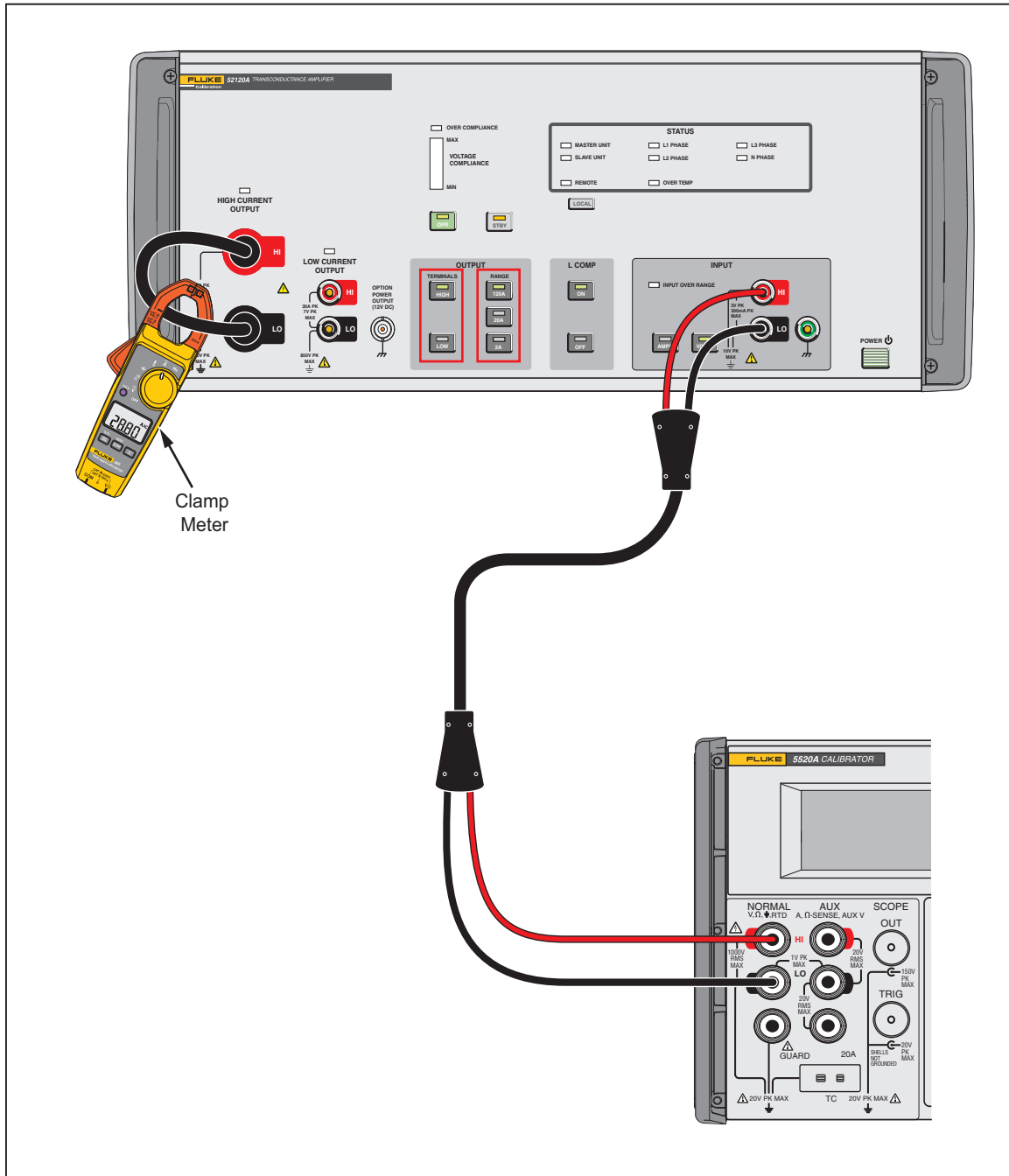

Figure 2-4. 5520A and 52120A Connections

gpp007.eps

2. Connect the short-link cable between the **HI** and **LO** terminals of the high-current output.

Note

You can also connect to the low-current output terminals if the current output is 20 amps or less.

3. Push the **VOLTS** button to set the input of the Product to volts. The indicator in the volts button illuminates to show that volts input is set.

Note

To operate the Product with a current input, push the  button and connect a current source to the input terminals of the Product.



⚠ Caution

To prevent damage to the Product, make sure you do not go above the maximum input voltage or current. See the Maximum Input Level specifications in Chapter 1.

4. Push the LCOMP ON or OFF as necessary.





Note

When LCOMP is on, Product bandwidth and accuracy are decreased.

5. Push , , or  to set the output range. The indicator in the range button illuminates to show the set range.

Note

Only the 2 amp and 20 amp range can be set to the low-current terminals.

6. Push  or  to set the output current terminals. The indicator in the button illuminates to show which terminals will source the output current.
7. Set the voltage source output to a voltage that gets the necessary current out of the Product. The input voltage range of the Product is 0 volts to 2 volts. To output 15 amps from the Product on the 20-amp range, set the input voltage to 1.5 volts. See the specifications section in Chapter 1 for input voltage and current limits. When the input value is more than the limit, the Product sets itself to the standby mode.
8. Connect the output terminals to the load. Make sure the connections are tight.
9. Put the clamp of the clamp meter around the short-link cable and read the current on the clamp meter display.
10. Push  to output the current.
11. Push  to turn off the output current.

How to Setup Multiple Amplifiers

When more than 120 amps is necessary, you can use a maximum of 10 Products connected in parallel.

Greater than 120 Amps Operation

To setup multiple amplifiers for more than 120 amps output:

Connect one end of the control cable to the rear-panel control output connector on one Product. Connect the other end of the cable to the rear-panel control input connector on a second Product. See Figure 2-5.

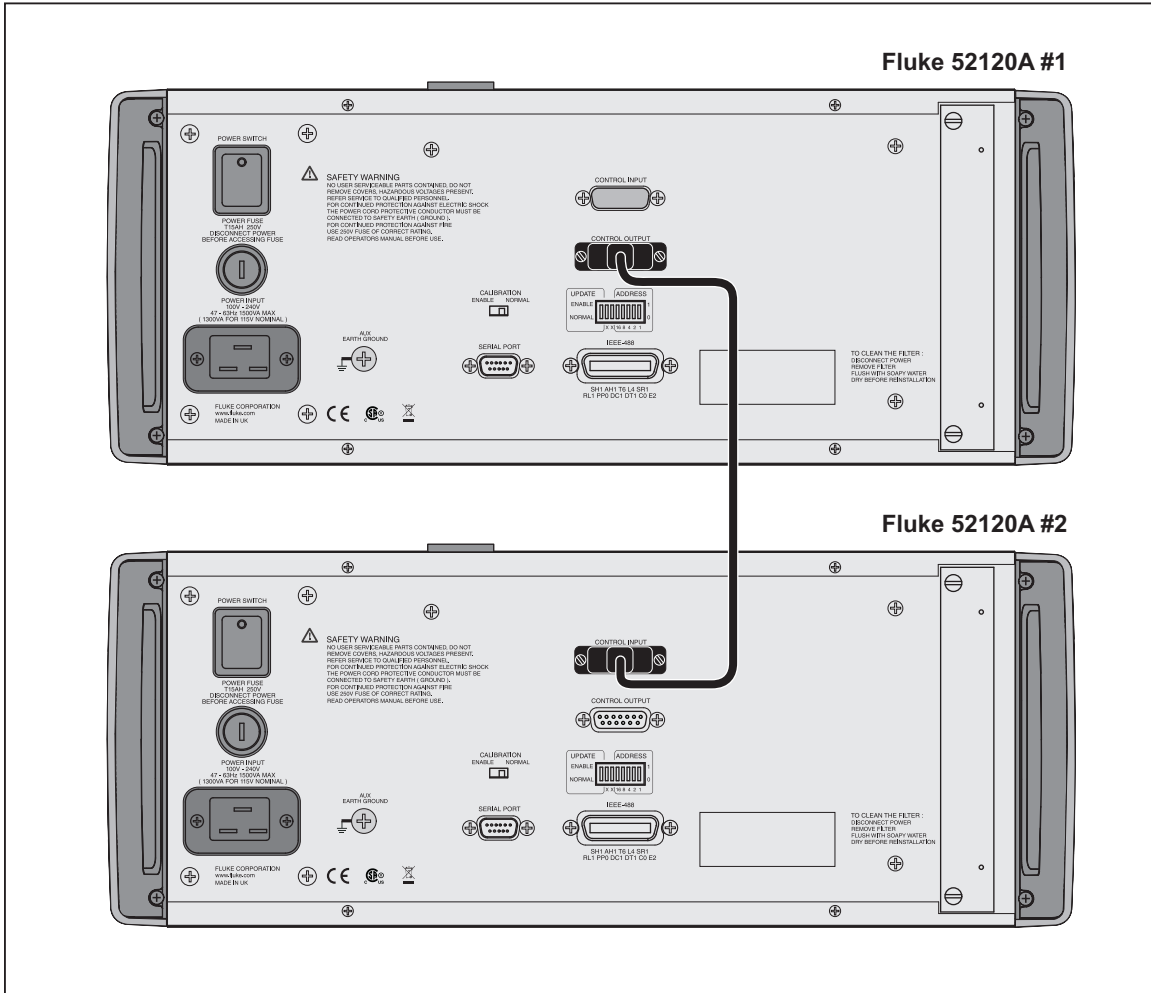

Figure 2-5. Master to Slave Connections

gpp017.eps

The first Product is the master and the second the slave. Connect the input signal to the master Product front-panel terminals. The second Product senses the input signal through the control cable. The two Products are controlled through the front panel of the master Product. All the keys but the STBY key are turned off on the slave Product.

Connect the outputs of amplifier 1 and 2 to the load as shown in Figure 2-6.

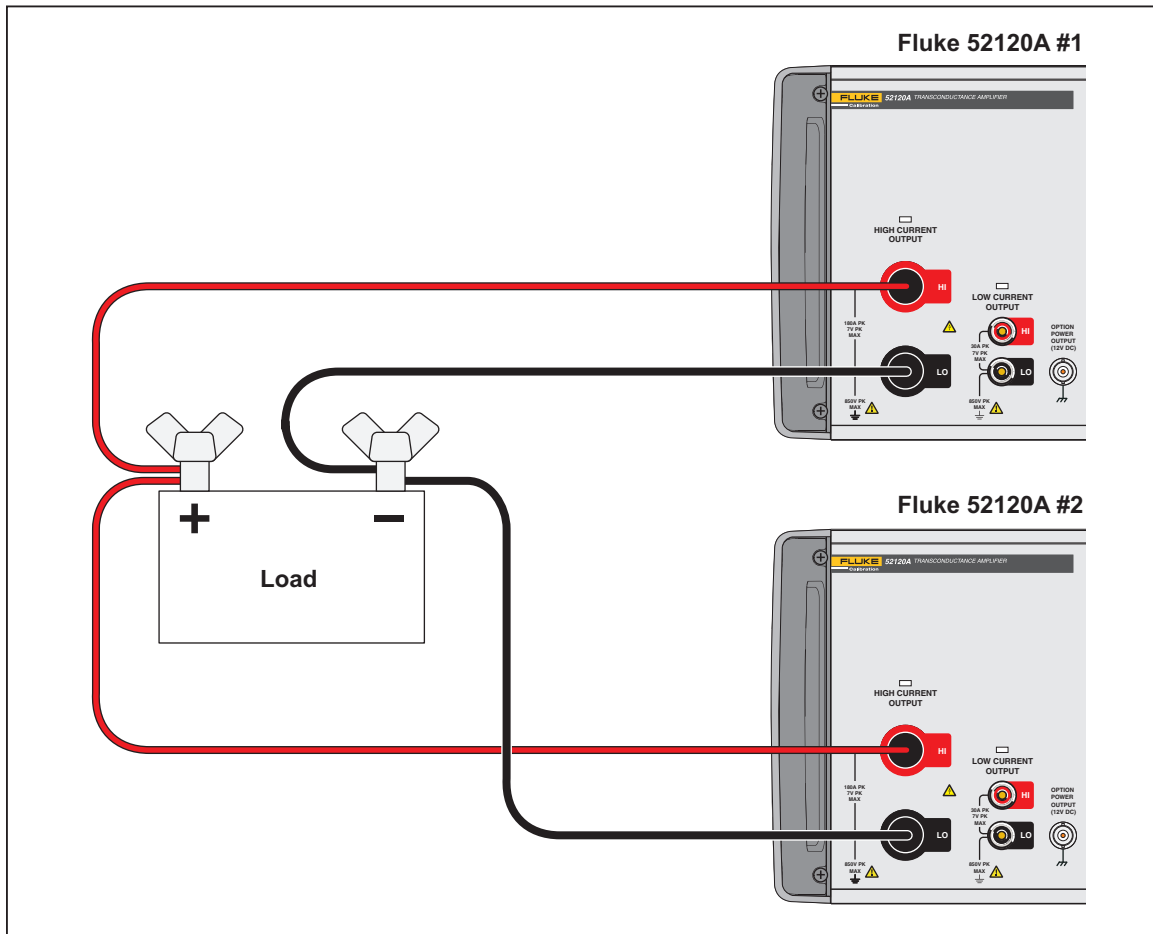

Figure 2-6. Two Amplifier Outputs Connected in Parallel

gpp009.eps

Closed-Loop Operation

When better load regulation and phase-angle control is necessary, connect the Product in a closed-loop configuration with a 6105A or 6100B. Through the feedback loop, the 6105A senses signal phase angle and amplitude to adjust the output and supply a more accurate current signal.

To connect the feedback circuit, connect one end of the control cable to the Control Input connector on the rear panel of the Product. Connect the other end of the cable to the Current Amplifier Control Output connector on the rear panel of the 6105A or 6100B. See Figure 2-7.

Remove all front-panel connections between the 6105A or 6100B and the Product. Turn off and then turn on the 6105A or 6100B to initialize the analogue and control connections between the instruments. The status indicators of the Product will show slave mode operation. See Figure 2-3. The 6105A or 6100B will have three more current ranges: 1 x Ext.2A, 1 x Ext.20A, and 1 x Ext.120A. The output terminals of the Product are set through the 6105A or 6100B Front Panel Terminal Configuration screen. All the keys but the STBY key are turned off on the Product.

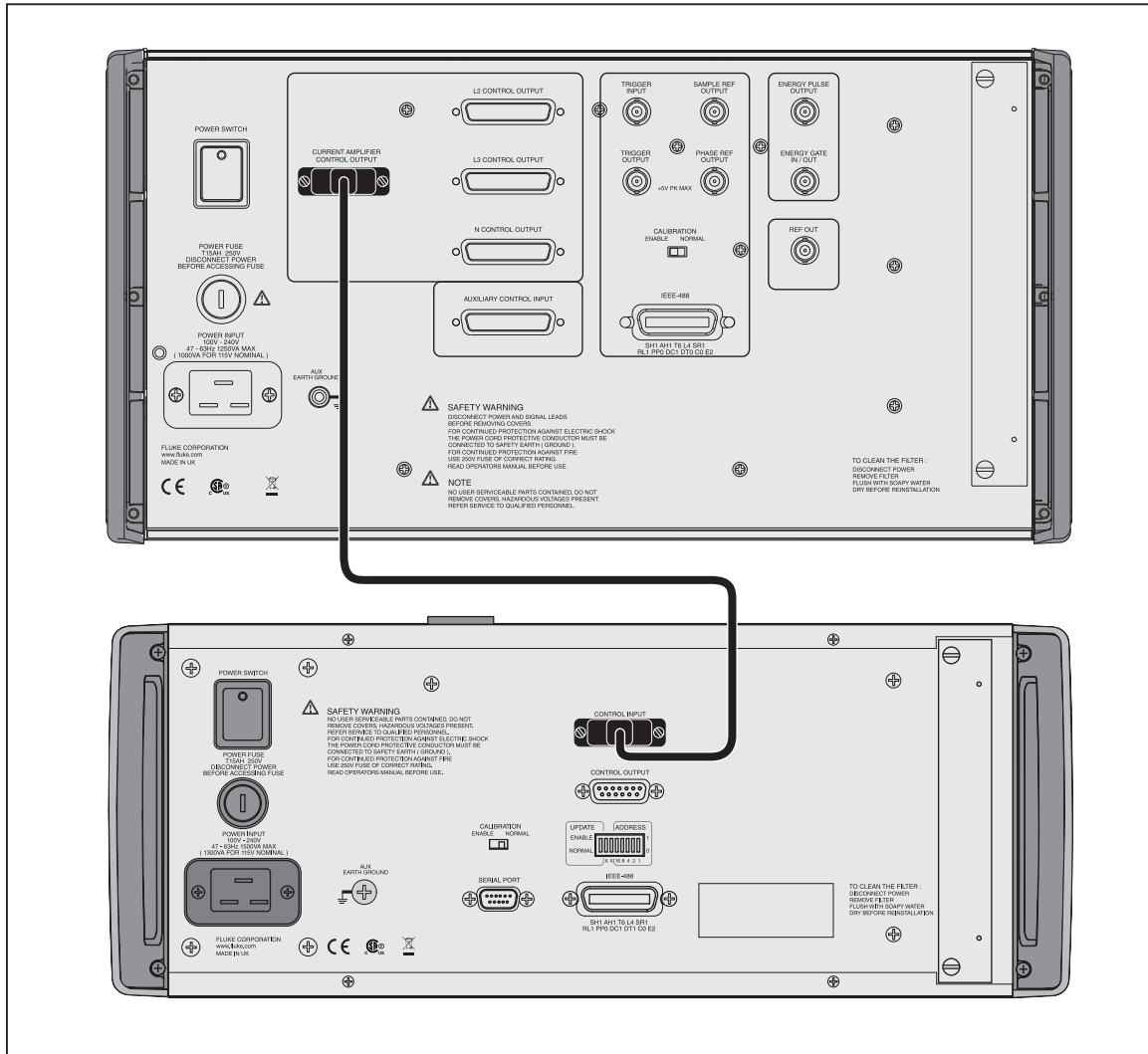
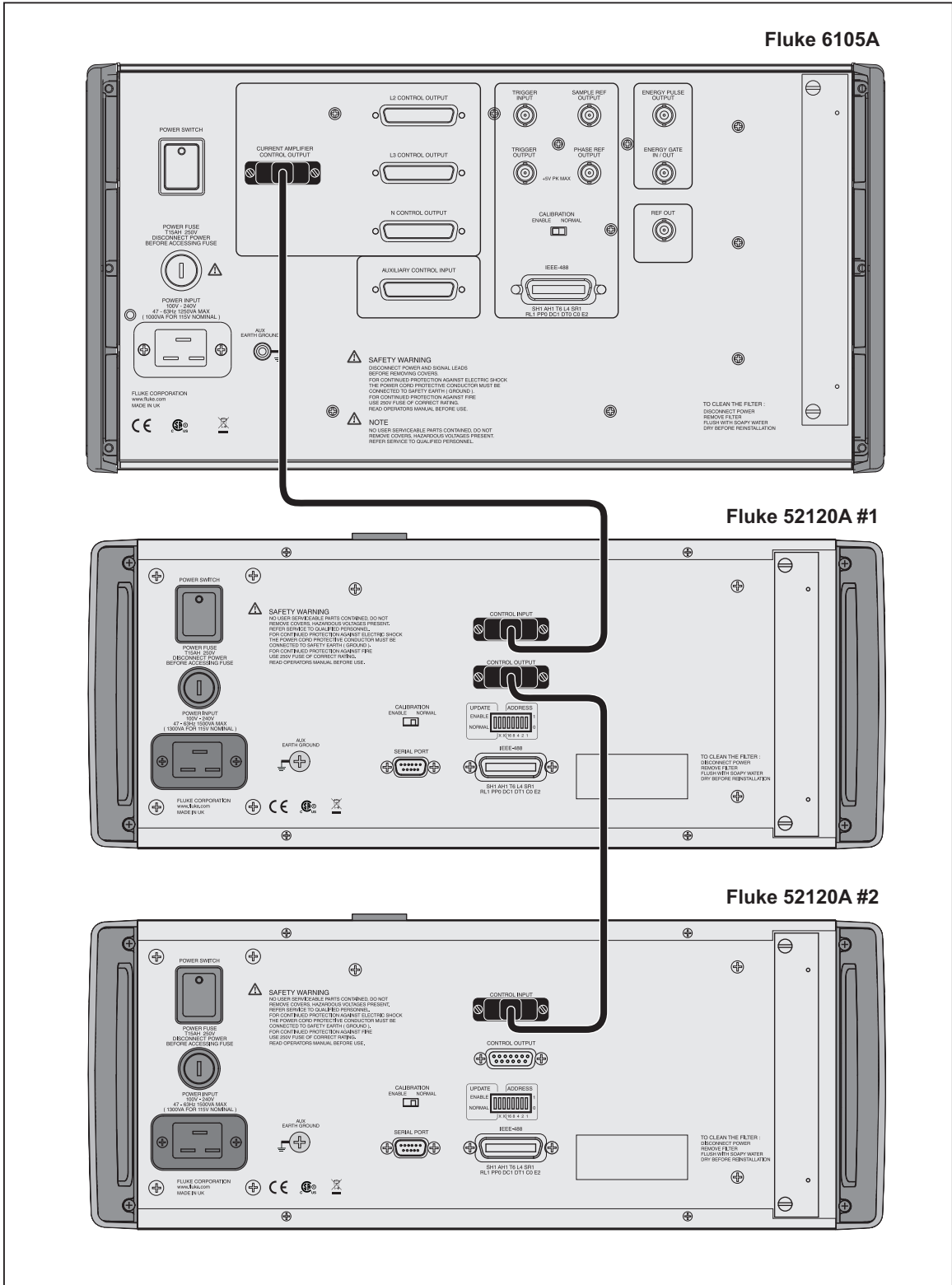

Figure 2-7. Feedback Cable Connections

gpp006.eps

See the Operated with 6105A or 6100B Control Loop section in the specifications of Chapter 1. These specifications include the accuracy of the 6100B or 6105A in this 6105A controlled mode of operation. A maximum of three Products can be connected in parallel for a maximum current of 360 Amps in closed-loop mode. Figure 2-8 shows how to connect multiple Products to a 6105A or 6100B.



gpp008.eps

Figure 2-8. Multiple Amplifier Connections

Note

The output of the 6105A is connected to the amplifiers through the control cable from the 6105A or 6100B.

You can set all the parameters of the amplifiers through the 6105A user interface. Refer to the 6105A Users Manual to learn more.

You can supply a maximum of 360 amps when you connect three Products to a 6105A or 6100B and connect the outputs in parallel. The amplitude and phase angle accuracy specifications for three Products in parallel are the same as for the Product.

Multi-Phase Current Outputs

For mutli-phase current output, use a 6105A for one phase and a 6106A for all other phases. The 6105A controls all 6106As. One Product is necessary for each phase angle. To set up a three-phase output:

1. Connect a control cable between the L2 Control Output connector of the 6105A and the Auxiliary Control Input connector of a 6106A.
2. Connect a second control cable between the L3 Control Output connector of the 6105A and the Auxiliary Control Input connector of a second 6106A. See Figure 2-9.

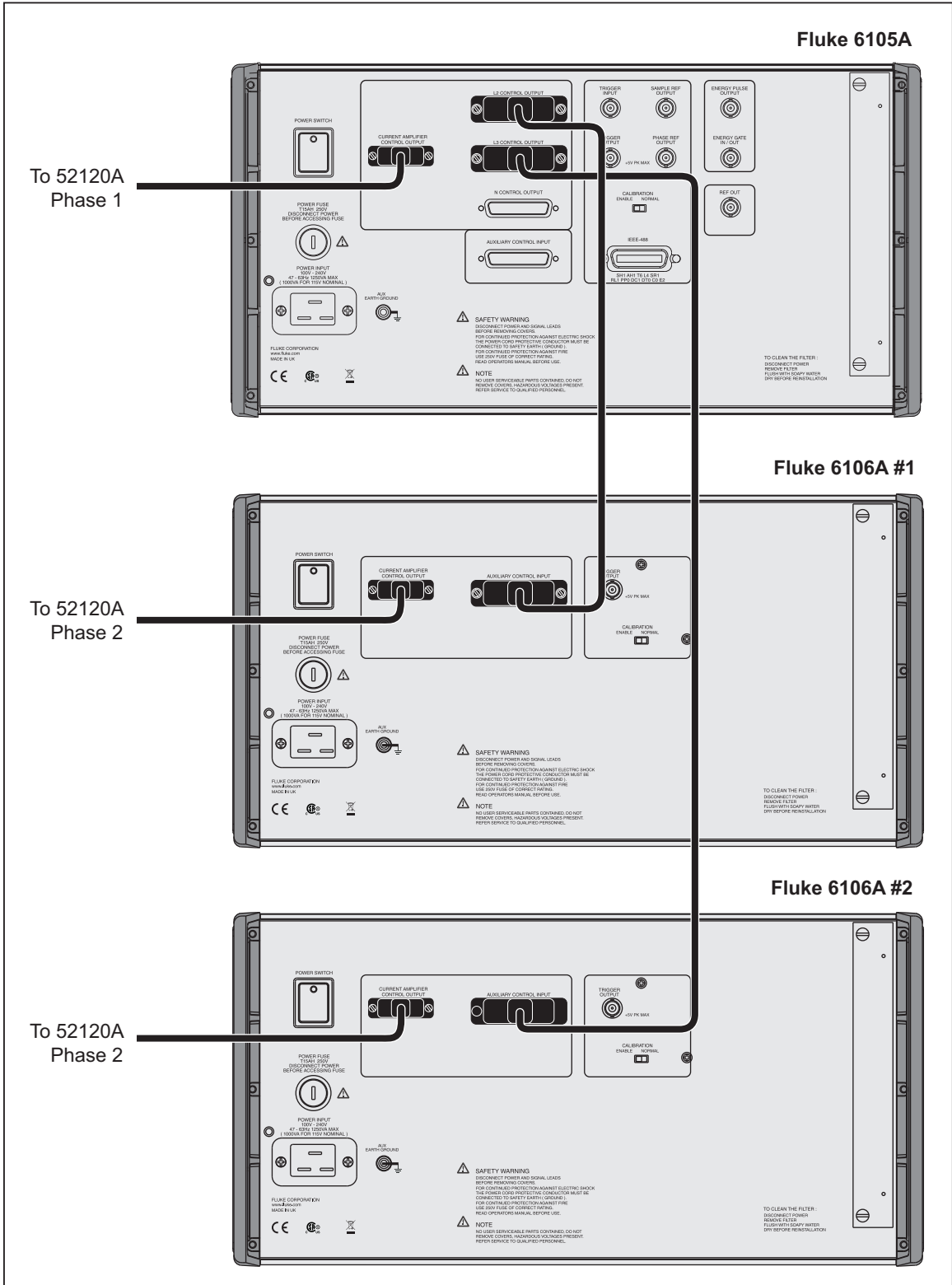

Figure 2-9. 6105A to 6106A Connections

gpp010.eps

3. Connect a control cable between the Current Amplifier Control Output connector on the rear panel of the 6105A and the Control Input connector on the rear panel of one the Products.

4. Connect a second control cable between the Current Amplifier Control Output connector on the rear panel of one of the 6106As and the Control Input connector on the rear panel of the second Product.
5. Do step 4 for the second 6106A.

Figure 2-7 shows the connection between a 6105A or 6106A and each Product.

In this setup, the 6105A controls the two 6106As. Each can be set to output a different phase signal to their related Products. Each Product current output is controlled by the 6105A or 6106A connected to their auxiliary control input.

How to Use the Accessory Coils with the Product

The accessory coils are used in the calibration of current clamps and Rogowski current coils. An input current of 120 amps into the 25-turn coil results in a magnetic field equivalent to 3000 A to calibrate clamp meters. An input of 120 amps into the 50-turn coil results in a magnetic field equivalent to 6000 A in a horseshoe-shaped coil to calibrate Rogowski current coils. The magnetic field of the coils changes in proportion to the input current.

Current/Hz Profile

The usable bandwidth of the accessory coils for a given input current is set by the voltage compliance limit of the current source. The voltage compliance limit is a function of coil impedance. With a voltage compliance limit of 4.5 volts in the Product, the maximum impedance that the Product can supply 120 A into is 0.0375 Ω . The maximum impedance includes the coil which is mostly inductive and the connections and cables.

Current Cable Connection

Make sure the connection at the coil input terminal posts are tight, so the connection cables and coil terminal posts do not get too hot. Keep the cable length to a practical minimum. For minimum loop impedance, put the cables close together and tie them together at regular intervals.

Current Clamp Calibration

Some current clamps and Rogowski coils are sensitive to their position in a magnetic field. To do a sensitivity test, move the position of the device to be calibrated in the accessory coil field and look for changes in the output. Usually a central position gives the best results.

Built-In Fan

A 12-V dc fan to cool the coil is built-in to the accessory coil. The electrical connection is a BNC-terminated cable that comes out of the coil base. The Product has a BNC connector on the front panel (OPTION POWER OUTLET) that supplies 12 V dc to the coil fan. If the accessory coils are used away from the Product, 12-V dc power can be supplied with the 52120A/COIL12V DC Power Supply. The fan must blow air through the coil.

Warning

To prevent fire, personal injury, or damage to equipment, do not use the accessory coil if the fan is not turned on.

Chapter 3

Remote Operations

Title	Page
Introduction.....	3-3
IEEE-488.2 Compliance	3-3
How to Set the Bus Address	3-3
Power On and *RST Conditions.....	3-4
SCPI Status Registers	3-4
Remote Commands.....	3-5
Supported Common Commands.....	3-6
Supported SCPI Commands	3-6
SCPI Command Summary	3-7
52120A SCPI Command Details	3-8
6105A SCPI Command Details	3-11
Calibration and Adjustment Command Extensions.....	3-12
6105A *OPT? Command	3-12

Introduction

This chapter contains instructions on how to operate the Product remotely through the IEEE 488.2 GPIB interface. The master unit in a chain of 52120A instruments can be controlled remotely through the IEEE 488.2 GPIB interface. Only the master unit is controlled by the remote commands. The remote interface is disabled when a unit is configured as a slave.

IEEE-488.2 Compliance

The Product is programmable for use on the IEEE Standard 488.1 interface bus (IEEE-488 bus). The interface also complies with supplemental standard IEEE-488.2. Devices connected to the bus in a system are designated as talkers, listeners, talker/listeners, or controllers. Under remote control of an instrument controller, the Product operates exclusively as a talker/listener on the IEEE-488 bus.

To learn more, read the standard specification in the publication *ANSI/IEEE Std. 488.1 – 1987* and *IEEE Std. 488.2 – 1988*.

How to Set the Bus Address

The address that the product responds to on the IEEE 488.1 bus is set by switches on the rear panel. See Figure 3-1. The right hand 5 of these switches are used to set the address. The right most switch (1) is the least significant bit, and switch 5 (16) is the most significant bit.

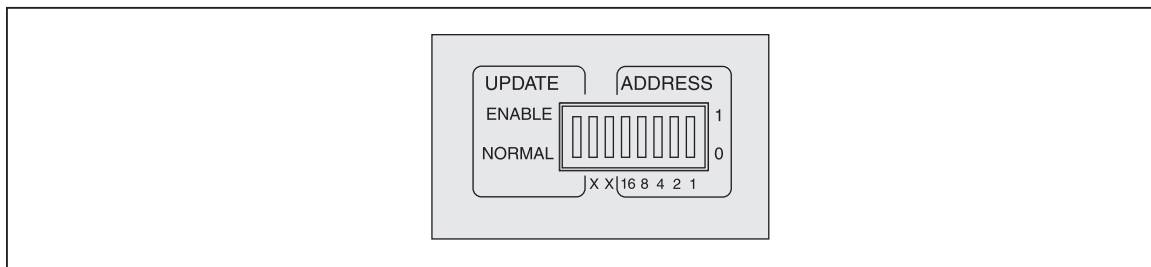

Figure 3-1. IEEE Bus Address Switches

gpp015.eps

Note

When the Product is a slave to a 52120A or 6105A/6100B, the GPIB interface is made passive and no longer can be addressed on the GPIB bus.

Use a pointed object (such as a pencil) to set the switches to the necessary GPIB address in binary. The five switches are labelled from right to left 1, 2, 4, 8, 16, their binary contribution to the address. Push the top of the switch to “set” the address bit. Push the bottom of the switch to “clear” the bit. The GPIB address is invalid if you set (address 31) or clear (address 0) all the address switches.

Note

The address switch is only read at power-on. A change to the address switch with power on must be followed by a power-cycle of the instrument. Only then will the Product answer to the new address.

Power On and *RST Conditions

All parameters are set to their default values when the Product is energized. Table 3-1 is a list of items that are set when the Product is turned on and when an *RST command is received through the GPIB interface. Subsequent changes to these parameters are lost when you turn off the Product.

Table 3-1. Power On and RST Defaults

Item	Power On State	*RST State
Input Terminals	Voltage	Voltage
Range	2A	2A
Output Terminals	High	High
Load Compensation	Off	Off
*ESR?	128	Unchanged
*ESE	255	Unchanged
*STB?	32	Unchanged
*SRE	255	Unchanged
:OPER:EVENT	0	Unchanged
:QUES:EVENT	0	Unchanged

SCPI Status Registers

Figure 3-2 shows the relationships of the questionable status register, the event status register, and the operation status register of the Product.

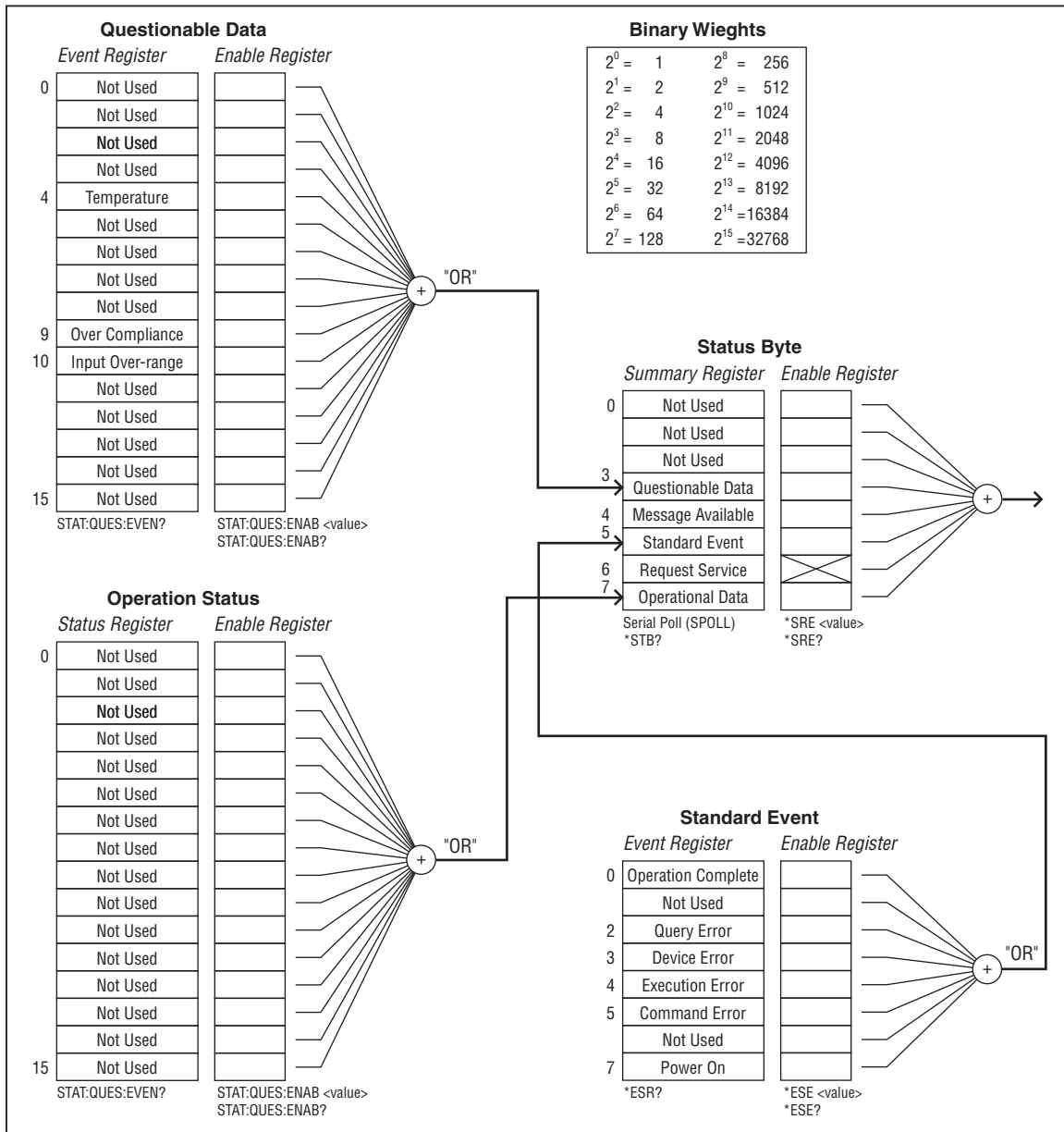

Figure 3-2. SCPI Status Registers

gpp011.eps

Bits 9 and 10 of the questionable data register do not get set on the condition register. They are transitory hardware events that clear three milliseconds after they are set. You can only see them in the STAT:QUES? register.

Remote Commands

This section documents the IEEE-488 remote commands for the Product. Remote commands duplicate operations that can be done from the front panel in local operation.

A complete alphabetical list of all commands, with protocol instructions, follow the summary tables. The parameters and responses for each command is shown, plus an example for each command.

Supported Common Commands

Tables 3-2 summarize the common commands implemented in the Product.

Table 3-2. Common Command Summary

Command	Description
*CLS	The clear common command resets all event registers and removes all errors from the error queue. It does not clear enable registers and transition filters. It also clears any pending *WAI, *OPC, and *OPC? actions.
*ESE	Sets the enable bits of the standard event enable register. This enable register contains a mask value for the bits to be enabled in the standard event status register. A bit that is set true in the enable register enables the corresponding bit in the status register. An enabled bit will set the ESB (Event Status Bit) in the Status Byte Register if the enabled event occurs. Parameter = NR1
*ESR?	This query command returns the contents of the standard event status register. Reading the standard event status register clears the register.
*IDN?	This query command gets the manufacturer, model, serial number, and firmware level for main and GPIB program in an ASCII response data element. The response is: <Manufacturer>, <Model>, <Serial Number>, <Firmware Level>. For example: Fluke,52120A,123456,1.00
*OPC	The operation complete command causes the device to set the operation complete bit in the standard event status register when all pending selected device operations have completed.
*OPC?	The operation complete query puts an ASCII character '1' into the device's output queue when all selected device operations have completed.
*OPT?	This query command gets a list of all the detectable options that are installed in the Product. Options that are not installed are identified with an ASCII '0'. There are no options for the 52120A as of this writing.
*RST	The reset command resets the instrument state. It is the third level of reset in the IEEE 488 3-level reset strategy. It has an effect only on the Product's functions and not the IEEE 488 bus.
*SRE	The service request enable register contains a mask value for the bits to be enabled in the status byte register. A bit that is set true in the enable register enables the related bit in the status byte register to set a service request (SRQ). Parameter = NR1
*STB?	This query command returns the value of the status byte. Bit 6 reports the master summary status bit (MSS). The MSS is set if the instrument has one or more causes for a service request.
*TST?	The self-test query causes an internal self-test. The response is always 0 (pass).
*WAI	The wait-to-continue command holds all commands to be done until all commands and queries that are in process are completed.

Supported SCPI Commands

This section contains the SCPI (Standard Commands for Programmable Instruments) commands available to program the Product. This section includes:

- A list of the supported SCPI commands.
- A discussion of how to use the command set.
- A detailed description of each command in the set.

The conventions used for SCPI command syntax in this Chapter are:

- Square brackets ([]) show optional keywords or parameters.
- Braces ({}) enclose parameters that are in a command string.
- Triangle brackets (<>) show you where you must put a value for the parameter.

There are SCPI commands that control the Product when it is used for stand-alone operation. There are also SCPI commands in the 6105A command set that control the Product when it is controlled by a 6105A. The 6105A commands for the Product are in the phase current control of the command tree. The branch is the EAMP (External AMPLifier) branch.

Note

The OUTPut[:STATe] command is used to control output state.

SCPI Command Summary

Tables 3-3 is a list of SCPI commands implemented in the Product. Table 3-4 is a list of 6105A SCPI commands that control the Product when it is controlled by a 6105A.

Table 3-3. SCPI Commands

Command	Description
SYStem	Path to SCPI commands
:VERsion?	Gets the SCPI version installed in the Product
:ERRor?	Gets the earliest error in the error queue
CHAIIn	Path the chain function
:FITTeD?	Gets number of units in chain
:IDN?	Gets instrument identification
INPUt	Path to input type coimmands
:TYPE(?)	Sets or gets input type selection
OUTPUt	Path to output commands
[:STATe](?)	Sets or gets the output state. Operate or standby
:TERMinAl	Path to output terminal commands
:ROUte(?)	Sets or gets which output terminals are used
[:SOURce]	Path to source commands
:CURRent	Path to source current commands
:RANGe(?)	Sets or gets the current range
:LCOmp(?)	Sets or gets the state of the LCOMP feature
:COMPliance?	Gets the percentage of compliance
CALibratIon	Path to the calibration function
:SECure	Path to calibration security function
:PASSword	Used to enter the password to enable calibration
:EXIT	Exits calibration mode
:ADJust?	Sets a specified calibration variable and returns results
:SAVE?	Saves the calibration adjustments to non-volatile memory
STATUs	Path to the status function
:OPER[:EVENT](?)	Gets the Operation Event Register contents
:ENABle(?)	Sets the Operation Event Register mask
CONDItion?	Gets the Operation Condition Register contents
:QUES[:EVENT](?)	Gets Questionable Event Register contents
:CONDItion	Sets the Questionable Event Register mask
:PRESent	Sets registers to a SCPI defined state

Table 3-4. 6105A SCPI Commands for the 52120A

Command	Description
[[:SOURce] :PHASe<x> :CURRent :EAMP :RANGe(?) :LCOMp(?) :TERMinal :MODE(?) :ROUte? :FITTed? :IDN?	Path to source commands Path to source phase commands Path to source current commands Path to External Amplifier commands (52120A) Used to set or query the range of the 52120A Sets or gets the state of the LCOMP feature of the 52120A Path to output terminal commands Sets or queries the terminal mode of the 52120A Sets or returns which output terminals are used in the 52120A Gets number of 52120A units in chain Gets the 52120A instrument identification
[[:SOURce] :CALibration :PHASe<x> :CURRent :RANGe :EAMP(?)	Path to source commands Path to calibration security function Path to source phase commands Path to source current commands Path to source range commands Sets or queries the 52120A

52120A SCPI Command Details

All SCPI commands recognized by the Product are contained in this section. Each command has a description and syntax rules.

CALibration:ADJust? <cpd>, <nrf>, <nrf>

Description Sets which parameter to adjust and retrieves if the adjustment was accepted or rejected.

Parameters <cpd> = GAIN The nrf values set the gain adjustment.
FLATness The nrf values set the flatness adjustment.
LFFLatness The nrf values set the lf flatness adjustment
OFFSet The nrf values set the offset adjustment.

<nrf>,<nrf> = The first nrf value is the target value and second nrf value is the actual value needed to achieve the target.

Example CAL:ADJ? GAIN,1.90000,1.90123

Returns 0 if the adjustment was successful and 1 if it failed. Use :SYST:ERR? for more data about the failure.

CALibration:SAVE?

Description Stores adjustment changes to non-volatile storage and retrieves if the save was successful or failed.

Example CAL:SAVE? Sends 0 if the save was successful and 1 if it failed. Use :SYST:ERR? for more data about the failure.

CALibration:SECure:PASSword <spd>

Description Sends a password to the Product to put the Product into adjustment mode.

Note

The calibration switch on the rear panel of the Product must be set to Enable before you send the password.

Parameters <spd> = (the password)

Example CAL:SEC:PASS "ADJUST" Sends the string ADJUST to the Product to allow calibration adjustments. Note the word ADJUST must be in quotes for this command.

CALibration:SECure:EXIT

Description Exits the calibration or adjustment mode.

Example CAL:SEC:EXIT Exits calibration adjustments.

Note

All changes will be lost the next time the Product is power cycled, unless CAL:SAVE? is done before the exit command.

CHAin:FITTed?

Description Gets the number of units in the chain.

Example CHA:FITT? Get back a number from 1 to n.

CHAin:IDN? <nrf>

Description Gets the identification string of an instrument in the chain.

Parameter <nrf> = 1 to 10 Index of the instrument in the chain.

Example CHA:IDN? 2 Gets back the identification string of the second instrument in the chain.

Note

*The command :CHA:IDN? 1 is equivalent of *IDN?.*

Returns <manufacturer>, <model>, <serial number>, <firmware>

INPut:TYPE(?) <cpd>

Description Sets or gets the input type selection.

Parameter <cpd> = CURRENT Sets the input type to current.
VOLTage Sets the input type to voltage.

Example INP:TYPE CURR Sets the input type to current.

INP:TYPE? Gets back CURR or VOLT depending on which type is set in the Product.

OUTPut[:STATe](?) <bool>

Description Sets or gets the state of the output signal.

Parameters <bool> = ON or 1 Enables the output signal (OPR).
OFF or 0 Disables the output signal (STBY).

Example OUTP ON Turn the Product output on.

OUTP? Gets back 1 if the Product is in operate mode.
Gets back 0 when the Product is in standby mode.

OUTPut:TERMinal:ROUte(?) <cpd>

Description Sets or gets which front-panel output terminal is in use.

Parameters <cpd> = LOW Output current on LOW terminals. 2A and 20A ranges.
HIGH Output current on HI terminals. All ranges.

Example OUTP:TERM HIGH Puts the output current through the HI terminals on the front panel of the Product.

OUTP:TERM? Gets back HIGH or LOW.

[:SOURce]:CURRent:RANGe(?) <nrf>

Description Sets or gets the current range of the Product.

Parameters <nrf> = 2 Sets output current range to 2 A.
= 20 Sets output current range to 20 A.
= 120 Sets output current range to 120 A.

Example CURR:RANG 20 Sets output current range to 20 A.

CURR:RANG? Gets back 2, 20, or 120.

[:SOURce]:CURRent:LCOMp(?) <bool>

Description Sets or gets the state of the LCOMP (inductive-load compensation) function.

Parameters <bool> = ON or 1 Turns on LCOMP.
OFF or 0 Turns off LCOMP.

Example CURR:LCOM ON LCOMP on.

CURR:LCOM? Gets back 1 or 0.

[:SOURce]:CURRent:COMPLiance?

Description Retrieves the percentage of compliance.

Example CURR:COMP? Gets back a number that shows the percentage of compliance.

SYSTem:VERsion?

Description Retrieves the SCPI command version of the Product.

Examples SYST:VERS? Gets back the SCPI version.

Returns 1999.0 This is an example. The number returned can be different,

SYSTem:ERRor?

Description Retrieves an error from the error queue. Errors are retrieved in first-in, first-out (FIFO) sequence. The response has two elements: a code number and error message. For some messages, supplementary information is supplied by a “;” separated clause. The error queue stores a maximum of 50 errors at which point no more errors are stored until errors are removed from the queue.

Examples SYST:ERR? Gets back the error at the head of the queue (earliest).

Calibration and Adjustment Command Extensions

There is a special calibration range used when you characterize the interconnections between the 6105A and the Product. You use the 6105A calibration command for this characterization.

[:SOURce] :CALibration:PHASe<x>:CURRent:RANGe:EAMP (?) <nrf>, <nrf>

Description Sets or gets the adjustment range of the Product assigned to the phase identified by x. The two <nrf> parameters are the low and high range limits.

Parameters <nrf>,<nrf> = 0,2 Sets the range to 2 A.
 0,20 Sets the range to 20 A.
 0,120 Sets the range to 120 A.

Note

There is a special calibration range that is necessary for the characterization of the interconnections between a 6105A and the Product. This range is set with high and low range parameters '0.24,2.4'.

To set the special calibration range use:

CAL: PHAS1: CURR: RANG: EAMP 0.2, 2.4

To set this range from the user mode, use:

[:SOURce] : PHASe<x> : CURRent : EAMP : RANGe : 0.2, 2.4

You can use this command when it is necessary to verify an adjustment at points not available in the calibration mode. A change of range after you use this command removes this special range from the dropdown list because it is not a normal operation range.

Returns <nrf>, <nrf>

6105A *OPT? Command

Send this command to a 6105A to identify the installed options by channel. The response will be eight comma-delimited values. One value for each channel. The values are binary weighted to show which options are installed. The data element type is Nr1, as specified in the IEEE 488.2 standard specifications. This list is terminated by a new line with an EOI character.

Phase 1 V, Phase 1 I, Phase 2 V, Phase 2 I, Phase 3 V, Phase 3 I, Neutral V, Neutral I

Table 3-5 is a list of each bit of a value and the description of each bit.

Table 3-5. *OPT? Bit Identification

Bit	Description
0	80A current option installed
1	bandwidth current option installed
2	energy timer/counter option installed
3	50mR shunt upgrade installed
4	Version II energy timer/counter option installed
5	20 MHz reference clock out option installed
6	50 A current option installed
7	Unit is compatible with 52120A

For a system made up of a 6100A and one 6101A with an 80A and bandwidth current option installed, *OPT? would respond with:

0, 0, 0, 3, 0, 0, 0, 0

Note

The bandwidth and 50mR shunt options are only used on older models of the 6100A and 6101A.

Chapter 4

Operator Maintenance

Title	Page
Introduction.....	4-3
How to Replace the Mains Input Fuse.....	4-3
How to Clean the Air Filter	4-3
How to Clean the Product.....	4-4
Replaceable Parts	4-4

Introduction

This chapter explains how to perform the routine user maintenance required to your instrument in optimal operating condition. The topics covered in this chapter include:

⚠️⚠️ Warning

To prevent possible electrical shock, fire, or personal injury:

- **Do not operate the Product with covers removed or the case open. Hazardous voltage exposure is possible.**
- **Use only specified replacement fuses.**
- **Remove the input signals before you clean the Product.**
- **Turn the Product off, remove the mains power cord, and disconnect all input and output cables before you clean the Product.**
- **Disconnect the mains power cord before you remove the Product covers.**

How to Replace the Mains Input Fuse

The mains input fuse holder is on the rear panel of the Product. To replace the fuse:

1. Switch the Product off with the rear-panel main power ON/OFF switch.
2. Remove the power cord from the mains input connector.
3. Use a flat-blade screwdriver to turn the fuse holder cap counterclockwise until the cap can be pulled from the holder.
4. Replace the fuse with a new one. See Table 4-1 for approved fuses.

Table 4-1. Approved Replacement Fuses

Manufacturer	Part Number	Rating
⚠️ Fluke	4109196	Anti-surge T 16AH 500V 6.35 mm X 32 mm
⚠️ SIBA	70 065 65 16A 189 140.16	
⚠️ For safety, use exact replacement only.		

How to Clean the Air Filter

⚠️ Caution

The Product can become too hot and be damaged if the area around the air intake is too small, the intake air is too warm, or the air filter becomes clogged.

You remove the air filter from the rear panel of the Product. To remove the air filter:

1. Switch the Product off with the rear-panel main power ON/OFF switch.
2. Remove the power cord from the mains input connector.
3. Loosen the two screws at the top and bottom vertical panel that covers the air filter.

Note

There must be 19 inches of clearance behind the Product to remove the air filter.

4. Pull the air filter out of the Product.
5. Clean the air filter with soapy water.
6. Dry the air filter thoroughly.
7. Install the air filter and tighten the knurled screws.

How to Clean the Product

Clean the external surfaces of the Product with a soft cloth dampened with water or a non-abrasive solution that will not damage plastic.

⚠ Caution

To prevent damage to the Product, do not use aromatic hydrocarbons or chlorinated solvents to clean the Product. These can cause damage to the plastic parts of the Product.

Replaceable Parts

Table 4-2 is a list of replaceable parts. To order parts, see the How to Contact Fluke section in Chapter 1.

Table 4-2. Replaceable Parts

Part	Fluke Part No.
Rear Interconnect Cable	4101345
52120A-4412 Cable, High Current 52120A (set of three)	4101350
Lead Kit, 52120A Volt/Current (set of two)	4044919

Chapter 5

Calibration

	Title	Page
Introduction.....		5-3
Calibration Correction Factors		5-3
Equipment Required		5-3
Initial Setup and Input Zero Adjustments.....		5-3
Calibration Verification – Standalone Mode.....		5-5
Equipment Setup		5-7
2 Amp Range Verification		5-7
20 Amp Range Verification		5-9
120 Amp Range Verification		5-11
Current Input Burden Resistor Verification		5-13
Amplitude Specification Limits, Pass/Fail Analysis		5-13
Calibration Adjustment – Standalone Mode		5-14
Equipment Set Up		5-14
How to Correct for Shunt Resistance Error		5-16
Adjustment Process		5-16
Adjustments Notes		5-16
Adjustments		5-16
Calibration Verification – Closed-Loop with 6100A or 6105A		5-22
Test Equipment		5-22
Power Line Frequency Confidence Check.....		5-22
Phase Angle Accuracy Confidence Check.....		5-23
Verify Amplitudes at DC and Higher Frequencies		5-23
Verify Phase Angles at Higher Frequencies		5-26

Introduction

This chapter contains the performance verification and calibration adjustment procedures for the Product. Annual calibration verification and adjustment is recommended to make sure the Product operates to specifications.

Calibration Correction Factors

You can use the Product as a standalone transconductance amplifier or as an extension to the 6100B and 6105A series calibrators. There are two different modes of operation. The calibration adjustment procedure has two phases and two sets of calibration factors. When you operate the Product standalone only the standalone calibration correction factors are applied.

The procedure to adjust the Product in standalone mode without a 6105A is given below. Equipment necessary to adjust and verify the Product to full specification when connected to a 6105A is not available commercially. A procedure to do a confidence check is included in this manual. But to make correction adjustments for operation with a 6105A, you must send the Product to a Fluke Service Center.

Repair to the Fluke 6105A Electrical Power Standard or the Product must be followed by a calibration at a Fluke Service Center. This is to make sure they operate to specifications.

Equipment Required

Table 5-1 is a list of test equipment necessary to verify and calibrate the Product.

Table 5-1. Calibration Equipment

Test Equipment	Recommended Model
Calibrator ^[1]	Fluke 5720A
2 A, 20 A, and 100 A Shunts	Fluke A40B
DMM with rear input option	Fluke 8508A
Electrical Power Standard	Fluke 6105A or 6100B
[1] Not necessary for closed loop mode verification and calibration.	

Initial Setup and Input Zero Adjustments

To setup for verification or calibration, connect the test equipment to the Product as shown in Figure 5-1.

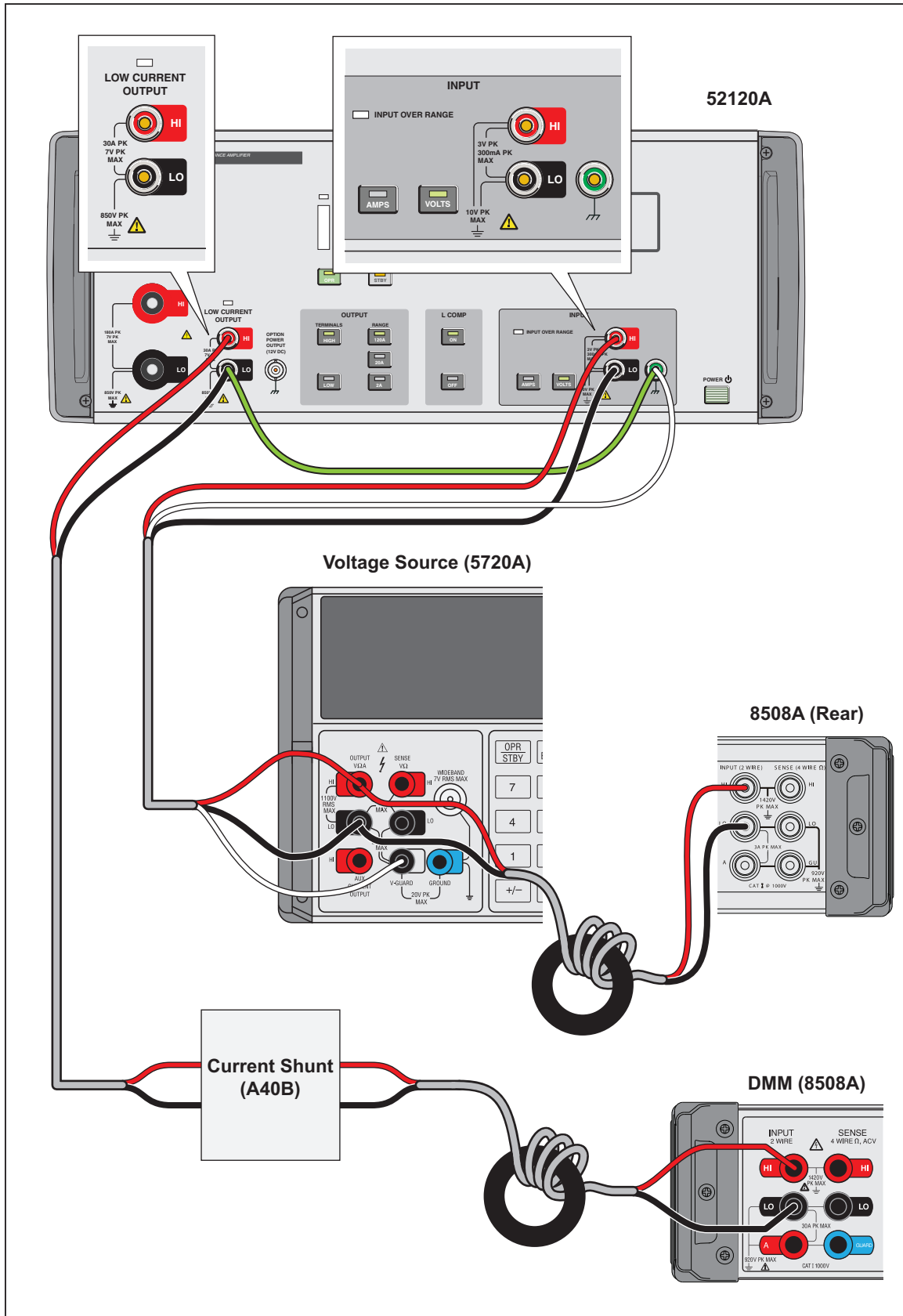





Figure 5-1. Test Equipment Connections

gpp013.eps

Note

All test equipment must be energized a sufficient time so they operate at their full specification. Refer to the applicable user documentation.

1. Set the calibrator to 0 volts dc in standby mode.
2. Open the guard to ground link on the calibrator.
3. Push  on the Product to set the input to volts.
4. Push  on the Product to set the output terminals.
5. Push  on the Product to set the range to 2 A.
6. Set the DMM to the 2 volt range.
7. Configure the DMM to 2wV, Resolution to 6 digits, Filter off, and Fast off.
8. Set DMM guard to local.
9. Set the DMM to front input.
10. Do a Zero Range on the DMM. This does a zero adjustment of the DCV, 2 V range.

Calibration Verification – Standalone Mode

Verification is done with LCOMP OFF. The Fluke 5720A supplies the input to the Product. The Product output current is changed to a voltage by the A40B shunt. The 8508A shows the shunt output voltage which is changed to output current with the 8508A Math function.

Conversion of A40B/8508A measurements to current

In the procedure below, the Fluke A40B shunts make a voltage from the current that flows through them. Use the formula that follows to calculate the equivalent current value.

$$\text{Equivalent current value} = \frac{\text{8508A measurement (V)}}{\text{Calibrated shunt value } (\Omega)}$$

For example, to calculate the equivalent current value for a DMM measurement of 0.47995 volts across a shunt with a calibration resistance of 0.040005 Ω :

$$\text{Equivalent current value} = \frac{0.479950}{0.040005} = 11.99725 \text{ A}$$

Product Input Protection: Measures to Keep Nuisance Input Overload Trips to a Minimum

Because of the relatively high power of the Product, the input has protection against over-voltage and over-current inputs. An input larger than the input limit level for more than three milliseconds causes the Product to go to Standby. This verification procedure uses a Fluke 5720A as the input signal source.

For some conditions, changes to the 5720A can cause the output to briefly go above the maximum input level for the set range. If this occurs, you can use two procedures to keep input overloads to a minimum. When the input is a voltage, set the Product to standby (STBY - output OFF) before you change the input signal. When the input signal is a current, turn off the 5720A output before you change function or level.

A40B Shunt Resistance Correction

Table 5-2 is a list of the nominal resistance values of the A40B shunts.

Table 5-2. Nominal Resistance for A40B Shunts

Shunt	Nominal Resistance
2 A	0.4 Ω
20 A	0.04 Ω
100 A	0.008 Ω

The shunts can have a maximum of 300 ppm resistance error, which shows on the calibration certificate. To get the necessary accuracies, you must correct for this error. If the certificate shows the deviation from nominal value, this value is the shunt error. The Correction necessary is $1 - \text{error}$.

For example, if the deviation from nominal (error) is +100 ppm, the correction is given by:

$$\text{Correction} = 1 - \text{deviation} = 1 - \frac{100}{10^6} = 1 - 0.0001 = 0.999900$$

If the certificate gives the actual measured value, then divide the nominal value by the measured value to get the correction.

For example, a 20A shunt has a nominal value of 0.04 Ω. If the measured value is 0.0400040 Ω, the correction is given by:

$$\text{Correction} = \frac{0.04}{0.040004} = 0.999900$$

System Characterization for AC Measurements

To keep measurement uncertainty of ac measurements to a minimum, you must characterize the 8508A against the 5720A at each A40B output voltage and frequency. You must use the 8508A Rear Input option so you do not have to change connections in the procedure. This procedure limits measurement uncertainty of the reference system to the linearity and short-term stability of the 5720A and 8508A. The uncertainty is summed together by root-sum-of-squares (RSS) with the ac accuracy of the A40B shunt. It is not necessary to calculate values manually because the 8508A Math Functions are used in the procedure below.

This verification measurement gives the transconductance of the Product. Amplitude errors in the voltage applied to the input of the Product (measured by the 8508A) also show as amplitude errors at the output. They are in proportion to the input errors. As this error is seen in the 5720A and the Product outputs, the amplitude error (ppm output) part of the 5720A specification can be ignored. The remaining measurement errors are the linearity error of the 5720A and the A40B accuracy.

For this document, the linearity of the 5720A is shown by the “+μV” specification value. This is actually pessimistic because other accuracy contributions are included in this part of the 5720A specification. The uncertainties shown in the measurements table also include a typical measurement noise contribution of 10 ppm for dc and 20 ppm for ac measurements and where the input to the A40B shunt is not full scale, the A40B power coefficient correction.

How to Use 8508A Math Functions to Simplify Error Corrections

In the procedure below, the 8508A '*m', '-c', '÷z' and '%' Math functions are used to give the measurement result as a percentage error that can be directly compared to the product specification. Refer to the *8508A Users Manual* for description of the math functions and their operation. The math is:

$$\left(\frac{(\text{Correction} \times \text{measured value} [*m] - \text{reference value} [-c])}{\text{Reference value} [\div z]} \right) \times 100$$

For each A40B shunt, calculate and type in the correction into the *m store. The reference value comes through the 8508A rear input from the 5720A. Disable all Math operations before the measurement sequence starts. With the characterized voltage applied at the rear input of the 8508A, use the Last Reading and Enter keys to store the current measurement into -c and '÷z' stores. Set the 8508A input to the front terminals. Turn on '*m', '-c', '÷z' and '%'.

For example, a correction value of 0.999900 is stored in 'm'. The reference value from the 8508A rear input is stored in 'c'. 'z' is set to 0.800008 V. The measured value from the front input is 0.799881 V. The percentage of error is calculated as:

$$\left(\frac{(0.999900 \times 0.799881 - 0.800008)}{0.800008} \right) \times 100 = -0.0259 \%$$



The system characterization procedure is not necessary for dc measurements. You make dc measurements with the 5720A output connected to the Product input and then measure through the A40B with the 8508A. The '-c' and '÷z' stores are preloaded with the expected voltage output from the shunt. For all of the shunts, the output is 0.8 when the input is full range. The correct values are shown in the verification results table. The '*m' store has the correction factor for the shunt used for the measurement. The accuracies of the 5720A, A40B shunt, and 8508A are summed with the noise and shunt power coefficient by root-sum-of-squares (RSS) to get the measurement uncertainty.

Equipment Setup

Setup the equipment as shown in Figure 5-1. Use the 2A A40B shunt for the shunt in the figure. Push  on the Product. Set the DMM (8508A) to the 2 volt range. Set the DMM to Input front. When the 5720A outputs dc, the DMM must be set for dc volts. When the 5720A outputs ac, the DMM must be set for ac volts. Configure the DMM for a rolling average of four measurements (MATH CONFIG, R, select 4, MATH AvR).

To maximize Product and shunt warm-up time, set the Product in operate (OPR) mode for the 8508A rear input measurements.

2 Amp Range Verification

1. Set the 5720A output to +1 Vdc and push  on the 5720A.
2. Push  on the Product.
3. Push  on the Product.
4. Set the DMM 'm' store to the 2 A shunt correction factor.
5. Set the DMM '-c' and '÷z' stores to 0.4.
6. Turn on the '*m', '-c' and '÷z', and % math functions on the DMM.
7. Let the measurement become stable for a minimum of one minute and then record the measured error in Table 5-3.
8. Set the 5720A output -1 V dc.
9. Set the DMM '-c' and '÷z' stores to 0.4. Record the measure error.

10. Set the DMM ‘-c’ and ‘÷z’ stores to 0.8.
11. Turn on the ‘*m’, ‘-c’ and ‘÷z’, and % math functions on the DMM.
12. Set the 5720A output to the values in Table 5-3 for the +2 and -2 volt verification points.
13. Set the DMM ‘-c’ and ‘÷z’ stores to -0.8 for the -2 volt measurement. Let each measurement become stable for a minimum of one minute and then record the measured error.
14. Set the 5720A output to the values in Table 5-3 for all the ac voltage verification points and record the measured error. Use the transfer method for all ac measurements.

For each ac measurement in Table 5-3:

- Set the 5720A output voltage and frequency to the reference level shown in Table 5-3.
- Let the measurement become stable for a minimum of one minute and then record the measured error in Table 5-3.
- Push  on the Product.

Note

For currents larger than 50 % of Product range, let the shunt become stable for a minimum of five minutes.

- Set the DMM to rear input.
- Turn off the ‘*m’, ‘-c’ and ‘÷z’, and % math functions on the DMM.
- Let the measurement become stable for a minimum of one minute. Longer when the 10 Hz and 40 Hz filter is on.
- Use Last Reading and Enter to store the last measurement in the ‘÷z’ and ‘-c’ stores of the DMM.
- Turn on the ‘-c’ and ‘÷z’ math functions on the DMM.

Note

The DMM measurement must be 0.000000 V plus a few digits of noise.

- Turn on the ‘*m’ and ‘%’ math functions to apply the correction factor and show the measurement in percent.
- Set the 5720A to the values in the row below the reference level row.
- Set the DMM to front input.
- Let the measurement become stable and then write in the measured error in Table 5-3.



Table 5-3. 2 Amp Range Verification

5720A Output	8508A ACV filter	8508A Input	A40B	Measured Error (%)	Product Specification (99 %)	Measurement uncertainty (99 %)	TUR
1 V dc	-	Front	2 A		±0.0200 %	±0.0036 %	5.6:1
-1 V dc	-	Front	2 A		±0.0200 %	±0.0036 %	5.6:1
2 V dc	-	Front	2 A		±0.0150 %	±0.0030 %	5.0:1

Table 5-3. 2 Amp Range Verification (cont.)

5720A Output	8508A ACV filter	8508A Input	A40B	Measured Error (%)	Product Specification (99 %)	Measurement uncertainty (99 %)	TUR
-2 Vdc	-	Front	2 A		±0.0150 %	±0.0030 %	5.0:1
0.56 V, 10 Hz	10	Rear	2 A	-	Reference level		
1.4 V, 10 Hz	10	Front	2 A		±0.1150 %	±0.0051 %	23:1
0.8 V, 57 Hz	40	Rear	2 A	-	Reference level		
2 V, 57 Hz	40	Front	2 A		±0.0850 %	±0.0037 %	23:1
0.8 V, 300 Hz	100	Rear	2 A	-	Reference level		
2 V, 300 Hz	100	Front	2 A		±0.1000 %	±0.0037 %	>25:1
0.8 V, 1 kHz	100	Rear	2 A	-	Reference level		
2 V, 1 kHz	100	Front	2 A		±0.1700 %	±0.0037 %	>25:1
0.8 V, 3 kHz	100	Rear	2 A	-	Reference level		
2 V, 3 kHz	100	Front	2 A		±0.9000 %	±0.0040 %	>25:1
0.8 V, 6 kHz	100	Rear	2 A	-	Reference level		
2 V, 6 kHz	100	Front	2 A		±0.2600 %	±0.0040 %	>25:1
0.8 V, 10 kHz	100	Rear	2 A	-	Reference level		
2 V, 10 kHz	100	Front	2 A		±6.0000 %	±0.0040 %	>25:1

20 Amp Range Verification

1. Push  on the Product and the 5720A.
2. Connect the 20 A shunt between the output of the Product and the DMM front input.
3. Set the DMM to front input.
4. Push  on the Product.
5. Set the 5720A output to +1 V dc.
6. Push  on the 5720A and the Product.
7. Let the measurement become stable for a minimum of one minute and then record the measured error in Table 5-3.
8. Set the DMM 'm' store to the 20 A shunt correction factor.
9. Set the DMM '-c' and '÷z' stores to 0.4.
10. Turn on the '*m', '-c' and '÷z', and % math functions on the DMM.
11. Set the DMM to front input.
12. Set the DMM '-c' and '÷z' stores to 0.4.
13. Set the 5720A output to -1 V dc.
14. Set the DMM '-c' and '÷z' stores to 0.8.
15. Turn on the '*m', '-c' and '÷z', and % math functions on the DMM.
16. Set the 5720A output to the values in Table 5-4 for the +2 V dc and -2 V dc

verification points.

17. Set the DMM ‘-c’ and ‘÷z’ stores to -0.8 for the -2 volt measurement.
18. Record the measured errors.
19. Set the 5720A output to the values in Table 5-4 for all the ac voltage verification points and record the measured error. Use the transfer method for all ac measurements.

For each ac measurement in Table 5-4:

- Set the 5720A output voltage and frequency to the reference level shown in Table 5-4.
- Push  on the Product.

Note

For currents larger than 50 % of Product range, let the shunt become stable for a minimum of five minutes.

- Set the DMM to rear input.
- Turn off the ‘*m’, ‘-c’ and ‘÷z’, and % math functions on the DMM.
- Let the measurement become stable for a minimum of one minute. Longer when the 10 Hz and 40 Hz filter is on.
- Use Last Reading and Enter to store the last measurement in the ‘÷z’ and ‘-c’ stores of the DMM.
- Turn on the ‘-c’ and ‘÷z’ math functions on the DMM.

Note

The DMM measurement must be 0.000000 V plus a few digits of noise.

- Turn on the ‘*m’ and ‘%’ math functions to apply the correction factor and show the measurement in percent.
- Set the 5720A to the values in the row below the reference level row.
- Set the DMM to front input.
- Let the measurement become stable and then write in the measured error in Table 5-4.



Table 5-4. 20 Amp Range Verification Points

5720A Output	8508A ACV filter	8508A Input	A40B	Measured Error (%)	Product Specification (99 %)	Measurement uncertainty (99 %)	TUR
1 V dc	-	Front	20 A		±0.0200 %	±0.0069 %	2.9:1
-1 V dc	-	Front	20 A		±0.0200 %	±0.0069 %	2.9:1
2 V dc	-	Front	20 A		±0.0150 %	±0.0036 %	4.1:1
-2 V dc	-	Front	20 A		±0.0150 %	±0.0036 %	4.1:1
0.56 V, 10 Hz	10	Rear	20 A	-	Reference level		
1.4 V, 10 Hz	10	Front	20 A		±0.1007 %	±0.0076 %	13:1
0.8 V, 57 Hz	40	Rear	20 A	-	Reference level		
2 V, 57 Hz	40	Front	20 A		±0.0750 %	±0.0057 %	13:1

Table 5-4. 20 Amp Range Verification Points (cont.)

5720A Output	8508A ACV filter	8508A Input	A40B	Measured Error (%)	Product Specification (99 %)	Measurement uncertainty (99 %)	TUR
0.8 V, 300 Hz	100	Rear	20 A	-	Reference level		
2 V, 300 Hz	100	Front	20 A		±0.0900 %	±0.0057 %	16:1
0.8 V, 1 kHz	100	Rear	20 A	-	Reference level		
2 V, 1 kHz	100	Front	20 A		±0.1600 %	±0.0057 %	>25:1
0.8 V, 3 kHz	100	Rear	20 A	-	Reference level		
2 V, 3 kHz	100	Front	20 A		±0.5000 %	±0.0068 %	>25:1
0.8 V, 6 kHz	100	Rear	20 A	-	Reference level		
2 V, 6 kHz	100	Front	20 A		±1.4000 %	±0.0068 %	>25:1
0.8 V, 10 kHz	100	Rear	20 A	-	Reference level		
2 V, 10 kHz	100	Front	20 A		±3.6000 %	±0.0068 %	>25:1

120 Amp Range Verification

1. Push  on the Product and 5720A.
2. Connect the 100 A shunt between the output of the Product and the DMM front input.
3. Push  on the Product.
4. Set the 5720A output to +0.6 V dc.
5. Set the DMM to front input.
6. Set the 5720A output to +0.6 V dc.
7. Set the DMM ‘m’ store to the 100 A shunt correction factor.
8. Set the DMM ‘-c’ and ‘÷z’ stores to 0.6.
9. Turn on the ‘*m’, ‘-c’ and ‘÷z’, and % math functions on the DMM.
10. Let the measurement become stable for a minimum of one minute and then record the measured error in Table 5-5.
11. Set the DMM ‘-c’ and ‘÷z’ stores to -0.6.
12. Set the 5720A output to -0.6 V dc and record the measured error.
13. Set the DMM ‘-c’ and ‘÷z’ stores to 0.8.
14. Turn on the ‘*m’, ‘-c’ and ‘÷z’, and % math functions on the DMM.
15. Set the 5720A output to the values in Table 5-5 for the +1 V dc and -1 V dc verification points.
16. Set the DMM ‘-c’ and ‘÷z’ stores to -0.8 for the -1 volt measurement.
17. Record the measured errors.
18. Set the 5720A output to the values in Table 5-5 for all the ac voltage verification points and record the measured error. Use the transfer method for all ac measurements.

For each ac measurement in Table 5-5:

- Set the 5720A output voltage and frequency to the reference level shown in Table 5-5.
- Push  on the Product.

Note

For currents larger than 50 % of Product range, let the shunt become stable for a minimum of five minutes.

- Set the DMM to rear input.
- Turn off the ‘*m’, ‘-c’ and ‘÷z’, and % math functions on the DMM.
- Let the measurement become stable for a minimum of one minute. Longer when the 10 Hz and 40 Hz filter is on.
- Use Last Reading and Enter to store the last measurement in the ‘÷z’ and ‘-c’ stores of the DMM.
- Turn on the ‘-c’ and ‘÷z’ math functions on the DMM.

Note

The DMM measurement must be 0.000000 V plus a few digits of noise.

- Turn on the ‘*m’ and ‘%’ math functions to apply the correction factor and show the measurement in percent.
- Set the 5720A to the values in the row below the reference level row.
- Set the DMM to front input.
- Let the measurement become stable and then write in the measured error in Table 5-5.





Table 5-5. 120 Amp Range Verification Points

5720A Output	8508A ACV filter	8508A Input	A40B	Measured Error (%)	Product Specification (99 %)	Measurement uncertainty (99 %)	TUR
0.6 V dc	-	Front	100 A		±0.0200 %	±0.0082 %	2.4:1
-0.6 V dc	-	Front	100 A		±0.0200 %	±0.0082 %	2.4:1
1 V dc	-	Front	100 A		±0.0160 %	±0.0047 %	3.4:1
-1 V dc	-	Front	100 A		±0.0160 %	±0.0047 %	3.4:1
0.56 V, 10 Hz	10	Rear	100 A	-	Reference level		
0.7 V, 10 Hz	10	Front	100 A		±0.0493 %	±0.120 %	4.1:1
0.8 V, 57 Hz	40	Rear	100 A	-	Reference level		
1 V, 57 Hz	40	Front	100 A		±0.0390 %	±0.0085 %	4.6:1
0.8 V, 300 Hz	100	Rear	100 A	-	Reference level		
1 V, 300 Hz	100	Front	100 A		±0.0660 %	±0.0085 %	7.8:1
0.8 V, 1 kHz	100	Rear	100 A	-	Reference level		
1 V, 1 kHz	100	Front	100 A		±0.2200 %	±0.0085 %	>25:1

Table 5-5. 120 Amp Range Verification Points (cont.)

5720A Output	8508A ACV filter	8508A Input	A40B	Measured Error (%)	Product Specification (99 %)	Measurement uncertainty (99 %)	TUR
0.8 V, 3 kHz	100	Rear	100 A	-	Reference level		
1 V, 3 kHz	100	Front	100 A		±0.6000 %	±0.0117 %	>25:1
0.8 V, 6 kHz	100	Rear	100 A	-	Reference level		
1 V, 6 kHz	100	Front	100 A		±1.5400 %	±0.0117 %	>25:1
0.8 V, 10 kHz	100	Rear	100 A	-	Reference level		
1 V, 10 kHz	100	Front	100 A		±4.9000 %	±0.0117 %	>25:1

Current Input Burden Resistor Verification

1. Push  on the Product and 5720A.
2. Push  on the Product.
3. Push  on the Product.
4. Set the output of the 5720A to +200 mA.
5. Push  on the 5720A.

Note

The rear input connection to the DMM is not necessary for this verification.

6. Set the DMM ‘m’ store to the 2 A shunt correction factor.
7. Set the DMM ‘-c’ and ‘÷z’ stores to 0.8.
8. Turn on the ‘*m’, ‘-c’ and ‘÷z’, and % math functions on the DMM.
9. Set the 5720A output to the values in Table 5-6 and record the measured error.

Table 5-6. Burden Resistor Verification Points

5720A Output	8508A ACV filter	8508A Input	A40B	Measured Error (%)	Product Specification (99 %)	Measurement uncertainty (99 %)	TUR
200 mA dc	-	Front	2 A		±0.0150 %	±0.0058 %	2.6:1
-200 mA dc	-	Front	2 A		±0.0150 %	±0.0058 %	2.6:1

Amplitude Specification Limits, Pass/Fail Analysis

Where the Test Uncertainty Ratio (TUR) of the measurements in Tables 5-3 through 5-6 is more than 4:1, the test results show a pass if they are not more than the product specification limits. The product specification and the measurement uncertainty are expressed with 99 % confidence level. This implies a normal distribution. If a more rigorous analysis is necessary, use a statistical calculation of pass or fail.

In the formula that follows, let y be the measured value, L the specification limit, and U the measurement uncertainty.

The specification is met when $y < \sqrt{L^2 - U^2}$

The specification is exceeded when $y > \sqrt{L^2 - U^2}$

Calibration Adjustment – Standalone Mode

You can do calibration adjustment in standalone mode only through the remote interface. See Chapter 3 for command instructions. It is recommended that you do the verification procedure above to find out if adjustments are necessary. Do a full verification after adjustments are made.

Equipment Set Up

To set up the test equipment for calibration adjustments:

1. Open the link between V-GUARD and Ground terminals on the 5720A.
2. Set Remote Guard on the 5720A.
3. Connect the equipment as shown in Figure 5-2.

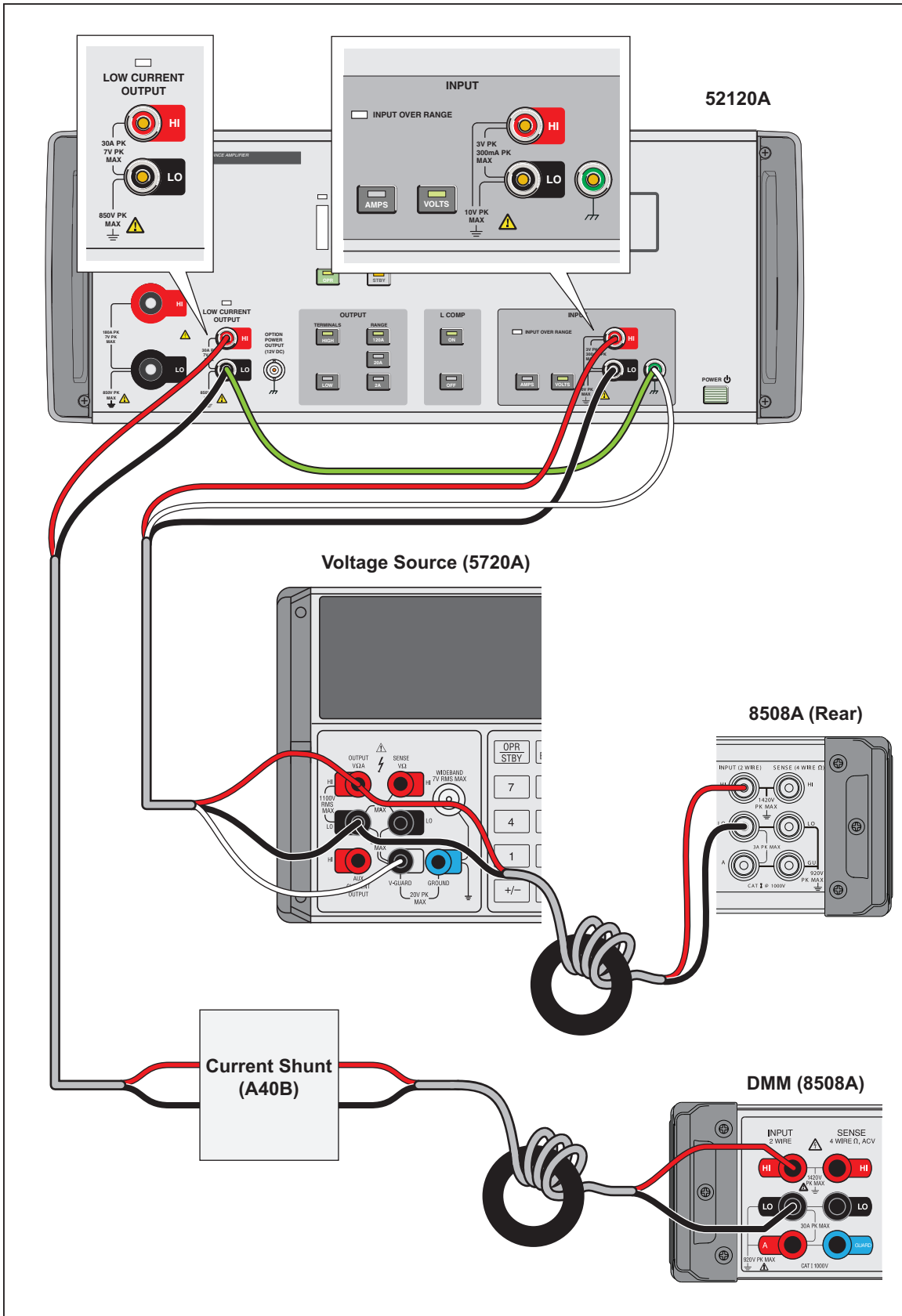

Figure 5-2. Calibration Adjustment Setup

gpp013.eps

Note

Start the connections with the 2 A current shunt.

4. On the rear panel of the Product, set the Calibration switch to **Enable**. See Figure 5-3.

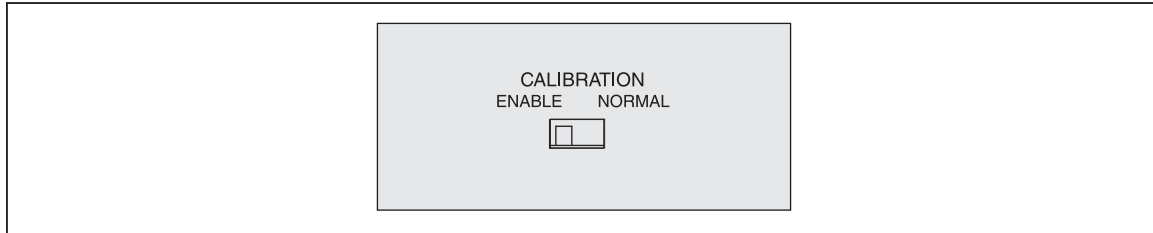

Figure 5-3. Calibration Enable Switch

gpp016.eps

How to Correct for Shunt Resistance Error

See the How to Use 8508A Math Functions to Simplify Error Corrections section above. Use the 8508A math function variable 'm'.

Adjustment Process

To start the adjustment procedure, you command the Product with a SCPI command through the GPIB interface.

Send `:CAL:SEC:PASS "ADJUST"` to the Product through the GPIB interface.

Note

The password is used so you do not accidentally overwrite a calibration constant. The password is case sensitive.

You can control the Product through the GPIB interface with remote commands, or push **LOCAL** on the front panel and use the front-panel keys.

You can learn more about the SCPI commands in Chapter 3.

In the procedure that follows, there are instructions for front-panel control on the Product. The remote commands are contained in Chapter 3.

Adjustments Notes

Two parameters are necessary for each adjustment : measured value and target value.

- Target value (T) is the usual value of the adjustment point in amps.
- Measured value (M) is the value measured with the 8508A and A40B shunt when the output is set to be the target value converted to amps.
- For dc, the measured value is the average of the positive and negative measurements.

The Product output current is measured as a voltage. The voltage must be changed to a current to use in the remote adjustment command. The 8508A 'z' store will hold the corrected shunt resistance value and divide the reported voltage by 'z'. The measured value in Amps is used in the adjustment command string. For example if the Target is 20 A and the measured value is 19.80000 A the adjustment command is:

```
CAL:ADJ? GAIN,20.0000,19.8000.
```

Adjustments

The adjustment steps that follow use the same sequence of steps for each range:

- Connect the shunt applicable for the Product range as shown in Figure 5-2.
- Set the Fluke 8508A to the 1 Volt dc range

- Do a Product dc zero adjustment
 - Do a Product voltage input dc gain adjustment (also sets the low frequency calibration constant).
 - Do a Product current input dc gain adjustment.
 - Do a Product ac Flatness adjustment at 6 kHz.
1. Connect the GPIB interface to an instrument controller.
 2. To setup the Product for adjustments, send the command: :CAL:SEC:PASS "ADJUST"
 3. Set the Product to standby with the command: :OUTP OFF





Note

You can also push  to set the Product in the standby mode. You must push  before all other front-panel operations.







4. Push  on the 5720A.
5. Connect the 2 A shunt between the Product output and the input of the DMM. See Figure 5-2.
6. Set the DMM to the DCV function on the 1V range.
7. Set the DMM to Resolution 6.
8. After the DMM measurement settles, push the Offset key.

Note

If the DMM does not show a measurement between 0.000008 V and -0.000008 V, verify the test equipment controls and connections. Then do the offset procedure again.





9. Set the DMM 'z' store to the 2 A shunt resistance value.
10. Turn on the '÷z' store on the DMM.
11. Write in the DMM measurement in the measured Current column in the Output Off and 2 A shunt row of Table 5-7.
12. Set the 5720A output to 0 V dc.
13. Push  on the on the 5720A.
14. Push  on the Product.
15. Push  on the Product.
16. After the measurement is stable, write the value shown on the DMM in the Measured Current column of Table 5-7.
17. Send the command: :CAL:ADJ? OFFS,0.00000,<measured value>
18. Set the 5720A output to the values in Table 5-7 for the 2 A shunt and 2 V dc and -2 V dc adjustment points. Write the values shown on the DMM in the Measured Current column of Table 5-7. Calculate the average amplitude of the absolute positive and negative values as given above.
19. Send the command: :CAL:ADJ? GAIN,2.00000,<calculated value>
20. Push  on the 5720A.
21. Push  on the Product.
22. Set the 5720A output to the values in Table 5-7 for the 2 A shunt and 200 mA dc

and -200 mA dc adjustment points.









23. Push  on the 5720A.
24. Push  on the Product.
25. Write the values shown on the DMM in the Measured Current column of Table 5-7. Calculate the average amplitude of the absolute positive and negative values as given above.
26. Send the command: :CAL:ADJ? GAIN, 2.00000, <calculated value>
27. Push  on the 5720A.
28. Push  on the Product.
29. Set the DMM to the ACV function and the 2V range.
30. Set the 5720A voltage output and frequency to the values in Table 5-7 for the 2 A shunt and 2 V at 6 kHz adjustment point.
31. Push  on the 5720A.
32. Push  on the Product.
33. Write the value shown in the DMM in the Measured Current column of Table 5-7.
34. Send the command: :CAL:ADJ? FLAT, 2.00000, <measured value>
35. Push  on the Product and the 5720A.
36. Connect the 20 A shunt between the Product output and the input of the DMM. See Figure 5-2.
37. Set the DMM to the DCV function on the 1V range.
38. Set the DMM to Resolution 6.
39. Turn off all DMM Math functions.
40. After the DMM measurement settles, push the Offset key.

Note

The DMM must show a measurement between 0.000008 V and -0.000008 V.





41. Write in the DMM measurement in the measured error column in the Output Off and 20A shunt row of Table 5-7.
42. Set the DMM 'z' store to the 20 A shunt resistance value.
43. Turn on the '÷z' store on the DMM.
44. Set the 5720A output to the value in Table 5-7 for the 20 A shunt and 0 V dc adjustment point.
45. Push  on the 5720A.
46. Push  on the Product.
47. Push  on the Product.
48. Push  on the Product.
49. Write the value shown on the DMM in the Measured Current column of Table 5-7.
50. Send the command: :CAL:ADJ? OFFS, 0.00000, <measured value>
51. Set the 5720A output to the values in Table 5-7 for the 20 A shunt and 2 V dc and -2 V dc adjustment points. Write the values shown on the DMM in the Measured Error column of Table 5-7. Calculate the average amplitude of the absolute positive

and negative values as given above.

52. Send the command: :CAL:ADJ? GAIN, 20.0000, <calculated value>
53. Push  on the 5720A.
54. Push  on the Product.
55. Set the 5720A output to the values in Table 5-7 for the 20 A shunt and 200 mA dc and -200 mA dc adjustment points.
56. Push  on the 5720A.
57. Push  on the Product.
58. Write the values shown on the DMM in the Measured Current column of Table 5-7. Calculate the average amplitude of the absolute positive and negative values as given above.
59. Send the command: :CAL:ADJ? GAIN, 20.0000, <calculated value>
60. Push  on the 5720A
61. Push  on the Product.
62. Set the DMM to the ACV function and the 2V range.
63. Set the 5720A voltage output and frequency to the values in Table 5-7 for the 20 A shunt and 2 V at 6 kHz adjustment point.
64. Push  on the 5720A.
65. Push  on the Product.
66. Write the value shown in the DMM in the Measured Current column of Table 5-7.
67. Send the command: :CAL:ADJ? FLAT, 20.0000, <measured value>
68. Push  on the Product and the 5720A.
69. Set the HIGH terminals on the Product.
70. Connect the 100 A shunt between the Product output and the input of the DMM. See Figure 5-2.
71. Set the DMM to the DCV function on the 1V range.
72. Set the DMM to Resolution 6.
73. Turn off all DMM Math functions.
74. After the DMM measurement settles, push the Offset key.

Note

The DMM must show a measurement between 0.000008 V and -0.000008 V.

75. Write in the DMM measurement in the measured error column in the Output Off and 100 A shunt row of Table 5-7.
76. Set the 5720A output to the values in Table 5-7 for the 100 A shunt and 0 V dc adjustment points.
77. Push  on the 5720A.
78. Push  on the Product.
79. Push  on the Product.
80. Push  on the Product.









81. Set the DMM 'z' store to the 100 A shunt resistance value.
82. Turn on the 'z' store on the DMM.
83. Write the value shown on the DMM in the Measured Current column of Table 5-7.
84. Send the command: :CAL:ADJ? OFFS,0.0000,<measured value>
85. Set the 5720A output to the values in Table 5-7 for the 100 A shunt and 1.0 V dc and -1.0 V dc adjustment points. Write the values shown on the DMM in the Measured Current column of Table 5-7. Calculate the average amplitude of the absolute positive and negative values as given above.
86. Send the command: :CAL:ADJ? GAIN,100.0000,<calculated value>
87. Push  on the 5720A.
88. Push  on the Product.
89. Set the 5720A output to the values in Table 5-7 for the 100 A shunt and 100 mA dc and -100 mA dc adjustment points.
90. Push  on the 5720A.
91. Push  on the Product.
92. Write the values shown on the DMM in the Measured Current column of Table 5-7. Calculate the average amplitude of the absolute positive and negative values as given above.
93. Send the command: :CAL:ADJ? GAIN,100.0000,<calculated value >
94. Push  on the 5720A.
95. Push  on the Product.
96. Set the DMM to the ACV function and the 2V range.
97. Set the 5720A voltage output and frequency to the values in Table 5-7 for the 100 A shunt and 1 V at 6 kHz adjustment point.
98. Push  on the 5720A.
99. Push  on the Product.
100. Write the value shown in the DMM in the Measured Current column of Table 5-7.
101. Send the command: :CAL:ADJ? FLAT,100.0000,<measured value>
102. Push  on the Product and the 5720A.

Table 5-7. Product Adjustment Points

Product Range	A40B Shunt	5720A Output	Measured Current (A)	Calculated Current (A)	Target Value
Output Off	2A	Off		–	–
2 A (Offset)	2A	0 V dc		–	0 A
M+	2A	2 V dc		–	–
M-	2A	-2 V dc		–	–
2 A (Gain)	$M = (M^+ - M^-)/2$		–		2 A
M+	2A	200 mA dc		–	–
M-	2A	-200 mA dc		–	–

Table 5-7. Product Adjustment Points (cont.)

Product Range	A40B Shunt	5720A Output	Measured Current (A)	Calculated Current (A)	Target Value
2 A (Gain)	$M = (M^+ - M^-)/2$		–		2 A
2 A (Flat)	2A	2 V, 6 kHz			2 A
Output Off	20A	Off		–	–
20 A (Offset)	20A	0 V dc		–	0 A
M+	20A	2 V dc		–	–
M-	20A	-2 V dc		–	–
20 A (Gain)	$M = (M^+ - M^-)/2$		–		20 A
M+	20A	200 mA dc		–	–
M-	20A	-200 mA dc		–	–
2 A (Gain)	$M = (M^+ - M^-)/2$		–		20 A
20 A (Flat)	20A	2 V, 6 kHz			20 A
Output Off	100A	Off		–	–
120 A (Offset)	100A	0 V dc		–	0 A
M+	100A	1.0 V dc		–	–
M-	100A	-1.0 V dc		–	–
120 A (Gain)	$M = (M^+ - M^-)/2$		–		100 A
M+	100A	100 mA dc		–	–
M-	100A	-100 mA dc		–	–
120 A (Gain)	$M = (M^+ - M^-)/2$		–		100 A
120 A (Flat)	100A	1.0 V, 6 kHz			100 A

103. Send the command: :CAL:SAVE? to transfer the correction data to non-volatile storage.

104. Send the command: :CAL:SEC:EXIT to exit the calibration adjustment mode.

Calibration Verification – Closed-Loop with 6100A or 6105A

This section contains instructions to do a verification of the Product in a closed-loop configuration is with a voltage standard. The closed-loop specifications for the Product are shown in Chapter 1. These specifications include the 1-year specifications for the Fluke 6105A Electrical Power Standard.

Test Equipment

Table 5-8 is a list of test equipment necessary to do a verification of the Product in closed-loop setup with a 6100B or 6105A Electrical Power Standard.

Table 5-8. Test Equipment for Closed-Loop Verification

Test Equipment	Recommended Model
Electrical Power Standard	Fluke 6105A
Power Meter ^[1]	As preferred
For frequencies above 850 Hz.	
2 A, 20 A, 100 A Shunts	Fluke A40B
DMM	Fluke 8508A
Phase Meter	Clarke-Hess 6000
[1] Power meter must have an accuracy $\leq 0.01\%$, separate inputs for voltage greater than 1000 V and maximum current of 120 A, displays voltage, current, phase angle, power factor (PF) or VA and watts.	

The 6105A rear output must be adjusted so errors are no larger than specification for the confidence checks below to be accurate.

The Power Meter is used as a check reference standard for power line frequencies but has no better accuracy than the Product for phase angle accuracy and for some amplitude measurements.

The measurement schemes below cannot be used to verify Product compliance with specification. If the measured result is significantly larger than the specification of the power meter, it is likely the Product is out of specification. The Product accuracy confidence test below can be done to verify accuracy.

Power Line Frequency Confidence Check

The power line frequency confidence check is one measurement on each Product range. If the power meter does not show phase angle directly, you can calculate the angle on VA, Watt and PF values. See the Phase Angle Accuracy Confidence Check section in this chapter. Make sure the voltage connection scheme to the power meter and the 6105A are the same (two wire or four wire connection). To do a power line frequency confidence check:

1. Set the 6105A voltage output to 120 V on the 180V range.
2. For each current range, set the 6105A range, rms, and phase angle in Table 5-9.

Table 5-9. Power Line Frequency Confidence Check Points

6105A			Measured Accuracy			
Range	RMS	Phase Angle (∅)	V	I	I + Limit	I - Limit
1 x Ext 2A	2 A	60°			2.000280	1.99720
1 x Ext 20A	20 A	60°			20.00280	19.99720
1 x Ext 120A	120 A	60°			120.0168	119.9832

Phase Angle Accuracy Confidence Check

To do a phase angle accuracy confidence check, set the range, rms, and phase angle of the 6105A to the values in Table 5-10.

Table 5-10. Phase Angle Accuracy Confidence Check Points

6105A			Measured Accuracy			
Range	RMS	Phase Angle (∅)	Phase Angle Error (∅)	PF	VA	Watts
1 x Ext 2A	2 A	60°				
1 x Ext 20A	20 A	60°				
1 x Ext 120A	120 A	60°				

To calculate phase angle from PF or VA and watts:

$$PF = \frac{Watts}{VA}$$

$$error(\emptyset) = \cos^{-1}(PF) - \theta$$

For example, if the power meter shows PF = 0.499894:

$$error(\emptyset) = \cos^{-1}(0.499894) - 60 = 0.007^\circ$$

Verify Amplitudes at DC and Higher Frequencies

Use the Fluke A40B and 8508A to verify amplitude accuracy.

2 Amp Range

1. Set the DMM to DCV function on the 2 V range.
2. Set the DMM ‘m’ store to the 2 A shunt correction factor.
3. Set the DMM ‘-c’ and ‘÷z’ stores to 0.4.
4. Turn on the ‘*m’, ‘-c’ and ‘÷z’, and % math functions on the DMM.
5. Set the 6105A range to 1 x Ext 2A.
6. Set the current and frequency of the 6105A to the values in Table 5-11 for the 1 A verification point.
7. Set the DMM ‘-c’ and ‘÷z’ stores to 0.8.
8. Set the DMM to ACV function.
9. Set the current and frequency of the 6105A to the values in Table 5-11 for the two 2 A verification point.

10. Set the DMM '-c' and '÷z' stores to 0.24.
11. Set the current and frequency of the 6105A to the values in Table 5-11 for the two 0.6 A verification points.
12. Set the DMM to the 200 mV range.
13. Set the DMM '-c' and '÷z' stores to 0.16.
14. Set the current and frequency of the 6105A to the values in Table 5-11 for the 0.4 A verification point.

Table 5-11. Amplitude Verification on 2 Amp Range

6105A		Measured Error (%)	Product Specification		Measurement Uncertainty	TUR	
RMS	Frequency		6105A (99 %)	6100B (99 %)		6105A	6100B
1 A	DC		±0.0350 %	±0.0720 %	±0.0029 %	12:1	25:1
2 A	57 Hz		±0.0170 %	±0.0210 %	±0.0125 %	1.1:1	1.7:1
2 A	850 Hz		±0.0170 %	±0.0210 %	±0.0106 %	1.3:1	1.9:1
0.6 A ^[1]	1083 Hz		±0.0687 %	±0.0687 %	±0.0175 %	3.9:1	3.9:1
0.6 A ^[2]	5643 Hz		±0.0687 %	±0.0687 %	±0.0175 %	3.9:1	3.9:1
0.4 A ^[3]	5643 Hz		±0.0770 %	±0.0770 %	±0.0154 %	5.0:1	5.0:1

[1] Fundamental 57 Hz, zero amplitude, 19th harmonic at 0.6 A
 [2] Fundamental 57 Hz, zero amplitude, 50th harmonic at 0.6 A
 [3] Fundamental 57 Hz, zero amplitude, 99th harmonic at 0.4 A

20 Amp Range

1. Set the DMM to the DCV function and the 2 V range.
2. Set the DMM 'm' store to the 20 A shunt correction factor.
3. Set the DMM '-c' and '÷z' stores to 0.4.
4. Turn on the '*m', '-c' and '÷z', and % math functions on the DMM.
5. Set the 6105A range to 1 x Ext 20A.
6. Set the current and frequency of the 6105A to the values in Table 5-12 for the 10 A verification point.
7. Set the DMM '-c' and '÷z' stores to 0.8.
8. Set the DMM to ACV function
9. Set the current and frequency of the 6105A to the values in Table 5-12 for the two 20 A verification points.
10. Set the DMM '-c' and '÷z' stores to 0.24.
11. Set the current and frequency of the 6105A to the values in Table 5-12 for the two 6 A verification points.
12. Set the DMM to the 200 mV range.
13. Set the DMM '-c' and '÷z' stores to 0.16.
14. Set the current and frequency of the 6105A to the values in Table 5-12 for the 4 A verification point.

Table 5-12. Amplitude Verification on 20 Amp Range

6105A		Measured Error (%)	Product Specification		Measurement Uncertainty	TUR	
RMS	Frequency		6105A (99 %)	6100B (99 %)		6105A	6100B
10 A	DC		±0.0350 %	±0.0720 %	±0.0035 %	10:1	21:1
20 A	57 Hz		±0.0140 %	±0.0210 %	±0.0126 %	1.1:1	1.7:1
20 A	850 Hz		±0.0140 %	±0.0210 %	±0.0107 %	1.3:1	2.0:1
6 A ^[1]	1083 Hz		±0.0687 %	±0.0687 %	±0.0188 %	3.7:1	3.7:1
6 A ^[2]	2850 Hz		±0.0687 %	±0.0687 %	±0.0215 %	3.2:1	3.2:1
4 A ^[3]	5643 Hz		±0.0770 %	±0.0770 %	±0.0179 %	4.3:1	4.3:1
<p>[1] Fundamental 57 Hz, zero amplitude, 19th harmonic at 6 A [2] Fundamental 57 Hz, zero amplitude, 50th harmonic at 6 A [3] Fundamental 57 Hz, zero amplitude, 99th harmonic at 4 A</p>							

120 Amp Range

1. Set the DMM to the DCV function and the 2 V range.
2. Set the DMM ‘m’ store to the 100 A shunt correction factor.
3. Set the DMM ‘-c’ and ‘÷z’ stores to 0.4.
4. Turn on the ‘*m’, ‘-c’ and ‘÷z’, and % math functions on the DMM.
5. Set the 6105A range to 1 x Ext 20A.
6. Set the current and frequency of the 6105A to the values in Table 5-13 for the 60 A verification point.
7. Set the DMM ‘-c’ and ‘÷z’ stores to 0.8.
8. Set the DMM to ACV function.
9. Set the current and frequency of the 6105A to the values in Table 5-13 for the two 100 A verification points.
10. Set the DMM ‘-c’ and ‘÷z’ stores to 0.288.
11. Set the current and frequency of the 6105A to the values in Table 5-13 for the two 36 A verification points.
12. Set the DMM to the 2 mV range.
13. Set the current and frequency of the 6105A to the values in Table 5-13 for the 24 A verification point.

Table 5-13. Amplitude Verification on 120 Amp Range

6105A		Measured Error (%)	Product Specification		Measurement Uncertainty	TUR	
RMS	Frequency		6105A (99 %)	6100B (99 %)		6105A	6100B
60 A	DC		±0.0300 %	±0.0720 %	±0.0046 %	6.5:1	16:1
100 A	57 Hz		±0.0146 %	±0.0216 %	±0.0131 %	1.1:1	1.6:1
100 A	850 Hz		±0.0146 %	±0.0216 %	±0.0112 %	1.3:1	1.9:1
36 A ^[1]	1083 Hz		±0.0687 %	±0.0687 %	±0.0185 %	4.3:1	4.3:1
36 A ^[2]	2850 Hz		±0.0687 %	±0.0687 %	±0.0214 %	3.8:1	3.8:1
24 A ^[3]	5643 Hz		±0.0770 %	±0.0770 %	±0.0193 %	4.0:1	4.0:1
<p>[1] Fundamental 57 Hz, zero amplitude, 19th harmonic at 36 A [2] Fundamental 57 Hz, zero amplitude, 50th harmonic at 36 A [3] Fundamental 57 Hz, zero amplitude, 99th harmonic at 24 A</p>							

Verify Phase Angles at Higher Frequencies

Make sure the voltage connection scheme to the phase meter and on the 6105A are the same (two wire or four wire connection).

Note

The specification of the Clarke-Hess 6000 has a specification that is wider than the specification for the Product below 180 Hz.

1. Set the 6105A voltage output to 23 V on the 23 V range.
2. Connect the 6105A output to the phase meter reference channel.
3. Connect the 2 A shunt between the 6105A and the second input to the phase meter.
4. Set the 6105A range to 1 x Ext 2A.
5. Set the current, frequency, and phase angle to the values in Table 5-14.

Table 5-14. Phase Angle Verification on 2 Amp Range

6105A			Measured Angle	Product Specification	Measurement Uncertainty	TUR
RMS	Frequency	Phase Angle				
2 A	200 Hz	0 °		0.025 °	0.020 °	1:3
2 A	850 Hz	0 °		0.045 °	0.020 °	2.3:1
2 A	850 Hz	-90 °		0.045 °	0.020 °	2.3:1
2 A	850 Hz	+90 °		0.045 °	0.020 °	2.3:1
0.6 A	2907 Hz ^[1]	0 °		0.325 °	0.030 °	10:1
0.4 A	5643 Hz ^[2]	0 °		0.645 °	0.040 °	16:1
<p>[1] Fundamental zero amplitude, 51st harmonic of 57 Hz at 0.6 A [2] Fundamental zero amplitude, 99th harmonic at 0.4 A</p>						

6. Connect the 20 A shunt between the 6105A and the second input to the phase meter.
7. Set the 6105A range to 1 x Ext 20A.

8. Set the current, frequency, and phase angle to the values in Table 5-15.

Table 5-15. Phase Angle Verification on 20 Amp Range

6105A			Measured Angle	Product Specification	Measurement Uncertainty	TUR
RMS	Frequency	Phase Angle				
20 A	200 Hz	0 °		0.025 °	0.020 °	1:3
20 A	850 Hz	0 °		0.045 °	0.020 °	2.3:1
20 A	850 Hz	-90 °		0.045 °	0.020 °	2.3:1
20 A	850 Hz	+90 °		0.045 °	0.020 °	2.3:1
6 A	2907 Hz ^[1]	0 °		0.325 °	0.030 °	10:1
4 A	5643 Hz ^[2]	0 °		0.645 °	0.040 °	16:1
[1] Fundamental zero amplitude, 51 st harmonic of 57 Hz at 6 A [2] Fundamental zero amplitude, 99 th harmonic at 4 A						

9. Connect the 100 A shunt between the 6105A and the second input to the phase meter.

10. Set the 6105A range to 1 x Ext 120A.

11. Set the current, frequency, and phase angle to the values in Table 5-16.

Table 5-16. Phase Angle Verification on 120 Amp Range

6105A			Measured Angle	Product Specification	Measurement Uncertainty	TUR
RMS	Frequency	Phase Angle				
100 A	200 Hz	0 °		0.025 °	0.020 °	1:3
100 A	850 Hz	0 °		0.045 °	0.020 °	2.3:1
100 A	850 Hz	-90 °		0.045 °	0.020 °	2.3:1
100 A	850 Hz	+90 °		0.045 °	0.020 °	2.3:1
36 A	2907 Hz ^[1]	0 °		0.325 °	0.030 °	10:1
24 A	5643 Hz ^[2]	0 °		0.645 °	0.040 °	16:1
[1] Fundamental zero amplitude, 51 st harmonic of 57 Hz at 36 A [2] Fundamental zero amplitude, 99 th harmonic at 24 A						

