

**5700A**  
CALIBRATOR

Operator Reference  
Guide

**FLUKE**

# Contents

<b>SAFETY SUMMARY</b> .....	<b>1</b>
<b>FUSE AND LINE VOLTAGE LABEL LOCATION</b> .....	<b>2</b>
<b>FRONT PANEL REFERENCE</b> .....	<b>3</b>
<b>REAR PANEL REFERENCE</b> .....	<b>11</b>
<b>CABLE RECOMMENDATION</b> .....	<b>13</b>
<b>UUT CONNECTION DIAGRAMS</b> .....	<b>14</b>
<b>BASIC OPERATION</b> .....	<b>20</b>
<b>RS-232-C INTERFACE PARAMETER CHOICES</b> .....	<b>22</b>

## SAFETY SUMMARY

### WARNING



### LETHAL VOLTAGE

MAY BE PRESENT ON THE TERMINALS. OBSERVE ALL SAFETY PRECAUTIONS!

TO AVOID ELECTRICAL SHOCK HAZARD, THE OPERATOR SHOULD NOT ELECTRICALLY CONTACT THE OUTPUT HI OR SENSE HI BINDING POSTS. DURING OPERATION, LETHAL VOLTAGES OF UP TO 1100V AC OR DC MAY BE PRESENT ON THESE TERMINALS.

WHENEVER THE NATURE OF THE OPERATION PERMITS, KEEP ONE HAND AWAY FROM EQUIPMENT TO REDUCE THE HAZARD OF CURRENT FLOWING THROUGH VITAL ORGANS OF THE BODY.

### SYMBOLS MARKED ON EQUIPMENT



DANGER — High voltage.



Protective ground (earth) terminal.



Attention — refer to the manual. This symbol is to indicate that information about usage of a feature is contained in the manual.

### USE THE PROPER FUSE

To avoid fire hazard, use only the fuse specified on the line voltage selection switch label, and which is identical in type, voltage rating, and current rating.

### GROUNDING THE 5700A

The 5700A is a Safety Class I (grounded enclosure) instrument as defined in IEC 348. The enclosure is grounded through the grounding conductor of the power cord. To avoid electrical shock, plug the power cord into a properly wired earth grounded receptacle before connecting anything to any of the 5700A terminals. A protective ground connection by way of the grounding conductor in the power cord is essential for safe operation.

### DO NOT REMOVE COVER

To avoid personal injury, do not remove the 5700A cover. Do not operate the 5700A without the cover properly installed. There are no user-serviceable parts inside the 5700A, so there is no need for the operator to ever remove the cover.

## FUSE AND LINE VOLTAGE LABEL LOCATION

CAUTION FOR FIRE PROTECTION REPLACE ONLY WITH A 250V FUSE OF INDICATED RATING.

VOLTAGE SELECTION	S2	S3	S4	FUSE-F1	VOLTAGE SELECTION	S2	S3	S4	FUSE-F1
100V	■	□	□	T 2.5A 250V (SB)	200V	■	■	■	T 1.25A 250V (SB)
110V	■	■	□		220V	■	■	■	
115V	■	■	■		230V	■	■	■	
120V	■	■	■		240V	■	■	■	

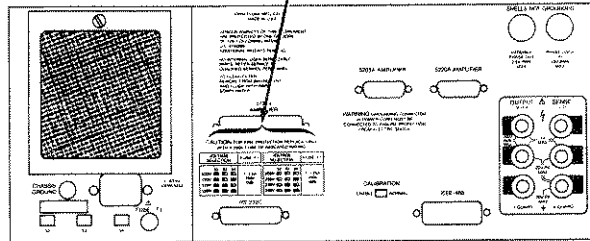







## FRONT PANEL REFERENCE

NAME	FUNCTION
<b>OUTPUT DISPLAY</b>	
Shows output amplitude and frequency. The top line shows the active output value (or potential output value if in standby) in up to eight digits plus a polarity sign. The bottom line shows output frequency (or potential output frequency if the 5700A is in standby) in five digits. Annunciators below the amplitude line on the Output Display indicate the following active conditions:	
<b>OPERATE</b>	Lit when an output is active at the binding posts or auxiliary amplifier
<b>STANDBY</b>	Lit when the 5700A is in standby
<b>ADDR</b>	Lit when the 5700A is addressed over the IEEE-488 interface
<b>ØLCK</b>	Lit when the 5700A output is phase locked to a signal at the rear panel PHASE LOCK IN connector
<b>ØSHF</b>	Lit when the 5700A output has a programmed phase difference with a signal at the rear panel VARIABLE PHASE OUT connector
<b>U</b>	(Unsettled.) When you change the output, this annunciator lights until the output settles to within specification.
<b>CONTROL DISPLAY</b>	
Shows data entries, UUT error adjustments, softkey labels, and other prompts and messages. Softkey labels identify the function of the softkey directly below them. Several softkey labels together are called a menu. The changing menus provide access to many different functions through the five softkeys plus the PREV MENU key.	
<div style="border: 1px solid black; display: inline-block; padding: 2px 5px; margin-bottom: 5px;">                     OPR STBY                 </div>	
Toggles the 5700A between operate and standby modes. In standby mode, the OUTPUT binding posts are internally disconnected from the 5700A. The 5700A normally starts up in standby.	
The 5700A automatically switches to standby when any of the following events occur:	
<ul style="list-style-type: none"> <li>● The RESET key is pressed.</li> <li>● A voltage <math>\geq 22V</math> is selected when the previous output voltage was less than 22V.</li> </ul>	

## FRONT PANEL REFERENCE (cont)

NAME	FUNCTION
<ul style="list-style-type: none"> <li>● The output location is changed, for example by selecting an amplifier. (Excluding selecting the 5725A for ac voltage, or for current if the 5700A current output location is set to "5725A").</li> <li>● Output function is changed between ac or dc voltage &gt;22V, ac or dc current, or resistance. Exceptions are switching from any voltage to &lt;22V, and in 5100B mode when switching between dc and ac current.</li> </ul>	
<div style="border: 1px solid black; padding: 2px; width: fit-content; margin-bottom: 5px;">EX SNS</div> <p>Opens and closes an internal connection between the SENSE and OUTPUT binding posts. The 5700A powers up with SENSE and OUTPUT connected internally (the SENSE binding posts are open circuited) and the EX SNS indicator off. Pressing EX SNS disconnects the sense lines from the OUTPUT binding posts, connects them to the SENSE binding posts internally, and lights the EX SNS indicator.</p> <p>External Sensing should be used in the dc voltage function when the UUT draws enough current to produce a significant voltage drop in the cables, and in the resistance function when the UUT has a four-wire ohms input and the 5700A is set to 100 k<math>\Omega</math> or less. External sensing can also be used in the two-wire ohms function to activate two-wire compensation circuitry to the UUT terminals. Refer to the connection diagrams for examples of usage.</p>	
<div style="border: 1px solid black; padding: 2px; width: fit-content; margin-bottom: 5px;">EX GRD</div> <p>Opens and closes an internal connection between the V GUARD (voltage guard) and OUTPUT LO. The 5700A powers up with the voltage guard internally connected to OUTPUT LO and the EX GRD indicator off. Pressing the EX GRD key disconnects OUTPUT LO from the voltage guard and lights the indicator.</p> <p>The V GUARD binding post provides an external connection point for the voltage internal guard. For a UUT with floating (ungrounded) inputs, the V GUARD should be connected to LO internally. (The EX GRD key is toggled so that the indicator is off.) For a UUT with a grounded input, the GUARD may be externally connected to the grounded UUT input. (The EX GRD key is toggled so that the EX GRD indicator is lit.) Refer to the connection diagrams for examples of usage.</p>	
<div style="border: 1px solid black; padding: 2px; width: fit-content; margin-bottom: 5px;">W BND</div> <p>Enables and disables the Option 5700A-03 Wideband AC Voltage Module and sets the 5700A to standby mode. When enabled, the W BND indicator lights and ac voltage output over the range of 10 Hz to 30 MHz is available at the front panel WIDEBAND connector. The wideband function is disabled whenever W BND is specifically de-selected or when another function (such as current) is selected.</p>	

## FRONT PANEL REFERENCE (cont)

NAME	FUNCTION
	<p>Enables or disables output from an amplifier, when it would not otherwise be automatically selected. Sets the 5700A to standby if this selection moves the output location.</p> <p>When available, an amplifier is automatically selected for output settings that exceed 5700A capabilities but fall within the limits of the selected amplifier. The BOOST key is only needed to activate an amplifier for an output setting that is available from either the 5700A or the amplifier. This allows you to take advantage of amplifier capabilities besides extended range, such as higher compliance voltage.</p> <p>For both voltage and current, the amplifier is assumed to be a 5725A unless another model is designated in the setup menus.</p>
	<p>Aborts the current operational state of the 5700A and recalls the previous set of menu choices. Some menus display a more specific label for this key, such as "DONE Setting Up".</p>
<p><b>Softkeys</b> </p>	<p>The functions of the five unlabeled softkeys are identified by labels on the Control Display directly above each key. The functions change during operation so that many different functions are accessible through these keys. A group of softkey labels is called a menu. A group of interconnected menus is called a menu tree.</p>
<p><b>POWER Switch</b></p>	
<p>Turns the power on and off.</p>	
<div style="display: flex; align-items: center; gap: 10px;">     </div>	
<p>The output adjustment controls. If any of these keys are pressed or the knob is rotated, a digit on the Output Display becomes highlighted and the output increments or decrements as the knob is rotated. If a digit rolls past 0 or 9, the digit to its left or right is carried. An error display appears on the Control Display, showing the difference between the original (reference) output and the new (adjusted) output.</p>	
<p>The [—] and [—] keys adjust the magnitude of changes by moving the highlighted digit. In the ac functions, the AMPL/FREQ key allows you to move from</p>	

## FRONT PANEL REFERENCE (cont)

NAME	FUNCTION
	<p>voltage or current to frequency and back. In practice, for voltage and current outputs, the knob and arrow keys are used to adjust output until the UUT reads correctly. The error display then displays UUT deviation from the reference.</p> <p>Since resistances are not adjustable, the knob and arrow keys adjust a value on the Control Display to equal the UUT reading.</p> <p>The rotary knob is also used to adjust the phase of the ac output signal with respect to a signal at the VARIABLE PHASE OUT connector after the "Phase Ctrl's Menu" softkey is pressed.</p>
RESET	<p>Except when operating in remote, aborts the current operating state of the 5700A and returns the 5700A to the power-up default state.</p>
SCALE	<p>Identifies a UUT full-scale endpoint for checking linearity and does not change the output. If the output was adjusted with the rotary knob, subsequent keyed-in output values are multiplied by a scale factor. Scaling is deactivated by pressing SCALE again, or by selecting another function. Scaling is not available for resistance outputs.</p>
LIMIT	<p>Calls up a menu that allows you to specify limits beyond which the 5700A will not operate, to protect your test equipment and personnel.</p>
÷10	<p>Immediately changes the output to one tenth the reference value (not necessarily the present output value) if the value is within performance limits.</p>
X 10	<p>Immediately changes the output to ten times the reference value (not necessarily the present output value) if the value is within performance limits. This key sets the 5700A to standby if this change is from below 22V to 22V or more.</p>
SPEC	<p>Causes the 5700A to compute and display the 5700A uncertainty for the present output setting for the calibration interval selected in the setup menus.</p>



## FRONT PANEL REFERENCE (cont)

NAME	FUNCTION
<b>OFFSET</b>	Identifies a UUT zero-scale endpoint and does not change the output. Subsequent keyed-in output values have the offset value (the 5700A output value when <b>OFFSET</b> was pressed) added to them. Offset mode is deactivated by pressing <b>OFFSET</b> again or by selecting another function. Offsets are available for dc outputs only.
<b>CE</b>	Clears a partially completed keypad entry from the Control Display or clears an error message that requires acknowledgement. If there is a partially completed entry when <b>CE</b> is pressed, the output is unaffected.
<b>NEW REF</b>	Only active during error mode operation, the <b>NEW REF</b> key establishes the present output value as a new reference for meter error computation.
<b>dBm</b>	When in the ac volts or wideband function, and if no entry is in progress, the <b>dBm</b> key shows the equivalent dBm output on the Control Display. For the ac voltage function, dBm is calculated for a 600Ω load. For the wideband function, dBm is calculated for a 50Ω resistive termination at the end of a 3-foot 50Ω coaxial cable.
<b>NOTE</b>	
The formula to compute dBm is: $10 * \log (\text{power in mW})$	
Examples:	
For 3.0V into a 600Ω load, $\text{dBm} = 10 \log (15.000) = 11.7609 \text{ dBm}$	
For 3.0V into a 50Ω load, $\text{dBm} = 10 \log (180.000) = 22.5527 \text{ dBm}$	
<b>ENTER</b>	Loads a newly entered output value showing on the Control Display into the 5700A. The new value can come from the numeric keypad. If you press <b>ENTER</b> without identifying the units for the entry, the 5700A keeps the units that were last used. This allows you, for example, to enter 1 mV, and then later simply

## FRONT PANEL REFERENCE (cont)

NAME	FUNCTION
------	----------

enter 10 to obtain 10V. (The "V" units were saved from the last entry, but not the multiplier, "m".) Another function of the ENTER key is to recall the currently-programmed reference value in error mode operation.

### Output Function Keys

Select the output function. The output functions are:

<input type="button" value="dBm"/>	Decibels relative to 1 mW
<input type="button" value="V"/>	Voltage
<input type="button" value="A"/>	Current
<input type="button" value="Ω"/>	Resistance
<input type="button" value="Hz"/>	Frequency

When Hz is entered, the 5700A automatically switches to ac. When a new signed (+ or -) output value is entered without specifying Hz, the 5700A automatically switches back to dc.

### Multiplier Keys

Select output value multipliers. For example, if you enter 33, then m, then V, then ENTER, the 5700A output value is 33 mV. The multiplier keys are:

<input type="button" value="μ"/>	micro	( $10^{-6}$ or 0.000001)
<input type="button" value="m"/>	milli	( $10^{-3}$ or 0.001)
<input type="button" value="k"/>	kilo	( $10^3$ or 1,000)
<input type="button" value="M"/>	mega	( $10^6$ or 1,000,000)

### Numeric Keypad

Used to enter the digits of the output amplitude and frequency, as well as other data such as the time and date. The proper sequence to enter a value is to press the digits of the output value, a multiplier key (if necessary), an output function key, then ENTER. For example, to obtain an output of 20 mV, you would press the following sequence of keys: 2 0 m V ENTER.



If the output function is dc voltage, current, ac voltage entered in dBm, or a wideband output entered in dBm, pressing +/- then ENTER toggles the polarity of the output. If the output function is ac voltage or current, pressing +/- then ENTER changes the output to dc.

## FRONT PANEL REFERENCE (cont)

NAME	FUNCTION
<b>WIDEBAND Connector</b>	
<p>A Type "N" connector that provides a connection point for output from the Option 5700A-03 Wideband AC Module. Wideband output specifications are stated for output levels present at the end of its 3-foot 50Ω coaxial cable terminated into a 50Ω purely resistive load. The connector shell is connected to chassis ground.</p>	
<b>GND Binding Post</b>	
<p>If the 5700A is the location of the ground reference point in a system, the GND binding post can be used for connecting other instruments to earth ground. (The chassis is normally connected to earth ground through the three-conductor line cord instead of through the earth ground binding post.)</p>	
<b>V GUARD Binding Post</b>	
<p>Provides an external connection point for the internal voltage guard. For a UUT with floating (ungrounded) inputs, the V GUARD should be connected to LO internally (EX GRD key toggled so that the EX GRD indicator is off.) For a UUT with a grounded input, the V GUARD must be externally connected to the grounded UUT input (EX GRD key toggled so that the EX GRD indicator is lit). The maximum allowable potential between the V GUARD connector and chassis ground is 20V peak.</p>	
<b>SENSE Binding Posts</b>	
<p>Used in the resistance and voltage functions for sensing at the UUT after you have selected external sense with the EX SNS key or by remote command. The LED indicator above the EX SNS key lights when external sensing is selected.</p>	
<p>External Sensing should be used in the dc voltage function when the UUT draws enough current to produce a significant voltage drop in the cables, and in the resistance function when the UUT has a four-wire ohms input and the 5700A is set to 100 kΩ or less. External sensing can also be used in the two-wire ohms function to allow the two-wire compensation circuitry to the UUT terminals. Refer to the connection diagrams for examples of usage.</p>	
<b>OUTPUT Binding Posts</b>	
<p>Provide connection points for ac and dc current and voltage output, as well as resistance. The function of each OUTPUT binding post is defined below:</p>	

### FRONT PANEL REFERENCE (cont)

NAME	FUNCTION
LO	The common binding post for all output functions including 5725A amplified voltage output, but not Option 5700A-03 Wideband AC or other auxiliary amplifier output.
HI	The active binding post for all output functions including 5725A amplified voltage output, but not Option 5700A-03 Wideband AC or other auxiliary amplifier output.
AUX CURRENT OUTPUT	An optional active binding post for current. It is convenient to use the AUX CURRENT OUTPUT binding post when calibrating a UUT with a separate current input terminal.

## REAR PANEL REFERENCE

NAME	FUNCTION
<b>5725A AMPLIFIER Connector</b>	<p>Provides the analog and digital interface for the Fluke 5725A Amplifier.</p>
<b>5205A AMPLIFIER Connector</b>	<p>Provides the analog and control interface for either the Fluke 5205A or 5215A Precision Power Amplifier.</p>
<b>5220A AMPLIFIER Connector</b>	<p>Provides the analog and control interface for the Fluke 5220A Transconductance Amplifier.</p>
<b>VARIABLE PHASE OUT BNC Connector</b>	<p>Provides access to a variable-phase nominal 2.5V rms sine-wave signal. The phase of this signal can be adjusted using the arrow keys and rotary knob (or by remote commands) to lead or lag the main 5700A output signal by up to 180 degrees. The connector shell is not connected directly to chassis ground. It is connected internally to the OUTPUT LO binding post. The maximum allowable potential between the connector shell and chassis ground is 20V peak.</p>
<b>PHASE LOCK IN BNC Connector</b>	<p>Provides the input for an external signal onto which the 5700A can be phase locked. (1 to 10V rms, 10 k<math>\Omega</math> input impedance.) The connector shell is not connected directly to chassis ground. It is connected internally to the OUTPUT LO binding post. The maximum allowable potential between the connector shell and chassis ground is 20V peak.</p>
<b>REAR PANEL BINDING POSTS</b>	<p>The rear-panel OUTPUT, SENSE, and V GUARD and I GUARD binding posts are alternative connections to the UUT. An internal cable enables either the front or rear binding posts. The procedure to disable the front panel binding posts and enable the rear panel binding posts involves opening the cover of the 5700A and is a service personnel procedure only.</p> <p>The I GUARD binding post provides an external connection point for the internal current guard. The current guard is used when the 5700A is supplying low-level ac current through a long cable to remove errors introduced by leakage through the cable capacitance. The I GUARD binding post is available on the rear panel</p>

## REAR PANEL REFERENCE (cont)

NAME	FUNCTION
<p>where it is convenient for system applications. Refer to the connection diagrams for examples of usage.</p>	
<p><b>AUX CURRENT OUTPUT</b> is not available on the rear panel binding posts.</p>	
<p><b>IEEE-488 CONNECTOR</b></p>	
<p>A standard interface connector for operating the 5700A in remote control as a Talker or Listener on the IEEE-488 Bus.</p>	
<p><b>CALIBRATION SWITCH</b></p>	
<p>A slide switch that write enables and disables the nonvolatile memory that stores calibration constants, dates, and setup parameter settings. Switching to ENABLE write enables the memory, and switching to NORMAL protects data in memory from being overwritten. The switch is recessed to allow the metrologist to cover it with a calibration sticker to guarantee calibrator integrity.</p>	
<p><b>RS 232C Connector</b></p>	
<p>A male (DTE) serial port connector for transmitting internal calibration constant data to a printer, monitor, or host computer, and for remote control of the 5700A.</p>	
<p><b>F1 Fuseholder</b></p>	
<p>The line power fuse. See "FUSE AND LINE VOLTAGE AND FUSE LABEL LOCATION" for correct ratings.</p>	
<p><b>Line Voltage Selection Switches</b></p>	
<p>Select the operating line voltage. See "FUSE AND LINE VOLTAGE AND FUSE LABEL LOCATION" for correct ratings.</p>	
<p><b>CHASSIS GROUND Binding Post</b></p>	
<p>A binding post that is internally grounded to the chassis. If the 5700A is the location of the ground reference point in a system, this binding post can be used for connecting other instruments to earth ground. (The chassis is normally connected to earth ground through the three-conductor line cord instead of through the earth ground binding post.)</p>	

### CABLE RECOMMENDATIONS

OUTPUT FUNCTION	CABLE RECOMMENDATIONS
DC Voltage AC Voltage $\leq 10$ kHz AC Current $\leq 2A, \leq 10$ kHz DC Current $\leq 2A$ Resistance	Low Thermal EMF Test Leads (5440A-7002) or twisted shielded pair
AC Voltage $> 10$ kHz	SENSE/GUARD: Triaxial cable or Twinax (e.g., Alpha 2829/2), OUTPUT: Coaxial  Or: SENSE: Coaxial, OUTPUT: Coaxial GUARD Lead: Separate wire
AC Current with Guard	Triaxial cable
Wideband AC	3 ft (1m) 50 $\Omega$ coaxial cable with Type "N" male connector supplied with the option. A 50 $\Omega$ feedthrough terminator is also supplied for connecting to meters with impedance higher than 50 $\Omega$ .
Voltage-Boosted Output, 5205A or 5215A	Use the cable supplied with the amplifier
Voltage-Boosted Output, 5725A	Low Thermal EMF Test Leads (5440A-7002) (Output is at the 5700A front panel.)
Current-Boosted Output, 5725A, 5220A	16-gauge or heavier twisted-pair insulated wire, as short as possible to minimize resistance and inductance. (Output is at the amplifier terminals.)

# UUT CONNECTION DIAGRAMS

DC VOLTAGE, AC VOLTAGE  $\leq 10$  kHz

A.  EX SNS : OFF  EX GRD : OFF

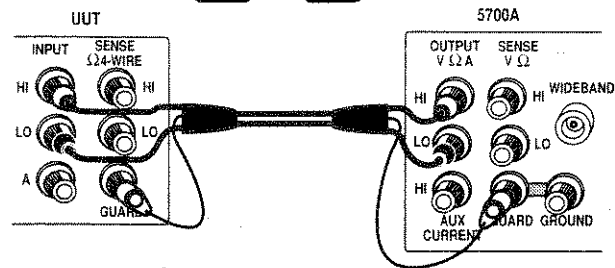

B.  EX SNS : ON  EX GRD : ON

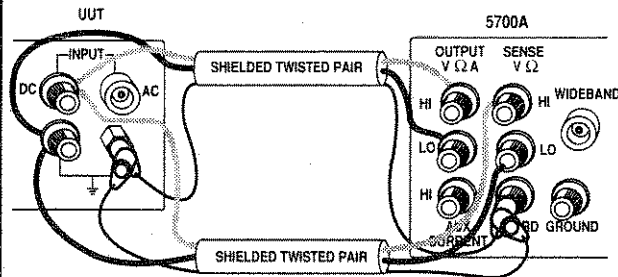

C.  EX SNS : OFF  EX GRD : ON

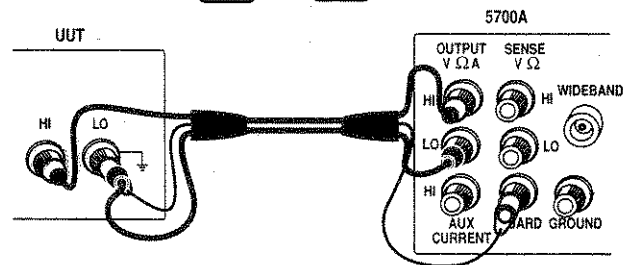



## UUT CONNECTION DIAGRAMS (cont)

AC VOLTAGE >10 kHz

A.  EX SNS : ON  EX GRD : OFF

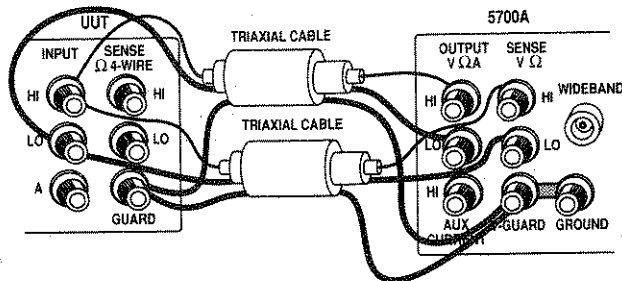

B.  EX SNS : OFF  EX GRD : OFF

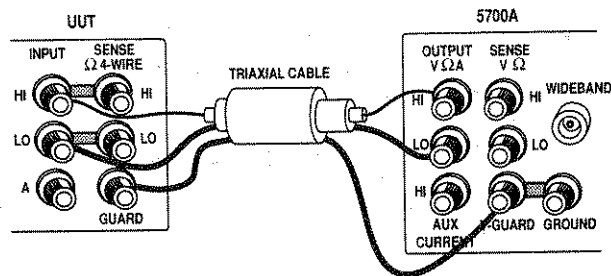

### NOTE

Keep the SENSE leads as short as possible.

Be careful not to exceed the capacitive load limit of 1000 pF up to 220V, 600 pF 220 to 1100V. (1000 pF with 5725A Amplifier.)

## UUT CONNECTION DIAGRAMS (cont)

### AC CURRENT $\leq 2A$

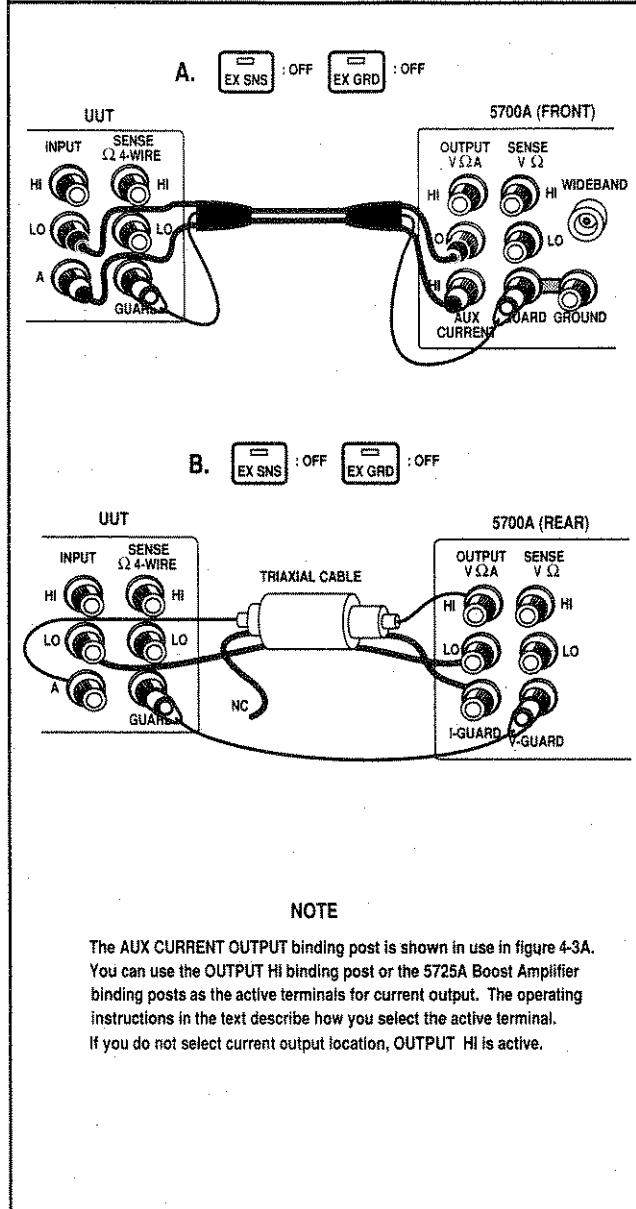

# UUT CONNECTION DIAGRAMS (cont)

## RESISTANCE

A.  EX SNS : ON     EX GRD : OFF    2-WIRE COMP OFF

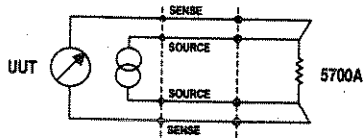
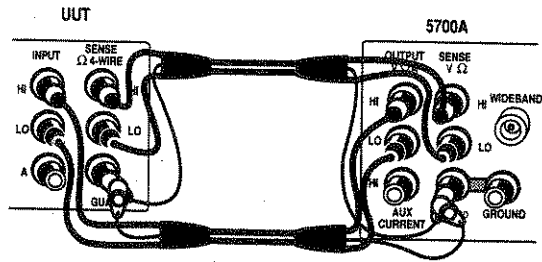

B.  EX SNS : OFF     EX GRD : OFF    2-WIRE COMP OFF

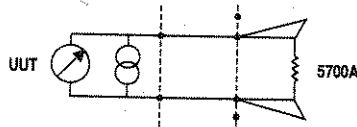
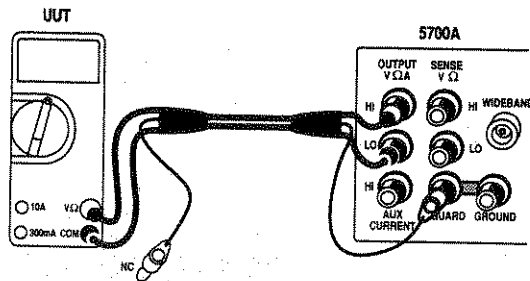

# UUT CONNECTION DIAGRAMS (cont)

## RESISTANCE (cont)

C.  EX SNS : ON     EX GRD : OFF    2-WIRE COMP ON

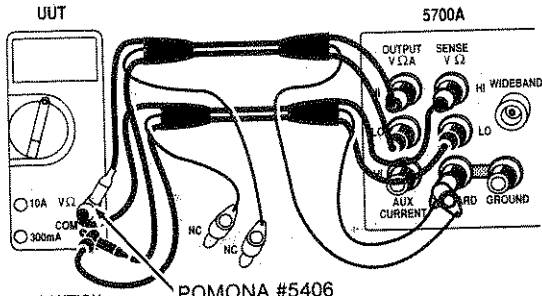

CAUTION  
USE CONNECTIONS WITH EXPOSED PLUG TIPS FOR THE OHMS FUNCTION ONLY.

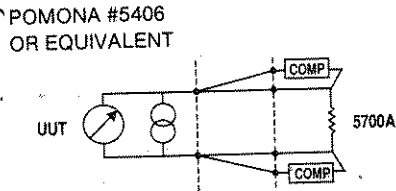

D.  EX SNS : OFF     EX GRD : OFF    2-WIRE COMP ON

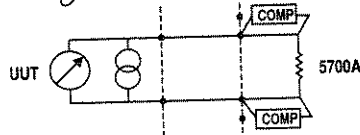
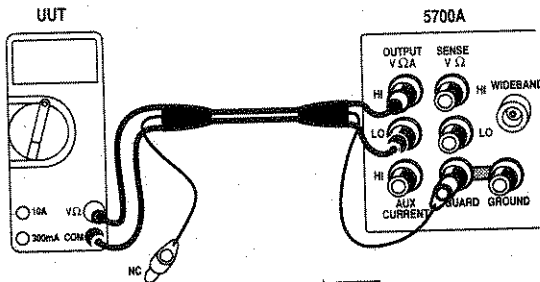

## UUT CONNECTION DIAGRAMS (cont)

### WIDEBAND AC VOLTAGE OUTPUT (OPTION 5700A-03)

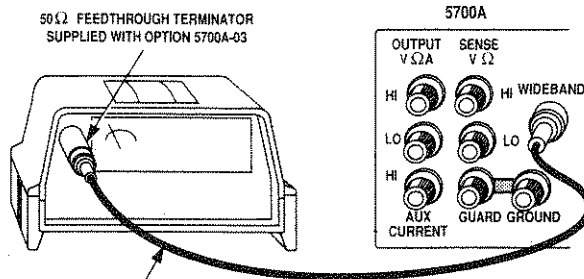

#### NOTE

For wideband meters with higher than 50  $\Omega$  input impedance, use the 50  $\Omega$  feedthrough terminator at the meter connection end.  
For all wideband applications, take care to achieve a good 50  $\Omega$  impedance match (use cabland connectors with a characteristic input impedance of 50  $\Omega$ ).

### 5725A AMPLIFIED CURRENT OUTPUT

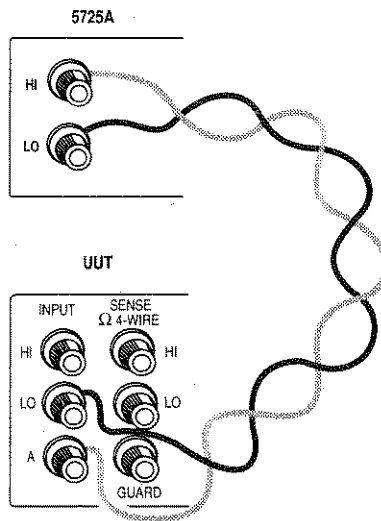

## BASIC OPERATION

To set the output, simply press the following sequence of keys to select an output function and amplitude:

[numeric keys] [multiplier] [function]

For example, to set the output to 10 mV dc, press:

To set an ac output, press the following additional keys:

[numeric keys] [multiplier]

For example, to change the present 10 mV dc to 10 mV ac at 1.8 kHz, press:

To change the output back to dc, simply press:

, or

## ERROR MODE OPERATION

Activate error mode by rotating the rotary knob, pressing an arrow key, or pressing [AMPL/FREQ]. When you enter error mode, the starting value is the reference from which errors are computed. A new reference is established when you exit and reenter error mode. The table below lists the actions that cause the 5700A to exit error mode.

KEYS	ACTION
ENTER	Returns to the previous reference value.
+/- ENTER	Establishes a new reference.
A keypad entry + ENTER	Establishes a new reference.
NEW REF	Establishes the present output as a new reference.
X 10	Sets the 5700A to ten times the reference value and establishes a new reference.
÷10	Sets the 5700A to one-tenth the reference value and establishes a new reference.
OFFSET	Identifies the present output as a zero-scale endpoint for scaling and establishes 0.0 as the new reference.
SCALE	Identifies the present output as a full-scale endpoint for scaling and causes the display to show scale error.
RESET	Returns to the power-up state.
The "Setup Menus" softkey	Opens the setup menu.

**RS-232-C INTERFACE PARAMETER CHOICES  
(DEFAULT IN PARENTHESIS)**

<b>PARAMETER</b>	<b>CHOICES</b>	<b>DEFAULT SETTING</b>
Data Bits	7 or 8	8
Stop Bits	1 or 2	1
Flow Control	Ctrl S/Ctrl Q (XON/XOFF), RTS, or none	Ctrl S/Ctrl Q
Parity Checking	Odd, even, or none	None
Baud Rate	110, 300, 600, 1200, 2400, 4800, 9600, or 19200	9600
Timeout Period	0 to 30 seconds	0 (No timeout)
EOL (End Of Line)	CR, LF, or CR LF	CR LF
EOF (End Of File)	Any two ASCII characters	No characters