

5700A/5720A

Series II Multi-Function Calibrator

Operator Guide

PN 601648

May 1996

© 1996 Fluke Corporation, Inc.

All rights reserved. Printed in U.S.A.

FLUKE®

Contents

What is in this Guide?	2
Safety Summary	2
⚠ Fuse and Line Voltage	4
Basic Operation.....	5
A Short Calibration Exercise.....	5
Warming up the Calibrator	5
Exercise: Running dc Zero Calibration	6
Connecting a Meter.....	6
Applying a dc Voltage	7
Checking the Calibrator Uncertainty	7
Exercise: Activating Error Mode	8
Checking the Meter's Higher and Lower Ranges	8
Exercise: Applying an ac Voltage	9
Front Panel Features.....	10
Output Display (Left Side)	10
Control Display (Right Side)	10
Display Screen Saver.....	11
Front Panel Keys	12
Front Panel Connectors	21
Rear Panel Features	23
Rear Panel Connectors	23
Switches and Fuse Holder.....	26
Cable Recommendations.....	27
Connecting to a UUT (Unit Under Test)	28
Using Error Mode	35
Operating in Remote	37
RS-232-C Interface Parameters.....	38

What is in this Guide?

The *Operator Guide* begins with safety information, a short meter calibration exercise for new users, then continues with a condensation of information from the *Operator Manual*. For complete information about the Calibrator's features, functions, and operating procedures, refer to the *Operator Manual*.

Safety Summary

Warning



Lethal voltage may be present on the terminals. Observe all safety precautions in this guide.

To avoid electrical shock hazard, the operator should not electrically contact the OUTPUT HI or SENSE HI binding posts. During operation, lethal voltages of up to 1100V ac or dc may be present on these terminals.

Whenever possible, keep one hand away from the equipment to reduce the hazard of current flowing through vital organs of the body.

Symbols Marked on Equipment



Warning - Risk of electric shock.



Ground Protective ground (earth) terminal.



Attention Refer to the manual for information about this feature. This symbol appears on the rear panel ground terminal and by the fuse holder.

Use the Proper Fuse

To avoid fire hazard, use only the fuse specified on the line voltage selection switch label.

Safety Summary (cont.)



Grounding the Calibrator

The Calibrator is a Safety Class I (grounded enclosure) instrument. The enclosure is grounded through the grounding conductor of the power cord. To avoid electrical shock, plug the power cord into a properly wired earth grounded receptacle before making any connections to the Calibrator terminals. A protective ground connection by way of the grounding conductor in the power cord is essential for safe operation.



Do Not Remove the Cover

To avoid personal injury, do not remove the Calibrator cover. Do not operate the Calibrator without the cover properly installed. There are no user-serviceable parts inside the Calibrator, so there is no need to ever remove the cover.

! Fuse and Line Voltage

The correct fuse type for each voltage selection is indicated on the rear panel as shown in the following figure.

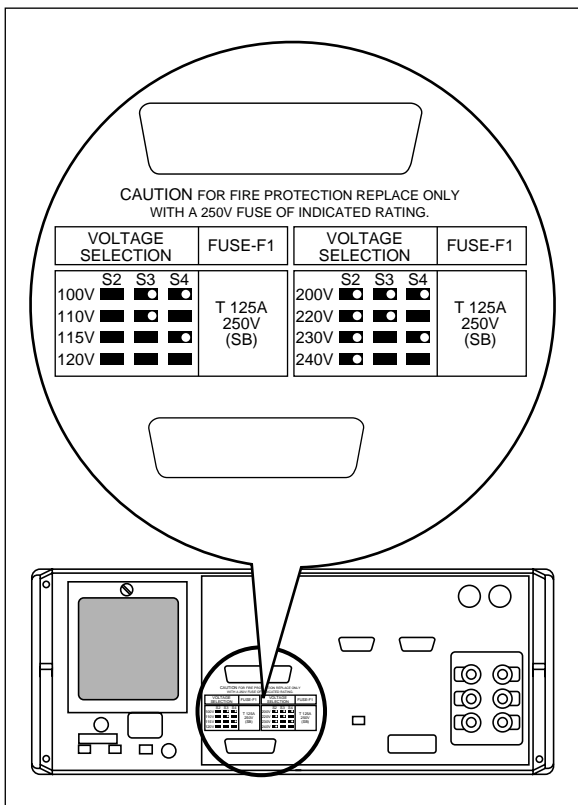

Line Power Label and Switch Locations

Basic Operation

To set the output, simply press the following sequence of keys to select an output function and amplitude:

[numeric keys] [multiplier] [function]

For example, to set the output to 10 mV dc, press:

To set an ac output, press the following additional keys:

[numeric keys] [multiplier]

For example, to change the present 10 mV dc to 10 mV ac @ 1.8 kHz, press:

To change the output back to dc, press:

or

A Short Calibration Exercise

If you are not familiar with the Calibrator, you will find that the following exercise quickly teaches you some important front panel operations.

Warming up the Calibrator

When you first turn the Calibrator on, you should let it warm up for 30 minutes. This ensures that the Calibrator meets or exceeds its specifications.

Exercise: Running dc Zero Calibration

DC Zero is a brief internal process that removes offset errors. The specifications require that you run dc Zero at least every 30 days.



To run dc Zero, press the following sequence of softkeys:

Setup Menus Cal Zero

Press any key, then press  twice to return to normal operation.

Connecting a Meter

Typical connections for handheld and benchtop meters are shown on the next page. The diagrams show the use of Fluke Model 5440-7002 Low Thermal Cables. Other types of cable may be used for this exercise. To connect either type of meter, proceed as follows:

1. Verify that the Calibrator is on, and is in standby mode (STANDBY indicator lit). If the Calibrator is not in standby, press .
2. Set the meter to the lowest range that reads 10V dc.
3. Connect the shield lead (if your cables are shielded) to V GUARD on the Calibrator.
4. Verify that both  and  are off. Press them if they are lit.
5. Connect the meter input LO to the Calibrator OUTPUT LO.
6. Connect the meter input HI to the Calibrator OUTPUT HI.

Exercise: Connecting a Meter (cont.)

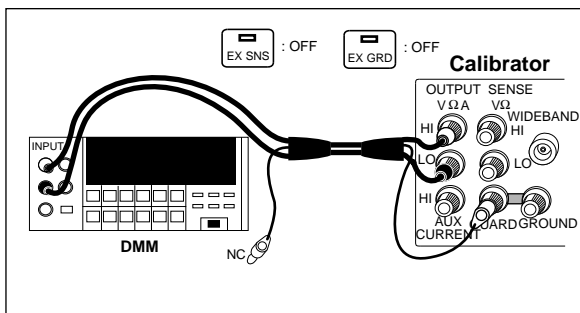
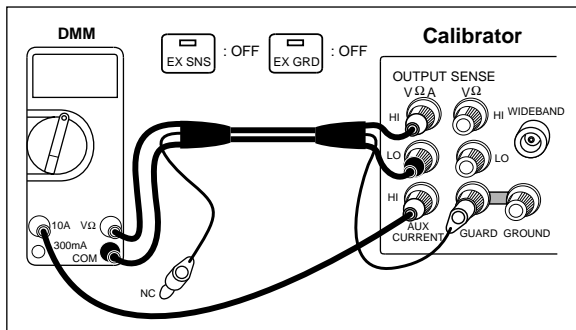

Applying a dc Voltage

Apply 10V dc to the meter by pressing the following sequence of keys:



Checking the Calibrator Uncertainty

Press **SPEC**. The total uncertainty for the 10V you are applying to the meter is displayed on the Control Display (the large dot-matrix display on the right side of the front panel). This number depends on the setting of the calibration cycle and specification confidence level in a setup menu.

Press **PREV MENU** to clear the uncertainty display.

Exercise: Activating Error Mode

Chances are the meter reads something other than exactly 10V. To quickly check the error of the meter, turn the rotary knob to obtain a meter reading of exactly 10V, and read the error off the Control Display.

Turning the knob is all it takes to activate error mode. When you turn the knob, the least significant digit is highlighted. This digit changes as you turn the knob. To change a higher order digit, thereby speeding up the adjustment rate, press .

The error on the Control Display is a combination of offset, scale, and linearity errors. You can view component parts of the error by pressing and .

Checking the Meter's Higher and Lower Ranges

To check the meter error at 100V dc, first set the meter range (if applicable) to the lowest range that reads 100V. Press . This sets a new reference equal to ten times the previous reference of 10V dc. (Pressing was necessary because the Calibrator goes into standby when it crosses the safety threshold from below 22V to over 22V.) Turn the rotary knob to re-activate error mode and determine the meter error at 100V.

Now press . Set the meter range switch (if applicable) to the lowest range that reads 1V.

To end the error mode session, press . This recalls the reference value and exits error mode.

Press to set the output to 0 mV dc in standby.

Exercise: Applying an ac Voltage

There is no “ac mode” switch on the Calibrator. You change a dc output to ac by entering a frequency through the keypad and pressing

ENTER

To test the meter at 10V at 1 kHz, set the meter to read 10V ac, press [1] [0] [V], then [1] [k] [Hz] [ENTER] [OPR STBY]. Adjust the rotary knob for a reading on the meter of exactly 10V.

To test the meter's flatness, press [AMPL FREQ]. The 0.1 Hz digit is highlighted. Press [←] four times. Turn the knob to change the 1 kHz digit until the Calibrator is set to 10 kHz. Press [AMPL FREQ] and turn the knob again to check the meter's accuracy at 10 kHz. Each time you change the frequency, you need to wait for the Calibrator output to settle (the “u” annunciator will go out).

This ends the front panel exercise. To zero the output and go to standby, press [RESET].

Front Panel Features

Following is a brief description of the Calibrator's front panel features.

Output Display (Left Side)

Shows output amplitude and frequency. The top line shows the active output value in up to eight digits, plus a polarity sign. The bottom line shows output frequency in five digits. Annunciators below the amplitude line on the output display indicate the following active conditions:

- OPERATE Lit when an output is active at the binding posts or auxiliary amplifier.
- STANDBY Lit when the Calibrator is in standby.
- ADDR Lit when the Calibrator is addressed over the IEEE-488 interface.
- ØLCK Lit when the Calibrator output is phase locked to a signal at the rear panel PHASE LOCK connector.
- ØSHF Lit when the Calibrator output has a programmed phase difference with a signal at the rear panel VARIABLE PHASE OUT connector.
- u (Unsettled) Lights when the output is changed, and remains lit until the output settles to within specification.

Control Display (Right Side)

Shows data entries, UUT error adjustments, softkey labels, and other prompts and messages. Each softkey label identifies the functions of the softkey that appears directly below it. All of the softkey labels that appear on the display at once are referred to as a menu. When you access the function provided through the softkeys, you open up other menus, containing new softkey labels.

Display Screen Saver

Both the Output and Control displays blank automatically after 30 minutes of inactivity, unless the Calibrator is in one of the operating states that overrides the screen saver.

If the screen saver has activated, you can restore the display by pressing . Pressing another key or turning the knob restores the display and performs the command sent by the key or knob.

The screen saver does not operate:

- if any part of the Setup menu is displayed.
- during remote operation.
- during calibration or diagnostics.
- when an error message is displayed.

Front Panel Keys



Toggles the Calibrator between operate and standby modes. In standby mode, the OUTPUT binding posts are internally disconnected from the Calibrator. The Calibrator powers up in standby mode.



The Calibrator automatically switches to standby mode when:

-  is pressed.
- the Calibrator is sourcing an ac or dc voltage below 22V, and a voltage greater than 22V is selected.
- the output function is changed, e.g., from dc current to ac current.
- the output location is changed.

The Calibrator does not switch to standby when the voltage is switched from any ac or dc voltage to an ac or dc voltage less than 22V.

Front Panel Keys (cont.)





Opens and closes an internal connection between the SENSE and OUTPUT binding posts. The Calibrator powers up with these two binding posts connected internally (the SENSE binding posts are open circuited), and the  indicator off. Toggling  on (so it lights) disconnects the sense lines from the OUTPUT binding posts.

External sensing should be used in the following function under the stated conditions.

- In the dc voltage function when the UUT draws enough current to produce a significant voltage drop in the cables.
- In the resistance function when the UUT has a four-wire input and the Calibrator is set to 100 k Ω or less.
- External sensing can also be used in the two-wire ohms function to activate two-wire compensation circuitry to the UUT terminals.

Front Panel Keys (cont.)



Opens and closes an internal connection between the V GUARD (voltage guard) and OUTPUT LO. The Calibrator powers up with the V GUARD internally connected to OUTPUT LO and the  indicator off. Toggling  on (so it lights) disconnects OUTPUT LO from the V GUARD.

The V GUARD binding post provides an external connection point for the voltage internal guard. For a UUT with ungrounded inputs, the V GUARD should be connected to LO internally. (The EX GRD key is toggled off.) For a UUT with a grounded input, the GUARD may be externally connected to the grounded UUT input. (The EX GRD key is toggled on.)



Enables and disables the -03 Wideband AC option and sets the Calibrator to standby mode. When enabled, the ac voltage output over the range of 10 Hz to 30 MHz is available at the front panel WIDEBAND connector. The wideband function is disabled whenever  is toggled off, or when another function (such as current) is selected.

Front Panel Keys (cont.)



Enables or disables output from an amplifier, when it would not otherwise be automatically selected. Sets the Calibrator to standby if this selection moves the output location.

When available, an amplifier is automatically selected for output settings that exceed Calibrator capabilities, but fall within the limits of the selected amplifier. The  key is only needed to activate an amplifier for an output setting that is available from either the Calibrator or from the amplifier. This allows you to take advantage of amplifier capabilities other than extended range (i.e. higher compliance voltage).

For both voltage and current, the amplifier is assumed to be a 5725A unless another model is designated in the Setup menus.



Aborts the current operation of the Calibrator and recalls the previous menu. Some menus display a more specific label for this key, such as "DONE setting up."

Softkeys 

The functions of the five unlabeled softkeys are provided through each menu in the Control Display, with each function located directly above the softkey that activates that function. Many of these functions access new menus that contain a new set of functions for the softkeys, providing access to many capabilities and configuration options through the menu tree.



POWER switch

Turns the power on and off.

Front Panel Keys (cont.)



These keys are the output adjustment controls. If any of these keys are pressed, or if the knob is turned, a digit on the Output Display becomes highlighted. Turning the knob adjusts the output value. An error display appears on the Control Display, showing the difference between the original (reference) output and the new (adjusted) output.

The  and  keys move the highlight to the digit you wish to change. In the ac functions, the  key allows you to move amongst voltage, current, and frequency. In practice, for voltage and current outputs, the knob and arrow keys are used to adjust output until the UUT reads correctly. The error display shows the UUT deviation from the reference.



During local operation, pressing  aborts the current operating state of the Calibrator and returns the Calibrator to the power-up default state. (This key is not effective during remote operation.)



Identifies a UUT full-scale endpoint for checking linearity, and does not change the output. If the output was adjusted with the rotary knob, subsequent keyed-in output values are multiplied by a scale factor. Scaling is deactivated by pressing  again, or by selecting another function. Scaling is not available for resistance outputs.

Front Panel Keys (cont.)

LIMIT

Calls up a menu that allows you to specify limits beyond which the Calibrator will not operate. This can be used to set limits that protect both operators and equipment.

÷10

Changes the output to one tenth the reference value (which is not necessarily the same as the present output value). The value only changes if the new value is within performance limits.

x10

Changes the output to ten times the reference value (which is not necessarily the same as the present output value). The value only changes if the new value is within performance limits. This key sets the Calibrator to standby if this change is made from a value less than 22V to one that is greater than or equal to 22V.

SPEC

Causes the Calibrator to compute and display its uncertainty for the present output setting for the calibration interval and specification confidence level selected in the setup menus.

OFFSET

Identifies a UUT zero-scale endpoint and does not change the output. Subsequent keyed-in output values have the offset value (the Calibrator output value when **OFFSET** was pressed) added to them. Offset mode is deactivated by pressing **OFFSET** again, or by selecting another function. Offsets are available for dc outputs only.

Front Panel Keys (cont.)

CE

Clears a partially completed keypad entry from the Control Display, or clears an error message that required acknowledgment. If there is a partially completed entry when **CE** is pressed, the output is unaffected.

NEW
REF

This key is only active during error mode operation. It establishes the present output value as a new reference for meter error computation.

dBm

When in the ac volts, or wideband function, and if no entry is in progress, the **dBm** key shows the equivalent dBm output on the Control Display. For the ac voltage function, dBm is calculated for a 600Ω load. (For ac outputs less than 220 mV, the Calibrator output impedance is always 50Ω because the output is resistively divided.) For the wideband function, dBm is calculated for a 50Ω resistive termination at the end of a three-foot 50Ω coaxial cable.

Note

The formula to compute dBm is:

$$\text{dBm} = 10 \log (\text{power in mW})$$

Examples:

For 3.0V into a 600Ω load:

$$\text{dBm} = 10 \log (15.000) = 11.7609 \text{ dBm}$$

for 3.0V into a 50Ω load:

$$\text{dBm} = 10 \log (180.000) = 22.5527 \text{ dBm}$$

Front Panel Keys (cont.)

ENTER

Loads a newly keyed-in output value showing on the Control Display into the Calibrator. If you press without identifying the units for the entry, the Calibrator keeps the units (except Hz) that were last used. This allows you to alter values for a function without keying in the units every time. The multipliers are not retained, for example, you can enter 1 mV, and then later simply enter 10 to obtain 10V.

In addition to these functions, the key recalls the currently programmed reference value during error mode operation.

(Output Function Keys)

These keys select the output function as follows:

Decibels relative to 1 mW

Voltage

Current

Resistance

Frequency

When a value, then are selected, the Calibrator automatically switches to ac. To change back to dc, enter 0 or enter a signed (+ or - amplitude).

(Multiplier Keys)

These keys select output value multipliers. For example, if you enter 33, then m, then V, then ENTER, the Calibrator output value is 33 mV.

micro (10^{-6} or 0.000001)

milli (10^{-3} or 0.001)

kilo (10^3 or 1000)

Mega(10^6 or 1,000,000)

Front Panel Keys (cont.)

- (Numeric Keypad)

Used to enter the digits of the output amplitude and frequency, as well as other data such as the time and date. The proper sequence for entering a value is to enter the digits, then any necessary multipliers, an output function key, then .

For example, to obtain an output of 20 mV, you would press the following sequence of keys:

. The key is available for decimal places.

If the output function is dc voltage, current, ac voltage entered in dBm, or a wideband output entered in dBm, pressing toggles the polarity of the output. If the output function is ac voltage or current, pressing changes the output to dc.

Front Panel Connectors

WIDEBAND Connector

A type “N” connector that provides a connection point for output from the -03 Wideband AC option. Wideband output specifications are stated for output levels present at the end of its three-foot 50Ω coaxial cable terminated into a 50Ω purely resistive load. The connector shell is connected to chassis ground.

GND Binding Post

If the Calibrator is the location of the ground reference point in a system, the GND binding post can be used for connecting other instruments to earth ground. (The chassis is normally connected to earth ground through the three-conductor line cord instead of through the earth ground binding post.)

V GUARD Binding Post

Provides an external connection point for the internal voltage guard. For a UUT with floating (ungrounded) inputs, the C GUARD should be connected to LO internally (EX GRD key toggled off). For a UUT with a grounded input, the V GUARD must be externally connected to the grounded UUT input (EX GRD key toggled on). The maximum allowable potential between the V GUARD connector and chassis ground is 20V peak.

Front Panel Connectors (cont.)

SENSE Binding Posts

Used in the resistance and voltage functions for sensing at the UUT after you have selected external sense by toggling the  key on, or by remote command.

External sensing should be used in the dc voltage function when the UUT draws enough current to produce a significant voltage drop in the cables, and in the resistance function when the UUT has a four-wire ohms input and the Calibrator is set to 100 k Ω or less. External sensing can also be used in the two-wire ohms function to allow the two-wire compensation circuitry to the UUT terminals. Refer to the connection diagrams for examples of usage.

OUTPUT Binding Posts

Provide connection points for ac and dc current and voltage output, as well as for resistance. The function of each OUTPUT binding post is defined below:

LO	The common binding post for all output functions including Calibrator amplified voltage output, but not for Option -03 Wideband AC or auxiliary amplifier output.
HI	The active binding post for all output functions, including 5725A amplified voltage output; does not include Option -03 Wideband AC or auxiliary amplifier output.
AUX CURRENT OUTPUT	An optional active binding post for current. This output is convenient for calibrating UUTs that have a separate current input terminal.

Rear Panel Features

The following list provides descriptions of the connectors and switches on the Calibrator's rear panel.

Rear Panel Connectors

5725A AMPLIFIER Connector

Provides the analog and digital interface for the Fluke 5725A Amplifier.

5205A AMPLIFIER Connector

Provides the analog and control interface for either the Fluke 5205A or 5215A Precision Power Amplifier.

5220A AMPLIFIER Connector

Provides the analog and control interface for the Fluke 5220A Transconductance Amplifier.

VARIABLE PHASE OUT BNC Connector

Provides access to a variable-phase nominal 2.5V rms sine wave signal. The phase of this signal can be adjusted using the arrow keys and rotary knob (or by remote commands) to lead or lag the main Calibrator output signal by up to 180°. The connector shell is not connected directly to chassis ground; it is connected internally to the OUTPUT LO binding post. The maximum allowable potential between the connector shell and chassis ground is 20V peak.

Rear Panel Connectors (cont.)

PHASE LOCK IN BNC Connector

Provides the input for an external signal onto which the Calibrator can be phase locked (1V to 10V rms, 10 k Ω input impedance). The connector shell is not connected directly to chassis ground; it is connected internally to the OUTPUT LO binding post. The maximum allowable potential between the connector shell and chassis ground is 20V peak.

IEEE-488 CONNECTOR

This is a standard interface connector for operating the Calibrator in remote control as either a Talker or a Listener of the IEEE-488 Bus.

RS 232C Connector

A male (DTE) serial port connector for transmitting internal calibration constant data to a printer, monitor, or host computer. This connector is also used for remote control of the Calibrator.

Rear Panel Connectors (cont.)

The OUTPUT, SENSE, and V GUARD binding posts on the rear panel are alternative connections to the UUT. An internal cable enables either the front or rear binding posts. The procedure to disable the front panel binding posts and enable the rear panel binding posts involves opening the cover of the Calibrator, which should only be done by authorized service personnel.

The I GUARD binding post provides an external connection point for the internal current guard. The current guard is used when the Calibrator is supplying low-level ac current through a long cable to remove errors introduced by leakage through the cable capacitance.

Refer to the connection diagrams for examples of usage.

AUX CURRENT OUTPUT

This output is not available on the rear panel binding posts.

CHASSIS GROUND Binding Post

A binding post that is internally grounded to the chassis. If the Calibrator is the location of the ground reference point in a system, this binding post can be used for connecting other instruments to earth ground. (The chassis is normally connected to earth ground through the three-conductor line cord instead of through the earth ground binding post.)

Switches and Fuse Holder

CALIBRATION SWITCH

A slide switch that enables and disables the capability to write to nonvolatile memory. This switch is used for recording and then storing calibration constants, dates, and parameter settings. When this switch is in the ENABLE position, you can write to memory; when in the NORMAL position, the data in the memory is protected from being overwritten. The switch is recessed in order to allow the metrologist to cover it with a calibration sticker to guarantee calibrator integrity.

F1 Fuse Holder

This holds the line power fuse. See “Fuse and Line Voltage” at the beginning of this guide for the location of the correct ratings.

Line Voltage Selection Switches

Select the operating line voltage. See “Fuse and Line Voltage” at the beginning of this guide for the location of the label that shows the correct ratings.

Cable Recommendations

Output Function	Cable Recommendations
DC Voltage AC Voltage ≤ 10 kHz AC Current $\leq 2A$, ≤ 10 kHz DC Current $\leq 2A$ Resistance	Low Thermal EMF Test Leads (5440A-7002) or twisted shielded pair
AC Voltage > 10 kHz	SENSE/GUARD: Triaxial cable or Twinax (e.g., Alpha 2829/2). OUTPUT: Coaxial Or: SENSE: Coaxial, OUTPUT: Coaxial GUARD Lead: Separate wire
AC Current with Guard	Triaxial cable
Wideband AC	3 feet (1m) 50 Ω coaxial cable with Type "N" male connector supplied with the option. A 50 Ω feedthrough terminator is also supplied for connecting to meters with impedance higher than 50 Ω .
Voltage-Boosted Output, 5205A or 5215A	Use the cable supplied with the amplifier.
Voltage-Boosted Output, 5725A	Low Thermal EMF Test Leads (5440A-7002). (Output is at the Calibrator front panel.)
Current-Boosted Output, 5725A, 5220A	16-gauge or heavier twisted-pair insulated wire, as short as possible to minimize resistance and inductance. (Output is at the amplifier terminals.)

Connecting to a UUT (Unit Under Test)

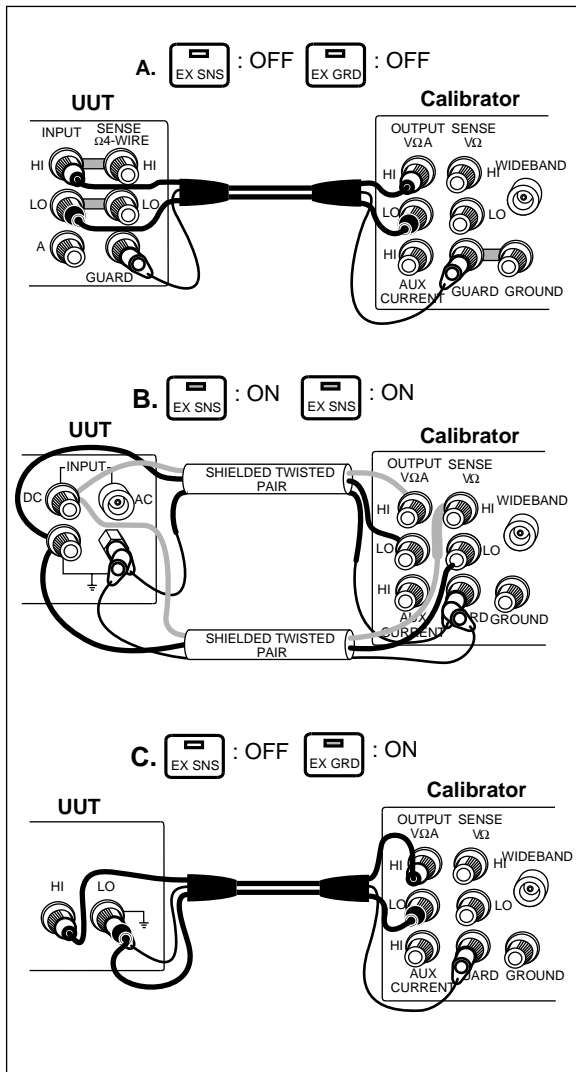

DC Voltage, AC Voltage ≤ 10 kHz

Connecting to a UUT (cont.)

A. EX SNS : ON EX GRD : OFF

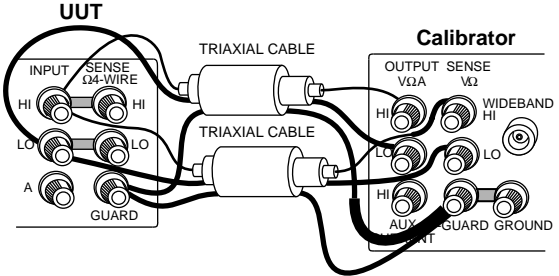

B. EX SNS : OFF EX GRD : OFF

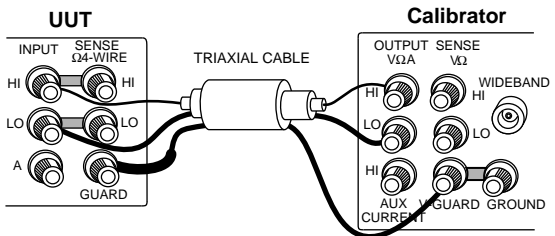

NOTE

Keep the SENSE leads as short as possible.
 Be careful not to exceed the capacitive load limit of 1000 pF up to 220V, 600 pF 220 to 1100V. (1000 pF with 5725A Amplifier.)

AC Voltage >10 kHz

Connecting to a UUT (cont.)

A. EX SNS : OFF EX GRD : OFF

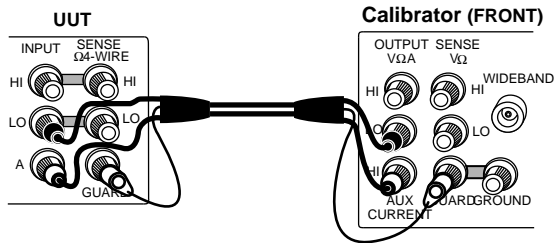

B. EX SNS : OFF EX GRD : OFF

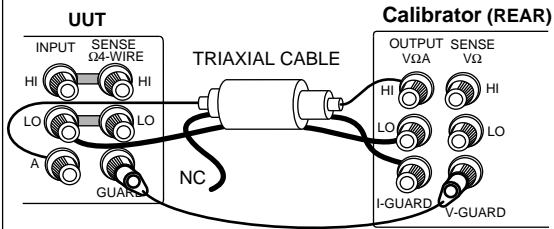

AC Current $\leq 2A$

Connecting to a UUT (cont.)

C. EX SNS : ON EX GRD : OFF 2-WIRE
COMP
ON

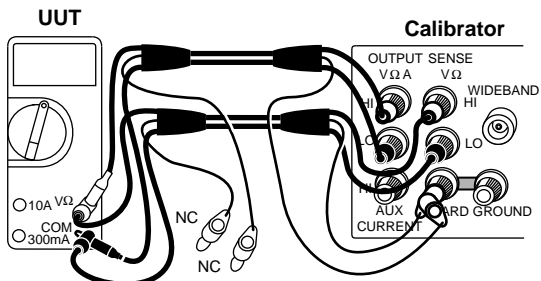

Caution

Use Connections With Exposed Plug Tips
For The Ohms Function Only.

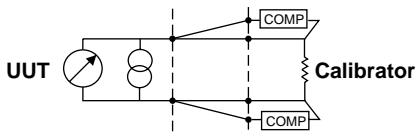

D. EX SNS : OFF EX GRD : OFF 2-WIRE
COMP
ON

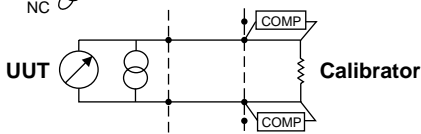
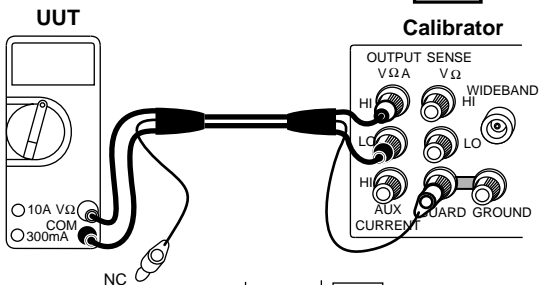

Resistance (cont.)

Connecting to a UUT (cont.)

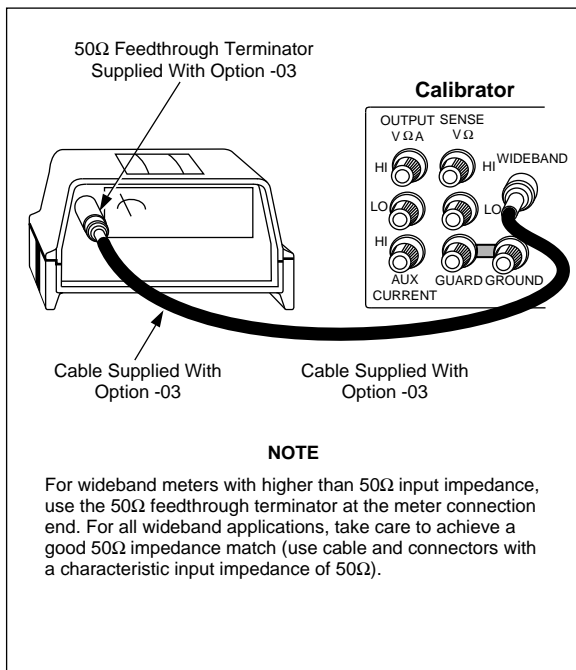

Wideband AC Voltage Output (Option -03)

Connecting to a UUT (cont.)

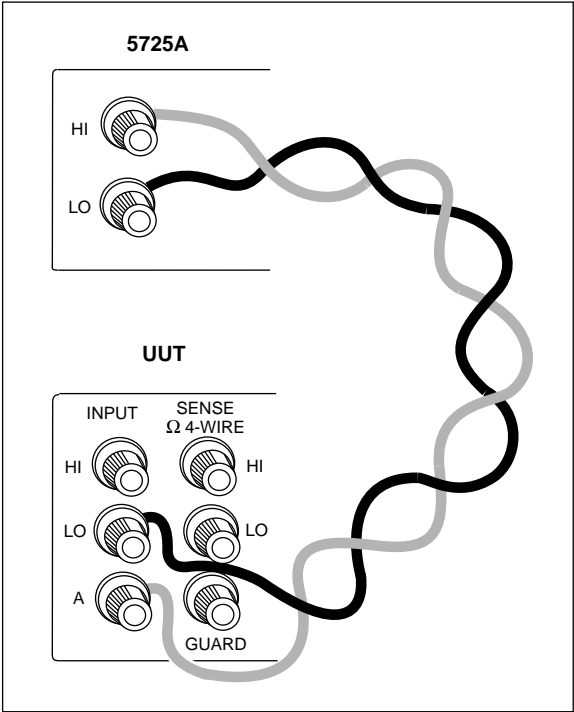

5725A Amplified Current Output

Using Error Mode

Activate error mode by turning the rotary knob, pressing an arrow key, or pressing . When you enter error mode, the starting value is the reference from which errors are computed. A new reference is established when you exit and reenter error mode. The following table lists the actions that cause the Calibrator to exit error mode.

Using Error Mode (cont.)

Keys	Action
<input type="button" value="ENTER"/>	Returns to the previous reference value.
<input type="button" value="+/-"/> , then <input type="button" value="ENTER"/>	Establishes a new reference.
A keypad entry, then <input type="button" value="ENTER"/>	Establishes a new reference.
<input type="button" value="NEW REF"/>	Establishes the present output as a new reference.
<input type="button" value="X10"/>	Sets the Calibrator to ten times the reference value and establishes a new reference.
<input type="button" value="+10"/>	Sets the Calibrator to one-tenth the reference value and establishes a new reference.
<input type="button" value="OFFSET"/>	Identifies the present output as a zero-scale endpoint for scaling, and establishes 0.0 as the new reference.
<input type="button" value="SCALE"/>	Identifies the present output as a full-scale endpoint for scaling and causes the display to show scale error.
<input type="button" value="RESET"/>	Returns to the power-up state.
The "Setup Menu" softkey	Opens the setup menu.

Operating in Remote

To operate the Calibrator remotely, proceed as follows:

1. Turn off the Calibrator power.
2. Connect a remote interface to either the RS-232C or IEEE-488 connector on the Calibrator rear panel.
3. Turn on the Calibrator power.
4. Choose the correct remote parameters using the softkey menus:
 - a. Setup Menus Instmt Setup Remote Port Setup
 - b. Select Remote Port type (GPIB = IEEE-488), Remote lang (NORMAL or emulation mode)
 - c. Select either GPIB Port Setup or RS-232 Port Setup.
 - d. If GPIB: select the address.
 - e. If RS-232: select the parameters in the next table.

RS-232-C Interface Parameters

Parameter	Choices	Default Setting
Data Bits	7 or 8	8
Stop Bits	1 or 2	1
Flow Control	Ctrl S/Ctrl Q (XON/XOFF), RTS, or none	Ctrl S/Ctrl Q
Parity Checking	Odd, even, or none	none
Baud Rate	110,300,600,1200, 2400,4800,9600, or 19200	9600
Time-out Period	0 to 30 seconds	0 (no time-out)
EOL (End of Line)	CR, LF, or CR LF	CR LF
EOF (End of File)	Any two ASCII characters	no characters