

10
10 4

845A/845AB

High Impedence Voltmeter Null Detector

Instruction Manual

P/N 294173
November 1967



WARRANTY

Notwithstanding any provision of any agreement the following warranty is exclusive:

The JOHN FLUKE MFG. CO., INC., warrants each instrument it manufactures to be free from defects in material and workmanship under normal use and service for the period of 1-year from date of purchase. This warranty extends only to the original purchaser. This warranty shall not apply to fuses, disposable batteries (rechargeable type batteries are warranted for 90-days), or any product or parts which have been subject to misuse, neglect, accident, or abnormal conditions of operations.

In the event of failure of a product covered by this warranty, John Fluke Mfg. Co., Inc., will repair and calibrate an instrument returned to an authorized Service Facility within 1 year of the original purchase; provided the warrantor's examination discloses to its satisfaction that the product was defective. The warrantor may, at its option, replace the product in lieu of repair. With regard to any instrument returned within 1 year of the original purchase, said repairs or replacement will be made without charge. If the failure has been caused by misuse, neglect, accident, or abnormal conditions of operations, repairs will be billed at a nominal cost. In such case, an estimate will be submitted before work is started, if requested.

THE FOREGOING WARRANTY IS IN LIEU OF ALL OTHER WARRANTIES, EXPRESS OR IMPLIED, INCLUDING BUT NOT LIMITED TO ANY IMPLIED WARRANTY OF MERCHANTABILITY, FITNESS, OR ADEQUACY FOR ANY PARTICULAR PURPOSE OR USE. JOHN FLUKE MFG. CO., INC., SHALL NOT BE LIABLE FOR ANY SPECIAL, INCIDENTAL, OR CONSEQUENTIAL DAMAGES, WHETHER IN CONTRACT, TORT, OR OTHERWISE.

If any failure occurs, the following steps should be taken:

1. Notify the JOHN FLUKE MFG. CO., INC., or nearest Service facility, giving full details of the difficulty, and include the model number, type number, and serial number. On receipt of this information, service data, or shipping instructions will be forwarded to you.
2. On receipt of the shipping instructions, forward the instrument, transportation prepaid. Repairs will be made at the Service Facility and the instrument returned, transportation prepaid.

SHIPPING TO MANUFACTURER FOR REPAIR OR ADJUSTMENT

All shipments of JOHN FLUKE MFG. CO., INC., instruments should be made via United Parcel Service or "Best Way" prepaid. The instrument should be shipped in the original packing carton; or if it is not available, use any suitable container that is rigid and of adequate size. If a substitute container is used, the instrument should be wrapped in paper and surrounded with at least four inches of excelsior or similar shock-absorbing material.

CLAIM FOR DAMAGE IN SHIPMENT TO ORIGINAL PURCHASER

The instrument should be thoroughly inspected immediately upon original delivery to purchaser. All material in the container should be checked against the enclosed packing list. The manufacturer will not be responsible for shortages against the packing sheet unless notified immediately. If the instrument is damaged in any way, a claim should be filed with the carrier immediately. (To obtain a quotation to repair shipment damage, contact the nearest Fluke Technical Center.) Final claim and negotiations with the carrier must be completed by the customer.

The JOHN FLUKE MFG. CO., INC., will be happy to answer all applications or use questions, which will enhance your use of this instrument. Please address your requests or correspondence to: JOHN FLUKE MFG. CO., INC., P.O. BOX C9090, EVERETT, WASHINGTON 98206, ATTN: Sales Dept. For European Customers: Fluke (Holland) B.V., P.O. Box 5053, 5004 EB, Tilburg, The Netherlands.

*For European customers, Air Freight prepaid.

John Fluke Mfg. Co., Inc., P.O. Box C9090, Everett, Washington 98206

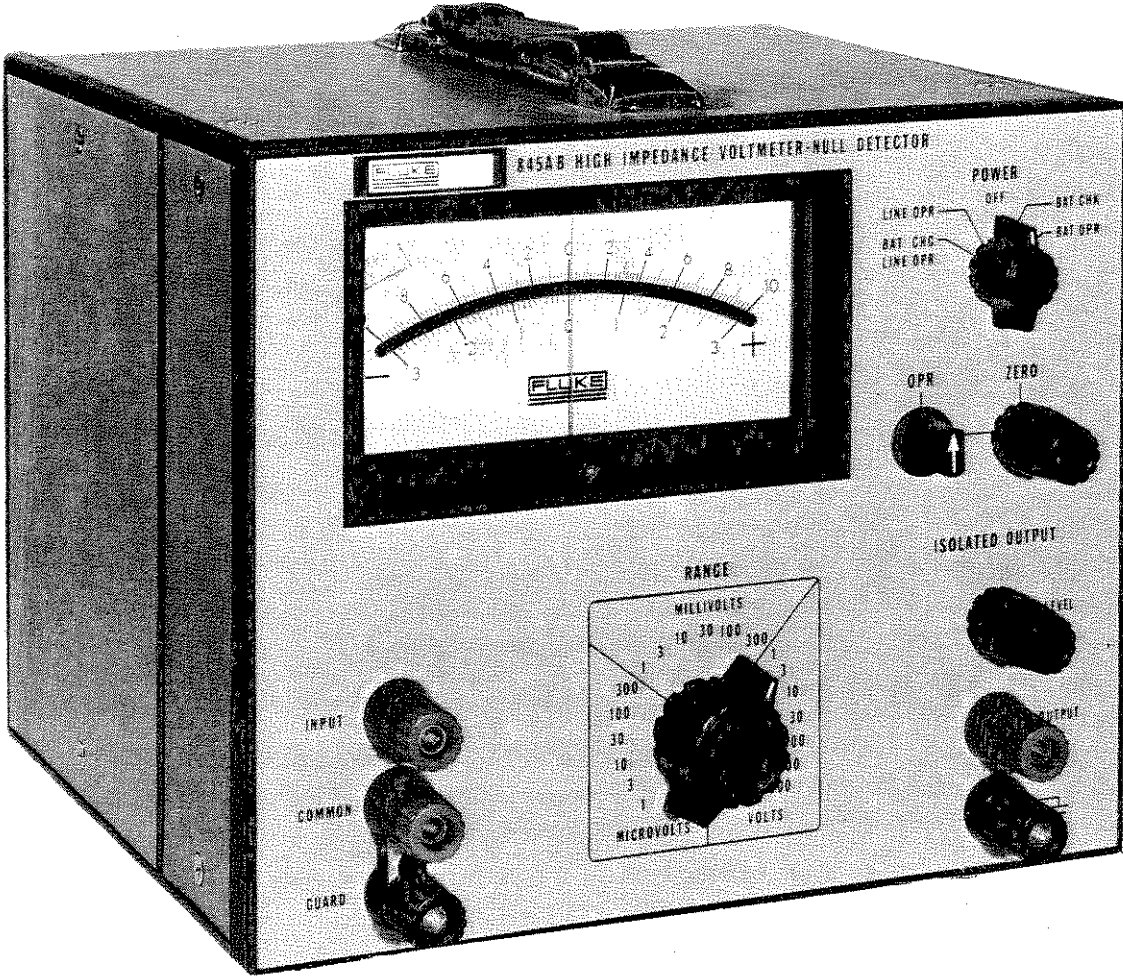

MODEL 845AB HIGH IMPEDANCE VOLTMETER-NULL DETECTOR

SECTION I

INTRODUCTION AND SPECIFICATIONS

1-1. INTRODUCTION

1-2. The Fluke Model 845 High Impedance Voltmeter-Null Detector allows measurement of dc voltages from one microvolt to 1000 volts dc in 19 ranges. When used as a null detector on the 100 millivolt range and below, the input impedance is 10 megohms. A linear recorder output allows the instrument to be used for production testing and also as a dc amplifier with a maximum gain of 120 db.

1-3. The instrument consists of the line powered Model 845A, and the line-battery-powered Model 845AB. The instruments are half-rack in size, and are equipped with resilient feet and a tilt-up bail for field or bench use. A single instrument may be mounted in a standard 19 inch rack by means of metal handle rack adapter kit 881A-102. Two instruments may be mounted side-by-side in a standard 19 inch rack by means of metal handle rack adapter kit 881A-103.

1-4. ELECTRICAL SPECIFICATIONS

INPUT VOLTAGE RANGE

1 microvolt to 1000 volt dc end scale in nineteen ranges, using X1 and X3 progression.

INPUT RESISTANCE

100 megohms on 300 millivolt range and above,
10 megohms on 100 millivolt range and below.

ACCURACY

$\pm(2\%$ end scale + 0.1 microvolt).

MAXIMUM METER NOISE (Input Shorted)

<u>RANGE</u>	<u>NOISE (peak-to-peak)</u>
1 microvolt	0.20 microvolt
3 microvolt	0.25 microvolt
10 microvolt - 1000 volt	0.30 microvolt

METER RESPONSE TIME (to 90% of reading)

<u>RANGE</u>	<u>TIME</u>
1 microvolt	5 seconds
3 microvolt	3 seconds
10 microvolt - 1000 volt	1-1/2 seconds

INPUT ISOLATION

Better than 10^{12} ohms at less than 50% relative humidity and 25° C regardless of line, chassis, or recorder grounding. Better than 10^{10} ohms up to 80% relative humidity and 35° C. With driven guard, isolation improves by at least one order of magnitude up to 10^{13} ohms. Any input terminal may be floated 1100 volts off chassis ground.

DC COMMON MODE REJECTION

Better than 160 db, input short-circuited,
80% relative humidity.
Better than 140 db, open-circuited,
50% relative humidity.
Better than 120 db, open-circuited,
80% relative humidity.

AC COMMON MODE REJECTION (below 100 kHz)

100 volts rms or 120 db greater than end scale, whichever is less, will effect reading less than 2% of end scale. Input open-circuited.

AC NORMAL MODE REJECTION (60 Hz and above)

AC voltages 60 db above end scale will effect reading less than 2% of end scale. Maximum ac voltage not to exceed 750 volts rms.

RECORDER OUTPUT

0-1 volt, one side at chassis ground; linear to 0.5% of end scale. Source impedance, 5k to 7.5k. Response time is approximately half that of the meter, therefore noise may exceed meter noise by 6 db.

STABILITY OF ZERO

Better than 0.15 microvolt/hour.
Better than 0.3 microvolt/day.

TEMPERATURE COEFFICIENT OF ZERO

Less than 0.1 microvolt/°C from 15° C to 35° C.
Less than 0.2 microvolt/°C from 0° C to 50° C.

ZERO CONTROL RANGE

± 5 microvolt minimum.

OVERLOAD PROTECTION

Up to 1100 volts dc may be applied on any range. Typical recovery time is 4 seconds.

INPUT POWER

Model 845A

115/230 volts ac $\pm 10\%$, 50 to 440 Hz, approximately 3 watts.

Model 845AB

Rechargeable battery or 115/230 volts ac $\pm 10\%$, 50 to 440 Hz, approximately 6 watts during recharge (40 hours operation on full charge, batteries trickle-charged while instrument operates from line power).

RELATIVE HUMIDITY RANGE

0 to 80%.

SHOCK

Meets hammer blow requirements of MIL-T-945A and MIL-S-901B.

VIBRATION

Meets 10 Hz to 55 Hz tests of MIL-T-945A.

1-5. ENVIRONMENTAL SPECIFICATIONS

OPERATING TEMPERATURE RANGE

Within all specifications from 15°C to 35°C.

Within all specifications from 0°C to 50°C except:

Maximum noise and meter response time - derated by a factor of two.

DC Common Mode Rejection - derated by 20 db.

STORAGE TEMPERATURE RANGE

Model 845A -40°C to +70°C.

Model 845AB -40°C to +60°C.

1-6 MECHANICAL SPECIFICATIONS

MOUNTING

Resilient feet provide for bench and portable use. For side-by-side EIA rack mounting of two units, add Adapter Kit 881A-103 (includes handle-brackets and key plate). For EIA rack mounting of a single unit, add Adapter Kit 881A-102.

WEIGHT

Model 845A 9 pounds.

Model 845AB 10-1/4 pounds.

SIZE

8 inches high by 8-1/2 inches wide by 9 inches deep.

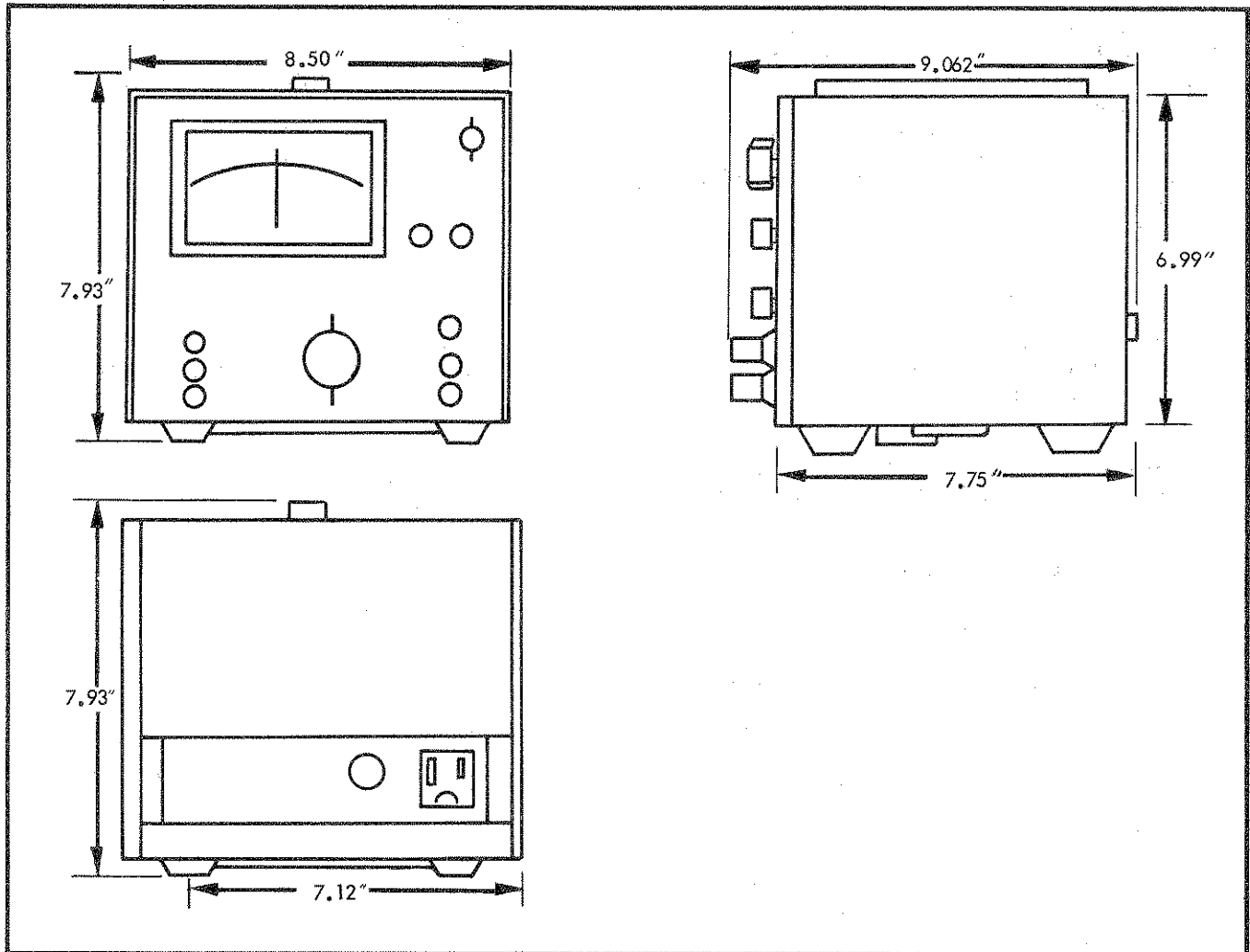

Figure 1-1. MODEL 845 OUTLINE DRAWING



static awareness



A Message From
John Fluke Mfg. Co., Inc.

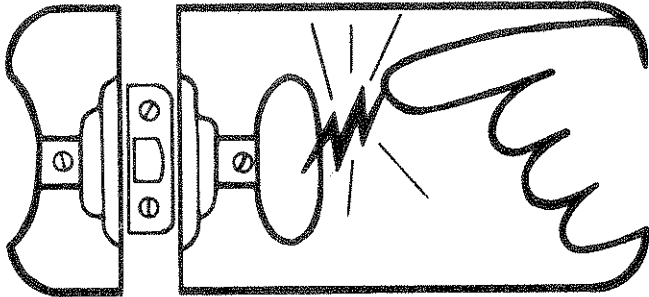

Some semiconductors and custom IC's can be damaged by electrostatic discharge during handling. This notice explains how you can minimize the chances of destroying such devices by:

1. Knowing that there is a problem.
2. Learning the guidelines for handling them.
3. Using the procedures, and packaging and bench techniques that are recommended.

The Static Sensitive (S.S.) devices are identified in the Fluke technical manual parts list with the symbol



The following practices should be followed to minimize damage to S.S. devices.

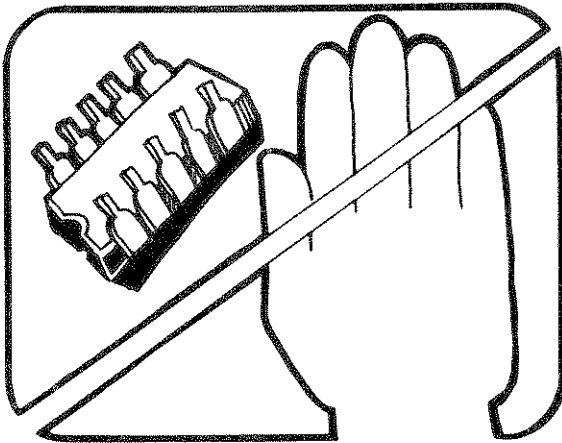

1. MINIMIZE HANDLING

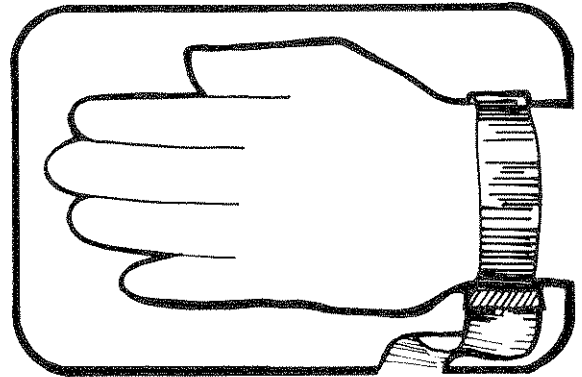

3. DISCHARGE PERSONAL STATIC BEFORE HANDLING DEVICES

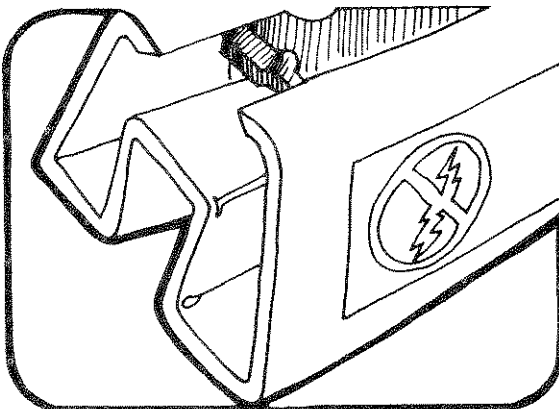

2. KEEP PARTS IN ORIGINAL CONTAINERS UNTIL READY FOR USE.

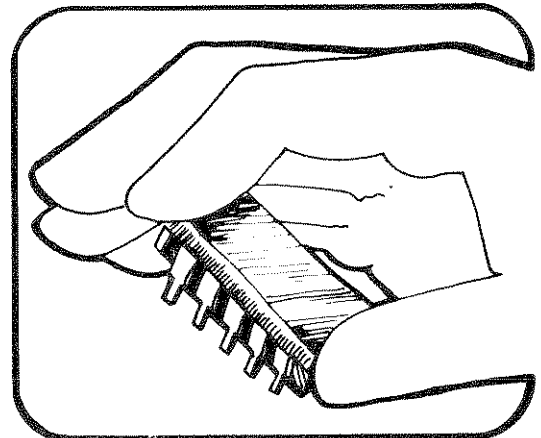

4. HANDLE S.S. DEVICES BY THE BODY

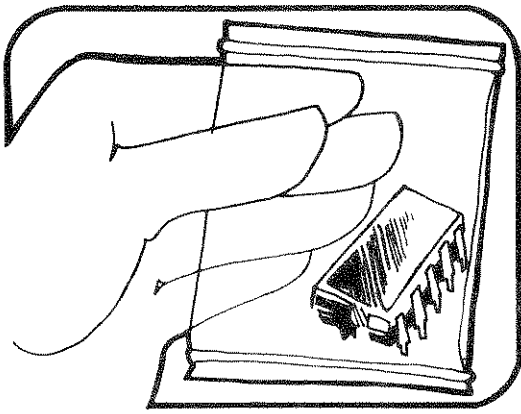

5. USE ANTI-STATIC CONTAINERS FOR HANDLING AND TRANSPORT

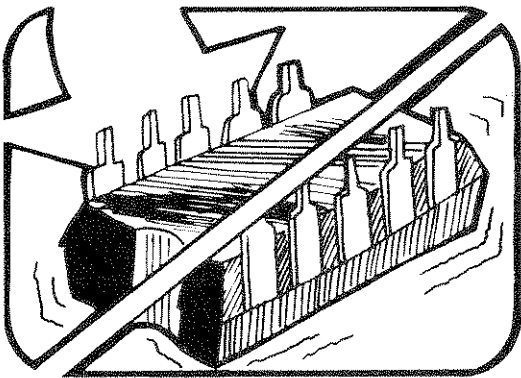

6. DO NOT SLIDE S.S. DEVICES OVER ANY SURFACE

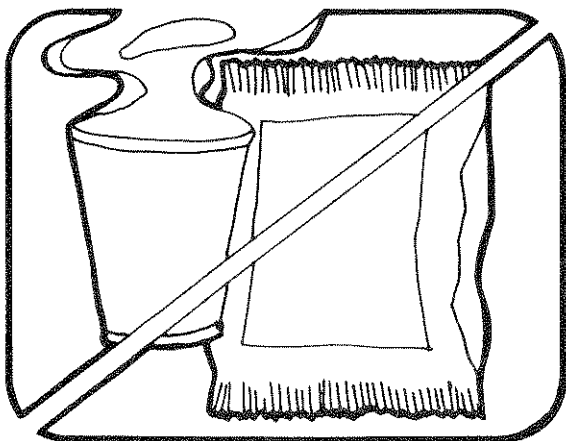

7. AVOID PLASTIC, VINYL AND STYROFOAM® IN WORK AREA

PORTIONS REPRINTED
WITH PERMISSION FROM TEKTRONIX, INC.
AND GENERAL DYNAMICS, POMONA DIV.

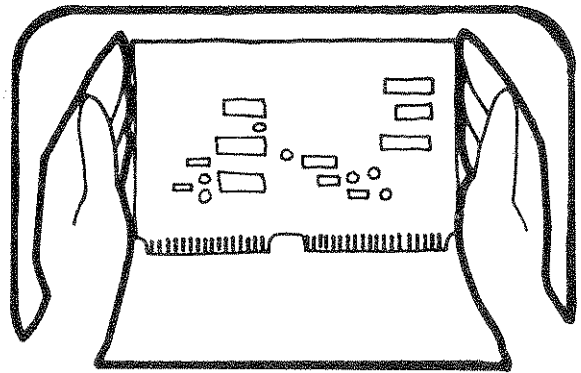

8. WHEN REMOVING PLUG-IN ASSEMBLIES, HANDLE ONLY BY NON-CONDUCTIVE EDGES AND NEVER TOUCH OPEN EDGE CONNECTOR EXCEPT AT STATIC-FREE WORK STATION. PLACING SHORTING STRIPS ON EDGE CONNECTOR USUALLY PROVIDES COMPLETE PROTECTION TO INSTALLED SS DEVICES.

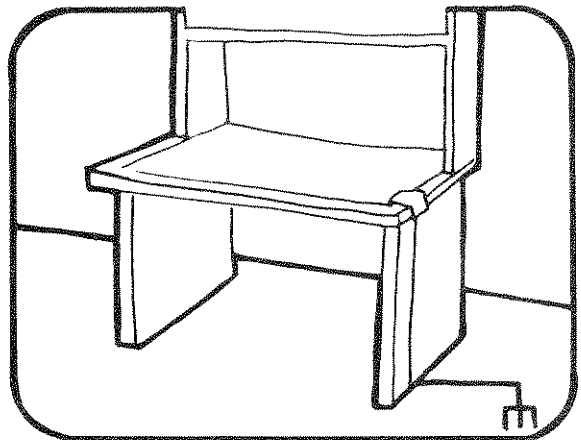

9. HANDLE S.S. DEVICES ONLY AT A STATIC-FREE WORK STATION
10. ONLY ANTI-STATIC TYPE SOLDER-SUCKERS SHOULD BE USED.
11. ONLY GROUNDED TIP SOLDERING IRONS SHOULD BE USED.

Anti-static bags, for storing S.S. devices or pcbs with these devices on them, can be ordered from the John Fluke Mfg. Co., Inc.. See section 5 in any Fluke technical manual for ordering instructions. Use the following part numbers when ordering these special bags.

John Fluke Part No.	Description
680892	5" x 8" Bag
680934	8" x 10" Bag
680942	8" x 12" Bag
680983	12" x 16" Bag
681023	18" x 18" Bag

Pink Poly Sheet	Wrist Strap
30" x 60" x 60 Mil	P/N TL6-60
P/N RC-AS-1200	\$7.00
\$20.00	

SECTION II

OPERATING INSTRUCTIONS

2-1. INTRODUCTION

2-2. This section of the manual contains information necessary to operate the Model 845 High Impedance Voltmeter-Null Detector. Should any difficulties be encountered during operation of your instrument, feel free to contact your nearest John Fluke Sales Representative or write directly to the John Fluke Mfg. Co. Inc.

2-3. CONTROLS, TERMINALS, AND INDICATOR

2-4. The location and function of the front-panel controls are described in Figure 2-1. Detailed operating descriptions are given in the following paragraphs.

2-5. PRELIMINARY OPERATION

2-6. Connect the Model 845 line plug to a 115 volt ac power outlet or to 230 volts ac, if the instrument is so wired. If your instrument is a Model 845A, proceed with steps a and b. If your instrument is a Model 845AB, check the batteries as outlined in paragraph 2-7. Upon completion of a satisfactory battery check, proceed with steps c and d.

WARNING!

The round pin on the polarized three-prong plug connects the instrument case to power system ground. Use a three-to-two pin adapter when connecting to a two-contact outlet. For personnel safety, connect the short lead from the adapter to a high-quality earth ground.

a. Place the Model 845A controls as follows:

POWER	ON
RANGE	10 MICROVOLTS
OPR	ZERO

b. Adjust the ZERO control for an initial zero meter deflection. Place the RANGE switch to the 1 MICROVOLT RANGE and re-zero with the ZERO control.

c. Place the Model 845AB controls as follows:

POWER	LINE OPR or BAT OPR
RANGE	10 MICROVOLTS
OPR	ZERO

d. Adjust the ZERO control for an initial zero meter deflection. Place the RANGE switch to the 1 MICROVOLT RANGE and re-zero with the ZERO control.

2-7. MODEL 845AB BATTERY CHECK

2-8. The Model 845AB batteries must be in the proper charge state for the instrument to operate properly in the BAT OPR mode. To check the batteries proceed as follows:

- a. Place the POWER switch to BAT CHK position.
- b. The Model 845AB meter needle should deflect within the BATTERY OK region. If the meter needle does not stay within the BATTERY OK region for at least 10 seconds, charge the batteries as indicated in paragraph 2-9. If the batteries are adequately charged, refer to paragraph 2-5.

2-9. MODEL 845AB BATTERY CHARGING

2-10. If the Model 845AB is left in the BAT OPR mode for an extended period of time, the batteries will become discharged. If the batteries are fully discharged, the instrument will not operate properly in the LINE OPR mode until the battery voltage can be brought up to 3/4 of full voltage. This will require about 15 minutes of charging. To charge the Model 845AB batteries proceed as follows:

- a. Connect the line plug to a 115 volt ac power outlet or to 230 volts ac, if the instrument is so wired.
- b. Place the POWER switch to BAT-CHG LINE OPR. After 16 hours the batteries will be fully charged and capable of operating the instrument for at least 40 hours.

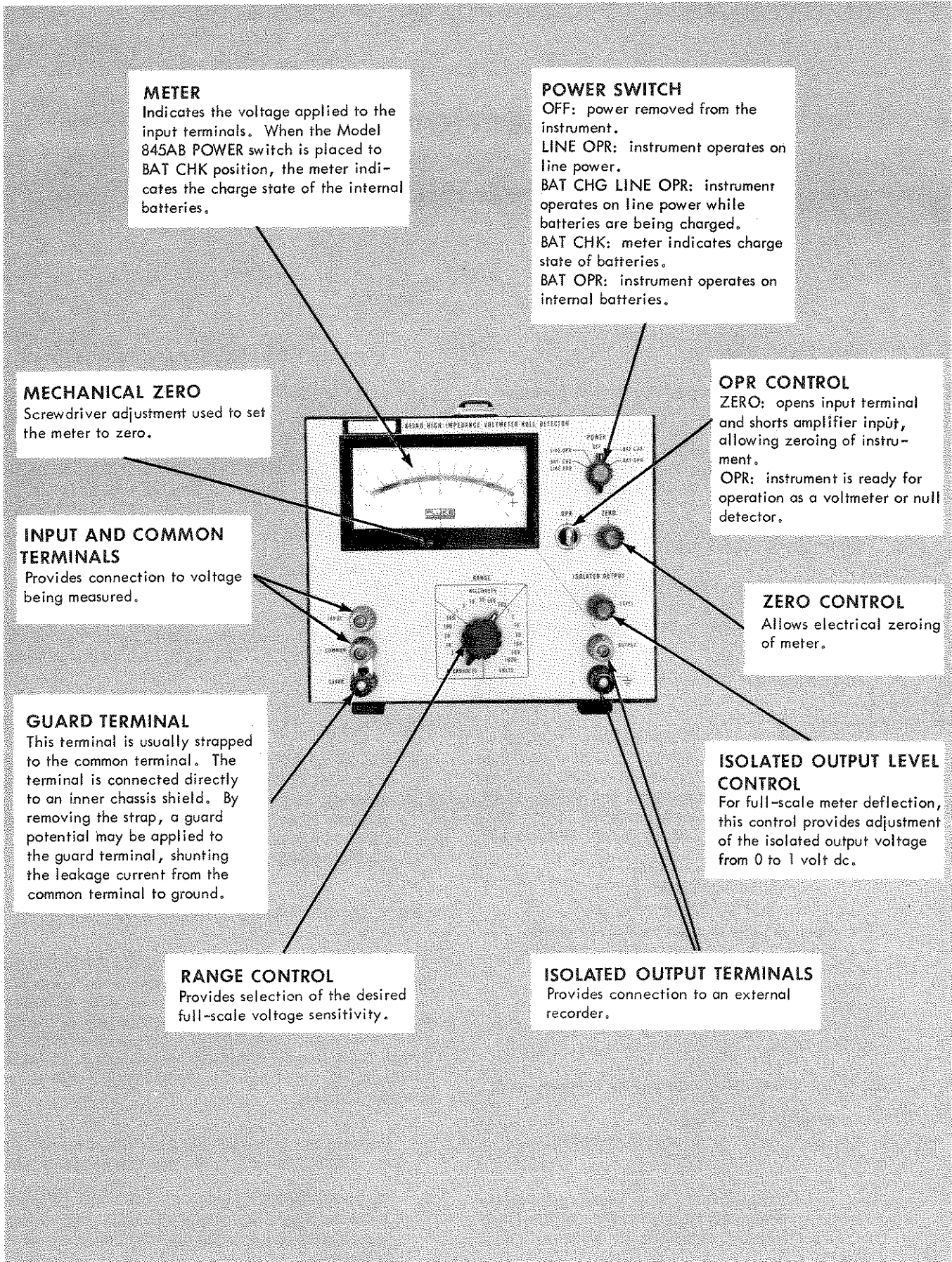

Figure 2-1. CONTROLS, TERMINALS, AND INDICATORS

2-11. MECHANICAL ZEROING

2-12. It may be necessary to adjust the mechanical zero control of the Model 845 at more frequent intervals than complete calibration. To mechanically zero the instrument proceed as follows:

- Place the RANGE switch to 1000 VOLTS and the POWER switch to ON or to LINE OPR.
- Adjust the mechanical zero adjustment screw for zero meter deflection.
- Place the RANGE switch to 10 MICROVOLTS and electrically zero the instrument as outlined in paragraph 2-5.
- Repeat steps a through c until the meter is mechanically and electrically zeroed.

2-13. OPERATION AS A HIGH IMPEDANCE VOLTMETER

2-14. To operate the Model 845 as a High Impedance Voltmeter, perform the preliminary operations according to paragraph 2-5 and proceed as follows:

- Place the controls as follows:

POWER	ON/LINE OPR or BAT OPR
OPR	OPR
RANGE	1000 VOLTS

Note!

When measuring voltages in the microvolt ranges, use copper wire having low thermal EMF's.

- Connect the voltage to be measured to the Model 845 INPUT terminal and connect the common point of the voltage being measured to the Model 845 COMMON terminal.
- Deflection of the meter indicates the polarity and magnitude of the measured voltage. Increase the sensitivity of the Model 845 for maximum on-scale deflection.

2-15. OPERATION AS A NULL DETECTOR

2-16. The Model 845 may be used to monitor small voltage differences in bridge circuits, potentiometers, and other measuring apparatus. In most of these applications the circuits are adjusted for zero deflection or a null on the Model 845. Equipment connections for various types of null detector configurations are illustrated by Figure 2-2 through 2-4. To operate the Model 845 as a Null Detector perform the preliminary operations according to paragraph 2-5 and proceed as follows:

- Select the desired equipment application as illustrated by Figure 2-2 through 2-4 and make the appropriate equipment connections.

- Place the Model 845 controls as follows:

POWER	ON/LINE OPR or BAT OPR
OPR	OPR
RANGE	as desired

- Adjust the circuit being measured for zero or a null deflection on the Model 845 meter.

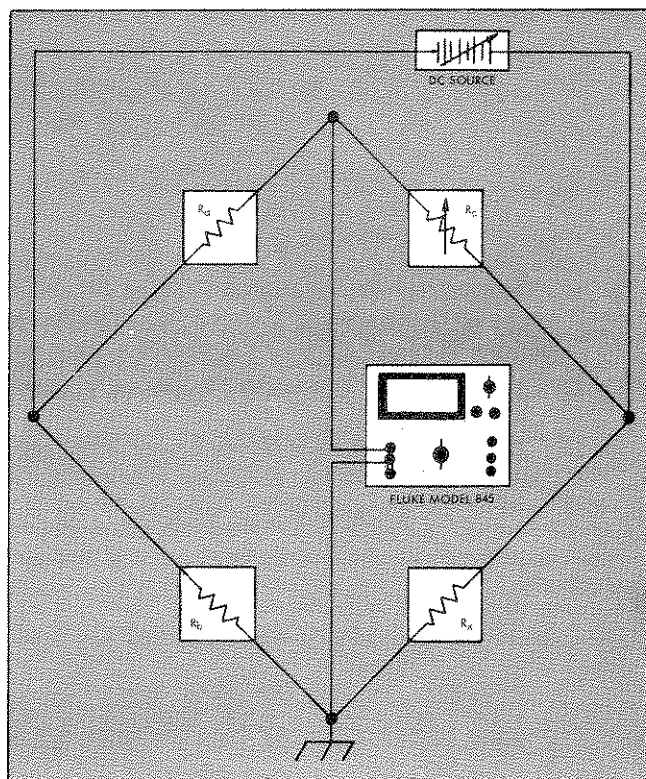

Figure 2-2. BRIDGE DETECTOR-FLOATING SUPPLY

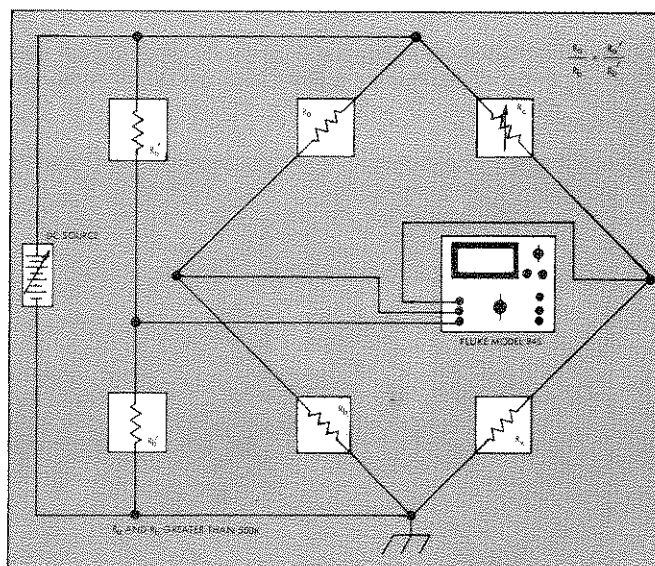

Figure 2-3. BRIDGE DETECTOR-HIGH RESISTANCE

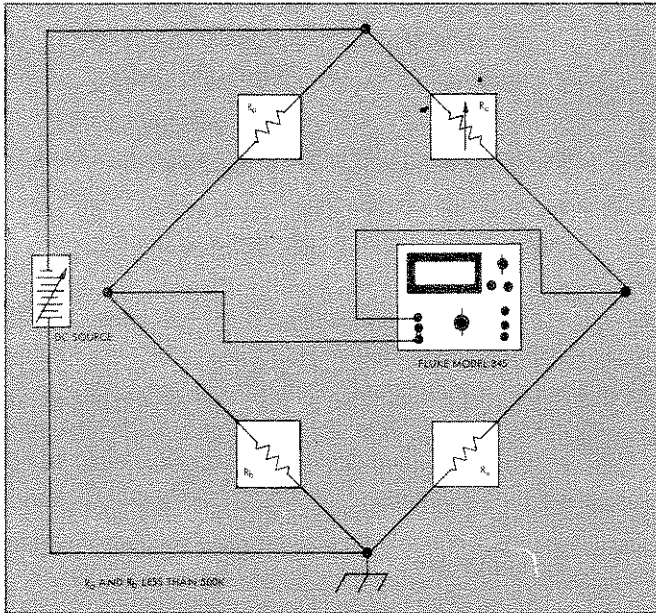

Figure 2-4. BRIDGE DETECTOR-FLOATING NULL DETECTOR

2-17. MEASURING VOLTAGES WITH A STANDARD CELL

2-18. The Model 845 may be used with a voltage divider and a standard cell to calculate unknown voltages with a high degree of accuracy. Connect the equipment as illustrated in Figure 2-5. Perform the preliminary operation as outlined in paragraph 2-5 and proceed as follows:

- a. Place the Model 845 controls as follows:

POWER	ON/LINE OPR or BAT OPR
OPR	OPR
RANGE	as desired

- b. Adjust the voltage divider for zero or null deflection on the Model 845 meter while placing the RANGE switch to successively more sensitive ranges.
- c. Calculate the unknown voltage by dividing the standard cell voltage by the final division ratio of the divider.

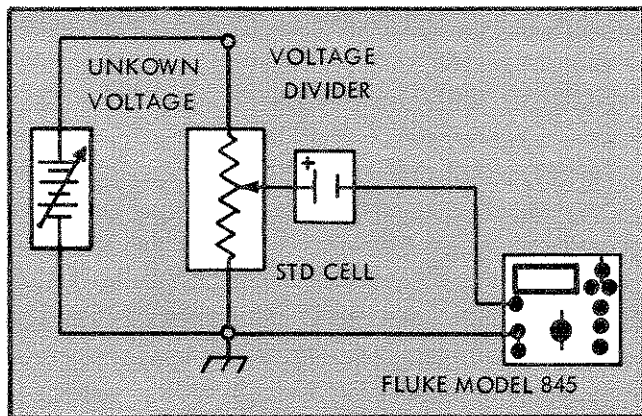

Figure 2-5. STANDARD CELL VOLTAGE MEASUREMENTS

2-19. USE OF ISOLATED OUTPUT

2-20. DC ISOLATION AMPLIFIER

2-21. The Model 845 may be used as a dc isolation amplifier having a voltage gain of up to 120 db, depending on the settings of the RANGE switch and the OUTPUT LEVEL control. To compute the maximum voltage gain on any range of the Model 845, use the following formula:

$$\text{Voltage gain in db} = 20 \log_{10} \frac{1 \text{ volt (maximum isolated output)}}{\text{RANGE (in volts)}}$$

2-22. RECORDER OUTPUT

2-23. The Model 845 ISOLATED OUTPUT may be used to provide an output voltage, adjustable from zero to one volt for a full-scale meter deflection for use with a recorder. Since the output is isolated from the input, floating measurements can be made without the use of a floating recorder. To use the adjustable recorder output, proceed as follows:

- a. Connect the recorder to the ISOLATED OUTPUT terminals.

Note!

The lower ISOLATED OUTPUT terminal is connected to chassis ground. If a ground reference is undesirable, disconnect the green wire between the power supply circuit board and the grounding pin on the ac line plug. Refer to Figure 2-6 for wire location.

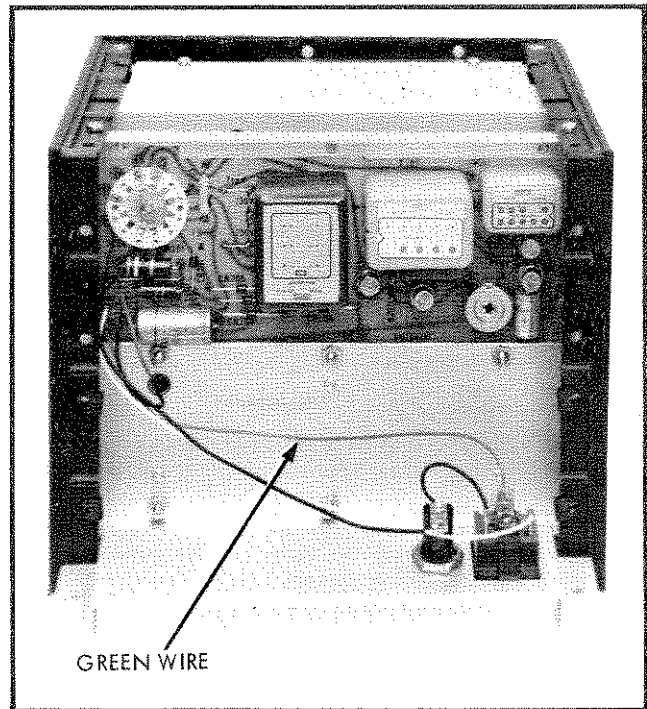

Figure 2-6. CHASSIS GROUND-WIRE LOCATION

- b. Turn the recorder on.
- c. Proceed as outlined in paragraph 2-13 or 2-15, as desired.
- d. Adjust the ISOLATED OUTPUT LEVEL control for the desired output to the recorder. This control has a log taper so that smooth control is possible at both high and low settings.

Note!

The ISOLATED OUTPUT current capability is 100 microamperes with a 5 kilohm source impedance.

2-24. OPERATING NOTES

2-25. SPURIOUS VOLTAGES AND CURRENTS

2-26. Voltage measurements at the microvolt level involve the persistent problems of thermoelectric effects. These effects may be compensated for by temporarily disconnecting the voltage from the circuit under measurement and noting the meter deflection of the Model 845 on the desired range. This reading must then be subtracted from all subsequent voltage measurements. A thorough understanding of these effects can lead to reducing or eliminating them completely.

2-27. THERMOELECTRIC VOLTAGES

2-28. If a circuit is composed of two dissimilar metals, a net voltage will result if the two dissimilar junctions are maintained at different temperatures. These thermoelectric voltages, also known as thermals, thermocouple voltages, or Seebeck voltages, can be reduced by using metals having low thermoelectric potentials and keeping all junctions at the same temperature. The terminals of the Model 845 are made of pure copper, gold-flashed to prevent tarnish. For lowest thermal voltages, all connections to the Model 845 should be made with pure copper wire. Silver plated copper or solder coated copper also produce satisfactory results. Tinned copper is less satisfactory than silver plated or solder coated copper. Nickel and nickel-based alloys are not suitable for connections to the instrument. Excellent results can be obtained using ordinary TV twin lead, or even lamp cord if high insulation resistance is not required. If shielding is necessary, use a length of flat braid over the cable.

2-29. HIGH SOURCE IMPEDANCE

2-30. Due to the very high input resistance and extreme sensitivity of the Model 845, it is charge sensitive. Thus, a person's body potential, an electrostatic voltage, can cause charge redistribution at the input to the instrument and result in meter needle deflection as a hand approaches the input terminals. Careful shielding will eliminate this problem. Also, due to charges that may be deposited on the input terminals when the OPR switch is set to ZERO, an appreciable transient will result when the switch is set to OPR if nothing is connected to the input terminals. Turning the switch back

and forth will dissipate this charge, eliminating the problem. With a high source impedance, the response of the instrument is unavoidably slow due to the low pass filter used to suppress superimposed noise. However, the design of the low pass filter is such that common mode rejection is extremely high while the response time for the normally encountered low source impedances is very fast.

2-31. OVERLOAD VOLTAGES

2-32. The instrument is designed to withstand up to 1100 volts dc or 1100 volts peak ac continuously applied between any two of the three input terminals, or between cabinet ground and any of the three input terminals, regardless of the setting of the RANGE or OPR switch. However, repeated or continuous overloads above 200 volts in the ranges below 3 millivolts will result in excessive dissipation in the protective, low-pass-filter resistor R110. This will result in thermal voltages which may take several minutes to subside after the overload is removed.

2-33. GUARDING

2-34. The instrument has an inner chassis connected to the GUARD terminal on the front panel. Ordinarily, this GUARD terminal is strapped to the COMMON terminal. When connected in this way, the inner chassis serves as a shield. This greatly improves the leakage resistance to ground and the common mode rejection. However, since the inner chassis is available at the GUARD terminal, it may be driven at the same voltage as the COMMON terminal. This further increases the leakage resistance and common mode rejection by about ten times. The voltage used to drive the GUARD terminal should be obtained from a separate source or by means of a voltage divider connected directly across the source so that the leakage currents do not cause voltage drops across impedances in the circuit under measurement.

2-35. INCREASING INPUT RESISTANCE

2-36. In the 1 microvolt to 1 millivolt ranges, a 10 megohm resistor is connected directly across the input of the instrument. The input resistance may be increased on these ranges by disconnecting the 10 megohm resistor where it attaches to the RANGE switch. However, the input resistance will no longer be well defined. Typical input resistances with the 10 megohm resistor removed, are as follows:

RANGE	INPUT RESISTANCE
1 microvolt	300 megohms
3 microvolt	1000 megohms
10 microvolt	3000 megohms
30 microvolt to 1 millivolt	10,000 megohms

