

# 8508A

Reference Multimeter

Users Manual

PN 1673798

July 2002 Rev. 6, 3/13

© 2002-2013 Fluke Corporation, All rights reserved. Printed in UK. Specifications are subject to change without notice.

All product names are trademarks of their respective companies.

## LIMITED WARRANTY AND LIMITATION OF LIABILITY

Each Fluke product is warranted to be free from defects in material and workmanship under normal use and service. The warranty period is one year and begins on the date of shipment. Parts, product repairs, and services are warranted for 90 days. This warranty extends only to the original buyer or end-user customer of a Fluke authorized reseller, and does not apply to fuses, disposable batteries, or to any product which, in Fluke's opinion, has been misused, altered, neglected, contaminated, or damaged by accident or abnormal conditions of operation or handling. Fluke warrants that software will operate substantially in accordance with its functional specifications for 90 days and that it has been properly recorded on non-defective media. Fluke does not warrant that software will be error free or operate without interruption.

Fluke authorized resellers shall extend this warranty on new and unused products to end-user customers only but have no authority to extend a greater or different warranty on behalf of Fluke. Warranty support is available only if product is purchased through a Fluke authorized sales outlet or Buyer has paid the applicable international price. Fluke reserves the right to invoice Buyer for importation costs of repair/replacement parts when product purchased in one country is submitted for repair in another country.

Fluke's warranty obligation is limited, at Fluke's option, to refund of the purchase price, free of charge repair, or replacement of a defective product which is returned to a Fluke authorized service center within the warranty period.

To obtain warranty service, contact your nearest Fluke authorized service center to obtain return authorization information, then send the product to that service center, with a description of the difficulty, postage and insurance prepaid (FOB Destination). Fluke assumes no risk for damage in transit. Following warranty repair, the product will be returned to Buyer, transportation prepaid (FOB Destination). If Fluke determines that failure was caused by neglect, misuse, contamination, alteration, accident, or abnormal condition of operation or handling, including overvoltage failures caused by use outside the product's specified rating, or normal wear and tear of mechanical components, Fluke will provide an estimate of repair costs and obtain authorization before commencing the work. Following repair, the product will be returned to the Buyer transportation prepaid and the Buyer will be billed for the repair and return transportation charges (FOB Shipping Point).

THIS WARRANTY IS BUYER'S SOLE AND EXCLUSIVE REMEDY AND IS IN LIEU OF ALL OTHER WARRANTIES, EXPRESS OR IMPLIED, INCLUDING BUT NOT LIMITED TO ANY IMPLIED WARRANTY OF MERCHANTABILITY OR FITNESS FOR A PARTICULAR PURPOSE. FLUKE SHALL NOT BE LIABLE FOR ANY SPECIAL, INDIRECT, INCIDENTAL, OR CONSEQUENTIAL DAMAGES OR LOSSES, INCLUDING LOSS OF DATA, ARISING FROM ANY CAUSE OR THEORY.

Since some countries or states do not allow limitation of the term of an implied warranty, or exclusion or limitation of incidental or consequential damages, the limitations and exclusions of this warranty may not apply to every buyer. If any provision of this Warranty is held invalid or unenforceable by a court or other decision-maker of competent jurisdiction, such holding will not affect the validity or enforceability of any other provision.

Fluke Corporation  
P.O. Box 9090  
Everett, WA 98206-9090  
U.S.A.

Fluke Europe B.V.  
P.O. Box 1186  
5602 BD Eindhoven  
The Netherlands

11/99

To register your product online, visit [register.fluke.com](http://register.fluke.com)

# Table of Contents

Chapter	Title	Page
<b>1</b>	<b>Introduction and Safety Information.....</b>	<b>1-1</b>
	Introduction.....	1-3
	How to Contact Fluke.....	1-3
	Unpacking and Inspection.....	1-4
	Standard Accessories.....	1-4
	Optional Accessories.....	1-5
	Storing and Shipping the Multimeter.....	1-6
	Line Voltage.....	1-6
	Power Voltage Selector and Fuses.....	1-6
	Changing Supply Voltage or Replacing Line Fuse.....	1-6
	Calibration Enable Switch.....	1-7
	System Use.....	1-7
	Safety Considerations and Symbols.....	1-7
	General Safety Summary.....	1-7
	Safety Information.....	1-8
	Symbols.....	1-10
	Protection Class I.....	1-11
	Protective Earth/Ground.....	1-11
	Do Not Operate Without Covers.....	1-11
	Safe Operating Conditions.....	1-11
	Fuse Requirements.....	1-12
	Rear Panel Detail.....	1-12
	The Power Cable and Power Supply Disconnection.....	1-12
	Terminal Connections.....	1-13
	Measurement Category I.....	1-13
	Maintenance and Repair.....	1-13
	Moving and Cleaning.....	1-13
<b>2</b>	<b>Getting Acquainted with the Basics.....</b>	<b>2-1</b>
	Introduction.....	2-3
	Input Terminals.....	2-3
	The Front Panel Displays.....	2-4
	Front Panel Keys.....	2-4
	Soft-Keys and Manual Conventions.....	2-4
	Numeric Keyboard.....	2-5

Exiting a Menu .....	2-5
Major Function Keys .....	2-5
Direct Action Keys .....	2-6
Mode Keys .....	2-6
Rear Panel .....	2-7
Labels .....	2-7
Fuses .....	2-7
Voltage Selector .....	2-7
Power Input and Power Switch .....	2-7
Calibration Switch .....	2-7
Rear Panel Connectors and Pin Designations .....	2-8
Rear Inputs .....	2-8
External Trigger Input .....	2-8
IEEE 488 Input/Output .....	2-8
Power-On Configuration .....	2-8
The 8508A-LEAD Measurement Lead Kit .....	2-9

### **3 Making Measurements ..... 3-1**

Introduction .....	3-3
Making Connections to the Multimeter -- General Guidelines .....	3-4
Using the Measurement Functions .....	3-5
DC Voltage .....	3-5
Measuring DC Voltage .....	3-7
Making Input Connections .....	3-7
AC Voltage .....	3-8
Measuring AC Voltage .....	3-11
Induced Interference .....	3-11
Common Mode Rejection .....	3-11
Lead Considerations .....	3-11
Resistance .....	3-11
High Voltage Ohms .....	3-13
True Ohms .....	3-15
Measuring Resistance .....	3-17
2-Wire Measurements .....	3-17
4-wire Measurements .....	3-17
4-wire High Resistance Measurements .....	3-18
4-wire Resistance Zero .....	3-18
$\Omega$ Guard .....	3-19
DC Current .....	3-21
Measuring DC Current .....	3-22
AC Current .....	3-23
Measuring AC Current .....	3-24
Temperature .....	3-25
Measuring Temperature .....	3-28
Multimeter Inputs .....	3-29
Input .....	3-29
Using the INPUT Key .....	3-29
SCAN OPERATIONS .....	3-30
Tru Ohms Ratio .....	3-31
Monitoring Modes .....	3-32
Monitor Key .....	3-32
Displaying Signal Frequency .....	3-32
Displaying Standard Deviation .....	3-32
Devn Menu .....	3-32

Displaying Maximum, Minimum, and Peak-to-Peak Readings .....	3-33
MAX Menu .....	3-33
Limit-Checking .....	3-33
Monitor Menu Tree .....	3-34
Utility .....	3-34
Using the Selftest Functions .....	3-37
Test Menu Tree.....	3-38
Test Key .....	3-39
Using the Math Functions.....	3-40
Math Functions and Menu Tree.....	3-40
Math Configuration .....	3-41
Clear Functions .....	3-42
<b>4 Remote Operations Using the IEEE 488 Interface .....</b>	<b>4-1</b>
Introduction.....	4-3
Interface Capability: IEEE Standards 488.1 and 488.2 .....	4-3
The Multimeter in IEEE 488.2 Terminology .....	4-3
Programming Options .....	4-3
Capability Codes .....	4-3
Interconnections.....	4-4
Using the 8508A Reference Multimeter in a System .....	4-5
Setting the Multimeter Address.....	4-5
Remote Operation General Considerations .....	4-5
Syntax Diagrams in this Manual .....	4-5
The 8508A Status Reporting Structure.....	4-8
Types of Status Information Available.....	4-9
Syntax Diagrams of Major 8508A Functions.....	4-10
DC Voltage.....	4-10
AC Voltage.....	4-11
Resistance: Normal OHMS .....	4-13
Resistance: High Voltage OHMS.....	4-14
Resistance: True OHMS.....	4-15
DC Current .....	4-16
AC Current .....	4-17
Using Platinum Resistance Thermometers to obtain Temperature. ....	4-18
Determine the PRT identity.....	4-18
Entering or Editing the Characteristics of a PRT to Non-volatile Store.....	4-19
Recalling the Characteristics of a Known PRT .....	4-20
Deleting a Known PRT from the Non-volatile Store .....	4-20
Input.....	4-21
Guard .....	4-21
Measurement Gate Width.....	4-22
Maximum, Minimum and Peak-Peak .....	4-22
Limits.....	4-24
Recall Limits .....	4-24
Enable Limits.....	4-24
Standard Deviation .....	4-25
Syntax Diagrams of Math Functions .....	4-25
Averaging .....	4-25
Multiplication .....	4-27
Subtraction.....	4-28
Division .....	4-29
Decibel Calculations.....	4-30
Syntax Diagram of Test .....	4-31

Selftest .....	4-31
Device Errors and Syntax Diagrams.....	4-31
Error Detection .....	4-31
Recall Device Errors.....	4-32
Triggering and Reading Operations.....	4-33
Trigger Source Selector.....	4-33
Execute Trigger .....	4-34
Execute Trigger and Take a Reading .....	4-34
Settling Delay .....	4-34
Input Zero .....	4-36
Wait .....	4-36
Reading Recall.....	4-36
Access to the Internal Buffer Memory .....	4-37
Internal Operations Commands .....	4-39
Reset .....	4-39
Complete Operations .....	4-40
Status Reporting.....	4-40
Instrument I/D and Setup.....	4-44
Calibration Commands and Messages.....	4-46
Calibration Sequences .....	4-46
Protected User Data.....	4-48
Special Calibrations.....	4-49
<b>5 Specifications .....</b>	<b>5-1</b>
Specifications.....	5-3
General Specifications.....	5-3
Maximum Voltage and Current Inputs.....	5-4
DC and AC Voltage .....	5-4
DC and AC Current.....	5-4
Resistance and Temperature .....	5-4
Electrical Measurement Specifications.....	5-5
DC Current .....	5-6
AC Voltage.....	5-7
AC Current .....	5-9
Resistance.....	5-11
Temperature.....	5-13
Read Rate and Additional Uncertainty .....	5-14
Applying the Specifications.....	5-15
Introduction .....	5-15
Absolute and Relative Specifications .....	5-15
Applying User's Calibration Uncertainties .....	5-16
Operating and Calibration Temperature Ranges .....	5-16
Applying Temperature Coefficient Specifications .....	5-16
Ratio Measurements .....	5-17
Additional Errors.....	5-17
<b>6 Adjustment and Verification.....</b>	<b>6-1</b>
Introduction.....	6-3
Adjustment Overview .....	6-3
Adjustment Interval and Performance .....	6-3
Adjustment Points.....	6-3
Non-Nominal Values.....	6-4
Enabling Access to Calibration Adjustment Mode.....	6-4
Calibration Menus.....	6-4

Accessing the Calibration Menus and Calibration Mode .....	6-4
Calibration Menu .....	6-5
SET VALUE Menu .....	6-5
SPOT CAL Menu .....	6-6
SPOT (1 to 6) RMS Menus .....	6-6
SPOT FREQUENCY (1 to 6) Menu .....	6-7
Special Calibration .....	6-7
SPCL Menu .....	6-7
SER # Menu .....	6-8
Hvlin Menu .....	6-8
Non-volatile input offset compensation .....	6-9
Routine Adjustment .....	6-9
Equipment Required for Adjustment .....	6-10
Preparing for Adjustment .....	6-11
Interconnections .....	6-12
ADC Adjustment .....	6-14
DC Voltage Adjustment .....	6-14
AC Voltage Adjustment .....	6-17
Resistance Adjustment .....	6-19
AC Current Adjustment .....	6-30
Frequency Adjustment .....	6-32
Cal Due Date Entry .....	6-32
Non-Volatile Input Offset Adjustment .....	6-33
ACV Spot Frequency Adjustment .....	6-34
Performance Verification .....	6-35
Equipment Requirements .....	6-36
Interconnections .....	6-36
Applicable Verification Tolerance and Conditions .....	6-36
Preparation .....	6-37
DC Voltage Checks .....	6-37
AC Voltage Checks .....	6-40
Resistance Checks .....	6-42
Normal $\Omega$ Checks .....	6-44
Normal LoI $\Omega$ checks .....	6-44
Tru $\Omega$ checks .....	6-44
Tru $\Omega$ LoI checks .....	6-44
HiV $\Omega$ checks .....	6-44
DC Current Checks .....	6-46
AC Current Checks .....	6-48
Frequency Checks .....	6-50

**Appendices**

A Error Codes and Message .....	A-1
B Rack Mount Kit .....	B-1
C Rack Mount Slide Kit .....	C-1





# List of Tables

Table	Title	Page
1-1.	Standard Accessories .....	1-4
1-2.	Additional Accessories for the Multimeter .....	1-5
1-3.	Power Input Fuse 1.....	1-12
1-4.	Current Function Rear Input Fuse 2.....	1-12
3-1.	Identifying and Avoiding Errors .....	3-4
3-1.	Additional Accessories for the Multimeter .....	3-19
4-1.	IEEE Interface Capability .....	4-4
4-2.	Delay Defaults for DCV, DCI, ACV, and ACI.....	4-35
4-3.	Delay Defaults for Ohms, Tru Ohms, and Hi Ohms .....	4-35
6-1.	Required Equipment for Calibration and Performance Verification.....	6-10
6-2.	Calibration Sequence .....	6-12
6-3.	DC Voltage Calibration Points and Sequence.....	6-15
6-4.	AC Voltage Calibration Points and Sequence.....	6-18
6-5.	Resistance Calibration Points and Sequence.....	6-20
6-6.	DC Current Calibration Points and Sequence .....	6-29
6-7.	AC Current Calibration Points and Sequence .....	6-31
6-8.	DC Voltage Verification Points and Sequence .....	6-39
6-9.	AC Voltage Verification Points and Sequence .....	6-41
6-10.	Resistance Verification Points and Sequence .....	6-45
6-11.	DC Current Verification Points and Sequence.....	6-47
6-12.	AC Current Verification Points and Sequence.....	6-49



# List of Figures

Figure	Title	Page
1-1.	Rear Panel - Power Input Fuse and line Power Locations .....	1-12
2-1.	Front Panel Displays .....	2-3
2-2.	Front and Rear Input Terminals .....	2-3
2-3.	Sample of the Main Display .....	2-4
2-4.	8508A Rear Panel Detail.....	2-7
2-5.	The 8508A-LEAD Measurement Lead Kit.....	2-10
3-1.	Simple Lead Connections .....	3-7
3-2.	Twisted-Pair Cable Connections.....	3-7
3-3.	External Guard Connections .....	3-7
3-4.	Internal Guard Connections .....	3-8
3-5.	2-Wire Measurements .....	3-17
3-6.	4-Wire Measurements .....	3-18
3-7.	4-Wire High Resistance Measurements .....	3-18
3-8.	Resistance Zero Measurements .....	3-19
3-9.	$\Omega$ Guard Measurements .....	3-20
3-10.	Internal Guard Connections .....	3-20
3-11.	PRT Connections .....	3-28
3-12.	Tru $\Omega$ Ratio Measurements .....	3-31
4-1.	IEEE 488 Input/Output Connector.....	4-4
4-2.	8508A Status Report Structure.....	4-8
6-1.	Equipment Connections Required for Calibration .....	6-13



# **Chapter 1**

## ***Introduction and Safety Information***

<b>Title</b>	<b>Page</b>
Introduction.....	1-3
How to Contact Fluke.....	1-3
Unpacking and Inspection.....	1-4
Standard Accessories.....	1-4
Optional Accessories.....	1-5
Storing and Shipping the Multimeter.....	1-6
Line Voltage.....	1-6
Power Voltage Selector and Fuses.....	1-6
Changing Supply Voltage or Replacing Line Fuse.....	1-6
Calibration Enable Switch.....	1-7
System Use.....	1-7
Safety Considerations and Symbols.....	1-7
General Safety Summary.....	1-7
Safety Information.....	1-8
Symbols.....	1-10
Protection Class I.....	1-11
Protective Earth/Ground.....	1-11
Do Not Operate Without Covers.....	1-11
Safe Operating Conditions.....	1-11
Fuse Requirements.....	1-12
Rear Panel Detail.....	1-12
The Power Cable and Power Supply Disconnection.....	1-12
Terminal Connections.....	1-13
Measurement Category I.....	1-13
Maintenance and Repair.....	1-13
Moving and Cleaning.....	1-13



## Introduction

The Fluke 8508A Reference Multimeter (hereafter "the Multimeter") is designed for the most demanding measurement applications and provides extremely high measurement precision in both stand-alone and systems applications.

Chapter 1 'Introduction and Safety Information' provides unpacking, storage and shipping instructions, line voltage, and safety information.

Chapter 2 'Getting Acquainted with the Basic' provides an introduction to the front panel keys operation and rear panel connector details.

Chapter 3 provides detailed access information to the full range of multimeter facilities, with suggestions for measurement techniques.

Chapter 4 provides detailed information for remote control access via the IEEE 488 interface.

Chapter 5 provides specification details for the multimeter.

Chapter 6 provides detailed information for access to calibration menus, suggested calibration methods and verification of the multimeter.

### **⚠⚠ Warning**

**To avoid electric shock, personal injury, or death, carefully read the information under *Safety Considerations* before attempting to install, use, or service the Multimeter.**

## How to Contact Fluke

To contact Fluke, call one of the following telephone numbers:

- Technical Support USA: 1-877-355-3225
- Calibration/Repair USA: 1-877-355-3225
- Canada: 1-800-36-FLUKE (1-800-363-5853)
- Europe: +31-40-2675-200
- Japan: +81-3-6714-3114
- Singapore: +65-6799-5566
- China: +86-400-810-3435
- Brazil: +55-11-3759-7600
- Anywhere in the world: +1-425-446-6110

To see product information and download the latest manual supplements, visit Fluke Calibration's website at [www.flukecal.com](http://www.flukecal.com).

To register your product, visit <http://flukecal.com/register-product>.

## Unpacking and Inspection

Every care is taken in the choice of packing material to ensure that your equipment will reach you in perfect condition.

If the equipment has been subject to excessive handling in transit, the fact will probably be visible as external damage to the shipping carton.

In the event of damage, the shipping container and cushioning material should be kept for the carrier's inspection.

Carefully unpack the equipment and check for external damage to the case, sockets etc. If the shipping container and packing material are undamaged, they should be retained for use in subsequent shipments. If damage is found notify the carrier and your sales representative immediately.

For orders of the model 8508A/01 check that the instrument has the six terminals on the rear panel for connection of signals.

## Standard Accessories

The standard accessories supplied with the instrument are shown in Table 1-1. The type of power cable supplied is determined at the time of ordering.

Table 1-2 lists additional accessories available for use with the Multimeter.

**Table 1-1. Standard Accessories**

Description	Location	Order Number
Power Cable	USA	LC1 284174
	UK	LC4 769455
	Europe	LC3 769422
	Swiss	LC5 769448
	India	LC7 782771
	China / Fiji / New Zealand	LC6 658641
	Brazil	LC42 3841347
General Purpose Probe Kit and Wallet comprising: 2x Test Leads with 4mm Safety shroud plugs (Red and Black)		1903307
2x Test Probe (Red and Black)		1907075
2x Crocodile clips (Red and Black)		1908153
2x 4w Zero PCB		2463103
Users Manual		1673798



**Optional Accessories**

**Table 1-2. Additional Accessories for the Multimeter**

Description	Order Number	
Rack Mount Kit	Y8508	1886215
Rack Mount Slide Kit	Y8508S	1886232
Platinum Resistance Probe, Case and certificate. R0 100 Ohms Hart 5626-15-S	8508A – PRT	1886194
Standard Platinum Resistance Probe, Case and certificate. R0 25.5 Ohms. Calibration by comparison Hart 5699 1920-4-7	8508A – SPRT	1886182
Accredited UKAS calibration	1883673	
Accredited NVLAP calibration	4022363	
Calibration Kit comprising 1G Ohm standard, 2x 4 wire Zero PCB and connecting lead for 5720A/5725	8508A-7000K	1886226
Mesurement Lead Kit and Wallet comprising: 4x Shielded leads with gold spades 1x High-current lead with gold spades 1x General Purpose Probe Kit (as above)	8508A – LEAD	1886203

Please note that accessories (except for Accredited Calibration) are generally shipped separately, please refer to the Packing List supplied with your 8508A.

## Storing and Shipping the Multimeter

The Multimeter should be stored under cover. The shipping container provides the most suitable receptacle for storage, as it provides the necessary shock isolation for normal handling operations.

Place the Multimeter inside a sealed bag. Place the bag into the cushioning material inside the shipping container, and put the whole package in a location that complies with the storage environment specification described in Chapter 5.

If the Multimeter is shipped, use the original shipping container if possible. It provides shock isolation for normal handling operations. Any other container should provide similar shock isolation to the following approximate internal packing dimensions (the front terminals should be free):

Container	Length	Width	Depth
Box	630 mm (25 in)	550 mm (22 in)	230 mm (9 in)
Cushioned	480 mm (19 in)	440 mm (17.3 in)	100 mm (4 in)

Place the instrument inside a sealed bag. Fit the bag into the cushioning material inside the shipping container, and secure the whole package.

## Line Voltage

### Power Voltage Selector and Fuses

The instrument is packed ready for use with a line voltage determined at the time of ordering.

8508A 115 or 8508A/01 115	For 100V to 120V supplies
8508A 240 or 8508A/01 240	For 200V to 240V supplies

### Changing Supply Voltage or Replacing Line Fuse

The integrated POWER SWITCH, POWER INPUT plug contain the fuse drawer which gives access to the line fuse and the line voltage selector.

Insert a small screwdriver blade in the narrow recess above the catch over the fuse drawer to gain access to the fuse and the voltage selector.

To change from one voltage to the other, remove the voltage selector block and rotate until the desired voltage faces outward. Refit the selector block and fit the corresponding fuse. Check that the desired voltage is visible in the cutout of the fuse drawer.

For 200 V to 240 V supplies 230 is shown in the voltage selector window on the rear panel.

For 100 V to 120 V supplies 115 is shown in the window.

Refer to Table 1-3 for full details of replacement Power Input fuse types.

## Calibration Enable Switch

This two-position switch on the rear panel protects the instrument calibration memory.

The instrument was initially calibrated at the factory and the switch covered with a calibration sticker, so the sticker and the switch should remain as delivered, until immediate recalibration is intended.

If the calibration menu is selected while the calibration switch is not in the enabled position, the menu is replaced by the warning message:

CALIBRATION DISABLED

## System Use

The Multimeter is designed as standard to form part of a system, conforming to IEEE 488.2 Standard Digital Interface. The Device Documentation Requirements of this standard are provided in Chapter 4.

## Safety Considerations and Symbols

This sections addresses safety considerations and describes symbols that appear on the Multimeter.

A **⚠** **Warning** statement identifies conditions or practices that could result in injury or death.

A **⚠** **Caution** statement identifies conditions or practices that could result in damage to the Multimeter or equipment to which it is connected.

### **⚠⚠ Warning**

**This instrument can deliver a lethal electric shock.**

**To avoid electric shock, personal injury, or death, carefully read the information under *Safety Considerations* before attempting to install, use, or service the Multimeter.**

## General Safety Summary

This instrument has been designed and tested in accordance with the European standard publication EN61010-1 : 2001 and U.S. / Canadian standard publications UL 61010-1:2004 and CAN/CSA-C22.2 No.61010.1-04. The instrument has been supplied in a safe condition.

This manual contains information and warnings that must be observed to keep the instrument in a safe condition and ensure safe operation.

Using or servicing this Multimeter in conditions other than as specified in the Users Manual could compromise your safety.

To use the use the Multimeter correctly and safely, read and adhere to the precautions on the "Safety Page" and follow all the safety instructions or warnings given throughout this manual that relate to specific measurement functions. In addition, follow all generally accepted safety practices and procedures required when working with and around electricity.

## Safety Information

A **Warning** identifies conditions and procedures that are dangerous to the user.

### Warning













To prevent possible electrical shock, fire, or personal injury:

- Read all safety information before you use the Product.
- Carefully read all instructions.
- Use the Product only as specified, or the protection supplied by the Product can be compromised.
- Use extreme caution when the Product is in use. The Product can supply a lethal electric shock.
- Do not use the Product if it operates incorrectly.
- Examine the Product before use. Do not use the Product if it shows signs of damage. Carefully examine the insulation around the connectors.
- Do not use the Product around explosive gas, vapor, or in damp or wet environments.
- Do not use and disable the Product if it is damaged.
- Do not apply more than the rated voltage, between the terminals or between each terminal and earth ground.
- Do not touch voltages >30 V ac rms, 42 V ac peak, or 60 V dc.
- Measure a known voltage first to make sure that the Product operates correctly.
- Do not use test leads if they are damaged. Examine the test leads for damaged insulation, exposed metal, or if the wear indicator shows. Check test lead continuity.
- Use conductors of adequate gauge to make current measurements. High current can cause excessive heating of underrated conductors and can cause a fire.
- Use this Product indoors only.
- Use only the mains power cord and connector approved for the voltage and plug configuration in your country and rated for the Product.
- Make sure the ground conductor in the mains power cord is connected to a protective earth ground. Disruption of the protective earth could put voltage on the chassis that could cause death.
- Replace the mains power cord if the insulation is damaged or if the insulation shows signs of wear.
- If the mains power cord is to be the accessible disconnect device, the mains power cord must not be longer than 3 meters (118.1 inches).
- Remove all probes, test leads, and accessories that are not necessary for the measurement.
- Do not remove the cover until the test leads are removed.
- Turn the Product off and remove the mains power cord. Stop for two minutes to let the power assemblies discharge before you open the fuse door.
- Do not operate the Product with covers removed or the case open. Hazardous voltage exposure is possible.

- **Disconnect the mains power cord before you remove the Product covers.**
- **Remove the input signals before you clean the Product.**
- **Use only specified replacement parts.**
- **Use only specified replacement fuses.**
- **The mains power service must be rated for 16 A, and if the mains power cord is internally fused, a 10 A fuse must be fitted in the mains power cord plug.**
- **Have an approved technician repair the Product.**
- **When the cover is removed, voltages more than 1.5 KV can be present.**
- **Properly terminate the sense leads to prevent exposure to hazardous voltages on the sense terminals. The voltage sense terminals are at output voltage when the two-wire function is set.**
- **Never touch a lead or terminal on the Product when a dangerous voltage is present.**
- **Do not use low voltage spade-terminated leads to connect to a hazardous voltage (>32 V ac rms or >42 V pk). A general purpose probe kit is supplied with the Product for safe measurement at higher voltages.**
- **Do not touch exposed metal on banana plugs, they can have voltages that could cause death.**
- **Do not use test leads if they are damaged. Examine the test leads for damaged insulation and measure a known voltage.**
- **Use the correct terminals, function, and range for measurements.**
- **Keep fingers behind the finger guards on the probes.**
- **Connect the common test lead before the live test lead and remove the live test lead before the common test lead.**
- **Remove signal connections before the protective ground connection is removed. For example, the mains power cord must be connected when the signal leads are connected.**
- **Do not connect or disconnect signal leads while they are connected to a hazardous voltage or current source.**
- **Disconnect power and discharge all high-voltage capacitors before you measure resistance, continuity, capacitance, or a diode junction.**
- **Before the Product is connected to a circuit to make a current measurement, check the fuses on the Product and turn off the power to the circuit.**
- **Limit operation to the specified measurement category, voltage, or amperage ratings.**
- **Do not connect measurement probes directly to mains.**
- **Complete safety tests after a part replacement to make sure the Product is safe.**
- **Do not connect an external capacitance greater than 50 nF to the Product terminals.**

## Symbols

The following safety and electrical symbols may be used on the Multimeter or in this manual.

	Risk of danger. Important information. See manual.		AC (Alternating Current).
	Hazardous voltage. Voltage >30 V dc or ac peak might be present.		DC (Direct Current).
	AC or DC (Alternating or Direct Current)		Potentially hazardous voltage.
	Digital signal.		Power ON / OFF
	Earth ground.		Fuse.
	Recycle.		Double insulated.
<b>CAT II</b>	Measurement Category II is applicable to test and measuring circuits connected directly to utilization points (socket outlets and similar points) of the low-voltage MAINS installation.		
<b>CAT III</b>	Measurement Category III is applicable to test and measuring circuits connected to the distribution part of the building's low-voltage MAINS installation.		
<b>CAT IV</b>	Measurement Category IV is applicable to test and measuring circuits connected at the source of the building's low-voltage MAINS installation.		
	This product complies with the WEEE Directive (2002/96/EC) marking requirements. The affixed label indicates that you must not discard this electrical/electronic product in domestic household waste. Product Category: With reference to the equipment types in the WEEE Directive Annex I, this product is classed as category 9 "Monitoring and Control Instrumentation" product. Do not dispose of this product as unsorted municipal waste. Go to Fluke's website for recycling information.		
<b>CE</b>	Product conforms with the requirements of the applicable EC directives.		

## Protection Class I

### Protective Earth/Ground

The Multimeter **must** be operated with a Protective Earth/Ground connected via the power cable's protective earth/ground conductor. The Protective Earth/Ground connects to the instrument before the line & neutral connections when the supply plug is inserted into the power socket on the back of the instrument.

#### Warning

To avoid possible electric shock, personal injury, or death:

- Ensure that no interruption of the protective ground conductor inside or outside the instrument has occurred. Any interruption of the protective ground is likely to make the instrument dangerous.
- Make signal connections to the instrument after making the protective ground connection.
- Remove signal connections before removing the protective ground connection, i.e. the power cable must be connected whenever signal leads are connected.

### Do Not Operate Without Covers

#### Warning

To avoid possible electric shock, personal injury, or death, do not operate the instrument with its covers removed.

The covers protect users from live parts, and unless otherwise stated, must only be removed by qualified service personnel for maintenance and repair purposes.

Removing the covers may expose voltages in excess of 1.5 kV peak.

### Safe Operating Conditions

#### Warning

To avoid electric shock or fire hazard, do not apply to or subject the Multimeter to any condition that is outside specified range. See Chapter 5 of this manual for detailed instrument specifications and operating conditions.

Only operate the Multimeter within the manufacturer's specified operating conditions. Examples of operating condition specifications examples that must be considered include:

- Ambient temperature
- Ambient humidity
- Power supply voltage & frequency
- Maximum terminal voltages or currents
- Altitude
- Ambient pollution level
- Exposure to shock and vibration

#### Caution

To avoid possible damage to the Multimeter, consider direct sunlight, radiators and other heat sources when assessing ambient temperature.

Before connecting the Multimeter to the supply, make sure that ac supply voltage connector on the rear panel is set to the correct voltage and that the correct fuses are fitted.

**Fuse Requirements**

**⚠ Caution**

To avoid fire hazard, use only the fuse arrangements that appear in the fuse specification Tables 1-3 and 1-4 below.

Additionally, the supply network must be fused at a maximum of 16 A, and if the power cable plug is internally fused, a 10 A fuse must be fitted in the power cable plug.

Table 1-3. Power Input Fuse 1 - T 1.25AH 250V

Power Input Fuse F1	Fuse Action	Fuse Rating IEC 127 (UL/CSA)	Fluke Part No.	Manufacturer & Type No.
115 VAC, 230 VAC	TH Time delay HBC	1.25 A (2 A) @ 250 V	2059740	Schurter 0001.2505
				Bussman S505-1.25-R
				Littelfuse 215 1.25P
				Bel Fuse 5HT 1.25-R

Table 1-4. Current Function Rear Input Fuse 2 - F 1.6AH 250V

Fuse Action	Fuse Rating IEC 127 (UL / CSA)	Fluke Part No.	Manufacturer & Type No.
FH Fast acting HBC	1.6 A (2 A) @ 250 V	1582072	Bussman S501-1.6-R
			Littelfuse 021601.6HXP
			Littelfuse 021601.6MXP

**Rear Panel Detail**

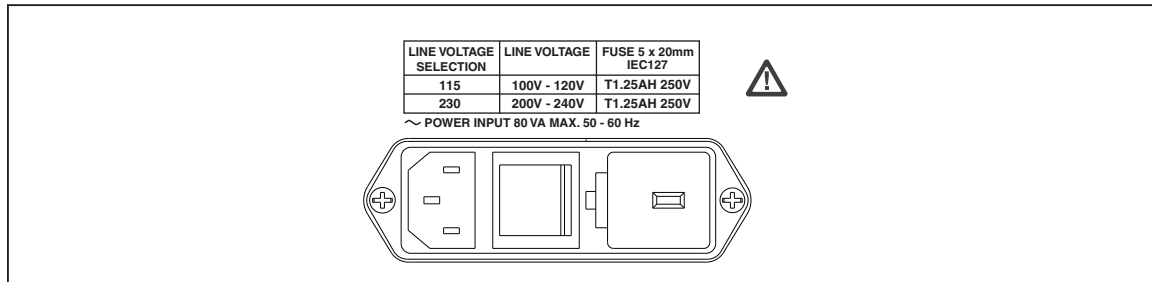

Figure 1-1. Rear Panel – Power Input Fuse and line Power Locations

**The Power Cable and Power Supply Disconnection**

The intended power supply disconnect device is the ON/OFF switch that is located on the Multimeter's rear panel.

The ON/OFF switch **must** be readily accessible while the instrument is operating. If this operating condition cannot be met, the power cable plug or other power disconnecting device **must** be readily accessible to the operator.

**⚠⚠ Warning**

To avoid electric shock and fire hazard, make sure that the power cable is not damaged, and that it is adequately rated against power supply network fusing.

If the power cable plug is to be the accessible disconnect device, the power cable must not be longer than 3 meters.



### **Terminal Connections**

Make sure that the instrument is correctly grounded (earth ground) via the power cable before and while any other connection is made.

### **Measurement Category I**

Measurement and/or guard terminals are designed for connection at Measurement Category I.

#### **⚠⚠ Warning**

**To avoid electric shock and fire hazard, do not connect the Multimeter terminals directly to the ac line power, to an ac line power current transformer, or to any other voltage or current source that may (even temporarily) exceed the instrument's peak ratings.**

#### **⚠⚠ Warning**

**To avoid injury or death, do not connect or disconnect signal leads while they are connected to a hazardous voltage or current source.**

**Make sure that signal leads are in a safe condition before you handle them.**

**This instrument can deliver a lethal electric shock. Never touch any lead or terminal unless you are absolutely certain that no dangerous voltage is present.**

### **Maintenance and Repair**

#### **⚠ Warning**

**For protection against injury and fire hazard, use only manufacturer supplied parts that are relevant to safety. Perform Safety tests after replacing any part that is relevant to safety.**

Observe all applicable local and/or national safety regulations and rules while performing any work.

First disconnect the instrument from all signal sources, then from the ac line supply before removing any cover.

Any adjustment, parts replacement, maintenance or repair should be carried out only by the manufacturer's authorized service personnel.

### **Moving and Cleaning**

First disconnect the Multimeter from all signal sources, then from the AC line power before moving or cleaning.

Use only a damp, lint-free cloth to clean fascia and case parts.



## **Chapter 2**

# **Getting Acquainted with the Basics**

Title	Page
Introduction.....	2-3
Input Terminals.....	2-3
The Front Panel Displays.....	2-4
Front Panel Keys.....	2-4
Soft-Keys and Manual Conventions.....	2-4
Numeric Keyboard .....	2-5
Exiting a Menu .....	2-5
Major Function Keys.....	2-5
Direct Action Keys.....	2-6
Mode Keys.....	2-6
Rear Panel.....	2-7
Labels .....	2-7
Fuses.....	2-7
Voltage Selector .....	2-7
Power Input and Power Switch .....	2-7
Calibration Switch.....	2-7
Rear Panel Connectors and Pin Designations.....	2-8
Rear Inputs.....	2-8
External Trigger Input .....	2-8
IEEE 488 Input/Output.....	2-8
Power-On Configuration.....	2-8
The 8508A-LEAD Measurement Lead Kit.....	2-9



## Introduction

Chapter 2 introduces the front and rear panel features of the 8508A Reference Multimeter (hereafter, referred to as the Multimeter). Figure 2-1 shows the Multimeter's front panel controls, indicators, and connectors.

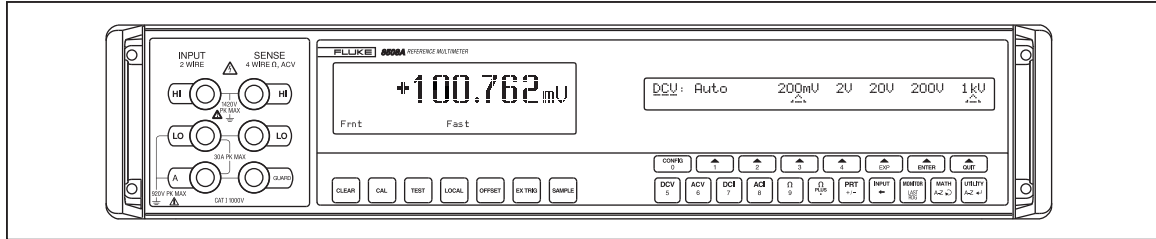

Figure 2-1. Front Panel Displays

adj002f.eps

## Input Terminals

### ⚠️ Warning

To avoid electric shock, personal injury, or death, never touch any lead or terminal on the Multimeter unless you are absolutely certain that no dangerous voltage is present.

The 8508A Multimeter has only front terminals. The 8508A/01 has both front and rear panel input terminals (Figures 2-2). Select either, or Scan both from the Input menu or via IEEE-488 remote control.

For maximum input limits, refer to product specifications in Chapter 5.

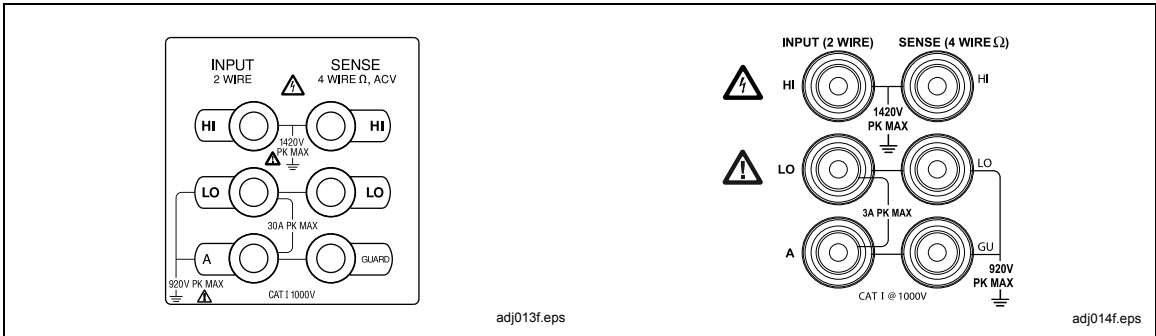

Figure 2-2. Front and Rear Input Terminals

adj013f.eps

adj014f.eps

Three pairs of 4 mm ‘banana’ terminals are fitted on the left of the front panel and, as an option, on the right of the rear panel . Their functions are as follows:

INPUT 2 wire		SENSE 4WIRE Ω, ACV	
<b>HI</b>	Voltage High Ohms High (2 – wire)	<b>HI</b>	Voltage High (4-wire <i>front only</i> ) Ohms High (4-wire)
<b>LO</b>	Voltage Low Current Low Ohms Low (2-wire)	<b>LO</b>	Voltage Low (4-wire <i>front only</i> )  Ohms Low (4wire)
<b>A</b>	Current High ( <i>only 2A max on rear</i> )	<b>GUARD</b>	

## The Front Panel Displays

The front panel (Figure 2-1) has two displays:

- The display on the left, the main display, is used to show all measurement readings, with status legends on the bottom line, and measurement qualifiers on the line above. Figure 2-3 shows details of the main display, including annunciators.
- The display on the right is used to display menus for the softkeys situated below. It is also used for error messages and status information when in remote.



adj360f.eps

Figure 2-3. Sample of the Main Display

## Front Panel Keys

There are four types of keys (Figure 2-1) on the front panel:

- The major measurement function keys:
- The mode keys:
- Direct action keys that immediately initiate an action or set a state:
- The "soft-keys" point to a menu label on the display above, indicating the operation and setting of the Multimeter:

System messages may appear to clarify settings or operations.

## Soft-Keys and Manual Conventions



### Soft-Keys

adj015f.eps

- A Menu softkey accesses a new menu.

In this manual, a Menu soft-key is shown as displayed or in a Helvetica-regular font:

Example: **Res1** or Res1

- A Toggle softkey enables or disables a selection

The enabled selection is indicated with a **⌘** symbol.

In this manual, a Toggle soft-key is shown as displayed or in Helvetica-italic-underline font :

Example: ***Filt*** or Filt

- A Choice softkey chooses a state (e.g., selects a range) or triggers a direct action.

The selected state or action is indicated as displayed with a **⌘** symbol.

In this manual, a Choice soft-key is shown as displayed or in Helvetica-underline font:

Example: 100mV or 100mV

### Numeric Keyboard

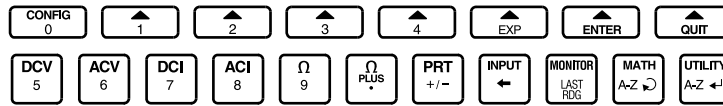

adj012f.eps

#### Numeric Keyboard

The operation of the numeric keys is enabled for appropriate menus. The active keys are:

numerals 0 to 9.

decimal point

polarity

for exponent

for backspace

to enter the last reading taken

to confirm the numeric entry

to abort the numeric entry.

When the numeric keyboard is active other keys are locked out.

For some operations the two alpha selection keys are enabled along with the numeric keys.

selects the alpha characters (upper case only) and cycles A through Z.

enters the selected character and moves the entry point one character to the right.

### Exiting a Menu

You can generally exit from any menu by pressing a measurement function key or a mode key.

For those menus where the numeric or alpha numeric keyboard is active, exit by pressing either Enter or Quit. For some menus, a special soft key permits exit by a single keystroke.

### Major Function Keys

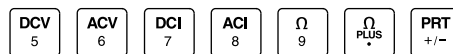

adj016f.eps

Each measurement function has a CONFIG (Configuration) menu, from which you can select function-dependent parameters such as resolution and filter settings.

Once set, the instrument remembers the function dependant parameters until you change it or turn the Multimeter off.

## Direct Action Keys



adj017f.eps

### Direct Action Keys

 Press to disable internal triggers and enable all external trigger sources. The Ext annunciator on the main display is lit.

An external trigger for a measurement may be generated either by pressing the Sample key, by sending an appropriate trigger command via the IEEE-488 interface, or by a falling edge (TTL) at the External Trigger input on the rear panel.

 Press to trigger a single-shot measurement if the Multimeter is in Ext'trig mode. All measurements triggered using the Sample key are subject to the standard internal time delays before A-D conversion. These are listed on Table 4-2 and 4-3. During the measurement the Busy annunciator on the main display is lit.

### NOTE

*In calibration mode this key will initiate a calibration operation.*

 Press to return the Multimeter to the control of the front panel when operating on the IEEE-488 bus. While in Local, any delays set up during remote programming are suspended, and the standard internal delays are reinstated. The Local mode can be disabled remotely by a controller using the LLO (Local Lockout) function.

 Press to store the displayed value in memory. This temporary value will be subsequently subtracted from the next measured value. The Offset annunciator on the main display is lit. To cancel this subtraction press the Offset key.

## Mode Keys

 Press to enter calibration mode. Access to calibration mode is enabled (or restricted) by a calibration switch on the rear panel. The CAL annunciator on the left hand display indicates that Calibration mode is active.

 Press to gain access to test operations.

 Press to gain access to guarding, input zero operation, selection of alternate inputs, and scanning operations. Several left hand display annunciators are used to indicate the status of input, guard and zero selection.

 Provides additional monitoring operations on measurements e.g. frequency (in AC), and recorded measurements of maximum, minimum, and peak to peak.

 Provides additional mathematical operations on measurements e.g. averaging, multiplication by M, subtraction of C, and division by Z. The Math annunciator on the left hand display indicates that a Mathematical operation is active.

 Press to gain access to bus address, display adjustments, line frequency selection, and information on cal due date, serial number and spot frequency.

 Press to gain access to removing Input zero for the range selected or all the ranges in the selected function.

The instrument can also be reset to the power up state.



## Rear Panel

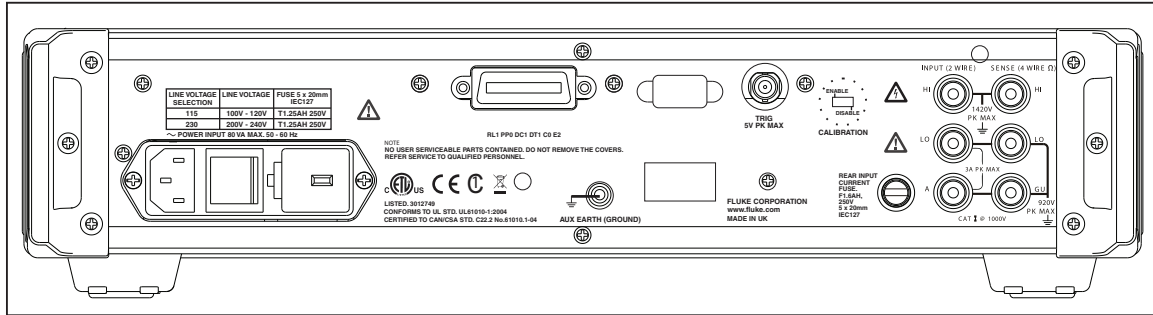

Figure 2-4. 8508A Rear Panel Detail

adj018f.eps

### Labels

Attached to the rear panel is the identification label for the instrument, and a modification strike label.

### Fuses

**⚠ Power Fuse:** Located in the fuse drawer which is part of the integrated module for power input and voltage selection.

**⚠ Rear Input Current Fuse:** Protects the current measuring circuitry when using the rear terminals for signal input.

### ⚠⚠ Warning

To avoid damage to the Multimeter, or shock, injury, or death, use **ONLY** fuses with the amperage, interrupt, voltage, and speed ratings specified.

Refer to the safety information and "Fuse Requirements" in Chapter 1 of this manual.

### Voltage Selector

The power line voltage selector block is located behind the fuse block drawer, and adapts the instrument to either 115V or 230V line inputs.

### Power Input and Power Switch

The power input socket and power ON/OFF switch are part of the integrated module for power input and voltage selection. Power on default configuration is listed later in this chapter.

### Calibration Switch

Access to calibration mode is enabled (or restricted) by the rear panel calibration switch. Setting the switch to ENABLE will allow access to the calibration mode via the front panel CAL key and the CALIBRATION menu, and will also enable the remote IEEE-488 interface calibration commands.

The calibration switch should always be set to DISABLE on completion of any calibration operations. Applying an integrity seal or calibration sticker to cover the rear panel Calibration switch is a convenient way to ensure the security of calibration and prevent unauthorized access to the switch.

## Rear Panel Connectors and Pin Designations

### Warning

This instrument can deliver a lethal electric shock.

To avoid electric shock, personal injury, or death, never touch any lead or terminal unless you are absolutely certain that no dangerous voltage is present.

### Rear Inputs

For details of rear input terminals see Figure 2-2

### External Trigger Input

This co-axial BNC socket can be used to trigger a measurement when external triggers are enabled.

The single pin is pulled up internally to +5V, and requires a negative-going TTL edge to initiate the reading.

### IEEE 488 Input/Output

The IEEE 488 input/output is a 24-way Amphenol connector which is directly compatible with the IEEE 488 interface and the IEC 625 Bus.

Note that the Bus Address is set from the front panel. See Chapter 4 for more information about the IEEE 488 connector and remote operations.

## Power-On Configuration

To turn the Multimeter on, use the Power Switch on the rear panel. The Multimeter powers on in the following configuration:

<b>Function</b>	DCV
<b>Range</b>	1 kV
<b>Resolution</b>	7-1/2 digits
<b>Input</b>	Front
<b>Filter</b>	Off
<b>Fast</b>	On
<b>External Guard</b>	Off
<b>Scan</b>	Off
<b>Monitor</b>	Off
<b>Math</b>	Off

## The 8508A-LEAD Measurement Lead Kit

### Warning

#### SAFE USE OF MEASUREMENT LEADS

To avoid electric shock and potential injury or death, **DO NOT** use low voltage spade-terminated leads to connect to hazardous voltage (>32V ac rms or > 42V pk). A General Purpose Probe Kit is provided for Safe measurement at higher voltages.

A General Purpose Probe Kit is provided with the Multimeter. Instructions for use are included.

The optional 8508A-LEAD Measurement Lead Kit is a comprehensive set of high integrity measurement leads, designed for metrology applications. The kit and its contents are described below and shown in figure 2-5. The kit includes the following:

1. Five low-thermal-EMF low-leakage leads sets for low voltage precision measurement applications. All five lead sets feature gold-plated 6mm spade terminations.
  - Four of the leads are low-thermal, PTFE insulated and shielded for signal applications.
  - One lead is a heavy gauge lead for high current (>2A rms) applications.
2. One General Purpose Probe Kit for general purpose and High Voltage measurement applications.

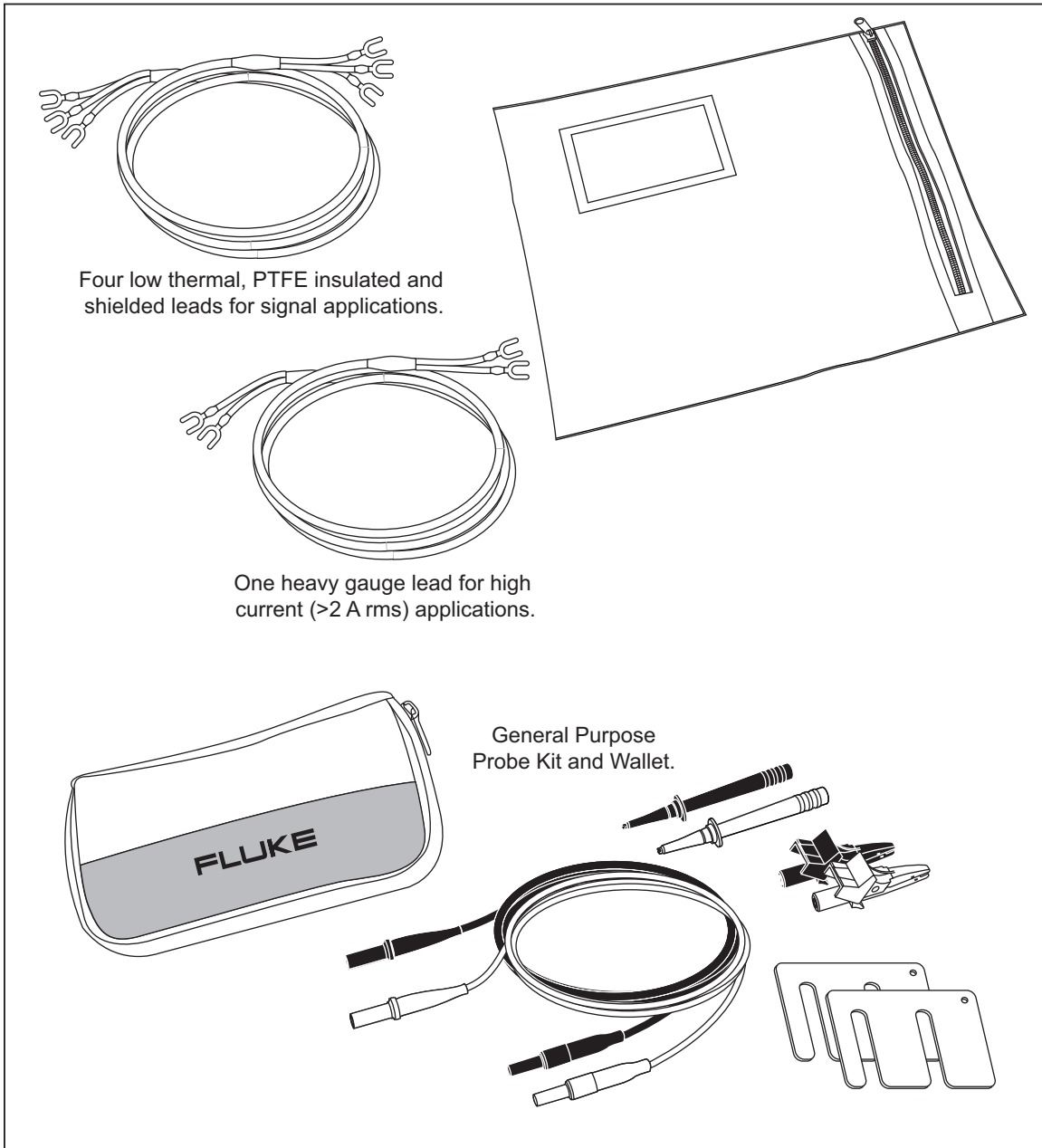

Figure 2-5. The 8508A-LEAD Measurement Lead Kit

adj388f.eps

## Chapter 3

# Making Measurements

Title	Page
Introduction.....	3-3
Making Connections to the Multimeter -- General Guidelines.....	3-4
Using the Measurement Functions.....	3-5
DC Voltage.....	3-5
Measuring DC Voltage.....	3-7
Making Input Connections.....	3-7
AC Voltage.....	3-8
Measuring AC Voltage.....	3-11
Induced Interference.....	3-11
Common Mode Rejection.....	3-11
Lead Considerations.....	3-11
Resistance.....	3-11
High Voltage Ohms.....	3-13
True Ohms.....	3-15
Measuring Resistance.....	3-17
2-Wire Measurements.....	3-17
4-wire Measurements.....	3-17
4-wire High Resistance Measurements.....	3-18
4-wire Resistance Zero.....	3-18
Ω Guard.....	3-19
DC Current.....	3-21
Measuring DC Current.....	3-22
AC Current.....	3-23
Measuring AC Current.....	3-24
Temperature.....	3-25
Measuring Temperature.....	3-28
Multimeter Inputs.....	3-29
Input.....	3-29
Using the INPUT Key.....	3-29
SCAN OPERATIONS.....	3-30
Tru Ohms Ratio.....	3-31
Monitoring Modes.....	3-32
Monitor Key.....	3-32
Displaying Signal Frequency.....	3-32
Displaying Standard Deviation.....	3-32
Devn Menu.....	3-32

Displaying Maximum, Minimum, and Peak-to-Peak Readings .....	3-33
MAX Menu .....	3-33
Limit-Checking .....	3-33
Monitor Menu Tree .....	3-34
Utility .....	3-34
Using the Selftest Functions .....	3-37
Test Menu Tree.....	3-38
Test Key .....	3-39
Using the Math Functions.....	3-40
Math Functions and Menu Tree.....	3-40
Math Configuration .....	3-41
Clear Functions .....	3-42

## Introduction

### **⚠⚠ Warning**

The Multimeter can deliver a lethal electric shock.

To avoid electric shock, personal injury, or death, carefully read the information under "Safety Considerations" in Chapter 1 before attempting to install, use, or service the 8508A Reference Multimeter.

A "**⚠⚠ Warning**" statement identifies conditions or practices that could result in injury or death.

A "**⚠ Caution**" statement identifies conditions or practices that could result in damage to the Multimeter or equipment to which it is connected.

Chapter 3 explains in detail how to use the 8508A Reference Multimeter's (hereafter "the Multimeter") measurement functions and operating modes. It is organized to provide easy access to the following functions and modes.

#### **Functions**

DC Voltage    AC Voltage    Resistance    DC Current    AC Current    Temperature

#### **Modes**

Input Control    Monitoring    Math    Utility    Clear    Test

The topics covered in Chapter 3 include: making connections, input limits, types of configurations, accessing and selecting measurement modes, and calculations available.

Product specifications and operating limits are in Chapter 5. See Chapter 6 for calibration menus and the recommended calibration routines. All error messages displayed by the Multimeter's front panel or generated by the IEEE 488 system bus are collected and described in Appendix A.

Before proceeding make sure that the Multimeter has been properly installed and prepared for operation as described in Chapter 1.

### **⚠⚠ Warning**

The Multimeter can deliver a lethal electric shock. To avoid possible electric shock, personal injury, or death:

- Ensure that no interruption of the protective ground conductor inside or outside the instrument has occurred. Any interruption of the protective ground is likely to make the instrument dangerous.
- Never touch any lead or terminal unless you are absolutely certain that no dangerous voltage is present.

## Making Connections to the Multimeter -- General Guidelines

The 8508A Reference Multimeter is capable of providing highly accurate traceable measurements. To attain this accuracy, it is necessary to make connections to any external circuitry or load correctly. A few guidelines are given in Table 3-1.

**Table 3-1. Identifying and Avoiding Errors**

Sources of Inaccuracy	Avoiding or Minimizing Inaccuracy
<p><b>Thermal EMFs</b></p> <p>These can give rise to series (Normal) mode interference, particularly where large currents have a heating effect at junctions.</p> <p>In otherwise thermoelectrically-balanced measuring circuits, cooling caused by drafts can upset the balance.</p>	<ul style="list-style-type: none"> <li>• Screen thermal junctions from draughts.</li> <li>• Allow time for thermal equilibrium to be reached before taking readings.</li> <li>• Use conductors, joints and terminals with a good margin of current-carrying capacity.</li> <li>• Avoid thermoelectric junctions where possible:               <ul style="list-style-type: none"> <li>* Use untinned single-strand copper wire of high purity.</li> <li>* Avoid making connections through Nickel, Tin, Brass and Aluminum. If oxidation is a problem, use gold-plated copper terminals, and replace the terminals before the plating wears off.</li> <li>* If joints must be soldered, low-thermal solders are available, but crimped joints are preferred.</li> <li>* Use low-thermal switches and relays where they form part of the measuring circuit.</li> <li>* Balance one thermal EMF against another in opposition, where possible. (Switch and relay contacts, terminals etc.)</li> </ul> </li> </ul>
<p><b>E-M Interference</b></p> <p>Noisy or intense electric, magnetic and electromagnetic effects in the vicinity can disturb the measurement circuit. Some typical sources are:</p> <ul style="list-style-type: none"> <li>• Static electric fields.</li> <li>• Fluorescent lighting.</li> <li>• Inadequate shielding, filtering or grounding of power lines.</li> <li>• Transients from local switching.</li> <li>• Induction and radiation fields of local E-M transmitters.</li> <li>• Excessive common mode voltages between source and load.</li> </ul> <p>The disturbances can be magnified by the capacitance of the user's hand. Electrical interference has greatest effect in high impedance circuits. Separation of leads and creation of loops in the circuit can intensify the disturbances.</p>	<ul style="list-style-type: none"> <li>• Choose as "quiet" a site as possible (a screened cage may be necessary if interference is heavy or circuit impedance is high). Suppress as many sources as possible.</li> <li>• Always keep interconnecting leads as short as possible, especially unshielded lengths.</li> <li>• Run leads together as twisted pairs in a common shield to reduce loop pick-up area, but beware of leakage problems and excessive capacitance.</li> <li>• Where both source and load are floating, connect Lo to ground at the source to reduce common mode voltages.</li> <li>• If an external measurement ground connection has been made, select External Guarding at the Multimeter in Voltage and Current functions and deselect External Guarding in Ohms and PRT functions.</li> <li>• When connecting to a Multifunction Calibrator such as the Fluke 5720A or 5520A, follow the above Guarding and Grounding advice and deselect External Guard at the Calibrator.</li> </ul>
<p><b>Lead Resistance</b></p> <p>The resistance of the test leads can drop significant voltages between the source and load, especially at high load currents.</p>	<ul style="list-style-type: none"> <li>• Keep all leads as short as possible.</li> <li>• Use conductors with a good margin of current-carrying capacity.</li> <li>• Use External Guard or 4-wire connections where necessary.</li> </ul>
<p><b>Lead Insulation Leakage</b></p> <p>This can cause significant errors in measurement circuits at high voltages and high resistances. Some insulating materials suffer greater losses than others, e.g. PVC has more leakage than PTFE.</p>	<p>Choose low loss insulated leads - PTFE is preferred to PVC. When running leads together in shielded pairs, avoid large voltages between leads in the same screen, especially if using PVC insulation.</p>



## Using the Measurement Functions

If you are unfamiliar with the front panel controls, review the relevant sections of Chapter 2.

### DC Voltage

Press **DCV** key to display the DCV menu.

```
DCV: Auto      200mV  2V  20V  200V  1kV
              Δ
```

adj055f.eps

#### DCV Menu

- DCV** This function provides both 2-wire and 4-wire measurements, in decade ranges from 200mV to 200V and a 1kV range.
- Auto** To cancel autoranging and enter a manually selected range, press any range selection or the Auto softkey. The Multimeter enters the selected range or reverts to the auto-selected range.

### DCV Configuration (4 wire Sense, Resolution, LP Filtering and Fast)

Press the Config key to see the DCV CONFIG menu:

```
DCV_CONFIG: 4wV Res1 Filt Fast
```

adj056f.eps

#### DCV Configuration Menu

- 4wV** Allows operation with calibrators which provide a remote 4 wire sensing capability by providing connections between **INPUT HI** and **SENSE HI** and between **INPUT LO** and **SENSE LO**.  
The 4wV annunciator in the left-hand display indicates that 4-wire sensing is active.
- Res1** Provides selection of the numerical resolution for subsequent readings.
- Filt** Controls a three-pole analog filter for increased noise rejection.  
The Filter annunciator on the left-hand display indicates that the filter is active and indicates its cut-in frequency.
- Fast** Select a higher read rate. This will result in an increase in uncertainty due to noise.  
The Fast annunciator on the left-hand display indicates that the higher read rate is active.

**DCV Resolution**

Press the Resl key to see the DCV RESL menu:

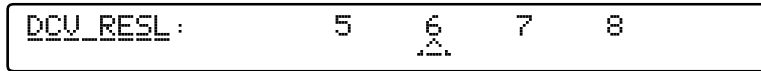

**DCV Resolution Menu**

adj058f.eps

- 5 5-1/2-digits resolution
- 6 6-1/2-digits resolution
- 7 7-1/2-digits resolution
- 8 8-1/2-digits resolution

To revert to the DCV CONFIG menu, press the CONFIG key.

To revert to the DCV menu from either DCV RESL or DCV CONFIG, press the DCV key.

Refer to Table 3-2 for the ADC integration times applicable to the various resolution and Fast On/Off settings.

**Table 3-2. Analog to Digital Converter (ADC) signal integration times**

Function	Resolution	Integration Time	
		Fast On	Fast Off
DCV, DCI <sup>1</sup> , Ohms, True Ohms, PRT <sup>2</sup>	5-1/2	3.3ms	1 PLC
	6-1/2	1 PLC	16 PLC
	7-1/2	64 PLC	4 x 64 PLC
	8-1/2	4 x 64 PLC	16 x 64 PLC
HiV Ohms	5-1/2	64 PLC	
	6-1/2	64 PLC	

Note: PLC = Power Line Cycles = 20ms at 50Hz line, 16.67ms at 60Hz line.  
 1. DCI maximum resolution 7-1/2 digits.  
 2. Fast On not available in PRT.

**DC Voltage - Movement between Menus**

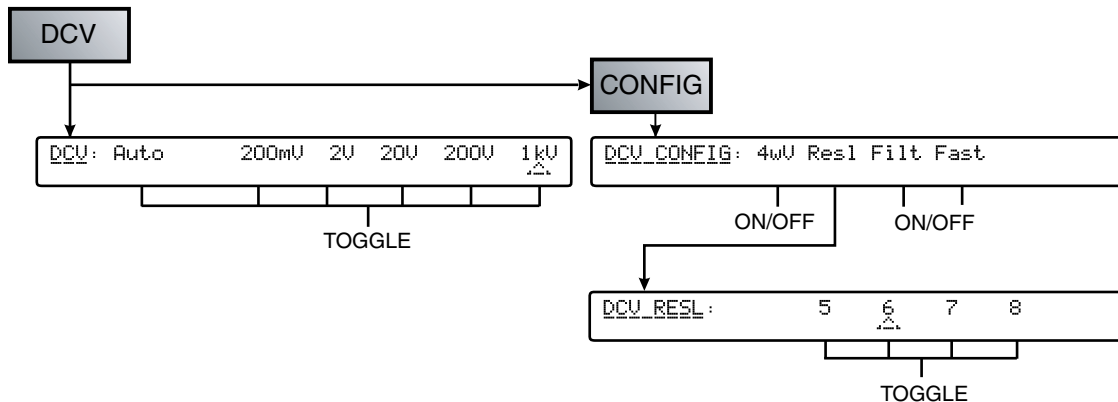

**DC Voltage Menu Tree**

adj054f.eps

## Measuring DC Voltage

### Making Input Connections

#### Simple Lead Connection

For the majority of applications the simple lead connection without external guard will be adequate. See Figure 3-1. The disadvantage of this simple arrangement is that the connecting leads can form a loop. If a stray alternating magnetic field (e.g., from the line transformer of a neighboring instrument) passes through the loop, it will behave as a single-turn secondary winding inducing unwanted AC voltages into the measuring circuit. Use of a twisted-pair will reduce the loop area and adjacent twists will cancel any induced voltages. If problems with stray pick-up are encountered, it is recommended that a shielded twisted-pair cable be used with the screen connected to the **Lo** terminal at the source as shown in Figure 3-2.

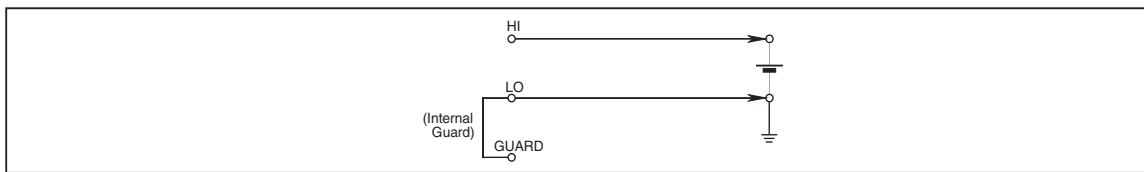

Figure 3-1. Simple Lead Connections

adj059f.eps

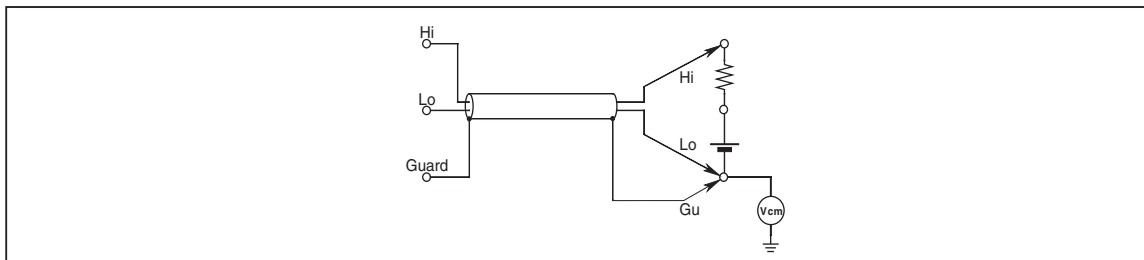

Figure 3-2. Twisted-Pair Cable Connections

adj060f.eps

#### Common Mode Rejection - Use of External Guard Connection

Use the **Guard** terminal with External Guard selected when the source to be measured presents an unbalanced impedance to the measuring terminals, and common mode voltages are present. Regardless of how the **Hi** and **Lo** terminals are connected, the **Guard** terminal should be referred to the source of common mode voltage, as shown in Figure 3-3. This ensures that errors caused by common mode currents in the measuring circuit are minimized by providing a separate common mode current path.

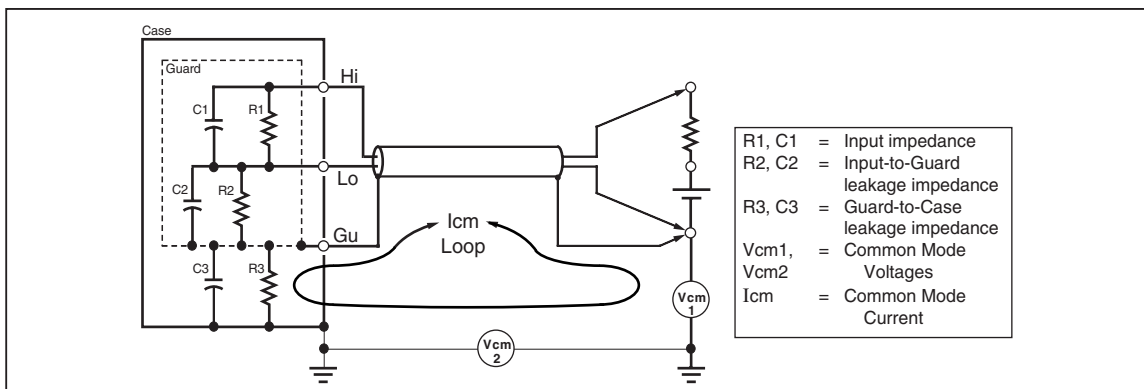

Figure 3-3. External Guard Connections

adj061f.eps

### Internal Guard Connections

**External Guard not selected:** The Guard terminals on the front and rear panels are isolated from each other and from any internal connection. The internal guard shields and tracks are connected directly to the internal 0V.

**External Guard selected:** The internal guard shields and tracks are disconnected from the internal 0V, and connected to the **Guard** terminal of the selected front or rear input.

**Ohms Guard:** In the Ohms or PRT Functions the External Guard selection is modified to provide an Ohms Guard. In these cases the internal guard shields, tracks and selected front or rear Guard terminal are connected to the internal 0V.

The simplified diagram in Figure 3-4 illustrates the switching arrangement.

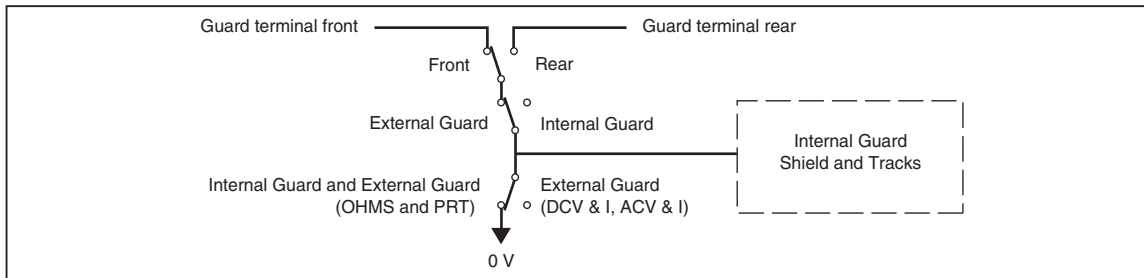

Figure 3-4. Internal Guard Connections

adj062f.eps

### Selecting External Guard (ExGd)

See Figure 3-3 for a description of External Guard Connections.

To select **External Guard**:

1. Press Input key to enter the INPUT menu.

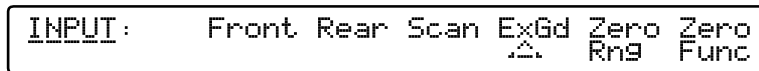

INPUT Menu

adj064f.eps

2. Press the menu key ExGd to toggle the Multimeter's Guarding options.

The ExGd annunciator on the left-hand display indicates that External Guarding is selected.

### AC Voltage

Press the ACV key to see the ACV menu.

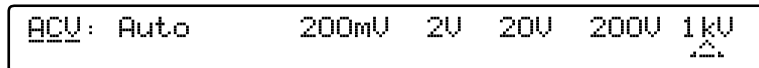

ACV Menu

adj066f.eps

- ACV** This function provides both 2-wire and 4-wire measurements, in decade ranges from 200mV to 200V and a 1kV range.
- Auto** To cancel autoranging and enter a manually selected range, press any range selection or the Auto softkey. The Multimeter enters the selected range or reverts to the auto-selected range.

**ACV Configuration (4 wire Sense, Resolution, RMS Filtering, Transfer mode, DC-Coupled and Spot Frequency)**

Press the Config key to see the ACV CONFIG menu.

```
ACV_CONFIG: 4wV Res1 Filt Tfer DCcP Spot
```

adj067f.eps

**ACV CONFIG Menu**

**4wV** Allows operation with calibrators which provide a remote 4 wire sensing capability by providing, at an internal reference plane within the DMM, connections between **INPUT HI** and **SENSE HI** and between **INPUT LO** and **SENSE LO**. Use of an internal reference plane can be helpful in 4wire AC, AC transfer, or 4wire AC – DC transfer applications.

The 4wV annunciator in the left-hand display indicates that 4-wire sensing is active.

**Res1** Provides selection of the resolution for subsequent readings.

**Filt** Provides selection of various filters for the RMS converter, allowing measurements to be made down to the chosen filter frequency. One of four filters is always in circuit. The 40Hz filter is the default selection at power on.

The Filter annunciator on the left-hand display indicates that the filter is active and indicates its frequency.

**Tfer** Controls the internal electronic AC-DC transfer for AC measurement, improving linearity and temperature performance at the expense of read rate. Tfer on is the default selection at power on.

The Tfer annunciator on the left-hand display indicates that internal AC-DC transfer is active.

**DCcP** DC couples the input circuitry to include DC signal components in the AC measurement when selected.

*Note*

*DC-coupled should be selected for signal frequencies less than 40 Hz.*

The DC coupled annunciator in the left-hand display indicates active state.

**Spot** Selects the Spot Frequency measurement mode, where calibration constants derived for up to six previously calibrated spots (Sp1 thru 6) are applied for signal frequencies within  $\pm 10\%$  of a spot frequency. This can be used to significantly reduce flatness errors in Sine Wave (low crest factor) measurement applications.

The Spot annunciator on the left-hand display indicates that Spot corrections are active.



## Measuring AC Voltage

### Induced Interference

If inference signals are present or lead pickup takes place during AC measurements, any induced interfering signals will combine with the signal being measured and result in measurement errors. In some circumstances, it may be possible to filter out the unwanted external signals, but it is generally more effective to reduce the interference before it is induced. This is most easily accomplished by operating in a quiet environment, e.g., using a screened cage and, if possible, using twisted or shielded measurement leads as discussed below.

### Common Mode Rejection

The principles of external guarding, outlined in the description of DC voltage measurement, apply generally to AC voltage measurement. For AC a further advantage can be gained by using the external guard as a shield for the input leads.

### Lead Considerations

In all cases, AC voltage measurement accuracy is improved by shortening the leads to the minimum practical length to reduce lead capacitance, lead inductance and loop area. Shielded twisted pair leads are recommended for low frequency measurements and coaxial leads are recommended for low and high frequency measurements. Users should take care to avoid measurement errors from the interaction of lead capacitance and inductance with any source output impedance. Additional information and guidance is available in the Fluke publication Calibration: Philosophy in Practice (ISBN 0-9638650-0-5).

## Resistance

Press  $\Omega$  to go to the OHM menu.

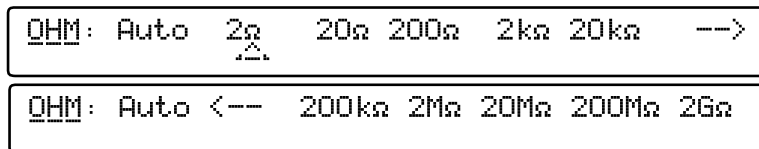

OHM Menu

adj073f.eps

- |      |   |
|------|---|
| OHM  | This function provides both 2-wire and 4-wire measurements, in decade ranges from <u>2 Ω</u> to <u>2 GΩ</u> .   |
| Auto | To cancel autoranging and enter a manually selected range, press any range selection or the Auto softkey. The Multimeter enters the selected range or reverts to the auto-selected range. |

### OHMS Configuration (Resolution, Filter, Fast, Low Current and 4-Wire Operation)

Press the Config key to see the OHMS CONFIG menu.

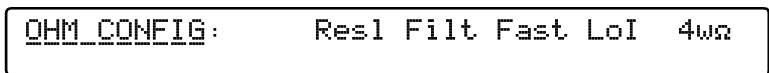

adj074f.eps

#### OHM CONFIG Menu

- Res1** Provides selection of the resolution for subsequent readings.
- Filt** Controls a single-pole analog filter for increased noise rejection.  
The Filter annunciator on the left-hand display indicates that the filter is active.
- Note*
- The pole or time constant of the filter is formed by a Capacitance of 22 nF across the resistor under test.*
- Fast** Select a higher read rate. This will result in an increase in uncertainty due to noise.  
The Fast annunciator on the left-hand display indicates that the higher read rate is active.
- LoI** Controls the measurement currents. The current in use for the selected range is indicated in the left-hand display together with the maximum voltage that will appear across the measured resistance at full scale.  
With LoI selected the behaviour of Auto Ranging is modified such that the Multimeter will only range up to the 20 MΩ Range.
- Note*
- Low Current resistance measurement may be desirable to reduce any self-heating in the device under test or to avoid conduction of any parallel semi-conductor junction.*
- 4wΩ** Selects 4-wire resistance measurements in which the stimulus current is fed through the test resistance from the instrument's **INPUT Hi** and **Lo** terminals. The resulting potential difference is sensed by the **SENSE Hi** and **Lo** terminals. Otherwise all measurements are 2-wire, current being sourced and potential differenced sensed from the **INPUT Hi** and **Lo** terminals.  
The 4wΩ annunciator in the left-hand display indicates that 4 wire sensing is active.



**OHMS Resolution**

Press the Resl key to see the OHMS RESL menu:



adj075f.eps

**OHM RESL Menu**

- 5 5-1/2-digits resolution
- 6 6-1/2-digits resolution
- 7 7-1/2-digits resolution
- 8 8-1/2-digits resolution

Refer to Table 3-2 for the ADC integration times applicable to the various resolution and Fast On/Off settings.

To revert to the OHMS CONFIG menu, press the Config key.

**Ohms - Movement between Menus**

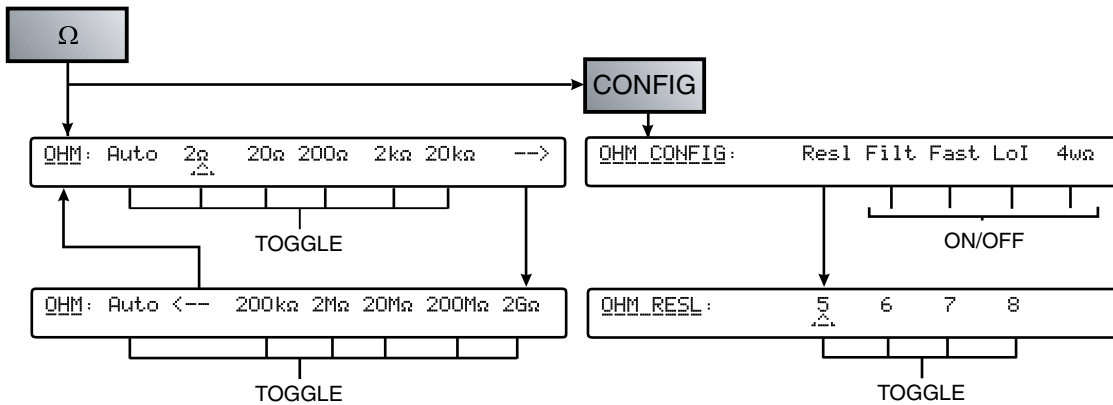

adj076f.eps

**Ohms Movement Between Menu**

**High Voltage Ohms**

Press the Ω PLUS key to see the expanded Ohms selection for True Ohms function and the High Voltage Ohms function. Press HiVΩ key to see the HiVΩ menu:

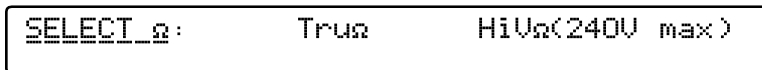

adj077f.eps

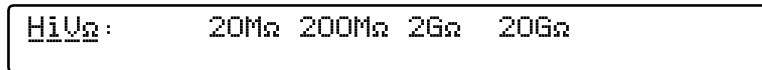

adj078f.eps

**HiVΩ Menu**

The function provides both 2-wire and 4-wire measurements of resistance, in decade ranges from 20 MΩ to 20 GΩ. The measurement is performed at High Voltage using a current source with high compliance. The resulting increase in Current through the unknown resistor is valuable to the reduction of leakage and bias current uncertainties. The function may also be used alongside the normal Ohms function to determine Voltage Coefficient in the unknown resistor.

The MAXIMUM voltage that could appear across the measured resistor is 240 V. No autoranging is provided in this function.

**⚠⚠ Warning**

**DANGER OF LETHAL ELECTRIC SHOCK**

To avoid LETHAL electrical shock DO NOT CONNECT EXTERNAL CAPACITANCE greater than 50 nF to the Multimeter terminals.

The maximum voltage across the measured resistor or open Multimeter terminals while using the HiV $\Omega$  function is 240 V. The maximum current that the Multimeter will source while using HiV $\Omega$  is 10  $\mu$ A (Lo to Hi), or 2.0 mA (Guard to Hi if Ext Guard is selected). These characteristics are not considered “Hazardous Live” within the Safety standards applied to this instrument. However, capacitors (>50 nF) external to the Multimeter could accumulate LETHAL charge while making a HiV $\Omega$  measurement. DO NOT TOUCH the Multimeter terminals or circuitry under test unless you are sure it is safe to do so.

**⚠⚠ CAUTION**

To avoid equipment damage when using the HiV $\Omega$  function make sure that circuits or components connected to the Multimeter can withstand at least 240 V dc.

*HiV $\Omega$  Configuration (Resolution, Filter, and 4-Wire Operation)*

Press the Config key to see the HiV $\Omega$  CONFIG menu.

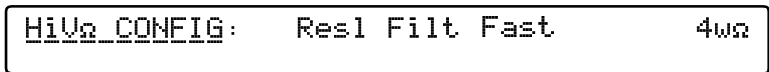

adj079f.eps

**HiV $\Omega$  CONFIG Menu**

- |      |   |
|------|---|
| Res1 | Provides selection of the resolution for subsequent readings.   |
| Filt | Controls a single-pole analog filter for increased noise rejection.<br>The Filter annunciator on the left-hand display indicates that the filter is active. |

*Note*

*The pole or time constant of the filter is formed by a Capacitance of 22 nF across the resistor under test.*

- |             |  |
|-------------|--|
| Fast        | Select a higher read rate. This will result in an increase in uncertainty due to noise.  |
| 4w $\Omega$ | Selects 4-wire resistance measurements in which the stimulus current is fed through the test resistance from the instrument's <b>INPUT Hi</b> and <b>Lo</b> terminals. The resulting potential difference is sensed by the <b>SENSE Hi</b> and <b>Lo</b> terminals. Otherwise all measurements are 2-wire, current being sourced and potential difference being sensed from the <b>INPUT Hi</b> and <b>Lo</b> terminals. |

**HIVΩ Resolution**

Press the Resl key to see the HiΩ RESL menu:

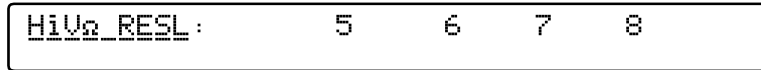

adj080f.eps

**HiVΩ RESL Menu**

- 5 5-1/2-digits resolution
- 6 6-1/2-digits resolution
- 7 7-1/2-digits resolution
- 8 8-1/2-digits resolution

Refer to Table 3-2 for the ADC integration times applicable to the various resolution and Fast On/Off settings.

To revert to the HiVΩ CONFIG menu, press the Config key.

To revert to the HiVΩ menu from either HiVΩ RESL or HiVΩ CONFIG, press the HiVΩ menu key.

**HiVΩ - Movement between Menus**

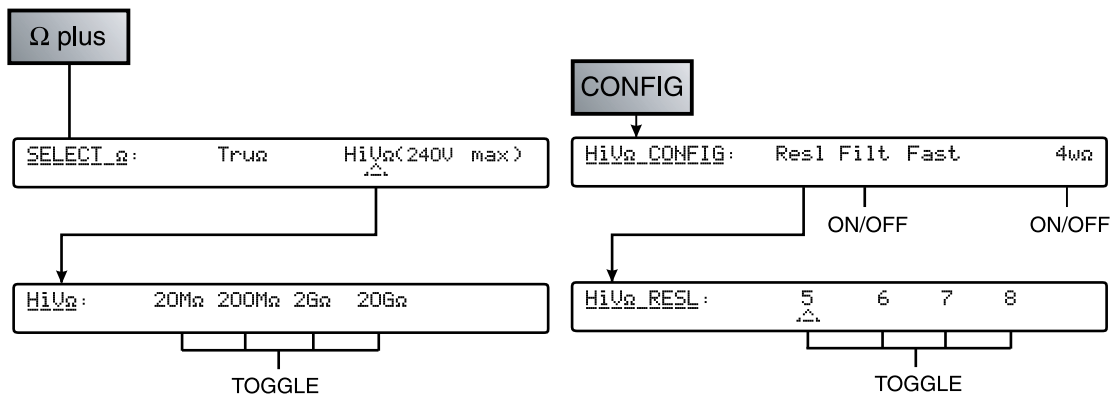

adj085f.eps

**HiVΩ Movement Between Menu**

**True Ohms**

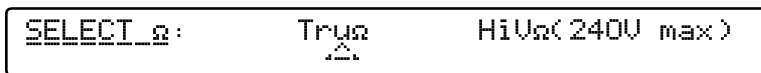

adj081f.eps

**TruΩ Menu**

Press the Ω PLUS key to see the expanded Ohms selection for True Ohms function and the High Voltage Ohms function. Press the Tru Ω key for the Tru Ω menu.

The TruΩ mode takes two measurements per reading. The second measurement is made with the current reversed relative to the first measurement. The two measurements are combined to eliminate the effects of any external EMFs that may be present.

**TruΩ** This function provides only 4-wire measurements of resistance, in decade ranges from 2 Ω to 20 kΩ. The stimulus current is fed through the test

resistance from the instrument's **INPUT Hi** and **Lo** terminals and the resulting potential difference is sensed by the **SENSE Hi** and **Lo** terminals

**Auto** To cancel autoranging and enter a manually selected range, press any range selection or the Auto softkey. The Multimeter enters the selected range or reverts to the auto-selected range.

### TRUΩ Configuration (Resolution, Fast, and Low Current)

Press the Config key to see the TRUΩ CONFIG menu.

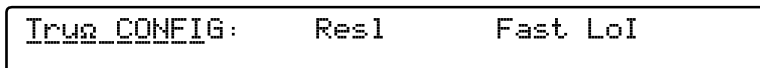

adj082f.eps

#### TRUΩ CONFIG Menu

- Res1** Provides selection of the resolution for subsequent readings.
- Fast** Select a higher read rate. This will result in an increase in uncertainty due to noise.
- LoI** Controls the measurement currents. The current in use for the selected range is indicated in the left-hand display together with the maximum voltage that will appear across the measured resistance at full scale.

### TRUΩ Resolution

Press the Res1 key to see the TRUΩ RESL menu:

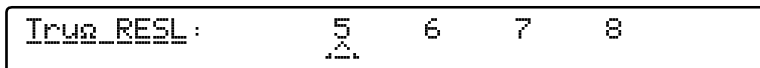

adj083f.eps

#### TRUΩ RESL Menu

- 5 5-1/2-digits resolution
- 6 6-1/2-digits resolution
- 7 7-1/2-digits resolution
- 8 8-1/2-digits resolution

Refer to Table 3-2 for the ADC integration times applicable to the various resolution and Fast On/Off settings.

To revert to the TRUΩ CONFIG menu, press the Config key.

**TRUΩ - Movement between Menus**

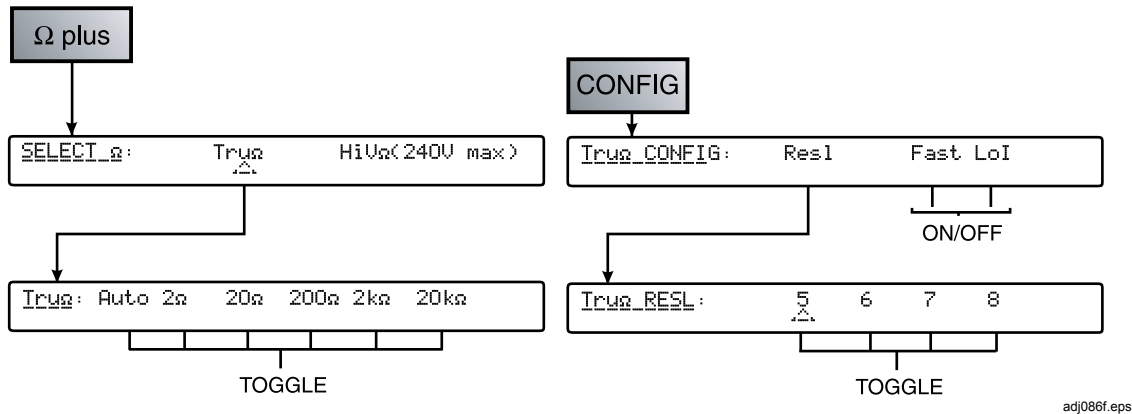

**TRUΩ Movement Between Menu**

adj086f.eps

**Measuring Resistance**

**2-Wire Measurements**

For many applications the simple 2-wire arrangement will be adequate. See Figure 3-5. However, the value displayed will include the resistance of the connecting leads.

Use a shielded twisted-pair cable, preferably of PTFE insulation, to reduce induced voltages, induced charge and shunt leakage resistance, particularly where Rx is high.

2-wire resistance measurement is not available when in TruΩ mode and is not well suited to use in the 2 Ω range. In the latter case zero compensation for lead and internal resistance contributions may limit full-scale readout. 2-wire measurements above 1.5 Ω should be made using higher ranges.

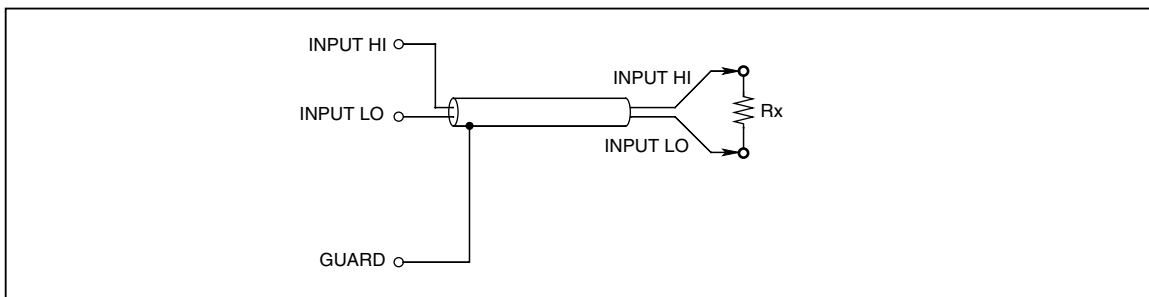

**Figure 3-5. 2-Wire Measurements**

adj091f.eps

**4-wire Measurements**

With a 4-wire connection the lead resistances have negligible effect and only the value of Rx is displayed.

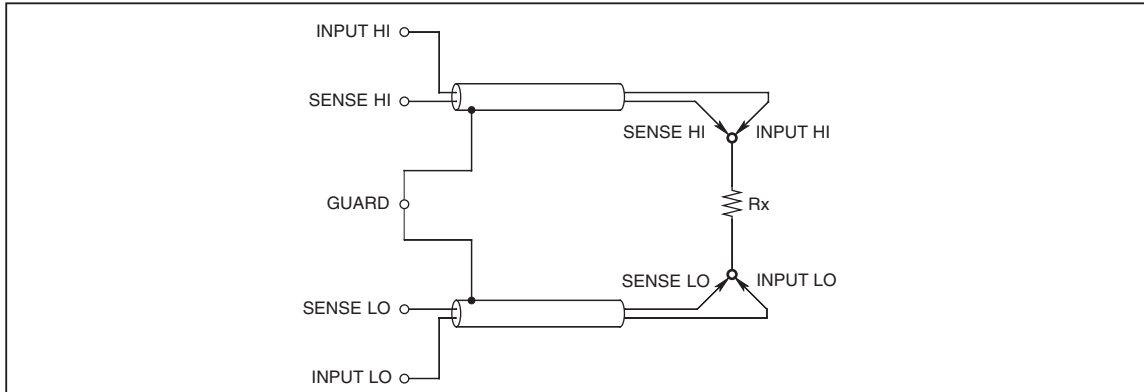

Figure 3-6. 4-Wire Measurements

adj092f.eps

### 4-wire High Resistance Measurements

When making very high resistance measurements above about 1 M $\Omega$ , a metal screen can be wrapped around the resistor to reduce noise, usually caused by charge injection. Connecting the **GUARD** terminal to the screen will intercept leakage via the screen (in parallel with the unknown resistor). The resistor under test should not be grounded, as this will make the measurement noisier.

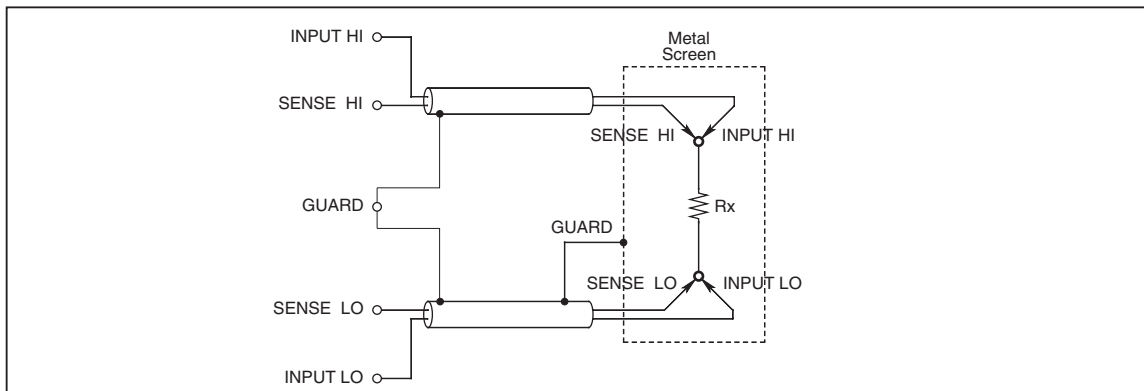

Figure 3-7. 4-Wire High Resistance Measurements

adj093f.eps

### 4-wire Resistance Zero

For accurate measurements of resistance it is essential that a correctly connected zero source be used when performing an Input-Zero operation before making a series of measurements. The preferred arrangement shown in Figure 3-8 ensures that thermal and induced EMF effects, and bias current effects, associated with the multimeter and the measurement cables are eliminated.

Two precision 4wire short accessories are supplied as standard within the 8508A – LEAD leadkit. Fitted over the Input Hi, Input Lo, Sense Hi and Sense Lo terminals these provide a convenient means of zeroing the 8508A inputs at the terminals. Use of the 4-wire short device at the multimeter terminals does not address potential sources of error within measurement cables.

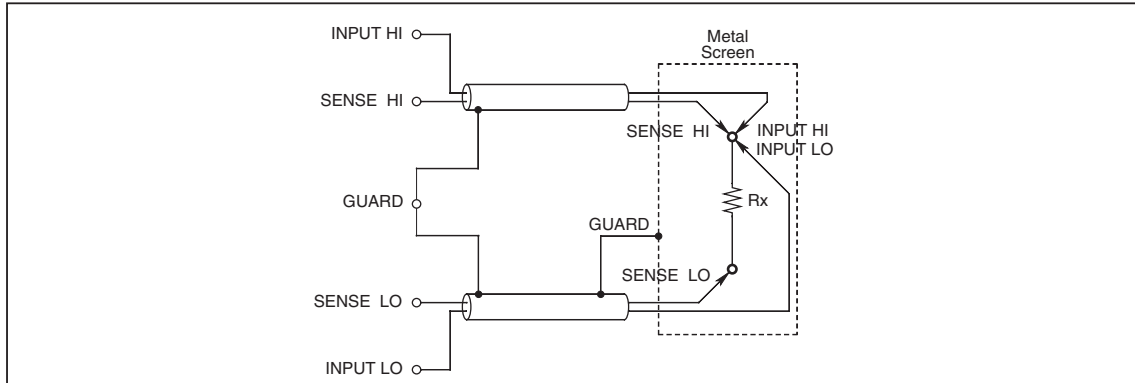

Figure 3-8. 4-Wire Resistance Zero Measurements

adj094f.eps

### **Ω Guard**

In the resistance function with Ext Grd selected the Guard terminal functions as **Ω Guard**. Using the Guard terminal as **Ω Guard**, the **Ω Guard** feature can be used to make ‘in-circuit’ resistance measurements by guarding out parallel resistance paths so that only the value of Rx will be displayed.

Similarly, **Ω Guard** can be used to reduce the settling time if Rx is shunted by any capacitance and a suitable tapping point is available. The connections for making **Ω Guard** measurements are shown in Figure 3-9. Selection of External Guard is required.

Table 3-3. Minimum Guard Resistances

Range	Minimum value for Ra and Rb
2 Ω, 20 Ω	200 Ω
200 Ω	2 kΩ
2 kΩ, 20 kΩ, 200 kΩ, 2 MΩ	20 kΩ
20 MΩ, 200 MΩ, 2 GΩ, 20 GΩ	200 kΩ

Providing that Ra and Rb are greater than the values shown in Table 3-3. Minimum Guard Resistances, and the **Ω Guard** resistance (Rg) is less than 1 Ω; the actual value can be calculated from the displayed value Rd by:

$$R_x = R_d \times (1 + E)$$

Deviation fraction ‘E’ can be found within 1 % by the simplified formula:

$$E = (R_d \times R_g) / (R_a \times R_b)$$

(Where Rg is the **Ω Guard** lead-resistance from the junction of Ra and Rb)

Example:

If Rd = 100 Ω, Rg = 1 Ω, Ra = Rb = 10 kΩ, then the value of E is given by:

$$E = (100 \times 1) / (10 \text{ k} \times 10 \text{ k}) = 10^{-6} \text{ (1 ppm of readings)}$$

The value of Rx is thus given by:

$$\begin{aligned} R_x &= 100 \times (1 + 10^{-6}) \text{ Ohms,} \\ &= 100.0001 \text{ Ohms} \end{aligned}$$

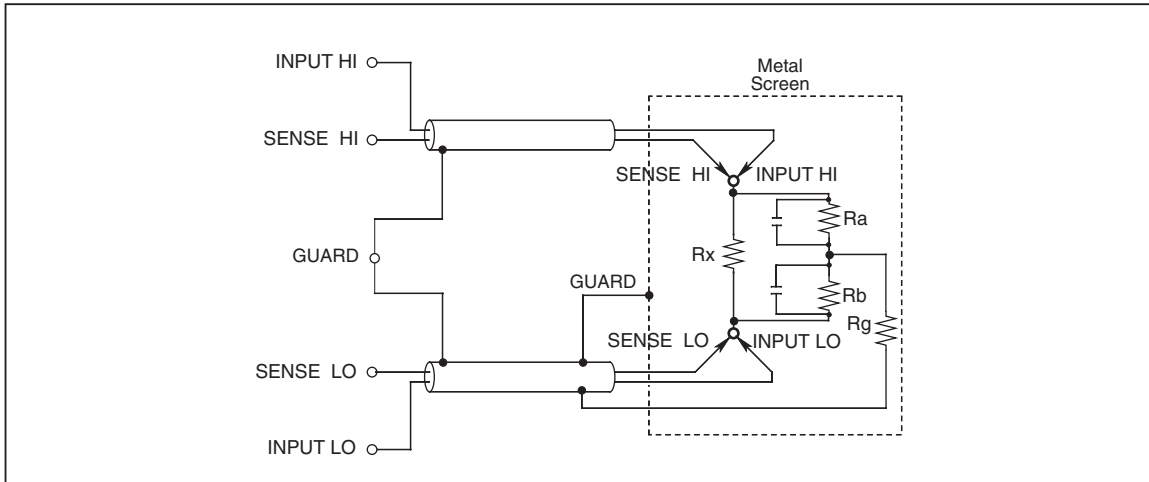

Figure 3-9.  $\Omega$  Guard Measurements

adj095f.eps

### Internal Guard Connections

**External Guard not selected:** In the Ohms or PRT Functions the Guard terminals on the front and rear panels are isolated from each other and from any internal connection. The internal guard shields and tracks are connected directly to the internal 0 V.

**External Guard selected:** In the Ohms or PRT Functions selecting the External Guard provides an Ohms Guard function. The internal guard shields, tracks, and the selected front or rear Guard terminal are connected to the internal 0 V.

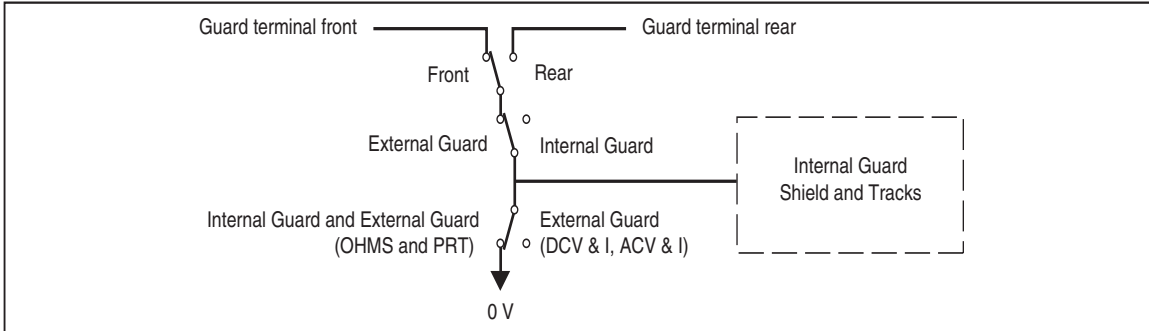

Figure 3-10. Internal Guard Connections

adj062f.eps

### Selecting External Guard (ExGd)

See Figure 3-9 for connections when using the  $\Omega$  Guard feature.

To select **External Guard**:

1. Press Input key to enter the INPUT menu.

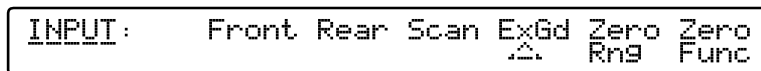

INPUT Menu

adj064f.eps

2. Press the menu key ExGd to toggle the Multimeter's Guarding options.

The ExGd annunciator on the left-hand display indicates that External Guarding is selected.



### DC Current

Press the DCI key to show the DCI menu.



adj097f.eps

#### DCI Menu

- DCI This function provides measurements, in decade ranges from 200µA to 20A. (NOTE: the 20A range is only available on the front terminals. The front current terminal is not fused.)
- Auto To cancel autoranging and enter a manually selected range, press any range selection or the Auto softkey. The Multimeter enters the selected range or reverts to the auto-selected range.

### DCI Configuration (Resolution, LP Filter and Fast)

Press the Config key to see the DCI CONFIG menu. Resl is a menu key; Filt and Fast are toggle keys.

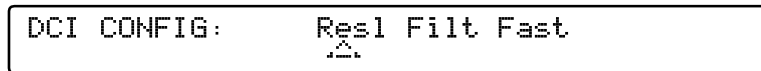

adj098f.eps

#### DCI Configuration Menu

- Resl Provides selection of the resolution for subsequent readings.
- Filt Controls a three-pole analog filter for increased noise rejection.  
The Filter annunciator on the left-hand display indicates that the filter is active and indicates its cut-in frequency.
- Fast Select a higher read rate. This will result in an increase in uncertainty due to noise.  
The Fast annunciator on the left-hand display indicates that the higher read rate is active.

### DCI Resolution

Press the Resl key to see the DCI RESL menu:

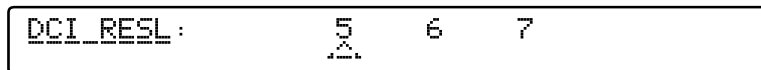

adj099f.eps

#### DCI RESL Menu

- 5 5-1/2-digits resolution
- 6 6-1/2-digits resolution
- 7 7-1/2-digits resolution

Refer to Table 3-2 for the ADC integration times applicable to the various resolution and Fast On/Off settings.

To revert to the DCI CONFIG menu, press the Config key.

### DC Current - Movement between Menus

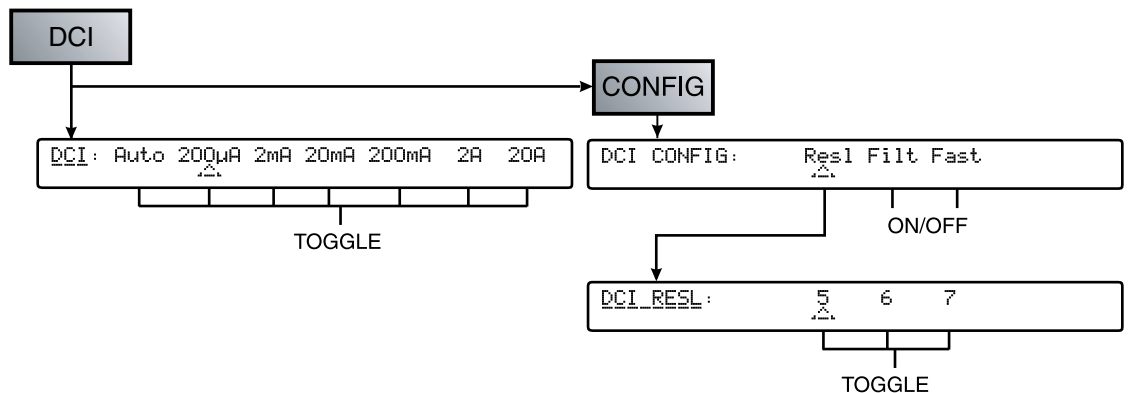

adj100f.eps

DCI Movement Between Menu

### Measuring DC Current

Insert the Multimeter in the current path via its **INPUT A** and **INPUT Lo** terminals, so that conventional current flows from the source Hi into the Multimeter's **A** terminal and back to the source Lo out of the **Lo** terminal.

Similar connection considerations are required for DC current measurement as for DC voltage measurement. Use shielded twisted-pair cable to reduce induced interference signals, and connect **Guard** to the source of common mode voltage, to provide a separate common mode current path.

### **⚠⚠ Warning**

#### **HIGH CURRENT FLOW**

**To avoid fire hazard make sure that conductors of adequate gauge are used when making current measurement. High Current can cause excessive heating of underrated conductors and may cause a fire.**

#### *Note*

*The Current path between DMM terminals is not made when the Current functions are not in use or when Front or Rear terminals are deselected.*

#### *Note*

*Maximum Input Current capability and protection. The front input terminals may be used to measure currents up to 20 A. The front input A terminal protection is automatic and self-resetting, and does not interrupt current flow. Damage is likely to occur if more than 20 A is applied.*

*The Rear input terminals may be used to measure currents up to 2 A only. The rear input A terminal is protected by a fuse mounted on the rear panel.*

### AC Current

Press the ACI key to show the ACI menu:

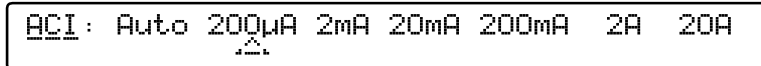

adj101f.eps

#### ACI Menu

- ACI** This function provides measurements, in decade ranges from 200µA to 20A. (NOTE: the 20A range is only available on the front terminals. The front current terminal is not fused.)
- Auto** To cancel autoranging and enter a manually selected range, press any range selection or the Auto softkey. The Multimeter enters the selected range or reverts to the auto-selected range.

### ACI Configuration (Resolution, RMS Filtering and DC Coupled)

Press the Config key to see the ACI CONFIG menu:

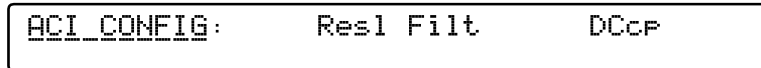

adj102f.eps

#### ACI CONFIG Menu

- Res1** Provides selection of the resolution for subsequent readings.
- Filt** Provides selection of various filters for the RMS converter, allowing measurements to be made down to the chosen filter frequency. One of four filters is always in circuit. The 40Hz filter is the default selection at power on.  
The Filter annunciator on the left-hand display indicates that the filter is active and indicates its frequency.
- DCcP** Controls the measurement-coupling configuration.

#### Note

*DC-coupled should be selected for signal frequencies less than 40 Hz.*

The DC coupled annunciator in the left-hand display indicates active state.

### ACI Resolution

Press the Res1 key to see the ACI RESL menu:

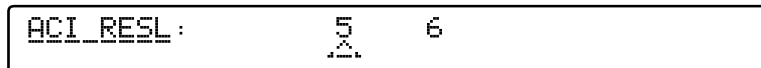

adj103f.eps

#### ACI RESL Menu

This menu offers the following resolution choices:

- 5 5-1/2-digits resolution
- 6 6-1/2-digits resolution

To revert to the ACI CONFIG menu, press the **Config** key.

### ACI Filter

Press the Filt key to see the ACI FILT menu:

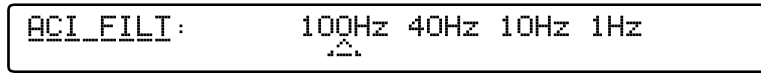

ACI Filt Menu

adj104f.eps

The ACI FILT menu allows selection of one of four RMS filters. The indicated value is the lowest signal frequency that can be measured without degradation of accuracy or excessive reading variation.

### AC Current - Movement between Menus

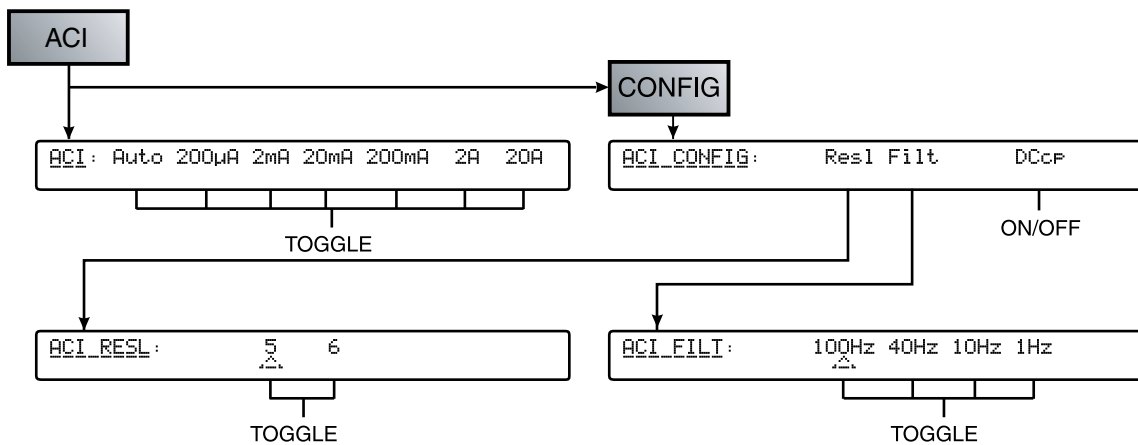

ACI Movement Between Menu

adj100f.eps

### Measuring AC Current

Insert the Multimeter in the current path via its **A** and **Lo** terminals.

Similar connection considerations are required for AC current measurement as for AC voltage measurement. Use shielded twisted pair cable to reduce induced interference signals, and connect Guard to the source of common mode voltage via the screen, to provide a separate common mode current path. The 8508A is designed to minimise the burden (compliance) voltage generated when making current measurements, thus improving measurement accuracy. However, it is recommended that leads of the minimum practical length be used to reduce lead capacitance, lead inductance and loop area.

### ⚠⚠ Warning

#### HIGH CURRENT FLOW

**To avoid fire hazard make sure that conductors of adequate guage are used when making current measurement. High Current can cause excessive heating of underated conductors and may cause a fire.**

#### Note

*The Current path between DMM terminals is not made when the Current functions are not in use or when Front or Rear terminals are deselected.*

*Note*

*Lead Impedance - When making AC current measurements pay particular attention to the lead impedance, especially lead capacitance at high frequencies on the lower current ranges. (See "Measuring AC Voltage" earlier in this chapter.)*

*Note*

*Maximum Input Current capability and protection - The front input terminals may be used to measure currents up to 20 A. The front input A terminal protection is automatic and self-resetting, and does not interrupt current flow. Damage is likely to occur if more than 20 A is applied.*

*The Rear input terminals may be used to measure currents up to 2 A only. The rear input A terminal is protected by a fuse mounted on the rear panel.*

**Temperature**

The 8508A provides a temperature readout by measuring the resistance of the connected PRT or SPRT probe, and converting the resistance value to temperature. The multimeter autoranges between the 200 Ω LoIΩ range and the 2 kΩ Normal Ω range depending on the resistance value obtained at the temperature being measured.

Press the PRT key to show the PROBE # menu:

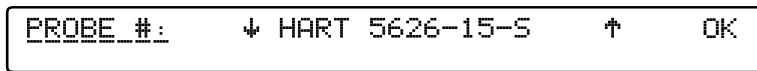

adj105f.eps

Select OK to ensure the probe indicated is selected.

**Probe# Menu**

**PRT** This function converts resistance measurements from a connected PRT to temperature. This requires that the characteristics of the probe being used are available for the conversion algorithm. The 8508A will store up to 100 sets of probe characteristics and the first menu encountered is used to select from a scrollable list of entered probe identities.

Once selected, the stored probe characteristics are used to configure the instrument hardware and implement the conversion of subsequent measurements.

If no probes have been stored, then only a default 100 Ω probe is available. To add a new probe, select OK. Press the CONFIG key, select PROBE, then select NEW and follow the instructions for new probe entry below.

Temperature is displayed on the main left-hand display, and the measured resistance value is also displayed on the right hand display.

**PRT Configuration (Temperature Units, Resolution, Probe Configuration Management)**

Press the Config key to see the PRT CONFIG menu:

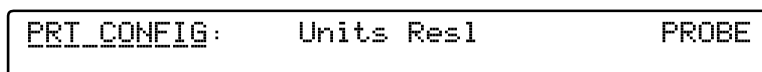

adj106f.eps

**PRT CONFIG Menu**

**Units** Provides selection for temperature units.

- Res1 Provides selection of the temperature resolution for subsequent readings.
- PROBE This is the entry point to manage PRT probe information.

### *PROBE Configuration Management (New, Edit, Delete)*

```
PROBE_CONFIG: Edit New Delete Exit
```

#### **PROBE CONFIG Menu**

adj107f.eps

The utilization and management of PRT probe data depends upon a probe identity. For example, before using the edit and delete capabilities a probe identity must be selected. For a new probe, defining an identity is the first step in the sequence of establishing the probe's characteristics.

### *New PROBE Entry*

```
Probe # = Enter Quit
```

#### **PROBE# Menu**

adj108f.eps

For entry of the characteristics of a new PRT probe a **directed sequence** of menus, initiated with a NEW command, should be followed. The first menu establishes the identity of the probe using the alphanumeric keyboard entry system. (NOTE: no duplication checks are made on the identity.)

```
CONNECTION: 2wr 3wr 4wr
```

#### **Connection Menu**

adj109f.eps

Selection of the connection method will determine the measurement configuration that is used by the Multimeter. This characteristic cannot be modified via the Edit capability.

- 2wr 2-wire probe configuration. Resistance measurements will be made using the 2-wire connection, with a single polarity stimulus current.
- 3wr 3-wire probe configuration. An equivalent 3-wire measurement will be made by automatically taking a reading with the resistance circuits in 2-wire with a single polarity stimulus current and also in 4-wire with polarity reversal of the stimulus current, and performing a calculation. Equal resistance is assumed for all three probe-leads. Input zeros for 2-wire and 4-wire resistance must be performed prior to the selection of the PRT as these are used in the calculation to remove offsets and internal lead resistance.
- 4wr 4-wire probe configuration. Resistance measurements will be made using the 4-wire connection, with a polarity reversal of the stimulus current.

```
CONVERSION:  SPRT      cvd-  cvd-  cvd
              ITS90     α      A      dflt
```

adj110f.eps

**Conversion Menu**

Select the conversion algorithm to be applied. This characteristic cannot be modified via the Edit capability. A measurement annunciator in the left-hand display indicates the active conversion algorithm.

**SPRT ITS90** This algorithm converts resistance to temperature according to the ITS-90 specifications for SPRTs. For details see the NIST Technical Note 1265, *Guidelines for Realizing the International Temperature Scale of 1990*. The user-defined parameters for the ITS-90 conversion include two subranges which are entered in subsequent conversion specific menus.

**cvd-α** This algorithm converts resistance to temperature using the Callender-Van Dusen equations. The user-defined parameters are supplied in the Alpha( $\alpha$ ), Delta( $\delta$ ), and Beta( $\beta$ ) format and are entered in subsequent conversion specific menus.

**cvd-A** This algorithm converts resistance to temperature using the Callender-Van Dusen equations. The user-defined parameters are supplied A, B, C coefficients and are entered in subsequent conversion specific menus.

*Note*

*The coefficients Alpha( $\alpha$ ), Delta( $\delta$ ), Beta( $\beta$ ) and A, B, C belong to reciprocally related polynomial expressions. Either may be used according to preference or available data.*

**cvd-dflt** This algorithm converts resistance to temperature using the Callender-Van Dusen equations. The only user-defined parameter is the  $R_0$  value entered in a subsequent conversion specific menu. The other coefficients are defaulted to A = 3.9083E-3, B = -5.775E-7, C = -4.183E-12.

**Coefficient Entry for a New PROBE**

On selection of a conversion method the algorithm specific coefficients are set to default values. The subsequent menus to modify these coefficients are conversion specific. The default value for the coefficient may be entered with a labeled softkey.

SPRT ITS90

```
Coeff R0P = ?      Enter Dflt
 1 of 6

Coeff a+ = ?      Enter Dflt
 2 of 6

Coeff b+ = ?      Enter Dflt
 3 of 6

Coeff c+ = ?      Enter Dflt
 4 of 6

Coeff a- = ?      Enter Dflt
 5 of 6

Coeff b- = ?      Enter Dflt
 6 of 6
```

adj111f.eps

**Coefficient Menus**

The  $R_{tp}$  is the resistance of the probe at the triple point of water. For a probe calibrated for the subrange W7 the coefficient  $a^+$  is equivalent to  $a_7$ , coefficient  $b^+$  is equivalent to  $b_7$ , and  $c^+$  to  $c_7$ . Similarly for a probe calibrated for the subrange W4 the coefficient  $a^-$  is equivalent to  $a_4$ , and  $b^-$  to  $b_4$ . Other subrange coefficients can be substituted for W4 and W7 coefficients. Unused coefficients should be defaulted to 0.

cvd- $\alpha$

A similar group of menus appear for the cvd-A conversion and for the cvd-dflt conversion only the Ro menu appears.

On entry of the final coefficient a check is made against limits for correct algorithm operation. A message is displayed indicating the coefficients in error. Coefficient values are not updated.

### Measuring Temperature

Connect the PRT or SPRT probe to the multimeter in the same way as when making resistance measurements, using the appropriate connection shown in figure 3-11. The corresponding 2, 3, or 4-wire measurement configuration will be automatically set based on the stored probe characteristics for the probe selection made. Selection of Ex Gd is recommended.

*Note:*

*Any input zero operations required must be performed in the resistance function on the 200  $\Omega$  LoI $\Omega$  and 2 k $\Omega$  Normal  $\Omega$  ranges prior to entering the PRT function. Input zeros must be performed in both 2-wire and 4-wire resistance modes when using the 3-wire PRT configuration.*

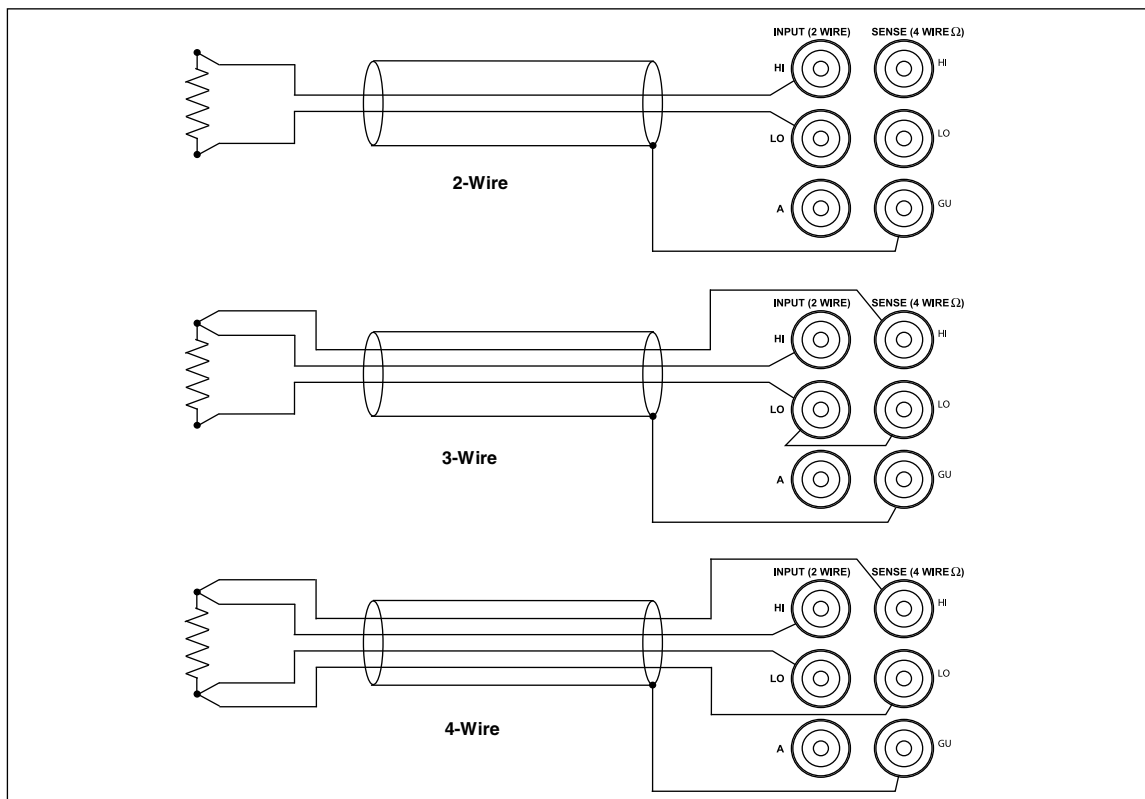

Figure 3-11. PRT Connections

adj131f.eps



## Multimeter Inputs

### Input

The Input key and its menu allow you to select either the Front or Rear panel terminals as the input to the Multimeter: The scan softkey gives access to dual-channel measurement and processing selection which produces a single result.

### Using the INPUT Key

Press the Input key to see the INPUT menu:



adj113f.eps

#### INPUT key Menu

- Front Selects Front Input terminals only.
- Rear Select Rear Input terminals only.

*Note*

*Total Isolation State - You can put the Multimeter in a state of total isolation by deselecting all the selections on the INPUT and SCAN menus. In this state, the Multimeter has no input.*

*This state is useful in a remote control system, to isolate the Multimeter from the system's analog bus.*

- Scan Readings are taken alternately from each channel, then measurements are combined as per the selection.

*Note*

*Selecting Front or Rear cancels any Scan selection.*

- ExGd When On, the internal guards are decoupled from LO and connected to the Guard terminal. Operation of Guard in the resistance function is modified, and includes Ohms Guard. Refer to the 'making measurements' section for each function for more details.

- Zero Rng Initiates a series of measurements to determine and correct for the Input Zero and save the result in volatile memory. An indication of the application of an input zero will appear on the left-hand display. Independent zero corrections are provided for Front and Rear terminals and, when in Ohms functions, 2 wire and four wire connections and normal and low current operation. Input Zero may be up to 0.5 % of Range.  
  
For AC always use the lowest possible range. After the Input Zero all subsequent readings will be RSS corrected by this zero.

- Zero Fnc Initiates a series of measurements on each range in the function starting with the highest range, to determine and correct for the Input Zero for each range.

*Note*

*Input Zeros - Input zero stores are cleared on power up, and may also be cleared by the user from the CLEAR menu, accessed by pressing the CLEAR key.*

## SCAN OPERATIONS

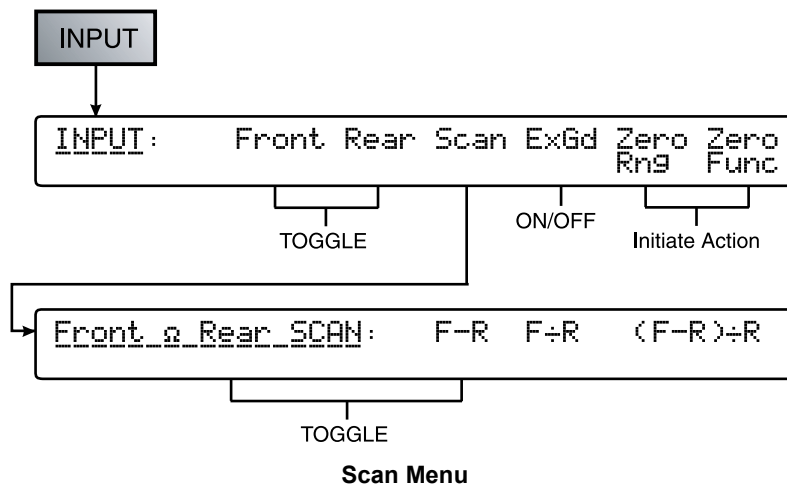

adj128f.eps

In each of three Scan modes, measurements are taken alternately from the Front and Rear Terminals and are combined mathematically to produce a single result as shown below.

- F-R** Readings are taken alternately from the front terminals and then the rear to produce the displayed result; Front reading – Rear reading.
- F÷R** Readings are taken alternately from the front terminals and then the rear to produce the displayed result; Front reading / Rear reading.
- (F-R)÷R** Readings are taken alternately from the front terminals and then the rear to produce the displayed result; This is the normalized ‘deviation’ value.

*Note*

*Scan of the Current functions - Scan is not available in the ACI and DCI functions.*

*Note*

*Scan of the Ohms functions - In the Ohms and HiV Ohms functions the Scan Operation switches both current stimulus and potential difference measurement between the Front and Rear terminals. The Tru Ohms Ratio feature described below scans only the potential difference measurement between Front and Rear terminals, maintaining stimulus current through both Front and Rear terminals.*

### ⚠⚠ Warning

#### DANGER OF LETHAL ELECTRIC SHOCK

To avoid LETHAL electrical shock DO NOT CONNECT EXTERNAL CAPACITANCE greater than 50 nF to the Multimeter terminals.

The maximum voltage across the measured resistor or open Multimeter terminals while using the HiVΩ function is 240 V. The maximum current that the Multimeter will source while using HiVΩ is 10 μA (Lo to Hi), or 2.0 mA (Guard to Hi if Ext Guard is selected). These characteristics are not considered “Hazardous Live” within the Safety standards applied to this instrument. However, capacitors (>50 nF) external to the Multimeter could accumulate LETHAL charge while making a HiVΩ measurement. DO NOT TOUCH the Multimeter terminals or circuitry under test unless you are sure it is safe to do so.

**⚠⚠ Caution**

**HIGH VOLTAGE**

To avoid equipment damage when using the HiV $\Omega$  function make sure that circuits or components connected to the Multimeter can withstand at least 240 V dc.

*Note*

*Scan of Temperature Measurement - Scan Mode is not available in the PRT Function. Temperature Measurements from two PRTs (each with its own linearization coefficients) connected to the Front and Rear Terminals may however be compared under remote control of the DMM.*

**Tru Ohms Ratio**

When the Tru Ohms Scan Mode of operation is selected a stimulus current (of alternating polarity) is applied through both resistors simultaneously, and the potential difference measured across the resistors is scanned between the Front and Rear Terminals, as shown in figure 3-12. This measurement technique can be beneficial for lower value resistance measurements between an unknown and a reference resistor, and reduces self heating (power) modulation that would otherwise result from scanning the stimulus current between the two resistors under test.

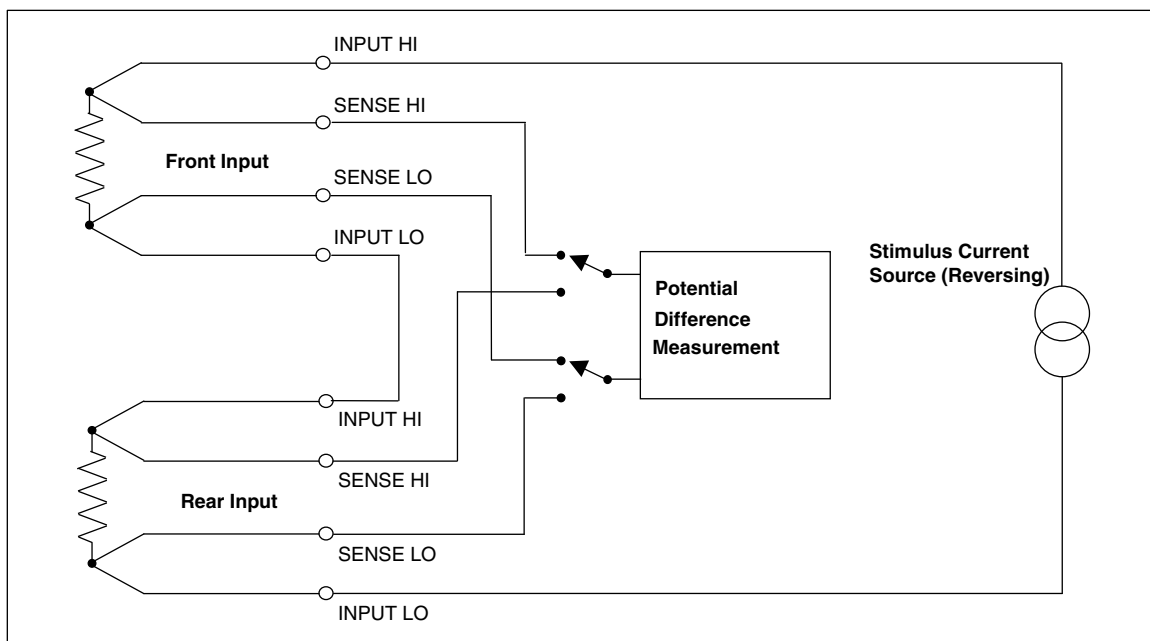

**Figure 3-12. Tru $\Omega$  Ratio Measurements**

adj132f.eps

The sequence of measurement is:

1. Set Forward Current, Measure potential difference at Rear.
2. Set Reverse Current, Measure potential difference at Rear.
3. Set Forward Current, Measure potential difference at Front.
4. Set Reverse Current, Measure potential difference at Front.

Autorange is not available in this mode.

## Monitoring Modes

### Monitor Key

Press the Monitor key to display MONITOR menu:

```
MONITOR:  Freq Devn Limit Max Min PkPk
```

MONITOR menu

adj116f.eps

### Displaying Signal Frequency

When measuring AC voltage or current, select the Freq key to display the frequency corresponding to the rms value shown on the main display. The response rate for the ACV function frequency measurements can be set in the MONITOR CONFIG menu. When Fast is not selected, the frequency measurements are made with a 1 s response rate at a 6.5-digit resolution, otherwise all frequency measurements are made with a 50 ms response rate at a 4.5-digit resolution. The 1 s response rate will slow down the ACV reading rate.

### Displaying Standard Deviation

Press the Devn key to calculate and display the population standard deviation of a block of readings.

The population standard deviation is calculated as 
$$\sqrt{\frac{\sum_{i=1}^n (x_i - \bar{x})^2}{n - 1}}$$

For the standard deviation of a rolling block of readings the AvR rolling average mode must be configured and selected from the MATH menus.

For the standard deviation of a fixed block of readings the BlocN block average mode must be configured and selected from the MATH menus.

### Devn Menu

```
Display STD Deviation in:  FFM  Abs
```

Standard Deviation Menu

adj146f.eps

This menu allows selection of the displayed format for the standard deviation.

**FFM** Displays the standard deviation of the block relative to the block mean.

**Abs** Displays the standard deviation of the block as an absolute value.

```
STD DEVIATION = xxxxxxxx
```

Standard Deviation display

adj147f.eps

### Displaying Maximum, Minimum, and Peak-to-Peak Readings

The MAX, MIN, and PKPK menus have the same format and show information derived from measurements taken since the Min, Max, or Pkpk mode was reset.

Once one of the three menus has been entered, you can select either of the other two without going through the MONITOR menu.

MAX or MIN can be cleared by its own Reset soft key, but the Reset soft-key on the PKPK menu clears both the Max and Min memory.

In DCV and DCI, the MAX value is the most positive (or least negative) measurement and the MIN value is the most negative (or least positive) measurement.

#### Note

*Because Pkpk does not store a value except as a result of calculating the difference between a maximum and a minimum value, if the MAX or MIN memory is cleared, the PKPK menu value is also cleared until the first measurement enters the cleared memory. After this, the PKPK menu value reflects the change by showing the new difference between the maximum and minimum values.*

*The Multimeter does not clear the MAX or MIN values upon a change of function, range, or other measurement parameter. These can be cleared only by pressing the appropriate Reset key.*

### MAX Menu

```
MAX =                               Reset Max Min Pkpk
```

MAX menu

adj117f.eps

### Limit-Checking

Select the Limit key to display whether high and low limits that were previously set, have been exceeded by the **most recent** measurement.

The display indicates a HI LIMIT if the most recent measurement is above the high limit of a preset range, LO LIMIT if it is below the low limit, or PASS if it is within the limit range.

Limits can be defined from the LIMIT menu, or from MONITOR CONFIG Menu.

```
LIMIT:    PASS                       Hilt Lolt Quit
```

LIMIT menu

adj118f.eps

Hi Lt/Lo Lt The last HI LIMIT/ LO LIMIT value is displayed and the numeric keyboard is activated to allow entry of a new limit. Enter completes the new limit or Quit leaves the value unchanged.

### Monitor Menu Tree

An overview of the Monitor mode and a diagram of the Monitor menu tree follows.

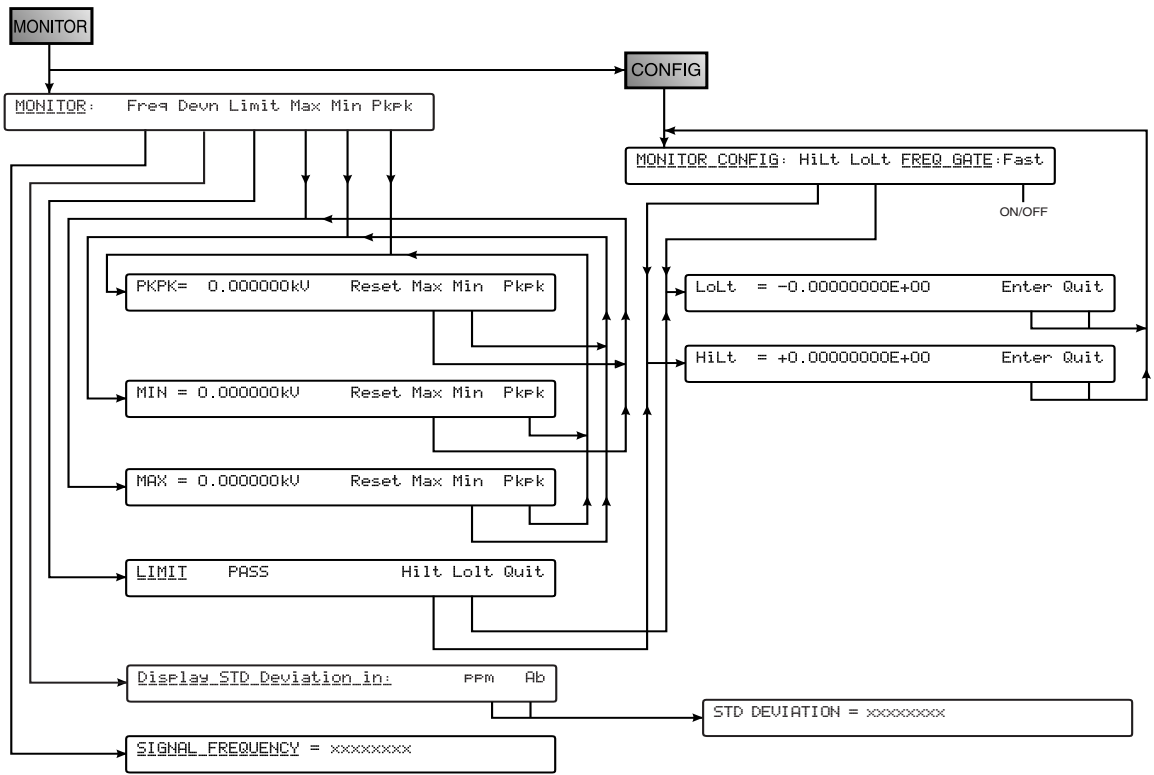

Monitor Menu Tree

adj114f.eps

*Note*

From any of these menus, pressing the Config hard key will enter the MONITOR CONFIG menu; pressing the Monitor key reverts to the MONITOR menu.

### Utility

Press the Utility key to see the UTILITY menu:

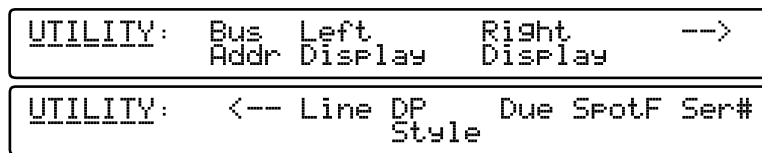

Utility Menu

adj119f.eps

This menu has the following menu key selections:

**Bus Addr** Displays the ADDRESS menu to view and change the IEEE-488 bus address of the Multimeter.

**Left Dis** Provides a contrast menu for adjustment to the left hand or main display.

- Right Display** Provides a contrast menu for adjustment to the right hand display.
- Line** Provides selection of the power line frequency for the Multimeter.
- SpotF** When in ACV function this softkey displays the SPOTF menu to view the spot frequencies at which the Multimeter has been calibrated.
- Ser#** Displays the SER# menu, to view the serial number of the Multimeter and version of the software in it.
- Due** Displays the CAL DUE date. This shows the user-entered recommended date for recalibration of the instrument.
- Style** Provides selection for display styles for the measurements.

### IEEE 488 ADDRESS

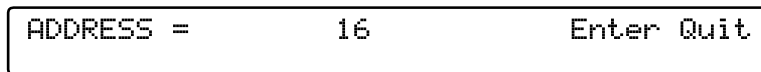

IEEE Bus address key Menu

adj120f.eps

The menu displays the present address value, and the numeric-keyboard keys are activated. Any valid numeric value (0-30) may be entered.

### LINE Frequency

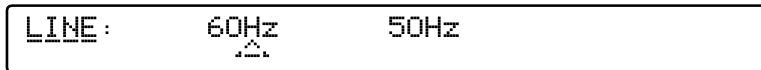

Line Frequency

adj121f.eps

This selection adjusts the integration time of the Analogue to Digital convertor to align with an integral number of power line cycles at 50 Hz or 60 Hz. Correct setting is critical to the Normal Mode and Common Mode rejection of the instrument. Once set, the LINE frequency is retained even after the Multimeter is turned OFF.

### SPOTF Menu

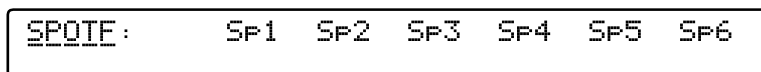

SPOTF Menu

adj122f.eps

This display is for information only. The Spot Frequencies cannot be altered except via Calibration at new values.

The SPOTF menu has six soft keys (Sp1 through Sp6), each allows the user to view one of the six possible spot frequencies that could have been calibrated for the currently active ACV range.

### SER# Display

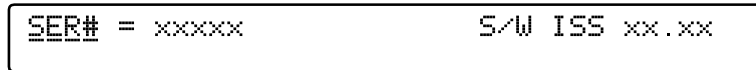

Ser# display

adj123f.eps

This display is for information only. The serial number cannot be altered except in one of the calibration menus at the factory.

The software issue number (last four digits) is embedded in the software itself, and is not user-alterable.

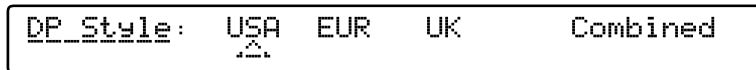

TOGGLE

DP Style Menu

adj144f.eps

The DP style allows the selection of the display format for the readings.

USA	+10,000104 <sub>U</sub>
EUR	+10,000104 <sub>U</sub>
UK	+10·000104 <sub>U</sub>
Combined	+10·000,104 <sub>U</sub>

adj387f.eps

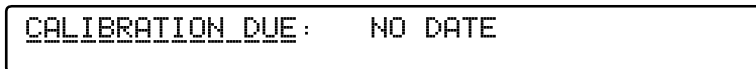

Calibration Due Menu

adj145f.eps

Calibration Due: this displays the date optionally entered during the exit from the most recent calibration.



**Status Reporting - Movement between Menus**

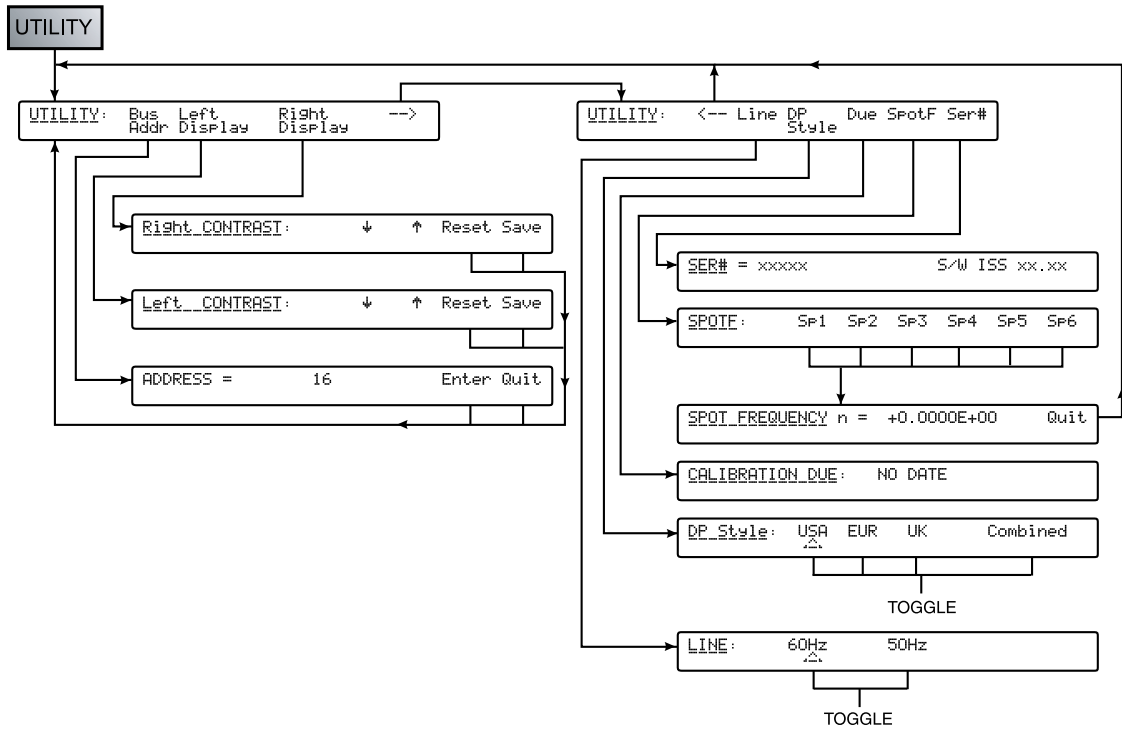

Status Reporting -- Movement Between Menus

adj124.eps

**Using the Selftest Functions**

This section covers the Multimeter's selftest functions that can be performed via the Test key. An overview of the Test mode and a diagram of the Test menu tree is provided in the following figure.

### Test Menu Tree

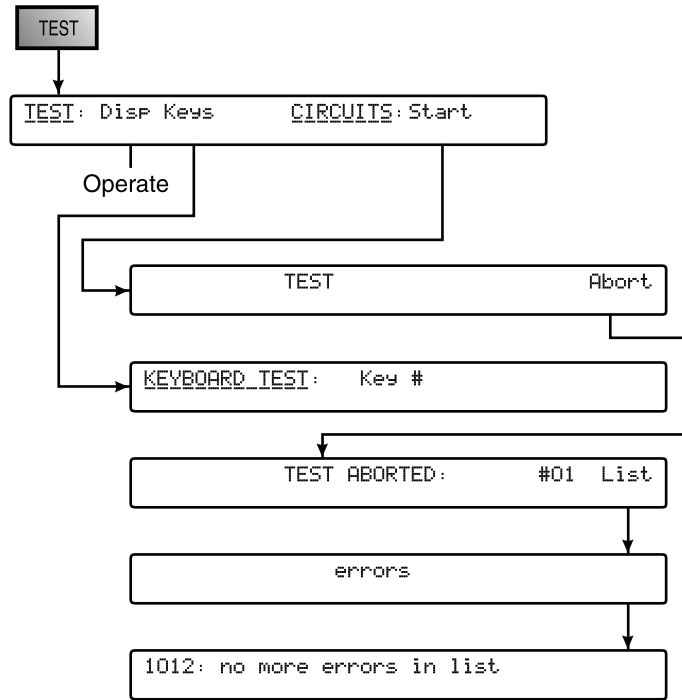

Test Menu Tree

adj125.eps

### Test Key

Press the Test key to display the TEST menu, from which you can choose to perform a variety of selftests.



adj126f.eps

#### TEST Menu

The TEST menu allows you to initiate front panel display and key tests and 'Circuit' test.

Please note that the instrument should be allowed a warm up period of 10 minutes before performing an internal self test and that ambient temperature should be between 15 °C and 35 °C.

**Disp** Press any key **other** than Test to step both displays through a sequence of 'walking strobes', which allow you to inspect segments and complete blocks.

Press Test during the Disp checks to terminate the display test.

**Keys** Press Keys to test all keys other than Test. The key's hexadecimal matrix position appears to the left of a colon; to the right of the colon an S is followed by the key's switch number, and the name of the key is given on the right of the display.

Press Test during the Key checks to terminate the key test.

**Start** Press to start a selftest and disable all other function keys, signal inputs and normal trigger sources.

While selftest is running the display shows a reference number of the test currently being performed.

A fail indicator (?) may be added to the display, and this will persist to the end of the test sequence. Press the Abort key to stop the test. In the TEST ABORT and TEST UNSUCCESSFUL menus, repeatedly pressing the List key reads out the failures in turn. The memory of each failure is lost as it is read.

Appendix A contains a list of the failure-message numbers.

#### Note

*The success of Selftest can be inhibited by:*

*Temperature not in the range: 5 °C to 40 °C, and presence of excessive RFI or Line noise.*

## Using the Math Functions

### Math Functions and Menu Tree

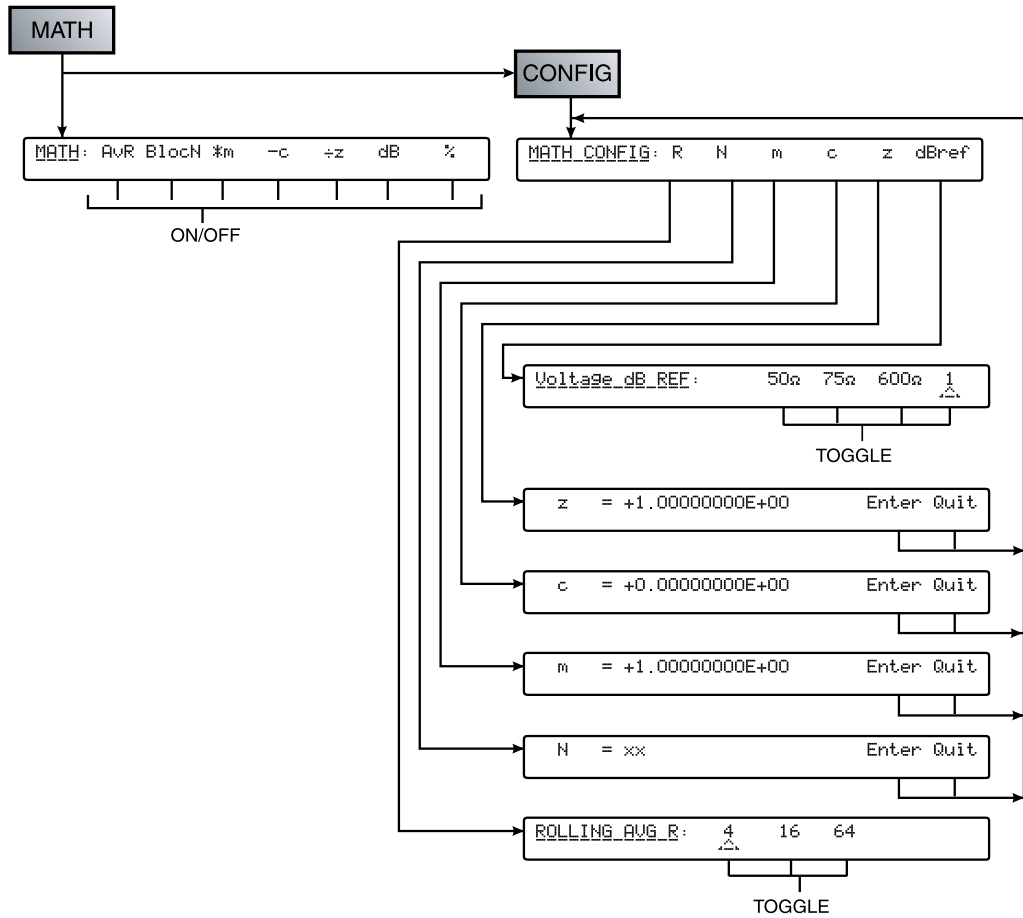

Math Menu Tree

adj127f.eps

Press the Math key to display the MATH menu. The MATH menu provides selections for a variety of linear, averaging, and logarithmic calculations.

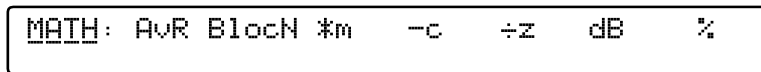

MATH Menu

adj129f.eps

Mathematical operations are performed on the readings obtained from the main measurement function in strict left-to-right order. All operations are independently selectable. The activation of any math operation displays the 'MATH' legend on the main (left-hand) display and the measurement units e.g. V will not be displayed except when the only math operation is '-C'. An exponent is added to the numeric value displayed to scale the mathematical results.

All constants (except %) used in the mathematical operations are set in the MATH CONFIG menu.

*Note*

From any of the menus below, pressing the Config key enters the MATH CONFIG menu; pressing the Math key reverts to the MATH menu.

Press Enter or Quit to revert automatically to the MATH CONFIG menu.

AvR	Causes a rolling average of <b>R</b> readings to be made. AvR cross-cancels with BlocN.
BlocN	Causes a block average of <b>N</b> readings to be made. BlocN cross-cancels with AvR.
$\times m$	Causes the measurement to be multiplied by a constant, <b>m</b> .
$- c$	Causes a constant, <b>c</b> , to be subtracted from the measurement.
$\div z$	Causes the measurement to be divided by the constant, <b>z</b> .
dB	Causes the measurement to be expressed in dB relative to <b>1</b> , or to <b>z</b> , or to <b>dBref</b> . Constants <b>dBref</b> and <b>z</b> are defined via the MATH CONFIG menu.
$\times 100$	Causes the measurement to be multiplied by <b>100</b> .

**Math Configuration**

Press the Config key from the MATH menu to display the MATH CONFIG menu, from which you can store the various constants used by the Math operations.

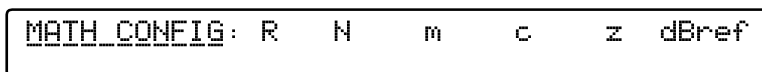

adj130f.eps

**MATH CONFIG menu**

The MATH CONFIG menu has six menu keys.

<b>R</b>	Provides selection of the number of readings used in rolling average.
<b>N</b>	Provides a numeric entry menu for the value of N. The most recent N value is shown and the keyboard is activated. Press Enter to store the new value or Quit to leave the old value intact and return to the MATH CONFIG menu.
<b>m</b>	Provides a numeric entry menu for the value of the multiplier constant, m.
<b>c</b>	Provides a numeric entry menu for the value of the subtractor constant, c.
<b>z</b>	Provides a numeric entry menu for the value of the divisor constant, z.
<b>dBref</b>	Provides selection of the decibel reference constant, dBREF. Only voltage functions can utilize all the settings. Other functions will utilize a unity reference. <u>50 Ω</u> Selects a reference of 1 mW in 50 Ω. <u>75 Ω</u> Selects a reference of 1 mW in 75 Ω. <u>600 Ω</u> Selects a reference of 1 mW in 600 Ω <u>1</u> Selects a unity reference value.

## Clear Functions

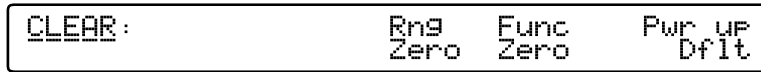

adj143f.eps

### CLEAR Menu

The 'input zero' corrections will remain active until power down, but the selections available in this menu will allow the corrections to be cleared.

- |             |  |
|-------------|--|
| Rng Zero    | Removes the correction for the currently selected range and function.      |
| Func Zero   | Removes the correction for all ranges for the currently selected function. |
| Pwr UP Dflt | Sets the instrument to the conditions which exist at power up.             |

## Chapter 4

# Remote Operations Using the IEEE 488 Interface

Title	Page
Introduction.....	4-3
Interface Capability: IEEE Standards 488.1 and 488.2 .....	4-3
The Multimeter in IEEE 488.2 Terminology .....	4-3
Programming Options .....	4-3
Capability Codes .....	4-3
Interconnections.....	4-4
Using the 8508A Reference Multimeter in a System .....	4-5
Setting the Multimeter Address.....	4-5
Remote Operation General Considerations.....	4-5
Syntax Diagrams in this Manual .....	4-5
The 8508A Status Reporting Structure.....	4-8
Types of Status Information Available.....	4-9
Syntax Diagrams of Major 8508A Functions.....	4-10
DC Voltage.....	4-10
AC Voltage.....	4-11
Resistance: Normal OHMS .....	4-13
Resistance: High Voltage OHMS.....	4-14
Resistance: True OHMS.....	4-15
DC Current .....	4-16
AC Current .....	4-17
Using Platinum Resistance Thermometers to obtain Temperature. ....	4-18
Determine the PRT identity.....	4-18
Entering or Editing the Characteristics of a PRT to Non-volatile Store.....	4-19
Recalling the Characteristics of a Known PRT .....	4-20
Deleting a Known PRT from the Non-volatile Store .....	4-20
Input.....	4-21
Guard .....	4-21
Measurement Gate Width.....	4-22
Maximum, Minimum and Peak-Peak .....	4-22
Limits.....	4-24
Recall Limits .....	4-24
Enable Limits.....	4-24
Standard Deviation .....	4-25
Syntax Diagrams of Math Functions .....	4-25
Averaging .....	4-25
Multiplication .....	4-27

Subtraction.....	4-28
Division .....	4-29
Decibel Calculations.....	4-30
Syntax Diagram of Test .....	4-31
Selftest .....	4-31
Device Errors and Syntax Diagrams.....	4-31
Error Detection .....	4-31
Recall Device Errors.....	4-32
Triggering and Reading Operations.....	4-33
Trigger Source Selector.....	4-33
Execute Trigger .....	4-34
Execute Trigger and Take a Reading .....	4-34
Settling Delay .....	4-34
Input Zero .....	4-36
Wait .....	4-36
Reading Recall.....	4-36
Access to the Internal Buffer Memory .....	4-37
Internal Operations Commands .....	4-39
Reset .....	4-39
Complete Operations .....	4-40
Status Reporting.....	4-40
Instrument I/D and Setup.....	4-44
Calibration Commands and Messages.....	4-46
Calibration Sequences .....	4-46
Protected User Data.....	4-48
Special Calibrations.....	4-49



## Introduction

Chapter 4 provides the information necessary to operate the 8508A Reference Multimeter remotely via the IEEE 488 Interface. (Hereafter, the 8508A is also referred to as "the Multimeter" or, in the context of IEEE 488.2 terminology, "the device")

For users unfamiliar with the IEEE 488 Interface, refer to the standard specification, which appears in the publications ANSI/IEEE Std. 488.1-1987 and IEEE Std. 488.2-1988.

A complete description of all commands and queries, along with syntax diagrams, is provided under "Command, Queries, and Syntax Diagrams" later in this chapter.

The material in this chapter is organized in the following categories:

- **Interface Capability**  
Introduction to the IEEE 488.1 subsets that are implemented in the Fluke 8508A, satisfying IEEE 488.2.
- **Interconnections**  
Description of the rear panel IEEE 488 connector and its pin designations.
- **Using the Multimeter in a System**  
Addressing, remote operation, programming guidance.
- **Syntax Diagrams in this Manual**  
An introduction to syntax diagrams
- **The 8508A Status Reporting Structure**
- **Programming Commands and Queries**  
Detailed descriptions of both common and device-specific commands and queries, including syntax diagrams.

## Interface Capability: IEEE Standards 488.1 and 488.2

The Fluke 8508A Reference Multimeter conforms to the Standard Specification IEEE 488.1-1987: *IEEE Standard Digital Interface for Programmable Instrumentation*, and to IEEE 488.2-1988: *Codes, Formats, Protocols and Common Commands*.

### The Multimeter in IEEE 488.2 Terminology

In IEEE 488.2 terminology, the Multimeter is a **device** containing a **system interface**.

As such, it can be connected to a **system** via its **system bus** and put into programmed communication with other bus-connected **devices** under the direction of a system **controller**.

### Programming Options

The Multimeter can be programmed via the IEEE Interface to do the following:

- Change its operating state (e.g., function, range etc).
- Transmit measurements and its own status data over the bus.
- Request service from the system controller.

### Capability Codes

The codes that apply to the 8508A Reference Multimeter and a short description of each are given in Table 4-1. They also appear on the rear of the instrument next to the interface connector. These codes conform to the capabilities required by IEEE 488.2. Appendix C of the IEEE 488.1 standard contains a complete description of each code.

Table 4-1. IEEE Interface Capability

IEEE 488.1 Subset	Interface Function
SH1	Source Handshake Capability
AH1	Acceptor Handshake Capability
T6	Talker (basic talker, serial poll, unaddressed to talk if addressed to listen)
L4	Listener (basic listener, unaddressed to listen if addressed to talk)
SR1	Service Request Capability
RL1	Remote/Local Capability (including Local Lockout)
PP0	No Parallel Poll Capability
DC1	Device Clear Capability
DT1	Device Trigger Capability
C0	No Controller Capability
E2	Open-Collector and Three-State Drivers

## Interconnections

Instruments fitted with an IEEE 488 interface communicate with each other through a standard set of interconnecting cables, as specified in the IEEE 488.1 Standard document.

The interface socket is fitted on the rear panel. It accommodates the specified connector, whose pin designations are also standardized as shown in Figure 4-1.

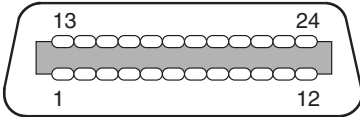

adj194f.eps

IEEE 488 Input/Output - Pin Layout and Designations		
Pin No.	Name	Description
1	DIO 1	Data Input/Output Line 1
2	DIO 2	Data Input/Output Line 2
3	DIO 3	Data Input/Output Line 3
4	DIO 4	Data Input/Output Line 4
5	EOI	End or Identify
6	DAV	Data Valid
7	NRFD	Not Ready For Data
8	NDAC	Not Data Accepted
9	IFC	Interface Clear
10	SRQ	Service Request
11	ATN	Attention
12	SHIELD	Shielding on cable (connected to 1281 safety ground)
13	DIO 5	Data Input/Output Line 5
14	DIO 6	Data Input/Output Line 6
15	DIO 7	Data Input/Output Line 7
16	DIO 8	Data Input/Output Line 8
17	REN	Remote Enable
18	GND 6	Gnd wire of DAV twisted pair
19	GND 7	Gnd wire of NRFD twisted pair
20	GND 8	Gnd wire of NDAC twisted pair
21	GND 9	Gnd wire of IFC twisted pair
22	GND 10	Gnd wire of SRQ twisted pair
23	GND 11	Gnd wire of ATN twisted pair
24	GND	8508A Logic Ground (internally connected to 8508A Safety Ground)

Figure 4-1. IEEE 488 Input/Output Connector

## Using the 8508A Reference Multimeter in a System

### Setting the Multimeter Address

The Multimeter will only respond to Talk or Listen commands from the controller at a specified address. The Multimeter address can only be set manually; using the ADDRESS menu that is accessed via the Utility menu.

To change the address, proceed as follows:

1. Press the UTILITY key to see the menu:

```
UTILITY:  Bus Left  Right  -->
          Addr Display Display
UTILITY:  <-- Line DP  Due SpotF Ser#
          Style
```

adj119f.eps

#### UTILITY menu

2. Press Bus Addr to display the ADDRESS menu from which you can enter or change the Multimeter's IEEE-488 bus address.

```
ADDRESS =      16      Enter Quit
```

adj120f.eps

#### ADDRESS menu

The menu displays the present address and the numeric-keyboard keys are activated.

3. Enter any valid numeric value between 0 and 30. If you enter an invalid address, 1007: data entry error is displayed.
4. Press Enter to store the new address OR press Quit to leave the old address unchanged.

### Remote Operation General Considerations

When the 8508A Reference Multimeter is operating under the direction of the controller, the right hand display indicates Remote Operation together with the function and range settings. The front panel controls are disabled with the exception of LOCAL (provided *Local Lockout* has not been programmed).

### Syntax Diagrams in this Manual

The following paragraphs describe the syntax diagrams used in this manual.

- Syntactic elements are connected by lines with directional symbols to indicate the flow, which generally proceeds from left to right.
- Repeatable elements have a right-to-left reverse path shown around them, which will also contain a separator such as a comma.
- When it is possible to bypass elements, a left-to-right path is shown around them.
- When there is a choice of elements, the path branches to the choices.

### The Program Message

Each Program Message may consist of only one syntactic element plus its terminator, or may be subdivided into many "Program Message Units", separated by semi-colons (;)

which are known as "Program Message Unit Separators". Thus the semi-colon cannot be used for any other purpose.

As you can see from the diagram, multiple Program Message Units can be sent if they are separated using semi-colons (shown in the repeat path). The starting circle is used only for the diagram to indicate the start of a complete Program Message.

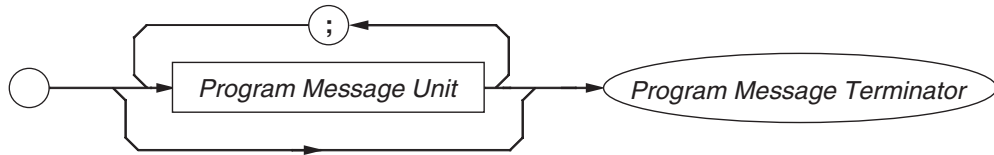

Syntax Diagram of a Simple Program Message

adj199f.eps

### Use of Italics

Notice that the names of some elements are shown here in italics which indicate "non-literal" text (i.e., names given to particular elements) The actual characters to be sent, are shown in plain-text capitals.

### Upper/Lower Case Equivalence

The Multimeter will not differentiate between upper and lower case characters in literal program text.

### Numeric Representation

The Multimeter accepts a "Flexible Numeric Representation" (*Nrf*), when receiving numbers.

Decimal numeric responses from the Multimeter are in either Nr1 or Nr3 format. In this manual, all syntax diagrams for query contain the response format.

### The Program Message Terminator

The message terminator for the 8508A Reference Multimeter is the hexadecimal number 0A, characterized in IEEE 488.2 as **NL**. Alternatively, the **EOI** (end or identify) line can be set true with the last byte to be sent. This is represented on the syntax diagram by /<sup>^</sup>END/.

### The Program Message Unit

Program Message Units (PMUs) can be "Terminal" or "Non-terminal". The final PMU in any Program Message is always Terminal (includes the terminator), whereas all preceding PMUs within the Program Message are obviously Non-terminal. Most of the commands in this handbook are described in the form of non-terminal message units:

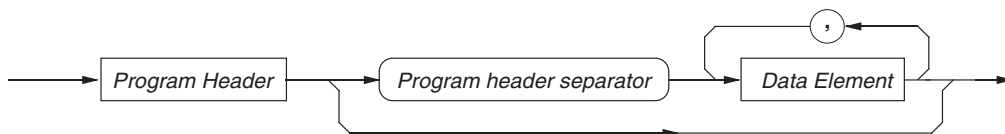

Non-Terminal Program Message Unit

adj352f.eps

To save space, the name 'program header separator' is abbreviated to 'phs'.

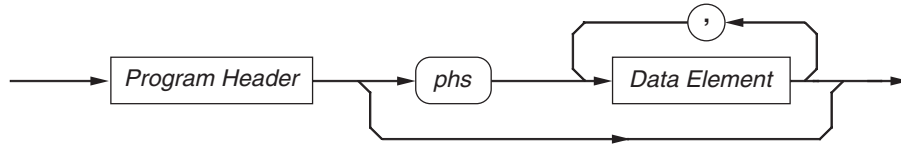

adj201f.eps

**Program Header Separator - phs**

**The Program Header**

The 'Program Header' provides the main command identification. This may be followed by 'Program Data Elements' and these must be separated from the 'Program Header' by a 'Program Header Separator'.

**The Program Header Separator**

The 'Program Header Separator' is one or more 'white space' characters excluding the message terminator (NL).

**Program Data Elements**

Four versions of the defined program data elements are employed. They are emphasized in the following syntax diagrams, taken from the commands available for the Multimeter:

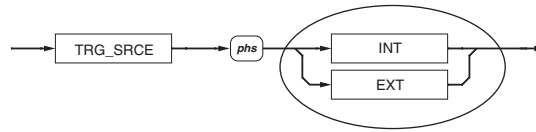

adj203f.eps

**Character**

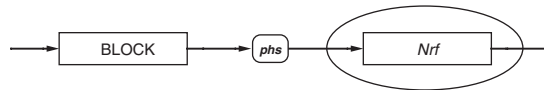

adj204f.eps

**Decimal Numeric**

(*Nrf* can be expressed in any of the ways defined by the Standard document.)

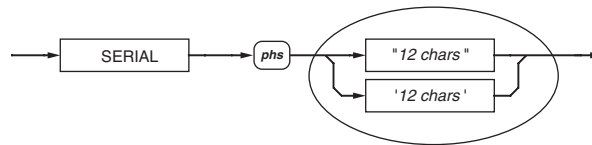

adj205f.eps

**String**

(The maximum size of the string is specified in the command detail.)

**Arbitrary Block Data Elements**

Both the "Definite" and "Indefinite" forms specified in the Standard document are used, as shown in the Syntax diagram below. The *user message* must be limited to a maximum of 63 bytes.

The Definite form can be fitted into an assembly of message units, but the Indefinite form (lower path) has no exit to further message units. In this case the program message must be terminated to inform the instrument that the block is complete.

Note that the slash-delimited **/^END/** box is not outlined. This is to draw attention to the fact that it is not a data element, but represents the **EOI** line being set true with the last byte **NL** to terminate the program message.

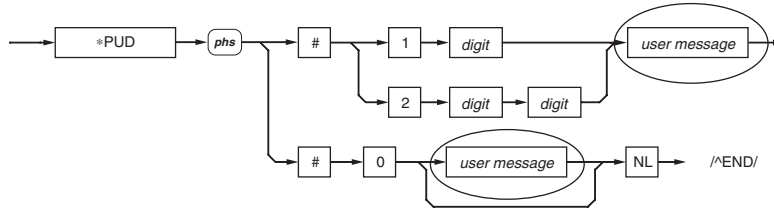

Arbitrary Block Data Element

adj206f.eps

### The 8508A Status Reporting Structure

The IEEE 488.2 status reporting structure provides the application programmer with a mechanism to choose the status information required at each stage in the application program.

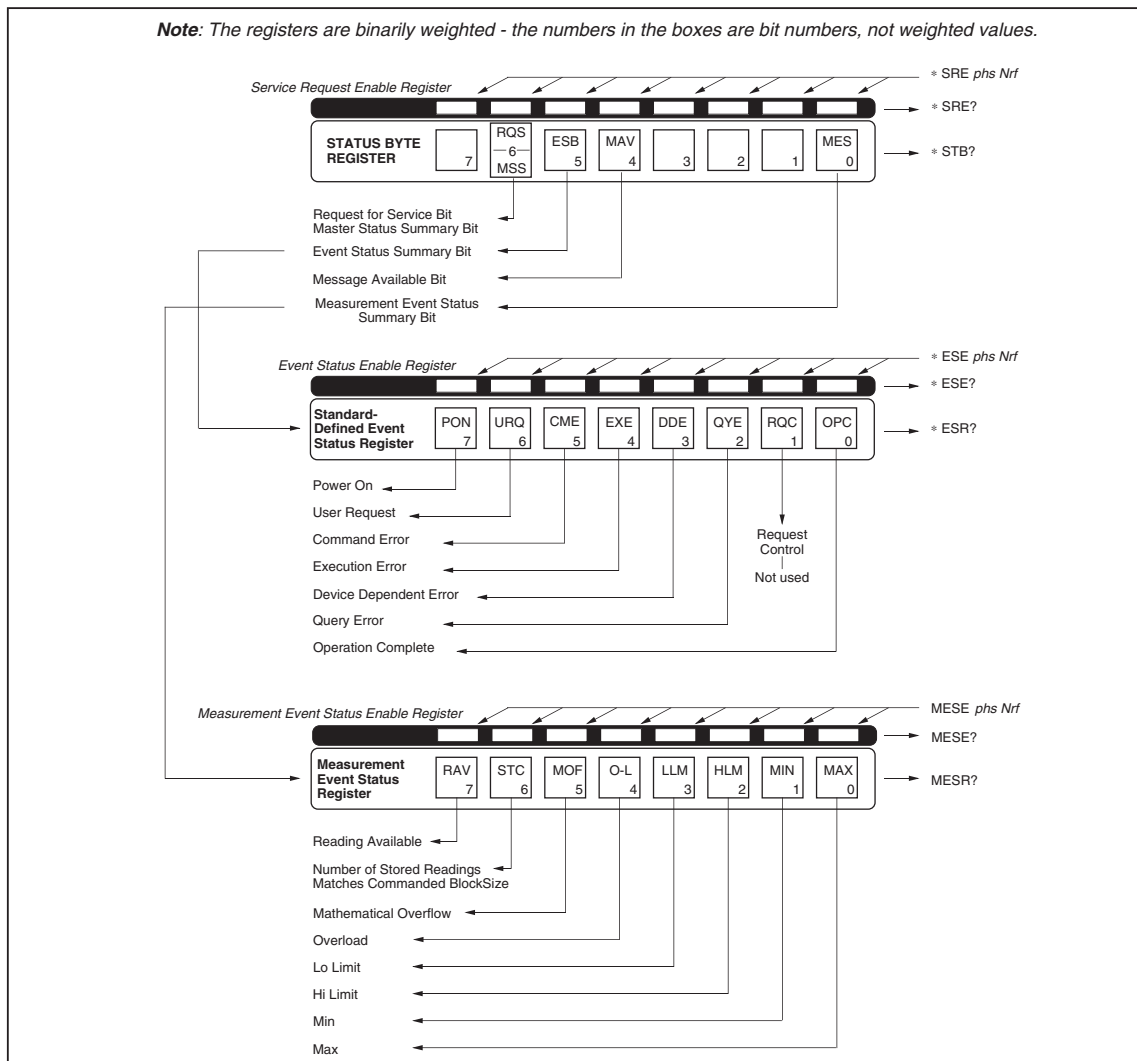

Figure 4-2. 8508A Status Report Structure

adj206f.eps

### Standard-Defined and Device-Specific Features

In the 8508A, the structure has three main registers, as follows:

- **The Status Byte Register**, and its associated enable register, control the generation of the **Status Byte**, which summarizes the remainder of the status structure.
- **The Event Status Register**, and its associated enable register, control the generation of the **Event Status Byte**, whose component bits report Standard-defined types of events. This register is summarized by the **ESB** bit 5 in the **Status Byte**.
- **The Measurement Event Status Register**, and its associated enable register, control the generation of the **Measurement Event Status Byte**, whose component bits relate to measurement events in the 8508A. It is summarized by the **MES** bit 0 in the **Status Byte**.

In the **Event Status Byte** the **EXE** bit is associated with a queue of execution errors related to the 8508A programmed condition, and the **DDE** bit is associated with a queue of device-dependent errors related to 8508A internal faults.

*A Note about Queues. These are 'historical' (Last-in - Last Out) stacks, and when the queue stack is full the eldest entries are discarded. It is recommended that the application read the queue as soon as its summary bit is set true, particularly the error bits, otherwise the original cause of the error can be discarded as subsequent dependent errors fill up the stack. However any message indicated by the MAV bit should be read before attempting to obtain the ESR status byte.*

### Access via the Application Program

The application designer has access to three enable registers to enable or disable any individual bit in these registers.

Thus the application programmer can decide which assigned events will generate an **SRQ**, by enabling their event bits and then enabling the appropriate summary bit(s) in the **Status Byte**. The Controller can be programmed to read the **Status Byte** during a resulting serial poll, and be directed to the appropriate **Event Register** to discover which event was responsible for originating the **SRQ**.

### Types of Status Information Available

#### Status Summary Information

The **Status Byte (STB)** consists of flag bits which direct the Controller's attention to the type of event which has occurred.

#### Standard-defined events

The following events are flagged in the 8-bit latched **Event Status Register (ESR)**, read-accessible to the controller.

- Power On - the instrument's power supply has been switched on.
- User Request - This capability is not available in the 8508A.
- Command Error - a received bus command does not satisfy the syntax rules programmed into the instrument interface's parser, and so is not recognized as a valid command.
- Execution Error - a received command has been successfully parsed, but it cannot be executed owing to the current programmed condition of the instrument.

- Device-Dependent Error - a reportable internal operating fault has been detected.
- Query Error - the controller is following an inappropriate message exchange protocol, in attempting to read data from the output queue.
- Request Control - provided for devices which are able to assume the role of controller. This capability is not available in the 8508A.
- Operation Complete - initiated by a message from the controller, indicates that the 8508A has completed all selected pending operations.

### Measurement events

The following events are flagged in another 8-bit latched register, called the **Measurement Event Status Register (MESR)**, read-accessible to the controller.

- A measurement has been completed from an initiating trigger.
- When the instrument has been commanded to store a number of measurements in a block, and the specified number of measurements in the block has been stored.
- Mathematical Overflow
- Overload
- Low Limit Reached
- High Limit Reached
- New Minimum Value Established
- New Maximum Value Established

## Syntax Diagrams of Major 8508A Functions

### DC Voltage

The following commands are used to select the DCV function and set its configuration.

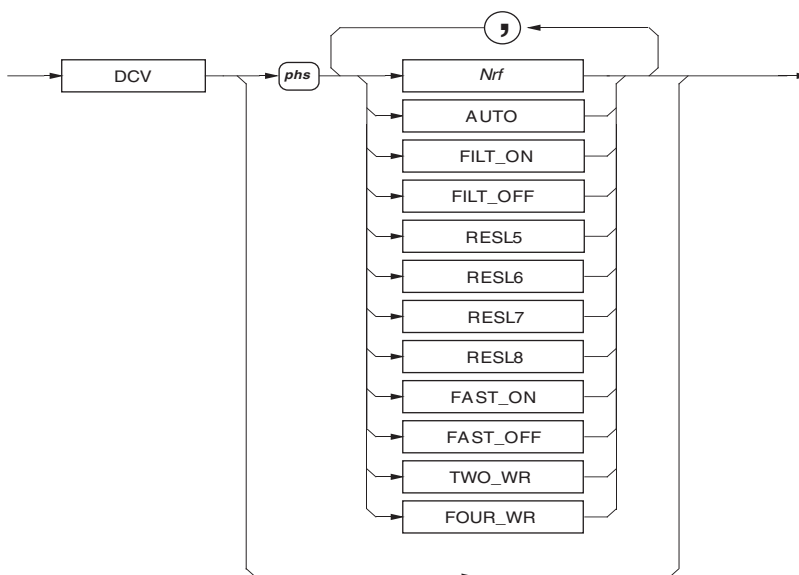

DC Voltage

adj209f.eps



**Nrf**

A numeric value that selects the range for the expected signal. For example, an **Nrf** of 2, 10, or even 15.6789, selects the 20 V range. Any valid numeric value cancels autorange.

**AUTO**

Selects the autorange mode where the multimeter will determine the appropriate range for the measured signal.

If the signal exceeds the maximum capability then RANGE OVERLOAD appears on the front panel, and the appropriate bit is set in the device status registers.

**FILT\_ON / FILT\_OFF**

FILT\_ON inserts a hardware analog filter into the signal path.

**RESL5 / RESL6 / RESL7 / RESL8**

Sets the resolution of the measurement to 5.5, 6.5, 7.5 or 8.5 digits.

**FAST\_ON / FAST\_OFF**

FAST\_ON Reduces the A-D integration time, for faster conversions.

**TWO\_WR**

Requires only a connection to the input terminals.

**FOUR\_WR**

Requires a connection to the input terminals and to the sense terminals.

**Power On and Reset Conditions**

1kV, FILT\_OFF, RESL7, FAST\_ON, TWO\_WR

**AC Voltage**

The following commands are used to select the ACV function and set its configuration.

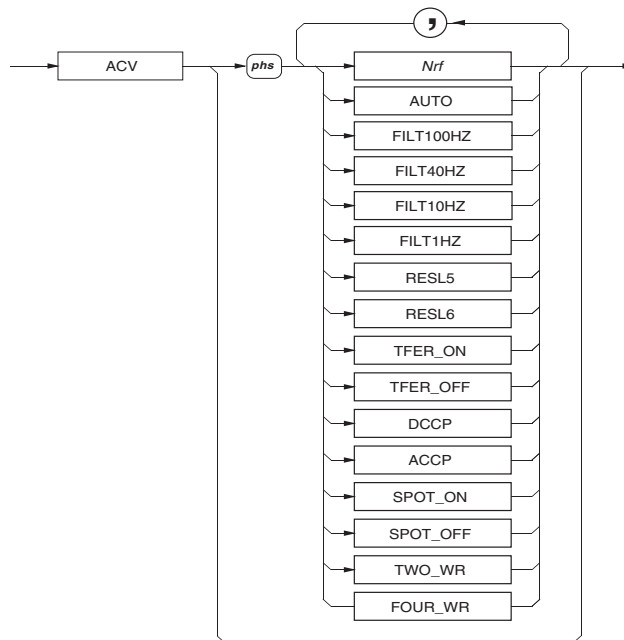

**AC Voltage**

adj210f.eps

### **Nrf**

A numeric value that selects the range for the expected signal. For example, an **Nrf** of 2, 10, or even 15.6789, selects the 20 V range. Any valid numeric value cancels autorange.

### **AUTO**

Selects the autorange mode where the multimeter will determine the appropriate range for the measured signal. If the signal exceeds the maximum capability then RANGE OVERLOAD appears on the front panel and the appropriate bit is set in the device status registers.

### **FILT100HZ / FILT40HZ / FILT10HZ / FILT1HZ**

Selects the chosen analog filter for the RMS converter, thus allowing measurement to be made at frequencies down to the chosen filter frequency. One of the four available filters is always in circuit.

### **TFER\_ON**

This selects an internal electronic AC-DC transfer mode for AC measurement which improves linearity and temperature performance.

### **TFER\_OFF**

The instrument can take faster readings at some reduction in accuracy.

### **DCCP**

Selects DC-coupled measurements. *Note - DC-coupled should be selected for signal frequencies less than 40 Hz.*

### **ACCP**

Selects AC-coupled measurements.

### **RESL5 / RESL6**

Sets the resolution of the measurement to 5.5 or 6.5 digits.

### **SPOT\_ON / SPOT\_OFF**

Applies spot frequency corrections (previously calibrated) when the signal frequency is within 10 % of the spot frequencies.

### **TWO\_WR**

Requires only a connection to the INPUT terminals.

### **FOUR\_WR**

Requires a connection to the INPUT terminals and to the SENSE terminals.

### **Measurements of RMS Value and Frequency**

For each RMS measurement trigger, a parallel measurement of signal frequency is also triggered (4.5 or 6.5 digit frequency resolution depending on gate width selection).

### **Power On and Reset Conditions**

1kV, FILT40HZ, RESL6, TFER\_ON, ACCP, SPOT\_OFF, TWO\_WR

**Recall of Spot Frequency Value**

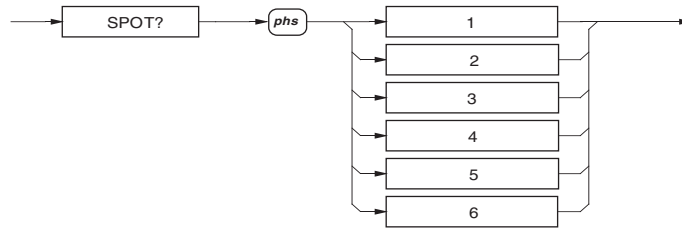

adj211f.eps

**Recall of Spot Frequency**

(Nr3) Recalls the frequency value for the specified calibrated spot on the active ACV range.

**Resistance: Normal OHMS**

The following commands are used to select the Normal OHMS function and set its configuration.

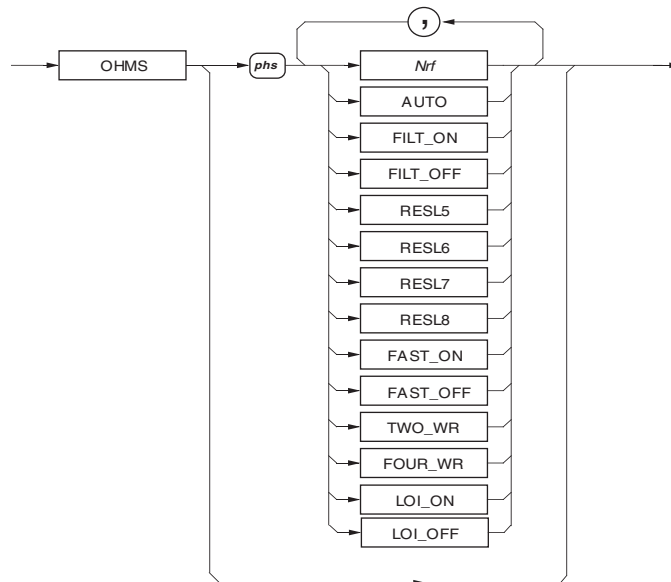

adj212f.eps

**Normal OHMS**

**Nrf**

A numeric value that selects the range for the expected signal. Any valid numeric value cancels autorange.

**AUTO**

Selects the autorange mode where the multimeter will determine the appropriate range for the measured signal. If the signal exceeds the maximum capability then RANGE OVERLOAD appears on the front panel and the appropriate bit is set in the device status registers.

**FILT\_ON / FILT\_OFF**

FILT\_ON inserts a hardware analog filter into the measurement signal path.

**RESL5 / RESL6 / RESL7 / RESL8**

Sets the resolution of the measurement to 5.5, 6.5, 7.5, or 8.5, digits.

**FAST\_ON / FAST\_OFF**

FAST\_ON Reduces the A-D integration time, for faster conversions.

**TWO\_WR**

Selects 2-wire Ohms (Use Hi and Lo terminals). (For backwards compatibility TWR can also be used.)

**FOUR\_WR**

Selects 4-wire Ohms. (For backwards compatibility FWR can also be used.)

**LOI\_ON / LOI\_OFF**

Selects low current mode.

**Power On and Reset Conditions**

20 k $\Omega$ , FILT\_OFF, RESL7, FAST\_ON, TWO\_WR, LOI\_OFF

**Resistance: High Voltage OHMS**

The following commands are used to select the High Voltage OHMS function and set its configuration.

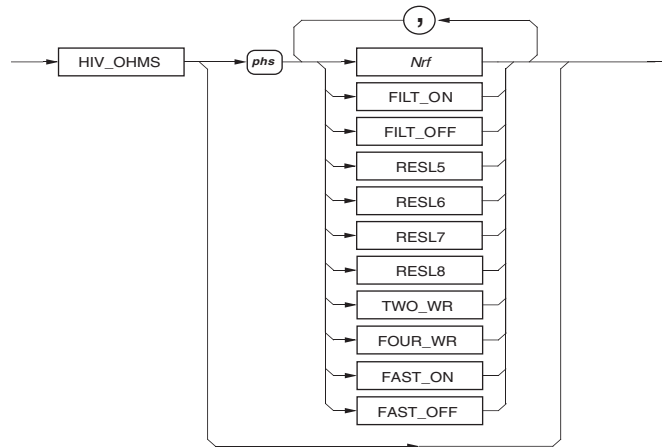

**High Voltage OHMS**

adj213f.eps

**Nrf**

A numeric value that selects the range for the expected signal. Any valid numeric value cancels autorange.

**FILT\_ON / FILT\_OFF**

FILT\_ON inserts a hardware analog filter into the measurement signal path.

**RESL5 / RESL6 / RESL7 / RESL8**

Sets the resolution of the measurement to 5.5, 6.5, 7.5, or 8.5, digits.

**FAST\_ON / FAST\_OFF**

FAST\_ON Reduces the A-D integration time, for faster conversions.

**TWO\_WR**

Selects 2-wire Ohms (Use Hi and Lo terminals). (For backwards compatibility TWR can also be used.)

**FOUR\_WR**

Selects 4-wire Ohms. (For backwards compatibility FWR can also be used.)

**Power On and Reset Conditions**

20 MΩ, FILT\_OFF, RESL6, FAST\_OFF, TWO\_WR

**Resistance: True OHMS**

The following commands are used to select the True OHMS function and set its configuration.

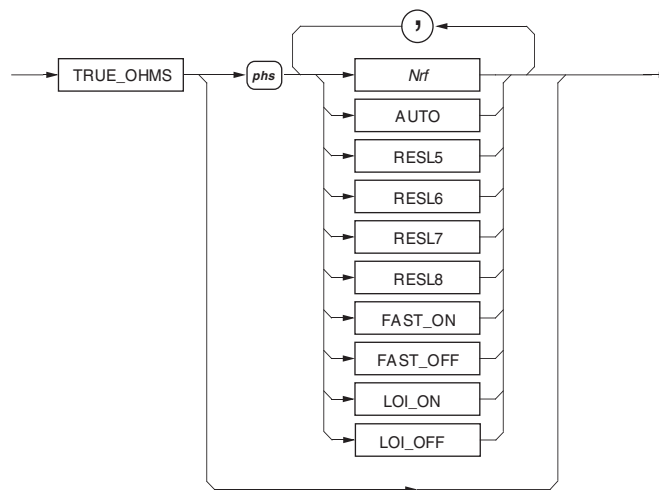

**True OHMS**

adj214f.eps

**Nrf**

A numeric value that selects the range for the expected signal. Any valid numeric value cancels autorange.

**AUTO**

Selects the autorange mode where the multimeter will determine the appropriate range for the measured signal. If the signal exceeds the maximum capability then RANGE OVERLOAD appears on the front panel and the appropriate bit is set in the device status registers.

**RESL5 / RESL6 / RESL7 / RESL8**

Sets the resolution of the measurement to 5.5, 6.5, 7.5, or 8.5 digits.

**FAST\_ON / FAST\_OFF**

FAST\_ON Reduces the A-D integration time, for faster conversions.

**LOI\_ON / LOI\_OFF**

Selects low current mode.

**Power On and Reset Conditions**

20 kΩ, RESL7, FAST\_ON, LOI\_OFF

## DC Current

The following commands are used to select the DCI function and set its configuration.

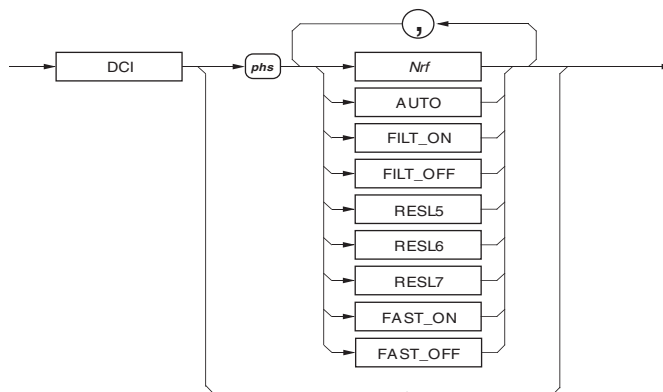

DC Current

adj215f.eps

### Nrf

A numeric value that selects the range for the expected signal. Any valid numeric value cancels autorange.

### AUTO

Selects the autorange mode where the multimeter will determine the appropriate range for the measured signal. If the signal exceeds the maximum capability then RANGE OVERLOAD appears on the front panel and the appropriate bit is set in the device status registers.

### FILT\_ON / FILT\_OFF

FILT\_ON inserts a hardware analog filter into the measurement signal path.

### RESL5 / RESL6 / RESL7

Sets the resolution of the measurement to 5.5, 6.5, or 7.5 digits.

### FAST\_ON / FAST\_OFF

FAST\_ON Reduces the A-D integration time, for faster conversions.

### Power On and Reset Conditions

2A, FILT\_OFF, RESL7, FAST\_ON

## AC Current

The following commands are used to select the ACI function and set its configuration.

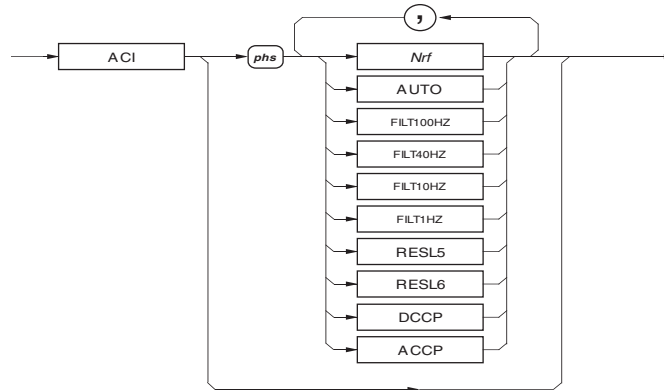

AC Current

adj216f.eps

### Nrf

A numeric value that selects the range for the expected signal. Any valid numeric value cancels autorange.

### AUTO

Selects the autorange mode where the multimeter will determine the appropriate range for the measured signal. If the signal exceeds the maximum capability then RANGE OVERLOAD appears on the front panel and the appropriate bit is set in the device status registers.

### FILT100HZ / FILT40HZ / FILT10HZ / FILT1HZ

Selects the chosen analog filter for the RMS converter, thus allowing measurement to be made at frequencies down to the chosen filter frequency. One of the four available filters is always in circuit.

### RESL5 / RESL6

Sets the resolution of the measurement to 5.5 or 6.5 digits.

### DCCP

Selects DC-coupled measurements. *Note - DC-coupled should be selected for signal frequencies less than 40 Hz.*

### ACCP

Selects AC-coupled measurements.

### Measurements of RMS Value and Frequency

For each RMS measurement trigger, a parallel measurement of signal frequency is also triggered (4.5 or 6.5 digit frequency resolution depending on gate width selection).

### Power On and Reset Conditions

2A, FILT40HZ, RESL6, ACCP

**Using Platinum Resistance Thermometers to obtain Temperature.**

The following commands are used to select the PRT function and set its configuration.

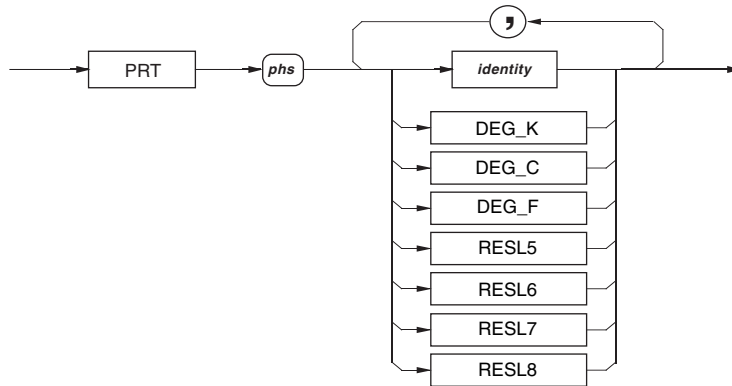

**Platinum Resistance Thermometers**

adj356f.eps

**Identity**

This is a string value and thus must be enclosed in *double quotes* and must be identical in all respects with the identity of an already entered PRT. This command will set the selected PRT as the active measurement probe.

**DEG\_K / DEG\_C / DEG\_F**

This selects the format for presentation of the temperature.

**RESL5 / RESL6 / RESL7 / RESL8**

Sets the resolution of the measurement and the temperature display to 5.5, 6.5, 7.5 or 8.5 digits.

**Execution Errors**

If the identity does not match one of the stored PRT identities the error 1026 is generated.

**Power On and Reset Conditions**

The active probe identity if available, DEG\_C, RESL6

**Determine the PRT identity.**



**PRT Identity**

adj353f.eps

**Response:**

(string) Active Probe, (string) next inactive probe

There is always the one identity returned as a string, but the second identity is obtained from an incremental search of the available identities. If no other identities exist then the second string with the separating comma is not appended.

This command can be used to increment through the list of PRT's stored. The user should check for a second appearance of the inactive identity to determine when all possible identities have been viewed.



**Entering or Editing the Characteristics of a PRT to Non-volatile Store**

The following commands are used to construct a PRT identity and set associated parameters and coefficients.

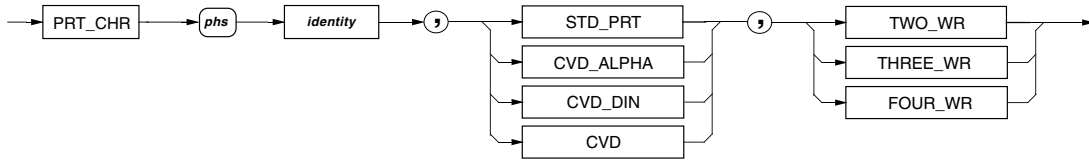

adj357f.eps

**Entering or editing PRT characteristics**

This command with its associated parameter can be used to enter characteristics of a new PRT identity to the non-volatile store.

**Identity**

This is a string value and thus must be enclosed in *double* , limited to 17 characters.

**STD\_PRT**

This selects the conversion algorithm to be used. The ITS90 conversion is used for a standard PRT.

**CVD\_ALPHA**

This selects the conversion algorithm (Callender Van Deusen) to be used and the method for expressing the conversion coefficients ( $R_{zero} \alpha \beta \delta$ ).

**CVD\_DIN**

This selects the conversion algorithm to be used and the method for expressing the conversion coefficients ( $R_{zero} A B C$ ).

**CVD**

This selects the conversion algorithm to be used and requires only the  $R_{zero}$  value. The other parameters are set to a default value.

**TWO\_WR / THREE\_WR / FOUR\_WR**

This specifies the type of connection and thus the measurement method.



adj358f.eps

**Entering or Editing PRT Coefficients**

This command with its associated parameter is used to enter the coefficients, or to edit the existing coefficients of a PRT with a known identity. *NOTE that when editing all the parameters MUST be given in the correct order.* The numbers entered are associated in the following manner:

- For CVD only one number is required for the  $R_{zero}$  value.
- For CVD\_DIN the first number is the  $R_{zero}$  value, the second is the A coefficient, the third the B coefficient and the fourth is the C coefficient.
- For CVD\_ALPHA the first number is the  $R_{zero}$  value, the second is the  $\alpha$  coefficient, the third the  $\beta$  coefficient and the fourth is the  $\delta$  coefficient.
- For STD\_PRT the first number is the resistance of the probe at the triple point of water. The second is the a+ value ( $a_7$ ). The third is the b+ value ( $b_7$ ). The fourth is the c+ value ( $c_7$ ). The fifth is the a- value ( $a_4$ ). The sixth is the b- value ( $b_4$ ).

### Execution Errors

If the identity is unknown an error is generated for the coefficient entry.

An error is generated if any of the coefficients exceed the limits for correct algorithm operation.

### Recalling the Characteristics of a Known PRT

#### PRT\_DATA?



adj355f.eps

#### Recalling PRT data

Recalls the characterization data and associated coefficients for the probe identity given.

#### Response Format:

This is a variable length response consisting of comma separated elements :

(string) Identity , algorithm , connection , (Nr3)  $R_{tp}$  or  $R_{zero}$  , (Nr3) coefficient1 , (Nr3) coefficient2 , (Nr3) coefficient3 , (Nr3) coefficient4 , (Nr3) coefficient5

The 'Identity' consists of 17 ASCII characters enclosed with quotes.

The 'algorithm' will be one of the following: **STD\_PRT** or **CVD\_ALPHA** or **CVD\_DIN** or **CVD**.

The 'connection' will be one of the following: **TWO\_WR** or **THREE\_WR** or **FOUR\_WR**.

The first numeric value will be the resistance of the PRT at either the triple point of water (STD\_PRT) or zero degrees C (all CVD).

The number of coefficients appended to this response detailed above is dependant on the algorithm used:

- For CVD there will be no further coefficients.
- For CVD\_DIN and CVD\_ALPHA there are three comma separated numbers.
- For STD\_PRT there are five comma separated numbers.

### Deleting a Known PRT from the Non-volatile Store

#### PRT\_DEL



adj354f.eps

#### Deleting a known PRT

Removes the probe from the store of probe data for the identity given.

**Input**

The following commands are used to select an input; or combined usage of the two inputs to calculate the Ratio, Difference and Deviation measurement modes. The selections are mutually exclusive.

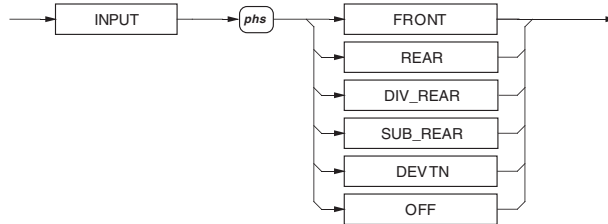

**Input and Ratio Configurations**

adj217f.eps

**FRONT**

This selects the front terminals.

**REAR**

This selects the rear terminals. *NOTE – the DCI/ACI signals that can be applied to the rear terminals are restricted to 2A max. and scan operations for these function are not available. Also 4 wire sense for voltage is not available.*

**OFF**

This isolates all the terminals and deselects the scanning measurements.

**DIV\_REAR**

This selects the measurement at the front terminals followed by a measurement at the rear terminals and computes the ratio of the signals (Front / Rear).

**SUB\_REAR**

This selects the measurement at the front terminals followed by a measurement at the rear terminals and computes the difference of the signals (Front - Rear).

**DEVTN**

This selects the measurement at the front terminals followed by a measurement at the rear terminals and computes the deviation of the signals (Front – Rear / Rear).

**Power On and Reset Conditions**

FRONT

**Exit from a Scanning Mode**

Achieved by selecting one of the two inputs or OFF.

**Guard**

Selection of guarding for all functions.

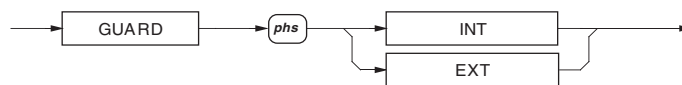

**Remote Guard**

adj218f.eps

### INT / EXT

This selects the connection of the multimeter's guarding. (For backwards compatibility LCL & REM can also be used.)

For scan operations, the guard selection is applied to the channel currently being applied to the A-D converter.

### Power On and Reset Conditions

INT (internal)

### Measurement Gate Width

This command selects the gate width for frequency readings during AC measurements.

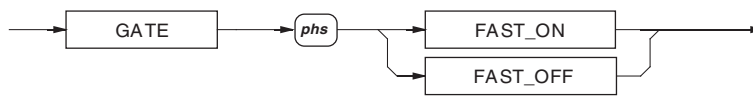

Measurement Gate Width

adj220f.eps

### FAST\_ON

Selects a gate width of 50ms, and a frequency resolution of 4.5 digits.

### FAST\_OFF

Selects a gate width of 1s, and a frequency resolution of 6.5 digits.

Both selections are mutually exclusive.

The use of the longer gate width results in a 6.5 digit frequency measurement. The frequency gate is triggered at the same point as the A-D conversion which could be significantly shorter than 1 second. This may reduce the read-rate, as the measurement processing cannot begin until both the frequency gate and the A-D conversion are complete.

### Power On and Reset Conditions

FAST\_ON.

### Maximum, Minimum and Peak-Peak

#### Recall Stored Values

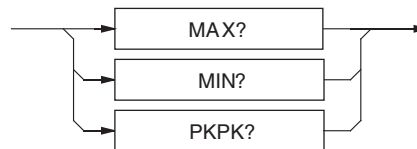

Recall Stored values

adj221f.eps

### MAX?

Recalls the stored value of the maximum signal value to be measured since the most-recent general reset, store reset or function change.

### MIN?

Recalls the stored value representing the minimum signal value to be measured since the most-recent general reset, store reset or function change.

**PKPK?**

Obtains the stored value representing the difference between the maximum and minimum signal values to be measured since the most-recent general reset, store reset or function change.

**Response Format**

(Nr3) Max or Min:

The returned value represents the signal with two exceptions:

- When an overload has occurred, and thus the maximum is not measurable, the response is +200.000000E+33.
- When no measurement has been made since a reset, the response is -20.0000000E+36.

(Nr3) PkPk:

The returned value represents the difference between the max and min signals with two exceptions:

- When an overload occurs in one or both stores, the computation is still performed and thus the response indicates a numeric difference which has an obviously overlarge exponent.
- When no measurement has been made since a reset, the response is -40.00000000E+36.

**Function Change, Power On and Reset:**

These automatically clear Max, Min, and thus PkPk values.

*Reset Max and Min Memories*

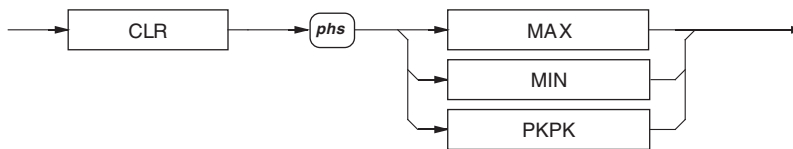

**Reset Max and Min Memories**

adj222f.eps

**MAX / MIN**

Resets the specified store only.

**PKPK**

Resets both the MAX and MIN stores.

**Function Change, Power On and Reset:**

These automatically clear Max, Min, and thus PkPk values.

### Limits

Each command sets its corresponding limit, for comparison with each measurement when enabled.

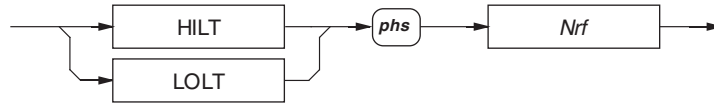

Setting Hi/Lo Limits

adj223f.eps

### Nrf

A Decimal Numeric Data element that represents the mathematical value to be used for limit-checking. Its resolution is 8.5 significant digits; numbers in excess of this resolution will be rounded to it. The limits are stored in non volatile memory.

### Recall Limits

Each of these queries recalls its corresponding limit value.

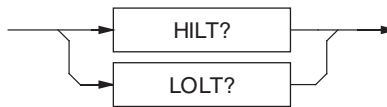

Recall Limits

adj224f.eps

### HILT?

(Nr3) Recalls the set Hi Limit value.

### LOLT?

(Nr3) Recalls the set Low limit value.

### Enable Limits

These commands enable and disable the checking of measurements against preset limits.

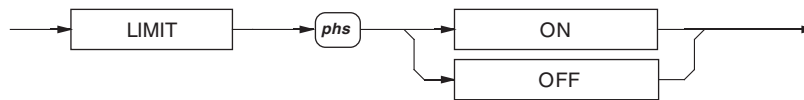

Enable Limits

adj225f.eps

### Note

*Limit calculations are performed after all math operations are complete. Thus the choice of limit values should be relevant to the result of the math operation on the measured signal.*

### Power On and Reset Conditions

OFF

### Standard Deviation

Each of these queries recalls the stored standard deviations for a block of readings.

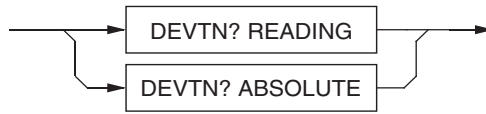

**Recall Standard Deviation**

adj363f.eps

#### DEVTN? READING

(Nr3) Recalls the standard deviation of the block relative to the mean of the block.

#### DEVTN? ABSOLUTE

(Nr3) Recalls the standard deviation of the block as an absolute quantity.

*Note*

*To obtain a valid standard deviation value the AvR or BlocN average mode must be configured and enabled.*

## Syntax Diagrams of Math Functions

*Note*

*Combinations of math operations are allowed, but they must be performed in the following order:*

1. Averaging (**AVG**)
2. Multiplication (**MUL\_M**)
3. Subtraction (**SUB\_C**)
4. Division (**DIV\_Z**)
5. Decibels (**DB**).

### Averaging

Two forms of averaging are available:

- **Rolling Average**

Processes successive readings to provide a measurement which is the arithmetic mean of the most-recent "R" (4, 16, or 64) readings. When the window has filled with the selected number of readings, the earliest reading is discarded as each new reading is added. The mean is updated with every new reading.

- **Block Average**

Continuously calculates the arithmetic mean of successive readings until a block of "N" readings is complete, then presents the mean of the whole block. A new block of N readings is started, but the old block's mean remains on the display until the new block is completed, when the new mean is presented.

### Enable Averaging

All selections are mutually exclusive.

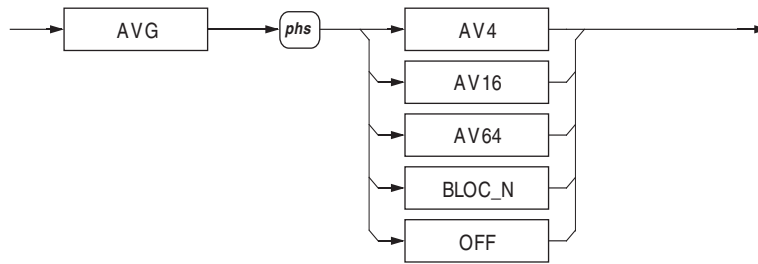

adj226f.eps

#### Enable Averaging

##### AVG AV...

Averages the number of readings requested (4, 16, or 64) as a rolling average.

##### Note

*From a cleared average memory, the average is the mean of the number of readings to date, until the selection window number is reached. The average memories are cleared on each command update.*

##### AVG BLOC\_N

Selects N readings for a block average.

##### Note

*The parameter BLOC\_N selects the average of N readings, where only one result is obtained after the required number of readings (internally triggered) have been obtained.*

##### AVG OFF

Turn averaging OFF; the number N is not destroyed.

#### Power On and Reset Conditions

OFF

### Set Block Size

Sets the integer constant N for use with the averaging math function.



adj227f.eps

#### Set Block Size

##### Nrf

An integer value to be used as the number of readings to be taken and averaged in each block.. This value is saved in non volatile memory.

Example:

N 15 sets the number of readings to be averaged to 15.

#### Execution Errors

Execution errors will be generated when  $N > 10,000$ .

Power On and Reset Conditions: No Change. The number N is saved at Power Off.



**Recall Block Size**

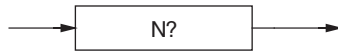

**Recall block Size**

adj228f.eps

**N?**

(Nr1) Recalls the active value of "N".

**Multiplication**

Each signal value is multiplied by a user-defined factor "M".

**Enable Multiplication**

Selects the multiplication operation to be performed on the measurement.

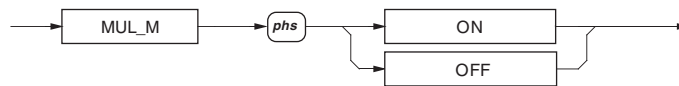

**Enable Multiplication**

adj229f.eps

**Power On and Reset Conditions**

OFF

**Set Multiplication Constant**

This command allows the definition of the factor M, to be used as the multiplication factor.

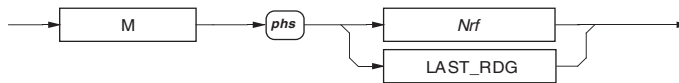

**Set multiplication constant**

adj230f.eps

**Nrf**

A numeric value required for use in the **MUL\_M** command. The decimal data resolution is 8.5 digits; numbers exceeding this resolution will be rounded to 8.5 digits. This value is saved in non volatile memory.

Example:

M -3E+2 Sets M at -300.

**LAST\_RDG**

Place the most recent reading into the numeric memory.

The mathematical processing capability is limited in the range of numbers which it can successfully handle. The maximum resolution of the mantissa is 8.5 digits, and the exponent is limited to  $\pm 15$ . Calculations which result in values outside this range will produce a mathematical overflow error.

### Recall Multiplication Constant

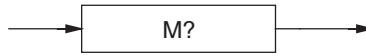

**Recall Multiplication Constant**

adj231f.eps

#### **M?**

(Nr3) Recalls the defined value of M.

### Subtraction

A user-defined constant "C" is subtracted from each signal value.

#### Enable Subtraction

Selects the subtraction operation to be performed on the measurement.

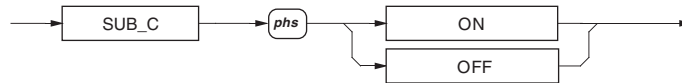

**Enable Subtraction**

adj232f.eps

#### Power On and Reset Conditions

OFF.

#### Set Subtraction Constant

This command allows the definition of the constant C.

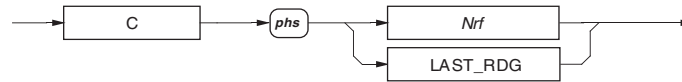

**Set Subtraction Constant**

adj233f.eps

#### **Nrf**

A numeric value required for use in the SUB\_C processing. The decimal data resolution is 8.5 digits; numbers exceeding this resolution will be rounded to 8.5 digits. This value is saved in non volatile memory.

Example:

C 10E2 sets the C constant to 1000.

#### **LAST\_RDG**

Places the most recent reading into the numeric store.

The mathematical processing capability is limited in the range of numbers which it can successfully handle. The maximum resolution of the mantissa is 8.5 digits, and the exponent is limited to  $\pm 15$ . Calculations which result in values outside this range will produce an error indicated by the invalid response when accessed by a query command.

**Recall Subtraction Constant**

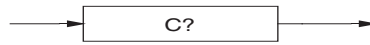

**Recall Subtraction Constant**

adj234f.eps

**C?**

(Nr3) Recalls the defined value of C.

**Division**

Each signal value is divided by a user-defined factor "Z".

**Enable Division**

Selects the division operation to be performed on the measurement.

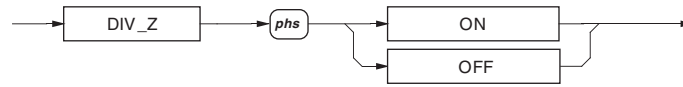

**Enable Division**

adj235f.eps

**Power On and Reset Conditions**

OFF

**Set Division Constant**

This command allows the definition of the factor Z.

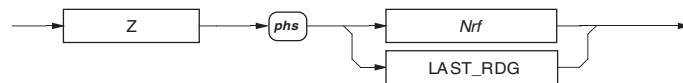

**Set Division Constant**

adj236f.eps

**Nrf**

A numeric value required for use in the DIV\_Z processing. The decimal data resolution is 8.5 digits; numbers exceeding this resolution will be rounded to 8.5 digits. Divide by zero will set bit 5 (MOF) of the Measurement Event Status Byte. This value is saved in non volatile memory.

Example:

Z -56.999 sets Z to -56.999.

**LAST\_RDG**

Places the most recent reading into the numeric memory.

The mathematical processing capability is limited in the range of numbers which it can successfully handle. The maximum resolution of the mantissa is 8.5 digits, and the exponent is limited to  $\pm 15$ . Calculations which result in values outside this range will produce an error indicated by the invalid response when accessed by a query command.

**Recall Division Constant**

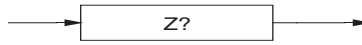

**Recall Division Constant**

adj237f.eps

**Z?**

(Nr3) Recalls the defined value of z.

**Decibel Calculations**

Decibel operations calculate, and express in decibels, the ratio of the reading to one of four standard references: unity, and 1 mW in either 50 Ω, 75 Ω or 600 Ω. As the dB calculation is set as the final part of any calculation, it is also possible to use the other Math operations to alter the effective reference value.

**Enable dB Calculation**

Selects the decibel operation to be performed on the measurement. This operation computes the dB ratio of a corrected A-D result and a stored reference value "R".

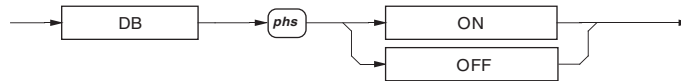

**Enable dB Calculation**

adj238f.eps

**ON / OFF**

Displays the result of the calculation  $20\log[(\text{Reading})/\text{dB Ref}]$ .

**Power On and Reset Conditions**

OFF.

**Set dB Reference Value**

The user defines the value of the reference R, to be used in dB calculation. All selections are mutually exclusive.

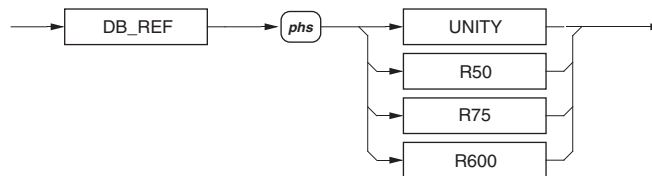

**Set dB Reference**

adj239f.eps

**UNITY**

Selects a dB reference of unity, in whole units of the active function.

Each of the following commands selects the dB reference voltage (as shown in parenthesis), which corresponds to 1 mW in the given impedance. These are only available for use in voltage functions

R50	50 Ω (i.e., 0.223606800V)
R75	75 Ω (i.e., 0.273861280V)
R600	600 Ω (i.e., 0.774596670V)

**Power On and Reset Conditions**

UNITY.

**Recall dB Reference Value**



**Recall dB Reference Value**

adj240f.eps

**DB\_REF?**

(Nr3) Recalls the current value of the DB\_REF voltage.

The value returned is the voltage value assigned to the program data elements:

The element UNITY: +1.00000000E+00.

The element R50: +223.606800E-03.

The element R75: +273.861280E-03.

The element R600: +774.596670E-03.

**Syntax Diagram of Test**

**Selftest**

This command conforms to the IEEE 488.2 standard requirements.



**Selftest**

adj241f.eps

**\*TST?**

Executes a selftest.

The success of Selftest can be inhibited by:

- Temperature not in the range: 5 °C to 40 °C.
- Presence of excessive RFI or Line noise.

**Response**

(Nr1) The value returned identifies pass (0) or failure (1) of self test. The errors numbers can be found in the device dependent error queue.

**Execution Errors:**

Selftest is not permitted when calibration is enabled.

**Device Errors and Syntax Diagrams**

**Error Detection**

All errors which cannot be recovered transparently result in some system action to inform the user via a message, and where possible restore the system to an operational condition. Errors are classified by the method with which they are handled.

- Recoverable errors report the error and continue.
- System errors which cannot be recovered cause the system to halt with a message displayed. Restarting the system from power on may clear the error, but generally such messages are caused by hardware or software faults.

A device-dependent error (DDE) is generated if the device detects an internal operating fault (e.g., during self-test). The **DDE** bit (3) is set *true* in the Standard-defined **Event Status Byte**, and the error code number is appended to the **Device-Dependent Error** queue.

In remote operations, the error is reported by the mechanisms described in the section which deals with status reporting, and the queue entries can be read destructively as LIFO by the query command **DDQ?**. The remote user can ignore the queue, but it is good practice to read the errors as they occur.

In local (front panel) operations, the DDE status is checked at the end of the operation (e.g., Cal, Zero, Test). If *true*, an error has occurred, and the content of the last entry in the queue is displayed on the front panel. The local user cannot continue until the queue has been read.

If both bus and front panel users attempt to read the queue concurrently, the error data is read out destructively on a first-come, first-served basis. Thus one of the users cannot read the data on one interface as it has already been destroyed by reading on the other. This difficulty should be solved by suitable application programming to avoid the possibility of a double readout. Ideally the IEEE 488 interface should set the instrument into REMS or RWLS to prevent confusion.

The code numbers for device dependent errors, with their associated descriptions, are given in Appendix A.

### Recall Device Errors

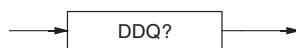

Recall Device Errors

adj243f.eps

#### DDQ?

Recalls the last error from the queue of device-dependent errors (e.g., errors recorded during a failed selftest). The queue is organized as a last-in - first-out stack, its individual entries being destructively read. If there are no entries in the queue, then use of this command generates a result of 0.

#### Note

*Read the queue until empty. To prevent unrelated history of errors being retained, read the queue until empty on each occurrence of a device-dependent error.*

#### Response

(Nr1) The value returned is a specified integer value indicating the fault.

### Recall Execution Errors



Recall Execution Error

adj268f.eps

### EXQ?

Recalls the last error from the queue of execution errors. An execution error occurs when a command cannot be complied with.

**Read the Queue until Empty.** It is good practice to read the queue until empty on each occurrence of execution error, to prevent unrelated history of errors being retained.

### Response

(Nr1) The value returned is a integer value indicating the fault.

The execution error queue operates as a Last In - First Out stack, and individual entries are read destructively. If there are no entries in the queue, then use of this command produces a result of zero. For details of the number/fault relationship refer to Appendix A.

### Power On and Reset Conditions

The queue is cleared.

## Triggering and Reading Operations

### Trigger Source Selector

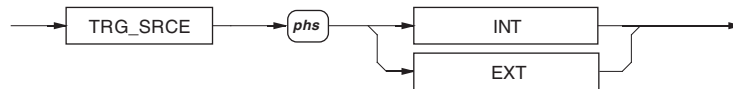

Trigger Source Selector

adj244f.eps

### INT

Selects the internal interval counter as the source, and disables external trigger sources.

### EXT

Disables internal triggers and enables three external trigger sources:

- Rear panel trigger socket.
- Controller-generated **GET** or **\*TRG** commands.
- Front panel Sample key. This will have been disabled when the instrument was transferred from Local to Remote Control.

Selections are mutually exclusive.

### Note

*Internal triggers or uncontrolled rear panel triggers can produce unexpected results, due to the time required for the A-D conversion, and the A-D triggers being unsynchronized with the IEEE 488 bus operations. Such triggers should be avoided unless they form an essential ingredient of the required measurement.*

### Power On and Reset Conditions

INT.

### Execute Trigger

This command conforms to the IEEE 488.2 standard requirements.



Execute Trigger

adj245f.eps

#### \*TRG

Equivalent to a Group Execute Trigger (**GET**). Causes a single reading to be taken.

### Execute Trigger and Take a Reading

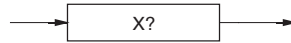

Execute Trigger and Take Reading

adj246f.eps

#### X?

Equivalent to performing an Execute Trigger (\*TRG ; RDG?) followed by a reading query. X? is intended for high speed use.

### Settling Delay

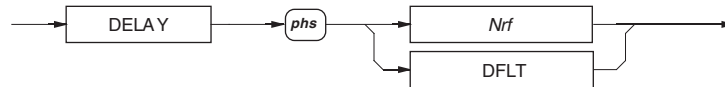

Setting Delay

adj247f.eps

#### Nrf

A numeric value for the required settle delay. The minimum period allowed is 0, and the maximum is 65,000 seconds.

Examples:

DELAY 0.001 sets a settle delay after trigger of 1ms before the reading begins

DELAY DFLT sets the default delay for the selected function, range, filter etc.

The programmed delay is active with TRG\_SRCE EXT selected, although delays may be programmed whilst it is in Remote with default (internal) triggers selected. They will then become active upon the selection of the external trigger.

#### Delay Selection Resolution

<0.01 s	10 $\mu$ s
0.01 s to 0.1 s	100 $\mu$ s
0.1 s to 1 s	1 ms
1 s to 10 s	10 ms
>10 s	100 ms

#### Execution Errors:

Execution errors are generated if an attempt is made to program the delays when the instrument is not in remote control.

An execution error is generated if the selected value of Nrf exceeds the limiting value.

#### Power On and Reset Conditions

DFLT



**Delay Default Tables**

The delays listed in the following tables are active unless a specific delay is programmed.

Once programmed, a specific delay will be applied to all subsequent readings providing External Trigger mode is selected until either the DELAY DFLT command is received, or the instrument is returned to local control. Delays then return to their default values.

**Table 4-2. Delay Defaults for DCV, DCI, ACV, and ACI**

Function	Filter.	Resolution			
		5	6	7	8
DCV	Out	0.08 s	0.1 s	1 s	5 s
	In	0.8 s	1 s	5 s	10 s
DCI	Out	0.08 s	0.1 s	0.1 s	---
	In	0.8 s	1 s	1 s	---
ACV Norm (Scan)	100 Hz	0.25 (0.5) s	0.3 (1.25) s	---	---
	40 Hz	0.6 (1.25) s	0.75 (3.25) s		
	10 Hz	2 (5) s	2.5 (12.5) s		
	1 Hz	20 (50) s	25 (125) s		
ACI	100 Hz	0.25 s	---	---	---
	40 Hz	0.6 s			
	10 Hz	2 s			
	1 Hz	20 s			

**Table 4-3. Delay Defaults for Ohms, Tru Ohms, and Hi Ohms**

Function	Filter	Resolution			
		5	6	7	8
1 Ω-100 kΩ	Out	0.8 s	1 s	5 s	10 s
	In	0.8 s	1 s	5 s	10 s
1 MΩ	Out	0.8 s	1 s	5 s	10 s
	In	2.5 s	3 s	5 s	10 s
10 MΩ	Out	2.5 s	3 s	5 s	10 s
	In	8 s	10 s	30 s	30 s
100 MΩ	Out	2.5 s	3 s	5 s	10 s
	In	8 s	10 s	30 s	30 s
1 GΩ	Out	2.5 s	3 s	5 s	10 s
	In	8 s	10 s	30 s	30 s
1 Ω-10 kΩ Tru Ohm	Out	0.08 s	0.1 s	1 s	5 s
	In	0.8 s	1 s	5 s	10 s
10/100 MΩ HV Ohm	Out	8 s	10 s	20 s	50 s
	In	25 s	30 s	50 s	50 s
1/10 GΩ HV Ohm	Out	10 s	10 s	20 s	50 s
	In	30 s	30 s	50 s	50 s

## Input Zero

Determines and corrects for the input zero and stores the result in volatile memory. An Input Zero is stored only for the input channel selected. Each input has its own set of Input Zero stores, for all of the applicable range/function combinations. For OHMS function an independent Input Zero should be executed for the two/four wire connection and for the low/normal current selection. The PRT function utilizes input zero's obtained in the relevant OHMS/TRU\_OHMS ranges.

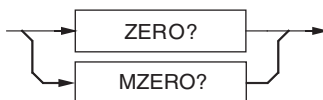

Input Zero

adj248f.eps

### ZERO?

Causes an Input Zero operation to be executed for the selected range and function, if the instrument is not in a calibration mode.

### MZERO?

Multiple ranges are zeroed for the selected function, starting at the highest range. If an error is detected further zeroing ceases.

### Responses

The value returned (Nr1) identifies pass (0) or failure (1) of input zero. The error can be found in the device dependent error queue.

### Execution Errors

Execution errors are generated if calibration is **enabled**, PRT function is selected or a scan operation is selected.

## Wait

This command conforms to the IEEE 488.2 standard requirements.



Wait

adj249f.eps

### \*WAI

Prevents the instrument from executing any further commands or queries until the No Pending Operations Flag is set *true*. This is a mandatory command for IEEE-488.2 but has no relevance to this instrument as there are no parallel processes requiring Pending Operation Flags.

## Reading Recall



Reading Recall - Voltage, Current and Resistance Readings

adj250f.eps

### Voltage, Current and Resistance Readings

#### RDG?

( Nr3) Recalls the most recently triggered reading taken by the instrument.



At the completion of the block of measurements, bit 0 of the 8508A **Status Byte** is set, providing the appropriate bits of the **Service Request Enable** register (bit 0) and **Measurement Event Status Enable** register (bit 6) are set. Use of commands associated with this internal store prior to the completion of the specified number of readings, will abort the diversion of results.

**Execution Errors**

Occur when the numeric value exceeds the specified limits.

**Power On and Reset Conditions**

Diversion to the internal store is inoperative.

*Note*

*If **BLOCK pbs Nrf** is selected in external trigger mode, **Nrf** triggers will be required to complete this sequence.*

**Recall the Number of Results**



**Recall Number of Results**

adj295f.eps

**COUNT?**

(Nr1) Recalls the number of measurements contained in the internal store.

If this command is used before a commanded block is complete, the diversion of measurements to store is aborted.

This number is set to zero when **BLOCK** command is executed.

**Recall Measurements from Internal Memory**



**Recall Measurements from Internal Memory**

adj296f.eps

**BLOCK?**

(Nr3) Recalls a series of readings between two store locations in the reading buffer. If this command is used before a commanded block is complete, the diversion of measurements to store is aborted.

**Memory Locations**

The first *Nrf* represents the location of the first reading of the series in the buffer, and the second *Nrf* represents the last reading of the series. All readings between these locations (inclusive) are recalled.

Example:

Locations of readings stored by BLOCK 16

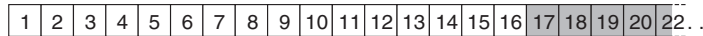

BLOCK? 6,11 recalls selected readings consecutively from the stored block:

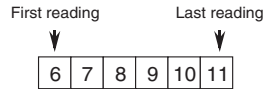

**Block of 16 Readings**

adj297f.eps

### Execution Errors

Occur when the start point number is greater than the finish point number, or when the finish point number is greater than the number of readings actually saved. An execution error will also result from either of the numbers being zero.

### Power On and Reset Conditions

No stored readings are available.

## Internal Operations Commands

All of the commands under this heading are common commands defined in the IEEE-488.2 standard.

### Reset



**Reset**

adj252f.eps

### \*RST

Resets the instrument to a defined condition.

The reset condition is independent of past-use history of the instrument except as noted below:

\*RST does not affect the following:

- The selected address of the instrument
- Calibration data that affect specifications
- SRQ mask conditions
- Contents of the Status Byte Register and Event Status Register
- The state of the IEEE 488 interface
- Stored math constants.

The action of the front panel Reset key is not equivalent to \*RST, but is a subset of it.

## Complete Operations

### \*OPC

A synchronization command that generates an operation complete message in the standard **Event Status Register** when all pending operations have been processed by the parser.



**Complete**

adj253f.eps

### OPC?

A synchronization command that places the ASCII character '1' in the output queue when all pending operations have been processed by the parser.



**Complete?**

adj254f.eps

## Status Reporting

Most of the commands in this sub-section are standard reporting commands defined in the IEEE-488.2 standard.

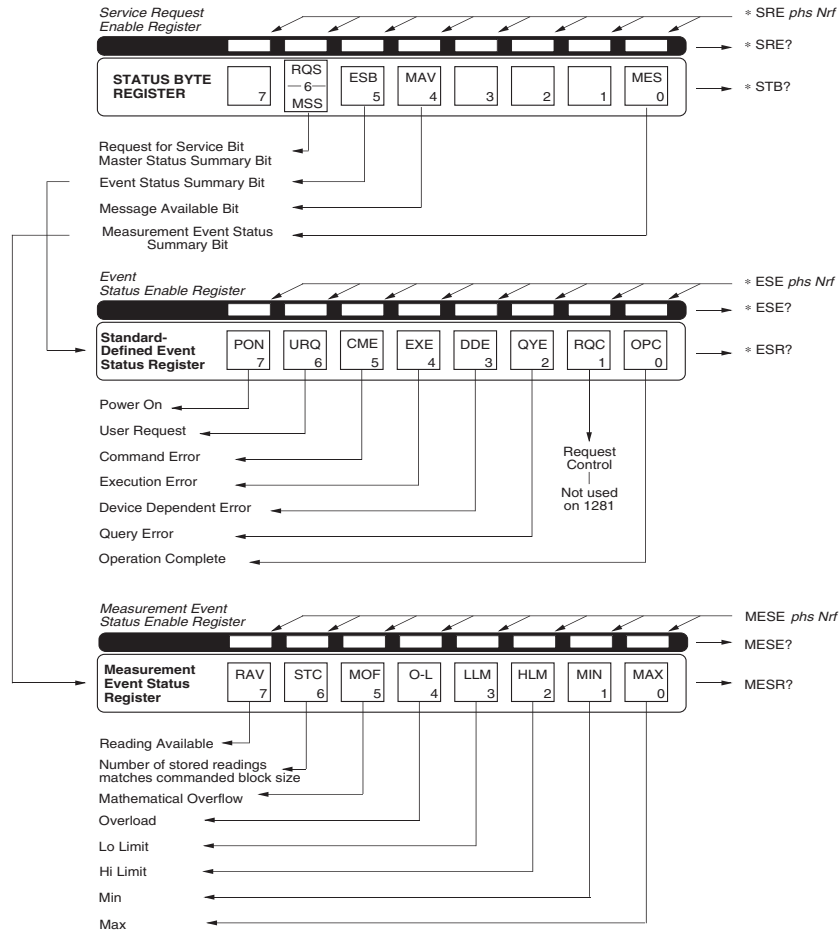

**Status Data Structure**

adj255f.eps

**Read Service Request Register**



**Read Service Request Register**

adj266f.eps

**\*STB?**

(Nr1) Recalls the service request register for summary bits. The returned value, when converted to base 2 (binary), identifies the summary bits as detailed in the status data structure diagram. There is no method of clearing this byte directly. Its condition relies on the clearing of the overlying status data structure.

**Service Request Enable**

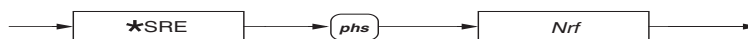

**Service Request Enable**

adj262f.eps

**\*SRE**

Enables the standard and user-defined summary bits in the service request byte, which will generate a service request.

**Nrf**

A number which, when rounded to an integer and expressed in base 2 (binary), enables the appropriate bits in this register. The detail definition is contained in the IEEE 488.2 document and in the status data structure diagram.

**Recall Service Request Enable**



**Recall Service Request Enable**

adj263f.eps

**\*SRE?**

(Nr1) Recalls the enable mask for the standard defined event register. The returned value, when converted to base 2 (binary), identifies the enabled bits which will generate a service request. The detail is contained in the IEEE 488.2 document and in the status data structure diagram.

**Read Event Status Register**



**Read Event Status Register**

adj259f.eps

**\*ESR?**

(Nr1) The value returned, when converted to base 2 (binary), identifies the bits as defined in the IEEE 488.2 standard and detailed in the status data structure diagram.

**Power On and Reset Conditions**

The Power On condition depends on the condition stored by the common \*PSC command - if 0 then it is not cleared; if 1 then the register is cleared. Reset has no effect.

**Event Status Enable**



**Event Status Enable**

adj260f.eps

**\*ESE**

Enables the standard defined event bits which will generate a summary message in the status byte.

**Nrf**

A number which, when rounded to an integer and expressed in base 2 (binary), enables the appropriate bits in this event register. The detail definition is contained in the IEEE 488.2 document, and in the status data structure diagram.

**Recall Event Status Enable**



**Recall Event Status Enable**

adj261f.eps



**\*ESE?**

(Nr1) Recalls the enable mask for the standard defined event register. The returned value, when converted to base 2 (binary), identifies the bits as defined in the IEEE 488.2 standard and detailed in the status data structure diagram.

**Power On and Reset Conditions**

The Power ON condition depends on the condition stored by the common **\*PSC** command - if 0 then it is not cleared; if 1 then the register is cleared. Reset has no effect.

*Read Measurement Event Register*



**Read Measurement Event Register**

adj258f.eps

**MESR?**

(Nr1) Destructively reads the measurement event register which, when converted to base 2 (binary), identifies the events that have occurred since the most-recent read or general clear of this register. The detail is contained in the status data structure diagram. The register is also cleared by the common command **\*CLS**.

**Power On and Reset Conditions**

The register is cleared.

*Measurement Event Enable*

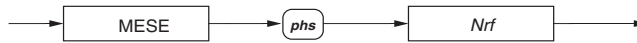

**Measurement Event Enable**

adj257f.eps

**MESE**

Enables the measurement event bits which will generate a summary message in the service request byte. See the device status reporting model for detail.

**Nrf**

A number which, when rounded to an integer and expressed in base 2 (binary), enables the appropriate bits in this event enable register.

*Recall Measurement Event Enable*

This measurement event status data structure conforms to the IEEE 488.2 standard requirements for this structure.



**Recall Measurement Event Enable**

adj256f.eps

**MESE?**

(Nr1) Recalls the measurement status register enable mask which, when converted to base 2 (binary), identifies the enabled bits which will generate a summary message in the service request byte.

**Power On and Reset Conditions**

Cleared (i.e., nothing enabled).

## Clear Status



Clear Status

adj265f.eps

### \*CLS

Clears all the event registers and queues except the output queue. The output queue and **MAV** bit will be cleared if \*CLS immediately follows a "Program Message Terminator".

## Power On Status Clear

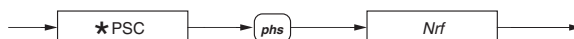

Power On Status Clear

adj264f.eps

### \*PSC

Sets the flag controlling the clearing of defined registers at Power On.

### Nrf

A number which, when rounded to an integer value of zero, sets the *power on clear flag* false. This allows the instrument to assert **SRQ** at power on.

When the value rounds to an integer value other than zero it sets the *power on clear flag* true, which clears the standard *event status enable* and *service request enable* registers so that the instrument will not assert an **SRQ** on power up. This data is saved in non volatile memory for use at Power On.

## Recall Status Clear Flag

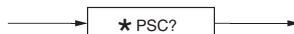

Recall Power On Status Clear)

adj267f.eps

### \*PSC?

(Nr1) Recalls the saved Power On status condition: false (0) and true (1).

## Instrument I/D and Setup

### I/D (Identification)



I/D

adj269f.eps

### \*IDN?

Recalls the instrument's manufacturer, model number, serial number and firmware level.

### Response

The data contained in the four comma separated fields is organized as follows:

- First field - Manufacturer
- Second field - Model
- Third field - Serial number

- Fourth field - Firmware level (issue.revision).

### Options



#### Options

adj270f.eps

#### \*OPT?

(String) Recalls the instrument's option configuration which matches the options provided in the sales literature.

Example:

“8508A/01” -- for instrument fitted with rear terminals.

### Setting Line Frequency

Selection of line frequency setting adjusts the integration time of the A-D converter for improved line frequency noise rejection.

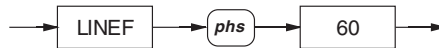
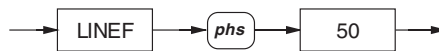

#### Setting Line Frequency 50 Hz or 60 Hz

adj281f.eps

#### LINEF 50

Selects a line frequency operation of 50Hz.

#### LINEF 60

Selects a line frequency operation of 60Hz.

The selection is saved in non volatile memory. *Note The only allowed values of **Nrf** are **50** for 50Hz, and **60** for 60Hz. Numbers exceeding the defined data element resolution will be rounded to that resolution.*

### Power On and Reset Conditions

Reactivated at Power On

### Recall of Line Frequency Setting



#### Recall Line Frequency Setting

adj282f.eps

#### LINEF?

(Nr1) Recalls the active setting for line frequency.

## Calibration Commands and Messages

### ⚠⚠ Caution

The descriptions in the following pages are intended only as a guide to the messages available to calibrate the instrument. They contain neither examples nor calibration routines, and should NOT be used directly as a basis for calibrating any part of the instrument. Some of the commands, if used unwisely, will obliterate an expensive calibration or re-calibration.

### Calibration Sequences

Remote calibration via the IEEE 488 system bus generally follows similar sequences (and is subject to similar constraints) as for local calibration. But because the remote method does not require a human operator to gain access to a sequence of commands via a single menu screen, it is possible to group commands together within bus message units.

For this reason the user should not always expect to find a one-to-one correspondence between the local and remote calibration commands.

Refer to Chapter 6 for details of the required calibration points and procedure.

### Enable Calibration

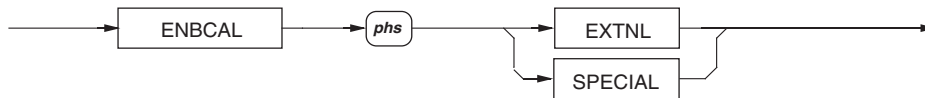

adj271f.eps

Enable Calibration

#### ENBCAL

Allows access to the calibration operations, provided the calibration key switch on the instrument rear panel is set to "ENABLE".

#### EXTNL

Selects the external calibration facility where the user supplies the calibration source signals and the calibration trigger commands.

#### SPECIAL

Allows access to a mode for 'special' calibrations and entry of protected data.

#### Execution Errors

An execution error is generated if the rear panel switch is not in the ENABLE position.

#### Power On and Reset Conditions

Calibration disabled.

### Trigger "External Calibration"

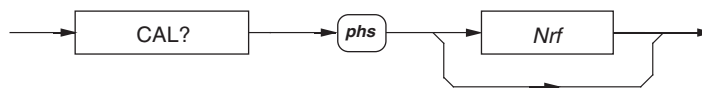

adj272f.eps

Trigger External Calibration

**CAL?**

Triggers an external calibration event, including the "SET" feature used for local calibration.

**Nrf**

A numeric value representing the "SET" calibration value. This is used as the target for the actual measured value. The difference between these two values is used to determine the calibration factors. The *Nrf* value is rounded to 8.5 digits resolution.

If the *Nrf* data element is included then *phs* is required. The number must conform to the limits required for the function being calibrated.

If the program header separator (*phs*) and *Nrf* are omitted, the instrument assumes that the nominal calibration point value is the target for the actual measured value.

**Response**

(Nr1) The value returned identifies the success (0) or failure (1) of the calibration exercise:

**Execution Errors**

If calibration is not enabled, or if the number used is incompatible with the setting being calibrated.

*Select Spot Frequency*

Selects the spot frequency store to be used by the calibration trigger (ACV only).



adj273f.eps

**Spot Frequency**

**SELSPOT**

Allows the user to select a spot frequency on the active ACV range by entering the spot number. The user then enters the target value that calibrates the selected spot.

**1st Nrf**

A decimal numeric data element representing the selected spot frequency store, from 1 to 6.

**2nd Nrf**

A decimal numeric element that represents the **SET** value to be applied. This value is preceded by the "SET" element. This is used as the target for the actual measured value.

The frequency that will be assigned to the spot number, is allocated by the Multimeter's frequency detector. To complete the calibration a calibration trigger is required (CAL?).

Numbers that exceed the required resolution will be rounded.

**Execution Errors**

If calibration is not enabled, or if the 1st *Nrf* is out of range.

*Calibration Due Date*



adj275f.eps

**Calibration Due Date**

**EXT\_DUE?**

(String) Returns the user-entered recommended date for the re-calibration of the instrument. The date is that most-recently entered either as a parameter of **EXITCAL**, or when an exit was made from the front panel calibration mode.

**Protected User Data**

**Entry of User Data**

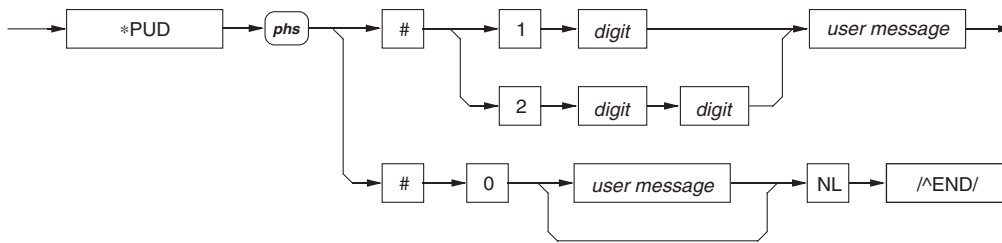

**Protected User Data**

adj277f.eps

where:

*phs* = Program Header Separator

*digit* = one of the ASCII-coded numerals

*user message* = any message up to 63 bytes maximum

**\*PUD**

Allows a user to enter up to 63 bytes of data into a protected area to identify or characterize the instrument. The two representations above are allowed depending on the message length and the number of 'digits' required to identify this. The instrument must be in the calibration mode for this command to execute.

**Execution Errors**

Execution errors are generated if the instrument is not in calibration mode.

**Recall of User Data**

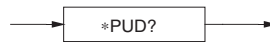

**Recall User Data**

adj278f.eps

**\*PUD?**

Recalls previously entered user data: If no message is available, the value of the two digits is 00.

The data area contains 63 bytes of data.

**Response Syntax**



**Response Syntax**

adj279f.eps

where:

*digit* = one of the ASCII-coded numerals

*user message* = the saved user message

## Special Calibrations

### Perform a "Special" Calibration

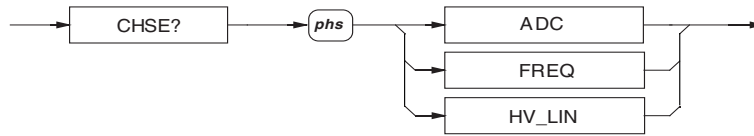

Special Calibration

adj280f.eps

#### CHSE?

Triggers special calibration

#### ADC

Aligns the different resolutions available from the analog to digital converter, so that there are no significant differences in readings when changing resolutions with a constant input value.

#### FREQ

Calibrates the frequency counter against an external frequency standard, by correcting an internal frequency 'gain' factor.

#### HV\_LIN

ONLY used after the five linearity measurements have been taken using the command HV\_LIN? <parameter>, to calculate the DC high voltage linearity correction from these measurements.

#### Response

(Nr1) The value returned identifies the success (0) or failure (1) of the calibration step.

#### Execution Errors

If special calibration is not enabled.

### "Special" measurement commands for DCV Linearity Calculations

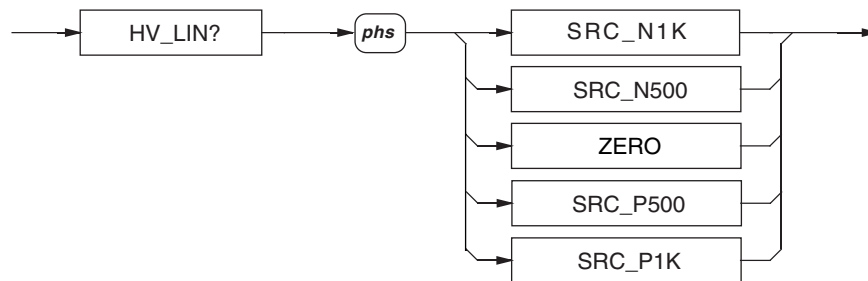

"Special" measurement commands for DCV Linearity Calculations

adj361f.eps

#### HV\_LIN?

Triggers a measurement and records the result for use with the special calibration command CHSE? HV\_LIN. The signal supplied for each measurement should match the supplied parameter.

#### SRC\_N1K

Measurement source is -1000V DC.

**SRC\_N500**

Measurement source is -500V DC.

**ZERO**

Measurement source is 0.0V DC.

**SRC\_P500**

Measurement source is +500V DC.

**SRC\_P1K**

Measurement source is +1000V DC.

**Response**

(Nr1) The value returned identifies the success (0) or failure (1) of the measurement.

**Execution Errors**

If special calibration is not enabled.



**Exit from Calibration**

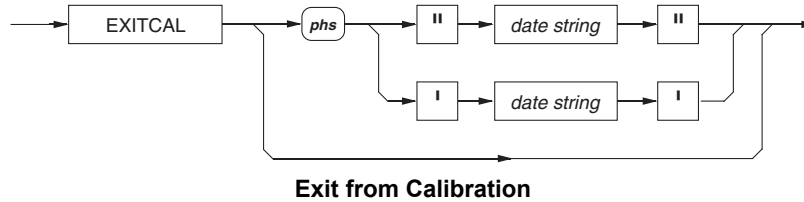

adj284f.eps

**EXITCAL**

Exits calibration mode giving the operator the option of entering a due date, or bypassing it as shown in the syntax diagram.

**Date string**

Represents a string which should contain 8 ASCII characters, indicating the date next due for external calibration. Any format is suitable, and the date can be returned using the **EXT\_DUE?** command. It can also be displayed by a front panel user, who can enter a new date only via the (protected) calibration mode menu.

**Execution Errors**

If the calibration switch is not in the enabled position.

**Set Instrument Serial Number**

This number is originally set at manufacture to match the serial number on the rear panel plate and stored in non-volatile RAM.

It can be changed only when in special calibration mode. User-access has been provided so that an inventory or asset number can be used to replace the manufacturer's serial number.

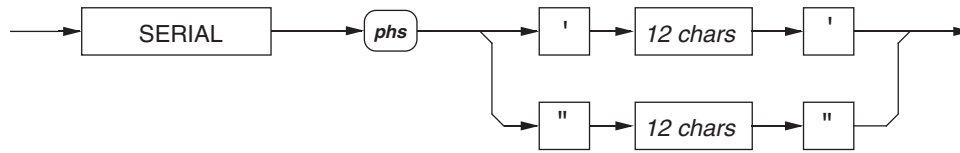

Set Instrument Serial Number

adj290f.eps

**SERIAL**

Allows access to change the serial number.

**chars**

ASCII printing characters.

The number is in quotes to allow a free format to be used for the serial number itself. It can be recalled together with the manufacturer's name, model number and firmware level, using the standard IEEE 488 identification message **\*IDN?**

**Execution Errors**

Occur if special calibration is not enabled.

### Clear Calibration Memory

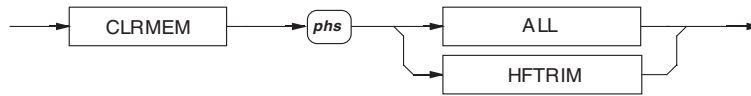

#### Clear Calibration Memory

adj289f.eps

#### CLRMEM

Clears the calibration correction memories.

#### **⚠⚠ Caution**

**This command can obliterate the results of an expensive original calibration or re calibration!**

The extent of clear is defined by programming the following options:

#### ALL

Clears all

#### HFTRIM

Clears AC HF frequency response correction only.

#### Execution Errors

If special calibration is not enabled.

# Chapter 5 Specifications

Title	Page
Specifications.....	5-3
General Specifications.....	5-3
Maximum Voltage and Current Inputs.....	5-4
DC and AC Voltage.....	5-4
DC and AC Current.....	5-4
Resistance and Temperature.....	5-4
Electrical Measurement Specifications.....	5-5
DC Current.....	5-6
AC Voltage.....	5-7
AC Current.....	5-9
Resistance.....	5-11
Temperature.....	5-13
Read Rate and Additional Uncertainty.....	5-14
Applying the Specifications.....	5-15
Introduction.....	5-15
Absolute and Relative Specifications.....	5-15
Applying User's Calibration Uncertainties.....	5-16
Operating and Calibration Temperature Ranges.....	5-16
Applying Temperature Coefficient Specifications.....	5-16
Ratio Measurements.....	5-17
Additional Errors.....	5-17



## Specifications

### General Specifications

#### Power

##### Voltage

115 V Setting .....	100 V to 120 V rms designed for additional voltage fluctuations $\pm 10$ %.
230 V Setting .....	200 V to 240 V rms designed for additional voltage fluctuations $\pm 10$ %.

Frequency ..... 50 Hz to 60 Hz designed for additional frequency variation of  $\pm 3$  Hz.

Consumption ..... < 80 VA

Power Cord ..... NEMA 5-15 plug, IEC 60320-C13 receptacle, cable 3 core 18AWG to SVT

#### Dimensions

Height ..... 88 mm (3.5 inches)

Width ..... 427 mm (16.8 inches)

Depth ..... 487 mm (19.2 inches)

Weight ..... 11.5 kg (25.5 lbs)

#### Environment

##### Temperature

Operating ..... 0 °C to 50 °C

Specified Operation ..... 5 °C to 40 °C

Calibration (TCal) ..... 20 °C to 25 °C

Factory Cal Temp ..... 23 °C

Storage ..... -20 °C to 70 °C

Warm Up ..... 4 hours to full uncertainty specification.

##### Relative Humidity (non- condensing)

Operating<sup>[18]</sup> ..... 5 °C to 40 °C < 90 %.

Storage ..... 0 °C to 70 °C < 95 %

##### Altitude

Operating ..... < 2000 meters

Storage ..... < 12000 meters

Vibration and Shock ..... Complies with MIL-PRF-28800F Class 3.

**Safety** ..... Designed and tested to IEC/EN61010-1: 2001,  
UL 61010-1:2004,  
CAN/CSA-C22.2 No.61010.1-04,  
CE marked and ETL (US & C) listed.  
Pollution Degree 2.  
Installation Category II.  
Equipment Class I (single insulation / Earthed metal case).  
Protection against water ingress IP20 (general indoor conditions).

**EMC** ..... EN61326-1:2006 class B,  
FCC Rules part 15 sub part B,

#### Measurement Isolation

Guard to Safety Ground ..... < 3300 pF, > 10 G $\Omega$ .

##### Lo to Guard

In Remote Guard ..... < 2800 pF, > 10 G $\Omega$  (Not in Resistance function).

In Local Guard ..... Lo and Guard terminals are internally shorted  
(in Resistance < 2800 pF, > 10 G $\Omega$ ).

#### Autorange

Range Up ..... 100 % of range.

Range Down ..... 9 % of range (18 % on 1000 V range).

**Remote Interface** ..... IEEE 488.2

**Warranty** ..... 1 Year



## Electrical Measurement Specifications

*Note*

Fluke guarantees 8508A performance verification using specifications stated to 99 % confidence level.

### DC Voltage

#### DC Voltage <sup>[1] [2] [3]</sup>

Range	Full Scale <sup>[15]</sup>	Uncertainty Relative to Cal Stds			Absolute Uncertainties	
		± (ppm Reading + ppm Range) <sup>[4]</sup>				
		24 hour TCal ±1 °C	90 day TCal ±1 °C	365 day TCal ±1 °C	365 day TCal ±1 °C	365 day TCal ±5 °C
<b>95 % Confidence Level</b>						
200 mV	199.990 000	0.7 + 0.5	1.4 + 0.5	2.7 + 0.5	4.5 + 0.5	5.0 + 0.5
2 V	1.999 900 00	0.5 + 0.2	1.4 + 0.2	2.7 + 0.2	3.0 + 0.2	3.5 + 0.2
20 V	19.999 000 0	0.5 + 0.2	1.4 + 0.2	2.7 + 0.2	3.0 + 0.2	3.5 + 0.2
200 V	199.990 000	1.0 + 0.2	2.6 + 0.2	4.0 + 0.2	4.5 + 0.2	5.5 + 0.2
1000 V	1050.000 00	1.0 + 0.5	2.6 + 0.5	4.0 + 0.5	4.5 + 0.5	5.5 + 0.5
<b>99 % Confidence Level</b>						
200 mV	199.990 000	0.8 + 0.6	2.0 + 0.6	3.5 + 0.6	6.0 + 0.6	6.5 + 0.6
2 V	1.999 900 00	0.6 + 0.25	1.8 + 0.25	3.5 + 0.25	4.0 + 0.25	4.5 + 0.25
20 V	19.999 000 0	0.6 + 0.25	1.8 + 0.25	3.5 + 0.25	4.0 + 0.25	4.5 + 0.25
200 V	199.990 000	1.2 + 0.25	3.5 + 0.25	5.2 + 0.25	6.0 + 0.25	7.0 + 0.25
1000 V	1050.000 00	1.2 + 0.6	3.5 + 0.6	5.2 + 0.6	6.0 + 0.6	7.0 + 0.6

#### DC Voltage (Secondary Specifications) <sup>[1] [2] [3]</sup>

Range	Transfer Uncertainty 20 mins ±1 °C ± (ppm Reading+ ppm Range)	Temperature Coefficient		
		15 °C - 30 °C	5 °C - 15 °C 30 °C - 40 °C	5 °C - 40 °C <sup>[16]</sup>
		± ppm Reading/°C		± V/°C
200 mV	0.4 + 0.3	0.4	0.6	100 n
2 V	0.12 + 0.1	0.3	0.5	200 n
20 V	0.12 + 0.1	0.3	0.5	1 μ
200 V	0.4 + 0.1	0.7	1.0	20 μ
1000 V	0.4 + 0.3	0.7	1.0	100 μ

**Type** ..... Multi-slope, multi-cycle A-D Converter

**CMRR** (1 kΩ unbalance) <sup>[5]</sup> ..... 140 dB at DC and 1 - 60 Hz

**NMRR** <sup>[5]</sup>

Filter Out ..... 60 dB at 50/60 Hz ±0.09 %

Filter In ..... 110 dB at 50/60 Hz ±0.09 %

**Protection** (All ranges)..... 1 kV rms

**Input Impedance**

200 mV to 20 V Ranges..... > 10 GΩ

200 V & 1000 V Ranges ..... 10.1 MΩ ± 1 %

**Max Input Current** ..... 50 pA

**Ratio Accuracy**

Range to Range..... Apply an RSS summation of Net Front Input Accuracy and Net Rear Input Accuracy <sup>[17]</sup>

Within Range ..... Using the 24 hour or 20 minute Transfer Uncertainty specifications as appropriate, apply an RSS summation of specified accuracy of the Front Input signal and the specified accuracy of the Rear Input signal <sup>[17]</sup>

**Settling Time** (to 10 ppm step size)

Filter Out ..... < 50 ms

Filter In ..... < 1 s

**DC Current**

**DC Current** <sup>[1] [2] [3]</sup>

Range	Full Scale <sup>[15]</sup>	Uncertainty Relative to Cal Stds			Absolute Uncertainties	
		± (ppm Reading + ppm Range) <sup>[4]</sup>				
		24 hour TCal ±1 °C	90 day TCal ±1 °C	365 day TCal ±1 °C	365 day TCal ±1 °C	365 day TCal ±5 °C
<b>95 % Confidence Level</b>						
200 µA	199.990 00	5.5 + 2.0	6.0 + 2.0	6.5 + 2.0	12 + 2.0	12 + 2.0
2 mA	1.999 900 0	5.5 + 2.0	6.0 + 2.0	6.5 + 2.0	12 + 2.0	12 + 2.0
20 mA	19.999 000	6.5 + 2.0	7.0 + 2.0	8.0 + 2.0	13 + 2.0	14 + 2.0
200 mA	199.990 00	28 + 4.0	30 + 4.0	33 + 4.0	36 + 4.0	48 + 4.0
2 A	1.999 900 0	80 + 8.0	125 + 8.0	170 + 8.0	170 + 8.0	185 + 8.0
20 A	19.999 000	200 + 20	290 + 20	380 + 20	380 + 20	400 + 20
<b>99 % Confidence Level</b>						
200 µA	199.990 00	7.0 + 2.0	7.5 + 2.0	8.0 + 2.0	15 + 2.0	16 + 2.0
2 mA	1.999 900 0	7.0 + 2.0	7.5 + 2.0	8.0 + 2.0	15 + 2.0	16 + 2.0
20 mA	19.999 000	8.0 + 2.0	9.0 + 2.0	10 + 2.0	16 + 2.0	18 + 2.0
200 mA	199.990 00	35 + 4.0	37 + 4.0	40 + 4.0	45 + 4.0	60 + 4.0
2 A	1.999 900 0	100 + 8.0	150 + 8.0	205 + 8.0	210 + 8.0	225 + 8.0
20 A	19.999 000	250 + 20	350 + 20	450 + 20	455 + 20	500 + 20

**DC Current (Secondary Specifications)** <sup>[1] [2] [3]</sup>

Range	Input Impedance (Ω)		Temperature Coefficient		
			15 °C - 30 °C	5 °C - 15 °C 30 °C - 40 °C	5 °C - 40 °C <sup>[16]</sup>
	Front	Rear	± ppm Reading/°C		± A/°C
200 µA	150	150	0.4	0.6	50 p
2 mA	15.2	15.2	0.4	0.6	300 p
20 mA	1.8	1.9	1.2	1.8	3 n
200 mA	1.2	1.3	6.0	9.0	50 n
2 A	0.3	0.4	8.0	12	500 n
20 A	0.04	-	15	20	10 µ

**Type**..... Multi-slope, multi-cycle A-D Converter

**Protection**

Front Input..... 20 A rms

Rear Input ..... 2 A rms, Rear Panel Fuse

**Settling Time**

200 µA to 200 mA Ranges, to 10 ppm step size .... Filter Out < 50 ms, Filter In < 1 s

**2 A Range**

to 100 ppm step size..... < 1 s

to 75 ppm step size..... < 30 s

to 30 ppm step size..... < 5 minutes

**20 A Range (at 10 A)**

to 300 ppm step size..... < 1 s

to 250 ppm step size..... < 30 s

to 100 ppm step size..... < 5 minutes



**AC Voltage**

**AC Voltage** <sup>[1] [2] [6] [7] [9]</sup>

Range	Full Scale <sup>[15]</sup>	Frequency (Hz)	Uncertainty Relative to Cal Stds			Absolute Uncertainties	
			± (ppm Reading + ppm Range) <sup>[4]</sup>				
			24 hour TCal ±1 °C	90 day TCal ±1 °C	365 day TCal ±1 °C	365 day TCal ±1 °C	365 day TCal ±5 °C
<b>95% Confidence Level</b>							
200 mV	199.990 0	1 - 10	80 + 70	120 + 70	120 + 70	160 + 70	165 + 70
		10 - 40	80 + 20	120 + 20	120 + 20	130 + 20	140 + 20
		40 - 100	60 + 20	100 + 20	100 + 20	110 + 20	115 + 20
		100 - 2 k	40 + 10	100 + 10	100 + 10	105 + 10	110 + 10
		2k - 10 k	60 + 20	100 + 20	100 + 20	105 + 20	135 + 20
		10k - 30 k	250 + 30	300 + 40	300 + 40	305 + 40	340 + 40
30k - 100 k	400 + 100	700 + 100	700 + 100	705 + 100	765 + 100		
2 V, 20 V & 200 V	1.999 900 19.999 00 199.990 0	1 - 10	70 + 60	100 + 60	100 + 60	140 + 60	150 + 60
		10 - 40	70 + 10	100 + 10	100 + 10	105 + 10	115 + 10
		40 - 100	50 + 10	80 + 10	80 + 10	85 + 10	90 + 10
		100 - 2 k	30 + 10	60 + 10	60 + 10	65 + 10	75 + 10
		2 k - 10 k	50 + 10	80 + 10	80 + 10	85 + 10	110 + 10
		10 k - 30 k	100 + 20	200 + 20	200 + 20	205 + 20	220 + 20
		30 k - 100 k	250 + 100	500 + 100	500 + 100	505 + 100	570 + 100
100 k - 300 k	0.15 % + 0.1 %	0.3 % + 0.1 %	0.3 % + 0.1 %	0.3 % + 0.1 %	0.3 % + 0.1 %		
300 k - 1 M	1 % + 0.5 %	1 % + 1 %	1 % + 1 %	1 % + 1 %	1 % + 1 %		
1000 V <sup>[8]</sup>	1050.000	1 - 10	70 + 70	100 + 70	100 + 70	140 + 70	150 + 70
		10 - 40	70 + 20	100 + 20	100 + 20	110 + 20	120 + 20
		40 - 10 k	50 + 20	80 + 20	80 + 20	95 + 20	115 + 20
		10 k - 30 k	100 + 40	200 + 40	200 + 40	205 + 40	225 + 40
		30 k - 100 k	250 + 200	500 + 200	500 + 200	510 + 200	580 + 200
<b>99% Confidence Level</b>							
200 mV	199.990 0	1 - 10	90 + 80	140 + 80	140 + 80	200 + 80	210 + 80
		10 - 40	90 + 25	140 + 25	140 + 25	145 + 25	160 + 25
		40 - 100	70 + 25	115 + 25	115 + 25	125 + 25	135 + 25
		100 - 2 k	45 + 12	115 + 12	115 + 12	125 + 12	135 + 12
		2 k - 10 k	70 + 25	115 + 25	115 + 25	125 + 25	165 + 25
		10 k - 30 k	270 + 35	340 + 50	340 + 50	345 + 50	395 + 50
30 k - 100 k	450 + 120	750 + 120	750 + 120	755 + 120	855 + 120		
2 V, 20 V & 200 V	1.999 900 19.999 00 199.990 0	1 - 10	80 + 70	115 + 70	115 + 70	180 + 70	190 + 70
		10 - 40	80 + 12	115 + 12	115 + 12	120 + 12	135 + 12
		40 - 100	60 + 12	90 + 12	90 + 12	95 + 12	110 + 12
		100 - 2 k	35 + 12	70 + 12	70 + 12	75 + 12	90 + 12
		2 k - 10 k	60 + 12	90 + 12	90 + 12	95 + 12	135 + 12
		10 k - 30 k	115 + 25	240 + 25	240 + 25	245 + 25	260 + 25
		30 k - 100 k	270 + 120	550 + 120	550 + 120	555 + 120	650 + 120
100 k - 300 k	0.15 % + 0.12 %	0.3 % + 0.12 %	0.3 % + 0.12 %	0.3 % + 0.12 %	0.3 % + 0.12 %		
300 k - 1 M	1 % + 0.6 %	1 % + 1.2 %	1 % + 1.2 %	1 % + 1.2 %	1 % + 1.2 %		
1000 V <sup>[8]</sup>	1050.000	1 - 10	80 + 80	115 + 80	115 + 80	180 + 80	190 + 80
		10 - 40	80 + 25	115 + 25	115 + 25	135 + 25	145 + 25
		40 - 10 k	60 + 25	90 + 25	90 + 25	110 + 25	140 + 25
		10 k - 30 k	115 + 50	240 + 50	240 + 50	250 + 50	265 + 50
		30 k - 100 k	270 + 250	600 + 250	600 + 250	615 + 250	700 + 250

**AC Voltage (Secondary Specifications)<sup>[1] [2] [9]</sup>**

Range	Frequency (Hz)	Temperature Coefficient	
		15 °C - 30 °C	5 °C - 15 °C 30 °C - 40 °C
		± ppm Reading/°C	
200 mV	1 - 10	5	10
	10 - 40	5	10
	40 - 100	5	10
	100 - 2 k	5	10
	2 k - 10 k	12	20
	10 k - 30 k	15	20
	30 k - 100 k	40	60
2 V 20 V 200 V	1 - 10	5	10
	10 - 40	5	10
	40 - 100	5	10
	100 - 2 k	5	10
	2 k - 10 k	10	15
	10 k - 30 k	12	20
	30 k - 100 k	40	60
	100 k - 300 k 300 k - 1 M	60 80	90 120
1000 V	1 - 10	5	10
	10 - 40	5	10
	40 - 10 k	10	15
	10 k - 30 k	12	20
	30 k - 100 k	40	60

**Type** ..... True rms, AC coupled measures AC component with up to 1000 V DC bias on any range. DC coupled gives  $\sqrt{(ac^2 + dc^2)}$

**CMRR** (1 kΩ unbalance)<sup>[5]</sup> ..... > 90 dB DC - 60 Hz

**Crest Factor**

200 mV to 200 V ranges ..... 10:1 at 12 % range, 5:1 at 50 % range, 2.5:1 at full range

1000 V range ..... 10:1 at 25 % range, 5:1 at full range

**Protection** (All ranges) ..... 1 kV rms

**Input Impedance** ..... 1 MΩ in parallel with 150 pF

**DC Accuracy** (DC Coupled) ..... Add ±(50 ppm Reading + 50 ppm Range + 20 μV)

**Ratio Accuracy**

Range to Range ..... Apply an RSS summation of Net Front Input and Rear Input Accuracy<sup>[17]</sup>

Within Range ..... Using the 24 hour specifications as appropriate, apply an RSS summation of specified accuracy of the Front Input signal and the specified accuracy of the Rear Input signal<sup>[17]</sup>

**Settling Time** (to 100 ppm step size)

100 Hz filter ..... < 0.5 s

40 Hz filter ..... < 1.25 s

10 Hz filter ..... < 5 s

1 Hz filter ..... < 50 s

**Frequency Measurement**

Signal Amplitude Range ..... 5 % of range to limit set by maximum V/Hz

Gate Mode ..... Normal Fast

Resolution ..... 6.5 digits 4.5 digits

Frequency Range ..... 10 Hz - 1 MHz 200 Hz - 1 MHz

Accuracy (1 year, 13 °C - 33 °C) ..... ± (10 ppm of Reading + 2 digits) ± 2 digits

Sample Interval ..... 1 s 50 ms

**AC Current**

**AC Current** <sup>[1] [2] [6] [9]</sup>

Range	Full Scale <sup>[15]</sup>	Frequency (Hz)	Uncertainty Relative to Cal Stds			Absolute Uncertainties	
			± (ppm Reading + ppm Range) <sup>[4]</sup>				
			24 hour TCal ±1 °C	90 day TCal ±1 °C	365 day TCal ±1 °C	365 day TCal ±1 °C	365 day TCal ±5 °C
<b>95% Confidence Level</b>							
200 µA	199.990 0	1 - 10	200 + 100	250 + 100	250 + 100	475 + 100	500 + 100
		10 - 10 k	200 + 100	250 + 100	250 + 100	475 + 100	500 + 100
		10 k - 30 k	500 + 100	600 + 100	600 + 100	650 + 100	710 + 100
		30 k - 100 k	0.35 % + 100	0.4 % + 100	0.4 % + 100	0.4 % + 100	0.4 % + 100
2 mA & 20 mA	1.999 900 19.9990 00	1 - 10	200 + 100	250 + 100	250 + 100	290 + 100	310 + 100
		10 - 10 k	200 + 100	250 + 100	250 + 100	280 + 100	300 + 100
		10 k - 30 k	500 + 100	600 + 100	600 + 100	650 + 100	710 + 100
		30 k - 100 k	0.35 % + 100	0.4 % + 100	0.4 % + 100	0.4 % + 100	0.4 % + 100
200 mA	199.990 0	1 - 10	200 + 100	250 + 100	250 + 100	290 + 100	310 + 100
		10 - 10 k	200 + 100	250 + 100	250 + 100	250 + 100	290 + 100
		10 k - 30 k	500 + 100	600 + 100	600 + 100	600 + 100	625 + 100
2 A	1.999 900	10 - 2 k	500 + 100	600 + 100	600 + 100	600 + 100	620 + 100
		2 k - 10 k	600 + 100	700 + 100	700 + 100	710 + 100	735 + 100
		10 k - 30 k	0.25 % + 100	0.3 % + 100	0.3 % + 100	0.3 % + 100	0.3 % + 100
20 A	19.999 00	10 - 2 k	700 + 100	800 + 100	800 + 100	800 + 100	820 + 100
		2 k - 10 k	0.2 % + 100	0.25 % + 100	0.25 % + 100	0.25 % + 100	0.25 % + 100
<b>99% Confidence Level</b>							
200 µA	199.990 0	1 - 10	250 + 120	300 + 120	300 + 120	590 + 120	620 + 120
		10 - 10 k	250 + 120	300 + 120	300 + 120	590 + 120	620 + 120
		10 k - 30 k	600 + 120	700 + 120	700 + 120	775 + 120	800 + 120
		30 k - 100 k	0.35 % + 120	0.4 % + 120	0.4 % + 120	0.4 % + 120	0.4 % + 120
2 mA & 20 mA	1.999 900 19.999 00	1 - 10	250 + 120	300 + 120	300 + 120	380 + 120	400 + 120
		10 - 10 k	250 + 120	300 + 120	300 + 120	340 + 120	370 + 120
		10 k - 30 k	600 + 120	700 + 120	700 + 120	775 + 120	800 + 120
		30 k - 100 k	0.35 % + 120	0.4 % + 120	0.4 % + 120	0.4 % + 120	0.4 % + 120
200 mA	199.990 0	1 - 10	250 + 120	300 + 120	300 + 120	380 + 120	400 + 120
		10 - 10 k	250 + 120	300 + 120	300 + 120	305 + 120	360 + 120
		10 k - 30 k	600 + 120	700 + 120	700 + 120	700 + 120	740 + 120
2 A	1.999 900	10 - 2 k	600 + 120	700 + 120	700 + 120	705 + 120	725 + 120
		2 k - 10 k	700 + 120	800 + 120	800 + 120	815 + 120	860 + 120
		10 k - 30 k	0.25 % + 120	0.3 % + 120	0.3 % + 120	0.3 % + 120	0.3 % + 120
20 A	19.999 00	10 - 2 k	800 + 120	900 + 120	900 + 120	900 + 120	920 + 120
		2 k - 10 k	0.2 % + 120	0.25 % + 120	0.25 % + 120	0.25 % + 120	0.25 % + 120

**AC Current (Secondary Specifications)** <sup>[1] [2] [6] [9]</sup>

Range	Frequency (Hz)	Temperature Coefficient		Input Impedance (Ω)		
		15 °C - 30 °C	5 °C - 15 °C 30 °C - 40 °C	Range	Front	Rear
		± ppm Reading/°C				
200 μA, 2 mA & 20 mA	1 - 10	10	15	200 μA	150	150
	10 - 10 k	10	15	2 mA	15.2	15.2
	10 k - 30 k	12	20	20 mA	1.8	1.9
	30 k - 100 k	40	60			
200 mA	1 - 10	10	15		1.2	1.3
	10 - 10 k	15	20			
	10 k - 30 k	15	20			
2 A	10 - 2 k	10	15		0.3	0.4
	2 k - 10 k	15	20			
	10 k - 30 k	20	30			
20 A	10 - 2 k	20	25		0.04	-
	2 k - 10 k	25	30			

**Type**..... True rms, AC coupled. DC coupled gives  $\sqrt{(ac^2 + dc^2)}$

**Crest Factor**..... 3:1 at 50 % range, 1.5:1 at full range

**Protection**

Front Input..... 20 A rms

Rear Input ..... 2 A rms, Rear Panel Fuse

**Settling Time**

	200 μA to 200 mA Ranges to 100 ppm of step	2 A Range to 100 ppm of step	20 A Range (at 10 A) to 300 ppm of step
100 Hz filter.....	< 0.5 s	< 1 s	< 1 s
40 Hz filter.....	< 1.25 s	< 2 s	< 2 s
10 Hz filter.....	< 5 s	< 10 s	< 10 s
1 Hz filter.....	< 50 s	< 50 s	< 50 s

**Resistance**

**Resistance** <sup>[1] [2] [3]</sup>

Range	Full Scale <sup>[15]</sup>	Mode <sup>[10]</sup>	Uncertainty Relative to Cal Stds			Absolute Uncertainties	
			± (ppm Reading + ppm Range) <sup>[4]</sup>				
			24 hour TCal ±1 °C	90 day TCal ±1 °C	365 day TCal ±1 °C	365 day TCal ±1 °C	365 day TCal ±5 °C
<b>95% Confidence Level</b>							
2 Ω	1.999 900 00	Normal	5.0 + 2.0	8.0 + 2.0	10 + 2.0	15 + 2.0	17 + 2.0
20 Ω	19.999 000 0	Normal	2.5 + 0.7	4.5 + 0.7	7.0 + 0.7	9.0 + 0.7	9.5 + 0.7
200 Ω	199.990 000	Normal	1.5 + 0.25	4.0 + 0.25	7.0 + 0.25	7.5 + 0.25	8.0 + 0.25
2 kΩ	1.999 900 00	Normal	1.0 + 0.25	3.5 + 0.25	7.0 + 0.25	7.5 + 0.25	8.0 + 0.25
20 kΩ	19.999 000 0	Normal	1.0 + 0.25	3.5 + 0.25	7.0 + 0.25	7.5 + 0.25	8.0 + 0.25
200 kΩ	199.990 000	Normal	1.0 + 0.25	3.5 + 0.25	7.0 + 0.25	7.5 + 0.25	8.0 + 0.25
2 MΩ	1.999 900 00	Normal	2.0 + 0.5	4.0 + 0.5	7.0 + 0.5	8.5 + 0.5	9.0 + 0.5
20 MΩ	19.999 000 0	Normal	3.5 + 5.0	6.0 + 5.0	9.0 + 5.0	15 + 5.0	20 + 5.0
200 MΩ	199.990 000	Normal	20 + 50	25 + 50	30 + 50	60 + 50	120 + 50
2 GΩ	1.999 900 00	Normal	250 + 500	350 + 500	500 + 500	525 + 500	1510 + 500
2 Ω	1.999 900 00	Lo Current	5.0 + 2.0	8.0 + 2.0	10 + 2.0	15 + 2.0	17 + 2.0
20 Ω	19.999 000 0	Lo Current	2.5 + 0.7	4.5 + 0.7	7.0 + 0.7	9.0 + 0.7	9.5 + 0.7
200 Ω	199.990 000	Lo Current	2.5 + 0.7	5.0 + 0.7	7.0 + 0.7	7.5 + 0.7	8.0 + 0.7
2 kΩ	1.999 900 00	Lo Current	2.5 + 0.7	5.0 + 0.7	7.0 + 0.7	7.5 + 0.7	8.0 + 0.7
20 kΩ	19.999 000 0	Lo Current	2.5 + 0.7	5.0 + 0.7	7.0 + 0.7	7.5 + 0.7	8.0 + 0.7
200 kΩ	199.990 000	Lo Current	5.0 + 0.5	6.5 + 0.5	7.0 + 0.5	7.5 + 0.5	8.0 + 0.5
2 MΩ	1.999 900 00	Lo Current	7.0 + 0.5	8.0 + 0.5	9.0 + 0.5	10 + 0.5	15 + 0.5
20 MΩ	19.999 000 0	Lo Current	20 + 5.0	20 + 5.0	25 + 5.0	35 + 5.0	90 + 5.0
200 MΩ	199.990 000	Lo Current	250 + 500	350 + 500	500 + 500	515 + 500	1505 + 500
2 GΩ	1.999 900 00	Lo Current	250 + 500	350 + 500	500 + 500	525 + 500	1510 + 500
20 MΩ	19.999 000 0	High Voltage	2.0 + 0.5	4.0 + 0.5	7.0 + 0.5	15 + 0.5	17 + 0.5
200 MΩ	199.990 000	High Voltage	3.5 + 5.0	6.0 + 5.0	9.0 + 5.0	60 + 5.0	65 + 5.0
2 GΩ	1.999 900 00	High Voltage	20 + 50	25 + 50	30 + 50	150 + 50	180 + 50
20 GΩ <sup>[18]</sup>	19.999 000 0	High Voltage	250 + 500	350 + 500	500 + 500	525 + 500	1510 + 500
<b>99% Confidence Level</b>							
2 Ω	1.999 900 00	Normal	6.0 + 2.5	10 + 2.5	12 + 2.5	19 + 2.5	22 + 2.5
20 Ω	19.999 000 0	Normal	3.0 + 0.9	5.5 + 0.9	8.5 + 0.9	11.5 + 0.9	12.0 + 0.9
200 Ω	199.990 000	Normal	1.8 + 0.3	5.0 + 0.3	8.5 + 0.3	9.5 + 0.3	10 + 0.3
2 kΩ	1.999 900 00	Normal	1.2 + 0.3	4.5 + 0.3	8.5 + 0.3	9.5 + 0.3	10 + 0.3
20 kΩ	19.999 000 0	Normal	1.2 + 0.3	4.5 + 0.3	8.5 + 0.3	9.5 + 0.3	10 + 0.3
200 kΩ	199.990 000	Normal	1.2 + 0.3	4.5 + 0.3	8.5 + 0.3	9.5 + 0.3	10 + 0.3
2 MΩ	1.999 900 00	Normal	2.5 + 0.6	5.0 + 0.6	8.5 + 0.6	10.5 + 0.6	12 + 0.6
20 MΩ	19.999 000 0	Normal	4.5 + 6.0	7.5 + 6.0	12 + 6.0	20 + 6.0	25 + 6.0
200 MΩ	199.990 000	Normal	25 + 60	30 + 60	35 + 60	75 + 60	150 + 60
2 GΩ	1.999 900 00	Normal	325 + 600	450 + 600	650 + 600	675 + 600	1810 + 600
2 Ω	1.999 900 00	Lo Current	6.0 + 2.5	10 + 2.5	12 + 2.5	19 + 2.5	22 + 2.5
20 Ω	19.999 000 0	Lo Current	3.0 + 0.9	5.5 + 0.9	8.5 + 0.9	11.5 + 0.9	12.0 + 0.9
200 Ω	199.990 000	Lo Current	3.0 + 0.9	6.5 + 0.9	8.5 + 0.9	9.5 + 0.9	10.0 + 0.9
2 kΩ	1.999 900 00	Lo Current	3.0 + 0.9	6.5 + 0.9	8.5 + 0.9	9.5 + 0.9	10.0 + 0.9
20 kΩ	19.999 000 0	Lo Current	3.0 + 0.9	6.5 + 0.9	8.5 + 0.9	9.5 + 0.9	10.0 + 0.9
200 kΩ	199.990 000	Lo Current	6.0 + 0.6	8.0 + 0.6	9.0 + 0.6	9.5 + 0.6	10.0 + 0.6
2 MΩ	1.999 900 00	Lo Current	8.0 + 0.6	10.0 + 0.6	12.0 + 0.6	13.0 + 0.6	17.0 + 0.6
20 MΩ	19.999 000 0	Lo Current	25 + 6.0	25 + 6.0	30 + 6.0	45 + 6.0	110 + 6.0
200 MΩ	199.990 000	Lo Current	325 + 600	450 + 600	650 + 600	670 + 600	1810 + 600
2 GΩ	1.999 900 00	Lo Current	325 + 600	450 + 600	650 + 600	675 + 600	1810 + 600
20 MΩ	19.999 000 0	High Voltage	2.5 + 0.6	5.0 + 0.6	8.5 + 0.6	19 + 0.6	20 + 0.6
200 MΩ	199.990 000	High Voltage	4.5 + 6.0	7.5 + 6.0	12 + 6.0	75 + 6.0	80 + 6.0
2 GΩ	1.999 900 00	High Voltage	25 + 60	30 + 60	35 + 60	195 + 60	230 + 60
20 GΩ <sup>[18]</sup>	19.999 000 0	High Voltage	325 + 600	450 + 600	650 + 600	675 + 600	1810 + 600

**Resistance - Normal Mode (Secondary Specifications)** <sup>[1] [2] [3] [10]</sup>

Range	Measurement Current	Transfer Uncertainty 20 mins ±1 °C ± (ppm Reading + ppm Range)	Temperature Coefficient		
			15 °C - 30 °C	5 °C - 15 °C 30 °C - 40 °C	5 °C - 40 °C <sup>[16]</sup>
			± ppm Reading/°C		± Ω/°C
2 Ω	100 mA	2.0 + 2.0	1.5	2.5	1.5 μ
20 Ω	10 mA	0.8 + 0.7	0.6	1.0	15 μ
200 Ω	10 mA	0.2 + 0.15	0.5	0.8	20 μ
2 kΩ	1 mA	0.2 + 0.15	0.5	0.8	200 μ
20 kΩ	100 μA	0.2 + 0.15	0.5	0.8	2 m
200 kΩ	100 μA	0.2 + 0.15	0.5	0.8	10 m
2 MΩ	10 μA	0.5 + 0.5	0.6	1.0	100 m
20 MΩ	1 μA	2.5 + 5	2	3	1
200 MΩ	100 nA	15 + 50	20	30	10
2 GΩ	10 nA	200 + 500	200	300	100

**Resistance - Lo Current Mode (Secondary Specifications)** <sup>[1] [2] [3] [10]</sup>

Range	Measurement Current	Transfer Uncertainty 20 mins ±1 °C ± (ppm Reading + ppm Range)	Temperature Coefficient		
			15 °C - 30 °C	5 °C - 15 °C 30 °C - 40 °C	5 °C - 40 °C <sup>[16]</sup>
			± ppm Reading/°C		± Ω/°C
2 Ω	100 mA	2.0 + 2.0	1.5	2.5	1.5 μ
20 Ω	10 mA	0.8 + 0.7	0.6	1.0	15 μ
200 Ω	1 mA	0.8 + 0.7	0.6	1.0	150 μ
2 kΩ	100 μA	0.8 + 0.7	0.6	1.0	1.5 m
20 kΩ	10 μA	0.8 + 0.7	0.6	1.0	15 m
200 kΩ	10 μA	0.5 + 0.5	0.6	1.0	20 m
2 MΩ	1 μA	2.0 + 0.5	2	3	200 m
20 MΩ	100 nA	15 + 5	20	30	2
200 MΩ	10 nA	200 + 500	200	300	20
2 GΩ	10 nA	200 + 500	200	300	100

**Resistance - High Voltage Mode (Secondary Specifications)** <sup>[1] [2] [3]</sup>

Range	Measurement Current	Transfer Uncertainty 20 mins ±1 °C ± (ppm Reading + ppm Range)	Temperature Coefficient		
			15 °C - 30 °C	5 °C - 15 °C 30 °C - 40 °C	5 °C - 40 °C <sup>[16]</sup>
			± ppm Reading/°C		± Ω/°C
20 MΩ	10 μA	0.5 + 0.5	0.6	1.0	2
200 MΩ	1 μA	2.0 + 0.5	2.0	3	20
2 GΩ	100 nA	15 + 50	20	30	200
20 GΩ <sup>[18]</sup>	10 nA	200 + 500	200	300	2k

**Type**..... True 4-wire with Ohms guard. 2-wire selectable.

**2 Wire Adder**..... ±(10 pA/Ir) x 10<sup>6</sup> ppm of Reading ±50 mΩ ±3 mΩ/°C, where Ir is the measurement current, where the temperature related factor is based on the temperature difference between the present operating temperature and the temperature where the instrument was last zeroed.

**Max Lead Resistance**..... 10 Ω in any or all leads, 1 Ω on 2 Ω range

**Full Scale Measurement Voltage**

Normal Mode ..... 200 mV/2 V/20 V

Lo Current Mode ..... 200 mV/2 V/20 V

High Voltage Mode ..... 200 V

**Protection (All ranges)** ..... 250 V rms, 360 V pk

**Ratio Accuracy**

Range to Range..... Apply an RSS summation of Net Front Input and Rear Input Accuracy <sup>[17]</sup>  
 Within Range ..... Using the 24 hour or 20 minute Transfer Uncertainty specifications as appropriate, apply an RSS summation of specified accuracy of the Front Input signal and the specified accuracy of the Rear Input signal <sup>[17]</sup>

**Settling Time** ..... Up to 200 kΩ range generally the same as DC Voltage Filter In but depends on external connections

**Temperature**

**Temperature Readout** <sup>[1] [2] [3]</sup>

Resistance Range	Absolute Resistance Measurement Uncertainty 365 day Tcal ±1 °C <sup>[4]</sup> ±(ppm Reading + mΩ) <sup>[11]</sup>	Typical Equivalent Temperature Measurement Uncertainty <sup>[12]</sup>			
		Probe Type	Nominal Temperature (°C)	Resistance (Ω)	Accuracy ± (°C)
<b>95% Confidence Level</b>					
0 - 199.990 000 Ω	7.5 + 0.14	25 Ω PRT/SPRT	-200	5	0.0016
		25 Ω PRT/SPRT	0	25	0.0033
		25 Ω PRT/SPRT	660	84	0.0096
		100 Ω PRT/SPRT	-200	20	0.0007
		100 Ω PRT/SPRT	0	100	0.0023
		100 Ω PRT/SPRT	232	185	0.0042
200 - 1999.900 00 Ω	7.5 + 0.5	100 Ω PRT/SPRT	400	250	0.0069
<b>99% Confidence Level</b>					
0 - 199.990 000 Ω	9.5 + 0.18	25 Ω PRT/SPRT	-200	5	0.0021
		25 Ω PRT/SPRT	0	25	0.0042
		25 Ω PRT/SPRT	660	84	0.0122
		100 Ω PRT/SPRT	-200	20	0.0009
		100 Ω PRT/SPRT	0	100	0.0029
		100 Ω PRT/SPRT	232	185	0.0053
200 - 1999.900 00 Ω	9.5 + 0.6	100 Ω PRT/SPRT	400	250	0.0086

**Temperature Readout (Secondary Specifications)** <sup>[1] [2] [3]</sup>

Resistance Range	Resistance Measurement Uncertainty				
	Transfer Uncertainty 20 Minute ±1 °C ±(ppm Reading + mΩ) <sup>[11]</sup>	2-Wire Adder (Ω)	3-Wire Adder (Ω)	Temp Coeff. ± ppm Reading/°C	
				15 °C - 30 °C	5 °C - 15 °C 30 °C - 40 °C
0 - 199.990 000 Ω	0.8 + 0.14	0.1	0.005	0.6	1.0
200 - 1999.900 00 Ω	0.2 + 0.5	0.1	0.005	0.5	0.8

**Type** ..... 4-wire current reversal resistance measurement with readout of equivalent temperature. 2-wire and 3-wire selectable without current reversal. Refer to Resistance specifications for additional details.

**Temperature Range** ..... -200 °C to 660 °C, readout also available in °F or K.

**Linearization** ..... ITS-90 or Callendar van Dusen. Entry and storage of coefficients and nominal resistance for up to 100 probes.

**Current Source** ..... 1 mA

## Read Rate and Additional Uncertainty

Read Rate and Additional Uncertainty

Function	Resolution	Filter Frequency (Hz)	Read Rate (readings/second)		Additional Errors <sup>[13]</sup> ± (ppm Reading + ppm Range)	
			Normal	Fast	Normal	Fast
DCV, DCI & Ohms <sup>[10]</sup>	8		1/25	1/6	0 + 0	0 + 0.1
	7		1/6	1/2	0 + 0.1	0 + 0.5
	6		2	35	1.0 + 0.5	0 + 2.5
	5		35	150	0 + 5	0 + 25
ACV & ACI <sup>[6]</sup>	6	1	1/50		0 + 0	
		10	1/5		0 + 0	
		40	1/2		0 + 0	
		100	1		0 + 0	
	5	1	1/50		0 + 5	
		10	1/5		0 + 5	
		40	1/2		0 + 5	
		100	2		0 + 5	
ACV Transfer Off <sup>[6]</sup>		1	1/25		200 + 20	
		10	1/2.5		200 + 20	
		40	1		200 + 20	
		100	4		200 + 20	
PRT & Tru Ohms <sup>[14]</sup>	8	-	1/90	1/30	0 + 0	
	7	-	1/30	1/10	0 + 0.1	
	6	-	1/4	1/3	1.0 + 0.5	
	5	-	1/3	1/3	0 + 5	

### Notes to Performance Specifications

- [1] Specifications apply for max resolution in each function, normal mode
- [2] Assumes 4 hour warm-up period
- [3] Input zero or offset null required whenever the temperature moves more than  $\pm 1$  °C from the temperature at which the previous null/zero was performed.
- [4] TCal = Ambient calibration temperature
- [5] Integration time >1 Power Line cycle
- [6] Valid for signals >1 % Full Scale, Transfer Mode On. Signals must be DC coupled <40 Hz.
- [7] Max Volt.Hertz  $3 \times 10^7$
- [8] >300 V, <10 kHz add:  $\pm 0.0004 \times (\text{Reading}-300)^2$  ppm >300 V, 10 kHz - 30 kHz add:  $\pm (0.0004 + (\text{Frequency} - 10000) \times 10^{-7}) \times (\text{Reading}-300)^2$  ppm >300 V, >30 kHz add:  $\pm 0.0024 \times (\text{Reading}-300)^2$  ppm
- [9] Typical below 10 Hz for ACV, below 10 Hz and above 10 kHz for ACI.
- [10] Tru Ohms mode available on 2  $\Omega$  to 20 k $\Omega$  ranges. Read Rate reduced in Tru Ohms Mode. Specification for Tru Ohms same as corresponding Normal or Lo Current range
- [11] Valid for 4-wire sensor
- [12] Not including sensor uncertainty
- [13] Assume Range and Full Scale = 2000 V when calculating for 1000 V Range. For DCI, additional errors only apply in 5 digit resolution
- [14] Fast mode not available in PRT
- [15] The maximum display value for the Analog to Digital converter is 199 990 000 counts. This sets the maximum value measurable on each range to be a one followed by four nines. For example, the maximum measured values on the 2 V range on DC Voltage are  $\pm 1.999\ 900\ 00$  V. However, the 1000 V ranges are limited to a maximum 1050 V.
- [16] The zero TC specification only needs to be applied if an input zero has not been performed within  $\pm 1$  °C of the current operating temperature.
- [17] RSS (Root Sum Square). For more information refer to the Ratio Measurements portion of the "Applying the Specifications" area of these specifications
- [18] >2 G $\Omega$  Relative Humidity Operating <80 % to 30°C <70 % to 40°C



## Applying the Specifications

### Introduction

The Fluke 8508A has been designed specifically for metrologists. Not only does it provide the performance metrologists need, but it is specified in a way to allow users to really understand the uncertainties of the measurements, and easily make allowance for those uncertainty contributions when performing measurement uncertainty analyses and compiling uncertainty budgets. Contemporary metrology practices, including ISO17025 based laboratory accreditation schemes, require uncertainty analysis to be performed in accordance with the statistically based techniques described in the ISO Guide to the Expression of Uncertainty in Measurement (often referred to as the ‘GUM’). For convenience, the 8508A specifications are quoted at a coverage factor of  $k=2$ , equivalent to a confidence level of approximately 95 %, as required by these methods. Specifications are also provided at a confidence level of 99 %.

Performance specifications for the 8508A consist of two elements, the first is a contribution expressed as parts-per-million of the Reading, and the second contribution is expressed as parts-per-million of the Range. These must be evaluated and combined for the relevant reading and range values applicable to the measurement being made, ensuring that both elements are evaluated on the same basis, such as parts per million of the measured value or in absolute terms (volts, amps, ohms, etc). The two elements are combined by adding algebraically. For example measuring 10 V on the 20 VDC range and applying the 365 day  $\pm 1$  °C specifications:

First, expressing the contributions in terms of parts-per-million of the measured value:

$$= \pm \left( 3.0 + 0.2 \times \frac{20}{10} \right) = \pm (3.0 + 0.4) = \pm 3.4 \text{ ppm of } 10 \text{ V}$$

Second, expressing the contributions in volts:

$$= \pm (3.0 \times 10^{-6} \times 10 + 0.2 \times 10^{-6} \times 20) = \pm 3.4 \times 10^{-5} = \pm 34 \mu\text{V}$$

The 8508A is designed to provide accuracy and stability without the need for internal auto or self calibration routines which may otherwise compromise the continuity and traceability of measurement performance history. To realise the full potential of the 8508A performance accepted metrology practices should be employed, such as performing a zeroing or null operation to remove any offsets present in the measurement setup when making DC measurements. The 8508A specifications assume that these methods are employed.

### Absolute and Relative Specifications

The Relative to Calibration Standards specifications describe the performance of the 8508A itself for the time periods and temperature range listed excluding the uncertainty of the standards used to perform calibration of the 8508A during manufacture. The Absolute specifications include the uncertainty of the standards used to perform calibration of the 8508A at manufacture and may be used to determine the uncertainty of measurements made with the 8508A for periods up to 1 year and over a temperature range of  $\pm 5$  °C from calibration. If the user has their 8508A calibrated with different uncertainties, the Relative specifications can be combined with the uncertainties applicable to that calibration to determine the effective absolute uncertainty following that calibration.

### Applying User's Calibration Uncertainties

When the 8508A is calibrated by another laboratory the uncertainties of the calibration standards used may be applied by combining those uncertainties with the 8508A's Relative to Standards specifications. The applicable calibration uncertainties and the 8508A relative specifications must both be expressed at the same confidence level, and be combined in a RSS (Root Sum Square) summation. Accepted metrology practice mandates that calibration uncertainties are stated at 95 %. Check the applicable calibration uncertainties are stated at 95 % and then combine them with the 8508A 95 % Relative specifications. For example, if the 8508A is calibrated at 10 V DC with an uncertainty of 1.5 ppm at 95 %: The absolute uncertainty at 10 V for a period of 90 days and  $\pm 1$  °C from calibration is:

$$= \pm \sqrt{1.5^2 + \left(1.4 + 0.2 \times \frac{20}{10}\right)^2} = \pm 2.3 \text{ ppm of } 10 \text{ V}$$

### Operating and Calibration Temperature Ranges

As a metrology tool, the 8508A will commonly be used in a calibration laboratory where the temperature would be controlled to  $\pm 1$  °C, and the 8508A  $\pm 1$  °C specifications are applicable to those situations. The majority of electrical calibration laboratories operate at a nominal temperature of 23 °C, the temperature at which the 8508A is calibrated by Fluke during manufacture and service. The 8508A is also capable of being calibrated at any temperature between 20 °C and 25 °C and the  $\pm 1$  °C specifications will apply to operation within  $\pm 1$  °C of that calibration temperature. In the 8508A specification tables the temperature of calibration is referred to as TCal. Specifications for  $\pm 5$  °C are provided for situations where the 8508A is operated in environments with wider temperature variations up to  $\pm 5$  °C. For applications where the knowledge of the effect of temperature on 8508A performance is important, temperature coefficients are listed in the 8508A specifications. If the operating temperature is within the range 15 °C to 30 °C the 15 °C to 30 °C temperature coefficient specifications are applicable otherwise use the 5 °C to 15 °C/30 °C to 40 °C figures, provided the temperature lies within that range. The 8508A may be operated at temperatures between 0 °C and 50 °C, but performance is not specified outside the range 5 °C to 40 °C.

### Applying Temperature Coefficient Specifications

The 8508A specification tables include information for the typical operating conditions of  $\pm 1$  °C for calibration laboratories with tight temperature control, and  $\pm 5$  °C for calibration laboratories with looser temperature control or uncontrolled environments within that temperature range. For the majority of applications choosing the Absolute specifications for the most appropriate operating temperature range will be adequate. However performance at other temperatures may be determined by including an allowance for temperature coefficient over the additional temperature range. Care should be taken when making this calculation as an amount of temperature coefficient is already included in the 8508A specifications and those specifications are themselves based on combining contributions using techniques similar to those employed in uncertainty analysis. For example, consider operating at 33 °C, 10 °C from the 23 °C calibration temperature. The  $\pm 5$  °C specifications already include a contribution for 5 °C of temperature difference, so this amount of temperature effect must be removed before the effect of the 10 °C difference is added. Consider 10 V on the 20 VDC range: 365 day absolute specification (95 %) at 33 °C expressed in parts-per-million of 10 V is:

$$= \pm \sqrt{\left(3.5 + 0.2 \times \frac{20}{10}\right)^2 - (5 \times 0.3)^2 + (10 \times 0.5)^2} = \pm 6.16 \text{ ppm of } 10 \text{ V}$$

### Ratio Measurements

The 8508A Ratio mode will automatically take measurements of inputs applied to the front and rear terminals and display the result as a ratio in the voltage and resistance functions. The measurements can be made on the same range or different ranges. When making measurements on different ranges the error in each measurement is evaluated by applying the relevant specification for each range and combining the two specifications in an RSS summation, expressing the contributions in parts-per-million of the measured values. For example, making measurements of the ratio of 100 mV on the 200m VDC range and 100 V on the 200 VDC range, applying the 365 day  $\pm 1$  °C Absolute specifications:

$$= \pm \sqrt{\left(4.5 + 0.5 \times \frac{200 \times 10^{-3}}{100 \times 10^{-3}}\right)^2 + \left(4.5 + 0.2 \times \frac{200}{100}\right)^2} = \pm 7.37 \text{ ppm of the ratio}$$

Making measurements on the same range will eliminate range to range errors, such as drift since the time of calibration, and improve the result. When making measurements on the same range these errors will affect both measurements and effectively cancel, leaving short term noise and linearity as the dominant errors. The 20 minute Transfer Uncertainty Specifications are provided to describe the performance obtained when making ratio measurements on the same range. The error in each measurement is evaluated by applying the relevant 20 minute Transfer Uncertainty Specification for each value and combining the two specifications in an RSS summation, expressing the contributions in parts-per-million of the measured values. If the measurements are made within the same range, but independently (not using the ratio mode) with an elapsed time greater than 20 minutes but less than 24 hours between the measurements, then the 24 hour specifications should be applied instead.

For example, making measurements of the ratio of 5 V and 10 V on the 20 VDC range, applying the 20 minute Transfer Uncertainty specifications:

$$= \pm \sqrt{\left(0.12 + 0.1 \times \frac{20}{5}\right)^2 + \left(0.12 + 0.1 \times \frac{20}{10}\right)^2} = \pm 0.61 \text{ ppm of the ratio}$$

### Additional Errors

The 8508A specifications are listed for the maximum resolution in each function, using the Normal reading mode. For measurements taken in other resolutions or the Fast read mode additional error contributions listed in the Read Rate and Additional Uncertainty table must be included. These additional contributions must be added algebraically to the relevant specifications. For example measuring 10 V on the 20 VDC range at 5 digit resolution in Fast mode and applying the 365 day  $\pm 1$  °C Absolute specifications:

$$= \pm \left( (3.0 + 0) + (0.2 + 25) \times \frac{20}{10} \right) = \pm (3.0 + 50.4) = \pm 53.4 \text{ ppm of 10 V}$$

Other additional contributions apply in certain situations and are also to be added algebraically to the relevant specifications. These additional contributions include the DC Accuracy specification to be applied when making DC measurements on the AC Voltage function when DC coupled, and the High Voltage adder when making measurements above 300 V on the AC Voltage function.



## **Chapter 6**

### **Adjustment and Verification**

<b>Title</b>	<b>Page</b>
Introduction.....	6-3
Adjustment Overview .....	6-3
Adjustment Interval and Performance .....	6-3
Adjustment Points.....	6-3
Non-Nominal Values.....	6-4
Enabling Access to Calibration Adjustment Mode.....	6-4
Calibration Menus.....	6-4
Accessing the Calibration Menus and Calibration Mode .....	6-4
Calibration Menu.....	6-5
SET VALUE Menu .....	6-5
SPOT CAL Menu.....	6-6
SPOT (1 to 6) RMS Menus .....	6-6
SPOT FREQUENCY (1 to 6) Menu .....	6-7
Special Calibration .....	6-7
SPCL Menu .....	6-7
SER # Menu .....	6-8
Hvlin Menu.....	6-8
Non-volatile input offset compensation.....	6-9
Routine Adjustment .....	6-9
Equipment Required for Adjustment.....	6-10
Preparing for Adjustment .....	6-11
Interconnections .....	6-12
ADC Adjustment .....	6-14
DC Voltage Adjustment .....	6-14
AC Voltage Adjustment .....	6-17
Resistance Adjustment .....	6-19
AC Current Adjustment.....	6-30
Frequency Adjustment.....	6-32
Cal Due Date Entry .....	6-32
Non-Volatile Input Offset Adjustment .....	6-33
ACV Spot Frequency Adjustment .....	6-34
Performance Verification.....	6-35
Equipment Requirements .....	6-36
Interconnections .....	6-36
Applicable Verification Tolerance and Conditions .....	6-36
Preparation.....	6-37

DC Voltage Checks .....	6-37
AC Voltage Checks .....	6-40
Resistance Checks .....	6-42
Normal $\Omega$ Checks .....	6-44
Normal LoI $\Omega$ checks .....	6-44
Tru $\Omega$ • checks .....	6-44
Tru $\Omega$ LoI checks.....	6-44
HiV $\Omega$ checks .....	6-44
DC Current Checks.....	6-46
AC Current Checks.....	6-48
Frequency Checks .....	6-50

## Introduction

Chapter 6 describes the calibration menus, and lists the adjustment and performance verification procedures for the 8508A Reference Multimeter. Remote commands for adjustment of the 8508A are described in Chapter 4 Remote Operations using the IEEE 488 Interface. In this chapter menu and button selections are shown as all-caps text.

## Adjustment Overview

The 8508A is adjusted via an electronic autocal feature which allows full adjustment of all functions from the front panel (or remotely via the IEEE 488.2 Interface). No hardware adjustments are required.

For each combination of function and range, an appropriate calibration standard (source) is input. At each setting, one keystroke immediately calibrates to the standard by updating an internal non-volatile memory. The instrument automatically determines whether the operation is to be a Zero or Range Gain adjustment; or for AC ranges whether it is to be a Zero, LF Gain or HF Gain adjustment. As part of the adjustment procedure, a non-volatile input-offset compensation is derived independently for the front and rear inputs. The autocal process can operate only when the rear panel Calibration switch is in the 'Enable' position. Applying a calibration integrity seal to prevent access to the rear panel Calibration switch is a convenient way to ensure the security of adjustment. When an adjustment operation is performed the 8508A internal adjustment memory is immediately updated. It is possible to adjust a single range or single point if the user chooses to do so. However, it is recommended that the adjustment procedure listed later in this chapter be followed closely.

## Adjustment Interval and Performance

It is recommended that the 8508A be adjusted on either a 365-day or 90-day interval depending on the requirements of the applications for which the 8508A is used and the performance specifications required. The performance of the 8508A is specified for periods of 365 days and 90 days – if readjustment takes place on a 90-day cycle use the 90-day specifications for improved performance.

During manufacture, the 8508A is adjusted with low uncertainties, reflected in the Absolute Specifications listed in Chapter 5 Specification section. After readjustment, the user should apply the uncertainties for the standards and for the process applicable to that adjustment by combining those calibration uncertainties with the 8508A Relative to Standards specifications, as described in Chapter 5.

Many 8508A owners prefer using Fluke calibration services instead of maintaining their own standards to support their 8508A. To help ensure optimum performance from the 8508A, Fluke offers our calibration service at a variety of worldwide locations. Our worldwide service network provides fast efficient calibration to ensure low uncertainties and optimum accuracy consistent with the original adjustment at manufacture.

## Adjustment Points

There is generally more than one adjustment point for each range. An initial measurement (made when the adjustment is triggered) determines the intended adjustment point. The points for each range and function are listed later in this chapter.

### **Non-Nominal Values**

The Set facility allows the user to set the adjustment target to the value of the calibration standard available. This facility is most useful when the user's calibration standard is not available at the nominal values specified, or when the user has knowledge of the actual output of the calibration standard at the required points. In these cases, the use of the Set facility with a table of errors for the calibration source is recommended and will improve the accuracy of the 8508A adjustment.

## **Enabling Access to Calibration Adjustment Mode**

### **Rear Panel Calibration Switch**

The setting of a Calibration-switch on the rear panel enables or restricts access to the Calibration mode. Setting the switch to ENABLE allows access to the adjustment mode via the front panel CAL key and the CALIBRATION menu, and also enables the remote IEEE 488 interface adjustment commands. Setting the switch to DISABLE and applying a calibration integrity seal to cover the Calibration-switch is a convenient way to ensure the security of calibration and to prevent unauthorized access to the switch.

## **Calibration Menus**

### **Accessing the Calibration Menus and Calibration Mode**

Pressing the CAL key on the front panel causes the instrument to respond as follows:

1. Enters the adjustment (CAL) mode
2. Displays and allows access to the CALIBRATION menu
3. Displays the CAL legend on the main display

To exit the CALIBRATION menu Press the Quit softkey. On exit the instrument displays the prompt to enter a calibration due date.

When in CAL mode the following front panel keys become inoperative: CLEAR, TEST, OFFSET, PRT and INPUT. Also the function of the SAMPLE key changes to become the trigger key for initiating an adjustment operation.

### **⚠ Caution**

**When in CAL mode with the CAL legend appearing on the main display the function of the SAMPLE key is modified from normal operation. If pressed, the SAMPLE key will initiate an adjustment operation and permanently alter the instrument calibration state. To avoid accidental mis-adjustment do not attempt to operate the instrument in External Trigger mode from the front panel when in Cal, and only press the SAMPLE key when an adjustment operation is intended to be performed.**



**Calibration Menu**

This menu allows adjustment operations at the adjustment point nominal values via Auto, or selection of adjustment operations at non-nominal values via Set. It also offers access to the special calibration menu. The CAL legend appears in the left-hand display when in CAL mode.

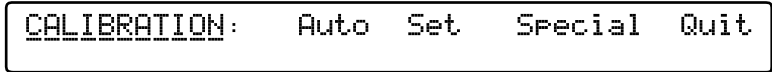

adj134f.eps

**CALIBRATION Menu**

This menu defines four *menu* keys:

- Auto** Indicates to the user that the adjustment point is automatically set according to the amplitude (and frequency in ACV) of the signal detected. Auto is the default selection on entry to the CALIBRATION menu. Refer to the tables appearing later in this chapter for the adjustment points for the selected range.
- Set** The Set feature is available in all functions, allowing the user to enter the true value of the calibration standard where it differs from the nominal adjustment point value. Pressing Set displays the SET VALUE menu except in ACV Spot Frequency mode, when the SPOT CAL menu is displayed. Spot Frequency adjustment reduces flatness errors within  $\pm 10\%$  of the spot frequency. Set is not available for DCV, DCI, and Resistance range zero calibrations.
- Special** Special CAL is indicated on the main display. The SPCL menu is displayed which allows pre-adjustment of the instrument, adjustment of the frequency counter, and entry to other calibration utilities.
- Quit** Exits from the CALIBRATION menu via the CALIBRATION DUE ? menu, where the recommended next adjustment date can be entered, before finally quitting the calibration mode.

**SET VALUE Menu**

This menu is obtained by pressing the Set key in the CALIBRATION menu on all functions except ACV Spot Frequency.

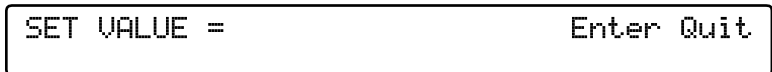

adj139f.eps

**SET VALUE Menu**

When this menu appears, it shows the nominal adjustment point value, allowing the user to enter the true output value of the calibration standard at the point to be adjusted. The numeric keyboard is activated, locking out all other keys. The Set value is entered in exponential format expressed in Volts, Amps, or Ohms, and must be above 20 % of range (40 % on the 1000 V DCV and ACV ranges). The SAMPLE key has no effect until the Set value is stored by pressing the Enter key.

The 8508A always chooses the most-recently stored Set value when adjusting. Set is not available for DCV, DCI, and Resistance range zero adjustments.

**⚠ Caution**

**Enter:** The new value is stored and the numeric keyboard is de-activated. The set value remains on the dot-matrix display for comparison with the reading on the main display after the **SAMPLE** key has been pressed.

**Quit:**Reverts to the **CALIBRATION** menu.

**SPOT CAL Menu**

This menu is obtained by pressing the **Set** key in the **CALIBRATION** menu when the 8508A is in **ACV Spot Frequency** mode. It provides a means of adjusting the 8508A at any of six user-specific spot frequencies, at non-nominal adjustment values for each **ACV** range. The 8508A will already be set to an **ACV** range on entry to the menu.

```
SPOT_CAL:  SP1  SP2  SP3  SP4  SP5  SP6
```

adj140f.eps

**SPOT CAL Menu**

This menu allows a user to select a spot frequency (**Sp $x$** ) for the selected range. It defines six *menu* keys:

- SP1:** Displays the **SPOT 1 RMS** menu, where users define the RMS value for the Spot Frequency 1 adjustment point on the currently selected range.
- SP2-6:** Same as **Sp1** but permitting their own RMS values to be defined.

**SPOT (1 to 6) RMS Menus**

On entry to one of the six **SPOT** ( $x = 1$  to 6) **RMS** menus, the nominal cardinal point value is displayed and the numeric keyboard is activated. A numeric value can be entered that represents the RMS value of the calibration standard signal.

```
SPOT n RMS =                               Enter Quit
```

adj141f.eps

**SPOT n RMS Menus**

- Enter** Stores the displayed RMS value and de-activates the numeric keyboard. The dot-matrix display moves to the **SPOT FREQUENCY (1 to 6)** menu, showing the adjustment signal frequency.
- Quit** Reverts to the **SPOT CAL** menu, not storing any new Spot value.

*Note*

*The **SAMPLE** key is still enabled in the next menu.*

**SPOT FREQUENCY (1 to 6) Menu**

Enter this menu by pressing Enter in the SPOT (1 to 6) RMS menu, which also stores the RMS value keyed in during this menu. The value in the SPOT FREQUENCY (1 to 6) menu is the measured frequency of the present adjustment input signal.

```
SPOT FREQUENCY n =                               Quit
Use SAMPLE to initiate CAL operation
```

adj142f.eps

**SPOT FREQUENCY n Menu**

Pressing the SAMPLE key causes the selected ACV range to be spot-adjusted at the adjustment signal frequency. The frequency value is stored and can be viewed from the UTILITY menu. If ACV Spot Frequency mode is selected, any subsequent measurement on this range whose frequency is within  $\pm 10\%$  of the stored frequency is accuracy enhanced by reducing frequency response flatness errors.

**Adjust the spot at a new frequency:**

To adjust the spot at a new frequency, change the input signal to the desired new frequency and press SAMPLE as before.

**Quit** Reverts to the SPOT CAL menu with the original Spot adjustment intact.

**Special Calibration**

The SPCL menu provides alignment of the ADC and adjustment of the frequency counter.

It also allows the High Voltage Linearity Pre-Adjustment to be performed and a section of the Non-Volatile memory to be cleared for test purposes. These facilities are used in the factory for initial pre-adjustment processes; they should not require access during the life of the instrument unless repairs have been carried out. They appear here for completeness.

**SPCL Menu**

The SPCL menu appears after pressing the Special key in the CALIBRATION menu. At the same time the instrument is placed in special calibration mode, the Special CAL legend appears on the main display.

When in Special CAL mode the following front panel keys remain inoperative: CLEAR, TEST, OFFSET, PRT and INPUT. Also, the function of the SAMPLE key changes to become the trigger key for initiating the Hvlin adjustment operation.

```
SPCL: Adc Freq Hvlin      ClrNV Ser# Quit
```

adj137f.eps

**SPCL Menu**

The SPCL menu provides the selection:

- Adc** Aligns the different resolutions available from the instrument's analog-to-digital converter, so that there are no significant differences in readings when changing resolutions with a constant input value. No external input signals are required for this adjustment. Adjustment is initiated directly by making this selection from the SPCL menu.
- Freq** Calibrates the frequency counter against an external source. Adjustment is initiated directly by making this selection from the SPCL menu.

- Hvlin Selects the sequence required to correct the linearity of the 1kV DC range.
- ClrMv Provides the capability to clear a section of the non-volatile memory for 'test purposes only'.
- Ser# Permits entry of the instrument's serial number.
- Quit Reverts to the CALIBRATION menu.

### SER # Menu

This menu is obtained by pressing Ser# in the SPCL menu. On entry to the menu, the most-recently-entered serial number is shown, and the numeric keyboard is activated. A numeric value can be entered.

```
SER# = xxxxxx          Enter Quit
```

adj138f.eps

### SER# Menu

The SER# menu provides the selection:

- Enter Stores the new serial number, de-activates the numeric keyboard, and reverts to the SPCL menu.
- Quit Reverts to the SPCL menu, leaving the old serial number intact.

### Hvlin Menu

This menu sequence is obtained by selecting Hvlin from the SPCL menu. It allows the linearity of the 1kV DC range to be adjusted with the application of five input signals of -1000V, -500V, 0V, +500V and +1000V in turn, with the 1kV DC range selected. On entry to the menu, the user is prompted to apply the first input signal required and step through the sequence:

```
1st signal for Hvlin= -1000      NEXT  
Press SAMPLE to measure & save
```

```
2nd signal for Hvlin= -500      PREV NEXT  
Press SAMPLE to measure & save
```

```
3rd signal for Hvlin= 0.0      PREV NEXT  
Press SAMPLE to measure & save
```

```
4th signal for Hvlin= +500      PREV NEXT  
Press SAMPLE to measure & save
```

```
5th signal for Hvlin= +1000     PREV CALC  
Press SAMPLE to measure & save
```

adj135f.eps

### Hvlin Menus

Pressing the SAMPLE key initiates the adjustment operation at the signal level displayed for the step in progress and; also, saves the result for calculation of the Hvlin linearity correction factor at the end of the sequence.

- PREV Moves back to the previous menu allowing the user to repeat the previous step in the sequence if required.
- NEXT Moves forward through the sequence to the next step and signal level.
- CALC Initiates calculation and storage of the high voltage linearity correction factor, completing the Hvlin adjustment process.

## **Non-volatile input offset compensation**

Good metrology practice should ensure that all high-precision measurements made with the 8508A are preceded by an input zero of each measurement. However, a non-volatile input-offset compensation is independently available for the front and rear inputs. This compensation is retained after power down and is unaffected by clearing the volatile input zeros. It is cleared by performing range zero adjustments. Compensation is available on all functions, and includes separate compensation of 2-wire and 4-wire measurements in the resistance functions.

Non-volatile input-offset compensation adjustment is available only when the rear panel calibration keyswitch is in the ENABLE position and the CAL legend is not shown on the main display.

Adjustment is performed by initiating an input zero operation with the 8508A in this condition, using the INPUT menu as described in Chapter 3 or using the IEEE 488 input zeroing commands described in Chapter 4. Apply a high-integrity low-thermal emf 4-wire short to the input terminals for this operation. Following adjustment for a particular combination of function, range, and input a compensation is stored for the corresponding non-volatile input zero, and the Zero legend is shown on the main display. The Zero legend may be removed from the display without affecting the stored non-volatile compensation by using one of the following operations:

1. Power the instrument down.
2. Press the CLEAR key and make any of the selections from the CLEAR menu.
3. Entering CAL mode.

## **Routine Adjustment**

The 8508A is a Digital Reference Multimeter offering state-of-the-art performance. This procedure is intended as a guide for qualified metrology personnel who have access to a standards laboratory with equipment available to support an instrument of this level of accuracy. It reflects the adjustment process used by Fluke to perform 8508A adjustment implemented in an automated system, but as a manual procedure for users to follow. The procedure is based on the following assumptions:

1. Users are familiar with relevant best measurement practice.
2. Users will take precautions to avoid introducing errors from sources such as thermal emfs, leakages, electromagnetic interference, etc.
3. Users will make adequate allowance for equipment stabilization and measurement settling times.

This routine adjustment procedure describes the adjustment points and sequence of operations required to adjust the 8508A and assumes calibration standards of adequate traceable uncertainty are available – in this case a Fluke 5720A calibrator and 5725A amplifier used with an 8508A-7000 Calibration Kit. The procedure assumes the user is able to adjust and characterize the calibration standards, without describing the process required to do so.

Characterization of the 5720A/5725A combination allows the 8508A to be adjusted with uncertainties lower than otherwise available from that equipment. The characterization process determines the 5720A/5725A errors from nominal at the values required for 8508A adjustment, and may be performed using Fluke's recommended verification procedures appearing in the 5700A/5720A Service Manual as a guide. If a characterized 5720A/5725A combination is available where the error from nominal at the various points required is known, those errors may be taken into account during 8508A

adjustment to reduce the uncertainties. The errors may be determined by measurement against suitable standards or may be taken from an applicable certificate of calibration. The uncertainty of the characterized calibrator should be combined with the 8508A Relative to Standards specifications to determine the 8508A performance after adjustment. (RSS summation is recommended).

If the calibrator is not characterized to determine its errors from nominal, its output should be assumed to be nominal at all points. Its performance specifications should be used to provide calibration uncertainties to be combined with the 8508A Relative to Standards specifications to determine the 8508A performance after adjustment. (RSS summation is recommended).

See Chapter 5 for more details of combining 8508A Relative to Standards specifications and calibration uncertainties.

*Note*

*The instrument should be thoroughly checked to ensure it is operating correctly before attempting adjustment. A performance verification procedure appears later in this section.*

**Equipment Required for Adjustment**

The equipment required for Adjustment and Performance Verification is listed in Table 6-1.

**Table 6-1. Required Equipment for Adjustment and Performance Verification**

Equipment Required
Fluke 5720A Multifunction Calibrator <sup>1 2</sup>
Fluke 5725A Amplifier <sup>2</sup>
Fluke 8508A-7000K Calibration kit comprising 1 G $\Omega$ Standard, two precision low thermal emf 4-wire short devices, and connecting leads.
1. Availability of a 1 MHz frequency reference signal may be required for 5720A frequency locking during 8508A frequency adjustment procedure. 2. Best uncertainties are obtained by characterizing the outputs of the 5720A and 5725A at the points used for 8508A adjustment.

Alternate equipment may be used, but users should ensure it provides adequate calibration uncertainties. Performance of the 8508A after adjustment should be determined by combining the applicable calibration uncertainties provided by the calibration equipment with the 8508A Relative to Standards specifications. (RSS summation is recommended).

### Preparing for Adjustment

The following procedures represent the recommended order of adjustment, giving all the necessary setup commands.

1. Allow the instrument to warm-up under power in the specified environment for at least 4 hours.
2. Press the CLEAR key, select Pwr Up Dflt to restore the power up default configuration and display the DCV menu.
3. Set the rear panel Calibration switch to Enable. Removal of the calibration integrity seal covering the Calibration switch will be necessary.
4. Press the CAL key.
5. The CALIBRATION menu is displayed.

The calibration menu appears, and the CAL legend appears on the main display. When entering CAL mode and selecting a function the optimum resolution for performing adjustment in that function is automatically selected.

#### Note

*It is recommended that the default resolutions are used for adjustment purposes. Other resolutions may be selected and adjustment operations performed, but accuracy of adjustment will be degraded if adjustment is performed in lower resolutions.*

#### Caution

**When in CAL mode with the CAL legend appearing on the main display, the function of the SAMPLE key is modified from normal operation. If pressed, the SAMPLE key will initiate an adjustment operation and permanently alter the instrument calibration state. To avoid accidental mis-adjustment do not attempt to operate the instrument in External Trigger mode from the front panel when in Cal, and only press the SAMPLE key when an adjustment operation is intended to be performed.**

Table 6-2. Adjustment Sequence

General Sequence for Full Instrument Adjustment <sup>1</sup>	
Enable Calibration	Set rear panel calibration switch to ENABLE.
Enter Cal mode	Access CALIBRATION menu .
HVlin Cal	Corrects linearity of the 1 kV DC range. Performed only if required.
Adc Cal	Analog to digital converter alignment. Performed only if required.
DCV	Range Zeros and Range Gains (200 mV to 1 kV Ranges).
ACV	Range Zeros, Range LF Gains and Range HF Gains (200 mV to 1 kV Ranges).
DCI	Range Zeros and Range Gains (200 $\mu$ A to 20A Ranges).
ACI	Range Zeros and Range Gains (200 $\mu$ A to 20A Ranges).
Frequency	Frequency counter cal at 1MHz
Ohms	Range Zeros and Range Gains: Ohms: 2 $\Omega$ to 2 G $\Omega$ Ranges, then Lol Ohms. Tru $\Omega$ : 2 $\Omega$ to 20 k $\Omega$ Ranges, then Lol Tru $\Omega$ . HiV $\Omega$ : 20 M $\Omega$ to 20 G $\Omega$ Ranges.
Exit Cal mode	Quit the CALIBRATION menu.
NV input offsets	Front & rear non-volatile input offset adjustments: DCV, Ohms, Tru $\Omega$ , HiV $\Omega$ (including Lol , 2 & 4-wire).
Set CAL DUE	Set the date for the next adjustment
Disable Calibration	Set rear panel calibration switch to DISABLE.
1. To meet user's need, just one range on one function can be adjusted.	

### Interconnections

The Fluke 8508A-7000K Calibration kit contains a specially designed lead set which connects directly to the terminals of the 8508A, the 5720A, and the 5725A for the purpose of 8508A calibration. It is recommended that this lead kit be used to avoid introducing measurement errors due to interconnections and to duplicate the configuration used by Fluke for 8508A calibration. Figure 6-1 shows the interconnections used in detail. If alternate leads are substituted, make sure they are metrology grade leads, and of adequate voltage and current ratings. Leads should be kept as short as possible, constructed from low capacitance low leakage dielectric material (PTFE) with low thermal emf terminations, and exactly duplicate the configuration and interconnections shown.

When adjusting the 2 G $\Omega$  and 20 G $\Omega$  resistance ranges the 1 G $\Omega$  standard resistor supplied in the Fluke 8508A-7000K Calibration kit plugs directly into the 8508A front input terminals, without any interconnecting leads. If alternate resistance standards are used for resistance adjustment, refer to the resistance-measurements section of Chapter 3 *Making Measurements* for connection details.

The Fluke 8508A-7000K Calibration kit also contains two precision low-thermal emf 4-wire shorting devices for use when performing the non-volatile input offset adjustments at the front and rear input terminals. These devices link the input terminals in the following order: Input Lo to Input Hi to Sense Hi to Sense Lo. If these devices are not available it is recommended that a U-shaped piece of thick bare copper wire be used to link the terminals in the same manner.



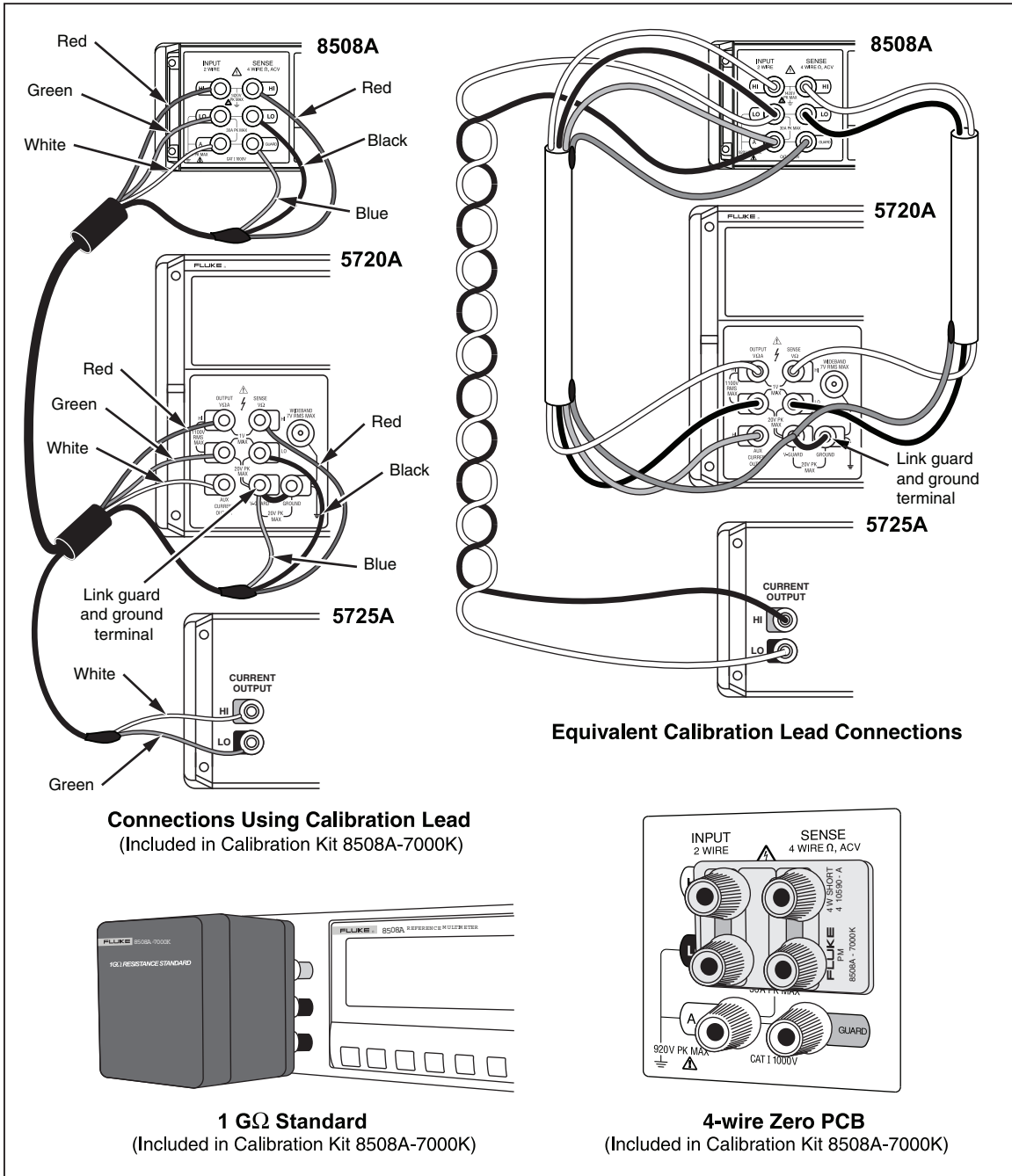

Figure 6-1. Equipment Connections Required for Calibration

adj381f.eps

### ADC Adjustment

ADC (analog to digital converter) adjustment aligns the different resolutions available from the 8508A analog to digital converter, so that there are no significant differences in readings when changing resolutions with a constant input value. It is recommended that ADC CAL is only performed if performance verification indicates significant resolution differences. If required, it is recommended that ADC adjustment is performed before any other calibrations.

No external equipment or signals are required to perform ADC adjustment.

### Procedure

1. Ensure that no signals are present on the 8508A inputs. The 8508A may be left connected to the calibrator as shown above provided the calibrator output is set to STANDBY.
2. On the 8508A, Press CAL to enter the CALIBRATION menu, and select SPCL.
3. Select Adc to initiate the adjustment operation, which will take approximately 3 minutes to complete.

Adjustment is complete when the Busy legend goes out.

### DC Voltage Adjustment

#### Warning

**The Calibrator can deliver a lethal electric shock.**

**To avoid electric shock when performing the following adjustment procedures:**

- **Never touch any lead or terminal unless you are absolutely certain that no dangerous voltage is present.**
- **Make sure that signal leads are in a safe condition before you handle them in any way.**

### Initial Setup

1. On the 8508A, press the CAL key.
2. Press the DCV key.
3. Press the CONFIG key and deselect FILT.
4. Press the DCV key and select 1 kV range.
5. In adjustment mode the resolution defaults to RESL7 in the DCV function. It is recommended that this resolution is used for adjustment of all DCV ranges.
6. Confirm that the 8508A is configured for internal guard (External Guard is deselected) by checking that the ExGd legend does not appear on the left-hand display.
7. Ensure that the calibrator output is set to STANDBY and configured for Internal Guard (EX GRD is deselected).
8. Connect the Calibrator to the 8508A as shown in Figure 6-1.

#### *Note*

*After making the connections allow at least 30 minutes for thermal emfs in the leads to stabilize.*

**Range Zero and Gain Adjustment Procedure**

After the initial setup and connecting up, use the following procedure to adjust range zero, then positive and negative range gains on all DCV ranges. Just one range can be adjusted if required, but for a full adjustment start with the 200 mV range and work up to the 1kV range, as shown in Table 6-3.

**Table 6-3. DC Voltage Adjustment Points and Sequence**

8508A Range	Point	Voltage
200 mV	Zero	0 mV
	Range Gain +ve	+100 mV
	-1 digit	-0.00001 mV
	Range Gain -ve	-100 mV
2 V	Zero	0 V
	Range Gain +ve	+1 V
	-1 digit	-0.0000001 V
	Range Gain -ve	-1 V
20 V	Zero	0 V
	Range Gain +ve	+10 V
	-1 digit	-0.000001 V
	Range Gain -ve	-10 V
200 V	Zero	0 V
	Range Gain +ve	+100 V
	-1 digit	-0.00001 V
	Range Gain -ve	-100 V
1000 V	Zero	0 V
	Range Gain +ve	+1000 V
	Range Gain -ve	-1000 V

The procedure assumes the user has knowledge of the actual output value of the calibrator at the range gain values, from a measurement or from a certificate of calibration. The **Set** feature allows a user to enter the true output value of the calibration standard where it differs from the nominal range gain point. If the calibrator output is considered to be exactly nominal, use of the **Set** feature is not required, also **omit** steps 7 and 13 for the Range Gain Points.

On each range, the 8508A automatically recognizes the appropriate value as range zero or range gain from the applied signal amplitude and polarity.

## Range Zero and Gain Points

### Notes

- *To overcome thermal EMF differences when the calibrator polarity is changed, it is necessary to reference negative Range Gain to the minimum negative output (-1 digit) on that range.*
  - *For the 8508A 200V and 1kV DC ranges, setting the Calibrator to the Range Gain point will cause the Calibrator output to revert to Standby. It will be necessary to reselect OPR to operate the output.*
  - *For the 1kV DC range the Calibrator cannot be Range locked for the zero adjustments, omit steps 2, 9, 10 and 11.*
1. On the 8508A, select the required range.
  2. On the Calibrator, select the positive Range Gain point Output value. Deselect AUTO to range lock the calibrator.
  3. On the Calibrator, set zero output. Select OPR to operate the calibrator output.
  4. On the 8508A, press CAL to enter the Calibration Menu.
  5. Press SAMPLE to initiate the adjustment operation. Adjustment is complete when the busy legend goes out and the adjusted measurement is displayed.
  6. On the Calibrator, select the positive Range Gain point Output value.
  7. If the Set feature is being used:  
On the 8508A, select Set on the CALIBRATION Menu.  
Use the numeric keys with the SET VALUE menu to enter the true output value of the calibrator at the range gain value, then press Enter.
  8. Press SAMPLE to initiate the adjustment operation. Adjustment is complete when the busy legend goes out and the adjusted measurement is displayed.
  9. On the Calibrator set an output of -1 digit.
  10. On the 8508A, press CAL to enter the Calibration Menu.
  11. Press SAMPLE to initiate the adjustment operation. Adjustment is complete when the busy legend goes out and the adjusted measurement is displayed.
  12. On the Calibrator, select the negative Range Gain point Output value, allowing for the -1 digit offset.
  13. If the Set feature is being used:  
On the 8508A, select Set on the CALIBRATION Menu.  
Use the numeric keys with the SET VALUE menu to enter the true output value of the calibrator at the range gain value, then press Enter.
  14. Press SAMPLE to initiate the adjustment operation. Adjustment is complete when the busy legend goes out and the adjusted measurement is displayed.
  15. On the Calibrator, deselect LOCKED to allow the Calibrator to Auto range. Set zero output and select STBY to put the Calibrator output into Standby.
  16. On the 8508A, select DCV to revert to the range menu.

## AC Voltage Adjustment

### **⚠⚠ Warning**

The Calibrator can deliver a lethal electric shock.

To avoid electric shock when performing the following adjustment procedures:

- Never touch any lead or terminal unless you are absolutely certain that no dangerous voltage is present.
- Make sure that signal leads are in a safe condition before you handle them in any way

### *Initial Setup and Connections*

1. Press the ACV key, select the 1 kV range.
2. In calibration mode in the ACV function Transfer mode defaults to On for enhanced performance, resolution defaults to RESL6, and the 100Hz RMS filter is automatically selected. It is recommended that this resolution, Transfer On and 40Hz Filter is used for adjustment of all ACV ranges.
3. Confirm that the 8508A is configured for internal guard (External Guard is deselected) by checking that the ExGd legend does not appear on the left-hand display.
4. Ensure that the calibrator output is set to STANDBY and configured for Internal Guard (EX GRD is deselected).
5. Connect the Calibrator to the 8508A as shown in Figure 6-1.

### *Range Zero, LF, and HF Gain Adjustment Procedure (not in Spot Frequency mode)*

Use the following procedure to adjust range zero then range LF and HF gains on all ACV ranges at the voltages and frequencies detailed in Table 6-4. Just one range can be adjusted if required, but for a full-adjustment start with the 200 mV range and work up to the 1kV range.

**Table 6-4. AC Voltage Adjustment Points and Sequence**

8508A Range	Point	Voltage	Frequency
200 mV	Zero (5 % Range)	10 mV	1 kHz
	Range Gain LF	100 mV	1 kHz
	Range Gain HF	100 mV	60 kHz
2 V	Zero (0.5 % Range)	10 mV	1 kHz
	Range Gain LF	1V	1 kHz
	Range Gain HF	1V	60 kHz
20 V	Zero (0.5 % Range)	100 mV	1 kHz
	Range Gain LF	10 V	1 kHz
	Range Gain HF	10 V	60 kHz
200 V	Zero (0.5 % Range)	1 V	1 kHz
	Range Gain LF	100 V	1 kHz
	Range Gain HF	100 V	60 kHz
1000 V <sup>1</sup>	Zero (0.5 % Range)	5 V	1 kHz
	Range Gain LF	500 V	1 kHz
	Range Gain HF	500 V	30 kHz

1. 1000V range Gain adjustments may be performed at voltages above 500V. The 1000V range Gain and Zero adjustments should be performed together, with the Zero cal performed at 1 % of the nominal value used for Gain cal.

The procedure assumes the user has knowledge of the actual output value of the calibrator at each point, from a measurement or from a certificate of calibration. The **Set** feature allows a user to enter the true output value of the calibration standard where it differs from the nominal point. If the calibrator output is considered to be exactly nominal, use of the **Set** feature is not required when adjusting at full range, also **omit** steps 4, 8, and 12. Adjusting the 1000V range at the recommended 500V requires a Set Value of 500 before the Zero cal.

On each range, the 8508A automatically recognizes the appropriate value as range zero from the applied signal amplitude, and automatically recognizes the range LF and HF gain points from the applied signal frequency.

1. On the 8508A, select the required range.
2. On the Calibrator, select the Range Zero point Output Voltage and Frequency. Select OPR to operate the calibrator output.
3. On the 8508A, press CAL to enter the Calibration Menu.
4. If the Set feature is being used:  
On the 8508A, select Set on the CALIBRATION Menu.  
Use the numeric keys with the SET VALUE menu to enter the true output value of the calibrator at the range zero point, then press Enter.
5. Press SAMPLE to initiate the adjustment operation.  
Adjustment is complete when the busy legend goes out and the adjusted measurement is displayed.
6. On the Calibrator, select the Range Gain LF point Output Voltage and Frequency.
7. On the 8508A, press CAL to enter the Calibration Menu.

8. If the Set feature is being used:  
On the 8508A, select Set on the CALIBRATION Menu.  
Use the numeric keys with the SET VALUE menu to enter the true output value of the calibrator at the range gain LF point, then press Enter.
9. Press SAMPLE to initiate the adjustment operation.  
Adjustment is complete when the busy legend goes out and the adjusted measurement is displayed.
10. On the Calibrator, select the Range Gain HF point Output Voltage and Frequency.
11. On the 8508A, press CAL to enter the Calibration Menu.
12. If the Set feature is being used:  
On the 8508A, select Set on the CALIBRATION Menu.  
Use the numeric keys with the SET VALUE menu to enter the true output value of the calibrator at the range gain HF point, then press Enter.
13. Press SAMPLE to initiate the adjustment operation.  
Adjustment is complete when the busy legend goes out and the adjusted measurement is displayed.  
Note that HF calibrations are iterative, and repeating the HF adjustment may improve the result.
14. On the Calibrator, select STBY to put the Calibrator output into Standby.
15. On the 8508A, select ACV to revert to the range menu.

*Note*

*During adjustment of the AC Voltage 20V Range Gain LF point, the 8508A will also derive the DC coupled calibration factor.*

### **Resistance Adjustment**

When adjusting the resistance function, each of the resistance modes (Normal, LoI, Tru $\Omega$ , Tru $\Omega$  LoI and HiV $\Omega$ ) must be individually adjusted. The following procedure assumes use of a multifunction calibrator and adjusts each resistance mode in turn, range by range. If individual standard resistors are used it may be more convenient to adjust all the modes in turn for each resistance value to avoid connecting the same resistance standard several times during the adjustment sequence. A 1G $\Omega$  standard resistor provided in the 8508A-7000K Calibration kit is used for ranges above 200 M $\Omega$  as the highest resistance available from the 5720A calibrator is 100 M $\Omega$ .

In order to minimize connection changes it is recommended that all adjustments using the 1 G $\Omega$  Standard resistor are performed together after all other resistance points.

**Table 6-5. Resistance Adjustment Points and Sequence**

<b>8508A Range</b>	<b>Modes</b>	<b>Point</b>	<b>Resistance</b>
2 $\Omega$	Normal, Normal LoI, Tru $\Omega$ , Tru $\Omega$ LoI	Zero	0 $\Omega$
		Range Gain	1 $\Omega$
20 $\Omega$	Normal, Normal LoI, Tru $\Omega$ , Tru $\Omega$ LoI	Zero	0 $\Omega$
		Range Gain	10 $\Omega$
200 $\Omega$	Normal, Normal LoI, Tru $\Omega$ , Tru $\Omega$ LoI	Zero	0 $\Omega$
		Range Gain	100 $\Omega$
2 k $\Omega$	Normal, Normal LoI, Tru $\Omega$ , Tru $\Omega$ LoI	Zero	0 $\Omega$
		Range Gain	1 k $\Omega$
20 k $\Omega$	Normal, Normal LoI, Tru $\Omega$ , Tru $\Omega$ LoI	Zero	0 $\Omega$
		Range Gain	10 k $\Omega$
200 k $\Omega$	Normal, Normal LoI	Zero	0 $\Omega$
		Range Gain	100 k $\Omega$
2 M $\Omega$	Normal, Normal LoI	Zero	0 $\Omega$
		Range Gain	1 M $\Omega$
20 M $\Omega$	Normal, Normal LoI, HiV $\Omega$	Zero	0 $\Omega$
		Range Gain	10 M $\Omega$
200 M $\Omega$	Normal, Normal LoI, HiV $\Omega$	Zero	0 $\Omega$
		Range Gain	100 M $\Omega$
2 G $\Omega$	Normal, Normal LoI, HiV $\Omega$	Zero	0 $\Omega$
		Range Gain	1 G $\Omega$
20 G $\Omega$	HiV $\Omega$	Zero	0 $\Omega$
		Range Gain	Optional <sup>1</sup>
1. 20 G $\Omega$ range gain is adjusted automatically during 2 G $\Omega$ HiV $\Omega$ range gain adjustment, but may be adjusted separately (after 2 G $\Omega$ HiV $\Omega$ range adjustment) at 10 G $\Omega$ if a standard is available.			



### Initial Setup and Connections

1. On the 8508A, select CLEAR, Pwr Up Dflt to select DCV 1kV range.
2. Ensure that the calibrator output is set to STANDBY and configured for Internal Guard (EX GRD is deselected).
3. Connect the calibrator to the 8508A as shown above in Figure 6-1.

#### Note

*After making the connections allow at least 30 minutes for thermal emfs in the leads to stabilise.*

4. On the calibrator select zero  $\Omega$  and OPR to operate the output. Select EX SNS.
5. In calibration mode the resolution defaults to RESL7 in the resistance function. It is recommended that this resolution is used for adjustment of all resistance ranges. HiV $\Omega$  is restricted to RESL6.
6. Confirm the 8508A is configured for internal guard (External Guard is deselected) by checking that the ExGd legend does not appear on the left hand display.

### Normal $\Omega$ Mode Adjustment

1. Press the CAL key. Press the  $\Omega$  key and select 2  $\Omega$  range.
2. Press the CONFIG key and deselect Filt. Ensure Lol is deselected. Ensure 4 W $\Omega$  is selected.

### Range Zero and Gain Adjustment Procedure

After the initial setup and connecting up, use the following procedure to adjust range zero and range gain for the ranges and points detailed in Table 6-5 for the Normal  $\Omega$  mode. For the 2 G $\Omega$  range use the 1 G $\Omega$  standard resistor in place of the calibrator. Just one range can be adjusted if required, but for a full-adjustment start with the 2  $\Omega$  range and work up to the 2 G $\Omega$  range.

Note that EX SNS (4-wire) is not available on the 5720A 100 M $\Omega$  range, and the 8508-7000K 1 G $\Omega$  standard resistor is used as a 2-wire device with the calibrator 2-wire resistance zero used for the corresponding zero points. Ensure 4W $\Omega$  is deselected on the 8508A when adjusting the 200 M $\Omega$  and 2 G $\Omega$  range, range zero, and range gain points.

On each range, the 8508A automatically recognizes the appropriate value as range zero or range gain from the applied resistance value.

#### Note

*It is unlikely that the resistance standard will be at exactly the nominal value required. The **Set** feature allows a user to enter the true output value of the calibration standard where it differs from nominal range gain point. If the resistance value is exactly the nominal value required, omit step 6 for the Range Gain Point.*

### Range Zero and Gain Points

1. On the 8508A, press the  $\Omega$  key and select the required range.
2. On the Calibrator select zero and OPR to operate the output.  
Alternatively if using a standard resistor, connect the standard resistor for a 4 wire resistance zero.
3. On the 8508A press CAL to enter the CALIBRATION menu.
4. Press SAMPLE to initiate the adjustment operation.  
Adjustment is complete when the busy legend goes out and the calibrated measurement is displayed.
5. On the Calibrator select the range gain resistance value.  
Alternatively if using a standard resistor, re-connect the standard resistor to measure it's resistance.
6. If the Set feature is being used:  
On the 8508A, select Set on the CALIBRATION Menu.  
Use the numeric keys with the SET VALUE menu to enter the true output value of the calibrator at the range gain point, then press Enter.
7. Press SAMPLE to initiate the adjustment operation.  
Adjustment is complete when the busy legend goes out and the calibrated measurement is displayed.
8. Press the  $\Omega$  key to revert to the ranges menu.

### LoI $\Omega$ Mode Adjustment

Follow the procedure for Normal  $\Omega$  Mode Adjustment ensuring that LoI is selected. Press the  $\Omega$  key. Press the CONFIG key and select LoI.

### Range Zero and Gain Adjustment Procedure

After the initial setup and connecting up, use the following procedure to adjust range zero and range gain for the ranges and points detailed in Table 6-5 for the LoI mode. For the 2 G $\Omega$  range use the 1 G $\Omega$  standard resistor in place of the calibrator. Just one range can be adjusted, if required, but for a full-adjustment start with the 2  $\Omega$  range and work up to the 2 G $\Omega$  range.

Note that EX SNS (4-wire) is not available on the 5720A 100 M $\Omega$  range, and the 8508-7000K 1 G $\Omega$  standard resistor is used as a 2-wire device with the calibrator 2-wire resistance zero used for the corresponding zero points. 4W $\Omega$  is deselected on the 8508A when adjusting the 200 M $\Omega$  and 2 G $\Omega$  range, range zero, and range gain points.

On each range, the 8508A automatically recognizes the appropriate value as range zero or range gain from the applied resistance value.

#### *Note*

*It is unlikely that the resistance standard will be at exactly the nominal value required. The **Set** feature allows a user to enter the true output value of the calibration standard where it differs from nominal range gain point. If the resistance value is exactly the nominal value required, omit step 6 for the Range Gain Point.*

### Range Zero and Gain Points

1. On the 8508A, press the  $\Omega$  key and select the required range.
2. On the Calibrator select zero and OPR to operate the output.  
Alternatively if using a standard resistor, connect the standard resistor for a 4 wire resistance zero.
3. On the 8508A press CAL to enter the CALIBRATION menu.
4. Press SAMPLE to initiate the adjustment operation.  
Adjustment is complete when the busy legend goes out and the calibrated measurement is displayed.
5. On the Calibrator select the range gain resistance value.  
Alternatively if using a standard resistor, re-connect the standard resistor to measure it's resistance.
6. If the Set feature is being used:  
On the 8508A, select Set on the CALIBRATION Menu.  
Use the numeric keys with the SET VALUE menu to enter the true output value of the calibrator at the range gain point, then press Enter.
7. Press SAMPLE to initiate the adjustment operation.  
Adjustment is complete when the busy legend goes out and the calibrated measurement is displayed.
8. Press the  $\Omega$  key to revert to the range menu.

### Tru $\Omega$ Mode Adjustment

Follow the procedure for Normal  $\Omega$  Mode Adjustment except select the  $\Omega$  Plus key followed by Tru $\Omega$  instead of selecting the  $\Omega$  key.

### Range Zero and Gain Adjustment Procedure

After the initial setup and connecting up, use the following procedure to adjust range zero and range gain for the ranges and points detailed in Table 6-5 for the Tru  $\Omega$  mode. Just one range can be adjusted, if required, but for a full-adjustment start with the 2  $\Omega$  range and work up to the 20 k $\Omega$  range.

On each range, the 8508A automatically recognizes the appropriate value as range zero or range gain from the applied resistance value.

#### Note

*It is unlikely that the resistance standard will be at exactly the nominal value required. The **Set** feature allows a user to enter the true output value of the calibration standard where it differs from nominal range gain point. If the resistance value is exactly the nominal value required, omit step 6 for the Range Gain Point.*

### Range Zero and Gain Points

1. On the 8508A, press the  $\Omega$  Plus key followed by the Tru $\Omega$  to select the required range.
2. On the Calibrator select zero and OPR to operate the output.  
Alternatively if using a standard resistor, connect the standard resistor for a 4 wire resistance zero.
3. On the 8508A press CAL to enter the CALIBRATION menu.
4. Press SAMPLE to initiate the adjustment operation.  
Adjustment is complete when the busy legend goes out and the calibrated measurement is displayed.
5. On the Calibrator select the range gain resistance value.  
Alternatively if using a standard resistor, re-connect the standard resistor to measure it's resistance.
6. If the Set feature is being used:  
On the 8508A, select Set on the CALIBRATION Menu.  
Use the numeric keys with the SET VALUE menu to enter the true output value of the calibrator at the range gain point, then press Enter.
7. Press SAMPLE to initiate the adjustment operation.  
Adjustment is complete when the busy legend goes out and the calibrated measurement is displayed.
8. Press the  $\Omega$  Plus key followed by Tru $\Omega$  to revert to the range menu.

### Tru $\Omega$ LoI Mode Adjustment

Follow the procedure for Normal $\Omega$  Mode Adjustment except select the  $\Omega$  Plus key followed by Tru $\Omega$  instead of selecting the  $\Omega$  key. Press the CONFIG key and select LoI.

### Range Zero and Gain Adjustment Procedure

After the initial setup and connecting up, use the following procedure to adjust range zero and range gain for the ranges and points detailed in Table 6-5 for the Tru $\Omega$  LoI mode. Just one range can be adjusted if required, but for a full adjustment start with the 2  $\Omega$  range and work up to the 20 k $\Omega$  range.

On each range, the 8508A automatically recognizes the appropriate value as range zero or range gain from the applied resistance value.

#### *Note*

*It is unlikely that the resistance standard will be at exactly the nominal value required. The **Set** feature allows a user to enter the true output value of the calibration standard where it differs from nominal range gain point. If the resistance value is exactly the nominal value required, omit step 6 for the Range Gain Point.*

### Range Zero and Gain Points

1. On the 8508A, press the  $\Omega$  Plus key followed by the Tru $\Omega$  to select the required range.
2. On the Calibrator select zero and OPR to operate the output.  
Alternatively if using a standard resistor, connect the standard resistor for a 4 wire resistance zero.
3. On the 8508A press CAL to enter the CALIBRATION menu.
4. Press SAMPLE to initiate the adjustment operation.  
Adjustment is complete when the busy legend goes out and the calibrated measurement is displayed.
5. On the Calibrator select the range gain resistance value.  
Alternatively if using a standard resistor, re-connect the standard resistor to measure it's resistance.
6. If the Set feature is being used:  
On the 8508A, select Set on the CALIBRATION Menu.  
Use the numeric keys with the SET VALUE menu to enter the true output value of the calibrator at the range gain point, then press Enter.
7. Press SAMPLE to initiate the adjustment operation.  
Adjustment is complete when the busy legend goes out and the calibrated measurement is displayed.
8. Press the  $\Omega$  Plus key followed by the Tru $\Omega$  to revert to the range menu.

### HiV $\Omega$ Mode Adjustment

#### Warning

**The Multimeter can deliver a lethal electric shock when operating in the High Voltage Resistance mode. Voltages up to 240V may appear on the terminals.**

**To avoid electric shock when performing the following adjustment procedures:**

- **Never touch any lead or terminal unless you are absolutely certain that no dangerous voltage is present.**
  - **Make sure that signal leads are in a safe condition before you handle them in any way.**
1. Press the CAL key. Press the  $\Omega$  Plus key and select HiV $\Omega$ . Select the 20 M $\Omega$  range.
  2. Press the CONFIG key and deselect Filt. Select 4 W $\Omega$ .

### Range Zero and Gain Adjustment Procedure

After the initial setup and connecting up, use the following procedure to adjust range zero and range gain for the ranges and points detailed in Table 6-5 for the HiV $\Omega$  mode. Just one range can be adjusted if required, but for a full adjustment start with the 20 M $\Omega$  range and work up to the 20 G $\Omega$  range.

For the 2 G $\Omega$  range use the 1 G $\Omega$  standard resistor in place of the calibrator. To avoid the requirement for a 10 G $\Omega$  standard, the 20 G $\Omega$  range is automatically adjusted when the 2 G $\Omega$  range gain adjustment is triggered. A 10 G $\Omega$  standard resistor may be used for adjusting the 20 G $\Omega$  range if available, but if performed, this operation must take place after the 2 G $\Omega$  range gain point adjustment to avoid the automatic process overwriting the result.

Voltages of approximately 200 V will be developed across the resistance standard at full scale, ensure the resistance standards used are suitable for operation at these voltages.

Note that EX SNS (4-wire) is not available on the 5720A 100 M $\Omega$  range, and the 8508-7000K 1 G $\Omega$  standard resistor is used as a 2-wire device with the calibrator 2-wire resistance zero used for the corresponding zero points. 4W $\Omega$  is deselected on the 8508A when adjusting the 200 M $\Omega$  and 2 G $\Omega$  range, range zero, and range gain points.

On each range, the 8508A automatically recognizes the appropriate value as range zero or range gain from the applied resistance value.

#### *Note*

*It is unlikely that the resistance standard will be at exactly the nominal value required. The **Set** feature allows a user to enter the true output value of the calibration standard where it differs from nominal range gain point. If the resistance value is exactly the nominal value required, omit step 6 for the Range Gain Point .*

## Range Zero and Gain Points

### Note

For the 20M $\Omega$  range use 4 wire, for 200M $\Omega$ , 2G $\Omega$  and 20G $\Omega$  ranges use 2 wire mode on both the Calibrator and 8508A.

1. On the 8508A, press the  $\Omega$  Plus key and select HiV $\Omega$ , select the required range.
2. On the Calibrator select zero and OPR to operate the output.  
Alternatively if using a standard resistor, connect the standard resistor for a resistance zero.
3. On the 8508A press CAL to enter the CALIBRATION menu.
4. Press SAMPLE to initiate the adjustment operation.  
Adjustment is complete when the busy legend goes out and the calibrated measurement is displayed.
5. On the Calibrator select the range gain resistance value.  
Alternatively if using a standard resistor, re-connect the standard resistor to measure it's resistance.
6. If the Set feature is being used:  
On the 8508A, select Set on the CALIBRATION Menu.  
Use the numeric keys with the SET VALUE menu to enter the true output value of the calibrator at the range gain point, then press Enter.
7. Press SAMPLE to initiate the adjustment operation.  
Adjustment is complete when the busy legend goes out and the calibrated measurement is displayed.
8. Press the  $\Omega$  Plus key followed by HiV $\Omega$  to revert to the range menu.

## DC Current Adjustment

### Warning

**The Calibrator can deliver a lethal electric shock.**

**To avoid electric shock when performing the following adjustment procedures:**

- **Never touch any lead or terminal unless you are absolutely certain that no dangerous voltage is present.**
- **Make sure that signal leads are in a safe condition before you handle them in any way.**

### *Initial Setup*

1. On the 8508A, press the CAL key.
2. Press the DCI key. Press CONFIG key and deselect Filt.  
Press the DCI key, select 200  $\mu$ A range.
3. In calibration mode the resolution defaults to RESL7 in the DCI function. It is recommended that this resolution is used for adjustment of all DCI ranges.
4. Confirm that the 8508A is configured for internal guard (External Guard is deselected) by checking that the ExGd legend does not appear on the left-hand display.
5. Ensure that the calibrator output is set to STANDBY and configured for Internal Guard (EX GRD is deselected).
6. Connect the Calibrator to the 8508A as shown in Figure 6-1.

### *Range Zero and Gain Adjustment Procedure*

After the initial setup and connecting up, use the following procedure to adjust range zero, then positive and negative range gains on all DCI ranges. Just one range can be adjusted if required, but for a full adjustment start with the 200  $\mu$ A range and work up to the 20A range, as shown in Table 6-6.



**Table 6-6. DC Current Adjustment Points and Sequence**

8508A Range	Point	Current
200 $\mu$ A	Zero	0 $\mu$ A
	Range Gain +ve	+100 $\mu$ A
	Range Gain -ve	-100 $\mu$ A
2 mA	Zero	0 mA
	Range Gain +ve	+1 mA
	Range Gain -ve	-1 mA
20 mA	Zero	0 mA
	Range Gain +ve	+10 mA
	Range Gain -ve	-10 mA
200 mA	Zero	0 mA
	Range Gain +ve	+100 mA
	Range Gain -ve	-100 mA
2 A	Zero	0 A
	Range Gain +ve	+1 A
	Range Gain -ve	-1 A
20 A	Zero	0 A
	Range Gain +ve	+10 A
	Range Gain -ve	-10 A

The procedure assumes the user has knowledge of the actual output value of the calibrator at the range gain values, from a measurement or from a certificate of calibration. The Set feature allows a user to enter the true output value of the calibration standard where it differs from the nominal range gain point. If the calibrator output is considered to be exactly nominal, use of the Set feature is not required, also **omit** steps 7 and 10 for the Range Gain Points.

On each range, the 8508A automatically recognizes the appropriate value as range zero or range gain from the applied signal amplitude and polarity.

### *Range Zero and Gain Points*

1. On the 8508A, select the required range.
2. On the Calibrator, select the positive Range Gain point Output value. Deselect AUTO to range lock the calibrator.
3. On the Calibrator, set zero output. Select OPR to operate the calibrator output.
4. On the 8508A, press CAL to enter the Calibration Menu.
5. Press SAMPLE to initiate the adjustment operation. Adjustment is complete when the busy legend goes out and the calibrated measurement is displayed.

6. On the Calibrator, select the positive Range Gain point Output value.
7. If the Set feature is being used:  
On the 8508A, select Set on the CALIBRATION Menu.  
Use the numeric keys with the SET VALUE menu to enter the true output value of the calibrator at the range gain value, then press Enter.
8. Press SAMPLE to initiate the adjustment operation.  
Adjustment is complete when the busy legend goes out and the calibrated measurement is displayed.
9. On the Calibrator, select the negative Range Gain point Output value.
10. If the Set feature is being used:  
On the 8508A, select Set on the CALIBRATION Menu.  
Use the numeric keys with the SET VALUE menu to enter the true output value of the calibrator at the range gain value, then press Enter.
11. Press SAMPLE to initiate the adjustment operation.  
Adjustment is complete when the busy legend goes out and the calibrated measurement is displayed.
12. On the Calibrator, deselect LOCKED to allow the Calibrator to Auto range.  
Set zero output and select STBY to put the Calibrator output into Standby.
13. On the 8508A, select DCI to revert to the range menu.

### **AC Current Adjustment**

#### **⚠⚠ Warning**

**The Calibrator can deliver a lethal electric shock.**

**To avoid electric shock when performing the following adjustment procedures:**

- **Never touch any lead or terminal unless you are absolutely certain that no dangerous voltage is present.**
- **Make sure that signal leads are in a safe condition before you handle them in any way.**

### **Initial Setup and Connections**

1. Press the ACI key, and select the 200 $\mu$ A range.
2. In calibration mode in the ACI function resolution defaults to RESL6 and the 100Hz RMS filter is automatically selected. It is recommended that this resolution and 40Hz Filter is used for adjustment of all ACI ranges.
3. Confirm that the 8508A is configured for internal guard (External Guard is deselected) by checking that the ExGd legend does not appear on the left-hand display.
4. Ensure that the calibrator output is set to STANDBY and configured for Internal Guard (EX GRD is deselected).
5. Connect the Calibrator to the 8508A as shown in Figure 6-1.

**Range Zero and LF Gain Adjustment Procedure**

After the initial setup and connecting up, use the following procedure to adjust range zero then range gain on all ACI ranges at the currents and frequencies detailed in Table 6-7. Just one range can be adjusted if required, but for a full-adjustment start with the 200  $\mu$ A range and work up to the 20A range.

**Table 6-7. AC Current Adjustment Points and Sequence**

8508A Range	Point	Current	Frequency
200 $\mu$ A	Zero (5 % Range)	10 $\mu$ A	305 Hz
	Range Gain	100 $\mu$ A	305 Hz
2 mA	Zero (0.5 % Range)	10 $\mu$ A	305 Hz
	Range Gain	1 mA	305 Hz
20 mA	Zero (0.5 % Range)	100 $\mu$ A	305 Hz
	Range Gain	10 mA	305 Hz
200 mA	Zero (5 % Range)	10 mA	305 Hz
	Range Gain	100 mA	305 Hz
2 A	Zero (5 % Range)	100 mA	305 Hz
	Range Gain	1 A	305 Hz
20 A	Zero (5 % Range)	1 A	305 Hz
	Range Gain	10 A	305 Hz

The procedure assumes the user has knowledge of the actual output value of the calibrator at each point, from a measurement or from a certificate of calibration. The **Set** feature allows a user to enter the true output value of the calibration standard where it differs from the nominal point. If the calibrator output is considered to be exactly nominal, use of the **Set** feature is not required, also **omit** steps 4 and 8.

On each range, the 8508A automatically recognizes the appropriate value as range zero or range gain from the applied signal amplitude.

1. On the 8508A, select the required range.
2. On the Calibrator, select the Range Zero point Output Current and Frequency. Select OPR to operate the calibrator output.
3. On the 8508A, press CAL to enter the Calibration Menu.
4. If the Set feature is being used:  
On the 8508A, select Set on the CALIBRATION Menu.  
Use the numeric keys with the SET VALUE menu to enter the true output value of the calibrator at the range zero point, then press Enter.
5. Press SAMPLE to initiate the adjustment operation.  
Adjustment is complete when the busy legend goes out and the calibrated measurement is displayed.
6. On the Calibrator, select the Range Gain point Output Current and Frequency.
7. On the 8508A, press CAL to enter the Calibration Menu.
8. If the Set feature is being used:  
On the 8508A, select Set on the CALIBRATION Menu.  
Use the numeric keys with the SET VALUE menu to enter the true output value of the calibrator at the range gain point, then press Enter.

9. Press SAMPLE to initiate the adjustment operation.  
Adjustment is complete when the busy legend goes out and the calibrated measurement is displayed.
10. On the Calibrator, select STBY to put the Calibrator output into Standby.
11. On the 8508A, select ACI to revert to the range menu.

### **Frequency Adjustment**

The 8508A frequency adjustment operation requires a signal at exactly 1MHz (Set is not available on the 8508A for frequency adjustment). If the calibrator frequency output is not exactly nominal or sufficiently close to nominal it may be phase locked to an external reference frequency at the required output frequency applied to its rear panel phase lock input, for example from a laboratory frequency standard or off-air reference receiver. If used, the calibrator should be disconnected from the frequency reference and phase locking disabled before attempting any other adjustment operations with the calibrator.

Alternatively, the 1MHz frequency reference may be used directly as an input signal for the 8508A for frequency adjustment.

### **Initial Setup and Connections**

1. Press the ACV key, select the 2 V range.
2. Confirm that the 8508A is configured for internal guard (External Guard is deselected) by checking that the ExGd legend does not appear on the left-hand display.
3. Ensure that the calibrator output is set to STANDBY and configured for Internal Guard (EX GRD is deselected).
4. Connect the Calibrator to the 8508A as shown in Figure 6-1.
5. If required, connect the calibrator rear panel phase lock input to a 1MHz reference frequency and enable phase locking via the front panel menus.

### **Procedure**

1. On the calibrator select 1V 1MHz, select OPR to operate the calibrator output.
2. On the 8508A, Press CAL to enter the CALIBRATION menu, and select SPECIAL.
3. Select Freq to initiate the adjustment operation.  
Adjustment is complete when the Busy legend goes out.
4. On the 8508A select QUIT from the SPCL menu.
5. On the Calibrator, set STANDBY.

### **Cal Due Date Entry**

On completion of all adjustment operations it is recommended that the user updates the stored CAL due date with the date for the next adjustment. For consistency, this date should be the same as the adjustment due date shown on any adjustment stickers the user may also attach to the instrument. It is also recommended that a calibration integrity seal is applied to prevent unauthorized access to the rear panel calibration enable switch.

### **Set Cal Due Date**

1. Press the CAL key and select Quit.
2. From the CAL DUE ? menu use the keypad to key in the adjustment due date. Up to eight characters may be entered in any format. Any character available from the keypad may be used, but it is recommended that one of the common date formats such as dd.mm.yy or mm.dd.yy is used for ease of interpretation.
3. Press ENTER to store the CAL Due Date and exit from Calibration mode.

### **Non-Volatile Input Offset Adjustment**

Use the following procedure to perform non-volatile input offset adjustment on all DCV and resistance ranges (including LoI, 2-wire, and 4-wire) for the front and rear inputs.

### **Initial Setup and Connections**

1. Press the CAL key and select Quit.
2. From the CAL DUE ? menu select Quit.
3. The instrument will exit from CAL mode, the CAL legend on the main display will extinguish, and the right-hand display will revert to the currently selected function menu.
4. Disconnect all leads and connect a 8508-7000K precision 4-wire short device to the front input terminals and also, if fitted, to the rear input terminals as shown above.
5. On 8508A select CLEAR, and select Pwr Up Dflt.

### **Procedure**

1. Press the DCV key.
2. Press the INPUT key and select Front.
3. From the INPUT Menu select Zero Func.  
Adjustment is complete when the Busy legend goes out.
4. If the Rear Input is fitted  
From the INPUT Menu select Rear.  
From the INPUT Menu select Zero Func.  
Adjustment is complete when the Busy legend goes out.
5. Press the  $\Omega$  key. Press CONFIG key, deselect LoI and deselect 4W $\Omega$ .  
Repeat steps 2, 3 and 4.
6. Press the  $\Omega$  key. Press CONFIG key, select LoI and deselect 4W $\Omega$ .  
Repeat steps 2, 3 and 4.
7. Press the  $\Omega$  key. Press CONFIG key, deselect LoI and select 4W $\Omega$ .  
Repeat steps 2, 3 and 4.
8. Press the  $\Omega$  key. Press CONFIG key, select LoI and select 4W $\Omega$ .  
Repeat steps 2, 3 and 4.
9. Press the  $\Omega$  Plus key and select Tru $\Omega$ . Press CONFIG key, deselect LoI.  
Repeat steps 2, 3 and 4.
10. Press the  $\Omega$  Plus key and select Tru  $\Omega$ . Press CONFIG key, select LoI.  
Repeat steps 2, 3 and 4.
11. Press the  $\Omega$  Plus key and select HiV $\Omega$ . Press CONFIG key, deselect 4W $\Omega$ .  
Repeat steps 2, 3 and 4.
12. Press the  $\Omega$  Plus key and select HiV $\Omega$ . Press CONFIG key, select 4W $\Omega$ .  
Repeat steps 2, 3 and 4.
13. Press the DCV key and remove the shorting devices from the input terminals.

### **Calibration Mode Disable**

1. Set the rear panel Calibration Enable switch to DISABLE .
2. Apply a security seal to cover the rear panel Calibration Enable switch to prevent unauthorized access.

## **ACV Spot Frequency Adjustment**

The ACV Spot frequency mode adjustment is not normally performed as part of routine adjustment. ACV Spot frequency adjustment is only performed if the user intends to make use of spot frequency mode. In spot frequency mode the accuracy of AC Voltage measurements can be improved by adjusting the 8508A at specific frequencies of interest, reducing frequency response flatness errors at these points. The following procedure provides guidance on spot frequency adjustment for users wishing to make use of Spot frequency mode.

### **To Adjust at Spot Frequencies**

Spot Adjustment is available only when in AC Voltage function with Spot already selected on the ACV CONFIG menu. Each spot (six per range) can be adjusted at a valid input frequency to a non-nominal RMS value. In subsequent use, frequency response flatness errors are reduced within  $\pm 10\%$  of the adjusted spot frequency.

Set up and connect the 8508A as described under AC Voltage Adjustment, Initial Setup and Connections. The configuration defaults to Tfer and RESL6 (both required).

Proceed as follows:

1. Select ACV and select the required Range.
2. On the Calibrator, set the Output Voltage and Frequency.  
Select OPR to operate the calibrator output.
3. Press the CONFIG key and select Spot.
4. Press the CAL key.  
The CALIBRATION menu is displayed.
5. Select Set.  
The SPOT CAL menu is displayed.
6. Select the soft key for the required spot, 1 to 6 (Sp1 to Sp6).  
The SPOT (x = 1 to 6) RMS menu is displayed.
7. Key in the true RMS output value of the standard, then select Enter.  
The SPOT FREQUENCY menu is displayed, showing the frequency at which the spot will be adjusted.
8. Press SAMPLE to initiate the adjustment operation.  
Adjustment is complete when the Busy legend goes out and the adjusted measurement is displayed. Select QUIT to return to the SPOT CAL menu.
9. On the Calibrator, set STANDBY.
10. On the 8508A, select other spots as required, repeating the process for each selection.

### **Performance Verification**

The 8508A is a Digital Reference Multimeter offering state of the art performance. This procedure is intended as a guide for qualified metrology personnel who have access to a standards laboratory with equipment available to verify the performance of an instrument of this level of accuracy. The procedure assumes users are familiar with relevant best measurement practice, and will take precautions to avoid introducing errors from sources such as thermal emfs, leakages, electromagnetic interference, etc. It also assumes users will make adequate allowance for equipment stabilization and measurement settling times.

This routine performance verification procedure describes the test points and sequence of operations required to check the 8508A and assumes calibration references of adequate traceable uncertainty are available – in this case a Fluke 5720A calibrator and 5725A amplifier used with an 8508A-7000 Calibration Kit. The procedure assumes the user is able to adjust and characterize the adjustment standards, without describing the process required to do so. Refer to the Routine Adjustment section for more information on the characterization process.

### **Equipment Requirements**

The equipment required for performance verification of the 8508A is identical to the equipment required for routine adjustment listed in Table 6-1. Alternate equipment may be used, but users should ensure it provides adequate uncertainties, and consider the impact of those uncertainties on allowable tolerance limits.

### **Interconnections**

The Fluke 8508A-7000K Calibration kit contains a specially designed lead set which connects directly to the terminals of the 8508A, the 5720A, and the 5725A for the purpose of 8508A adjustment and performance verification. It is recommended that this lead kit be used to avoid introducing measurement errors due to interconnections and to duplicate the configuration used by Fluke for 8508A Calibration. A diagram showing the interconnections used in detail appears in the Routine Adjustment section. If alternate leads are substituted users must ensure they are metrology grade leads, and of adequate voltage and current rating. Leads should be kept as short as possible, constructed from low capacitance low leakage dielectric material (PTFE) with low thermal emf terminations, and exactly duplicate the configuration and interconnections shown.

When checking the 2 G $\Omega$  and 20 G $\Omega$  resistance ranges the 1 G $\Omega$  standard resistor supplied in the Fluke 8508A-7000K Calibration kit plugs directly into the 8508A front input terminals without any interconnecting leads. If alternate resistance standards are used for verifying performance of the resistance function, refer to the resistance measurements section of Chapter 3 'Making Measurements' for connection details.

### **Applicable Verification Tolerance and Conditions**

The tolerances\* listed in this verification procedure are derived from the 8508A 365 day Tcal  $\pm 1^\circ\text{C}$  99 % Confidence Level Absolute specifications, which include contributions for the performance of the 8508A itself and the uncertainty of the calibration standards used to perform adjustment of the 8508A at the Fluke factory. They are applicable to a verification performed within a period of 365 days from adjustment and at a temperature within  $\pm 1^\circ\text{C}$  of the temperature at which adjustment was performed ( $23^\circ\text{C}$  for calibrations performed by Fluke). It is recommended that these tolerances only be used for verification of the 8508A following adjustment by Fluke, and if the above time period and temperature conditions are met. No allowance has been made for the uncertainty of the equipment used for verification. If the required conditions are met but the temperature lies within  $\pm 5^\circ\text{C}$  of factory adjustment, it is recommended that the user applies the 365 day Tcal  $\pm 5^\circ\text{C}$  Absolute specifications instead.

For other circumstances, such as following adjustment by another laboratory, it is recommended that the user derive verification tolerances\* from the applicable 8508A 99 % Confidence Level Relative to Standards specifications (90 day or 365 day) combined with the calibration uncertainties applicable to the previous adjustment. (RSS summation is recommended, with calibration uncertainties also expressed at 99 % confidence level).

The 8508A temperature coefficient specifications should also be applied if the temperature at verification is outside the range applicable to the 8508A specifications to be used.

Refer to Chapter 5 for further information on applying specifications and combining uncertainties.

Note that the tolerance testing is done with 7-digit resolution for speed and efficiency reasons. However, the tolerance limits are based on the tighter specifications of 8-digit measurement resolution. (The minor tolerance adders for the reduced resolution are disregarded as practically insignificant in most cases. These adders apply to DC volts,



DC current, Ohms and Temperature function verifications.) It is recommended that the 8-digit resolution mode be used if performance verification shows a borderline out-of-tolerance condition. In such cases 8-digit mode can be selected and the specifically borderline verification tests can be repeated. This will provide additional confidence in the in-tolerance or out-of-tolerance decision made during verification.

\* Fluke guarantees 8508A performance verification using specifications stated to 99 % confidence level.

### Preparation

1. Allow the instrument to warm-up under power in the specified environment for at least 4 hours.
2. Press the CLEAR key, select Pwr Up Dflt to restore the power up default configuration and display the DCV menu.
3. Press the Test key and select START to initiate a selftest. Should the instrument fail, contact your local authorized Service Center, ensuring that the full circumstances of the failure are reported.

### DC Voltage Checks

#### Warning

**The Calibrator can deliver a lethal electric shock.**

**To avoid electric shock when performing the following adjustment procedures:**

- **Never touch any lead or terminal unless you are absolutely certain that no dangerous voltage is present.**
- **Make sure that signal leads are in a safe condition before you handle them in any way.**

### Equipment Configuration

1. On the 8508A press the DCV key, and select 1 kV range. Ensure that the 8508A is configured for internal guard (External Guard is deselected) by checking that the ExGd legend does not appear on the left hand display.
2. Ensure that the Calibrator output is set to STANDBY and configured for Internal Guard (EX GRD is deselected)
3. Connect the equipment as described for Routine Adjustment.

#### Note

- *After making the connections allow at least 30 minutes for thermal emfs in the leads to stabilise.*
- *To overcome thermal EMF differences when the calibrator polarity is changed, it is necessary to reference negative Range Gain to the minimum negative output (-1 digit) on that range.*
- *For the 8508A 200V and 1kV DC ranges, setting the Calibrator to the Range Gain point will cause the Calibrator output to revert to Standby. It will be necessary to reselect OPR to operate the output For the 1kV DC range the Calibrator cannot be Range locked for the zero adjustments, omit steps 2, 7 and 8.*

**Procedure**

Repeat the following sequence for each range, starting with the 200mV range and working up to the 1kV range, as listed in Table 6-8. An input zero operation is performed on each 8508A range prior to performing the range verification measurements with the calibrator set to zero by range locking the calibrator in the range from which the output will be obtained.

1. On the 8508A, select the required range.
2. On the Calibrator, select the positive Range Gain point Output value.  
Note for the 20 V range, select 20 V to put the calibrator on it's 22 V range.  
Deselect AUTO to range lock the calibrator.
3. On the Calibrator, set zero output.  
Select OPR to operate the calibrator output.
4. On the 8508A, press the Input key, and select Zero Rng to initiate the zeroing operation.  
The busy legend will appear, and then extinguish when the operation is complete.
5. On the Calibrator, select the positive Range Gain point Output value.
6. Record the 8508A reading. Compare the result with the allowable tolerance, taking into account any known error from nominal of the calibrator for this output.
7. On the Calibrator set an output of -1 digit.
8. On the 8508A, press the Input key, and select Zero Rng to initiate the zeroing operation.  
The busy legend will appear, and then extinguish when the operation is complete.
9. On the Calibrator, select the negative Range Gain point Output value, allowing for the -1 digit offset.
10. Note the 8508A reading. Compare the result with the allowable tolerance, taking into account any known error from nominal of the calibrator for this output.
11. On the Calibrator, deselect LOCKED to allow the Calibrator to Auto range.  
Set zero output and select STBY to put the Calibrator output into Standby.
12. On the 8508A, select DCV to revert to the range menu.

**Table 6-8. DC Voltage Verification Points and Sequence**

8508A Range	Voltage	Tolerance <sup>1</sup>
200 mV	0 mV	Perform input zero operation to calibrator range locked zero output
	+100 mV	$\pm 0.00072$ mV
	-0.00001 mV	Perform input zero operation to calibrator range locked -1d output
	-100 mV	$\pm 0.00072$ mV
2 V	0 V	Perform input zero operation to calibrator range locked zero output
	+1 V	$\pm 0.0000045$ V
	-0.0000001 V	Perform input zero operation to calibrator range locked -1d output
	-1 V	$\pm 0.0000045$ V
20 V	0 V	Perform input zero operation to calibrator range locked zero output
	+1 V	$\pm 0.000009$ V
	+10 V	$\pm 0.000045$ V
	+19 V	$\pm 0.000081$ V
	-0.000001 V	Perform input zero operation to calibrator range locked -1d output
	-1 V	$\pm 0.000009$ V
	-10 V	$\pm 0.000045$ V
	-19 V	$\pm 0.000081$ V
200 V	0 V	Perform input zero operation to calibrator range locked zero output
	+100 V	$\pm 0.00065$ V
	-0.00001 V	Perform input zero operation to calibrator range locked -1d output
	-100 V	$\pm 0.00065$ V
1000 V	0 V	Perform input zero operation to calibrator zero output
	+1000 V	$\pm 0.0066$ V
	-1000 V	$\pm 0.0066$ V
1. Based on 365 day Tcal $\pm 1^{\circ}\text{C}$ 99 %CL Absolute specifications. See comments in Applicable Verification Tolerance section above regarding the impact of calibration uncertainties and use of other specifications.		

## AC Voltage Checks

### **⚠⚠ Warning**

The Calibrator can deliver a lethal electric shock.

To avoid electric shock when performing the following adjustment procedures:

- Never touch any lead or terminal unless you are absolutely certain that no dangerous voltage is present.
- Make sure that signal leads are in a safe condition before you handle them in any way.

### Equipment Configuration

1. On the 8508A press the ACV key, and select 1kV range. Ensure Tfer On is selected. Ensure that the 8508A is configured for internal guard (External Guard is deselected) by checking that the ExGd legend does not appear on the left hand display.
2. Ensure that the Calibrator output is set to STANDBY and configured for Internal Guard (EX GRD is deselected)
3. Connect the equipment as described for Routine Adjustment.

### Procedure

Repeat the following sequence for each range, starting with the 200mV range and working up to the 1kV range, as listed in Table 6-9.

1. Select the required 8508A range.
2. On the 8508A press CONFIG and select the appropriate filter for the point being verified as listed in Table 6-9.

#### *Note*

*DC-coupled should be selected for signal frequencies less than 40 Hz.*

3. On the calibrator set the output to the voltage and frequency for the point being verified as listed in Table 6-9. Set the output to OPERATE.
4. Note the 8508A reading. Compare the result with the allowable tolerance, taking into account any known error from nominal of the calibrator for this output.
5. Repeat steps 2 – 4 for each point to be verified on the 8508A range to be verified.
6. Set the calibrator output to STANDBY.

**Table 6-9. AC Voltage Verification Points and Sequence**

<b>8508A Range</b>	<b>Voltage</b>	<b>Frequency</b>	<b>8508A Filter</b>	<b>Tolerance <sup>1</sup></b>
200 mV	100 mV	20 Hz	10 Hz	± 0.0195 mV
	100 mV	55 Hz	40 Hz	± 0.0175 mV
	100 mV	1 kHz	40 Hz	± 0.0149 mV
	100 mV	3 kHz	40 Hz	± 0.0175 mV
	100 mV	10 kHz	40 Hz	± 0.0175 mV
	100 mV	30 kHz	40 Hz	± 0.0445 mV
	100 mV	60 kHz	40 Hz	± 0.0995 mV
	100 mV	100 kHz	40 Hz	± 0.0995 mV
2 V	1 V	20 Hz	10 Hz	± 0.000144 V
	1 V	55 Hz	40 Hz	± 0.000119 V
	1 V	1 kHz	40 Hz	± 0.000099 V
	1 V	3 kHz	40 Hz	± 0.000119 V
	1 V	10 kHz	40 Hz	± 0.000119 V
	1 V	30 kHz	40 Hz	± 0.000295 V
	1 V	60 kHz	40 Hz	± 0.000795 V
	1 V	100 kHz	40 Hz	± 0.000795 V
	1 V	500 kHz	40 Hz	± 0.034000 V
	1 V	1 MHz	40 Hz	± 0.034000 V
20V	1 V	1 kHz	40 Hz	± 0.00032 V
	10 V	20 Hz	10 Hz	± 0.00144 V
	10 V	55 Hz	40 Hz	± 0.00119 V
	10 V	1 kHz	40 Hz	± 0.00099 V
	10 V	3 kHz	40 Hz	± 0.00119 V
	10 V	10kHz	40 Hz	± 0.00119 V
	10 V	30 kHz	40 Hz	± 0.00295 V
	10 V	60 kHz	40 Hz	± 0.00795 V
	10 V	100 kHz	40 Hz	± 0.00795 V
	10 V	500 kHz	40 Hz	± 0.34000 V
	10 V	1 MHz	40 Hz	± 0.34000 V
	19 V	1 kHz	40 Hz	± 0.00167 V

Table 6-9. AC Voltage Verification Points and Sequence (cont)

8508A Range	Voltage	Frequency	8508A Filter	Tolerance <sup>1</sup>
200V	100 V	20 Hz	10 Hz	± 0.0144 V
	100 V	55 Hz	40 Hz	± 0.0119 V
	100 V	1 kHz	40 Hz	± 0.0099 V
	100 V	3 kHz	40 Hz	± 0.0119 V
	100 V	10 kHz	40 Hz	± 0.0119 V
	100 V	30 kHz	40 Hz	± 0.0295 V
	100 V	60 kHz	40 Hz	± 0.0795 V
	100 V	100 kHz	40 Hz	± 0.0795 V
1000 V	500 V	55 Hz	40 Hz	± 0.088 V
	500 V	1 kHz	40 Hz	± 0.088 V
	500 V	3 kHz	40 Hz	± 0.088 V
	500 V	10 kHz	40 Hz	± 0.088 V
	500 V	30 kHz	40 Hz	± 0.223 V
	1000 V	1 kHz	40 Hz	± 0.331 V
	1000 V	30 kHz	40 Hz	± 1.476 V

1. Based on 365 day Tcal ±1°C 99 %CL Absolute specifications. See comments in Applicable Verification Tolerance section above regarding the impact of calibration uncertainties and use of other specifications.

### Resistance Checks

When verifying the resistance function, each of the resistance modes (Normal $\Omega$ , Tru $\Omega$ , LoI $\Omega$  and HiV $\Omega$ ) must be individually checked. The following procedure assumes use of a multifunction calibrator and verifies each resistance mode in turn, range by range. If individual standard resistors are used it may be more convenient to check all the modes in turn for each resistance value to avoid connecting the same resistance standard several times during the sequence. A 1 G $\Omega$  standard resistor is used for ranges above 200 M $\Omega$  as the highest resistance available from the 5720A calibrator is 100 M $\Omega$ .

In order to minimize connection changes it is recommended that all measurements using the 1 G $\Omega$  Standard resistor are performed together after all other resistance points.

### Equipment Configuration

1. On the 8508A, select CLEAR, Pwr Up Dflt to select DCV 1 kV range.
2. Ensure that the calibrator output is set to STANDBY and configured for Internal Guard (EX GRD is deselected).
3. Connect the calibrator to the 8508A as described for Routine Adjustment.

#### Note

*After making the connections allow at least 30 minutes for thermal emfs in the leads to stabilise.*

4. On the calibrator select zero  $\Omega$  and OPR to operate the output. Select EX SNS.
5. Confirm the 8508A is configured for internal guard (External Guard is deselected) by checking that the ExGd legend does not appear on the left hand display.

### Procedure

Perform the following sequence for each resistance mode and each range, as listed in Table 6-10, starting with the 2  $\Omega$  range and working up to the 2 G $\Omega$  range for the Normal $\Omega$  and Normal $\Omega$  LoI resistance modes. Then continue the sequence for the Tru $\Omega$  and Tru $\Omega$  LoI modes, starting with the 2  $\Omega$  range and working up to the 20 k $\Omega$  range. Finally complete the sequence for the HiV $\Omega$  mode, starting with the 20 M $\Omega$  range and working up to the 20 G $\Omega$  range. An input zero operation is performed on each 8508A range with the calibrator set to zero  $\Omega$  prior to performing the range verification measurements. A separate zero operation is required on each range for each resistance mode.

Note that EX SNS (4-wire) is not available on the 5720A 100 M $\Omega$  range, and the 8508-7000K 1 G $\Omega$  standard resistor is used as a 2-wire device with the calibrator 2-wire resistance zero used for the corresponding zero point. Ensure 4W $\Omega$  is deselected on the 8508A when checking the 200 M $\Omega$  and 2 G $\Omega$  range, range zero, and range gain points.

#### Warning

**The Multimeter can deliver a lethal electric shock when operating in the High Voltage Resistance mode. Voltages up to 240V may appear on the terminals.**

**To avoid electric shock when performing the following adjustment procedures:**

- **Never touch any lead or terminal unless you are absolutely certain that no dangerous voltage is present.**
- **Make sure that signal leads are in a safe condition before you handle them in any way.**

### **Normal $\Omega$ Checks**

1. Press the  $\Omega$  key.
2. Press the CONFIG key and select 4W $\Omega$ . Ensure LoI is deselected.
3. Select the required 8508A range.
4. On the Calibrator, select zero  $\Omega$  and Operate. Alternatively if using a standard resistor connect the standard resistor for a 4-wire resistance zero. (For the 200 M $\Omega$  range and above, de-select Ex SNS on the calibrator and de-select 4W $\Omega$  on the 8508A.)
5. On the 8508A press the INPUT key, and select Zero Rng to initiate the zeroing operation.  
  
The Busy legend will appear, and then extinguish when the zero operation has completed.
6. On the Calibrator, select Range Gain point Output value. Alternatively if using a standard resistor re-connect the standard resistor to measure its resistance.
7. Note the 8508A reading. Compare the result with the allowable tolerance, taking into account the actual value of the calibrator resistance output for this value or the calibrated value of the resistance standard used.
8. Repeat steps 3 – 7 for the remaining ranges of the selected resistance mode. (For the 2G  $\Omega$  and 20 G $\Omega$  ranges the 8508-7000K 1 G $\Omega$  standard resistor is used in place of the calibrator. For the 200 M $\Omega$  range and above, de-select Ex SNS on the calibrator and de-select 4W $\Omega$  on the 8508A).

### **Normal LoI $\Omega$ checks**

Follow the procedure for Normal  $\Omega$  checks ensuring that LoI is selected.  
Press the  $\Omega$  key. Press the CONFIG key and select LoI.

### **Tru $\Omega$ checks**

Follow the procedure for Normal  $\Omega$  checks except select the  $\Omega$  Plus key followed by Tru  $\Omega$  instead of selecting the  $\Omega$  key (2  $\Omega$  to 20 k $\Omega$  ranges only).

### **Tru $\Omega$ LoI checks**

Follow the procedure for Normal  $\Omega$  checks except select the  $\Omega$  Plus key followed by Tru $\Omega$  instead of selecting the  $\Omega$  key. Press the CONFIG key and select LoI (2  $\Omega$  to 20 k $\Omega$  ranges only).

### **HiV $\Omega$ checks**

Follow the procedure for Normal  $\Omega$  checks except select the  $\Omega$  Plus key followed by HiV  $\Omega$  instead of selecting the  $\Omega$  key.



**Table 6-10. Resistance Verification Points and Sequence**

8508A Range	Resistance	Tolerance <sup>1</sup>	
		Normal $\Omega$ and Tru $\Omega^2$	Normal $\Omega$ LoI and Tru $\Omega$ LoI <sup>2</sup>
2 $\Omega$	0 $\Omega$	Perform input zero operation to calibrator zero output	
	1 $\Omega$	$\pm 0.0000240 \Omega$	$\pm 0.0000240 \Omega$
20 $\Omega$	0 $\Omega$	Perform input zero operation to calibrator zero output	
	10 $\Omega$	$\pm 0.000133 \Omega$	$\pm 0.000133 \Omega$
200 $\Omega$	0 $\Omega$	Perform input zero operation to calibrator zero output	
	100 $\Omega$	$\pm 0.00101 \Omega$	$\pm 0.00113 \Omega$
2 k $\Omega$	0 k $\Omega$	Perform input zero operation to calibrator zero output	
	1 k $\Omega$	$\pm 0.000101 \text{ k}\Omega$	$\pm 0.000113 \text{ k}\Omega$
20 k $\Omega$	0 k $\Omega$	Perform input zero operation to calibrator zero output	
	10 k $\Omega$	$\pm 0.000101 \text{ k}\Omega$	$\pm 0.000113 \text{ k}\Omega$
200 k $\Omega$	0 k $\Omega$	Perform input zero operation to calibrator zero output	
	100 k $\Omega$	$\pm 0.00101 \text{ k}\Omega$	$\pm 0.00107 \text{ k}\Omega$
2 M $\Omega$	0 M $\Omega$	Perform input zero operation to calibrator zero output	
	1 M $\Omega$	$\pm 0.0000117 \text{ M}\Omega$	$\pm 0.0000142 \text{ M}\Omega$
20 M $\Omega$	0 M $\Omega$	Perform input zero operation to calibrator zero output	
	10 M $\Omega$	$\pm 0.000320 \text{ M}\Omega$	$\pm 0.000570 \text{ M}\Omega$
200 M $\Omega$	0 M $\Omega$	Perform input zero operation to calibrator zero output	
	100 M $\Omega$	$\pm 0.01950 \text{ M}\Omega$	$\pm 0.18700 \text{ M}\Omega$
2 G $\Omega$	0 G $\Omega$	Perform input zero operation to calibrator zero output	
	1 G $\Omega$	$\pm 0.0018750 \text{ G}\Omega$	$\pm 0.0018750 \text{ G}\Omega$

**Table 6-10. Resistance Verification Points and Sequence (cont)**

8508A Range	Resistance	Tolerance <sup>1</sup>
		HiVΩ <sup>2</sup>
20 MΩ	0 GΩ	Perform input zero operation to calibrator zero output
	10 MΩ	± 0.000202 MΩ
200 MΩ	0 GΩ	Perform input zero operation to calibrator zero output
	100 MΩ	± 0.00870 MΩ
2 GΩ	0 GΩ	Perform input zero operation to calibrator zero output
	1 GΩ	± 0.0003150 GΩ
20 GΩ	0 GΩ	Perform input zero operation to calibrator zero output
	1 GΩ	± 0.012675 GΩ

1. Based on 365 day Tcal ±1°C 99 %CL Absolute specifications. See comments in Applicable Verification Tolerance section above regarding the impact of calibration uncertainties and use of other specifications.

2. Ranges require separate input zero operation in each resistance mode.

### DC Current Checks

#### Equipment Configuration

1. Ensure that the calibrator output is set to STANDBY and configured for Internal Guard (EX GRD is deselected).
2. Connect the equipment as described for Routine Adjustment.
3. Press the DCI key
4. Confirm that the 8508A is configured for internal guard (External Guard is deselected) by checking that the ExGd legend does not appear on the left-hand display.

#### Procedure

Repeat the following sequence for each range, starting with the 200μA range and working up to the 20A range, as listed in Table 6-11. An input zero operation is performed on each 8508A range prior to performing the range verification measurements with the calibrator set to zero by range locking the calibrator in the range from which the output will be obtained.

1. On the 8508A, select the required range.
2. On the Calibrator, select the positive Range Gain Point Output value. Deselect AUTO to range lock the calibrator.
3. On the Calibrator, set zero output. Select OPR to operate the calibrator output.
4. On the 8508A, press the Input key, and select Zero Rng to initiate the zeroing operation. The busy legend will appear, and then extinguish when the operation is complete.
5. On the Calibrator, select the positive Range Gain point Output value.
6. Note the 8508A reading. Compare the result with the allowable tolerance, taking into account any known error from nominal of the calibrator for this output.

7. On the Calibrator, select the negative Range Gain Point Output value.
8. Note the 8508A reading. Compare the result with the allowable tolerance, taking into account any known error from nominal of the calibrator for this output.
9. On the Calibrator, deselect LOCKED to allow the Calibrator to Auto range. Set zero output and select STBY to put the Calibrator output into Standby.
10. On the 8508A, select DCI to revert to the range menu.

**Table 6-11. DC Current Verification Points and Sequence**

8508A Range	Current	Tolerance <sup>1</sup>
200 $\mu$ A	0 $\mu$ A	Perform input zero operation to calibrator range locked zero output
	+100 $\mu$ A	$\pm$ 0.00190 $\mu$ A
	-100 $\mu$ A	$\pm$ 0.00190 $\mu$ A
2 mA	0 mA	Perform input zero operation to calibrator range locked zero output
	+1mA	$\pm$ 0.0000190 mA
	-1mA	$\pm$ 0.0000190 mA
20 mA	0 mA	Perform input zero operation to calibrator range locked zero output
	+10mA	$\pm$ 0.000200 mA
	-10mA	$\pm$ 0.000200 mA
200 mA	0 mA	Perform input zero operation to calibrator range locked zero output
	+100mA	$\pm$ 0.00530 mA
	-100mA	$\pm$ 0.00530 mA
2 A	0 A	Perform input zero operation to calibrator range locked zero output
	+1A	$\pm$ 0.0002260 A
	-1A	$\pm$ 0.0002260 A
20 A	0 A	Perform input zero operation to calibrator range locked zero output
	+10A	$\pm$ 0.004950 A
	-10A	$\pm$ 0.004950 A
1. Based on 365 day Tcal $\pm$ 1°C 99 %CL Absolute specifications. See comments in Applicable Verification Tolerance section above regarding the impact of calibration uncertainties and use of other specifications.		

## **AC Current Checks**

### **Equipment Configuration**

1. Ensure that the calibrator output is set to STANDBY and configured for Internal Guard (EX GRD is deselected).
2. Connect the equipment as described for Routine Adjustment.
3. Press the ACI key
4. Confirm that the 8508A is configured for internal guard (External Guard is deselected) by checking that the ExGd legend does not appear on the left-hand display.

### **Procedure**

Repeat the following sequence for each range, starting with the 200 $\mu$ A range and working up to the 20A range, as listed in Table 6-12.

1. Select the required 8508A range.
2. On the calibrator set the output to the current and frequency for the point being verified as listed in Table 6-12. Set the output to OPERATE.
3. Note the 8508A reading. Compare the result with the allowable tolerance, taking into account any known error from nominal of the calibrator for this output.
4. Repeat steps 2 – 4 for each point to be verified on the 8508A range to be verified.
5. Set the calibrator output to STANDBY.

**Table 6-12. AC Current Verification Points and Sequence**

<b>8508A Range</b>	<b>Current</b>	<b>Frequency</b>	<b>Tolerance <sup>1</sup></b>
200 $\mu$ A	100 $\mu$ A	305 Hz	$\pm 0.0830 \mu$ A
	100 $\mu$ A	1 kHz	$\pm 0.0830 \mu$ A
	100 $\mu$ A	3 kHz	$\pm 0.0830 \mu$ A
	100 $\mu$ A	5 kHz	$\pm 0.0830 \mu$ A
	100 $\mu$ A	10 kHz	$\pm 0.0830 \mu$ A
2 mA	1 mA	305 Hz	$\pm 0.000580$ mA
	1 mA	1 kHz	$\pm 0.000580$ mA
	1 mA	3 kHz	$\pm 0.000580$ mA
	1 mA	5 kHz	$\pm 0.000580$ mA
	1 mA	10 kHz	$\pm 0.000580$ mA
20 mA	10 mA	305 Hz	$\pm 0.00580$ mA
	10 mA	1 kHz	$\pm 0.00580$ mA
	10 mA	3 kHz	$\pm 0.00580$ mA
	10 mA	5 kHz	$\pm 0.00580$ mA
	10 mA	10 kHz	$\pm 0.00580$ mA
200 mA	100 mA	305 Hz	$\pm 0.0545$ mA
	100 mA	1 kHz	$\pm 0.0545$ mA
	100 mA	3 kHz	$\pm 0.0545$ mA
	100 mA	5 kHz	$\pm 0.0545$ mA
	100 mA	10 kHz	$\pm 0.0545$ mA
2 A	1 A	305 Hz	$\pm 0.000945$ A
	1 A	1 kHz	$\pm 0.000945$ A
	1 A	3 kHz	$\pm 0.001055$ A
	1 A	5 kHz	$\pm 0.001055$ A
	1 A	10 kHz	$\pm 0.001055$ A
20 A	10 A	305 Hz	$\pm 0.01140$ A
	10 A	1 kHz	$\pm 0.01140$ A
	10 A	3 kHz	$\pm 0.02740$ A
	10 A	5 kHz	$\pm 0.02740$ A
	10 A	10 kHz	$\pm 0.02740$ A

1. Based on 365 day Tcal  $\pm 1^\circ$ C 99 %CL Absolute specifications. See comments in Applicable Verification Tolerance section above regarding the impact of calibration uncertainties and use of other specifications.

## **Frequency Checks**

### **Equipment Configuration**

1. Ensure that the calibrator output is set to STANDBY and configured for Internal Guard (EX GRD is deselected).
2. Connect the equipment as described for Routine Adjustment.
3. Press the ACV key, select the 2V range
4. Confirm that the 8508A is configured for internal guard (External Guard is deselected) by checking that the ExGd legend does not appear on the left-hand display.

### **Procedure**

1. On the 8508A press MONITOR and then CONFIG. Deselect **FREQ GATE Fast**.
2. Press the MONITOR key and select **FREQ**.
3. On the calibrator set the output voltage to 1V and frequency to 1MHz. Set the output to **OPERATE**.
4. Note the 8508A frequency reading. Check the result is within  $\pm 0.000012\text{MHz}$ , taking into account any known error from nominal of the calibrator output frequency for this point.
5. Set the calibrator output to **STANDBY**.

# Appendix A

## Error Codes and Message

### Introduction

#### Note

*For the sake of completeness, this appendix collects together the error codes which might be generated either on the instrument front panel, or via the IEEE 488 system bus.*

### Error Detection

Errors are classified by the method with which they are handled:

- Recoverable errors are reported to the user and the Multimeter continues operation.
- Fatal errors are reported to the user but the Multimeter cannot recover and halts operation. Restarting the Multimeter from power on may clear the error, but generally such messages are caused by hardware or software faults, which require repair by a service center.

### Error Messages

#### Fatal Errors

For all fatal errors, the error condition is reported only via the front panel.

The processor stops after displaying the message. A user must respond by retrying operation from power on, and initiate repair if the fault persists. The following is a list of error numbers displayed, with their associated fault descriptions:

9000-	System Kernel Fault
9001-	Run Time System Error
9002-	Unexpected Exception
9003-	PROM Sumcheck Failure
9004-	RAM Check Failure
9005-	Serial Interface Fault
9006-	Option Test Failure
9007-	Unknown Engine Instruction
9099-	Undefined Fatal Error

### Recoverable Errors

Recoverable errors consist of:

- Command Errors
- Execution Errors
- Device-Dependent Errors

Command Errors can only be generated due to incorrect remote programming.

Some Execution Errors and all Device-Dependent Errors can all be generated by manual operation as well.

Each of the reportable Execution and Device-Dependent Errors are identified by a code number.

### Command Errors (CME)

Command Errors are generated when the remote command does not conform to the device command syntax or to the IEEE 488.2 generic syntax. The CME bit (5) is set true in the Standard-defined Event Status Byte, but there is no associated queue.

The error is reported by the mechanisms described in the sub-section of Chapter 4 that deals with status reporting.

Errors generated due to incorrect front panel manipulation are not reported to the bus; and vice versa.

### Execution Errors (EXE)

An Execution Error is generated if a received command cannot be executed because it is incompatible with the current device state, or because it attempts to command parameters which are out-of-limits.

In remote operation, the EXE bit (4) is set true in the Standard-defined Event Status Byte, and the error code number is appended to the Execution Error queue.

The error is reported by the mechanisms described in the sub-section of Chapter 4 that deals with status reporting, and the queue entries can be read destructively as LIFO by the Common query command EXQ?.

There is no queue when execution errors are generated during manual operation, the description of the error being presented directly on the Menu display.

The Execution Error numbers are given below, with their associated descriptions.

1000-	EXE queue empty when recalled	1021-	Test not allowed when Cal enabled
1001-	Option not installed	1024-	Illegal Range/Input Combination
1002-	Calibration disabled	1025-	Auto not available in TruΩ ratio
1005-	Input Zero not allowed in Scan	1026-	Probe identity unrecognized
1007-	Data entry error	1027-	Input Zero not allowed in PRT
1008-	Must be in AC Function	1028-	Only allowed in Voltage function
1010-	Divide-by-zero not allowed	1029-	Scan modes not allowed in PRT
1012-	No more errors in list	1030-	Scan modes not allowed in ACI/DCI
1013-	Data out of limit	1031-	4wV not available via rear input
1014-	Illegal Range/Function combination	1032-	Input Zero not allowed in Cal
1015-	Command allowed only in Remote	1033-	Calibration not allowed in PRT
1016-	Not in Special Calibration	1034-	PRT Coef Limit @ a+, b+, c+, a-, b-,
1035-	Cannot edit the default PRT	1036-	Block or Rolling average required



### Device-Dependent Errors (DDE)

A Device-Dependent Error is generated if the device detects an internal operating fault (e.g., during self-test). The DDE bit (3) is set *true* in the Standard-defined Event Status Byte, and the error code number is appended to the Device-Dependent Error queue.

In remote mode operations, the error is reported by the mechanisms described in the subsection of Chapter 4 that deals with status reporting, and the queue entries can be read destructively as LIFO by the Common query command DDQ?.

In local mode operations, the DDE status is checked at the end of the operation (e.g., Cal, Zero, Test). If *true*, an error has occurred, and the content of the last entry in the queue is displayed on the front panel.

If both bus and front panel users attempt to read the queue concurrently, the error data is read out destructively on a first-come, first-served basis. Thus one of the users cannot read the data on one interface as it has already been destroyed by reading on the other. This difficulty should be solved by suitable application programming to avoid the possibility of a double readout. Ideally the IEEE 488 interface should set the instrument into REMS or RWLS to prevent confusion. The bus can ignore the queue, but the front panel user will have to read it to continue.

### Device-Dependent Error Lists

Device-dependent errors are associated mainly with test and calibration operations. The error numbers in the following pages are therefore listed in these categories. There is some overlap.

#### External Calibration Operations

##### Correction Errors

2000- Error During Zero Cal  
 2001- Error During Gain+ Cal  
 2002- Error During Gain- Cal  
 2003- Error During HF trim Cal  
 2004- Error During Input Zero  
 2005- Error During Lol Zero Cal  
 2006- Error During Lol Gain Cal  
 2008- Error During A to D Cal  
 2010- Error During Frequency Cal  
 2012- Error During DCcp Cal  
 2025- Error During HiV Lin Read  
 2026- Error During HiV Lin Calc

##### Corruptions

2014- Serial Number Corrupt  
 2015- Cal Due Date Corrupt  
 2017- Bus Address Corrupt  
 2018- Line Frequency Corrupt  
 2020- Invalid Corrections (ram)  
 2021- Calibration Corrupt  
 2022- NV RAM Write Failure

##### Micellaneous

2109- Bad Data from Analog Sys  
 2022- NV Ram write failure  
 2023- Engine – Load factor err  
 2024- Engine – Store factor err

## Self-Test Errors

These self-test error numbers will appear only if the test has not been successful, and should be reported for interpretation to your local Fluke service center, so that the fault can be analyzed.

A short description of the test step is also given.

<b>Reference Tests</b>	
2101	Main Ref Check.
2111	6.2V Ref Check.
<b>DC Volts Tests</b>	
2201	100mV Range Zero Check.
2211	1V Range Zero Check.
2221	10V Range Zero Check
2231	100V Range Zero Check.
2241	100mV Range Positive Gain Check.
2251	100mV Range Negative Gain Check.
2261	1V Range Positive Gain Check.
2271	1V Range Negative Gain Check.
2281	10V Range Positive Gain Check.
2291	10V Range Negative Gain Check.
2301	100V Range Positive Gain Check.
2311	100V Range Negative Gain Check.
<b>DC Current Tests</b>	
2401	100 $\mu$ A DC Range: Zero Input Check.
2411	100 $\mu$ A DC Range: 100 $\mu$ A Input Gain Check.
2421	1mA DC Range: Zero Input Check.
2431	1mA DC Range: 1mA Input Gain Check.
2441	10mA DC Range: Zero Input Check.
2451	100 $\mu$ A DC Range: 10mA Input Gain Check.
2461	100mA DC Range: Zero Input Check.
2471	100 $\mu$ A DC Range: 100mA Input Gain Check.
2481	1A DC Range: Zero Input Check.
2491	1A DC Range: 100mA Input Gain Check.
<b>Current Tests (AC additional)</b>	
2501	1mA AC Range: Zero Input Check.
2511	1mA AC Range: 1mA Input Gain Check.
<b>Resistance Tests</b>	
2601	Follower Offset Check.
2611	Follower 100mA Output Check.
2621	Follower 10mA Output Check.
2631	Follower 1mA Output Check.
2641	3.6V Clamp Check.
2651	6.7V Clamp Check.
2661	27V Clamp Check.
2671	Current Sink Clamp Check.
2681	10 $\mu$ A Current Sink and Follower 10V Output Check.
2691	1 $\mu$ A Current Sink Check.
2701	100nA Current Sink Check.
2711	10nA Current Sink Check.
2721	HV Ohms Follower Offset Check.
2731	HV Ohms Follower Output Voltage Check.
2741	240V Clamp Check.

<b>AC Volts Tests</b>	
2801	100mV AC Range: Zero Input Check.
2811	100mV AC Range: +179mV DC Input Checks at Pre-Amp Output
2821	100mV AC Range: -179mV DC Input Checks at Pre-Amp Output
2831	1V AC Range: Zero Input Check.
2841	1V AC Range: +993mV DC Input Checks at Pre-Amp Output
2851	1V AC Range: -993mV DC Input Checks at Pre-Amp Output
2861	1V AC Range: +993mV DC Input Checks at RMS Converter Output
2871	1V AC Range: -993mV DC Input Checks at RMS Converter Output
2881	10V AC Range: Zero Input Check.
2891	10V AC Range: +9.78V DC Input Checks at Pre-Amp Output
2901	10V AC Range: -9.78V DC Input Checks at Pre-Amp Output
2911	100V AC Range: Zero Input Check.
2921	100V AC Range: +9.78V DC Input Checks at Pre-Amp Output
2931	100V AC Range: -9.78V DC Input Checks at Pre-Amp Output
2941	1000V AC Range: Zero Input Check.
2951	1000V AC Range: +9.78V DC Input Checks at Pre-Amp Output
2961	1000V AC Range: -9.78V DC Input Checks at Pre-Amp Output



# **Appendix B**

## **Rack Mount Kit**

### **Introduction**

A Rack Mount Kit for mounting the Multimeter in a standard 19-inch equipment rack is available as an Option.

For instructions on how to install the kit and mount the Multimeter in the equipment rack refer to Figure B-1 and the following procedure. The numbers in the drawing relate directly to the numbers in the procedure.

#### *Note*

*Do not remove the top or bottom cover to rack mount the Multimeter.*

1. Remove each of the two rear corner blocks by first removing their three hex screws.
2. With the corner blocks removed, re-install the top and bottom screws from each corner block. These screws secure the Multimeter's top and bottom covers.
3. Slide out and remove the side-cover-strips from the Multimeter.
4. Attach each front rack-mount ear as follows:
  - a. With the front rack-mount ear parallel to the front panel and extending away from the Multimeter, slide its extension into the Multimeter's side cover-strip opening.
  - b. Secure the rack-mount extension (side cover-strip opening) to the Multimeter using the three hex screws provided with the kit..
5. Remove the four feet and the two tilt-stands as follows:
  - a. Use a flat blade screwdriver to press the tab in the recess of the foot moulding, this allows the part to be removed.
  - b. Store safely for possible future use.

6. Fit the instrument to the rack as follows:
  - a. Attach the two rear rack-mount ears to the back of the equipment rack so they are ready to receive the instrument.
  - b. With assistance, slide the instrument into the rack, positioning the extension of the rear rack-mount ears in each side-cover strip opening. Push the instrument home, and secure the front rack-mount ears to the front of the equipment rack.

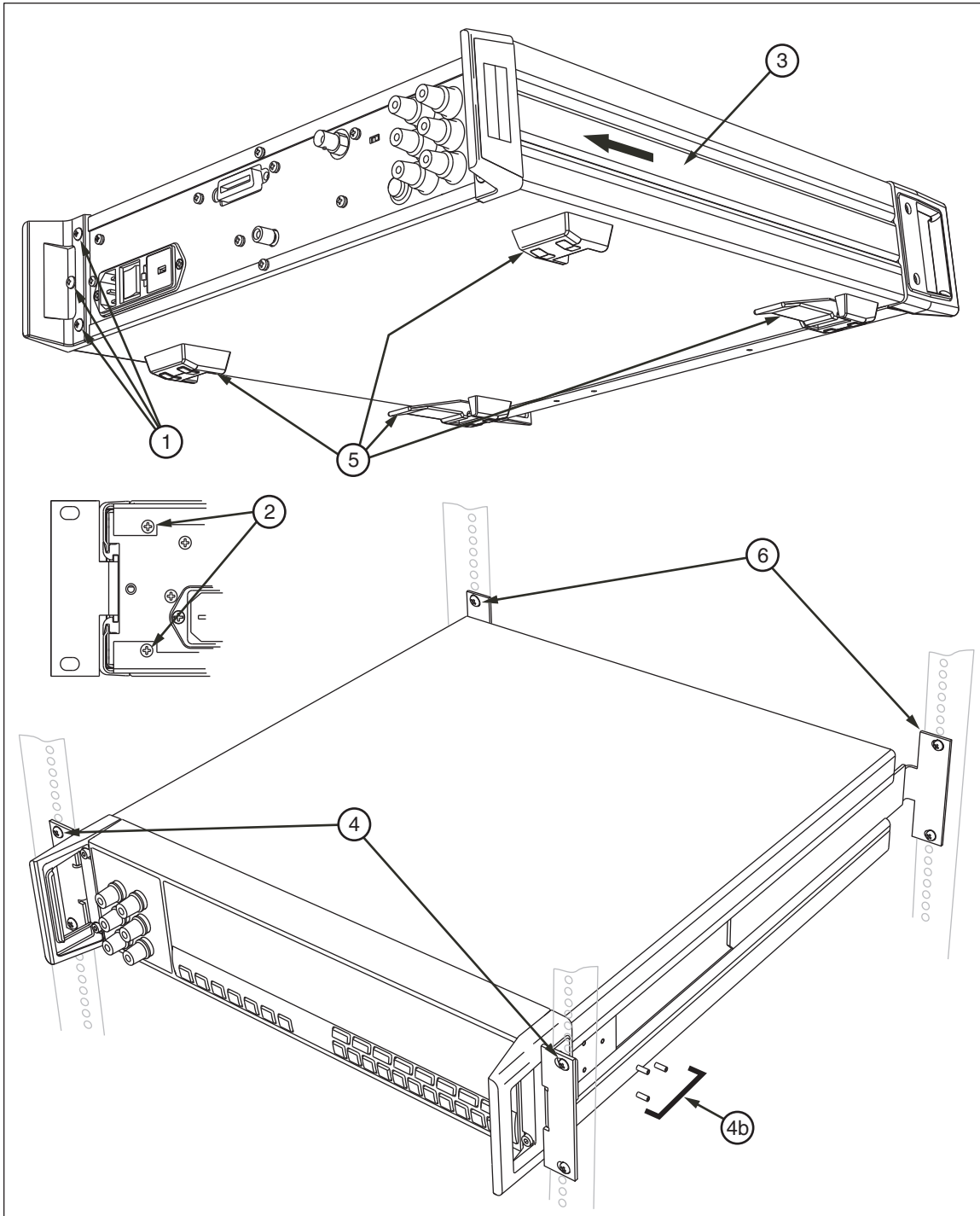

Figure B-1. Installing the 8508A Rack Mount Kit

adj359f.eps

# Appendix C

## Rack Mount Slide Kit

### Introduction

A Rack Mount Slide Kit for mounting the Multimeter in a standard 19-inch equipment rack is available as an Option.

For instructions on how to install the kit and mount the Multimeter in the equipment rack refer to Figure C-1 and the following procedure. The numbers in the drawing relate directly to the numbers in the procedure.

#### *Note*

*Do not remove the top or bottom cover to rack mount the Multimeter.*

1. Remove each of the two rear corner blocks by first removing their three hex screws.
2. With the corner blocks removed, re-install the top and bottom screws from each corner block. These screws secure the Multimeter's top and bottom covers.
3. Slide out and remove the side-cover-strips from the Multimeter.
4. Attach each front rack-mount ear as follows:
  - a. With the front rack-mount ear parallel to the front panel and extending away from the Multimeter, slide its extension into the Multimeter's side cover-strip opening.
  - b. Secure the rack-mount extension (side cover-strip opening) to the Multimeter using the four hex screws provided with the kit.
  - c. Attach a slide bar to both sides of the Multimeter. Secure each using two screws.
5. Remove the four feet and the two tilt-stands as follows:
  - a. Use a flat blade screwdriver to press the tab in the recess of the foot moulding, this allows the part to be removed.
  - b. Store safely for possible future use.

6. Fit the instrument to the rack as follows:
  - a. Attach a pair of rack-mount ears and a slide-rail to each side of the equipment rack so they are ready to receive the instrument.
  - b. With assistance, and from the front of the equipment rack, insert the end of each slide bar (on the Multimeter) into the appropriate slide-bar on the equipment rack. Push the instrument home, and secure the front rack-mount ears to the front of the equipment rack.

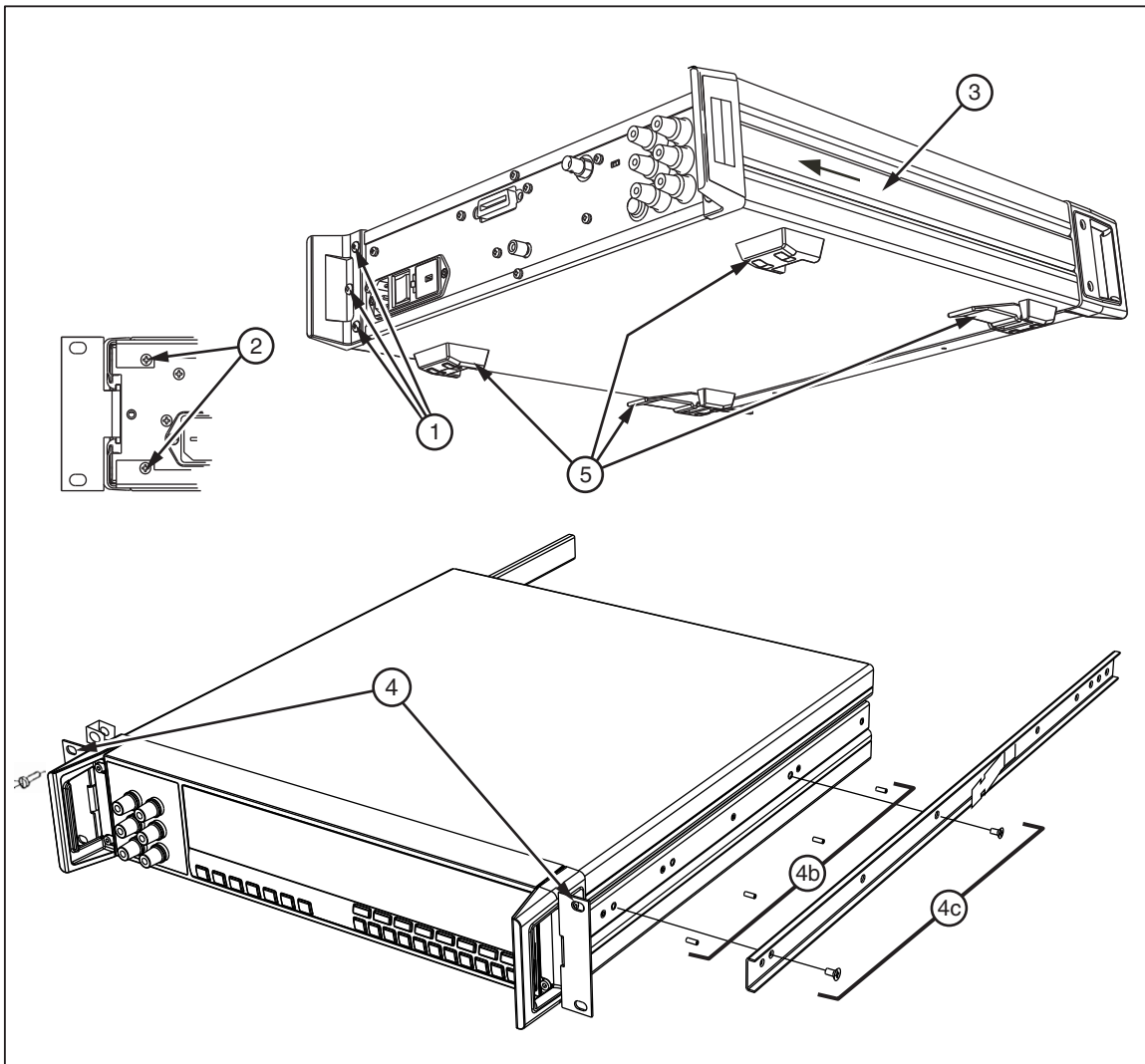

Figure C-1. Installing the 8508A Rack Mount Slide Kit

adj362f.eps