

8845A/8846A

Digital Multimeter

Calibration Manual

January 2007, Rev. 1, 11/07

© 2007 Fluke Corporation, All rights reserved. Specifications subject to change without notice.
All product names are trademarks of their respective companies.

LIMITED WARRANTY AND LIMITATION OF LIABILITY

Each Fluke product is warranted to be free from defects in material and workmanship under normal use and service. The warranty period is one year and begins on the date of shipment. Parts, product repairs, and services are warranted for 90 days. This warranty extends only to the original buyer or end-user customer of a Fluke authorized reseller, and does not apply to fuses, disposable batteries, or to any product which, in Fluke's opinion, has been misused, altered, neglected, contaminated, or damaged by accident or abnormal conditions of operation or handling. Fluke warrants that software will operate substantially in accordance with its functional specifications for 90 days and that it has been properly recorded on non-defective media. Fluke does not warrant that software will be error free or operate without interruption.

Fluke authorized resellers shall extend this warranty on new and unused products to end-user customers only but have no authority to extend a greater or different warranty on behalf of Fluke. Warranty support is available only if product is purchased through a Fluke authorized sales outlet or Buyer has paid the applicable international price. Fluke reserves the right to invoice Buyer for importation costs of repair/replacement parts when product purchased in one country is submitted for repair in another country.

Fluke's warranty obligation is limited, at Fluke's option, to refund of the purchase price, free of charge repair, or replacement of a defective product which is returned to a Fluke authorized service center within the warranty period.

To obtain warranty service, contact your nearest Fluke authorized service center to obtain return authorization information, then send the product to that service center, with a description of the difficulty, postage and insurance prepaid (FOB Destination). Fluke assumes no risk for damage in transit. Following warranty repair, the product will be returned to Buyer, transportation prepaid (FOB Destination). If Fluke determines that failure was caused by neglect, misuse, contamination, alteration, accident, or abnormal condition of operation or handling, including overvoltage failures caused by use outside the product's specified rating, or normal wear and tear of mechanical components, Fluke will provide an estimate of repair costs and obtain authorization before commencing the work. Following repair, the product will be returned to the Buyer transportation prepaid and the Buyer will be billed for the repair and return transportation charges (FOB Shipping Point).

THIS WARRANTY IS BUYER'S SOLE AND EXCLUSIVE REMEDY AND IS IN LIEU OF ALL OTHER WARRANTIES, EXPRESS OR IMPLIED, INCLUDING BUT NOT LIMITED TO ANY IMPLIED WARRANTY OF MERCHANTABILITY OR FITNESS FOR A PARTICULAR PURPOSE. FLUKE SHALL NOT BE LIABLE FOR ANY SPECIAL, INDIRECT, INCIDENTAL, OR CONSEQUENTIAL DAMAGES OR LOSSES, INCLUDING LOSS OF DATA, ARISING FROM ANY CAUSE OR THEORY.

Since some countries or states do not allow limitation of the term of an implied warranty, or exclusion or limitation of incidental or consequential damages, the limitations and exclusions of this warranty may not apply to every buyer. If any provision of this Warranty is held invalid or unenforceable by a court or other decision-maker of competent jurisdiction, such holding will not affect the validity or enforceability of any other provision.

Fluke Corporation
P.O. Box 9090
Everett, WA 98206-9090
U.S.A.

Fluke Europe B.V.
P.O. Box 1186
5602 BD Eindhoven
The Netherlands

11/99

To register your product online, visit register.fluke.com

Table of Contents

Chapter	Title	Page
1	Introduction and Specifications.....	1-1
	Introduction.....	1-3
	Safety Information	1-3
	Symbols.....	1-4
	General Safety Summary.....	1-4
	Description of IEC 61010 Measurement Categories	1-6
	Organization of the Calibration Manual	1-7
	Chapter 1 – Introduction and Specifications	1-7
	Chapter 2 – General Maintenance	1-7
	Chapter 3 – Performance Test and Calibration.....	1-7
	Chapter 4 – List of Replaceable Parts	1-7
	Operating Instructions.....	1-7
	Accessories	1-7
	General Specifications	1-9
	Power.....	1-9
	Dimensions	1-9
	Display.....	1-9
	Environment	1-9
	Safety	1-9
	EMC	1-9
	Triggering.....	1-9
	Memory	1-10
	Math Functions.....	1-10
	Electrical.....	1-10
	Remote Interfaces	1-10
	Warranty	1-10
	Electrical Specifications	1-10
	DC Voltage Specifications	1-10
	Input Characteristics.....	1-11
	8846A Accuracy.....	1-11
	8845A Accuracy.....	1-11
	Additional Errors.....	1-11
	AC Voltage Specifications	1-11
	Input Characteristics.....	1-12
	8846A Accuracy.....	1-12

8845A Accuracy.....	1-13
Additional Low Frequency Errors.....	1-13
Resistance.....	1-14
Input Characteristics.....	1-14
8846A Accuracy.....	1-14
8845A Accuracy.....	1-15
Additional Ohms Errors.....	1-15
DC Current.....	1-15
Input Characteristics.....	1-15
Accuracy (8846A).....	1-16
Accuracy (8845A).....	1-16
Additional Current Errors.....	1-16
AC Current.....	1-17
Input Characteristics.....	1-17
8846A Accuracy.....	1-17
8845A Accuracy.....	1-18
Additional Low Frequency Errors.....	1-19
Frequency.....	1-19
8846A Accuracy.....	1-19
8845A Accuracy.....	1-20
Gate Time vs. Resolution.....	1-20
Additional Low Frequency Errors.....	1-20
Capacitance (8846A Only).....	1-20
Temperature (8846A only).....	1-21
Continuity.....	1-21
Diode Test.....	1-21
Measurement Rates (IEEE488[4]).....	1-22
Measurement Uncertainty.....	1-22
Interpreting Accuracy Specifications.....	1-23
24-Hour Accuracy.....	1-23
90-Day and 1-Year Accuracy.....	1-23
Temperature Coefficients.....	1-23
Configuring for Highest Accuracy Measurements.....	1-23
DC Voltage, DC Current, and Resistance Measurements.....	1-23
AC Voltage and AC Current Measurements:.....	1-23
Frequency and Period Measurements:.....	1-23

2 General Maintenance 2-1

Introduction.....	2-3
Warranty Repairs and Shipping Information.....	2-3
General Maintenance Information.....	2-3
Required Equipment.....	2-3
Power Requirements.....	2-3
Static Safe Handling.....	2-3
Cleaning.....	2-4
Fuse Replacement.....	2-4
Line-Power Fuse.....	2-4
Current-Input Fuses.....	2-5
If the Meter Does Not Turn On.....	2-7
Display Tests.....	2-7
Disassembly Procedures.....	2-7
General Disassembly.....	2-7
Main Chassis Disassembly.....	2-8
Front Panel Disassembly.....	2-8

	Assembly Procedures.....	2-8
3	Performance Test and Calibration	3-1
	Introduction.....	3-3
	Required Equipment	3-3
	Test Considerations.....	3-5
	Performance Tests.....	3-5
	Volts DC Verification.....	3-5
	Volts DC Ratio Verification	3-8
	Volts AC and Frequency Verification	3-9
	4-Wire Ohms Verification	3-14
	2-Wire Ohms Verification	3-16
	2X4 Test Lead Verification Steps	3-18
	Rear Panel Terminal Verification Steps	3-18
	Capacitance Verification Steps (8846A only)	3-21
	DC Current Verification Steps	3-22
	AC Current Verification Steps	3-25
	Adjustment (Calibration)	3-27
	Unlocking the Meter for Adjustments (Calibration)	3-28
	Unlocking the Meter for Adjustments Over a Remote Interface.....	3-28
	Changing the Calibration Password	3-28
	Resetting the Calibration Password.....	3-28
	Changing the Calibration Date Remotely.....	3-29
	Equipment for Calibration.....	3-29
	Adjustment Process	3-30
	Aborting a Calibration Process.....	3-36
	Sample Adjustment Program.....	3-36
4	List of Replaceable Parts.....	4-1
	Introduction.....	4-3
	How to Obtain Parts.....	4-3
	How to Contact Fluke	4-3
	Parts	4-4
 Appendices		
	A Verification Forms	A-1
	B Example Adjustment Program	B-1

List of Tables

Table	Title	Page
1-1.	Safety and Electrical Symbols.....	1-4
1-2.	Safety Information	1-5
1-3.	Accessories.....	1-7
2-1.	Line Voltage to Fuse Rating.....	2-5
3-1.	Required Test Equipment.....	3-3
3-2.	8846A DC Volts Verification Steps.....	3-6
3-3.	8845A DC Volts Verification Steps.....	3-7
3-4.	8846A DC Volts Ratio Verification Steps	3-9
3-5.	8845A DC Volts Ratio Verification Steps	3-9
3-6.	8846A AC Volts Verification Steps.....	3-11
3-7.	8845A AC Volts Verification Steps.....	3-12
3-8.	8845A/8846A AC Volts Frequency Verification Steps	3-13
3-9.	8846A 4-Wire Ohms Verification Steps	3-15
3-10.	8845A 4-Wire Ohms Verification Steps	3-15
3-11.	8846A 2-Wire Ohms Verification Steps	3-17
3-12.	8845A 2-Wire Ohms Verification Steps	3-17
3-13.	8846A Rear-Panel Terminal Verification Steps (Optional Test)	3-20
3-14.	8845A Rear-Panel Terminal Verification Steps (Optional Test)	3-20
3-15.	8846A Capacitance Verification Steps	3-21
3-16.	8846A DC Current Verification Steps	3-23
3-17.	8845A DC Current Verifications Steps.....	3-24
3-19.	8845A AC Current Verification Steps	3-27
3-20.	8845A/8846A Adjustment Steps.....	3-31
4-1.	Replaceable Parts	4-4
A-1.	Blank Verification Record for 90-Day Specifications	A-2
A-2.	Blank Verification Record for 1-Year Specifications	A-10

List of Figures

Figure	Title	Page
1-1.	IEC 61010 Measurement Category (CAT) Levels.....	1-6
2-1.	Line Fuse Replacement.....	2-5
2-2.	Current Input Fuse Replacement.....	2-6
3-1.	DC Volts Test Equipment Setup with 5520A.....	3-6
3-2.	DC Volts Ratio Test Equipment Setup with 5520A and 5720A.....	3-8
3-3.	AC Volts Test Equipment Setup with 5520A.....	3-10
3-4.	4-Wire Ohms Test Equipment Setup.....	3-14
3-5.	2-Wire Ohms Test Equipment Setup.....	3-16
3-6.	Rear-Panel Terminals Equipment Setup.....	3-19
3-7.	Capacitance Equipment Setup.....	3-21
3-8.	100 mA DC Current Equipment Setup.....	3-22
3-9.	AC Current Equipment Setup.....	3-25
3-10.	Calibration Jumper Location.....	3-29
4-1.	Final Assembly.....	4-7

Chapter 1

Introduction and Specifications

Title	Page
Introduction.....	1-3
Safety Information	1-3
Symbols	1-4
General Safety Summary.....	1-4
Description of IEC 61010 Measurement Categories	1-6
Organization of the Calibration Manual	1-7
Chapter 1 – Introduction and Specifications	1-7
Chapter 2 – General Maintenance	1-7
Chapter 3 – Performance Test and Calibration.....	1-7
Chapter 4 – List of Replaceable Parts	1-7
Operating Instructions.....	1-7
Accessories	1-7
General Specifications	1-9
Power	1-9
Dimensions	1-9
Display.....	1-9
Environment	1-9
Safety.....	1-9
EMC	1-9
Triggering.....	1-9
Memory	1-10
Math Functions.....	1-10
Electrical.....	1-10
Remote Interfaces	1-10
Warranty	1-10
Electrical Specifications	1-10
DC Voltage Specifications	1-10
AC Voltage Specifications	1-11
Resistance	1-14
DC Current	1-15
AC Current	1-17
Frequency	1-19
Capacitance (8846A Only).....	1-20
Temperature (8846A only).....	1-21
Continuity.....	1-21

Diode Test	1-21
Measurement Rates (IEEE488[4]).....	1-22
Measurement Uncertainty	1-22
Interpreting Accuracy Specifications.....	1-23
24-Hour Accuracy	1-23
90-Day and 1-Year Accuracy	1-23
Temperature Coefficients	1-23
Configuring for Highest Accuracy Measurements	1-23
DC Voltage, DC Current, and Resistance Measurements	1-23
AC Voltage and AC Current Measurements:	1-23
Frequency and Period Measurements:.....	1-23

Introduction

The 8845A and 8846A are 6-1/2 digit, dual-display multimeters designed for bench-top, field service, and system applications. Their full complement of measurement functions plus its RS-232, IEEE 488, and Ethernet Remote Interfaces makes these multimeters ideal candidates for precision manual measurements and use in automated systems. For portability, these multimeters include a carrying handle that also serves as a bail for bench top operation.

There are a few additional features in the 8846A that are not present in the 8845A. These features will be identified with the annotation of “8846A Only” by each feature that is found only in that model. Separate specification tables are also used to clarify the differences between these two models.

The following is a list of some of the features and functions:

- Bright, large-digit, wide-viewing-angle display
- Dual display for displaying two properties of an input signal (e.g., ac voltage in one display and frequency in the other).
- Remote operation via IEEE 488, RS-232, and Ethernet interface.
- Trigger in and measurement-complete out
- Front panel USB port for optional memory (8846A Only)
- 6-1/2 digit resolution
- Half-rack width
- True rms ac
- 2 and 4-wire resistance measurements
- Extended 10 Ω and 1 G Ω ranges (8846A Only)
- Frequency measurements to 300 kHz (8846A to 1 MHz)
- Capacitance measurements (8846A Only)
- Temperature measurement (8846A Only)
- 10 A current capability
- Decibels (dB and dBm) with variable reference impedance and audio power measurement capability
- Input terminals on both front and rear panels of the meter
- Closed-case calibration (no internal calibration adjustments)

This calibration manual focuses on performance verification and calibration of the Fluke 8845A and 8846A Digital Multimeters (hereafter referred to as the Meter).

Safety Information

This section addresses safety considerations and describes symbols that may appear on the Meter or in the manual.

A **Warning** statement identifies conditions or practices that could result in injury or death.

A **Caution** statement identifies conditions or practices that could result in damage to the Meter or equipment to which it is connected.

















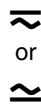

Warning

To avoid electric shock, personal injury, or death, carefully read the information under “Safety Information” before attempting to install, use, or service the Meter.

Symbols

Table 1-1 is a list of safety and electrical symbols that appear on the Meter or in this manual.

Table 1-1. Safety and Electrical Symbols

Symbol	Description	Symbol	Description
	Risk of danger. Important information. See manual		Display ON / OFF
	Hazardous voltage. Voltage > 30 V dc or ac peak might be present		Earth ground
	AC (Alternating Current)		Capacitance
	DC (Direct Current)		Diode
 or 	AC or DC (Alternating or Direct Current)		Fuse
			Digital signal
	Continuity test or continuity beeper tone		Maintenance or Service
	Potentially hazardous voltage	CAT II	IEC 61010 Overvoltage (installation or measurement) Category 2.
	Double insulated		Recycle
	Static awareness. Static discharge can damage part(s)		Do not dispose of this product as unsorted municipal waste. Go to Fluke's website for recycle information.

General Safety Summary

This instrument has been designed and tested in accordance with the European standard publication EN 61010-1:2001 and U.S. / Canadian standard publications UL 61010-1A1 and CAN/CSA-C22.2 No.61010.1. The Meter has been supplied in a safe condition.

This manual contains information and warnings that must be observed to keep the instrument in a safe condition and ensure safe operation.

To use the Meter correctly and safely, read and follow the precautions in Table 1-2, and follow all the safety instructions or warnings given throughout this manual that relate to specific measurement functions. In addition, follow all generally accepted safety practices and procedures required when working with and around electricity.

Table 1-2. Safety Information

⚠️⚠️ Warning

To avoid possible electric shock, personal injury, or death, read the following before using the Meter:

- Use the Meter only as specified in this manual, or the protection provided by the Meter might be impaired.
- Do not use the Meter in wet environments.
- Inspect the Meter before using it. Do not use the Meter if it appears damaged.
- Inspect the test leads before use. Do not use them if insulation is damaged or metal is exposed. Check the test leads for continuity. Replace damaged test leads before using the Meter.
- Verify the Meter's operation by measuring a known voltage before and after using it. Do not use the Meter if it operates abnormally. Protection may be impaired. If in doubt, have the Meter serviced.
- Whenever it is likely that safety protection has been impaired, make the Meter inoperative and secure it against any unintended operation.
- Servicing of the Meter should be performed by qualified service personnel.
- Do not apply more than the rated voltage, as marked on the Meter, between the terminals or between any terminal and earth ground.
- While in IEC Measurement Category II environments, do not apply voltages above 600 V ac to the input of the Meter. See “Description of IEC 61010 Measurement Categories” later in this chapter.
- Always use the power cord and connector appropriate for the voltage and outlet of the country or location in which you are working.
- Always use a power cord with a ground connection and ensure the ground is properly connected to the power distribution system.
- Remove test leads from the Meter before opening the case.
- Never remove the cover or open the case of the Meter without first removing it from the main power source.
- Use caution when working with voltages above 30 V ac rms, 42 V ac peak, or 42 V dc. These voltages pose a shock hazard.
- Use only the replacement fuse(s) specified by the manual.
- Use the proper terminals, function, and range for your measurements.
- Do not operate the Meter around explosive gas, vapor, or dust.
- When using probes, keep your fingers behind the finger guards.
- When making electrical connections, connect the common test lead before connecting the live test lead; when disconnecting, disconnect the live test lead before disconnecting the common test lead.
- Disconnect circuit power and discharge all high-voltage capacitors before testing resistance, continuity, diodes, or capacitance.
- Before measuring current, check the Meter's fuses and turn OFF power to the circuit before connecting the Meter to the circuit.
- When servicing the Meter, use only specified replacement parts.

⚠ Caution

To prevent damage to the Meter, do not change the position of the Front/Rear switch while signals are applied to either the front or rear input terminals.

Description of IEC 61010 Measurement Categories

The IEC 61010 safety standard defines four Overvoltage (Installation) Categories (CAT I to CAT IV) based on the magnitude of danger from transient impulses as shown in Figure 1-1.

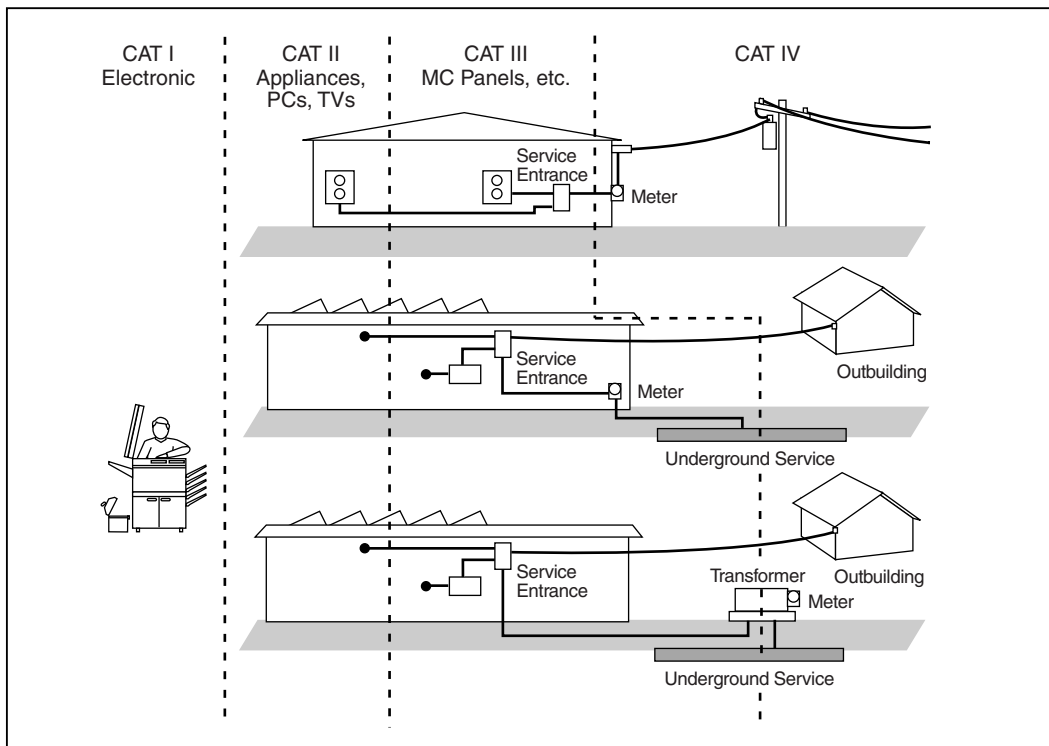

Figure 1-1. IEC 61010 Measurement Category (CAT) Levels

cat_levels.eps

The IEC 61010 Measurement CAT level indicates the level of protection the instrument provides against impulse withstand voltage.

CAT I equipment is designed to protect against transients from high-voltage, low-energy sources, such as electronic circuits or a copy machine.

CAT II equipment is designed to protect against transients from energy-consuming equipment supplied from the fixed installation, such as TVs, PCs, portable tools, and other household appliances.

CAT III equipment is designed to protect against transients in equipment in fixed equipment installations, such as distribution panels, feeders and short branch circuits, and lighting systems in large buildings.

CAT IV equipment is designed to protect against transients from the primary supply level, such as an electricity meter or an overhead or underground utility service.

Organization of the Calibration Manual

This calibration manual is divided into the following chapters:

Chapter 1 – Introduction and Specifications

This chapter introduces the Fluke 8845A and 8846A Digital Multimeters, describing their features, and accessories. This chapter also discusses use of the Calibration Manual and the various conventions used in describing the meter’s circuitry and presents a complete set of specifications.

Chapter 2 – General Maintenance

Chapter 2 provides maintenance information covering handling, cleaning, and fuse replacement. Access and reassembly procedures are also explained in this chapter.

Chapter 3 – Performance Test and Calibration

This chapter provides performance verification procedures related to the specifications presented in Chapter 1. To maintain these specifications, a full adjustment/calibration procedure is also presented.

Chapter 4 – List of Replaceable Parts

Chapter 4 includes parts lists for all standard assemblies and information on how and where to order parts.

Operating Instructions

Full operating instructions are provided in the Fluke *8845A/8846A Users Manual*. Reference to these instructions may be necessary during some of the maintenance and repair procedures presented in this Calibration Manual.

Accessories

Table 1-3 lists the available accessories for the 8845A and 8846A.

Table 1-3. Accessories

Model/Fluke PN	Description
TL71	Test Lead Set, Premium DMM
TL910	Precision Electronic Probe Set
TL80A	Basic Electronic DMM Test Set
8845A-TPIT	Test Probe Ic Tip (Set Red & Black)
8845A-EFPT	Extended Fine Pt Tip Adap Set (Set Red/Black)
884X-SHORT	4-Wire short
TL2X4W-PTII	2x4 Wire Ohms 1000V Test lead
884X-RTD	100 Ohm RTD Temperature Probe
884X-512M	USB Memory 512M

Table 1-3. Accessories (cont)

Model/Fluke PN	Description
884X-1G	USB Memory 1 GB
884X-USB	USB to RS232 cable adapter
884X-ETH	Ethernet Interface Cable
RS43	RS232 Cable (RS43, 2m)
Y8021	IEEE488 cable (1m)
Y8022	IEEE488 cable (2m)
884X-CASE	Black Case
FVF-UG	FlukeView Forms Software Upgrade - NO cable
FVF-SC4	Flukeview Forms W/Cable For 8845/8846
FVF-SC5	Flukeview Forms -Basic For 8845/8846
Y8846S	Rack Mount Kit 8845A & 8846A Single
Y8846D	Rack Mount Kit 8845A & 8846A Dual
FUSE	Fuse, 11A, 1000V, Fast, .406inx1.5in, Bulk
FUSE	Fuse, .440 mA, 1000V, Fast, .406X1.375, Bulk
2132558	Calibration, Traceable, w/ Data
1259800	Calibration, Traceable, w/o Data
1256480	Calibration, Z540 Traceable, w/ Data
1258910	Calibration, Z540 Traceable, w/o Data
1256990	Calibration, Accredited
1024830	Agreement, Extended Warranty
2426684	Agreement, Calibration, Traceable, w/ Data
1028820	Agreement, Calibration, Traceable, w/o Data
1259170	Agreement, Calibration, Z540 Traceable, w/ Data
1258730	Agreement, Calibration, Z540 Traceable, w/o Data
1259340	Agreement, Calibration, Accredited
2441827	Agreement, Calibration, Primary Standards Lab
1540600	Agreement, Calibration, Artifact

General Specifications

Power

Voltage	
100 V Setting	90 V to 110 V
120 V Setting	108 V to 132 V
220 V Setting	198 V to 242 V
240 V Setting	216 V to 264 V
Frequency	47 Hz to 440 Hz. Automatically sensed at power-on.
Power Consumption.....	28 VA peak (12 Watt average)

Dimensions

Height.....	88 mm (3.46 in.)
Width.....	217 mm (8.56 in.)
Depth	297 mm (11.7 in.)
Weight.....	3.6 kg (8.0 lbs)
Shipping Weight.....	5.0 kg (11.0 lbs)

Display

Vacuum Fluorescent Display, dot matrix

Environment

Temperature	
Operating	0 °C to 55 °C
Storage	-40 °C to 70 °C
Warm Up.....	1 hour to full uncertainty specifications
Relative Humidity (non-condensing)	
Operating	0 °C to 28 °C <90 % 28 °C to 40 °C <80 % 40 °C to 55 °C <50 %
Storage	-40 °C to 70 °C <95 %
Altitude	
Operating	2,000 Meters
Storage	12,000 Meters
Vibration and Shock.....	Complies with MIL-T-28800F Type III, Class 5 (Sine only)

Safety

Designed to comply with IEC 61010-1:2000-1, UL 61010-1A1, CAN/CSA-C22.2 No. 61010.1, CAT I 1000V/CAT II 600V

EMC

Designed to comply with IEC 61326-1:2000-11 (EMC) when used with shielded communications cables. This Meter has shown susceptibility to radiated frequencies greater than 1 V/m from 250 to 450 MHz.

Triggering

Samples per Trigger	1 to 50,000
Trigger Delay	0 s to 3600 s; in 10 µS increments
External Trigger Delay.....	<1 mS
External Trigger Jitter	<500 µS
Trigger Input	TTL Levels
Trigger Output.....	5 V maximum (open collector)

Memory

8845A	10,000 measurements, internal only
8846A	10,000 measurements, internal, and up to 2 Gigabyte capacity with USB memory module (available separately, see “Accessories”) through front-panel USB port

Math Functions

Zero, dBm, dB, MX+B, Offset, DCV ratio and TrendPlot, Histogram, Statistics (min/max/average/standard deviation), and Limit Test

Electrical

Input Protection	1000 V all ranges
Overrange	20 % on all ranges except 1000 V dc, 1000 V ac (8846A), 750 V ac (8845A), Diode, and 10 A ranges

Remote Interfaces

- RS-232C, DTE 9-pin, 1200 to 230400 baud (RS-232C to USB cable available to connect the Meter to a PC USB port. See Accessories)
- IEEE 488.2
- LAN and “Ethernet 10/100 base T with DHCP (for IP_ADDRes) option”

Warranty

One year

Electrical Specifications

Accuracy specifications are valid for 6½ digit resolution mode after at least a 1-hour warm-up with Auto Zero enabled. 24-hour specifications are relative to calibration standards and assume a controlled electromagnetic environment per EN 61326-1:2000-11

DC Voltage Specifications

Maximum Input	1000 V on any range
Common Mode Rejection	140 dB at 50 or 60 Hz ±0.1 % (1 kΩ unbalance)
Normal Mode Rejection	60 dB for NPLC of 1 or greater with analog filter off and power line frequency ±0.1 % 100 dB for NPLC of 1 or greater with analog filter on and power line frequency ±0.1 %
Measurement Method	Multi-ramp A/D
A/D Linearity	0.0002 % of measurement +0.0001 % of range
Input Bias Current	<30 pA at 25 °C
Autozero Off Operation	Following instrument warm-up at calibration temperature ±1 °C and less than 10 minutes, add error: 0.0002 % range additional error + 5 μV.
Analog Filter	When using the analog filter, specifications are relative to within one hour of using the ZERO function for that range and NPLC setting.
DC Ratio	Accuracy is +/- (Input accuracy + Reference accuracy), where Input accuracy = DC Voltage accuracy for the HI to LO Input (in ppm of the Input voltage), and Reference accuracy = DC Voltage accuracy for the HI to LO (Sense) Reference (in ppm of the Reference voltage).
Settling Considerations	Measurement settling times are affected by source impedance, cable dielectric characteristics, and input signal changes.

Input Characteristics

Range	Resolution	Resolution			Input Impedance
		4½ Digits	5½ Digits	6½ Digits	
100 mV	100.0000 mV	10 µV	1 µV	100 nV	10 MΩ or >10 GΩ ^[1]
1 V	1.000000 V	100 µV	10 µV	1 µV	10 MΩ or >10 GΩ ^[1]
10 V	10.00000 V	1 mV	100 µV	10 µV	10 MΩ or >10 GΩ ^[1]
100 V	100.0000 V	10 mV	1 mV	100 µV	10 MΩ ±1%
1000 V	1,000.000 V	100 mV	10 mV	1 mV	10 MΩ ±1%

[1] Inputs beyond ±14 V are clamped through 200 kΩ typical. 10 MΩ is default input impedance.

8846A Accuracy

Accuracy is given as ± (% measurement + % of range)

Range	24 Hour (23 ±1 °C)	90 Days (23 ±5 °C)	1 Year (23 ±5 °C)	Temperature Coefficient/ °C Outside 18 to 28 °C
100 mV	0.0025 + 0.003	0.0025 + 0.0035	0.0037 + 0.0035	0.0005 + 0.0005
1 V	0.0018 + 0.0006	0.0018 + 0.0007	0.0025 + 0.0007	0.0005 + 0.0001
10 V	0.0013 + 0.0004	0.0018 + 0.0005	0.0024 + 0.0005	0.0005 + 0.0001
100 V	0.0018 + 0.0006	0.0027 + 0.0006	0.0038 + 0.0006	0.0005 + 0.0001
1000 V	0.0018 + 0.0006	0.0031 + 0.001	0.0041 + 0.001	0.0005 + 0.0001

8845A Accuracy

Accuracy is given as ± (% measurement + % of range)

Range	24 Hour (23 ±1 °C)	90 Days (23 ±5 °C)	1 Year (23 ±5 °C)	Temperature Coefficient/ °C Outside 18 to 28 °C
100 mV	0.003 + 0.003	0.004 + 0.0035	0.005 + 0.0035	0.0005 + 0.0005
1 V	0.002 + 0.0006	0.003 + 0.0007	0.004 + 0.0007	0.0005 + 0.0001
10 V	0.0015 + 0.0004	0.002 + 0.0005	0.0035 + 0.0005	0.0005 + 0.0001
100 V	0.002 + 0.0006	0.0035 + 0.0006	0.0045 + 0.0006	0.0005 + 0.0001
1000 V	0.002 + 0.0006	0.0035 + 0.0010	0.0045 + 0.0010	0.0005 + 0.0001

Additional Errors

Digits	NPLC	Additional NPLC Noise Error
6½	100	0 % of range
6½	10	0 % of range
5½	1	0.001 % of range
5½	.2	0.0025 % of range +12 µV
4½	0.02	0.017 % of range +17 µV

AC Voltage Specifications

AC Voltage specifications are for ac sinewave signals >5 % of range. For inputs from 1 % to 5 % of range and <50 kHz, add an additional error of 0.1 % of range, and for 50 kHz to 100 kHz, add 0.13 % of range.

Maximum Input 750 V rms or 1000 V peak (8845A), 1000 V rms or 1414 V peak (8846A) or 8×10^7 volts-Hertz product (whichever is less) for any range.

Measurement Method AC-coupled true-rms. Measures the ac component of input with up to 1000 V dc bias on any range.

AC Filter Bandwidth:

Slow 3 Hz – 300 kHz

Medium 20 Hz – 300 kHz

Fast 200 Hz – 300 kHz

Common Mode Rejection 70 dB at 50 Hz or 60 Hz ±0.1 % (1 kΩ unbalance)

Maximum Crest Factor..... 5:1 at Full Scale
 Additional Crest Factor Errors (<100 Hz)..... Crest factor 1-2, 0.05 % of full scale
 Crest factor 2-3, 0.2 % of full scale
 Crest factor 3-4, 0.4 % of full scale
 Crest factor 4-5, 0.5 % of full scale

Input Characteristics

Range	Resolution	Resolution			Input Impedance
		4½ Digits	5½ Digits	6½ Digits	
100 mV	100.0000 mV	10 µV	1 µV	100 nV	1 MΩ ±2 % shunted by <100 pf
1 V	1.000000 V	100 µV	10 µV	1 µV	
10 V	10.00000 V	1 mV	100 µV	10 µV	
100 V	100.0000 V	10 mV	1 mV	100 µV	
1000 V	1,000.000 V	100 mV	10 mV	1 mV	

8846A Accuracy

Accuracy is given as ± (% measurement + % of range)

Range	Frequency	24 Hour (23 ±1 °C)	90 Days (23 ±5 °C)	1 Year (23 ±5 °C)	Temperature Coefficient/ °C Outside 18 to 28 °C
100 mV	3 – 5 Hz	1.0 + 0.03	1.0 + 0.04	1.0 + 0.04	0.1 + 0.004
	5 – 10 Hz	0.35 + 0.03	0.35 + 0.04	0.35 + 0.04	0.035 + 0.004
	10 Hz – 20 kHz	0.04 + 0.03	0.05 + 0.04	0.06 + 0.04	0.005 + 0.004
	20 – 50 kHz	0.1 + 0.05	0.11 + 0.05	0.12 + 0.05	0.011 + 0.005
	50 – 100 kHz	0.55 + 0.08	0.6 + 0.08	0.6 + 0.08	0.06 + 0.008
	100 – 300 kHz ^[1]	4.0 + 0.50	4.0 + 0.50	4.0 + 0.50	0.20 + 0.02
1 V	3 – 5 Hz	1.0 + 0.02	1.0 + 0.03	1.0 + 0.03	0.1 + 0.003
	5 – 10 Hz	0.35 + 0.02	0.35 + 0.03	0.35 + 0.03	0.035 + 0.003
	10 Hz – 20 kHz	0.04 + 0.02	0.05 + 0.03	0.06 + 0.03	0.005 + 0.003
	20 – 50 kHz	0.1 + 0.04	0.11 + 0.05	0.12 + 0.05	0.011 + 0.005
	50 – 100 kHz	0.55 + 0.08	0.6 + 0.08	0.6 + 0.08	0.06 + 0.008
	100 – 300 kHz ^[1]	4.0 + 0.50	4.0 + 0.50	4.0 + 0.50	0.2 + 0.02
10 V	3 – 5 Hz	1.0 + 0.02	1.0 + 0.03	1.0 + 0.03	0.1 + 0.003
	5 – 10 Hz	0.35 + 0.02	0.35 + 0.03	0.35 + 0.03	0.035 + 0.003
	10 Hz – 20 kHz	0.04 + 0.02	0.05 + 0.03	0.06 + 0.03	0.005 + 0.003
	20 – 50 kHz	0.1 + 0.04	0.11 + 0.05	0.12 + 0.05	0.011 + 0.005
	50 – 100 kHz	0.55 + 0.08	0.6 + 0.08	0.6 + 0.08	0.06 + 0.008
	100 – 300 kHz ^[1]	4.0 + 0.50	4.0 + 0.50	4.0 + 0.50	0.2 + 0.02
100 V	3 – 5 Hz	1.0 + 0.02	1.0 + 0.03	1.0 + 0.03	0.1 + 0.003
	5 – 10 Hz	0.35 + 0.02	0.35 + 0.03	0.35 + 0.03	0.035 + 0.003
	10 Hz – 20 kHz	0.04 + 0.02	0.05 + 0.03	0.06 + 0.03	0.005 + 0.003
	20 – 50 kHz	0.1 + 0.04	0.11 + 0.05	0.12 + 0.05	0.011 + 0.005
	50 – 100 kHz	0.55 + 0.08	0.6 + 0.08	0.6 + 0.08	0.06 + 0.008
	100 – 300 kHz ^[1]	4.0 + 0.50	4.0 + 0.50	4.0 + 0.50	0.2 + 0.02
1000 V	3 – 5 Hz	1.0 + 0.015	1.0 + 0.0225	1.0 + 0.0225	0.1 + 0.00225
	5 – 10 Hz	0.35 + 0.015	0.35 + 0.0225	0.35 + 0.0225	0.035 + 0.00225
	10 Hz – 20 kHz	0.04 + 0.015	0.05 + 0.0225	0.06 + 0.0225	0.005 + 0.00225
	20 – 50 kHz	0.1 + 0.03	0.11 + 0.0375	0.12 + 0.0375	0.011 + 0.00375
	50 – 100 kHz ^[2]	0.55 + 0.06	0.6 + 0.06	0.6 + 0.06	0.06 + 0.006
	100 – 300 kHz ^{[1][2]}	4.0 + 0.375	4.0 + 0.375	4.0 + 0.375	0.2 + 0.015

[1] Typically 30 % reading error at 1 MHz

[2] 1000 Volt range is limited to 8 X 10⁷ volt-Hertz

8845A Accuracy

Accuracy is given as \pm (% measurement + % of range)

Range	Frequency (Hz)	24 Hour (23 \pm 1 $^{\circ}$ C)	90 Days (23 \pm 5 $^{\circ}$ C)	1 Year (23 \pm 5 $^{\circ}$ C)	Temperature Coefficient/ $^{\circ}$ C Outside 18 to 28 $^{\circ}$ C
100 mV	3 – 5 Hz	1.0 + 0.03	1.0 + 0.04	1.0 + 0.04	0.10 + 0.004
	5 – 10 Hz	0.35 + 0.03	0.35 + 0.04	0.35 + 0.04	0.035 + 0.004
	10 Hz – 20 kHz	0.04 + 0.03	0.05 + 0.04	0.06 + 0.04	0.005 + 0.004
	20 – 50 kHz	0.1 + 0.05	0.11 + 0.05	0.12 + 0.05	0.011 + 0.005
	50 – 100 kHz	0.55 + 0.08	0.6 + 0.08	0.6 + 0.08	0.06 + 0.008
	100 – 300 kHz ^[1]	4.0 + 0.50	4.0 + 0.50	4.0 + 0.50	0.2 + 0.02
1 V	3 – 5 Hz	1.0 + 0.02	1.0 + 0.03	1.0 + 0.03	0.1 + 0.003
	5 – 10 Hz	0.35 + 0.02	0.35 + 0.03	0.35 + 0.03	0.035 + 0.003
	10 Hz – 20 kHz	0.04 + 0.02	0.05 + 0.03	0.06 + 0.03	0.005 + 0.003
	20 – 50 kHz	0.1 + 0.04	0.11 + 0.05	0.12 + 0.05	0.011 + 0.005
	50 – 100 kHz	0.55 + 0.08	0.6 + 0.08	0.6 + 0.08	0.06 + 0.008
	100 – 300 kHz ^[1]	4.0 + 0.50	4.0 + 0.50	4.0 + 0.50	0.2 + 0.02
10 V	3 – 5 Hz	1.0 + 0.02	1.0 + 0.03	1.0 + 0.03	0.1 + 0.003
	5 – 10 Hz	0.35 + 0.02	0.35 + 0.03	0.35 + 0.03	0.035 + 0.003
	10 Hz – 20 kHz	0.04 + 0.02	0.05 + 0.03	0.06 + 0.03	0.005 + 0.003
	20 – 50 kHz	0.1 + 0.04	0.11 + 0.05	0.12 + 0.05	0.011 + 0.005
	50 – 100 kHz	0.55 + 0.08	0.6 + 0.08	0.6 + 0.08	0.06 + 0.008
	100 – 300 kHz ^[1]	4.0 + 0.50	4.0 + 0.50	4.0 + 0.50	0.2 + 0.02
100 V	3 – 5 Hz	1.0 + 0.02	1.0 + 0.03	1.0 + 0.03	0.1 + 0.003
	5 – 10 Hz	0.35 + 0.02	0.35 + 0.03	0.35 + 0.03	0.035 + 0.003
	10 Hz – 20 kHz	0.04 + 0.02	0.05 + 0.03	0.06 + 0.03	0.005 + 0.003
	20 – 50 kHz	0.1 + 0.04	0.11 + 0.05	0.12 + 0.05	0.011 + 0.005
	50 – 100 kHz	0.55 + 0.08	0.6 + 0.08	0.6 + 0.08	0.06 + 0.008
	100 – 300 kHz ^[1]	4.0 + 0.50	4.0 + 0.50	4.0 + 0.50	0.2 + 0.02
750 V	3 – 5 Hz	1.0 + 0.02	1.0 + 0.03	1.0 + 0.03	0.1 + 0.003
	5 – 10 Hz	0.35 + 0.02	0.35 + 0.03	0.35 + 0.03	0.035 + 0.003
	10 Hz – 20 kHz	0.04 + 0.02	0.05 + 0.03	0.06 + 0.03	0.005 + 0.003
	20 – 50 kHz	0.1 + 0.04	0.11 + 0.05	0.12 + 0.05	0.011 + 0.005
	50 – 100 kHz ^[2]	0.55 + 0.08	0.6 + 0.08	0.6 + 0.08	0.06 + 0.008
	100 – 300 kHz ^{[1][2]}	4.0 + 0.5	4.0 + 0.5	4.0 + 0.5	0.2 + 0.02

[1] Typically 30 % reading error at 1 MHz
 [2] 750 Volt range is limited to 8 X 10⁷ volt-Hertz

Additional Low Frequency Errors

Error is stated as % of reading.

Frequency	AC Filter		
	3HZ (slow)	20HZ (medium)	200HZ (fast)
10 – 20 Hz	0	0.25	–
20 – 40 Hz	0	0.02	–
40 – 100 Hz	0	0.01	0.55
100 – 200 Hz	0	0	0.2
200 Hz – 1 kHz	0	0	0.02
>1 kHz	0	0	0

Resistance

Specifications are for 4-wire resistance function, 2 x 4-wire resistance, or 2-wire resistance with zero. If zero is not used, add 0.2 Ω for 2-wire resistance plus lead resistance, and add 20 m Ω for 2 x 4-wire resistance function.

Measurement Method	Current source referenced to LO input
Max. Lead Resistance (4-wire ohms)	10 % of range per lead for 10 Ω , 100 Ω , 1 k Ω ranges. 1 k Ω per lead on all other ranges
Input Protection	1000 V on all ranges
Common Mode Rejection	140 dB at 50 or 60 Hz \pm 0.1 % (1 k Ω unbalance)
Normal Mode Rejection	60 dB for NPLC of 1 or greater with analog filter off and power line frequency \pm 0.1 % 100 dB for NPLC of 1 or greater with analog filter on and power line frequency \pm 0.1 %
Analog Filter	When using the analog filter, specifications are relative to within one hour of using the ZERO function for that range and NPLC setting.

Input Characteristics

Range	Resolution	Resolution			Source Current
		4½ Digits	5½ Digits	6½ Digits	
10 Ω ^[1]	10.00000 Ω	1 m Ω	100 $\mu\Omega$	10 $\mu\Omega$	5 mA/13 V
100 Ω	100.0000 Ω	10 m Ω	1 m Ω	100 $\mu\Omega$	1 mA/6 V
1 k Ω	1.000000 k Ω	100 m Ω	10 m Ω	1 m Ω	1 mA/6 V
10 k Ω	10.00000 k Ω	1 Ω	100 m Ω	10 m Ω	100 μ A/6 V
100 k Ω	100.0000 k Ω	10 Ω	1 Ω	100 m Ω	100 μ A/13 V
1 M Ω	1.000000 M Ω	100 Ω	10 Ω	1 Ω	10 μ A/13 V
10 M Ω	10.00000 M Ω	1 k Ω	100 Ω	10 Ω	1 μ A/13 V
100 M Ω	100.0000 M Ω	10 k Ω	1 k Ω	100 Ω	1 μ A 10 M Ω /10 V
1.0 G Ω ^[1]	1.000000 G Ω	100 k Ω	10 k Ω	1 k Ω	1 μ A 10 M Ω /10 V

[1] 8846A Only

8846A Accuracy

Accuracy is given as \pm (% measurement + % of range)

Range	24 Hour (23 \pm 1 $^{\circ}$ C)	90 Days (23 \pm 5 $^{\circ}$ C)	1 Year (23 \pm 5 $^{\circ}$ C)	Temperature Coefficient/ $^{\circ}$ C Outside 18 to 28 $^{\circ}$ C
10 Ω	0.003 + 0.01	0.008 + 0.03	0.01 + 0.03	0.0006 + 0.0005
100 Ω	0.003 + 0.003	0.008 + 0.004	0.01 + 0.004	0.0006 + 0.0005
1 k Ω	0.002 + 0.0005	0.008 + 0.001	0.01 + 0.001	0.0006 + 0.0001
10 k Ω	0.002 + 0.0005	0.008 + 0.001	0.01 + 0.001	0.0006 + 0.0001
100 k Ω	0.002 + 0.0005	0.008 + 0.001	0.01 + 0.001	0.0006 + 0.0001
1 M Ω	0.002 + 0.001	0.008 + 0.001	0.01 + 0.001	0.001 + 0.0002
10 M Ω	0.015 + 0.001	0.02 + 0.001	0.04 + 0.001	0.003 + 0.0004
100 M Ω	0.3 + 0.01	0.8 + 0.01	0.8 + 0.01	0.15 + 0.0002
1 G Ω	1.0 + 0.01	1.5 + 0.01	2.0 + 0.01	0.6 + 0.0002

8845A Accuracy

Accuracy is given as \pm (% measurement + % of range)

Range	24 Hour (23 \pm 1 $^{\circ}$ C)	90 Days (23 \pm 5 $^{\circ}$ C)	1 Year (23 \pm 5 $^{\circ}$ C)	Temperature Coefficient/ $^{\circ}$ C Outside 18 to 28 $^{\circ}$ C
100 Ω	0.003 + 0.003	0.008 + 0.004	0.01 + 0.004	0.0006 + 0.0005
1 k Ω	0.002 + 0.0005	0.008 + 0.001	0.01 + 0.001	0.0006 + 0.0001
10 k Ω	0.002 + 0.0005	0.008 + 0.001	0.01 + 0.001	0.0006 + 0.0001
100 k Ω	0.002 + 0.0005	0.008 + 0.001	0.01 + 0.001	0.0006 + 0.0001
1 M Ω	0.002 + 0.001	0.008 + 0.001	0.01 + 0.001	0.0010 + 0.0002
10 M Ω	0.015 + 0.001	0.02 + 0.001	0.04 + 0.001	0.0030 + 0.0004
100 M Ω	0.3 + 0.01	0.8 + 0.01	0.8 + 0.01	0.1500 + 0.0002

Additional Ohms Errors

Digits	NPLC	Additional NPLC Noise Error
6 $\frac{1}{2}$	100	0 % of range
6 $\frac{1}{2}$	10	0 % of range
5 $\frac{1}{2}$	1	0.001 % of range
5 $\frac{1}{2}$	0.2	0.003 % of range \pm 7 m Ω
4 $\frac{1}{2}$	0.02	0.017 % of range \pm 15 m Ω

DC Current

Input Protection.....	Tool-accessible 11 A/1000 V and 440 mA/1000 V fuses, limits of 400 mA continuous 550 mA for 2 minutes on, 1 minute off.
Common Mode Rejection	140 dB at 50 or 60 Hz \pm 0.1 % (1 k Ω unbalance)
Normal Mode Rejection	60 dB for NPLC of 1 or greater with analog filter off and power line frequency \pm 0.1 % 100 dB for NPLC of 1 or greater with analog filter on and power line frequency \pm 0.1 %
Analog Filter.....	When using the analog filter, specifications are relative to within one hour of using the ZERO function for that range and NPLC setting.

Input Characteristics

Range	Resolution	Resolution			Shunt Resistance (Ohms)	Burden Voltage
		4 $\frac{1}{2}$ Digits	5 $\frac{1}{2}$ Digits	6 $\frac{1}{2}$ Digits		
100 μ A	100.0000 μ A	10 nA	1 nA	100 pA	100 Ω	<0.015 V
1 mA	1.000000 mA	100 nA	10 nA	1 nA	100 Ω	<0.15 V
10 mA	10.00000 mA	1 μ A	100 nA	10 nA	1 Ω	<0.025 V
100 mA	100.0000 mA	10 μ A	1 μ A	100 nA	1 Ω	<0.25 V
400 mA ^[3]	400.000 mA	100 μ A	10 μ A	1 μ A	1 Ω	<0.50 V
1 A ^[2]	1.000000 A	100 μ A	10 μ A	1 μ A	0.01 Ω	<0.05 V
3 A ^[1]	3.00000A	1 mA	100 μ A	10 μ A	0.01 Ω	<0.15 V
10 A	10.00000 A	1 mA	100 μ A	10 μ A	0.01 Ω	<0.5 V

[1] Part of 10 A range.

[2] Available on the front panel terminal only.

[3] 400 mA available in software version 2.0 or greater only. 400 mA continuously; 550 mA for 2 minutes on, 1 minute off.

Accuracy (8846A)

Accuracy is given as \pm (% measurement + % of range)

Range	24 Hour (23 \pm 1 $^{\circ}$ C)	90 Days (23 \pm 5 $^{\circ}$ C)	1 Year (23 \pm 5 $^{\circ}$ C)	Temperature Coefficient/ $^{\circ}$ C Outside 18 to 28 $^{\circ}$ C
100 μ A	0.01 + 0.02	0.04 + 0.025	0.05 + 0.025	0.002 + 0.003
1 mA	0.007 + 0.005	0.030 + 0.005	0.05 + 0.005	0.002 + 0.0005
10 mA	0.007 + 0.02	0.03 + 0.02	0.05 + 0.02	0.002 + 0.002
100 mA	0.01 + 0.004	0.03 + 0.005	0.05 + 0.005	0.002 + 0.0005
400 mA ^[3]	0.03 + 0.004	0.04 + 0.005	0.05 + 0.005	0.005 + 0.0005
1 A ^[2]	0.03 + 0.02	0.04 + 0.02	0.05 + 0.02	0.005 + 0.001
3 A ^{[1][2]}	0.05 + 0.02	0.08 + 0.02	0.1 + 0.02	0.005 + 0.002
10 A ^[2]	0.1 + 0.008	0.12 + 0.008	0.15 + 0.008	0.005 + 0.0008
<p>[1] Part of 10 A range [2] Available at front panel connectors only [3] 400 mA available in software version 2.0 or greater only. 400 mA continuously; 550 mA for 2 minutes on, 1 minute off.</p>				

Accuracy (8845A)

Accuracy is given as \pm (% measurement + % of range)

Range	24 Hour (23 \pm 1 $^{\circ}$ C)	90 Days (23 \pm 5 $^{\circ}$ C)	1 Year (23 \pm 5 $^{\circ}$ C)	Temperature Coefficient/ $^{\circ}$ C Outside 18 to 28 $^{\circ}$ C
100 μ A	0.01 + 0.02	0.04 + 0.025	0.05 + 0.025	0.002 + 0.003
1 mA	0.007 + 0.005	0.030 + 0.005	0.05 + 0.005	0.002 + 0.0005
10 mA	0.007 + 0.02	0.03 + 0.02	0.05 + 0.02	0.002 + 0.002
100 mA	0.01 + 0.004	0.03 + 0.005	0.05 + 0.005	0.002 + 0.0005
400 mA ^[3]	0.03 + 0.004	0.04 + 0.005	0.05 + 0.005	0.005 + 0.0005
1 A ^[2]	0.03 + 0.02	0.04 + 0.02	0.05 + 0.02	0.005 + 0.001
3 A ^{[1][2]}	0.05 + 0.02	0.08 + 0.02	0.10 + 0.02	0.005 + 0.002
10 A ^[2]	0.10 + 0.008	0.12 + 0.008	0.15 + 0.008	0.005 + 0.0008
<p>[1] Part of 10 A range [2] Available at front panel connectors only [3] 400 mA available in software version 2.0 or greater only. 400 mA continuously; 550 mA for 2 minutes on, 1 minute off.</p>				

Additional Current Errors

Digits	NPLC	Additional NPLC Noise Error for 1 mA, 100 mA, 400 mA, 3A and 10A	Additional NPLC Noise Error for 100 μ A, 10 mA, 1A
6 $\frac{1}{2}$	100	0 % of range	0 % of range
6 $\frac{1}{2}$	10	0 % of range	0 % of range
5 $\frac{1}{2}$	1	0.001 % of range	0.01 % of range
5 $\frac{1}{2}$	0.2	0.011 % of range \pm 4 μ A	0.11 % of range \pm 4 μ A
4 $\frac{1}{2}$	0.02	0.04 % of range \pm 4 μ A	0.28 % of range \pm 4 μ A

AC Current

The following ac current specifications are for sinusoidal signals with amplitudes greater than 5 % of range. For inputs from 1 % to 5 % of range, add an additional error of 0.1 % of range.

- Input Protection Tool accessible 11 A/1000 V and 440 mA/1000 V fuses, limits of 400 mA continuous 550 mA for 2 minutes on, 1 minute off.
- Measurement Method ac-coupled true-rms, dc-coupled to the fuse and shunt (no blocking capacitor)
- AC Filter Bandwidth
 - Slow 3 Hz to 10 kHz
 - Medium 20 Hz to 10 kHz
 - Fast 200 Hz to 10 kHz
- Maximum Crest Factor 5:1 at full scale
- Additional Crest Factor Errors (<100 Hz) Crest factor 1-2, 0.05 % of full scale
Crest factor 2-3, 0.2 % of full scale
Crest factor 3-4, 0.4 % of full scale
Crest factor 4-5, 0.5 % of full scale

Input Characteristics

Range	Resolution	Resolution			Shunt Resistance (Ohms)	Burden Voltage
		4½ Digits	5½ Digits	6½ Digits		
100 µA ^[1]	100.0000 µA	10 nA	1 nA	100 pA	100 Ω	<0.015 V
1 mA ^[1]	1.000000 mA	100 nA	10 nA	1 nA	100 Ω	<0.15 V
10 mA	10.00000 mA	1 µA	100 nA	10 nA	1 Ω	<0.025 V
100 mA	100.0000 mA	10 µA	1 µA	100 nA	1 Ω	<0.25 V
400 mA ^[4]	400.000 mA	100 µA	10 µA	1 µA	1 Ω	<0.50 V
1 A ^[3]	1.000000 A	100 µA	10 µA	1 µA	0.01 Ω	<0.05 V
3 A ^{[2],[3]}	3.00000 A	1 mA	100 µA	10 µA	0.01 Ω	<0.05 V
10 A ^[3]	10.00000 A	1 mA	100 µA	10 µA	0.01 Ω	<0.5 V

[1] 8846A Only
 [2] Part of 10 A range
 [3] Available at front panel connectors only
 [4] 400 mA available in software version 1.0.700.18 or greater only. 400 mA continuously; 550 mA for 2 minutes on, 1 minute off; maximum crest factor 3:1 at 400mA

8846A Accuracy

Accuracy is given as ± (% measurement + % of range)

Range	Frequency (Hz)	24 Hour (23 ±1 °C)	90 Days (23 ±5 °C)	1 Year (23 ±5 °C)	Temperature Coefficient/ °C Outside 18 to 28 °C
100 µA	3 – 5 Hz	1.1 + 0.06	1.1 + 0.06	1.1 + 0.06	0.2 + 0.006
	5 – 10 Hz	0.35 + 0.06	0.35 + 0.06	0.35 + 0.06	0.1 + 0.006
	10 Hz – 5 kHz	0.15 + 0.06	0.15 + 0.06	0.15 + 0.06	0.015 + 0.006
	5 – 10 kHz	0.35 + 0.7	0.35 + 0.7	0.35 + 0.7	0.03 + 0.006
1 mA	3 – 5 Hz	1.0 + 0.04	1.0 + 0.04	1.0 + 0.04	0.1 + 0.006
	5 – 10 Hz	0.3 + 0.04	0.3 + 0.04	0.3 + 0.04	0.035 + 0.006
	10 Hz – 5 kHz	0.1 + 0.04	0.1 + 0.04	0.1 + 0.04	0.015 + 0.006
	5 – 10 kHz	0.2 + 0.25	0.2 + 0.25	0.2 + 0.25	0.03 + 0.006
10 mA	3 – 5 Hz	1.1 + 0.06	1.1 + 0.06	1.1 + 0.06	0.2 + 0.006
	5 – 10 Hz	0.35 + 0.06	0.35 + 0.06	0.35 + 0.06	0.1 + 0.006
	10 Hz – 5 kHz	0.15 + 0.06	0.15 + 0.06	0.15 + 0.06	0.015 + 0.006
	5 – 10 kHz	0.35 + 0.7	0.35 + 0.7	0.35 + 0.7	0.03 + 0.006
100 mA	3 – 5 Hz	1.0 + 0.04	1.0 + 0.04	1.0 + 0.04	0.1 + 0.006
	5 – 10 Hz	0.3 + 0.04	0.3 + 0.04	0.3 + 0.04	0.035 + 0.006
	10 Hz – 5 kHz	0.1 + 0.04	0.1 + 0.04	0.1 + 0.04	0.015 + 0.006
	5 – 10 kHz	0.2 + 0.25	0.2 + 0.25	0.2 + 0.25	0.03 + 0.006

8846A Accuracy (cont)

Range	Frequency (Hz)	24 Hour (23 ±1 °C)	90 Days (23 ±5 °C)	1 Year (23 ±5 °C)	Temperature Coefficient/ °C Outside 18 to 28 °C
400 mA ^[3]	3 – 5 Hz	1.0 + 0.1	1.0 + 0.1	1.0 + 0.1	0.1 + 0.006
	5 – 10 Hz	0.3 + 0.1	0.3 + 0.1	0.3 + 0.1	0.035 + 0.006
	10 Hz – 1 kHz	0.1 + 0.1	0.1 + 0.1	0.1 + 0.1	0.015 + 0.006
	1kHz – 10 kHz	0.2 + 0.7	0.2 + 0.7	0.2 + 0.7	0.03 + 0.006
1 A ^[2]	3 – 5 Hz	1.0 + 0.04	1.0 + 0.04	1.0 + 0.04	0.1 + 0.006
	5 – 10 Hz	0.3 + 0.04	0.3 + 0.04	0.3 + 0.04	0.035 + 0.006
	10 Hz – 5 kHz	0.1 + 0.04	0.1 + 0.04	0.1 + 0.04	0.015 + 0.006
	5 – 10 kHz	0.35 + 0.7	0.35 + 0.7	0.35 + 0.7	0.03 + 0.006
3 A ^{[1][2]}	3 – 5 Hz	1.1 + 0.06	1.1 + 0.06	1.1 + 0.06	0.1 + 0.006
	5 – 10 Hz	0.35 + 0.06	0.35 + 0.06	0.35 + 0.06	0.035 + 0.006
	10 Hz – 5 kHz	0.15 + 0.06	0.15 + 0.06	0.15 + 0.06	0.015 + 0.006
	5 – 10 kHz	0.35 + 0.7	0.35 + 0.7	0.35 + 0.7	0.03 + 0.006
10 A ^[2]	3 – 5 Hz	1.1 + 0.06	1.1 + 0.06	1.1 + 0.06	0.1 + 0.006
	5 – 10 Hz	0.35 + 0.06	0.35 + 0.06	0.35 + 0.06	0.035 + 0.006
	10 Hz – 5 kHz	0.15 + 0.06	0.15 + 0.06	0.15 + 0.06	0.015 + 0.006
	5 – 10 kHz	0.35 + 0.7	0.35 + 0.7	0.35 + 0.7	0.03 + 0.006

[1] Part of 10 A range
 [2] Available only on front panel connectors
 [3] 400 m available in software version 1.0.700.18 or greater only. 400 mA continuously; 550 mA for 2 minutes on, 1 minute off; maximum crest factor 3:1 at 400mA; specification for current above 329 mA is typical.

8845A Accuracy

Accuracy is given as ± (% measurement + % of range)

Range	Frequency (Hz)	24 Hour (23 ±1 °C)	90 Days (23 ±5 °C)	1 Year (23 ±5 °C)	Temperature Coefficient/ °C Outside 18 to 28 °C
10 mA	3 – 5 Hz	1.1 + 0.06	1.1 + 0.06	1.1 + 0.06	0.2 + 0.006
	5 – 10 Hz	0.35 + 0.06	0.35 + 0.06	0.35 + 0.06	0.1 + 0.006
	10 Hz – 5 kHz	0.15 + 0.06	0.15 + 0.06	0.15 + 0.06	0.015 + 0.006
	5 – 10 kHz	0.35 + 0.7	0.35 + 0.7	0.35 + 0.7	0.03 + 0.006
100 mA	3 – 5 Hz	1.0 + 0.04	1.0 + 0.04	1.0 + 0.04	0.1 + 0.006
	5 – 10 Hz	0.3 + 0.04	0.3 + 0.04	0.3 + 0.04	0.035 + 0.006
	10 Hz – 5 kHz	0.1 + 0.04	0.1 + 0.04	0.1 + 0.04	0.015 + 0.006
	5 – 10 kHz	0.2 + 0.25	0.2 + 0.25	0.2 + 0.25	0.03 + 0.006
400 mA ^[3]	3 – 5 Hz	1.0 + 0.1	1.0 + 0.1	1.0 + 0.1	0.1 + 0.006
	5 – 10 Hz	0.3 + 0.1	0.3 + 0.1	0.3 + 0.1	0.035 + 0.006
	10 Hz – 1 kHz	0.1 + 0.1	0.1 + 0.1	0.1 + 0.1	0.015 + 0.006
	1kHz – 10 kHz	0.2 + 0.7	0.2 + 0.7	0.2 + 0.7	0.03 + 0.006
1 A ^[2]	3 – 5 Hz	1.0 + 0.04	1.0 + 0.04	1.0 + 0.04	0.1 + 0.006
	5 – 10 Hz	0.3 + 0.04	0.3 + 0.04	0.3 + 0.04	0.035 + 0.006
	10 Hz – 5 kHz	0.1 + 0.04	0.1 + 0.04	0.1 + 0.04	0.015 + 0.006
	5 – 10 kHz	0.35 + 0.7	0.35 + 0.7	0.35 + 0.7	0.03 + 0.006
3 A ^{[1][2]}	3 – 5 Hz	1.1 + 0.06	1.1 + 0.06	1.1 + 0.06	0.1 + 0.006
	5 – 10 Hz	0.35 + 0.06	0.35 + 0.06	0.35 + 0.06	0.035 + 0.006
	10 Hz – 5 kHz	0.15 + 0.06	0.15 + 0.06	0.15 + 0.06	0.015 + 0.006
	5 – 10 kHz	0.35 + 0.7	0.35 + 0.7	0.35 + 0.7	0.03 + 0.006

8845A Accuracy (cont)

Range	Frequency (Hz)	24 Hour (23 ±1 °C)	90 Days (23 ±5 °C)	1 Year (23 ±5 °C)	Temperature Coefficient/ °C Outside 18 to 28 °C
10 A ^[2]	3 – 5 Hz	1.1 + 0.06	1.1 + 0.06	1.1 + 0.06	0.2 + 0.006
	5 – 10 Hz	0.35 + 0.06	0.35 + 0.06	0.35 + 0.06	0.035 + 0.006
	10 Hz – 5 kHz	0.15 + 0.06	0.15 + 0.06	0.15 + 0.06	0.015 + 0.006
	5 – 10 kHz	0.35 + 0.7	0.35 + 0.7	0.35 + 0.7	0.03 + 0.006
[1] Part of the 10 A range [2] Available only at front panel connectors [3] 400 m available in software version 1.0.700.18 or greater only. 400 mA continuously; 550 mA for 2 minutes on, 1 minute off; maximum crest factor 3:1 at 400mA; specification for current above 329 mA is typical.					

Additional Low Frequency Errors

Error is stated as % of reading.

Frequency	AC Filter		
	3HZ (slow)	20HZ (medium)	200HZ (fast)
10 – 20 Hz	0	0.25	–
20 – 40 Hz	0	0.02	–
40 – 100 Hz	0	0.01	0.55
100 – 200 Hz	0	0	0.2
200 Hz – 1 kHz	0	0	0.02
> 1 kHz	0	0	0

Frequency

- Gate Times Programmable to 1 s, 100 ms, and 10 ms
- Measurement Method Flexible counting technique. AC-coupled input using the ac voltage measurement function.
- Settling Considerations When measuring frequency or period after a dc offset voltage change, errors may occur. For the most accurate measurement, wait up to 1 second for the input blocking capacitor to settle.
- Measurement Considerations To minimize measurement errors, shield inputs from external noise when measuring low-voltage, low-frequency signals.

8846A Accuracy

Accuracy is given as ± % measurement

Range	Frequency	24 Hour (23 ±1 °C)	90 Days (23 ±5 °C)	1 Year (23 ±5 °C)	Temperature Coefficient/ °C Outside 18 to 28 °C
100 mV to 1000 V ^{[1][2]}	3 – 5 Hz	0.1	0.1	0.1	0.005
	5 – 10 Hz	0.05	0.05	0.05	0.005
	10 – 40 Hz	0.03	0.03	0.03	0.001
	40 Hz – 300 kHz	0.006	0.01	0.01	0.001
	300 kHz – 1 MHz	0.006	0.01	0.01	0.001
[1] Input >100 mV. For 10 – 100 mV, multiply percent measurement error by 10. [2] Limited to 8 X 10 ⁷ volt-Hertz					

8845A Accuracy

Accuracy is given as \pm % measurement

Range	Frequency	24 Hour (23 \pm 1 $^{\circ}$ C)	90 Days (23 \pm 5 $^{\circ}$ C)	1 Year (23 \pm 5 $^{\circ}$ C)	Temperature Compensation/ $^{\circ}$ C Outside 18 to 28 $^{\circ}$ C
100 mV to 750 V ^{[1][2]}	3 – 5 Hz	0.1	0.1	0.1	0.005
	5 – 10 Hz	0.05	0.05	0.05	0.005
	10 – 40 Hz	0.03	0.03	0.03	0.001
	40 Hz – 300 kHz	0.006	0.01	0.01	0.001
<p>[1] Input >100 mV. For 10 – 100 mV, multiply percent measurement error by 10. [2] Limited to 8 X 10⁷ volt-Hertz</p>					

Gate Time vs. Resolution

Gate Time	Resolution
0.01	5½
0.1	6½
1.0	6½

Additional Low Frequency Errors

Error stated as percent of measurement for inputs >100 mV. For 10 – 100 mV, multiply percent by 10.

Frequency	Resolution		
	6½	5½	4½
3 – 5 Hz	0	0.12	0.12
5 – 10 Hz	0	0.17	0.17
10 – 40 Hz	0	0.2	0.2
40 – 100 Hz	0	0.06	0.21
100 – 300 Hz	0	0.03	0.21
300 Hz – 1 kHz	0	0.01	0.07
> 1 kHz	0	0	0.02

Capacitance (8846A Only)

Accuracy is stated as \pm (% of measurement + % of range)

Range	Resolution	1 Year Accuracy ^[1] (23 \pm 5 $^{\circ}$ C)	Temperature Coefficient/ $^{\circ}$ C Outside 18 to 28 $^{\circ}$ C
1 nF	1 pF	2% \pm 2.5 %	0.05 + 0.05
10 nF	10 pF	1% \pm 0.5 %	0.05 + 0.01
100 nF	100 pF	1% \pm 0.5 %	0.01 + 0.01
1 μ F	1 nF	1% \pm 0.5 %	0.01 + 0.01
10 μ F	10 nF	1% \pm 0.5 %	0.01 + 0.01
100 μ F	100 nF	1% \pm 0.5 %	0.01 + 0.01
1 mF	1 μ F	1% \pm 0.5 %	0.01 + 0.01
10 mF	10 μ F	1% \pm 0.5 %	0.01 + 0.01
100 mF	100 μ F	4% \pm 0.2 %	0.05 + 0.05
<p>[1] Stated accuracy is attained when Zero function is used.</p>			

Temperature (8846A only)

Test Current 1 mA

Accuracy is stated as \pm °C and is based on a Platinum RT100 (DIN IEC 751, 385 type) RTD with less than 10 ohms lead resistance. The accuracy listed in the table below are valid only when using the 4-wire RTD measurement function. Specifications do not include probe accuracy, which must be added.

Range	Resolution	Accuracy		Temperature Coefficient/ °C Outside 18 to 28 °C
		90 Days (23 \pm 5 °C)	1 Year (23 \pm 5 °C)	
-200 °C	0.001 °C	0.06	0.09	0.0025
-100 °C	0.001 °C	0.05	0.08	0.002
0 °C	0.001 °C	0.04	0.06	0.002
100 °C	0.001 °C	0.05	0.08	0.002
300 °C	0.001 °C	0.1	0.12	0.002
600 °C	0.001 °C	0.18	0.22	0.002

Digits	NPLC	Additional NPLC Noise Error
6 ½	100	0 °C
6 ½	10	0 °C
5 ½	1	0.03 °C
5 ½	0.2	0.12 °C
4 ½	0.02	0.6 °C

Continuity

Continuity Threshold Selectable between 1 Ω and 1000 Ω

Test Current 1 mA

Response Time 300 samples/sec with audible tone

Accuracy is given as \pm (% measurements + % of range)

Range	24 Hour (23 \pm 1 °C)	90 Days (23 \pm 5 °C)	1 Year (23 \pm 5 °C)	Temperature Coefficient/ °C Outside 18 to 28 °C
1000.0 Ω	0.002 + 0.01	0.008 + 0.02	0.01 + 0.02	0.001 + 0.002

Diode Test

Test Current 100 μ A or 1 mA

Response Time 300 samples/sec with audible tone.

Accuracy is given as \pm (% measurements + % of range)

Range	24 Hour (23 \pm 1 °C)	90 Days (23 \pm 5 °C)	1 Year (23 \pm 5 °C)	Temperature Coefficient/ °C Outside 18 to 28 °C
5.0000 V	0.002 + 0.002	0.008 + 0.002	0.01 + 0.002	0.001 + 0.002
10.0000 V	0.002 + 0.001	0.008 + 0.002	0.01 + 0.002	0.001 + 0.002

Measurement Rates (IEEE488[4])

Function	Digits	Setting	Integration Time 60 Hz (50 Hz)	Measurements/Second ^[1]	
				8845A	8846A
DC Volts, DC Current, and Resistance	6½	100 NPLC	1.67 (2) s	0.6 (0.5)	0.6 (0.5)
	6½	10 NPLC	167 (200) ms	6 (5)	6 (5)
	5½	1 NPLC	16.7 (20) ms	60 (50)	60 (50)
	5½	0.2 NPLC	3.3 ms	270	270
	4½	0.02 NPLC	500 us	995	995
AC Voltage and AC Current ^[2]	6½	3 Hz		0.47	0.47
	6½	20 Hz		1.64	1.64
	6½	200 Hz ^[3]		4.5	4.5
Frequency and Period	6½	1 s		1	1
	5½	100 ms		9.8	9.8
	4½	10 ms		80	80
Capacitance	6 1/2			NA	2

[1] Typical measurement rates with auto-zero off, delay = 0, display off, auto range off and math off.
 [2] Maximum measurement rates for 0.01 % of ac step. When dc input varies, additional settling delay is required.
 [3] For remote operation or external trigger using default settling delay
 [4] Speeds available in OutG SW 1.0.700.18 or higher. Note that the measurements rates for RS232 can vary depending on the baud rate chosen. If the baud rate selected is 115,200, the maximum measurement rate is 711 measurement/s. The LAN bus has a maximum measurement rate of 963 measurement/s.

Measurement Uncertainty

The Meter's measurement uncertainties are expressed in the form (% of reading + % of range). In addition to the reading error and range error, you may need to add additional errors for certain operating conditions. If the Meter is operated outside the temperature range specified, an additional temperature coefficient error must be applied. For dc voltage, dc current, and resistance measurements, apply an additional reading-speed error. For ac voltage and ac current measurements, apply an additional low frequency error or crest factor error.

The "% of reading" error varies according to the input level on the selected range. This error is expressed in percent of input measurement. The "% of range" error represents the floor noise of the range and represents the lowest meaningful resolution for that range. The following example shows the reading error applied to the Meter's 24-hour 10 Vdc specification: 0.0013% of input + 0.0004% of range.

Assuming the Meter is set to the 10V range with an input voltage of 1 V, the measurement uncertainty would be: +/- [(0.0013% x 1V) + (0.0004% x 10V)].

Permissible High Value = 1 + 0.000053V = 1.000053 V

Permissible Low Value = 1 - 0.000053V = 0.999947 V

Interpreting Accuracy Specifications

The following sections provide a clearer understanding of specifications over time and with temperature variations.

24-Hour Accuracy

The 24-hour accuracy specification indicates the Meter's relative accuracy over its full measurement range for short time intervals and within a stable environment. Short-term accuracy is usually specified for a 24-hour period and for a ± 1 °C temperature range.

90-Day and 1-Year Accuracy

The longer duration accuracy specifications are valid at the calibration temperature (T_{cal}) ± 5 °C temperature range. These specifications include the initial calibration errors plus the Meter's long-term drift errors.

Temperature Coefficients

Accuracy is usually specified at the calibration temperature (T_{cal}) ± 5 °C temperature range. This is a common temperature range for many operating environments. Add additional temperature coefficient errors to the accuracy specification if the Meter is operated outside the ± 5 °C temperature range (the specification is per °C).

Configuring for Highest Accuracy Measurements

The measurement configurations shown below assume that the Meter is in its power-on or reset state. It is also assumed that auto-ranging is enabled to ensure proper full-scale range selection.

DC Voltage, DC Current, and Resistance Measurements

Select NPLC and 100 (NPLCs) for highest instrument resolution and accuracy.

For the best dc voltage accuracy, set INPUT HIGH INPUT Z (impedance) to GOhm (for the 100 mV, 1 V, and 10 V ranges).

For the best resistance measurement accuracy, use the 4-wire ohms function (4W).

For 2-wire ohms, dc voltage and dc current measurements, set **AUTOZERO** to **ON** to remove thermal EMF and offset errors.

Zero the test lead resistance for 2-wire and 4-wire ohms measurements and zero to remove any interconnection offset for dc voltage measurements.

AC Voltage and AC Current Measurements:

Set the AC FILTER to **3 Hz: SLOW**.

Frequency and Period Measurements:

Set the GATE TIME to **1 sec**.

Chapter 2

General Maintenance

Title	Page
Introduction.....	2-3
Warranty Repairs and Shipping Information.....	2-3
General Maintenance Information	2-3
Required Equipment.....	2-3
Power Requirements.....	2-3
Static Safe Handling.....	2-3
Cleaning.....	2-4
Fuse Replacement.....	2-4
Line-Power Fuse.....	2-4
Current-Input Fuses.....	2-5
If the Meter Does Not Turn On.....	2-7
Display Tests.....	2-7
Disassembly Procedures	2-7
General Disassembly.....	2-7
Main Chassis Disassembly.....	2-8
Front Panel Disassembly.....	2-8
Assembly Procedures.....	2-8

Introduction

This chapter provides handling, cleaning, fuse replacement, disassembly, and assembly instructions for the Meter.

Warranty Repairs and Shipping Information

If your meter is still under warranty, see the warranty information at the front of this manual for instructions on returning the unit. A list of Fluke telephone numbers and the website address can be found in the “How to Contact Fluke” section of Chapter 4.

General Maintenance Information

The following sections describe how to maintain the Meter.

Required Equipment

Equipment required for calibration, troubleshooting, and repair of the Meter is listed in Table 3-1.

Power Requirements

Warning

To avoid electric shock, connect the Meter’s power cord to a power receptacle with earth ground.

The Meter operates on power distribution standards found throughout the world, and must be set up to operate on the correct line voltage power it. The Meter is packed ready for use with a line voltage determined at the time of ordering. If the selected line voltage does not match the power the Meter will be plugged into, then the Meter’s line voltage setting must be changed and the line fuse possibly replaced. See the *8845A/8846A Users Manual* for information on switching the Meter’s line voltage.

If you have not already done so, plug the line cord into the connector on the rear of the Meter.

Static Safe Handling

All integrated circuits, including surface mounted ICs, are susceptible to damage from electrostatic discharge (ESD). Modern integrated circuit assemblies are more susceptible to damage from ESD than ever before.

Integrated circuits today can be built with circuit lines less than one micron thick, allowing more than a million transistors on a 1/4-inch square chip. These submicron structures are sensitive to static voltages under 100 volts. This much voltage can be generated on a dry day by simply moving your arm. A person can develop a charge of 2,000 volts by walking across a vinyl tile floor, and polyester clothing can easily generate 5,000 to 15,000 volts during movement against the wearer. These low voltage static problems are often undetected, because a static charge must be in the 30,000 to 40,000 volt range before a person will feel a shock.

Most electronic components manufactured today can be degraded or destroyed by ESD. While protection networks are used in CMOS devices, they can only reduce, not eliminate, component susceptibility to ESD.

ESD may not cause an immediate failure in a component; a delayed failure or "wounding" effect is caused when the semiconductor’s insulation layers or junctions are

punctured. The static problem is thus complicated in that failure may occur anywhere from two hours to six months after the initial damage.

Two failure modes are associated with ESD. First, a person who has acquired a static charge can touch a component or assembly and cause a transient discharge to pass through the device. The resulting current ruptures the junctions of a semiconductor. The second failure mode does not require contact with another object. Simply exposing a device to the electric field surrounding a charged object can destroy or degrade a component. MOS devices can fail when exposed to static fields as low as 30 volts.

Observe the following rules for handling static-sensitive devices:

1. Handle all static-sensitive components in a static-safe work area.

Use grounded static-control table mats on all repair benches, and always wear a grounded wrist strap. Handle boards by their nonconductive edges only. Store plastic, vinyl, and Styrofoam objects outside the work area.

2. Store and transport all static-sensitive components and assemblies in static shielding bags or containers.

Static-shielding bags and containers protect components and assemblies from direct static discharge and external static fields. Store components in their original packages until they are ready for use.

Cleaning

⚠⚠ Warning

To avoid electric shock or damage to the Meter, never get water inside the meter.

⚠ Caution

To avoid damaging the Meter's housing, do not apply solvents to the Meter.

If the Meter requires cleaning, wipe it down with a cloth lightly dampened with water or a mild detergent. Do not use aromatic hydrocarbons, chlorinated solvents, or methanol-based fluids to wipe down the meter.

Fuse Replacement

The Meter employs fuses to protect both the line-power and current measurement inputs.

Line-Power Fuse

The Meter has a line-power fuse in series with the power supply. Table 2-1 indicates the proper fuse for each of the four line voltage selections. This fuse is located on the rear panel.

To replace this fuse:

1. Unplug the power cord from the Meter and remove any test leads.
2. Remove the fuse holder by inserting a small screwdriver blade in the narrow recess to the left of the fuse holder and pry to the right until the holder pops out, as shown in Figure 2-1. The Meter is shipped with a replacement fuse of the same rating as the fuse installed in the fuse block.

3. Remove the fuse and replace with one rated appropriately for the selected line-power voltage. See Table 2-1 for fuse ratings with specific line voltage.
4. Replace the selector block back into the fuse holder.

⚠ ⚠ Warning

To avoid electric shock or fire, do not use makeshift fuses or short-circuit the fuse holder. Use only Fluke fuses.

Table 2-1. Line Voltage to Fuse Rating

Line Voltage Selection	Fuse Rating	Fluke Part No.
100	0.25 A, 250 V (slow blow)	166306
120	0.25 A, 250 V (slow blow)	166306
220	0.125 A, 250 V (slow blow)	166488
240	0.125 A, 250 V (slow blow)	166488

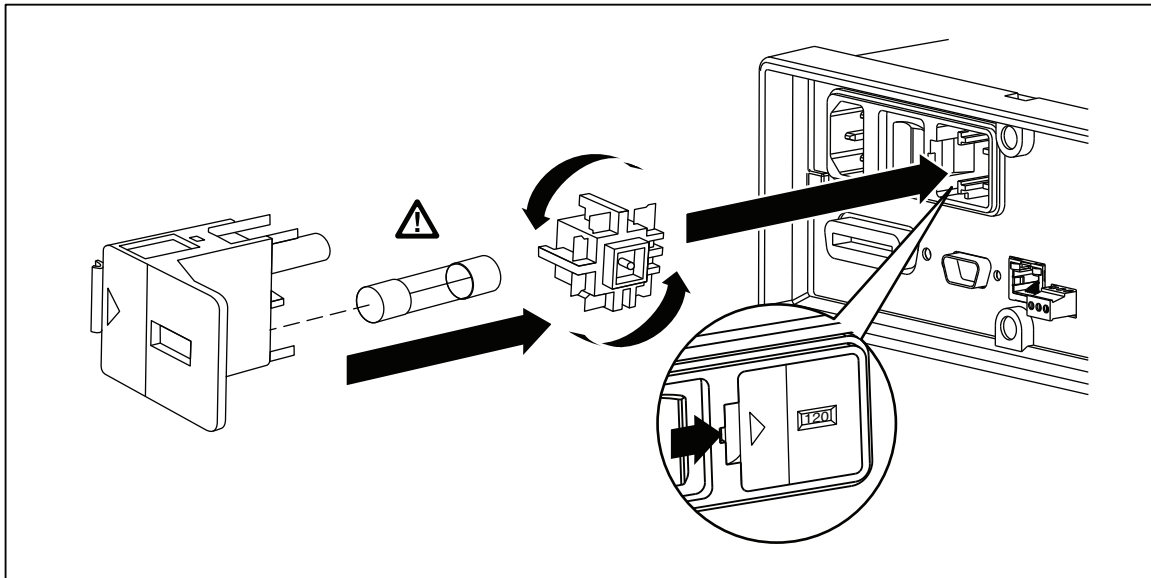

Figure 2-1. Line Fuse Replacement

caw0201f.eps

Current-Input Fuses

The 100 mA and 10 A inputs are protected by user-replaceable fuses.

- The 100 mA input is protected by a fuse (A1F2) rated at 440 mA, 1000 V (fast blow), 10,000 A minimum breaking capacity.
- The 10 A input is protected by a fuse (A1F1) rated at 11 A, 1000 V (fast blow), 10,000 A minimum breaking capacity.

⚠ Warning

For protection against fire or arc flash, replace a blown fuse only with one from Fluke.

If the Meter Does Not Turn On

Use the following steps to help solve problems encountered when turning on the Meter.

1. Verify the Meter's power switch is in the "On" position.
2. Make sure that the power cord is firmly plugged into the power module on the rear of the Meter.
3. Make sure the power source the Meter is plugged into is energized.
4. Ensure the Meter's power line voltage is set to the proper value for your country. See the "Fuse Replacement" section earlier in this chapter for instructions on changing the Meter's voltage setting.
5. Verify that the power-line fuse is good.

If these steps don't solve the problem, then contact Fluke for more help. See the "Contacting Fluke" section in Chapter 4 for contact information.

Display Tests

To test the pixels on the front panel display, use the following steps.

1. Press .
2. Press the SYSTEM softkey.
3. Press the DISPLAY softkey.

All pixels of the display should be illuminated.

Disassembly Procedures

⚠⚠ Warning

To avoid electric shock, disconnect the Meter from power before removing the cover.

Only qualified service personnel should attempt servicing this Meter.

To disassemble the Meter, a #2 Phillips screwdriver and small crescent wrench are required. There are three sets of disassembly instructions: general, main chassis, and front panel.

General Disassembly

To disassemble the Meter:

1. Turn off the power by turning off the mains power at the rear of the Meter and removing the power cord. The front panel power key only puts the Meter in a power-save mode and does not remove mains power from the Meter.
2. Remove all cables from the Meter.
3. Remove the Meter bumpers by pulling from a corner and stretching the bumpers off the Meter.
4. Remove the bail by rotating the handle upright to a 90° angle from the top of the Meter and pull bail out from the sides of the Meter.
5. Remove the top cover by removing the four screws on the bottom of the chassis, and slide the cover towards the back of the Meter.

6. Remove the wedges from the front and rear input modules by rotating the top toward the chassis middle and pulling up. See Figure 4-1.
7. Remove both sets of screws holding the front panel to the chassis (8-32 pan head and 6-32 flat head undercut). See Figure 4-1.
8. Gently remove the front panel by pulling it forward and set it aside.
9. Remove the plastic handle caps from the chassis sides by rotating the front slightly inward and pulling forward.

Main Chassis Disassembly

To disassemble the Meter's main chassis:

1. Carefully remove the transformer connectors from the main board.
2. Carefully remove the screws that hold the transformer and its bracket to the chassis while holding the transformer so that it cannot drop on the circuits.
3. Carefully lift the transformer out of the chassis and place the transformer behind the instrument with the power module leads still attached.
4. Remove the jackscrews for the RS-232 and IEEE488 connectors to the chassis.
5. Remove the screws holding the main circuit board to the chassis (three 6-32 pan-head screws).
6. Remove the main circuit board.

Front Panel Disassembly

To disassemble the Meter's front panel:

1. Remove the one 6-32 pan head and two 6-32 flat head undercut screws holding the display shield to the rest of the front panel assembly and remove the shield.
2. Remove the thread-forming screw holding the front panel shield to the front panel and remove the shield.
3. Remove the three thread-forming screws from the keypad assembly and remove display module.

Assembly Procedures

To assemble the three parts of the Meter, follow the disassembly instructions in reverse order.

Chapter 3

Performance Test and Calibration

Title	Page
Introduction.....	3-3
Required Equipment	3-3
Test Considerations.....	3-5
Performance Tests.....	3-5
Volts DC Verification.....	3-5
Volts DC Ratio Verification.....	3-8
Volts AC and Frequency Verification.....	3-9
4-Wire Ohms Verification.....	3-14
2-Wire Ohms Verification.....	3-16
2X4 Test Lead Verification Steps	3-18
Rear Panel Terminal Verification Steps	3-18
Capacitance Verification Steps (8846A only).....	3-21
DC Current Verification Steps	3-22
AC Current Verification Steps	3-25
Adjustment (Calibration)	3-27
Unlocking the Meter for Adjustments (Calibration)	3-28
Unlocking the Meter for Adjustments Over a Remote Interface.....	3-28
Changing the Calibration Password	3-28
Resetting the Calibration Password.....	3-28
Changing the Calibration Date Remotely.....	3-29
Equipment for Calibration.....	3-29
Adjustment Process	3-30
Aborting a Calibration Process.....	3-36
Sample Adjustment Program.....	3-36

Introduction

This chapter of the Calibration Manual provides performance tests to verify the Meter is operating within published specifications as well as a complete calibration procedure. The performance test and, if necessary, the calibration procedure can be performed both periodically and after service or repair.

The performance tests can be used as an acceptance test upon receipt of the Meter. Use the 90-day specifications when performing an acceptance test after performing a calibration.

Required Equipment

Table 3-1 lists the equipment required for performance testing and calibration of the Meter.

Table 3-1. Required Test Equipment

Function	Instrument Type	Model	Comments
Volts dc	Standard	Fluke 5520A	Must be characterized with 8508A
	8½ digit meter	Fluke 8508A	Used to characterize the 5520A
	4-wire short	Fluke low thermal 4-wire short or equivalent	Fluke PN 2653346
	Alternate standard ^[1]	Fluke 5720A	
Volts ac	Standard	Fluke 5520A	Must be characterized with 8508A
	8½ digit meter	Fluke 8508A	Used to characterize the 5520A. Note: TURs <4:1 at 1 V, 10 V, and 100 V at 20 kHz
	4-wire short	Fluke low thermal 4-wire short or equivalent	Fluke PN 2653346
	Alternate standard ^[1]	Fluke 5720A	
Frequency	Standard	Fluke 5520A	
	Alternate standard	Fluke 5520A with any scope option	
	Alternate standard	Function generator	Specifications include 0.075 % frequency accuracy from 3 – 40 Hz and 0.0025 % accuracy for frequencies up to 1 MHz

Table 3-1. Required Test Equipment (cont.)

Function	Instrument Type	Model	Comments
Ohms	Standard	Fluke 5520A	Must be characterized with 8508A
	8½ digit meter	Fluke 8508A	Used to characterize the 5520A
	4-wire short	Fluke low thermal 4-wire short or equivalent	Fluke PN 2653346
	Alternate standard	Fluke 5720A or equivalent	
	Alternate standard resistor ^[1]	Fluke 8508A-7000K 1 Gohm resistor or equivalent (better than ±0.35 % maximum uncertainty)	Used for calibrating/verifying 1 GΩ range in the 8846A when a 5520A is not available.
Capacitance (8846A only)	Standard	Fluke 5520A	TURS <4:1 at 1 nF, 10 nF, 100 μF, 1 mF, and 10 mF.
	Alternate standards	1 nF, 10 nF, 100 nF, 1 μF, 10 μF, 100 μF, 1 mF, 10 mF, and 100 mF standards	Standards must be ±0.25 % and rated for at least 5 V
Current dc	Standard	Fluke 5520A	Must be characterized with 8508A
	8½ digit meter	Fluke 8508A	Only used to characterize the 5520A
	Alternate standard ^[1]	Fluke 5720A with Fluke 5725A	Note: TUR <4 at 10 A
Current ac	Standard	Fluke 5520A	Must be characterized with 8508A
	8½ digit meter	Fluke 8508A	Only used to characterize the 5520A or 5720A
	Alternate standard ^[1]	Fluke 5720A with Fluke 5725A	TUR at 1 A at 5 kHz < 4:1. Must characterize with 8508A at 100 μA at 5 kHz. 100 μA, 1 mA, 10 mA, 100 mA, 1 A and 2 A at 10 kHz.
Cables	To reduce the possibility of inducing errors with ac signals picked up by the test leads, use short, shielded twisted-pair PTFE-insulated test cables between the test equipment and the Meter. Fluke makes a 2 foot (PN 738716) and 4 foot (PN 738724) PTFE insulated test cable for this purpose.		
	Fluke USB to RS232 cable (PN 2675479) or Fluke IEEE 488 cable (2 meter, PN 708297)		
[1] Other alternate standards beside those listed can be used as long as they provide sufficient traceable [Test uncertainty Ratios(TURs)] at each calibration and verification point.			

Test Considerations

For optimum performance, all test procedures should comply with the following recommendations:

- Assure the calibration ambient temperature (T_{cal}) is stable and between 18 °C and 28 °C. Ideally the calibration should be performed at 23 °C \pm 2 °C.
- Assure ambient relative humidity is less than 80%.
- Allow a 60-minute warm-up period.
- Use shielded twisted-pair PTFE-insulated cables to reduce settling and noise errors.
- Keep all input cables as short as possible.
- Ensure that the calibration standards and test procedures used do not introduce additional errors.

Note

Ideally, the standards used to verify and adjust the Meter should be four times more accurate than each full-scale error specification of the Meter.

- User Fluke's low thermal 4-Wire short for all voltages and ohmic shorts. See Table 3-1 for Fluke part number..

Performance Tests

The following performance tests are provided to ensure that the Meter is in proper operating condition. If the Meter fails any of the performance tests, calibration adjustment and/or repair is needed. The performance test works best if executed in the sequence shown in Table 3-2.

Each of the measurements listed in the following tests assumes the Meter is being tested after a one-hour warm-up in an environment with an ambient temperature of 18 to 28°C and a relative humidity of less than 80%.

Note

All instrument settings for verification use power up conditions except as noted by the verification step.

Volts DC Verification

Connect the Meter to the test equipment as shown in Figure 3-1 and, depending on which meter you are calibrating, apply the voltages listed in Table 3-2 or Table 3-3. Some verification test steps are firmware dependant. To determine the firmware revision of the UUT:

1. Press ,
2. Press the softkey labeled System.
3. Press the softkey labeled Version.

Note the OutG SW value.

Verification forms can be found in Appendix A which can be copied and used to record each meter reading.

Table 3-2. 8846A DC Volts Verification Steps (cont.)

Nominal Input (V)	Range	90-day Test Limits		1-year Test Limits	
		High	Low	High	Low
1 V ^[1]	1	1.000025 V	0.999975 V	1.000032 V	0.999968 V
-1 V ^[1]	1	-0.999975 V	-1.000025 V	-0.999968 V	-1.000032 V
0 V	10	50.0 μV	-50.0 μV	50.0 μV	-50.0 μV
5 V ^[1]	10	5.000140 V	4.999860 V	5.000170 V	4.999830 V
-5 V ^[1]	10	-4.999860 V	-5.000140 V	-4.999830 V	-5.000170 V
10 V ^[1]	10	10.000230 V	9.999770 V	10.000290 V	9.999710 V
-10 V ^[1]	10	-9.999770 V	-10.000230 V	-9.999710 V	-10.000290 V
0 V	100	600.0 μV	-600.0 μV	600.0 μV	-600.0 μV
100 V ^[1]	100	100.0033 V	99.9967 V	100.0044 V	99.9956 V
-100 V ^[1]	100	-99.9967 V	-100.0033 V	-99.9956 V	-100.0044 V
0 V	1000	10.0 mV	-10.0 mV	10.0 mV	-10.0 mV
1 kV ^[1]	1000	1000.0410 V	999.9590 V	1000.0510 V	999.9490 V
-1 kV ^[1]	1000	-999.9590 V	-1000.0410 V	-999.9490 V	-1000.0510 V

[1] 5520A must be used with 8508A to obtain suitable test uncertainty ratio.

Table 3-3. 8845A DC Volts Verification Steps

Nominal Input (V)	Range	90-day Test Limits		1-year Test Limits	
		High	Low	High	Low
0 V	0.100	3.5 μV	-3.5 μV	3.5 μV	-3.5 μV
100.0 mV ^[1]	0.100	100.0075 mV	99.9925 mV	100.0085 mV	99.9915 mV
-100.0 mV ^[1]	0.100	-99.9925 mV	-100.0075 mV	-99.9915 mV	-100.0085 mV
0 V	1	7.0 μV	-7.0 μV	7.0 μV	-7.0 μV
1 V ^[1]	1	1.000037 V	999.963 mV	1.000047 V	999.953 mV
-1 V ^[1]	1	-999.963 mV	-1.000037 V	-999.953 mV	-1.000047 V
0 V	10	50.0 μV	-50.0 μV	50.0 μV	-50.0 μV
5 V ^[1]	10	5.00015 V	4.99985 V	5.000225 V	4.999775 V
-5 V ^[1]	10	-4.99985 V	-5.00015 V	-4.999775 V	-5.000225 V
10 V ^[1]	10	10.00025 V	9.99975 V	10.0004 V	9.9996 V
-10 V	10	-9.99975 V	-10.00025 V	-9.9996 V	-10.0004 V
0 V	100	600.0 μV	-600.0 μV	600.0 μV	-600.0 μV
100 V	100	100.0041 V	99.9959 V	100.0051 V	99.9949 V
-100 V	100	-99.9959 V	-100.0041 V	-99.9949 V	-100.0051 V
0 V	1000	10.0 mV	-10.0 mV	10.0 mV	-10.0 mV
1 kV	1000	1.000045 kV	999.955E+0	1.000055 kV	999.945 V
-1 kV	1000	-999.955 V	-1.000045 kV	-999.945 V	-1.000055 kV

[1] 5520A must be used with 8508A to obtain suitable test uncertainty ratio.

Volts DC Ratio Verification

Connect the Meter to the test equipment as shown in Figure 3-2 and depending on which meter you are calibrating, apply the voltages listed in Table 3-4 or Table 3-5. Verification forms can be found in Appendix A which can be copied and used to record each meter reading.

Note

Note that the Ratio function is only available in Outguard SW version 2.0 and later.

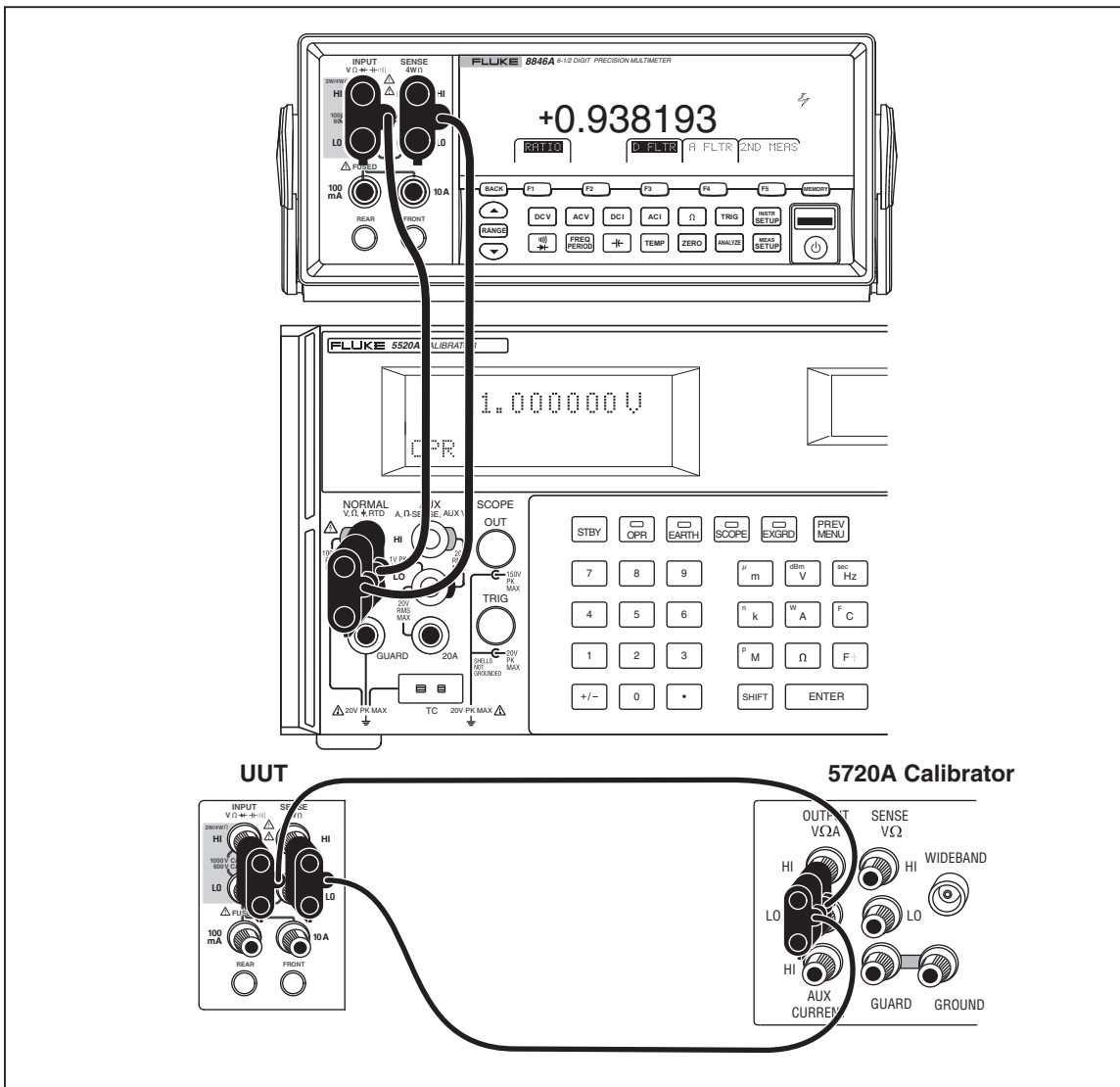

Figure 3-2. DC Volts Ratio Test Equipment Setup with 5520A and 5720A

caw037.eps

Table 3-4. 8846A DC Volts Ratio Verification Steps

Nominal Input (V)	Range	90-day Test Limits		1-year Test Limits ^[1]	
		High	Low	High	Low
100 mV ^[2]	0.100 V	1.00012 V	0.99988 V	1.000144 V	0.999856 V
1 V ^[2]	1 V	1.00005 V	0.99995 V	1.000064 V	0.999936 V
-10 V	10 V	1.000046 V	0.999954 V	1.000058 V	0.999942 V

[1] Using 5520A output to the Hi/Lo and Sense Hi/Lo terminals.
[2] Optional test.

Table 3-5. 8845A DC Volts Ratio Verification Steps

Nominal Input (V)	Range	90-day Test Limits		1-year Test Limits ^[1]	
		High	Low	High	Low
100 mV ^[2]	0.100 V	1.00015 V	0.99985 V	1.00017 V	0.99983 V
1 V ^[2]	1 V	1.000074 V	0.999926 V	1.000094 V	0.999906 V
-10 V	10 V	1.00005 V	0.99995 V	1.00008 V	0.99992 V

[1] Using 5520A output to the Hi/Lo and Sense Hi/Lo terminals.
[2] Optional test.

Volts AC and Frequency Verification

Connect the Meter to the test equipment as shown in Figure 3-3 and, depending on which meter you are calibrating, apply the voltage listed in Table 3-6 or Table 3-7. Verification forms can be found in Appendix A which can be copied and used to record each meter reading.

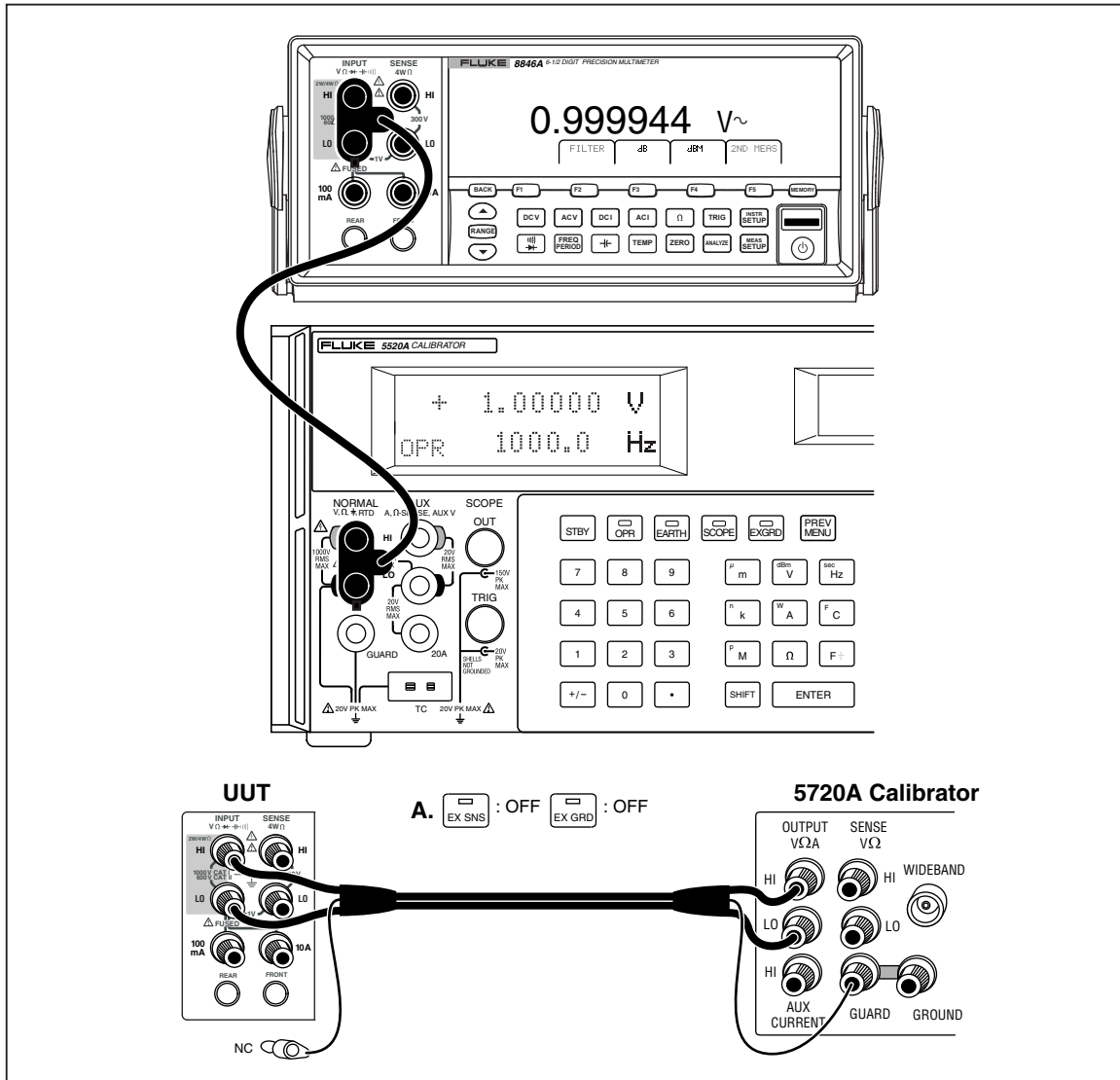

Figure 3-3. AC Volts Test Equipment Setup with 5520A

caw024.eps

Table 3-6. 8846A AC Volts Verification Steps

Nominal Input		Range	90-day Test Limits		1-year Test Limits	
Ampl.	Freq.		High	Low	High	Low
100.0 mV ^[1]	10 Hz	0.100	100.09 mV	99.91 mV	100.1 mV	99.9 mV
100.0 mV	20 kHz	0.100	100.09 mV	99.91 mV	100.1 mV	99.9 mV
100.0 mV	50 kHz	0.100	100.16 mV	99.84 mV	100.17 mV	99.83 mV
100.0 mV	100 kHz	0.100	100.68 mV	99.32 mV	100.68 mV	99.32 mV
100.0 mV	300 kHz	0.100	104.5 mV	95.5 mV	104.5 mV	95.5 mV
1 V ^[1]	10 Hz	1	1.0008 V	999.2 mV	1.0009 V	999.1 mV
1 V	20 kHz	1	1.0008 V	999.2 mV	1.0009 V	999.1 mV
1 V	50 kHz	1	1.0016 V	998.4 mV	1.0017 V	998.3 mV
1 V	100 kHz	1	1.0068 V	993.2 mV	1.0068 V	993.2 mV
1 V	300 kHz	1	1.045 V	955.0 mV	1.045 V	955.0 mV
10 V ^[1]	10 Hz	10	10.008 V	9.992 V	10.009 V	9.991 V
10 V ^[1]	20 kHz	10	10.008 V	9.992 V	10.009 V	9.991 V
10 V	50 kHz	10	10.016 V	9.984 V	10.017 V	9.983 V
10 V	100 kHz	10	10.068 V	9.932 V	10.068 V	9.932 V
3 V	300 kHz	10	3.17 V	2.83 V	3.17 V	2.83 V
100 V	45 Hz	100	100.08 V	99.92 V	100.09 V	99.91 V
100 V ^[1]	20 kHz	100	100.08 V	99.92 V	100.09 V	99.91 V
100 V	50 kHz	100	100.16 V	99.84 V	100.17 V	99.83 V
100 V ^[1]	100 kHz	100	100.68 V	99.32 V	100.68 V	99.32 V
1000 V	45 Hz	1000	1000.800	999.200	1.0009 kV	999.1 V
1000 V	1 kHz	1000	1000.800	999.200	1.0009 kV	999.1 V
1000 V ^[1]	10 kHz	1000	1000.800	999.200	1.0009 kV	999.1 V
320 V	20 kHz	1000	320.460	319.540	320.492 V	319.508 V
320 V	50 kHz	1000	320.852 V	319.148 V	320.884 V	319.116 V
320 V	100 kHz	1000	322.72 V	317.28 V	322.72 V	317.28 V

[1] 5520A must be used with 8508A to obtain suitable test uncertainty ratio.

Table 3-7. 8845A AC Volts Verification Steps

Nominal Input		Range	90-day Test Limits		1-year Test Limits	
Ampl.	Freq.		High	Low	High	Low
100.0 mV ^[1]	10 Hz	0.100	100.09 mV	99.91 mV	100.1 mV	99.9 mV
100.0 mV	20 kHz	0.100	100.09 mV	99.91 mV	100.1 mV	99.9 mV
100.0 mV	50 kHz	0.100	100.16 mV	99.84 mV	100.17 mV	99.83 mV
100.0 mV	100 kHz	0.100	100.68 mV	99.32 mV	100.68 mV	99.32 mV
100.0 mV	300 kHz	0.100	104.5 mV	95.5 mV	104.5 mV	95.5 mV
1 V ^[1]	10 Hz	1	1.0008 V	999.2 mV	1.0009 V	999.1 mV
1 V	20 kHz	1	1.0008 V	999.2 mV	1.0009 V	999.1 mV
1 V	50 kHz	1	1.0016 V	998.4 mV	1.0017 V	998.3 mV
1 V	100 kHz	1	1.0068 V	993.2 mV	1.0068 V	993.2 mV
1 V	300 kHz	1	1.045 V	955.0 mV	1.045 V	955.0 mV
10 V ^[1]	10 Hz	10	10.008 V	9.992 V	10.009 V	9.991 V
10 V ^[1]	20 kHz	10	10.008 V	9.992 V	10.009 V	9.991 V
10 V	50 kHz	10	10.016 V	9.984 V	10.017 V	9.983 V
10 V	100 kHz	10	10.068 V	9.932 V	10.068 V	9.932 V
3 V	300 kHz	10	3.17 V	2.83 V	3.17 V	2.83 V
100 V	45 Hz	100	100.08 V	99.92 V	100.09 V	99.91 V
100 V ^[1]	20 kHz	100	100.08 V	99.92 V	100.09 V	99.91 V
100 V	50 kHz	100	100.16 V	99.84 V	100.17 V	99.83 V
100 V ^[1]	100 kHz	100	100.68 V	99.32 V	100.68 V	99.32 V
750 V	45 Hz	750	750.600	749.400	750.675 V	749.325 V
750 V	1 kHz	750	750.600	749.400	750.675 V	749.325 V
750 V	10 kHz	750	750.600	749.400	750.675 V	749.325 V
320 V	20 kHz	750	320.385	319.615	320.417 V	319.583 V
320 V	50 kHz	750	320.727 V	319.273 V	320.759 V	319.241 V
320 V	100 kHz	750	322.52 V	317.48 V	322.52 V	317.48 V

[1] 5520A must be used with 8508A to obtain suitable test uncertainty ratio.

Table 3-8. 8845A/8846A AC Volts Frequency Verification Steps

Nominal Input		90-day Test Limits		1-year Test Limits	
Ampl.	Freq.	High	Low	High	Low
1 V	10 Hz	10.00300 Hz	9.99700 Hz	10.00300 Hz	9.99700 Hz
1 V	40 Hz	40.0040 Hz	39.9960 Hz	40.00400 Hz	39.9960 Hz
100 mV	300 kHz	300.030 kHz	29.99700 kHz	300.0300 kHz	29.99700 kHz
100 mV	1 MHz ^[1]	1.000100 MHz	999.9000 kHz	1.0001000 MHz	999.9000 kHz
[1] 8846A Only.					

4-Wire Ohms Verification

Connect the Meter to the test equipment as shown in Figure 3-4 and, depending on which meter you are calibrating, apply the resistance listed in Table 3-9 or Table 3-10. Verification forms can be found in Appendix A which can be copied and used to record each meter reading.

Note

For zero (0) ohms tests, use the 4-wire short to short the Hi/Lo and Sense inputs.

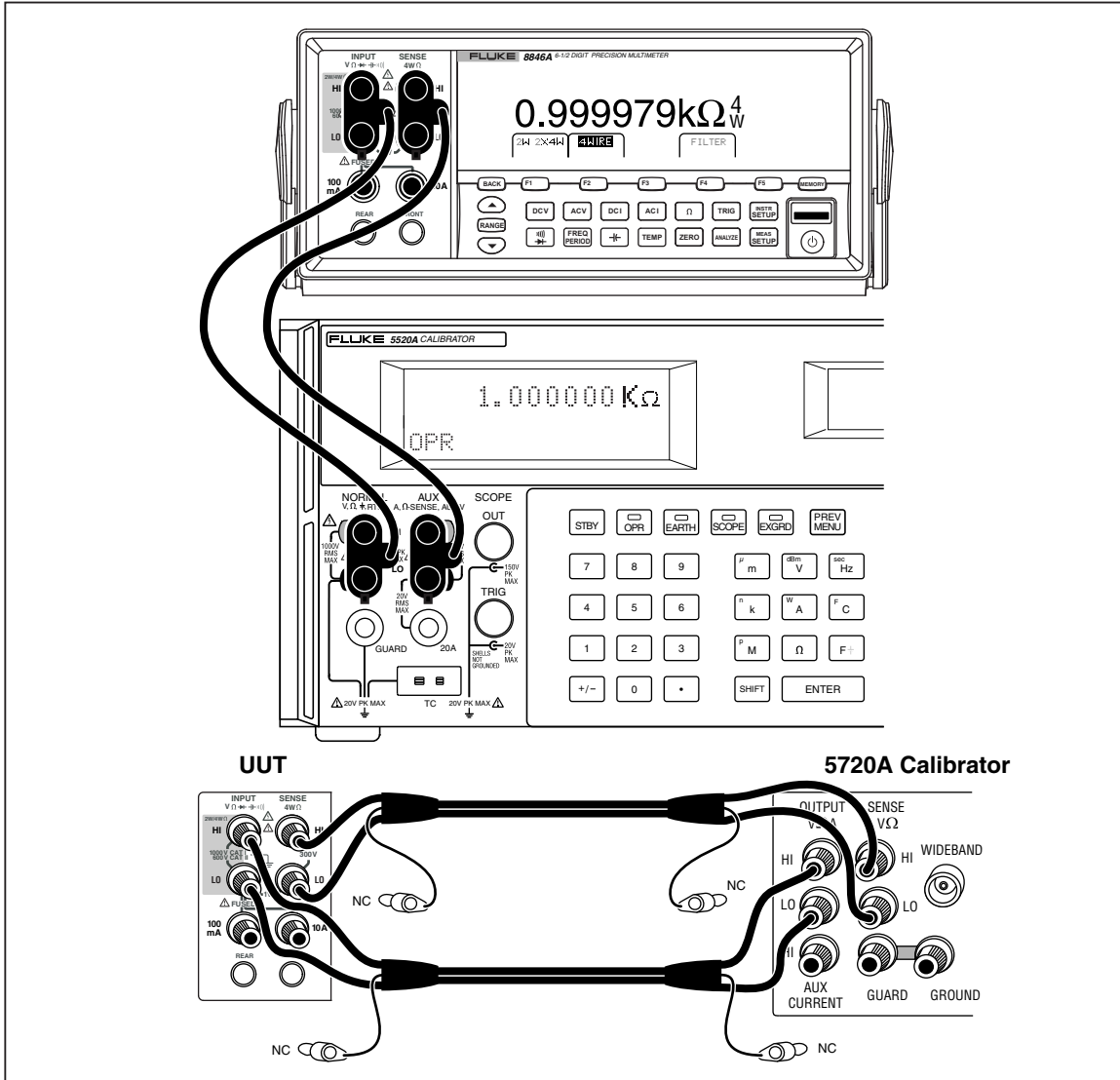

Figure 3-4. 4-Wire Ohms Test Equipment Setup

caw025.eps

Table 3-9. 8846A 4-Wire Ohms Verification Steps

Nominal Input	Range	90-day Test Limits		1-year Test Limits	
		High	Low	High	Low
0 Ω ^[1]	10	3.0 mΩ	0 Ω	3.0 mΩ	0 Ω
10 Ω ^[1]	10	10.00380 Ω	9.99620 Ω	10.00400 Ω	9.99600 Ω
0 Ω ^[2]	100	4.0 mΩ	0 Ω	4.0 mΩ	0 Ω
100 Ω ^[1]	100	100.0120 Ω	99.9880 Ω	100.01400 Ω	99.98600 Ω
0 Ω	1000	10.0 mΩ	0 Ω	10.0 mΩ	0 Ω
1 kΩ	1000	1000.090 Ω	999.910	1.00011000 kΩ	999.89000
0 Ω	10000	100.0 mΩ	0 Ω	100.0 mΩ	0 Ω
10 kΩ	10000	10.00090 kΩ	9999.10	1.000110 kΩ	9998.90
0 Ω	100000	1.000000	0 Ω	1.000000	0 Ω
100 kΩ	100000	100.0090 kΩ	99991.0	10.00110 kΩ	99989.0
[1] 5520A must be used with 8508A to obtain suitable test uncertainty ratio.					

Table 3-10. 8845A 4-Wire Ohms Verification Steps

Nominal Input	Range	90-day Test Limits		1-year Test Limits	
		High	Low	High	Low
0 Ω ^[1]	100	4.0 mΩ	0 Ω	4.0 mΩ	0 Ω
100 Ω ^[1]	100	100.0120 Ω	99.9880 Ω	100.01400 Ω	99.98600 Ω
0 Ω	1000	10.0 mΩ	0 Ω	10.0 mΩ	0 Ω
1 kΩ	1000	1.00009 kΩ	999.910 Ω	1.000110 kΩ	999.89000 Ω
0 Ω	10000	100.0 mΩ	0 Ω	100.0 mΩ	0 Ω
10 kΩ	10000	10.00090 kΩ	9999.10 Ω	10.00110 kΩ	9998.90 Ω
0 Ω	100000	1.000000 Ω	0 Ω	1.000000 Ω	0 Ω
100 kΩ	100000	100.0090 kΩ	99.9910 kΩ	100.0110 kΩ	99.9890 kΩ
[1] 5520A must be used with 8508A to obtain suitable test uncertainty ratio.					

2-Wire Ohms Verification

Connect the Meter to the test equipment as shown in Figure 3-5 and, depending on which meter you are calibrating, apply the resistance listed in Table 3-11 or Table 3-12. Verification forms can be found in Appendix A which can be copied and used to record each meter reading.

Note

For zero (0) ohms tests, use the 4-wire short to short the Hi/Lo and Sense inputs.

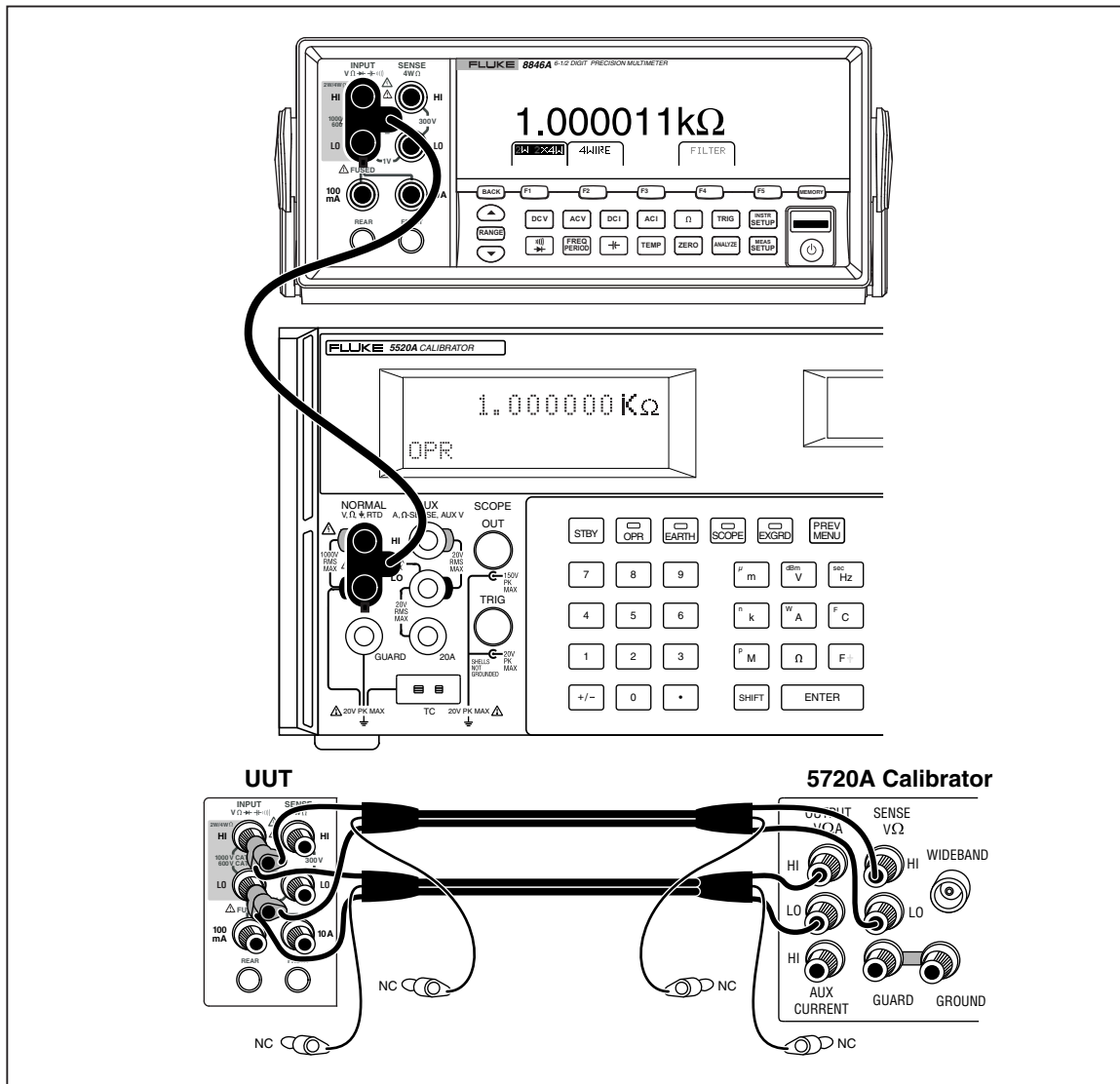

Figure 3-5. 2-Wire Ohms Test Equipment Setup

caw026.eps

Table 3-11. 8846A 2-Wire Ohms Verification Steps

Nominal Input	Range	90-day Test Limits ^[1]		1-year Test Limits ^[1]	
		High	Low	High	Low
0 Ω ^{[2] [3]}	100	4.0 mΩ	0 Ω	4.0 mΩ	0 Ω
100 Ω ^{[2] [3]}	100	100.01200 Ω	99.988 Ω	100.0140 Ω	99.9860 Ω
0 Ω	1000	10.0 mΩ	0 Ω	10.0 mΩ	0 Ω
1.000 kΩ	1000	1.00009 kΩ	999.910 Ω	1.000110 kΩ	999.890 Ω
0 Ω	10000	0.100000 Ω	0 Ω	0.100000 Ω	0 Ω
10.000 kΩ	10000	10.00090 kΩ	9.99910 kΩ	10.00110 kΩ	9.99890 kΩ
0 Ω	100000	1.000000 Ω	0 Ω	1.000000 Ω	0 Ω
100.000 kΩ	100000	100.0090 kΩ	99.9910 kΩ	100.0110 kΩ	99.9890 kΩ
0 Ω	1000000	10.00000 Ω	0 Ω	10.00000 Ω	0 Ω
1.00000 MΩ ^[2]	1000000	1.000090 MΩ	0.999910 MΩ	1.000110 MΩ	0.999890 MΩ
0 Ω ^[2]	10000000	100.0000 Ω	0 Ω	100.0000 Ω	0 Ω
10.0000 MΩ ^[2]	10000000	10.00210 MΩ	9.99790 MΩ	10.00410 MΩ	9.995900 MΩ
0	100000000	10.00000 kΩ	0 Ω	10.00000 kΩ	0 Ω
100.000 MΩ	100000000	100.8100 MΩ	99.1900 MΩ	100.8100 MΩ	99.1900 MΩ
0	1000000000	100.0000 kΩ	0 Ω	1.000000 MΩ	0 Ω
1.00000 GΩ ^[2]	1000000000	1.015100 GΩ	0.984900 GΩ	1.020100 GΩ	0.979900 GΩ

[1] Zero Meter before each measurement.
 [2] 5520A must be used with 8508A to obtain suitable test uncertainty ratio.
 [3] Optional test.

Table 3-12. 8845A 2-Wire Ohms Verification Steps

Nominal Input	Range	90-day Test Limits ^[1]		1-year Test Limits ^[1]	
		High	Low	High	Low
0 ^{[2] [3]}	100	4.0 mΩ	0 Ω	4.0 mΩ	0 Ω
100 Ω ^{[2] [3]}	100	100.01200 Ω	99.9880 kΩ	100.0140 Ω	99.9860 Ω
0	1000	10.0 mΩ	0 Ω	10.0 mΩ	0 Ω
1.000 kΩ	1000	1.000090 kΩ	0.99991 kΩ	1.000110 kΩ	0.999890 kΩ
0 Ω	10000	0.100000 Ω	0 Ω	0.100000 Ω	0 Ω
10.000 kΩ	10000	10.00090 kΩ	9.99910 kΩ	10.00110 kΩ	9.99890 kΩ
0 Ω	100000	1.000000 Ω	0 Ω	1.000000 Ω	0 Ω

Table 3-10. 8845A 2-Wire Ohms Verification Steps (cont.)

Nominal Input	Range	90-day Test Limits ^[1]		1-year Test Limits ^[1]	
		High	Low	High	Low
100.000 kΩ	100000	100.0090 kΩ	99.9910 kΩ	100.0110 kΩ	99.9890 kΩ
0 Ω	1000000	10.00000 Ω	0 Ω	10.00000 Ω	0 Ω
1.00000 MΩ ^[2]	1000000	1.000090 MΩ	0.999910 MΩ	1.000110 MΩ	0.999890 MΩ
0 ^[1]	10000000	100.0000 Ω	0 Ω	100.0000 Ω	0 Ω
10.0000 MΩ ^[2]	10000000	10.002100 MΩ	9.997900 MΩ	10.004100 MΩ	9.995900 MΩ
0	100000000	10000.00 Ω	0 Ω	10000.00 Ω	0 Ω
100.0000 MΩ	100000000	100.8100 MΩ	99.19000 MΩ	100.8100 MΩ	99.19000 MΩ

[1] Zero Meter before each measurement.
 [2] 5520A must be used with 8508A to obtain suitable test uncertainty ratio.
 [3] Optional test.

2X4 Test Lead Verification Steps

This optional test verifies Meter operation with the TL2X4W-PT 2X4-Wire Test Leads. To verify 2X4 Test Lead performance:

1. Plug the TL2X4W-PT 2X4-Wire Test Leads into the HI and LO terminals of the Meter (correct orientation is with the bump down)
2. Press Ω .
3. If not already highlighted, press the **2X4WIRE** soft key.
4. Connect the probe tips together to get the lowest reading.

The Meter should read under 3 milliohms. If the Meter reads above 3 milliohms, clean off the probes with a damp cloth and repeat step 4 above.

Note

If the leads are damaged, replace them.

Rear Panel Terminal Verification Steps

This optional test verifies Meter operation through the rear-panel input terminals.

After connecting the Meter to the test equipment as shown in Figure 3-6, apply the nominal values listed in Table 3-13 or Table 3-14, depending on which meter you are calibrating.

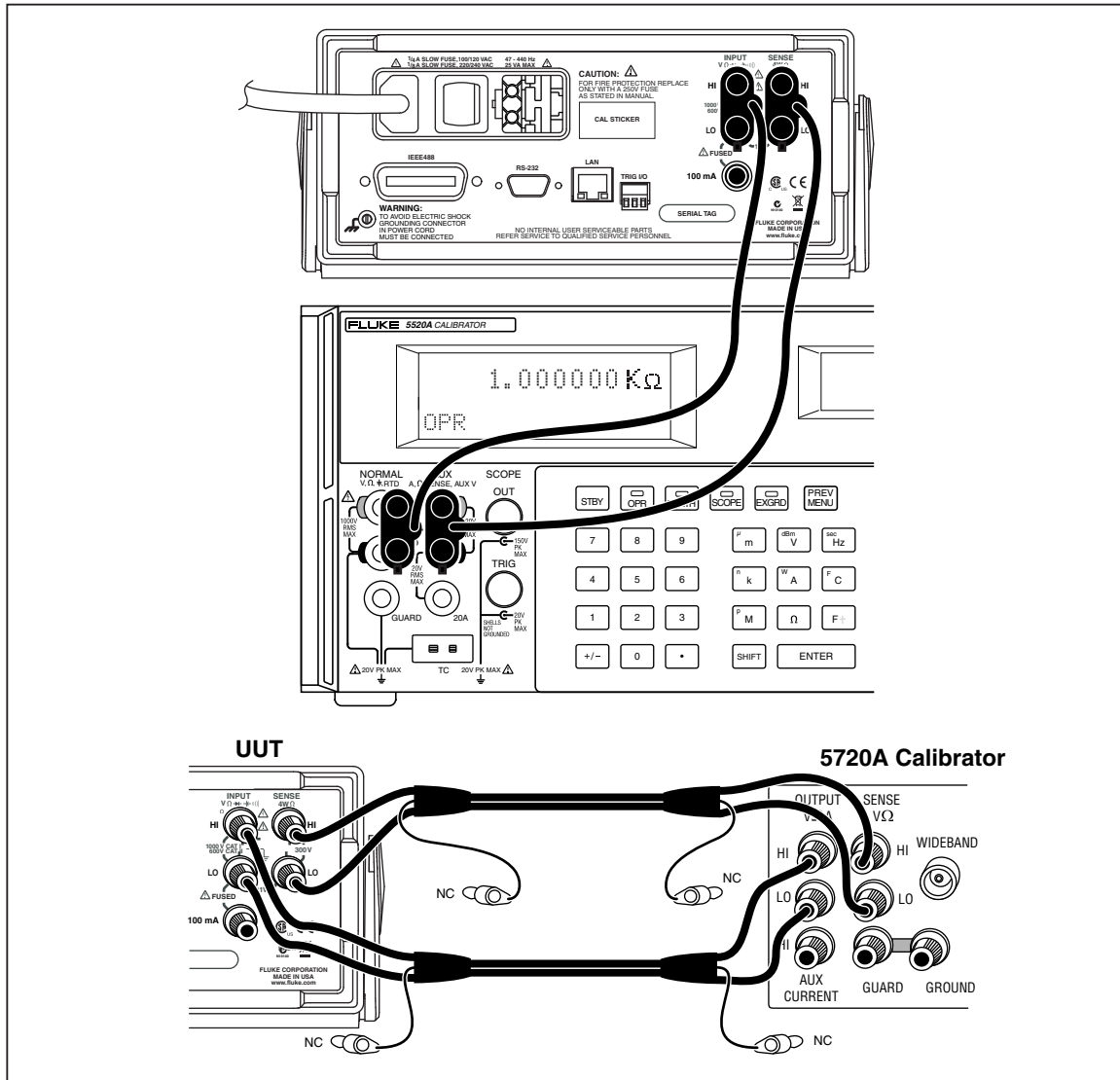

Figure 3-6. Rear-Panel Terminals Equipment Setup

caw027.eps

Table 3-13. 8846A Rear-Panel Terminal Verification Steps (Optional Test)

Nominal Input	Range	90-day Test Limits		1-year Test Limits	
		High	Low	High	Low
10 V dc ^[1]	10 V	10.00023 V	9.99977 V	10.00029 V	9.99971 V
1000 Ω	4-W 1 k Ω	1000.09 Ω	999.91 Ω	1000.11 Ω	999.89 Ω
100 mA	100 mA	0.100035 A	0.099965 A	0.100055 A	0.099945 A
[1] 5520A must be used with 8508A to obtain suitable test uncertainty ratio.					

Table 3-14. 8845A Rear-Panel Terminal Verification Steps (Optional Test)

Nominal Input	Range	90-day Test Limits		1-year Test Limits	
		High	Low	High	Low
10 V dc ^[1]	10 V	10.00025 V	9.99975 V	10.0004 V	9.9996 V
1000 Ω	4-W 1 k Ω	1000.09 Ω	999.91 Ω	1000.11 Ω	999.89 Ω
100 mA	100 mA	0.100035 A	0.099965 A	0.100055 A	0.099945 A
[1] 5520A must be used with 8508A to obtain suitable test uncertainty ratio.					

Capacitance Verification Steps (8846A only)

Connect the Meter to the test equipment as shown in Figure 3-7, and apply the capacitance values listed in Table 3-15. Verification forms can be found in Appendix A which can be copied and used to record each meter reading.

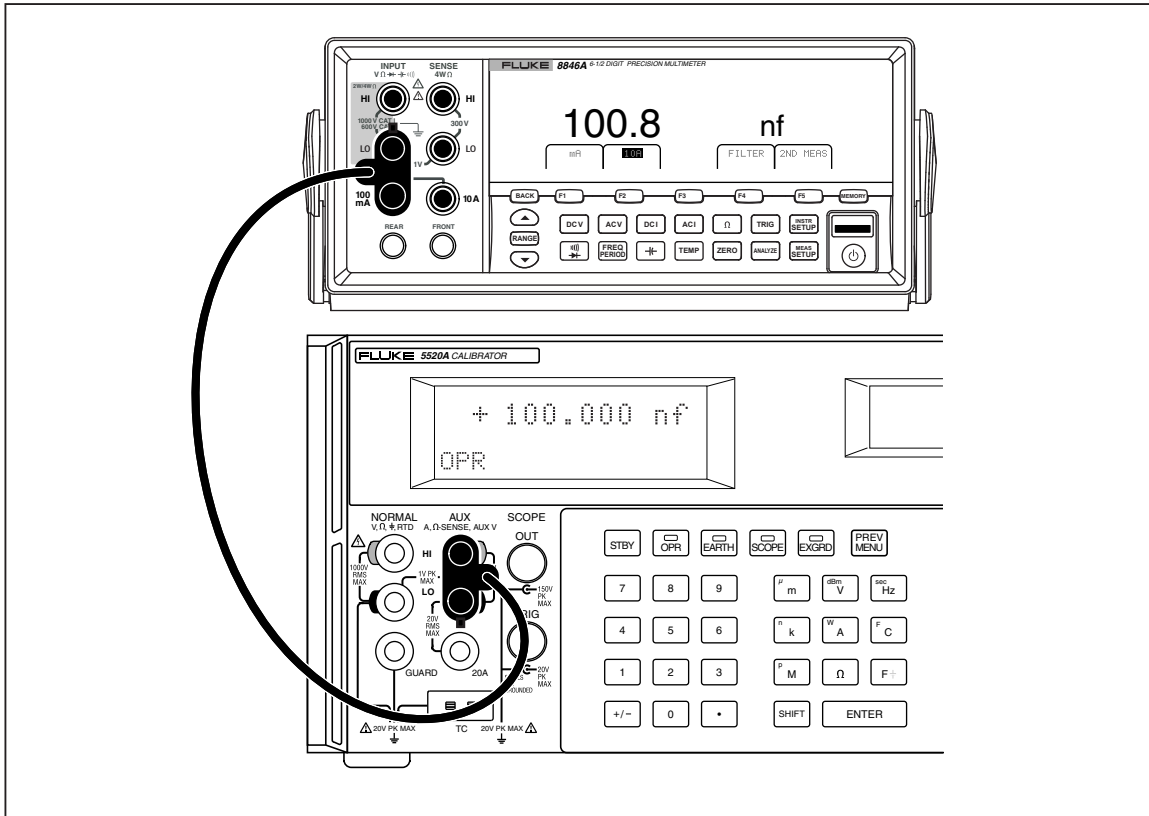

caw029.eps

Figure 3-7. Capacitance Equipment Setup

Table 3-15. 8846A Capacitance Verification Steps

Nominal Output	Range	1-year Test Limits	
		High (F)	Low (F)
0 nF	1.0 nF	25.0 pF	0 nF
1.0 nF	1.0 nF	1.045 nF	955.0 pF
10.0 nF	10.0 nF	10.15 nF	9.85 nF
100.0 nF	100.0 nF	101.5 nF	98.5 nF
1.0 μF	1.0 μF	1.015 μF	985.0 nF
10.0 μF	10.0 μF	10.15 μF	9.85 μF
100.0 μF	100.0 μF	101.5 μF	98.5 μF
1.0 mF	1.0 mF	1.015 mF	985.0 μF
10.0 mF	10.0 mF	10.15 mF	9.85 mF
100.0 mF	100.0 mF	104.2 mF	95.8 mF

DC Current Verification Steps

Connect the Meter to the test equipment as shown in Figure 3-8 and, depending on which meter you are calibrating, apply the nominal values listed in Table 3-16 or Table 3-17. Verification forms can be found in Appendix A which can be copied and used to record each meter reading.

Note

The 400 mA range is available only in with Outguard SW version 2.0 and later.

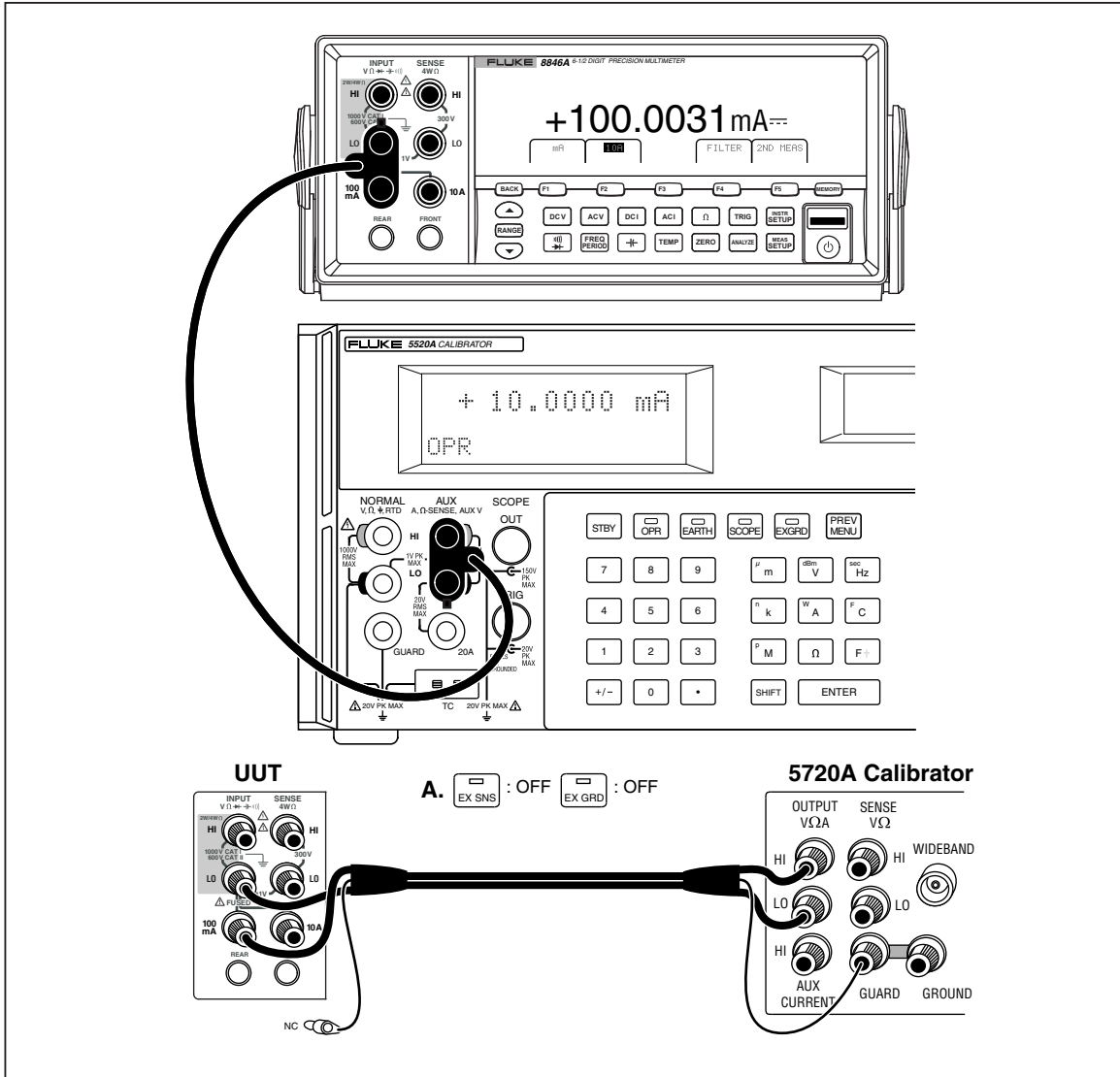

Figure 3-8. 100 mA DC Current Equipment Setup

caw022.eps

Table 3-16. 8846A DC Current Verification Steps

Nominal Input	Range	90-day Test Limits		1-year Test Limits	
		High	Low	High	Low
0 A ^[1]	100.0 μA	25.0 ηA	-25.0 ηA	25.0 ηA	-25.0 ηA
100.0 μA ^[1]	100.0 μA	100.065 μA	99.935 μA	100.075 μA	99.935 μA
-100.0 μA ^[1]	100.0 μA	-99.935 μA	-100.065 μA	-99.925 μA	-100.065 μA
0 A ^[1]	1.0 mA	50.0 ηA	-50.0 ηA	50.0 ηA	-50.0 ηA
1.0 mA	1.0 mA	1.00035 mA	999.65 μA	1.00055 mA	999.45 μA
-1.0 mA	1.0 mA	-999.65 μA	-1.00035 mA	-999.45 μA	-1.00055 mA
0 A	10.0 mA	2.0 μA	-2.0 μA	2.0 μA	-2.0 μA
10.0 mA	10.0 mA	10.005 mA	9.995 mA	10.007 mA	9.993 mA
-10.0 mA	10.0 mA	-9.995 mA	-10.005 mA	-9.993 mA	-10.007 mA
0 A	100.0 mA	5.0 μA	-5.0 μA	5.0 μA	-5.0 μA
100.0 mA	100.0 mA	100.035 mA	99.965 mA	100.055 mA	99.945 mA
-100.0 mA	100.0 mA	-99.965 mA	-100.035 mA	-99.945 mA	-100.055 mA
0 A	400 mA	20.0 μA	-20.0 μA	20.0 μA	-20.0 μA
400 mA	400 mA	400.18 mA	399.82 mA	400.22 mA	399.78 mA
-400 mA	400 mA	-399.82 mA	-400.18 mA	-399.78 mA	-400.22 mA
Move the connector from the 400 mA jack to the 10 A jack on the UUT for the following steps.					
0 A	1 A	200.0 μA	-200.0 μA	200.0 μA	-200.0 μA
1 A ^[1]	1 A	1.0006 A	999.4 mA	1.0007 A	999.3 mA
-1 A ^[1]	1 A	-999.4 mA	-1.0006 A	-999.3 mA	-1.0007 A
0 A	3 A	600.0 μA	-600.0 μA	600.0 μA	-600.0 μA
1.9 A	3 A	1.90212 A	1.89788 A	1.9025 A	1.8975 A
-1.9 A	3 A	-1.9978 A	-2.0022 A	-1.9974 A	-2.0026 A
0 A	10 A	800.0 μA	-800.0 μA	800.0 μA	-800.0 μA
10 A ^[1]	10 A	10.0128 A	9.9872 A	10.0158 A	9.9842 A
-10 A ^[1]	10 A	-9.9872 A	-10.0128 A	-9.9842 A	-10.0158 A
[1] 5520A must be used with 8508A to obtain suitable test uncertainty ratio.					

Table 3-17. 8845A DC Current Verifications Steps

Nominal Input	Range	90-day Test Limits		1-year Test Limits	
		High	Low	High	Low
0 A ^[1]	100.0 μ A	25.0 η A	-25.0 η A	25.0 η A	-25.0 η A
100.0 μ A ^[1]	100.0 μ A	100.065 μ A	99.935 μ A	100.075 μ A	99.935 μ A
-100.0 μ A ^[1]	100.0 μ A	-99.935 μ A	-100.065 μ A	-99.925 μ A	-100.065 μ A
0 A ^[1]	1.0 mA	50.0 η A	-50.0 η A	50.0 η A	-50.0 η A
1.0 mA	1.0 mA	1.00035 mA	999.65 μ A	1.00055 mA	999.45 μ A
-1.0 mA	1.0 mA	-999.65 μ A	-1.00035 mA	-999.45 μ A	-1.00055 mA
0 A	10.0 mA	2.0 μ A	-2.0 μ A	2.0 μ A	-2.0 μ A
10.0 mA	10.0 mA	10.005 mA	9.995 mA	10.007 mA	9.993 mA
-10.0 mA	10.0 mA	-9.995 mA	-10.005 mA	-9.993 mA	-10.007 mA
0 A	100.0 mA	5.0 μ A	-5.0 μ A	5.0 μ A	-5.0 μ A
100.0 mA	100.0 mA	100.035 mA	99.965 mA	100.055 mA	99.945 mA
-100.0 mA	100.0 mA	-99.965 mA	-100.035 mA	-99.945 mA	-100.055 mA
0 A	400 mA	20.0 μ A	-20.0 μ A	20.0 μ A	-20.0 μ A
400 mA	400 mA	400.18 mA	399.82 mA	400.22 mA	399.78 mA
-400 mA	400 mA	-399.82 mA	-400.18 mA	-399.78 mA	-400.22 mA
Move the connector from the 400 mA jack to the 10 A jack on the UUT for the following steps.					
0 A	1 A	200.0 μ A	-200.0 μ A	200.0 μ A	-200.0 μ A
1 A ^[1]	1 A	1.001 A	999.0 mA	1.0007 A	998.75 mA
-1 A ^[1]	1 A	-999.0 mA	-1.001 A	-999.3 mA	-1.0007 A
0 A	3 A	600.0 μ A	-600.0 μ A	600.0 μ A	-600.0 μ A
1.9 A ^[1]	3 A	1.90288 A	1.89712 A	1.9025 A	1.8975 A
-1.9 A ^[1]	3 A	-1.89788 A	-1.90212 A	-1.8975 A	-1.9025 A
0 A	10 A	800.0 μ A	-800.0 μ A	800.0 μ A	-800.0 μ A
10 A ^[1]	10 A	10.0128 A	9.9872 A	10.017 A	9.983 A
-10 A ^[1]	10 A	-9.9872 A	-10.0128 A	-9.983 A	-10.017 A

AC Current Verification Steps

Connect the Meter to the test equipment as shown in Figure 3-9 and, depending on which meter you are calibrating, apply the nominal values listed in Table 3-18 or Table 3-19. Verification forms can be found in Appendix A which can be copied and used to record each meter reading.

Note

The 400 mA range is only available in Outguard version 2.0 and later.

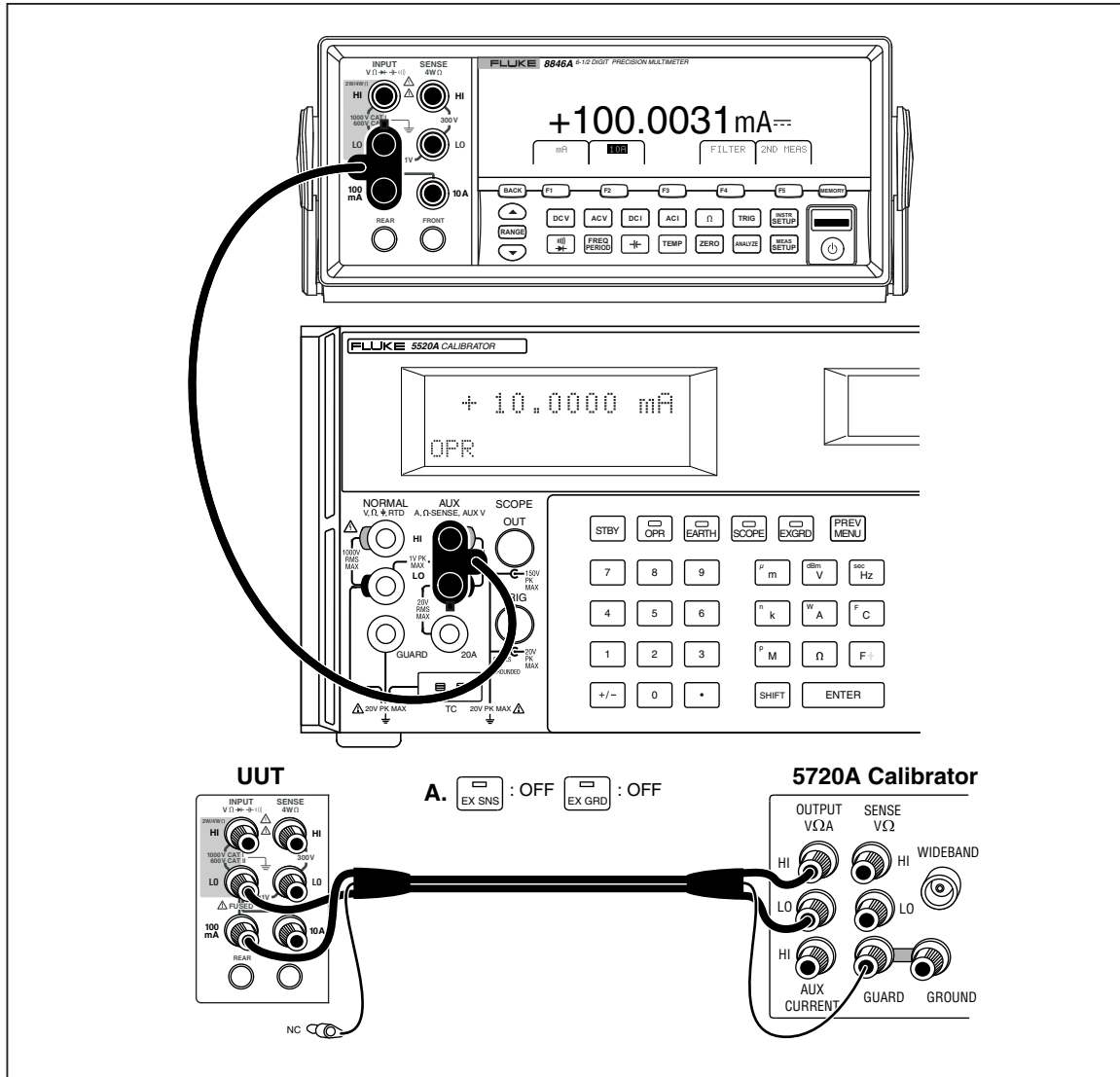

Figure 3-9. AC Current Equipment Setup

caw022.eps

Table 3-18. 8846A AC Current Verification Steps

Nominal Output		Range	90-day Test Limits		1-year Test Limits	
Amplitude	Freq.		High	Low	High	Low
100.0 $\mu\text{A}^{[1]}$	10 Hz	100.0 μA	100.14 μA	99.86 μA	100.14 μA	99.86 μA
100.0 μA	1 kHz	100.0 μA	100.14 μA	99.86 μA	100.14 μA	99.86 μA
100.0 $\mu\text{A}^{[1]}$	5 kHz	100.0 μA	100.14 μA	99.86 μA	100.14 μA	99.86 μA
100.0 $\mu\text{A}^{[1]}$	10 kHz	100.0 μA	100.45 μA	99.55 μA	100.45 μA	99.55 μA
1.0 $\text{mA}^{[1]}$	10 Hz	1.0 mA	1.0014 mA	998.6 μA	1.0014 mA	998.6 μA
1.0 mA	1 kHz	1.0 mA	1.0014 mA	998.6 μA	1.0014 mA	998.6 μA
1.0 $\text{mA}^{[1]}$	5 kHz	1.0 mA	1.0014 mA	998.6 μA	1.0014 mA	998.6 μA
1.0 $\text{mA}^{[1]}$	10 kHz	1.0 mA	1.0045 mA	995.5 μA	1.0045 mA	995.5 μA
10.0 $\text{mA}^{[1]}$	10 Hz	10.0 mA	10.014 mA	9.986 mA	10.014 mA	9.986 mA
10.0 mA	1 kHz	10.0 mA	10.014 mA	9.986 mA	10.014 mA	9.986 mA
10.0 $\text{mA}^{[1]}$	5 kHz	10.0 mA	10.014 mA	9.986 mA	10.014 mA	9.986 mA
10.0 $\text{mA}^{[1]}$	10 kHz	10.0 mA	10.045 mA	9.955 mA	10.045 mA	9.955 mA
100.0 $\text{mA}^{[1]}$	10 Hz	100.0 mA	100.14 mA	99.86 mA	100.14 mA	99.86 mA
100.0 mA	1 kHz	100.0 mA	100.14 mA	99.86 mA	100.14 mA	99.86 mA
100.0 $\text{mA}^{[1]}$	5 kHz	100.0 mA	100.14 mA	99.86 mA	100.14 mA	99.86 mA
100.0 $\text{mA}^{[1]}$	10 kHz	100.0 mA	100.45 mA	99.55 mA	100.45 mA	99.55 mA
329.0 $\text{mA}^{[1]}$	10 Hz	400 mA	330.387 mA	327.613 mA	330.387 mA	327.613 mA
329.0 $\text{mA}^{[1]}$	1 kHz	400 mA	329.729 mA	328.271 mA	329.729 mA	328.271 mA
329.0 $\text{mA}^{[1]}$	5 kHz	400 mA	332.458 mA	325.542 mA	332.458 mA	325.542 mA
329.0 $\text{mA}^{[1]}$	10 kHz	400 mA	332.458 mA	325.542 mA	332.458 mA	325.542 mA
1 $\text{A}^{[1]}$	45 Hz	1 A	1.0014 A	998.6 mA	1.00140 A	998.6 mA
1 A	1 kHz	1 A	1.0014 A	998.6 mA	1.00140 A	998.6 mA
1 $\text{A}^{[1]}$	5 kHz	1 A	1.0014 A	998.6 mA	1.00140 A	998.6 mA
1 $\text{A}^{[1]}$	10 kHz	1 A	1.0105 A	989.5 mA	1.01050 A	989.5 mA
1.9 $\text{A}^{[1]}$	45 Hz	3 A	1.90465 A	1.89535 A	1.90465 A	1.89535 A
1.9 A	1 kHz	3 A	1.90465 A	1.89630 A	1.90465 A	1.89535 A
1.9 $\text{A}^{[1]}$	10 kHz	3 A	1.92765 A	1.87235 A	1.92765 A	1.87235 A
10 $\text{A}^{[1]}$	45 Hz	10 A	10.02100 A	9.97900 A	10.02100 A	9.97900 A
10 A	1 kHz	10 A	10.02100 A	9.97900 A	10.02100 A	9.97900 A
Notes:						
[1] Optional test						

Table 3-19. 8845A AC Current Verification Steps

Nominal Output		Range	90-day Test Limits		1-year Test Limits	
Ampl	Freq		High	Low	High	Low
10.0 mA ^[1]	10 Hz	10.0 mA	10.014 mA	9.986 mA	10.014 mA	9.986 mA
10.0 mA	1 kHz	10.0 mA	10.014 mA	9.986 mA	10.014 mA	9.986 mA
10.0 mA ^[1]	5 kHz	10.0 mA	10.014 mA	9.986 mA	10.014 mA	9.986 mA
10.0 mA ^[1]	10 kHz	10.0 mA	10.045 mA	9.955 mA	10.045 mA	9.955 mA
100.0 mA ^[1]	10 Hz	100.0 mA	100.14 mA	99.86 mA	100.14 mA	99.86 mA
100.0 mA	1 kHz	100.0 mA	100.14 mA	99.86 mA	100.14 mA	99.86 mA
100.0 mA ^[1]	5 kHz	100.0 mA	100.14 mA	99.86 mA	100.14 mA	99.86 mA
100.0 mA ^[1]	10 kHz	100.0 mA	100.45 mA	99.55 mA	100.45 mA	99.55 mA
329.0 mA ^[1]	10 Hz	400 mA	330.387 mA	327.613 mA	330.387 mA	327.613 mA
329.0 mA ^[1]	1 kHz	400 mA	329.729 mA	328.271 mA	329.729 mA	328.271 mA
329.0 mA ^[1]	5 kHz	400 mA	332.458 mA	325.542 mA	332.458 mA	325.542 mA
329.0 mA ^[1]	10 kHz	400 mA	332.458 mA	325.542 mA	332.458 mA	325.542 mA
1 A ^[1]	45 Hz	1 A	1.0014 A	998.6 mA	1.00140 A	998.6 mA
1 A	1 kHz	1 A	1.0014 A	998.6 mA	1.00140 A	998.6 mA
1 A ^[1]	5 kHz	1 A	1.0014 A	998.6 mA	1.00140 A	998.6 mA
1 A ^[1]	10 kHz	1 A	1.0105 A	989.5 mA	1.01050 A	989.5 mA
1.9 A ^[1]	45 Hz	3 A	1.90465 A	1.89535	1.90465 A	1.89535 A
1.9 A	1 kHz	3 A	1.90465 A	1.89630	1.90465 A	1.89535 A
1.9 A ^[1]	10 kHz	3 A	1.92765 A	1.87235	1.92765 A	1.87235 A
10 A ^[1]	45 Hz	10 A	10.01900 A	9.98100 A	10.02100 A	9.97900 A
10 A	1 kHz	10 A	10.01900 A	9.98100 A	10.02100 A	9.97900 A

Notes:
[1] Optional test

Adjustment (Calibration)

Meter adjustments, or calibration, should be performed at the desired interval, or whenever a verification test indicates a Meter function is out of tolerance. The Meter accuracy will stay within specifications only if the adjustment procedure is performed at regular intervals. A one-year interval is adequate for most applications. The Meter's accuracy specifications are not valid beyond the one-year interval.

Meter adjustments are accessed only through the remote interface with a series of adjustment steps. The remote program directs the test equipment to apply a series of shorts, opens, voltages, currents, and capacitance (8846A only) to the Meter. At each step, the Meter internally makes the necessary adjustment to bring the Meter into specification. No internal mechanical adjustments are necessary.

Using an automated, computer-controlled procedure, the calibration and verification procedures can be performed on the Meter in under 60 minutes. A sample adjustment program is listed on the “Sample Adjustment Program” section later in this manual. A MetCal program is available at www.fluke.com to adjust the Meter.

The Meter’s adjustments are password protected to prevent accidental or unauthorized adjustments. The security password must be entered through the front panel or remote interface before adjustments can be made to the Meter.

Unlocking the Meter for Adjustments (Calibration)

To unlock the Meter for adjustments from the front panel:

1. Press .
2. Press **CAL**.
3. Press **UNLOCK CAL**.

Press the soft key labeled **--** to decrement the character or **++** to increment the character. The character can be set to 0 through 9, A through Z, period (.), and dash (-).

To move to the next character, press **-->**.

4. Press **ENTER** to enter the password and unlock the Meter for adjustments.

Find the CALIBRATION:SECURE:STATE command in the “Supported SCPI Commands” section of the *8846A/8845A Programmers Manual* for information on unlocking the Meter for calibration.

The Meter is shipped from the factory with the password set to **FLUKE884X**.

Unlocking the Meter for Adjustments Over a Remote Interface

To unlock the Meter, send the following command:

```
"CAL:SEC:STAT OFF, FLUKE884X"
```

To relock the Meter, send the following command:

```
"CAL:SEC:STAT ON, FLUKE884X"
```

Changing the Calibration Password

The calibration password can be changed only through the remote interface. Find the CALIBRATION:SECURE:CODE command in the “Supported SCPI Commands” section of the *8846A/8845A Programmers Manual* for information on changing the calibration password.

Resetting the Calibration Password

If the calibration password has is lost or forgotten, the password can be reset to **FLUKE884X** by performing the following actions.

Note

*Before taking the following steps, try to use the factory default password **FLUKE884X**.*

1. Perform the general disassembly steps in the “Disassembly Instructions” section.
2. Connect a jumper across W2, as shown in Figure 3-10.

3. Reconnect the power cord between the Meter and a power outlet.
4. Turn the Meter on.

On power-up, the password will automatically be reset to **FLUKE884X**.

5. Turn the Meter off and disconnect the power cord.
6. Remove the jumper connected above in step 2.
7. Reassemble the Meter.

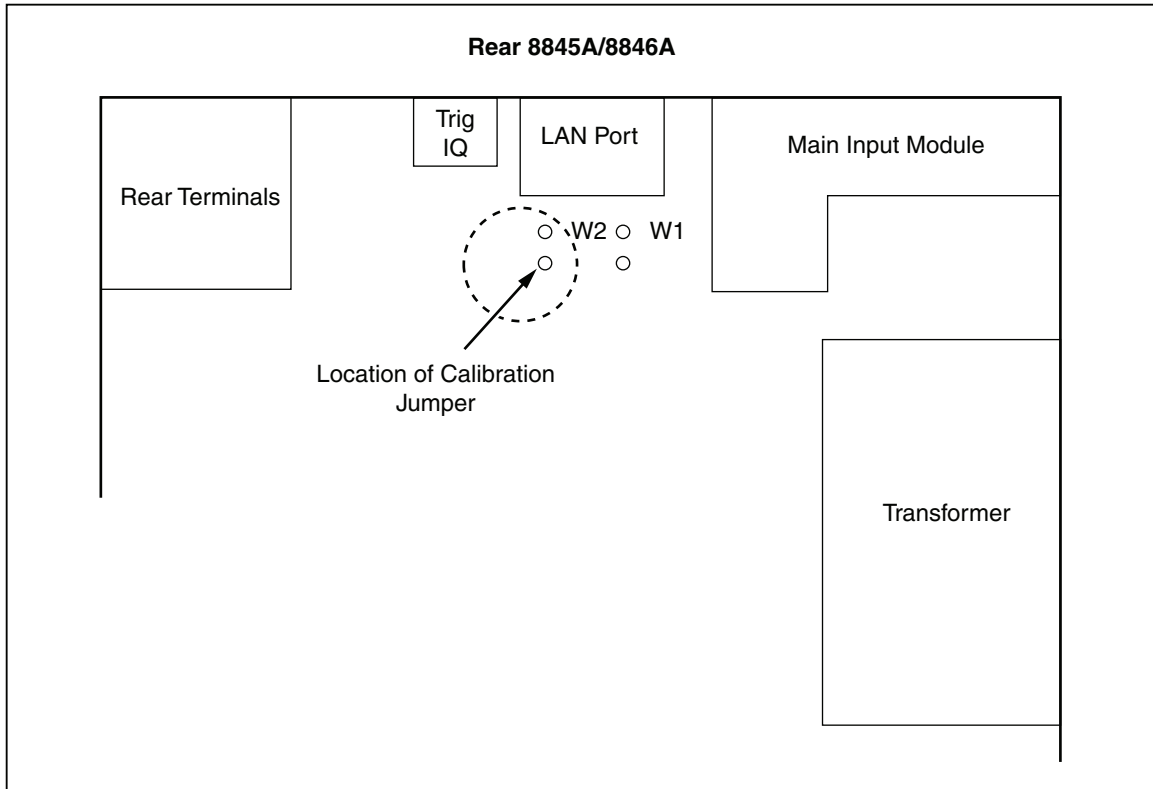

Figure 3-10. Calibration Jumper Location

caw028.eps

Changing the Calibration Date Remotely

The 8845A's calibration date can only be changed remotely.

Note

Calibration must be enabled before sending the following command.

```
"CAL:DATE mm/dd/yyyy"
```

The 8846A calibration date is automatically updated when the "CAL:REC" command is sent. See the 8845A 8846A Programmers Manual for more details.

Equipment for Calibration

The required equipment for calibration is that same the equipment listed in Table 3-1.

Adjustment Process

The adjustment steps differ slightly between the 8845A and 8846A. In both cases, they are divided into four areas: open adjust, zero adjust, rear panel zero adjust, and gain adjust.

Table 3-20 lists the step numbers, the description of the adjustment, the measurement adjustment type (open, zero, or gain adjust), the Meter value/range being adjusted, the amplitude of the adjustment signal, and if required the frequency of the adjustment signal.

Table 3-20. 8845A/8846A Adjustment Steps

Step	Modes	Value Range	Input Signal	Description	Series
Open					
0	ORES	100000000	open	OHM 100M open terminals	Y
1	ORES	1000000000	open	OHM 1G open terminals (8846A only)	Y
2	ZCAP	1.00E-09	open	CAP 1 nF open terminals (8846A only)	N
ACV Zero					
3	ZVAC	100.0E-3	4-wire low-thermal short	AC 100 mV	Y
4	ZVACS	100.0E-3	4-wire low-thermal short	AC 100 mV	Y
5	ZVAC	1	4-wire low-thermal short	AC 1V	Y
6	ZVACS	1	4-wire low-thermal short	AC 1V	Y
7	ZVAC	10	4-wire low-thermal short	AC 10V	Y
8	ZVACS	10	4-wire low-thermal short	AC 10V	Y
9	ZVAC	100	4-wire low-thermal short	AC 100V	Y
10	ZVACS	100	4-wire low-thermal short	AC 100V	Y
11	ZVAC	1000	4-wire low-thermal short	AC 1000V	Y
12	ZVACS	1000	4-wire low-thermal short	AC 1000V	N
DCV Zero					
13	ZVDC	1000	4-wire low-thermal short	DC 1000V	Y
14	ZVDC	100	4-wire low-thermal short	DC 100V	Y
15	ZVDC	10	4-wire low-thermal short	DC 10V	Y
16	ZVDC	1	4-wire low-thermal short	DC 1V	Y
17	ZVDC	0.1	4-wire low-thermal short	DC 100mV	N
18	DFVDC	0.1	4-wire low-thermal short	DC 100mV	N
Ohm Zero					
19	ZRES	10000000	4-wire low-thermal short	4W Ohm 10 MOHM	Y
20	ZRES	1000000	4-wire low-thermal short	4W 1 MOHM	Y
21	ZRES	100000	4-wire low-thermal short	4W 100 KOHM	Y
22	ZRES	10000	4-wire low-thermal short	4W 10 KOHM	Y
23	ZRES	1000	4-wire low-thermal short	4W 1 KOHM	Y
24	ZRES	100	4-wire low-thermal short	4W 100 OHM	Y

Table 3-18. 8845A/8846A Adjustment Steps (cont)

Step	Modes	Value Range	Input Signal	Description	Series
25	ZRES	10	4-wire low-thermal short	4W 10 OHM (8846A only)	N
Rear Ω Zero					
26	ZRES	100000	4-wire low-thermal short	4W 100 KOHM rear input	Y
27	ZRES	10000	4-wire low-thermal short	4W 10 KOHM rear input	Y
28	ZRES	1000	4-wire low-thermal short	4W 1 KOHM rear input	Y
29	ZRES	100	4-wire low-thermal short	4W 100 OHM rear input	Y
30	ZRES	10	4-wire low-thermal short	4W 10 OHM rear input (8846A only)	N
Rear DCV Zero					
31	ZVDC	1	4-wire low-thermal short	DC 1V rear input	Y
32	ZVDC	0.1	4-wire low-thermal short	DC 100 mV rear input	N
Low I Zero					
33	ZIDC	100.0E-3	100mA to Lo short	DC 100 mA	Y
34	ZIDC	1.0E-3	100mA to Lo short	DC 1 mA	Y
35	ZIDC	10.0E-3	100mA to Lo short	DC 10 mA	Y
36	ZIDC	100.0E-6	100mA to Lo short	DC 100 μ A	Y
37	ZIAC	0.0	100mA to Lo short	AC 100 μ A	Y
38	ZIACS	0.0	100mA to Lo short	AC 100 μ A	Y
39	ZIAC	1.0E-3	100mA to Lo short	AC 1 mA	Y
40	ZIACS	1.0E-3	100mA to Lo short	AC 1 mA	Y
41	ZIAC	10.0E-3	100mA to Lo short	AC 10 A	Y
42	ZIACS	10.0E-3	100mA to Lo short	AC 10 mA	Y
43	ZIAC	100.0E-3	100mA to Lo short	AC 100 mA	Y
44	ZIACS	100.0E-3	100mA to Lo short	AC 100 mA	N
Hi I Zero					
45	ZIDC	10	10 A to Lo short	DC 10 A	Y
46	ZIDC	1	10 A to Lo short	DC 1 A	Y
47	ZIAC	1	10 A to Lo short	AC 1 A	Y

Table 3-18. 8845A/8846A Adjustment Steps (cont)

Step	Modes	Value Range	Input Signal	Description	Series
48	ZIACS	1	10 A to Lo short	AC 1 A	Y
49	ZIAC	10	10 A to Lo short	AC 10 A	Y
AC	ZIACS	10	10 A to Lo short	AC 10 A	N
50	Linearity				
51	ACLIN	1.19	1.19 @ 1200 Hz	AC 1 V	N
52	ACLIN	0.8	0.8 @ 1200 Hz	AC 1 V	N
53	ACLIN	0.4	0.4 @ 1200 Hz	AC 1 V	N
54	ACLIN	0.005	0.005 @ 1200 Hz	AC 1 V	N
ACV Gain					
55	GVAC	0.1	0.1 @ 1200 Hz	AC 100 mV	Y
56	GVACS	0.1	0.1 @ 1200 Hz	AC 100 mV	N
57	ACPOLE	0.1	0.1 @ 50000 Hz	A 100 mV	N
58	GVAC	1	1 @ 1200 Hz	AC 1 V	Y
59	GVACS	1	1 @ 1000 Hz	AC 1 V	N
60	FVAC	1	1 @ 10 Hz	AC 1 V	N
61	ACPOLE	1	1 @ 50000 Hz	AC 1 V	N
62	GVAC	10	10 @ 1200 Hz	AC 10 V	Y
63	GVACS	10	10 @ 1200 Hz	AC 10 V	N
64	ACPOLE	10	10 @ 50000 Hz	AC 10 V	N
65	GVAC	100	100 @ 1200 Hz	AC 100 V	Y
66	GVACS	100	100 @ 1200 Hz	AC 100 V	N
67	ACPOLE	100	100 @ 50000 Hz	AC 100 V	N
68	GVAC	1000	1000 @ 1200 Hz	AC 1000 V (8845A use 750V on 750V range)	Y
69	GVACS	1000	1000 @ 1200 Hz	AC 1000 V (8845A use 750V on 750V range)	N
70	ACPOLE	1000	329 @ 50000 Hz	AC 1000 V (use 8845A 750V range)	N
VDC Gain					
71	GVDC	1000	1000	DC 1000 V	N
72	GVDC	-1000	-1000	DC 1000 V	N
73	GVDC	100	100	DC 100 V	N
74	GVDC	-100	-100	DC 100 V	N

Table 3-18. 8845A/8846A Adjustment Steps (cont)

Step	Modes	Value Range	Input Signal	Description	Series
75	GVDC	10	10	DC 10 V	N
76	GVDC	-10	-10	DC 10 V	N
77	GVDC	1	1	DC 1 V	N
78	GVDC	-1	-1	DC 1 V	N
79	GVDC	0.1	0.1	DC 100 mV	N
80	GVDC	-0.1	-0.1	DC 100 mV	N
Hi IDC Gain					
81	GIDC	1	1	DC 1 A	N
82	GIDC	-1	-1	DC 1 A	N
83	GIDC	10	10	DC 10 A	N
84	GIDC	-10	-10	DC 10 A	N
Hi IAC Gain					
85	GIAC	10	10	AC 10 A	Y
86	GIACS	10	10	AC 10 A	N
87	GIAC	1	1	AC 1 A	Y
88	GIACS	1	1	AC 1 A	N
Low IAC Gain					
89	GIAC	100.0E-3	100.0E-3	AC 100 mA	Y
90	GIACS	100.0E-3	100.0E-3	AC 100 mA	N
91	GIAC	10.0E-3	10.0E-3	AC 10 mA	Y
92	GIACS	10.0E-3	10.0E-3	AC 10 mA	N
93	GIAC	1.0E-3	1.0E-3	AC 1 mA	Y
94	GIACS	1.0E-3	1.0E-3	AC 1 mA	N
95	GIAC	100.0E-6	100.0E-6	AC 100 μ A	N
96	GIACS	100.0E-6	100.0E-6	AC 100 μ A	N
Lo IDC Gain					
97	GIDC	100.0E-6	100.0E-6	DC 100 μ A	N
98	GIDC	-100.0E-6	-100.0E-6	DC 100 μ A	N
99	GIDC	1.0E-3	1.0E-3	DC 1 mA	N
100	GIDC	-1.0E-3	-1.0E-3	DC 1 mA	N

Table 3-18. 8845A/8846A Adjustment Steps (cont)

Step	Modes	Value Range	Input Signal	Description	Series
101	GIDC	10.0E-3	10.0E-3	DC 10 mA	N
102	GIDC	-10.0E-3	-10.0E-3	DC 10 mA	N
103	GIDC	100.0E-3	100.0E-3	DC 100 mA	N
104	GIDC	-100.0E-3	-100.0E-3	DC 100 mA	N
Ω Gain					
105	GRES	100000000	100000000	R 100M Ω	N
106	GRES	10000000	10000000	4W 10M Ω	N
107	GRES	1000000	1000000	4W 1M Ω	N
108	GRES	100000	100000	4W 100 kΩ	N
109	GRES	10000	10000	4W 10 kΩ	N
110	GRES	1000	1000	4W 1 kΩ	N
111	GRES	100	100	4W 100 Ω	N
112	GRES	10	10	4W 10 Ω (8846A only)	N
Misc Gain					
113	GRES	1000000000	1000000000	R1G Ω (8846A only)	N
114	GCAP1	10.0E-9	10.0E-9	C10NF (8846A only)	Y
115	GCAP2	10.0E-9	10.0E-9	C10NF (8846A only)	N

Once familiar with the calibration series of setups, the calibration time may be sped up by using the command “**CAL OFF**”. This command allows the instrument to automatically go to the next logical step in the series. The last column in Table 3-20 identifies which steps in the series can be run automatically. For example, all of the Open steps can be run by entering:

```
CAL:CAL ORES, 100000000
CAL? OFF
```

Another example is automatically running the ACV zeros from step 3 through step 12 in Table 3-20 with:

```
CAL:CAL ZVAC, 100.0E-3
CAL? OFF
```

Notes

Using the CAL? command without an argument turns off the single step feature.

AC linearity steps must be run with AC Gain steps to complete the AC calibration.

Aborting a Calibration Process

⚠ Caution

Aborting a calibration process while the Meter is attempting to write new calibration constants to memory may corrupt the calibration constants memory.

To abort a running calibration process, stop the program or issue a device clear command over the remote interface. No constants are saved until the Meter receives a record command.

Sample Adjustment Program

The example below shows an IEEE 488 program that uses some of the commands to adjust the 1V ACV portion of the Meter. Note that the ACV linearity adjustment must be followed with a gain adjustment. Print is an output command to the Meter. Input Line reads a response from the Meter.

```
INIT PORT 0<CR>
CLEAR PORT 0<CR>
# Enable Calibration
PRINT @<address of meter>, "CAL:SEC:STAT OFF, FLLUKE448X"
# Zeros
### Calibrate AC Linearity Set input value to 1.19V@1200Hz
# V@1200Hz
PRINT @<address of meter>, "CAL:VAL ACLIN,1.19"
PRINT @<address of meter>, "CAL? ON"
INPUT LINE @<address of meter>, A$
### Calibrate AC Linearity Set input value to 0.8V@1200Hz
# 0.8V@1200Hz
PRINT @<address of meter>, "CAL:VAL ACLIN,0.8"
PRINT @<address of meter>, "CAL? ON"
INPUT LINE @<address of meter>, A$
### Calibrate AC Linearity Set input value to 0.4V@1200Hz
# 0.4V@1200Hz
PRINT @<address of meter>, "CAL:VAL ACLIN,0.4"
PRINT @<address of meter>, "CAL? ON"
INPUT LINE @<address of meter>, A$
### Calibrate AC Linearity Set input value to 0.05V@1200Hz
# 0.005V@1200Hz
PRINT @<address of meter>, "CAL:VAL ACLIN,0.005"
PRINT @<address of meter>, "CAL? ON"
INPUT LINE @<address of meter>, A$PRINT @<address of meter>, "CAL:VAL"
### ACV Gain for 1V
PRINT @<address of meter>, "CAL:VAL ZVAC,1"
PRINT @<address of meter>, "CAL? ON"
INPUT LINE @<address of meter>, A$
PRINT @<address of meter>, "CAL:VAL ZVACS,1"
PRINT @<address of meter>, "CAL? ON"
INPUT LINE @<address of meter>, A$
# Disable Calibration
PRINT @<address of meter>, "CAL:SEC:STAT ON, FLUKE884X"
```

For more information about writing a program to remotely control the Meter, refer to the *8845A/8846A Programmer's Manual*.

Chapter 4
List of Replaceable Parts

Title	Page
Introduction.....	4-3
How to Obtain Parts.....	4-3
How to Contact Fluke.....	4-3
Parts	4-4

Introduction

This chapter contains an illustrated list of replaceable parts for the Fluke 8845A and 8846A Digital Multimeters. Parts are listed by assembly and alphabetized by reference designator. Each assembly is accompanied by an illustration showing the location of each part and its reference designator. The parts lists provide the following information:

- Reference designator
- An indication if the part is subject to static discharge damage
- Description
- Fluke stock number
- Total quantity
- Any special notes (i.e., factory-selected part)

⚠ Caution

An asterisk (*) indicates a part that may be damaged by static discharge.

How to Obtain Parts

Electrical components may be ordered directly from the manufacturer by using the manufacturer's part number, or from the Fluke Corporation and its authorized representatives by using the part number under the heading FLUKE STOCK NO.

Parts price information is available from the Fluke Corporation or its representatives. Prices are also available in a Fluke Replacement Parts Catalog, which is available on request.

In the event that the part ordered has been replaced by a new or improved part, the replacement will be accompanied by an explanatory note and if necessary, installation instructions.

To ensure prompt delivery of the correct part, include the following information when you place an order:

- Instrument model and serial number
- Part number and revision level of the pca containing the part.
- Reference designator
- Fluke stock number
- Description (as given under the DESCRIPTION heading)
- Quantity

How to Contact Fluke

To contact Fluke, visit Fluke's web site at www.fluke.com or call one of the following telephone numbers:

USA and Canada: 1-888-99-FLUKE (1-888-993-5853)
Europe: +31 402-675-200
Japan: +81-3-3434-0181

Singapore: +65-738-5655
 Anywhere in the world: +1-425-446-5500

Visit Fluke's web site at www.fluke.com.

Parts

Table 4-1 lists the replaceable parts for the 8845A and 8846A Digital Multimeters. Figure 4-1 identifies the parts within the Meter.

Table 4-1. Replaceable Parts

Ref. Desig.	Description	Part Number	Qty
A1	8846A-4001,MAIN PCA*	2456914	1
	8845A-4001,MAIN PCA*	2165053	1
A1F1	FUSE 11A, 1000v, FAST .406" X 1.5"	803293	1
A1F2	FUSE 440A, 1000V, FAST .406" X 1.5"	943121	1
A2	8846A-4002,PCA, DISPLAY/KEYBOARD	2454039	1
	8845A-4002,PCA, DISPLAY/KEYBOARD	2430557	1
F1	FUSE, 0.25A, 250V,SLOW .25" X 1.25" (for 100 to 120 VAC mains power)	166306	1
	FUSE, 0.125, 250V, SLOW .25" X 1.25" (for 200 to 240 VAC mains power)	166488	
H1	SCREW,SCREW,FHU,P,LOCK,MAG SS,6-32,.250	320093	9
H2	SCREW,8-32,.250,PAN,PHILLIPS,STEEL,ZINC-CLEAR,LOCK	228890	2
H3	SCREW,SCREW,WH,P,THD FORM,STL,5-20,.312	494641	5
H4	SCREW,6-32,.250,PAN,PHILLIPS,STEEL,ZINC-CLEAR,LOCK	152140	4
H5	SCREW,SCREW,FH,P,LOCK,STL,8-32,.312	281725	2
H6	NUT,NUT,HEX,STL,8-32	110544	1
H7	CONNECTOR,TERMINAL BLOCK,PLUGGABLE,3.5MM CTR,RT ANG,3 POS,BULK	2434588	1
H8	CONNECTOR ACCESSORY,MICRO-RIBBON,SCREW LOCK,M3.5,6-32,STEEL,BLACK ZINC	854737	2
H9	CONNECTOR ACCESSORY,D-SUB JACK SCREW,4-40,.250 L,W/FLAT WASHER	1777348	2
H10	NUT,NUT,EXT LOCK,STL,8-32	195263	1
H11	SCREW,4-24,.250,PAN,PHILLIPS,STEEL,ZINC-CLEAR,TYPE B THD FORM	1626602	1
H12	SCREW,6-32,1.000,PAN,PHILLIPS,STEEL,ZINC-CLEAR,LOCK	114215	1
H13	SCREW,6-32,.250,PAN,SLOT/PHILLIPS COMBO,STEEL,ZINC-CHROMATE	855192	1
MP1	8845A-2020, FUSE DOOR	2439239	1
MP2	8845A-2001, TOP COVER	2439097	1

Table 4-1. Replaceable Parts (cont)

Ref. Desig.	Description	Part Number	Qty
MP3	8846A-2001,FRONT PANEL	2454063	1
	8845A-2005,FRONT PANEL	2439123	1
MP4	8845A-2006,REAR PANEL TERMINAL BLOCK	2439138	1
MP5	8845A-2008,HANDLE	2439150	1
MP6	8845A-2009,REAR BOOT	2439161	1
MP7	8845A-2010,FRONT BOOT	2439177	1
MP8	POWER ENTRY MODULE,KG10.6101.105,AC INLET, ON/OFF LINE SWITCH,FUSE DRAWER,BULK	2437071	1
MP9	FILTER PART,FILTER,LINE,PART,FUSE DRWR W/SHRT BAR	944277	1
MP10	FILTER PART,FILTER,LINE,PART,VOLTAGE SELECTOR	944272	1
MP11	8845A-2004,FRONT PANEL SHIELD	2439200	1
MP12	8845A-8003,FRONT PANEL DECAL	2454088	1
MP13	8846A-2002,LENS	2454074	1
	8845a-2014,LENS	2454056	1
MP14	8845A-2015,AC TOP SHIELD	2454111	1
MP15	8845A-2003,CHASSIS	2439189	1
MP16	8845A-2002,WEDGE	2439114	2
MP17	FOAM PAD,URETHANE,.250 IN X.375 IN X .062 IN THK,ADHESIVE	2567386	4
MP18	8845A-2025,TRANSFORMER BRACKET	2546476	1
MP19	8845A-2026,DISPLAY SHIELD	2559056	1
MP20	8845A-8004,REAR PANEL DECAL	2454095	1
MP21	8845A-2023,PUSH ROD	2526849	1
MP22	FLUKE 27-2002,COVER, FUSE	665031	1
MP23	8845A-2027,HANDLE CAP, PLASTIC PART	2663315	2
S1	8846A-8001,KEYPAD	2454042	1
	8845a-8001,KEYPAD	2439221	1
S2	8845A-2013,SWITCHBODY	2440417	1
S3	8845A-4201,FRONT / REAR SWITCH ASSEMBLY	2571214	1
T1	TRANSFORMER,POWER,100/120/220/240V,50/60HZ,31:7:1:1:7,14W,8845A-6501,EI100,BULK	2455793	1
W1	2620A-4403,WIRE ASSY,GROUND	874099	1
W2	8845A-4402,WIRE ASSY	2584378	1
TM1	CD-ROM, PROGRAMMER AND USERS MANUAL, 8845A/8846A	2453193	1

Table 4-1. Replaceable Parts (cont)

Ref. Desig.	Description	Part Number	Qty
LC1	LC1 LINE CORD,NORTH AM,10A,5-15/IEC,18/3,SVT,6.0 FT	284174	1
	TEST LEAD SET,600V/1KV,PROBE-R/A PLUG,BLACK/RED	802980	1

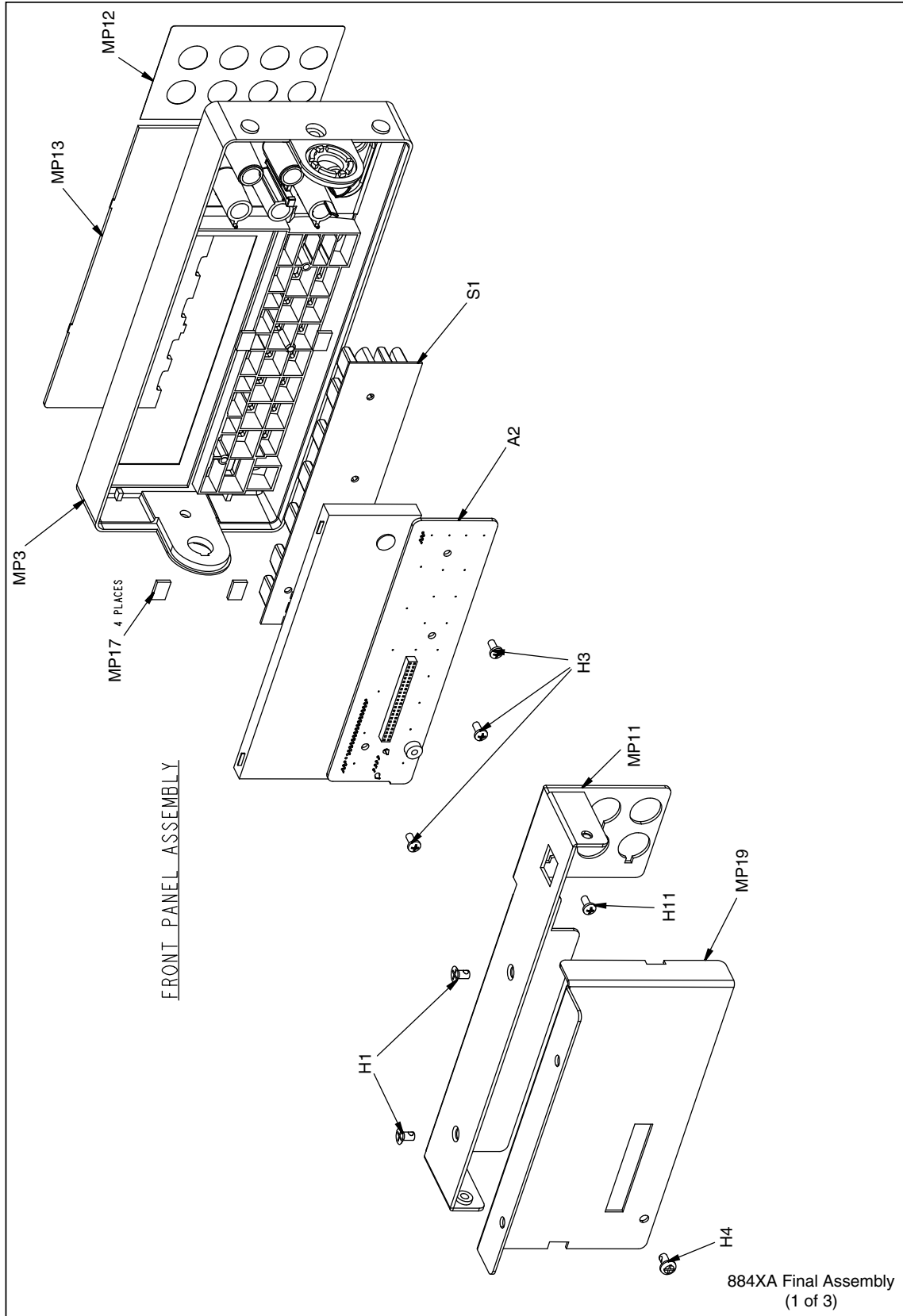
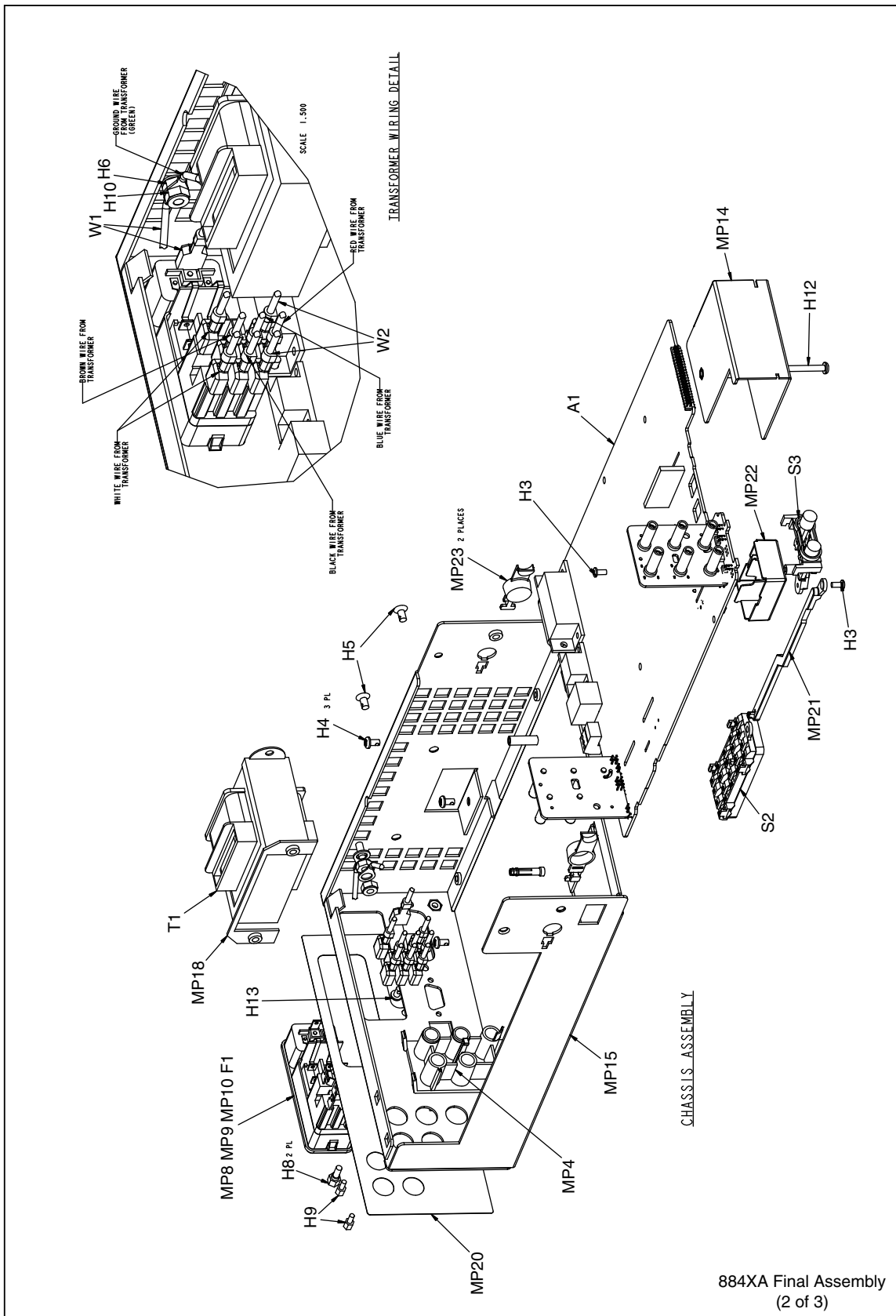

Figure 4-1. Final Assembly



884XA Final Assembly
 (2 of 3)

caw0302f.emf

Figure 4-1. Final Assembly (cont)

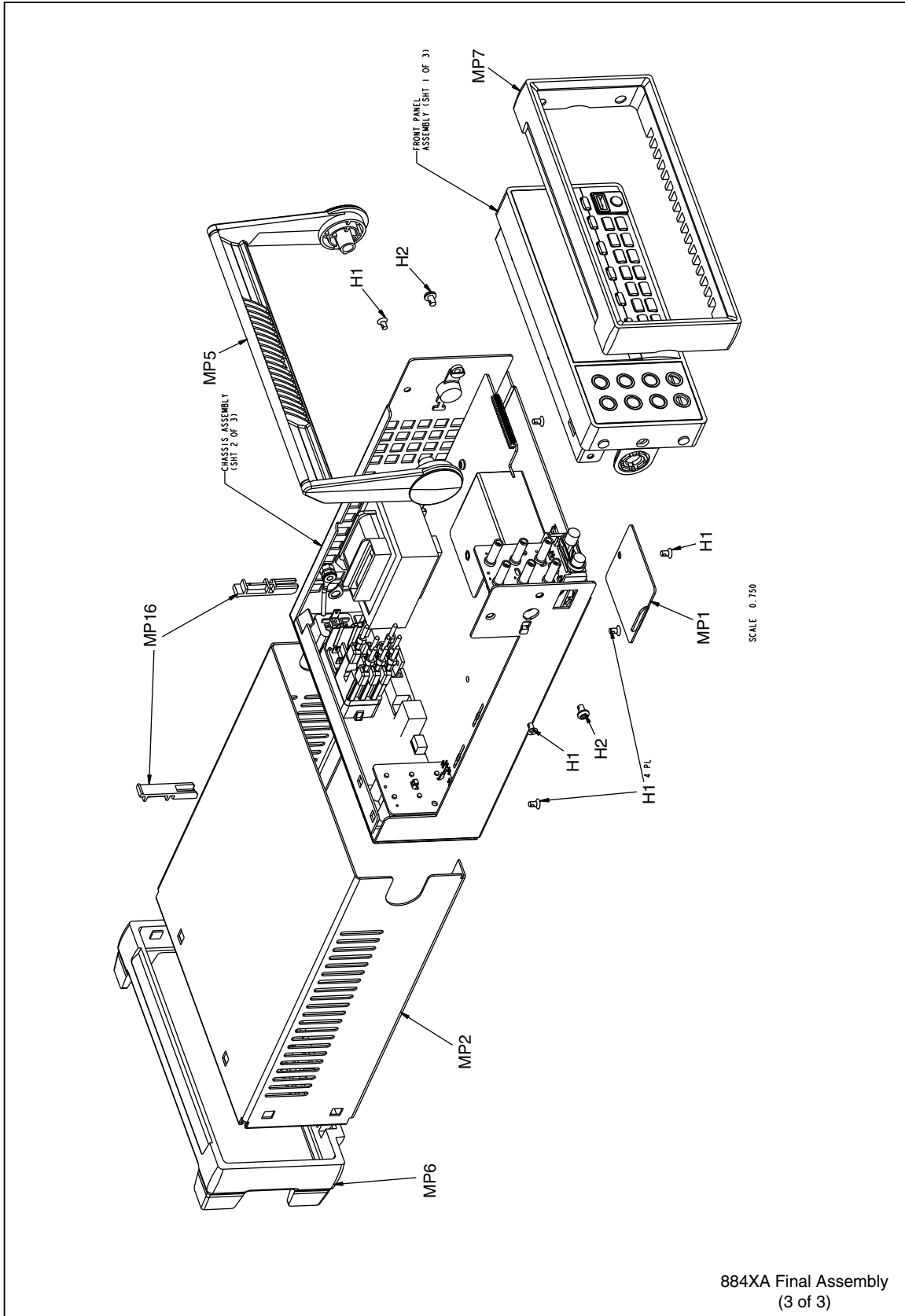

884XA Final Assembly
 (3 of 3)

caw0303f.emf

Figure 4-1. Final Assembly (cont)

Appendices

Appendix	Title	Page
A	Verification Forms	A-1
B	Example Adjustment Program	B-1

Appendix A

Verification Forms

Introduction

The following tables are forms used to collect Meter readings while performing the verification procedures contained in Chapter 3. Appendix pages may be copied as needed to record meter readings.

Table A-1. Blank Verification Record for 90-Day Specifications

Nominal Output		Range	Test Limits		Results	Pass/Fail
Ampl.	Freq.		High	Low		
8846A DC Volts						
0		0.100	3.5E-6	-3.5E-6		
100.0E-3		0.100	100.006E-3	99.994E-3		
-100.0E-3		0.100	-99.994E-3	-100.006E-3		
0		1	7.0E-6	-7.0E-6		
1		1	1.000025	0.999975		
-1		1	-0.999975	-1.000025		
0		10	50.0E-6	-50.0E-6		
5		10	5.000140	4.999860		
-5		10	-4.999860	-5.000140		
10		10	10.000230	9.999770		
-10		10	-9.999770	-10.000230		
0		100	600.0E-6	-600.0E-6		
100		100	100.0033	99.9967		
-100		100	-99.9967	-100.0033		
0		1000	10.0E-3	-10.0E-3		
1000		1000	1000.0410	999.9590		
-1000		1000	-999.9590	-1000.0410		
8846A DC Ratio						
100.0E-3		0.100	1.00012	0.99988		
1		1	1.00005	0.99995		
-10		10	1.000046	0.999954		
8845A DC Volts						
0		0.100	3.5E-6	-3.5E-6		
100.0E-3		0.100	100.0075E-3	99.9925E-3		
-100.0E-3		0.100	-99.9925E-3	-100.0075E-3		
0		1	7.0E-6	-7.0E-6		
1		1	1.000037E+0	999.963E-3		
-1		1	-999.963E-3	-1.000037E+0		
0		10	50.0E-6	-50.0E-6		
5		10	5.00015E+0	4.99985E+0		
-5		10	-4.99985E+0	-5.00015E+0		

Table A-1. Blank Verification Record for 90-Day Specifications (cont)

Nominal Output		Range	Test Limits		Results	Pass/Fail
Ampl.	Freq.		High	Low		
8845A DC Volts (cont)						
10		10	10.00025E+0	9.99975E+0		
-10		10	-9.99975E+0	-10.00025E+0		
0		100	600.0E-6	-600.0E-6		
100		100	100.0041E+0	99.9959E+0		
-100		100	-99.9959E+0	-100.0041E+0		
0		1000	10.0E-3	-10.0E-3		
1000		1000	1.000045E+3	999.955E+0		
-1000		1000	-999.955E+0	-1.000045E+3		
8845A DC Ratio						
100.0E-3		0.100	1.00015	0.99985		
1		1	1.000074	0.999926		
-10		10	1.00005	0.99995		
8845A/8846A AC Volts						
100.0E-3	10	0.100	100.09E-3	99.91E-3		
100.0E-3	20000	0.100	100.09E-3	99.91E-3		
100.0E-3	50000	0.100	100.16E-3	99.84E-3		
100.0E-3	100000	0.100	100.68E-3	99.32E-3		
100.0E-3	300000	0.100	104.5E-3	95.5E-3		
1	10	1	1.0008E+0	999.2E-3		
1	20000	1	1.0008E+0	999.2E-3		
1	50000	1	1.0016E+0	998.4E-3		
1	100000	1	1.0068E+0	993.2E-3		
1	300000	1	1.045E+0	955.0E-3		
10	10	10	10.008E+0	9.992E+0		
10	20000	10	10.008E+0	9.992E+0		
10	50000	10	10.016E+0	9.984E+0		
10	100000	10	10.068E+0	9.932E+0		
3	300000	10	3.17E+0	2.83E+0		

Table A-1. Blank Verification Record for 90-Day Specifications (cont)

Nominal Output		Range	Test Limits		Results	Pass/Fail
Ampl.	Freq.		High	Low		
8845A/8846A AC Volts (cont)						
100	45	100	100.08E+0	99.92E+0		
100	20000	100	100.08E+0	99.92E+0		
100	50000	100	100.16E+0	99.84E+0		
100	100000	100	100.68E+0	99.32E+0		
8846A Only AC Volts						
1000	45	1000	1000.800	999.200		
1000	1000	1000	1000.800	999.200		
1000	10000	1000	1000.800	999.200		
320	20000	1000	320.460	319.540		
320	50000	1000	320.852E+0	319.148E+0		
320	100000	1000	322.72E+0	317.28E+0		
8845A Only AC Volts						
750	45	750	750.600	749.400		
750	1000	750	750.600	749.400		
750	10000	750	750.600	749.400		
320	20000	750	320.385	319.615		
320	50000	750	320.727E+0	319.273E+0		
320	100000	750	322.52E+0	317.48E+0		
8845A/8846A Frequency						
1	10		10.00300	9.99700		
1	40		40.00400	39.99600		
0.1	300000		300030.0	299970.0		
8846A Only Frequency						
0.1	1000000		1000100.0	999900.0		
8846A Only 4-Wire Resistance						
0		10	3.0E-3	0		
10		10	10.00380	9.99620		
8845A/8846A 4-Wire Resistance						
0		100	4.0E-3	0		
100		100	100.0120	99.9880		
0		1000	10.0E-3	0		

Table A-1. Blank Verification Record for 90-Day Specifications (cont)

Nominal Output		Range	Test Limits		Results	Pass/Fail
Ampl.	Freq.		High	Low		
8845A/8846A 4-Wire Resistance (cont)						
1000		1000	1000.090	999.910		
0		10000	100.0E-3	0		
10000		10000	10000.90	9999.10		
0		100000	1.000000	0		
100000		100000	100009.0	99991.0		
0		100	0.0040	0		
100		100	100.0120	99.9880		
0		1000	10.0E-3	0		
1000		1000	1000.090	999.910		
0		10000	100.0E-3	0		
10000		10000	10000.90	9999.10		
0		100000	1.000000	0		
100000		100000	100009.0	99991.0		
0		1000000	10.00000	0		
1000000		1000000	1000090	999910		
0		10000000	100.0000	0		
10000000		10000000	10002100	9997900		
0		100000000	10000.00	0		
100000000		100000000	100810000	99190000		
8846A Only 2-Wire Resistance						
0		1000000000	100000.0	0		
1000000000		1000000000	1015100000	984900000		
8845A/8846A Optional 2X4 Test Lead (Split Lead) test						
0		100	4.0E-3	0		
100		100	100.0120	99.9880		
8846A Optional Rear Panel Test						
10 V		DCV (10V)	10.00023 V	9.99977 V		
1000 Ω		4-W Ω (1 kΩ)	1000.09 Ω	999.91 Ω		
100 mA		DCI (100 mA)	0.100035 A	0.099965 A		

Table A-1. Blank Verification Record for 90-Day Specifications (cont)

Nominal Output		Range	Test Limits		Results	Pass/Fail
Ampl.	Freq.		High	Low		
8845A Optional Rear Panel Test						
10 V		DCV (10V)	10.00025 V	9.99975 V		
1000 Ω		4-W Ω (1 kΩ)	1000.09 Ω	999.91 Ω		
100 mA		DCI (100 mA)	0.100035 A	0.099965 A		
8846A Capacitance						
0		1.0E-9	25.0E-12	0		
1.0E-9		1.0E-9	1.045E-9	955.0E-12		
10.0E-9		10.0E-9	10.15E-9	9.85E-9		
100.0E-9		100.0E-9	101.5E-9	98.5E-9		
1.0E-6		1.0E-6	1.015E-6	985.0E-9		
10.0E-6		10.0E-6	10.15E-6	9.85E-6		
100.0E-6		100.0E-6	101.5E-6	98.5E-6		
1.0E-3		1.0E-3	1.015E-3	985.0E-6		
10.0E-3		10.0E-3	10.15E-3	9.85E-3		
100.0E-3		100.0E-3	104.2E-3	95.8E-3		
8846A DC Current						
0		100.0E-6	25.0E-9	-25.0E-9		
100.0E-6		100.0E-6	100.065E-6	99.935E-6		
-100.0E-6		100.0E-6	-99.935E-6	-100.065E-6		
0		1.0E-3	50.0E-9	-50.0E-9		
1.0E-3		1.0E-3	1.00035E-3	999.65E-6		
-1.0E-3		1.0E-3	-999.65E-6	-1.00035E-3		
0		10.0E-3	2.0E-6	-2.0E-6		
10.0E-3		10.0E-3	10.005E-3	9.995E-3		
-10.0E-3		10.0E-3	-9.995E-3	-10.005E-3		
0		100.0E-3	5.0E-6	-5.0E-6		
100.0E-3		100.0E-3	100.035E-3	99.965E-3		
-100.0E-3		100.0E-3	-99.965E-3	-100.035E-3		
0		400.0E-3	20.0E-6	20.0E-6		
400.0E-3		400.0E-3	400.18E-3	399.82E-3		
-400.0E-3		400.0E-3	399.82E-3	400.18E-3		
0		1	200.0E-6	-200.0E-6		

Table A-1. Blank Verification Record for 90-Day Specifications (cont)

Nominal Output		Range	Test Limits		Results	Pass/Fail
Ampl.	Freq.		High	Low		
8846A DC Current (cont)						
1		1	1.0006E+0	999.4E-3		
-1		1	-999.4E-3	-1.0006E+0		
0		3	600.0E-6	-600.0E-6		
1.9		3	1.90212E+0	1.89788E+0		
-1.9		3	-1.89788E+0	-1.90212E+0		
0		10	800.0E-6	-800.0E-6		
10		10	10.0128E+0	9.9872E+0		
-10		10	-9.9872E+0	-10.0128E+0		
8845A Only DC Current						
0		100.0E-6	25.0E-9	-25.0E-9		
100.0E-6		100.0E-6	100.065E-6	99.935E-6		
-100.0E-6		100.0E-6	-99.935E-6	-100.065E-6		
0		1.0E-3	50.0E-9	-50.0E-9		
1.0E-3		1.0E-3	1.00035E-3	999.65E-6		
-1.0E-3		1.0E-3	-999.65E-6	-1.00035E-3		
0		10.0E-3	2.0E-6	-2.0E-6		
10.0E-3		10.0E-3	10.005E-3	9.995E-3		
-10.0E-3		10.0E-3	-9.995E-3	-10.005E-3		
0		100.0E-3	5.0E-6	-5.0E-6		
100.0E-3		100.0E-3	100.035E-3	99.965E-3		
-100.0E-3		100.0E-3	-99.965E-3	-100.035E-3		
0		400.0E-3	20.0E-6	20.0E-6		
400.0E-3		400.0E-3	400.18E-3	399.82E-3		
-400.0E-3		400.0E-3	399.82E-3	400.18E-3		
0		1	200.0E-6	-200.0E-6		
1		1	1.001E+0	999.0E-3		
-1		1	-999.0E-3	-1.001E+0		
0		3	600.0E-6	-600.0E-6		
1.9		3	1.90288E+0	1.89712E+0		
-1.9		3	-1.89712E+0	-1.90288E+0		
0		10	800.0E-6	-800.0E-6		

Table A-1. Blank Verification Record for 90-Day Specifications (cont)

Nominal Output		Range	Test Limits		Results	Pass/Fail
Ampl.	Freq.		High	Low		
8845A Only DC Current (cont)						
10		10	10.0128E+0	9.9872E+0		
-10		10	-9.9872E+0	-10.0128E+0		
8846A Only AC Current						
100.0E-6	10	100.0E-6	100.14E-6	99.86E-6		
100.0E-6	1000	100.0E-6	100.14E-6	99.86E-6		
100.0E-6	5000	100.0E-6	100.14E-6	99.86E-6		
100.0E-6	10000	100.0E-6	100.45E-6	99.55E-6		
1.0E-3	10	1.0E-3	1.0014E-3	998.6E-6		
1.0E-3	1000	1.0E-3	1.0014E-3	998.6E-6		
1.0E-3	5000	1.0E-3	1.0014E-3	998.6E-6		
1.0E-3	10000	1.0E-3	1.0045E-3	995.5E-6		
8845A/8846A Current						
10.0E-3	10	10.0E-3	10.014E-3	9.986E-3		
10.0E-3	1000	10.0E-3	10.014E-3	9.986E-3		
10.0E-3	5000	10.0E-3	10.014E-3	9.986E-3		
10.0E-3	10000	10.0E-3	10.045E-3	9.955E-3		
100.0E-3	10	100.0E-3	100.14E-3	99.86E-3		
100.0E-3	1000	100.0E-3	100.14E-3	99.86E-3		
100.0E-3	5000	100.0E-3	100.14E-3	99.86E-3		
100.0E-3	10000	100.0E-3	100.45E-3	99.55E-3		
329.0E-3	10	400.0E-3	330.387E-3	327.613E-3		
329.0E-3	1000	400.0E-3	329.729E-3	328.271E-3		
329.0E-3	5000	400.0E-3	332.458E-3	325.542E-3		
329.0E-3	10000	400.0E-3	332.458E-3	325.542E-3		
1	45	1	1.0014E+0	998.6E-3		
1	1000	1	1.0014E+0	998.6E-3		
1	5000	1	1.0014E+0	998.6E-3		
1	10000	1	1.0105E+0	989.5E-3		
1.9	45	3	1.90465	1.89535		
1.9	1000	3	1.90465	1.89630		
1.9	10000	3	1.92765	1.87235		

Table A-1. Blank Verification Record for 90-Day Specifications (cont)

Nominal Output		Range	Test Limits		Results	Pass/Fail
Ampl.	Freq.		High	Low		
8845A/8846A Current (cont)						
10	45	10	10.02100	9.97900		
10	1000	10	10.02100	9.97900		

Table A-2. Blank Verification Record for 1-Year Specifications

Nominal Output		Range	Test Limits		Results	Pass/Fail
Ampl.	Freq.		High	Low		
8846A DC Volts						
0		0.100	3.5E-6	-3.5E-6		
100.0E-3		0.100	100.0072E-3	99.9928E-3		
-100.0E-3		0.100	-99.9928E-3	-100.0072E-3		
0		1	7.0E-6	-7.0E-6		
1		1	1.000032	0.999968		
-1		1	-0.999968	-1.000032		
0		10	50.0E-6	-50.0E-6		
5		10	5.000170	4.999830		
-5		10	-4.999830	-5.000170		
10		10	10.000290	9.999710		
-10		10	-9.999710	-10.000290		
0		100	600.0E-6	-600.0E-6		
100		100	100.0044	99.9956		
-100		100	-99.9956	-100.0044		
0		1000	10.0E-3	-10.0E-3		
1000		1000	1000.0510	999.9490		
-1000		1000	-999.9490	-1000.0510		
8846A DC Ratio						
100.0E-3		0.100	1.000144E+0	0.999856E+0		
1		1	1.000064E+0	0.999936E+0		
-10		10	1.000058E+0	0.999942E+0		
8845A DC Volts						
0		0.100	3.5E-6	-3.5E-6		
100.0E-3		0.100	100.0085E-3	99.9915E-3		
-100.0E-3		0.100	-99.9915E-3	-100.0085E-3		
0		1	7.0E-6	-7.0E-6		
1		1	1.000047E+0	999.953E-3		
-1		1	-999.953E-3	-1.000047E+0		
0		10	50.0E-6	-50.0E-6		
5		10	5.000225E+0	4.999775E+0		
-5		10	-4.999775E+0	-5.000225E+0		

Table A-2. Blank Verification Record for 1-Year Specifications (cont)

Nominal Output		Range	Test Limits		Results	Pass/Fail
Ampl.	Freq.		High	Low		
8845A DC Volts (cont)						
10		10	10.0004E+0	9.9996E+0		
-10		10	-9.9996E+0	-10.0004E+0		
0		100	600.0E-6	-600.0E-6		
100		100	100.0051E+0	99.9949E+0		
-100		100	-99.9949E+0	-100.0051E+0		
0		1000	10.0E-3	-10.0E-3		
1000		1000	1.000055E+3	999.945E+0		
-1000		1000	-999.945E+0	-1.000055E+3		
8845A DC Ratio						
100.0E-3		0.100	1.00017E+0	0.99983E+0		
1		1	1.000094E+0	0.999906E+0		
-10		10	1.000080E+0	0.99992E+0		
8845A/8846A AC Volts						
100.0E-3	10	0.100	100.1E-3	99.9E-3		
100.0E-3	20000	0.100	100.1E-3	99.9E-3		
100.0E-3	50000	0.100	100.17E-3	99.83E-3		
100.0E-3	100000	0.100	100.68E-3	99.32E-3		
100.0E-3	300000	0.100	104.5E-3	95.5E-3		
1	10	1	1.0009E+0	999.1E-3		
1	20000	1	1.0009E+0	999.1E-3		
1	50000	1	1.0017E+0	998.3E-3		
1	100000	1	1.0068E+0	993.2E-3		
1	300000	1	1.045E+0	955.0E-3		
10	10	10	10.009E+0	9.991E+0		
10	20000	10	10.009E+0	9.991E+0		
10	50000	10	10.017E+0	9.983E+0		
10	100000	10	10.068E+0	9.932E+0		
3	300000	10	3.17E+0	2.83E+0		

Table A-2. Blank Verification Record for 1-Year Specifications (cont)

Nominal Output		Range	Test Limits		Results	Pass/Fail
Ampl.	Freq.		High	Low		
8845A/8846A AC Volts (cont)						
100	45	100	100.09E+0	99.91E+0		
100	20000	100	100.09E+0	99.91E+0		
100	50000	100	100.17E+0	99.83E+0		
100	100000	100	100.68E+0	99.32E+0		
8846A Only AC Volts						
1000	45	1000	1.0009E+3	999.1E+0		
1000	1000	1000	1.0009E+3	999.1E+0		
1000	10000	1000	1.0009E+3	999.1E+0		
320	20000	1000	320.492E+0	319.508E+0		
320	50000	1000	320.884E+0	319.116E+0		
320	100000	1000	322.72E+0	317.28E+0		
8845A Only AC Volts						
750	45	750	750.675E+0	749.325E+0		
750	1000	750	750.675E+0	749.325E+0		
750	10000	750	750.675E+0	749.325E+0		
320	20000	750	320.417E+0	319.583E+0		
320	50000	750	320.759E+0	319.241E+0		
320	100000	750	322.52E+0	317.48E+0		
8845A/8846A Frequency						
1	10		10.00300	9.99700		
1	40		40.00400	39.99600		
0.1	300000		300030.0	299970.0		
8846A Only Frequency						
0.1	1000000		1000100.0	999900.0		
8846A Only 4-Wire Resistance						
0		10	3.0E-3	0		
10		10	10.00400	9.99600		
8845A/8846A 4-Wire Resistance						
0		100	4.0E-3	0		
100		100	100.01400	99.98600		
0		1000	10.0E-3	0		

Table A-2. Blank Verification Record for 1-Year Specifications (cont)

Nominal Output		Range	Test Limits		Results	Pass/Fail
Ampl.	Freq.		High	Low		
8845A/8846A 4-Wire Resistance (cont)						
1000		1000	1000.11000	999.89000		
0		10000	100.0E-3	0		
10000		10000	10001.10	9998.90		
0		100000	1.000000	0		
100000		100000	100011.0	99989.0		
8845A/8846A 2-Wire Resistance						
0		100	0.0040	0		
100		100	100.0140	99.99		
0		1000	10.0E-3	0		
1000		1000	1000.11000	999.89000		
0		10000	100.0E-3	0		
10000		10000	10001.10	9998.90		
0		100000	1.000000	0		
100000		100000	100011.0	99989.0		
0		1000000	10.00000	0		
1000000		1000000	1000110	999890		
0		10000000	100.0000	0		
10000000		10000000	10004100	9995900		
0		100000000	10000.00	0		
100000000		100000000	100810000	99190000		
8846A Only 2-Wire Resistance						
0		1000000000	100000.0	0		
1000000000		1000000000	1020100000	979900000		
8845A/8846A Optional 2X4 Test Lead (Split Lead) test						
0		100	4.0E-3	0		
100		100	100.01400	99.98600		
8846A Optional Rear Panel Test						
10 V		DCV (10V)	10.00029 V	9.99971 V		
1000 Ω		4-W Ω (1 kΩ)	1000.11 Ω	999.89 Ω		
100 mA		DCI (100 mA)	0.100055 A	0.099945 A		

Table A-2. Blank Verification Record for 1-Year Specifications (cont)

Nominal Output		Range	Test Limits		Results	Pass/Fail
Ampl.	Freq.		High	Low		
8845A Optional Rear Panel Test						
100 mV		DCV (10V)	0.1000085 V	0.0999915 V		
1000 Ω		4-W Ω (1 kΩ)	1000.11 Ω	999.89 Ω		
100 mA		DCI (100 mA)	0.100055 A	0.099945 A		
8846A Capacitance						
0		1.0E-9	25.0E-12	0		
1.0E-9		1.0E-9	1.045E-9	955.0E-12		
10.0E-9		10.0E-9	10.15E-9	9.85E-9		
100.0E-9		100.0E-9	101.5E-9	98.5E-9		
1.0E-6		1.0E-6	1.015E-6	985.0E-9		
10.0E-6		10.0E-6	10.15E-6	9.85E-6		
100.0E-6		100.0E-6	101.5E-6	98.5E-6		
1.0E-3		1.0E-3	1.015E-3	985.0E-6		
10.0E-3		10.0E-3	10.15E-3	9.85E-3		
100.0E-3		100.0E-3	104.2E-3	95.8E-3		
8846A DC Current						
0		100.0E-6	25.0E-9	-25.0E-9		
100.0E-6		100.0E-6	100.075E-6	99.935E-6		
-100.0E-6		100.0E-6	-99.925E-6	-100.065E-6		
0		1.0E-3	50.0E-9	-50.0E-9		
1.0E-3		1.0E-3	1.00055E-3	999.45E-6		
-1.0E-3		1.0E-3	-999.45E-6	-1.00055E-3		
0		10.0E-3	2.0E-6	-2.0E-6		
10.0E-3		10.0E-3	10.007E-3	9.993E-3		
-10.0E-3		10.0E-3	-9.993E-3	-10.007E-3		
0		100.0E-3	5.0E-6	-5.0E-6		
100.0E-3		100.0E-3	100.055E-3	99.945E-3		
-100.0E-3		100.0E-3	-99.945E-3	-100.055E-3		
0		400.0E-3	20.0E-6	20.0E-6		
400.0E-3		400.0E-3	400.22E-3	399.78E-3		
-400.0E-3		400.0E-3	399.78E-3	400.22E-3		
0		1	200.0E-6	-200.0E-6		

Table A-2. Blank Verification Record for 1-Year Specifications (cont)

Nominal Output		Range	Test Limits		Results	Pass/Fail
Ampl.	Freq.		High	Low		
8846A DC Current (cont)						
1		1	1.0007E+0	999.3E-3		
-1		1	-999.3E-3	-1.0007E+0		
0		3	600.0E-6	-600.0E-6		
1.9		3	1.9025	1.8975		
-1.9		3	-1.8975E+0	-1.9025E+0		
0		10	800.0E-6	-800.0E-6		
10		10	10.0158E+0	9.9842E+0		
-10		10	-9.9842E+0	-10.0158E+0		
8845A Only DC Current						
0		100.0E-6	25.0E-9	-25.0E-9		
100.0E-6		100.0E-6	100.075E-6	99.935E-6		
-100.0E-6		100.0E-6	-99.925E-6	-100.065E-6		
0		1.0E-3	50.0E-9	50.0E-9		
1.0E-3		1.0E-3	1.00055E-3	999.45E-6		
-1.0E-3		1.0E-3	-999.45E-6	-1.00055E-3		
0		10.0E-3	2.0E-6	-2.0E-6		
10.0E-3		10.0E-3	10.007E-3	9.993E-3		
-10.0E-3		10.0E-3	-9.993E-3	-10.007E-3		
0		100.0E-3	5.0E-6	-5.0E-6		
100.0E-3		100.0E-3	100.055E-3	99.945E-3		
-100.0E-3		100.0E-3	-99.945E-3	-100.055E-3		
0		400.0E-3	20.0E-6	20.0E-6		
400.0E-3		400.0E-3	400.22E-3	399.78E-3		
-400.0E-3		400.0E-3	399.78E-3	400.22E-3		
0		1	200.0E-6	-200.0E-6		
1		1	1.0012E+0	998.8E-3		
-1		1	-998.8E-3	-1.0012E+0		
0		3	600.0E-6	-600.0E-6		
1.9		3	1.90288E+0	1.89712E+0		
-1.9		3	-1.89712E+0	-1.90288E+0		
0		10	800.0E-6	-800.0E-6		

Table A-2. Blank Verification Record for 1-Year Specifications (cont)

Nominal Output		Range	Test Limits		Results	Pass/Fail
Ampl.	Freq.		High	Low		
8845A Only DC Current (cont)						
10		10	10.0158E+0	9.9842E+0		
-10		10	-9.9842E+0	-10.0158E+0		
8846A Only AC Current						
100.0E-6	10	100.0E-6	100.14E-6	99.86E-6		
100.0E-6	1000	100.0E-6	100.14E-6	99.86E-6		
100.0E-6	5000	100.0E-6	100.14E-6	99.86E-6		
100.0E-6	10000	100.0E-6	100.45E-6	99.55E-6		
1.0E-3	10	1.0E-3	1.0014E-3	998.6E-6		
1.0E-3	1000	1.0E-3	1.0014E-3	998.6E-6		
1.0E-3	5000	1.0E-3	1.0014E-3	998.6E-6		
1.0E-3	10000	1.0E-3	1.0045E-3	995.5E-6		
8845A/8846A AC Current						
10.0E-3	10	10.0E-3	10.014E-3	9.986E-3		
10.0E-3	1000	10.0E-3	10.014E-3	9.986E-3		
10.0E-3	5000	10.0E-3	10.014E-3	9.986E-3		
10.0E-3	10000	10.0E-3	10.045E-3	9.955E-3		
100.0E-3	10	100.0E-3	100.14E-3	99.86E-3		
100.0E-3	1000	100.0E-3	100.14E-3	99.86E-3		
100.0E-3	5000	100.0E-3	100.14E-3	99.86E-3		
100.0E-3	10000	100.0E-3	100.45E-3	99.55E-3		
329.0E-3	10	400.0E-3	330.387E-3	327.613E-3		
329.0E-3	1000	400.0E-3	329.729 E-3	328.271E-3		
329.0E-3	5000	400.0E-3	332.458E-3	325.542E-3		
329.0E-3	10000	400.0E-3	332.458E-3	325.542E-3		
1	45	1	1.00140	998.6E-3		
1	1000	1	1.00140	998.6E-3		
1	5000	1	1.00140	998.6E-3		
1	10000	1	1.01050	989.5E-3		
1.9	45	3	1.90465	1.89535E+0		
1.9	1000	3	1.90465	1.89535E+0		
1.9	10000	3	1.92765	1.87235E+0		

Table A-2. Blank Verification Record for 1-Year Specifications (cont)

Nominal Output		Range	Test Limits		Results	Pass/Fail
Ampl.	Freq.		High	Low		
8845A/8846A AC Current (cont)						
10	45	10	10.02100	9.97900		
10	1000	10	10.02100	9.97900		

Appendix B

Example Adjustment Program

Introduction

Shown below is an adjustment program example for the 8845A and 8846A.

```
### Eastwood 8845A/8846A Calibration Adjustment Meta Program
*RST;SYST:REM
CAL:SEC:STAT OFF, FLUKE884X
# Open Adjust
## Remove all connections to front terminals
CAL:VAL ORES,100000000
CAL? ON
#
# 8846A Only - comment out if calibrating a 8845A
#
CAL:VAL ORES,1000000000
CAL? ON
CAL:VAL ZCAP,1.00E-09
CAL? ON
# end comment
CAL:REC
### CALIBRATION OF ZEROs
# Zero adjusts
## Place a 4-wire short on front and rear of instrument
CAL:VAL ZVAC,100.0E-3
CAL? ON
CAL:VAL ZVACS,100.0E-3
CAL? ON
CAL:VAL ZVAC,1
CAL? ON
CAL:VAL ZVACS,1
```

```
CAL? ON
CAL:VAL ZVAC,10
CAL? ON
CAL:VAL ZVACS,10
CAL? ON
CAL:VAL ZVAC,100
CAL? ON
CAL:VAL ZVACS,100
CAL? ON
CAL:VAL ZVAC,1000
CAL? ON
CAL:VAL ZVACS,1000
CAL? ON
CAL:VAL ZVDC,1000
CAL? ON
CAL:VAL ZVDC,100
CAL? ON
CAL:VAL ZVDC,10
CAL? ON
CAL:VAL ZVDC,1
CAL? ON
CAL:VAL ZVDC,0.1
CAL? ON
# Four 50/60 Hz zero adjust steps - OutGuard version 2.0 and above
CAL:VAL DFVDC60, 100E-3
CAL? ON
CAL:VAL DFVDC60_1, 100E-3
CAL? ON
CAL:VAL DFVDC50, 100E-3
CAL? ON
CAL:VAL DFVDC50_1, 100E-3
CAL? ON
# end comment
CAL:VAL ZRES,10000000
CAL? ON
CAL:VAL ZRES,1000000
CAL? ON
CAL:VAL ZRES,100000
CAL? ON
CAL:VAL ZRES,10000
CAL? ON
CAL:VAL ZRES,1000
CAL? ON
CAL:VAL ZRES,100
CAL? ON
CAL:VAL ZRES,10
CAL? ON
# Three Ratio zero adjust steps - OutGuard version 2.0 and above
CAL:VAL ZVDCREF, 10
CAL? ON
CAL:VAL ZVDCREF, 1
CAL? ON
CAL:VAL ZVDCREF, 100E-3
CAL? ON
CAL:REC
```

```

# end comment
## Rear short adjust - press the F/R switch to REAR - OutGuard version 2.0
and above
CAL:VAL ZRESR,100000
CAL? ON
CAL:VAL ZRESR,10000
CAL? ON
CAL:VAL ZRESR,1000
CAL? ON
CAL:VAL ZRESR,100
CAL? ON
CAL:VAL ZRESR,10
CAL? ON
# end comment
# Two dcV rear zero adjust steps - OutGuard version 2.0 and above
CAL:VAL ZVDCR,1
CAL? ON
CAL:VAL ZVDCR,100E-3
CAL? ON
# end comment
# Two rear Ratio zero adjust steps - OutGuard version 2.0 and above
CAL:VAL ZVDCRREF,1
CAL? ON
CAL:VAL ZVDCRREF,100E-3
CAL? ON
# end comment
## Front adjust - press the F/R switch to FRONT
# 400 mA dc Current zero adjust steps - OutGuard version 2.0 and above
CAL:VAL ZIDC,400.0E-3
CAL? ON
# end comment
# Front dc Current zeros adjust
CAL:VAL ZIDC,100.0E-3
CAL? ON
CAL:VAL ZIDC,1.0E-3
CAL? ON
CAL:VAL ZIDC,10.0E-3
CAL? ON
CAL:VAL ZIDC,100.0E-6
CAL? ON
CAL:REC
# Front ac Current zeros adjust
CAL:VAL ZIAC,0.0
CAL? ON
CAL:VAL ZIACS,0.0
CAL? ON
CAL:VAL ZIAC,1.0E-3
CAL? ON
CAL:VAL ZIACS,1.0E-3
CAL? ON
CAL:VAL ZIAC,10.0E-3
CAL? ON
CAL:VAL ZIACS,10.0E-3
CAL? ON
CAL:VAL ZIAC,100.0E-3

```

```
CAL? ON
CAL:VAL ZIACS,100.0E-3
CAL? ON
# Two 400 mA ac zero adjust steps - OutGuard version 2.0 and above
CAL:VAL ZIAC,400.0E-3
CAL? ON
CAL:VAL ZIACS,400.0E-3
CAL? ON
#
CAL:VAL ZIDC,10
CAL? ON
CAL:VAL ZIDC,1
CAL? ON
CAL:VAL ZIAC,1
CAL? ON
CAL:VAL ZIACS,1
CAL? ON
CAL:VAL ZIAC,10
CAL? ON
CAL:VAL ZIACS,10
CAL? ON
CAL:REC
### Calibrate AC Linearity
# 1.19V@1200Hz
## set calibrator to output 1.19V@1200Hz
CAL:VAL ACLIN,1.19
CAL? ON
## set calibrator to output 0.8V@1200Hz
# 0.8V@1200Hz
CAL:VAL ACLIN,0.8
CAL? ON
## set calibrator to output 0.4 V@1200Hz
# 0.4V@1200Hz
CAL:VAL ACLIN,0.4
CAL? ON
## set calibrator to output 0.005V@1200Hz
# 0.005V@1200Hz
CAL:VAL ACLIN,0.005
CAL? ON
CAL:REC
### Calibrate 100 mV AC Gain @1200 Hz
## set calibrator to output 0.1 V@1200Hz
# 100 mV AC range
CAL:VAL GVAC,0.1
CAL? ON
### Calibrate 100 mV AC Gain @1200 Hz
# 100 mV AC Gain
CAL:VAL GVACS,0.1
CAL? ON
### Calibrate 100 mV AC Pole @50000 Hz
## set calibrator to output 0.1 V@50000Hz
# 100 mV AC Pole
CAL:VAL ACPOLE,0.1
CAL? ON
### Calibrate 1 V AC Gain @1200 Hz
```



```

## set calibrator to output 1.0 V@1200Hz
# 1 V AC Gain
CAL:VAL GVAC,1
CAL? ON
### Calibrate 1 V AC Gain @1000 Hz
## set calibrator to output 1.0 V@1000Hz
# 1 V AC Gain
CAL:VAL GVACS,1
CAL? ON
### Calibrate 1 V AC Slow @10 Hz
## set calibrator to output 1.0 V@10Hz
# AC Slow
CAL:VAL FVAC,1
CAL? ON
### Calibrate 1 V AC Pole @50000 Hz
## set calibrator to output 1.0 V@50000Hz
# 1 V AC Fast
CAL:VAL ACPOLE,1
CAL? ON
### Calibrate 10 V AC Gain @1200 Hz
## set calibrator to output 10.0 V@1200Hz
# 10 V AC Gain
CAL:VAL GVAC,10
CAL? ON
### Calibrate 10 V AC Gain @1200 Hz
# 10 V AC Gain
CAL:VAL GVACS,10
CAL? ON
### Calibrate 10 V AC Pole @50000 Hz
## set calibrator to output 10.0 V@50000Hz
# 10 V AC Pole
CAL:VAL ACPOLE,10
CAL? ON
### Calibrate 100 V AC Gain @1200 Hz
## set calibrator to output 100.0 V@1200Hz
# 100 V AC Gain
CAL:VAL GVAC,100
CAL? ON
### Calibrate 100 V AC Gain @1200 Hz
# 100 V AC Gain
CAL:VAL GVACS,100
CAL? ON
### Calibrate 100 V AC Pole @50000 Hz
## set calibrator to output 100.0 V@50000Hz
# 100 V AC Pole
CAL:VAL ACPOLE,100
CAL? ON
#
# 8845A - uncomment if adjusting 8845A
#
### Calibrate 750 V AC Gain @1200 Hz
# set calibrator to output 750.0 V@1200Hz
# 750 V AC Gain
#CAL:VAL GVAC,750
#CAL? ON

```

```
# Calibrate 750 V AC Gain @1200 Hz
# 750 V AC Gain
#CAL:VAL GVACS,750
#CAL? ON
# end comment
#
# 8846A - uncomment if adjusting 8846A
#
### Calibrate 1000 V AC Gain @1200 Hz
## set calibrator to output 1000.0 V@1200Hz
# 1000 V AC Gain
CAL:VAL GVAC,1000
CAL? ON
### Calibrate 1000 V AC Gain @1200 Hz
# 1000 V AC Gain
CAL:VAL GVACS,1000
CAL? ON
### Calibrate 1000/750 V AC Pole @50000 Hz
## set calibrator to output 329.0 V@50000Hz
# 1000/750 V AC Pole
CAL:VAL ACPOLE,329
CAL? ON
# end comment
CAL:REC
### Calibrate 1000 V DC
## set calibrator to output 1000 Vdc
# 1000V DC
CAL:VAL GVDC,1000
CAL? ON
## set calibrator to output -1000 Vdc
# -1000V DC
CAL:VAL GVDC,-1000
CAL? ON
### Calibrate 100 V DC
## set calibrator to output 100 Vdc
# 100V DC
CAL:VAL GVDC,100
CAL? ON
## set calibrator to output -100 Vdc
# -100V DC
CAL:VAL GVDC,-100
CAL? ON
### Calibrate 10 V DC
## set calibrator to output 10 Vdc
# 10V DC
CAL:VAL GVDC,10
CAL? ON
## set calibrator to output -10 Vdc
# -10V DC
CAL:VAL GVDC,-10
CAL? ON
### Calibrate 1 V DC
## set calibrator to output 1 Vdc
# 1V DC
CAL:VAL GVDC,1
```

```

CAL? ON
## set calibrator to output -1 Vdc
# -1V DC
CAL:VAL GVDC,-1
CAL? ON
### Calibrate 0.1 V DC
## set calibrator to output 100 mVdc
# 0.1V DC
CAL:VAL GVDC,0.1
CAL? ON
## set calibrator to output -100 mVdc
# -0.1V DC
CAL:VAL GVDC,-0.1
CAL? ON
CAL:REC
### Calibrate 1 A DC
## set calibrator to output 1 Adc
# 1 A DC
CAL:VAL GIDC,1
CAL? ON
## set calibrator to output -1 Adc
# -1 A DC
CAL:VAL GIDC,-1
CAL? ON
### Calibrate 10 A DC
## set calibrator to output 10 Adc
# 10 A DC
CAL:VAL GIDC,10
CAL? ON
## set calibrator to output -10 Adc
# -10 A DC
CAL:VAL GIDC,-10
CAL? ON
CAL:REC
### Calibrate 10 A ac @1200 Hz
## set calibrator to output 10A ac@1200Hz
# 10 A AC
CAL:VAL GIAC,10
CAL? ON
# 10 A AC Gain
CAL:VAL GIACS,10
CAL? ON
### Calibrate 1 A ac @1200 Hz
## set calibrator to output 1A ac@1200Hz
# 1 A AC
CAL:VAL GIAC,1
CAL? ON
# 1 A AC Gain
CAL:VAL GIACS,1
CAL? ON
### Calibrate 0.4 A AC @1200 Hz - OutGuard version 2.0 and above
## set calibrator to output 329mA ac@1200Hz
# 0.4 A AC
CAL:VAL GIAC,329.0E-3
CAL? ON

```

```
# 0.4 A AC Gain
CAL:VAL GIACS,329.0E-3
CAL? ON
### Calibrate 100mA AC @1200 Hz
## set calibrator to output 100mA ac@1200Hz
# 100mA AC
CAL:VAL GIAC,100.0E-3
CAL? ON
# 100mA AC Gain
CAL:VAL GIACS,100.0E-3
CAL? ON
### Calibrate 10mA AC @1200 Hz
## set calibrator to output 10mA ac@1200Hz
# 10mA AC
CAL:VAL GIAC,10.0E-3
CAL? ON
# 10mA AC Gain
CAL:VAL GIACS,10.0E-3
CAL? ON
#
# 8846A - uncomment if adjusting 8846A
#
# Calibrate 0.001 A AC @1200 Hz 8846 only
## set calibrator to output 0.001A ac@1200Hz
# 0.001 A AC
CAL:VAL GIAC,1.0E-3
CAL? ON
# 0.001 A AC
CAL:VAL GIACS,1.0E-3
CAL? ON
# Calibrate 0.0001 A AC @1200 Hz 8846 only
## set calibrator to output 0.0001 ac@1200Hz
# 0.0001 A AC
CAL:VAL GIAC,100.0E-6
CAL? ON
# 0.0001 A AC
CAL:VAL GIACS,100.0E-6
CAL? ON
# end comment
CAL:REC
### Calibrate 0.0001 ADC
## set calibrator to output 0.0001A dc
# 0.0001 ADC
CAL:VAL GIDC,100.0E-6
CAL? ON
## set calibrator to output -0.0001A dc
# -0.0001 ADC
CAL:VAL GIDC,-100.0E-6
CAL? ON
### Calibrate 0.001 ADC
## set calibrator to output 0.001A dc
# 0.001 ADC
CAL:VAL GIDC,1.0E-3
CAL? ON
## set calibrator to output -0.001A dc
```

```

# -0.001 ADC
CAL:VAL GIDC,-1.0E-3
CAL? ON
### Calibrate 0.01 ADC
## set calibrator to output 0.01A dc
# 0.01 ADC
CAL:VAL GIDC,10.0E-3
CAL? ON
## set calibrator to output -0.01A dc
# -0.01 ADC
CAL:VAL GIDC,-10.0E-3
CAL? ON
### Calibrate 0.1 ADC
## set calibrator to output 0.1A dc
# 0.1 ADC
CAL:VAL GIDC,100.0E-3
CAL? ON
## set calibrator to output -0.1A dc
# -0.1 ADC
CAL:VAL GIDC,-100.0E-3
CAL? ON
### Calibrate 0.4 ADC
## set calibrator to output 0.400A dc - OutGuard version 2.0 and above
# 0.4 ADC
CAL:VAL GIDC,400.0E-3
CAL? ON
## set calibrator to output -0.400A dc - OutGuard version 2.0 and above
# -0.4 ADC
CAL:VAL GIDC,-400.0E-3
CAL? ON
CAL:REC
### Calibrate 100 MOhm
## set calibrator to output 100M Ohms
# 100 MOhm
CAL:VAL GRES,100000000
CAL? ON
### Calibrate 10 MOhm 4-wire
## set calibrator to output 10M Ohms
# 10 MOhm
CAL:VAL GRES,10000000
CAL? ON
### Calibrate 1 MOhm 4-wire
## set calibrator to output 1M Ohms
# 1 MOhm
CAL:VAL GRES,1000000
CAL? ON
### Calibrate 100 kOhm 4-wire
## set calibrator to output 100k Ohms
# 100 kOhm
CAL:VAL GRES,100000
CAL? ON
### Calibrate 10 kOhm 4-wire
## set calibrator to output 10k Ohms
# 10 kOhm
CAL:VAL GRES,10000

```

```
CAL? ON
### Calibrate 1 kOhm 4-wire
## set calibrator to output 1k Ohms
# 1 kOhm
CAL:VAL GRES,1000
CAL? ON
### Calibrate 100 Ohm 4-wire
## set calibrator to output 100 Ohms
# 100 Ohm
CAL:VAL GRES,100
CAL? ON
### Calibrate 10 Ohm 4-wire
## set calibrator to output 10 Ohms
# 10 Ohm
CAL:VAL GRES,10
CAL? ON
CAL:REC
#
# 8846A - uncomment if adjusting 8846A
#
### Calibrate 1G Ohm 8846 only
# Attach 1G Ohms to hi/lo terminals
# 1G Ohm - unremark
CAL:VAL GRES,1000000000
CAL? ON
### Calibrate 10 nF 8846 only
## apply 10nF standard
# 10 nF
CAL:VAL GCAP1,10.0E-9
CAL? ON
### Calibrate 10 nF 8846 only
# apply 10nF standard
# 10 nF gain
CAL:VAL GCAP2,10.0E-9
CAL? ON
# end comment
CAL:REC
# Turn on the calibration protection
CAL:SEC:STAT ON, FLUKE884X
## power unit down to make new constants operational
```