

2280 SERIES

DATA LOGGER

User Guide

P/N 758276

February 1985

©1986 John Fluke Mfg. Co. Inc., all rights reserved. Litho in U.S.A.



WARRANTY

John Fluke Mfg. Co., Inc. (Fluke) warrants this Instrument to be free from defects in material and workmanship under normal use and service for a period of ninety (90) days from date of shipment. Software is warranted to operate in accordance with its programmed instructions on appropriate Fluke instruments. It is not warranted to be error free. This warranty extends only to the original purchaser and shall not apply to fuses, computer media, batteries or any instrument which, in Fluke's sole opinion, has been subject to misuse, alteration, abuse or abnormal conditions of operation or handling.

Fluke's obligation under this warranty is limited to repair or replacement of an instrument which is returned to an authorized service center within the warranty period and is determined, upon examination by Fluke, to be defective. If Fluke determines that the defect or malfunction has been caused by misuse, alteration, abuse, or abnormal conditions of operation or handling, Fluke will repair the instrument and bill purchaser for the reasonable cost of repair. If the instrument is not covered by this warranty, Fluke will, if requested by purchaser, submit an estimate of the repair costs before work is started.

To obtain repair service under this warranty purchaser must forward the instrument, (transportation prepaid) and a description of the malfunction to the nearest Fluke Service Center. The instrument shall be repaired at the Service Center or at the factory, at Fluke's option, and returned to purchaser, transportation prepaid. The instrument should be shipped in the original packing carton or a rigid container padded with at least four inches of shock absorbing material. FLUKE ASSUMES NO RISK FOR IN-TRANSIT DAMAGE.

THE FOREGOING WARRANTY IS PURCHASER'S SOLE AND EXCLUSIVE REMEDY AND IS IN LIEU OF ALL OTHER WARRANTIES, EXPRESS OR IMPLIED, INCLUDING BUT NOT LIMITED TO ANY IMPLIED WARRANTY OF MERCHANTABILITY, FITNESS FOR ANY PARTICULAR PURPOSE OR USE. FLUKE SHALL NOT BE LIABLE FOR ANY SPECIAL, INDIRECT, INCIDENTAL, OR CONSEQUENTIAL DAMAGES OR LOSS WHETHER IN CONTRACT, TORT, OR OTHERWISE.

CLAIMS

Immediately upon arrival, purchaser shall check the packing container against the enclosed packing list and shall, within thirty (30) days of arrival, give Fluke notice of shortages or any nonconformity with the terms of the order. If purchaser fails to give notice, the delivery shall be deemed to conform with the terms of the order.

The purchaser assumes all risk of loss or damage to instruments upon delivery by Fluke to the carrier. If an instrument is damaged in-transit, PURCHASER MUST FILE ALL CLAIMS FOR DAMAGE WITH THE CARRIER to obtain compensation. Upon request by purchaser, Fluke will submit an estimate of the cost to repair shipment damage.

Fluke will be happy to answer all questions to enhance the use of this instrument. Please address your requests or correspondence to: JOHN FLUKE MFG. CO., INC., P.O. BOX C9090, EVERETT, WA 98206, ATTN: Sales Dept. For European Customers: Fluke (Holland) B.V., P.O. Box 5053, 5004 EB, Tilburg, The Netherlands.

CONTENTS

1	GETTING STARTED.....	1-1
	Overview	1-2
	Introduction	1-3
	Manual Organization	1-4
	Connecting the Units	1-5
	Additional Hardware	1-5
	Establishing Communications	1-6
	Making a Backup Diskette	1-6
	Conventions of ProLogger	1-7
	How is ProLogger Structured	1-8
	Using ProLogger for the First Time	1-9
	Error Conditions	1-11
	Getting Stopped	1-11
2	PROLOGGER OFF LINE FUNCTIONS	2-1
	Introduction	2-2
	Off Line Windows	2-3
	Main Menu	2-4
	Set Up	2-5
	Port Select	2-6
	Parameters	2-7
	Baud Rate	2-8
	Sound	2-9
	Sound Edit	2-10
	Octave	2-11
	Disk Utility	2-12
	Select Type	2-13
	File Select	2-14
	Name File.....	2-15
	Directory	2-16
	Delete File	2-17
	File Select	2-14
	Name File	2-15
	Copy File	2-18
	Down Load	2-19
	File Select	2-14
	Name File	2-15
	Lotus Format	2-21
	File Select	2-14
	Name File	2-15
	Select Cell	2-22
	2280B	3-1

CONTENTS

3	PROLOGGER ON LINE COMMUNICATIONS	3-1
	Introduction	3-2
	Display Window	3-3
	Program Status Window	3-4
	Printer/Recording Window	3-5
	Function Keys	3-6
	Record	3-7
	Function Summary	3-8
	Notes on Operation	3-9
	Suggested 2280B Program Dos and Don'ts	3-11

SECTION 1

GETTING STARTED

CONTENTS

Overview	1-2
Introduction	1-3
Manual Organization	1-4
Connecting the Units	1-5
Additional Hardware	1-5
Establishing Communications	1-6
Making a Backup Diskette	1-6
How ProLogger is Structured	1-7
Conventions of Prologger	1-8
Using ProLogger for the First Time	1-9
Error Conditions	1-11
Getting Stopped	1-11

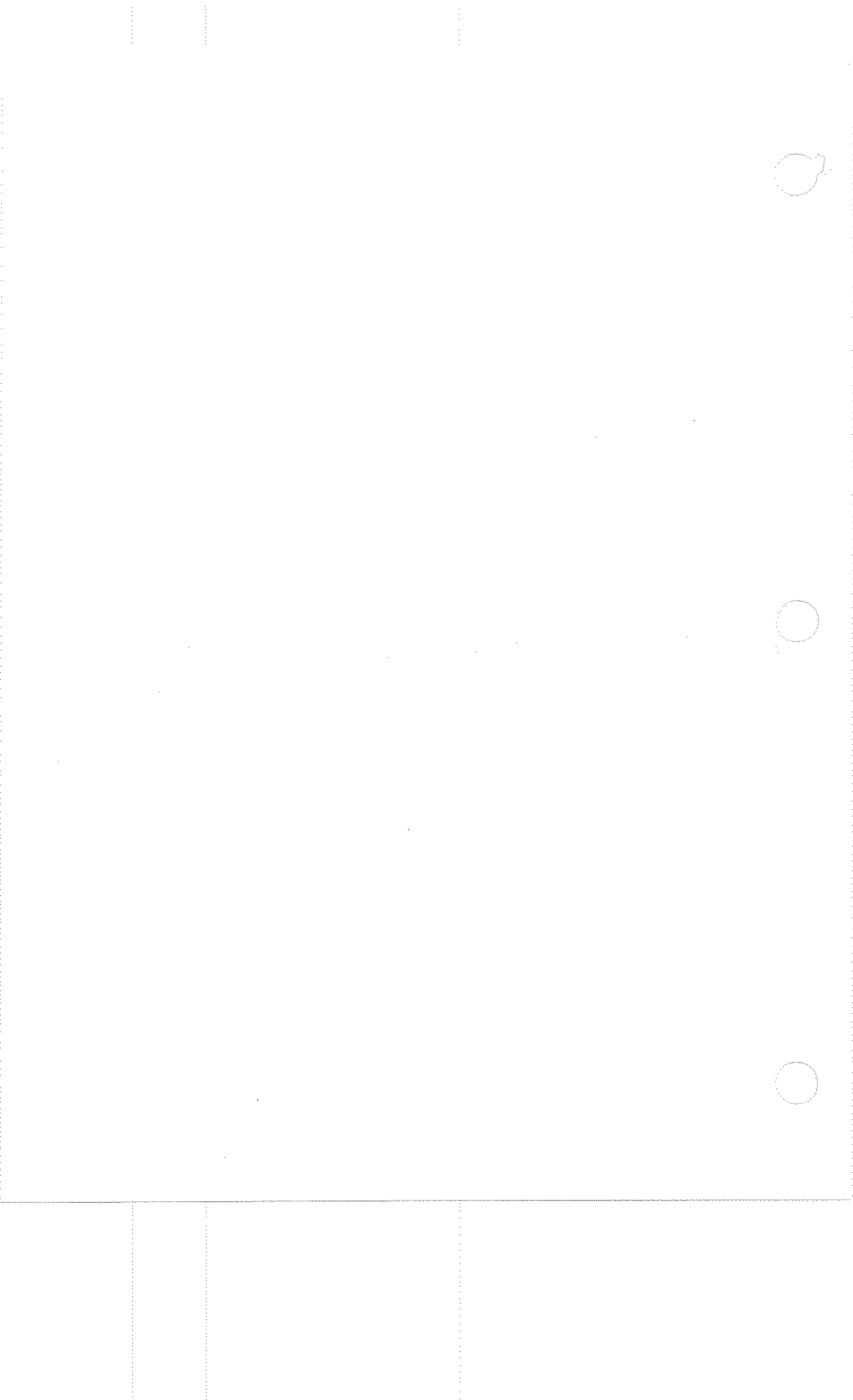

OVERVIEW

ProLogger is a communications utility for the IBM Personal Computer and the Fluke 2280B Data Logging System. This software tool establishes serial communication with the 2280B and uses the IBM disk drives for storage. Extensive use of the IBM function keys and windowing provide an easy to use package.

In this manual, reference to the 2280B also includes the Fluke 2280A and 2285B models.

Using ProLogger, you can :

- O Record data from the 2280B onto the IBM disks.
- O Translate data files to Lotus 1-2-3 format.
- O Transfer files to other disks.
- O Record 2280B programs on disk.
- O Download 2280B programs.
- O Remotely control the 2280B.

This manual explains how to use ProLogger to remotely interface with the 2280B.

ProLogger software operates with MS-DOS versions 2.1 and above.

1/Getting Started

INTRODUCTION

ProLogger is a serial communication utility between an IBM PC and a Fluke 2280B Data Logging System. It requires that each unit have a serial interface and that an appropriate cable connect the two together. The user must have booted the PC with a MS-DOS 2.1 or later diskette.

ProLogger provides "Off Line" functions to establish such things as baud rate, file names, and the prompting sound for the program to use. Additional functions download 2280B programs, copy or view ASCII files, and reformat 2280B data to a Lotus 1-2-3 format.

"On Line", ProLogger emulates a 2280B front panel operation. If you have used a 2280B, then you will immediately feel at home here. If you are familiar with the 2280B remote operation through a terminal, again you will find ProLogger to be an extension rather than a limit to your abilities.

The ProLogger package comes in two parts:

- Floppy Diskette
- This Manual

MANUAL ORGANIZATION

This manual is organized so you can learn the various functions step by step. You do not have to read the entire manual before using ProLogger. This manual does not replace the 2280B programmers manual, or the IBM Personal Computer DOS manual. It should be used along with these manuals, because a certain familiarity with them is assumed. Explanations and examples are included where they are needed to clarify the use of ProLogger and to avoid numerous cross references.

This manual is divided into three sections:

- Section 1 This section gives an overview of the manual, explaining the purpose of ProLogger, and how the manual is arranged to assist you in using the available features of ProLogger.
- This section helps you get started by explaining how to physically connect the two units, how to create a backup diskette, and how to get started with the ProLogger disk.
- Section 2 The second section describes each of the "Off Line" functions of ProLogger.
- Section 3 The third section describes the "On Line" function of ProLogger. While the layout and use of the function keys is to emulate the front panel operation of the 2280B, the IBM keyboard is fully active and acting as a remote terminal. Particular attention is paid in this section to suggested 2280B programming options to work with ProLogger.

1/Getting Started

CONNECTING THE UNITS

In order for the IBM PC and 2280B to communicate, both units must have a serial interface, and an appropriate RS-232-C cable or cables, to connect the two.

The Fluke 2280B must have a -341 RS-232-C Interface Option installed as Port A.

With the number of IBM PC compatible computers and interface cards, we are unable to give detailed part numbers for the IBM serial interface, or Color Graphics Adapter (CGA) cards.

The IBM PC-XT comes with a serial port (COM1) which connects directly to the 2280B-341 with a null modem cable.

Any other PC must have a serial card installed. Consult the manual for the serial interface purchased for pin outs. In some cases it will be necessary to construct an adapter cable from the IBM interface connector to the standard 25 pin RS-232-C connector.

If modems link the 2280B and PC, additional cables will be required.

ProLogger may be connected to either the PC's serial interface port designated "COM1" or "COM2" if available.

ADDITIONAL HARDWARE

Besides the serial interfaces, cables, (and modems) required to establish a serial connection, ProLogger does not require the PC to have a color graphics card, however, if one is available and compatible with the IBM Color Graphics Adapter (CGA) card, then ProLogger appears in color.

While ProLogger uses color, a color monitor is not required. We have observed slight differences in the ProLogger display using the PC-AT EGA card (no border) and noted a third party color card that caused some areas of the display to be invisible until the card was switched to an emulation (of the IBM CGA) mode.

1/Getting Started

NOTE: If your computer drives a monochrome monitor with a color board (shades of green?), there is a hidden switch in ProLogger to emulate the standard monochrome display. From the Sound Menu, hit ALT <F3> (Alt sound off) to toggle the color display to monochrome.

ESTABLISHING COMMUNICATIONS

Once the RS-232-C cabling for your particular configuration has been established, it is necessary to program the 2280B Output Parameters to match those set by and in ProLogger.

Specifically, from the 2280B front panel, set the output device program for Port A characteristics, device type (RS-232-C), baud rate (your choice), parity (none), and fill characters (0).

The 2280B will remember your selections until you change them.

ProLogger sets the COM port, baud rate, and databits/parity to those you select in "Set Up".

MAKING A BACKUP DISKETTE

It is a good idea to make a backup copy of any software diskette you receive - just in case the inadvertant "can't-happen-to-me" does. Fluke has made no attempt to copy protect ProLogger for just that reason.

Before loading ProLogger, refer to the IBM PC manual for instructions on how to make a copy of a disk (DISKCOPY). Copy the ProLogger software to a backup disk, and then put the original away in a safe place. Use the copy for your normal day-to-day tasks.

The ProLogger diskette is sent with a write protect tab in place to remind you that you really don't want to modify the original. This Tab must be removed to actually use the disk.

1/Getting Started

HOW PROLOGGER IS STRUCTURED

Physically, there are three files on the master ProLogger disk:

- PROLOG.EXE - the main program
- CONCISE.EXE - a routine called by the download function if the 2280B program specified has not been converted from the ASCII listing you get from the 2280B to the 2280B concise command format (done by this program).
- PROINIT.VAL - the storage file for the COM port parameters, sound string, Recording file name, and Download file name.

Functionally, ProLogger can be divided into an On Line, or communication, section and the Off Line functions.

The On Line communication function of ProLogger was designed to emulate the actual front panel operation of the 2280B. If you are a 2280B user, with or without experience with its RS-232-C interface, ProLogger On Line, will be extremely familiar. The only new features for you will be the "RECORD" and "M.MENU" function keys, and the addition of a "program status" window for ProLogger messages. The On Line function is detailed in section 3 of this manual.

The Off Line functions of ProLogger were designed to provide you with access to the IBM PC disk system without experience in MS-DOS. Its functions, detailed in section 2, are based on one common screen with four window areas.

1/Getting Started

In describing the functions of ProLogger, two file names will be mentioned often. Briefly these files are :

- | | |
|----------------|---|
| Recording file | - On line recording is to this file.
- Off line, this is the source file for the copy function, or for conversion to Lotus 1-2-3 format. |
| Download file | - This is the name of the 2280B program recorded on disk that you wish to download to 2280B. |

CONVENTIONS OF PROLOGGER

ProLogger, particularly in the Off line mode, is menu driven, with 'nested' menus. This means for example that choosing "Set Up" allows you to choose "Sound" which allows you choose "Edit" which allows you choose the "Octave" menu. In this form of program, it is sometimes easy to get lost. ProLogger adopts two conventions to eliminate this problem.

The first is simply displaying the name of the current menu. This name is often slightly more descriptive form of the function key last selected. For example, the menu name "Disk Utility" appears when "DISK" was selected via a function key.

The second convention is that, except at the top most menu, (the Main Menu), the lowest left function key on the IBM keyboard, (F9), will always return you to the next highest menu. That is, it will back you out one level at a time. Further, selecting <Alt><F9> will immediately return you to the Main Menu.

1/Getting Started

USING PROLOGGER FOR THE FIRST TIME

Boot the PC using your normal Operating System Disk. When DOS is loaded, insert ProLogger to either of the drives. (Yes, you can copy it to the Hard Disk if you have one.) Assign the drive with ProLogger as the system device. For example, if the diskette is inserted in drive B:, then when the Operating System prompt appears, type B: to make that drive the default drive.

Type PROLOG followed by the <Enter> key. The first ProLogger Off line screen will appear.

Color check: the border should be dark blue, the background red, there are four windows, the lower two are light blue. Of course if you have a monochrome monitor, all these should be black with the window names, and all of the lower two windows in high intensity.

The four windows are common for all the Off line menus. As menu choices are made via selection of the function keys, new information is displayed in the window areas to reflect the new choices available.

1/Getting Started

The four windows are:

Menu Name	The name of the currently selected menu. When you start ProLogger, the top level menu name is "Main Menu". This window then simply tells you where you are.
Current Selection	Displays current selections available for change from this or subsequent menus. For example, from the "Set Up" menu, you can change the baud rate, or enter the "Sound" menu. The current selection shows the present baud rate, and the program prompt sound in IBM format. Error messages may also be displayed here.
Function key	The IBM function keys are used to make most of the program off line inputs. This window represents the function key layout on the PC. This may be thought of as ten windows with the name of the selections available in the appropriate key location. The function key number appears next to each block for clarity (particularly for non IBM keyboards). The lower left function key will return you to the calling, or next highest, menu.
Menu Description	Menu description might be thought of as an ever present help file, describing the current function key choices. At times, this window doubles as a viewing, or input area after a selection has been made. For example, in the file copy menu, this area describes choices available: to view the selected file, or to copy it to the selected destination. If "View" is selected, then the contents of the file are viewed in this window. If "Copy" is selected, then the message "Copying" and a series of "." show the activity in this area.

1/Getting Started

ERROR CONDITIONS

Usually ProLogger handles errors by displaying equivalent text to the IBM error code number and allowing you to try again.

Some errors are not recoverable in the IBM and will require you reboot ProLogger. These are usually hardware associated errors. Consult the IBM basic manual for the error code and correct the problem.

GETTING STOPPED

ProLogger exits from the "Set Up" menu to the Operating System by selecting the function key labeled "SYSTEM" <F8>.

SECTION 2

PROLOGGER OFF LINE FUNCTIONS

CONTENTS

Introduction	2-2
Off Line Windows	2-3
Main Menu	2-4
Set Up	2-5
Port Select	2-6
Parameters	2-7
Baud Rate	2-8
Sound	2-9
Sound Edit	2-10
Octave	2-11
Disk Utility	2-12
Select Type	2-13
File Select	2-14
Name File.....	2-15
Directory	2-16
Delete File	2-17
File Select	2-14
Name File	2-15
Copy File	2-18
Down Load	2-19
File Select	2-14
Name File	2-15
Lotus Format	2-21
File Select	2-14
Name File	2-15
Select Cell	2-22
2280B	3-1

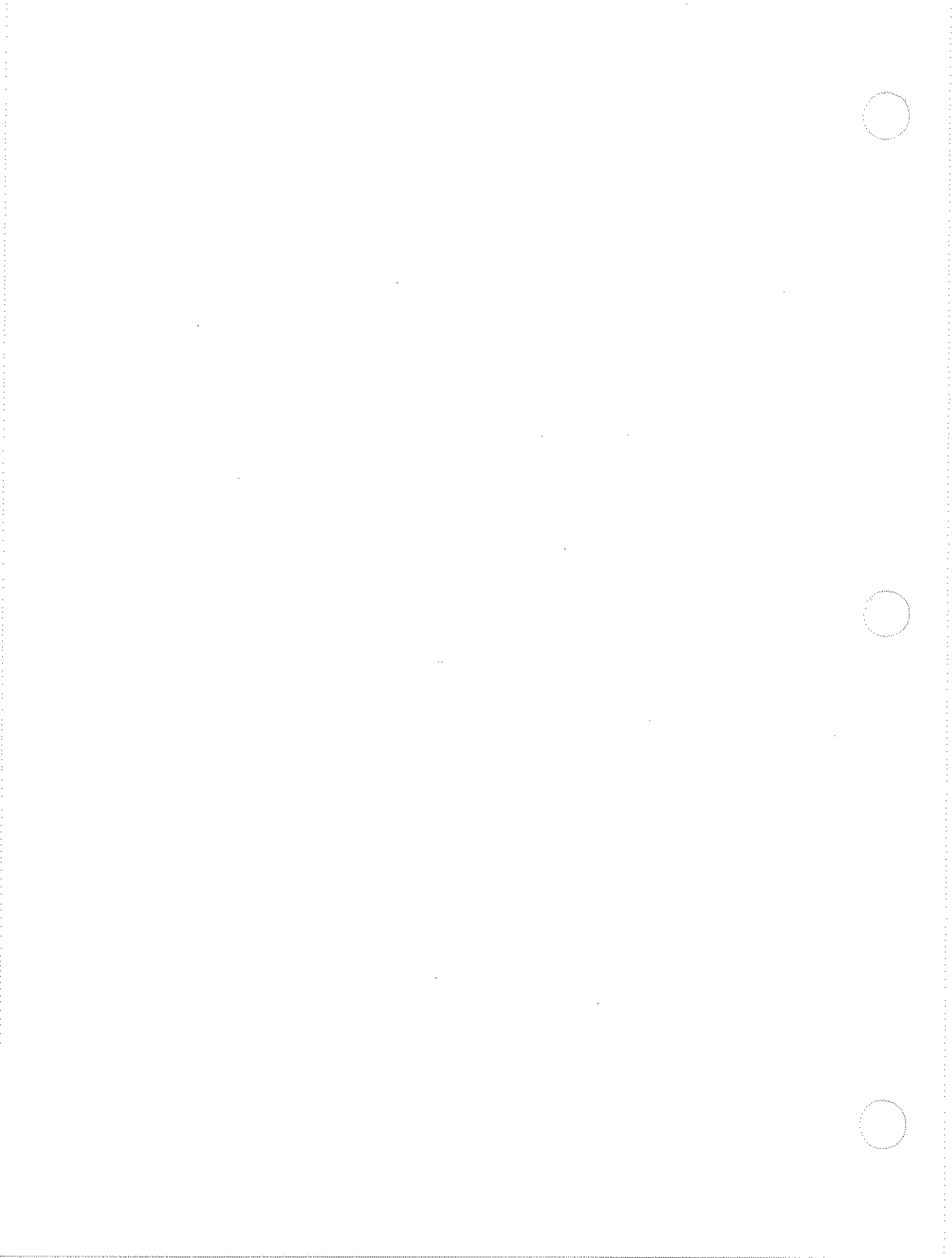

INTRODUCTION

ProLogger is a software tool designed to facilitate communication with the Fluke 2280B Data Logging System, to allow convenient storage of data to the IBM PC disk drives, and to provide a method to put that data in a Lotus 1-2-3 format for transfer to a Lotus disk.

Functionally, ProLogger can be divided into an On Line, or communication, section and the Off Line functions.

The On Line communication function of ProLogger was designed to emulate the actual front panel operation of the 2280B. If you are a 2280B user, with or without experience with its RS-232-C interface, ProLogger On Line, will be extremely familiar. The only new features for you will be the "RECORD" and "M.MENU" function keys, and the addition of a "program status" window for ProLogger messages. The On Line function is detailed in section 3 of this manual.

The Off Line functions of ProLogger were designed to provide you with access to the IBM PC disk system without experience in MS-DOS. Its functions, detailed in this section, are based on one common screen with four window areas.

2/ProLogger Off Line

OFF LINE WINDOWS

ProLogger's Off Line functions are based on a common screen with four window areas. As menu choices are made via selection of the function keys, new information is displayed in these window areas to reflect the new choices available.

The four windows are:

Menu Name	The name of the currently selected menu. When you start ProLogger, the top level menu name is "Main Menu". This window then simply tells you where you are.
Current Selection	Displays current selections available for change from this or subsequent menus. For example, from the "Set Up" menu, you can change the baud rate, or enter the "Sound" menu. The current selection shows the present baud rate, and the program prompt sound in IBM format. Error messages may also be displayed here.
Function key	The IBM function keys are used to make most of the program off line inputs. This window represents the function key layout on the PC. This may be thought of as ten windows with the name of the selections available in the appropriate key location. The function key number appears next to each block for clarity (particularly for non IBM keyboards). The lower left function key will return you to the calling, or next highest, menu.
Menu Description	Menu description might be thought of as an ever present help file, describing the current function key choices. At times, this window doubles as a viewing, or input area after a selection has been made. For example, in the file copy menu, this area describes choices available: to view the selected file, or to copy it to the selected destination. If "View" is selected, then the contents of the file are viewed in this window. If "Copy" is selected, then the message "Copying" and a series of "." show the activity in this area.

MAIN MENU

--- Menu Name ---	--- current selection ---
Main Menu	ProLogger Program Version number for communication parameters to 2280B Recording file drive and name Download file drive and name
--- f key ---	--- menu description ---
<F1> SET UP	Communications set up menu - branch to Set Up. Options: select and test the baud rate, branch to modify the program sound prompt, or leave ProLogger.
<F3> DISK	Disk file utility menu - branch to the disk utility. Options: select the file names, examine the disk directories, delete files from the disks, and copy or view the selected Recording file.
<F5> DNLOAD	Download 2280 program - branch to Down Load Utility. Options: select a different file name, or transmit the selected file to the 2280B, replacing the 2280B's operating program.
<F7> LOTUS	Translate data files to Lotus 1-2-3 format - branches to Lotus Format. Options: select a different file name, or translate the selected file to Lotus 1-2-3 format.
<F9> 2280B	Start communications with 2280 - branch to the on line communications screen.

SET UP

--- Menu Name ---	---	current selection ---
-----	-----	-----
Set Up		2280B communication parameters Printer communication parameters Program prompt sound string in IBM format
--- F key ---	---	menu description ---
-----	-----	-----
<F1> 2280B		2280 Selects the IBM Com port and parameters for communication with the 2280B
<F3> PRINTER		PRINTER selects the IBM COM port and parameters or parallel port for the printer
<F5> SOUND		SOUND allows definition of the noise prompt - branches to Sound menu Options: enable or disable the sound prompt, play the sound, or edit the sound
<F6> TEST		TEST initiates communications port check
<F8> SYSTEM		SYSTEM exits the program to DOS - ends ProLogger
<F9> M.MENU		M.MENU returns to Main Menu

PORT SELECT

--- Menu Name ---	---	current selection ---
Port Select		2280/Printer port parameters
--- F key ---		--- menu description ---
<F1> COM1:	COM1:	Selects the IBM COM port 1
<F3> COM2:	COM2:	Selects the IBM COM port 2
<F5> LPT1:	LPT1:	Selects the parallel port *printer option only
<F8> NULL:	NULL:	Selects for no printer port *printer option only
<F9> SET UP:	SET UP:	Returns to Set Up menu

Selection of COM1: or COM2: branches to "Parameters" menu for selection of baudrate, databits and parity.

PARAMETERS

--- Menu Name ---	--- current selection ---
Parameters	2280/Printer port parameters

--- F key ---	--- menu description ---
<F1> BAUD	BAUD Selects the baud rate
<F3> 7DB,E	7DB,E Selects 7 data bits and even parity
<F4> 7DB,O	7DB,O Selects 7 data bits and odd parity
<F5> 7DB,N	7DB,N Selects 7 data bits and no parity
<F6> 8DB,N	8DB,N Selects 8 data bits and no parity
<F9> PORT	PORT Returns to the Port Select

BAUD RATE

--- Menu Name ---	--- current selection ---
Baud Rate	2280/Printer port characteristics
---	---
--- F key ---	--- menu description ---
<F1> - <F7> 110 - 9600	#### Selects the baud rate for the device
<F9> PARAMETER	PARAMETER Returns to the Parameter menu

SOUND

--- Menu Name ---	---	current selection ---
Sound		Program prompt sound string in IBM format
--- F key ---		--- menu description ---
<F1> PLAY	PLAY	Plays the current program sound.
<F3> OFF	OFF	Disables program sound - sound string is still in memory, but is disabled.
<F5> ON	ON	Enables the last edited program sound
<F7> EDIT	EDIT	Allows the user to edit the sound - branches to the Sound Edit menu. Options: enter a new sound string, including the octave.
<F9> SET UP	SET UP	Returns to the set up menu

ALT OFF will toggle ProLogger from color to black and white mode for use with computers which drive monochrome displays with color driver boards. The colors of ProLogger were chosen such that when viewed on a monochrome monitor, the high/low intensity displays would be appropriate. When a monochrome display is driven by a color board, you get "shades" of monochrome. In this case, "ALT OFF" will clarify the display. Note that if you do have a color monitor and prefer a black and white display, there will still be some color Online.

SOUND EDIT

<u>-- Menu Name --</u>	<u>--- current selection ---</u>
Sound Edit	Program prompt sound string in IBM format
<u>--- F key ---</u>	<u>--- menu description ---</u>
<F1> - <F7> C - B	A-G Adds the selected note to the sound < all notes are 1/16 TH notes>
<F8> REST	REST Adds a null note
<F10> OCTAVE	OCTAVE Changes the octave of the next notes - branches to Octave menu. Options: select the octave.
<F9> SOUND	SOUND Returns to the sound menu

OCTAVE

--- Menu Name ---	---	current selection ---
Octave		Program prompt sound string in IBM format
--- F key ---	---	menu description ---
<F1> - <F7> 1 - 0	0-6	Selects the octave for the next notes < Octave 3 starts at middle C > Selection automatically returns to edit
<F9> EDIT	EDIT	Returns to sound edit without change

DISK UTILITY

--- Menu Name ---	--- current selection ---
Disk Utility	Recording file drive and name Download file drive and name
--- F key ---	--- menu description ---
<F1> SELECT	SELECT Allows the user to specify Recording, and Download - branches to select type menu. options: select type and enter name and drive.
<F3> DIR	DIR Displays disk directories - branches to Directory menu. Options: select drive and display directory for all files, or just files with .DAT or .PRN extentions.
<F5> DELETE	DELETE Allows the user to delete unwanted files - branches to Delete File menu. Options: select drive and file to delete and delete it.
<F7> COPY	COPY Allows the user to view, rename, transfer, or print the recording file. - branches to Copy File menu. Options: display, rename, copy, or print the Recording file.
<F9> M.MENU	M.MENU Returns to the Main Menu

2/ProLogger Off Line

SELECT TYPE

--- Menu Name ---	--- current selection ---
Select Type	Recording file drive and name Download file drive and name
--- F key ---	--- menu description ---
<F1>select RECORD	RECORD Selects the active recording file - branches to Select Type menu. Options: select drive and name for Recording file.
<F3>select DNLOAD	DNLOAD Selects the download file for dnload - branches to Select Type menu. Options: select drive and name for Download file.
<F9> DISK	DISK Returns to the Disk Utility Menu

FILE SELECT

<u>-- Menu Name --</u>	<u>--- current selection ---</u>
File Select	Displays the drive and file name for <u>either</u> the Recording, Download, Copy, or Delete functions.
<u>--- F key ---</u>	<u>--- menu description ---</u>
<F1> - <F3> A: - C:	A:-C: Selects the disk drive for the file - selects and automatically branches to the Name File menu.
<F5> NAME	NAME Allows the user to enter the file name - branches to Name File without changing the current drive selection.
<F9> RETURN	RETURN Returns to previous menu

2/ProLogger Off Line

NAME FILE

-- Menu Name --	--- current selection ---
Name File	Displays the drive and file name for <u>either</u> the Recording, Download, Copy, or Delete functions.
---	---
--- F key ---	--- menu description ---
-----	-----

TYPE FILE NAME

<CR> ENTERS FILE NAME

<F9> ABORT ABORT Returns without changing file name

This screen uses the " menu description " area for input. The keyboard is active as well as F9.

ProLogger locks out the DOS wild cards "?" and "*" from the file name as well as limiting the name and extension to eight and three characters respectively. Only one "." is allowed, and the routine automatically enters it when eight characters have been typed. Note, this has the effect that typing a full eight character name plus "." is treated as an extra "." and you are warned (beeped) at for your efforts.

DIRECTORY

<u>-- Menu Name --</u>	<u>--- current selection ---</u>
Directory	Display selected drive.
<u>-- F key ---</u>	<u>--- menu description ---</u>
<F1> - <F3> A: - C:	A:-C: Selects the drive to check
<F5> *.DAT	*.DAT Displays all .DAT files - suggested extention for data files.
<F6> *.PRN	*.PRN Displays LOTUS 1-2-3 format files
<F7> *.*	*.* Displays complete directory
<F9> DISK	DISK Returns to Disk Utility Menu

ProLogger clears the screen, displays the selected directory, and prompts you to hit any key to continue. At this point you are returned to the Directory Menu.

DELETE FILE

--- Menu Name ---	--- current selection ---
Delete File	Displays the drive and of the file to be deleted.

--- F key ---	--- menu description ---
<F1> FILE	FILE Allows the user to enter a new file name - branches to File Select. Options: enter drive and name.
<F5> DELETE	DELETE Deletes the selected file
<F9> DISK	DISK Returns to Disk Utility Menu

ProLogger either acknowledges deletion of the file, or advises of its inability to do so in the current selection block.

COPY FILE

--- Menu Name ---	---	current selection ---
Copy File		Recording file drive and name Printer port parameters
---	F key ---	---
		menu description ---
<F1>	VIEW	VIEW Copies the recording file to the screen
<F3>	RENAME	RENAME Allows the recording file to be renamed
<F5>	COPY	COPY Duplicates/transfers the Recording file
<F7>	PRINT	PRINT Prints the recording file
<F9>	DISK	DISK Returns to the disk utility menu

Rename braches to "Name File" for new name entry.
Copy branches to "File Select" for destination drive name entry.

View clears the "menu description" window and displays the contents of the selected Recording file in this window area. The prompt, "<Hit any key to abort>" is displayed while the file is being displayed. Hitting a key will cancel the display of the file.

Note that <Ctrl><Num Lock> will pause the display (it also halts the program!) until another key is touched.

During the Copy operation, the "menu description" window indicates "Copying" and a line of "*" is printed, (one "*" for each line that is transfered) to indicate activity. Hitting any key during the transfer will cancel the operation.

2/ProLogger Off Line

DOWN LOAD

Menu Name	current selection
F key	menu description
Down Load	Download file drive and name
<F1> FILE	FILE Allows the user to enter a new file name
<F5> DNLOAD	DNLOAD Downloads the selected file to the 2280B
<F9> M.MENU	M.MENU Returns to Main Menu

ProLogger must obviously have a 2280B program on a disk in order to download it to the 2280B. How did it get there? The following example will show how to do so.

To "up load" a 2280B program, you select a Recording file name, such as "CONFIG01.ASC" from the Select Type menu series. Next, bring ProLogger "On line" with the 2280B.

2280B prompt	enter
"MAIN MENU CHOICE <M FOR MENU>?"	<L>
"<L> LIST PROGRAM AND CONFIGURATION"	<CR>
"L: LIST MENU CHOICE <A-Z>"	<D>
"L<D> SELECT LIST OUTPUT DEVICE"	<CR>
"LD: LIST OUTPUT DEVICE <1-3>?"	<2>
"LD<2> PORT A"	<CR>
"L: LIST MENU CHOICE <A-Z>"	<E>

Floke MUST BE IN PROGRAM MODE !!

***** Press <F10> if you haven't already *****

The label "RECORD" on the screen will turn red and flash indicating that the record function is on. The "--- printer window ---" label will change to the name of the Recording file. All information displayed in this window will now be recorded to disk.

"L<E> LIST EVERYTHING"

<CR>

The 2280B program is being recorded as it's printed. When the listing stops, ("LIST MENU CHOICE ..." is displayed and the program sound has prompted) again hit <F10> "RECORD" to turn off the recording and close the file. Hit <F9> "M.MENU" to return off line.

You now have the 2280B program listing in ASCII form (thats why the .ASC extention for this file name was suggested). This listing can be viewed from the Copy File menu to confirm that you retrieved it.

The 2280B would not however understand this ASCII format if we tried to transmit it back. DNLOAD opens the specified download file on the selected drive, and checks to see if it has already converted this ASCII listing to the 2280B concise command format. If not, then it runs the "CONCISE" program from the ProLogger disk and saves the converted version under the same name and on the same drive, but under the extention ".PRG".

If the Download file hasn't been converted, but you assigned it the extention ".PRG" before you recorded it, or when you copied it, then ProLogger will rename your ASCII version with the ".ASC" extention.

ProLogger commands the 2280B to erase the program currently in memory, then transmit the concise version to reprogram it.

If you view the converted file, you will see the 2280B concise command string entries corresponding to the ASCII listing, with the file starting with the word "CONCISE". This is the flag that ProLogger looks for at the start of the file to determine if it can download the file as is, or needs to convert it first. If you have a 2280B program in concise command string format that was not recorded with ProLogger, you will need to add the word "CONCISE"<CR> to the beginning of the file for Prologger to recognize it.

2/ProLogger Off Line

LOTUS FORMAT

<u>-- Menu Name --</u>	<u>--- current selection ---</u>
Lotus Format	Recording file drive and name Lotus file drive and name
<u>--- F key ---</u>	<u>--- menu description ---</u>
<F1> FILE	FILE Allows the user to enter a new file name
<F5> LOTUS	LOTUS Begins the translation process for Lotus - branches to Select Cell routine. Options: include or exclude as a Lotus cell channel number, name, data, and/or units (if recorded) in file.
<F9> M.MENU	M.MENU Returns to the Main Menu

ProLogger will create a new file on the same drive, and with the same name as the recording file, but with the Lotus "PRN" extension.

If the recording file has a name with the "PRN" extension, ProLogger will rename the recording file with the "DAT" extension.

SELECT CELL

--- Menu Name ---	---	current selection ---
-----	-----	-----
Select Cell		Recording file drive and name Testing : status of data file translation
---	---	menu description ---
-----	-----	-----
<F1> CHAN *	CHAN	Channel number included in Lotus data
<F3> LABEL *	LABEL	Channel label included in Lotus data
<F5> UNITS *	UNITS	Channel units included in Lotus data
<F8> START	START	Begins the translation process
<F9> ABORT	ABORT	Terminates file translation

* <F2> <F4> <F6> Labels are either "N/A" (not available), "YES", or "NO".

N/A indicates that the field is not available in the data.

NO indicates that the field will not be included in the Lotus data.

YES indicates the field will be included.

The ProLogger will automatically assign date, time, and group number, as separate Lotus Rows.

Each scan group will form one Row, each channel value separated by a space from the next value.

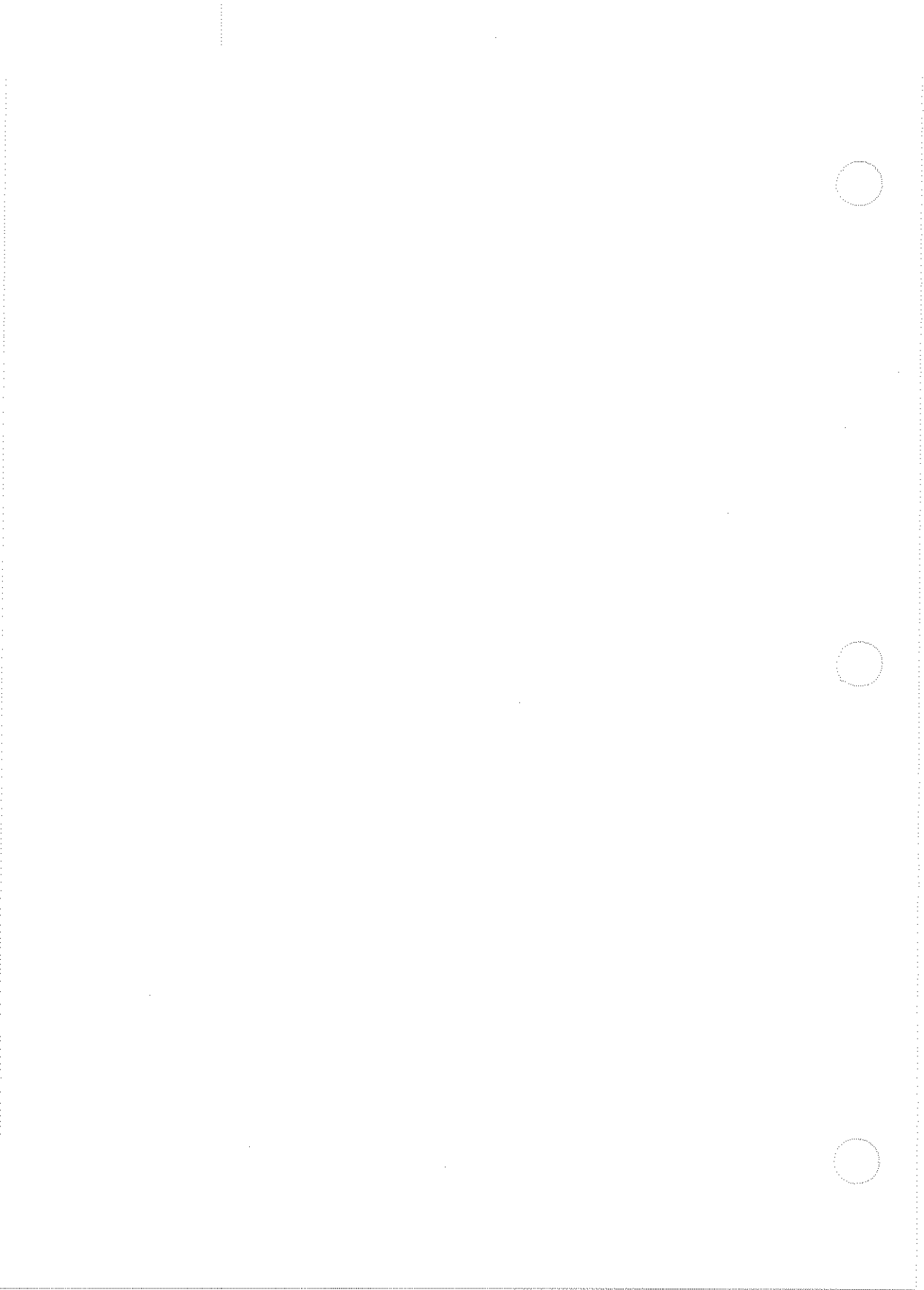

SECTION 3

PROLOGGER ON LINE COMMUNICATIONS

CONTENTS

Introduction	3-2
Display Window	3-3
Program Status Window	3-4
Printer/Recording Window	3-5
Function Keys	3-6
Record	3-7
Function Summary	3-8
Notes on Operation	3-9
Suggested 2280B Program Dos and Don'ts	3-11



INTRODUCTION

The On line communication function of ProLogger was designed to emulate the 2280B front panel operation with the added capability to record information from the 2280B on the IBM PC disk.

In a very real sense, ProLogger makes the PC act as a terminal, transmitting the characters you type, and displaying the information returned by the 2280B. The PC function keys <F1> - <F8> are used to transmit the commands that cause the 2280B to initiate a SCAN or ACKnowledge an alarm for example.

ProLogger's communication screen, like the offline screen, has four windows, but is restructured to more closely resemble the 2280B. One of ProLogger's main on line tasks is to determine where to print the 2280B information it recieved.

3/ProLogger On Line

DISPLAY WINDOW

The forty character "--- display ---" window emulates the 2280B display. ProLogger turns on the IBM cursor and prompts with the program sound whenever the 2280B is waiting for your command. The software determines that its your turn based on either recieving the backspaces which would position the cursor on a terminal for your input, or, from having timed out without seeing a <CR>.

(We have seen monitor data, during a scan, alternating display between the printer window and this display window, but that's a special feature obtained by virtue of the multi readings per line format.) - More on that under "NOTES ON OPERATION" in this section.

2280B Prompts displayed here are in green. Keyboard input is printed here in white. An example:

```
          --- display ---                               enter
          _____
MAIN MENU CHOICE <M FOR MENU>? A                       <F2>

*** The green "A" is replaced by a white "#", the actual character
*** sent by ProLogger to command the 2280B to perform a single
*** scan. Followed quickly by the following in green:
<S> SCAN GROUP NUMBER = 9                               <1>
[unclear] [unclear] [unclear] [unclear] [unclear] [unclear]

*** The green "9" is briefly replaced by a white "1" which is
*** reprinted in green as the 2280B echos the character.

SCAN GROUP NUMBER = 1_                                  <CR>

*** Since scan group 1 is programmed, and the output assigned to
*** Port A is "ALL DATA", the display window now remains the same
*** as data begins to scroll up the "printer window", until the
*** single scan is complete.

MAIN MENU CHOICE <M FOR MENU>? A
```

PROGRAM STATUS WINDOW

ProLogger uses this window to display messages concerning the last keyboard input, error messages, and, on its lowest line, activity on the serial communication link.

In the last example, each new "display" was preceded by a green "RS-232" flashing in the lower left corner of the status window. This string is printed as ProLogger receives new RS-232 information, and disappears when it completes a line, or times out.

If more than forty characters were received in one input (that multi readings per line could get you here) an additional string would print next to the "RS-232" message : "> 40 characters". If more than 255 characters had come in without a <CR>, the message "> 255 characters" would be displayed. Note that >40 only means the program didn't display the extra characters, but >255 means trouble, the input was terminated at 255.

If in the last example, <1> was entered from the numeric keypad rather than the top keyboard row, and the IBM <Num Lock> was not on, ProLogger would play the program prompt twice and display in the upper left corner, in bright yellow, the message "NUM LOCK not on OR not a valid key". This message would remain until another keyboard input was made. Nothing would have been transmitted to the 2280B.

If an entry is made that the 2280 does not recognize - such as <2> in response to MAIN MENU CHOICE <M FOR MENU>? the 2280 will respond with two chr\$(7) characters (beeps). ProLogger will sound the beeps, will not Record them, will print in bright yellow, "2280 disagreed with command", and will add its own two program sound prompts just to make sure everyone knows. While you can turn off the program sound, you can not turn off the beeps.

PRINTER/RECORDING WINDOW

Beneath the "--- display ---" window is a black on white "--- printer window ---". Data and 2280B program menus 'print' here. Data in this windows scrolls (12 lines of 40 characters) as in the 2280B printer.

ProLogger prints any input from the 2280B that ended in <CR> to this window. If that input had more than 40 characters, the first 40 print to the screen and the program status window briefly indicates that ">40 characters" were received.

Entering <M> from the MAIN MENU CHOICE <..... prompt prints the same 2280B MENU that would normally be printed on its printer. In remote operation, additional Menu items would be displayed to a terminal screen (the RS-232 status message indicates something has been received, but the 'printer window' does not reflect it). ProLogger supresses printing these items, 1) because they would scroll the first items off the screen, and 2) because the function keys issue these commands for you.

When the RECORD function is activated, the window name changes from "--- printer window ---" to "--- " Recording file drive and name "----". This is to indicate that anything that 'prints' to the window now is also being recorded to that file. This allows you to turn the RECORD function on and still command the 2280B without recording your inputs, or the prompts. While the window may scroll because it received a <CR><LF> from the 2280B, the blank lines are not recorded to disk.

While the >40 characters limit applies to the display, the entire string - up to 255 characters, is recorded.

When the "RECORD but don't display" function is engaged (<Alt><F10>), a "Recording" message is flashed with each input line to indicate activity and the display of data is disabled.

FUNCTION KEYS

ProLogger uses the function keys to send the commands to the 2280B consistant with their labels. The function key labels emulate their 2280B counterparts LED operation. These labels are red when "OFF", and bright yellow when "ON". At times, ProLogger will cause a label to flash bright yellow to indicate an indeterminate state.

For example, SCAN is on, and you enter <F2> (S.SCAN). The SCAN label is yellow, as is the "REMOTE" label, but the "S.SCAN" label is flashing yellow. The --- display --- is:

```
SCAN GROUP NUMBER = 9
```

If at this point you hit <CR>, if scan group 9 is programmed, then the S.SCAN label will change to bright yellow. If you hit instead <F7> (EXIT) then "S.SCAN" will turn red.

ProLogger issues a command "<" to the 2280 whenever it returns to the top level menu and decodes the status byte that is returned to update its function key labels. Issueing this command when a scan is taking place with PORT A its destination, interrupts that data. ProLogger would rather be "indeterminate" or even wrong temporarily on the "LED" status then potentially interrupt data you are recording. You however can choose to check the status by entering "<" when you wish.

Function keys <F9> "M.MENU" and <F10> "RECORD" are displayed in high intensity white rather than the red (LED off) or high intensity yellow (LED on) to set these two keys apart from the 2280B standard operation keys.

3/ProLogger On Line

RECORD

ProLogger allows you to record anything that would normally print to the --- printer window --- except blank lines.

You can transfer data recorded to the 2280B tape cartridge.

You can record scan data in real time.

You can record the 2280B Program listing currently in 2280 memory.

You can record any 2280B Program on its tape cartridge.

You can record the tape directory, monitor data, you can even record the menus if you wish.

ProLogger will not record the command interaction between you and the 2280B as you tell it what data to send you. - Except, if you ask for a menu, which would print to the window and thus be recorded.

RECORD open the Recording file on the specified drive to "Append" data to what, if anything, is already there. This means you can record a series of single scans, or add data to an earlier file. It also means that you can record scan data into a file with a 2280B program and visa versa. For most users that would probably be a mistake.

When RECORD is active its label is red and flashing, and the printer window heading shows the Recording file name, then <F10> RECORD will close the Recording file. The label and printer heading will return to the off state. It is a good idea to go off line and select a new Recording file at this time.

Each time ProLogger scrolls the printer/record window, up to 480 characters are printed to the screen. When you are recording data, in particular data recorded on the tape, it may not be necessary to actually see the data. In this case, ProLogger will run faster by disabling the scrolling display. This is accomplished by entering <F10> while holding down <Alt>. The window will indicate when it's recording a line, but not scroll. Once disabled, scrolling can be re enabled by repeating the command. <F10> RECORD will close the file as always and re enable the scrolling.

FUNCTION SUMMARY

-- F keys --	transmitted	2280B action
<F1> SCAN	&	Same as SCAN button on front.
<F2> S.SCAN	#	Same as SINGLE SCAN on front.
<F3> PLOT	;	Same as PLOT on front. Note, PLOT on 2280B sends data to its printer only. ProLogger does not have access to this PLOT.
<F4> MONITR	%	Same as MONITOR on front.
<F5> ACK		@Same as Alarm ACK on front.
<F6> LOCAL	<CTRL X>	Puts 2280B in remote.
	<CTRL W>	Locks out LOCAL from front.
REMOTE	\$	Puts 2280B in Terminal prompt mode.
	<CTRL Z>	Returns the 2280B to local control.
<F7> EXIT	^	Same as EXIT on front.
<F8> CLEAR	\	Same as CLEAR on front.
<F9> M.MENU	<CTRL Z>	Returns 2280B to local control.
	XOFF	May issue XOFF if 2280B was left with SCAN, or MONITOR still transmitting to PORT A. - branches to ProLogger off line functions.
<F10>RECORD		- causes ProLogger to record all data displayed in the 'printer/record window' except blank lines.
<Alt><F10> (without display)		- causes ProLogger to record RECORD all data that would have been displayed in the 'printer/record window' but without displaying the data. Disabling the scrolling window increases the speed in which the data can be recorded.

3/ProLogger On Line

NOTES ON OPERATION

ProLogger is a software utility for communicating to the 2280B over its RS-232-C interface. While ProLogger emulates the 2280B front panel operation, it is important to remember that you are in fact at PORT A.

ProLogger, in order to allow you the maximum flexibility, does very little "automatically". This means that you need to program the 2280B to give you what you expect over its interface.

In particular, keep in mind where you've told the 2280B to send its data, or listing, or taped data. You can command the 2280B to list the program currently in memory, but unless you have specified the listing device as PORT A, the listing isn't going to show up on the IBM PC screen! The same applies to Scan Group Data Output Device Control, and Tape Function Directory Output Device.

ProLogger will even allow you to change the 2280B baud rate - from the one you are already communicating on! That change would become effective as soon as the 2280B returned to its MAIN MENU, at which time ProLogger would not be able to communicate unless you went off line and changed the IBM baud rate to match. Yes, allowing this change in the 2280B programming could cause much confusion, but someone may have a good reason to do so.

ProLogger upon coming on On Line, puts the 2280B in Remote, locks out local control, puts the 2280B in "terminal prompting" mode, and proceeds to look for keyboard, and serial inputs.

Each time ProLogger sees that the 2280B is at its top menu choice, it commands the 2280B to return its LED status byte. You will get two sound prompts whenever the 2280B returns to this menu for this reason. Note, if you have instructed the 2280B to automatically display menu, you will also get two menus printed at this top level.

ProLogger allows you to "type ahead", ie: it does not wait for the 2280B to respond before reading the next key. This is very useful in programming a channel label over a 300 baud modem. It does however allow ProLogger to mistakenly display menu prompt information in the printer/record window (and therefore record the menu prompt if the record function is on). This only happens if you type more than one <RETURN> before receiving the menu prompt.

3/ProLogger On Line

ProLogger suppresses the display of the 2280B MAIN MENU choices except for those standardly printed from front panel control. The choices suppressed are:

- <g> Scan
- <#> Single Scan
- <;> Plot
- <%> Monitor
- <@> Acknowledge
- <"> System LED status

These characters can be typed, and will have the same function as hitting their associated Function Key. In addition <!> is the command to the 2280B to escape from it's current menu level all the way to it's MAIN MENU CHOICE level. This is a useful command to remember.

On going off line, ProLogger returns the 2280B to local control, and if the 2280B was still transmitting on RS-232, pauses that output.

3/ProLogger On Line

SUGGESTED 2280B PROGRAM DO'S AND DON'T

<U> Output Device Program

- Don't Change the baud rate during operation.
- Do Set NUMBER OF FILL CHARACTERS to zero.
Fill characters appear before the 2280B output string, and thus will offset the displayed "printer/record window data".
- Do DISABLE time out, or at least set to a large number.
If you are displaying scan data to PORT A, ProLogger will probably not accept it and display it as fast as the 2280B can send it. If the 2280B time out is short, the data transmitted will be terminated when the 2280B "times out".
- Do Be careful with READINGS/LINE. ProLogger will only display the first 40 characters received per line, and will terminate an input string after 255 characters have been received without a <CR>. You control via COMPRESSION FORMAT the number of characters per reading, and should set the number of readings per line accordingly so as not to exceed 255. One READING PER LINE is a nice number, and will exceed the printer window display only if DATA TYPE INDICATORS are on.

<Z> System Program <7> Select Menu Options

- Do Set AUTOMATICALLY DISPLAY MENU to NO. ProLogger will cause double menus to be displayed at the top level if this is turned on.
- Do Set DECEND MENUS WITHOUT ENTER to NO. ProLogger will work fine, but unless you really know your 2280B programming, you will find it easier to get around with this left off.

<K> Scan Group Program <4> Data output Device Control

Do Note that if the DATA OUTPUT CONTROL for PORT A is set to <1> NO DATA, then no data will be transmitted from the scan to ProLogger. One interesting effect that can occur is when group x is set to trigger group y on alarm, and group y has not had its Port A DATA OUTPUT turned on. Data would be sent to ProLogger UNTIL an alarm was encountered, then nothing.

CONTENTS

Section 1 How to Use This Guide

Introduction	1-3
Organization of This Guide	1-5
If You're Using a 2280A or 2285A Data	
Logger	1-8
How to Use the Manual Set	1-9
2280 User Guide	1-9
2280 System Guide	1-9
2280 Service Manual	1-9
Logging Data With a 2280	1-10

Contents, continued

Section 2 Introduction to Programming and Operations

Introduction	2-3
Programming Overview	2-5
The Front Panel	2-6
How the Menus Work	2-9
The Programming Form	2-11
Keys that Move You Through the Menus	2-14
Programming Keys	2-17
Miscellaneous Keys	2-18
Operating Keys	2-20
The Programming Modules	2-22
Scan Groups	2-22
Channel Programming	2-24
Alarm Lists	2-25
System Programming	2-27
Plot Programs	2-28
Output Device Programs	2-29
Tutorial	2-31
Creating a New Program	2-31
Measure and Average Two Thermocouples	2-32
Erasing the Program Memory	2-33
Programming a Scan Group	2-35
Programming Channels	2-40
Programming an Alarm List	2-46
Writing a Plot Program	2-50

Contents, continued

Section 3 Programming and Menu Reference

Introduction	3-3
Menu Reference Overview	3-4
 CHANNEL PROGRAMMING	 3a
Program a Channel or a Block	3a-2
P,C,D, or L	3a-2
Channel Function	3a-4
Channel Menu Choice	3a-4
Alarm List Number	3a-4
Channel Units	3a-5
Channel Units	3a-5
Channel Label	3a-6
Channel Expression or Procedure	3a-8
 SCAN GROUP PROGRAMMING	 3b
Group Number	3b-2
P,C,D, or L	3b-2
Scan Group Menu Choice	3b-4
Scan Group Label	3b-4
Scan Group Channel List	3b-4
Scan Trigger Mode	3b-9
Data Output Device Control	3b-12
Other Scan Group Trigger	3b-13
 ALARM LISTS	 3c
Alarm List Number	3c-2
P,C,D, or L	3c-2
Alarm List Menu Choice	3c-4
Limits Information	3c-4
Dead Band Value	3c-7

Contents, continued

OUTPUT DEVICE PROGRAMMING	3d
Output Menu Choice	3d-1
Printer Format	3d-2
Port A, Port B, and Cartridge Tape Formats	3d-3
Port Characteristics	3d-5
Alarm Ack Logging Device	3d-9
Data Transfer Filter	3d-9
PLOT PROGRAMMING	3e
Plot Menu Choice	3e-2
Parameters	3e-2
Common Plot Interval for All Four Channels	3e-3
SYSTEM PROGRAMMING	3f
System Menu Choice	3f-1
Line Frequency	3f-2
Calendar Date and Time	3f-2
Temperature Units	3f-3
Access Code	3f-3
Scan Trigger Enable Times	3f-3
Interpolation Tables	3f-4
Select Menu Options	3f-5

Contents, continued

Section 4 Advanced Math Programming

Introduction	4-2
Advanced Math Functions	4-3
Advanced Math Operators	4-18
Exponentiation	4-18
Logical Operators	4-19
Relational Operators	4-22
Advanced Programming Technique and Examples	4-27
Integrate a Value	4-28
Counter	4-30
Shift Register	4-32
Average Value	4-34
Rolling Average	4-36
Changing Logging Interval With Time	4-38
Changing Logging Rate on Alarm	4-40
Standard Deviation Over Time	4-42
Additional Techniques	4-44
Save Maximum Value of a Channel	4-44
Save Minimum Value of a Channel	4-46
Exclude Open Thermocouples From Calculations	4-48

Contents, continued

Section 5 Operating the 2280 From the Front Panel

Introduction	5-2
Turning the 2280 On and Off	5-2
Operating Modes	5-4
Monitoring	5-5
Scanning	5-7
Single Scan	5-9
Plotting	5-11
User Status Functions	5-13
Alarm Acknowledgement	5-14
Return to Local	5-16
System Status	5-16
Operating Notes	5-17
Power Failure and Power Up	5-17
Initialization of Outputs	5-18
Changing Limit Values While Scanning ...	5-18
Changing Pseudo Channel Values While Scanning	5-18
Auxiliary Functions	5-19
Data Transfer Operation	5-19
Port A or B as Source Device	5-21
Cartridge Tape Drive as Source Device ..	5-22

Contents, continued

Section 6 Recording Information

Introduction	6-3
Printer Operation	6-4
Printer On/Off Settings	6-4
Printer Operator Switch	6-7
Paper Advance	6-7
Take Up Off	6-7
Take Up On	6-7
Printer Paper Removal and Loading	6-8
Paper Removal	6-8
Installing New Paper	6-9
Cartridge Tape Drive Operation	6-10
Removal and Loading	6-10
Operation	6-11
Tape Format Programming	6-11
Tape Functions	6-11
Listing Tape Directories	6-12
Specifying Output Devices	6-13
Delete Files to End of Directory ..	6-14
Initializing a Tape	6-15
Saving a Program	6-16
Loading a Program	6-17
Data Transfer Operation	6-18
Output Format Examples	6-19
Retensioning Tapes	6-22

Contents, continued

Section 7 Programming and Operation From a Terminal
or Computer

Introduction	7-3
Required Hardware	7-3
Front Panel and Remote Control	7-4
Prompting and Concise Command Modes	7-7
More on Concise Commands	7-9
Character Set	7-11
Special Characters Used With RS-232	7-13
Programming/Operating With an RS-232	
Terminal	7-14
Getting Started	7-14
Remote Access and Lockout	7-15
Entering the Prompting Mode	7-17
Special Commands	7-18
Programming/Operating With an RS-232	
Computer	7-20
Getting Started	7-20
Remote Access and Lockout	7-22
Concise Command Strings	7-23
Special Commands	7-23
Programming Examples	7-24
Erasing Program Memory	7-24
Programming a Scan Group	7-26
Programming a Channel	7-26
Transferring Data Recorded on	
Cartridge Tape	7-27
Collecting Data From a Single Scan	7-28
Programming Hints and Suggestions	7-29
Start and Complete Each Command	
at the Main Menu	7-29
Don't Execute the Diagnostics From	
Remote	7-29

Contents, continued

Programming/Operating With an IEEE-488	
Computer	7-30
Getting Started	7-30
IEEE-488 Functional Capabilities	
Supported	7-31
Concise Command Strings	7-31
IEEE-488 Unique Commands	7-32
IEEE-488 Interface Commands	7-37
Serial Poll	7-38
Programming Examples	7-39
Programming Hints and Suggestions	7-39
Read All the Data You Ask For	7-39

Section 8 Error Messages and System Alarms

Introduction	8-2
Errors and Alarms	
Alarms	8-3
Errors	8-4
Channel Alarms	8-5
User Programmed Alarm Messages	8-6
System Alarms	8-7
Logged Messages That Generate No Alarm	8-7
Alphabetical Listing of Error Messages	8-9

Section 9 Appendices

Glossary	9a-1
2285B Documentation	9b-1
2280A Documentation	9c-1
Cartridge Tape Format	9d-1

Index

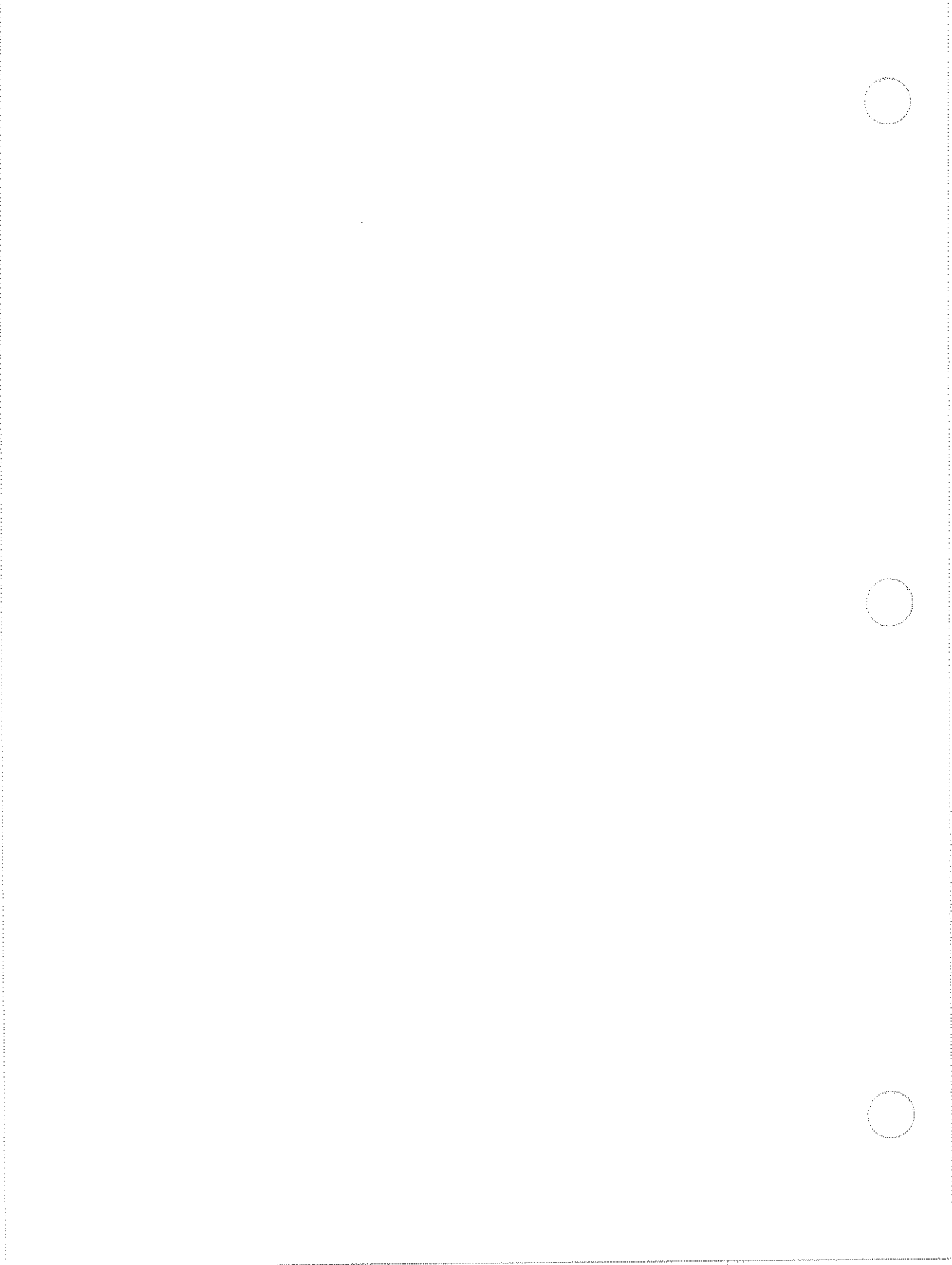

Section 1
How to Use This Guide

CONTENTS

Introduction	1-3
Organization of This Guide	1-5
If You're Using a 2280A or 2285B Data Logger	1-8
How to Use the Manual Set	1-9
2280 User Guide	1-9
2280 System Guide	1-9
2280 Service Manual	1-9
Logging Data With a 2280	1-10



INTRODUCTION

This guide contains program design and operating information and instructions for the 2280 Series Data Logger. It's written in clear, non-technical language and arranged so that it's easy to access and task oriented.

We refer to the setting up process as programming, although in a strict sense it is not; you won't be using a computer language. The 2280 is entirely menu driven. When designing programs, all you need to do is respond to prompts as they appear and make selections from the menus. Each menu takes you one step closer to setting up the tasks you want the 2280 to perform.

Check out this introductory section first before you begin programming, and familiarize yourself with the layout of information in this guide. Decide what level of instructions you need. If you've used a programmable data logger before, you may only need this guide for quick reference situations, and you'll probably be able to locate all the information you need by using the index and looking up specific tasks.

At the end of this first section is a brief and general overview of data logging which should give you a feel for the potential uses of your 2280.

Section 2 starts with a discussion of the most prominent programming characteristics of the 2280, and includes an introduction to the 2280 Series Programming Form. This form helps to clarify and simplify the programming process and requires some explanation of its own.

1/Introduction

The rest of Section 2 is a concise tutorial which walks you through some of the most commonly used tasks. The tutorial is designed for someone with little or no experience with the 2280, and it provides complete step-by-step instructions for each task. You may spend more time reading the entire tutorial than initially planned, but consider it time well spent. Once you've completed it, you should be knowledgeable enough to design almost any program on your own, without the use of a guide.

The menu reference in section 3 answers questions about individual 2280 programming menus and their selections. The menu reference can also be used to answer specific questions about different programming steps.

Someone with a working knowledge of the 2280 Series Data Logging system may still need occasional reinforcement. The balance of this book covers general user operations and contains sections devoted to programming with the Advanced Math Option, remote programming, cartridge tape use, and error messages.

1/Organization of This Guide

ORGANIZATION

Section 1 How to Use This Guide

This first section describes the organization of the User Guide and gives descriptions of the kinds of information contained in the other 2280 guides.

Section 1 also contains a brief explanation of the principles involved in data acquisition systems and provides a general introduction to data logging.

Section 2 Introduction to Programming and Operations

Section 2 is for new users and operators; it includes an introduction to the user interface and covers the keypad, the menus and programming modules, and the programming form.

Following the introduction is a concise walk-through tutorial designed to teach basic programming and operating skills.

Section 3 Programming and Menu Reference

Section 3 discusses all of the programming utility options and menus available. Each module is diagrammed, with menus presented in the same sequence the user sees them. The reference point for users in this section is the program module first, the specific menu in question within that module, and then the individual menu item.

1/Organization of This Guide

Section 4 Programming with the Advanced Math Option

Section 4 discusses programming capabilities and functions available with the Advanced Math Board (Option -211) installed followed by advanced programming techniques. Specific examples and sample programs are included.

Section 5 Operating the 2280 From the Front Panel

Section 5 contains almost everything you need to know about operating the 2280 once programming has been completed. All of the available input and output capabilities are discussed in detail, from a front panel point of view.

Section 6 Recording Information

Section 6 explains how to use the various data recording features of the 2280 Series of Data Loggers. Included are programming and switch setting instructions for the printer and the cartridge tape drive and useful information about transferring data to external data collection systems.

Section 7 Remote Programming and Operation

Programming and operating the 2280 from RS-232 terminals and computers and IEEE-488 computers are described in detail here. Section 7 includes prompting and concise command strings, remote access and lockout, and programming examples.

1/Organization of This Guide

Section 8 Error Messages and System Alarms

Following brief error and alarm definitions, Section 8 contains an alphabetized reference of all error messages and system alarms, their causes, and what you need to do about them.

Section 9 Appendices

The Glossary contains 2280-related terminology definitions and additional reference information.

The distinctions between the 2280A, 2280B, and 2285B Data Loggers are discussed in Appendix B and C. These appendices also describe which portions of the manual set applies to specific models only.

Appendix D contains formatting information for the Cartridge Tape Option.

INDEX

1/Organization of This Guide

If You're Using a 2280A or 2285B Data Logger.....

This User Guide provides comprehensive documentation for all 2280 Series Data Loggers. The main body of this manual specifically documents the 2280B Data Logger.

Almost all of the reference information in this guide also applies to the 2280A and 2285B Data Loggers. Differing descriptions are presented in the following appendices,

- o 2285B Differences - Appendix B
- o 2280A Differences - Appendix C

HOW TO USE THE MANUAL SET

2280 User Guide

The 2280 User Guide describes the 2280 from top to bottom. A beginner could use the guide as a complete course in programming and operating the 2280 in a data acquisition system, whereas a more experienced user would probably only need parts of this manual for orientation and quick reference. An untrained operator will find all of the operating basics here as well.

2280 System Guide

The 2280 System guide describes all aspects of installing the 2280 in a data logging system. This guide serves as a complete course in defining the user's data logging functions, identifying system requirements, making the necessary hardware connections, and verifying correct operation. An inexperienced user may need all of this information to get the Data Logger up and running. A user already familiar with data logging may only need incidental reference to this information. In either case, each element of the installation process is easily accessible and fully referenced.

2280 Service Manual

The 2280 Service Manual is primarily a maintenance guide to the instrument. The manual covers theory of operation for mainframe and option assemblies, general maintenance and cleaning, performance testing, calibration, troubleshooting, and repair. Parts lists are also included.

1/How to Use the Manual Set

LOGGING DATA WITH A 2280

Our ability to measure is said to be the key to modern technology. A brief look at the history of technical advances seems to bear out this claim. Ever finer machining tolerances, for example, allow us to create the optical devices necessary to produce smaller and smaller microcircuits. Precise temperature monitoring allows us to create incredibly tough alloys, exotic plastic compounds, and durable molded products.

Measurement requires tools. The more accurate the tool, the more precise the measurement, which in turn gives us tighter control of the variables we measure. If measurement is the key to technology, then precise tools are the key to measurement.

In the industrial process environment, it is essential to gather complex data from a variety of sources and interpret this data in a meaningful way. In the research laboratory, any experiment is meaningless unless the resulting data can be collected. We need tools to collect this information. Data collection tools can range from a strip of litmus paper, to a notebook, to a huge mainframe computer.

The Fluke 2280 Series of Data Loggers are the precision tools for the job. From simple data collection to fairly complex control functions, the 2280's provide the necessary precision for both industrial process monitoring and research tasks.

The Data Logger Environment

The data logger finds its best use simultaneously monitoring several channels of data and logging the returned values. Each channel is connected to some type of physical transducer such as a flowmeter, thermocouple, strain gauge, or RTD. The 2280 can perform scaling or data conversion functions on this raw data to render it more meaningful.

For example, many transducers output a voltage or resistance to indicate a physical value such as foot-pounds of force or cubic feet per minute. Collected information can later be analyzed to pinpoint failure causes, generate histograms or frequency distributions of various recurring phenomena, or as a performance record of individual specimens.

Almost any manufacturing process, for example, can require some form of continuous quality monitoring. The 2280 has been used in a tremendous variety of environments, such as continuously monitoring autoclave temperature in sterilizing pharmaceutical products; comparing signal reproduction characteristics of digital audio disks against a reference standard; recording power supply performance under simulated forced-air cooling conditions; and recording the performance characteristics of helicopter-rotor air-speed sensors.

These types of environments have several features in common. They all require programming so that many channels of information are monitored, read frequently, and checked continually and simultaneously. The 2280 forms the heart of these various process-monitoring systems. In many instances the data logger is programmed to trigger alarm conditions which begin recording data performance only during out-of-range operating conditions.

1/Logging Data With a 2280

By using these and other features of the 2280, you can achieve the maximum utility possible in your application. Think of the 2280 as a data sponge you can use to soak up information from virtually any process. If you can find a transducer for the phenomena you want to monitor, the 2280 can probably read it.

Research Data Logging

The 2280 has also been used in a number of research applications, including automobile performance tests. The 2280 is frequently used to monitor a variety of engine and chassis parameters under actual road conditions. The portability and 12V dc operation allow it to be used in both unusual and demanding environments. In situations similar to automobile road tests, the 2280 can be used to collect real-time data under experimental conditions for later study and analysis with data processing equipment.

The data logger will continue to play an important role in the test and measurement industry. In the future data loggers will be increasingly accepted and used in industrial process monitoring and control applications. Data loggers will continue to become more accessible to users (as they become easier to use) and will pack increasing power into smaller and smaller components.

Section 2
Introduction to Programming and Operations

CONTENTS

Introduction	2-3
Programming Overview	2-5
The Front Panel	2-6
How the Menus Work	2-9
The Programming Form	2-11
Keys that Move You Through the Menus	2-14
Programming Keys	2-17
Miscellaneous Keys	2-18
Operating Keys	2-20
The Programming Modules	2-22
Scan Groups	2-22
Channel Programming	2-24
Alarm Lists	2-25
System Programming	2-27
Plot Programs	2-28
Output Device Programs	2-29
Tutorial	2-31
Creating a New Program	2-31
Measure and Average Two Thermocouples	2-32
Erasing the Program Memory	2-33
Programming a Scan Group	2-35
Programming Channels	2-40
Programming an Alarm List	2-46
Writing a Plot Program	2-50



2-2

INTRODUCTION

Programming the 2280 simply means pushing a few buttons. You program it only in the sense that you tell it what to do; you're actually just setting up monitor and scanning processes using the menus and the keypad. The display prompts you as you go with a series of menu choices; you respond by typing in the name or number of the feature you wish to select. It's all much easier than you might infer from the word "programming" which usually suggests learning and invoking a complex and cryptic computer language.

This section explores the programming task for the uninitiated. We start with a quick look at the data logger's programmable features and introduce the programming form. Next is a detailed tutorial, with walk-through instructions for common tasks. The section concludes with instructions on how to save the program to cartridge tape, and then, how to reload the saved program.

If you've already encountered menu-driven programmable instruments, you may be able to skip the tutorial and simply refer to individual sections for information on specific features. The 2280 Series Programming Form is an excellent aid to programming. It provides a reproduction of each menu you'll be selecting from, along with worksheet space so you can figure out how you want your program to fit together before you key it in.

2/Introduction

Programming with the advanced math board is discussed in Section 4, followed by advanced techniques and programming examples. If you don't need to go through the tutorial but still need assistance from time to time, Section 3 contains a complete programming reference section with detailed instructions for each menu and entry field in each module.

This guide is written as clearly as possible, but there's always a chance you'll run across unfamiliar terminology or function descriptions. The overview and tutorial are still worth referring to if this happens, and you'll find definitions in the Glossary helpful as well.

PROGRAMMING OVERVIEW

In essence, a data logger does the work of a person with a pen and a notebook, jotting down numbers read from meters or gauges. On the surface, the process doesn't seem very complicated. How the data logger goes about its work can become complicated, though, depending upon how many features are used.

For example, in addition to programming the data logger to monitor something, you can also program it to draw some conclusion about a measurement, and, if the measurement meets a given condition, (i.e., it's too high or too low), you can have it measure another process variable it would not otherwise check.

Unlike the person jotting down numbers in a notebook, the data logger can record data in a variety of ways. Using the 2280, you can store measurements on the internal printer or on magnetic tape, you can display data on the 40 character display, upload it to a host system, or do all of these simultaneously. The data logger plots measurements, too. It's a major step up from the guy with a notebook.

THE FRONT PANEL

The 2280 series data loggers are programmed and operated through the front panel keypad. The keys are divided into two areas, OPERATOR and PROGRAMMER (see illustration.) The OPERATOR keys can be used at any time, but the front panel programming door must be open to access the PROGRAMMER keys.

The operating portion of the keypad contains numerical keys, SCAN, SINGLE SCAN, MONITOR and PLOT operating keys, along with the ALARM ACK (alarm acknowledgment) and REMOTE/LOCAL user function keys.

The programming portion of the keypad contains the alphabetical characters along with six programming module keys,

- o CHANNEL PROGRAM
- o ALARM LIST PROGRAM
- o SCAN GROUP PROGRAM
- o PLOT PROGRAM
- o OUTPUT DEVICE PROGRAM
- o SYSTEM PROGRAM

The programming portion of the keypad also contains additional programming and operating keys, such as LIST, DATA TRANSFER, DELETE CHAR (delete character), MENU, TAPE, and SPACE.

2/The Front Panel

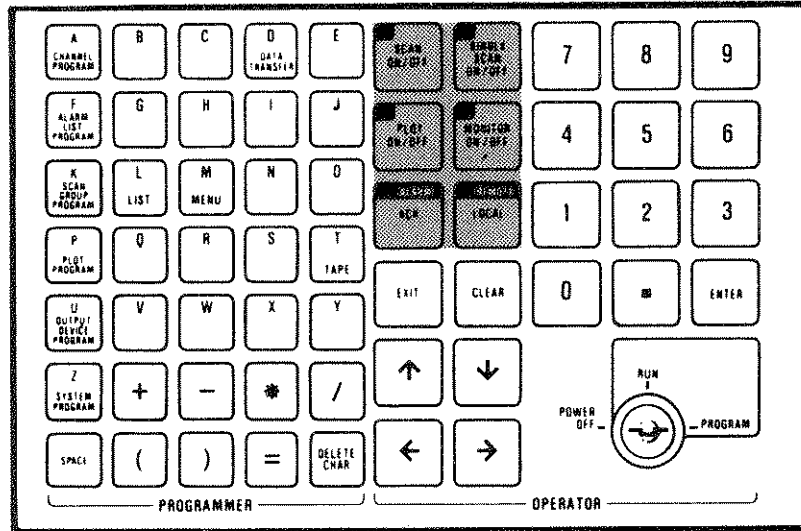

2/The Front Panel

In addition to controlling the 2280 from the front panel you have the ability to operate and program it from a terminal or computer. This is referred to as remote access and is discussed in Section 7 of this guide.

A security feature of the 2280 is the locked access to the programming functions. Once the data logger is programmed, you can turn the key to RUN and remove it so you can continue to monitor processes and log data, but only selected users can alter programs or enter new ones. It is possible to alter certain programmed characteristics and values while the key is in the RUN position; see Section 5, Operating the 2280 From the Front Panel, for more information about this feature.

With the keyswitch in the PROGRAM position and the door open, you have access to all of the available programming and operating features.

If you press a wrong key when programming or operating (for example, if you try to select a 5 and the menu you're in doesn't offer a 5), you'll hear a beeping noise. This warning noise, actually, three beeps in quick succession, tells you to try another entry; the wrong key is being used. But, don't worry, nothing terrible will happen to your program. You simply need to look at the current menu and select a different key.

HOW THE MENUS WORK

The 2280 Series Data Loggers are menu-driven; you do all the programming by making selections from menus. There are only a few user defined entry fields. This kind of system takes most of the learning curve out of setting up process monitoring, and it makes programming and operating considerably easier for most users. You can access each programming module from the main menu.

Programming is divided into six groups (referred to as modules), each of which contains sets and then subsets of menus for programming the options present in that group. You select the desired option by merely entering the indicated key. Each menu clearly spells out what is available, while simultaneously narrowing the entire field as you descend into the chosen menu subset.

Some menus are simple listings of programmable features available in a given section, and other menus actually allow you to set characteristics and limits, specify output devices, and the like. Along with the menu title, the display shows the previous setting (if already programmed) or the preset default selection.

Each of the modules is designed to handle a specific type of information; channel programming is for programming channels, output device programming is for specifying output device characteristics and formats, and so on. We'll briefly discuss each module on the following pages. This section uses mostly introductory descriptions of the modules and how they work together; the more detailed point-by-point entry instructions are found in the Programming Reference Section in Section 3 of this guide.





THE PROGRAMMING FORM

The 2280 Series Programming Form should help in planning your program; it also provides a written record of the programs implemented. You can also refer to it as you edit part or all of any existing program. The programming form allows you to pinpoint the module and specific menu you need to change an existing program. Changing one field has no effect on other fields in the program.

An added benefit in using the form is that you can refer to it while you are sitting in front of the 2280 and programming it. The modules, menus, and displayed prompts will seem clearer and more cohesively linked together. The programming form is a great aid in following your progress through the menus.



2/The Programming Form

<A> CHANNEL PROGRAM

CHANNEL #/BLOCK	CHANNEL FUNCTION #/RANGE A-Z	CHANNEL MENU CHOICE - 1-9 - 7		
PCD OR L	ALARM LIST	CHANNEL UNITS	CHANNEL EXPRESSION of PROCEDURE	CHANNEL LABEL
1-299 300-399 400-499	EXAMPLE 1: JET-17	SA (ms) EXAMPLE 2: 17	EXAMPLE: JET-17-1-100-100	EXAMPLE: JET-17-1-100

CHANNEL FUNCTION MENU		USER DEFINED RTD CONTACTS		LOGGING FORMER MENU
1: HUBBARD CHANNEL	1: 1.000	1: STAT1	1: /	1: 1.000
2: HUBBARD CHANNEL	2: 0.000	2: STAT2	2: /	2: 0.000
3: HUBBARD CHANNEL	3: 0.000	3: STAT3	3: /	3: 0.000
4: HUBBARD CHANNEL	4: 0.000	4: STAT4	4: /	4: 0.000
5: HUBBARD CHANNEL	5: 0.000	5: STAT5	5: /	5: 0.000
6: HUBBARD CHANNEL	6: 0.000	6: STAT6	6: /	6: 0.000
7: HUBBARD CHANNEL	7: 0.000	7: STAT7	7: /	7: 0.000
8: HUBBARD CHANNEL	8: 0.000	8: STAT8	8: /	8: 0.000
9: HUBBARD CHANNEL	9: 0.000	9: STAT9	9: /	9: 0.000
10: HUBBARD CHANNEL	10: 0.000	10: STAT10	10: /	10: 0.000
11: HUBBARD CHANNEL	11: 0.000	11: STAT11	11: /	11: 0.000
12: HUBBARD CHANNEL	12: 0.000	12: STAT12	12: /	12: 0.000
13: HUBBARD CHANNEL	13: 0.000	13: STAT13	13: /	13: 0.000
14: HUBBARD CHANNEL	14: 0.000	14: STAT14	14: /	14: 0.000
15: HUBBARD CHANNEL	15: 0.000	15: STAT15	15: /	15: 0.000
16: HUBBARD CHANNEL	16: 0.000	16: STAT16	16: /	16: 0.000
17: HUBBARD CHANNEL	17: 0.000	17: STAT17	17: /	17: 0.000
18: HUBBARD CHANNEL	18: 0.000	18: STAT18	18: /	18: 0.000
19: HUBBARD CHANNEL	19: 0.000	19: STAT19	19: /	19: 0.000
20: HUBBARD CHANNEL	20: 0.000	20: STAT20	20: /	20: 0.000
21: HUBBARD CHANNEL	21: 0.000	21: STAT21	21: /	21: 0.000
22: HUBBARD CHANNEL	22: 0.000	22: STAT22	22: /	22: 0.000
23: HUBBARD CHANNEL	23: 0.000	23: STAT23	23: /	23: 0.000
24: HUBBARD CHANNEL	24: 0.000	24: STAT24	24: /	24: 0.000
25: HUBBARD CHANNEL	25: 0.000	25: STAT25	25: /	25: 0.000
26: HUBBARD CHANNEL	26: 0.000	26: STAT26	26: /	26: 0.000
27: HUBBARD CHANNEL	27: 0.000	27: STAT27	27: /	27: 0.000
28: HUBBARD CHANNEL	28: 0.000	28: STAT28	28: /	28: 0.000
29: HUBBARD CHANNEL	29: 0.000	29: STAT29	29: /	29: 0.000
30: HUBBARD CHANNEL	30: 0.000	30: STAT30	30: /	30: 0.000

<F> ALARM LIST PROGRAM

ALARM LIST #	ALARM LIST MENU CHOICE - 1-7 - 7		SEAD BAND
PCD OR L	LIMITS INFORMATION		
1-100	ALARM MESSAGE		
1	EXAMPLE: JET-17-1-100-100		
2			
3			
4			
5			
6			
7			
8			
9			
10			
11			
12			
13			
14			
15			
16			
17			
18			
19			
20			
21			
22			
23			
24			
25			
26			
27			
28			
29			
30			

<K> SCAN GROUP PROGRAM

GROUP #	SCAN GROUP MENU CHOICE - 1-3 - 7			DATA OUTPUT DEVICE CONTROL	OTHER SCAN GROUP TRIGGER
PCD OR L	SCAN GROUP LABEL	SCAN GROUP CHANNEL LIST	SCAN TRIG MODE		
1-9	EXAMPLE: JET-17-1-100-100	EXAMPLE: JET-17-1-100-100	EXAMPLE: JET-17-1-100-100		

1: Scan Group	2: Channels	3: Scan Mode	4: Data Output	5: Other Scan Group Trigger
1: 1.000	1: 1.000	1: 1.000	1: 1.000	1: 1.000
2: 0.000	2: 0.000	2: 0.000	2: 0.000	2: 0.000
3: 0.000	3: 0.000	3: 0.000	3: 0.000	3: 0.000
4: 0.000	4: 0.000	4: 0.000	4: 0.000	4: 0.000
5: 0.000	5: 0.000	5: 0.000	5: 0.000	5: 0.000
6: 0.000	6: 0.000	6: 0.000	6: 0.000	6: 0.000
7: 0.000	7: 0.000	7: 0.000	7: 0.000	7: 0.000
8: 0.000	8: 0.000	8: 0.000	8: 0.000	8: 0.000
9: 0.000	9: 0.000	9: 0.000	9: 0.000	9: 0.000

2/The Programming Form

< Z > SYSTEM PROGRAM

SYSTEM MENU CHOICE 1-7 ?							
1	2	3	4	5	6	7	
LINE FREQUENCY	CALENDAR DATE & TIME	TEMPERATURE UNITS	ACCESS CODE	MAIN TABLE ENTRY	INTERPOLATION TABLES	SELECT MENU OPTIONS	
100	MM/DD/YY	°C	12345	12345	TABLE ENTRY	NO	YES
						NO	YES

< P > PLOT PROGRAM

PLOT MENU CHOICE 1-4 ?					
PARAMETERS					COMMON PLOT INTERVAL FOR ALL FOUR PLOTS
PLOT #	1	2	3	4	
SYMBOL	PLOT INTERVAL
CHARACTER	
LINE STYLE	
MARKER	

< U > OUTPUT DEVICE PROGRAM

OUTPUT MENU CHOICE 1-8 ?							
1	2	3	4	5	6	7	8
PRINTER FORMAT	PORT A FORMAT	PORT B FORMAT	CARTRIDGE TAPE FORMAT	PORT A CHARACTERISTICS	PORT B CHARACTERISTICS	ALARM ACKNOWLEDGMENT LOGGING DEVICE	DATA TRANSFER FILTER
1 COMPRESSOR SYMBOL 1. NAME 2. CHARACTERS 3. LINE STYLE 4. MARKER				1 DEVICE TYPE 1. SERIAL 2. PARALLEL 3. DATA RECORD TYPE 4. ENDING 5. ENDING 6. ENDING			1. YES 2. NO 3. YES 4. NO
2 DATA TYPE INDICATOR 1. YES 2. NO				3. PRIORITY 1. HIGH 2. LOW 3. PRIORITY 4. NUMBER OF 5. NUMBER OF 6. NUMBER OF			
3 CHAR READING LINE 1. YES 2. NO				7. TIME OUT 1. ENABLED 2. DISABLED			
4 START OF DATA SEQUENCE 1. YES 2. NO							
5 END OF DATA SEQUENCE 1. YES 2. NO							
6 LINE TERMINATION SEQUENCE 1. YES 2. NO							

KEYS THAT MOVE YOU THROUGH THE MENUS

The ENTER key steps you through the menus and is the key you use to make selections from within them. The term "stepping through" refers to the process of moving through the menu hierarchy to either view the selections or alter them. Most fields have a default setting that you can see by selecting the field. Once you select the field, the data logger displays the existing entry.

The 2280 presents a programming menu tree for each program module, and menu selections can be displayed on the front panel screen by pressing the up arrow or down arrow key. Use these keys to help find your place in the menus and also to clearly spell out the choices and selections available at a given point. You can scroll through the menus using the up arrow or down arrow keys, but to enter a menu and make selections from it you need to use the ENTER key. Using only the ENTER key to move through menus causes you to select whatever the earlier program or preset default entries are. Make sure these are the selections you want.

2/Keys That Move You Through the Menus

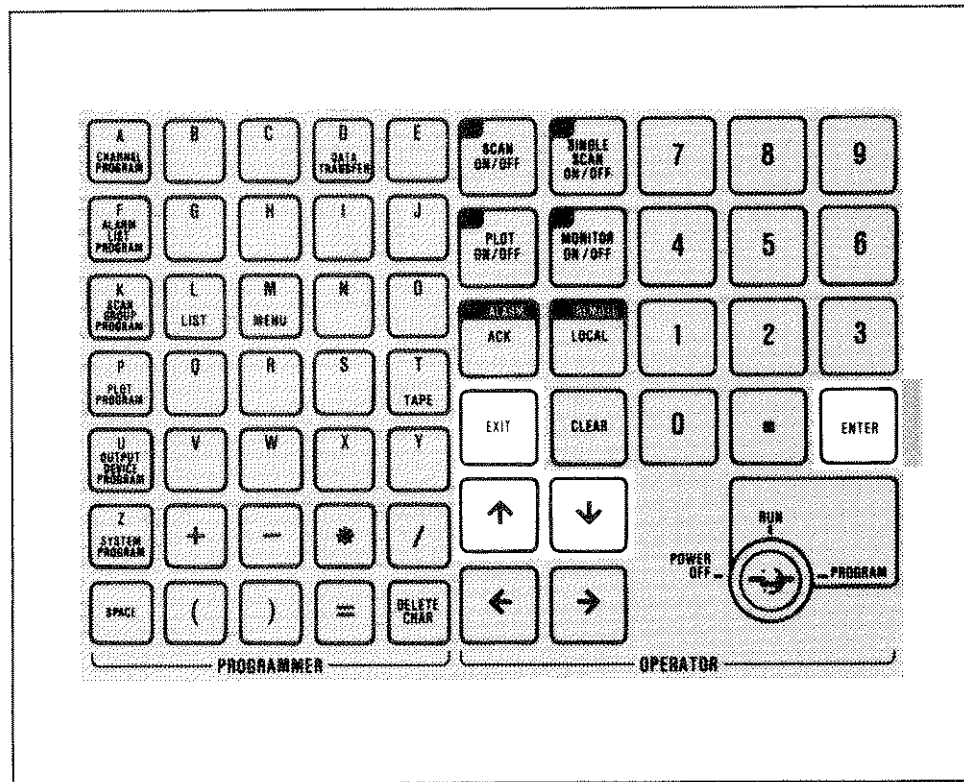

KEYS THAT MOVE YOU THROUGH THE MENUS

2/Keys That Move You Through the Menus



A: CHANNEL FUNCTION <A-Z>? **D**

The example display above shows the channel functions (A-Z) that can be selected at this point. In this example, the cursor highlights channel function D. Pressing ENTER at this point selects D. Any of the other channel functions can be selected by pressing the appropriate letter (A-Z), and then ENTER. The cursor-highlighted letter represents the last selection made, or (if none have been made), the default setting.

Press the EXIT key repeatedly to step back out of the menu hierarchy when you're finished. Depending upon the menu level, the number of times you press EXIT will vary from only once, to four or more times.

Programs are not being altered nor are items selected when EXIT is being used.

Use the alphanumeric keys for fields requiring user defined entries (i.e., scan group labels, alarm messages, etc.), and then press ENTER to store your entry.

THE PROGRAMMING KEYS

Some of the keys in the programming portion of the keyboard are marked for selecting specific functions. When you're at the main menu (MAIN MENU CHOICE <M FOR MENU>? A), you can select programming modules, or menus, or some other function without searching for the appropriate letter key. The programming keys can be used in addition to their alphabetical characters; the labels are strictly an added cue for making selections easier to find.

MISCELLANEOUS KEYS

The 2280 keypads contain a number of other doubly marked keys. LIST, TAPE, and DATA TRANSFER keys provide convenient access to common utility tasks and are discussed in the Operating section of this guide. (Section 5).

The Menu Key

The front panel display provides prompts for selections as you use the 2280, but an especially helpful prompt is the MENU key. When you see bracketed numbers or letters on the display (which indicates a choice of selections), you can usually print the current menu by pressing 'M'. The menu selection available will be listed onto the printer or whatever menu listing device you've specified.

Space, Delete Character, and Clear Keys

The SPACE, DELETE CHAR, and CLEAR keys are for editing programming entries. Use the SPACE key to place spaces between words or expressions while entering characters into user defined fields.

The DELETE CHAR key removes characters one at a time as they appear under the cursor. If the cursor is at the end of a string being edited, the characters to the left of the key will be deleted.

The CLEAR key deletes the entire field being edited and returns the cursor to the beginning position.

2/Miscellaneous Keys

Right → and Left ← Arrow Keys

The right arrow and left arrow keys are primarily used to position the cursor when changing an entry. Use these keys after you've entered a menu to move to a specific point in an entry field without disturbing the existing characters. These cursor control keys won't alter an entry or a program.

For example, let's say you've noticed a spelling error in a channel label. To correct it, first scroll through the menus in the channel programming module to the proper entry field. Then, use the right arrow key to advance across the displayed characters to reach the error you plan to correct. From this point, use the delete key to remove the offending character or characters, and then enter the corrected message.

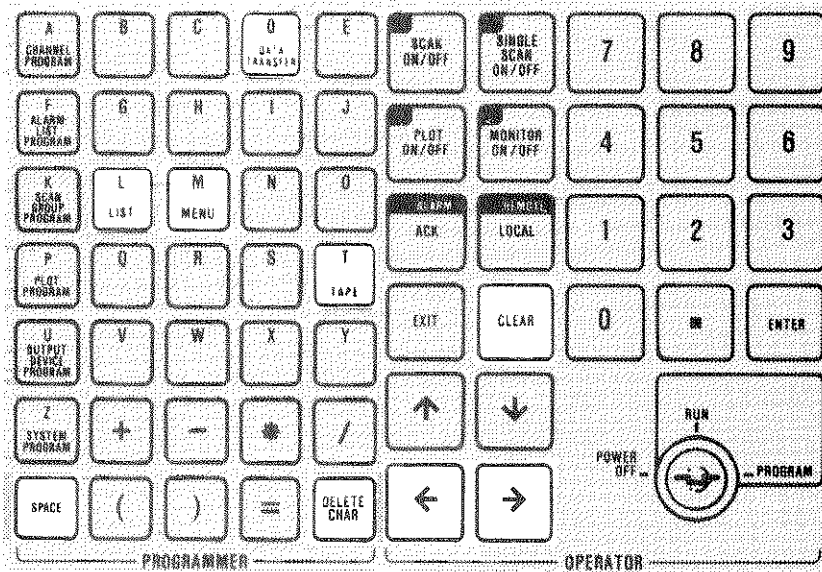

MISCELLANEOUS KEYS

THE OPERATING AND USER FUNCTION KEYS

The right side of the 2280 front panel keypad contains the numerical keys, along with keys that move you through the menus (ENTER, EXIT, up arrow and down arrow), and the operating and user function keys. The operating keys toggle on and off and have a light indicating their status.

The SCAN, SINGLE SCAN, PLOT, and MONITOR keys are discussed in greater detail in the Operating section of this guide. (Section 5).

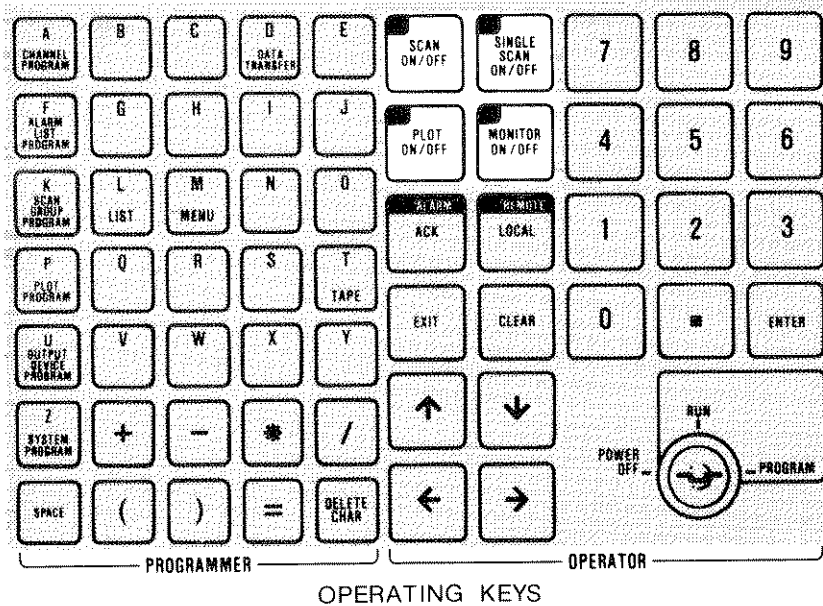

2/Operating and User Function Keys

The ALARM ACK and REMOTE/LOCAL keys are referred to as user function keys. They are used in very specific circumstances and are also discussed in the Operating section.

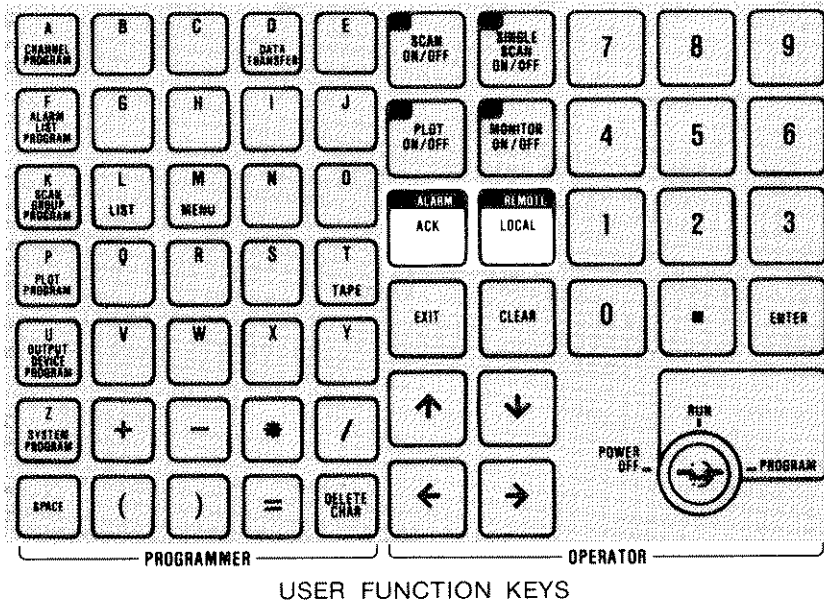

THE PROGRAMMING MODULES

Scan Groups

In most cases, you'll have several measurements to make, not just one. Therefore, the main program unit is a scan group. A scan group is a list of channels to be processed or scanned. A scan group program, in turn, tells the data logger what inputs to read, what calculations to make, what outputs to set, where to route collected data, whether additional scan groups are to be started, and so on. You can program up to ten different scan groups on the 2280.

<K> SCAN GROUP PROGRAM

SCAN GROUP MENU CHOICE < 1-5 > ?											
GROUP #	<1>	<2>	<3>	<4>					<5>		
P.C.D. or L.	SCAN GROUP LABEL	SCAN GROUP CHANNEL LIST	SCAN TRIG MODE	DATA OUTPUT DEVICE CONTROL					OTHER SCAN GROUP TRIGGER		
1	0 No Alphanumeric Characters EXAMPLE ENGINE 2 TEST	FORMAT One channel only: C# Three channels only: C# C# C# Four and More: C# C# C# C# C# C# C#	W#3 Only one see menu below	1	2	3	4	5	6	7	8

Input channels, output channels, and pseudo channels that you want processed as a group are all lumped together as a scan group. You can create different scan groups using the same input, output, and pseudo channels in different combinations, or with new channels.

2/The Programming Modules

A scan group is really a procedure. Each programmed step will be to read an input channel, perform the calculations in a pseudo channel, or send a value to an output channel. Each scan group is given a channel list showing the channel data to be collected and specifying the order in which the channels within a scan group will be logged.

The 2280 can only perform one task at a time, so it's important to set priorities in the scan groups you're working with. The lower the assigned number, the higher the priority. For example, if you've programmed groups 4 and 5 to be scanned at the same time, group 4 will be executed first. The prioritizing only occurs if more than one scan group is used.

Alarm Lists

Aside from simply writing down numbers, occasionally you'll want the data logger to take further action if it gets a reading outside the range in which it should be. Such a condition is called an alarm. The conditions that are to trigger further action and the conditional tasks to be done are programmed as an alarm list.

<F> ALARM LIST PROGRAM

ALM LIST #	ALARM LIST MENU CHOICE < 1,2 >7				
	P.C.D. OR L.	< 1 > LIMITS INFORMATION			< 2 > DEAD BAND
	1-1-1	1-1-2	1-1-3	1-1-4	1-1-5
	1-1-1	1-1-2	1-1-3	1-1-4	1-1-5
	1-1-1	1-1-2	1-1-3	1-1-4	1-1-5
1					
2					
3					
4					
1					
2					
3					
4					
1					
2					
3					
4					
1					
2					
3					
4					
1					
2					
3					
4					
1					
2					
3					
4					

1-1-1 Never 1-1-2 During Alarm 1-1-3 On Alarm Transition

2/The Programming Modules

An alarm list program contains instructions setting high and low limits to be checked. It also determines which high or low values will trigger an alarm, whether a message will accompany an alarm, and whether there is to be any dead band or hysteresis associated with it. An alarm list can also be set up to initiate other scan groups.

Alarm list programming affords you tremendous flexibility and control over the monitoring and scanning processes already set up.

2/The Programming Modules

System Programming

System programming is a sort of catchall for selecting instrument characteristics that don't relate specifically to any one of the other five groups. Time and calendar date, temperature units, access code, and line frequency are set in system programs. These values probably won't need to be changed very often.

< Z > SYSTEM PROGRAM

SYSTEM MENU CHOICE < 1-7 >						
< 1 > LINE FREQUENCY	< 2 > CALENDAR DATE & TIME	< 3 > TEMPERATURE UNITS	< 4 > ACCESS CODE	< 5 > SCAN TRIGGER ENABLE TIMES	< 6 > INTERPOLATION TABLES	< 7 > SELECT MENU OPTIONS
1 - 40 Hz 2 - 50 Hz	Year: MM/DD Month: MM/DD Day: MM/DD	1 - Degrees C 2 - Degrees F 3 - Celsius	_____	1st Start Time: _____ 2nd Stop Time: _____	1st TABLE NO: 2nd TABLE NO: 3rd TABLE NO: 4th TABLE NO: 5th TABLE NO:	1st MENU NO: 2nd MENU NO: 3rd MENU NO: 4th MENU NO: 5th MENU NO:

2/The Programming Modules

Plot Programs

The internal printer can be programmed to plot fluctuating values obtained from up to four different channels.

< P > PLOT PROGRAM

PLOT MENU CHOICE < 1,2 > ?					
< 1 > PARAMETERS PLOT NUMBER - 1-4 - ?				< 2 > COMMON PLOT INTERVAL FOR ALL FOUR PLOTS	
PLOT #	< 1 >	< 2 >	< 3 >	< 4 >	PLOT INTERVAL
SYMBOL:	*****	*****	*****	*****	*****
Set Channel # Plot					HH MM SS
Set External Source					
Set Rightmost Value					

Plotting is a relatively simple matter to set up. You only need to specify the left and right most values for each channel to be plotted; then you set the common plotting interval. The plotting interval is independent of any other scanning activity.

Plotting is especially useful for providing a visual correlation between channels.

2/The Programming Modules

Output Device Programs

Output device programs determine the format that logged data assumes on the printer, the devices connected to ports A and B, and on the cartridge tape drive. In addition, various device characteristics may be determined for ports A and B.

< U > OUTPUT DEVICE PROGRAM

OUTPUT MENU CHOICE - 1-8-7								
1 - PRINTER FORMAT	2 - PORT A FORMAT	3 - PORT B FORMAT	4 - CARTRIDGE TAPE FORMAT	5 - MENU	6 - PORT A CHARACTER- ISTICS	7 - PORT B CHARACTER- ISTICS	8 - ALARM ACKNOWLEDGE- MENT LOGGING DEVICE	9 - DATA TRANSFER FILTER
1 - COMPRESSION FORMAT 1 - Off 2 - On				1 - DEVICE TYPE 1 - ASCII 2 - BINARY			1 - None 2 - Printer 3 - Cartridge Drive	1 - None 2 - Printer 3 - Cartridge Drive
2 - DATA TYPE INDICATOR 1 - None 2 - ASCII 3 - BINARY				2 - PARALLEL OF RECORD TYPE 1 - ASCII 2 - BINARY			4 - Port A 5 - Port B	4 - Port A 5 - Port B
3 - CHARACTERISTICS 1 - None 2 - Printer 3 - Cartridge Drive				3 - BINARY 1 - None 2 - Printer 3 - Cartridge Drive				
4 - START OF DATA INDICATOR 1 - None 2 - Printer 3 - Cartridge Drive				4 - BINARY 1 - None 2 - Printer 3 - Cartridge Drive				
5 - END OF DATA INDICATOR 1 - None 2 - Printer 3 - Cartridge Drive				5 - BINARY 1 - None 2 - Printer 3 - Cartridge Drive				
6 - LINE TERMINATION INDICATOR 1 - None 2 - Printer 3 - Cartridge Drive				6 - BINARY 1 - None 2 - Printer 3 - Cartridge Drive				

The output device module is also used to select hardware configurations, such as RS-232 or IEEE-488 cards. For example, the data sent simultaneously to the cartridge tape and to the RS-232 port can differ in format, the number of readings per line, and the sequence of characters used to indicate the end of a line.

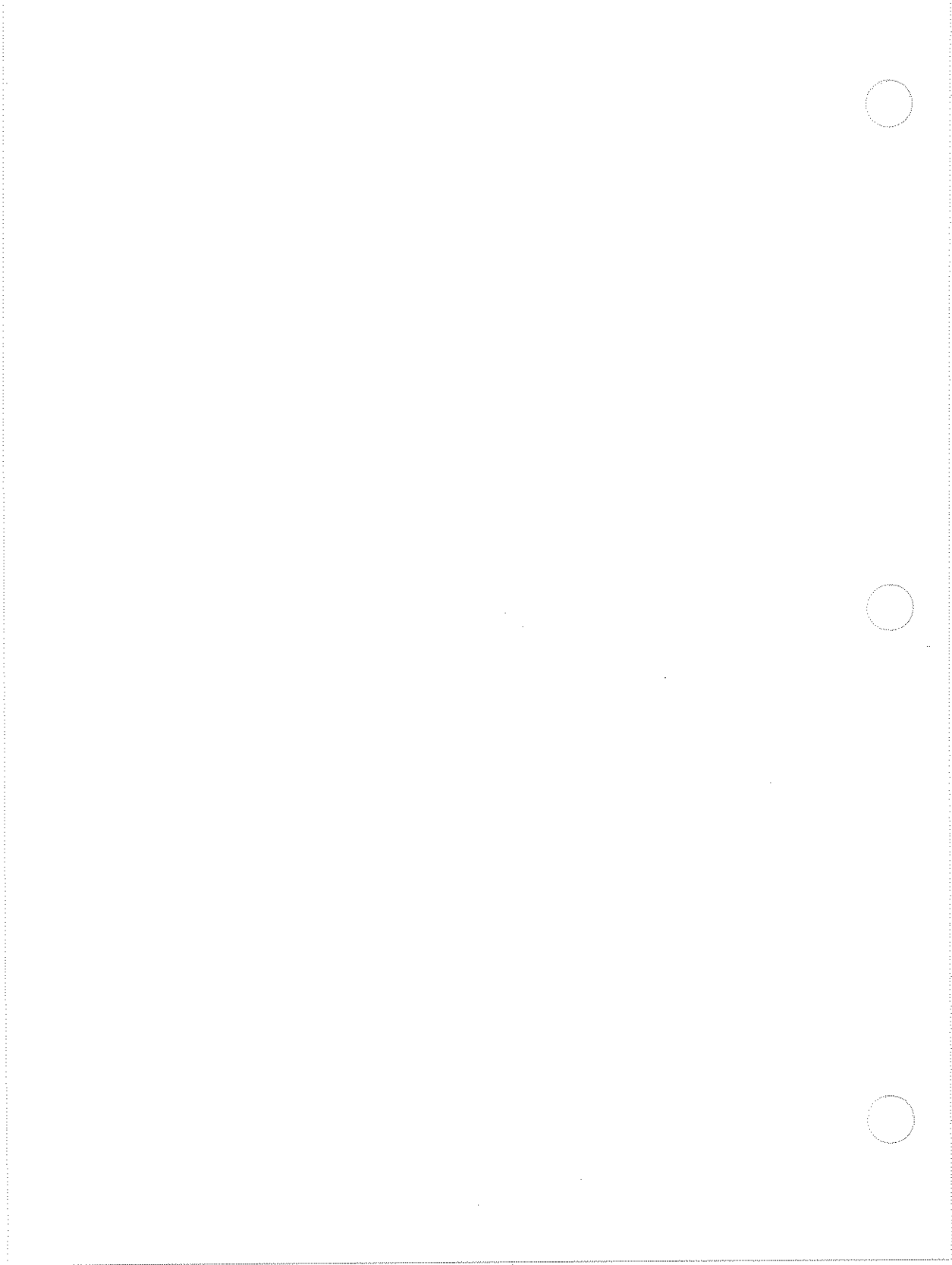

TUTORIAL

This tutorial is designed to teach uninitiated users fundamental techniques for programming and operating the 2280 Series Data Loggers from the front panel. A simple but useful sample program is put together here, complete with scanning and an alarm. A more detailed programming reference is provided in Section 3 of this guide.

Creating a New Program

Use the following three-step approach to set up monitor and scanning processes with the 2280.

1. Determine exactly what you want the program to accomplish.
2. Fill out the 2280 Series Programming Form. As you do, take into consideration all of the aspects and capabilities available to you. Make sure the program does precisely what you want it to do.
- 3 Key the program into the data logger.

With the programming form in front of you, the first two steps can be done pretty much at the same time. When you're writing a new program, use the form as a kind of worksheet to get your thoughts onto paper, and try various combinations of program options to analyze whether what you want is actually what will work.

2/Creating a New Program

Once you have the program on paper in the exact form you want, it's a simple matter to key it in. Follow the displayed prompts, and refer to the form for help in locating menus and fields within the six modules. Don't worry if you make an error in putting together a program--errors rarely create serious problems and are generally easy to find and repair.

Before you start the following lesson, please make certain the 2280 hardware you are using contains an analog to digital converter (set at address "0"), a scanner, and thermocouples connected to channels 8 and 9. Refer to the 2280 Series System Guide for answers to hardware configuration questions.

If you get an error message you don't understand while programming, turn to the error and alarm definitions in Section 8 of this guide. The alphabetical listing (by the first letter of the displayed message) makes them easy to find.

Writing a Program to Measure and Average Two Thermocouples

In this lesson, you'll program three different kinds of channels to measure temperature with two thermocouples. This sample program involves programming channels 8, 9 and 10, one scan group (which you designate as scan group number 5), an alarm list (number 10) and finally, plotting the input results of the programmed channels.

First, the 2280 needs to accept the measurements on input channels. The reading obtained from channel 8 (labeled Temperature 1), is displayed as degrees Celsius. The channel 9 reading (Temperature 2) is converted mathematically and displayed in degrees Fahrenheit.

2/Creating a New Program

Next, you'll play with the resulting input values by manipulating them with further computations. You'll write a pseudo channel procedure to do so. Channel 10 (labeled Difference), is programmed as a pseudo channel to convert channel 8 input to Fahrenheit, compute the difference in temperature between channels 8 and 9, and then display that difference during scanning.

Scan group number 5 is set up to execute a scan of the three channels every fifteen seconds. You'll program the alarm list to trigger an alarm any time the difference measured by channel 10 exceeds fifteen degrees Fahrenheit.

You finish the lesson by programming the printer to plot the values of the three programmed channels.

Erasing the Program Memory

It's a good idea to remove any earlier programming instructions from the instrument memory prior to entering the program described in the following pages. With the front panel door open, turn the keyswitch to PROGRAM. The display reads,

```
MAIN MENU CHOICE (M FOR MENU)? A
```

This main menu is the starting point for programming each of the six modules and is also the point you return to when you've completed programming. Press the **MENU** key to list the main menu choices onto the printer.

To delete programming currently in the 2280 memory, select,



2/Erasing the Program Memory

The display now reads,

```
<E> ERASE ALL OF PROGRAM MEMORY
```

Press **ENTER** and the display changes to,

```
REALLY ERASE ALL MEMORY (Y,N)? N
```

This step is to remind you that erasing the memory permanently removes it; make certain it's what you want to do. You can view the existing programming by selecting **L** and pressing **ENTER** from the main menu. The **LIST** function prints the current programming and configuration list onto the built-in printer.

To proceed with deleting the program memory, press,



and



Now the main menu is displayed again and you're ready to begin programming.

2/Programming a Scan Group

Programming a Scan Group

<K> SCAN GROUP PROGRAM

GROUP #	SCAN GROUP MENU CHOICE < 1-5 >						
	<1> SCAN GROUP LABEL	<2> SCAN GROUP CHANNEL LIST	<3> SCAN TRIG MODE	<4> DATA OUTPUT DEVICE CONTROL		<5> OTHER SCAN GROUP TRIGGER	
P,C,D, or L				pick one for each device			
0-9	0-90 Alphabetic characters EXAMPLE: ENGINE 2 TEST	FORMAT: One channel only: C# Channel Block only: C# C# Channel and Blocks: C# C# C# C# C# C# C#	(pick only one see menu below)	Output	Alarm	Type	Trans
5		C8 C9 C10	2 00:00:15	2			

<1> On Demand Only <3> Continuous <5> Externally Triggered <1> No Data <3> Alarm Data <1> Never Alarm <3> Any Alarm Transition
<2> Time Interval HH:MM:SS <4> Discrete Time HH:MM:SS <6> Scan Once <2> All Data <4> Alarm Trans Data <2> Any Alarm <4> Always

A scan group is the foundation of all data logging activities within the 2280. In this first exercise you'll program scan group 5 to scan three channels every fifteen seconds and send the output to the printer.

Keep the 2280 Series Programming Form nearby to refer to if you have difficulty following the menu prompts. To enter and program the scan group module (from the main menu), select,

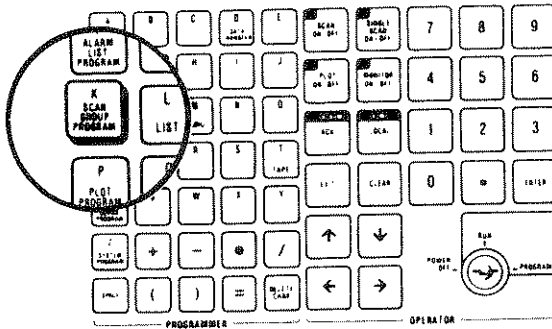

2/Programming a Scan Group

The display responds with,

```
<K> PROGRAM A SCAN GROUP
```

Press the **ENTER** key to choose the displayed selection. In addition to choosing what's displayed, using **ENTER** propels you through the menu selections as you type in your program. Each time you hit **ENTER** you are automatically advanced to the next menu choice whether you've entered something in a field or have chosen to leave the field blank.

The display reads,

```
SCAN GROUP NUMBER = 0
```

You're designating this group as number 5, so press,

5 and then **ENTER**

The display now reads,

```
PROGRAM, COPY, DELETE OR LIST <P, C, D, OR L>? P
```

You plan to **PROGRAM** scan group 5. The cursor always highlights the preset (or default) selection; it's what you want here, so choose it by pressing **ENTER**.

The display reads,

```
K: SCAN GROUP MENU CHOICE <1-5>? 1
```

2/Programming a Scan Group

If bracketed numbers or letters follow a displayed menu title (e.g., scan group), you can usually list the menu selections onto the printer by pressing,

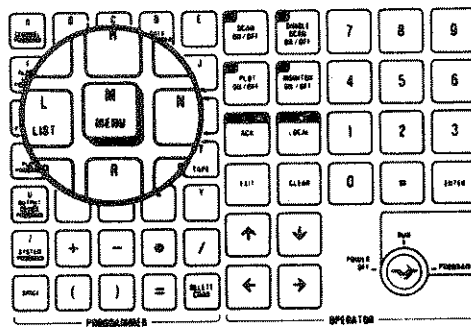

Press the MENU key now to see the scan group menu choices. The selections are also printed in the corresponding module sections on the 2280 Series Programming Form.

Scan group label is the first menu encountered in this section; you're not adding a label to scan group 5, so to move to the second menu, press 2. The display reads,

```
K (2) SCAN GROUP CHANNEL LIST
```

Press ENTER to enter the menu and specify the list of channels. The scan group is to be composed of channels 8, 9, and 10. At the prompt CL: (channel list), key in,

```
CB C9 C10
```

ENTER

2/Programming a Scan Group

After you've entered the channel numbers, you'll see another **CL:** on the display, followed by a blank line. Enough space has been allotted in this field for unlimited lines of channel numbers (with each line containing up to 75 characters), but since you're entering only one line, hit **ENTER** again to move on.

The third menu, scan trigger mode, allows you to specify how often and under what circumstances you want the list of channels scanned. Our program calls for scanning every fifteen seconds.

ENTER the third menu and the prompt is,

```
K3: TRIGGER MODE (1-6)? 1
```

In addition to using the **MENU** key to view your choices, you can display the current selections by pressing any of the menu choice indicators. In this case, those indicators are the digits, 1 through 6.

Press 2 now to select the time interval scan, and then press **ENTER** again. The format is hours, minutes, and then seconds. Use the right arrow key to scroll across the displayed default time and change the field to read,

```
TIME INTERVAL = 00:00:15
```

ENTER this. Next, you'll go on to menu four to specify which data is logged to which physical device. In this program, all scan group data is to go to the printer. Press **ENTER** and at the prompt,

```
K4: DEVICE (1-5)? 1
```

2/Programming a Scan Group

press the **MENU** key to see a list of the five devices. You want to program the printer, which is the second choice. Press 2, and then press **ENTER**. The prompt now reads,

```
K42: TYPE OF DATA (1-4)? 1
```

Again, press **MENU** if you wish to see what choices are available here. You want all data generated to go to the printer, so select 2, and then press **ENTER**. You don't need to change anything in the remaining fields, so our scan group is now completely programmed. Use the **EXIT** key to return to the main menu. To execute the scan from the front panel, press,

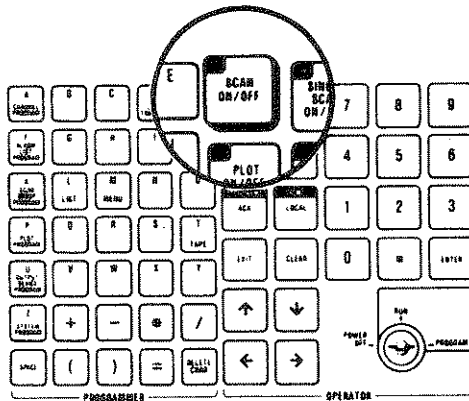

and watch the printer. There isn't any input data to log since the channels listed in this group haven't been programmed yet, but you can get a feeling for the format of the channel readings by running a scan now. This scan executes every fifteen seconds (as it was programmed), and it's stopped when you press the **SCAN** key again. The operating keys toggle on and off and have a light that indicates when they are on. The lesson will continue by programming channels 8, 9, and 10.

2/Programming Channels

Programming Channels **<A>** CHANNEL PROGRAM

CHANNEL #/BLOCK	CHANNEL FUNCTION & RANGE < A-Z >	CHANNEL MENU CHOICE < 1-5 >?																																																																																																																
		< 1 > ALARM LIST# 0-1499 EXAMPLE: (JTIC) T	< 2 > CHANNEL UNITS 0-5 chars EXAMPLE: DEG F	< 3 > CHANNEL EXPRESSION or PROCEDURE 0-75 characters Refer to programmed channel as: CX. EXAMPLE: CX * 1.8 + 32.0	< 4 > CHANNEL LABEL 0-15 characters EXAMPLE: EXHAUST TEMP	< 5 > LOGGING FORMAT (see menu below)																																																																																																												
0-1499 or C4-C6 B	(see menu below) EXAMPLE: (JTIC) T TK				TEMP I																																																																																																													
CHANNEL FUNCTION MENU				USER DEFINED RTD CONSTANTS		LOGGING FORMAT MENU																																																																																																												
<ul style="list-style-type: none"> <P> PSEUDO CHANNEL <D> VOLTS/CURRENT <1> 54.000 MVDC <2> 9.0000 VDC <3> 512.00 MVDC <4> 64.000 MVDC <5> 64.0 MA <6> 250.0 VAC <7> 64.000 MV/0.010 <A> A/D CALIBRATION <1> CALIBRATION <2> SPECIAL <7> THERMOCOUPLE <1> J (NBS) <2> K (NBS) <3> T (NBS) <4> E (NBS) 	<ul style="list-style-type: none"> <R> R (NBS) <S> S (NBS) B (NBS) <N> N (NBS) <C> W-SRE VS W-2BRE <M> J (DIN) <V> T (DIN) R - RTD <1> 365 DC VOLTS SCANNER <2> 10 OHM CU DC VOLTS SCANNER <3> USER DEFINED DC VOLTS SCANNER <4> 365 RTD SCANNER TEMP LT 425.00 C <5> 10 OHM CU RTD SCANNER LO RANGE 	<ul style="list-style-type: none"> <E> USER DEFINED RTD SCANNER LO RANGE <7> 365 RTD SCANNER TEMP 0T 425.0 C <E> USER DEFINED RTD SCANNER HI RANGE User Defined RTD constants 1st RTD (default = 100.0) 2nd ALPHA (default = 3.90E-3) 3rd DELTA (default = 1.404) 4th C4 (default = .2059E-11) <C> COUNTER/TOTALIZER <1> COUNTS <2> FREQUENCY <3> STATUS OUTPUT 1st Zero Result (1-14 chars) 2nd Nonzero Result (1-14 chars) <3> STATUS INPUT 1st Zero Result (1-14 chars) 2nd Nonzero Result (1-14 chars) <D> ANALOG OUTPUT BINARY INPUT <Z> RESISTANCE <1> 512.00 OHMS DC VOLTS SCANNER <2> 64.000 OHMS DC VOLTS SCANNER <3> 512.00 OHMS RTD SCANNER <4> 2048.0 OHMS RTD SCANNER <5> 64.000 OHMS RTD SCANNER 	<table border="1"> <thead> <tr> <th>Change</th> <th>RO</th> <th>Range</th> <th>Units</th> <th>CF</th> </tr> </thead> <tbody> <tr><td> </td><td> </td><td> </td><td> </td><td> </td></tr> <tr><td> </td><td> </td><td> </td><td> </td><td> </td></tr> <tr><td> </td><td> </td><td> </td><td> </td><td> </td></tr> <tr><td> </td><td> </td><td> </td><td> </td><td> </td></tr> <tr><td> </td><td> </td><td> </td><td> </td><td> </td></tr> <tr><td> </td><td> </td><td> </td><td> </td><td> </td></tr> <tr><td> </td><td> </td><td> </td><td> </td><td> </td></tr> <tr><td> </td><td> </td><td> </td><td> </td><td> </td></tr> <tr><td> </td><td> </td><td> </td><td> </td><td> </td></tr> <tr><td> </td><td> </td><td> </td><td> </td><td> </td></tr> <tr><td> </td><td> </td><td> </td><td> </td><td> </td></tr> <tr><td> </td><td> </td><td> </td><td> </td><td> </td></tr> <tr><td> </td><td> </td><td> </td><td> </td><td> </td></tr> <tr><td> </td><td> </td><td> </td><td> </td><td> </td></tr> <tr><td> </td><td> </td><td> </td><td> </td><td> </td></tr> <tr><td> </td><td> </td><td> </td><td> </td><td> </td></tr> <tr><td> </td><td> </td><td> </td><td> </td><td> </td></tr> <tr><td> </td><td> </td><td> </td><td> </td><td> </td></tr> <tr><td> </td><td> </td><td> </td><td> </td><td> </td></tr> <tr><td> </td><td> </td><td> </td><td> </td><td> </td></tr> <tr><td> </td><td> </td><td> </td><td> </td><td> </td></tr> </tbody> </table>	Change	RO	Range	Units	CF																																																																																																										<ul style="list-style-type: none"> <1> Auto <2> none <3> none <4> none <5> none <6> none <7> none
Change	RO	Range	Units	CF																																																																																																														

From the main menu, press,

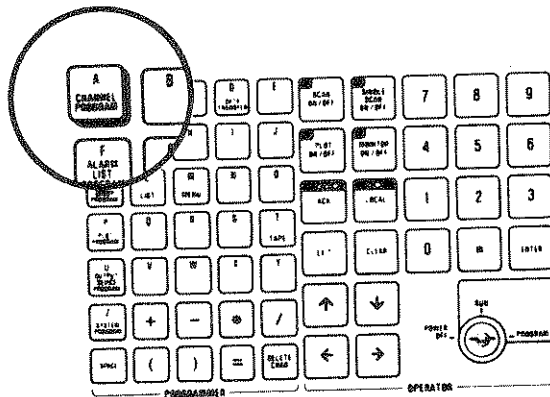

to access the channel programming module. You can also use the ENTER key to choose channel programming since it's the default selection.

2/Programming Channels

You're working with channel 8 first and will program it to receive input on a K-type thermocouple, and to have a channel label of TEMP 1.

When prompted for the CHANNEL NUMBER (OR BLOCK), press:

8 and then **ENTER**

The prompt now reads,

```
PROGRAM, COPY, DELETE OR LIST <P, C, D, OR L>? P
```

You're going to program channel 8, and **program** is the default setting, so press **ENTER** to choose it. The display reads,

```
A: CHANNEL FUNCTION <A-Z>? P
```

Press **MENU** to list the selections available. The default selection is P for pseudo channel, and since you're using a thermocouple in this program, change the entry to T, and then press **ENTER**. The display reads,

```
AT: TC TYPE <J, K, ....etc>? J
```

Program settings are available for quite an array of thermocouple types; press **MENU** to see the complete list. In this exercise you're using a K type thermocouple (CHROMEL vs ALUMEL), so press K, and then press **ENTER**.

AT: CHANNEL MENU Choice <1-5> ?

Tutorial/Programming Channels

The program for channel 8 doesn't call for an alarm list number, channel units, or a channel procedure, so press **4**, followed by **ENTER**, to bypass those programming options and advance to the fourth menu choice. The prompt is,

CHANNEL LABEL (15 CHR5 MAX) =

The label for channel 8 is **TEMP 1**. Locate the alphanumeric characters on the 2280 front panel now and key them in. Use the right and left arrow and delete character keys if you need to make corrections as you type. When the label appears correct, press **ENTER**.

Channel 8 is programmed now; use **EXIT** to return to the main menu to program channel 9.

<A> CHANNEL PROGRAM

CHANNEL #/BLOCK	CHANNEL FUNCTION & RANGE < A-Z >	CHANNEL MENU CHOICE < 1-5 > ?																																	
		< 1 > ALARM LIST#	< 2 > CHANNEL UNITS	< 3 > CHANNEL EXPRESSION or PROCEDURE	< 4 > CHANNEL LABEL	< 5 > LOGGING FORMAT																													
P.C.D. OR L. 0-1499 or Cx C#	(See menu below) EXAMPLE (J,C),T,1	0-1400	0-8 CHS. EXAMPLE DEG F	0-75 characters Refer to programmed channel as Cx. EXAMPLE: Cx = Cx * 1.8 + 32.6	0-15 characters EXAMPLE EXHAUST TEMP	(See menu below)																													
9	TK		DEG F	CX = CX * 1.8 + 32	TEMP 2																														
CHANNEL FUNCTION MENU						LOGGING FORMAT MENU																													
<ul style="list-style-type: none"> <P> PSEUDO CHANNEL VOLTS CURRENT <1> 84 150 VDC <2> 8 0000 VDC <3> 517 00 MVDC <4> 84 000 MVDC <5> 84 0 MA <8> 250 0 VAC <7> 84 000 SP-OTD -A> A/D CALIBRATION <1> CALIBRATION <2> SPECIAL -T> THERMOCOUPLE <3> J (INBS) <4> K (INBS) <T> T (INBS) <E> E (INBS) 	<ul style="list-style-type: none"> <R> R (INBS) <S> S (INBS) B (INBS) <N> N (INBS) <C> W-SRE VS W-NIRE <J> J (DN) <Y> T (DN) -R> RTD <1> 363 DC VOLTS SCANNER <2> 10 0MA CU DC VOLTS SCANNER -U> USER DEFINED DC VOLTS SCANNER <3> 363 RTD SCANNER TEMP <4> 363 RTD SCANNER TEMP LT 425 00 G <5> 10 0MA CU RTD SCANNER LD RANGE 	<ul style="list-style-type: none"> <E> USER DEFINED RTD SCANNER LD RANGE <7> 363 RTD SCANNER TEMP DT 425 0 G <E> USER DEFINED RTD SCANNER HI RANGE SCANNER HI RANGE User Defined RTD expressions 1st RO (default = 100 R) 2nd ALPHA (default = 3 90E-3) 3rd DELTA (default = 1 00E) 4th CX (default = 20599E-11) -C> COUNTER/TOTALIZER <1> COUNTS <2> FREQUENCY <S> STATUS OUTPUT 1st Zero Result (1-14 chrs) 	<ul style="list-style-type: none"> <S> STATUS INPUT 1st Zero Result (1-14 chrs) 2nd Nonzero Result (1-14 chrs) <D> ANALOG OUTPUT BCD/BINARY INPUT <E> RESISTANCE <1> 517 00 OHMS DC VOLTS SCANNER <2> 84 000 OHMS DC VOLTS SCANNER <3> 758 00 OHMS RTD SCANNER <4> 504 0 OHMS RTD SCANNER <5> 84 000 KCHMS RTD SCANNER 	<table border="1" style="width: 100%; text-align: center;"> <tr> <td>Output</td> <td>NO</td> <td>Auto</td> <td>Auto</td> <td>Auto</td> <td>Auto</td> </tr> <tr> <td> </td> <td> </td> <td> </td> <td> </td> <td> </td> <td> </td> </tr> <tr> <td> </td> <td> </td> <td> </td> <td> </td> <td> </td> <td> </td> </tr> <tr> <td> </td> <td> </td> <td> </td> <td> </td> <td> </td> <td> </td> </tr> <tr> <td> </td> <td> </td> <td> </td> <td> </td> <td> </td> <td> </td> </tr> </table>	Output	NO	Auto	Auto	Auto	Auto																									<ul style="list-style-type: none"> <1> Auto <2> none <3> N.M.S.S. <4> none <5> none <6> none <7> none
Output	NO	Auto	Auto	Auto	Auto																														

2/Programming Channels

As you get further along in this lesson, you have more and more responsibility for moving through the menus on your own to locate needed entry fields. Starting at the main menu, use the same techniques for programming channel 9 as for channel 8, except, of course, when the prompt asks for the CHANNEL OR BLOCK NUMBER, enter 9.

Like channel 8, this program is for a type K thermocouple and it isn't associated with an alarm list. Key in T and K in the channel function menu, and then press **ENTER**. Leave the field for alarm list number blank.

You want channel 9 to log values in degrees Fahrenheit and in order for it to do so, you need to add channel units and a channel expression.

Press 2 (when presented with the prompt CHANNEL MENU CHOICE <1-5>), and then press **ENTER** to advance to the second selection in the menu choice. When the prompt is,

```
AT(2) CHANNEL UNITS
```

Press **ENTER** and the display will read,

```
CHANNEL UNITS (6 CHRS MAX) =
```

The temperature units are **DEGREES FAHRENHEIT** for this channel, but you're limited to six characters in this field so you have to abbreviate the entry. Following the displayed equal sign, type in,

DEG F and then press **ENTER**.

2/Programming Channels

Instructions to press the ENTER key appear only in new situations. Use the ENTER key on your own to store entered selections and to move through the menu hierarchy.

From the main menu, enter the channel programming module, label this channel as 10, and advance to the channel function prompt. Select P here to indicate that channel 10 is a pseudo channel. Channel 10 is associated with an alarm list that we'll designate as alarm list number 10. At the prompt,

```
ALARM LIST NUMBER = 0
```

type in 10, and press ENTER. The units that channel 10 displays are in degrees Fahrenheit, so at the channel unit prompt, enter DEG F.

This pseudo channel converts channel 8 input from degrees Celsius to degrees Fahrenheit, computes the difference between channels 8 and 9, and then displays the difference when scanned. At the channel procedure field, the prompt is,

CP:

Type in $C10=(C8*1.8+32)-C9$ and then ENTER.

After you've entered the procedure, you'll see another CP: on the display, followed by a blank line. Enough space has been allotted in this field for unlimited lines of procedures (with each line containing up to 75 characters), but since you're entering only one line, hit ENTER again to move on.

The only other field you need to worry about for channel 10 is the label. At the channel label prompt, type in the label, which is, DIFFERENCE.

When you've completed these steps, EXIT back to the main menu to program the alarm list.

2/Programming Channels

Programming an Alarm List

◁▷ ALARM LIST PROGRAM

ALM LIST #	ALARM LIST MENU CHOICE < 1,2 >?					
P.C.D. OR L.	< 1 >					< 2 >
	LIMITS INFORMATION					DEAD BAND
0-1499	< 1 >	< 2 >	< 3 >	< 4 >	< 5 >	
	LIMIT #	BDONE	LIMIT VALUE	ALARM MESSAGE 0-60 characters	ALARM SCAN TRIGGER	LIMITZ
EXAMPLE: EXHAUST TEMP OVER LIMIT						
1	H	15	DELTA TEMP OVER LIMIT			
10						

This alarm list program is designed to trigger an alarm any time the difference between channel 8 and channel 9 (as compared and displayed by channel 10) exceeds fifteen degrees Fahrenheit.

2/Programming Channels

From the main menu display, select,

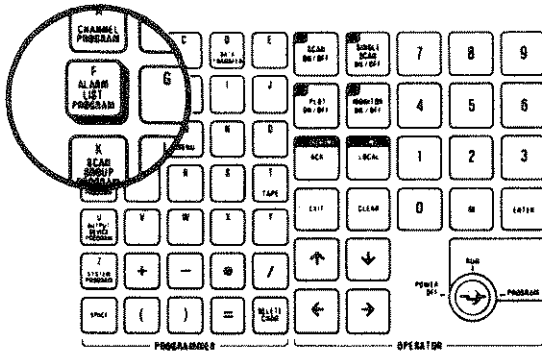

then use the **ENTER** key to reach the prompt,

```
ALARM LIST NUMBER = 0
```

You're designating this alarm list program as number 10, so enter it over the displayed default. When you've finished, press **ENTER**. A lot of default selections work for us in this program so you'll be using the **ENTER** key frequently.

You're **programming** this alarm list, so use **ENTER** to select the P. When you've advanced to the prompt,

```
F: ALARM LIST MENU CHOICE <1,2>? 1
```

use the **MENU** key to list the two programming choices available. You want to program the limits information (which is the default setting), so use **ENTER** again to indicate this.

2/Programming Channels

You have the capability of assigning up to four limits per channel here. You're only programming one limit, so press **ENTER** and then use **MENU** again to print the list of menu choices.

Use **ENTER** again to set the alarm for values exceeding the **HIGH** sense. **ENTER** the second menu of the limit menu choice to indicate exactly how high the limit value should be to trigger an alarm. At the prompt,

```
LIMIT VALUE = 0.0
```

key in 15, and then press **ENTER**. Alarm list 10 is now programmed to indicate an alarm condition whenever scanning or monitoring occurs and the difference between channel 8 and channel 9 exceeds fifteen degrees Fahrenheit. It helps to have a message corresponding to the alarm condition, especially if more than one alarm list is programmed. Press **ENTER** to access the third menu, and to assign a message to this alarm. When the display reads,

```
ALARM MESSAGE (40 CHRS MAX) =
```

type in the message **DELTA TEMP OVER LIMIT**, and press **ENTER**. Use the right and left arrow and delete character keys for editing or for correcting typing errors.

This program doesn't call for triggering other scan groups, deleting earlier programmed limits, or working with a dead band, so leave the remaining fields unchanged and **EXIT** to the main menu.

2/Programming Channels

Press the **SCAN** key again now and watch the printed results. Feel free to experiment a bit if you like during scanning by dipping the end of the channel 9 thermocouple into hot coffee, or by heating it slightly by other available means.

Experimenting may cause an alarm to be triggered, which can easily be acknowledged by pressing the front panel alarm acknowledgement key.

When you're finished playing with your scan group, press the **SCAN** key again to stop the scan. Return to the main menu. You'll complete the lesson by writing a plot program next.

2/Programming Channels

Writing a Plot Program

< P > PLOT PROGRAM

PLOT MENU CHOICE < 1,2 >?				
< 1 > PARAMETERS PLOT NUMBER < 1-4 > ?				< 2 > COMMON PLOT INTERVAL FOR ALL FOUR PLOTS
PLOT #:	< 1 >	< 2 >	< 3 >	< 4 >
SYMBOL:
1st) Channel to Plot	8	9	10	
2nd) Leftmost Value	20	50	-20	
3rd) Rightmost Value	80	100	+20	
				PLOT INTERVAL 00:00:05 HH. MM. SS

A plot program is perhaps the easiest of all to put together for the 2280. To plot from 1 to 4 channels, specify the channel numbers, the right and left values to plot between, and the time interval you wish between executions of plotting. This program is designed to plot the values of the three channels (8 through 10) that you've already programmed.

From the main menu, press,

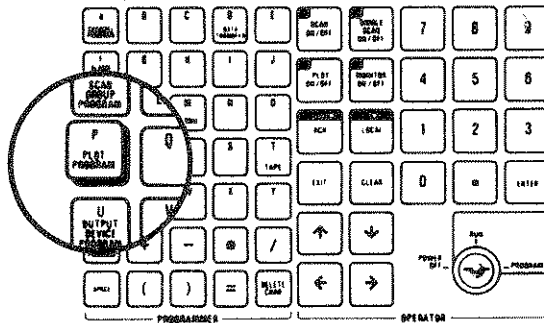

and then press ENTER. Use the MENU key to list onto the printer the two programming choices available here. You can also use the up and down arrow keys to view the menu selections.

2/Writing a Plot Program

Identify the channel numbers and the parameters for each channel for the first step. Press **ENTER** again, and the display reads,

```
PLOT NUMBER (1-4)? 1
```

Use **ENTER** to access the first menu and at the prompt,

```
CHANNEL TO PLOT =
```

type in **C8** and press **ENTER**. Channel 8 input is read in degrees Celsius, and the range you'll plot will be from twenty to fifty degrees.

When the display reads,

```
LEFT MOST VALUE =
```

type in **20**, and press **ENTER**. At the prompt,

```
RIGHT MOST VALUE =
```

enter **50** and press **ENTER** again. That's all there is to specifying plotting parameters. You'll be advanced by the system to the next menu to program another channel to plot. Follow the same entry procedures now on your own to specify left and right most values for channels 9 and 10.

As the handwritten program at the beginning of this plotting section indicates, the left most value for channel 9 (**C9**) is **50**, the right most value is **100**.

2/Writing a Plot Program

When the parameters for channel 9 are entered, type in the plotting range for channel 10 (C10). Set the left most value to -20 and the right most value to +20.

You're not programming plot number 4, so press EXIT to return to the prompt,

```
P: PLOT MENU CHOICE (1,2)? 2
```

As you can see from the display, you've been advanced to the second menu of the plot menu choice. Press ENTER now to access it so you can set the plotting interval. At the display,

```
PLOT INTERVAL = 00:00:01
```

use the right arrow key to scroll across the display to the position indicating seconds. The format is hours, minutes, and then seconds. This program calls for plotting every five seconds, so, using the right arrow key, scroll across the displayed time and change it to read,

```
00:00:05
```

2/Writing a Plot Program

Press **ENTER**, and the plot program is complete. To execute the plot program you've just written, return to the main menu and press,



The values from the three programmed channels will be displayed onto the printer at intervals of five seconds. Press the **PLOT** key again to stop plotting.

Use the **LIST** key, as demonstrated at the beginning of this tutorial, to print the program you've just written onto the built-in printer.

Turn the instrument off (using the keyswitch) and your program is stored in the 2280 memory for at least ninety days. The lesson is now complete.

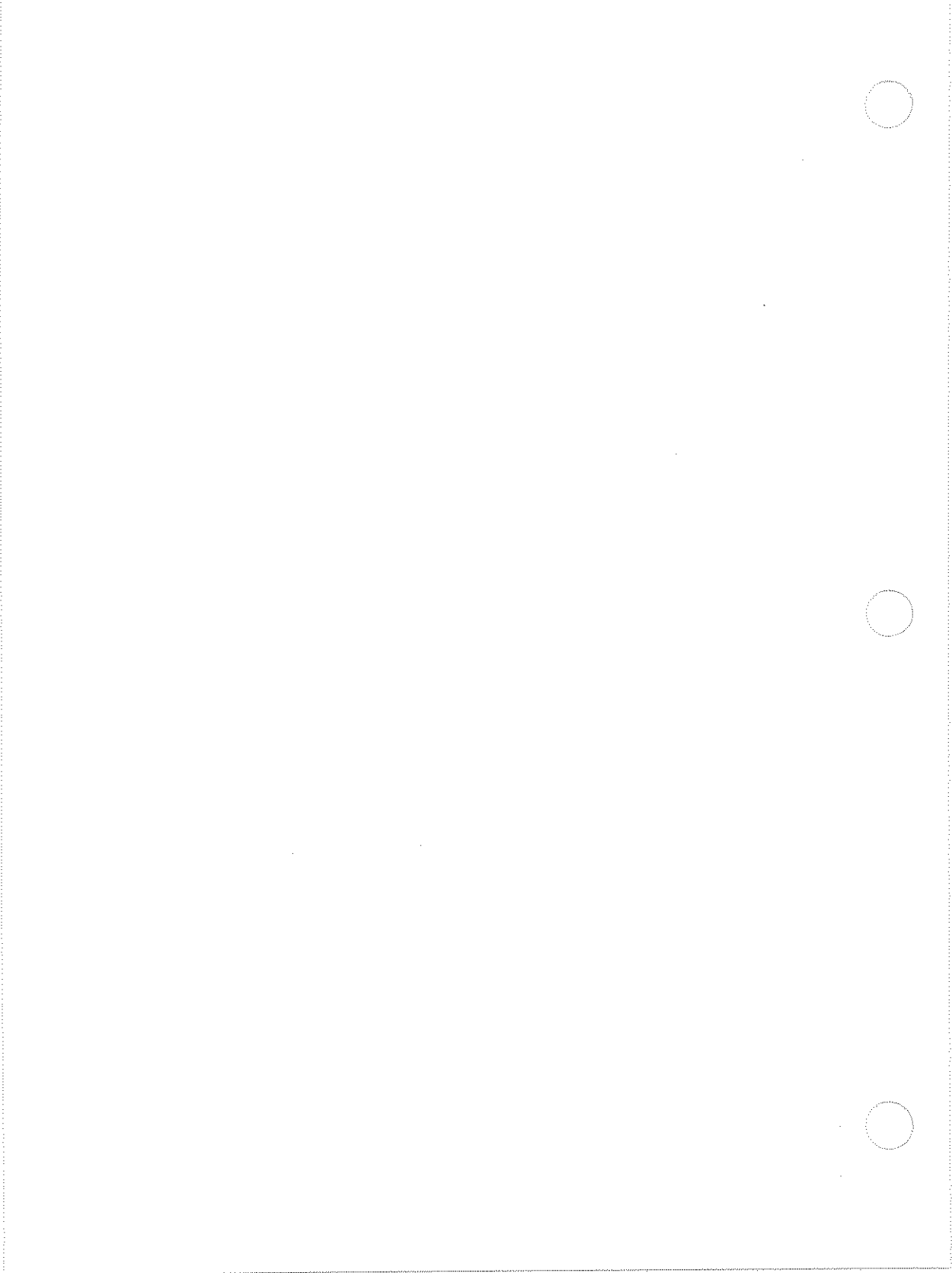

Section 3
Programming and Menu Reference

CONTENTS

Introduction	3-3
Menu Reference Overview	3-4
CHANNEL PROGRAMMING	3a
Program a Channel or a Block	3a-2
P,C,D, or L	3a-2
Channel Function	3a-4
Channel Menu Choice	3a-4
Alarm List Number	3a-4
Channel Units	3a-5
Channel Units	3a-5
Channel Label	3a-6
Channel Expression or Procedure	3a-8

SCAN GROUP PROGRAMMING	3b
Group Number	3b-2
P,C,D, or L	3b-2
Scan Group Menu Choice	3b-4
Scan Group Label	3b-4
Scan Group Channel List	3b-4
Scan Trigger Mode	3b-9
Data Output Device Control	3b-12
Other Scan Group Trigger	3b-13
 ALARM LISTS	 3c
Alarm List Number	3c-2
P,C,D, or L	3c-2
Alarm List Menu Choice	3c-4
Limits Information	3c-4
Dead Band Value	3c-7
 OUTPUT DEVICE PROGRAMMING	 3d
Output Menu Choice	3d-1
Printer Format	3d-2
Port A, Port B, and Cartridge Tape Formats	3d-3
Port Characteristics	3d-5
Alarm Ack Logging Device	3d-9
Data Transfer Filter	3d-9
 PLOT PROGRAMMING	 3e
Plot Menu Choice	3e-2
Parameters	3e-2
Common Plot Interval for All Four Channels	3e-3
 SYSTEM PROGRAMMING	 3f
System Menu Choice	3f-1
Line Frequency	3f-2
Calendar Date and Time	3f-2
Temperature Units	3f-3
Access Code	3f-3
Scan Trigger Enable Times	3f-3
Interpolation Tables	3f-4
Select Menu Options	3f-5

INTRODUCTION

This section takes you through each entry field of each menu available from the six programming modules. The menus are presented in the same sequence that they are encountered while you are programming. Designed for ease of reference, this section allows you to pinpoint a menu or entry field you have questions about and locate it individually to see how to handle it.

Use the 2280 Programming Form for a worksheet and also to assist you in finding your place as you go through the menus. Sometimes the entry fields and varying levels within different menus can be a bit confusing. The programming form also provides a convenient program reference of values and characteristics you've assigned to the 2280.

The Introduction to Programming and Operating (section 2 in this guide) contains simplified general programming and operating explanations and a tutorial geared to the uninitiated user. If the reference information here in section 3 doesn't answer basic questions you have, it might be helpful for you to go back and read the earlier sections first.

3/Menu Reference Overview

MENU REFERENCE OVERVIEW

The 2280 series of data loggers are programmed by using a menu-driven system--you don't have to learn a computer software language to set up monitor and scanning processes. The programs are divided into six modules (or groups) of programmable features, each accessed by the 2280 front panel keypad.

Using the programming form helps you to plan your entry before you commit it to the data logger's memory. But, don't worry if you change your mind once you've written and entered a program. It's an easy matter to alter programs after they've been keyed in.

This section takes you through the modules detailed on the 2280 Series Programming Form and explains each set of options available under the different menus. If you have questions about a menu entry, locate information for that field in the following sequence,

1. Identify the program module first (i.e., channel, alarm list, scan group, etc.). Turn to the corresponding module section on the following pages.
2. Find the menu in question within the tabbed module section. Refer to the 2280 Series Programming Form if you need assistance in finding the menu title.
3. Pinpoint the specific menu (or entry field within a menu) that you need information about. The menus are presented in the same sequence in which they are encountered while programming.

3/Menu Reference Overview

This reference section covers each entry field of each menu and module available when programming the 2280 Series of Data Loggers. Using it and the programming form, you'll have no problems quickly putting together your own individualized program for data acquisition and monitoring.

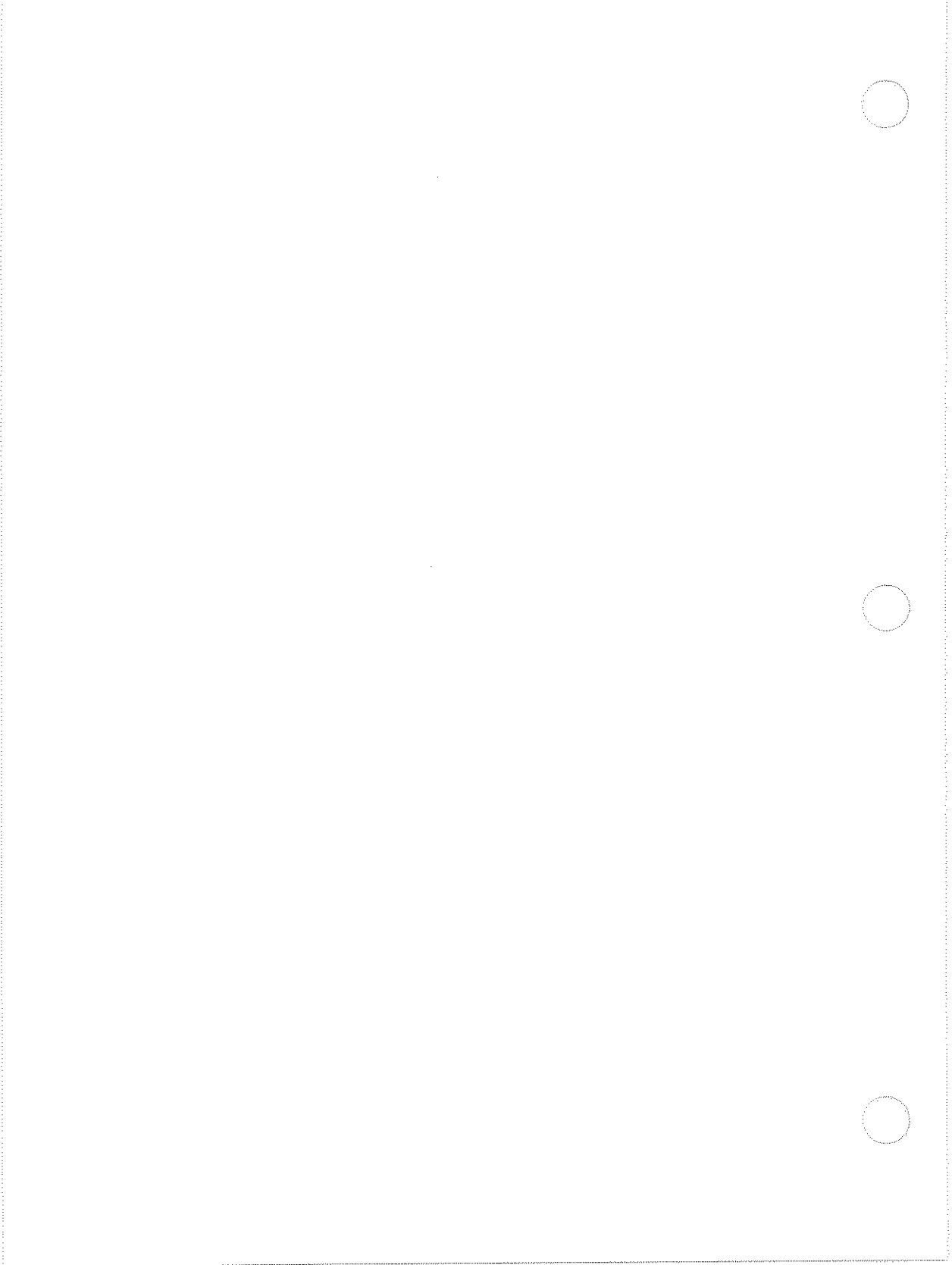

CHANNEL PROGRAMMING	3a
Program a Channel or a Block	3a-2
P,C,D, or L	3a-2
Program	3a-2
Copy	3a-3
Delete	3a-3
List	3a-4
Channel Function	3a-4
Channel Menu Choice	3a-4
Alarm List Number	3a-4
Channel Units	3a-5
Channel Label	3a-6
Logging Format	3a-6
Channel Expression or Procedure	3a-8
Inserting and Editing Lines	
of Text	3a-9
Editing and Deleting Lines ...	3a-9
Inserting Lines into Current	
Set of Lines	3a-10
Input Channel Expression	3a-11
Output/Pseudo Channel Math	
Procedure	3a-11
Basic Operators for Channel	
Expressions and Procedures ...	3a-12
Special Math Functions Without	
the Advanced Math Option	3a-15

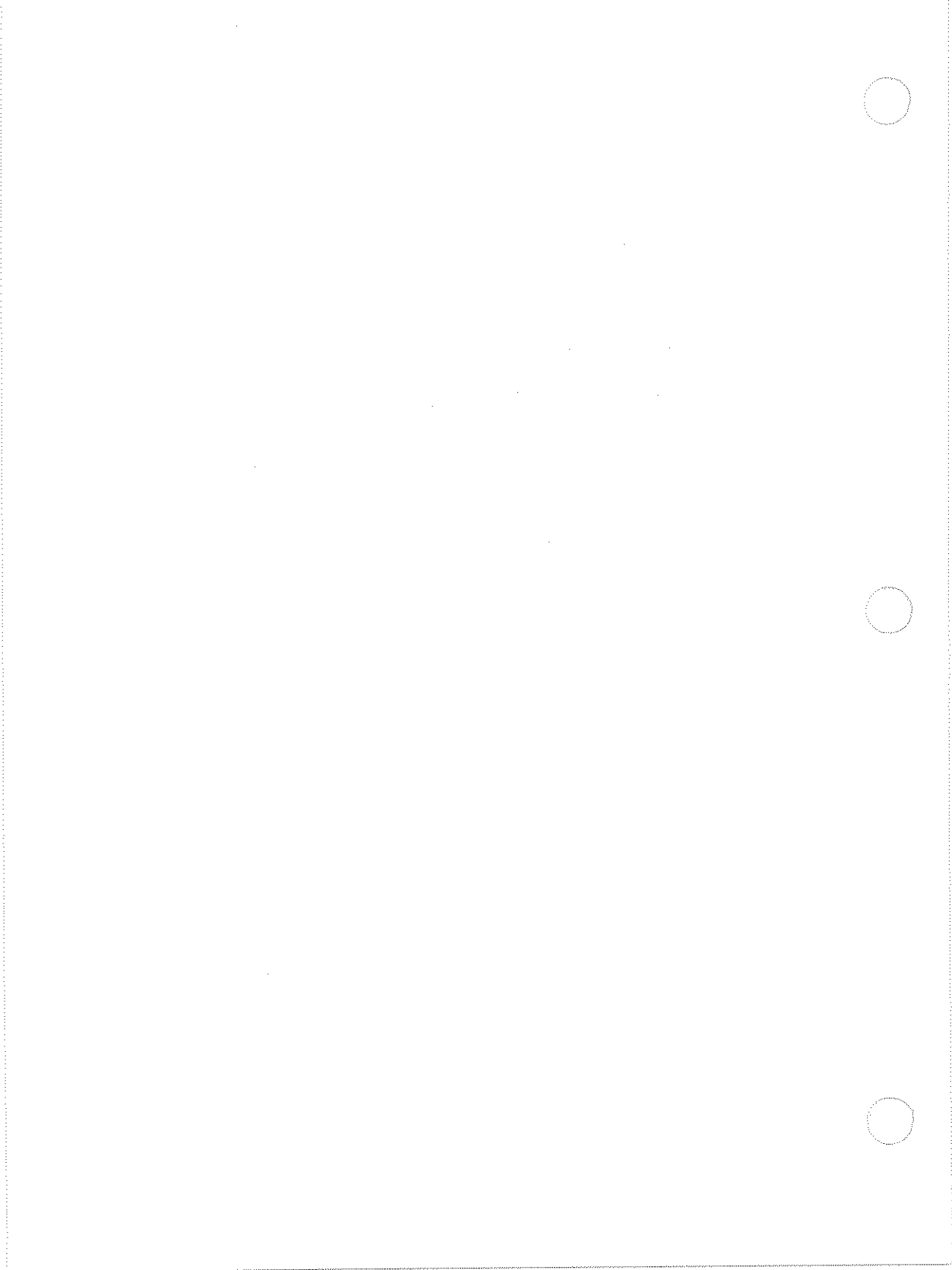

3a/Channel Programming

A channel is the building block for a scan group. Each channel can be defined as a measurement (or input) channel, an output channel, or as a pseudo (or dummy) channel used to perform calculations between other channels.

Program each channel as an input, output, or pseudo channel, and then combine them into a scan group.

PROGRAM A CHANNEL OR A BLOCK

Specify the numeric channel, or group of channels (referred to as a block), that you wish to work with. The assigned number or numbers may be up to four digits long, from 0 to 1499.

Program each channel separately (for example, C9) or in blocks of related channels for ease of reference (for example, C1...25). A program encompassing a block of channels uses less program memory space than separate programs for each channel.

If you select a channel or block that has already been programmed, the existing program will be displayed when you enter each menu.

P,C,D, or L

Program, Copy, Delete, or List the Channel or Block number you've specified.

PROGRAM

When you select program, you have access to each menu in the same sequence as you see on the programming form. Use program to enter a new program, or to change values or characteristics entered earlier.

Program is the default selection for this field so you can select it by merely pressing the ENTER key.

3a/Channel Programming

COPY

If you choose copy, the system first checks to see if the channel designated to receive the copied parameters is already programmed. If so, the old program must be deleted before new parameters can be copied into it.

The prompt is,

CHANNEL EXISTS, DELETE<Y,N>? N

If you press Y, then press ENTER (or if the channel wasn't previously programmed), the prompt becomes,

CHANNEL TO COPY FROM =

Now, enter the channel number whose program you want copied to the new channel. Press ENTER, and the channel is programmed completely.

The system responds with the prompt,

CHANNEL OR BLOCK COPIED

When you press ENTER, the system returns the prompt,

CHANNEL NUMBER (OR BLOCK) =

This indicates that you can now enter the number of another channel to be programmed. Press the EXIT key when you're finished to return to the main menu.

DELETE

Delete removes the program from the channel or block number you've chosen. The program is permanently deleted, so use this selection judiciously.

Delete also frees space in the 2280 memory for other program parameters.

3a/Channel Programming

LIST

Listing a channel or block prints the current program parameters onto the printer (or other listing device, if installed and selected).

CHANNEL FUNCTION

The channel function entry defines the category of input and output hardware associated with a given channel. Measurement input and output functions are assigned here also.

A channel may also be designated a pseudo channel here. A pseudo channel doesn't have anything physically connected to it; it's generally used as a mathematical expression for a specified channel, or between that channel and any other channel.

Enter the program specifications you desire (from the printed menu or from the programming form) by entering the letter shown for the function you wish to choose. Section 5 of the 2280 System Guide provides several measurement and output examples.

CHANNEL MENU CHOICE

The channel menu choice contains five programmable fields. They are alarm list number, channel units, channel expression or procedure, channel label, and logging format.

Alarm List Number

This field is for the number of the alarm list associated with the channel or block of channels being programmed. If no alarm list is programmed in connection with this channel number, leave the entry field blank and no limits checking will occur when this channel is scanned.

3a/Channel Programming

For ease of reference, it's recommended that you use the same number for the alarm list as you do for the programmed channel or channels associated with it.

Channel Units

You can enter up to six characters indicating the engineering units used in programming this channel or block of channels.

The channel function has a default channel unit that corresponds to it; if you leave this field blank, the default will be indicated when you scan or monitor this channel or group of channels. The preset selections are as follows.

DEFAULT CHANNEL UNITS

Function and Range =====	Default Units =====
64.000V dc	V
8.000V dc	V
512.00mV dc	MV
64.000mV dc	MV
64.0 mA	MA
250.0V ac	VAC
64.000 mV/OTD	MV/OTD
Thermocouples	F, or C, or CMV
RTD	F, or C
Pseudo	none
Counts	none
Frequency	HZ
Status Output	none
Status Input	none
Analog Output	none
BCD/Binary	none
Resistance	OHMS

3a/Channel Programming

Channel Label

You can program a channel label to identify or describe any channel. One label, containing up to 15 characters, may be used for each channel or block of channels.

Once programmed, the label is then included whenever channel information is displayed or recorded. The exception is when the compressed output format is selected, in which case the label is omitted in order to save space.

Logging Format

The logging format automatically used with the chosen channel function (choice 1 below) can be changed, if desired, to any of the other choices.

- <1> Auto
- <2> .nnnnn
- <3> n.nnnn
- <4> nn.nnn
- <5> nnn.nn
- <6> nnnn.n
- <7> nnnnn

In cases 3 through 7, one leading zero to the left of the decimal point is displayed where appropriate. When format 2 is used, there is no leading zero. The '+' sign is never displayed. The automatic logging formats for each of the channel functions are listed below.

The floating decimal format always displays 5 digits, along with the appropriate decimal location. If one of the fixed formats is assigned and the value of that channel exceeds the range of that format, the format will shift to an appropriate decimal location.

3a/Channel Programming

The logged number is usually a rounded off representation of the number inside the 2280. Since the display and logging space is limited to 5 digits, numbers must be rounded off. A number such as .000004 is displayed as .00000. Also, if the internal number 46.895 is logged with the format nnn.nn, it will come out as 46.90.

Automatic Logging Formats for Each Channel Function

FUNCTION/CONDITION	AUTO FORMAT
<hr/>	
Input Channels WITHOUT Expressions	
DC Volts, DC Current, AC Volts, Resistance	(As appropriate for each measurement range)
RTD	nnn.nn
Thermocouple	nnnn.n
Counts, BCD/Binary Input	nnnnn
Frequency	Floating Decimal
Input Channels with Expressions	Floating Decimal
Analog Output or Pseudo Channels	Floating Decimal
Status Input and Output	
zero result	ZERO
nonzero result	ONE

3a/Channel Programming

Channel Expression or Procedure

Channel expressions allow you to convert the results of a channel measurement from a raw number to a more meaningful value. Any math or scaling function (any combination of addition, subtraction, multiplication, or division, in an algebraic form), can be applied to the reading obtained from the channel.

With the advanced math option installed, more complex computations, math manipulations, and trigonometric functions are possible. See section 4 of this guide, Advanced Math Programming, or refer to Option -211 of the options section in the 2280 Series System Guide for more information.

In any simple math expression with multiple operations, the data logger will evaluate the operations in the following order.

1. Negation
2. Multiplication
3. Addition and subtraction

Also, operations inside parentheses are evaluated before those outside parentheses.

The range for valid numbers is between $2.72E-20$ and $9.22E18$. Numbers smaller than $2.72E-20$ are set to zero, and numbers larger than $9.22E18$ cause a MATH OVERFLOW ERROR (see section 8 of this guide, Error Messages and System Alarms).

3a/Channel Programming

A measurement or input channel may have an expression in which an assignment operator (=) causes the logged value of the channel to be some function of its raw reading. It is only one line long. It cannot reference any channels by number, and it must refer to itself as CX.

An output or pseudo channel may have a multi-line procedure. Each line (or statement) contains an assignment channel number, an assignment operator, and an expression. When the expression is evaluated, the result is assigned to the assignment channel (which may be an output or a pseudo channel). It may refer to multiple channels by number as well as to itself by number, or as C". Each line in a procedure, and the one line of an expression, may be up to 75 characters long. Channel expressions and procedures are further defined in the following paragraphs.

INSERTING AND EDITING LINES OF TEXT

Channel procedures and interpolation tables can exist as multiple lines in a configuration program. Use the following steps when these lines need editing, or if you want to insert additional lines.

Editing and Deleting Lines

To edit or delete lines in a set, call up the desired parameter so the first line is displayed. Use the <up arrow> and <down arrow> keys to display the line you wish to edit or delete.

To delete a line, press the CLEAR key, and then press ENTER.

3a/Channel Programming

There are two ways to edit lines.

1. To replace a line, simply start keying in new characters over the old ones. The old characters will be deleted.
2. Use the <right arrow> or <left arrow> key to move the cursor to the character you want to change.

Remove the character with the DELETE CHAR key and then enter the new characters. When the line appears the way you want it to, press ENTER. If the syntax is correct you will be prompted for another line. Use EXIT to return to the main menu.

Inserting Lines into Current Set of Lines

To insert lines into a set that is already programmed, call up the desired parameter so the first line in the set is displayed.

Use the <up arrow> and <down arrow> keys to scroll to the line after which the insertion is to take place.

Press the ENTER key. A blank field is now available for entry of the new line. When you're finished inserting lines, move to a new line and press EXIT.

If you are inserting a new line at the beginning of a set, use the <up arrow> key to scroll up past the top line. All lists wrap around from the top to the bottom and have an empty line separating the two.

3a/Channel Programming

INPUT CHANNEL EXPRESSION

For input channels, the expression must refer to no channel other than the one for which it is written. The channel in question is written in the expression as CX. For example, an $mx+b$ scaling for channel 23 might be entered as $CX=3*CX+4$, (CX= is the displayed prompt). The expression translates to,

Assign a new value to the channel which is 3 times its measured value plus 4. (If programming in the block mode, then CX refers to the channel number being processed at that time).

For example, assume that you are programming the block of input channels 4 through 7, and you have assigned to them the simple expression $CX=5*CX+9$. When the reading for channel 4 is taken during scanning, the expression is evaluated as $5*C4+9$. When the channel 5 reading is taken, the expression is evaluated as $5*C5+9$, and so on for channels 6 and 7.

OUTPUT/PSEUDO CHANNEL MATH PROCEDURE

The procedure programmed for an output or pseudo channel follows the same rules for the order of operation evaluation as channel expressions do. It differs from the input channel expression as follows.

The output or pseudo channel procedure may contain, in addition to CX, any other input, output or pseudo channel numbers. It must refer to itself as CX if you are programming in the block mode. Any other channel in the procedure is referred to by number.

3a/Channel Programming

The most recently assigned value is used for any output channel or pseudo channel that appears in the procedure on the right hand side of an assignment operator (=). Any input channel on the right hand side of an assignment operator will be read by the system to obtain a current value.

An example of a procedure is a running average of the last three readings of channel 20. Write the procedure for channel 100 as,

```
C100 = (C101 + C102 + C20)/3  ENTER
C101 = C102  ENTER
C102 = C20  ENTER  ENTER
```

Pressing **ENTER** a second time enters a blank line that signifies the end of the procedure.

This example illustrates that,

- o A procedure may have multiple lines, each of which is ENTERED.
- o Explicit channel numbers may be used both in reference to the channel being programmed and in reference to other channels in the procedure.

To save memory space, you can use pseudo channels in procedures without having any channel programming for them.

BASIC OPERATORS FOR CHANNEL EXPRESSIONS AND PROCEDURES

Basic operators that can be used in channel expressions and procedures without the advanced math option are addition, subtraction/negation, multiplication, division and parentheses.

ADDITION

Format: (operand1) + (operand2)

Usage: Operates between two operand to form their algebraic sum. If an operand doesn't appear directly to the left of the addition character, then the '+' character is interpreted as the positive unary operator (i.e. it signifies multiplication by +1).

Examples:

C23+6.34
+C256

SUBTRACTION/NEGATION

Format: (operand1)- (operand2)

Usage: Operates between two operands, forming the result by subtracting the right operand from the left. If an operand doesn't appear directly to the left of the subtraction character, or if it is preceded by another operator, then the minus sign is interpreted as a negative unary operator, which simply inverts the algebraic sign of the operand following it (negation).

Examples:

C9-C452
-C29
C5*-3.17

3a/Channel Programming

MULTIPLICATION

Format: (operand1) * (operand2)

Usage: Operates between two operands, giving the product of multiplying one by the other.

Examples:

C39*68.03E3
C2*C9

DIVISION

Format: (operand1) / (operand2)

Usage: Operates between two operands such that the one on the left of the division operator is the dividend, while the one on the right is the divisor. The dividend is divided by the divisor to produce the result.

Examples:

C35/C4
100/C28

PARENTHESES

Format: (expression)

Usage: Encloses multiple operands and causes all enclosed operators to be executed before those that are outside this operator. Parentheses may be nested three deep.

Examples:

$C20 = (C1+C2+C3+C4)/4$ is the average of 4 channels.

$C20 = C1+C2+C3+C4/4$ is not the average of 4 channels.

3a/Channel Programming

SPECIAL MATH FUNCTIONS WITHOUT THE ADVANCED MATH OPTION

The special capabilities available when performing math expressions (without the advanced math option installed) are alarm status, error status, reference voltage, linearization, and RTD function.

3a/Channel Programming

ALMn

Format: ALMn(1x//2x//3x// etc.)

Usage: The alarm status function, when evaluated, gives the status (1 = exceeded, 0 = not exceeded) of a particular limit (n) of the channel or block designated in the function. The format of the function is ALMn (channel list), where n is a number from 1 to 4, and the channel list is a single channel, a block of channels, or a combination of blocks and single channels separated (//). For example, the function written as,

```
ALM2(C98//C100..102//C200)
```

when evaluated, will tell whether channel 98, 100 to 102, or 200 has exceeded limit #2 of its assigned alarm list.

Examples:

```
ALM1(C9)  
ALM4(C9...C15)
```

A typical use of this function is to connect a status output channel with a limit on an input channel. For example, consider the following function, where C20 is a status output channel,

```
C20 = ALM2(C1)
```

This becomes an alarm output indicating the state of alarm 2 on input channel 1. C20 should then be included in a scan group channel list. The inclusion of C20 will cause C1 to be read and processed to provide an immediate update of the status output channel based on the input channel's alarm state.

HERMOCOUPLE REFERENCE VOLTAGE

Format: REFn(temperature)

Usage: This function can be used in applications where temperature is being monitored with thermocouples that are terminated in an external isothermal block. When the function is evaluated, it gives the compensating millivolts for specified thermocouple terminated at a specific temperature.

These compensating millivolts, when added to the millivolts measured from the thermocouple, provide the necessary correction to cancel out the effect of the secondary thermocouple formed at the thermocouple termination.

The format of the function is REFn(t) where n is a single letter corresponding to the desired thermocouple type (as shown in the thermocouple selection menu), and (t) one of the following,

- o A constant temperature---for cases where the thermocouple is terminated in an isothermal block at a fixed temperature.
- o A channel number---where the channel is an input channel measuring the actual temperature of the external isothermal block.
- o An expression---that, when evaluated gives the temperature of the external reference block.

3a/Channel Programming

The temperature units used in these cases are the same as programmed in the system program. If the system temperature units are compensated millivolts, degrees Celsius is assumed.

A common example of how this function can be used is in applications where thermocouples are used to measure temperatures located far away from the physical data logger.

As a cost saving measure, the thermocouples can be terminated in an isothermal block close to the temperatures being monitored. The millivolt signals from the thermocouples can then be connected to the 2280 with copper wire.

If the isothermal block used is kept at a constant temperature (for example in an oven at 50 degrees Celsius, and NBS type R thermocouples are used), the reference junction correction can be determined by the following expression,

REFR(50)

If in this example, the temperature of the isothermal block is not held at a constant, but is being measured by the 2280 (using a platinum RTD, for instance) the reference junction correction can be determined by,

REFR(C100)

where C100 is the RTD channel measuring the temperature of the isothermal block.

THERMOCOUPLE LINEARIZATION

Format: LINn(millivolts)

Usage: When evaluated, this function gives the temperature as measured by a specific type of thermocouple. Use this in applications where temperature is being measured with thermocouples not terminated on the standard 2280 isothermal input connector (2280A-175).

Example:

```
CX = LINR(CX+REFR(C100))
```

The format is LINn(m), where n is a single letter corresponding to the type of thermocouple used (as shown in the thermocouple selection menu) and 'm' is one of the following:

- o A channel number---where the channel is an input channel measuring the millivolt signal of a thermocouple.
- o An expression---that, when evaluated, gives the millivolts to be converted to temperature for the specified thermocouple type.

The temperature units used in these cases is the same one programmed in the system program. If the system temperature units are compensated millivolts, the value of the argument is returned unchanged.

3a/Channel Programming

A common example of how this function can be used is in applications where thermocouples are used to measure temperatures located far away from the physical data logger. As a cost saving measure, the thermocouples can be terminated in an isothermal block close to the temperatures being monitored. The millivolt signals from the thermocouples can then be connected to the 2280 with copper wire.

If the isothermal block used is kept at a constant temperature (for example in an oven at 50 degrees Celsius, and NEBS type R thermocouples are used), the temperature being measured by the thermocouples can be determined by the following expression,

$$CX = LINR(CX + REFR(50))$$

where the current channel is programmed to measure millivolts on the 64-millivolt range with an open thermocouple detection (MV/OTD).

If in this example, the temperature of the isothermal block is not held at a constant, but is being measured by the 2280 (using a platinum RTD, for instance) the temperature can be determined by,

$$CX = LINR(CX + REFR (C100))$$

where C100 is the RTD channel measuring the temperature of the isothermal block.

3a/Channel Programming

LIN1

Format: LIN1 (ohms)

Usage: When evaluated in an expression, the LIN1 function applies a 385 DIN platinum linearization on the value of the parameter which is expected to be the resistance of the RTD probe in ohms.

Example:

LIN1(CX)

LIN2

Format: LIN2(ohms)

Usage: When evaluated in an expression, the LIN2 function applies a 10 ohm Cu RTD linearization on the value of the parameter which is expected to be the resistance of the probe in ohms.

Example:

LIN2(CX)

3a/Channel Programming

RTD

Format: RTD(ohms//RO//alpha//delta//c4)

Usage: When evaluated in an expression, the RTD function applies a user defined platinum RTD linearization on the value of the resistance of the RTD probe.

Example:

```
RTD(CX//100.00//0.00390//1.494//-0.205984E-11)
```

This function returns the temperature of a calibrated RTD. The following probe characteristics are required.

ohms	(ohms)
RTD ice-point resistance	(RO)
RTD alpha value	(alpha)
RTD delta value	(delta)
C4 value	(c4)

If any of the last four parameters above are omitted the following defaults will be used.

RO	100.00
alpha	0.00390
delta	1.494
c4	-0.205984E-11

The RTD constants must be specified in order. For example, if you need to specify a C4 that differs from the default, you must also specify RO, alpha, and delta. This is true even if they are the same as the default settings.

The temperature unit used in this function is the same one programmed in the system program. If the system temperature units are compensated millivolts, degrees Celsius is assumed.

ERROR STATUS

Format: ERR (1x//2x//3x//etc.)

Usage: The error status function is used to find the lowest valued error number (i.e., the one with the highest priority) currently active on the channel or block of channels listed.

These errors aren't fatal to system operation, but do indicate that something is wrong. The priority (ranging from 0 through 5) indicates the severity of the problem. The delimiter "//" is used to separate the various channels listed. An error value of zero indicates that none of the channels in the list are in error.

Error reporting codes are as follows:

- (1) Dead Serial Link Device
- (2) Broken Thermocouple
- (2) Propagated Error
- (3) No Reading
- (4) Out of Measurable Range
- (4) Out of Temperature Range
- (5) Argument Out of Range
- (5) Bad RTD Constants
- (5) Arithmetic Overflow
- (5) Denominator of Zero
- (5) Negative Argument
- (5) Zero Argument

Example:

The function ERR(C99//C100...104), when evaluated, gives the lowest valued error number currently active of channel 99 or 100 through 104.

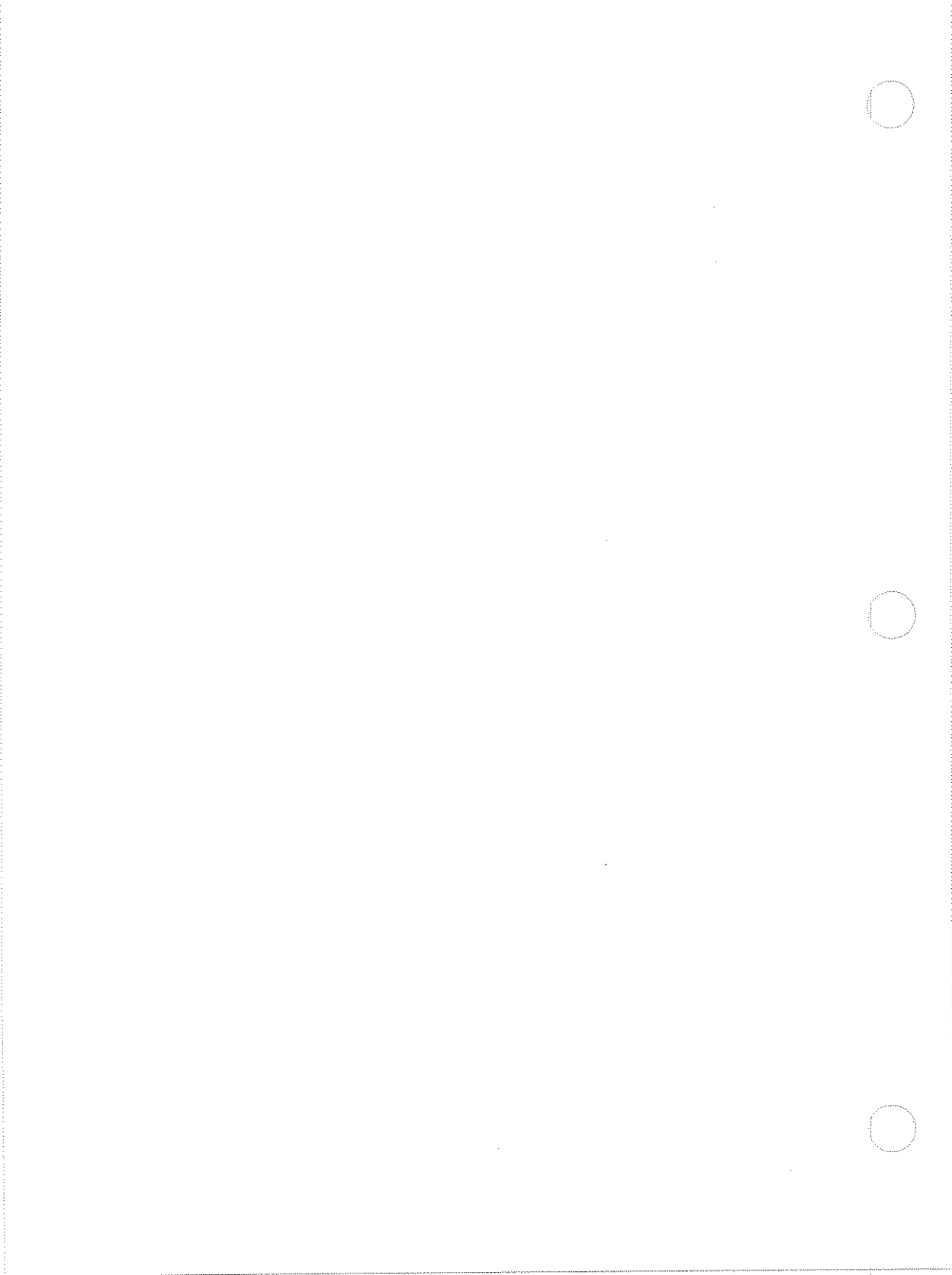

SCAN GROUP PROGRAMMING

3b

Group Number	3b-2
P,C,D, or L	3b-2
Program	3b-2
Copy	3b-2
Delete	3b-3
List	3b-3
Scan Group Menu Choice	3b-4
Scan Group Label	3b-4
Scan Group Channel List	3b-4
Inserting and Editing Lines	
of Text	3b-5
Editing and Deleting Lines ...	3b-5
Inserting Lines into Current	
Set of Lines	3b-6
Execution Sequence of Scan	
Group Channel Lists	3b-6
Scan Trigger Mode	3b-9
On Demand Only	3b-9
Time Interval HH.MM.SS	3b-9
Continuous	3b-9
Discrete Time HH.MM.SS	3b-10
Externally Triggered	3b-10
Scan Once	3b-11
Shortcuts to Keying in Time	3b-11
The System Program Sometimes	
Affects Scanning	3b-11
Data Output Device Control	3b-12
Other Scan Group Trigger	3b-13

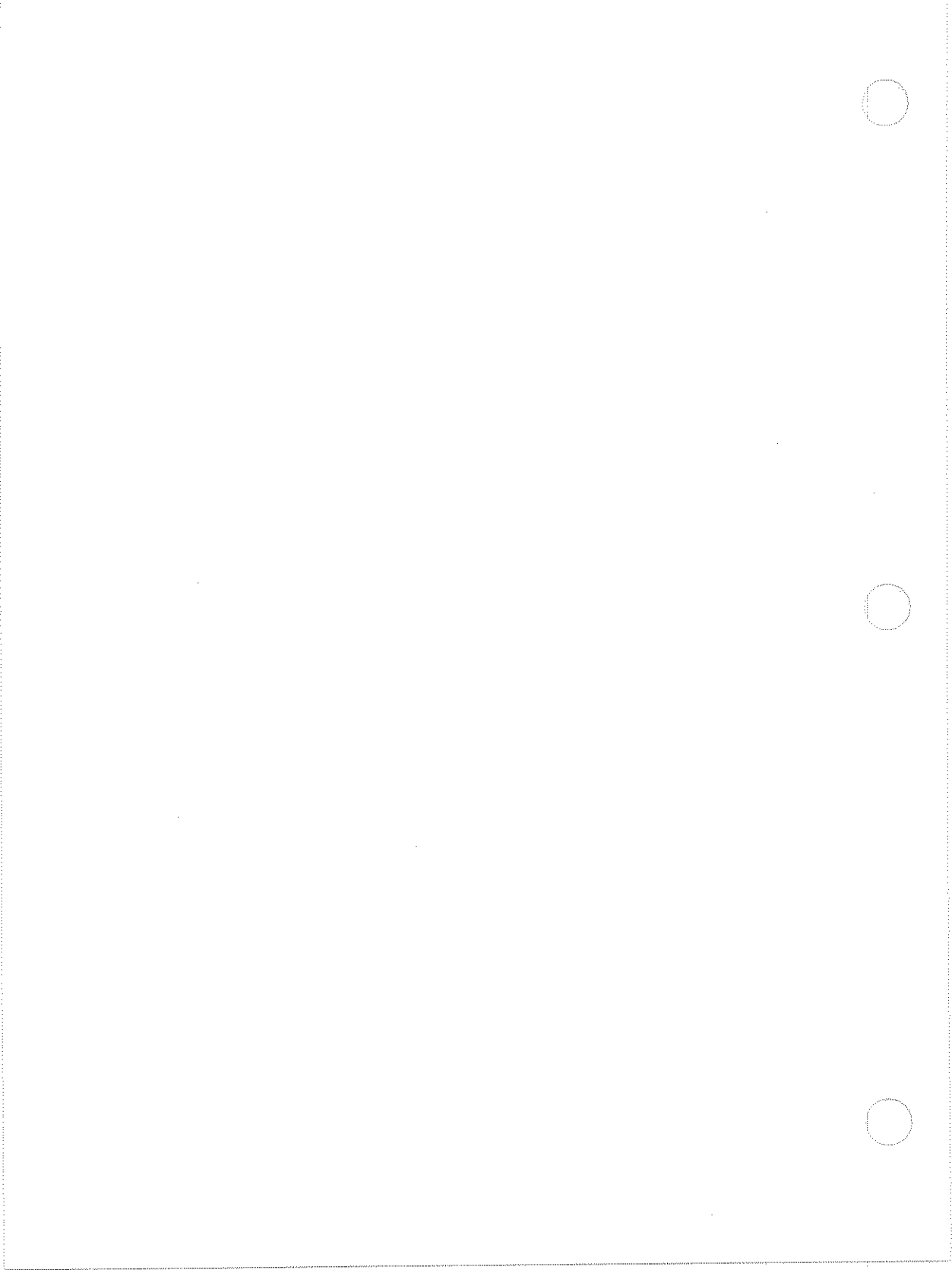

SCAN GROUP PROGRAMMING

<K> SCAN GROUP PROGRAM

GROUP #	SCAN GROUP MENU CHOICE < 1-5 >?													
	< 1 >	< 2 >	< 3 >	< 4 >		< 5 >								
	P.C.D. or L.	SCAN GROUP LABEL	SCAN GROUP CHANNEL LIST	DATA OUTPUT DEVICE CONTROL		OTHER SCAN GROUP TRIGGER								
00	0-Av Apptch/Retn/Unbrk/Brk EXAMPLE: ENGINE / TEST	SUMMARY 0-1-Av Apptch/Retn/Unbrk/Brk 0-2-Av Apptch/Retn/Unbrk/Brk 0-3-Av Apptch/Retn/Unbrk/Brk 0-4-Av Apptch/Retn/Unbrk/Brk	pick any one see items below	1	2	3	4	5	6	7	8	9	Scan Group to Trigger (0)	Trigger Condition (see instr. book)

1 - On Demand Only 3 - Continuous 5 - Extensity Triggered
 2 - Full Memory (see MM SS) 4 - Discrete Time (see MM SS) 6 - Scan Drive
 7 - No Data 8 - Alarm Data 9 - None
 8 - No Data 4 - Alarm Trace Data 2 - Any Alarm
 1 - None 3 - Any Alarm 5 - Any Alarm
 2 - Any Alarm 4 - Any Alarm 6 - Any Alarm

A scan group is a collection of input, output, and pseudo channels you program to be monitored or scanned and recorded as a group. A given channel may be included in any or all scan groups and may appear more than once in a list, but input channels are only measured once each time a scan is executed.

A scan group is really a procedure. Each programmed step reads an input channel, performs the calculations in a pseudo channel, and sends a value to an output channel. Each scan group is given a channel list showing the channel data to be collected and specifying the order in which the channels within a scan group will be logged.

Each scan group behaves as an independent task with its own trigger conditions. To program a scan group, enter all of the attributes needed to spell out what those conditions are.

3b/Scan Groups

GROUP NUMBER

Up to ten scan groups (numbered 0 through 9) can be programmed. You can group channels together for process monitoring, data acquisition and recording, or because they have a logical association with one another.

The number of a scan group also indicates its priority. The lower the number, the higher the scan group priority.

The priority affects the scheduling of scan groups when more than one scan group is triggered for execution. The scan group triggered with the highest priority becomes active when the current active scan group is completed. Only one group can be actively scanning at any time.

P,C,D, or L

Program, Copy, Delete, or List the Scan Group number you've specified.

PROGRAM

When you select program, you have access to each menu in the same sequence as you see on the programming form. Use program to enter new scan group parameters or to change values or characteristics entered earlier.

Program is the default setting for this field so you can select it by merely pressing the ENTER key.

COPY

If you choose copy, the system first checks to see if the scan group designated to receive the copied parameters is already programmed. If so, the old program must be deleted before new parameters can be copied into it.

3b/Scan Groups

The prompt is,

SCAN GROUP EXISTS, DELETE<Y,N>? N

If you press Y, then ENTER (or if the scan group wasn't previously programmed), the prompt becomes,

SCAN GROUP TO COPY FROM =

Now, enter the scan group number whose program you want copied to the new scan group. Press ENTER and the scan group is programmed completely.

The system responds with,

SCAN GROUP COPIED

When you press ENTER, the system returns the prompt,

SCAN GROUP NUMBER =

This indicates that you can now enter the number of another scan group to be programmed. Press the EXIT key when you're finished to return to the main menu.

DELETE

Delete removes the program from the scan group number you've chosen. The program is permanently deleted, so use this selection judiciously.

Delete also frees space in the 2280 memory for other program parameters.

LIST

The list function prints the current scan group program onto the printer (or other listing device, if installed and selected).

3b/Scan Groups

SCAN GROUP MENU CHOICE

There are five areas of programming available through the scan group menu choice. These parameters can be programmed in any order, but by following the system prompts you will automatically be stepped forward to the next programming option each time you press ENTER.

Scan Group Label

Each scan group can have a label consisting of up to 40 characters. If no previous label has been programmed, an empty field will be displayed. If you want to change a label for a given scan group, key in the new label over the old one.

During scanning the label appears before the logged data. The label is optional, and scanning is not affected if you leave it off.

Scan Group Channel List

Enter the number of the channel, or block of channels, you want to scan. This list is a series of channel identifiers (numbers and/or blocks), and each channel or block specified here will produce one or more lines of logged data. If more than one identifier is included, you can separate them with spaces to make them easier to read.

The scan group channel list can be of any length and specify channels in any sequence. It can contain multiple lines, each of which can be up to 75 characters long.

3b/Scan Groups

Single channel numbers and blocks must start with a 'C', but the second channel of a block doesn't need it. The second channel number listed must, of course, be larger than the first. Following are examples of three different (but acceptable) ways to enter a scan group channel list.

```
C37
C10..20 C78 C1300..1350
C43..C52
```

INSERTING AND EDITING LINES OF TEXT

Scan group channel lists can exist as multiple lines in a configuration program. Use the following steps when these lines need editing, or if you want to insert additional lines.

Editing and Deleting Lines

To edit or delete lines in a set, call up the desired parameter so the first line is displayed. Use the <up arrow> and <down arrow> keys to display the line you wish to edit or delete.

To delete a line, press the CLEAR key, and then press ENTER.

There are two ways to edit lines.

1. To replace a line, simply start keying in new characters over the old ones. The old characters will be deleted.
2. Use the <right arrow> or <left arrow> key to move the cursor to the character you want to change. Remove the character with the DELETE CHAR key and then enter the new characters. When the line appears the way you want it to, press ENTER. If the syntax is correct you will be prompted for another line. Use EXIT to return to the main menu.

3b/Scan Groups

Inserting Lines into Current Set of Lines

To insert lines into a set that is already programmed, call up the desired parameter so the first line in the set is displayed.

Use the <up arrow> and <down arrow> keys to scroll to the line after which the insertion is to take place.

Press the ENTER key. A blank field is now available for entry of the new line. When you're finished inserting lines, move to a new line and press EXIT.

If you are inserting a new line at the beginning of a set, use the <up arrow> key to scroll up past the top line. All lists wrap around from the top to the bottom and have an empty line separating the two.

Execution Sequence of Scan Group Channel Lists

A scan group channel list is in fact a program. Like a program, the precise sequence in which the channels are measured and then processed is important. When a channel list is executed, it is done in two stages,

1. Scan Sequence

First, the input channels specified directly in the channel list, or indirectly in the channel procedures of the list, are read only once regardless of the number of times a channel may appear in the list. The values of these readings are then used in the execution sequence.

2. Execution Sequence

After the required channels are read, the scan group channel list is executed in the same order the channels appear in the list. The values read in the scan sequence for input channels are logged as they are encountered in the execution sequence.

If a pseudo or output channel has a procedure in its channel programming, the procedure is first executed top to bottom. Then the pseudo or output channel is logged.

If, in a procedure, any assignments are made to pseudo channels, their storage locations are overwritten with the updated values.

If any assignments are made to an output channel, its storage location is overwritten, and the output device is programmed with the new value. This is done each time an assignment is made to the output channel.

Following is an example of a scan group channel list, with the accompanying channel expressions or procedures. The explanation column below shows how scans are executed, and in what sequence. The channel list for this example would be entered as,

C36 C41..48 C59 C217 C172 C84..89

In this example, channels 0 through 99 are input channels, 100 through 199 are output channels, and 200 through 299 are pseudo channels.

3b/Scan Groups

LINE #	LIST	EXPLANATION
1	C36 Expression: None	Channel 36 is measured and results are logged. Since there is no channel expression, the decimal point position is determined by the type of measurement.
2	C41..48 Expression: None	Channels 41 through 48 are measured and logged in that order.
3	C59 Expression: C59 is part of the programmed block C55..70. Its programmed expression is: 3*CX+4	Channel 59 is measured. Then the expression is applied, with CX being the C59 measurement. The result is logged in the format chosen in Channel Programming.
4	C217 Procedure: C217=C217+1	This is a pseudo channel with an attached channel procedure. First, the procedure is executed (i.e., C217 is incremented). Then the result is logged in the programmed format.
5	C172 Procedure: CX=C64*2+17.3 C204=C204-1	This is an output channel with an attached channel procedure. The first procedure statement is an assignment to CX (C172). First, the right side of the assignment is evaluated using the measured value of C64. The result is then assigned to location C172. The second statement in the procedure decrements C204. This is done next. Then, finally, the current value of C172 is logged in its programmed format.
6	C84..89 Expression: These input channels are programmed individually. Only 1 of them, C88, has an attached expression: CX*1.5	First, channels 84 to 87 are measured and logged. Then C88 is measured, its expression applied, then logged in its programmed format. Finally, C89 is measured and logged.

Scan Trigger Mode

For each scan group, you can program specific conditions for triggering to occur, or you can design a scan to trigger on demand only. In the latter case, scanning and recording take place on the group only when a single scan request is made from the front panel, or remote device, or when triggered by another scan.

ON DEMAND ONLY

With this feature, scanning is triggered by someone going to the front panel, pressing the scan button, and requesting a scan group number. It's also possible to program another scan to trigger a scan group.

A scan can always be triggered on demand from the front panel even if it has a different trigger mode programmed.

TIME INTERVAL HH.MM.SS.

Time Interval causes the scan group to be executed at a given interval ranging from 1 second to 24 hours. Entry is made in hours, minutes, and seconds.

Scanning will be repeated each time the programmed interval has expired, starting from the time scanning is enabled. For example, an entry of 00.01.30 would trigger the scan group every one minute and 30 seconds, from the time scanning is enabled.

CONTINUOUS

This mode causes the scan group to be continuously active and should be used with caution. If applied to a high priority scan group, it will keep lower priority scan groups from ever being allowed to execute. The minimum scan cycle time is the length of one scan.

3b/Scan Groups

DISCRETE TIME HH.MM.SS.

This tells the data logger to scan once at a certain time each day. The 2280 uses a 24 hour clock.

Time values are entered in the form of hours, minutes and seconds, with a "wild digit" allowed for each digit position.

EXAMPLES

- o 09.00.00 causes the scan group to trigger every day at 9 am.
- o XX.00.00 causes a trigger once every hour on the hour, since X matches all digits 0 through 9.
- o "08.XX.00" causes a trigger once every minute, on the minute, between 8 am and 9 am. The last scan would occur at 8:59:00 am.

EXTERNALLY TRIGGERED

This feature causes the scan group to be triggered as a result of the hardware trigger input line changing from a low to a high state. This input line is located in connector J25 on the rear panel of the 2280 and is discussed in detail in section 3 of the 2280 Series System Guide.

The minimum scan cycle time is the length of one scan.

CAN ONCE

This setting causes the data logger to trigger the specified group once only when the scan button is pushed. This is useful as an initialization scan group for PID equations or to preset strain gauges or counters.

SHORTCUTS TO KEYING IN TIME

When you are entering times for time intervals or discrete times, you can use shortened entries.

EXAMPLES

- o 01.30.00 can be entered as 1.30 or 1.3
- o 0X.00.00 can be entered as X

Shortened entries should be left justified. A 1 or 2 digit entry gives the hour, not the seconds, and a 3 or 4 digit entry gives hours and minutes, not minutes and seconds.

THE SYSTEM PROGRAM SOMETIMES AFFECTS SCANNING

All of the scan trigger modes, except scan on demand and scan once, are affected by the scan trigger window parameters programmed in the system programming module. If the trigger window is programmed to allow scanning only within a particular time window, then these scan triggering modes are disabled outside of that window.

Any scan group can always be triggered on demand by means of the SINGLE SCAN ON/OFF key.

3b/Scan Groups

Data Output Device Control

In order to log or display data, the data output device control parameters must be programmed.

For each available output device---the display, the printer, the tape cartridge, Port A or Port B---select one of the following types of data output.

1. No Data
2. All Data
3. Alarm Data---This records any channel that is out of limits when scanned.
4. Alarm Transition Data---This selection records individual channel data only when that channel undergoes an alarm transition (i.e., goes out of limit, or comes back within limit).

Each output device can be programmed independently, so an RS-232-C printer at port B could be logging alarm data while a computer at port A has access to all data.

In addition, while data may be sent to any or all available devices in a particular configuration, the data throughput rate, and therefore the scanning speed, will be no faster than the slowest device.

3b/Scan Groups

Other Scan Group to Trigger

Another scan group (or the same one) can be programmed to be triggered at the completion of the current scan. This feature is programmed in two stages.

1. Program the number of the scan group to be triggered on completion of the current scan.
2. Program the conditions under which you want that scan group to trigger upon completion of the current scan. You have four choices here,
 - a. Never (default). The scan group is not triggered at completion of the current scan.
 - b. Any Alarm. The selected scan group is triggered upon completion of the current scan if there were any channels in alarm in the current scan.
 - c. Any Alarm Transition. The selected scan group is triggered upon completion of the current scan if any channel underwent a transition (went out or came back in limit) during it.
 - d. Always. The selected scan group is triggered upon completion of the current scan.

Conditions 2 and 3 are useful for obtaining additional data when limits are being exceeded. For example, by using condition 2 to trigger the same scan group, you can obtain a continuous scan-on-alarm configuration.

Two scan groups might have the same channels in them. One might scan continuously for alarms but log no data. When an alarm occurs, it can trigger the higher priority group, which could log all data on alarms.

Condition 4 is useful for chaining scan groups together. Use this to set up a loop of scan groups, each triggering the next in turn.

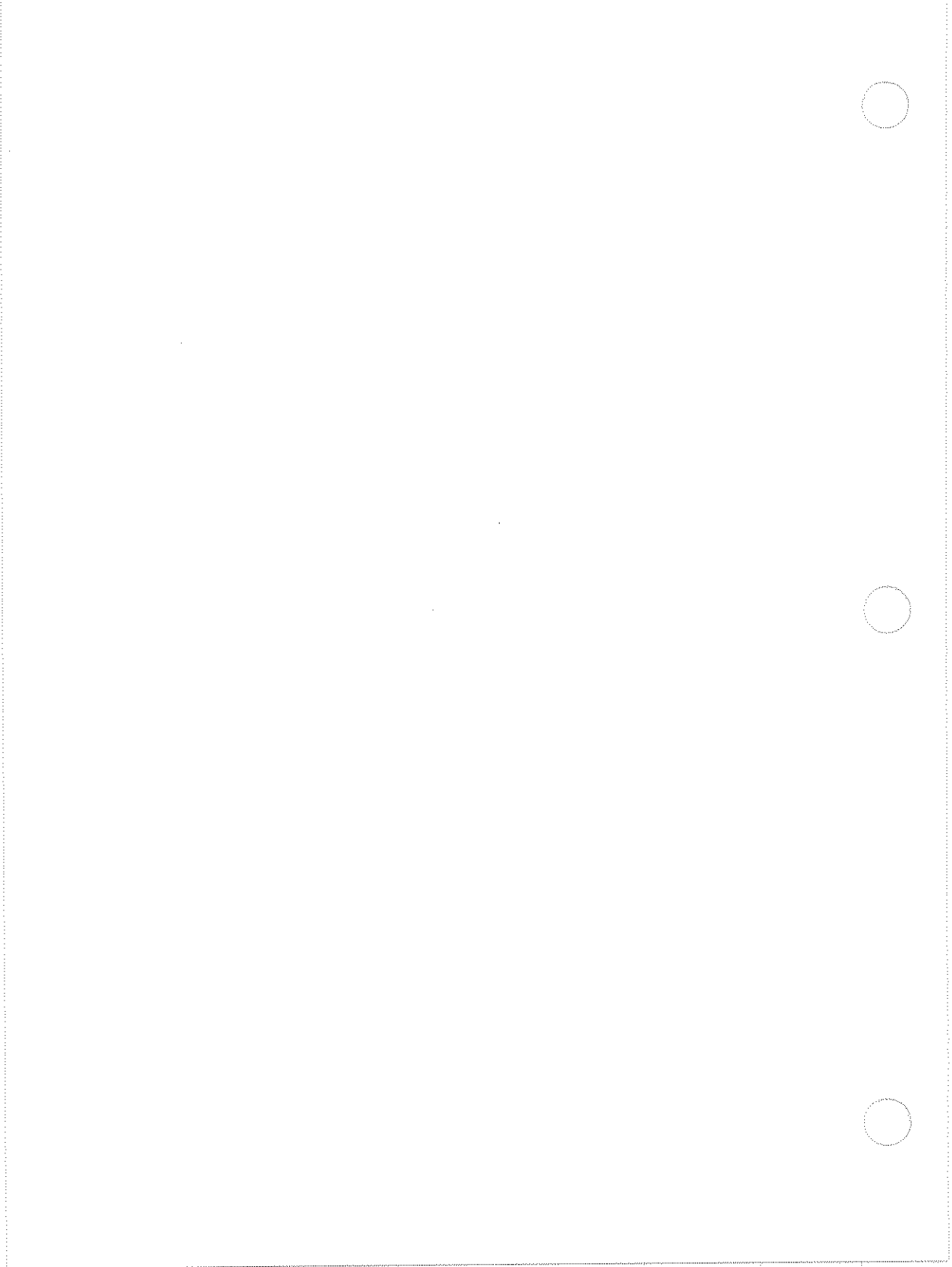

ALARM LISTS	3c
Alarm List Number	3c-2
P,C,D, or L	3c-2
Program	3c-2
Copy	3c-3
Delete	3c-3
List	3c-4
Alarm List Menu Choice	3c-4
Limits Information	3c-4
Sense	3c-4
Limit Value	3c-5
Alarm Message	3c-5
Alarm Scan Trigger	3c-6
Dead Band Value	3c-7

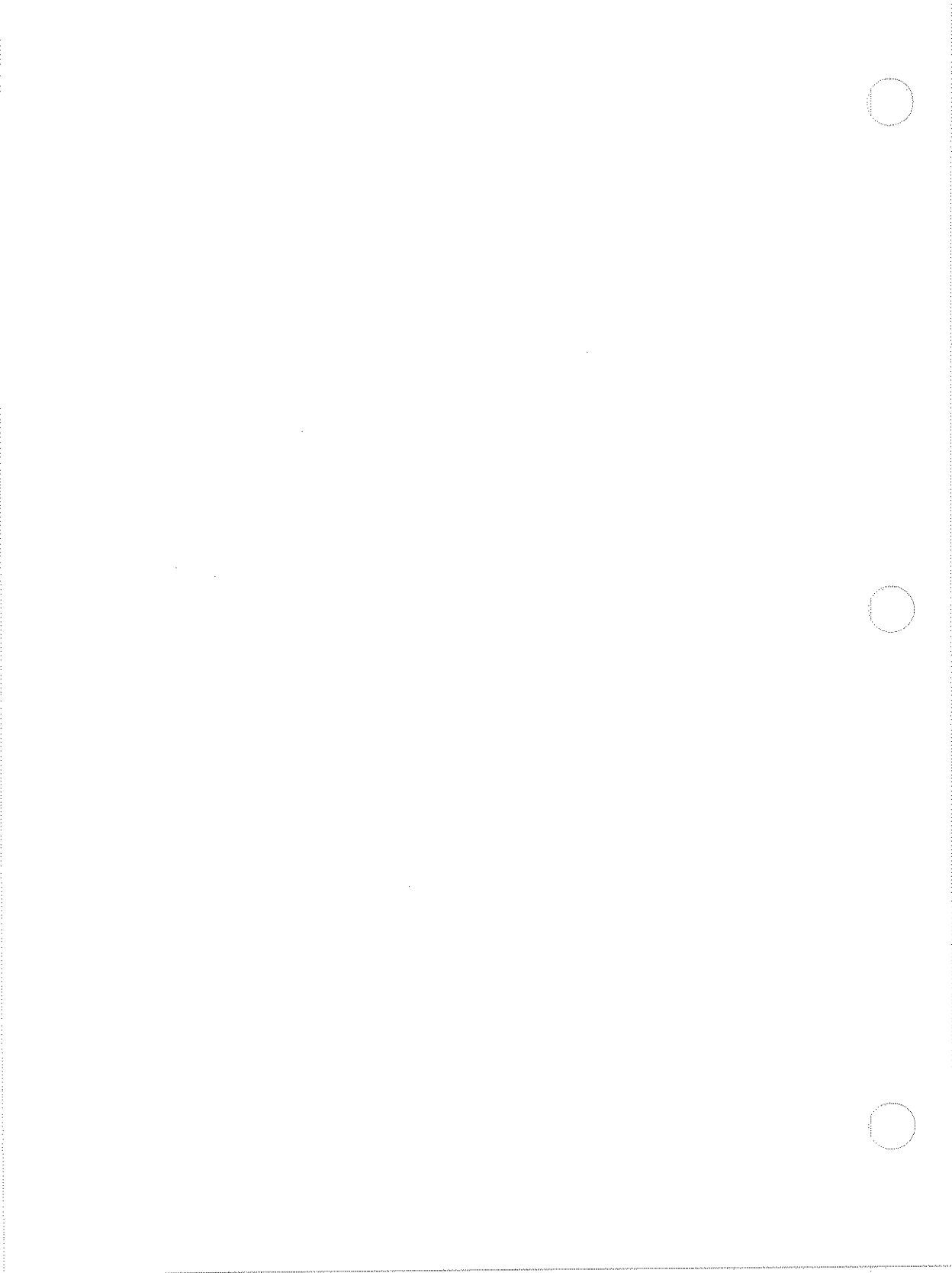

ALARM LISTS

<F> ALARM LIST PROGRAM

ALM LIST #	ALARM LIST MENU CHOICE < 1,2 >7						
	P.C.D. OR L.	< 1 > LIMITS INFORMATION					< 2 > DEAD BAND
0 1 2 3 4	0 1 2 3 4	1 2 3 4	1 2 3 4	1 2 3 4	1 2 3 4	1 2 3 4	1 2 3 4
	LIMIT #	RANGE	LIMIT VALUE	ALARM MESSAGE	ALARM SCAN TRIGGER	1st TRG	2nd TRG
	TL			0 NO LIMITS	GROUP	TRG	TRG
				EXAMPLE EXHAUST SEMI OVER LIMIT	1 2 3 4	1 2 3 4	1 2 3 4
1							
2							
3							
4							
1							
2							
3							
4							
1							
2							
3							
4							
1							
2							
3							
4							
1							
2							
3							
4							
1							
2							
3							
4							
1							
2							
3							
4							
1							
2							
3							
4							

An alarm list contains instructions setting high and low limits to be checked against measured or computed channel values. It also determines whether high or low values will generate an alarm, whether a message will accompany an alarm, and whether there is to be any dead band or hysteresis associated with the limits.

3c/Alarm Lists

An alarm list can also be set up to trigger a scan group. Each alarm list is programmed for the purpose of assigning it to one or more channels during channel programming.

You can specify any number of alarm lists, and each can contain from one to four individual limits. For each limit, four types of information are entered: sense, value, alarm message and alarm scan to trigger. In addition, a dead band value may be entered to apply to all four limits in the list. These are all detailed in the following paragraphs.

Limit values can be changed while the data logger is scanning. This is especially useful for situations where the 2280 is being used for monitoring and emergency shutdowns.

ALARM LIST NUMBER

Assign each alarm list a number between 0 and 1499. Since all alarms will be referenced by a channel program it's a good idea to use the same number for both the alarm list and the corresponding channel.

P,C,D, or L

Program, Copy, Delete, or List the alarm list number you've specified.

PROGRAM

When you select program, you have access to each menu in the same sequence as you see on the programming form. Use program to enter new alarm list parameters, or to change values or characteristics entered earlier.

Program is the default setting for this field so you can select it by merely pressing the ENTER key.

COPY

If you choose copy, the system first checks to see if the alarm list designated to receive the copied parameters is already programmed. If so, the old program must be deleted before new parameters can be copied into it.

The prompt is,

ALARM LIST EXISTS, DELETE<Y,N>? N

If you press Y, then ENTER (or if the alarm list wasn't previously programmed), the prompt becomes,

ALARM LIST TO COPY FROM =

Now, enter the alarm list number whose program you want copied to the new alarm list. Press ENTER and the scan group is programmed completely.

The system responds with the prompt,

ALARM LIST COPIED

When you press ENTER, the system returns the prompt,

ALARM LIST NUMBER =

This indicates that you can now enter the number of another alarm list to be programmed. Press the EXIT key when you're finished to return to the main menu.

DELETE

Delete removes the program from the alarm list number you've chosen. The program is permanently deleted, so use this selection judiciously.

Delete also frees space in the 2280 memory for other program parameters.

3c/Alarm Lists

LIST

The list function prints the current alarm list program onto the printer (or other listing device, if installed and selected).

ALARM LIST MENU CHOICE

This section contains the limits information and dead band menus.

Limits Information

Up to four limits can be specified in a single alarm list. Each of the limits is programmed with a high or low sense, a value, a message, and a trigger condition.

SENSE

Enter H for a high value or L for a low value.

LIMIT VALUE

The limit value, entered in floating point or scientific notation, is the reference value for any channel programmed to that particular alarm list.

After any linearization, scaling or math expressions have been performed on the channel (or when assignments are made to channels on the left side of a math statement in channel procedures), the result is compared to the limit value(s) of that channel's alarm list. If none of the limits are exceeded, no further action takes place.

If the reading is outside one or more limits, the alarm information (ALM), is added to the log of the channel whose value tripped the limit.

ALARM MESSAGE

The alarm message feature allows you to add relevant alarm messages for the channel or block of channels associated with the limit value being exceeded. From 0 to 40 characters can be used. This feature is optional.

A message must be programmed in order for a limits exceeded condition to be entered in the alarm queue.

For example, suppose the alarm list being programmed is associated with a channel measuring the temperature of liquid oxygen to ensure that the temperature doesn't elevate enough to convert the oxygen back to gas. The associated alarm message might be,

OXYGEN NEAR BOIL, ADD COOLANT

The message is logged after the channel reading and then added to the alarm queue, lighting the front panel ALARM LED.

3c/Alarm Lists

When you acknowledge the alarm by pressing the ACK key, the message is displayed on the 2280 front panel.

If multiple messages are queued up, the ALARM LED stays on. Press the ALARM ACK key to receive each message in the queue. After the last message is displayed, the ALARM LED will go out.

ALARM SCAN TRIGGER

The alarm scan trigger allows you to select by number a scan group to be triggered due to a channel's limit condition. The conditions to choose from are,

1. Never (default). The alarm state of a channel will not cause the selected scan group to be triggered.
2. During Alarm. The selected scan group is triggered each time the associated limit is exceeded.
3. On Alarm Transition. The selected scan group is triggered only when the associated limit changes by going out of limit or by coming back within limit.

Choices 2 and 3 above can be used to trigger a higher priority scan group with the same scan group channel list, to create an "all data on alarm" or "all data on alarm transition" function. Channel alarms that occur while plotting is active won't trigger another scan group.

Dead Band Value

The dead band applies to all limits of an alarm list, and is entered in floating point or scientific notation.

It causes a difference in the thresholds at which a channel goes out of limits and comes back within limits. This difference is a kind of buffer zone that must be passed through before an alarm transition is acknowledged by the data logger. The hysteresis introduced may be used to minimize nuisance transitions caused by noisy or fluctuating inputs.

With a dead band, the value at which a channel passes out of limits is not the same as the value at which it comes back within limits.

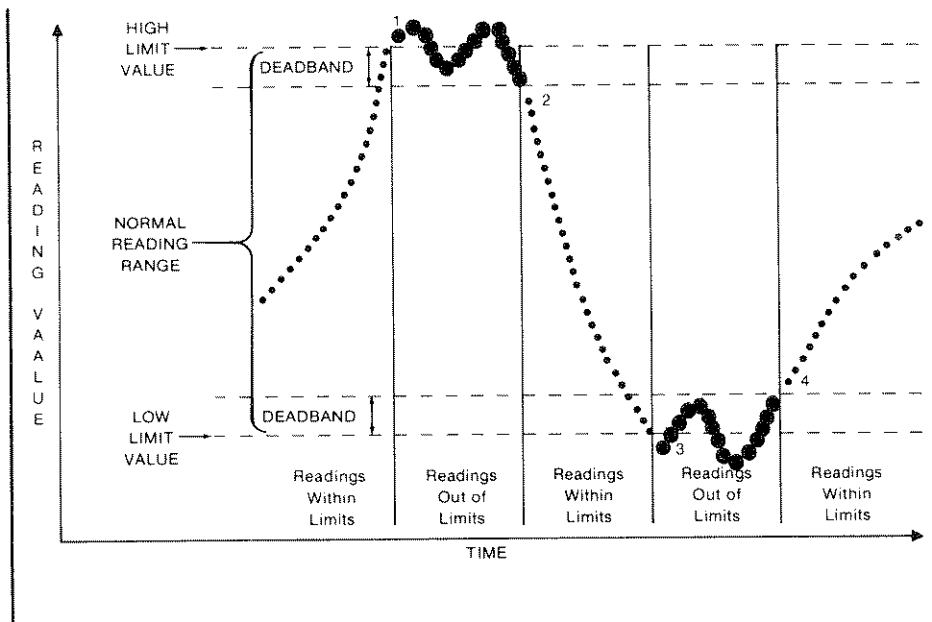

Deadband

Alarm data is logged during the time intervals labeled **Readings Out of Limits**.

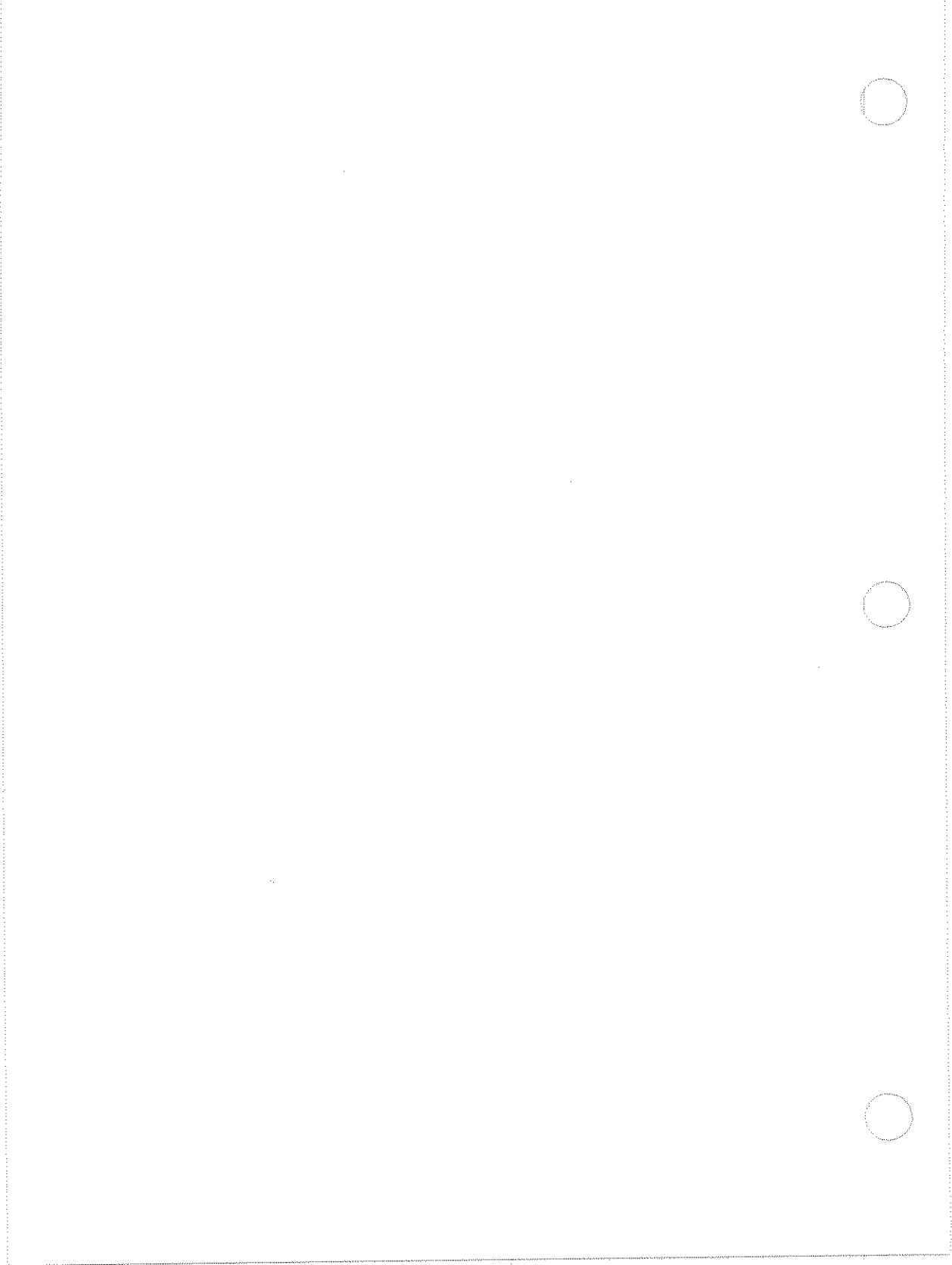

OUTPUT DEVICE PROGRAMMING	3d
Output Menu Choice	3d-1
Printer Format	3d-2
Port A, Port B, and Cartridge	
Tape Formats	3d-3
Port Characteristics	3d-5
IEEE-488 Interface	3d-5
Parallel Interface	3d-6
RS-232-C Interface	3d-7
Timeout	3d-8
Port A Characteristics are Saved ..	3d-8
Alarm Ack Logging Device	3d-9
Data Transfer Filter	3d-9

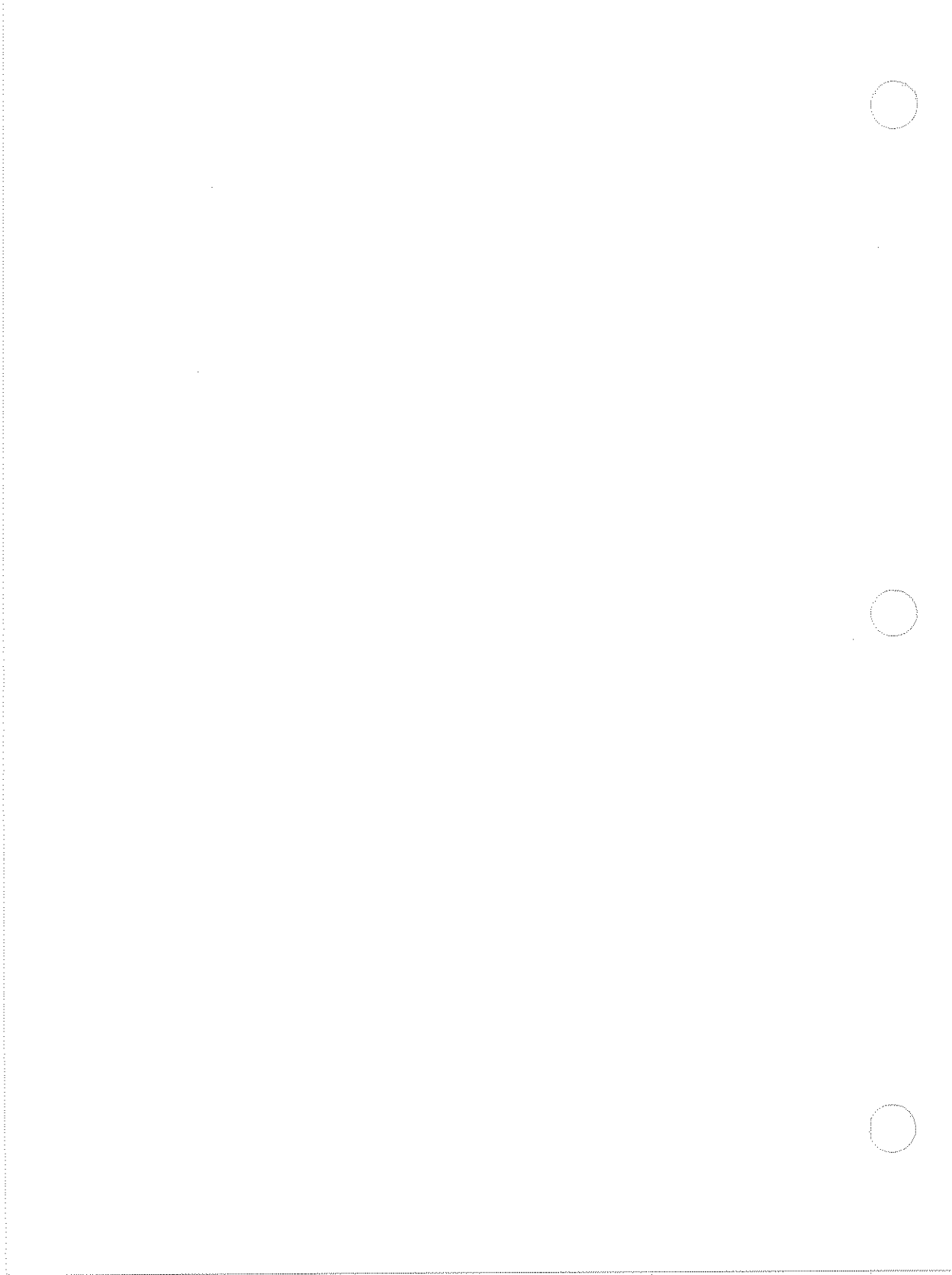

OUTPUT DEVICE PROGRAMMING

< U > OUTPUT DEVICE PROGRAM

OUTPUT MENU CHOICE 1-8-7								
1 PRINTER FORMAT	2 PORT A FORMAT	3 PORT B FORMAT	4 CARTRIDGE TAPE FORMAT	5 PORT A CHARACTER- ISTICS	6 PORT B CHARACTER- ISTICS	7 ALARM ACKNOWLEDGE- MENT LOGGING DEVICE	8 DATA TRANSFER FILTER	
MENU ←				MENU ←				
1 COMPRESSION FORMAT 1. 1 2. 2 3. 3				1 DEVICE TYPE 1. 1 2. 2	3 RECORD TYPE 1. 1 2. 2	4 ALARM ACKNOWLEDGE- MENT LOGGING DEVICE 1. 1 2. 2 3. 3	5 DATA TRANSFER FILTER 1. 1 2. 2 3. 3	
2 DATA TYPE INDICATORS 1. 1 2. 2				3 RECORD RATE 1. 1 2. 2 3. 3	4 PRIORITY 1. 1 2. 2 3. 3			
3 START OF DATA RECORDS 1. 1 2. 2				5 TIME OUT 1. 1 2. 2 3. 3				
4 END OF DATA RECORDS 1. 1 2. 2								
5 LINE TERMINATION INDICATORS 1. 1 2. 2								

If the default device characteristics and logging formats in the following section satisfy your needs, no output device programming is necessary. If, however, you want to change some of the settings, you need to read this section.

OUTPUT MENU CHOICE

Output device programs determine the format that logged data assumes on the printer, the devices connected to port A and B, and on the Cartridge Tape Drive (Option -214). In addition, various device characteristics may be determined for ports A and B.

3d/Output Device

Some choices are simple. For the printer, for example, the choice is between normal or compressed printing. For other devices though, there are a number of selections that can be made for other formats and for port characteristics.

The front panel display doesn't require programming. It displays data one channel at a time, and is updated 2 1/2 times per second. The data is displayed in the following sequence.

DATA TYPE	MAXIMUM CHARACTERS
=====	=====
Channel number	5
Channel label	15
Value	7
Channel units	6
Alarm flag	3

You can program any or all of the following devices to log data.

Printer Format

You can choose between the normal format, which is the same as the display, or the compressed format (i.e., channel number and value), with 3 channels given in one line.

If the limited information provided in the compressed format is enough for you, try to use it. It reduces the amount of paper used and increases the printer's useful throughput, since the printer speed is determined in lines per seconds, not channels per second.

Port A, Port B, and Cartridge Tape Formats

For each of these three output devices, choose the desired characteristics for the following six parameters.

1. Compression Format

Choose one of four levels of compression for logged data. Number 1 is the default choice.

1. channel #, label, value, units, alarm flag (40 characters)
2. channel #, value, units, alarm flag (24 characters)
3. channel #, value. (13 characters)
4. value only. (8 characters)

2. Data Type Indicators (choose YES or NO)

Logged data is a mixture of channel data, scan group information, and alarm messages. While the mixture may be easily distinguished by you, it may be difficult for a computer to sort out and identify. You can simplify the reading operation by tagging the beginning of each line with an identifying character. This function simply inserts a tag character before each type of logged message if YES is selected here. The default choice is NO.

3d/Output Device

The tag corresponding to each type is as follows,

TAG	LOGGED MESSAGE
===	=====
A	Alarm Message
B	Begin Scan Group Message
C	Channel Reading
E	End Scan Group Message
H	Scan Group Header Message
K	Alarm Acknowledgement Message
Z	Scan or Single Scan is Turned Off.

3. Channel Readings per Line

Specify how many channel readings are to appear on each line before a line terminator is recorded. The choice is made based on the level of data compression chosen (see compression format #1, above), and the fact that the data logger inserts four spaces between channel readings when there is more than one reading per line.

Enter any number between 1 (which is the default selection) and 99.

4. SD -- Start of Data

A sequence of up to four characters can be used to flag the beginning of a scan group. The sequence is sent prior to a begin scan group message. The default is an empty sequence. More details on programming this section are given in Line Termination below.

5. ED -- End of Data

Up to four characters may be used in a sequence to flag the end of a scan group. If the sequence is used, it will be sent after an end scan group message. The default is an empty sequence.

6. LT -- Line Termination

This sequence of up to four characters ends each logged message or line of output. LT defaults to the ASCII <CR> and <LF>.

Each character in the sequence is entered in its decimal equivalent representation, and individual characters are separated by "//". The sequence consists of a decimal number (containing up to 2 digits) for each ASCII character. For example, the default line termination sequence would read,

13//10

The appendix of the 2280 Series System guide contains an ASCII-to-decimal conversion chart.

Port Characteristics

Ports A and B can have a variety of devices plugged into them. Each device has its own operating characteristics that require programming. Port A and port B are individually programmed in one of three areas, according to the type of device being used.

When the time comes to actually trigger a scan, the interface installed and the characteristics programmed must agree, or an error will occur. These characteristics are detailed in the following paragraphs.

IEEE-488 INTERFACE

The IEEE-488 Interface requires no front panel programming.

3d/Output Device

PARALLEL INTERFACE CHARACTERISTICS

The parallel recording characteristics allow you to define the type of data encoding, and the record type.

1. Data Encoding Choices

The default for this field is the first selection, ASCII Odd Parity.

1. ASCII Odd Parity
2. ASCII Even Parity
3. BCDIC
4. BCDIC Odd Parity
5. BCDIC Even Parity

2. Record Type Choices

The default selection for this field is a fixed record length of 1024 characters.

1. Fixed Record Length. Use this to specify the number of characters recorded before a record gap signal is generated. When a scan group is completed, the current record contains the fill character,

\$

and is then terminated with a record gap signal. The range of possible entries is from 1 to 4095 characters.

2. Variable Record Length. In this mode a record gap signal is given at the end of each scan group.

RS-232-C INTERFACE CHARACTERISTICS

The RS-232-C interface card is equipped with a stall feature. If the device it's connected to sends a Control S (ASCII X-OFF, DC3 or decimal 19), the character stream to the device is suspended. The stream is only resumed after the device receives a Control Q (ASCII X-ON, DC1 or Decimal 17). Alternatively, the RS-232-C device may use the modem control lines (Data Set Ready, Clear to Send, Received Line Signal Detect) to stall the 2280.

To control the flow of data from the 2280 in this manner, send the stall signal two or three characters before the buffer overflows. The 2280 can't stall instantly; it takes a few milli-seconds to respond.

If a printer is connected, it can use Control S and Q to regulate the character flow to suit its printing speed. If scan data is being logged, a stalled RS-232-C I/F will eventually halt the scan until it's unstalled.

Halting a scan in this manner may also cause critical alarm checking to stop. To avoid this, a device timeout (allows scanning to pause and wait for the interface to un stall) can be programmed. If the un stall does not occur within the programmed device timeout period, the 2280 resumes scanning and discards all output data to the interface until the stall condition is removed.

The RS-232-C I/F requires programmed parameters for:

1. Baud Rate. 110 (default), 300, 600, 1200, 2400, 4800, 9600, or 19200.
2. Parity. Even, Odd, or None (default).
3. Number of Fill Characters. Enter the number of null fill characters to be sent to the RS-232-C device after each line termination (LT) sequence. Possible entries are 0 through 99 (default =0).

3d/output device

If a port is programmed for one type of interface, but if a different one (or none at all) is installed, an error message will be created when a scan is attempted.

The output device characteristics do not take on their new values until you exit back to the main menu level.

TIMEOUT

Device timeout programming provides the capability for the 2280 to continue critical scanning and limit checking when the RS-232 or IEEE-488 interface halts scanning.

Output or data from the RS-232 interface can be stalled (temporarily suspended) using the modem control signals or when the interface receives a Control S character from the computer or peripheral. This can also occur with the IEEE-488 interface if the bus controller does not read all the data from the interface.

An enabled device timeout allows the 2280 to resume scanning and discard output data after scanning has been suspended for the programmed time period. The data output will resume when the stall condition is removed.

If the device timeout is disabled, scanning will be suspended until the stall condition is removed. No data will be discarded.

PORT A CHARACTERISTICS ARE SAVED

Port A characteristics are saved when an "erase all programming" function is performed even though you won't see the characteristics when you list the program. Using the ENTER key to scroll through the menus to check the settings causes you to select the default characteristics and override any earlier program settings. Make certain the default characteristics are what you want. To reprogram, simply select different characteristics.

Alarm Acknowledgement Logging Device

It is sometimes desirable to keep a log of alarm messages and the times at which they occur and are acknowledged. This can be done with an alarm acknowledgement logging device connected to the 2280.

Acknowledgement information includes the channel number, the alarm message, the time an alarm occurred, and the time it was acknowledged. You can choose which acknowledgement device, if any, will log this information. Select from,

1. None (default)
2. Printer
3. Cartridge Tape
4. Port A
5. Port B

Data Transfer Filter

It's possible for you to transfer data from a cartridge tape or Kennedy magtape to some other device. In most instances you'll enter the same character strings for the start of data, end of data, and line termination for both the source and destination devices. However, it may be necessary to have different strings for different devices.

If it is necessary to have different strings for different devices, the data transfer filter can convert a sequence of ASCII characters used for the source device into the sequence used by the destination device. Only one sequence can be changed with the data transfer filter, and the programming specifics are discussed in the line terminator portion of this section.

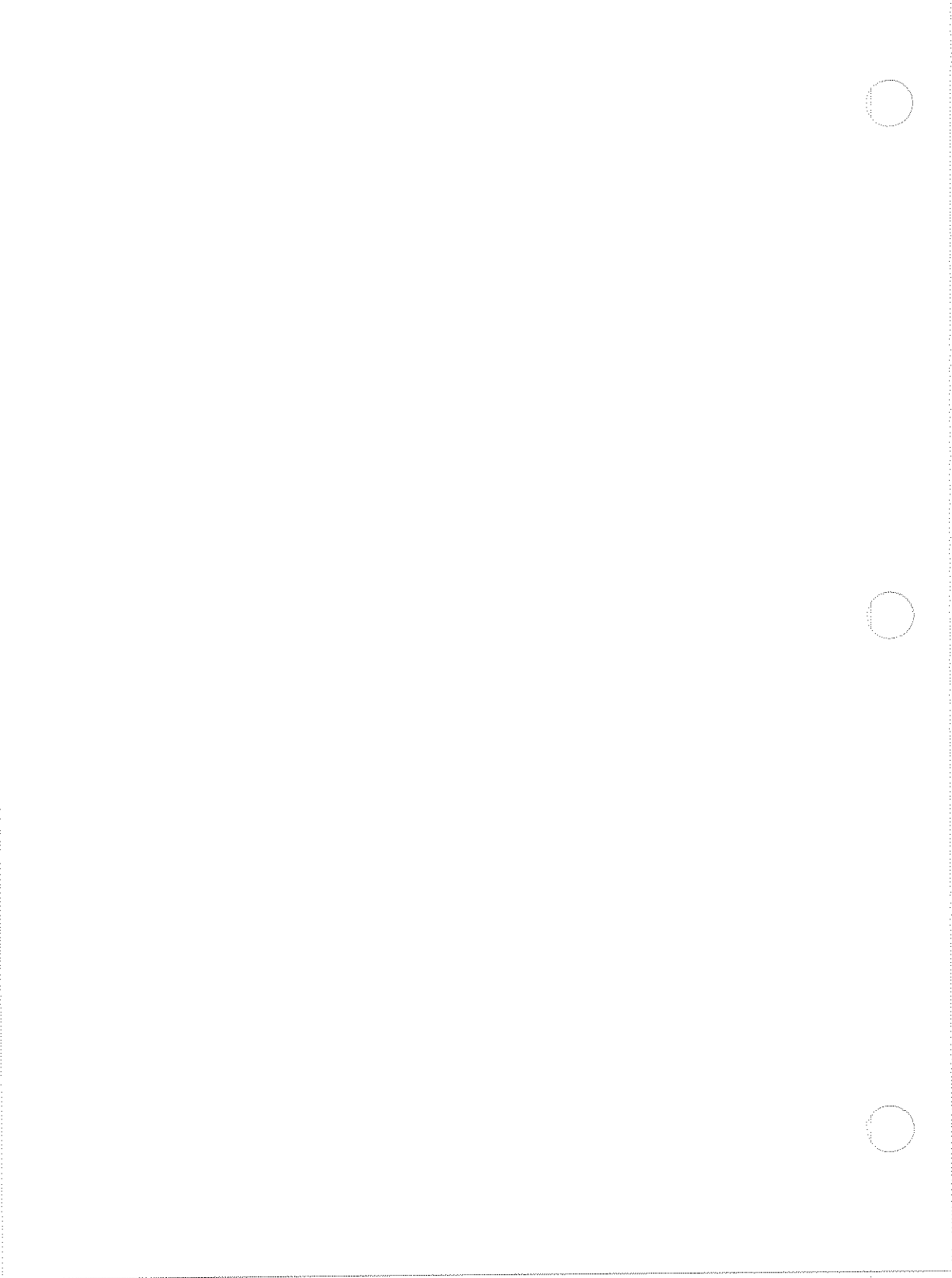

PLOT PROGRAMMING

3e

Plot Menu Choice	3e-2
Parameters	3e-2
Channel to Plot	3e-2
Left Most and Right Most Values ...	3e-2
Common Plot Interval for All Four	
Channels	3e-3

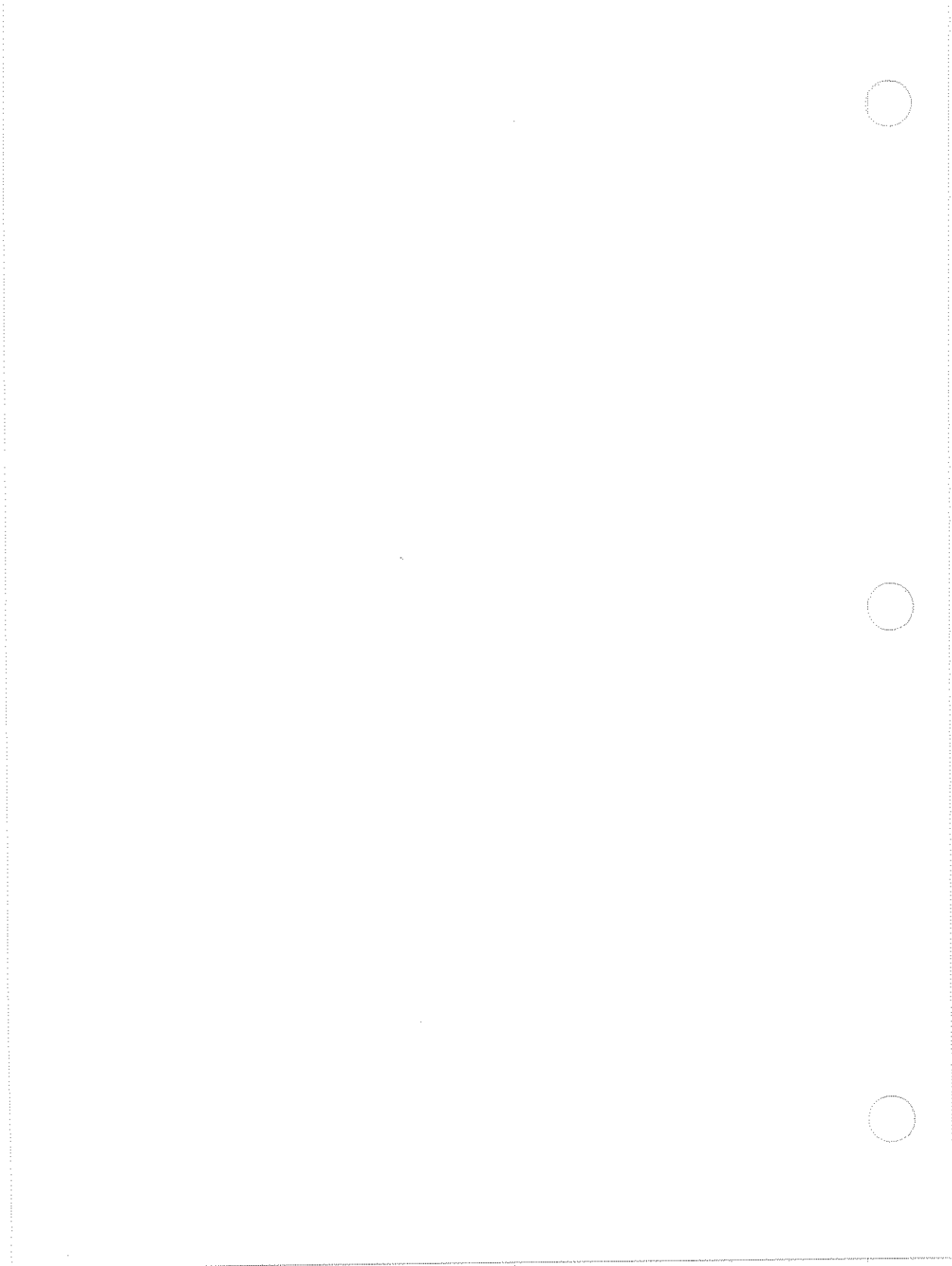

PLOT PROGRAMMING

< P > PLOT PROGRAM

PLOT MENU CHOICE < 1,2 >?					< 2 >
< 1					< 2 >
PARAMETERS					COMMON PLOT INTERVAL FOR ALL FOUR PLOTS
PLOT #:	~1~	~2~	~3~	~4~	PLOT INTERVAL
SYMBOL:
100 Channel to Plot				
2nd 0% Reference Value				
3rd 100% Reference Value				
Plot Interval				

With the 2280, you can plot the values of four separate channels simultaneously onto the built-in printer. To write a plot program, simply specify the 0% and 100% values of up to four plot channels, and indicate the desired plotting interval. These channels are then plotted whenever the plot function is requested.

A plot program is treated by the system as the highest priority scan group; when it's activated, its channels are scanned at the programmed interval before any other scan group. If a scan group is currently active when the plot interval occurs, the plot group will be the next one scanned when the current group is finished.

3e/Plot Programming

PLOT MENU CHOICE

Parameters

Plot channels can consist of any combination of input, output, or pseudo channels. Remember that the math procedure of a pseudo or output channel can include several assignments using other measurement, output, or pseudo channels.

If pseudo channels are being plotted, the channel procedure for the channel of plot #1 is executed first, then the channel procedure for the channel of plot #2, and so on. This means that if the channel procedure for channel 0 is,

```
CO = CO+1  
and  
Plot #1 = CO  
Plot #2 = CO
```

the plotted value for plot #2 will be 1 greater than that for plot #1.

CHANNEL TO PLOT

For each plot channel (1 through 4), enter the number of the channel whose reading you wish to plot.

LEFT MOST AND RIGHT MOST VALUES

Specify the left and right most values between which the channel readings will be plotted. These values are entered in floating point or scientific notation corresponding to the channel values that will fall at the left and right edges of the paper. For example, an entry may read, 500.0 or 1.25E3.

Common Plot Interval for All Four Channels

The channels are plotted as a group. Enter the plotting interval for the selected channels in the hours, minutes, and seconds format.

For example, if you want the readings taken every 30 seconds, the plot interval entry is **00.00.30**. If you want the reading taken every 90 minutes, the plot interval entry is **01.30.00** (or 1.30). Plotting has higher priority than scanning, so if the plot interval time is smaller than the time required to log and plot the four channels, no scan groups will become active. This is referred to as continuous plotting.

Keep in mind when you're plotting that the printer isn't available for other uses. If a long scan group is active at the time plot is triggered, the actual time plotting begins will be delayed.

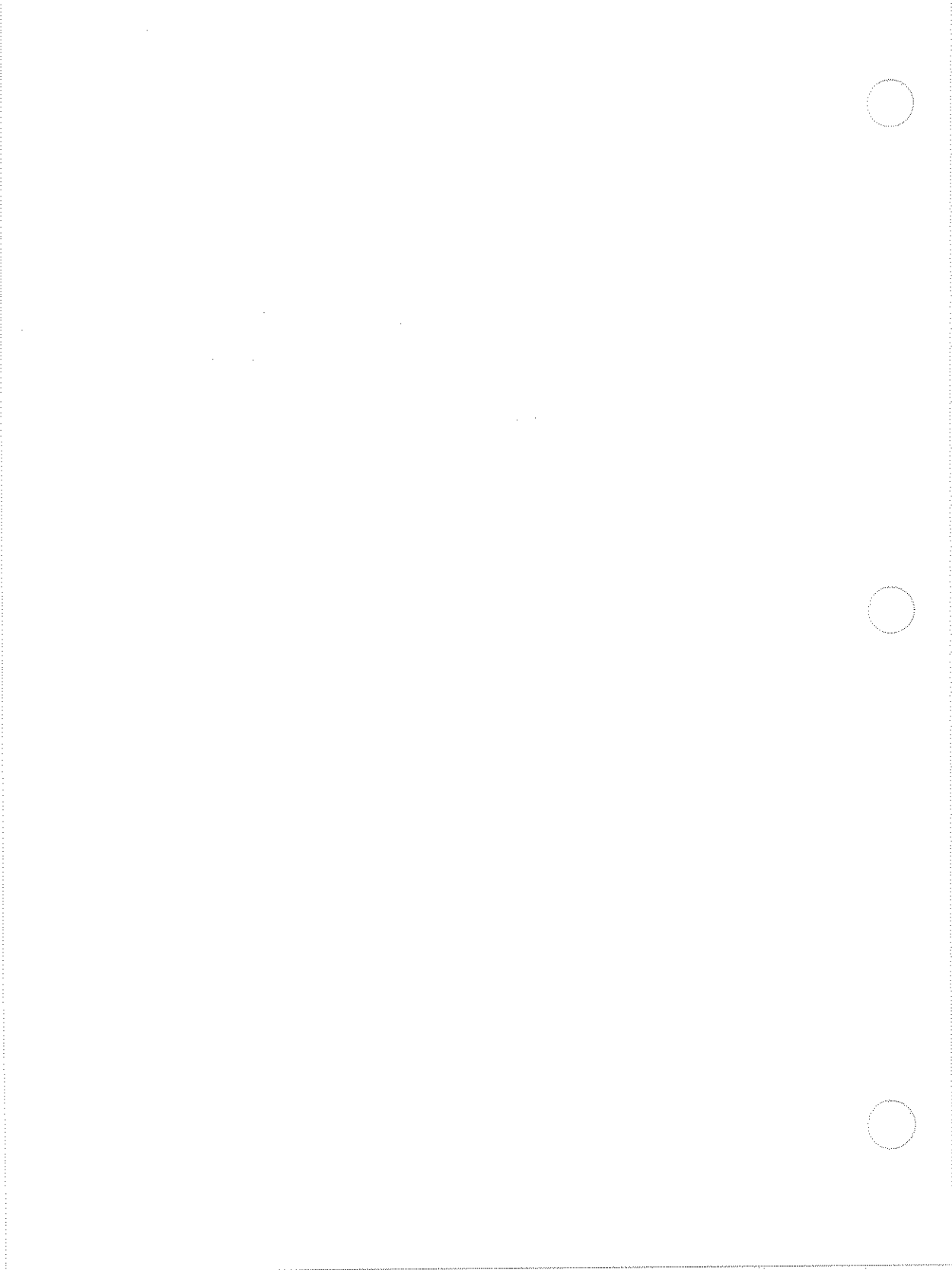

SYSTEM PROGRAMMING

3f

System Menu Choice	3f-1
Line Frequency	3f-2
Calendar Date and Time	3f-2
Temperature Units	3f-3
Access Code	3f-3
Scan Trigger Enable Times	3f-3
Interpolation Tables	3f-4
Select Menu Options	3f-5
Automatically Display Menu	3f-5
Descend Menus Without Enter	3f-5

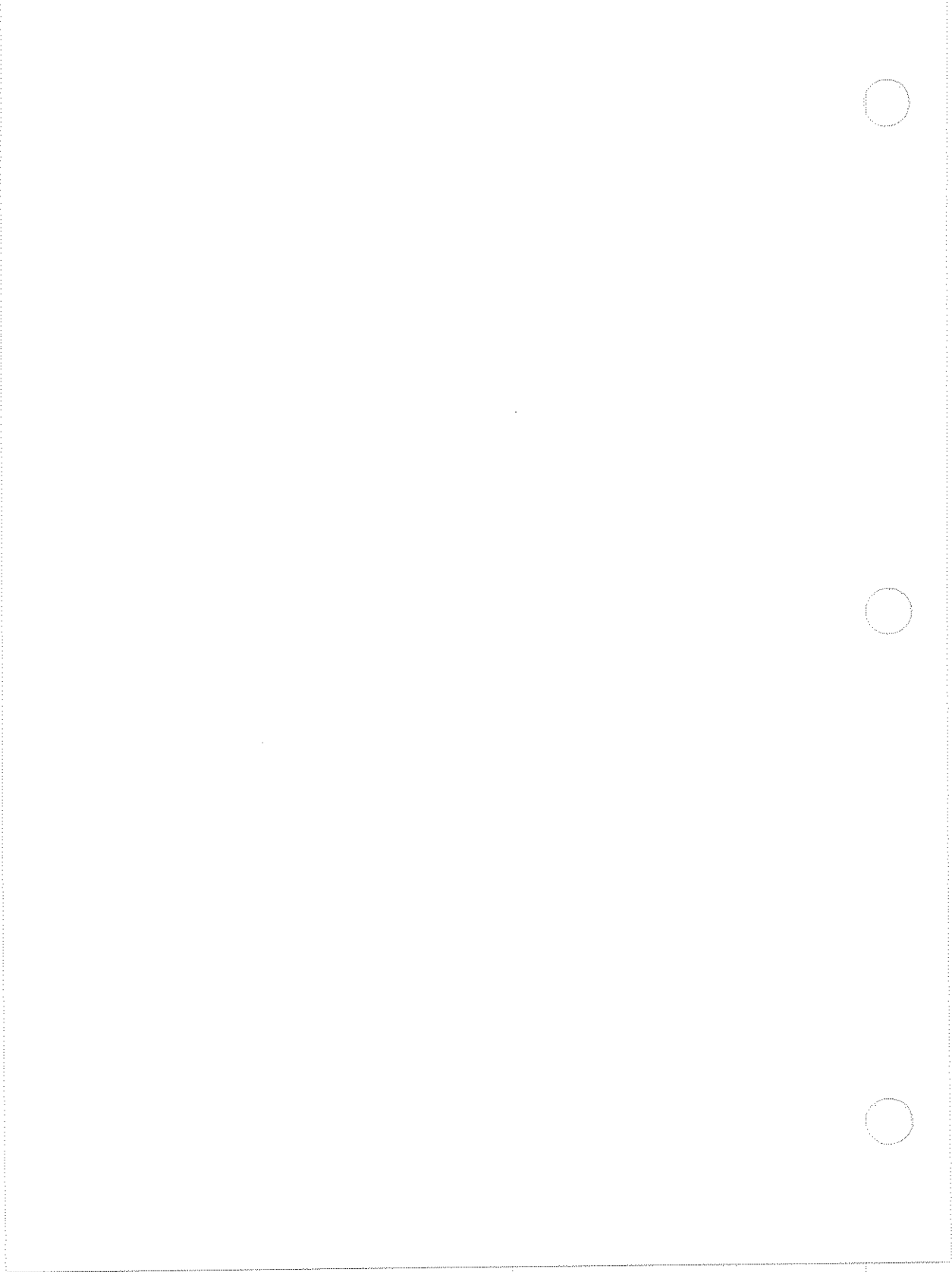

SYSTEM PROGRAMMING

< Z > SYSTEM PROGRAM

SYSTEM MENU CHOICE < 1-7 >																																											
< 1 >	< 2 >	< 3 >	< 4 >	< 5 >	< 6 >	< 7 >																																					
LINE FREQUENCY	CALENDAR DATE & TIME	TEMPERATURE UNITS	ACCESS CODE	SCAN THRESHOLD ENABLE TIMES	INTERPOLATION TABLES	SELECT MENU OPTIONS																																					
1 00.0 2 00.0	MON SUN 00 MON 00 SUN 00	1 Celsius 2 Fahrenheit 3 Centigrade	00000000 00000000	MON 00 00 SUN 00 00	<table border="1"> <tr> <th>100</th> <th>101</th> <th>102</th> <th>103</th> </tr> <tr> <td>TABLE SELECTION</td> <td>TABLE SELECTION</td> <td>TABLE SELECTION</td> <td>TABLE SELECTION</td> </tr> <tr> <td>TABLE SELECTION</td> <td>TABLE SELECTION</td> <td>TABLE SELECTION</td> <td>TABLE SELECTION</td> </tr> <tr> <td>TABLE SELECTION</td> <td>TABLE SELECTION</td> <td>TABLE SELECTION</td> <td>TABLE SELECTION</td> </tr> <tr> <td>TABLE SELECTION</td> <td>TABLE SELECTION</td> <td>TABLE SELECTION</td> <td>TABLE SELECTION</td> </tr> </table>	100	101	102	103	TABLE SELECTION	TABLE SELECTION	TABLE SELECTION	TABLE SELECTION	TABLE SELECTION	TABLE SELECTION	TABLE SELECTION	TABLE SELECTION	TABLE SELECTION	TABLE SELECTION	TABLE SELECTION	TABLE SELECTION	TABLE SELECTION	TABLE SELECTION	TABLE SELECTION	TABLE SELECTION	<table border="1"> <tr> <th>10</th> <th>20</th> </tr> <tr> <td>SELECT MENU OPTION</td> <td>SELECT MENU OPTION</td> </tr> <tr> <td>SELECT MENU OPTION</td> <td>SELECT MENU OPTION</td> </tr> <tr> <td>SELECT MENU OPTION</td> <td>SELECT MENU OPTION</td> </tr> <tr> <td>SELECT MENU OPTION</td> <td>SELECT MENU OPTION</td> </tr> <tr> <td>SELECT MENU OPTION</td> <td>SELECT MENU OPTION</td> </tr> <tr> <td>SELECT MENU OPTION</td> <td>SELECT MENU OPTION</td> </tr> <tr> <td>SELECT MENU OPTION</td> <td>SELECT MENU OPTION</td> </tr> </table>		10	20	SELECT MENU OPTION	SELECT MENU OPTION	SELECT MENU OPTION	SELECT MENU OPTION	SELECT MENU OPTION	SELECT MENU OPTION	SELECT MENU OPTION	SELECT MENU OPTION	SELECT MENU OPTION	SELECT MENU OPTION	SELECT MENU OPTION	SELECT MENU OPTION	SELECT MENU OPTION	SELECT MENU OPTION
100	101	102	103																																								
TABLE SELECTION	TABLE SELECTION	TABLE SELECTION	TABLE SELECTION																																								
TABLE SELECTION	TABLE SELECTION	TABLE SELECTION	TABLE SELECTION																																								
TABLE SELECTION	TABLE SELECTION	TABLE SELECTION	TABLE SELECTION																																								
TABLE SELECTION	TABLE SELECTION	TABLE SELECTION	TABLE SELECTION																																								
10	20																																										
SELECT MENU OPTION	SELECT MENU OPTION																																										
SELECT MENU OPTION	SELECT MENU OPTION																																										
SELECT MENU OPTION	SELECT MENU OPTION																																										
SELECT MENU OPTION	SELECT MENU OPTION																																										
SELECT MENU OPTION	SELECT MENU OPTION																																										
SELECT MENU OPTION	SELECT MENU OPTION																																										
SELECT MENU OPTION	SELECT MENU OPTION																																										

System programs are a sort of catchall for selecting instrument characteristics that don't relate specifically to any one of the other five groups. Time and calendar date, temperature units, access code, and line frequency are all determined in a system program. These values probably won't need to be changed very often.

SYSTEM MENU CHOICE

The system program module is divided into seven different menus, each for programming specific system-wide parameters.

3f/System Programming

Line Frequency

Choose either 50 or 60 Hz.; only analog to digital converters need this information for maximum noise rejection.

All measurement nodes (A/D converters) in the system are assumed to be operating with the same line frequency. If the system is battery operated, and there are ac power lines in the area, the frequency should be the same as the power lines. If the local line frequency is 400 Hz, program the system for 50 Hz, since 400 is a multiple of 50.

The frequency entered has no effect on the internal clock, which is crystal operated.

Calendar Date and Time

The date is entered as day (1 or 2 digits), month (3-letter abbreviation), and year (2 digits). Entering a space (for clarity) between the day, month, and year is optional.

Enter the time as hours, minutes, and then seconds, with the minutes and seconds being optional entries. The 2280s use a 24-hour clock.

Some entry examples are,

Date - 3 DEC 85, 24 JUL 85, or 10MAY85

Time - 7.43.39 (for 7 hours, 43 minutes, 39 seconds)

2.32 (for 2 hours, 32 minutes, 0 seconds)

13 (for 13 hours, 0 minutes, 0 seconds)

Once programmed, the date and time are correctly maintained with the power on and for at least 30 days with the power off.

Temperature Units

The temperature unit entered here affects the system-wide temperature units for the instrument. You can select degrees Celsius, degrees Fahrenheit, or compensated millivolts. This selection causes implicit translation of numeric data on analog measurement channels whose input function is a thermocouple or RTD.

Degrees Celsius is assumed for RTDs if compensated millivolts is selected.

Access Code

The access code, if entered, allows you to control access to the scan, plot, changing limits or pseudo channel values while scanning, and single scan functions. The code consists of an alphanumeric string of one to six characters.

Once an access code is programmed, an operator must correctly enter the code string whenever starting or stopping a process. The default is no code if the programmer chooses not to enter one, in which case the access code is neither requested nor required when a command is entered by the operator.

Scan Trigger Enable Times

This feature allows you to enable scanning and plotting only between the start and stop times entered. The start and stop times define a scan window.

The default start and stop times are both 00:00:00 and when they are equal, the scan window is always open. The scan window affects only the continuous, time interval, discrete time, and hardware triggering mechanisms. The start and stop times have no effect on the single scan function. You can scan on demand by using the front panel SINGLE SCAN ON/OFF key, regardless of the scan window setting.

3f/System Programming

A scan group executing when the window closes is completed normally. Scan groups that are triggered before the window closes (but which haven't been executed because they have lower priority than the group now running), will be executed.

Interpolation Tables

You can define up to ten interpolation tables, each labeled with a number from 0 to 9. The contents of a table are entered as pairs of numbers, and you must enter at least two pairs. The pairs consist of an input value followed by an output value.

The pairs must be in ascending or descending order of the input; they encompass the maximum and minimum values expected from channels that use the table.

A table should not contain two entries with the same input value since that implies a discontinuity. Table conversion is initiated when a channel expression references the table number as a function. The argument of the expression is the input measurement to be converted.

For example, the expression $TBL7(CX)+3.14$ indicates that the raw input reading of the channel will be converted to an output using the values in interpolation table 7. The value 3.14 will then be added to produce the resulting reading for the channel.

Interpolation tables can be programmed at any time, but the program that uses them won't run without an advanced math processor (option -211) installed.

If the input measurement falls between points in the table, a linear interpolation is used to determine the output. You might, for instance, use the interpolation table function for a channel with a transducer, which must convert input volts to a pressure output in a non-linear relationship.

3f/System Programming

In a chosen interpolation table, you could program at least the minimum and maximum input values expected, each paired with its corresponding output value. For example, if a transducer is used which outputs between 0.1 and 0.2V dc, corresponding to an input of 10 to 200 pounds per square inch (in a non-linear fashion), the table might look like this,

```
0.100//10
0.120//30
0.140//60
0.160//100
0.180//150
0.200//200
```

Notice that the relationships are non-linear, and thus cannot be converted with a simple $mx+b$ scaling. Further details on this and other advanced math features are covered in Advanced Math Programming (section 4 of this guide) and the Options section (option -211) of the 2280 Series System Guide.

Select Menu Options

AUTOMATICALLY DISPLAY MENU

When the system is set to automatically display menus, each time a set of new choices is offered during programming, the menu for it is automatically listed,

DESCEND MENUS WITHOUT ENTER

You can speed the keypressing mechanics of programming by eliminating the need to press ENTER after each entry is chosen. This step should probably only be used by an experienced 2280 programmer, since it takes away the option of checking your menu choices before they're entered.

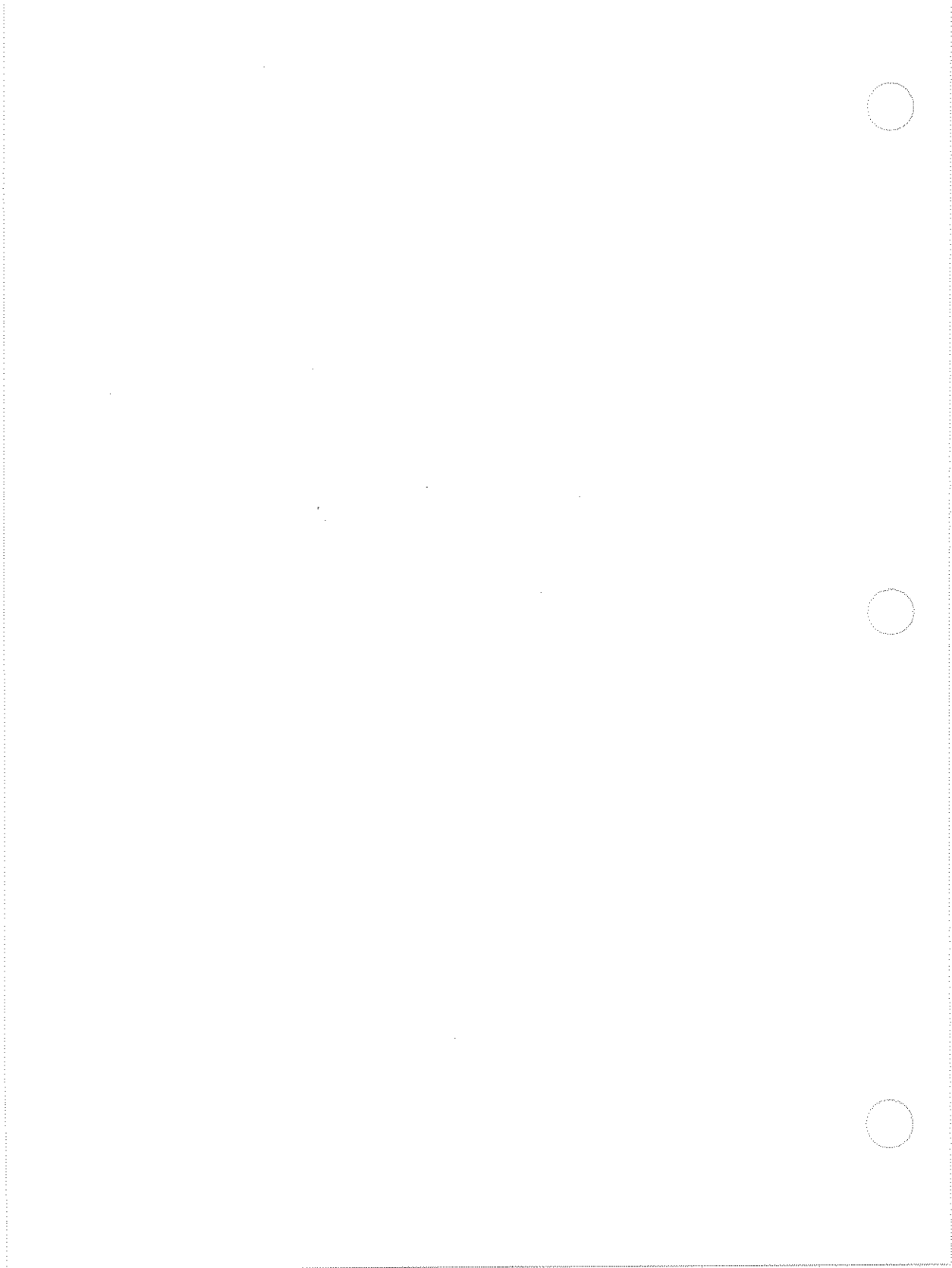

Section 4
Advanced Math Programming

CONTENTS

Introduction	4-2
Advanced Math Functions	4-3
Advanced Math Operators	4-18
Exponentiation	4-18
Logical Operators	4-19
Relational Operators	4-22
Advanced Programming Technique and Examples	4-27
Integrate a Value	4-28
Counter	4-30
Shift Register	4-32
Average Value	4-34
Rolling Average	4-36
Changing Logging Interval With Time	4-38
Changing Logging Rate on Alarm	4-40
Standard Deviation Over Time	4-42
Additional Techniques	4-44
Save Maximum Value of a Channel	4-44
Save Minimum Value of a Channel	4-46
Exclude Open Thermocouples From Calculations	4-48

INTRODUCTION

This section contains a summary of additional functions and operations available when the 2280 Series Data Logger has the Advanced Math Option (2280A-211) installed. It discusses operational details and syntax and uses typical expressions and situations for illustration.

This section also offers programming techniques that allow your 2280 Series Data Logger to perform both advanced data reduction and analysis, and to enhance its operational flexibility. The 2280 is unique in that it can be programmed to perform custom calculations without requiring the user to learn (and debug) a computer language.

The capabilities of the 2280 Series Data Loggers extend beyond their ability to perform calculations upon input data. Pseudo channels allow calculations ranging from the averaging of a group of channels, to calculating F_0 (equivalent sterilization time) to computing the mass flow of a gas. Pseudo channels also augment the ability of the 2280 to perform specialized data acquisition and logging tasks. The data logging rate can be changed on detection of an alarm or preset condition, or even after a period of time has elapsed. This section explains how.

FUNCTIONS AVAILABLE WITH THE ADVANCED MATH OPTION

With the Advanced Math Option installed, the speed with which your 2280 Series Data Logger can perform calculations is increased. Special functions that are available without the math board (which are described in Channel Programming, Section 3a) are still available with the option installed and execute more rapidly and more efficiently. They are,

ALMx	Alarm Status
ERR	Error Status
LINx	Thermocouple Linearization
LIN1	385 DIN Platinum RTD
LIN2	10 ohm Copper RTD
REFx	Thermocouple Reference Voltage
RTD	User Defined Platinum RTD

In addition, the Advanced Math Option allows for a number of extra functions that can be performed on channel or pseudo channel data. These additional functions are also described in this section.

ABS	Absolute Value
ACOS	Inverse Cosine
ASIN	Inverse Sine
ATAN	Inverse Tangent
COS	Cosine
EXP	Exponential
GAV	Group Average
INT	Integer Part
LOG	Common Logarithm
LN	Natural Logarithm
MAX	Maximum Value
MIN	Minimum Value
SD	Standard Deviation
SIN	Sine
SQR	Square Root
TAN	Tangent
TBL	Interpolation Table
TIME	Elapsed Time

4/Advanced Math Functions

ALMn

Format: ALMn(1x//2x//3x//etc.)

Usage: The alarm status function, when evaluated, gives the status (1 = exceeded, 0 = not exceeded) of a particular limit (n) of the channel or block designated in the function. The format of the function is ALMn (channel list), where n is a number from 1 to 4, and the channel list is a single channel, a block of channels, or a combination of blocks and single channels separated (//). For example, the function written as,

ALM2(C98//C100..102//C200)

when evaluated, will tell whether channel 98, 100 to 102, or 200 has exceeded limit #2 of its assigned alarm list.

Examples:

ALM1(C9)

ERROR STATUS

Format: ERR(1x//2x//3x//etc.)

Usage: The error status function is used to find the lowest valued error number (i.e., the one with the highest priority) currently active on the channel or block of channels listed.

These errors aren't fatal to system operation, but do indicate that something is wrong. The priority (ranging from 0 through 6) indicates the severity of the problem. The delimiter "//" is used to separate the various channels listed.

An error value of zero indicates that none of the channels in the list are in error.

Error reporting codes are as follows:

- (1) Dead Serial Link Device
- (2) Broken Thermocouple
- (2) Propagated Error
- (3) No Reading
- (4) Out of Measurable Range
- (4) Out of Temperature Range
- (5) Argument Out of Range
- (5) Bad RTD Constants
- (5) Arithmetic Overflow
- (5) Denominator of Zero
- (5) Negative Argument
- (5) Zero Argument

Example:

The function ERR(C99//C100...104), when evaluated, gives the lowest valued error number currently active of channel 99 or 100 through 104.

4/Advanced Math Functions

THERMOCOUPLE LINEARIZATION

Format: LINn(millivolts)

Usage: When evaluated, this function gives the temperature as measured by a specific type of thermocouple. Use this in applications where temperature is being measured with thermocouples not terminated on the standard 2280 isothermal input connector (2280A-175).

Example:

```
CX = LINR(CX+REFR(C100))
```

The format is LINn(m), where n is a single letter corresponding to the type of thermocouple used (as shown in the thermocouple selection menu) and 'm' is one of the following,

- o A channel number---where the channel is an input channel measuring the millivolt signal of a thermocouple.
- o An expression---that, when evaluated, gives the millivolts to be converted to temperature for the specified thermocouple type.

The temperature units used in these cases is the same one programmed in the system program. If the system temperature units are compensated millivolts, the value of the argument is returned unchanged.

4/Advanced Math Functions

LIN1

Format: LIN1(ohms)

Usage: When evaluated in an expression, the LIN1 function applies a 385 DIN platinum linearization on the value of the parameter which is expected to be the resistance of the RTD probe in ohms.

Example:

LIN1(CX)

LIN2

Format: LIN2(ohms)

Usage: When evaluated in an expression, the LIN2 function applies a 10 ohm Cu RTD linearization on the value of the parameter which is expected to be the resistance of the RTD probe in ohms.

Example:

LIN2(CX)

4/Advanced Math Functions

THERMOCOUPLE REFERENCE VOLTAGE

Format: REF n (temperature)

Usage: This function can be used in applications where temperature is being monitored with thermocouples that are terminated in an external isothermal block. When the function is evaluated, it gives the compensating millivolts for a specified thermocouple terminated at a specific temperature.

These compensating millivolts, when added to the millivolts measured from the thermocouple, provide the necessary correction to cancel out the effect of the secondary thermocouple formed at the thermocouple termination.

The format of the function is REF n (t) where n is a single letter corresponding to the desired thermocouple type (as shown in the thermocouple selection menu), and (t) is one of the following,

- o A constant temperature---for cases where the thermocouple is terminated in an isothermal block at a fixed temperature.
- o A channel number---where the channel is an input channel measuring the actual temperature of the external isothermal block.
- o An expression---that, when evaluated, gives the temperature of the external reference block.

The temperature units used in these cases is the same one programmed in the system program. If the system temperature units are compensated millivolts, degrees Celsius is assumed.

4/Advanced Math Functions

RTD

Format: RTD(ohms//RO//alpha//delta//c4)

Usage: When evaluated in an expression, the RTD function applies a user defined platinum RTD linearization on the value of the resistance of the RTD probe.

Example:

```
RTD(CX//100.00//0.00390//1.494//-0.205984E-11)
```

This function returns the temperature of a calibrated RTD. The following probe characteristics are required.

ohms	(ohms)
RTD ice-point resistance	(RO)
RTD alpha value	(alpha)
RTD delta value	(delta)
C4 value	(c4)

If any of the last four parameters above are omitted the following defaults will be used.

RO	100.00
alpha	0.00390
delta	1.494
c4	-0.205984E-11

The RTD constants must be specified in order. For example, if you need to specify a C4 that differs from the default, you must also specify RO, alpha, and delta. This is true even if they are the same as the default settings.

The temperature unit used in this function is the same one programmed in the system program. If the system temperature units are compensated millivolts, degrees Celsius is assumed.

4/Advanced Math Functions

FUNCTIONS AVAILABLE ONLY WITH THE MATH BOARD

The following functions are only available in the 2280 Series Data Loggers when the Advanced Math Option is installed.

ABSOLUTE VALUE

Format: ABS(x)

Usage: When evaluated in an expression, an ABS function gives the absolute value of x.

Example:

ABS(C16)

The absolute value of C16 is returned.

SQUARE ROOT

Format: SQR(x)

Usage: When evaluated in an expression, a square root function gives the number which, when multiplied by itself, results in the value of x. The expression must always be a positive value.

Example:

SQR(C23)

The Square Root of C23 is determined.

EXPONENTIAL

Format: EXP(x)

Usage: When evaluated in an expression, an exponential function gives the base of the natural log, "e", raised to the power x. The value returned is always positive.

Examples:

EXP(.707)
EXP(C8)
EXP(ABS(C6))

SINE

Format: SIN(x)

Usage: When evaluated in an expression, a sine function gives the sine of angle x. X is assumed to be in radians.

Examples:

SIN(314.16E-02)
SIN(C8)

COSINE

Format: COS(x)

Usage: When evaluated in an expression, a COS function gives the cosine of angle x. X is assumed to be in radians.

Examples:

COS(7.07E-01)
COS(C3+C4)

4/Advanced Math Functions

TANGENT

Format: TAN(x)

Usage: When evaluated in an expression, a TAN function gives the tangent of angle x. X is assumed to be in radians.

Examples:

```
TAN(SIN(.707))  
TAN(3.14+C6) (note the use of the value of Pi)  
TAN(C9)
```

INVERSE SINE

Format: ASIN(x)

Usage: When evaluated in an expression, an inverse sine function gives the angle, in radians, whose sine is x. The value of the expression must be between -1 and +1, and the value returned will be between $-\pi/2$ and $\pi/2$.

Examples:

```
ASIN(1)  
ASIN(C23)
```

4/Advanced Math Functions

INVERSE COSINE

Format: ACOS(x)

Usage: When evaluated in an expression, an inverse cosine function gives the angle, in radians, whose cosine is x. The value of the expression must be between -1 and +1, and the value returned will be between 0 and Pi.

Examples:

```
ACOS(0.986E-01)
ACOS(SIN(C3))
```

INVERSE TANGENT

Format: ATAN(x)

Usage: When evaluated in an expression, an inverse tangent function gives the angle, in radians, whose tangent is x. The magnitude of the value returned will always be between -Pi/2 and Pi/2.

Examples:

```
ATAN(3.6872E+15)
ATAN(SIN(2.3)+C6)
```

COMMON LOGARITHM

Format: LOG(x)

Usage: When evaluated in an expression, a common logarithm function gives the value by which ten must be raised to obtain the value of x. X must have a positive non-zero value.

Examples:

```
LOG(1.0E06)
LOG(C3)
```

4/Advanced Math Functions

NATURAL LOGARITHM

Format: LN(x)

Usage: When evaluated in an expression, a natural logarithm gives the value by which the irrational constant "e" must be raised to obtain the value of x. X must have a value that is positive and non-zero.

Examples:

LN(C12)
LN(2+LOG(84.3E+02))

TABLE INTERPOLATION

Format: TBLn(x)

Usage: This function uses x as the independent variable to perform a linear interpolation in the user-defined table n. n is a pre-programmed interpolation table numbered between 0 and 9. When performed it returns a corresponding dependent variable value.

If x is outside the input range of the table, a linear extrapolation is performed to get a dependent variable value. It is not recommended that you allow the independent variable to be outside the values encompassed by the table. If so, large errors and unpredictable results could occur.

- o If the interpolation table contains no points, zero is always returned.
- o If the table only contains one pair of points, the dependent value of that pair is returned.

Examples: TBL1(5.0)
TBL9(C45)

4/Advanced Math Functions

INTEGER PART

Format: INT(x)

Usage: When evaluated in an expression, the INT function gives the integer part of operand x.

Examples:

```
INT(C34)
INT(5.3 + 7/2)
```

MAXIMUM VALUE

Format: MAX(1x//2x//3x//etc)

Usage: When evaluated in an expression, the MAX function gives the maximum value among all the operands specified as x. If a single channel is specified, the function is evaluated as that channel's current reading. Channel numbers can be specified individually or in block form (with the format: Cx..y).

- o The various operands specified in x are separated by the delimiter: //.

Examples:

```
MAX(C987)
MAX(C1..23)
MAX(C4//C7//C23)
MAX(C34//C48..57//C67)
MAX(C21//5.0//LOG(C37))
```

4/Advanced Math Functions

MINIMUM VALUE

Format: MIN(1x//2x//3x//etc)

Usage: When evaluated in an expression, the MIN function gives the minimum value among all the operands specified as x. Channel numbers may be specified in individual or block form. If a single channel is specified then the function is evaluated as that channel's current reading.

- o The various operands specified in x are separated by the delimiter: //

Examples:

```
MIN(C98)
MIN(C6..9//C234)
```

STANDARD DEVIATION

Format: SD(1x//2x//3x//etc)

Usage: When evaluated in an expression, this function gives the standard deviation over all the operands specified as x. Channel numbers may be specified individually or in block form.

- o The various operands specified in x are separated by the delimiter: "/"

Examples:

```
SD(C3..25)
SD(C2//C5..9//7.4)
```

4/Advanced Math Functions

GROUP AVERAGE

Format: GAV(x)

Usage: When evaluated in an expression, this function gives the group average of all the operands specified as x. If only one operand is entered as x, the evaluation of that operand itself is the group average.

If the value of any of the operands is invalid because of an error (open TC, RTD over/under temperature, DC voltage over range, divide by zero, etc) that operand is excluded from the calculation of the average.

- o The delimiter "/" is used to separate the various operands specified.

Examples:

```
GAV(C0..9)
GAV(C23)
GAV(5.3//5.9/C10)
```

ELAPSED TIME

Format: TIME

Usage: The elapsed time in seconds since the scan was initiated is determined. The elapsed time is set to zero when the SCAN key is pressed, or when plotting begins and scanning is inactive.

- o Elapsed times shorter than 194 days will have 1 second resolution.
- o Elapsed times between 195 and 388 days will have two second resolution.
- o Elapsed times between 389 days and 776 days will have four second resolution.

Example: TIME

4/Advanced Math Operators

OPERATORS AVAILABLE WITH THE ADVANCED MATH OPTION

Basic operators used in channel expressions-- addition, subtraction, multiplication, and parentheses --are always available when programming the 2280 Series Data Loggers. Installing the Advanced Math Option also adds exponentiation, logical operators (OR, AND, XOR, etc.), and relational operators (Greater Than, Less than, etc.) to your programming capabilities. The following pages cover the use of these additional operators.

EXPONENTIATION

Format: (operand1) ** (operand2)

Usage: The exponentiation operator works between two operands by raising operand1 to the power indicated by operand2.

Examples:

```
3.6 ** C7
C98 ** LOG(C10)
-7.3 ** 2
```

CAUTION

If operand1 is negative, operand2 must be an integer, otherwise, a "NON-INTEGER POWER OF NEGATIVE BASE" error is reported.

4/Advanced Math Operators

LOGICAL OPERATORS

The following logical operators are available when the Advanced Math Option (2280A-211) is installed.

AND
NOT
OR
XOR

NOTE

Be careful when using logical operators with numbers other than 1 and 0. Logical operators look at whether or not a number is equal to zero. To a logical operator, the numbers .000001 and 100 are the same, since neither is equal to zero. The 2280 only logs 5 digits so the first number would be logged as .00000 (zero). Thus, you could get a number logged as zero, but evaluated as 1 by a logical operator.

4/Advanced Math Operators

AND

Format: (operand1) AND (operand2)

Usage: The AND operator performs the logical "and" function between the operands on either side of it.

Any operand having a non-zero value is interpreted as a logical "1". Otherwise it is interpreted as a logical "0".

Operand		Result
1	2	
0	0	0
1	0	0
0	1	0
1	1	1

Examples:

ALM1(C34) AND C501 (where C501 is a Status Output)

If limit number 1 on channel 34 is exceeded and status output C501 is set, a logic 1 is returned. Otherwise, a logic 0 is returned.

4/Advanced Math Operators

NOT

Format: NOT (operand)

Usage: The NOT operator performs an inversion of the logical value of the operand it precedes.

Operand	Result
1	0
0	1
1	0

Example:

NOT C6

OR

Format: (operand1) OR (operand2)

Usage: The OR operator performs the logical "or" function between the operands. Any operand having a non-zero value is interpreted as a logical "1". Otherwise it is interpreted as a logical "0".

Operand 1	Operand 2	Result
0	0	0
1	0	1
0	1	1
1	1	1

Examples:

C3 OR C7
ALM2(C3) OR ALM3(C3)

If limit number 2 or number 3 of channel C3 is exceeded, then return a logic 1, otherwise return a logic 0.

4/Advanced Math Operators

EXCLUSIVE OR

Format: (operand1) XOR (operand2)

Usage: The XOR operator performs the logical exclusive or function between operands on either side of it. Any operand having a non-zero value is interpreted as a logical "1". Otherwise it is interpreted as a logical "0".

Operand		Result
1	2	
0	0	0
1	0	1
0	1	1
1	1	0

Example: C2 XOR C14

RELATIONAL OPERATORS

The following relational operators are available with the Advanced Math Option installed.

EQ	Equal
GE	Greater than or equal
GT	Greater than
LE	Less than or equal
LT	Less than
NE	Not equal

Since the 2280 Series Data Loggers have 5-digit logging resolution, differences could be created between logged data and relational operators.

For example, $10.0002 > 10.0$ is clearly satisfied, but the number 10.0002 is logged as 10.000, with the 2 truncated. As a result, the number is treated as greater than 10.0 internally, even though it is logged as 10.000.

EQ (Equal)

Format: (operand1) EQ (operand2)

Usage: The EQ operator returns a value of one if the values of the two operands are equal. Otherwise a value of zero is returned.

Examples:

```
C2 EQ C48  
LOG(C24) EQ 2
```

CAUTION

Take extreme care when using the EQ operator. You may want to test for 10.0 EQ CX and have that condition trigger something. But it's very possible the value of CX will vary around 10.0 without ever being equal to 10.0.

GE (Greater than or equal)

Format: (operand1) GE (operand2)

Usage: The GE operator returns a value of one if the value of operand1 is greater than or equal to that of operand2. Otherwise, a value of zero is returned.

Examples:

```
C329 GE -10.87  
C49 GE C58
```

4/Advanced Math Operators

GT (Greater Than)

Format: (operand1) GT (operand2)

Usage: The GT operator returns a value of one if the value operand1 is greater than that of operand2. Otherwise, a value of zero is returned.

Examples:

```
C4 GT MAX(C5..9)
C5 GT C100
```

LE (Less Than Or Equal)

Format: (operand1) LE (operand2)

Usage: The LE operator returns a value of one if the channel value of operand1 is less than or equal to that of operand2. Otherwise, a value of zero is returned.

Examples:

```
C496 LE 3.87
C34 LE C695
```

LT (Less Than)

Format: (operand1) LT (operand1)

Usage: The LT operator compares operand1 with operand2 and returns a value of one if operand1 is less than that operand2. Otherwise, a value of zero is returned.

Examples:

```
C3 LT C45
```

4/Advanced Math Operators

NE (Not Equal)

Format: (operand1) NE (operand2)

Usage: The NE operator returns a value of one if the values of the two operands are not equal. Otherwise a value of zero is returned.

Example:

```
C45 NE C69
387.6 NE LOG(C16)
```



4/Advanced Programming Techniques

ADVANCED PROGRAMMING TECHNIQUES AND EXAMPLES

The following paragraphs discuss advanced programming techniques that help to ensure user-created equations can be executed by the 2280 Series Data Loggers. The equations and procedures programmed for pseudo channels allow solutions to a large number of application problems, and allow almost infinite variation. In short, there are no right or wrong solutions to almost any problem. Programming forms with suggested programming solutions are offered for each problem shown here.

Following are some suggested building blocks that should prove useful in approaching an applications problem. Most problems can be broken into smaller segments that usually contain at least one of these three fundamentals,

- o the integrator
- o the counter
- o the shift register

4/Advanced Programming Techniques

Integrate a Value

Integrating, or summing the value of a measured channel over time is the first programming building block. It can be directly used in computing statistics such as average and standard deviation, along with many other applications. Pseudo channels are used to perform the integration, each time the measured value is scanned, its value is added to the current value of the pseudo channel. When scanning or plotting is begun, the 2280 Series Data Logger initializes the value of pseudo channels to 0. Because of this, no special provision needs to be made for initialization.

Problem

An automobile manufacturer wants to accurately measure the distance a car travels during a test. A fifth wheel that generates a pulse every 10 feet has been installed on the car and connected to a Counter/Totalizer option (2280B-167). Scan the Counter/Totalizer channels every 20 seconds and accumulate the total distance traveled.

<A> CHANNEL PROGRAM

CHANNEL MENU CHOICE <14> >

CHANNEL FUNCTION & RANGE <A.1>	CHANNEL LIST <2>	CHANNEL EXPRESSION OF PROCEDURE <3>	CHANNEL LABEL <4>	LOGGING FORMAT <5>
P.C.D. OR L. 0-100	FEET	OX = 10 * OX	WHEEL INPUT	
0-100	P	FEET 0.100 = 1000 I. 00	DISTANCE INPUT	

CHANNEL FUNCTION MENU

<1> CHANNEL	<2> CHANNEL LIST	<3> CHANNEL EXPRESSION OF PROCEDURE	<4> CHANNEL LABEL	<5> LOGGING FORMAT
<6> CHANNEL RANGE	<7> CHANNEL UNIT	<8> CHANNEL EXPRESSION OF PROCEDURE	<9> CHANNEL LABEL	<10> LOGGING FORMAT
<11> CHANNEL RANGE	<12> CHANNEL UNIT	<13> CHANNEL EXPRESSION OF PROCEDURE	<14> CHANNEL LABEL	<15> LOGGING FORMAT

<K> SCAN GROUP PROGRAM

SCAN GROUP MENU CHOICE <15> >

GROUP #	SCAN GROUP LABEL	SCAN GROUP CHANNEL LIST	DATA OUTPUT GROUP TRIGGER
04			
5			

<F> ALARM LIST PROGRAM

ALARM LIST MENU CHOICE <12> >

P.C.D. OR L.	LIMITS INFORMATION	ALARM MESSAGE
0-100	ALARM MESSAGE	ALARM MESSAGE
1	ALARM MESSAGE	ALARM MESSAGE
2	ALARM MESSAGE	ALARM MESSAGE
3	ALARM MESSAGE	ALARM MESSAGE
4	ALARM MESSAGE	ALARM MESSAGE
5	ALARM MESSAGE	ALARM MESSAGE
6	ALARM MESSAGE	ALARM MESSAGE
7	ALARM MESSAGE	ALARM MESSAGE
8	ALARM MESSAGE	ALARM MESSAGE
9	ALARM MESSAGE	ALARM MESSAGE
10	ALARM MESSAGE	ALARM MESSAGE
11	ALARM MESSAGE	ALARM MESSAGE
12	ALARM MESSAGE	ALARM MESSAGE
13	ALARM MESSAGE	ALARM MESSAGE
14	ALARM MESSAGE	ALARM MESSAGE
15	ALARM MESSAGE	ALARM MESSAGE
16	ALARM MESSAGE	ALARM MESSAGE
17	ALARM MESSAGE	ALARM MESSAGE
18	ALARM MESSAGE	ALARM MESSAGE
19	ALARM MESSAGE	ALARM MESSAGE
20	ALARM MESSAGE	ALARM MESSAGE
21	ALARM MESSAGE	ALARM MESSAGE
22	ALARM MESSAGE	ALARM MESSAGE
23	ALARM MESSAGE	ALARM MESSAGE
24	ALARM MESSAGE	ALARM MESSAGE
25	ALARM MESSAGE	ALARM MESSAGE
26	ALARM MESSAGE	ALARM MESSAGE
27	ALARM MESSAGE	ALARM MESSAGE
28	ALARM MESSAGE	ALARM MESSAGE
29	ALARM MESSAGE	ALARM MESSAGE
30	ALARM MESSAGE	ALARM MESSAGE
31	ALARM MESSAGE	ALARM MESSAGE
32	ALARM MESSAGE	ALARM MESSAGE
33	ALARM MESSAGE	ALARM MESSAGE
34	ALARM MESSAGE	ALARM MESSAGE
35	ALARM MESSAGE	ALARM MESSAGE
36	ALARM MESSAGE	ALARM MESSAGE
37	ALARM MESSAGE	ALARM MESSAGE
38	ALARM MESSAGE	ALARM MESSAGE
39	ALARM MESSAGE	ALARM MESSAGE
40	ALARM MESSAGE	ALARM MESSAGE
41	ALARM MESSAGE	ALARM MESSAGE
42	ALARM MESSAGE	ALARM MESSAGE
43	ALARM MESSAGE	ALARM MESSAGE
44	ALARM MESSAGE	ALARM MESSAGE
45	ALARM MESSAGE	ALARM MESSAGE
46	ALARM MESSAGE	ALARM MESSAGE
47	ALARM MESSAGE	ALARM MESSAGE
48	ALARM MESSAGE	ALARM MESSAGE
49	ALARM MESSAGE	ALARM MESSAGE
50	ALARM MESSAGE	ALARM MESSAGE
51	ALARM MESSAGE	ALARM MESSAGE
52	ALARM MESSAGE	ALARM MESSAGE
53	ALARM MESSAGE	ALARM MESSAGE
54	ALARM MESSAGE	ALARM MESSAGE
55	ALARM MESSAGE	ALARM MESSAGE
56	ALARM MESSAGE	ALARM MESSAGE
57	ALARM MESSAGE	ALARM MESSAGE
58	ALARM MESSAGE	ALARM MESSAGE
59	ALARM MESSAGE	ALARM MESSAGE
60	ALARM MESSAGE	ALARM MESSAGE
61	ALARM MESSAGE	ALARM MESSAGE
62	ALARM MESSAGE	ALARM MESSAGE
63	ALARM MESSAGE	ALARM MESSAGE
64	ALARM MESSAGE	ALARM MESSAGE
65	ALARM MESSAGE	ALARM MESSAGE
66	ALARM MESSAGE	ALARM MESSAGE
67	ALARM MESSAGE	ALARM MESSAGE
68	ALARM MESSAGE	ALARM MESSAGE
69	ALARM MESSAGE	ALARM MESSAGE
70	ALARM MESSAGE	ALARM MESSAGE
71	ALARM MESSAGE	ALARM MESSAGE
72	ALARM MESSAGE	ALARM MESSAGE
73	ALARM MESSAGE	ALARM MESSAGE
74	ALARM MESSAGE	ALARM MESSAGE
75	ALARM MESSAGE	ALARM MESSAGE
76	ALARM MESSAGE	ALARM MESSAGE
77	ALARM MESSAGE	ALARM MESSAGE
78	ALARM MESSAGE	ALARM MESSAGE
79	ALARM MESSAGE	ALARM MESSAGE
80	ALARM MESSAGE	ALARM MESSAGE
81	ALARM MESSAGE	ALARM MESSAGE
82	ALARM MESSAGE	ALARM MESSAGE
83	ALARM MESSAGE	ALARM MESSAGE
84	ALARM MESSAGE	ALARM MESSAGE
85	ALARM MESSAGE	ALARM MESSAGE
86	ALARM MESSAGE	ALARM MESSAGE
87	ALARM MESSAGE	ALARM MESSAGE
88	ALARM MESSAGE	ALARM MESSAGE
89	ALARM MESSAGE	ALARM MESSAGE
90	ALARM MESSAGE	ALARM MESSAGE
91	ALARM MESSAGE	ALARM MESSAGE
92	ALARM MESSAGE	ALARM MESSAGE
93	ALARM MESSAGE	ALARM MESSAGE
94	ALARM MESSAGE	ALARM MESSAGE
95	ALARM MESSAGE	ALARM MESSAGE
96	ALARM MESSAGE	ALARM MESSAGE
97	ALARM MESSAGE	ALARM MESSAGE
98	ALARM MESSAGE	ALARM MESSAGE
99	ALARM MESSAGE	ALARM MESSAGE
100	ALARM MESSAGE	ALARM MESSAGE

FLUKE 2280 SERIES PROGRAMMING FORM

REV. 08/2018 BY: T. BROWN

4/Advanced Programming Techniques

Counter

The second major building block, a simple variation on the integrator, is a counter. Instead of adding a measured value to a pseudo channel each time, a constant--usually 1--is added.

Counters can be used to keep track of how many times a channel has been scanned or how often events occur. For example, how many times a measured channel has been scanned. By placing the counter in a scan group that is scanned on a periodic basis, the elapsed time associated with an event can also be measured.

Problem

A brewery is monitoring the pH of its effluent. They want to know the number of minutes the pH spends over limit and how often the excess occurs. The pH is monitored every 30 seconds.

To determine the total time the pH exceeds its programmed alarm limit, the ALM function is used instead of a constant. Every time channel 10 is scanned and the pH is over limit, $ALM1(C10)=1$, and every time the value is below the limit value, $ALM1(C10)=0$.

4/Advanced Programming Techniques

<A> CHANNEL PROGRAM

CHANNEL MENU CHOICE <1-4>

CHANNEL FUNCTION & RANGE <A-Z>	ALARM UNITS <1>	CHANNEL LIST <2>	CHANNEL EXPRESSION OF PROCEDURE <3>	CHANNEL LABEL <4>	LOGGING FORMAT <5>
10	D-5	10	10=0.075 * AX - 3.5	EXHAUST PH	
100	P		000=0.002 * ALMS (0.0) * Z	MINUTES BURN	
101	P		1001=0.002 * ALM (1.0)	MINUTES IN ALRM	

<F> ALARM LIST PROGRAM

ALARM LIST MENU CHOICE <1-2>

P.C.D. OR L 1-6	LIMIT	LIMIT VALUE	LIMIT UNIT	LIMIT MESSAGE	LIMIT INFORMATION	LIMIT BAND
10	10	10.000	PH	EXAMPLE EXHAUST TEMP OVER LIMIT	1-6	
2						
3						
4						
5						
6						

<K> SCAN GROUP PROGRAM

SCAN GROUP MENU CHOICE <1-4>

GROUP #	SCAN GROUP LABEL <1>	SCAN GROUP CHANNEL LIST <2>	SCANNING LOGSE <3>	DATA OUTPUT GROUP NUMBER <4>	OTHER SCAN GROUP NUMBER <5>
60					
61	010	0100	01000000	1	

CHANNEL FUNCTION MENU

- <1> CHANNEL CHANGES
- <2> CHANNEL LIST
- <3> CHANNEL EXPRESSION
- <4> CHANNEL LABEL
- <5> CHANNEL LOGGING
- <6> CHANNEL BAND
- <7> CHANNEL MESSAGE
- <8> CHANNEL INFORMATION
- <9> CHANNEL LIMIT
- <0> CHANNEL MESSAGE
- <10> CHANNEL MESSAGE
- <11> CHANNEL MESSAGE
- <12> CHANNEL MESSAGE
- <13> CHANNEL MESSAGE
- <14> CHANNEL MESSAGE
- <15> CHANNEL MESSAGE
- <16> CHANNEL MESSAGE
- <17> CHANNEL MESSAGE
- <18> CHANNEL MESSAGE
- <19> CHANNEL MESSAGE
- <20> CHANNEL MESSAGE
- <21> CHANNEL MESSAGE
- <22> CHANNEL MESSAGE
- <23> CHANNEL MESSAGE
- <24> CHANNEL MESSAGE
- <25> CHANNEL MESSAGE
- <26> CHANNEL MESSAGE
- <27> CHANNEL MESSAGE
- <28> CHANNEL MESSAGE
- <29> CHANNEL MESSAGE
- <30> CHANNEL MESSAGE
- <31> CHANNEL MESSAGE
- <32> CHANNEL MESSAGE
- <33> CHANNEL MESSAGE
- <34> CHANNEL MESSAGE
- <35> CHANNEL MESSAGE
- <36> CHANNEL MESSAGE
- <37> CHANNEL MESSAGE
- <38> CHANNEL MESSAGE
- <39> CHANNEL MESSAGE
- <40> CHANNEL MESSAGE
- <41> CHANNEL MESSAGE
- <42> CHANNEL MESSAGE
- <43> CHANNEL MESSAGE
- <44> CHANNEL MESSAGE
- <45> CHANNEL MESSAGE
- <46> CHANNEL MESSAGE
- <47> CHANNEL MESSAGE
- <48> CHANNEL MESSAGE
- <49> CHANNEL MESSAGE
- <50> CHANNEL MESSAGE
- <51> CHANNEL MESSAGE
- <52> CHANNEL MESSAGE
- <53> CHANNEL MESSAGE
- <54> CHANNEL MESSAGE
- <55> CHANNEL MESSAGE
- <56> CHANNEL MESSAGE
- <57> CHANNEL MESSAGE
- <58> CHANNEL MESSAGE
- <59> CHANNEL MESSAGE
- <60> CHANNEL MESSAGE
- <61> CHANNEL MESSAGE
- <62> CHANNEL MESSAGE
- <63> CHANNEL MESSAGE
- <64> CHANNEL MESSAGE
- <65> CHANNEL MESSAGE
- <66> CHANNEL MESSAGE
- <67> CHANNEL MESSAGE
- <68> CHANNEL MESSAGE
- <69> CHANNEL MESSAGE
- <70> CHANNEL MESSAGE
- <71> CHANNEL MESSAGE
- <72> CHANNEL MESSAGE
- <73> CHANNEL MESSAGE
- <74> CHANNEL MESSAGE
- <75> CHANNEL MESSAGE
- <76> CHANNEL MESSAGE
- <77> CHANNEL MESSAGE
- <78> CHANNEL MESSAGE
- <79> CHANNEL MESSAGE
- <80> CHANNEL MESSAGE
- <81> CHANNEL MESSAGE
- <82> CHANNEL MESSAGE
- <83> CHANNEL MESSAGE
- <84> CHANNEL MESSAGE
- <85> CHANNEL MESSAGE
- <86> CHANNEL MESSAGE
- <87> CHANNEL MESSAGE
- <88> CHANNEL MESSAGE
- <89> CHANNEL MESSAGE
- <90> CHANNEL MESSAGE
- <91> CHANNEL MESSAGE
- <92> CHANNEL MESSAGE
- <93> CHANNEL MESSAGE
- <94> CHANNEL MESSAGE
- <95> CHANNEL MESSAGE
- <96> CHANNEL MESSAGE
- <97> CHANNEL MESSAGE
- <98> CHANNEL MESSAGE
- <99> CHANNEL MESSAGE
- <00> CHANNEL MESSAGE

4/Advanced Programming Techniques

Shift Register

The third major building block is a shift register. A shift register allows measured or calculated values from previous scans to be saved for future logging or calculations.

For example, a shift register can be used to save the previous ten readings for a measured channel. When that channel goes into alarm, the ten readings preceding the alarm can be recorded. The shift register operates by moving the measured value into a pseudo channel, and then moving the previous value of that pseudo channel into another pseudo channel, and so on.

When defining a shift register, it is neither necessary nor desirable to define a different pseudo channel for each cell of the shift register. Instead, use the ability of the 2280 Series Data Loggers to use multiple line channel procedures to define the cells.

Problem

An electronics company wants to monitor the temperature of a component on a power supply during a destructive test. When the supply fails, log the previous eight seconds of readings. In this example, when the output of the power supply drops below 4.5 V (the failure point), the alarm triggers scan group 3 which logs onto the printer the temperatures leading up to the failure.

<F> ALARM LIST PROGRAM

ALARM LIST MENU CHOICE <12>

ALM LIST #	P.C.D. OR L.	ALARM LABEL	LIMITS INFORMATION	LOG BAND
0		EXAMPLE: OVERTEMP	EXAMPLE: OVERTEMP OVER LIMIT	
1		EXAMPLE: OVERTEMP	EXAMPLE: OVERTEMP OVER LIMIT	
2		EXAMPLE: OVERTEMP	EXAMPLE: OVERTEMP OVER LIMIT	
3		EXAMPLE: OVERTEMP	EXAMPLE: OVERTEMP OVER LIMIT	
4		EXAMPLE: OVERTEMP	EXAMPLE: OVERTEMP OVER LIMIT	
5		EXAMPLE: OVERTEMP	EXAMPLE: OVERTEMP OVER LIMIT	
6		EXAMPLE: OVERTEMP	EXAMPLE: OVERTEMP OVER LIMIT	
7		EXAMPLE: OVERTEMP	EXAMPLE: OVERTEMP OVER LIMIT	
8		EXAMPLE: OVERTEMP	EXAMPLE: OVERTEMP OVER LIMIT	
9		EXAMPLE: OVERTEMP	EXAMPLE: OVERTEMP OVER LIMIT	

<A> CHANNEL PROGRAM

CHANNEL MENU CHOICE <14>

CHANNEL FUNCTION & RANGE <A2>	CHANNEL ALARM # <17>	CHANNEL ALARM # <18>	CHANNEL ALARM # <19>	CHANNEL LABEL <4>	LOGGING FORMAT <5>
0	0	0	0	EXAMPLE: OVERTEMP	EXAMPLE: OVERTEMP
1	1	1	1	EXAMPLE: OVERTEMP	EXAMPLE: OVERTEMP
2	2	2	2	EXAMPLE: OVERTEMP	EXAMPLE: OVERTEMP
3	3	3	3	EXAMPLE: OVERTEMP	EXAMPLE: OVERTEMP
4	4	4	4	EXAMPLE: OVERTEMP	EXAMPLE: OVERTEMP
5	5	5	5	EXAMPLE: OVERTEMP	EXAMPLE: OVERTEMP
6	6	6	6	EXAMPLE: OVERTEMP	EXAMPLE: OVERTEMP
7	7	7	7	EXAMPLE: OVERTEMP	EXAMPLE: OVERTEMP
8	8	8	8	EXAMPLE: OVERTEMP	EXAMPLE: OVERTEMP
9	9	9	9	EXAMPLE: OVERTEMP	EXAMPLE: OVERTEMP

<K> SCAN GROUP PROGRAM

SCAN GROUP MENU CHOICE <15>

GROUP #	SCAN GROUP LABEL <1>	SCAN GROUP CHANNEL LIST <2>	SCAN GROUP DEVICE CONTROL MODE <3>	ON-SCAN GROUP TRIGGER <5>
0	EXAMPLE: OVERTEMP	EXAMPLE: OVERTEMP	EXAMPLE: OVERTEMP	EXAMPLE: OVERTEMP
1	EXAMPLE: OVERTEMP	EXAMPLE: OVERTEMP	EXAMPLE: OVERTEMP	EXAMPLE: OVERTEMP
2	EXAMPLE: OVERTEMP	EXAMPLE: OVERTEMP	EXAMPLE: OVERTEMP	EXAMPLE: OVERTEMP
3	EXAMPLE: OVERTEMP	EXAMPLE: OVERTEMP	EXAMPLE: OVERTEMP	EXAMPLE: OVERTEMP
4	EXAMPLE: OVERTEMP	EXAMPLE: OVERTEMP	EXAMPLE: OVERTEMP	EXAMPLE: OVERTEMP

FLUKE 2280 SERIES PROGRAMMING FORM

4/Advanced Programming Techniques

Average Value

Use the GAV function (available with the Advanced Math Board) to determine the average of a measured or calculated value. The function is primarily useful for determining the average of a group of channels, not one channel over time.

One method of calculating an average over time is to integrate the measured or calculated value, count how many times the measured value has been scanned, and then divide the contents of the integrator by the contents of the counter.

Problem

An oven is being monitored during a 1 hour test. Measure the oven temperature every 10 seconds and compute the average temperature at the end of the test.

4/Advanced Programming Techniques

<A> CHANNEL PROGRAM

CHANNEL MENU CHOICE <1-5>

CHANNEL FUNCTION NAME <1-2>	CHANNEL UNITS <2-2>	CHANNEL EXPRESSION or PROCEDURE <3-3>	CHANNEL LABEL <4-4>	LOGGING FORMAT <5-5>
P.C.D. OR L. <1-1>	0-100	0-100	0-100	0-100
B	7.5K		OVEN TEMP	
51	51	OVEN TEMP	OVEN TEMP	
51	51	OVEN TEMP	OVEN TEMP	
51	51	OVEN TEMP	OVEN TEMP	

CHANNEL FUNCTION MENU

- <1> CHANNEL UNITS
- <2> CHANNEL EXPRESSION or PROCEDURE
- <3> CHANNEL LABEL
- <4> LOGGING FORMAT
- <5> USER DEFINED RTD CONSTANTS

<K> SCAN GROUP PROGRAM

SCAN GROUP MENU CHOICE <1-5>

GROUP #	SCAN GROUP LABEL <1-1>	SCAN GROUP CHANNEL LIST <2-2>	SCAN TRIG MODE <3-3>	DATA OUTPUT DEVICE CONTROL <4-4>	OTHER SCAN GROUP TRIGGER <5-5>
P.C.D. or L. <1-1>	0-100	0-100	0-100	0-100	0-100
5	DATA COLLECTION	51	1		
4	OVEN TEST	51	1		

<F> ALARM LIST PROGRAM

ALARM LIST MENU CHOICE <1-2>

ALARM LIST #	P.C.D. OR L.	LIMITS INFORMATION	DEAD BAND
1	51	ALARM TEST	
2			
3			
4			
5			
6			
7			
8			
9			
10			
11			
12			
13			
14			
15			
16			
17			
18			
19			
20			
21			
22			
23			
24			
25			
26			
27			
28			
29			
30			
31			
32			
33			
34			
35			
36			
37			
38			
39			
40			
41			
42			
43			
44			
45			
46			
47			
48			
49			
50			
51			
52			
53			
54			
55			
56			
57			
58			
59			
60			
61			
62			
63			
64			
65			
66			
67			
68			
69			
70			
71			
72			
73			
74			
75			
76			
77			
78			
79			
80			
81			
82			
83			
84			
85			
86			
87			
88			
89			
90			
91			
92			
93			
94			
95			
96			
97			
98			
99			
100			

FLUKE 2280 SERIES PROGRAMMING FORM

4/Advanced Programming Techniques

Rolling Average

Instead of an average over a period of time, often a rolling average, or the average over the last several readings is desired. Use the shift register building block for calculations of this type. The number of previous values to be averaged determines the number of cells in the shift register. To compute the rolling average the number of previous values are added together and then divided by the number of cells.

Problem

A rolling average is desired for profiling a refrigerator under test. Measure the temperature every second, and compute and output the rolling average for the last 4 readings.

FLUKE 2280 SERIES PROGRAMMING FORM

<F> ALARM LIST PROGRAM

ALARM LIST MENU CHOICE <1-2>

ALARM LIST	P.C.D. OR L	LOGGING FORMAT	CHANNEL LABEL	CHANNEL EXPRESSION OF PROCEDURE	CHANNEL UNITS	ALARM LIST	ALARM BAND	DEAD BAND
50			COUNTER	AVG = AX F	RES/AVG TEMP			
51			READING OFFER	CVI = 1.5				
52								
53								
54								
55								
56								
57								
58								
59								
60								
61								
62								
63								
64								
65								
66								
67								
68								
69								
70								

<A> CHANNEL PROGRAM

CHANNEL MENU CHOICE <1-5>

CHANNEL #/BLOCK	P.C.D. OR L	CHANNEL UNITS	CHANNEL EXPRESSION OF PROCEDURE	CHANNEL LABEL	LOGGING FORMAT
5					
50			AVG = AX F	COUNTER	
51			CVI = 1.5	READING OFFER	
60					
61					
62					
63					
64					
65					
66					
67					
68					
69					
70					

<K> SCAN GROUP PROGRAM

SCAN GROUP MENU CHOICE <1-5>

GROUP #	P.C.D. OR L	SCAN GROUP LABEL	SCAN GROUP CHANNEL LIST	SCAN TRIG MODE	DATA OUTPUT	OTHER SCAN GROUP TRIGGER
66						
7		POLLING AVG. AVERAGE	650 751 760 ... 625	3		6 2
6		POLLING AVG. AVERAGE	670	2		

4/Advanced Programming Techniques

Change Logging Interval with Time

Sometimes it is desirable to change a data logging interval after a period of time has elapsed. To accomplish this, multiple counters are required, one to serve as a master counter, and one counter for each of the different logging intervals desired. In general, the master counter is scanned at the largest common non-fractional time interval for the two logging rates.

Problem

Log the temperature from a group of thermocouples every 10 seconds for the first five minutes, and then log the temperatures once every 45 seconds.

In this example, scan group 3 is scanned every 5 seconds which is the largest common non-fractional time interval for the two logging rates. Channel 100 is the master counter and has two alarms, a low alarm at 59, and a high alarm at 60. Scan group 4 is scanned every 10 seconds, and triggers scan group 6 when $ALM1(C100)=1$. Scan group 5 is scanned every 45 seconds and triggers scan group 6 when $ALM2(C100)=1$.

<A> CHANNEL PROGRAM

CHANNEL MENU CHOICE <1-4>

CHANNEL #/BLOCK	CHANNEL FUNCTION & RANGE	ALM LIST	LIMITS	CHANNEL EXPRESSION or PROCEDURE	CHANNEL LABEL	LOGGING FORMAT
100	P	100	100	ALM=ALM1(100)	MASTER COUNTS	
101	P	101	101	ALM=ALM1(100)	TEMP INPUTS	
102	P	102	102			
103	T-T					

CHANNEL FUNCTION MENU

- <1> PERIOD CHANNEL
- <2> PULSE CHANNEL
- <3> RATE CHANNEL
- <4> RATE CHANNEL
- <5> RATE CHANNEL
- <6> RATE CHANNEL
- <7> RATE CHANNEL
- <8> RATE CHANNEL
- <9> RATE CHANNEL
- <10> RATE CHANNEL
- <11> RATE CHANNEL
- <12> RATE CHANNEL
- <13> RATE CHANNEL
- <14> RATE CHANNEL
- <15> RATE CHANNEL
- <16> RATE CHANNEL
- <17> RATE CHANNEL
- <18> RATE CHANNEL
- <19> RATE CHANNEL
- <20> RATE CHANNEL
- <21> RATE CHANNEL
- <22> RATE CHANNEL
- <23> RATE CHANNEL
- <24> RATE CHANNEL
- <25> RATE CHANNEL
- <26> RATE CHANNEL
- <27> RATE CHANNEL
- <28> RATE CHANNEL
- <29> RATE CHANNEL
- <30> RATE CHANNEL
- <31> RATE CHANNEL
- <32> RATE CHANNEL
- <33> RATE CHANNEL
- <34> RATE CHANNEL
- <35> RATE CHANNEL
- <36> RATE CHANNEL
- <37> RATE CHANNEL
- <38> RATE CHANNEL
- <39> RATE CHANNEL
- <40> RATE CHANNEL
- <41> RATE CHANNEL
- <42> RATE CHANNEL
- <43> RATE CHANNEL
- <44> RATE CHANNEL
- <45> RATE CHANNEL
- <46> RATE CHANNEL
- <47> RATE CHANNEL
- <48> RATE CHANNEL
- <49> RATE CHANNEL
- <50> RATE CHANNEL
- <51> RATE CHANNEL
- <52> RATE CHANNEL
- <53> RATE CHANNEL
- <54> RATE CHANNEL
- <55> RATE CHANNEL
- <56> RATE CHANNEL
- <57> RATE CHANNEL
- <58> RATE CHANNEL
- <59> RATE CHANNEL
- <60> RATE CHANNEL
- <61> RATE CHANNEL
- <62> RATE CHANNEL
- <63> RATE CHANNEL
- <64> RATE CHANNEL
- <65> RATE CHANNEL
- <66> RATE CHANNEL
- <67> RATE CHANNEL
- <68> RATE CHANNEL
- <69> RATE CHANNEL
- <70> RATE CHANNEL
- <71> RATE CHANNEL
- <72> RATE CHANNEL
- <73> RATE CHANNEL
- <74> RATE CHANNEL
- <75> RATE CHANNEL
- <76> RATE CHANNEL
- <77> RATE CHANNEL
- <78> RATE CHANNEL
- <79> RATE CHANNEL
- <80> RATE CHANNEL
- <81> RATE CHANNEL
- <82> RATE CHANNEL
- <83> RATE CHANNEL
- <84> RATE CHANNEL
- <85> RATE CHANNEL
- <86> RATE CHANNEL
- <87> RATE CHANNEL
- <88> RATE CHANNEL
- <89> RATE CHANNEL
- <90> RATE CHANNEL
- <91> RATE CHANNEL
- <92> RATE CHANNEL
- <93> RATE CHANNEL
- <94> RATE CHANNEL
- <95> RATE CHANNEL
- <96> RATE CHANNEL
- <97> RATE CHANNEL
- <98> RATE CHANNEL
- <99> RATE CHANNEL
- <100> RATE CHANNEL

 SCAN GROUP PROGRAM

SCAN GROUP MENU CHOICE <1-4>

GROUP #	SCAN GROUP LABEL	SCAN GROUP CHANNEL LIST	SCAN GROUP MODE	SCAN GROUP TRIGGER
1	100	100	100	100
2	101	101	101	101
3	102	102	102	102
4	103	103	103	103

<F> ALARM LIST PROGRAM

ALARM LIST MENU CHOICE <1-2>

ALM LIST #	P.C.D. OR L.	ALM INFO	LIMITS INFORMATION	BAND
1	100	100	100	100
2	101	101	101	101
3				
4				

2280 SERIES PROGRAMMING FORM



FORM 1000 10/1/80

4/Advanced Programming Techniques

Changing Logging Rate on Alarm

Changing the logging rate on the detection of an alarm is similar to changing the rate after a period of time. Instead of a master counter the channel (or channels) to be monitored for the alarm condition are put into the scan groups and checked for alarm conditions.

Problem

An battery manufacturer wants to record the voltages from a bank of batteries every 60 minutes. When the voltage on channel 3 drops below 1.3V log the voltages every 10 minutes.

FLUKE 2280 SERIES PROGRAMMING FORM

<F> ALARM LIST PROGRAM

ALARM LIST MENU CHOICE <1.2>

ALM LIST #	P.C.D. OR L	ALM INFO	ALM TRIGGER	ALM BAND
1	3		1.1.3 VOLTAGE UNDER LIMIT	
2				
3				

<A> CHANNEL PROGRAM

CHANNEL MENU CHOICE <1.4>

CHANNEL FUNCTION & RANGE	CHANNEL LIST	CHANNEL LIMITS	CHANNEL EXPRESSION OF PROCEDURE	CHANNEL LABEL	LOGGING FORMAT
1.1.1	3	0.1	BATTERY	BATTERY 1	0
1.1.2		0.1	BATTERY	BATTERY 2	0
1.1.3		0.1	BATTERY	BATTERY 3	0

<K> SCAN GROUP PROGRAM

SCAN GROUP MENU CHOICE <1.3>

GROUP #	P.C.D. OR L	SCAN GROUP LABEL	SCAN TRIG MODE	DATA / TRAIT DEVICE CONTROL	OTHER SCAN GROUP TRIGGER
1	3	BATTERY RETURN	0		
2		BATTERY SCANNING	0		
3		10 MINUTE RETURN	1		

4/Advanced Programming Techniques

Compute Standard Deviation of a Channel Over Time

Although a standard deviation function (SDV) is available with the Advanced Math Option, it's very inefficient for determining the standard deviation of a channel over time. Using the SDV function requires a shift register to hold all the desired readings. If the standard deviation of many channels is desired, or if the standard deviation is desired for many readings, the shift register may become very large and consume a large portion of program memory.

An alternate method for calculating the standard deviation makes use of two integrators and a counter. The equation for the standard deviation is:

$$\sigma = \sqrt{\frac{\sum X_i^2 - \bar{X}^2}{n-1}}$$

<A> CHANNEL PROGRAM

CHANNEL MENU CHOICE <1-4>

CHANNEL FUNCTION & RANGE	P.C.D. OR L	CHANNEL LIST	CHANNEL UNITS	CHANNEL EXPRESSION or PROCEDURE	CHANNEL LABEL	LOGGING FORMAT
100	P	100	V	$VX = VX + 15 \times C.A$	TEMPERATURE 1	
101	P	101	V	$VX = VX + 15$	SUM	
102	P	102	V	$VX = VX + 1$	N	
200	P	200	V	$IX = SIN(COR-COR) \times 100 \times 100$	SOV	
201	P	201	V	$VX = 100 \times 100$	MEAN	

CHANNEL FUNCTION MENU

- <1> CHANNEL CHOICE
- <2> CHANNEL LIST
- <3> CHANNEL UNITS
- <4> CHANNEL EXPRESSION or PROCEDURE
- <5> CHANNEL LABEL
- <6> LOGGING FORMAT

 SCAN GROUP PROGRAM

SCAN GROUP MENU CHOICE <1-4>

GROUP #	SCAN GROUP LABEL	SCAN GROUP CHANNEL LIST	SCANNING MODE	DATA OUTPUT DEVICE CONTROL	OTHER SCAN GROUP TRIGGER
00					
A	DATA COLLECTION	15 1000...102	3000/100		6
B	REPERT	200 1001	1		5

<F> ALARM LIST PROGRAM

ALARM LIST MENU CHOICE <1-2>

ALARM LIST OR L	P.C.D. OR L	LIMITS INFORMATION	ALARM MESSAGE	ALARM BAND
102	P	102	ALARM MESSAGE	ALARM BAND

2280 SERIES PROGRAMMING FORM

FLUKE 2280 REV 1 1984

4/Advanced Programming Techniques

Additional Programming Techniques

While the following techniques do not easily fit into the integrator, counter, and shift register building blocks previously covered, they may prove useful.

Save Maximum Value of a Channel

The following programming illustrates how to keep track of the largest value of a channel since the SCAN key was pressed.

This example takes advantage of the fact that the 2280 Series Data Loggers always reset pseudo channel values to 0 when scanning is started. The measured value in channel 10 is compared to the contents of the pseudo channel, and the larger of the two is saved. This example will work whenever the value of C10 is greater than zero.

4/Advanced Programming Techniques

FLUKE 2280 SERIES PROGRAMMING FORM

<A> CHANNEL PROGRAM

CHANNEL MENU CHOICE <14>

CHANNEL FUNCTION & RANGE <2>	<1> CHANNEL ALARM LIST P.C.D. OR L. EXAMPLE: 77C71	<3> CHANNEL LIMITS 84 pins EXAMPLE: C1 - C1, 13, 8, 50	<4> CHANNEL EXPRESSION or PROCEDURE 8-16 characters EXAMPLE: C1 - C1, 13, 8, 50	<5> CHANNEL LABEL 8-16 characters EXAMPLE: SENSIT TEMP	<6> LOGGING MENU
7-R					
P					

 ALARM LIST PROGRAM

ALARM LIST MENU CHOICE <12>

ALM LIST #	P.C.D. OR L.	<1> LIMIT VALUE	<2> SENSITIVITY	<3> BAND
1				
2				
3				
4				
5				
6				
7				
8				
9				
10				
11				
12				
13				
14				
15				
16				
17				
18				
19				
20				
21				
22				
23				
24				
25				
26				
27				
28				
29				
30				
31				
32				
33				
34				
35				
36				
37				
38				
39				
40				
41				
42				
43				
44				
45				
46				
47				
48				
49				
50				

<C> SCAN GROUP PROGRAM

SCAN GROUP MENU CHOICE <14>

GROUP #	P.C.D. OR L.	<1> SCAN GROUP LABEL	<2> SCAN GROUP CHANNEL LIST	<3> DATA OUTPUT DEVICE CONTROL	<4> OTHER SCAN GROUP TRIGGER
84					

4/Advanced Programming Techniques

Save Minimum Value of a Channel

The routine to save the minimum value of a channel since SCAN was pressed requires somewhat more work.

In this example, scan group 5 is triggered when the SCAN key is pushed and is used to initialize the value of C100 to a large positive number. The measured value is compared to that large number and saved. All further values are compared against the first and the smallest is saved.

FLUKE 2280 SERIES PROGRAMMING FORM

<F> ALARM LIST PROGRAM

ALARM LIST #	P.C.D. OR L	ALARM MESSAGE	LIMITS INFORMATION	DEAD BAND
1				
2				
3				
4				
5				
6				
7				
8				
9				
10				
11				
12				
13				
14				
15				
16				
17				
18				
19				
20				

<A> CHANNEL PROGRAM

CHANNEL #/BLOCK	CHANNEL FUNCTION & RANGE	ALARM LIST	CHANNEL UNITS	CHANNEL EXPRESSION OF PROCEDURE	CHANNEL LABEL	LOGGING FORMAT
1						
2						
3						
4						
5						
6						
7						
8						
9						
10						
11						
12						
13						
14						
15						
16						
17						
18						
19						
20						

<K> SCAN GROUP PROGRAM

GROUP #	SCAN GROUP LABEL	SCAN GROUP CHANNEL LIST	SCAN TRIG MODE	DATA OUTPUT	OTHER SCAN GROUP TRIGGER
1					
2					
3					
4					
5					
6					
7					
8					
9					
10					
11					
12					
13					
14					
15					
16					
17					
18					
19					
20					

4/Advanced Programming Techniques

Exclude Open Thermocouples from Calculations

A potential difficulty can occur when a thermocouple input is the measurement used for an integrator or shift register. If the thermocouple is broken, an OPEN TC message is generated. If the value from that channel is being used in any calculations, a PROPAGATED ERROR will occur and the previous contents of the integrator or shift register will be lost. One method to circumvent this is to use the GAV function available with the Advanced Math Option.

Problem

Compute the mean and standard deviation for a thermocouple input. Ignore all open TC conditions and exclude that reading from the calculations.

The GAV function automatically ignores any invalid readings it operates upon. Averaging the channel with 0 and then multiplying by 2 will result in the original reading when the measurement is valid, and in 0 if an open TC error is detected.

<A> CHANNEL PROGRAM

CHANNEL MENU CHOICE <1-4>

CHANNEL FUNCTION PAGE #	CHANNEL LIST	CHANNEL EXPRESSION OF PROCEDURE	CHANNEL LABEL	LOGGING FORMAT
1	1	Y = GAY (5.0) * X	TEMPERATURE 1	
2	2	X = 1.5 * Y + 150	SUM OF SQUARES	
3	3	Y = X + 150	SUM	
4	4	X = Y + 150	N	
5	5	Y = 50 * X - 1000	SDV	
6	6	X = 100 / Y	MEAN	

CHANNEL FUNCTION MENU

- <1> PERIOD CHANNEL
- <2> CHANNEL UNIT
- <3> CHANNEL UNIT
- <4> CHANNEL UNIT
- <5> CHANNEL UNIT
- <6> CHANNEL UNIT

<F> ALARM LIST PROGRAM

ALARM LIST MENU CHOICE <1-2>

ALM LIST #	P.C.D. OR L	LIMIT INFORMATION	ALARM MESSAGE
1	102	100	EXHAUST FLOW OVER LIMIT
2			
3			
4			
5			
6			
7			
8			
9			
10			
11			
12			
13			
14			
15			
16			
17			
18			
19			
20			
21			
22			
23			
24			
25			
26			
27			
28			
29			
30			

<K> SCAN GROUP PROGRAM

SCAN GROUP MENU CHOICE <1-4>

GROUP #	SCAN GROUP LABEL	SCAN GROUP CHANNEL LIST	SCANNING MODE	DATA OUTPUT DEVICE CONTROL	OTHER SCAN GROUP TRIGGER
1	DATA COLLECTION	1, 2, 3, 4, 5, 6, 7, 8, 9, 10, 11, 12, 13, 14, 15, 16, 17, 18, 19, 20, 21, 22, 23, 24, 25, 26, 27, 28, 29, 30	1	1	3
2	REPORT	1, 2, 3, 4, 5, 6, 7, 8, 9, 10, 11, 12, 13, 14, 15, 16, 17, 18, 19, 20, 21, 22, 23, 24, 25, 26, 27, 28, 29, 30	1	1	3

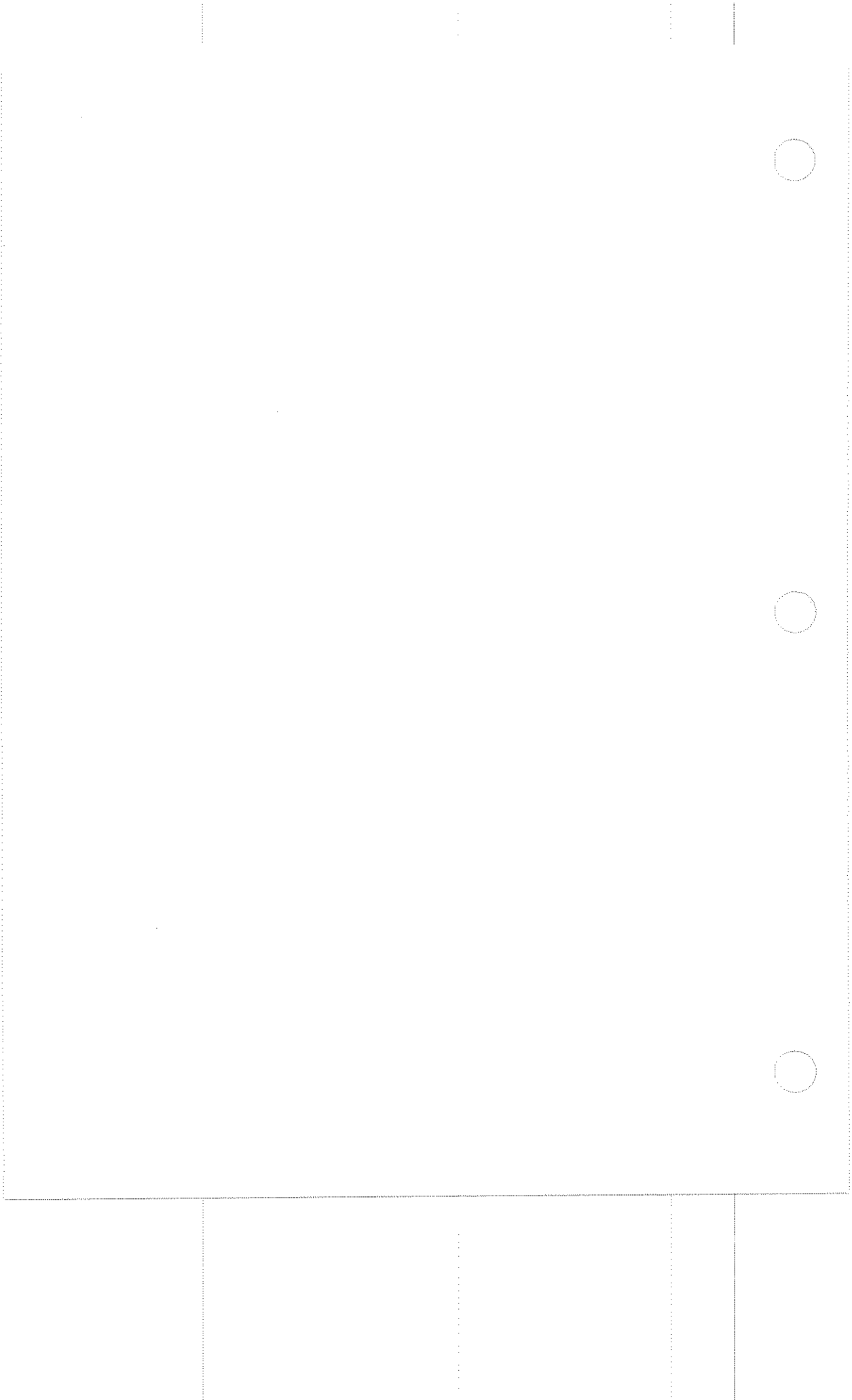

Section 5
Operating the 2280 From the Front Panel

CONTENTS

Introduction	5-2
Turning the 2280 On and Off	5-2
Operating Modes	5-4
Monitoring	5-5
Scanning	5-7
Single Scan	5-9
Plotting	5-11
User Status Functions	5-13
Alarm Acknowledgement	5-14
Return to Local	5-16
System Status	5-16
Operating Notes	5-17
Power Failure and Power Up	5-17
Initialization of Outputs	5-18
Changing Limit Values While Scanning ...	5-18
Changing Pseudo Channel Values While Scanning	5-18
Auxiliary Functions	5-19
Data Transfer Operation	5-19
Port A or B as Source Device	5-21
Cartridge Tape Drive as Source Device ..	5-22

5/Introduction

INTRODUCTION

Operation of the 2280 has been refined and streamlined through generations of data loggers. The scaled down front panel, with clearly marked operating and programming keys, the vacuum fluorescent display, and a menu-driven programming structure all contribute to the improved ease of use.

Users of the 2280 Series Data Loggers essentially customize their own data acquisition systems using the menu-driven user interface. In most cases, running the program they've set up is simple; the 2280 operating and user functions keys are clearly marked and conveniently accessed. This section contains basic operating instructions and describes the use of each of the operating keys.

TURNING THE 2280 ON AND OFF

Before turning on the 2280, make certain the interface cables and the power supply (whether battery or line power) are correctly connected. Please refer to the 2280 Series System Guide for information on hooking everything up.

To turn the data logger on, insert the key into the lower right front panel keyswitch and turn the key to the right. Turn the key to the RUN position (for operating) or the PROGRAMMING position depending upon what you intend to do. You have access to all of the operating functions with the key set to PROGRAMMING, but only a few programming functions when the key is set to the RUN position.

5/Turning the 2280 On and Off

With the instrument off, turn the key to RUN, and the display will show the prompt,

2280 SELF TEST

This prompt remains on the display until the 2280 initialization and self test have been completed. The version of software that is installed is briefly displayed next. After that, scanning or plotting are resumed if they were in progress when the 2280 was turned off. If they weren't running before, the following prompt is displayed,

SELECT RUN MODE OPERATION

This prompt indicates that only run mode operations may take place. Press one of the four operating keys now--SCAN, SINGLE SCAN, PLOT, or MONITOR--(depending on what you want to do), and enter the data you're prompted for. If the lockswitch is turned to PROGRAM when the 2280 is turned on, the opening prompt is,

MAIN MENU CHOICE <M FOR MENU>? A

In this case, both the programming and the operating modes are available, and an access code (if programmed) isn't required to operate the instrument. If any auxiliary functions are being run, don't turn the data logger off until they're completed, or until you stop them by pressing the EXIT key. The SCAN and PLOT front panel lights should be off before you turn the system off.

To turn the 2280 off, insert the key into the keyswitch and turn it to the left to the OFF position. Turning the machine off this way won't clear or alter the configuration program that's been entered or damage the files on the cartridge tape.

5/Operating Modes

OPERATING MODES

The 2280 contains four operating modes, monitor, scan, single scan, and plot. Each mode has a clearly labeled key on the instrument front panel, and a light indicator which is illuminated when a run mode has been selected and remains active. The operating keys toggle on and off. Push a key once to begin an operation and push it again to end the operation.

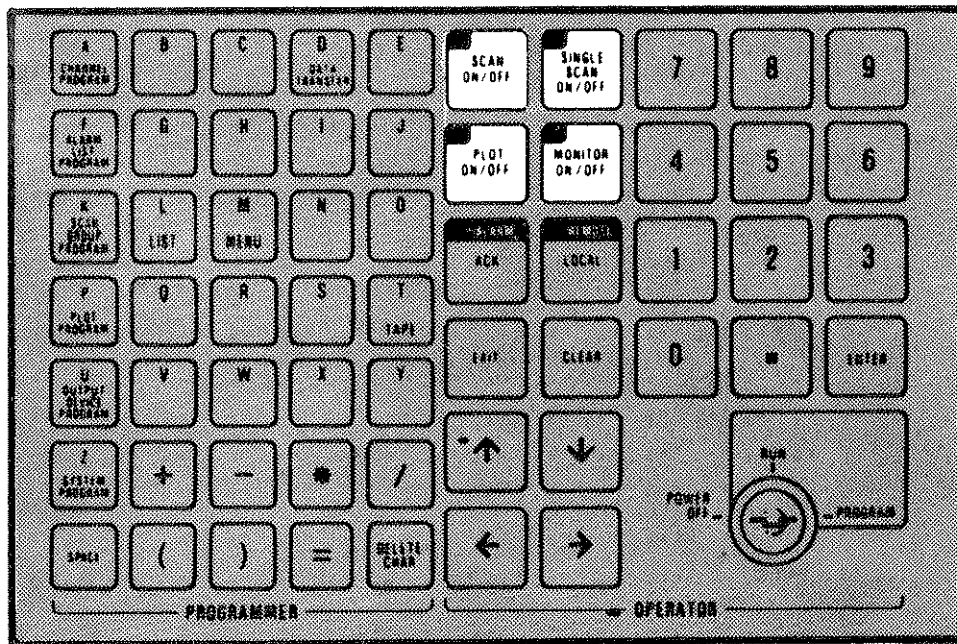

Monitoring

Use the monitor function to access a selected channel to continuously display the data generated from it. The information is updated after the completion of each scan, or two and a half times per second, whichever is slower.

Data acquired while monitoring goes to the display; if you're operating from remote it goes to port A. You can run monitor whether the 2280 is in scan, single scan, or plot modes, but if a scan is active when monitoring begins, the data output to the display is pre-empted. The data generated from the channel being monitored will appear on the display.

To request the monitor function, turn the instrument on, and press the MONITOR ON/OFF key on the front panel.

Key in the desired channel number when the system prompts for it and press the ENTER key. At this point the 2280 verifies that the selected channel physically exists, and that it's programmed consistent with the hardware configuration. If it isn't a valid channel number, or if the channel you've requested isn't programmed, an error message will be displayed until acknowledged. Refer to Section 8 of this guide for handling of error messages.

If it's a valid channel number, the MONITOR key light indicator remain on, and the number of the monitored channel will be displayed until data is available for display.

You can change the monitored channel by using the up or down arrow keys. Pressing the up arrow key increments the channel number by one and pressing the down arrow key decrements the channel number by one.

5/Monitoring

Data from other scan groups that normally goes to the display will not appear. That data is displaced by data from the channel you're monitoring. Also, the current alarm status of the monitored channel will be displayed, but no alarm messages will be logged, and no alarm scans triggered or channel procedures executed, until the channel comes up in a normal scan.

Stop the monitor function by pressing the MONITOR ON/OFF key again. The light indicator will then go out.

Scanning

The scan function causes the 10 scan groups (0-9) to be activated according to the trigger conditions specified in the configuration program.

Before starting a scan it's a good idea to get a copy of the program currently contained in the 2280 memory. The 2280 Series Programming Form should have all of this information, including the access code, the channel labels and file names and so forth.

With the instrument turned on and the SELECT RUN MODE OPERATION prompt displayed, activate the Scan function by pressing the front panel SCAN ON/OFF key. If an access code has been programmed the system will prompt for it at this point. Key it in and then press the ENTER key. If the access code is entered incorrectly, the message ACCESS DENIED will appear on the display and remain there until the EXIT key is pressed.

If an access code hasn't been programmed, or if the power keyswitch is in the PROGRAM position, pressing the SCAN ON/OFF key takes you directly to the SELECT RUN MODE prompt.

Scan group functions are checked for conformance to the actual physical configuration of the 2280 Data Logger. If consistent, you'll be allowed to proceed with your scan request. If not, an error message will be displayed, and the scan request will be denied. Operation cannot proceed until the problem is fixed.

If any of the scan groups are programmed for output to the cartridge tape (Opt -214), you'll be asked to enter a tape file name, which is from 1 to 10 characters. If the system requests one, key in the desired file name, and press the ENTER key.

5/Scanning

If each step is taken correctly the SCAN key light indicator will remain on and the display will return to the SELECT RUN MODE OPERATION prompt until data becomes available and is displayed. Individual scan groups are triggered by their programmed trigger conditions, not by turning on the scan function.

To turn the scan function off, simply press the SCAN ON/OFF key. The key toggles on and off. If no access code was programmed, the SCAN key light indicator will go off and scanning will stop.

If an access code was programmed, type it in at the prompt and press ENTER. At this point the SCAN LED goes out, scanning stops, and the message, STOPPED AT <Date> <Time> is sent to all logging devices used since scanning began. If the access code is entered incorrectly, the ACCESS DENIED prompt is displayed again, and scanning continues.

If data was being recorded to a tape file when the scan is turned off, then the file is closed. If the scan is turned back on later, the data will have to be entered into a new tape file, with another name.

Single Scan

Use this feature when you want to execute only one of a scan group, regardless of the programmed trigger order. If a scan group is currently active under the scan or plot function, the group requested by the single scan waits for completion of that current scan group before it begins.

If other scan groups are queued up, the scan group requested by the single scan function takes its place in the queue according to its priority and other preprogrammed parameters.

To request a single scan, turn the instrument on and press the front panel SINGLE SCAN ON/OFF key. If an access code is required, the system will prompt for it; key it in and press ENTER. If the code entered is incorrect, the ACCESS DENIED message will appear and remain on the display until either the ALARM ACK or EXIT key is pressed.

When access to the single scan function is granted, the prompt reads,

SCAN GROUP TO TRIGGER = 0.

Group 0 is the default choice. Displayed defaults are always selected by pressing ENTER. If another group is desired, key in the number, and then press ENTER.

If the scan mode was off when you requested a single scan, the 2280 checks the parameters of the selected scan group against the physical configuration of the data logger. If the cartridge tape wasn't programmed as an output device for the selected scan group, and no configuration error occurs, the scan becomes active.

5/Single Scan

If the scan mode was on when the SINGLE SCAN LED comes on, and there are other scan groups queued up to become active, then the single scan group is assigned a place in the queue based on its group number, with lower numbers getting higher priority.

When the cartridge tape is programmed as an output device for the selected scan group, the system will ask for the file name. Type in the desired file name at the prompt (using up to 10 characters) and then press the ENTER key. If the single scan group has the cartridge tape programmed as an output device (and scan is on), the data from the single scan will also go into the file that was opened when the scan mode was turned on.

Any single scan of a scan group will not trigger any other groups to scan after it regardless of the programming.

Single scan can be aborted before it's completed by pressing the SINGLE SCAN ON/OFF key again. If the scan function was off when single scan is aborted, the following message is sent to every logging device used during the single scan,

STOPPED AT <Date> <Time>

Also, if a tape file was opened, aborting the single scan function closes the file. When the single scan is completed, the SINGLE SCAN LED will go out.

Plotting

The 2280 Series Data Loggers have the capability of plotting the activity of up to four programmed plot channels onto the built-in printer. Plotting is available only within the window specified by the scan trigger enable times.

Each of the channels being plotted has its own individual symbol or character (see the 2280 Series Programming Form) that represents its value between the two boundaries over the programmed time interval. When one of the trend plots exceeds a boundary, the plot symbol for that channel changes to an overrange character (distinct from the assigned plot character), and the plot is pegged along that boundary until its data again comes back into the range of the plot.

While the PLOT key light indicator is on, all other logging output to the printer is pre-empted. This data will still be output to the other devices if it's been programmed to do so during scan group programming.

To request the plot function, turn the instrument on, and press the front panel PLOT ON/OFF key. If an access code is required, type it in at the prompt, and press ENTER. If the code is incorrectly entered, the ACCESS DENIED message will be displayed, and remain until the ALARM ACK or EXIT key is pressed.

If an access code hasn't been programmed, or if the keyswitch is turned to the PROGRAM position, plotting will begin as soon as you request it and the display will read,

SELECT RUN MODE OPERATION

5/Plotting

When the plot function is activated, the channels programmed in the plot group are checked against the actual 2280 configuration. If they don't agree, an error message is displayed. See section 8 of this guide for error message guidance. If they do agree, the PLOT key light indicator remains illuminated, and the 2280 prints out the following preliminary information,

- o The current date and time.
- o The plot interval time.
- o The numbers of the 1-4 channels whose values are about to be plotted and the symbol to be used for each.
- o The leftmost values of each plot channel.
- o The rightmost values of each plot channel.

After this preliminary information, the data logger prints the relative values of the channels programmed for trend analysis.

To turn off the plot function, press the PLOT ON/OFF key again. If an access code was programmed, type it in when requested, and then press the ENTER key. The PLOT key light indicator will go off and plotting will stop. If the 2280 is in the scan mode, normal data output to the printer is resumed if data is programmed to go to it.

5/User Status Functions

USER STATUS FUNCTIONS

The 2280 contains three user status functions, alarm acknowledgement, return to local control, and system status. Two of them, alarm acknowledgement, and return to local are accessed from the front panel keyboard and the other one, system status, is used only when operating from a remote location.

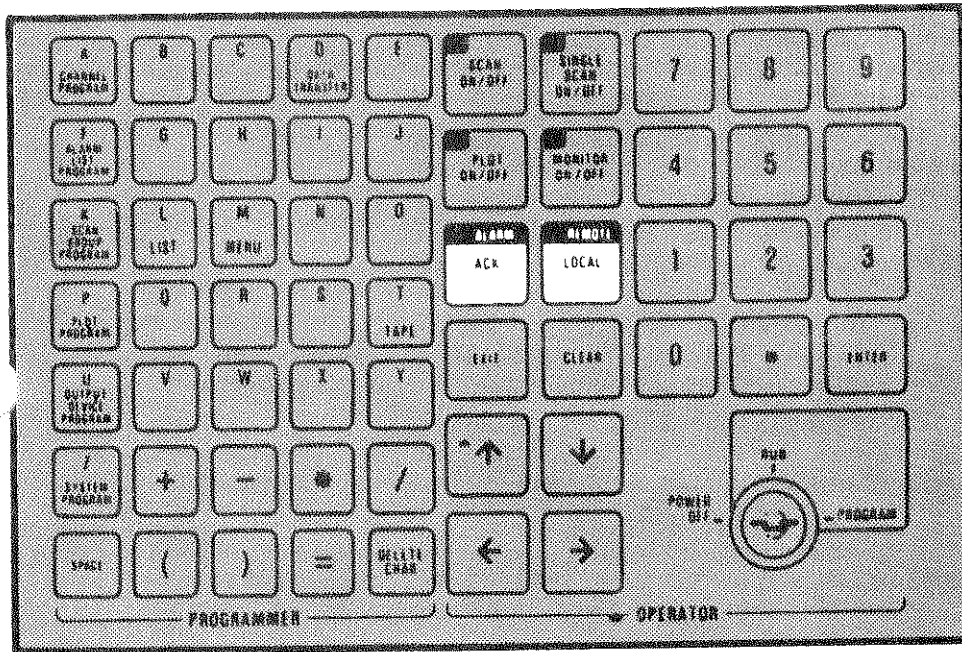

5/User Status Functions

Alarm Acknowledgement

If a limit on an alarm list has a programmed alarm message the message is placed in the alarm queue whenever its limit is exceeded. At the same time, the ALARM LED on the front panel will light and the alarm message can be viewed by pressing the ALARM ACK key.

The number of messages that can be stored in the alarm queue is limited only by the amount of unused system memory. When they've all been acknowledged, the LED goes out and the alarm output is turned off. The last alarm message displayed is cleared from the display by pressing EXIT.

The ALARM ACK key light indicator will be illuminated when,

- o Out-of-limit data is received from a programmed channel during the scan, single scan or plot modes (if an alarm message has been programmed for that limit).
- o A system alarm occurs.

When the ALARM light indicator comes on, the message associated with it is placed in the queue until the ALARM ACK key is pressed. Once acknowledged, the message remains on the display until the ALARM ACK key is pressed again to acknowledge another alarm message in the queue. The number of alarm messages that can be stored in the queue at any one time is limited only by the amount of user memory left available by the configuration program.

While it is not imperative that alarm messages are acknowledged, they are assumed to be of some importance. If the ALARM ACK key is pushed when the ALARM LED is off, the display will indicate ALL ALARMS ACKNOWLEDGED.

5/User Status Functions

If there are still unacknowledged alarms in the queue (the light indicator is on) when the scan mode is terminated, they can still be acknowledged in the normal manner. However, any time all four operating modes (scan, single scan, monitor and plot) are turned off, and then scan or plot is turned back on, any unacknowledged messages in the queue are erased. They will also be erased if any programming or auxiliary functions are performed. If scan is turned on while plot is on, any messages in the queue are retained.

Logged data that is destined for the display while an alarm message is viewed is pre-empted from the display. However, any data that is preprogrammed (during scan group programming) for other output devices will be recorded there normally.

If an alarm acknowledgement device has been programmed, each acknowledged alarm message is logged onto that device along with,

- o The time the message entered the queue.
- o The time it was acknowledged.
- o An indication of what caused the alarm.

If the user-defined alarm message is longer than 36 characters, the left part of the message may not appear on the front panel 40 character display. By moving the cursor to the beginning of the line with the left arrow key, you can view the first part of the line.

5/User Status Functions

Return to Local

When the 2280 is under remote control through port A of an RS-232-C or IEEE-488 device, the REMOTE key light indicator on the front panel will be illuminated.

If the remote operator hasn't locked out the front panel, it can be returned to local control by simply pressing the LOCAL key on the front panel. Refer to section 7 of this guide for more detailed information on local and remote programming.

System Status

When operating the 2280 from the front panel, you can easily see which features are active by simply viewing the indicator lights. When operating from a remote location the system status function must be used to determine which operating functions are active. (The six functions are scan, single scan, plot, monitor, alarm acknowledge and remote.) Section 7 of this guide discusses the System Status function in greater detail.

OPERATING NOTES

Power Failure and Power Up

Whenever power to a 2280 is interrupted in any manner, the configuration program and clock will be backed up in nonvolatile memory for at least 30 days.

Whenever a power-on or watchdog timeout occurs, the 2280 comes up in the following state,

- o All hardware assemblies are RESET, then released.
- o The 2280 will be in local control.
- o If power was lost while the SCAN or PLOT key front panel light indicators were illuminated, the scan or plot will automatically re-start. Before they restart, one of the following messages will be placed in the alarm queue for acknowledgement:

POWER FAILURE AT <DATE> <TIME>

The message is also sent to all data output devices associated with the scan group, with a line termination sequence sent before it to close any partially logged lines.

If a plot is to be restarted, the message is sent to the printer.

If the 2280 was in an operating mode when it lost power, it may be prevented from restarting that mode by an error condition when power is returned. If any system errors are detected at power-up, they will be displayed on the front panel.

You can acknowledge the error by pressing the EXIT key, and the 2280 will continue normal operation. However, depending on the nature of the error, you may need to take further action. See section 8 of this guide for assistance with error handling if necessary.

5/Operating Notes

Initialization of Outputs

All output and pseudo channels are initialized to zero when the 2280 is turned on. They are also reset under the following circumstances,

- o SCAN is off and PLOT or SINGLE SCAN is turned on.
- o SCAN is turned on.

If an output is in a 2281A Extender Chassis with its own power supply, and power cycles off and back on at that 2281A, then all outputs in that 2281A Extender Chassis are reset to zero.

Changing Limit Values While Scanning

It's possible to finetune the 2280 operation while it's running by altering the programmed setpoints. To change limit values while scanning is active, press the front panel ALARM LIST PROGRAM key. You will see the prompt,

CHANGE LIMIT VALUE <ENTER OR EXIT>

Press the ENTER key to change a value. Next you'll be asked for the alarm list number you wish to alter. Key in the number and change the value. Scanning continues during this procedure.

You can alter values when the keyswitch is in either the RUN or PROGRAM position, but if it's in RUN, and an access code has been programmed, you will be asked to type it in before you are allowed to continue. Press the EXIT key to return to normal operating conditions.

Changing Pseudo Channel Values While Scanning

Use the same steps as changing limit values above. The only difference is that you need to press the front panel CHANNEL PROGRAM key to access the channel values you want to change.

5/Auxiliary Functions

AUXILIARY FUNCTIONS

You have access to the following 2280 Data Logger auxiliary functions only when the front panel keyswitch is turned to the PROGRAM mode. The four operator modes (scan, single scan, monitor and plot) must be turned off as well. At this point, you can use any of the auxiliary functions by pressing a single key. The auxiliary functions are,

- o **Data transfer.** (Discussed in Section 6 of this guide.)
- o **Tape --** available if the cartridge tape drive is installed. (Discussed in Section 6 of this guide.)
- o **List.** (Described in the Tutorial in Section 2 of this guide.)
- o **Erase all programming.** (Described in the Tutorial in Section 2 of this guide.)

The following paragraphs describe the auxiliary functions. Refer to section 8 of this guide for error handling information.

Data Transfer Operation

The data transfer function allows you to transfer previously recorded data or program files from the cartridge tape or parallel interface (option -343/AA), to the printer, port A or port B.

If the cartridge tape drive is selected as the source device, you need to input the specific name of the file to be transferred. If the file is a data file, the logged data recorded within a time window may be singled out later for transfer.

5/Auxiliary Functions

If you choose not to enter specific start and stop times for a data transfer (when the cartridge tape is the source device), then all of the data in the file is transferred. The data transfer function continues until completed, or until the EXIT key is pressed. When you are transferring a program file, start and stop times are not relevant.

To start a data transfer procedure, press the D (DATA TRANSFER) key in response to the main menu prompt. The system acknowledges with the prompt,

<D> TRANSFER DATA

Press the ENTER key and the display becomes,

D: SOURCE DEVICE <1-3>? 1

You can now choose which of the three possible source devices you intend to use. Pressing the MENU key will show that the three choices are,

<1> CARTRIDGE TAPE DRIVE

<2> PORT A

<3> PORT B

Choose the desired source device by pressing the appropriate number key. The display then shows the choice taken. Press ENTER to record it, and then use the EXIT key to return to the main menu.

5/Auxiliary Functions

Port A or B as Source Device

If port A or B is chosen as the source device, press the ENTER key. The choice is then stored, and the displayed prompt is,

D: DESTINATION DEVICE <1-3>? 1

Pressing the MENU key shows that the three possible destination devices are,

<1> PRINTER

<2> PORT A

<3> PORT B

Choose the device you want by pressing the appropriate number key, followed by ENTER. The 2280 will begin transferring data from the source to the destination device until all data is transferred, or until the exit key is pressed. The main menu prompt will be displayed when it's finished.

5/Auxiliary Functions

Cartridge Tape Drive as Source Device

If the cartridge tape drive is chosen as the source device, press the ENTER key and the prompt asks for the file name. Enter the file name that represents the desired data on the tape cartridge. When you've correctly typed it in, press ENTER. The prompt becomes,

BEGIN AT: 01 JAN 00

If the complete data file is to be transferred, press ENTER for the current prompt and next three prompts. The prompts are,

BEGIN AT: 00:00:00

END AT: 31 DEC 99

END AT: 23:59:59

If only a portion of the data file is to be transferred, edit the begin and end times in the preceding prompts. Only those scan groups with a begin date and time between the edited begin and end dates and times will be transferred. If a file contains a saved program then the begin and end times will have no effect.

When the desired END AT: <time> is displayed, press ENTER. The parameter is then programmed, and the prompt becomes,

D: DESTINATION DEVICE <1-3>?

Choose the destination device now according to the previous instructions.

Section 6
Recording Information

CONTENTS

Introduction	6-3
Printer Operation	6-4
Printer On/Off Settings	6-4
Printer Operator Switch	6-7
Paper Advance	6-7
Take Up Off	6-7
Take Up On	6-7
Printer Paper Removal and Loading	6-8
Paper Removal	6-8
Installing New Paper	6-9
Cartridge Tape Drive Operation	6-10
Removal and Loading	6-10
Operation	6-11
Tape Format Programming	6-11
Tape Functions	6-11
Listing Tape Directories	6-12
Specifying Output Devices	6-13
Delete Files to End of Directory ..	6-14
Initializing a Tape	6-15
Saving a Program	6-16
Loading a Program	6-17
Data Transfer Operation	6-18
Output Format Examples	6-19
Retensioning Tapes	6-22



INTRODUCTION

The 2280 Series of Data Loggers allow you to record information in a variety of ways. This section discusses techniques for uploading data to other systems, along with the various interfaces used, and practical considerations involved with conditioning other system devices to receive data from the 2280 Series of Data Loggers.

Most of this section contains detailed information on using the Cartridge Tape Option and the 2280 Series built-in thermal printer.

PRINTER OPERATION

The 2280 contains a 40-column thermal printer that provides logging of multiple channels per line and can be programmed to plot values from one to four channels. While programming, the printer can be used to show available menu choices by simply pressing the MENU key. It is also available as an output device to LIST back the configuration program and the existent hardware.

Printer ON/OFF Settings

The 2280 printer has a separate power switch which must be turned to ON to be activated. It's located on the front right side of the printer drive board and can only be accessed when the printer drawer is pulled out. Push in the spring-loaded latch on the left side (just behind the printer window) and pull the drawer towards you. You'll see the ON/OFF switch. When the printer power switch is set to OFF, data sent to the printer will not be printed. The printer can be turned off without affecting the rest of the 2280 logging operation.

The printer ON/OFF switch provides a convenient method of selectively recording data onto the printer. Program the scan group so that all output goes to the printer and then turn the printer on only when you wish to record the data generated.

6/Printer Operation

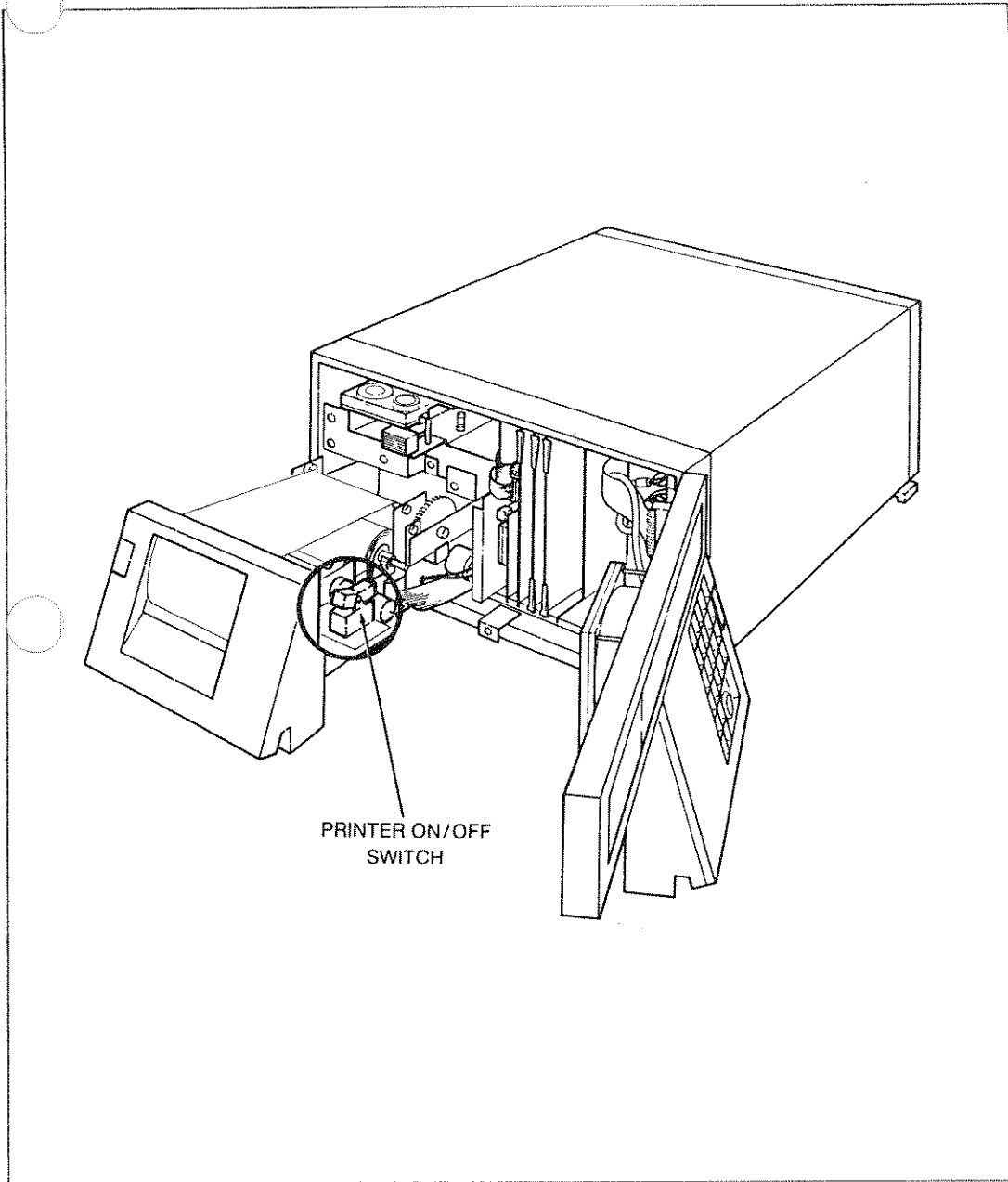

6/Printer Operation



6/Printer Operation

The Printer Operator Switch

The printer operator switch is accessed when the front panel printer door is open. The main printer switch must be ON before any of the paper switch settings are operable. The switch contains three settings. The bottom (TAKE UP OFF) and middle (TAKE UP ON) positions are stationary settings. The top position (PAPER ADVANCE) is spring-loaded, and must be held down to advance the paper.

PAPER ADVANCE

You can advance the printer paper by continuously pressing the printer button to the PAPER ADVANCE position. The paper continues to advance as long as the button is pressed. If data is being printed when PAPER ADVANCE is pushed, the 2280 finishes printing the current line first, and then advances the paper. While the paper is advancing, all data destined for the printer is held until the paper advance is terminated. No data is lost.

However, use of PAPER ADVANCE during plotting can cause one or more plot data lines to be lost.

TAKE UP OFF

This switch setting deactivates the motor powering the action of the take-up spindle. It has no effect on the printing of data. This setting allows you to go into the take-up spindle and examine previously printed data (or pull paper out of the roll) while the printer continues to log current data.

TAKE UP ON

This switch setting activates the motor that powers the take-up spindle. Thus, used printer paper is stored on the take-up spindle, to be removed when the paper on the supply spindle is exhausted.

6/Printer Operation

Printer Paper Removal and Loading

When a new paper supply must be loaded the following steps should be taken. Also, refer to the detailed illustration inside the printer door.

Release the printer "drawer" by pressing the printer slidelatch located to the left of and behind the printer cover door latch. Pull the printer out as far as it will come.

Deactivate the printer by moving the main printer power switch to the OFF position. This switch is located in the right corner of the Printer Drive Interface board.

PAPER REMOVAL

If used paper must be removed, tear it off at the serrated edge where the paper re-enters the inside of the printer. Locate the spring plate that holds the take-up spindle in place and pull this spring plate out with one hand while lifting the take-up spindle (with the used paper) out of its position.

Pinch the split end of the spindle together. (The spindle is opposite the gear). Slide the used paper off the take-up spindle and reinsert the spindle the same way you took it out.

Push the spring-loaded printer door latch (on the left side of the printer window) to the right and fold down the printer cover door.

Release the print head by pushing down on the print head release lever, located in the lower left corner of the printer's panel area.

Remove the supply spindle by putting your thumb on the thumb rest while pushing up on the spindle with your forefinger. Dispose of the old paper reel and any remaining paper.

6/Printer Operation

INSTALLING NEW PAPER

When you install the new roll of paper on the supply spindle make certain the loose end comes out from the bottom of the roll.

For best results, tear the loose end of the paper at a 45 degree angle, and insert it into the opening of the paper loading tray.

Use the slot in the tray to push the paper through the printer so the paper holds the switch arm down. Push the paper through until it slides past the print head and continues outside of the printer.

Once the paper is showing outside the printer, pull it out a few inches more. Run the paper through the return slot at the top of the printer, and pull it all the way back over the rear shaft.

Insert the paper through the slot in the take-up spindle. Secure it by turning the gear a few revolutions in a counterclockwise direction.

Secure the paper at the print head by pushing the print head release lever up into the operating position. Make sure the printer rocker switch is in the TAKE UP ON position.

Turn the main printer power switch to the ON position, close the printer cover door, and slide the printer back into the unit until it snaps into place.

Caution

We recommend that you use NCR T1302 or JUJO TP50KM-A paper in the 2280 printers. Both are available through John Fluke Mfg. Co., Inc. (Fluke Accessory Y2046) If any other type of paper is used, the printer warranty is voided.

6/Cartridge Tape Drive Operation

CARTRIDGE TAPE DRIVE OPERATION

The optional integrated DC-100 tape drive allows storage of system programs or logged data. Each tape is capable of storing approximately 500k bytes of information.

Data is stored on tape at the 2280's maximum operating speed with no holdups or throughput degradations. Stored data may be recalled at a later date and transferred to the system printer, or to an external computer or recorder by using the optional communication interfaces. The 2280 transfers data from tape at roughly 180 characters per second.

Programs saved onto tape allow the 2280 setup to be easily converted to different kinds of data acquisition configurations by simply loading a pre-defined program. Tape structures are file oriented for easy identification of stored programs.

Removal and Loading

Gain access to the cartridge tape slot in the front panel by gently lifting the bottom part of the cartridge drawer window. This causes the window to swing up and open.

To remove a tape, open the window and push the recessed button in the lower right corner of the opening. The tape will be ejected enough so you can get a grip on it and slip it the rest of the way out.

To load a tape simply open the window, and slide the cartridge into the slot until it is firmly in place.

6/Cartridge Tape Drive Operation

Operation

The Cartridge Tape Drive option has basically six functions performed by a programmer. They are,

- o Storing logged data.
- o Requesting a directory of stored files.
- o Deleting files on the tape.
- o Initializing the tape.
- o Writing a configuration program on the tape.
- o Loading a configuration program from the tape to the 2280.

Tape Format Programming

Instructions for programming the cartridge tape data storage in the format you want are provided in the scan group and output device programming portions of Section 3 of this manual.

Tape Functions

With the cartridge tape drive (Option -214) installed, you have a variety of tape functions available.

Tape functions can only be performed when all operating functions are turned off, the keyswitch is turned to the PROGRAM position, and the system is at the main menu.

6/Cartridge Tape Drive Operation

To request a tape function, press the T (TAPE) key in response to the main menu prompt. The system acknowledges with the prompt,

<T> PERFORM A TAPE FUNCTION

Press **ENTER** and the prompt becomes,

T: TAPE FUNCTION <1-6>? 1

You can now choose from six activities in the tape function menu. Press the **MENU** key to list the six choices onto the printer. The choices are,

- <1> TAPE DIRECTORY**
- <2> DELETE FILES TO END OF DIRECTORY**
- <3> INITIALIZE TAPE CARTRIDGE**
- <4> PROGRAM SAVE**
- <5> PROGRAM LOAD**
- <6> DIRECTORY OUTPUT DEVICE**

The following paragraphs describe how to use each tape function from the front panel.

LISTING TAPE DIRECTORIES

The first function available through the tape function menu is Tape Directory. Selecting this feature allows you to obtain a directory of all the files stored on a tape, both program and data files.

The directory is listed onto the printer, port A, or port B. The tape directory listing looks like,

FILE NAME	BLOCKS
DATA1	1
DATA2	5
PROG1	P 4

User program files that have been saved are indicated with a P in front of the file block size.

6/Tape Directory and Output Device Functions

SPECIFYING OUTPUT DEVICES

You may want to list a tape directory many times but will most likely use the same device each time.

To specify the output device you want a directory listing sent to, press **6** in response to the main tape function prompt. The system acknowledges with the display,

T<6> DIRECTORY OUTPUT DEVICE

Press **ENTER** and the prompt becomes,

DIRECTORY OUTPUT DEVICE <1-3>? 1

You can now choose which output device your directory will be sent to. Press **MENU** and you'll see the printer list the choices,

- <1> PRINTER**
- <2> PORT A**
- <3> PORT B**

Choose the device you want by pressing the corresponding number key, and press **ENTER** again.

6/Tape Directory and Output Device Functions

DELETE FILES TO THE END OF THE DIRECTORY

This function allows you to selectively delete the files on a tape from a specified file to the end of the tape.

To do so, enter the tape function menu from the main menu by pressing **T**, followed by **ENTER**, and then select function 2. The system will acknowledge with,

T<2> DELETE FILES TO END OF DIRECTORY

Press the **ENTER** key. The display reads,

FILE NAME =

Enter the file name that you want to start with in deleting files to the end of the directory. Remember, this is the first file to be deleted, NOT the last file to be saved.

Key in the file name and press **ENTER**. The system will begin deleting starting with the file specified, to the end of the directory. When finished, the 2280 will return to the main tape function menu prompt.

6/Tape Directory and Output Device Functions

INITIALIZING A TAPE

When performed on a blank tape, this function simply prepares the tape to accept data. When performed on a tape that already contains data or program information, all existing files are erased first and then the tape is initialized. Make sure there's nothing on the tape you want saved before you initialize it.

To initialize a tape, insert it and press 3 from the main tape function menu, followed by **ENTER**. The prompt reads,

T<3> INITIALIZE TAPE CARTRIDGE

Press **ENTER** again and the display becomes,

REALLY INITIALIZE TAPE <Y,N>? N

This step is a reminder that initialization deletes all existing files on the tape. Double check the tape. If there's doubt as to the contents of the tape, press **ENTER** to return to the main menu. From there you can obtain a directory listing of the tape to verify its contents. If the inserted tape is one you want, press **Y** in response to the above prompt and then press **ENTER**. When initialization is complete, the system returns to the main menu display again.

6/Tape Directory and Output Device Functions

SAVING A PROGRAM ONTO TAPE

This function allows you to save a configuration program onto a cartridge tape for future use. The program is written on the tape as a specific program file, and must be given a name at the time the save function is performed. This name should be recorded on the 2280 Series Programming Form for future reference.

When the entire configuration program on the programming form has been correctly entered into the 2280 memory, insert a properly labeled and initialized tape. The program can be saved onto tape by pressing **4** from the tape function menu. When the display reads,

T<4> PROGRAM SAVE

press **ENTER**. At the prompt,

FILE NAME =

Enter the name you want the program file to be saved under on the tape.

When you've keyed in the program name (up to 10 characters), press **ENTER**. The system will then write the entire configuration program onto the tape and, when it's finished, return to the main menu. The tape can now be removed and stored, or used to configure any 2280 Data Logger.

Use the **EXIT** key to abort the save operation. Once aborted, the file should be deleted from the cartridge tape.

6/Tape Directory and Output Device Functions

LOADING A PROGRAM FROM A CARTRIDGE TAPE

This function allows you to transfer an entire configuration program from a tape cartridge into the 2280 memory, thus preparing the instrument for data acquisition and processing.

First, retrieve the tape cartridge containing the desired configuration program, and insert it into the 2280. From the main menu prompt, access the tape function menu by pressing **T** and then **ENTER**.

Choose program load by pressing **5** in response to the main tape function menu. The system acknowledges with the prompt,

T<5> PROGRAM LOAD

Press **ENTER** and the display reads,

FILE NAME =

Key in the name of the program file you wish to load into 2280 memory. This is the name that was given the program at the program save function. Press **ENTER** and the 2280 will load that program from the tape cartridge. When finished, the system returns to the main menu prompt. The 2280 is now programmed for data logging.

Use the **EXIT** key to halt the load operation. Using **EXIT** however, leaves you with a partially programmed instrument. You can erase this partial program with the **E** (erase) function.

6/Tape Directory and Output Device Functions

DATA TRANSFER OPERATION

The data transfer function allows you to transfer a data or program file from one of three source devices.

- o Parallel I/F programmed as a mag tape at port A.
- o Parallel I/F programmed as a mag tape at port B.
- o Cartridge tape drive to one of three destination devices--the printer, or optional devices at either port A or port B.

If the cartridge tape drive is selected as the source device, you need to input the specific name of the file to be transferred. If the file is a data file, the logged data recorded within a time window may be singled out later for transfer.

If you choose not to enter specific start and stop times for a data transfer (when the cartridge tape is the source device), then all of the data in the file is transferred. The data transfer function continues until completed, or until the EXIT key is pressed. When you are transferring a program file, start and stop times are not relevant.

To start a data transfer procedure, press the D (DATA TRANSFER) key in response to the main menu prompt. The system acknowledges with the prompt,

<D> TRANSFER DATA

Press the ENTER key and the display becomes,

D: SOURCE DEVICE <1-3>? 1

6/Tape Directory and Output Device Functions

You can now choose which of the three possible source devices you intend to use. Pressing the **MENU** key will show that the three choices are,

<1> CARTRIDGE TAPE DRIVE

<2> PORT A

<3> PORT B

Choose the desired source device by pressing the appropriate number key. The display then shows the choice taken. Press **ENTER** to record it, and then use the **EXIT** key to return to the main menu.

OUTPUT FORMAT EXAMPLES

Measurement data generated during a scan sequence can be sent to the front panel display, internal printer, cartridge tape, or to an external data recording device or computer using an RS-232 or IEEE-488 interface installed in port A or B. The data formats for the recording devices are very similar. An example of the output format is shown below.

Line Number	Output
1	
2	
3	BEGIN SCAN GROUP 1 01 JAN 82 12:28:51
4	ENGINE PERFORMANCE TEST
5	
6	C 1 RUN SPEED 750.3 RPM ALM
7	RPM TOO LOW
8	C 2 EXHAUST MAN 390.3 DEGREES C
9	
10	END SCAN GROUP 1 01 JAN 82 12:28:54

6/Tape Directory and Output Device Functions

This format is determined by the cartridge tape, or port A or B format selections made in output device programming. The components of this output are further explained in the following table.

In all lines, the following conventions are used:

- o (lts) is used to represent the output of the programmed line termination sequence. The default is carriage return followed by line feed.
- o The symbols H, B, C, A, and E are the data type indicators and will be output if the recording of data type indicators has been enabled.
- o (sods) represents the start of data sequence.
- o (eods) represents the end of data sequence.

Line Number	Output and Explanation
-------------	------------------------

1	H(lts)
---	---------------

A blank line.

2	H(lts)
---	---------------

A blank line.

3	(sods)B BEGIN SCAN GROUP n dd mm yy hh:mm:ss(lts)
---	--

If (sods) is programmed, it will be output at the beginning of each BEGIN SCAN line.

6/Tape Directory and Output Device Functions

Line Number	Output and Explanation
4	H(scan group label)(lts) This line will be output if a scan group label has been programmed.
5	H(lts) A blank line.
6	C Cnnnn label -x.xxxx units ALM(lts) This is a channel reading. The characters ALM will be recorded at the end of the line if any of the channels limits have been exceeded. This line, and the one following (if appropriate) will be recorded for each channel in the scan group's channel list.
7	A(channel alarm message)(lts) This line is output if a limit (with programmed alarm message) is exceeded.
8	C Cnnnn label -x.xxxx units ALM(lts) Another channel reading.
9	H(lts) Another blank line.
10	E END SCAN GROUP n dd mmm yy hh:mm:ss(lts)(eods) The last line of a scan group output. If (eods) is programmed, it will be output last.

6/Tape Directory and Output Device Functions

RETENSIONING CARTRIDGE TAPES

For proper operation, cartridge tapes should periodically be retensioned. Retensioning means running the tape forward to the end and then rewinding it. This can be accomplished by using the Data Transfer Operation.

Transferring the dummy file named TENSION123 from the cartridge tape to the printer will cause the tape to wind forward to the end and then rewind. No data is actually transferred.

Section 7

Programming and Operation From a Terminal or Computer

CONTENTS

Introduction	7-3
Required Hardware	7-3
Front Panel and Remote Control	7-4
Prompting and Concise Command Modes	7-7
More on Concise Commands	7-9
Character Set	7-11
Special Characters Used With RS-232	7-13
Programming/Operating With an RS-232	
Terminal	7-14
Getting Started	7-14
Remote Access and Lockout	7-15
Entering the Prompting Mode	7-17
Special Commands	7-18

Programming/Operating With an RS-232	
Computer	7-20
Getting Started	7-20
Remote Access and Lockout	7-22
Concise Command Strings	7-23
Special Commands	7-23
Programming Examples	7-24
Erasing Program Memory	7-24
Programming a Scan Group	7-26
Programming a Channel	7-26
Transferring Data Recorded on	
Cartridge Tape	7-27
Collecting Data From a Single Scan	7-28
Programming Hints and Suggestions	7-29
Start and Complete Each Command	
at the Main Menu	7-29
Don't Execute the Diagnostics From	
Remote	7-29
Programming/Operating With an IEEE-488	
Computer	7-30
Getting Started	7-30
IEEE-488 Functional Capabilities	
Supported	7-31
Concise Command Strings	7-31
IEEE-488 Unique Commands	7-32
IEEE-488 Interface Commands	7-37
Serial Poll	7-38
Programming Examples	7-39
Programming Hints and Suggestions	7-39
Read All the Data You Ask For	7-39

INTRODUCTION

Once you've become comfortable programming and operating the 2280 Series Data Logger from the front panel keypad, it will be easy to carry the same principles over to a situation where the data logger is controlled from a terminal or a computer. The commands used to program and operate the data logger from remote are identical to those used from the front panel keypad.

REQUIRED HARDWARE

Remote control of the 2280 Series Data Loggers can be accomplished using either serial or parallel communication. The 2280A-341 RS-232 interface option provides an RS-232 capability in addition to 20 mA current loop.

The 2280A-342 IEEE-488 interface option is the parallel interface. The interface option used for remote control must be installed in the port A position; the port B position is used for data output only. Port A is the vertical slot closest to the center and furthest away from the power supply when viewed from the rear of the instrument.

For brevity, this section refers to RS-232 communication only. Current loop operations are functionally identical to RS-232.

7/Front Panel and Remote Control

FRONT PANEL AND REMOTE CONTROL

The 2280 can be programmed and operated from the front panel keyboard or from a terminal or computer. Front panel operation is referred to as **local control** and terminal or computer operation is referred to as **remote control**. The 2280's can successfully be operated either locally or in remote but not by a mixture of both modes. Therefore, we must have some means of establishing and controlling whether the instrument is to respond to local or remote commands.

Figure 7.1 presents an overview of the remote-local state transitions. When the 2280 is initially turned on it enters the local state and the front panel keypad is used to program or operate the instrument. If remote control is desired, you need to switch the instrument from the local state to remote, or to the remote with lockout state. The method of causing this change to occur depends on the type of interface used.

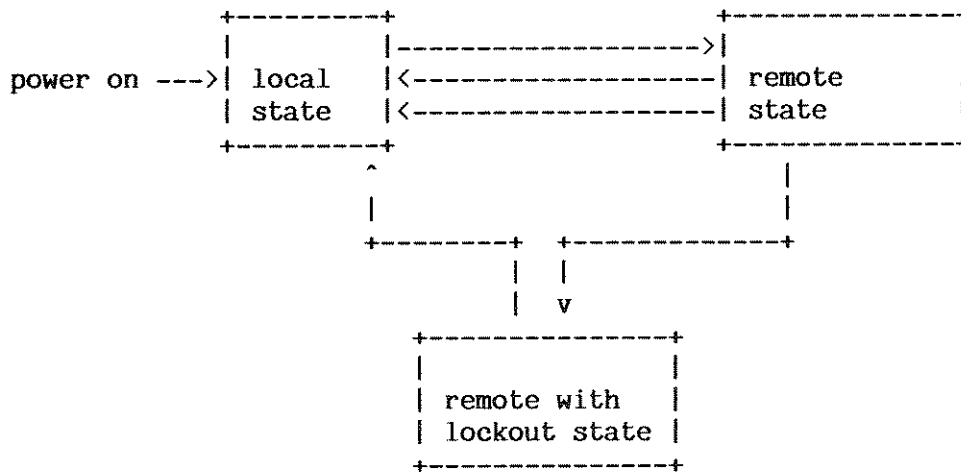

Figure 7.1 General Remote-Local State Diagram

7/Front Panel and Remote Control

With the RS-232 interface non-printing control characters, control-W, control-X, control-Y and control-Z are used. The IEEE-488 communication standard directly supports the remote-local state changes using messages defined within the standard.

In the local state, control of the instrument is through the front panel keyboard. The remote state allows control of the instrument from the computer or terminal connected at port A. All programming and operation of the 2280 is done using the terminal or the computer and most front panel controls are inoperative.

When the 2280 first enters the remote state, the front panel display will read,

IN REMOTE

While in remote, the LED indicator on the LOCAL key is illuminated and it becomes the only operative front panel key. Pressing LOCAL returns control of the instrument to the front panel keyboard. If any other key is pressed the internal beeper sounds three times to indicate that the key is inoperative.

The remote with lockout state is very similar to the remote state except that the LOCAL key also becomes inoperative. Control of the 2280 cannot be taken away from the terminal or computer using the front panel keypad. If LOCAL is pressed while the 2280 is in remote with lockout, the front panel display will read,

IN REMOTE WITH LOCKOUT

7/Front Panel and Remote Control

When local is entered again and control is returned to the front panel keypad, the light indicator on the LOCAL key is extinguished. If the keyswitch is in the PROGRAM position, the message,

MAIN MENU CHOICE <M FOR MENU>? A

appears on the display. If the keyswitch is in the RUN position, the display reads,

SELECT RUN MODE OPERATION

When control is returned to local, front panel operations and programming begin at the first menu regardless of the menu that was active when the return to local took place. This is also true when entering the remote state. Remote is entered at the main menu regardless of what menu level was active.

When the terminal or computer puts the 2280 into the remote control state the output timeout function for port A is disabled. Timeouts are described in Section 3 of this guide.

Programming and operating from remote using an RS-232 terminal or computer, or an IEEE-488 computer are described in detail in the following paragraphs.

7/Front Panel and Remote Control

PROMPTING AND CONCISE COMMAND MODES

There are two modes of remote control available with the 2280 Series of Data Loggers. One, called concise command mode, is used when the instrument is controlled using a computer. The other, called prompting mode, is used when the instrument is controlled using a terminal.

Concise mode involves the computer sending a string of characters to the 2280 to perform some function, and then reading back a response from the 2280 indicating whether the command was successful or not.

The following example illustrates that to program 2280 channel 100 to the 512 mV range, the computer would send the character string,

```
!A,100,P,D,3,!<carriage return>
^^^ ^^^^^^^^ ^
||| | ||||| | |
||| | ||||| | +- terminate the command
||| | ||||| | +---- return to main menu
||| | ||||| | +----- ENTER key
||| | ||||| | +----- 512.00 MVDC range
||| | ||||| | +----- ENTER key
||| | ||||| | +----- DC RANGE
||| | ||||| | +----- ENTER key
||| | ||||| | +----- PROGRAM the channel
||| | ||||| | +----- ENTER key
||| | ||||| | +----- channel 100
||| | ||||| | +----- ENTER key
||| | ||||| | +----- select CHANNEL PROGRAMMING
||| | ||||| | +----- return to the main menu
```

7/Prompting and Concise Commands

When received, the 2280 responds with the string,

:<lts>

where <lts> is used to indicate the programmed line termination sequence programmed for port A.

The prompting mode is very similar to front panel operation. All prompts and menu listings normally sent to the front panel are sent instead to the terminal.

For example, to program 2280 channel 100 to the 512 mV range, you would type the characters in response to the prompts appearing on the terminal as follows.

Terminal Prompt	Character(s) Typed
MAIN MENU CHOICE <M FOR MENU>? A	A
<A> PROGRAM A CHANNEL OR BLOCK	<return>
CHANNEL NUMBER (OR BLOCK) = C0	100<return>
PROGRAM COPY DELETE OR LIST<P,C,D,L>?P	P<return>
A: CHANNEL FUNCTION <A-Z>? P	D
A<D> DC VOLTS/CURRENT	<return>
AD: DC RANGE <1-5>? 1	3
AD<3> 512.00 MVDC	<return>
AD: CHANNEL MENU CHOICE <1-5>? 1	^
A: CHANNEL FUNCTION <A-Z>? D	^
CHANNEL NUMBER (OR BLOCK) = C100	^
MAIN MENU CHOICE <M FOR MENU>? A	

If you're using a computer for remote control you'll want to use the concise command mode. Use the prompting mode when the 2280 is programmed and operated interactively using a terminal. These operating characteristics are explained in more detail further on in this section of the manual.

The prompting mode is only available using the RS-232 interface. The IEEE-488 interface does not provide prompting mode.

7/Prompting and Concise Commands

More on Concise Commands

The following paragraphs describe concise command mode operation. They should be read and understood before you start programming a computer to control the 2280 from remote. The material is of a reference nature so skip ahead if you're reading this just to gain overall familiarity with the 2280's remote operation.

Concise command strings consist of a sequence of characters that are equivalent to keys that would be pressed on the 2280 front panel keypad to perform a particular programming or operating function. For example, the concise command for front panel keys,

L ENTER E ENTER would be, L,E,<cr>

with <cr> being the carriage return character.

A concise command must end with a carriage return and optional line feed character. The 2280 doesn't begin execution of the concise command until the carriage return is received. Within a concise command, the command character ' , ' is synonymous with the front panel ENTER key.

During execution of concise commands, all characters sent from the computer or terminal are discarded. The computer waits for the current concise command to complete before sending another command. The device clear and return to local single character commands are exceptions to this--they can both be sent from the computer at any time.

After a concise command has completed, a colon ':' character followed by the programmed line termination sequence is sent to the computer to indicate that the command has completed. This informs the computer that the next command can be sent. The colon character followed by the programmed line termination sequence is referred to as the command completion prompt.

7/Prompting and Concise Commands

When an error is detected during the execution of a concise command, the remainder of the command string is discarded. One or more error messages (lines of text terminated with the programmed line termination sequence) will be sent to the computer before the command complete prompt.

A concise command may be aborted at any time. A command in execution or a command only partially sent from the computer can be aborted by sending a device clear, or by performing a remote control to local control change.

There is no command completion prompt sent if the command is aborted. However, it's possible the device clear or remote-local change was sent just after the completion of the concise command. In this case the completion prompt may have been sent but not yet received by the computer. Therefore, your computer program must be prepared to receive some or no characters if a command is aborted while in execution. Also, note that the command will have been executed to the point where the command was aborted.

Concise command strings have a maximum length of 80 characters. If more than 80 characters are received before the command ending carriage return character, the command will be discarded, an error reported (?COMMAND TOO LONG), and the command completion prompt sent. The error message and completion prompt is sent after the command ending carriage return character is sent by the computer.

Sending the '\$' character to the 2280 when in the concise command mode (RS-232 interface only) also aborts the command. The concise command mode is automatically enabled when the remote state is entered.

7/Prompting and Concise Commands

Character Set

Commands used in programming or operating the 2280 from a terminal or computer are very similar to the commands typed on the front panel keypad. For example, the terminal or computer sending the ASCII character 'A' to the 2280 is the same as depressing the 'A' key on the front panel keypad. Most keys on the front panel keypad have a one for one equivalence to ASCII characters. A close look at the front panel keypad shows keys labeled SCAN, SINGLE SCAN, MONITOR, PLOT, and these keys don't have directly equivalent ASCII characters.

Table 7.1 identifies the relationship between front panel keypad labels and ASCII characters. The end of the table has some additional characters that are meaningful when controlling the 2280 from a terminal or computer. These characters are included in the table for reference and are explained in greater detail in the following paragraphs.

7/Prompting and Concise Commands

Table 7.1 ASCII Character Equivalents for Front Panel
Keyboard Keys and Other Important Codes

2280 Keyboard		
Key (or Function Performed)	ASCII	Decimal Code
SPACE	SPACE	32
*	*	42
+	+	43
-	-	45
/	/	47
0 through 9	0 through 9	48 through 57
=	=	61
A through Z	A through Z	65 through 90
SCAN	&	38
SINGLE SCAN	#	35
PLOT	;	59
MONITOR	%	37
ACK	@	64
EXIT	^	94
CLEAR	\	92
Up Arrow	[91
Down Arrow]	93
Left Arrow	<	60
Right Arrow	>	62
ENTER	<return> (Prompting)	13
	, (Concise)	46
DELETE CHARACTER	DEL	127
Return to Main Menu	!	33
Send System Status	"	34

7/Prompting and Concise Commands

Special Characters Used With RS-232

Several characters are required to program and operate the 2280 using the RS-232 option that don't appear on the instrument front panel. These characters are listed in table 7.2. Uses of most of the special characters are described later in this section.

Two of the characters, Control-S and Control-Q, allow the computer or terminal to pause and continue the output of data from the 2280 RS-232 interface. This flow control capability can be used by the computer to temporarily stop the 2280 from sending data if the 2280 is sending data too fast.

Table 7.2. RS-232 Special Command Characters

2280 Function Performed	Equivalent ASCII Character	Decimal Code
Enter Prompting Mode	\$	36
Send System Status	"	34
Device Clear	Control-C	3
Local to Remote	Control-X	24
Remote to Local	Control-Y	25
Remote to Local	Control-Z	26
Remote to Remote With Lockout	Control-W	23
Remote With Lockout to Local	Control-Z	26
Stall data output	Control-S	19
Unstall data output	Control-Q	17

7/Programming and Operating With An RS-232 Terminal

PROGRAMMING/OPERATING WITH AN RS-232 TERMINAL

Getting Started

It'll be easier for you to become familiar with programming and operating the 2280 from an RS-232 terminal if you take the steps described in the paragraphs below. First of all, verify that the 2280 can communicate with your terminal.

1. Make certain the 2280A-341 RS-232 interface option is installed in the port A position. This is the vertical slot nearest the center of the instrument when viewed from the rear.
2. Next, turn on the 2280 and set the front panel keyswitch to the PROGRAM position. Using the output device programming module, program the baud rate and parity of port A to match your terminal settings. The 2280 sends and receives seven data bits and one parity bit. If no parity is selected the parity bit position is always sent as zero.
3. Connect a cable between the RS-232 connector on the port A RS-232 option and your terminal.
4. Type a SPACE character and look for:

?TYPE CTRL-X FOR REMOTE CONTROL

If no message appears, your cable probably isn't making the proper connections between the terminal and the 2280A-341 RS-232 interface option. The problem is usually solved by swapping pins 2 and 3 (data transmit and receive) on one of the cable ends. If some other message appears (usually nonsense character sequences) the baud rate of the terminal and the 2280 are probably different and need to be corrected. Once you can get the above message displayed you're ready to proceed.

7/Programming and Operating With An RS-232 Terminal

Remote Access and Lockout

To program or operate the 2280 from a terminal the terminal first has to gain control of the instrument. As shown in the RS-232 remote/local state diagram (Figure 7.2), the terminal sends the Control-X character to put the instrument into remote. This makes all keys on the 2280 front panel inoperative except the LOCAL key.

While in the remote state, press the front panel LOCAL key to override the terminal and return programming and operating control to the front panel keypad. The remote-local state diagram shows what characters need to be typed from the terminal to move from the remote with local lockout state and cause other state transitions.

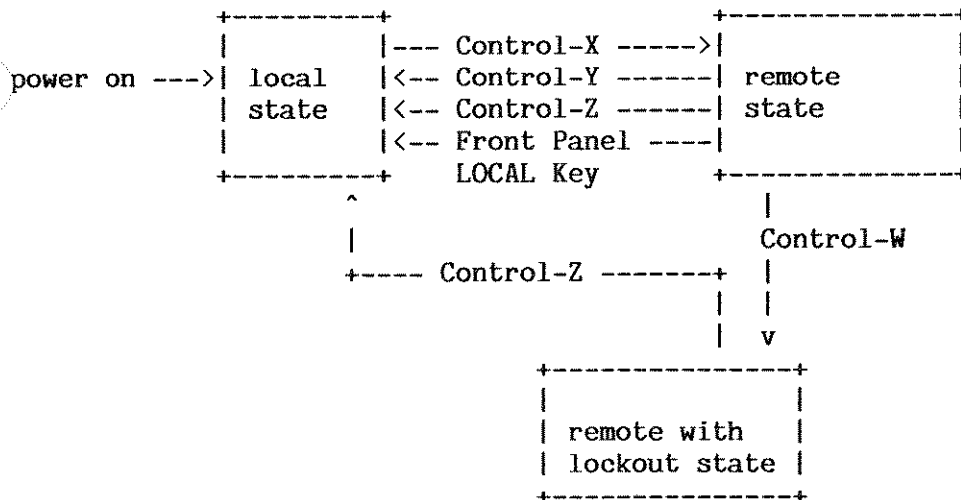

Figure 7.2 RS-232 Remote-Local State Diagram

7/Programming and Operating With An RS-232 Terminal

As an example, turn the 2280 keyswitch to the PROGRAM position and type the SPACE character on your terminal. Your terminal screen will read,

?TYPE CTRL-X FOR REMOTE CONTROL

and the front panel display on the data logger will read,

MAIN MENU CHOICE <M FOR MENU>? A

Type Control-X from the terminal. The 2280 display will now show,

IN REMOTE

You've successfully entered the remote state. Now type Control-Y or Control-Z. The 2280 display reads,

MAIN MENU CHOICE <M FOR MENU>? A

You've successfully returned control of the 2280 to the front panel keypad.

7/Programming and Operating With An RS-232 Terminal

Entering the Prompting Mode

Once you've changed programming and operation control of the 2280 from the front panel to the terminal by typing Control-X, the next step is to put the instrument into the prompting command mode. This allows the 2280 to be programmed and operated in very nearly the same way as it is operated from the instrument front panel.

When the instrument first enters the remote state the command mode defaults to concise mode. To enter the prompting mode, type the dollar sign (\$) character. The terminal screen should display the message,

```
MAIN MENU CHOICE <M FOR MENU>? A
```

Now programming and operation can proceed in the same fashion as front panel keypad operation. All menus requested while in the prompting mode are sent to the terminal instead of the 2280 printer. A useful feature for beginning programmers is the auto menu enable. This displays the current menu each time a new set of menu choices are available. Table 7.1 is a handy reference to determine what keys on your terminal access 2280 functions.

7/Programming and Operating With An RS-232 Terminal

Special Commands

There are two commands available through RS-232 remote terminal programming and operation that are not accessible through the 2280 front panel keypad.

STATUS COMMAND (")

The status command causes the 2280 to send information indicating what operating modes are currently active. You can see which of these are active when operating from the front panel by looking at the corresponding light indicators on the SCAN, SINGLE SCAN, PLOT, MONITOR, and ACK keys.

The status command consists of the double quote character '"'. It is recognized by the 2280 when the system is at at the main menu only. When the command is sent from the terminal, the 2280 sends a single character followed by the line termination sequence programmed for the port A device. The single character will be coded as follows.

(least significant bit)	bit 0	always a 1
	bit 1	ALARM indicator (ACK key)
	bit 2	MONITOR indicator
	bit 3	PLOT indicator
	bit 4	SINGLE SCAN indicator
	bit 5	SCAN indicator
	bit 6	always a 1
(most significant bit)	bit 7	always a 0

7/Programming and Operating With An RS-232 Terminal

The bit positions corresponding to the indicator are a one when the indicator is on and a zero when it's off. The resulting character value will be somewhere in the range from decimal 64 (hex 40) to decimal 127 (hex 7F).

DEVICE CLEAR COMMAND (Control C, decimal value 3)

The device clear command provides a mechanism to reset the 2280 to a known condition. This command can be issued at any time; it's not a main menu command. The device clear is a single Control-C character.

When the 2280 receives the device clear it,

1. Turns off scanning, plotting, single scan, and monitor.
2. Aborts any auxiliary function such as list, data transfer, load, and save.
3. Turns off the ALARM LED.
4. Resets all status outputs and analog outputs to their power up conditions.
5. Returns to the MAIN MENU CHOICE <M FOR MENU>? A or SELECT RUN MODE OPERATION prompt.

7/Programming and Operating With An RS-232 Computer

PROGRAMMING/OPERATING WITH AN RS-232 COMPUTER

Getting Started

The first thing you want to accomplish when using a computer to control the 2280 from remote is to ensure that the computer and the 2280 can exchange characters using their RS-232 interfaces. Perform the following steps to verify that the computer and the 2280 work together.

1. Make sure that the 2280A-341 RS-232 interface option is installed in the port A position. This is the vertical slot nearest the center of the instrument as viewed from the rear.
2. Connect a cable between the RS-232 connector on the port A RS-232 option and your computer or modem.
3. Next, turn on the 2280 and turn the keyswitch to the PROGRAM position. Using the output device program module, program the baud rate and parity of port A to match the setting of your computer interface. The 2280 sends and receives seven data bits and one parity bit. If no parity is selected the parity bit position is always sent as zero.
4. Write a short program on your computer that sends a character to the 2280. Have the program send a Control-X (decimal value 24) to the 2280.

7/Programming and Operating With An RS-232 Computer

5. Verify that the 2280 front panel displays the message,

IN REMOTE

If this prompt isn't displayed the cables probably aren't properly connected between the computer and the 2280A-341 RS-232 interface option. The problem is almost always solved by swapping pins 2 and 3 (data transmit and receive) on one of the cable ends. You may want to double check the baud rate settings too.

Once you get the above message displayed you have verified the ability of the 2280 to receive characters sent from the computer.

6. Turn the 2280 power switch off, then on, or press the LOCAL key on the front panel keypad. This puts the instrument back into the local state.

Write a short program on your computer that will receive a character from the 2280. Using it and the program from step 4, send a Control-X character and then a carriage return character to the 2280, and then read the characters from the 2280. The 2280 will send,

:<lts>

to the computer where <lts> is the line termination sequence for port A. If you haven't reprogrammed the line termination sequence it will consist of the two character default value which is the carriage return character followed by the line feed character.

When the above steps are successfully completed, you've demonstrated that the computer can receive characters from the 2280.

7/Programming and Operating With An RS-232 Computer

Remote Access and Lockout

Operations required for a computer to take control of the data logger are identical to those used when a terminal is controlling the 2280. These steps are summarized in Figure 7.3.

Most state transitions are caused by single characters sent from the computer to the 2280. The front panel LOCAL key can be used to move from the remote state to the local state. The 2280 does not send any characters in response to receiving the single character commands.

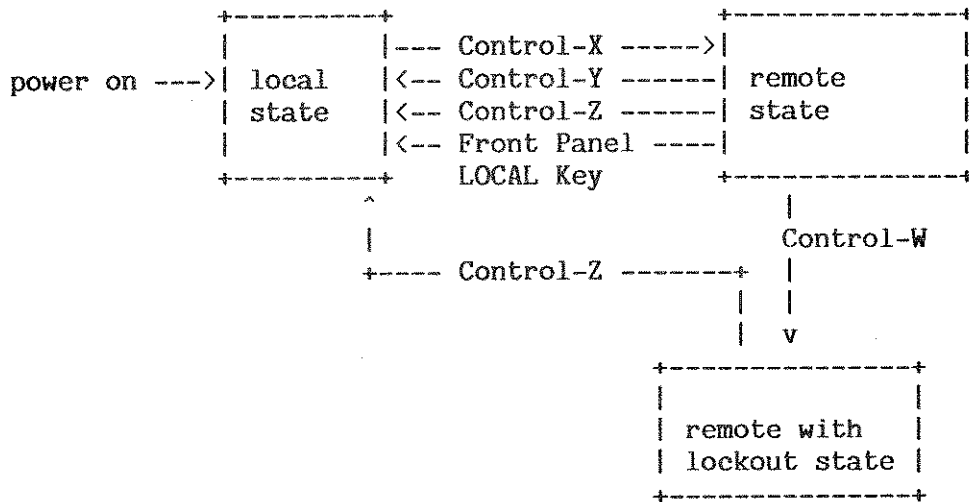

Figure 7.3 RS-232 Remote-Local State Diagram

Concise Command Strings

When a computer is used to control the 2280, concise commands should be used. The detailed description of the concise command mode operation that appears earlier in this section should be read before you begin writing computer programs to control the 2280.

7/Programming and Operating With An RS-232 Computer

Special Commands

There are two commands available through RS-232 remote computer programming and operation that are not accessible through the 2280 front panel keypad.

STATUS COMMAND ("`<carriage return>`")

The status command causes the 2280 to send information indicating what operating modes are currently active. From the front panel you can see which of these are running by looking at the corresponding light indicators on the SCAN, SINGLE SCAN, PLOT, MONITOR, and ACK keys.

The status command consists of the double quote character (") followed by the carriage return character. It's recognized by the 2280 at the main menu only.

When the command is sent from the computer, the 2280 sends a single character followed by the line termination sequence programmed for the port A device and the ':', followed by the line termination sequence, to indicate the completion of the concise command. The single character containing the status information are coded as follows.

(least significant bit)	bit 0	always a 1
	bit 1	ALARM indicator (ACK key)
	bit 2	MONITOR indicator
	bit 3	PLOT indicator
	bit 4	SINGLE SCAN indicator
	bit 5	SCAN indicator
	bit 6	always a 1
(most significant bit)	bit 7	always a 0

7/Programming and Operating With An RS-232 Computer

The bit positions corresponding to the indicator are a one when the indicator is on and a zero when it's off. The resulting character value will be somewhere in the range from decimal 64 (hex 40) to decimal 127 (hex 7F).

DEVICE CLEAR COMMAND (Control C, decimal value 3)

The device clear command provides a mechanism to reset the 2280 to a known condition. This command can be issued at any time--it's not a main menu command. The device clear is a single Control-C character. There's no response and the 2280 sends no characters to the device clear command.

When the 2280 receives the device clear it,

1. Turns off scanning, plotting, single scan, and monitor.
2. Aborts any auxiliary function such as list, data transfer, load, and save.
3. Turns off the ALARM LED.
4. Resets all status outputs and analog outputs to their power up conditions.
5. Returns to the MAIN MENU CHOICE <M FOR MENU>? A or SELECT RUN MODE OPERATION prompt.

Programming Examples

The following program is written in BASIC to run on the Fluke 1720A Instrument Controller. Translation of the program to run on any computer is easily accomplished.

ERASING PROGRAM MEMORY

This sample program puts the 2280 into remote, erases program memory, and then returns control to the instrument front panel.

7/Programming and Operating With An RS-232 Computer

```
10 ! open rs-232 port 0 on the 1720 for output to the 2280
20 OPEN "KBO:" AS NEW FILE 1%
30 !
40 ! open rs-232 port 1 on the 1720 for input from the 2280
50 OPEN "KBO:" AS OLD FILE 2%
60 !
70 ! put the 2280 into the remote state by sending a
80 ! a Control-X character (decimal 24). send one
90 ! character only.
100 PRINT #1%, CHR$(24%);
110 !
120 ! send the concise command to the 2280
130 PRINT #1, "!E,Y,!"
140 !
150 ! read the response to the command
160 INPUT LINE #2%, R$
170 !
180 ! if this is not the last line of the command
190 ! response, read more lines until we encounter the
200 ! one starting with the colon character
210 IF (LEFT(R$,1%) <> ":") THEN GOTO 150
220 !
230 ! return control to the front panel keypad
240 ! by sending a Control-Z character (decimal 26).
250 PRINT #1%, CHR$(26%);
260 !
270 END
```

7/Programming and Operating With An RS-232 Computer

PROGRAMMING A SCAN GROUP

Programming a scan group is a simple extension of the above program. If you wanted a scan group with the following attributes,

Scan Group Number:	0
Channel List:	0..99
Trigger Mode:	Interval 10 second period
Data Output:	Cartridge Tape all data

You can program this scan group by replacing line 130 of the sample BASIC program with the line,

```
130 PRINT #1,"!K,0,P,2,C0..99,,3,2,00:00:10,4,3,2,!"  
(carriage return)
```

PROGRAMMING A CHANNEL

Programming a channel is straight forward also. To program channel 0 as a current input with the measurement scaled such that a 4mA input will be recorded as 0.0 and a 20mA input as 500, with engineering units of PSI, replace line 130 of the previous sample program with the line,

```
130 PRINT #1, "!A,0,P,D,5,2,PSI,3,CX*31.25-125,!"  
(carriage return)
```

7/Programming and Operating With An RS-232 Computer

TRANSFERRING DATA RECORDED ON CARTRIDGE TAPE

To transfer recorded data on the cartridge tape, a program must perform the following steps.

1. Send the command to the 2280 to initiate the data transfer. The command will be something like,

```
!D,1,<file name>,<start data>,<start time>,  
  <end date>,<end time>,2,!<carriage return>
```

where <file name> is the name of the file to be transferred, and the <start ...> and <end ...> are sent if only a portion of the recorded file is to be transferred. All the comma characters must be included in the command. This initiates the transfer of data.

2. Read the data back a line at a time.
3. Read data lines until a line beginning with the ':' character is encountered signifying the completion of command execution.

7/Programming and Operating With An RS-232 Computer

COLLECTING DATA FROM A SINGLE SCAN

It's a little more involved to collect data output to port A from a single scan. First of all, the scan group must be programmed (from either the front panel or from remote) to output data to port A. Then the remote computer program must perform the following steps.

1. Start the single scan. The following command string starts a single scan on group 0.

```
!#0,!<carriage return>
```

2. Read back the command completion prompt from the above command. If no errors were encountered, it will be the string,

```
:<lts>
```

3. Now read the data from the single scan. Read lines one at a time. The last line of the scan group output data will be of the form,

```
STOPPED SINGLE SCAN 0 JAN 00 00:00:00
```

Your program must look for a string starting with 'STOPPED SINGLE' in each of the lines of data and stop reading data when this line is encountered.

7/Programming and Operating With An RS-232 Computer

Programming Hints and Suggestions

START AND COMPLETE EACH COMMAND AT THE MAIN MENU

To avoid confusion regarding menu position, it's best to always begin and end each command execution at the main menu. Each command should have the following general format.

! <command characters> !<carriage return>

As an example, the character sequence,

!E,Y,!<carriage return>

will erase the program memory within the 2280. The first and the last '!' characters returns programming to the main menu.

DON'T EXECUTE THE DIAGNOSTICS FROM REMOTE

The system diagnostics were designed to work from the front panel only and they won't work properly if executed from remote.

7/Programming and Operating With an IEEE-488 Computer

PROGRAMMING AND OPERATING WITH AN IEEE-488 COMPUTER

Getting Started

First, when using a computer to control the 2280 from remote, ensure that the computer and the 2280 can exchange characters using their IEEE-488 interfaces. Perform the following steps to verify that the computer and the 2280 work together.

1. Make sure that the 2280A-342 IEEE-488 interface option is installed in the port A position. This is the vertical slot nearest the center of the instrument as viewed from the rear.
2. Select the IEEE-488 bus address for the 2280 by positioning the thumbwheel switches on the rear panel of the 2280A-342 IEEE-488 interface.
3. Connect a shielded IEEE-488 cable between the IEEE-488 connector (port A) and your computer.
4. Next, turn the keyswitch to the PROGRAM position.
5. Write a short program on your computer that puts the 2280 into remote. The program needed to do this depends on the computer you're using. For example, if you were using the Fluke 1720A Instrument Controller executing the BASIC language statement,

```
10 REMOTE @2%
```

puts the IEEE-488 instrument with bus address 2 into the remote state.

6. The 2280 front panel display should read,

```
IN REMOTE
```

With this message, you've demonstrated that the computer used can communicate with the 2280.

7/Programming and Operating With an IEEE-488 Computer

IEEE-448 Functional Capabilities Supported

The 2280A-342 IEEE-488 interface supports the following IEEE-488 functional subsets when installed in the port A position.

SH1	Source Handshake	complete capability
AH1	Acceptor Handshake	complete capability
T5	Talker	talk only included
TE0	Extended Talker	no capability
L4	Listener	no listen only
LE0	Extended Talker	no capability
SR1	Service Request	complete capability
RL1	Remote/Local	complete capability
PPO	Parallel Poll	no capability
DC1	Device Clear	complete capability
DT0	Device Trigger	no capability
C0	Controller	no capability

Concise Command Strings

Use concise commands when a computer is used to control the 2280. Read the detailed description of concise command mode operation found earlier in this section before you begin writing computer programs to control the 2280.

7/Programming and Operating With an IEEE-488 Computer

IEEE-488 Unique Commands

There are several concise commands that pertain to IEEE-488 operation only. These are,

Command	Function
?ER	Send Error Status
?ID	Send 2280 Model Name and Software Version
?AD	Enable SRQ Generation on Data Ready
?DD	Disable SRQ Generation on Data Ready
?AA	Enable SRQ Generation on an Alarm Message
?DA	Disable SRQ Generation on an Alarm Message
?AS	Enable SRQ Generation on Single Scan Complete
?DS	Disable SRQ Generation on Single Scan Complete
?AX	Enable SRQ Generation on All Events
?DX	Disable SRQ Generation on All Events
?ST	Send 2280 Status
?TC	Set Carriage Return as Terminator
?TL	Set Line Feed as Terminator

Following are complete descriptions of each command. "Command" identifies the sequence of characters that must be sent to the 2280 to execute the command.

"Response" indicates what characters will be sent by the 2280 when the command completes execution. In each paragraph, <lts> is used to represent the line termination sequence of characters programmed for port A and <cr> represents the carriage return character.

Send Error Status

Command: ?ER<cr>
Response: <status byte><lts>:<lts>

This command sends a status character that contains the same information as the IEEE-488 status byte that can be read using an IEEE-488 serial poll. Table 7.4 identifies the coding of the status character.

7/Programming and Operating With an IEEE-488 Computer

Send 2280 Model Name and Software Version

Command: ?ID<cr>
Response: 2280<model designator><space>
 V<version string><lts>:<lts>

This command reports the version number of the 2280 mainframe software. The field <model designator> will be a single character--like A, B, or C.

<space> is a single space character. The <version string> will be something like '1.2' or '3.0'.

Enable or Disable SRQ Generation on Data Ready

Commands: ?AD<cr> and ?DD<cr>
Response: :<lts>

The ?AD command enables the 2280 to generate a service request whenever data is available for reading by the host computer. The ?DD command disables the generation of the SRQ.

Enable or Disable SRQ Generation on an Alarm Message

Command: ?AA<cr> and ?DA<cr>
Response: :<lts>

The ?AA command enables the 2280 to generate a service request when the data available for reading is an alarm message. The alarm message, if programmed, is recorded on the line following the channel reading. The ?DA disables the generation of an SRQ.

7/Programming and Operating With an IEEE-488 Computer

Enable or Disable SRQ Generation on Single Scan Complete

Command: ?AS<cr> and ?DS<cr>
Response: :<lts>

The ?AS command enables the 2280 to generate a service request whenever a single scan completes. The ?DS command does just the opposite.

Enable or Disable SRQ Generation on All Events

Command: ?AX<cr> and ?DX<cr>
Response: :<lts>

The ?AX command is synonymous with executing the ?AD, ?AA, and ?AS commands in sequence. The ?DX command has the same effect as executing the ?DD, ?DA, and ?DS commands in sequence.

7/Programming and Operating With an IEEE-488 Computer

Send 2280 Status

Command: ?ST<cr>
Response: <status character><lts>:<lts>

The response to this command is a single character followed by <lts> that provides the status of the 2280 front panel indicators, followed by a ':' and another <lts>. The single character coding is:

(least significant bit) bit 0 always a 1
bit 1 ALARM (ACK key)
bit 2 MONITOR
bit 3 PLOT
bit 4 SINGLE SCAN
bit 5 SCAN
bit 6 always a 1
(most significant bit) bit 7 always a 0

The bit position corresponding to the front panel indicator is a one when the indicator is on and a zero when it's off. The resulting character value will be in the range from decimal 64 (hex 40) to decimal 127 (hex 7F). For example, when the SCAN indicator is the only one on, the character 'a' is sent in response to the command.

Set Carriage Return as Terminator; Ignore Line Feed

Command: ?TC<cr>
Response: :<lts>

This command sets the command termination character to the carriage return character. All line feed characters received by the 2280 are ignored. The IEEE-488 EOI message may optionally be sent with the carriage return character.

7/Programming and Operating With an IEEE-488 Computer

Set Line Feed as Terminator; Ignore Carriage Return

Command: ?TL<cr>
Response: :<lts>

This command sets the command termination character to the line feed character. All carriage return characters received by the 2280 are ignored. The IEEE-488 EOI message may optionally be sent with the line feed character.

7/Programming and Operating With an IEEE-488 Computer

IEEE-488 Interface Commands

Several interface commands or messages are defined within the IEEE-488 standard. These commands are used to manage the IEEE-488 interface system, however, some of these commands affect the operation of the 2280. Table 7.3 identifies what the 2280 does in response to receiving the commands.

Table 7.3 2280 Response to IEEE-448 Commands

MNEMONIC	NAME	2280 ACTIONS
DCL	Device Clear	See description in preceding paragraphs.
GET	Group Execute Trigger	No action, message ignored.
GTL	Go to Local	Enter the local state.
LLO	Local Lockout	Disables the front panel LOCAL key.
MLA	My Listen Address	Addresses the 2280 to listen.
MTA	My Talk Address	Addresses the 2280 to talk.
PPC	Parallel Poll Configure	No action, message ignored.
PPE	Parallel Poll Enable	No action, message ignored.
PPU	Parallel Poll Unconfigure	No action, message ignored.
REN	Remote Enable	When REN is sent with the MLA message the 2280 will enter remote.
SDC	Selective Device Clear	Same as device clear.
SPD	Serial Poll Disable	Exits the serial poll mode.
SPE	Serial Poll Enable	Enters the serial poll mode; if the 2280 is addressed to talk, it sends the status byte to the system controller.
TCT	Take Control	No action, message ignored.
UNL	Unlisten	Releases the 2280 from being addressed to listen.
UNT	Untalk	Releases the 2280 from being addressed to talk.

7/Programming and Operating With an IEEE-488 Computer

Serial Poll

Information sent from the 2280 to the IEEE-488 system controller in the serial poll status byte is defined in table 7.4. There are four operating conditions or events in 2280 programming or operation that can cause a service request. These are,

- o Alarm message available for reading
- o Single scan complete
- o Data available for reading
- o Illegal command

Table 7.4. Serial Poll Status Byte Coding

BIT POSITION	MEANING
=====	
8765 4321	
xxxx xxx1	data available for reading
xxxx xx11	alarm message available for reading
xxxx 00xx	command accepted
xxxx 01xx	not in remote, can't process commands
xxxx 10xx	illegal control character in command
xxx1 xxxx	single scan complete
xx1x xxxx	alarm condition
x1xx xxxx	requesting service
0xxx xxxx	interface installed in port A
1xxx xxxx	interface installed in port B
=====	

7/Programming and Operating With an IEEE-488 Computer

Programming Examples

A few brief programming examples illustrating RS-232 computer control of the 2280 appear earlier in this section. These examples can easily be translated to provide some guidance for IEEE-488 control.

Programming Hints and Suggestions

READ ALL THE DATA YOU ASK FOR

It's important to read all of the data that you request from the 2280. You can't continue to send commands to the 2280 without reading the response from the previous commands. If this is attempted, the data output buffers of the 2280 become full and the communication path will stop working.

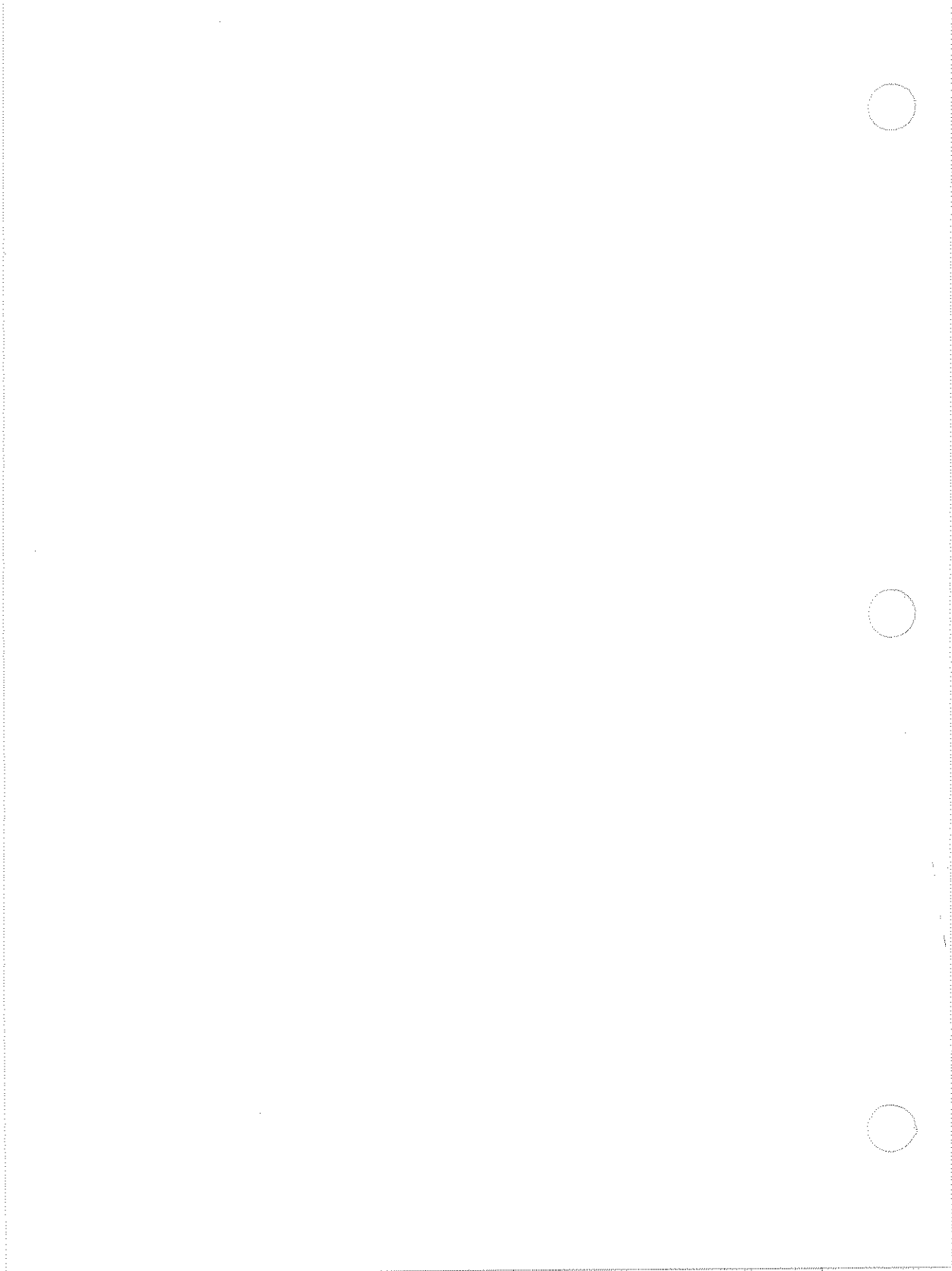

Section 8
Error Messages and System Alarms

CONTENTS

Introduction	8-2
Errors and Alarms	
Alarms	8-3
Errors	8-4
Channel Alarms	8-5
User Programmed Alarm Messages	8-6
System Alarms	8-7
Logged Messages That Generate No Alarm .	8-7
Alphabetical Listing of Error Messages	8-9

INTRODUCTION

When the 2280 detects that an error has occurred during programming or scanning, it lets you know. If the error occurs during programming, the data logger displays an ERROR message. If the error occurs during scanning, the data logger puts an ALARM message in the alarm queue and generates an alarm.

This section lists error and alarm messages exactly as they appear on the 2280 display or output device, and then gives a cause description and the appropriate response. For ease of reference, all messages are listed in alphabetical order, by the first letter of the first word in each message.

Errors or over-limit inputs cause alarms, and when they first occur, the data logger lights up the front panel ALARM LED. The 2280 can be programmed to write the alarm message to the alarm acknowledgement device after you've acknowledge the alarm.

ERRORS AND ALARMS

Alarms

Data logger alarms alert users when trouble is detected. When an alarm occurs while the 2280 is scanning, an alarm message is logged, and the alarm front panel alarm indicator light is illuminated. All alarms are classified as either channel alarms or system alarms. Channel alarms are traced directly to a specific channel or to a block of channels. A channel alarm can be easily recognized by a channel number appearing to the left of the error message. System alarms are not associated with any specific channel.

An alarm can be generated by a condition defined by the user, such as a measurement exceeding a limit, and this is referred to as a user programmed alarm. A user programmed alarm is a type of channel alarm. An alarm can also be generated by an error in the 2280 system itself while scanning or plotting is active. An error that occurs before scanning is started, or after it's stopped, won't generate an alarm.

Most alarm messages may be programmed to be logged on the alarm acknowledgment device. The device can be either port A or B (RS-232 or IEEE-488), the printer, or the cartridge tape. Alarm messages for a specific channel are also recorded on the data output device when that channel is logged.

8/Errors and Alarms

Errors

Errors can occur for a variety of reasons. Some are due to physical faults with the system, such as power-up errors, auxiliary functions errors or start/stop errors, and some are caused by programming errors.

In general, two types of programming errors can occur. They are,

- o Pressing an invalid key, for instance, attempting to select an item which doesn't appear on the current menu.
- o Attempting to enter syntactically unacceptable data, or data that conflicts with a previous entry.

The 2280 beeps once to acknowledge a correct entry, and it sounds three short beeps when you try to make an invalid entry. It won't accept invalid entries.

If incorrect syntax is entered, when you press ENTER an error message is displayed instead of a prompt for the next line. When you understand the error message, do the following,

- o Press the EXIT key. This brings the erroneous line back to the display, with the cursor positioned at the first error in the line.
- o Correct the error and press ENTER. If the line had more than one error, the process will have to be repeated until the entire line is correct.

Channel Alarms

As stated before, channel alarms are associated with a specific channel or block of channels. All messages generated by channel alarms are sent to the data output device(s) when the channel is logged.

Channel alarms may be grouped into three categories,

1. Serial Link Alarms -- Caused by a fault on the serial link, an input voltage or temperature out of range, a broken thermocouple, or a faulty a/d converter.
2. Math Execution Alarm -- Caused by a math argument out of range, arithmetic overflow, or division by zero.
3. User Programmed Alarms -- Caused by a user programmed limit being exceeded. The alarm message itself is written by the user.

The first two categories of alarms have error priority levels from 1 to 5 associated with their messages, with level 1 being the highest and 5 being the lowest priority alarms.

You can write a program to check the error priority level on a channel and take action only on a high priority error, ignoring all lower priority errors. To obtain the priority level of the error on a given channel, use the ERR function described in the Channel programming portion of section 3 of this guide.

If an error is present, the ERR function returns the priority of the error. If no error is present, the ERR function returns a value of 0.

Serial link alarms are caused by a fault on the serial link, an input voltage or temperature out of range, a broken thermocouple, or a faulty a/d converter.

8/Errors and Alarms

The third category, user programmed alarms, has no error priority level associated with it.

Channel alarms and system alarms generate messages that are stored in an alarm queue until they are acknowledged by the operator. When the alarm is acknowledged, the associated message is sent to the alarm acknowledgment device.

A channel alarm message is placed in the alarm queue when the following conditions occur.

- o Each time a user programmed alarm changes from a non alarm state to an alarm state. This is true for each of the four limits per channel that the user can program. The alarm must have an alarm message programmed in order for it to be entered in the queue.
- o Whenever a new serial link alarm or a math execution alarm occurs on a channel. The queue will not accept another alarm message on that channel until after the channel has been scanned without a serial link or math execution error.

User Programmed Alarm Messages

A user programmed alarm occurs when an input voltage or temperature exceeds a user defined limit. When inputs change from a normal state to an alarm state, the user's message (for example, TOO HOT--ADD COOLANT) is placed in the alarm queue, and the alarm LED lights up.

User programmed alarms are also recorded on the alarm acknowledgment device and data output device in generally the same format as all other errors.

System Alarms

System alarms are alarms not associated with any specific channel. They may indicate running out of paper, reaching the end of a cartridge tape, a faulty tape drive, full alarm queue, or power failure. System alarms are placed into the alarm queue each time they occur.

The causes and suggested solutions for these system errors are detailed in the following alphabetical listing of errors and alarms.

Logged Messages That Generate No Alarm

Certain messages are recorded on the data output device like any other alarm, but are not otherwise indicated to the user. These messages don't turn on the alarm LED, get placed in the alarm queue, or get sent to the alarm acknowledgment device. In this sense, they are warnings, not alarms.

For example the message,

CO PROPAGATED

indicates the procedure for channel 0 depends upon the value of another channel that has an error. The message is sent to the data output device but an alarm is not generated. To rectify the error, determine which dependent channel contains the error and correct it.



ALARM AND ERROR MESSAGES AND THEIR CAUSES

ACCESS DENIED

Cause

The access code you've entered is different than the one currently listed in the system program.

Solution

Enter the correct access code. It may be on the 2280 Series Programming Form, if not, you can list the system program and read it from there.

Another alternative is to turn the data logger keyswitch to PROGRAM and re-enter the access code.

ALARM LIST NOT FOUND, RE-ENTER

Cause

The alarm list number you requested to copy from hasn't been programmed.

Solution

Program the alarm list directly, or enter the correct number for the alarm list you want to copy.

8/Alphabetical Errors and Alarms

ALARM LIST NOT PROGRAMMED

Cause

While scanning is active, you've attempted to change a limit value of an alarm list number that is not programmed.

Solution

Make certain you're entering the correct number. If the number isn't programmed, stop the scan, program the alarm list and then start scanning again.

ALARM MESSAGES LOST

Cause

An alarm occurred when the alarm message queue was full and the new alarm message can't be stored.

Solution

Acknowledge one or more of the messages in the alarm queue to make room for new alarms as they occur.

ALARM NUMBER 1-4 NEEDED

Cause

You need to enter a number from 1 through 4 at ALMn (where "n" is between 1 and 4). The alarm number is either missing, or the digit you've specified is outside the range 1 through 4.

Solution

Add 1, 2, 3, or 4 to the function ALMn, or change the existing digit n to be within the range 1 to 4.

8/Alphabetical Errors and Alarms

ALL ALARMS ACKNOWLEDGED

Cause

You pressed the ACK key when there weren't any alarms to be acknowledged.

Solution

Press the EXIT key.

ALM

See Cn <user-defined message>

ARGMT NEG

See Cn ARGUMENT NEG IN <operation>

ARGMT OVER

See Cn ARG OUT OF RANGE IN <operation>

ARGMT ZERO

See Cn ARGUMENT ZERO IN <operation>

ASSIGNMENT OPERATOR NEEDED

Cause

The equal sign is missing after the assignment channel (Cx or Cn) at the beginning of the channel procedure statement. This error message also occurs if you fail to enter the assignment channel and assignment operator.

Solution

Change the line at the channel procedure to read:

CX= <expression> or CN= <expression>

8/Alphabetical Errors and Alarms

AT END OF CARTRIDGE TAPE

Case 1

Cause

While scanning is active, or while running a single scan, you've reached the end of the tape, or there's no more room to record data. Scanning will continue but any logging output sent to the cartridge tape won't be recorded.

Solution

Stop the scan, remove the tape, and insert another one. You can safely restart the scan.

Case 2

Cause

There is not enough room on the cartridge tape to store an entire program. A partial program will be saved onto the tape.

Solution

Delete the file containing the partial program. Remove the tape and insert another one. Save the program onto the second tape.

If the data on this tape is no longer wanted, initialize the tape (as described in the 2280 Series System Guide) and save the program.

8/Alphabetical Errors and Alarms

AT END OF TAPE

Cause

While reading from the Parallel Interface, you are trying to read past the double end-of-file mark - no files exist beyond this mark.

Solution

Stop trying to read past the double end-of-file.

AT END OF TAPE <time occurred> <time acknowledged>

Cause

This message is recorded on the alarm acknowledgement device (if programmed) in response to acknowledging the AT END OF CARTRIDGE TAPE alarm with the ALARM ACK key.

BAD TAPE DIRECTORY

Case 1

Cause

The tape you inserted hasn't been initialized.

Solution

Initialize the tape (see System Guide.)

Case 2

Cause

There is a problem with the tape drive hardware.

Solution

Substitute a known good tape. If the error message persists, have the tape drive repaired.

8/Alphabetical Errors and Alarms

Case 3

Cause

The tape you've inserted appears to have serious problems and none of it can be read.

Solution

If you've ruled out the above possible problems, your tape is probably ruined.

BLANK STRING

Cause

After you press EXIT, a blank line is displayed. You've apparently entered a line consisting of one or more blank spaces, and nothing else.

Solution

Press the CLEAR key, then press ENTER to delete the blank line.

BLANK TAPE

Cause

The inserted tape hasn't been initialized.

Solution

Initialize the tape as described in the 2280 Series System Guide.

8/Alphabetical Errors and Alarms

CARTRIDGE TAPE DEVICE FAILED

Cause

Several tape read errors occurred during a data transfer or program load, or the tape drive is unable to record data on the tape.

If scanning was active when the error occurred, then scanning continues, but any logging output sent to the cartridge tape is no longer recorded on the tape. The blocks of data already recorded on the tape are not lost.

The next time the cartridge tape is inserted and a tape operation is requested, the cartridge tape will be wound forward to determine how many blocks of data were recorded on the file before the cartridge tape was pulled.

Solution

Remove the tape and insert one you know is good. Try the operation that caused the error. If it happens again, have the cartridge tape interface and tape drive serviced.

8/Alphabetical Errors and Alarms

CARTRIDGE TAPE READ ERROR

Cause

During a data transfer, or a program load, a block of data on the cartridge tape cannot be read, even after several attempts.

If this error occurs during a data transfer, the bad block of data is skipped and the data transfer continues with the next block.

If this error occurs during a program load, the load is aborted.

Solution

Try the operation again. If the error persists, follow the cleaning instructions in the 2280 Series System Guide. After cleaning, try the operation again.

If the error is still present, try a known good tape. If the error goes away then the previously inserted tape is bad. If an error occurs with the known good tape, contact service personnel.

If one tape continues to have intermittent tape read errors while other tapes do not, replace the defective tape.

8/Alphabetical Errors and Alarms

CARTRIDGE TAPE REMOVED

Case 1

Cause

The cartridge tape was removed from the tape drive during a data transfer or program load. The operation is aborted.

Solution

Reinsert the same cartridge tape (or another one) and start the operation again. A program loaded in this manner probably won't work; you need to completely reload it from tape or re-enter it from the front panel.

Case 2

Cause

The cartridge tape was removed from the tape drive during a program save. Part of the user's program is left on the tape.

Solution

The program saved thus far will not operate properly if loaded into the data logger. Reinsert the tape and delete the file containing the partial user's program.

You can now repeat the program save operation.

8/Alphabetical Errors and Alarms

Case 3

Cause

A file name was requested and then the cartridge tape was removed while scanning, or during a single scan.

Scanning continues but any logging output sent to the tape is no longer recorded. The blocks of data already recorded on the tape are not lost.

The next time you insert the cartridge tape and request a tape operation, the cartridge tape will wind forward to determine how many blocks of data were recorded on the file before the tape was pulled.

Solution

To start recording again, you must stop and restart scanning. Recording on the tape will not resume if it is inserted.

Start the scan using a new file name.

CHANNEL NOT A PSEUDO CHANNEL

Cause

You've attempted to change the value of a pseudo channel while scanning is active, and the channel number you entered is programmed to some function other than a pseudo channel.

Solution

Make certain you're entering the correct channel number. To program the channel as a pseudo channel, stop the scan, enter the new program and then start the scan again.

8/Alphabetical Errors and Alarms

CHANNEL NOT IN ANY SCAN GROUP

Cause

While scanning is active, you've attempted to change the value of a pseudo channel that is not associated with any of the scan groups or channels programmed for plotting.

Solution

You can change the value of a pseudo channel when the 2280 is scanning or plotting as long as the channel meets one of the following criteria.

1. The number appears in a scan group channel list.
2. The number appears in a channel procedure. The channel procedure appears in a channel whose number is included in a scan group channel list.
3. The number is one of the channels to plot.

CHANNEL (OR BLOCK) NOT FOUND, RE-ENTER

Cause

The channel number you're trying to copy from hasn't been programmed.

Solution

Program the channel directly, or enter the correct number for the channel you want to copy.

8/Alphabetical Errors and Alarms

CHANNEL NUMBER NEEDED

Cause

One of the following has occurred,

- o A channel number, Cn, doesn't appear to the left of the channel procedure statement.
- o The letter C is not in front of a number.
- o There are no parameters for math functions that require one or more channel numbers.

When EXIT is pressed, the cursor is positioned where the channel number is expected.

Solution

Add the channel number, Cn, or insert the missing letter C.

Cn <user-defined message>

Cause

The value assigned to channel Cn has exceeded a user-defined alarm limit value.

Solution

Respond to the message, or redefine the alarm limit value.

8/Alphabetical Errors and Alarms

Cn ARG OUT OF RANGE <time occurred> <time acknowledged>

Cause

This message is recorded on the alarm acknowledgement device (if programmed) in response to acknowledging the Cn ARG OUT OF RANGE IN <operation> alarm using the ALARM ACK key.

Cn ARG OUT OF RANGE IN <operation>

Cause

During execution of Cn's channel expression or procedure, one of the operands for the <operation> was found to be too large or too small.

There is no value assigned to the channel appearing on the left hand side of the channel expression or procedure statement.

Solution

Modify the channel expression or procedure to bring the operand back into range.

Cn ARGUMENT NEG <time occurred> <time acknowledged>

Cause

This message is recorded on the alarm acknowledgement device (if programmed) in response to acknowledging the Cn ARGUMENT NEG IN <operation> alarm using the ALARM ACK key.

8/Alphabetical Errors and Alarms

Cn ARGUMENT NEG IN <operation>

Cause

While executing Cn's channel expression or procedure, a negative operand for the <operation> was found. A negative operand is not allowed.

There is no value assigned to the channel appearing on the left hand side of the channel expression or procedure statement.

Solution

Modify the channel expression or procedure so the operation does not have a negative operand.

Cn ARGUMENT ZERO <time occurred> <time acknowledged>

Cause

This message is recorded on the alarm acknowledgement device (if programmed) in response to acknowledging the Cn ARGUMENT ZERO IN <operation> alarm using the ALARM ACK key.

Cn ARGUMENT ZERO IN <operation>

Cause

While executing Cn's channel expression or procedure, a zero operand for the <operation> was found. A zero operand isn't allowed here.

There is no value assigned to the channel appearing on the left hand side of the channel expression or procedure statement.

Solution

Modify the channel expression or procedure so the operation doesn't have a zero operand.

8/Alphabetical Errors and Alarms

Cn DENOMINATOR ZERO <time occurred> <time acknowledged>

Cause

This message is recorded on the alarm acknowledgement device (if programmed) in response to acknowledging the Cn DENOMINATOR ZERO <operation> alarm using the ALARM ACK key.

Cn DENOMINATOR ZERO IN <operation>

Cause

During execution of Cn's channel expression or procedure, the <operation> appearing there attempted a division by zero.

There is no value assigned to the channel appearing on the left hand side of the channel expression or procedure statement.

Solution

Modify the channel expression or procedure so the operation does not have a zero argument.

If the <operation> is INTERPOLATION, then the table has two adjacent entries with the same input measurement value. Delete one of the entries or change one of the input measurement values.

8/Alphabetical Errors and Alarms

Cn FUNC DISAGREES WITH CONFIGURATION

Cause

The programmed channel function for channel Cn is not one of the allowed functions for the serial link device responding for channel Cn.

This error is detected whenever you attempt to start scan, single scan, monitor, or plot.

For example, this error occurs if you programmed Channel 0 as an analog output with the hardware configured with an a/d converter at address 0.

Solution

Do a list hardware configuration to find out what serial link device is responding for channel Cn.

If the wrong device is being listed, check all the serial link address switches to make sure they're correctly set.

If the wrong device is installed, install the correct serial link device. Also, make certain you've programmed channel Cn to respond to the desired function.

8/Alphabetical Errors and Alarms

Cn HAS NO SERIAL LINK DEVICE

Cause

The serial link device that is to respond to channel Cn is either not installed, not connected to the system, has an incorrect address switch setting, or has failed.

This error is detected whenever you attempt to start scan, single scan, monitor, or plot.

Solution

Check all the serial link address switches, cabling, and power supply (if the device is in a 2281A with an optional power supply).

If necessary, call service personnel.

Cn ILLEGAL BCD NO <time occurred> <time acknowledged>

Cause

This message is recorded on the alarm acknowledgement device (if programmed) in response to acknowledging the Cn ILLEGAL BCD NO <operation> alarm using the ALARM ACK key.

Cn ILLEGAL BCD NO

Cause

During a scan, a bcd digit with binary value greater than 9 is present on one or more of the digit fields for the digital input.

There is no value assigned to the channel Cn.

Solution

Check digital input line wiring.

8/Alphabetical Errors and Alarms

Cn Lm INPUT CHANNEL IN LHS

Cause

There is a measurement channel appearing on the left hand side (LHS) of line m in the channel procedure of channel Cn. This error is detected when you attempt to start a scan, single scan, monitor, or plot.

You cannot output to a measurement channel.

Solution

Change the channel number appearing on the left-hand side (LHS) of the procedure to a pseudo channel number or output channel number, or

Delete the programming for the measurement channel.

Cn Lm MATHBOARD REQUIRED

Cause

Line m of the procedure programmed for channel Cn requires the Advanced Math board (option -211), and the option is either not installed or has failed.

This error is detected when attempting to start a scan, single scan, monitor, or plot.

Solution

Perform one of the following:

- o Change the channel procedure statement so the Advanced Math option isn't needed.
- o Install the Advanced Math board.
- o If installed, have the Advanced Math board repaired.

8/Alphabetical Errors and Alarms

Cn MATH OVERFLOW <time occurred> <time acknowledged>

Cause

This message is recorded on the alarm acknowledgement device (if programmed) in response to acknowledging the Cn MATH OVERFLOW <operation> alarm using the ALARM ACK key.

Cn MATH OVERFLOW IN <operation>

Cause

While executing Cn's channel expression or procedure, the result of the <operation> was outside the range of $-9.22E18$ to $9.22E18$.

There is no value assigned to the channel appearing to the left of the channel expression or procedure statement.

Solution

Modify the channel expression or procedure so the result of the operation is within the allowable range.

Cn NO CONVERGENCE <time occurred> <time acknowledged>

Cause

This message is recorded on the alarm acknowledgement device (if programmed) in response to acknowledging the Cn NO CONVERGENCE <operation> alarm using the ALARM ACK key.

8/Alphabetical Errors and Alarms

Cn NO CONVERGENCE

Cause

Using the measured RTD resistance and the programmed RTD constants, the RTD temperature calculation cannot converge to a solution. This can happen while scanning, doing a single scan, monitoring, or plotting.

There is no value assigned to the channel Cn.

Solution

Check the programmed RTD constants for channel Cn to see if they are correct. If the constants seem okay, change the channel function of channel Cn to the resistance function, and then monitor channel Cn and determine if a valid RTD resistance is being measured for the RTD temperature.

If the resistance is okay, verify that the correct RTD constants are being programmed.

Cn NO DEVICE REPLY <time occurred> <time acknowledged>

Cause

This message is recorded on the alarm acknowledgement device (if programmed) in response to acknowledging the Cn NO DEVICE REPLY <operation> alarm using the ALARM ACK key.

8/Alphabetical Errors and Alarms

Cn NO DEVICE REPLY

Cause

While scanning, monitoring, plotting, or doing a single scan, a serial link device associated with channel Cn has stopped communicating over the serial link.

There is no value assigned to the channel Cn.

Solution

Check to see if the serial link cable has been disconnected, the address switch altered, or whether the device has lost power.

If the device is an a/d, it has power if the LED at the rear edge of the card next to the address switch is on.

If the device is installed in an extender chassis, 2281A, then the device has power if the LED on the front of the 2281A is on.

Cn NO MEASUREMENT <time occurred> <time acknowledged>

Cause

This message is recorded on the alarm acknowledgement device (if programmed) in response to acknowledging the Cn NO MEASUREMENT <operation> alarm using the ALARM ACK key.

8/Alphabetical Errors and Alarms

Cn NO MEASUREMENT

Cause

The A/D converter and scanner card associated with channel Cn can't complete a measurement because they aren't working properly. This alarm message can happen during scanning, single scan, monitoring, or plotting.

There is no value assigned to the channel Cn.

Solution

Have service personnel repair the a/d and scanner cards.

Cn NOT ON SERIAL LINK DEVICE

Cause

The channel number n is outside the range of channels for the serial link device associated with the block of ten channels that Cn is in.

This can occur with bcd/binary input, counter/totalizer input, and analog output when attempting to start a scan, single scan, monitor, or plot.

Solution

Change your channel number to within the range of channels for the serial link device.

8/Alphabetical Errors and Alarms

Cn OPEN TC <time occurred> <time acknowledged>

Cause

This message is recorded on the alarm acknowledgement device (if programmed) in response to acknowledging the Cn OPEN TC alarm using the ALARM ACK key.

Cn OPEN TC

Cause

The thermocouple for channel Cn is broken or damaged. This alarm message can occur during scanning, single scan, monitoring, or plotting.

There is no value assigned to the channel Cn.

Solution

Repair or replace the thermocouple or the thermocouple wiring.

Cn OVER RANGE <time occurred> <time acknowledged>

Cause

This message is recorded on the alarm acknowledgement device (if programmed) in response to acknowledging the Cn OVER RANGE alarm using the ALARM ACK key.

8/Alphabetical Errors and Alarms

Cn OVER RANGE

Cause

The input voltage for channel Cn exceeds the range programmed for it. This alarm message can occur during scanning, single scan, monitoring, or plotting. There is no value assigned to the channel Cn.

Solution

Program channel Cn with a higher voltage range or check and adjust the input voltage.

Cn OVER TEMP <time occurred> <time acknowledged>

Cause

This message is recorded on the alarm acknowledgement device (if programmed) in response to acknowledging the Cn OVER TEMP alarm using the ALARM ACK key.

Cn OVER TEMPERATURE

Cause

The temperature for channel Cn is outside the specified range for the thermocouple or RTD being used. This can occur during scanning, single scan, monitoring, or plotting.

Solution

Reduce the temperature being measured by the sensor, or replace the sensor with one that measures the higher or lower temperature.

If a different type of sensor is used, programming for channel Cn must be changed.

8/Alphabetical Errors and Alarms

Cn PREVIOUSLY DEFINED
Cn..m PREVIOUSLY DEFINED

Cause

The channel (Cn) or channels from the range specified (Cn..m) have already been programmed.

Solution

You have the following options,

- o Delete the previously programmed channel or channel block.
- o Program two blocks instead of just one.
- o Split the previously programmed channel block in two: copy the block to a temporary channel; delete the channel block; copy the temporary channel into the two new blocks.

Cn SERIAL LINK FAILURE OR OVERLAP

Case 1

Cause

Two or more devices are responding to the same serial link address.

Solution

Remove the serial link device associated with channel Cn and restart the operation.

If the error changes to Cn FUNC DISAGREES WITH CONF, or there is no error, then some other device is also addressed to respond for channel Cn.

Find the serial link device and change the address so it doesn't conflict with channel Cn.

8/Alphabetical Errors and Alarms

Case 2

Cause

The serial link device associated with channel Cn is faulty. This error occurs when you are trying to start a scan, single scan, monitor, or plot.

Solution

Remove the serial link device associated with channel Cn and restart the operation.

If the error changes to Cn HAS NO SERIAL LINK DEVICE, then the device you disconnected is faulty.

Cn SERIAL LINK SELF-TEST FAILED

Cause

The serial link device associated with channel number Cn is faulty.

Solution

Have the serial link device repaired.

Cn UNKNOWN SERIAL LINK DEVICES

Cause

The serial link device associated with channel Cn is not known to this version of software.

Solution

The 2280A and the 2285B cannot operate the 2280B-170 Analog Output or the 2280B-167 Counter/Totalizer options.

8/Alphabetical Errors and Alarms

Cn LIMIT m <time occurred> <time acknowledged>

Cause

This message is recorded on the alarm acknowledgement device (if programmed) in response to acknowledging the Cn <user defined message> alarm using the ALARM ACK key.

Cn OUT OF RANGE <time occurred> <time acknowledged>

Cause

This message is recorded on the alarm acknowledgement device (if programmed) in response to acknowledging the Cn OUT OF RANGE alarm using the ALARM ACK key.

Cn OUT OF RANGE

Case 1

Cause

The input frequency for channel Cn is below 1.5 Hz. There is no channel value assigned to channel Cn.

Solution

Increase the frequency to a value above 1.5 Hz.

Case 2

Cause

The number of counts for channel Cn has exceeded 8,388,607 counts. There is no channel value assigned to channel Cn.

Solution

Read channel Cn more often.

8/Alphabetical Errors and Alarms

COMMAND TOO LONG

Cause

A concise command string longer than 80 characters was received. The concise command is aborted.

Solution

Break the concise command string up into two or more substrings.

CX SYMBOL NEEDED

Cause

Channel number Cn was entered in a channel expression. The channel self reference, CX, is the only channel reference allowed in channel expressions.

When EXIT is pressed, the cursor is positioned where the channel self reference, CX, is expected.

Solution

Change the math so that no other channel number is used except CX.

If information from more than one channel is required in the computation, use a pseudo channel to perform the operation.

CURSOR POINTS TO ENTRY ERROR

Cause

A parsing error has occurred for a new feature added to the math board option, and your version of the 2280 Series controller software doesn't have the appropriate error message.

8/Alphabetical Errors and Alarms

DELIMITER NEEDED

Cause

The delimiter "/" is missing, or another character is located where the delimiter should be. When EXIT is pressed, the cursor is positioned where the delimiter is expected.

Solution

Remove unnecessary characters and add the delimiter.

DENOM ZERO

See Cn DENOMINATOR ZERO IN <operation>

DESTINATION DEVICE NOT AVAILABLE

Cause

The destination device you're trying to send data to is not installed, or has failed.

Solution

Request a valid destination device or install the one you've specified.

If the device you requested is installed, and you still get this error message, it probably needs repair.

8/Alphabetical Errors and Alarms

DIGIT EXPECTED DIGIT OR . EXPECTED

Cause

Another character is present where a digit or "." is expected in a floating point constant.

When EXIT is pressed, the cursor is positioned where the digit or "." is expected.

Solution

Remove the unwanted characters, or add characters to create the correct syntax.

EMPTY STRING

Cause

No file name or floating point number was present when the ENTER key was pushed.

Solution

Add the desired file name or floating point number before pressing ENTER.

FILE NAME ALREADY EXISTS

Cause

The filename you entered when requesting a program save, or when beginning a scan or single scan, has already been used on this tape for another file.

Solution

Use a filename unique to the cartridge tape. To find out which names have already been used, list the tape directory.

8/Alphabetical Errors and Alarms

FILE NAME NOT FOUND

Cause

The filename you requested for a program load or data transfer doesn't exist on this cartridge tape.

Solution

List the cartridge tape directory to determine what files are on this tape.

FUNCTION NOT AVAILABLE

Cause

The requested data transfer or tape functions, or selected channel functions, aren't available in this model of the 2280 Series Data Logger.

ILLEG BCD

See Cn ILLEGAL BCD NO

IN REMOTE

Cause

You pressed a key on the front panel, other than LOCAL when the REMOTE light is on.

Solution

If you want front panel control of the data logger, press the LOCAL key first.

8/Alphabetical Errors and Alarms

IN REMOTE WITH LOCKOUT

Cause

You pressed a front panel key while the 2280 was in the "remote with front panel lockout" state. The data logger is put into this state by a remote terminal or computer.

Solution

To return the data logger to local control, follow the instructions for "return-to-local" in the Remote Programming and Operations section of this user guide.

INCOMPATIBLE MATH BOARD SOFTWARE

Cause

The versions of math board software and controller board software are incompatible.

Solution

Contact the nearest Fluke service center.

LAST CHAN MUST BE GREATER THAN FIRST

Cause

The channel block Cn..m uses a first number (n) that is larger than the second number (m).

When you press EXIT, the cursor is positioned at the incorrect channel block.

Solution

Edit the channel block so the first number is smaller than the second.

8/Alphabetical Errors and Alarms

LEFT PARENTHESIS NEEDED

Cause

When EXIT is pressed, the cursor is positioned where the left parenthesis is expected.

Solution

Edit the line to correct the syntax error.

LIMIT NOT PROGRAMMED

Cause

While scanning is active, you've attempted to change a limit value in a number that has not been programmed.

Solution

Enter the correct alarm list or limit number, or stop scanning, program the limit number, and restart scanning.

LISTING DEVICE NOT AVAILABLE

Cause

You have requested the list function or list of tape directory from a device that is either not installed, or that has failed its self test.

Solution

Select one of the following:

- o Choose a different output device. Select from menu choices in the list or tape function.
- o If necessary, install the requested device.
- o If the device is already installed, and the error persists, have the device repaired.

8/Alphabetical Errors and Alarms

Math Execution Alarms

Math function alarms occur for a specific channel. The error message is followed by the <operation> being performed when the error occurred.

For example, a possible error message is MATH OVERFLOW IN ADDITION. The <operation> is ADDITION. Other possible operations are,

ADDITION	LINEARIZATION
ARC COSINE	MULTIPLICATION
ARC SINE	NATURAL LOG
COMMON LOG	POWER OF E
DIVISION	REFERENCE VOLTAGE
EXPONENTIATION	SQUARE ROOT
GROUP AVERAGE	STD DEVIATION
INTEGER PART	SUBTRACTION
INTERPOLATION	TANGENT

MATH BOARD APU TEST FAILED

Cause

The arithmetic processing unit on the advanced math option is not functioning properly.

The data logger will try to operate without using the math board.

Solution

Have the math board repaired. As a temporary solution, try starting a scan and plot, if plot is also programmed.

If there are no start-up errors, you can use the data logger without using the math board, but with a possible reduced throughput rate.

8/Alphabetical Errors and Alarms

MATH BOARD DOES NOT RESPOND

Cause

The math board is installed, but does not interrupt the controller board at power-up.

The data logger will try to operate without using the math board.

Solution

Have the math board repaired. As a temporary solution, try starting a scan and plot if plot is also programmed.

If there are no start-up errors, you can use the data logger without using the math board, but with a possible reduced throughput rate.

MATH BOARD INTERFACE FAILED

Cause

The math board is installed, but cannot communicate with the controller board.

The data logger will try to operate without using the math board.

Solution

Have the math board repaired. As a temporary solution, try starting a scan and plot, if plot is also programmed.

If there are no start-up errors, you can use the data logger without using the math board, but with a possible reduced throughput rate.

8/Alphabetical Errors and Alarms

MATH BOARD RAM TEST FAILED

Cause

There is a bad RAM or a faulty RAM control circuit on the math board.

The data logger will try to operate without using the math board.

Solution

Have the math board repaired. As a temporary solution, try starting a scan and plot, if plot is also programmed.

If there are no start-up errors, you can use the data logger without using the math board, but with a possible reduced throughput rate.

MATH BOARD ROM CHECKSUM TEST FAILED

Cause

There is a bad ROM or a faulty ROM control circuit on the math board.

The data logger will try to operate without using the math board.

Solution

Have the math board repaired. As a temporary solution, try starting a scan and plot, if plot is also programmed. If there are no start-up errors, you can use the data logger without using the math board, but with a possible reduced throughput rate.

8/Alphabetical Errors and Alarms

MATH OVER

See Cn MATH OVERFLOW IN <operation>

NEARING END OF TAPE <time occurred> <time acknowledged>

Cause

This message is recorded on the alarm acknowledgement device (if programmed) in response to acknowledging the NEARING END OF TAPE alarm using the ALARM ACK key.

NEARING END OF CARTRIDGE TAPE

Cause

The cartridge tape is almost full of logged data. This warning message occurs only during scan or single scan.

The 2280 Series Data Logger continues recording scan data on the cartridge tape until the end of the cartridge tape is reached.

Solution

Before the end of the cartridge tape is reached, stop the scan, remove the tape, and insert another tape with space for additional recording of logged data.

NO CONVRG

See Cn NO CONVERGENCE

NO MEASMNT

See Cn NO MEASUREMENT

8/Alphabetical Errors and Alarms

NO REPLY

See Cn NO DEVICE REPLY

NO ROOM ON TAPE

Cause

When you attempt to do a program save, or start a scan or a single scan, no room is available on the inserted cartridge tape.

Either the tape directory is full or there are no more blocks available on this tape.

Solution

Delete some of the files at the end of the directory (this is one of the tape function menu choices) or remove the cartridge tape and insert another one.

NO SCAN GROUPS PROGRAMMED

Cause

You've attempted to start a scan when there are no scan groups programmed.

Solution

Program one or more scan groups before you press the SCAN key.

8/Alphabetical Errors and Alarms

NO TAPE INSTALLED

Cause

You've requested a data transfer or tape operation, or attempted to start a scan or single scan, when there is no cartridge tape inserted.

Solution

Insert a cartridge tape and try again.

NOT A PROGRAM FILE

Cause

The filename selected for a program load is a data file instead of a program file.

Solution

Enter the name of a program file. Listing the tape directory will show you which files are program files.

NOT PROGRAMMED

Cause

You're trying to delete a channel, channel block, alarm list, or scan group that is not currently programmed.

Solution

Enter the correct number.

OPEN TC

See Cn OPEN TC

8/Alphabetical Errors and Alarms

OPERAND EXPECTED

Cause

Two math operators, (i.e., +, -, /, *, etc.) appear next to each other, or an operator was misspelled. When EXIT is pressed, the cursor is positioned where the operand is expected.

Solution

Correct the math expression.

OPERATOR EXPECTED

Cause

An operator, (i.e., +, -, /, *, etc.) is missing from the math expression or is misspelled.

When EXIT is pressed, the cursor is positioned where the operand is expected.

Solution

Correct the math expression.

OUT OF RANGE

See Cn OUT OF RANGE

8/Alphabetical Errors and Alarms

○ OUT OF USER MEMORY

Cause

The amount of information that can be stored by the 2280 has been exceeded, or there is not enough room in user memory to store the channel values as they are read, along with the other information needed during scanning.

Solution

Reduce the program size by eliminating any unused channel programs, scan groups, alarm lists, plot programming, or interpolation tables.

You can also delete or shorten any of the channel or scan group labels, channel expressions and procedures, or alarm messages.

○ OVER RANGE

See Cn OVER RANGE

OVER TEMP

See Cn OVER TEMPERATURE

PLOT NOT PROGRAMMED

Cause

You are attempting to plot parameters that haven't been programmed.

Solution

Program the desired parameters before beginning to plot.

8/Alphabetical Errors and Alarms

PORT <A or B> SELF-TEST FAILED

Cause

The designated port is faulty.

Solution

Have the device that is installed in the designated port repaired.

As a temporary solution, you can keep using the logger as long as you don't output data to the faulty port. The data logger will try to work without the port.

POWER FAILED <Date> <Time>

Cause

Power was lost while the instrument was scanning or plotting, and then was restored at the specified date and time.

Solution

Use a 12 volt battery as a power backup to the 2280 Series Data Logger.

POWER FAILED <time occurred> <time acknowledged>

Cause

This message is recorded on the alarm acknowledgement device in response to acknowledging the POWER FAILED alarm using the ALARM ACK key.

8/Alphabetical Errors and Alarms

PRINTER NOT AVAILABLE

Cause

The printer has a fault associated with it when attempting to start the plot function.

Solution

Have the printer repaired.

PRINTER OUT OF PAPER

Cause

The printer ran out of paper during a scan, single scan, plot, listing, or data transfer.

Solution

Replace the printer paper as described in the Recording chapter (section 6) of this user guide.

PROPAGATED

Cause

A channel procedure statement that assigns a value to the channel Cn is dependent upon another channel, Cm, which has an error.

The channel Cm has no value associated with it; therefore no value can be calculated for channel Cn.

Solution

Correct the problem associated with channel Cm.

8/Alphabetical Errors and Alarms

RAM TEST FAILED

Cause

There is a bad RAM or a faulty RAM control circuit on the controller or memory board.

The data logger will attempt to continue operation, but there is no guarantee as to what might happen.

Solution

Have the controller and memory boards repaired.

RIGHT PARENTHESIS NEEDED

Cause

You've entered a line missing a right parenthesis, or having too many left parenthesis.

When you press EXIT, the cursor is positioned where the right parenthesis is expected.

Solution

Add a right parenthesis, or remove a left one.

ROM CHECKSUM TEST FAILED

Cause

There is a bad ROM or a faulty ROM control circuit on the controller or memory board.

The data logger attempts to continue operation, with no guarantee what might happen.

Solution

Have the controller and memory boards repaired.

8/Alphabetical Errors and Alarms

○ SCAN GROUP NOT FOUND, RE-ENTER

Cause

The scan group you wish to copy from isn't programmed.

Solution

Program the scan group directly, or enter the correct number for the existing scan group you wish to copy.

SGn PORT <A or B> NOT PROGRAMMED FOR IEEE
SGn PORT <A or B> NOT PROGRAMMED FOR PARALLEL
SGn PORT <A or B> NOT PROGRAMMED FOR RS-232

Cause

○ The device installed in the indicated port is not the same as that selected in output device programming. SGn identifies the scan group number.

Solution

Change the device type specified in output device programming or have the correct option installed.

SGn PRINTER NOT AVAILABLE
SGn PORT A NOT AVAILABLE
SGn PORT B NOT AVAILABLE
SGn TAPE NOT AVAILABLE

Cause

The printer, port A, port B, or the tape has been selected as an output device in scan group SGn and the device is not installed or has failed.

Solution

○ Install or repair the output device.

8/Alphabetical Errors and Alarms

SGn NOT PROGRAMMED

Cause

You are attempting to start up a single scan for scan group SGn, which has not been programmed.

Solution

Enter the correct scan group number, or if it doesn't exist, program the desired scan group.

SINGLE CHANNEL NUMBER NEEDED

Cause

The channel number you've entered has too many C's in it.

Solution

Delete the extra C's. The channel number shouldn't have more than one C.

SOURCE DEVICE MUST BE MAGTAPE

Cause

You are requesting a data transfer from port A or port B that has an IEEE-488 (Option -342) or RS-232-C (Option -341) installed.

Solution

Install a Parallel Interface (Option -343/AA) to a Kennedy magtape. This is the only port A or port B device that data can be transferred from during a data transfer.

8/Alphabetical Errors and Alarms

SOURCE DEVICE NOT AVAILABLE

Cause

You are trying to transfer data from a device that is either not installed or that has failed.

Solution

Do one of the following,

- o Check to be certain you're entering the correct device number.
- o Install the desired device if it isn't present.
- o If the device is installed and you're entering the correct number, the device needs repair.

SOURCE SAME AS DESTINATION

Cause

When starting a data transfer, you specified the same device for both the destination and the source.

Solution

Select the correct source and destination devices.

8/Alphabetical Errors and Alarms

TABLE NUMBER 0-9 NEEDED

Cause

The "n" part of the interpolation table, TBLn, is not present, or is not a digit between 0 and 9.

When you press EXIT, the cursor is positioned where the table number n is expected.

Solution

Correct (or add) the table number.

TAPE DEVICE FAILED <time occurred> <time acknowledged>

Cause

This message is recorded on the alarm acknowledgement device in response to acknowledging the CARTRIDGE TAPE DEVICE FAILED alarm using the ALARM ACK key.

TAPE OPTION NOT AVAILABLE

Cause

The DC100A Cartridge Tape Drive option is not installed or has failed.

Solution

Install or repair the DC100A Cartridge Tape Drive.

TAPE REMOVED <time occurred> <time acknowledged>

Cause

This message is recorded on the alarm acknowledgement device in response to acknowledging the CARTRIDGE TAPE REMOVED alarm using the ALARM ACK key.

8/Alphabetical Errors and Alarms

TAPE SELF-TEST FAILED

Cause

The DC100A Cartridge Tape Drive option is faulty.

Solution

Have the DC100A Cartridge Tape Drive repaired.

As a temporary solution, as long as you don't output data to the tape drive, you can continue logging data. The 2280 will try to work without the tape drive option.

TAPE WRITE PROTECTED

Cause

The inserted cartridge tape has the RECORD tab in the "read only" position.

This error can occur when you start a scan, single scan or program save.

Solution

Remove the cartridge tape, move the RECORD tab to the record position, re-insert the tape, and start the operation again.

If you're deleting files to the end of the present directory, or are initializing the tape, make sure this is really what you want to do. The tape may have been write protected because the files are not supposed to be erased.

8/Alphabetical Errors and Alarms

TOO MANY OPERATOR LEVELS OR PARENTHESES

Cause

The math expression or statement has more than three pairs of nested parentheses.

When press EXIT, the cursor is positioned where the unexpected parentheses begin.

Solution

Change the expression or statement so there are no more than three levels of nested parentheses.

UNEXPECTED ADDITIONAL CHARACTERS

Cause

There are extra characters after the x-y number pair in the interpolation table entry.

For example, in,

3.4//5.6//6.1.

The string "//6.1" are extra characters.

When you press EXIT, the cursor is positioned where the unexpected additional characters begin.

Solution

Remove the extra characters.

8/Alphabetical Errors and Alarms

USE FORMAT DD MMM YY

Cause

Parts of the date are left out or mistyped, or the day of month is incorrect.

When you press EXIT, the cursor is positioned where the incorrect date format is located.

Solution

Edit the date so the numerical day of the month isn't too large for the month. For example, no month contains more than 31 days.

October 30, 1986 will read: 30 OCT 86

The three letters in the middle should be abbreviations of the month, with the year as the last two digits.

USE FORMAT HH.MM.SS WHERE HH<24

Cause

The time string entered contains hours larger than 23 or minutes or seconds larger than 59. Too many decimals may also be present.

When you press EXIT, the cursor is positioned where the incorrect time format is located.

Solution

Edit the time so hours are less than 24 and minutes and seconds are less than 60.

Make sure there is a decimal point located between the hours and minutes and between the minutes and seconds.

8/Alphabetical Errors and Alarms

USE FORMAT NN//NN//... WHERE NN<96

Cause

The numbers entered for ASCII values are too large or the delimiters are incorrect.

Solution

Use ASCII values less than 96, and use delimiters as shown in the error message.

USE NO MORE THAN SIX NUMBERS

Cause

There are more than six ASCII values in the ASCII sequence.

Solution

Use an ASCII sequence that is no longer than six ASCII values.

USER PROGRAM CORRUPTED

Cause

The user program was altered unintentionally. This can happen if RAM becomes faulty or if there is a fault with the user memory backup battery.

A minimum program is saved for the user.

Solution

Re-enter your program from the 2280 Series Programming Form or load it from cartridge tape.

If the problem continues, contact service personnel.

8/Alphabetical Errors and Alarms

○ USER PROGRAM LOST

Cause

The user program is no longer present when the data logger is turned on. This can happen when the 2280 Series Data Logger is turned off for a period longer than 30 days. It may also occur if there's a fault with the memory backup battery. A minimum program is saved for the user.

Solution

Re-enter your program from the 2280 Series Programming Form.

The data logger should retain your program in memory for at least thirty days. If the program isn't retained, the 2280 probably needs repair.

○ WATCH-DOG TIMEOUT <Date> <Time>

Cause

While the instrument was scanning or plotting, a hardware or software fault occurred, causing a hardware watch-dog timer to reset the data logger.

Solution

Contact service personnel, especially if the watch-dog timeout keeps occurring.

WATCH-DOG TIMEOUT <time occurred> <time acknowledged>

Cause

This message is recorded on the alarm acknowledgement device in response to acknowledging the WATCH-DOG TIMEOUT alarm using the ALARM ACK key.

8/Alphabetical Errors and Alarms

1499 IS THE LARGEST CHANNEL ALLOWED

Cause

A channel number larger than 1499 was entered.

Solution

Enter a channel number ≤ 1499 .

1499 IS THE LARGEST NUMBER ALLOWED

Cause

An alarm list number larger than 1499 was entered. If the alarm list number was less than 1499, check your channel programming. A number in a channel expression or procedure statement may be larger than 1499. When you press EXIT, the cursor is positioned where the incorrect number is located.

Solution

Change the alarm list number or channel number so it is less than or equal to 1499.

2.8E-20 IS SMALLEST CONSTANT ALLOWED

Cause

The magnitude of the constant that was entered, or that appears in a channel expression or procedure statement, is too small to be represented internally by the 2280 Series Data Logger.

When you press EXIT, the cursor is positioned where the incorrect constant is located.

Solution

Change to an absolute value larger than $2.71E-20$.

8/Alphabetical Errors and Alarms

2280 SELF-TEST

Cause

A device on the device bus is hanging up the bus. The controller card cannot communicate with the display to update the prompts.

The 2280 SELF-TEST message is displayed by the software whenever the display interface board receives a bus reset.

If working properly, this message is displayed 3 to 4 seconds after the data logger has been turned on. If the message continues, the data logger is locked up.

Solution

If the message continues to be displayed, have the unit repaired.

4095 IS LARGEST NUMBER ALLOWED

Cause

A fixed record length number greater than 4095 characters was entered for the parallel I/O.

Solution

Change the number to be less than, or equal to, 4095.

8/Alphabetical Errors and Alarms

9.2E18 IS LARGEST CONSTANT ALLOWED

Cause

The magnitude of the entered constant, or one that appears in a channel expression or procedure statement, is too large to be represented internally by the 2280 series data logger.

When you press EXIT, the cursor is positioned where the incorrect constant is located.

Solution

Change the number so its absolute value is smaller than 9.22E18.

99 IS THE LARGEST CHANNEL ALLOWED

Cause

A channel number larger than 99 was entered.

Solution

Change to a channel number ≤ 99 .

99 IS THE LARGEST NUMBER ALLOWED

Cause

An alarm list number larger than 99 has been entered, or a channel number larger than 99 appears in a channel expression or procedure statement.

When you press EXIT, the cursor is positioned where the incorrect number is located.

Solution

Enter an alarm list (or channel) number ≤ 99 .

8/Alphabetical Errors and Alarms

○ +, - OR DIGIT EXPECTED
+ , - , . OR DIGIT EXPECTED

Cause

Some other character is present where a

"+"
"_"
"."

or digit is expected in a floating point constant.

When you press EXIT, the cursor is positioned where the "+", "-", "."; or digit is expected.

Solution

Remove the unwanted characters or add characters to create the correct syntax.

○

○

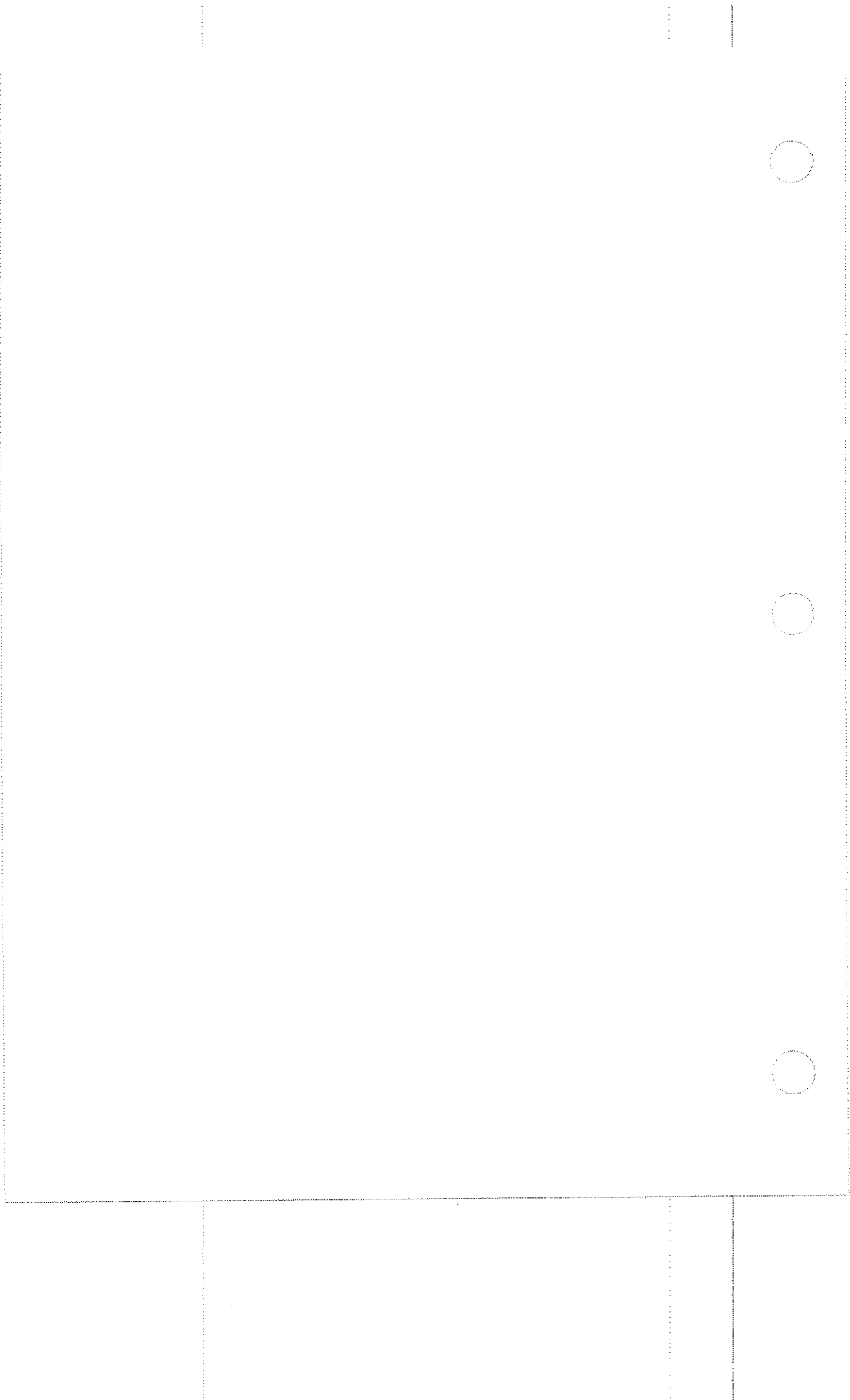

**Appendix 9a
Glossary**

a/d converter

Analog-to-Digital Converter. A circuit used to convert information in analog form (such as voltage or current measurements) into digital form.

ADC

See a/d converter.

address

The channel number that represents an I/O channel.

9a/Glossary

alarm acknowledgement device

The device (printer, cartridge tape, port A, or port B) where alarm messages are acknowledged and the time of the alarm is recorded.

analog

The representation of numerical quantities that do not have discrete values but that are continuously variable. Electrical measurements are analog in nature until converted into digital signals by an a/d converter. See digital.

ANSI

American National Standards Institute; an industry supported U.S. organization that primarily serves to coordinate and publish technical standards requested by its members.

arithmetic expression

An equation with arithmetic operators producing a numerical result.

arithmetic operator

A process to be applied to numerical values in an equation (+, -, /, etc.).

array

A group of numbers sharing the same variable name, followed by a subscript.

ASCII

American Standard Code for Information Interchange; ASCII is a standardized code set of 128 characters, including upper and lower case alphabet, numerals, and a set of control characters (line feed, carriage return, etc.)

baud

Originally used to express the capabilities of a telegraph transmission facility in terms of "modulation rate per unit of time." For practical purposes, it is now used interchangeably with "bits per second" as a unit of measure for data flow.

BCD

Binary Coded Decimal; BCD is a digital data format in which each digit of a decimal (base 10) number is represented in order, by its binary equivalent. For example, the decimal number 597 is represented as (0101 1001 0111) in BCD. See binary.

binary

The base two number system; binary numbers are made up of ones and zeros. The least significant digit represents one, the next digit represents twos, the next digit represents fours, and so on with each digit of the binary number corresponding to the next higher exponent of two. See also BCD.

bit

The smallest element of a binary number; a bit (contraction of "binary digit") either represents a high or a low state (one or zero, also mark or space).

9a/Glossary

bridge

In a measuring system, an instrument in which part or all of its circuit measures one or more electrical quantities. In a 2280 Series system, quarter-, half-, and full-bridge strain gauges can be used. See microstrain, strain gauge.

CCITT

Comite Consultatif International Telegraphic et Telephonique; an international organization concerned with devising and proposing standards for international telecommunications.

CD

Carrier Detect; RS-232-C, line 8. This signal is sent by DCE to tell DTE that a suitable carrier is present at the DCE. See also DTE, DCE.

channel expression

A computation applied to the raw input of same (measurement) channel

channel procedure

A set of expressions involving more than one channel.

concise command string

A set of commands used when the 2280 is controlled remotely by a computer.

Counter/Totalizer

The 2280 Series option that measures frequency and totalizes event occurrences.

○ CTS

Clear to Send; RS-232-C line 5. Sent by DCE to DTE when it is ready to accept data. See also DCE, DTE.

current shunt

Traditionally, a precision, low-value resistor placed across an ammeter's terminals to increase its range. The 2280 uses a current shunt resistor in the input circuitry of each channel of the current input connector (Option 2400A-171). The shunt resistor allows the current input to develop a voltage which the 2280A-161 Analog to Digital Converter can measure.

DAV

Data Valid; an IEEE-488 bus handshake signal, bus line 6. Indicates the availability data byte. See also handshake, NDAC, NRD.

○ DCE

Data Communication Equipment; the RS-232-C term for computer equipment that sends or receives data. Modems are examples of DCE. The other type of computer equipment specified by RS-232 is DTE, Data Terminal Equipment.

DCL

Device Clear, IEEE-488 Universal Command, ASCII code 20. This message, from the Controller, causes all instruments on the bus to reset the IEEE-488 interface of each instrument on the bus to a known state. The action taken by each instrument is unique for that instrument.

default

The value or state selected by system software (or firmware) when the user doesn't specify one.

9a/Glossary

delimiter

A character that sets the beginning and end of a string, and is not considered to be a part of the string. The two delimiters allowed by the 2280 Series are // (double slash) and : (colon).

digital

A circuit or device concerned only with high or low states (or pulses), generating a logical or numerical result. Digital computers, calculators, and digital watches use digital circuitry. See analog.

DSR

Data Set Ready; RS-232-C line 6. Indicator from DCE to DTE that a suitable line connection has been made, that all preliminary line protocol is complete, and that it is ready for data transfer. See also DCE, DTE.

DTE

Data Terminal Equipment; the RS-232-C Standard term for computer equipment where digital information originates or terminates. The 2280, terminals, and computers are examples of DTE. The other type of computer equipment specified by RS-232-C is DCE, Data Communication Equipment.

DTR

Data Terminal Ready; RS-232-C line 20. Sent by DTE to DCE when it is ready to transfer data.

EIA

Electronic Industries Association; the organization that devises electrical and data communication standards including RS-232-C and RS-422.

EOI

End Or Identify, IEEE-488 bus line 5. Often used by a Talker to designate the end of a data transfer sequence.

expression

A combination of variables, constants, numbers, or function references, separated by operators and parentheses in such a way that the whole can be reduced to a single result. See also arithmetic expression, logical expression, relational expression.

floating point

A numerical notation useful for computer calculations. In the 2280, the resolution of a floating point number is 7 digits, and its range is up to 38 places either side of the decimal. When the decimal point is out of range of the displayed digits, the number is displayed in exponential form ($E+mn$ or $E-mn$, where mn represents the number of places the decimal point must be moved; + for right and - for left). See also floating point variable, integer variable.

frequency

The cycles-per-second (Hertz) of ac signal. Can be measured in a 2280 system using the Counter/Totalizer Option (2280B-167).

gauge factor

A strain gauge parameter, gauge factor specifies the characteristics of the strain gauge material being used.

GND

Ground; RS-232-C line 1. A chassis connection intended for the cable shield. Not to be used for signal reference.

9a/Glossary

GPIB

General Purpose Interface Bus. This is a commonly used name for the IEEE-488 instrument interconnection bus.

handshake

The three-wire hardware protocol used to exchange data on the IEEE-488 Bus. Three bus lines (DAV, NRFD, NDAC) coordinate sending and receiving of data.

IEEE

Institute of Electrical and Electronic Engineers, Inc., 345 East 47th Street, New York, NY 10017. The IEEE is the publisher of Standard IEEE-488-1978, for interconnection of electronic instruments.

IEEE-488 Bus

A parallel bus system agreed upon by participating instrument manufacturers for interconnecting instruments to form a system.

IFC

Interface Clear; IEEE-488 Bus line 9. Set high by the controller to reset the IEEE-488 interface of each instrument on the bus to a known state. The action taken by each instrument on the bus is unique for that instrument.

interface

A hardware and software connection of a device to a system. For example, either the Serial Interface or the IEEE-488 Interface must be used to connect a host computer to the 2280.

interference

The presence of undesirable energy in a circuit, caused by electrostatically or electromagnetically coupled external circuits.

I/O

Input/Output.

isothermal

Means an area of equal temperature. The 2280 Series Thermocouple Input Connector (Option 2280A-175) uses an alloy isothermal terminal block to stabilize and equalize input lead temperatures.

Limit Values

Reference points used in alarm list programming.

Listener

IEEE-488 bus device designated by a Controller to receive data or instructions from a designated Talker or controller. There can be more than one Listener on a bus at the same time.

logical expression

An expression that can contain variables, constants, and function references, and is separated by logical operators and parentheses, yielding a logical result (true or false).

logical operator

A function that compares, selects, or matches. In the 2280, the logical operators are AND, OR, and NOT. These are used for Boolean operation. See also Boolean Algebra.

9a/Glossary

microstrain

The unit of strain measured by a strain gauge in a 2280 system.

MLA

My Listen Address; IEEE-488 Bus Listen Address. ASCII codes 32 through 62 correspond to MLA 0 to MLA 30, respectively. Each instrument on the bus must have a unique Listen Address. See also MTA.

modem

A transmitter and receiver of digital data. One modem receives data from an attached computer terminal and sends the data on a modulated carrier signal to another modem. The other modem demodulates the received carrier and sends the recovered data to another computer terminal.

MTA

My Talk Address; IEEE-488 Talk Address. ASCII codes 64 through 94 correspond to MTA 0 to MTA 30, respectively. Each instrument on the bus must have a unique Talk Address. See also MLA.

NDAC

Not Data Accepted; IEEE-488 handshake signal, bus line 8. Held high by each Listener until the current data byte is accepted. Only when all Listeners on the bus have released NDAC will it go low. See also DAV, handshake, NRFD.

NRFD

Not Ready For Data; IEEE-488 handshake signal, bus line 7. Held high by each Listener until it is ready to receive a data byte. Only when all listeners on the bus have released NRFD will it go low. See also DAV, handshake, NDAC.

operand

The components of a mathematical expression. Each, when evaluated, has an arithmetic value.

operator

A term for symbols within an application program (such as + or <) that identify operations to be performed. Also see arithmetic operator, logical operator.

overrange

The state indicated by a measurement instrument when an input signal is greater (or lower) than the range that the instrument can measure.

parallel data

The system where each bit is sent on a separate line. The IEEE-488 Bus transfers parallel data. See also serial data.

parity

A method of error detection that uses one extra bit for each unit of information (such as a character). The parity bit is set to one or zero so that the total number of one-bits in the byte is even or odd, depending on the type of parity in use.

Poisson's ratio

A strain gauge parameter; the ratio of the lateral strain to the longitudinal strain in a specimen subjected to a longitudinal stress.

port

A connection point used for data transfer. See interface.

9a/Glossary

port A

The right-hand interface port on the 2280 rear panel. Used for remote control and measurement data acquisition.

port B

The left-hand interface port on the 2280 rear panel. Used for measurement data acquisition only.

protective ground

The common chassis ground that is connected to earth ground through the ground wire in the line power cord. See also signal ground.

pseudo channel

A channel dedicated to special tasks performed on measurement information supplied by other channels.

REC

Received Data, RS-232-C line 3. This line carries the stream of serial data from DCE to DTE. See also serial data, DCE, DTE.

relational expression

An expression containing variables, constants, numbers, and function references, separated by relational operators and parenthesis in such a way that the whole can be reduced to a single (true or false) result. See also relational operator.

relational operator

An operator that compares the relative value of one variable, constant, number, or expression with another variable, constant, number or expression. Examples of relational operators are "EQ", "GT", "LT", "GE", and "LE". See also operator, relational expression.

RET

Return; RS-232-C line 7. A signal return line that serves as a zero voltage reference point for all other signals.

RFI

Radio Frequency Interference; see interference.

RS-232-C

A digital communications standard agreed upon by participating manufacturers of data communication equipment for the transfer of serial digital data between data communication equipment (DCE) and data terminal equipment (DTE). The 2280 is a DTE device. The standard is published and maintained by the Electronic Industries Association, 2001 Eye Street, N.w., Washington, D.C. 20006. See also DCE, DTE, serial data.

RTD

Resistance Temperature Detector; a device with a resistance that varies predictably with changes in temperature. Made of various materials, with platinum the most popular and accurate.

RTS

Request To Send; RS-232-C line 4. The signal from DTE to DCE when it has data to transmit. See also DTE, DCE.

9a/Glossary

scanner

An option in the 2280 system that selects a desired analog input channel for measurement.

SDC

Selective Device Clear; IEEE-488 Addressed Command, ASCII code 4. From the controller, this command causes the addressed Talker or Listener to reset to some defined state. The action taken by the device is unique to that instrument.

serial data

Information transmitted one bit at a time over a single line at a predefined bit rate (baud). See also baud.

serial link address

Address for a serial link device. The address range is manually set on the A/D Converter, Analog Output, and Digital I/O Assemblies.

serial link device

A 2280 assembly performing an output or measurement input function. There are positions (horizontal slots) for six such devices in each 2280.

serial port

A connection point on a computer that is used to transfer information in a serial manner. Data transmission through a serial port in the 2280 is in the form of asynchronous ASCII codes.

shield input

The input lead on various 2280 options that can be grounded or connected to the low lead at a measurement point to reduce interference. The shield input is attached to the braided shield wire surrounding the conductor in the cable.

signal ground

A conductor establishing electrical ground reference potential for all transmitting circuits in a communications network.

SRQ

Service Request; IEEE-488 bus line 10. This line allows a Talker or Listener (such as the 2280) to interrupt the host computer when ever necessary.

strain gauge

resistive transducer the electrical output of which is proportional to the amount it is deformed under stress or strain. Strain gauge circuits use fixed precision resistors and resistors bonded to a surface to be mechanically loaded, in quarter-, half-, or full-bridge configuration. See also bridge, gauge factor, microstrain.

Talker

An IEEE-488 connected instrument that has been designated by the Controller on the bus to send data to Listeners.

thermocouple

A pair of dissimilar conductors joined together, forming form a junction that generates a voltage when the opposite conductors are at different temperatures. The 2280 has provisions for 12 different types of thermocouples.

9a/Glossary

transducer

A device that converts energy from one form to another. An example of a transducer is a strain gauge.

XMT

Transmitted Data, RS-232-C line 2. The line that carries the stream of serial data from DTE to DCE. See also RS-232-C, serial data, DCE, DTE.

X-OFF

CTRL/S or DC3 ASCII code (decimal 19); sent by the receiving station to halt transmission from the sending station when information is coming too fast for the receiver to process. When able to receive more information, the receiving station sends X-ON to restart the transmitting station. See also X-ON.

X-ON

CTRL/Q or DC1 ASCII code (decimal 17); sent by the receiving station to cause the transmitting station to resume transmission of data after being halted by an X-OFF command. See also X-OFF.

Appendix 9b
Documentation for 2285B

INTRODUCTION

The 2280 Series manual set (User Guide, System Guide, and Service Manual) documents the 2280B Data Logger. These manuals, although compatible with the 2285B Data Logger, do require some further explanation. Some features can be used with the 2280B, but not with the 2285B. Also, some option assemblies cannot be used with the 2285B. This Appendix describes these differences.

FEATURES

The 2285B is an economical solution to a data logging system not requiring the expansion capabilities of the 2280B. The following configuration is possible:

- o The channel total for the 2285B is limited to 100.
- o The number of alarm lists is limited to 100.
- o The TAPE and DATA TRANSFER front panel keys are not functional (the Cartridge Tape option is not available).

9b/2285B

OPTIONS

The following option assemblies cannot be used with the 2285B:

- o Advanced Math Processor (2280A-211)
- o DC Cartridge Tape (2280A-214)
- o Counter/Totalizer (2280B-167)
- o Analog Output (2280B-170)

Appendix 9c
Documentation for 2280A

INTRODUCTION

The 2280 Series manual set (User Guide, System Guide, and Service Manual) documents the 2280B Data Logger. These manuals, although compatible with the 2280A Data Logger, do require some further explanation. Some features can be used with the 2280B, but not on the 2280A. Several option assemblies can be used with the 2280B, but not with the 2280A. This Appendix describes these differences.

9c/2280A

FEATURES

Features of the 2280A differ from those of the 2280B in the following areas:

- o Alarm Limits: alarm limits cannot be changed while scanning.
- o Pseudo Channels: pseudo channels values cannot be changed while scanning.
- o Scan Once Trigger Mode: not available on 2280A.
- o Remotely Terminated Thermocouples: not supported by 2280A. (the 64.000 mV with open thermocouple detect measurement range is not available.)
- o Time of Day: not shown during scanning.
- o AC voltage measurement require a programmed math expression. This expression adds the diode voltage drop incurred in the ac-to-dc conversion.
- o The LIN1, LIN2, and RTD functions are not available.

OPTIONS

The following option assemblies cannot be used with the 2280A:

- o RTD/Resistance Scanner and Connector (2280B-163/-177)
- o Counter/Totalizer (2280B-167)
- o Analog Output (2280B-170)

Appendix 9d
Cartridge Tape Format

Introduction	9d-2
Track Format	9d-4
Character Set	9d-4
Directory Blocks	9d-5
Locating Previously Written Information	9d-6
Data Blocks	9d-8
File Types	9d-9
Recovering Blocks After a Power Failure	9d-11

9d/Cartridge Tape Format

INTRODUCTION

The DC100 Cartridge Tape Interface option (hereafter called the "Cartridge") is a two-track system, employing Manchester phase encoding at a density of 1600 bits per inch. Data is written to or read from the tape while it is traveling past the head at 30 inches per second. The data format closely follows the standard for DC300 tapes (ANSI X3.56-1977); however, at the time of this writing there is no explicit standard for DC100 tapes. Data is stored as magnetic flux transitions in block form (sections of data separated by erased sections called gaps.) A gap is characterized by the absence of flux transitions.

Manchester phase encoding is a "self-clocking" coding scheme. This means that both the data and the data rate information can be recovered from the read signal as it comes off the tape. Ideally, bit-to-bit spacing is constant with this method; however, in reality spacing between adjacent bits varies slowly from bit to bit and can vary widely (as motor speed changes) between different blocks or drive units. One bits are always recorded as positive transitions, while zero bits are always recorded as negative transitions. Since bit-to-bit spacing is constant, extra transitions have to be inserted between adjacent zero bits or adjacent one bits. Figure 9d-1 illustrates the encoded bit sequence 011001 using Manchester phase encoding.



Figure 9d-1. Manchester Phase Encoding

9d/Cartridge Tape Format

The encoded format of a recorded block is illustrated in Figure 9d-2. The preamble (which always contains fifteen zero bits followed by a single one bit) immediately follows the gap. The preamble allows the hardware to sort out significant transitions by synchronizing the decoder hardware with the negative transitions: e.g., getting "on track" with the known fifteen zero bits.

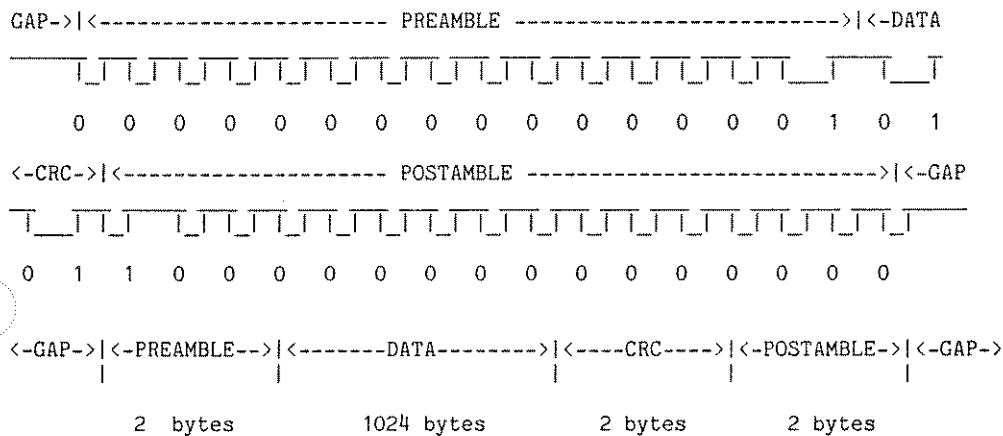

Figure 9d-2. Recorded Block Format

The data field of the block consists of a fixed number of bytes, followed by the two-byte crc (cyclic redundancy check). This code is used to check data integrity. The crc code is generated by the polynomial $x^{16} + x^{15} + x^2 + 1$.

9d/Cartridge Tape Format

TRACK FORMAT

The layout of blocks on the tape is the same for either track. The first block on the track starts approximately five inches after the Load Point hole. All gaps between blocks are approximately one inch long except for the gap between the second and third blocks on either track, which is about three inches long. Blocks are written only between the Load Point hole and the Early Warning hole.

CHARACTER SET

Characters recorded on the tape are restricted to the ASCII set; thus, the most significant bit of each byte in the data field of a block is cleared. In addition, characters from the range 60 to 7F (hexadecimal) are reserved for use as tokens (special symbols). The tokens currently used have the special meanings as described in Table 9d-1. Usage of these tokens is described later in the appropriate context.

Table 9d-1. Single Character Tokens

Token	Description
a	Encoded begin scan date marker
b	End-of-file marker
e	Equivalent to two space characters
f	Equivalent to four space characters
g	Equivalent to eight space characters
h	Equivalent to 16 space characters
i	Equivalent to 32 space characters
j	Begin forced line terminator
k	End forced line terminator
l	Data file type
m	Program file type

9d/Cartridge Tape Format

DIRECTORY BLOCKS

Information about all other blocks is contained in the two (redundant) "directory blocks" (the first two blocks on the first track.) All other valid blocks on tape (if any) are termed "data blocks".

The format of the directory blocks is given in Tables 9d-2 and 9d-3. All number fields are ASCII-encoded, right-justified decimal numbers. If the number is less than three digits long, it is padded with space characters on the left.

Table 9d-2. Directory Block Format

Byte Range	Description
0 - 2	Block number on this track (either 0 or 1)
3 - 5	Number of valid entries in the entry array
6 - 8	Next free block number
9 - 11	Number of blocks on track 1
12 - 14	Anti-aliasing number
15 - 29	Space padding
30 - 33	Programmed line terminator
34 - 1023	Entry array (55 entries using the format described in Table 9d-3. One entry is used for each file on the tape.

Table 9d-3. Directory Entry Format

Number of Bytes	Description
10	File name
1	File type token
3	File length, in blocks
4	Programmed line terminator

9d/Cartridge Tape Format

The information in the directory is used to locate any valid data block without ambiguity. But the recovery of data blocks after a power failure is an exception (covered later in this section).

Each track contains a variable number of data blocks, whose maximum is primarily related to tape speed. To accommodate this variation, the fourth field in the directory block contains the number of blocks on the first track (including directory blocks). If the first track is not full yet, this number is zero.

The third field in the directory contains the number of the next free block on the tape. If the tape is full, this number is set to zero. Data blocks are numbered consecutively, starting with the first block (block number 2) after the two directory blocks and ending with the last block on the second track.

LOCATING PREVIOUSLY WRITTEN INFORMATION

A previously recorded block is located by comparing its number to the directory field containing the number of blocks on track one. If this field is zero, all blocks are on track one and the block number is the distance from the load point. Otherwise, the block is on either track 1 (if its number is less than the number of blocks on track 1) or track 2 (if its number is greater than or equal to the number of blocks on track 1.)

If the block is on track 2, the location of the block is determined by subtracting the number of blocks on track 1 from the block's number, yielding the distance of the block from the load point. Note that blocks are numbered sequentially starting at zero (the two directory blocks are blocks 0 and 1), while block on track position numbers start at zero for each track.

Consider the following example. For a tape with three files and room left on track 2, a typical directory might look like Table 9d-4.

9d/Cartridge Tape Format

Table 9d-4. Example Directory

Directory Header	<ul style="list-style-type: none"> o Block number on this track: 0 Number of valid entries: 3 Next free block number: 352 Number of blocks on track 1: 261 Anti-aliasing number: 123 o Programmed line terminator: <SP><SP><CR><LF>
Entry Array	<ul style="list-style-type: none"> o File name: SCAN1 File type token: 1 File length: 153 (in blocks) Line terminator: <SP><SP><CR><LF> o File name: SCAN2 File type token: 1 File length: 196 Line terminator: <SP><SP><CR><LF> v o File name: PROG1 File type token: m File length: 1 Line terminator: <SP><SP><CR><LF>
Unused Entries	<ul style="list-style-type: none"> o File name: < 10 spaces > File type token: < 1 space > File length: < 3 spaces > Line terminator: <SP><SP><CR><LF> o o o v

9d/Cartridge Tape Format

To locate the first block of PROG1, the length of the previous files is summed and added to the number of the first block after the directory blocks:

$$2 + 153 + 196 = 351$$

Next, block number 351 is compared to the number of blocks on track one:

$$351 >= 261$$

implies that the block is on track 2, and has the block-on-track number $351 - 261 = 90$.

Locating the first block of SCAN1 is much easier. Since it is the first file on tape, it starts at block number two. Comparing this to the number of blocks on track one shows that its block-on-track number is also two.

DATA BLOCKS

The format of a data block differs from that for directory blocks. Table 9d-5 illustrates the format used for data blocks in both file types (data and program).

Table 9d-5. Data Block Format

Byte Range	Description
0 - 2	Block number on this track
3 - 12	File name
13 - 15	Anti-aliasing number
16 - 19	Programmed line terminator
20 - 1019	Data bytes
1020 - 1023	Programmed line terminator

9d/Cartridge Tape Format

When a data block is read, the block-on-track and file name fields are checked to verify that this is the desired block. When recovering blocks after a power failure, the anti-aliasing number is checked as well (see the section on recovering blocks). The block-on-track and anti-aliasing fields are decimal numbers, space-padded at the left if they are less than three digits long.

The data bytes field is surrounded by two four-character fields containing the programmed line termination sequence. If the sequence is less than four characters long, it is right-justified and padded with spaces at the left. These two line terminator fields guarantee that the data block header fields exist on a line of their own, easing the task of separating header information from data bytes.

FILE TYPES

Two file types are supported: data and program. The directory entry for a file contains a file type field which contains one of two tokens distinguishing the file type. Both file types use the same data block format (see Table 9d-5); the difference between them is in the contents of the data bytes field. Data files contain information logged from the 2280, while program files contain configuration and programming information.

In addition, if the data bytes field contains information obtained during a scan, the Cartridge prepends an encoded version of the date and time that the scan began. This is used by the Cartridge during a data transfer to filter out unwanted data. The encoded field contains 13 characters, the first of which is the token that marks the field (see Tables 9d-1 and 9d-6). The remaining twelve are digits representing the date and time. The data logged to the tape can be reformed by stripping every occurrence of the 'a' token and the twelve characters that follow.

9d/Cartridge Tape Format

Table 9d-6. Encoded Begin Scan Date Format

Byte Range	Description and Range of Values
0	'a' - Encoded begin scan date token
1 - 2	Year [00 , 01 , ... , 99]
3 - 4	Month [00 , 01 , ... , 11]
5 - 6	Day of Month [01 , 02 , ... , 31]
7 - 8	Hour [00 , 01 , ... , 23]
9 - 10	Minute [00 , 01 , ... , 59]
11 - 12	Second [00 , 01 , ... , 59]

Most files end with a partially full block. An end-of-file token is placed in the block immediately following the last valid character. The remainder of the data bytes field is padded with empty lines, using zero or more spaces per line combined with the programmed line terminator.

Data file information consists of a series of lines terminated with the programmed line terminator. The maximum line length is about 40 characters. Program file information (as received from the mainframe) has a much more mysterious structure, with no explicit line boundaries. (No attempt to describe the meaning of program file characters is made here.)

Consequently, a line terminator is forced onto the tape at periodic intervals by the Cartridge to turn program files into a series of lines. Each forced line terminator is prepended with a "begin line terminator" token and appended with an "end forced line terminator" token (see Table 9d-5). These tokens allow the Cartridge to strip these line terminators when loading programs into the 2280.

RECOVERING BLOCKS AFTER A POWER FAILURE

The 2280 possesses the ability to continue logging data to the same file on the tape after power has cycled. To do this, the Cartridge must be able to determine the number of blocks written successfully before power loss.

First, the directory is scanned to verify that the last directory entry was never closed - this is true if the entry's file length field is zero. Next, the potential blocks in the file are read until a read error occurs, the end of tape is encountered, or a block is read that does not belong to the file being recovered. To determine the latter, the filename and anti-aliasing fields of the block header are checked. The anti-aliasing field must match the anti-aliasing field in the directory header. When recovering blocks, examining the filename in the recovered block's header is not sufficient to make a reliable determination, since a file by the same name may have existed in the same place on tape before, and may be 'aliased' into reincarnation as blocks appended to the actual end of the file being recovered. This is not an altogether unlikely occurrence, since people tend to have pet names for files.

Anti-aliasing numbers were created to reduce the probability of aliasing to an acceptably low level. Every time the directory is rolled back (by initializing the tape or deleting files), a new random number (the anti-aliasing number) is placed in the directory header. A file being written also has the same number in every block header. Thus, an unclosed file has an anti-aliasing number in the header of every valid block that matches the anti-aliasing number in the directory. Aliasing candidates in the form of long-dead files are unlikely to have both the same filename and the same anti-aliasing number as the file currently being recovered.

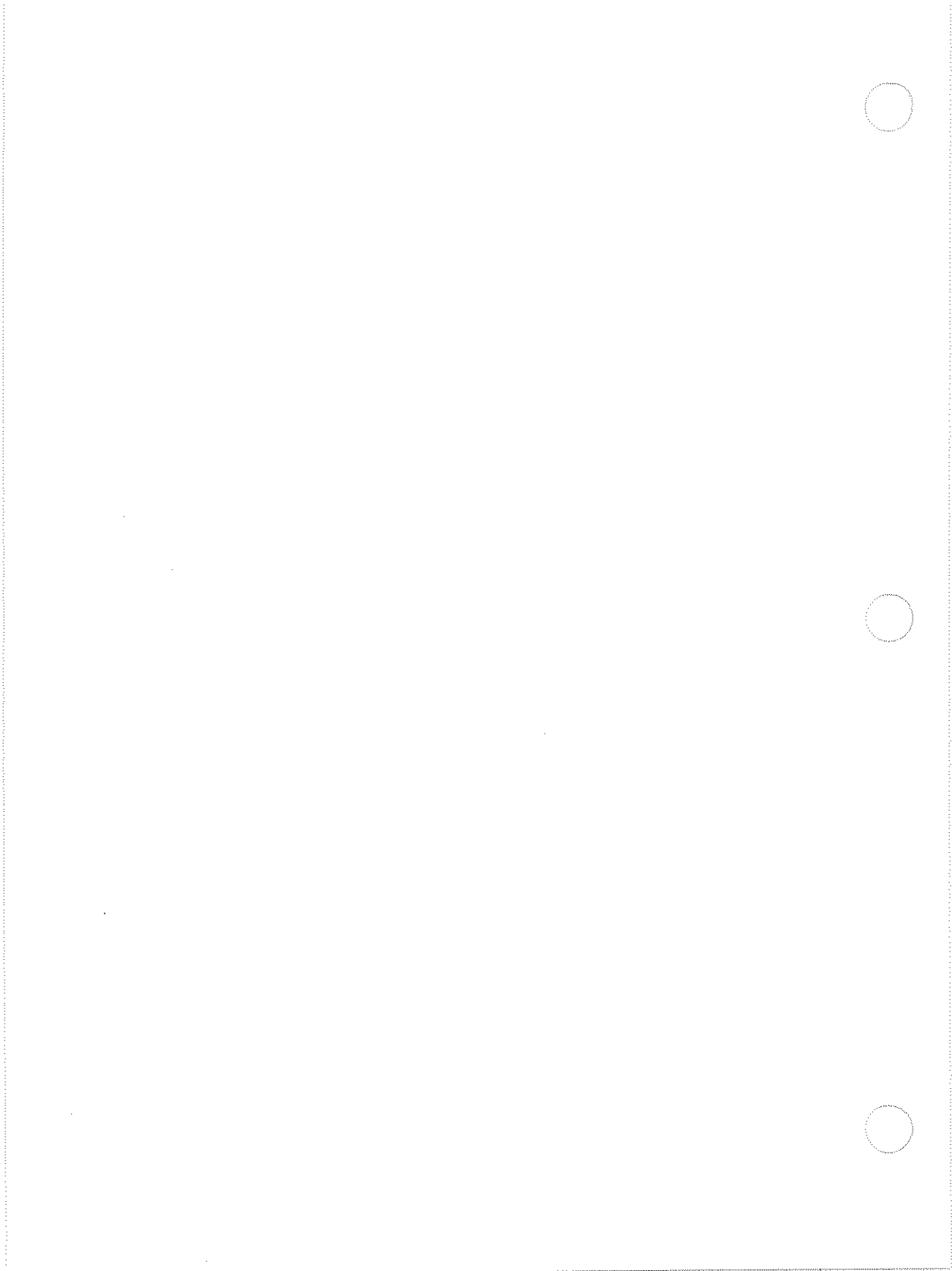

INDEX

2280 Service Manual 1-9
2280 System Guide 1-9
2280 User Guide 1-9
2280A Documentation 9c-1
2285B Documentation 9b-1

Access Code 3f-3
Additional Techniques 4-44
Advanced Math Functions 4-3
Advanced Math Operators 4-18
Advanced Programming Technique and Examples 4-27
Alarm Ack Logging Device 3d-9
Alarm Acknowledgement 5-14
Alarm List Menu Choice 3c-4
Alarm List Number 3a-4, 3c-2
Alarm Lists 2-25, 3c
Alarms 8-3
Alphabetical Listing of Error Messages 8-9
Auxiliary Functions 5-19
Average Value 4-34

Calendar Date and Time 3f-2
 Cartridge Tape Drive as Source Device 5-22
 Cartridge Tape Drive Operation 6-10
 Cartridge Tape Format 9d-1
 Changing Limit Values While Scanning 5-18
 Changing Logging Interval With Time 4-38
 Changing Logging Rate on Alarm 4-40
 Changing Pseudo Channel Values While Scanning 5-18
 Channel Alarms 8-5
 Channel Expression or Procedure 3a-8
 Channel Function 3a-4
 Channel Label 3a-6
 Channel Menu Choice 3a-4
 Channel Programming 3a, 2-24
 Channel Units 3a-5
 Character Set 7-11
 Collecting Data From a Single Scan 7-28
 Common Plot Interval for All Four Channels 3e-3
 Concise Command Strings 7-23, 7-31, 7-9
 Counter 4-30
 Creating a New Program 2-31

 Data Output Device Control 3b-12
 Data Transfer Filter 3d-9
 Data Transfer Operation 5-19, 6-18
 Dead Band Value 3c-7
 Delete Files to End of Directory 6-14
 Don't Execute the Diagnostics From Remote 7-29

 Entering the Prompting Mode 7-17
 Erasing Program Memory 7-24, 2-33
 Errors 8-4
 Exclude Open Thermocouples From Calculations 4-48
 Exponentiation 4-18

 Front Panel 2-6
 Front Panel and Remote Control 7-4

 Glossary 9a-1
 Group Number 3b-2

How the Menus Work 2-9
 How to Use the Manual Set 1-9

IEEE-488 Functional Capabilities Supported 7-31
 IEEE-488 Interface Commands 7-37
 IEEE-488 Unique Commands 7-32
 Initialization of Outputs 5-18
 Initializing a Tape 6-15
 Installing New Paper 6-9
 Integrate a Value 4-28
 Interpolation Tables 3f-4

Keys that Move You Through the Menus 2-14

Limits Information 3c-4
 Line Frequency 3f-2
 Listing Tape Directories 6-12
 Loading a Program 6-17
 Logged Messages That Generate No Alarm 8-7
 Logging Data With a 2280 1-10
 Logical Operators 4-19

Measure and Average Two Thermocouples 2-32
 Menu Reference Overview 3-4
 Miscellaneous Keys 2-18
 Monitoring 5-5

Operating Keys 2-20
 Operating Modes 5-4
 Operating Notes 5-17
 Operation 6-11
 Organization of This Guide 1-5
 Other Scan Group Trigger 3b-13
 Output Device Programming 3d, 2-29
 Output Format Examples 6-19
 Output Menu Choice 3d-1

Paper Advance 6-7
 Paper Removal 6-8
 Parameters 3e-2
 P,C,D, or L 3a-2, 3b-2, 3c-2
 Plot Menu Choice 3e-2
 Plot Programming 3e, 2-28
 Plotting 5-11
 Port A or B as Source Device 5-21
 Port A, Port B, and Cartridge Tape Formats 3d-3
 Port Characteristics 3d-5
 Power Failure and Power Up 5-17
 Printer Format 3d-2
 Printer On/Off Settings 6-4
 Printer Operation 6-4
 Printer Operator Switch 6-7
 Printer Paper Removal and Loading 6-8
 Program a Channel or a Block 3a-2
 Programming a Channel 7-26, 2-40
 Programming a Scan Group 2-35, 7-26
 Programming an Alarm List 2-46
 Programming Examples 7-24, 7-39
 Programming Form 2-11
 Programming Hints and Suggestions 7-29, 7-39
 Programming Keys 2-17
 Programming Modules 2-22
 Programming Overview 2-5
 Programming/Operating With an IEEE-488 Computer 7-30
 Programming/Operating With an RS-232 Computer 7-20
 Programming/Operating With an RS-232 Terminal 7-14
 Prompting 7-7

 Read All the Data You Ask For 7-39
 Relational Operators 4-22
 Remote Access and Lockout 7-15, 7-22
 Removal and Loading 6-10
 Required Hardware 7-3
 Retensioning Tapes 6-22
 Return to Local 5-16
 Rolling Average 4-36

Save Maximum Value of a Channel 4-44
 Save Minimum Value of a Channel 4-46
 Saving a Program 6-16
 Scan Group Channel List 3b-4
 Scan Group Label 3b-4
 Scan Group Menu Choice 3b-4
 Scan Group Programming 3b
 Scan Groups 2-22
 Scan Trigger Enable Times 3f-3
 Scan Trigger Mode 3b-9
 Scanning 5-7
 Select Menu Options 3f-5
 Serial Poll 7-38
 Shift Register 4-32
 Single Scan 5-9
 Special Characters Used With RS-232 7-13
 Special Commands 7-18, 7-23
 Specifying Output Devices 6-13
 Standard Deviation Over Time 4-42
 Start and Complete Each Command at the Main Menu 7-29
 System Alarms 8-7
 System Menu Choice 3f-1
 System Programming 2-27, 3f
 System Status 5-16

 Take Up Off 6-7
 Take Up On 6-7
 Tape Format Programming 6-11
 Tape Functions 6-11
 Temperature Units 3f-3
 Transferring Data Recorded on Cartridge Tape 7-27
 Turning the 2280 On and Off 5-2
 Tutorial 2-31

 User Programmed Alarm Messages 8-6
 User Status Functions 5-13

