

For the benefit and convenience of its customers, Fluke Corporation (Fluke) has reproduced this copy of a manual which is no longer in production. This manual has not been edited or updated since the revision date shown on the *lower left hand corner of the first page*. Fluke will not be liable for any claims, losses or damages of any kind incurred by any user arising from use of this manual.



Instruction Manual

Valuetronics International, Inc.
1-800-552-8258
MASTER COPY

Model 4200-05

IEEE-488 Compatible Interface

TABLE OF CONTENTS

TITLE	PAGE
INTRODUCTION	2
INTERFACE FUNCTIONS SUPPORTED	2
INSTALLATION DATA	2
Introduction	2
Configuring the Straps	2
Preamplifier Assembly Modification	3
Installation Into the Voltage Source	3
ADDRESS SWITCH SETTINGS	4
POWER ON CONDITIONS	5
IEEE-488 BUS OVERVIEW	5
Bus Organization	5
Data Bus Message Types	5
DEVICE DEPENDENT COMMANDS	7
SYNTAX OF COMMAND STRINGS	7
Definitions	7
Rules	8
Syntax of Numeric Entries	11
Command String Examples	11
ERROR HANDLING	12
General	12
Syntax and Out-of-Range Errors	12
Serial Poll Response	12
Status Response (-05 Option as a Talker)	13
Input Buffer Overflow	13
Inadvertent Maximum Output (4261A/4265A)	13
THEORY OF OPERATION	13
General Purpose Interface Adapter	15
Line Receivers/Drivers	15
Internal Bus	15
ROM Control	15
Transfer of Voltage Source Data	15
MAINTENANCE	16
Performance Test	16
Troubleshooting	16
List of Replaceable Parts	16

P/N 638478

OCTOBER 1981

©1981, John Fluke Mfg. Co., Inc., all rights reserved Litho in U.S.A.

INTRODUCTION

The IEEE-488 Compatible Interface, -05 Option for the Fluke 4200 Series Programmable Voltage Sources, provides voltage source remote control capability via any standard IEEE-488 bus. The 4200-05 option comprises a single printed circuit board assembly which mounts within the voltage source case through an opening provided in the rear panel. Device address selection for the voltage source containing the IEEE-488 Compatible Interface is provided by switches mounted on the rear panel of the assembly. The switches are accessible with the assembly installed in the voltage source. Connection of the IEEE-488 Compatible Interface to the IEEE-488 bus is made by means of a standard IEEE-488 compatible connector mounted on the rear panel.

WARNING

WITH THE -05 OPTION INSTALLED IN ANY 4200 SERIES PROGRAMMABLE VOLTAGE SOURCE, THE REAR PANEL GUARD TERMINAL OF THE VOLTAGE SOURCE CAN BE FLOATED TO 200 VOLTS, NOT TO 1000 VOLTS AS SPECIFIED IN THE VOLTAGE SOURCE MANUAL FOR OTHER INTERFACES.

INTERFACE FUNCTIONS SUPPORTED

Table 1 lists the IEEE-488 functions supported by the 4200-05 option:

INSTALLATION DATA

Introduction

When ordered at the time of voltage source purchase, the -05 Option is installed in the instrument and fully tested. In this case, it is only necessary to set the address switches and connect the IEEE-488 compatible cable. However, if the -05 Option is ordered separately from the voltage source, or if it is to be removed from one voltage source and installed in another, the following modifications are necessary:

- Internal straps must be configured to suit the particular voltage source type.
- A capacitor on the pre-amplifier assembly of certain recipient voltage sources (Models 4250A, 4265A, 4270A, and 4275A) must be changed.
- Address switches must also be set, either before or after installation of the option into the voltage source.

Configuring the Straps

The -05 Option contains four straps which must be configured to suit the particular voltage source. The -05 option is shipped from the factory with each of the three straps, shown in Figure 1, intact. The straps must be snipped using a pair of diagonal cutters to obtain the required configuration in accordance with Table 2.

Table 1. Supported IEEE-488 Functions

MNEMONIC	FUNCTION	CAPABILITY
SH1	Source Handshake	Complete capability
AH1	Acceptor Handshake	Complete capability
T6	Talker	Basic talker, serial poll response, unaddress if listener
L4	Listener	Basic listener, unaddress if talker — listen only mode not possible
SR1	Service Request	Complete capability — the power on condition is SR0 (no capability), changed to SR1 (full capability) by sending a device dependent message
DC1	Device Clear	Complete capability — device clear produces the same results as power on except for the interface states (listener, etc.); also, service requests are reset
DT1	Device Trigger	Complete capability — sending the GROUP EXECUTE TRIGGER message places the source in the operate mode
RL	Remote/Local	No capability
PP	Parallel Poll	No capability
C	Controller	No capability

ERRATA #1

On page 16, under "Troubleshooting",
ADD: A replacement module for the IEEE-488 Compatible Interface
Assembly may be ordered under FLUKE MODULE EXCHANGE PROGRAM.
Refer to the part list for ordering information.

On page 19, Table 12:
ADD: INTERFACE MODULE EXCHANGED|639658|89536|639658|1
(4200-7605)

On page 20, Table 12:
CHANGE: U23|IC, 2716, SPECIAL PROGRAM|*|89536|ORDER 4200A-4501 +
COMPLETE DESCRIPTION|1
TO: U23|IC, 2716, SPECIAL PROGRAM|629881|89536|629881|1

ERRATA #2

On page 3, Table 2, change the order of the column headings under "STRAPS",

FROM: 1 2 3 4
TO: 4 3 2 1

ERRATA #3

On page 8, Table 6, replace the first paragraph following the bulleted list with,

The clear command should be used to initialize the voltage source as good programming practice. The clear command resets the voltage source to the above conditions to ensure that the voltage source behaves predictably. The clear command is not needed when changing voltage outputs after initialization.

CHANGE/ERRATA INFORMATION

ISSUE NO: 3

4/84

This change/errata contains information necessary to ensure the accuracy of the following manual. Enter the corrections in the manual if either one of the following conditions exist:

1. The revision letter stamped on the indicated PCB is equal to or higher than that given with each change.
2. No revision letter is indicated at the beginning of the change/errata.

MANUAL

Title: 4200-05
Print Date: October 1981
Rev.- Date: ---

C/E PAGE EFFECTIVITY

Page No.	Print Date
1	4/84

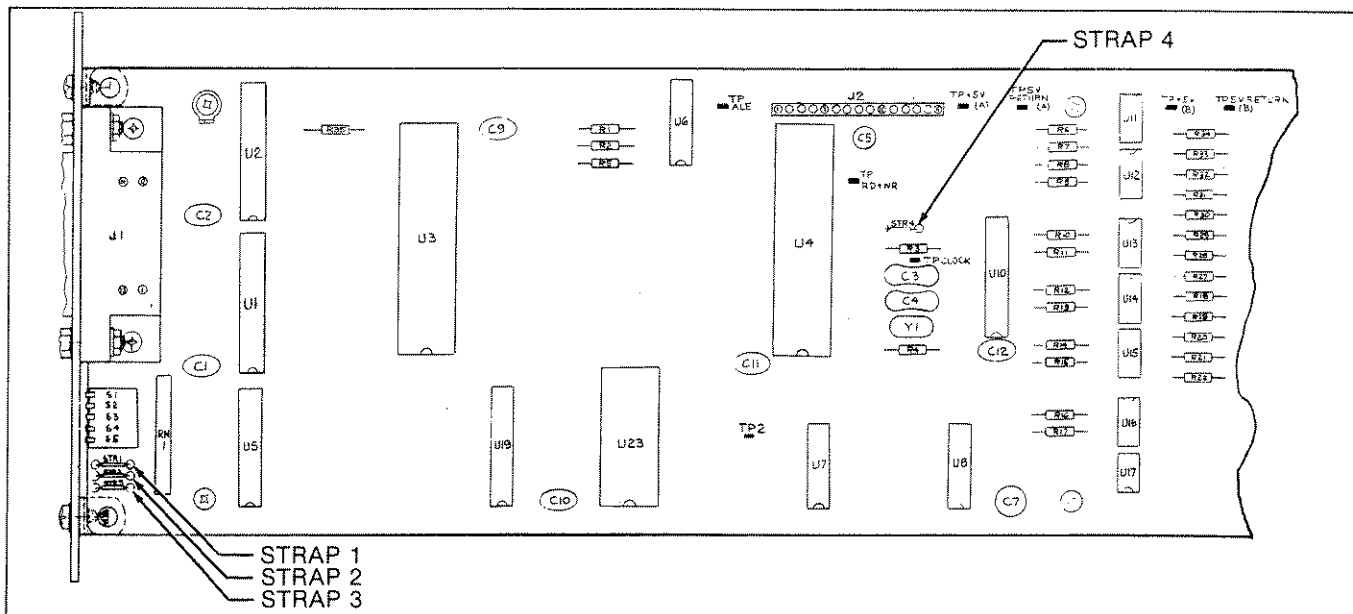

Figure 1. -05 Option Strap Locations

Table 2. -05 Option Strap Configurations

MODEL	STRAPS			
	1	2	3	4
4210	Closed	Closed	Closed	Open
4210 w/-07 Option	Closed	Closed	Closed	Open
4250	Closed	Closed	Open	Open
4250 w/-07 Option	Closed	Closed	Open	Open
4250 w/-06 Option	Closed	Closed	Open	Closed
4270	Closed	Open	Open	Open
4270 w/-07 Option	Closed	Open	Open	Open
4270 w/-06 Option	Closed	Open	Open	Closed
4216	Open	Closed	Closed	Open
4265	Open	Closed	Open	Open
4265 w/-06 Option	Open	Closed	Open	Closed
4275	Open	Open	Open	Open
4275 w/-06 Option	Open	Open	Open	Closed

NOTE: Strap 1 = bcd/binary ladder strap
 Strap 2 = 4270A/4275A strap
 Strap 3 = 4210A/4216A strap
 Strap 4 = current limit option strap

Preamplifier Assembly Modification

Installation of the -05 Option into an existing Model 4250A, 4265A, 4270A, or 4275A voltage source requires that a capacitor (C6) on the Preamplifier Assembly (A3) be changed from 330 pF to 1500 pF. To make this modification, proceed as follows:

1. Remove the top cover of the voltage source and locate the Preamplifier Assembly. (Refer to the respective instrument manual for identification of the Preamplifier Assembly.)

2. With reference to Figure 2, remove the existing C6 (330 pF) capacitor and replace with one of 1500 pF, Fluke part number 148326.

3. Install the Preamplifier Assembly and the top cover.

Installation Into the Voltage Source

Install the -05 Option into the 4200 series voltage source as follows (be sure that the straps are properly configured as listed in Table 2):

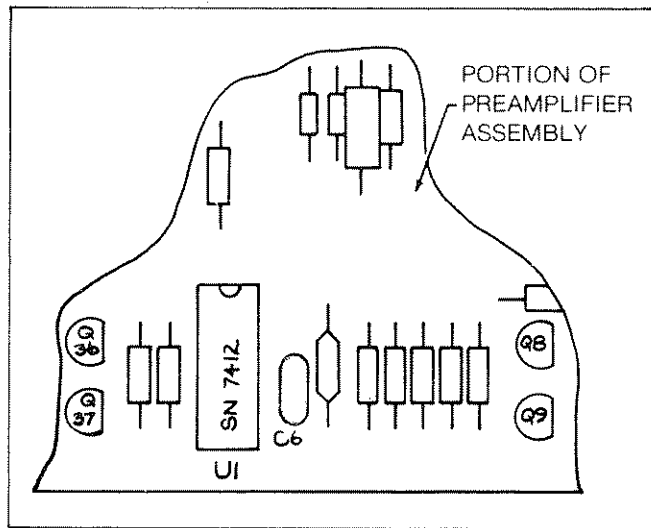

Figure 2. Location of C6 on Preamplifier Assembly

1. Remove the two screws which retain the existing Control Logic Assembly to the rear panel. Slide the existing Control Logic Assembly rearward and out of voltage source.
2. Insert the -05 Option into the vacant control logic slot and push the option forward until its rear panel contacts the rear panel of the voltage source.
3. Install the two retaining screws and connect the IEEE-488 compatible cable to the rear connector.

ADDRESS SWITCH SETTINGS

A set of five switches, accessible at the rear panel of the -05 Option, provide address assignment of the voltage source

utilizing the -05 Option in accordance with IEEE-488 requirements. The switches, shown in Figure 3, are set in accordance with Table 3 in order to assign the required address to the voltage source.

NOTE

The -05 Option reads the address set on the switches only during power-on. When changing the switch settings, be sure to switch power off then on again.

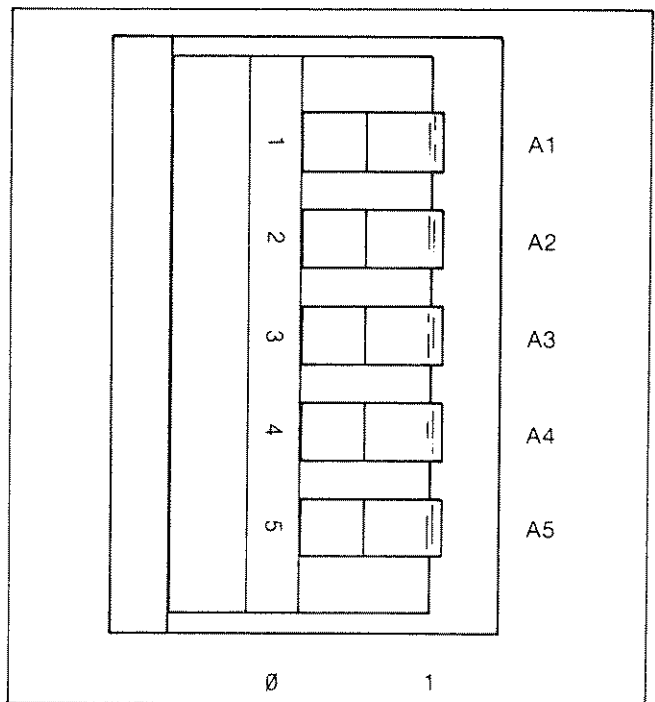

Figure 3. Address Assignment Switches

Table 3. Addresses/Switch Configurations

ADDRESS	SWITCH					ADDRESS	SWITCH				
	A5	A4	A3	A2	A1		A5	A4	A3	A2	A1
00	0	0	0	0	0	16	1	0	0	0	0
01	0	0	0	0	1	17	1	0	0	0	1
02	0	0	0	1	0	18	1	0	0	1	0
03	0	0	0	1	1	19	1	0	0	1	1
04	0	0	1	0	0	20	1	0	1	0	0
05	0	0	1	0	1	21	1	0	1	0	1
06	0	0	1	1	0	22	1	0	1	1	0
07	0	0	1	1	1	23	1	0	1	1	1
08	0	1	0	0	0	24	1	1	0	0	0
09	0	1	0	0	1	25	1	1	0	0	1
10	0	1	0	1	0	26	1	1	0	1	0
11	0	1	0	1	1	27	1	1	0	1	1
12	0	1	1	0	0	28	1	1	1	0	0
13	0	1	1	0	1	29	1	1	1	0	1
14	0	1	1	1	0	30	1	1	1	1	0
15	0	1	1	1	1						

POWER ON CONDITIONS

When power is applied, the -05 Option presents the address of the voltage source to the IEEE-488 bus for a period of approximately two seconds. During this period, the voltage source performs a self test which displays the device address on the front panel indicators of the voltage source. The -05 Option also initiates to the following conditions:

- Standby mode
- 000.0000 volts in the guard registers (output latches)
- 10% of low current limit range (if straps indicate -06 Option installed)
- Autorange mode
- SRQ response (on error) disabled

IEEE-488 BUS OVERVIEW

Bus Organization

Figure 4 shows how the IEEE-488 bus lines connect the voltage source to an IEEE-488 compatible controller. The IEEE-488 bus consists of 16 signal lines. Line assignments and descriptions are listed in Table 4. These lines fall into one of the following categories:

- Data Bus (8)
- Handshake Lines (3)
- Bus Management (5)

Data Bus Message Types

By means of the eight line data bus, the following types of data are sent between the controller and the voltage source at different times. (The transfer of any type of data over the data bus is handshake coordinated.)

- The system controller sends device dependent commands to the addressed voltage source(s).
- The system controller sends interface messages to the addressed voltage source(s).
- The addressed voltage source sends measurement data (if applicable), status response and serial poll response back to the system controller.

Table 5 lists the data bus lines (plus the bus management ATN line) and shows their configuration while transferring data to and from the voltage source.

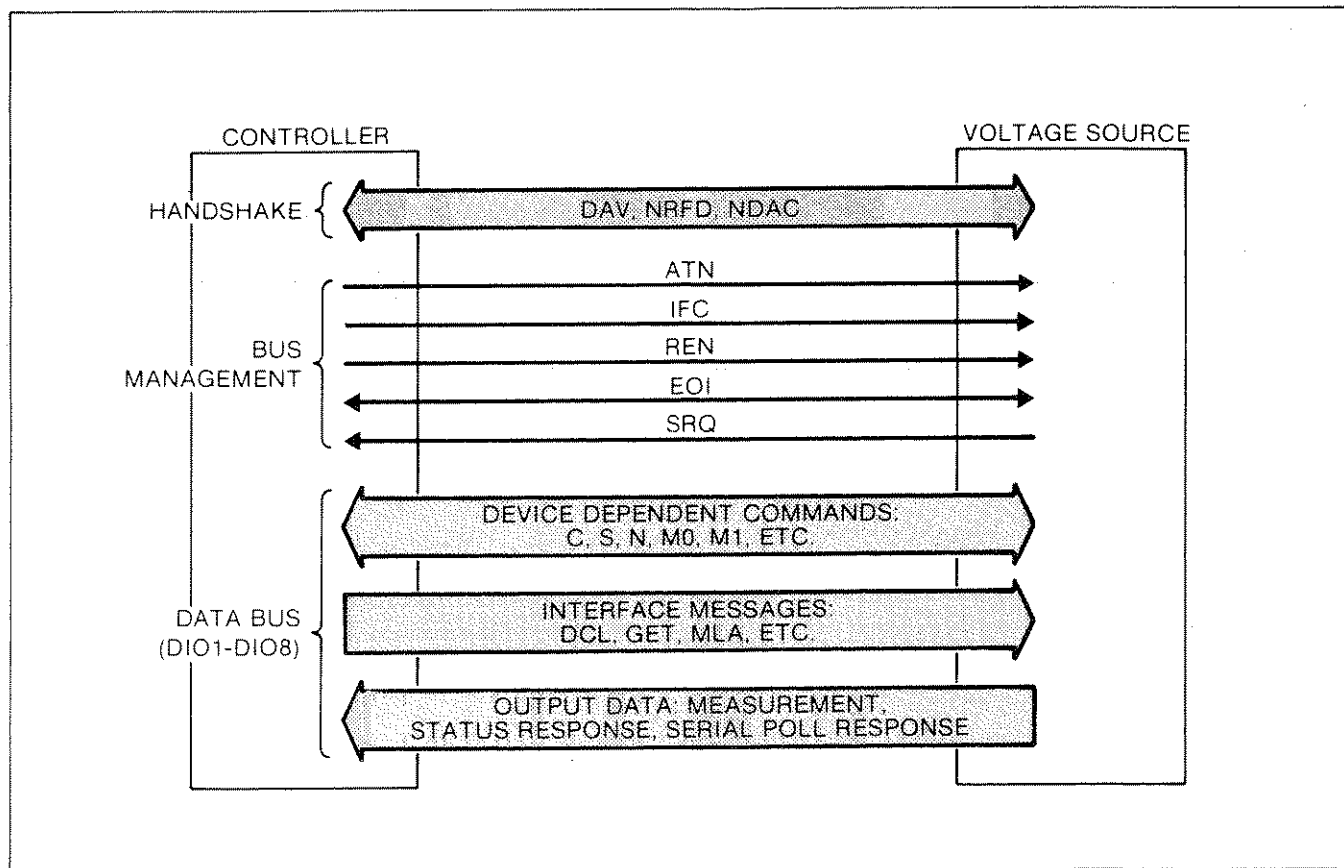

Figure 4. IEEE Bus Layout

Table 4. IEEE-488 Bus Signal Lines

CATEGORY	MNEMONIC	DEFINITION	FUNCTION
DATA BUS	DIO1-D108	Data Input/Output 1-8	Carries data, Device Dependent Commands, or Interface Messages in bit-parallel, byte-serial format. Information transfer is handshake coordinated and asynchronous.
HANDSHAKE	DAV	Data Valid	Low from source to indicate valid data on the DIO lines. Source won't change data until NDAC goes high. High from source to acknowledge that NDAC went high and data is no longer valid.
	NRFD	Not Ready For Data	Wired OR output from all acceptors. Low indicates that all acceptors acknowledge that valid data is on the DIO lines and that they have either read it or are proceeding to read it. High indicates that all acceptors are ready for more data.
	NDAC	Not Data Accepted	Wired OR output from all acceptors. Low during the handshake indicates that all acceptors have either read the data or are reading the data and the source must not change it. High indicates that all acceptors have accepted the data and the source may change the data. Low at the end of the handshake indicates that all acceptors have acknowledged DAV going high.
BUS MANAGEMENT	ATN	Attention	Set low by the controller to indicate DIO lines carry device dependent commands from the controller to the voltage source. Set high by the controller to indicate that DIO lines carry device dependent commands from the controller.
	IFC	Interface Clear	Set low by the controller to place the interface system in a known quiescent state.
	SRQ	Service Request	Low set by the voltage source to indicate the need for attention. If the Device Dependent command M1 is selected, a service request will be asserted whenever an error occurs.
	REN	Remote Enable	Not used.
	EOI	End or Identify	The controller may set EOI low at the end of any transfer.

Table 5. Data Bus Message Coding

			IEEE-488 BUS LINES														
BUS MESSAGE TYPE	MNEMONIC	MESSAGE NAME	DATA I/O								BUS MANAGEMENT					NOTES	
			D108	D107	D106	D105	D104	D103	D102	D101	ATN	EOI	SRQ	IFC	REN		
Bus Management	ATN	Attention	x	x	x	x	x	x	x	x	x	1	x	x	x	x	
	END	End	x	x	x	x	x	x	x	x	0	1	x	x	x		
	SRQ	Service Request	x	x	x	x	x	x	x	x	x	x	1	x	x		
	IFC	Interface Clear	x	x	x	x	x	x	x	x	x	x	x	1	x		
	REN	Remote Enable	x	x	x	x	x	x	x	x	x	x	x	x	x	1	
HANDSHAKE TRANSFER	Device Dependent Commands	DAB	Data Byte	x	D7	D6	D5	D4	D3	D2	D1	0	x	x	x	x	1,2
	Interface Messages	MLA	My Listen Address	x	0	1	L5	L4	L3	L2	L1	1	x	x	x	x	3
		UNL	Unlisten	x	0	1	1	1	1	1	1	1	x	x	x	x	
		MTA	My Talk Address	x	1	0	T5	T4	T3	T2	T1	1	x	x	x	x	3
		UNT	Untalk	x	1	0	0	1	0	1	0	0	1	x	x	x	
		DCL	Device Clear	x	0	0	1	0	1	0	0	1	x	x	x	x	
		SDC	Selected Dev Clear	x	0	0	0	0	1	0	0	1	c	c	c	c	
		SPE	Serial Poll Enable	x	0	0	1	1	0	0	0	1	x	x	x	x	
		SPD	Serial Poll Disable	x	0	0	1	1	0	0	1	1	x	x	x	x	
	GET	Group Execute Trig	x	0	0	0	1	0	0	0	1	x	x	x	x		
Serial Poll and Status	DAB	Data Byte	0	D7	D6	D5	D4	D3	D2	D1	0	x	x	x	x	1	

SYMBOLS: x = Don't Care
 1 = Logic one
 0 = Logic zero

NOTES: 1. D1-D7 are the data bits which equal the binary equivalent of the ASCII character being sent.
 2. A list and description of Device Dependent Commands is provided later in Table 605-6.
 3. L1-L5 and T1-T5 are the instrument address bits for the device.

DEVICE DEPENDENT COMMANDS

Device dependent commands are sent to the voltage source over the data bus (DI01-DI08). During the transmission of the device dependent commands, the bus management line ATN is false. Each of the device dependent commands for the 4200 series voltage sources is described in Table 6. (Note that NRx represents some numeric entry.)

SYNTAX OF COMMAND STRINGS

Definitions

The following definitions are provided in order to clarify several terms used in the subsequent text.

TERMINATOR

A character sent by the controller which notifies the

-05 Option to execute all commands sent since the last terminator. The following terminators are valid for use with the -05 Option:

- <LF>
- <CR><LF>
- <LF> with EOI line
- <CR><LF> with EOI line
- <,> with EOI line
- <DAB> with EOI line

where <LF> is an ASCII line feed character, <CR> is an ASCII carriage return character, <,> is an ASCII comma, and <DAB> is the last byte of a command.

COMMAND STRING

A contiguous set of characters ending with a terminator.

INPUT BUFFER

The input buffer provides temporary storage of up to 23 bytes of input data.

Rules

When sending commands, or series of commands, to the -05 Option, observe the following rules:

1. Command strings may be up to 23 bytes in length including the terminator. The 23 byte limitation is imposed by the capacity of the input buffer.
2. The terminator must be included within the command string, or the -05 Option notifies the controller of a string error, indicating an invalid string.

3. Multiple commands within a command string must be separated by commas in order to be executed. Commands not separated by commas are not executed, and cause the -05 Option to notify the controller of a string error.

4. The execution of commands begins, usually in the order they are received, upon receipt of a terminator.

5. The clear command (C), when executed, clears the input buffer so that any commands previously loaded in the buffer for execution are also cleared. For example, the command string "V100 <terminator> C <terminator>" creates a 100-volt output pulse equal to the time between executing the V100 command string and executing the C (clear) command string, while the command string "V100,C <terminator>" creates no output.

Table 6. Device Dependent Commands

COMMAND	FUNCTION
Clear (C)	<p>Upon receipt of a clear command, the voltage source:</p> <ul style="list-style-type: none"> • Enters the standby mode • Clears all input/output pointers • Clears errors • Clears the ladder latches to 000.0000V • Sets current limit to 10% of low range • Selects low voltage range • Selects internal reference • Disables service request response on errors • Selects autorange mode <p>All device dependent command messages contain a clear command (C) as the first command. The -05 Option requires the clear command in order to initialize the voltage source and allow the handshake and transmission of the subsequent commands.</p> <p>The clear command is an immediate character which suspends the handshake and transmission of all other data messages until all the above listed clear actions are complete (0.5 milliseconds). If during this period, a fast controller requests status by making the -05 Option a talker, the handshake will be delayed until the clear sequence is complete. If a fast controller conducts a serial poll during the clear sequence, it may receive an "old" status byte, i.e., one which reflects the status prior to the clear command.</p>
Standby (S)	Places the voltage source in the standby mode.
Operate (N)	Places the voltage source in the operate mode. If no range, (N) output voltage, or current limit value are previously commanded in the command message, the voltage source assumes the default values set by the clear command (C). If an out-of-range value was commanded, the previous valid value may be output. The status byte should be checked for errors before sending the operate command (N).
Enable/Disable SRQ Response (M NR1)	Sending M1 enables the voltage source to generate service requests on error conditions and/or string response errors. Sending M0 prevents the voltage from generating service requests on error conditions and/or string errors.

Table 6. Device Dependent Commands (cont)

COMMAND	FUNCTION																																																						
Polarity P<NR1>	Sets the voltage source output polarity. Sending P1 sets the output polarity to positive; sending P0 sets the output polarity to negative. (The absolute value of the output is unaffected.) Sending a command message which includes P1,P0,P1,P0,P1,P0, results in a squarewave type of output.																																																						
Range R<NR1>	Allows the voltage source to operate in autorange mode, or in the high range only. Sending R1 causes the voltage source to output in the high range only and is used where sudden steps in accuracy are undesirable. (Refer to the following table.) <table border="1" data-bbox="699 480 1276 746"> <thead> <tr> <th>4200 MODEL</th> <th>MAX. VOLTS LOW RANGE</th> <th>MIN. VOLTS HIGH RANGE</th> </tr> </thead> <tbody> <tr> <td>4210A</td> <td>N/A</td> <td>N/A</td> </tr> <tr> <td>4250A</td> <td>9.999(9)</td> <td>10.000(0)</td> </tr> <tr> <td>4270A</td> <td>9.999(9)</td> <td>10.000(0)</td> </tr> <tr> <td>4216A</td> <td>N/A</td> <td>N/A</td> </tr> <tr> <td>4265A</td> <td>16.383(9)</td> <td>16.384(0)</td> </tr> <tr> <td>4275A</td> <td>32.7679</td> <td>32.7680</td> </tr> </tbody> </table>	4200 MODEL	MAX. VOLTS LOW RANGE	MIN. VOLTS HIGH RANGE	4210A	N/A	N/A	4250A	9.999(9)	10.000(0)	4270A	9.999(9)	10.000(0)	4216A	N/A	N/A	4265A	16.383(9)	16.384(0)	4275A	32.7679	32.7680																																	
4200 MODEL	MAX. VOLTS LOW RANGE	MIN. VOLTS HIGH RANGE																																																					
4210A	N/A	N/A																																																					
4250A	9.999(9)	10.000(0)																																																					
4270A	9.999(9)	10.000(0)																																																					
4216A	N/A	N/A																																																					
4265A	16.383(9)	16.384(0)																																																					
4275A	32.7679	32.7680																																																					
	Sending R0 commands the autorange mode so that the option always selects the optimum range for output accuracy.																																																						
Volts V<NR2>	Causes the voltage source to produce an output equal to the value specified by the numeric entry NR2, including the embedded decimal point. (For example, sending V12.3456 to a Model 4270A produces an output of 12.3456 volts.) No rounding is performed except in the Model 4275A, and then only the fourth digit after the decimal point is rounded for values less than 32.7680 volts. In all models, the operate mode must be commanded in order to produce the specified output voltage.																																																						
External Reference X<NR2>	Causes the value of NR2 to be output, but in direct proportion to an externally applied reference voltage. The output voltage in relation to the value of NR2 is as follows: $E_{out} = NR2 \times (E_{ext}/10)$ For example, if the external reference voltage is +10V dc and NR2 is 5.000, Eout equals +5.000 volts; however, if the external reference voltage is +5V dc and NR2 is 5.000, Eout equals +2.500 volts.																																																						
Current Limit A<NR2>	Causes output current to be limited as near as possible to the value specified by the numeric entry NR2. Current limits are specified in amperes and rounding takes place up to four digits after the entered decimal point. Refer to the following table. <table border="1" data-bbox="695 1385 1271 1823"> <thead> <tr> <th rowspan="2"></th> <th colspan="4">VOLTAGE SOURCE MODEL</th> </tr> <tr> <th colspan="2">4270A/4275A</th> <th colspan="2">4250A/4265A</th> </tr> </thead> <tbody> <tr> <td rowspan="11">CURRENT LIMITS IN AMPS</td> <td>0.005</td> <td>0.10</td> <td>0.01</td> <td>0.2</td> </tr> <tr> <td>0.010</td> <td>0.15</td> <td>0.02</td> <td>0.3</td> </tr> <tr> <td>0.015</td> <td>0.20</td> <td>0.03</td> <td>0.4</td> </tr> <tr> <td>0.020</td> <td>0.25</td> <td>0.04</td> <td>0.5</td> </tr> <tr> <td>0.025</td> <td>0.30</td> <td>0.05</td> <td>0.6</td> </tr> <tr> <td>0.030</td> <td>0.35</td> <td>0.06</td> <td>0.7</td> </tr> <tr> <td>0.035</td> <td>0.40</td> <td>0.07</td> <td>0.8</td> </tr> <tr> <td>0.040</td> <td>0.45</td> <td>0.08</td> <td>0.9</td> </tr> <tr> <td>0.045</td> <td>0.50</td> <td>0.09</td> <td>1.0</td> </tr> <tr> <td>0.050</td> <td>0.55</td> <td>0.10</td> <td>1.1</td> </tr> <tr> <td>0.55</td> <td>0.00</td> <td>0.11</td> <td>0.0</td> </tr> </tbody> </table>		VOLTAGE SOURCE MODEL				4270A/4275A		4250A/4265A		CURRENT LIMITS IN AMPS	0.005	0.10	0.01	0.2	0.010	0.15	0.02	0.3	0.015	0.20	0.03	0.4	0.020	0.25	0.04	0.5	0.025	0.30	0.05	0.6	0.030	0.35	0.06	0.7	0.035	0.40	0.07	0.8	0.040	0.45	0.08	0.9	0.045	0.50	0.09	1.0	0.050	0.55	0.10	1.1	0.55	0.00	0.11	0.0
	VOLTAGE SOURCE MODEL																																																						
	4270A/4275A		4250A/4265A																																																				
CURRENT LIMITS IN AMPS	0.005	0.10	0.01	0.2																																																			
	0.010	0.15	0.02	0.3																																																			
	0.015	0.20	0.03	0.4																																																			
	0.020	0.25	0.04	0.5																																																			
	0.025	0.30	0.05	0.6																																																			
	0.030	0.35	0.06	0.7																																																			
	0.035	0.40	0.07	0.8																																																			
	0.040	0.45	0.08	0.9																																																			
	0.045	0.50	0.09	1.0																																																			
	0.050	0.55	0.10	1.1																																																			
	0.55	0.00	0.11	0.0																																																			
	In addition, current limiting commands require that the current limit option be installed in the voltage source, and that strap number 1 on the -05 Option must be in place (closed).																																																						

Table 6. Device Dependent Commands (cont)

COMMAND	FUNCTION
Squarewave Output K(NR1)	<p>Causes the voltage source to produce a 1 kHz squarewave output (frequency accurate to within 0.1%) using previously programmed voltage, polarity and current limit.</p> <p>Sending K0 causes the output voltage to swing between 0.000 volts and the previously programmed value. For example, the command message C,V-3.4,A0.01,K0 produces a 50% duty cycle squarewave switching between zero and -3.4 volts, with current limited to 10 mA.</p> <p>Sending K1 causes the output to swing between the positive and negative levels of a programmed voltage.</p> <p style="text-align: center;">NOTE</p> <p>Sending other device dependent commands or requesting status while in the squarewave output mode causes discontinuities in the output.</p> <p style="text-align: center;">CAUTION</p> <p>Any attempt to enter the direct ladder mode before terminating the squarewave mode results in unpredictable operation.</p> <p>Terminate the squarewave output mode by sending the interface message DCL or SDC, or by sending the device dependent clear command (C) to the voltage source.</p> <p style="text-align: center;">NOTE</p> <p>Although a current limit may be set, current limit errors are unreported in the squarewave output mode.</p>
Direct Ladder Access D(3 bytes)	<p>A four-byte command which provides much faster output response than a command message made up of P,R,X,V and A commands, but with limited error and syntax checking.</p> <p>The first byte of the command sequence is a D (ASCII), either upper or lower case. The succeeding three bytes contain the voltage, polarity, external reference, voltage range, current limit range, and high resolution option information required by the voltage source to set the output. The content of the last three bytes of the command sequence is described in Table 7.</p> <p>In this four-byte command, separators (,) and terminators slow down operations and should not be inserted. Spaces are not allowed between the D and the following three bytes.</p> <p>Note that the 4216A and 4265A voltage sources require only 14 bits of ladder data; bits 0 and 1 of the third byte are not used and may be either 1 or 0. Also, two's complement cannot be used as in other interface assemblies for the voltage sources.</p>

Table 7. Direct Ladder Access Programming Data

BIT	BCD VOLTAGE SOURCES	4216A		4265A		4275A		
		8.192 CODE	8.000 CODE	16V RANGE	65V RANGE	32V RANGE	110V RANGE	
2 N D B Y T E	7	A8	8.192	8.000	8.192	32.768	16.384	65.536
	6	A4	4.096	4.000	4.096	16.384	8.192	32.768
	5	A2	2.048	2.000	2.048	8.192	4.096	16.384
	4	A1	1.024	1.000	1.024	4.096	2.048	8.192
	3	B8	0.512	0.500	0.512	2.048	1.024	4.096
	2	B4	0.256	0.250	0.256	1.024	0.512	2.048
	1	B2	0.128	0.125	0.128	0.512	0.256	1.024
	0	B1	0.064	0.0625	0.064	0.256	0.128	0.512
3 R D B Y T E	7	C8	0.032	0.03125	0.032	0.128	0.064	0.256
	6	C4	0.016	*0.01562	0.016	0.064	0.032	0.128
	5	C2	0.008	*0.00781	0.008	0.032	0.016	0.064
	4	C1	0.004	*0.00391	0.004	0.016	0.008	0.032
	3	D8	0.002	*0.00195	0.002	0.008	0.004	0.016
	2	D4	0.001	*0.00097	0.001	0.004	0.002	0.008
	1	D2	**	**	**	**	0.001	0.004
	0	D1	**	**	**	**	0.0005	0.002
4 T H B Y T E	7	polarity bit, 0 = positive output						
	6	external reference bit, 0 = internal reference						
	5	high/low range bit - volts, 0 = low range						
	4	high/low range bit - current limit, 0 = low range						
	3	L8 for current limit	E8 for high resolution					
2	L4 option -06 (4250A	E4 option -07 in 4210A,						
1	L2 and 4265A)	E2 4250A and 4270A						
0	L1	E1						
*Refer to 4216A manual for theoretical output levels and resolution								
**Don't care								

Syntax of Numeric Entries

The following rules apply for coding the numeric entry (NR1 and NR2) portion of the commands in order to conform to the syntax checks performed by the -05 Option:

1. Leading and trailing spaces are allowed (except in the direct ladder access mode).
2. The allowed values for NR1 are 1 and 0. Sign may be used with NR1 (e.g. -1 +1 -0 +0) however, no spaces may be inserted between the sign and the numeric value. Also, leading zeros and decimal points are not allowed in NR1 values.
3. NR2 values may include:

Leading spaces and/or zeros, even mixed

Sign (+ or -)

Inserted spaces

Some examples of NR2 values include "+00109.123", "-", "12", and "+ 0 0 0 1.234567". Trailing spaces should not be used in NR2 numeric data.

NOTE

Neither NR1 nor NR2 numeric data are used in the direct ladder access mode (command D).

Command String Examples

Table 8 lists several examples of valid command strings and their effect on the voltage source output. Note that each command string begins with the clear command (c or C).

Table 8. Command String Examples

COMMAND STRING	OUTPUT RESULT
C,V1.2345678,N <CR><LF>	Voltage source goes to standby then outputs 1.2345 volts. If a current limit option is installed, the current is limited to 10% of the low limit range (due to the clear command).
n,v0,v1,v2,v3,v4 <CR><LF>	Produces a staircase type response on the output starting at zero volts and ending at 4 volts.
C,D123,v2,n <CR><LF>	Produces a 2 volt output.
c,n,d12	Produces a zero-volt output. The voltage source is in standby since the string contains no terminator. Also, only two bytes follow the "d" command, instead of the required three. The next byte will be used as the third entry.
c,n, <CR><LF>	Produces a zero-volt output with the voltage source in the operate mode.
c,n,v2v2000,v3 <CR><LF>	Produces a 2 volt output followed by a 3 volt output. Sets string error status since 2000 volts is out of range.
c,n,v2,k+0 <LF>	Produces a 1 kHz squarewave between zero and 2 volts, starting at zero volts (+ sign causes no error).
c,v2,n,k+0<LF>	Also produces a 1 kHz squarewave between zero and 2 volts, starting at two volts.

ERROR HANDLING

General

The -05 Option considers all syntax errors and out-of-range errors to be string errors. When a string error occurs, the -05 Option notifies the controller in either of two ways:

- By setting the appropriate bit of the serial poll response (generated in response to a serial poll [SPE] interface message from the controller). Refer to Table 5 for a list of interface messages.
- By transmitting the appropriate numeric data back to the controller in response to a my talk address (MTA) interface message from the controller.

The controller may use either of these interface messages to determine the status of the voltage source. Serial poll response and status reporting operations are described in subsequent paragraphs.

Syntax and Out-of-Range Errors

Syntax errors occur when the controller sends command strings which do not conform to the requirements of the -05 Option. Out-of-range errors occur when the controller sends commands which call for output voltages and/or current limits larger than the capability of the voltage source. Table 9 lists the maximum programmable voltage and current limit for each voltage source.

NOTE

The three straps on the PCB assembly must be configured to match the voltage source model to avoid out-of-range errors.

Serial Poll Response

When the controller conducts a serial poll, the -05 Option responds by placing a status byte on the data bus. Table 10 describes the status byte. Bit seven of the status byte indicates whether or not the voltage source requested service. A service request is only generated if the SRI mode was previously enabled by sending the device dependent command M1, and a syntax or out-of-range error occurred.

Table 9. Maximum Programmable Values

VOLTAGE SOURCE MODEL	MAXIMUM OUTPUT VOLTAGE	MAXIMUM CURRENT LIMIT
4210A	+/-9.999V	None
4250A	+/-65.9999V	1.1444A
4270A	+/-99.9999V	0.5722A
4216A	+/-16.383V	None
4265A	+/-65.532V	1.1444A
4275A	+/-110.999V	0.5722A

Table 10. Serial Poll Response

BIT NUMBER								MEANING
8	7	6	5	4	3	2	1	
0	0	0	0	0	0	0	0	No Errors, Standby Mode
0	0	0	0	0	0	0	1	No Errors, Operate Mode
0	x	1	0	0	0	1	x	String Error
0	x	1	0	0	1	0	x	Overload Error
0	1	x	0	0	x	x	x	Device Requesting Service
0	x	1	0	0	x	x	x	Abnormal (error) Condition Occurred

Note that bit seven resets after the -05 Option determines that the controller has conducted a serial poll sequence. Bit seven is also reset after the controller issues a device clear interface message or the clear device dependent command (C).

Status Response (-05 Option as a Talker)

When the -05 Option is addressed as a talker by means of the MTA interface message (which includes the address selected on the address switches), it responds with a four-byte status response. The format of the status response is:

S <NR1> <CR> <LF> (EOI)

The value of NR1, an ASCII number in the range of 0 through 7, indicates the -05 Option status as listed in Table 11. If the controller does not read all four bytes of the status response, the remaining byte(s) will be read during the next status response. As a result, the order of the next status response will be incorrect unless preceded by a DCL interface message or a clear device dependent command (C).

If enabled by an M1 device dependent command, the -05 Option raises the SRQ line upon the occurrence of a string and/or limit error. To clear string and limit errors, send the DCL interface message, or the C (clear) device dependent message to the -05 Option.

Input Buffer Overflow

Overflow of the input buffer is not possible. Normally the -05 Option holds off the RFD handshake line upon receipt of the terminator. When a command string longer than 23 bytes, with no terminator, is sent to the -05 Option, the handshake stops (RFD holdoff) after accepting the 23rd byte. The -05 Option releases the handshake in approximately 21 milliseconds and sets the string error status. The remainder of the command string still present in the output buffer of the controller is then accepted. *IF THE REMAINDER OF THE COMMAND STRING HAS THE APPEARANCE OF A VALID COMMAND, IT WILL BE EXECUTED.* If

the remainder of the command string does not have the appearance of a valid command string, error status is set.

Inadvertent Maximum Output (4261A/4265A)

When the interface is installed in a Model 4261A or Model 4265A voltage source, and is programmed for an out-of-range value of less than 17 or 66 volts (e.g. 16.384 or 65.533 volts), care should be exercised in using the P1 and P0 device dependent commands. As soon as the out-of-range value is detected the string error status is set and, if commanded to the M1 mode, an SRQ is generated. At this point, three registers within the microprocessor which normally contain a copy of the voltage sent across the guard, now contain the maximum setting possible (all ones). If the user now chooses to ignore the error status and sends polarity change commands, the voltage source output becomes maximum.

THEORY OF OPERATION

The -05 Option operates as a microcomputer system to receive commands and data over the IEEE-488 bus, apply voltage commands to the voltage source, and (upon request) send voltage source/-05 Option status back to the controller. Figure 5 shows that the -05 Option consists of line receivers/drivers, an IEEE-488 general purpose interface adapter (GPIA), a microcomputer, ROM (with address latch), an internal bus, tristate buffers, a guard crossing, and a series of output latches. By means of software stored in ROM U23, the microcomputer controls internal operations to receive, process and send messages over the IEEE-488 bus through the IEEE-488 GPIA.

Table 11. Status Codes

NR1	STATUS
0	Standby Mode, No Errors
1	Operate Mode, No Errors
2	Standby Mode, String Error
3	Operate Mode, String Error
4	Standby Mode, Limit Error
5	Operate Mode, Limit Error
6	Standby Mode, String Error, Limit Error
7	Operate Mode, String Error, Limit Error

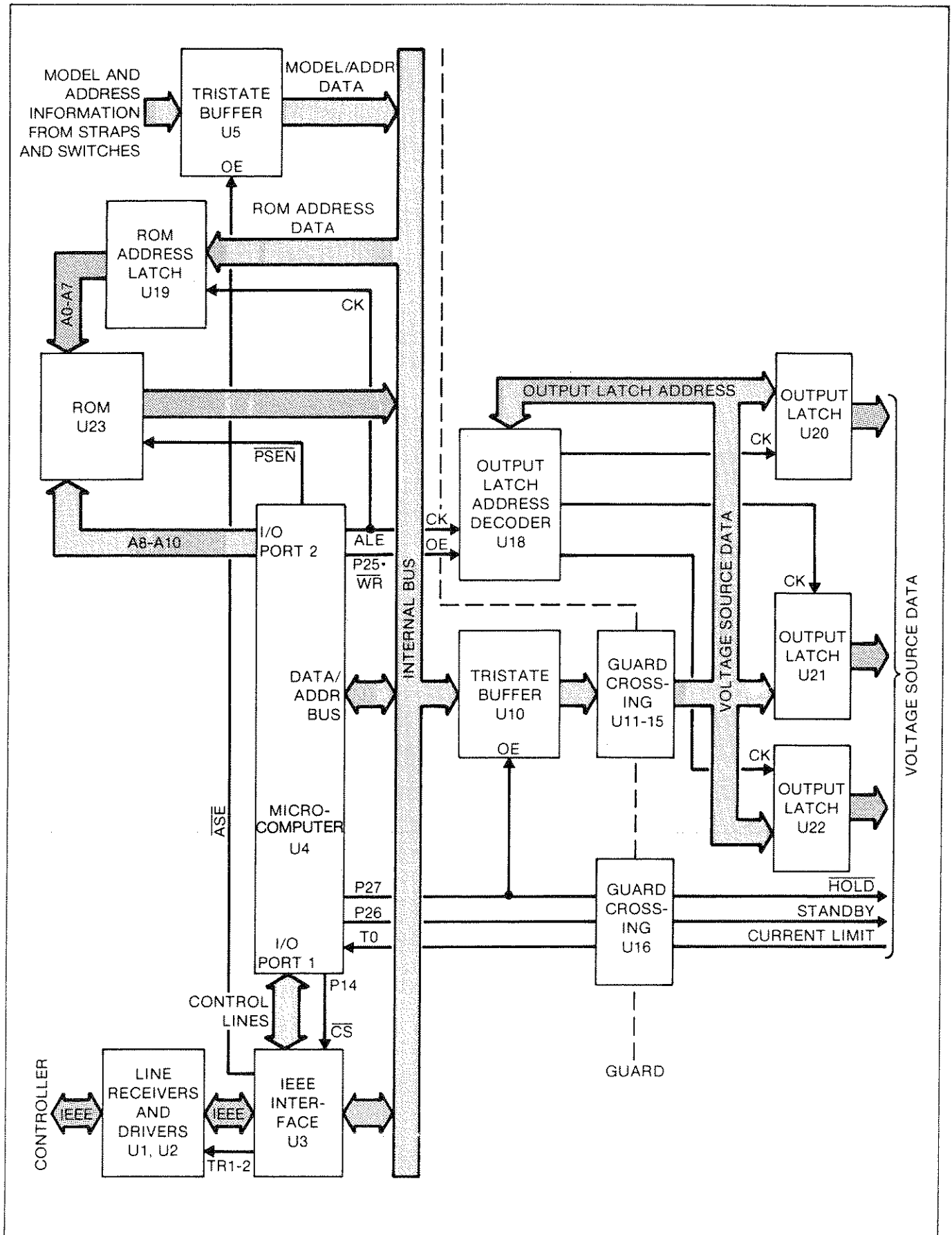

Figure 5. Block Diagram, -05 Option

General Purpose Interface Adapter

The GPIA is specifically designed for use with the IEEE-488 bus and handles bus protocol functions. The GPIA also provides transmit/receive lines (T/R1 and T/R2) to control the line receivers and drivers (U1 and U2) on the IEEE-488 bus. Operation of the GPIA is enabled by the P14 (I/O port 1) output of the micro-computer which is applied to the (CS) chip select input. The GPIA also receives clock and reset signals from the microcomputer.

The GPIA contains several registers which are accessible to the microcomputer. The registers are used by the microcomputer for transferring data to control the various functions of the GPIA and providing status information. The microcomputer makes register selection by means of control lines (RS0, RS1 and RS2) and the R/W line. The IRQ line from the GPIA enables interrupt of the microcomputer.

Line Receivers/Drivers

Connection to the IEEE-488 bus is provided by line receivers/drivers U1 and U2. The GPIA determines whether these devices act as receivers to obtain data from the bus, or as drivers to place data onto the bus.

Internal Bus

An internal eight-line bus provides for the following types of information transfer:

1. Messages and data from the GPIA to the microcomputer.
2. Messages and data from the microcomputer to the GPIA.
3. ROM (control software) address from the microcomputer.
4. ROM data (control software) to the microcomputer.
5. Voltage source data from the microcomputer.
6. Model and device address data from the switches and straps to the microcomputer.

The type of information transfer taking place on the internal bus at any given time is determined by the microcomputer, except at power-on, when the GPIA issues an ASE command to tristate buffer U5 to place the voltage source model and address switch information on the internal bus. The microcomputer reads this information from the data bus to internal RAM. The address data is used for comparison with MLA interface messages to select the -05 Option on the IEEE-488 bus; the strap information is used to address the software

(ROM) required to operate the -05 Option in a particular voltage source.

ROM Control

The ROM contains the operating software for the -05 Option. The microcomputer addresses ROM by first placing the low-order address bits (A0-A7) on the internal bus and then issuing the ALE (address latch enable) signal to ROM address latch U19. With the low-order ROM address bits applied to the ROM by U19, the microcomputer applies the high-order address bits directly to the ROM to place the addressed software command on the internal bus. The microcomputer, expecting the ROM data, reads the data appearing on the bus into its instruction register.

Transfer of Voltage Source Data

Commands and voltage values (command strings) sent over the IEEE-488 bus and received by the GPIA are transferred to a 23-byte input buffer contained within the microcomputer. When the microcomputer receives the terminator portion of the command string, it proceeds to assemble the command into a format (BCD or binary) compatible with the requirements of the voltage source. Once assembled, the voltage source data (up to three eight-bit bytes) is transferred via the internal bus, through a set of buffers (U10) and across the guard to a series of three output latches (U20, U21 and U22). The microcomputer maintains the buffers (U10) in a disabled state (by means of the P27 output of I/O port 2) any time data placed on the internal bus is not meant for voltage source. This action effectively isolates the voltage source input from internal microcomputer and GPIA operations unrelated to the sending of voltage data over to the voltage source.

Since only eight bits of voltage data can be placed on the internal bus at one time, the voltage source data is sent to the output latches, one byte at a time. Each byte of voltage source data is preceded by a byte address which directs the data byte to the appropriate output latch. When the microprocessor places the byte address on the internal bus, it writes the P27 output low to enable tristate buffer U10, and issues a high ALE signal to clock the byte address into the output latch address decoder U18. As a result, the buffer passes the byte address while the decoder accepts and stores it. (The low output at P27 also provides the hold signal required by the voltage source to maintain its output during changes in voltage selection.)

When the microcomputer places the byte of voltage source data on the internal bus, it writes the P25 output high and issues a WR signal to enable the output of U18 (the P27 output is still low to enable tristate buffer U10). With U10 enabled, the byte of voltage source data is applied to each of the output latches (U20, U21 and U22). However, only the output latch clocked by the output of U18 accepts the data passed by U10 for application to the

voltage source. The microcomputer repeats the addressing and loading of the output latches until all voltage source data is transferred across the guard. With the output latches loaded, the microcomputer writes a high to $\overline{P27}$ output to remove the hold command from the voltage source input. This allows the voltage source output to assume the value loaded into the output latches.

MAINTENANCE

Performance Test

The simplest way to check operation of the -05 Option is to operate the voltage source in which it is installed on the IEEE-488 bus in a normal manner. During operation, make sure the voltage source output corresponds to that programmed, and that proper status is reported back to the controller. If possible, isolate any problem to the voltage source or -05 Option by placing the -05 Option (re-strap if necessary) in a known good voltage source, or by substituting the -05 Option with one known to be good.

Troubleshooting

For the purpose of troubleshooting, the -05 Option can be divided into two basic circuit groups; the interface side and the voltage source side. Troubleshoot the interface side with a static controller. Exercise the -05 Option over the bus using normal troubleshooting techniques for IEEE-488 compatible equipment. For information on troubleshooting IEEE-488 compatible devices, refer to Fluke Technical Bulletin, Troubleshooting Information, C0076, available from your local Fluke sales office or service center.

The -05 Option contains a built-in self test, executed at power-on, which verifies proper operation of the microprocessor and voltage source side of the interface. The self test reads the positions of the rear panel address switches and displays the device address on the front panel indicators of the voltage source. For example, if the switches are set to address 14, the voltage source displays 14 in either binary or BCD form for a period of three seconds on the front panel indicators when power is applied. If the address fails to appear, check the ASE output of the GPIA (U4) for the low-going output required to enable the buffers of U5. If the ASE signal is present, and switch data appears at the output, a problem is indicated in the voltage source side of the interface.

To exercise the -05 Option during troubleshooting, send the K1 command. This command programs the voltage source to two different voltage levels (zero and that previously programmed) at a 1 kHz rate, and as a result creates much activity on the voltage source side of the circuit. The waveforms given in Figure 6 show the normal signals at several test points provided on the printed circuit board assembly. Use these waveforms to verify proper operation. (Also refer to the theory of operation for the operational details of the voltage source side of the circuit.) Verify that the hold signal to the voltage source goes low for approximately 40 microseconds in response to voltage commands sent over the IEEE-488 bus.

List of Replaceable Parts

The list of replaceable parts for the 4200-05 Option is given in Table 12. Refer to Section 5 of the Voltage Source Instruction Manual for ordering information.

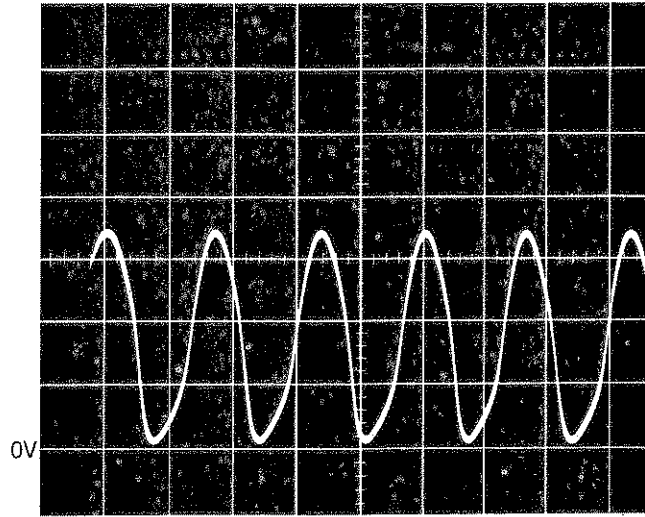

TEST POINT: TP CLOCK
 0.1 μ s/div.
 0.1V/div.

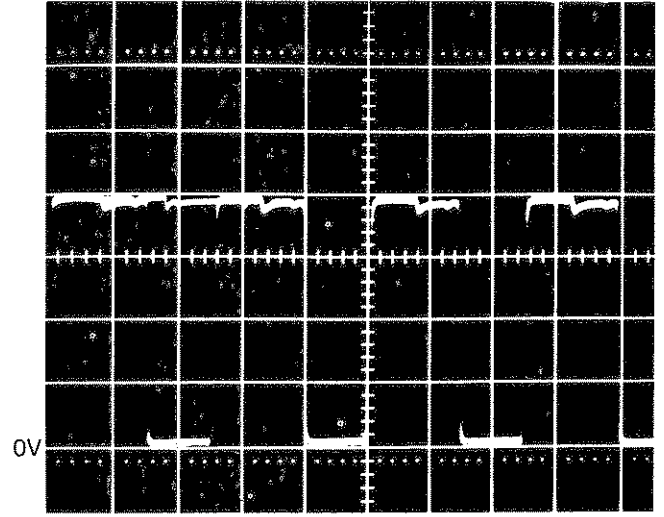

TEST POINT: U4-9 (\overline{PSEN})
 1.0 μ s/div.
 0.1V/div.

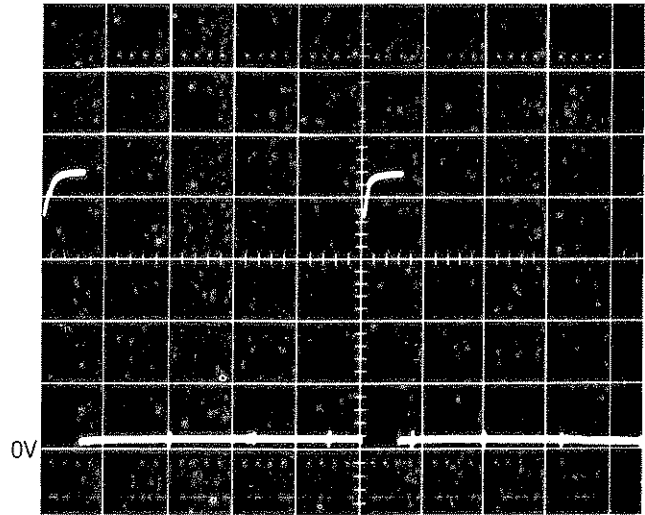

TEST POINT: TP RD+WR
 2.0 μ s/div.
 0.1V/div.
 UNDER CONTROL OF FLUKE 1720A
 (PULSES BECOME RANDOM WITHOUT
 CONTROLLER CONNECTED)

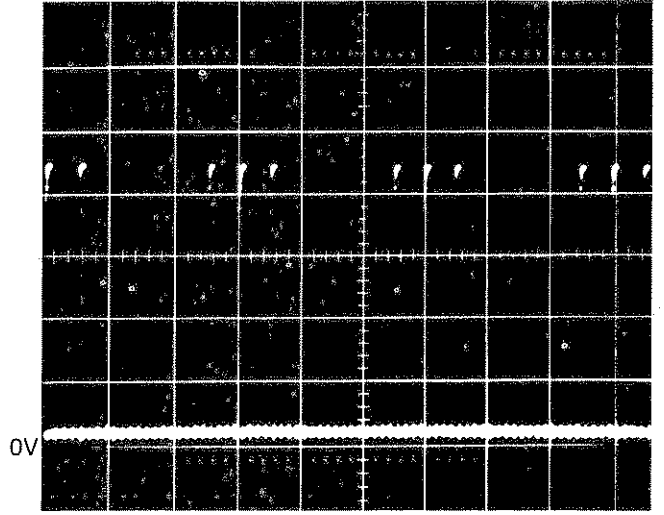

TEST POINT: TP RD+WR
 20 μ s/div.
 0.1V/div.
 UNDER CONTROL OF FLUKE 1720A

NOTE: ALL WAVEFORMS TAKEN WITH X10 PROBE.

Figure 6. Troubleshooting Waveforms

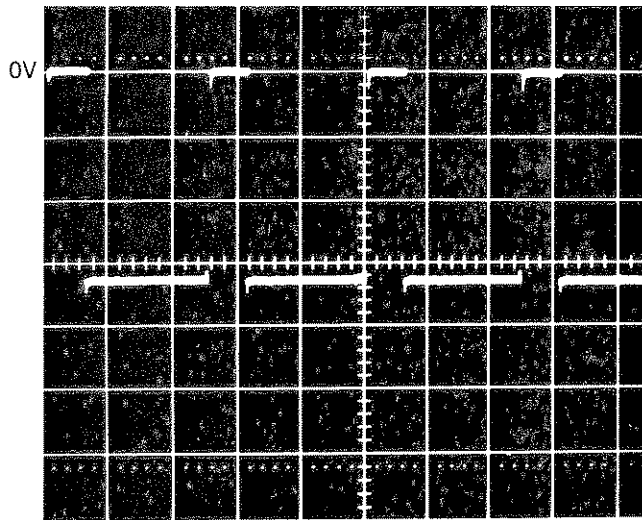

TEST POINT: ACROSS R14, (LOW TO U15-2)
 1.0 μ s/div.
 0.1V/div.

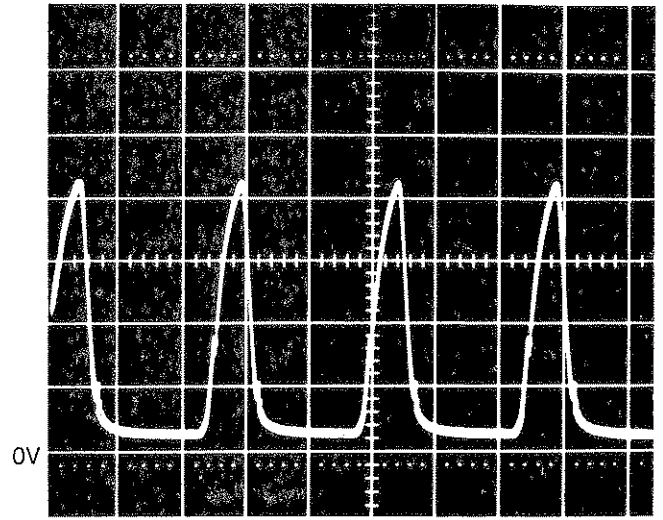

TEST POINT: U9-9
 1.0 μ s/div.
 0.1V/div.

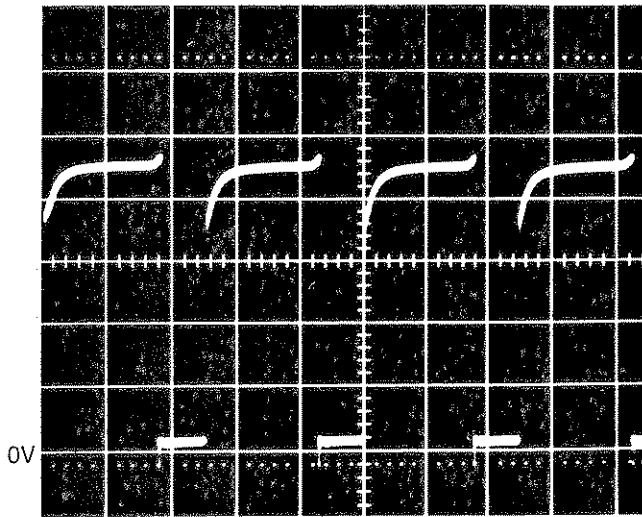

TEST POINT: U9-8
 1.0 μ s/div.
 1.0V/div.

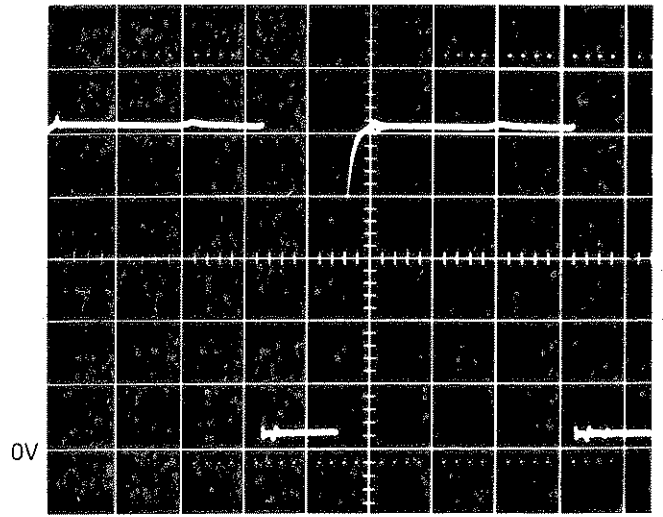

TEST POINT: TP $\overline{\text{ALE}}$
 0.5 μ s/div.
 0.1V/div.

NOTE: ALL WAVEFORMS TAKEN WITH X10 PROBE.

Figure 6. Troubleshooting Waveforms (cont)

Table 12. IEEE-488 Interface Assembly

REF DES	DESCRIPTION	FLUKE STOCK NO.	MFG SPLY CODE	MFG PART NO.	TOT QTY	REC QTY	NOTE
	INTERFACE ASSEMBLY FIGURE 7 (4200A-4005)	ORDER	BY	OPTION -05			
C1	CAP, CER, 0.1UF, GMV, 10V	368647	71590	UK10-104	9		
C2	CAP, CER, 0.1UF, GMV, 10V	368647	71590	UK10-104	REF		
C3	CAP, MICA, 22 PF +/-5%, 500V	148551	02759	DM15C220J	2		
C4	CAP, MICA, 22 PF +/-5%, 500V	148551	02759	DM15C220J	REF		
C5	CAP, TA, 1 UF +/-20%, 35V	161919	56289	196D010X0035G	1		
C6	CAP, TA, 10 UF +/-20%, 20V	330662	56289	196D106X0020KA1	3		
C7	CAP, TA, 10 UF +/-20%, 20V	330662	56289	196D106X0020KA1	REF		
C8	CAP, TA, 10 UF +/-20%, 20V	330662	56289	196D106X0020KA1	REF		
C9	CAP, CER, 0.1UF, GMV, 10V	368647	71590	UK10-104	REF		
C10	CAP, CER, 0.1UF, GMV, 10V	368647	71590	UK10-104	REF		
C11	CAP, CER, 0.1UF, GMV, 10V	368647	71590	UK10-104	REF		
C12	CAP, CER, 0.1UF, GMV, 10V	368647	71590	UK10-104	REF		
C13	CAP, CER, 0.1UF, GMV, 10V	368647	71590	UK10-104	REF		
C14	CAP, CER, 0.1UF, GMV, 10V	368647	71590	UK10-104	REF		
C15	CAP, CER, 0.1UF, GMV, 10V	368647	71590	UK10-104	REF		
CR1	DIODE, HI SPEED SWITCHING	203323	04713	1N4448	1		1
H1	SCREW, 2-56 X 3/8	196634	89536	196634	2		
H2	SCREW, LK, 4-40 X 1/4	185918	89536	185918	4		
H3	SCREW, LK, 3-32 X 1/4	178533	89536	178533	2		
H4	SCREW, LOCK (PANEL MOUNT KIT)	494773	89536	494773	1		
H5	WASHER, LOCK	110676	89536	110676	2		
H6	WASHER, FLAT #2	306415	89536	306415	2		
H7	WASHER, FLAT #4	110775	89536	110775	2		
H8	NUT, HEX	110668	73734	8000NP	2		
J1	CONN, RECEPT, 24-PIN, 1 AMP	500884	00779	55279-1	1		
J2	SOCKET, 16 CONTACT	485037	30035	SS-109-1-16C	1		
MP1	ANGLE BRACKET	404525	89536	404525	2		
R1	RES, DEP. CAR., 4.7K +/-5%, 1/4W	348821	80031	CR251-4-5P4K7	3		
R2	RES, DEP. CAR., 4.7K +/-5%, 1/4W	348821	80031	CR251-4-5P4K7	REF		
R3	RES, DEP. CAR., 4.7K +/-5%, 1/4W	348821	80031	CR251-4-5P4K7	REF		
R4	RES, DEP. CAR., 3.3K +/-5%, 1/4W	348813	80031	CR251-4-5P3K3	13		
R5	RES, CAR. DEP., 1K +/-5%, 1/4W	343426	80031	CR251-4-5P1K	1		
R6	RES, CAR. DEP., 330 +/-5%, 1/4W	368720	80031	CR251-4-5P330E	11		
R7	RES, CAR. DEP., 330 +/-5%, 1/4W	368720	80031	CR251-4-5P330E	REF		
R8	RES, CAR. DEP., 330 +/-5%, 1/4W	368720	80031	CR251-4-5P330E	REF		
R9	RES, CAR. DEP., 330 +/-5%, 1/4W	368720	80031	CR251-4-5P330E	REF		
R10	RES, CAR. DEP., 330 +/-5%, 1/4W	368720	80031	CR251-4-5P330E	REF		
R11	RES, CAR. DEP., 330 +/-5%, 1/4W	368720	80031	CR251-4-5P330E	REF		
R12	RES, CAR. DEP., 330 +/-5%, 1/4W	368720	80031	CR251-4-5P330E	REF		
R13	RES, CAR. DEP., 330 +/-5%, 1/4W	368720	80031	CR251-4-5P330E	REF		
R14	RES, CAR. DEP., 390 +/-5%, 1/4W	441543	80031	CR251-4-5P390E	2		
R15	RES, CAR. DEP., 390 +/-5%, 1/4W	441543	80031	CR251-4-5P390E	REF		
R16	RES, CAR. DEP., 330 +/-5%, 1/4W	368720	80031	CR251-4-5P330E	REF		
R17	RES, CAR. DEP., 330 +/-5%, 1/4W	368720	80031	CR251-4-5P330E	REF		
R18	RES, DEP. CAR., 3.3K +/-5%, 1/4W	348813	80031	CR251-4-5P3K3	REF		
R19	RES, DEP. CAR., 3.3K +/-5%, 1/4W	348813	80031	CR251-4-5P3K3	REF		
R20	RES, DEP. CAR., 3.3K +/-5%, 1/4W	348813	80031	CR251-4-5P3K3	REF		

Table 12. IEEE-488 Interface Assembly (cont)

REF DES	DESCRIPTION	FLUKE STOCK NO.	MFG SPLY CODE	MFG PART NO.	TOT QTY	REC QTY	N O T E
R21	RES, DEP. CAR., 3.3K +/-5%, 1/4W	348813	80031	CR251-4-5P3K3	REF		
R22	RES, CAR. DEP., 330 +/-5%, 1/4W	368720	80031	CR251-4-5P330E	REF		
R23	RES, CAR. DEP., 10K +/-5%, 1/4W	348839	80031	CR251-4-5P10K	5		
R24	RES, CAR. DEP., 10K +/-5%, 1/4W	348839	80031	CR251-4-5P10K	REF		
R25	RES, CAR. DEP., 10K +/-5%, 1/4W	348839	80031	CR251-4-5P10K	REF		
R26	RES, CAR. DEP., 10K +/-5%, 1/4W	348839	80031	CR251-4-5P10K	REF		
R27	RES, DEP. CAR., 3.3K +/-5%, 1/4W	348813	80031	CR251-4-5P3K3	REF		
R28	RES, DEP. CAR., 3.3K +/-5%, 1/4W	348813	80031	CR251-4-5P3K3	REF		
R29	RES, DEP. CAR., 3.3K +/-5%, 1/4W	348813	80031	CR251-4-5P3K3	REF		
R30	RES, DEP. CAR., 3.3K +/-5%, 1/4W	348813	80031	CR251-4-5P3K3	REF		
R31	RES, DEP. CAR., 3.3K +/-5%, 1/4W	348813	80031	CR251-4-5P3K3	REF		
R32	RES, DEP. CAR., 3.3K +/-5%, 1/4W	348813	80031	CR251-4-5P3K3	REF		
R33	RES, DEP. CAR., 3.3K +/-5%, 1/4W	348813	80031	CR251-4-5P3K3	REF		
R34	RES, DEP. CAR., 3.3K +/-5%, 1/4W	348813	80031	CR251-4-5P3K3	REF		
R35	RES, CAR. DEP., 10K +/-5%, 1/4W	348839	80031	CR251-4-5P10K	REF		
RN1	RESISTOR NETWORK, 10K	414003	89536	414003	1		
S1-S5	PIANO SWITCH ASSY.	454769	89536	454769	1		
TP	TEST POINTS (TYPICAL)	512889	00779	62395-1	7		
U1	IC, BUS TRANSCEIVER, DIGITAL	524835	04713	MC3447P	2	1	
U2	IC, BUS TRANSCEIVER, DIGITAL	524835	04713	MC3447P	REF		
U3	IC, GP INTERFACE ADAPTOR 8048	477794	04713	MC68488P	1	1	
U4	IC, MICRO COMPUTER	495077	89536	495077	1		
U5	IC, LO-PWR SCHOTTKY, TRI-ST OCTAL BUFFER	429902	12040	DM81LS95N	2	1	
U6	IC, LO-PWR SCHOTTKY, D F/F	393124	01295	SN74LS74N	1	1	
U7	IC, TTL, QUAD, 2-IN POS NAND GATE	393033	01295	SN74LS00N	1	1	
U8	IC, TTL HEX INVERTER	407593	01295	SN7406N	1	1	
U9	IC, TTL, SCHMT-TRIG POS NAND GATE	483180	01295	SN74LS14N	1	1	
U10	IC, LO-PWR SCHOTTKY, TRI-ST OCTAL BUFFER	429902	12040	DM81LS95N	REF		
U11	OPTO ISOLATOR	429894	28480	5082-4355	6	2	
U12	OPTO ISOLATOR	429894	28480	5082-4355	REF		
U13	OPTO ISOLATOR	429894	28480	5082-4355	REF		
U14	OPTO ISOLATOR	429894	28480	5082-4355	REF		
U15	OPTO ISOLATOR	429894	28480	5082-4355	REF		
U16	OPTO ISOLATOR	429894	28480	5082-4355	REF		
U17	OPTO ISOLATOR	380014	01295	T1L116	1	1	
U18	IC, TTL, 4-BIT D-TYPE REGULATOR	504480	01295	SN74S173N	1	1	
U19	IC, TTL, LO-PWR SCHOTTKY OCTAL D,FF	454892	01295	SN74LS273N	4	1	
U20	IC, TTL, LO-PWR SCHOTTKY OCTAL D,FF	454892	01295	SN74LS273N	REF		
U21	IC, TTL, LO-PWR SCHOTTKY OCTAL D,FF	454892	01295	SN74LS273N	REF		
U22	IC, TTL, LO-PWR SCHOTTKY OCTAL D,FF	454892	01295	SN74LS273N	REF		
U23	IC, 2716, SPECIAL PROGRAM	*	89536	* ORDER 4200A-4501 + COMPLETE DESCRIPTION	1		
XU1	SOCKET, IC, 8-PIN	478016	91506	308-AG39D	2		
	SOCKET, IC, 16-PIN	370312	91506	316-AG39D	3		
XU2	SOCKET, IC, 8-PIN	478016	91506	308-AG39D	REF		
XU2	SOCKET, IC, 16-PIN	370312	91506	316-AG39D	REF		
XU3	SOCKET, IC, 40-PIN	429282	09922	DILB40P-108	2		
XU4	SOCKET, IC, 40-PIN	429282	09922	DILB40P-108	REF		
XU5	SOCKET, IC, 20-PIN	454421	01295	C932002	6		
XU6	SOCKET, IC, 14-PIN	370304	12040	MM74C906M	4		

Table 12. IEEE-488 Interface Assembly (cont)

REF DES	DESCRIPTION	FLUKE STOCK NO.	MFG SPLY CODE	MFG PART NO.	TOT QTY	REC QTY	NOTE
XU7	SOCKET, IC, 14-PIN	370304	12040	MM74C906M	REF		
XU8	SOCKET, IC, 14-PIN	370304	12040	MM74C906M	REF		
XU9	SOCKET, IC, 14-PIN	370304	12040	MM74C906M	REF		
XU10	SOCKET, IC, 20-PIN	454421	01295	C932002	REF		
XU18	SOCKET, IC, 16-PIN	370312	91506	316-AG39D	REF		
XU19	SOCKET, IC, 20-PIN	454421	01295	C932002	REF		
XU20	SOCKET, IC, 20-PIN	454421	01295	C932002	REF		
XU21	SOCKET, IC, 20-PIN	454421	01295	C932002	REF		
XU22	SOCKET, IC, 20-PIN	454421	01295	C932002	REF		
XU23	SOCKET, IC, 24-PIN	376236	91506	324-AG390	1		
Y1	CRYSTAL, 6 MHZ +/-0.015%	461665	89536	461665	1	1	
	RECOMMENDED SPARE PARTS LIST	641795	89536	641795			

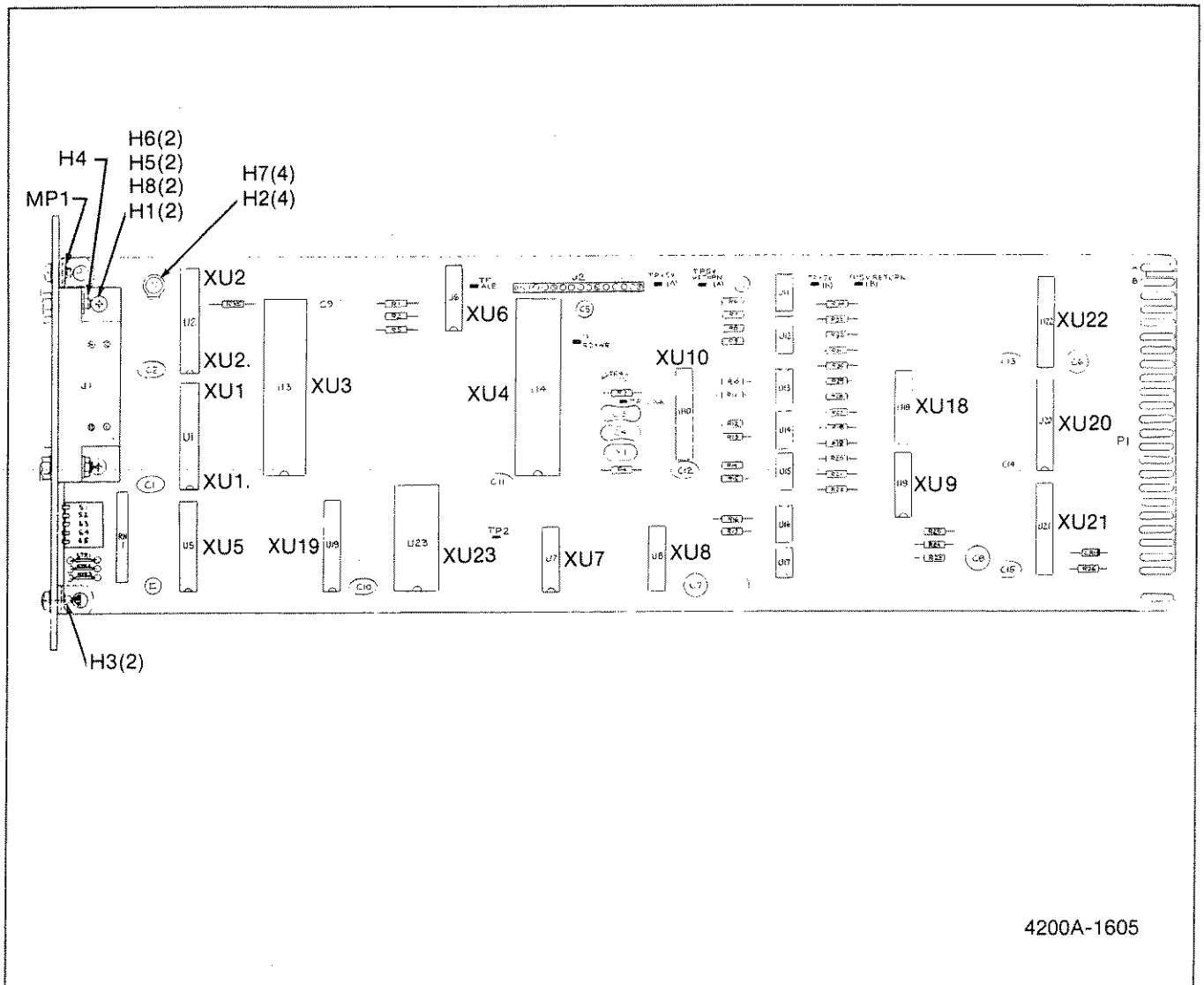

4200A-1605

Figure 7. IEEE-488 Interface Assembly

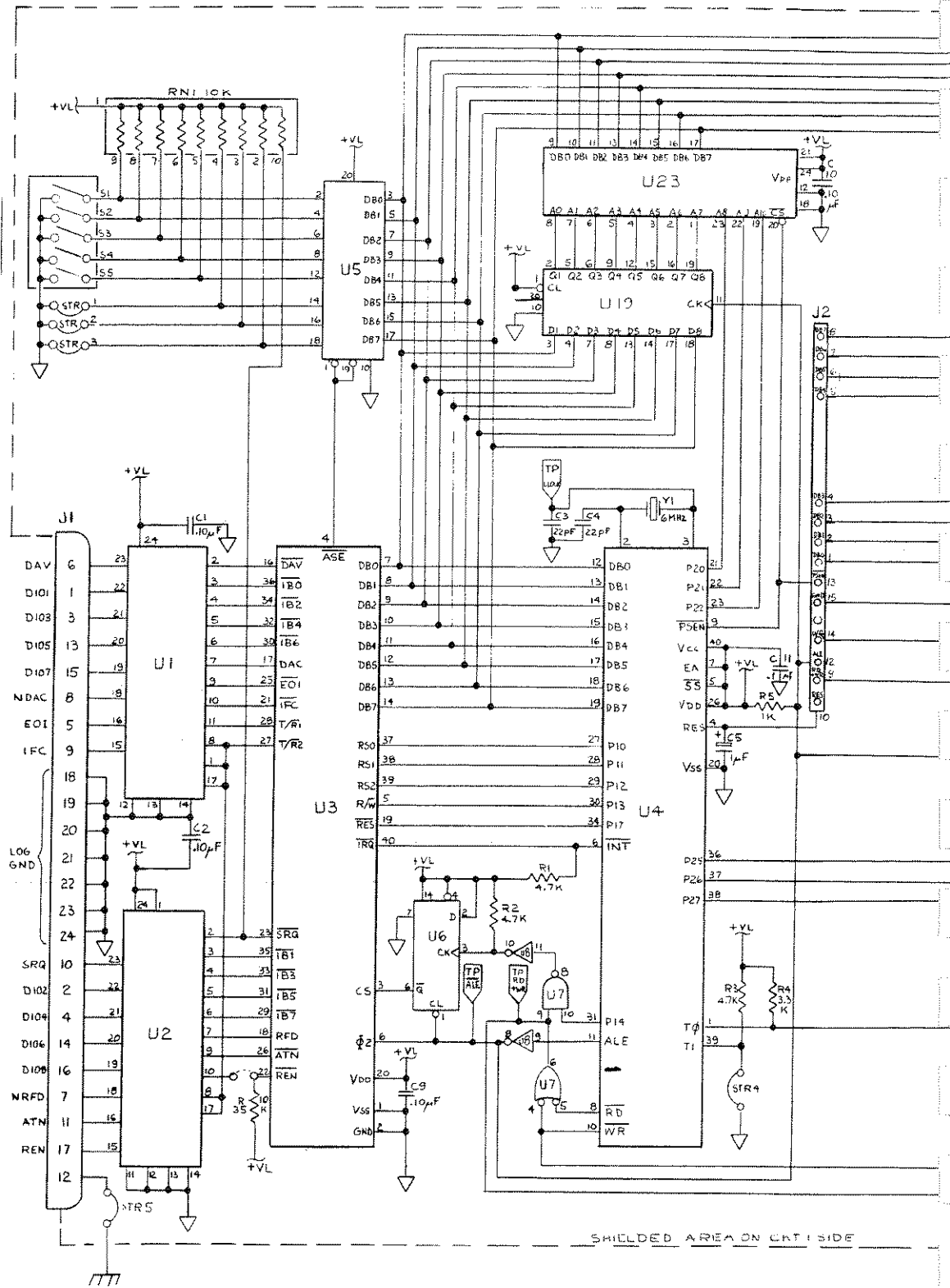

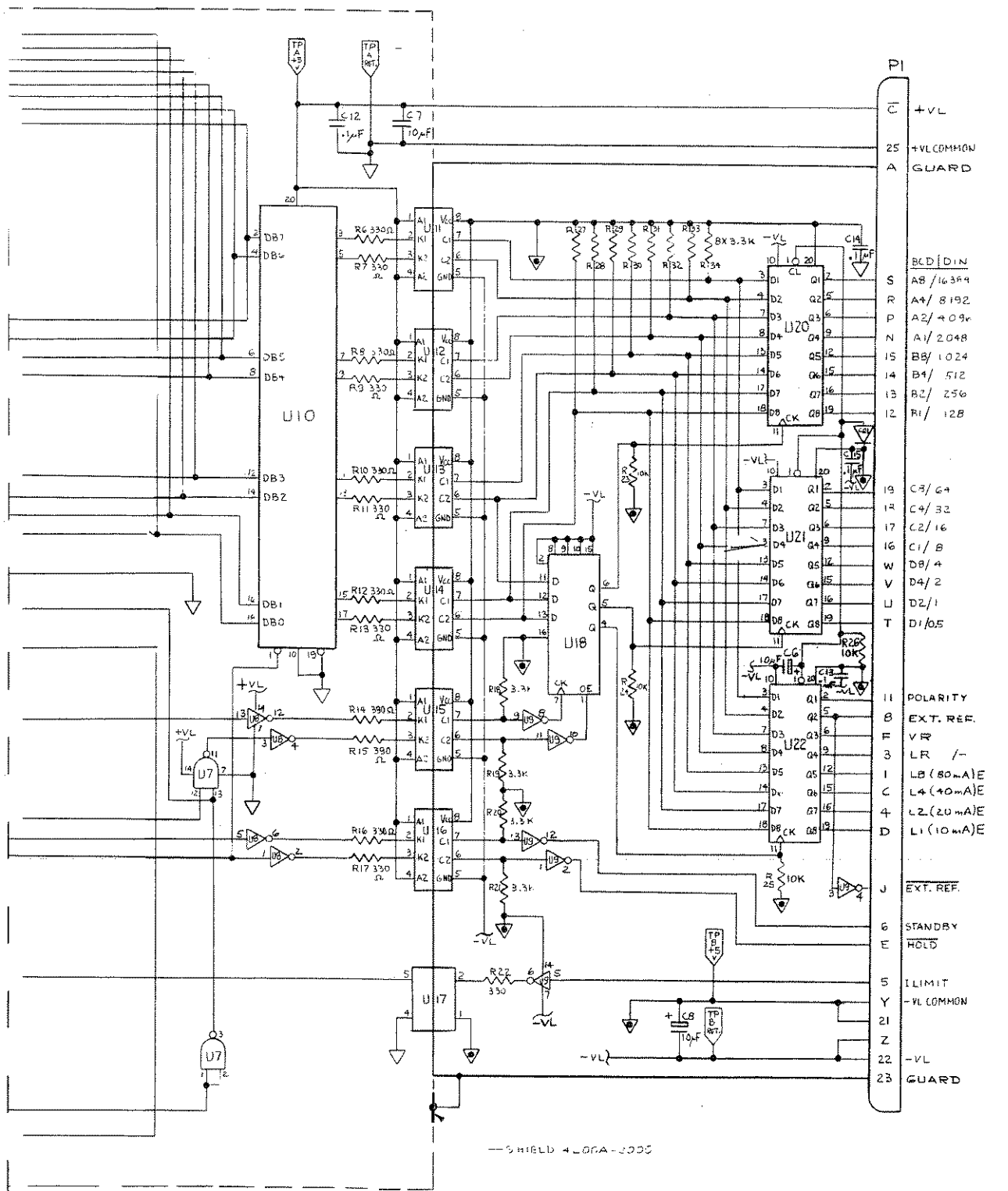

C	+VL
25	+VLCOMMON
A	GUARD
BCD I/O IN	
S	A8 / 16 3F4
R	A4 / 8 192
P	A2 / +0 9v
N	A1 / 2 048
15	B8 / 1 024
14	B4 / 512
13	B2 / 256
12	B1 / 128
POLARITY	
11	C3 / 64
10	C4 / 32
9	C2 / 16
8	C1 / 8
7	D8 / 4
6	D4 / 2
5	D2 / 1
4	D1 / 0.5
EXT. REF.	
3	LB (80mA)E
2	LA (+0mA)E
1	LZ (20mA)E
0	LI (10mA)E
EXT. REF.	
6	STANDBY
5	HOLD
5	ILIMIT
Y	-VL COMMON
21	
Z	-VL
22	
23	GUARD

--SHIELD 4 LOGA-2005

Figure 7. IEEE-488 interface Assembly (cont)