

410B DC Power Supply

Instruction Manual

P/N 294009
December 1965



WARRANTY

Notwithstanding any provision of any agreement the following warranty is exclusive:

The JOHN FLUKE MFG. CO., INC., warrants each instrument it manufactures to be free from defects in material and workmanship under normal use and service for the period of 1-year from date of purchase. This warranty extends only to the original purchaser. This warranty shall not apply to fuses, disposable batteries (rechargeable type batteries are warranted for 90-days), or any product or parts which have been subject to misuse, neglect, accident, or abnormal conditions of operations.

In the event of failure of a product covered by this warranty, John Fluke Mfg. Co., Inc., will repair and calibrate an instrument returned to an authorized Service Facility within 1 year of the original purchase; provided the warrantor's examination discloses to its satisfaction that the product was defective. The warrantor may, at its option, replace the product in lieu of repair. With regard to any instrument returned within 1 year of the original purchase, said repairs or replacement will be made without charge. If the failure has been caused by misuse, neglect, accident, or abnormal conditions of operations, repairs will be billed at a nominal cost. In such case, an estimate will be submitted before work is started, if requested.

THE FOREGOING WARRANTY IS IN LIEU OF ALL OTHER WARRANTIES, EXPRESS OR IMPLIED, INCLUDING BUT NOT LIMITED TO ANY IMPLIED WARRANTY OF MERCHANTABILITY, FITNESS, OR ADEQUACY FOR ANY PARTICULAR PURPOSE OR USE. JOHN FLUKE MFG. CO., INC., SHALL NOT BE LIABLE FOR ANY SPECIAL, INCIDENTAL, OR CONSEQUENTIAL DAMAGES, WHETHER IN CONTRACT, TORT, OR OTHERWISE.

If any failure occurs, the following steps should be taken:

1. Notify the JOHN FLUKE MFG. CO., INC., or nearest Service facility, giving full details of the difficulty, and include the model number, type number, and serial number. On receipt of this information, service data, or shipping instructions will be forwarded to you.
2. On receipt of the shipping instructions, forward the instrument, transportation prepaid. Repairs will be made at the Service Facility and the instrument returned, transportation prepaid.

SHIPPING TO MANUFACTURER FOR REPAIR OR ADJUSTMENT

All shipments of JOHN FLUKE MFG. CO., INC., instruments should be made via United Parcel Service or "Best Way" prepaid. The instrument should be shipped in the original packing carton; or if it is not available, use any suitable container that is rigid and of adequate size. If a substitute container is used, the instrument should be wrapped in paper and surrounded with at least four inches of excelsior or similar shock-absorbing material.

CLAIM FOR DAMAGE IN SHIPMENT TO ORIGINAL PURCHASER

The instrument should be thoroughly inspected immediately upon original delivery to purchaser. All material in the container should be checked against the enclosed packing list. The manufacturer will not be responsible for shortages against the packing sheet unless notified immediately. If the instrument is damaged in any way, a claim should be filed with the carrier immediately. (To obtain a quotation to repair shipment damage, contact the nearest Fluke Technical Center.) Final claim and negotiations with the carrier must be completed by the customer.

The JOHN FLUKE MFG. CO., INC., will be happy to answer all applications or use questions, which will enhance your use of this instrument. Please address your requests or correspondence to: JOHN FLUKE MFG. CO., INC., P.O. BOX C9090, EVERETT, WASHINGTON 98206, ATTN: Sales Dept. For European Customers: Fluke (Holland) B.V., P.O. Box 5053, 5004 EB, Tilburg, The Netherlands.

*For European customers, Air Freight prepaid.

John Fluke Mfg. Co., Inc., P.O. Box C9090, Everett, Washington 98206

Change/Errata Information

Issue No: 4 6/79

This change/errata contains information necessary to ensure the accuracy of the following manual. Enter the corrections in the manual if either one of the following conditions exist:

1. The instrument's pcb revision letter is equal to or higher than that which is indicated at the beginning of the change.
2. No revision letter is indicated at the beginning of the change/errata.

MANUAL

Title: MODEL 410B HIGH VOLTAGE DC POWER SUPPLY

Print Date: DECEMBER 1, 1965

Rev and Date: -----

C/E PAGE EFFECTIVITY

Page No.	Print Date
1	11/77
2	2/78
3	6/79

ERRATA #1

On page 2-2 paragraph 2-7e, change CAUTION note to read as follows:

CAUTION!

The sample string resistors in the 410B are subject to damage if the output voltage is reduced too rapidly. Pause approximately $\frac{1}{2}$ second in each switch position when reducing the setting of the first decade switch (1000 volt increments). The second decade should be set to 300 or greater or the HIGH VOLTAGE switch set to STANDBY RESET before the first decade is set to 0 (zero).

CHANGE #1-3091

On page 5-10, remove Q204 from Ref Desig group Q203 and Q204 and add it to group Q205 and Q206 (use Code D). Change the tot qty of Q203 from 3 to 2. Change the tot qty of Q205 and Q206 from 2 to 3.

CHANGE #2-6647

On page 5-9 delete the entire C215 entry and add the following new entry:
C215; Cap, optional or factory selected.

CHANGE #3-6720

On page 1-1, delete information under "INPUT POWER" and add: 100/115/230V ac, 50 to 500 Hz, approximately 300 VA at full output.

On page 2-1, delete information under paragraph 2-4 and add: Two power transformers (T1) are available for this instrument, 100/115V ac or 115/230V ac. On the rear panel of each instrument a decal indicates the operating voltage of the transformer installed. This operating voltage can be changed by altering the wiring configuration of the transformer. To change the operating voltage of the 115/230V ac transformer, refer to the decal located on the power transformer. Refer to the drawing below for changing the operating voltage of the 100/115V ac transformer. To gain access to the power transformer, remove the instrument's top cover and the Delay PCB Assembly.

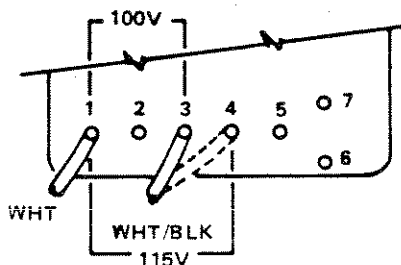

On page 5-3, add after T1 description: (115/230V). Add another listing for T1 as follows: T1; Transformer, Aux. (100/115V); Stock No. -5600-350918; Mfr. -89536; Mfr. Part No. -5600-350918; Tot. Qty. -1.

On the schematic diagram, add, as a separate note, the following primary configuration of T1 for the 100/115V ac power transformer.

Transformer connections shown are for 100V ac operation. For 115V ac operation, move the wire at terminal 3 to terminal 4 or 7.

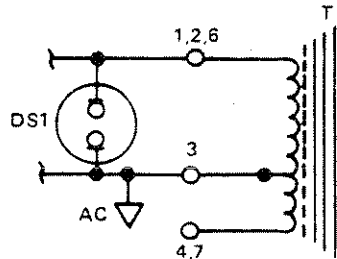

CHANGE #4-7609

On page 5-10, change the stock no, mfr, mfr part no, and tot qty for transistors Q211 and Q212 from: 4805-203489, 07910, CDQ 10656, REF to: 4819-168716, 07263, S19254, 2

CHANGE #5-8438

On page 5-7, add the following new entry: R155; Res, comp, 1.3k ± 5%, ½W; 4704-109157; 01121; EB1325; 1.

CHANGE #6-415-1030

On page 5-11, add the following replacement for voltage reference 83A1 (V201). V201, 83A1 Substitute PCB, 451047, 89536, 451047.

On the schematic, remove and replace V201, R219 and R220 with the reference substitute shown below. Connect pin 1 to junction of R221 and base of Q206. Connect pin 2 to junction of DS203 and R141 (0V).

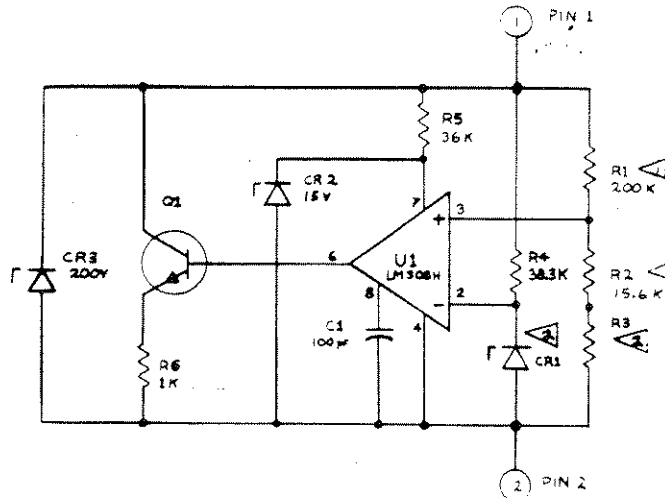

= Matched Components

CHANGE #7 - 11910

Rev. -G, Amplifier PCB Assembly

On the Functional Schematic (High Voltage Power Supply) make the following changes:

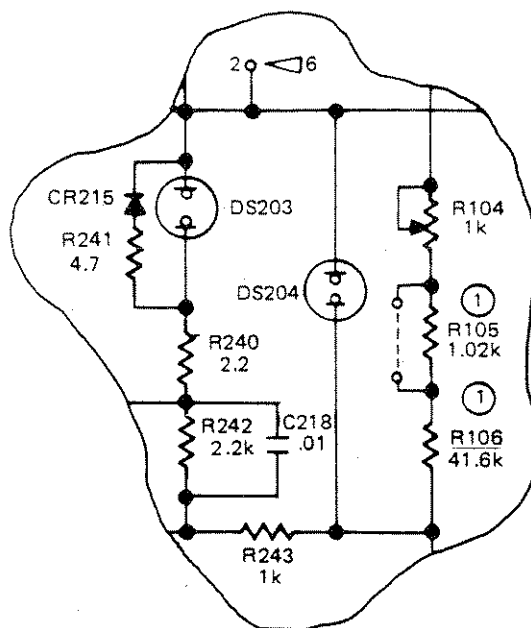

ADD: DS204

CHANGE #8 - 12060

Rev. -H, Amplifier PCB Assembly

On page 5-10, make the following changes:

FROM: Q211/Transistor, NPN, Si/4819-168716/07263/519254/Ref
 TO: Q211/Transistor, NPN, Si/4805-203489/07910/CDQ10656/Ref

CHANGE #9 - 12329

Rev.-B, Front Panel Assembly (410B-406)

On page 5-6, make the following changes:

FROM: Handle, 6-7/16"/2404-101584/05704/805/2
 TO: Handle/2404-494989/88245/1061-29/2

ERRATA #2

On page 1-1, under ELECTRICAL, add the following information:

Protection Class #1 (Relates solely to insulation or grounding properties further defined in IEC 348.)

TABLE OF CONTENTS

Section	Title	Page
I	INTRODUCTION AND SPECIFICATIONS	1-1
	1-1. Introduction	1-1
	1-2. General Description	1-1
	1-6. Receiving Inspection	1-1
	1-8. Specifications	1-1
	1-9. Electrical	1-1
	1-10. Mechanical	1-1
II	OPERATING INSTRUCTIONS	2-1
	2-1. Function of External Controls, Terminals, and Indicators	2-1
	2-3. Input Power	2-1
	2-5. Initial Operation	2-2
	2-7. General Purpose Use	2-2
	2-8. Use As A Calibrator	2-2
	2-10. Direct Calibration	2-3
	2-11. Precision Calibration	2-3
	2-12. Notes on Operation	2-3
	2-13. Meter Accuracy	2-3
	2-15. Overload Protection	2-4
	2-17. Polarity Switching	2-4
	2-19. Coaxial Cable Assembly	2-4
	2-22. Dage Type 486-1 Connector Assembly	2-4
	2-23. Amphenol MS 3106A Connector Assembly	2-5
III	THEORY OF OPERATION	3-1
	3-1. Introduction	3-1
	3-3. Overall Operation	3-1
	3-5. Circuit Descriptions	3-1
	3-6. Controls Relays	3-1
	3-8. Overcurrent Protection	3-2
	3-10. Main Output Voltage	3-2
	3-12. Feedback Amplifier	3-2
	3-14. Auxiliary Supplies	3-2
	3-16. Reference Voltage	3-2
	3-18. Accuracy	3-2
IV	MAINTENANCE	4-1
	4-1. Introduction	4-1
	4-3. Preventive Maintenance	4-1
	4-6. Troubleshooting	4-1
	4-9. Auxiliary	4-1
	4-10. Line Regulation and Ripple	4-1
	4-11. Load Regulation	4-3
	4-12. Stability	4-3
	4-13. Output at Zero Volts	4-4
	4-14. Calibration	4-4
	4-16. Reference Current Adjustment	4-4
	4-17. Overcurrent Trip Adjustment	4-4
	4-18. Meter Calibration	4-4

TABLE OF CONTENTS, *continued*

Section	Title	Page
V	LIST OF REPLACEABLE PARTS	5-1
	5-1. Introduction	5-1
	5-4. How To Obtain Parts	5-1
	5-7. Abbreviations	5-2
	5-8. Prefix Symbols	5-2
	5-9. Quantity Symbols	5-2
	5-10. Special Notes and Symbols	5-2
	5-11. Use Code Effectivity	5-15
VI	NOT APPLICABLE	
VII	GENERAL INFORMATION	7-1
	7-1. List of Abbreviations	7-1
	7-2. Federal Supply Codes for Manufacturers	7-3
	7-3. Fluke Technical Service Centers	7-10
	7-4. Sales Representatives - Domestic	7-11
	7-5. Sales Representatives - International	7-13
VIII	SCHEMATIC DIAGRAMS	8-1

LIST OF ILLUSTRATIONS

Figure	Title	Page
Frontispiece	Model 410B High Voltage DC Power Supply	iv
2-1.	Function of External Controls, Terminals and Indicators	2-1
2-2.	Typical Output Voltage Increment vs. Overcurrent Trip Setting	2-3
3-1.	Model 410B DC Power Supply - Block Diagram	3-1
4-1.	Troubleshooting	4-2
4-2.	Equipment Required for Troubleshooting and Calibration	4-3
5-1.	Final Assembly (Sheet 1 of 2)	5-4
5-1.	Final Assembly (Sheet 2 of 2)	5-5
5-2.	Front Panel Assembly	5-6
5-3.	Switch Circuit Board Assembly	5-8
5-4.	Amplifier Circuit Board Assembly	5-12
5-5.	Time Delay Circuit Board Assembly	5-13
5-6.	Rectifier Circuit Board Assembly	5-14

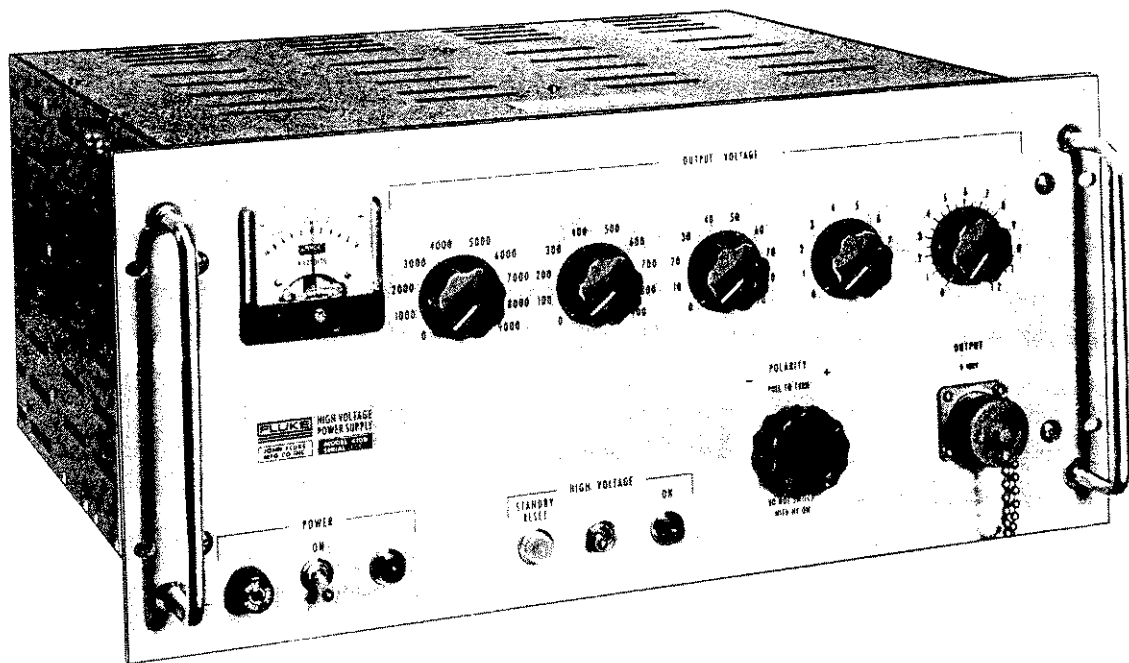

MODEL 410B HIGH VOLTAGE DC POWER SUPPLY

SECTION I

INTRODUCTION AND SPECIFICATIONS

1-1. INTRODUCTION

1-2. GENERAL DESCRIPTION

1-3. The Fluke Model 410B High Voltage DC Power Supply is capable of providing an output of 0 to 10,000 vdc at 0 to 10 milliamperes. The output voltage is selected by four decade switches and a vernier potentiometer. The instrument may be operated with either positive or negative output terminal grounded, as selected by a front-panel switch. Overcurrent protection is provided to return the supply to standby operation in the event of excessive load current.

1-4. The Model 410B is a hybrid design utilizing silicon transistors for the amplifier circuitry and a vacuum tube for the necessary high voltage series passing element. A time-delay relay is incorporated in the input circuitry, which prolongs the life of the high voltage passing tube. The reference element is a highly stable temperature compensated gas tube.

1-5. The package design provides for adequate cooling at high ambient temperatures without the use of cooling fans. Rubber feet are provided for bench top operation to permit unrestricted air flow through the bottom cover air vents. The front panel is punched for mounting in a standard 19 inch rack. Side panels are tapped for Jonathan #130 quick disconnect chassis slides or other rack mounting supports.

1-6. RECEIVING INSPECTION

1-7. This instrument has been thoroughly checked and tested before being shipped from the factory. Immediately after receiving the instrument, carefully inspect for damage which may have occurred in transit. If any damage is noted, follow the instructions outlined on the warranty page in the back of this manual.

1-8. SPECIFICATIONS

1-9. ELECTRICAL

OUTPUT VOLTAGE: 0 to $\pm 10,000$ VDC.

OUTPUT CURRENT: 0 to 10 milliamperes.

OUTPUT POLARITY: + or - grounded via front panel switch.

LINE REGULATION: 0.001% or 2 mv (whichever is greater) for 10% line change from nominal.

LOAD REGULATION: 0.001% or 5 mv (whichever is greater) for full load change.

STABILITY: $\pm 0.005\%$ per hour; $\pm 0.02\%$ per day after warmup.

RESOLUTION: 5 millivolts.

RIPPLE: Less than 1 mv RMS; less than 5 mv peak-to-peak.

VOLTAGE CALIBRATION:

0 to 9000V in 9 steps of 1000V

0 to 900V in 9 steps of 100V

0 to 90V in 9 steps of 10V

0 to 9V in 9 steps of 1V

0 to 1.2V vernier

CALIBRATION ACCURACY: $\pm 0.25\%$ or 250 mv (whichever is greater) with vernier at zero.

RESETABILITY: $\pm 0.05\%$ or 50 mv (whichever is greater).

RECOVERY TIME: Within 50 microseconds.

WARMUP TIME: 30 minutes.

OVERCURRENT TRIP: Set to latch off at 12 ma load current. Internally adjustable from 5 to 15 ma.

METER: 10,000-0-10,000 vdc ($\pm 3\%$).

OUTPUT CONNECTORS: MS3102A-18-16S front and rear (one mating connector supplied).

INPUT POWER: 115/230 VAC $\pm 10\%$, 50 - 60 Hz, approximately 300 VA at full output. Operation at 400 Hz available upon request.

1-10. MECHANICAL

HUMIDITY: 0 to 80%.

OPERATING TEMPERATURE RANGE: 0°C to 50°C.

STORAGE TEMPERATURE RANGE: -20°C to +70°C.

ALTITUDE, OPERATING: 0 to 10,000 ft.

ALTITUDE, NON-OPERATING: 0 to 50,000 ft.

VIBRATION: Meets MIL-T-945A.

SHOCK: Meets MIL-E-4970A (20 g's, 11 milliseconds in three principal axis).

TEMPERATURE COEFFICIENT OF OUTPUT: Less than 20 ppm per °C from +10°C to +40°C.

SIZE: 19" wide x 8-3/4" high x 15" behind panel (rack mount with resilient feet for bench use).

WEIGHT: Approximately 59 pounds.



static awareness



A Message From
John Fluke Mfg. Co., Inc.

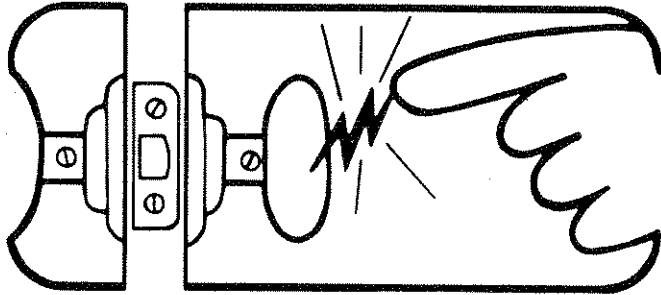

Some semiconductors and custom IC's can be damaged by electrostatic discharge during handling. This notice explains how you can minimize the chances of destroying such devices by:

1. Knowing that there is a problem.
2. Learning the guidelines for handling them.
3. Using the procedures, and packaging and bench techniques that are recommended.

The Static Sensitive (S.S.) devices are identified in the Fluke technical manual parts list with the symbol



The following practices should be followed to minimize damage to S.S. devices.

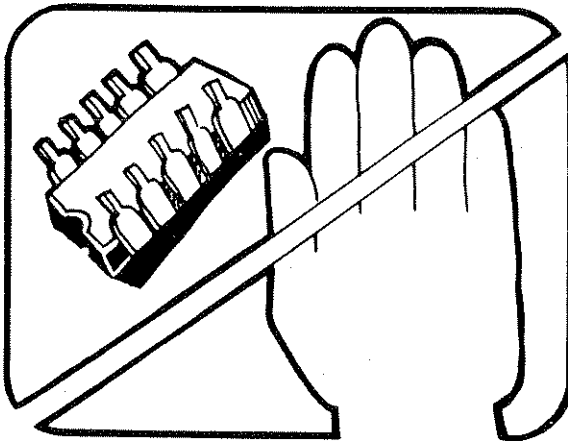

1. MINIMIZE HANDLING

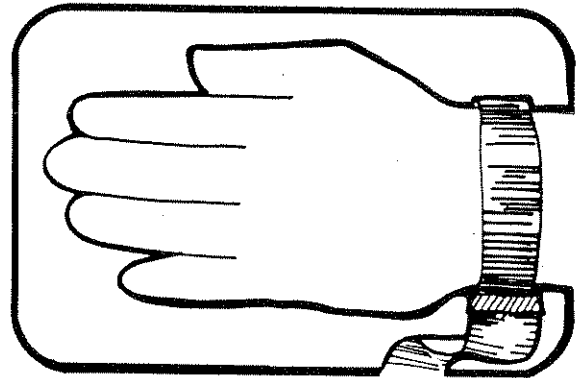

3. DISCHARGE PERSONAL STATIC BEFORE HANDLING DEVICES. USE A HIGH RESISTANCE GROUNDING WRIST STRAP.

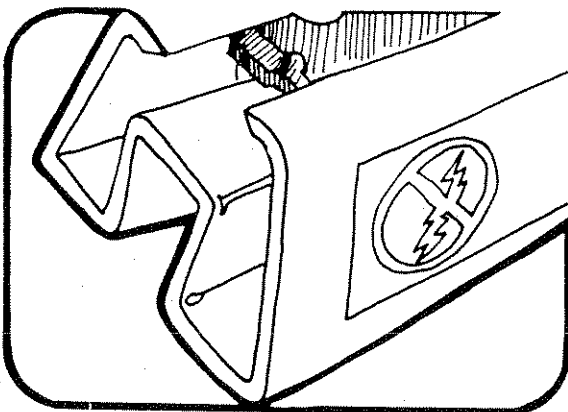

2. KEEP PARTS IN ORIGINAL CONTAINERS UNTIL READY FOR USE.

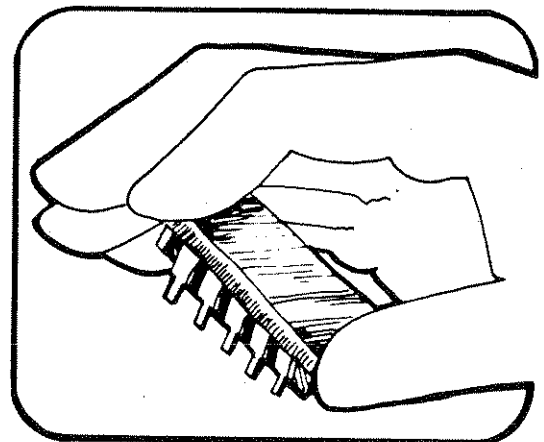

4. HANDLE S.S. DEVICES BY THE BODY

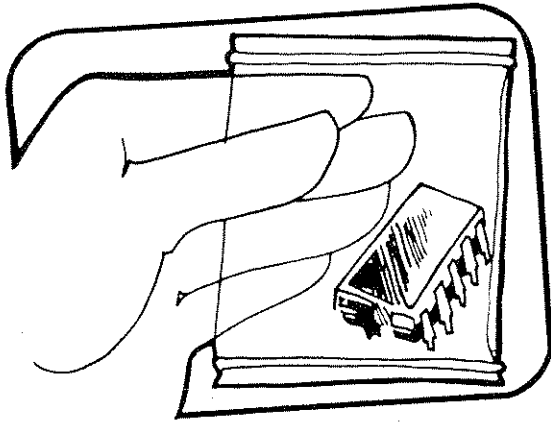

5. USE STATIC SHIELDING CONTAINERS FOR HANDLING AND TRANSPORT

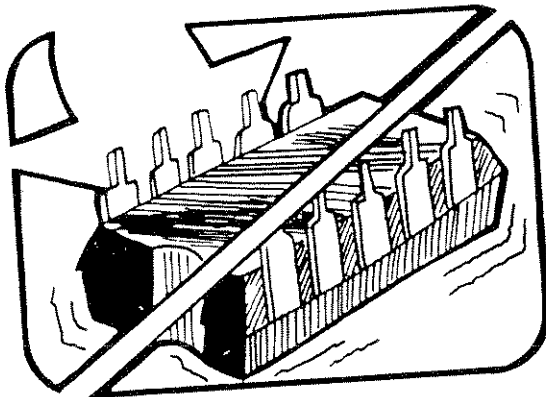

6. DO NOT SLIDE S.S. DEVICES OVER ANY SURFACE

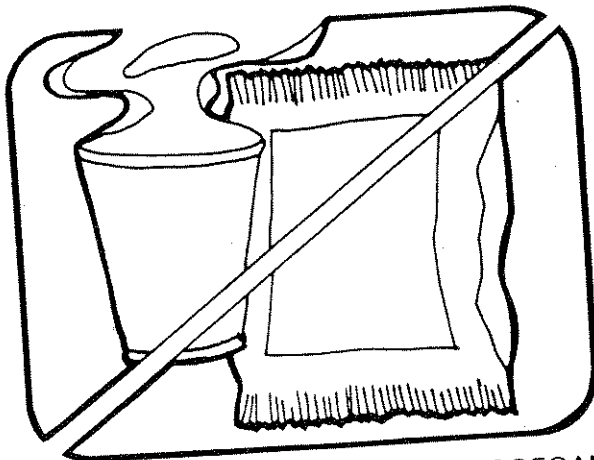

7. AVOID PLASTIC, VINYL AND STYROFOAM® IN WORK AREA

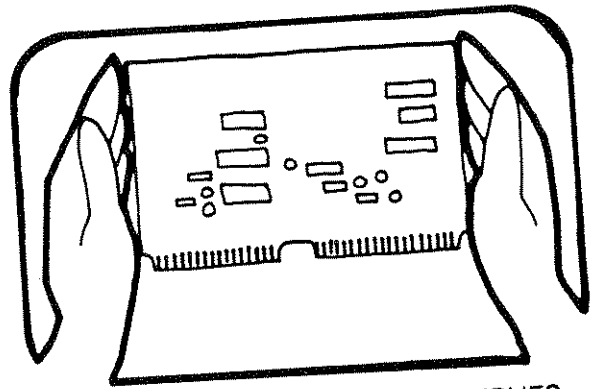

8. WHEN REMOVING PLUG-IN ASSEMBLIES, HANDLE ONLY BY NON-CONDUCTIVE EDGES AND NEVER TOUCH OPEN EDGE CONNECTOR EXCEPT AT STATIC-FREE WORK STATION. PLACING SHORTING STRIPS ON EDGE CONNECTOR HELPS TO PROTECT INSTALLED SS DEVICES.

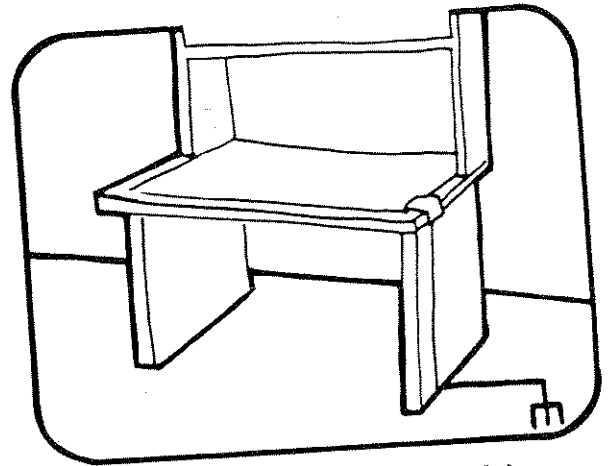

9. HANDLE S.S. DEVICES ONLY AT A STATIC-FREE WORK STATION
10. ONLY ANTI-STATIC TYPE SOLDER-SUCKERS SHOULD BE USED.
11. ONLY GROUNDED TIP SOLDERING IRONS SHOULD BE USED.

A complete line of static shielding bags and accessories is available from Fluke Parts Department, Telephone 800-526-4731 or write to:

JOHN FLUKE MFG. CO., INC.
PARTS DEPT. M/S 86
9028 EVERGREEN WAY
EVERETT, WA 98204

PORTIONS REPRINTED
WITH PERMISSION FROM TEKTRONIX, INC.
AND GENERAL DYNAMICS, POMONA DIV.

SECTION II

OPERATING INSTRUCTIONS

2-1. FUNCTION OF EXTERNAL CONTROLS, TERMINALS, AND INDICATORS

2-2. The function of external controls, terminals, and indicators on the 410B is given in Figure 2-1.

2-3. INPUT POWER

2-4. Input power to the 410B is 115 vac or 230 vac ($\pm 10\%$), at a frequency of 50 to 60 Hz. Instruments are

supplied for operation from 400 Hz when requested. The 410B is equipped with dual primary windings on transformer T1, which are usually connected in parallel for operation from 115 vac. When requested, instruments are wired with the primary windings connected in series for operation from 230 vac. If it becomes desirable to change from one operating voltage to the other, remove the top cover of the instrument, and change the jumper wires and the fuse as shown on the transformer decal.

CONTROL TERMINAL, OR INDICATOR	LOCATION	REFERENCE DESIGNATION	FUNCTION
POWER switch	Front panel	S1	Applies line power to the control circuit and to the auxiliary transformer.
POWER lamp	Front panel	DS1	Indicates the application of line power to the instrument circuitry.
Fuse	Front panel	F1	Protects the instrument against damage due to overload.
STANDBY-RESET lamp	Front panel	DS2	This lamp illuminates when the time delay cycle is completed when the HIGH VOLTAGE switch is set to STANDBY-RESET.
HIGH VOLTAGE switch	Front panel	S2	Energizes and de-energizes the primary of transformer T2.
HIGH VOLTAGE ON lamp	Front panel	DS3	This lamp illuminates when the HIGH VOLTAGE switch is set to ON (after the time-delay cycle is completed), indicating that the high voltage is available at the output connectors.
POLARITY switch	Front panel	S7	Used to select either a positive or negative output with respect to chassis ground. This switch must be pulled out to turn, which interrupts ac input power to the instrument.
OUTPUT VOLTAGE controls	Front panel	S3, S4, S5, S6, & R140	Switches S3, S4, S5, & S6 select the output voltage in steps of 1000V, 100V, 10V, and 1V, respectively. R140 provides a continuous output of 0 to 1.2 volts.
Voltmeter	Front panel	M1	Indicates the output voltage from -10.0 to +10.0 KV. Accuracy is approximately 3% of end scale.
OUTPUT connector	Front and back panels	J1 and J2	Provided for connecting the load circuit to the 410B.

Figure 2-1. FUNCTION OF EXTERNAL CONTROLS, TERMINALS, AND INDICATORS

2-5. INITIAL OPERATION

2-6. The following procedure is recommended when turning on the Model 410B for the first time after shipping or a long period of idleness. This procedure will minimize the possibility of accidental damage to the unit.

- a. The 410B is shipped with the series passing tube removed from the socket and packed in a carton, which is fastened to the top cover. Install this tube in its socket and connect the plate wire to the plate cap before applying power to the instrument.
- b. Connect the line plug to a 115 vac power source (or 230 vac if so wired).

WARNING

The round pin on the polarized three-prong plug connects the instrument case to power system ground. If a three-to-two pin adapter is used to connect to a two-contact outlet, connect the short lead on the adapter to a good ground.

Always cover the unused output connector with the cover provided to prevent accidental contact with the high voltage, and dirt accumulation on the connector.

- c. Set the HIGH VOLTAGE switch to STANDBY-RESET.
- d. Set the POWER switch to ON. The POWER lamp will illuminate. After approximately 30 seconds, the time-delay relay will close and the STANDBY-RESET lamp will illuminate.

CAUTION

The 410B is designed for convection cooling without the use of fans. For bench top operation, the rubber feet must be installed or other steps taken to ensure adequate spacing for unrestricted air flow through the vents in the bottom cover.

- e. Set the second OUTPUT VOLTAGE dial to 500.
- f. After the STANDBY-RESET lamp illuminates, set the HIGH VOLTAGE switch to ON. Carefully observe if the HIGH VOLTAGE lamp illuminates and if the output voltage rises to within 3% of 500 volts as indicated by the panel meter.

CAUTION

If the output voltage exceeds approximately 500 volts, immediately set the HIGH VOLTAGE switch to STANDBY-RESET.

- g. If the output voltage is 500 volts, the supply may be operated as in paragraph 2-7 or 2-8. If the output is not 500 volts, perform steps h. through j.
- h. Set the HIGH VOLTAGE switch to STANDBY-RESET.
- i. Locate and correct the source of trouble. Refer to Section IV.
- j. Repeat the initial operating procedure.

2-2

2-7. GENERAL PURPOSE USE

- a. Set the HIGH VOLTAGE switch to STANDBY-RESET.
- b. Set the POWER switch to ON. The POWER lamp will illuminate. After approximately 30 seconds, the time-delay relay will close and the STANDBY-RESET lamp will illuminate.
- c. Set the POLARITY switch to the desired polarity.
- d. Connect the load to the power supply. Be sure the connection is firm.

WARNING

This instrument can produce lethal voltage. Always set the HIGH VOLTAGE switch to STANDBY-RESET and wait until the output decays to zero before connecting or disconnecting the load.

- e. Set the OUTPUT VOLTAGE controls to the desired output. Check the external circuit for conflicts in grounding before applying power to the load.

CAUTION

The sampling string resistors in the 410B are subject to damage if the output voltage is reduced too rapidly. Pause approximately 1/2 second in each switch position when reducing the setting of the first decade switch (1000 volt increments).

- f. After the STANDBY-RESET lamp illuminates, set the HIGH VOLTAGE switch to ON. The STANDBY-RESET lamp will extinguish and the HIGH VOLTAGE ON lamp will illuminate. The meter will indicate the approximate output voltage.

NOTE

If the overcurrent trip level has been reduced to less than 8 ma, it may be necessary to set the HIGH VOLTAGE switch to ON with a reduced output voltage to prevent actuating the overcurrent trip. In this case, step e., above, would follow step f. Figure 2-2 is a graph of the approximate maximum output voltage increment vs. the overcurrent trip setting. For example, if the overcurrent trip point has been reduced to 6 ma, the output voltage must be set to less than 3000 volts (approximately) to prevent actuating the overcurrent trip when the HIGH VOLTAGE switch is set to ON. Figure 2-2 is typical, and is intended to show only the general characteristic.

- g. To remove the high voltage from the output connectors, set the HIGH VOLTAGE switch to STANDBY-RESET.

2-8. USE AS A CALIBRATOR

2-9. The 410B may be used for direct calibration of dc instruments to an accuracy of better than 0.25% or 250 millivolts at any voltage up to 10,000 volts. The

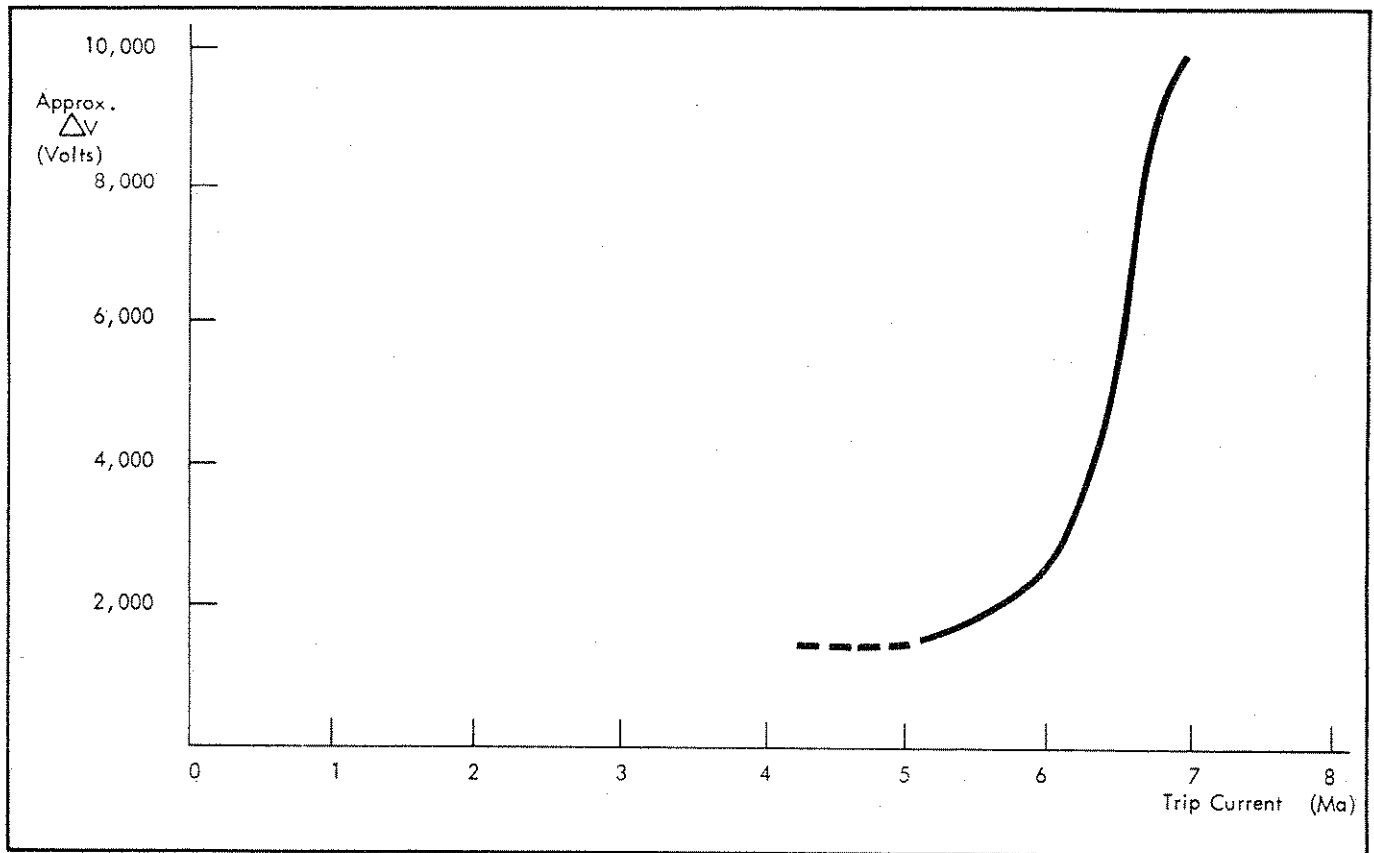

Figure 2-2. TYPICAL OUTPUT VOLTAGE INCREMENT VS. OVERCURRENT TRIP SETTING

four decade switches provide discrete steps with a resolution of one volt per step. The fifth dial provides a vernier with resolution of better than 5 millivolts for calibration between the cardinal points. When used with a Fluke differential voltmeter and voltage divider, the 410B is capable of calibrating dc instruments from 0 to 10,000 volts with an accuracy of 0.02% to 0.06%, depending upon the accuracy of the voltage divider and differential voltmeter used.

2-10. DIRECT CALIBRATION

a. Allow the power supply sufficient time to warm up to stable operating temperature, usually not less than one half hour. If possible, set the OUTPUT VOLTAGE dials for the maximum required output during warmup in order to stabilize the operating temperature of all of the sample-string resistors which will be used during calibration. When used in this manner the power supply will provide an output significantly better in stability and accuracy than is specified.

b. Set the POLARITY switch to the desired polarity.

c. Set the HIGH VOLTAGE switch to STANDBY-RESET.

d. Connect the instrument being calibrated to the OUTPUT connector.

e. Set the OUTPUT VOLTAGE dials to the initial calibration point.

f. Set the HIGH VOLTAGE switch to ON.

g. Successively set the OUTPUT VOLTAGE dials to the desired calibration points.

2-11. PRECISION CALIBRATION

a. Warm up supply as in paragraph 2-10a.

b. Set the POLARITY switch to the desired polarity.

c. Set the HIGH VOLTAGE switch to STANDBY-RESET.

d. Connect the instrument being calibrated to the OUTPUT connector. Also connect a voltage divider, such as a Fluke Model 80B-10 to the OUTPUT connector.

e. Connect a Fluke DC differential voltmeter to the output of the voltage divider. For calibration below 500 volts (1000 volts with the newer Fluke differential voltmeters) the voltage divider may be omitted.

f. Set the differential voltmeter to differentially measure the voltage at the desired calibration point. When the voltage divider is used, consider the division ratio when setting the dials of the voltmeter.

g. Set the HIGH VOLTAGE switch to ON.

h. Null the differential voltmeter by adjusting the power supply OUTPUT VOLTAGE dials. The accuracy of calibration is from 0.02% to 0.06%, depending on the accuracy of the differential voltmeter and voltage divider used.

i. Repeat steps f. and h. for as many calibration points as desired.

2-12. NOTES ON OPERATION

2-13. METER ACCURACY

2-14. The meter in the 410B has a basic accuracy of $\pm 2\%$. Since multiplying and shunting resistors are used, the overall accuracy is approximately $\pm 3\%$ of end scale. However, the accuracy of the supply is $\pm 0.25\%$ of the output voltage. For example, if a voltage of 5000 volts is selected, the output voltage will be 5000 (± 12.5) volts ($\pm 0.25\%$ of 5000 = ± 12.5). However, the panel meter may indicate 5000 (± 300) volts ($\pm 3\%$ of 10,000 = ± 300) and still be within specified accuracy. Consequently, the front panel controls should be relied upon to indicate the magnitude of the output voltage.

2-15. OVERLOAD PROTECTION

2-16. The 410B is protected from damage due to overload by an overcurrent trip circuit. This circuit will return the supply to standby operation if the output current exceeds the pre-set level. This level is internally adjustable, and is usually set for 12 milliamperes,

but may be adjusted to lower levels, down to approximately 5 milliamperes. If tripped, the supply may be returned to operation by setting the HIGH VOLTAGE switch to STANDBY-RESET, waiting 30 seconds for the time-delay relay to close, and then setting the HIGH VOLTAGE switch to ON.

2-17. POLARITY SWITCHING

2-18. The output polarity of the 410B may be changed by pulling out the POLARITY switch until it reaches the stop, rotating the switch to the desired polarity, and pushing the switch all the way back to the stop. An interlock (S9) actuated by the switch shaft disables the instrument when the switch is pulled out. In order to return the supply to operation, the HIGH VOLTAGE switch must be set to STANDBY-RESET. After 30 seconds, when the STANDBY-RESET lamp illuminates, set the HIGH VOLTAGE switch to ON.

2-19. COAXIAL CABLE ASSEMBLY

2-20. Coaxial cables used to connect the instrument to a load are not provided by John Fluke Mfg. Co., Inc. Procurement of cables and the assembly of mating cable connectors must be carefully undertaken to insure safety of personnel.

WARNING!

Extreme care should be exercised when utilizing high voltage conductors and connectors. Improper assembly of cable connectors or careless use of high voltage equipment may expose personnel to voltage of lethal magnitude.

2-21. General instructions are provided herein for the assembly of two types of cable connectors issued as an accessory item with John Fluke instruments. Additional information on the assembly of these connectors, or on other types of connectors considered for use with the instrument, may be obtained from the cable or connector vending agency.

2-22. DAGE TYPE 486-1 CONNECTOR ASSEMBLY

a. Cut cable off square on end. Slide outer sleeve over cable and slide back out of way. Trim cable to dim. shown being careful not to nick center conductor or braid. Tin dip center conductor. Remove all excess solder.

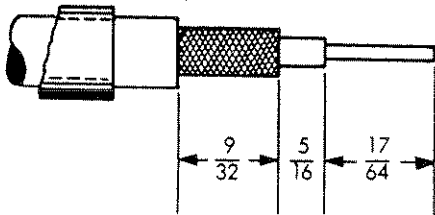

b. Rotate dielectric to slightly flare braid.

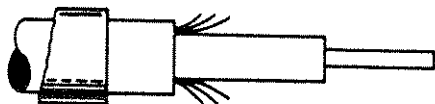

c. Push cable into nut sub-assembly until the center conductor is visible thru hole in contact. Soft solder center conductor thru hole in contact. Remove excess solder. Fold braid down over back end tube of nut. Trim excess braid if necessary.

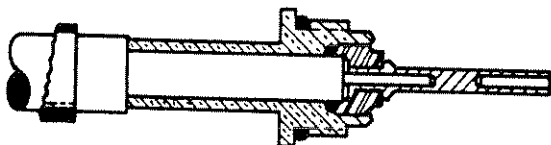

d. Slide outer sleeves over braid until it is flush against back of nut. Crimp as close to nut as possible using proper crimping tool.

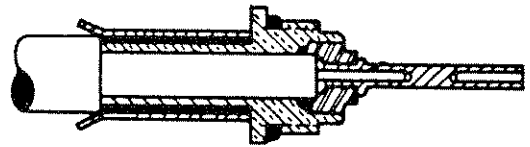

e. Insert finished cable assy. into body either jack or plug and tighten by rotating body. Do not rotate nut sub-assembly.

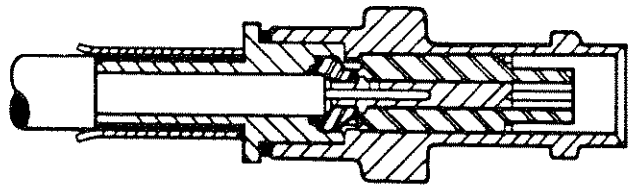

2-23. AMPHENOL MS 3106A CONNECTOR ASSEMBLY

a. Strip cable jacket, braid, and dielectric to dimensions shown. All cuts are to be sharp and square. Do not nick braid, dielectric, and center conductor. Tinning of center conductor is not necessary if contact is to be crimped. For solder method, tin center conductor avoiding excessive heat.



b. Disassemble connector by removing the back shell and retainer ring.

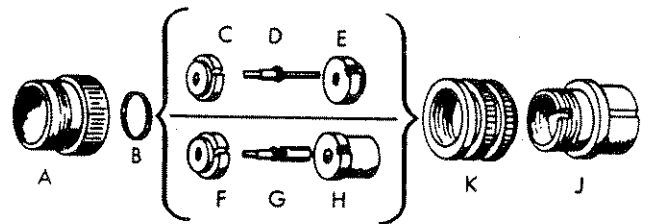

WITH PIN INSERT (Male)

- A Back Shell
- B Retainer Ring
- C Pin Rear Insert
- D Pin Contact
- E Pin Front Insert
- J Front Shell
- K Coupling Ring

WITH SOCKET INSERT (Female)

- A Back Shell
- B Retainer Ring
- F Socket Rear Insert
- G Socket Contact
- H Socket Front Insert
- J Front Shell
- K Coupling Ring

c. Insert cable thru clamp MS 3057A and rear components of connector. Place the cable center conductor into the socket contact.

d. Soft solder contact to cable center conductor. Do not get any solder on outside surfaces of contact. Avoid excessive heat to prevent swelling or dielectric.

Contact must butt against cable dielectric

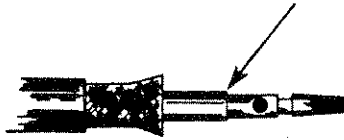

e. Provide a connection from the cable shield to the securing bolt of the cable clamp. The connecting copper wire should be approximately 5 inches long and size 14 or larger in diameter. A terminal lug should be used to connect the wire to the clamp. The wire should be carefully soldered to the shield, taking care not to damage the insulation of the cable. Loose ends of the shield should be clipped off to prevent shorting the center conductor or contact to the shield.

f. Assemble the cable connector by placing the contact into the socket front insert, then coupling the back shell to the front shell in the reverse of the disassembly procedure.

SECTION III

THEORY OF OPERATION

3-1. INTRODUCTION

3-2. This section of the manual describes the operation of the Model 410B. Reference is made to the functional schematic following Section V. This schematic is intended to aid in understanding the theory of operation, and in troubleshooting. A block diagram of the 410B is given in Figure 3-1. Operation of the 410B is discussed in the following paragraphs.

3-3. OVERALL OPERATION

3-4. The output voltage is controlled by the series passing tube V202, which is controlled by the feedback amplifier consisting of Q208 through Q214. Transistors Q213 and Q214 are connected as a differential amplifier, in which the output is proportional to the difference between the two inputs. The input of Q214 is connected to the summation point, which is the junction of the reference resistor R106, and the voltage control resistors R107 through R140. The feedback amplifier controls the output voltage so that the summation point is essentially at the same potential as the positive output bus. Any voltage difference between these two points is

amplified by the differential amplifier, and further amplified by Q212 through Q208, and applied to the grid of the series passing tube V202. The passing tube then increases or decreases its conductance until the voltage at the summation point is equal to the voltage of the positive bus. Tube V201 is a highly stable voltage reference which maintains a constant voltage of approximately 83 volts. Since the summation point is always held near zero volts, a constant current of 2 milliamperes flows through reference resistors R104 through R106, and also through voltage control resistors R107 through R140. The output voltage is equal to the IR drop across the voltage control resistors, and may thus be precisely controlled by varying the resistance of the voltage control string.

3-5. CIRCUIT DESCRIPTIONS

3-6. CONTROL RELAYS

3-7. A full-wave rectifier is formed by CR301 through CR304, which furnishes dc voltage to the control relays K301 and K302. Approximately 30 seconds after power is applied to the instrument, time-delay relay K301

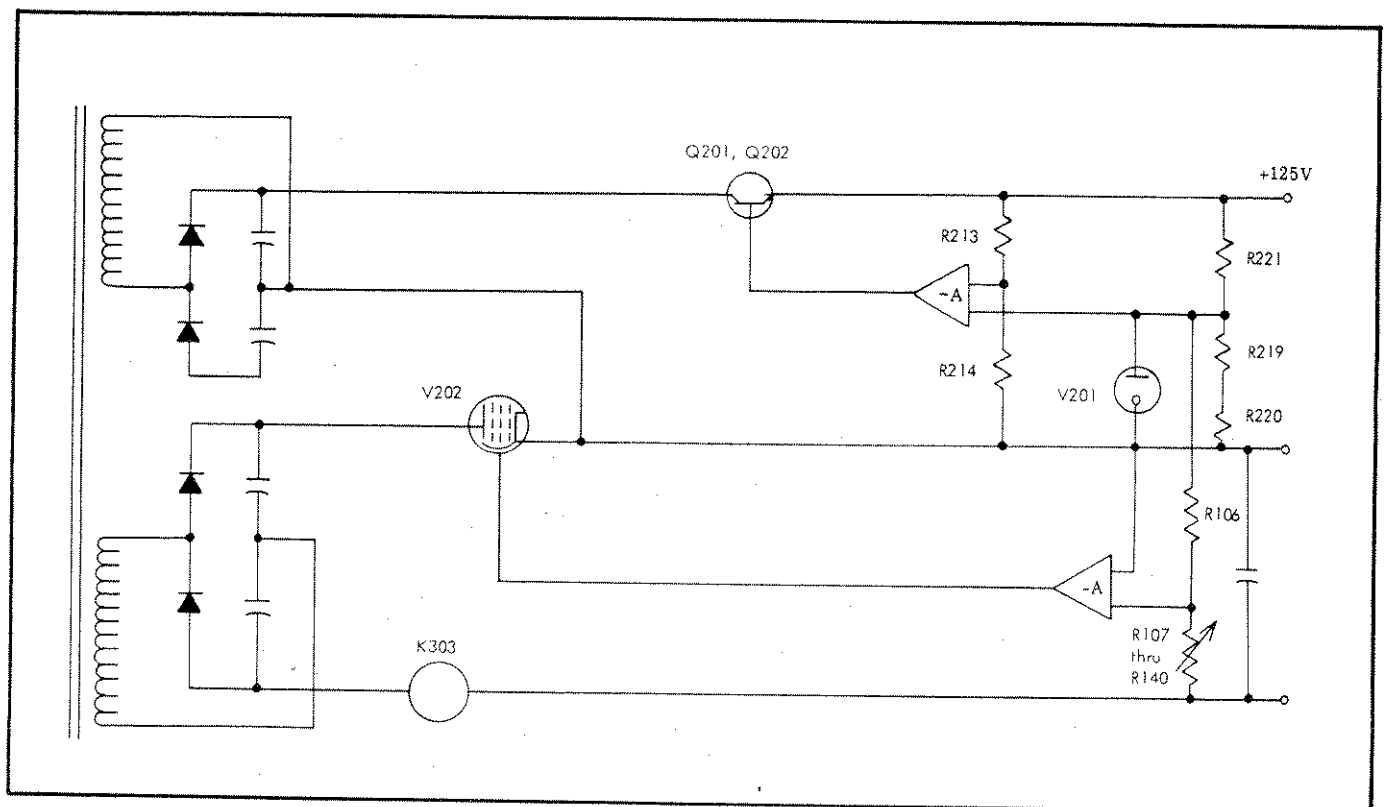

Figure 3-1. MODEL 410B DC POWER SUPPLY - BLOCK DIAGRAM

closes if S2 is set to the STANDBY-RESET position. This energizes K302, which opens K302A, removing K301 from the circuit, and closes K302B and K302C. When switch S2 is set to the HIGH VOLTAGE ON position after K302C is closed, the primary of transformer T2 is energized and transformer voltage is applied to CR401 and CR402.

3-8. OVERCURRENT PROTECTION

3-9. Relay K303 provides overcurrent protection. If the output current exceeds approximately 12 milliamperes, K303 is actuated, which closes K303A. This de-energizes K302, which closes K302A, and opens K302B and K302C, extinguishing the HIGH VOLTAGE ON lamp. The primary circuit of T2 is thus opened by K302C, and high voltage is removed from the output terminals. Before high voltage can be reapplied to the output terminals, switch S2 must be set to the STANDBY-RESET position. After the time-delay cycle is complete, voltage will be available at the output connector when the HIGH VOLTAGE switch, S2, is set to ON.

3-10. MAIN OUTPUT VOLTAGE

3-11. The main output voltage is developed by CR401, CR402, C3, C4, and R402 through R411. This is a full-wave, voltage-doubler circuit, which applies rectified, filtered, dc voltage to the plate of V202. The taps on the primary of T2 provide approximate control of the unregulated dc voltage, which minimizes power dissipation in V202 at low output voltage.

3-12. FEEDBACK AMPLIFIER

3-13. The feedback amplifier consists of essentially five stages composed of seven silicon transistors. Transistors Q213 and Q214 are connected as a differential amplifier. The output is taken from the collector load of Q214 and is applied to the common-emitter amplifier Q212. Output from the collector of Q212 is ac coupled back to the base of Q213 as negative feedback for loop stabilization. The output of Q212 is applied to the input of the compound-connected, emitter-follower pair of Q210 and Q211. This stage provides current gain and impedance matching between the high collector impedance of Q212 and the low emitter impedance of Q209. Transistors Q209 and Q208 are common base stages which provide the voltage gain and large voltage swing required by the grid of V202. C215 and R230 in the emitter of Q209 form a lead network for loop compensation.

3-14. AUXILIARY SUPPLIES

3-15. AC voltage for both the positive and negative auxiliary supplies is obtained from one transformer winding. One terminal of this winding is connected to the positive output of the 410B, which is the zero volt reference. The other terminal of the winding is con-

nected to the junction of two half-wave rectifiers and filters. The positive auxiliary voltage is obtained from CR201, CR202, and C202. Auxiliary voltages of +95 volts, +20 volts, and +10 volts are obtained from CR205, CR206, and CR207, respectively, which are connected across the positive auxiliary voltage. The negative auxiliary voltage is obtained from CR203, CR204, and C203. An auxiliary voltage of -110 volts is obtained from CR208. This arrangement of the +95V, +20V, +10V, and -110V auxiliary supplies provides shunt regulation of these supplies.

3-16. REFERENCE VOLTAGE

3-17. Reference voltage for the instrument is obtained from V201, a gas-filled reference tube. Resistor R219 has a temperature coefficient of $+0.45\%/^{\circ}\text{C}$, which provides temperature compensation for V201. Transistors Q205 and Q206 are used as a differential amplifier. Transistor Q203 is operated as an emitter-follower voltage regulator, which provides 100 volts for the collector of Q205 and the emitter of Q204. The base of Q205 samples the output voltage of the +125 volt auxiliary supply, through the voltage divider R213 and R214. The output from Q206 represents the amplified difference between the reference voltage and the voltage at the base of Q205. Transistor Q204 provides further amplification of this voltage difference for application to series regulators Q202 and Q201. Neon lamps DS201 and DS202 are safety devices to prevent possible burn-out of Q201 and Q202 if the output of the instrument becomes short-circuited.

3-18. ACCURACY

3-19. The main sampling string resistors in the 410B are accurate to within $\pm 0.1\%$. However, the accuracy of the 410B is specified as $\pm 0.25\%$, because the calibration accuracy also depends upon the stability of the reference voltage. The voltage of reference tube V201 (83A1) changes slightly due to aging. The accuracy of the supply will remain within $\pm 0.25\%$ for at least 30 days. The calibration accuracy may be maintained at better than 0.25% if the instrument is recalibrated more often than the usual calibration period of 30 days.

3-20. All calibrated power supplies have an accuracy limit (floor) as the output voltage approaches zero. This floor is caused by zero shift in the error amplifier, contact resistance in the sampling string circuit, and the accuracy of the sampling string resistors used for the least significant digits. The accuracy floor may be reduced by using more expensive components and additional circuitry. However, this results in greater initial cost and longer calibration time. Thus, very low accuracy floors are usually found only in precision calibrators. The 410B has an accuracy of $\pm 0.25\%$ or 250 millivolts, whichever is greater, when the first four voltage controls are used. Thus, the $\pm 0.25\%$ accuracy applies from 10,000 volts to 100 volts.

SECTION IV

MAINTENANCE

4-1. INTRODUCTION

4-2. Maintenance of the Model 410B DC Power Supply should consist primarily of occasional cleaning, tube replacement, and calibration. Preventive maintenance is discussed in paragraph 4-3. A discussion of troubleshooting and a troubleshooting chart are presented in paragraph 4-6. Calibration procedures and the equipment necessary are presented in paragraph 4-14.

WARNING

Caution should be exercised when servicing this power supply. The metal shell of some of the electrolytic capacitors may be as much as 10, 100 volts above chassis ground. Capacitors C5 and C219 are high-quality, oil-filled units capable of retaining a charge for several days. Before servicing or removing tubes, all capacitors and plate caps should be shorted to the chassis. It is recommended that the shorting wire remain connected to C5 and C219 during servicing to prevent build-up of capacitor voltage due to dielectric absorption.

4-3. PREVENTIVE MAINTENANCE

4-4. Periodic cleaning of the Model 410B is desirable because of the high voltage present. Any contamination, particularly on the high voltage capacitors, may cause corona discharge, which will appear as noise in the output voltage. Components may be cleaned with Freon, or with a lint-free rag saturated with denatured alcohol. Ceramic switches may be cleaned with denatured alcohol or tetrachloroethane. After cleaning, the ceramic surface should be coated with a 10% solution of Dow Corning silicon fluid (200 viscosity grade). Denatured alcohol or tetrachloroethane may be used as a thinner for the silicon fluid.

4-5. Printed circuit boards in the 410B are coated with a polyurethane compound to prevent moisture absorption. If components are replaced, it will be necessary to recoat the circuit board in the immediate area of the part replaced. Aerosol containers of Epocast, available from Furane Plastics, Inc., Los Angeles, California, provide a convenient way of recoating the circuit board area. The recoated circuit board does not require baking.

4-6. TROUBLESHOOTING

4-7. It is recommended that all checks be made with the POLARITY switch turned to negative output polarity, and when possible, the output voltage set to 500 volts. Most voltages are referred to the positive bus, and when

the output polarity is negative, the positive bus is connected to the earth grounded chassis. This affords some protection to the person performing the tests.

4-8. The power supply should be allowed to warm-up before the following accuracy checks. Usually, one-half hour of operation is adequate. Figure 4-1 is a list of various failures and probable causes. Reference to Figure 4-1 will occasionally indicate the cause of a failure. Components may be located by referring to Section V. A list of equipment required is given in Figure 4-2.

4-9. AUXILIARY VOLTAGES

- a. Connect the 881A common lead to the 410B chassis ground (shell of the OUTPUT connector).
- b. Set the POLARITY switch to negative.
- c. Set the POWER switch to ON.
- d. Set the OUTPUT VOLTAGE controls to zero.
- e. Set the HIGH VOLTAGE switch to ON.
- f. Connect the 881A positive lead to the junction of CR206 and CR207.
- g. The 881A should indicate +10 (± 1) vdc.
- h. Connect the 881A positive lead to the junction of CR205 and CR206.
- i. The 881A should indicate +20 (± 2) vdc.
- j. Connect the 881A positive lead to the junction of CR205 and R203.
- k. The 881A should indicate +95 (± 9.5) vdc.
- l. Connect the 881A positive lead to the junction of CR208 and R205.
- m. The 881A should indicate -110 (± 11) vdc.
- n. Connect the 881A positive lead to the positive end of C211. Also connect the 910A RMS Voltmeter across the same points as the 881A.
- o. The 881A should indicate 125 (± 2.25) vdc. The 910A should indicate less than 0.005 volts rms ripple.

4-10. LINE REGULATION AND RIPPLE

- a. Connect the variable transformer between the 410B and the line. Set the transformer to 115 volts output.

WARNING

A good power line ground must be provided when the variable transformer is used.

- b. Connect the 910A and the 881A across the OUTPUT connector. Also connect the oscilloscope across the OUTPUT connector.
- c. Set the POWER switch to ON.
- d. Set the HIGH VOLTAGE switch to ON.
- e. Set the OUTPUT VOLTAGE controls to 500 volts, and record the voltage indicated by the 881A.
- f. Increase the variable transformer output to 127 vac,

SYMPTOM	PROBABLE CAUSE	REMEDY
No output	Blown fuse Open heater of V202 Open R104; Shorted C219	Check fuse F1, and replace if necessary. Determine if tube will warm-up; if not replace. Check and replace if necessary.
Constant percentage error in output voltage	Out of calibration Defective R106	Recalibrate per paragraph 4-14. Check and replace if necessary.
Percentage error over part of range or Output erratic over part of range	Defective wirewound resistor in the sampling string. (R107 thru R140)	Set the output voltage to a maximum and decrease one switch position at a time until the error disappears. The defective resistor will be found at the last switch position in which the error was noted.
Output erratic over entire range	Defective V202 Defective output voltage switch, or dirty switch printed circuit board. Defective R104 or R106	Test and replace if necessary. Replace switch, clean printed circuit board. Check and replace if necessary.
Output rises to over 10KV and follows line voltage variations	Defective V202, or Q208 thru Q214 Open sampling resistor or switch	Test and replace if necessary. Test R107 thru R140, and S3 thru S6, and replace if necessary.
Poor load regulation	Defective Q208 thru Q214	Check and replace if necessary.
Output voltage suddenly rises above preset value	Internal arcing in V202	Check and replace if necessary.
Noise in output	Dirty high-voltage switches, capacitors, or printed circuit boards.	Clean per paragraph 4-4.
Excessive drift	Defective V201, Q213, or Q214	Check by replacement.
Excessive ripple	Excessive ripple in +125V auxiliary supply Defective C219, C5, Q213, or Q214	If auxiliary supply ripple exceeds approximately 5 mv, replace defective component. Check and replace if necessary.
Loss of control	Open R243	Check and replace if necessary.

Figure 4-1. TROUBLESHOOTING

EQUIPMENT	SPECIFICATIONS REQUIRED
Variable transformer	3 ampere capacity, 100 volts to 130 volts output.
RMS Voltmeter, Fluke Model 910A, or equivalent	RMS measurement of non-sinusoidal waves.
DC Differential Voltmeter, Fluke Model 881A, or equivalent	Voltmeter/Voltage Divider must be capable of measuring 0 to 10,000 vdc with a minimum accuracy of 0.05% + 50 microvolts. Voltmeter must have a 1 millivolt null detector for use with the 80E.
Voltage Divider, Fluke Model 80E-10, or equivalent	
Oscilloscope, Tektronix Model 541, with Type L plug-in unit, or equivalent	Minimum sensitivity of 5 mv/cm. 10 MHz bandwidth.
Blocking capacitor	0.05 microfarads, 10,000 vdc rating.
Load resistors	50K $\pm 5\%$, 5W 1K $\pm 5\%$, 2W
Insulated screwdriver	Must have solid insulated shaft capable of withstanding 10,000 vdc.

Figure 4-2. EQUIPMENT REQUIRED FOR TROUBLESHOOTING AND CALIBRATION

while observing the 910A. Ripple indicated by the 910A and by the oscilloscope should be less than 1 millivolt rms, and 5 millivolts peak-to-peak, respectively. The voltage change indicated by the 881A should be less than 5 millivolts.

g. Decrease the transformer output from 115 vac to 103 vac, while observing the 910A. Ripple indicated by the 910A and by the oscilloscope should be less than 1 millivolt rms and 5 millivolts peak-to-peak, respectively. The voltage change indicated by the 881A should be less than 5 millivolts from step e.

h. If desired, repeat steps e. through g. with the POLARITY switch in the opposite polarity.

i. Set the variable transformer to 115 vac output, and set the HIGH VOLTAGE switch to STANDBY-RESET.

j. Disconnect the 881A and the 910A.

k. Connect the 80E-10 Voltage Divider to the output of the 410B, and connect the 881A to the output of the voltage divider.

l. Connect the 10KV blocking capacitor in series with the 910A input, and connect the series combination across the 410B OUTPUT connector.

m. Set the HIGH VOLTAGE switch to ON.

n. Set the OUTPUT VOLTAGE controls to 10,000 volts, and record the voltage measured by the voltmeter/voltage divider combination.

o. Increase the variable transformer output to 127 vac, while observing the 910A. Ripple indicated by the 910A and by the oscilloscope should not exceed 1 millivolt rms and 5 millivolts peak-to-peak, respectively. The voltmeter/voltage divider should indicate less than 0.100 volts change in the 410B output voltage from the value measured in step n.

p. Decrease the transformer output from 115 vac to

103 vac, while observing the 910A. Ripple indicated by the 910A and by the oscilloscope should not exceed 1 millivolt rms and 5 millivolts peak-to-peak, respectively. The voltmeter/voltage divider should indicate less than 0.100 volts change in the 410B output voltage from the value measured in step n.

q. If desired, repeat steps n. through p. with the POLARITY switch in the opposite polarity.

4-11. LOAD REGULATION

a. Connect the variable transformer between the 410B and the line. Set the transformer to 103 vac output.

b. Connect the 881A across the OUTPUT connector.

c. Set the POWER switch to ON.

d. Set the HIGH VOLTAGE switch to ON.

e. Set the OUTPUT VOLTAGE controls to 500 volts.

f. Record the voltage indicated by the 881A.

g. Carefully connect the 50K load resistor across the OUTPUT connector. The load current should be 0.010 ampere.

h. The 881A should indicate less than 0.005 volts change from the voltage measured in step f.

4-12. STABILITY

a. Connect the 80E-10 to the output of the 410B, and connect the 881A to the output of the voltage divider.

b. Set the POWER switch to ON.

c. Set the HIGH VOLTAGE switch to ON.

d. Set the OUTPUT VOLTAGE controls to 10,000 volts.

e. After a minimum operating time of 30 minutes, record the voltage indicated by the voltmeter/voltage divider.

f. After an additional 60 minutes of operation, the voltage change indicated by the voltmeter/voltage divider should be less than 0.5 volt (0.0005 volt indicated by the 10V tap).

4-13. OUTPUT AT ZERO VOLTS

- a. Connect the voltmeter to the OUTPUT connector.
- b. Set the POWER switch to ON.
- c. Set the OUTPUT VOLTAGE controls to zero.
- d. Set the HIGH VOLTAGE switch to ON.
- e. The 881A should indicate less than 0.030 volts in both output polarities. If not, exchange Q213 and/or Q214 with another transistor of the same type used elsewhere in the instrument, so that the beta of the two transistors is more nearly equal.

4-14. CALIBRATION

4-15. The Model 410B may be calibrated as often as necessary. However, it is recommended that the reference voltage be checked every 30 days, and the overcurrent limit be checked every six months. As reference tube V201 (83A1) ages, the reference voltage changes slightly. It has been found that some reference tubes are more stable than others. However, most reference tubes will change by less than 0.1% for every 100 hours of operation after the first hundred hours. If the output voltage is recorded before the reference current is adjusted, a more realistic calibration period can be determined. The equipment required for calibration is given in Figure 4-2.

4-16. REFERENCE CURRENT ADJUSTMENT

- a. Connect the 80E-10 Voltage Divider to the output of the 410B, and connect the voltmeter to the output of the voltage divider.
- b. Set the OUTPUT VOLTAGE controls to 9,900 volts, using only the first two dials.
- c. Set the POLARITY switch to negative.
- d. Set the POWER switch to ON.
- e. Set the HIGH VOLTAGE switch to ON.
- f. Set the differential voltmeter to differentially measure 9,900 volts, considering the voltage divider ratio. For example, using the 80E-10 Voltage Divider, set the differential voltmeter to measure 9.9 volts.

WARNING

Use an insulated screwdriver to adjust R104. The case of this resistor is 85 volts above

chassis ground for negative output polarity, and may be as much as 10,085 volts above ground for positive output polarity.

g. After a minimum operating time of 30 minutes, adjust R104 for a null on the differential voltmeter. Within 24 volts of 9,900 volts is sufficient (24 millivolts with the 80E-10). This control may be adjusted through the access hole on the right side panel near the front.

4-17. OVERCURRENT TRIP ADJUSTMENT

- a. Connect a 1K \pm 5%, 2W resistor to the OUTPUT connector.
- b. Set the OUTPUT VOLTAGE controls to zero.
- c. Set the POLARITY switch to negative.
- d. Set the POWER switch to ON.
- e. Set the HIGH VOLTAGE switch to ON.
- f. Set the 410B for maximum current trip by turning R151 completely clockwise. This control may be adjusted through the access hole on the left side of the instrument.
- g. Set the OUTPUT VOLTAGE controls to that output voltage which will deliver 12 milliamperes to the load resistor. For example, 12 volts will deliver approximately 12 milliamperes to a 1K resistor.

NOTE

If it is desired to set the overcurrent trip to some value other than 12 milliamperes, then the output voltage in step g. should be chosen to provide the desired trip current.

h. Slowly turn R151 counter-clockwise until the overcurrent trip removes power from the high voltage transformer.

4-18. METER CALIBRATION

4-19. The panel meter is adjusted at the factory, and will not usually require attention. If adjustment is necessary, proceed as follows:

- a. Set the POWER switch to ON.
- b. Set the HIGH VOLTAGE switch to ON.
- c. Set the OUTPUT VOLTAGE controls to 10,000 volts.
- d. Adjust R150 so that meter deflection corresponds to 10KV. This resistor may be adjusted through the access hole on the bottom of the instrument.

SECTION V

LIST OF REPLACEABLE PARTS

5-1. INTRODUCTION

5-2. This section contains information necessary to describe all normally replaceable parts. Separate assembly lists are used to describe the parts on the final assembly and various assemblies and subassemblies. Each list has a corresponding illustration on which the parts for that list are identified. Parts are called out on both lists and illustrations by reference designations from the schematic diagram. Those parts (mechanical) which have no reference designation are shown on the illustrations by Fluke stock number.

5-3. Each list provides the following information on each part:

- a. The REFERENCE DESIGNATION column indicates the reference designation used on the schematic diagram.
- b. The DESCRIPTION column describes the part in words, along with any applicable values, tolerances, etc. Indentation is used to show assembly, subassembly, and parts relationship. See abbreviations and symbols on next page.
- c. Entries in the FLUKE STOCK NUMBER column indicate the number by which Fluke stocks the part. This number should be used when ordering parts from the Fluke factory or your Fluke representative.
- d. Entries in the MFR. column indicate a typical manufacture of the part by the manufacturer's code number. Appendix A lists the manufacturers and their code numbers.
- e. Entries in the MFR. PART NO. column are part numbers assigned by the manufacturer indicated in the Mfg. column.
- f. The number in the TOTAL QTY column indicates the total quantity of the part used in the instrument. "REF" indicates that the total quantity of the part has been previously given. The total quantity of each part is listed the first time the part appears. All other listings of the same part refer back to the reference designation of the first appearance of the part for the total quantity.
- g. The number in the REC. QTY. column indicates the recommended spares quantity necessary to support

approximately one to five instruments for a period of two years. The basis used to select the recommended spares quantity is that a small group of parts will be required to correct a majority of the problems that occur. Since there is a chance that any part may fail, a stock of at least one of every part used in addition to the recommended parts will be needed for complete maintenance during one year of isolated service.

h. The USE CODE column identifies certain parts which have been added, deleted, or modified during production of the instrument. Each part for which a use code has been assigned may be identified with a particular instrument serial number by consulting the Use Code Effectivity List at the end of this section. These changes are normally made when improved components become available or when the latest circuit improvements are developed by our engineering department. The serial number listed indicates the instruments in which that particular part was used. The symbol "~" is used to indicate an approximate serial number. If a different part should be used for replacement, it is listed by Fluke stock number in the description column.

5-4. HOW TO OBTAIN PARTS

5-5. Standard components have been used whenever possible. Thus, most parts can be obtained locally. However, parts may be ordered directly from the manufacturer using the manufacturer's part number or from Fluke using the Fluke stock number. In addition, the most commonly replaced parts that can not be obtained locally may be obtained from your Fluke representative. If a part you have ordered has been replaced by a new or improved part, Fluke will normally send you this part along with an explanation.

- 5-6. When ordering parts from Fluke always include:
- a. Reference designation, description, and Fluke stock number.
 - b. Instrument model and serial number.
 - c. Most structural parts are not listed. In this case, give complete description, function, and location of part.

5-7. ABBREVIATIONS

ac	alternating current
Al	aluminum
assy	assembly
cap	capacitor
car film	carbon film
cer	ceramic
comp	composition
conn	connector
cps	cycles per second
db	decibel
dc	direct current
dpdt	double pole double throw
dpst	double pole single throw
elect	electrolytic
fxd	fixed
Ge	germanium
gmV	guaranteed minimum value
Hz	hertz (cycles per second)
K	kilohm
kc or Kc	kilocycle
kHz or KHz	kilohertz (kilocycles per/sec)
kv	kilovolt
kva	kilovolt-ampere
ma	milliampere
Mc or MC	megacycle
MHz	megahertz (megacycles per/sec)
meg or M	megohm
met film	metal film
mfg	manufacturer
mv	millivolt
mw	milliwatt
na	nanoampere
pf	picofarad
piv	peak inverse voltage
pistc	plastic
pp	peak-to-peak
ppm	parts per million
rect	rectifier
res	resistor
rms	root-mean-square
sb	slow-blow
Si	silicon
S/N	serial number
sw	switch
spdt	single pole double throw
spst	single pole single throw
Ta	tantalum
tc	temperature coefficient
tstr	transistor
ua	microampere
uf	microfarad
uv	microvolt
va	volt ampere
vac	alternating current volts
var	variable
vdc	direct current volts
w	watt
wvdc	direct current working volts
ww	wirewound

5-8. PREFIX SYMBOLS

T	tera	10 ¹²
G	giga	10 ⁹
M	mega	10 ⁶
K or k	kilo	10 ³
h	hecto	10 ²
da	deka	10
d	deci	10 ⁻¹
c	centi	10 ⁻²
m	milli	10 ⁻³
u	micro	10 ⁻⁶
n	nano	10 ⁻⁹
p	pico	10 ⁻¹²
f	femto	10 ⁻¹⁵
a	atto	10 ⁻¹⁸

5-9. QUANTITY SYMBOLS

a or amp	ampere
f	farad
h	henry
hr	hour
Ω	ohm
sec	second
v or V	volt
w or W	watt

5-10. SPECIAL NOTES AND SYMBOLS

~ 000	Approximate serial number
Use 0000-000000	Part number indicated should be used if re- placement is required.

REF DESIG.	DESCRIPTION	FLUKE STOCK NO.	MFR.	MFR. PART NO.	TOT. QTY.	REC. QTY.	USE CODE
	Final Assembly (see Figure 5-1)	410B	89536				
	Front Panel Assembly (see Figure 5-2)	3158-175729 (410B-406)	89536	3158-175729	1		
	Switch PCB Assembly (see Figure 5-3)	1702-175679 (410B-401)	89536	1702-175679	1		
	Amplifier PCB Assembly (see Figure 5-4)	1702-175687 (410B-402)	89536	1702-175687	1		
	Time Delay PCB Assembly (see Figure 5-5)	1702-175695 (410B-403)	89536	1702-175695	1		
	Rectifier PCB Assembly (see Figure 5-6)	1702-175703 (410B-404)	89536	1702-175703	1		
C1, C2	Cap, cer, 0.01 uf -20/+80%, 500V (not illustrated)	1501-105668	56289	29C9B5	2		
C3, C4	Cap, oil, .25/.25 uf ±20%, 7.5KV	1505-163766	99120	LK-75-504C	1		
C5	Cap, oil, 0.25 uf ±20%, 10KV	1505-163758	99120	LK-100-254N	1		
C219	Cap, oil, 0.05 uf ±10%, 10KV	1505-161158	01884	SMLE503-10M	1		
J2	Connector, H. V.	2104-100172	02660	MS3102A-18-16S -C	2		
K301	Relay, time delay 115V, 30 sec.	4502-105288	70563	115N030T	1	1	
P1	Line cord set, 3 wire	6005-102822	70903	PVC-PH-70	1		
R1	Res, comp, 470Ω ±10%, 1W	4704-109710	01121	GB4711	1		
S3A	Switch section, rot., 11 positions, 1 pole	5107-176149	71590	PS-284	1		
S3B	Switch rotor assembly	5108-175612	89536	5108-175612	1		
S7	Switch, rotary	5110-175711	89536	5110-175711	1		
S8, S9, S10	Switch, interlock (S9 and S10 not illustrated)	5104-115196	01963	E13-00A	3		
T1	Transformer, aux.	5600-176032	89536	5600-176032	1		
T2	Transformer, H. V.	5600-176024	89536	5600-176024	1		
V202	Electron tube, type 4-65A	5701-192351	89536	5701-192351	1	1	
	Meter cover	3155-169813	97945	1704-462-Y	1		
	Feet, rubber (not illustrated)	2819-103309	83478	9102-W	4		
	Knob assembly, pol. sw.	2405-175620	89536	2405-175620	1		
	Switch detent, 10 position, short	5108-155945	76854	239914-H	3		
	Switch detent, 10 position, long	5108-167833	76854	246305-H	1		

REF. DESIG.	DESCRIPTION	FLUKE STOCK NO.	MFR.	MFR. PART NO.	TOT. QTY.	REC. QTY.	USE CODE
	Mating connector, H. V.	2104-100156	02660	MS3106A-18-16P	1		
	Knob, 1-1/2"	2405-170035	89536	2405-170035	5		
	Cable clamp	2804-100149	02660	AN3057 .0	1		
	Cap, H.V. connector	3155-172122	89536	3155-172122	2		

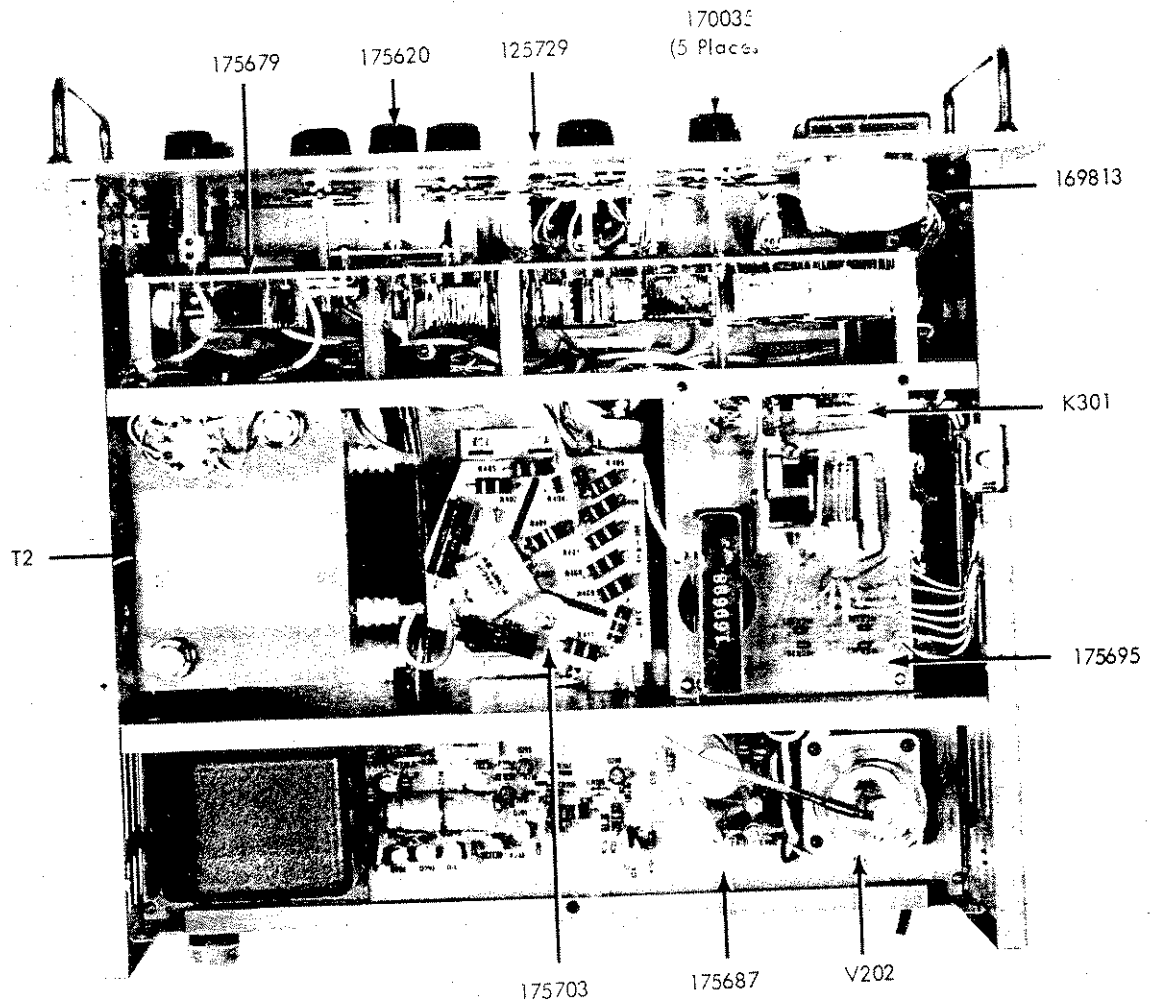

Figure 5-1. FINAL ASSEMBLY (Sheet 1 of 2)

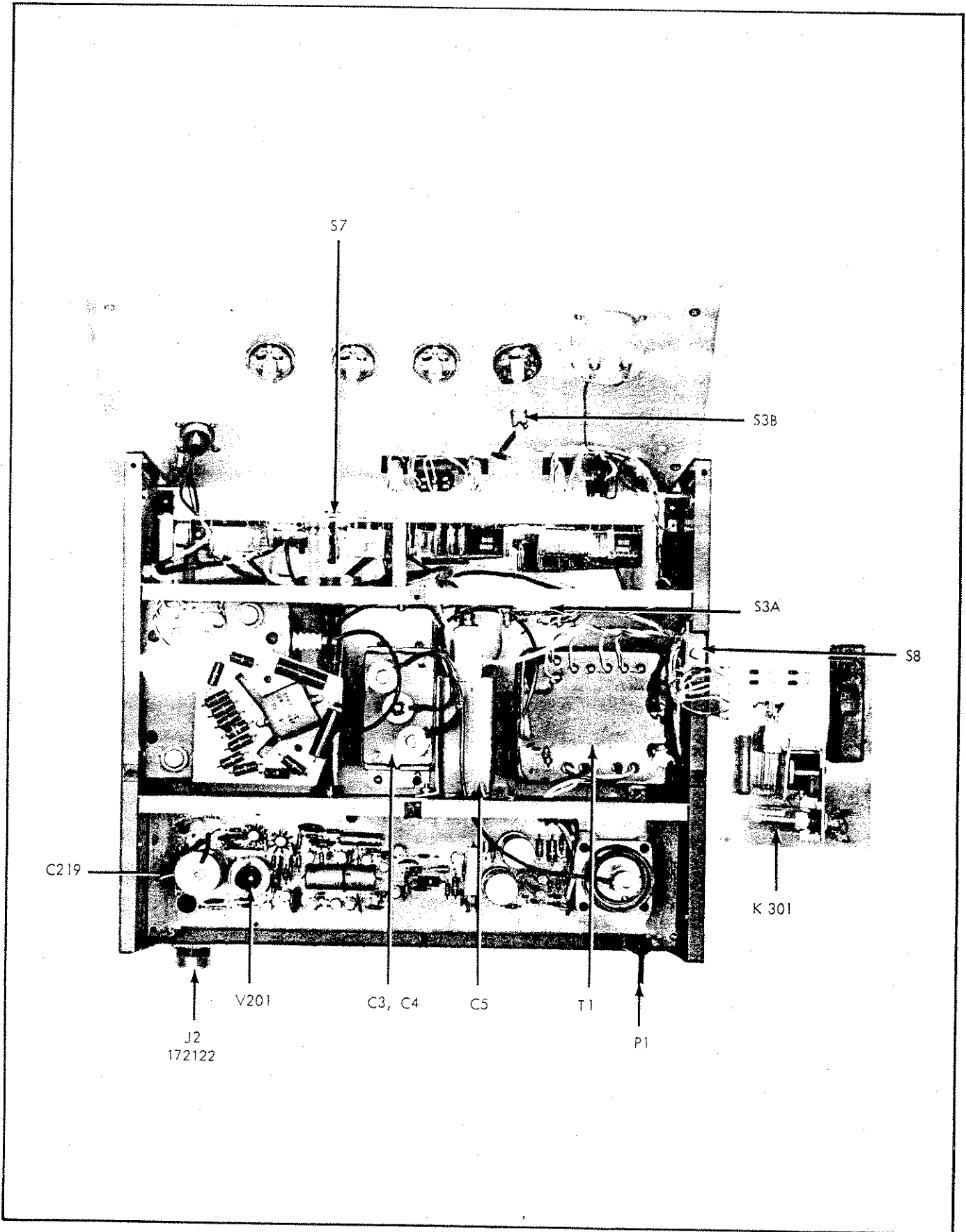

Figure 5-1. FINAL ASSEMBLY (Sheet 2 of 2)

REF DESIG.	DESCRIPTION	FLUKE STOCK NO.	MFR.	MFR. PART NO.	TOT. QTY.	REC. QTY.	USE CODE
	Front Panel Assembly	3158-175729 (410B-406)	89536	3158-175729	REF		
DS1	Lamp, red lens	3903-100206	91802	1040A1	2		
DS2	Lamp, white lens	3903-100214	91802	1040A4	1		
DS3	Lamp, red lens	3903-100206	91802	1040A1	REF		
F1	Fuse, 3A, sb (not illustrated)	5101-109280	03614	Type MDA	1	3	
J1	Connector, H. V.	2104-100172	02660	MS3102A-18-16S-C	REF		
M1	Meter, 50Ω, 500-0-500 ua ±2%	2901-166231	89536	2901-166231	1		
S1	Switch, toggle, DPST, 8A, 250V	5106-114835	04009	81024-GB	1		
S2	Switch, toggle, DPDT, 15A, 115V	5106-157883	73559	2GL50-63	1		
	Fuseholder	2102-100107	03614	HKP	1		
	Handle, 6-7/16"	2404-101584	05704	805	2		
	Cap, H.V. connector	3155-172122	89536	3155-172122	REF		

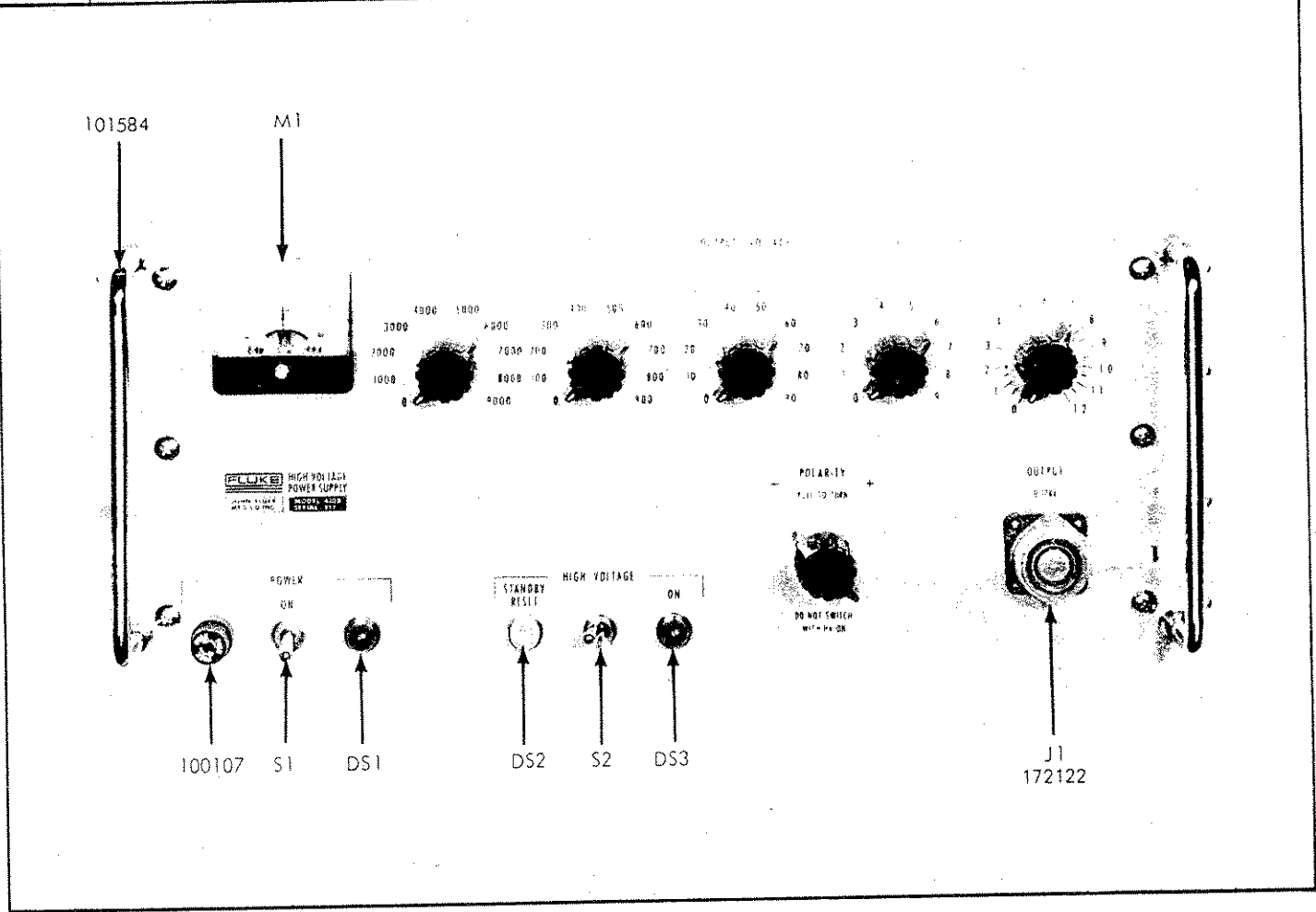

Figure 5-2. FRONT PANEL ASSEMBLY

REF DESIG.	DESCRIPTION	FLUKE STOCK NO.	MFR.	MFR. PART NO.	TOT. QTY.	REC. QTY.	USE CODE
	Switch PCB Assembly	1702-175679 (410B-401)	89536	1702-175679	REF		
C102	Cap, elect, 10 uf -10/+75%, 150V	1502-106351	56289	30D106G150DF4	1	1	
R104	Res, var, WW, 1K \pm 20%, 1-1/4W	4702-113266	71450	Type 110	1		
R105	Res, WW, 1.02K \pm 0.1%, 1/2W	4707-145128	89536	4707-145128	1		A
R106	Res, WW, 40K \pm 0.02%, 1/2W	4707-146530	89536	4707-146530	1	1	A
R106	Res, WW, 41.6K \pm 0.05%, 1 1/2W	4707-199778	89536	4707-199778	1	1	B
R107 thru R124	Res, WW, 250K \pm 0.05%, 2W	4707-156448	89536	4707-156448	18	2	
R125 thru R128	Res, WW, 100K \pm 0.1%, 1W	4707-142349	89536	4707-142349	4		
R129	Res, WW, 50K \pm 0.1%, 1W	4707-156455	89536	4707-156455	1		
R130 thru R133	Res, WW, 10K \pm 0.1%, 1W	4707-131664	89536	4707-131664	1		
R134	Res, WW, 5K \pm 0.1%, 1/2W	4707-149708	89536	4707-149708	1		
R135 thru R138	Res, met flm, 1K \pm 1%, 1/2W	4705-151324	75042	Type CEC-TO	6		
R139	Res, met flm, 499 Ω \pm 1%, 1/2W	4705-151514	75042	Type CEC-TO	1		
R140	Res, var, WW, 600 Ω \pm 10%, 2W	4702-155523	71450	Type 252	1		
R141	Res, comp, 4.7 Ω \pm 5%, 1W	4704-109785	01121	GB47G5	3		
R142 thru R148	Res, met flm, 2.67M \pm 1%, 2W	4705-169391	14298	CM-2	7		
R149	Res, met flm, 309 Ω \pm 1%, 1/2W	4705-172130	75042	Type CEC-TO	1		
R150, R151	Res, var, WW, 3K \pm 20%, 1-1/4W	4702-149781	71450	Type 110	2		
R152	Res, comp, 82 Ω \pm 5%, 1/2W	4704-108746	01121	EB8205	1		
R153	Res, comp, 4.7 Ω \pm 5%, 1W	4704-109785	01121	GB47G5	REF		
S4, S5, S6	Switch section, rot, 1 pole, 10 positions	5108-155978	76854	239956-FC	3		

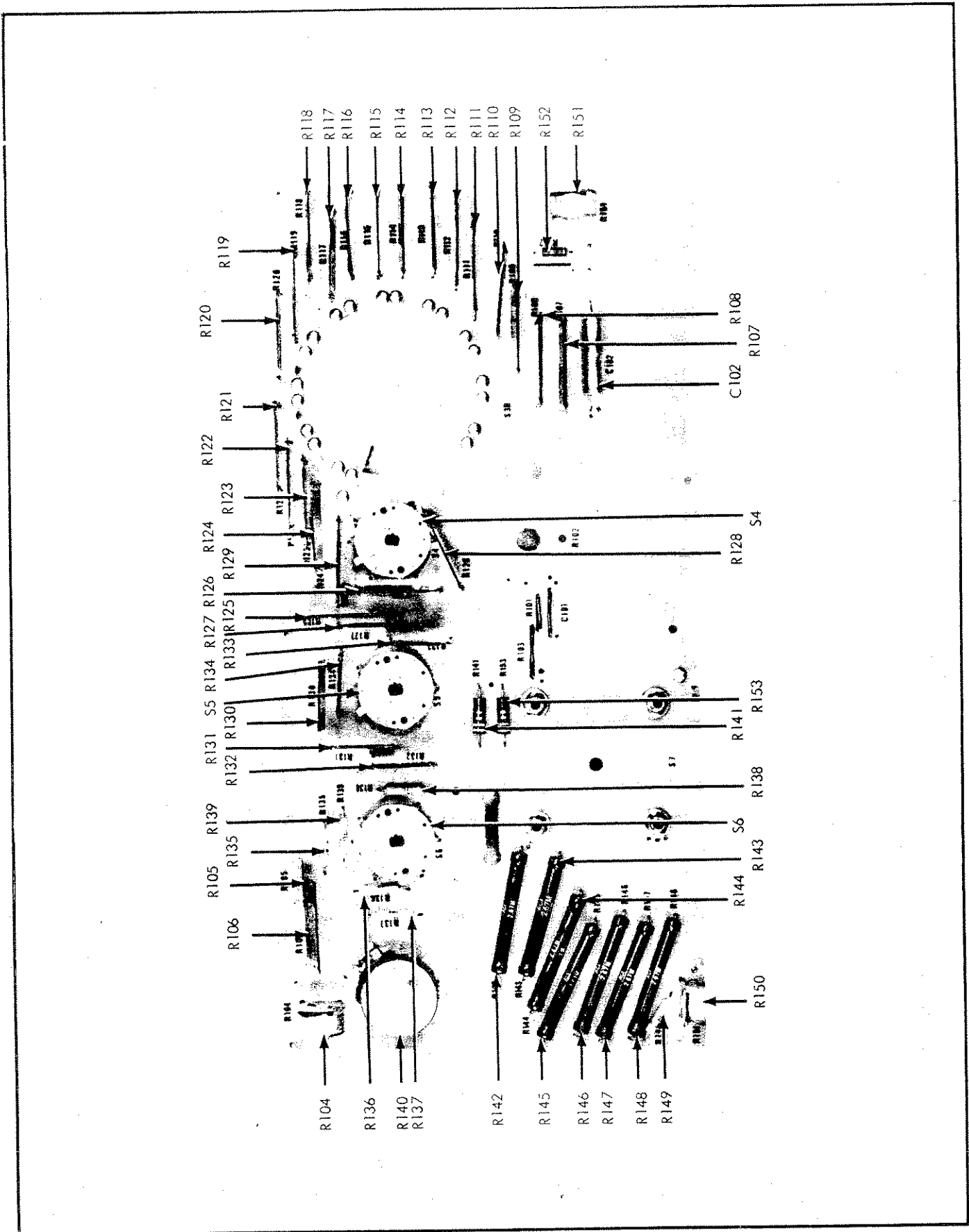





Figure 5-3. SWITCH CIRCUIT BOARD ASSEMBLY

REF DESIG.	DESCRIPTION	FLUKE STOCK NO.	MFR.	MFR. PART NO.	TOT. QTY.	REC. QTY.	USE CODE
	Amplifier PCB Assembly	1702-175687 (410B-402)	89536	1702-175687	REF		
C201	Cap, fxd, cer, 0.0033 uf $\pm 20\%$, 1KV	1501-106674	56289	5GA-D33	1		
C202, C203	Cap, fxd, elec, 40 uf -10/+100%, 500V	1502-106765	56289	Type 66D	2	1	
C204	Cap, fxd, elec, 200 uf -10/+75%, 12V	1502-150284	56289	30D207G012DF4	1	1	
C205, C206	Cap, fxd, cer, 0.1 uf -20/+80%, 500V	1501-105684	56289	41C92	5		
C207	Cap, fxd, cer, 0.0047 uf $\pm 10\%$, 500V	1501-106724	71590	CF-472	1		E
C207	Cap, fxd, cer, 0.005 uf $\pm 20\%$, 1KV	1501-105650	56289	C023B102H502M	1		F
C208, C209	Cap, fxd, cer, 0.1 uf -20/+80%, 500V	1501-105684	56289	41C92	REF		
C210	Cap, fxd, cer, 0.05 uf -20/+80%, 500V	1501-105676	56289	33C58	1		
C211	Cap, fxd, elect, 40 uf -10/+75%, 250V	1502-161273	56289	34D406G250GL4	1	1	
C212	Cap, fxd, cer, 0.01 uf -20/+80%, 500V	1501-105668	56289	29C9B5	1		
C215	Cap, fxd, cer, 180 pf $\pm 10\%$, 500V	1501-105890	71590	BB60181KS3N	1		
C216	Cap, fxd, cer, 0.0027 uf GMV, 500V	1501-106211	72982	ED-.0027	1		
C217	Cap, fxd, cer, 0.1 uf -20/+80%, 500V	1501-105684	56289	41C92	REF		
C218	Cap, fxd, cer, 0.01 uf GMV, 1.6KV	1501-106930	71590	DD16-103	1		
CR201 thru CR204	Diode, silicon, 600 PIV, 1A	4802-112383	05277	1N4822	10	2	
CR205	Diode, Si, zener, 75V, 0.005A	4803-168096	81483	1N3041A	1	1	
CR206, CR207	Diode, Si, zener, 10V, type 1N961A	4803-113324	07910	1N961A	2	1	
CR208	Diode, Si, zener, 110V, 0.005A	4803-168104	81483	1N3045A	1	1	
CR209	Diode, silicon, 600 PIV, 1A	4802-112383	05277	1N4822	REF		E
CR210, CR211	Diode, silicon, 100 PIV, 1A	4802-116111	05277	1N4822	4	1	
CR213, CR214	Diode, silicon, 100 PIV, 1A	4802-116111	05277	1N4822	REF		
CR215	Diode, Si, 200 PIV, 12A	4802-188854	04713	MR1112	1	1	
CR216, CR217	Diode, silicon, 600 PIV, 1A	4802-112383	05277	1N4822	REF		F
DS201 thru DS204	Lamp, neon, Type NE2E	3902-100347	71744	NE2E	4	2	
Q201, Q202	Transistor, NPN, Si, Type 2N3053	4805-150359	95303	2N3053	2	1	

REF DESIG	DESCRIPTION	STOCK NO	MFR	MFR PART NO	TOT QTY	REC QTY	USE CODE
Q203, Q204	Transistor, NPN, Si	4805-203489	07910	CDQ10656	3	2	
Q205, Q206	Transistor, NPN, Si	4805-203489	07910	CDQ10656	REF		C
Q205, Q206	Transistor, NPN, Si	4819-168716	07263	S19254	2		D
Q208, Q209, Q210	Transistor, PNP, Si	4805-190389	04713	SM4144	3	1	C
Q208, Q209, Q210	Transistor, PNP, Si	4805-159491	04713	SS7504	3		D
Q211, Q212	Transistor, NPN, Si	4805-203489	07910	CDQ10656	REF		
Q213, Q214	Transistor, NPN, Si	4805-203489	07910	CDQ10656	REF		C
Q213, Q214	Transistor, NPN, Si	4805-235812	89536	4805-235812	2		D
R201	Res, comp, 10 Ω \pm 10%, 1/2W	4704-108092	01121	EB1001	1		
R202, R203	Res, WW, 30K \pm 5%, 10W	4706-155432	06136	10F-30000	2		
R204	Res, comp, 75 Ω \pm 5%, 1/2W	4704-108753	01121	EB7505	1		
R205	Res, comp, 150K \pm 10%, 1W	4704-109801	01121	GB1541	1		
R206	Res, comp, 2.7K \pm 10%, 2W	4704-110148	01121	HB2721	1		C
R206	Res, comp, 2.2K \pm 10%, 2W	4704-109967	01121	HB2221	1		D
R207, R208	Res, comp, 6.2K \pm 5%, 1/2W	4704-108621	01121	EB6225	2		
R209	Res, met flm, 20K \pm 1%, 1/2W (not illustrated)	4705-162438	75042	Type CEC-TO	1		
R210	Res, met flm, 100K \pm 1%, 1/2W (not illustrated)	4705-151316	75042	Type CEC-TO	1		
R211	Res, comp, 47K \pm 10%, 1/2W	4704-108480	01121	EB4731	2		
R212	Res, comp, 2.7K \pm 5%, 1/2W	4704-108837	01121	EB2721	1		
R213	Res, met flm, 40.2K \pm 1%, 1/2W (not illustrated)	4705-161059	75042	Type CEC-TO	1		
R214	Res, met flm, 80.6K \pm 1%, 1/2W	4705-150680	75042	Type CEC-TO	1		
R215	Res, comp, 180K \pm 10%, 1/2W	4704-108431	01121	EB1841	1		
R216	Res, comp, 82K \pm 10%, 1/2W	4704-108498	01121	EB8231	2		
R217	Res, comp, 39K \pm 10%, 1/2W (not illustrated)	4704-108555	01121	EB3931	1		
R218	Res, comp, 330 Ω \pm 10%, 1/2W	4704-108589	01121	EB3311	1		
R219	Res, WW, 14K \pm 5%, +4500 PPM/ $^{\circ}$ C	4707-172072	89536	4707-172072	1		A
R219	Factory selected part						B

REF DESIG	DESCRIPTION	STOCK NO	MFR	MFR PART NO	TOT QTY	REC QTY	USE CODE
R220	Res, WW, 5K \pm 0.1%, 1/2W	4707-149708	89536	4707-149708	REF		A
R221	Res, WW, 4K \pm 0.03%, 1/2W	4707-131672	89536	4707-131672	1	1	A
R221	Factory selected part						B
R222	Res, comp, 10K \pm 10%, 1W	4704-109389	01121	GB1031	1		
R223, R224	Res, comp, 47 Ω \pm 10%, 1/2W	4704-108688	01121	EB4701	2		
R226	Res, comp, 68K \pm 10%, 2W	4704-110114	01121	HB6831	1		
R227	Res, comp, 1K \pm 10%, 1/2W	4704-108563	01121	EB1021	1		
R228, R229	Res, comp, 82K \pm 10%, 1/2W	4704-108498	01121	EB8231	REF		
R230	Res, comp, 270 Ω \pm 5%, 1/2W	4704-159616	01121	EB2715	1		
R231	Res, comp, 680 Ω \pm 10%, 1/2W	4704-108712	01121	EB6811	1		
R232	Res, comp, 47K \pm 10%, 1/2W	4704-108480	01121	EB4731	REF		
R233	Res, comp, 4.7K \pm 10%, 1/2W	4704-108381	01121	EB4721	2		
R234	Res, comp, 100K \pm 10%, 1/2W	4704-108126	01121	EB1041	1		
R235	Res, comp, 4.7K \pm 10%, 1/2W	4704-108381	01121	EB4721	REF		
R236	Res, met flm, 1K \pm 1%, 1/2W	4705-151324	75042	Type CEC-TO	REF		
R237, R238	Res, comp, 270K \pm 10%, 1/2W	4704-108258	01121	EB2741	2		
R239	Res, comp, 1.2M \pm 10%, 1/2W	4704-108407	01121	EB1251	1		
R240	Res, comp, 2.7 Ω \pm 10%, 1W (not illustrated)	4704-109850	01121	GB27G1	1		
R241	Res, comp, 4.7 Ω \pm 5%, 1W	4704-109785	01121	EB47G5	REF		
R242	Res, comp, 2.2K \pm 10%, 1/2W	4704-108605	01121	EB2221	1		
R243	Res, met flm, 1K \pm 1%, 1/2W (not illustrated)	4705-151324	75042	Type CEC-TO	1		
V201 V201	Electron Tube, volt. ref, Type 83A1 Factory selected	5701-170076	89536	5701-170076	1	1	A B
							



R221, R219, and V201 constitute a factory selected and matched set. For replacement, order part number 239707.

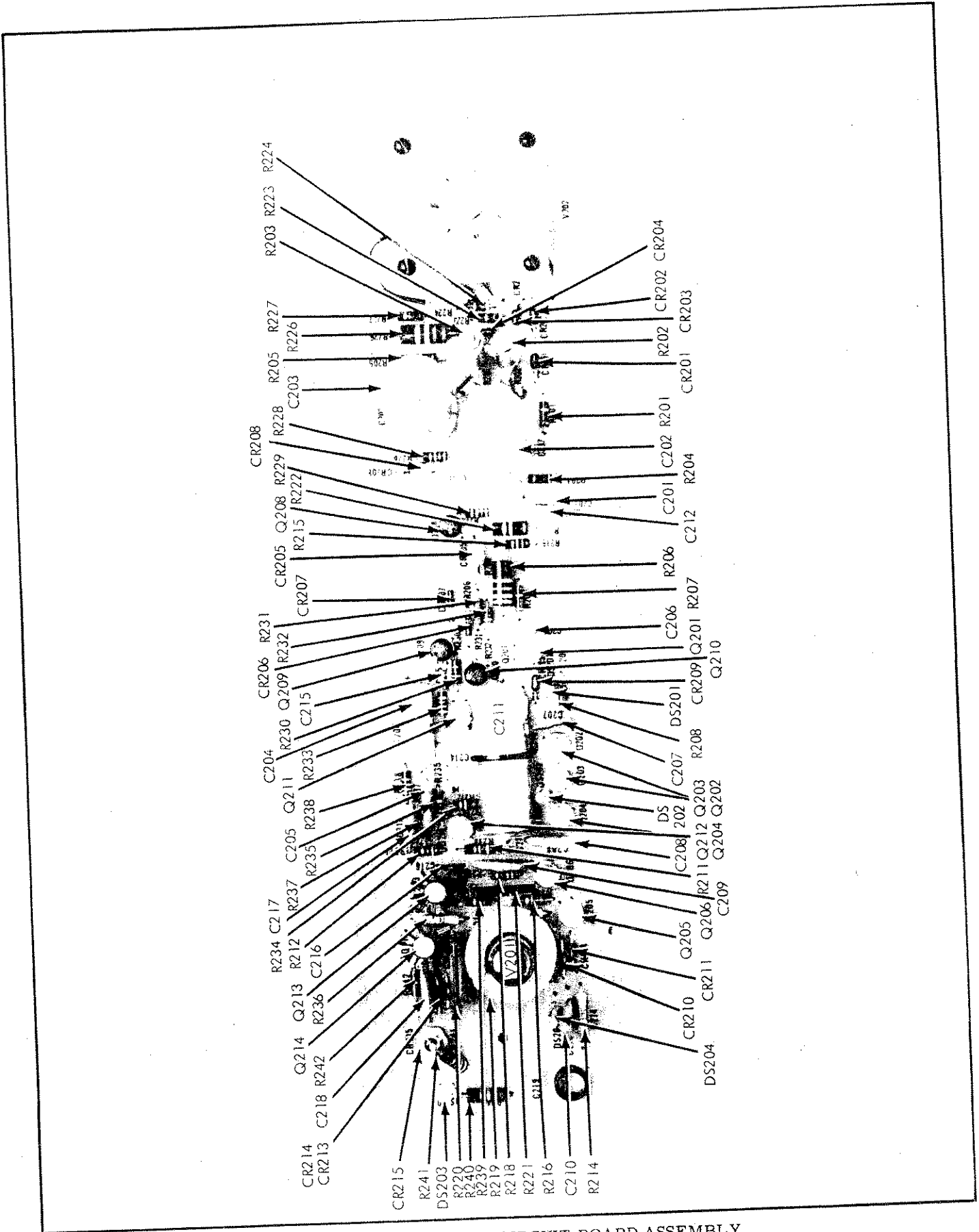

Figure 5-4. AMPLIFIER CIRCUIT BOARD ASSEMBLY

REF DESIG.	DESCRIPTION	FLUKE STOCK NO.	MFR.	MFR. PART NO.	TOT. QTY.	REC. QTY.	USE CODE
	Time Delay PCB Assembly	1702-175695 (410B-403)	89536	1702-175695	REF		
CR301 thru CR304	Diode, silicon, 600 PIV, 1A	4802-112383	05277	IN4822	REF		
K302	Relay, armature, DPDT, 230 VAC, 5A	4504-148940	73949	A410-060713-00	1		
K303	Reed switch	4501-169698	89536	4501-169698	1		
R301	Res, WW, 1K ±5%, 10W	4706-157933	06136	10F-1000	1		

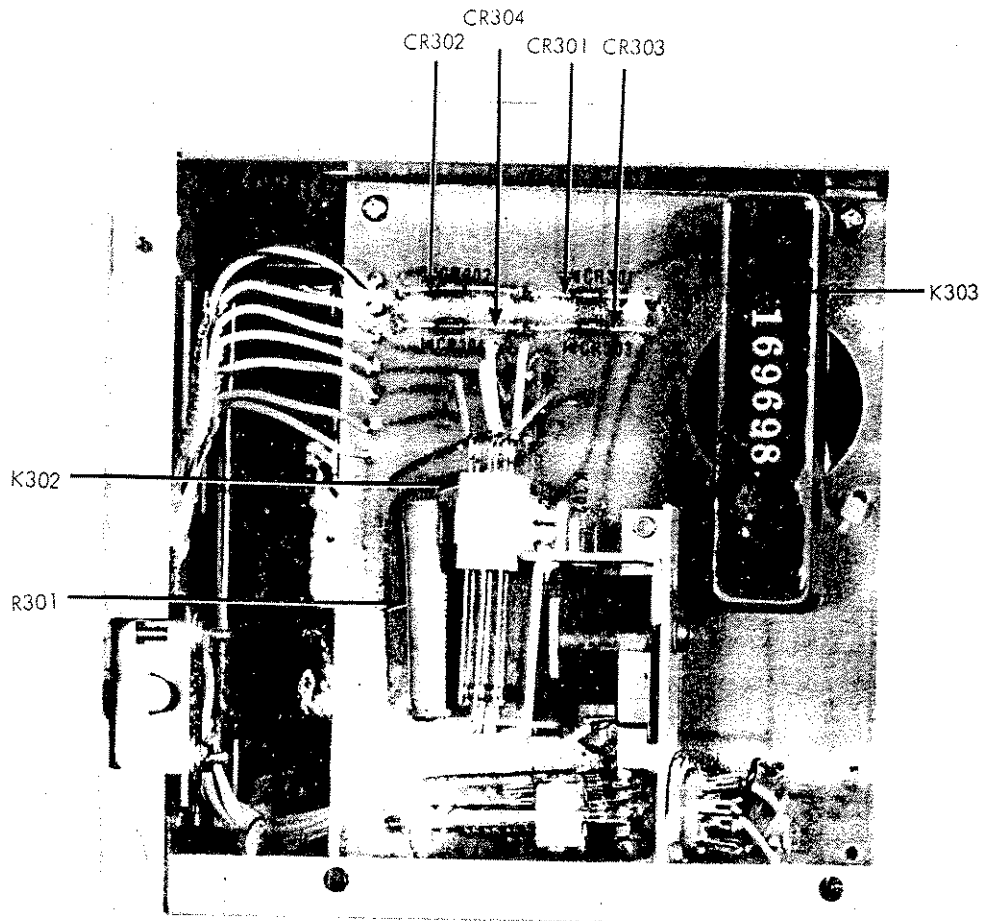

Figure 5-5. TIME DELAY CIRCUIT BOARD ASSEMBLY

5-11. USE CODE EFFECTIVITY

The following list of use codes is intended to allow the customer to determine the effectivity of all replaceable parts. All parts with no code are used on all instruments with serial numbers above 123. New codes will be added as necessary on forthcoming instruments.

USE CODE	EFFECTIVITY
No Code	Model 410B serial number 123 and on.
A	Model 410B serial number 123 thru 812.
B	Model 410B serial number 813 and on.
C	Model 410B serial number 123 thru 1072.
D	Model 410B serial number 1073 and on.
E	Model 410B serial number 123 thru approximately 1331.
F	Model 410B serial number approximately 1332 and on.

Section 7

General Information

7-1. This section of the manual contains generalized user information as well as supplemental information to the List of Replaceable Parts contained in Section 5.

List of Abbreviations and Symbols

A or amp	ampere	hf	high frequency	(+) or pos	positive
ac	alternating current	Hz	hertz	pot	potentiometer
af	audio frequency	IC	integrated circuit	p-p	peak-to-peak
a/d	analog-to-digital	if	intermediate frequency	ppm	parts per million
assy	assembly	in	inch(es)	PROM	programmable read-only memory
AWG	american wire gauge	intl	internal	psi	pound-force per square inch
B	bel	I/O	input/output	RAM	random-access memory
bcd	binary coded decimal	k	kilo (10 ³)	rf	radio frequency
°C	Celsius	kHz	kilohertz	rms	root mean square
cap	capacitor	kΩ	kilohm(s)	ROM	read-only memory
ccw	counterclockwise	kV	kilovolt(s)	s or sec	second (time)
cer	ceramic	lf	low frequency	scope	oscilloscope
cermet	ceramic to metal(seal)	LED	light-emitting diode	SH	shield
ckt	circuit	LSB	least significant bit	Si	silicon
cm	centimeter	LSD	least significant digit	serno	serial number
cmrr	common mode rejection ratio	M	mega (10 ⁶)	sr	shift register
comp	composition	m	milli (10 ⁻³)	Ta	tantalum
cont	continue	mA	milliampere(s)	tb	terminal board
crt	cathode-ray tube	max	maximum	tc	temperature coefficient or temperature compensating
cw	clockwise	mf	metal film	tcxo	temperature compensated crystal oscillator
d/a	digital-to-analog	MHz	megahertz	tp	test point
dac	digital-to-analog converter	min	minimum	u or μ	micro (10 ⁻⁶)
dB	decibel	mm	millimeter	uhf	ultra high frequency
dc	direct current	ms	millisecond	us or μs	microsecond(s) (10 ⁻⁶)
dmm	digital multimeter	MSB	most significant bit	uut	unit under test
dvm	digital voltmeter	MSD	most significant digit	V	volt
elect	electrolytic	MTBF	mean time between failures	v	voltage
ext	external	MTTR	mean time to repair	var	variable
F	farad	mV	millivolt(s)	vco	voltage controlled oscillator
°F	Fahrenheit	mv	multivibrator	vhf	very high frequency
FET	Field-effect transistor	MΩ	megohm(s)	vlf	very low frequency
ff	flip-flop	n	nano (10 ⁻⁹)	W	watt(s)
freq	frequency	na	not applicable	ww	wire wound
FSN	federal stock number	NC	normally closed	xfmr	transformer
g	gram	(-) or neg	negative	xstr	transistor
G	giga (10 ⁹)	NO	normally open	xtal	crystal
gd	guard	ns	nanosecond	xtfo	crystal oscillator
Ge	germanium	opnl ampl	operational amplifier	Ω	ohm(s)
GHz	gigahertz	p	pico (10 ⁻¹²)	μ	micro (10 ⁻⁶)
gmV	guaranteed minimum value	para	paragraph		
gnd	ground	pcb	printed circuit board		
H	henry	pF	picofarad		
hd	heavy duty	pn	part number		

Federal Supply Codes for Manufacturers

D9816 Westermann Wilhelm Augusta-Anlage Mannheim-Nackarau Germany	02533 Leigh Instruments Ltd. Frequency Control Div. Don Mills, Ontario, Canada	04713 Motorola Inc. Semiconductor Group Phoenix, Arizona	06665 Precision Monolithics Sub of Bourns Inc. Santa Clara, California
00199 Marcon Electronics Corp Keamy, New Jersey	02606 Fenwal Labs Division of Travenal Labs Morton Grove, Illinois	05236 Jonathan Mfg. Co. Fullerton, California	06666 General Devices Co. Inc. Indianapolis, Indiana
00213 Nytronics Comp. Group Inc. Darrington, South Carolina	0266 Bunker Ramo-Eltra Corp. Amphenol NA Div. Broadview, Illinois	05245 Corcom Inc. Libertyville, Illinois	06739 Electron Corp. Littleton, Colorado
00327 Weiwyn International Inc. Westlake, Ohio	02735 RCA-Solid State Div. Somerville, New Jersey	05276 ITT Pomona Electronics Div. Pomona, California	06743 Gould Inc. Foil Div. Eastlake, Ohio
00656 Aerovox Corp. New Bedford, Massachusetts	02799 Arco Electronics Inc. Chatsworth, California	05277 Westinghouse Elec. Corp. Semiconductor Div. Youngwood, Pennsylvania	06751 Components Inc. Sensor Div. Phoenix, Arizona
00686 Film Capacitors Inc. Passaic, New Jersey	03508 General Electric Co. Semiconductor Products & Batteries Auburn, New York	05397 Union Carbide Corp. Materials Systems Div. Cleveland, Ohio	06776 Robinson Nugent Inc. New Albany, Indiana
00779 AMP, Inc. Harrisburg, Pennsylvania	03797 Genisco Technology Corp. Eltronics Div. Rancho Dominguez, Calif.	05571 Sprague Electric Co. (Now 56289)	06915 Richco Plastic Co. Chicago, Illinois
01121 Allen Bradley Co. Milwaukee, Wisconsin	03877 Gilbert Engineering Co. Inc Incon Sub of Transitron Electronic Corp. Glendale, Arizona	05574 Viking Connectors Inc Sub of Criton Corp. Chatsworth, Calif.	06961 Vernitron Corp. Piezo Electric Div. Bedford, Ohio
01281 TRW Electronics & Defense Sector Lawndale, California	03888 KDI Electronics Inc. Pyrofilm Div. Whippany, New Jersey	05820 EG & G Wakefield Engineering Wakefield, Massachusetts	06980 Varian Associates Inc. Eimac Div. San Carlos, California
01295 Texas Instruments Inc. Semiconductor Group Dallas, Texas	03911 Clairex Corp. Clairex Electronics Div. Mount Vernon, New York	05972 Loctite Corp. Newington, Connecticut	07047 Ross Milton Co., The Southampton, Penna.
01537 Motorola Communications & Electronics Inc. Franklin Park, Illinois	03980 Muirhead Inc. Mountainside, New Jersey	06001 General Electric Co. Electric Capacitor Product Section Columbia, S. Carolina	07138 Westinghouse Electric Corp. Industrial & Government Tube Div. Homeheads, New York
01686 RCL Electronics/Shalleross Inc. Electro Components Div. Manchester, New Hampshire	04009 Cooper Industries, Inc. Arrow Hart Div. Hartford, Connecticut	06141 Fairchild Weston Systems Inc. Data Systems Div. Sarasota, Florida	07233 Benchmark Technology Inc. City of Industry, Calif.
01884 Sprague Electric Co. (Now 56289)	04217 Essex International Inc. Wire & Cable Div. Anaheim, California	06192 La Deau Mfg. Co. Glendale, California	07239 Biddle Instruments Blue Bell, Penna.
01961 Varian Associates Inc. Pulse Engineering Div. Convoy, Connecticut	04221 Midland-Ross Corp. Midtex Div. N. Mankato, Minnesota	06229 Electrovert Inc. Elmsford, New York	07256 Silicon Transistor Corp. Sub of BBF Inc. Chelmsford, Massachusetts
02111 Spectrol Electronics Corp. City of Industry, California	04222 AVX Corp. AVX Ceramics Div. Myrtle Beach, S. Carolina	06383 Panduit Corp. Tinley Park, Illinois	07261 Avnet Corp. Culver City, California
02114 Amperex Electronic Corp. Ferrox Cube Div. Saugerties, New York	04423 Telonic Berkley Inc. Laguna Beach, California	06473 Bunker Ramo Corp. Amphenol NA Div. SAMS Operation Chatsworth, California	07263 Fairchild Camera & Instrument Semiconductor Div. Mountain View, California
02131 General Instrument Corp. Government Systems Div. Westwood, Massachusetts		06555 Beede Electrical Instrument Penacook, New Hampshire	07344 Bircher Co. Inc., The Rochester, New York
02395 Sonar Radio Corp. Hollywood, Florida			

Federal Supply Codes for Manufacturers (cont)

<p>07557 Campion Co. Inc. Philadelphia, Penna.</p>	<p>09423 Scientific Components Inc. Santa Barbara, California</p>	<p>11711 General Instrument Corp. Rectifier Div. Hicksville, New York</p>	<p>12954 Microsemi Corp. Components Group Scottsdale, Arizona</p>
<p>07597 Burndy Corp. Tape/Cable Div. Rochester, New York</p>	<p>09579 CTS of Canada, Ltd Streetsville, Ontario</p>	<p>11726 Qualidyne Corp. Santa Clara, California</p>	<p>12969 Unitrode Corp. Lexington, Massachusetts</p>
<p>07716 TRW Inc. (Can use 11502) IRC Fixed Resistors/ Burlington Burlington, Iowa</p>	<p>09922 Burndy Corp. Norwalk, Connecticut</p>	<p>12014 Chicago Rivet & Machine Co. Naperville, Illinois</p>	<p>13050 Potter Co. Wesson, Mississippi</p>
<p>07792 Lerma Engineering Corp. Northampton, Massachusetts</p>	<p>09969 Dale Electronics Inc. Yankton, South Dakota</p>	<p>12040 National Semiconductor Corp. Danbury, Connecticut</p>	<p>13103 Thermalloy Co., Inc. Dallas, Texas</p>
<p>07810 Bock Corp. Madison, Wisconsin</p>	<p>09975 Burroughs Corp. Electronics Components Detroit, Michigan</p>	<p>12060 Diodes Inc. Northridge, California</p>	<p>13327 Solitron Devices Inc. Tappan, New York</p>
<p>07933 Raytheon Co. Semiconductor Div. Mountain View, Calif.</p>	<p>10059 Barker Engineering Corp. Kenilworth, New Jersey</p>	<p>12136 PIIC Industries Inc. Formerly Philadelphia Handle Co. Camden, New Jersey</p>	<p>13511 Bunker-Ramo Corp. Amphenol Cadre Div. Los Gatos, California</p>
<p>08235 Industro Transistor Corp. Long Island City, New York</p>	<p>10389 Illinois Tool Works Inc. Licon Div. Chicago, Illinois</p>	<p>12300 AMF Canada Ltd. Potter-Brumfield Guelph, Ontario, Canada</p>	<p>13606 Sprague Electric Co. (Use 56289)</p>
<p>08261 Spectra-Strip An Eltra Co. Garden Grove, Calif.</p>	<p>10582 CTS of Asheville Skyland, N. Carolina</p>	<p>12323 Practical Automation Inc. Shelton, Connecticut</p>	<p>13689 SPS Technologies Inc. Hatfield, Pennsylvania</p>
<p>08530 Reliance Mica Corp. Brooklyn, New York</p>	<p>11236 CTS Corp. Berne Div. Berne, Indiana</p>	<p>12327 Freeway Corp. Cleveland, Ohio</p>	<p>13919 Burr-Brown Research Corp. Tucson, Arizona</p>
<p>08718 ITT Cannon Electric Phoenix Div. Phoenix, Arizona</p>	<p>11237 CTS Corp of California Paso Robles Div. Paso Robles, California</p>	<p>12443 Budd Co., The Plastics Products Div. Phoenixville, Pennsylvania</p>	<p>14099 Semtech Corp. Newbury Park, California</p>
<p>08806 General Electric Co. Miniature Lamp Products Cleveland, Ohio</p>	<p>11295 ECM Motor Co. Schaumburg, Illinois</p>	<p>12581 Hitachi Metals International Ltd. Hitachi Magna-Lock Div. Big Rapids, Missouri</p>	<p>14140 McGray-Edison Co. Commercial Development Div. Manchester, New Hampshire</p>
<p>08863 Nylomatic Fallsington, Penna.</p>	<p>11358 Columbia Broadcasting System CBS Electronic Div. Newburyport, Massachusetts</p>	<p>12615 US Terminals Inc. Cincinnati, Ohio</p>	<p>14193 Cal-R-Inc. Santa Monica, California</p>
<p>08988 Skottie Electronics Inc. Archbald, Pennsylvania</p>	<p>11403 Vacuum Can Co. Best Coffee Maker Div. Chicago, Illinois</p>	<p>12617 Hamlin Inc. Lake Mills, Wisconsin</p>	<p>14298 American Components Inc. an Insilco Co. RPC Div. Conshohocken, Pennsylvania</p>
<p>09021 Aircro Inc. Aircro Electronics Bradford, Penna.</p>	<p>11502 TRW Inc. TRW Resistive Products Div. Boone, North Carolina</p>	<p>12697 Clarostat Mfg. Co. Inc. Dover, New Hampshire</p>	<p>14298 ACIC Inc. Sub of Insilco Corp. Research Triangle Park, NC</p>
<p>09023 Cornell-Dublier Electronics Fuquay-Varina, N. Carolina</p>	<p>11503 Keystone Columbia Inc. Freemont, Indiana</p>	<p>12749 James Electronic Inc. Chicago, Illinois</p>	<p>14329 Wells Electronics Inc. South Bend, Indiana</p>
<p>09214 General Electric Co. Semiconductor Products Dept. Auburn, New York</p>	<p>11532 Teledyne Relays Teledyne Industries Inc. Hawthorne, California</p>	<p>12856 MicroMetals Inc. Anaheim, California</p>	<p>14482 Watkins-Johnson Co. Palo Alto, California</p>
<p>09353 C and K Components Inc. Newton, Massachusetts</p>		<p>12881 Metex Corp. Edison, New Jersey</p>	<p>14552 Microsemi Corp. Santa Ana, California</p>
		<p>12895 Cleveland Electric Motor Co. Cleveland, Ohio</p>	<p>14655 Cornell-Dublier Electronics Div. of Federal Pacific Electric Co. Govt Cont Dept. Newark, New Jersey</p>

Federal Supply Codes for Manufacturers (cont)

14704 Crydom Controls (Division of Int Rectifier) El Segundo, California	16733 Cablewave Systems Inc. North Haven, Connecticut	18927 GTE Products Corp. Precision Material Products Business Parts Div. Titusville, Pennsylvania	23936 William J. Purdy Co. Pamotor Div. Burlingame, California
14752 Electro Cube Inc. San Gabriel, California	16742 Paramount Plastics Fabricators Inc. Downey, California	19315 Bendix Corp., The Navigation & Control Group Terboro, New Jersey	24347 Penn Engineering Co. S. El Monte, California
14936 General Instrument Corp. Discrete Semi Conductor Div. Hicksville, New York	16758 General Motors Corp. Delco Electronics Div. Kokomo, Indiana	19451 Perine Machinery & Supply Co.. Kent, Washington	24355 Analog Devices Inc. Norwood, Massachusetts
14949 Trompeter Electronics Chatsworth, California	17069 Circuit Structures Lab Burbank, California	19613 Minnesota Mining & Mfg. Co. Textool Products Dept. Electronic Product Div. Irving, Texas	24444 General Semiconductor Industries, Inc. Tempe, Arizona
15412 Amtron Midlothian, Illinois	17117 Electronic Molding Corp. Woonsocket, Rhode Island	19647 Caddock Electronics Inc. Riverside, California	24655 Genrad Inc. Concord, Massachusetts
15542 Scientific Components Corp. Mini-Circuits Laboratory Div. Brooklyn, New York	17338 High Pressure Eng. Co. Inc. Oklahoma City, Oklahoma	19701 Mepco/Centralab Inc. A N. American Philips Co. Mineral Wells, Texas	24759 Lenox-Fugle Electronics Inc. South Plainfield, New Jersey
15636 Elec-Trol Inc. Saugus, California	17545 Atlantic Semiconductors Inc. Asbury Park, New Jersey	20584 Enochs Mfg. Inc. Indianapolis, Indiana	24796 AMF Inc. Potter & Brumfield Div. San Juan Capistrano, Calif.
15782 Bausch & Lomb Inc. Graphics & Control Div. Austin, Texas	17745 Angstrom Precision, Inc. Hagerstown, Maryland	20891 Cosar Corp. Dallas, Texas	24931 Specialty Connector Co. Greenwood, Indiana
15801 Fenwal Electronics Inc. Div. of Kidde Inc. Framingham, Massachusetts	17856 Siliconix Inc. Santa Clara, California	21317 Electronics Applications Co. El Monte, California	25088 Siemen Corp. Islen, New Jersey
15818 Teledyne Inc. Co. Teledyne Semiconductor Div. Mountain View, California	18178 E G & Gvactee Inc. St. Louis, Missouri	21604 Buckeye Stamping Co. Columbus, Ohio	25099 Cascade Gasket Kent, Washington
15849 Useco Inc. (Now 88245)	18324 Signetics Corp. Sacramento, California	21845 Solitron Devices Inc. Semiconductor Group Rivera Beach, Florida	25403 Amperex Electronic Corp. Semiconductor & Micro-Circuit Div. Slatersville, Rhode Island
15898 International Business Machines Corp. Essex Junction, Vermont	18520 Sharp Electronics Corp. Paramus, New Jersey	22526 DuPont, El DeNemours & Co. Inc. DuPont Connector Systems Advanced Products Div. New Cumberland, Pennsylvania	25706 Daburn Electronic & Cable Corp. Norwood, New Jersey
16245 Conap Inc. Olean, New York	18542 Wabash Inc. Wabash Relay & Electronics Div. Wabash, Indiana	22767 ITT Semiconductors Palo Alto, California	26629 Frequency Sources Inc. Sources Div. Chelmsford, Massachusetts
16258 Space-Lok Inc. Burbank, California	18565 Chomerics Inc. Woburn, Massachusetts	22784 Palmer Inc. Cleveland, Ohio	26806 American Zettler Inc. Irvine, California
16352 Codi Corp. Linden, New Jersey	18612 Vishay Intertechnology Inc. Vishay Resistor Products Group Malvern, Pennsylvania	23050 Product Comp. Corp. Mount Vernon, New York	27014 National Semiconductor Corp. Santa Clara, California
16469 MCL Inc. LaGrange, Illinois	18632 Norton-Chemplast Santa Monica, California	23732 Tracor Applied Sciences Inc. Rockville, Maryland	27167 Coming Glass Works Coming Electronics Wilmington, North Carolina
16473 Cambridge Scientific Industries Div. of Chemed Corp. Cambridge, Maryland	18677 Scanbe Mfg. Co. Div. of Zero Corp. El Monte, California	23880 Stanford Applied Engineering Santa Clara, California	27264 Molex Inc. Lisle, Illinois
	18736 Voltronics Corp. East Hanover, New Jersey		27440 Industrial Screw Products Los Angeles, California

Federal Supply Codes for Manufacturers (cont)

27745 Associated Spring Barnes Group Inc. Syracuse, New York	30800 General Instrument Corp. Capacitor Div. Hicksville, New York	33297 NEC Electronics USA Inc. Electronic Arrays Inc. Div. Mountain View, California	49956 Raytheon Company Executive Offices Lexington, Massachusetts
27956 Relcom (Now 14482)	31019 Solid State Scientific Inc. Willow Grove, Pennsylvania	33919 Nortek Inc. Cranston, Rhode Island	50088 Thomson Components-Mostek Corp. Carrollton, Texas
28198 Positronic Industries Springfield, Missouri	31091 Alpha Industries Inc. Microelectronics Div. Hatfield, Pennsylvania	34333 Silicon General Inc. Garden Grove, California	50120 Eagle-Picher Industries Inc. Electronics Div. Colorado Springs, Colorado
28213 Minnesota Mining & Mfg. Co. Consumer Products Div. 3M Center Saint Paul, Minnesota	31323 Metro Supply Company Sacramento, California	34225 Advanced Micro Devices Sunnyvale, California	50157 Midwest Components Inc. Muskegon, Mississippi
28425 Serv-O-Link Eules, Texas	31448 Army Safeguard Logistics Command Huntsville, Alabama	34359 Minnesota Mining & Mfg. Co. Commercial Office Supply Div. Saint Paul, Minnesota	50541 Hypertronics Corp. Hudson, Massachusetts
28478 Deltrol Corporation Deltrol Controls Div. Milwaukee, Wisconsin	31746 Cannon Electric Woodbury, Tennessee	34371 Harris Corp. Harris Semiconductor Products Group Melbourne, Florida	50579 Litronix Inc. Cupertino, California
28480 Hewlett Packard Co. Corporate HQ Palo Alto, California	31827 Budwig Ramona, California	34649 Intel Corp. Santa Clara, California	51167 Aries Electronics Inc. Frenchtown, New Jersey
28484 Emerson Electric Co. Gearmaster Div. McHenry, Illinois	31918 ITT-Schadow Eden Prairie, Minnesota	34802 Electromotive Inc. Kenilworth, New Jersey	51372 Verbatim Corp. Sunnyvale, California
28520 Heyco Molded Products Kenilworth, New Jersey	32293 Intersil Cupertino, California	34848 Hartwell Special Products Placentia, California	51406 Murata Erie, No. America Inc. (Also see 72982) Marietta, Georgia
29083 Monsanto Co. Santa Clara, California	32539 Mura Corp. Westbury, Long Island, N.Y.	35009 Renfrew Electric Co. Ltd. IRC Div. Toronto, Ontario, Canada	51499 Amtron Corp. Boston, Massachusetts
29604 Stackpole Components Co. Raleigh, North Carolina	32559 Bivar Santa Ana, California	36665 Mitel Corp. Kanata, Ontario, Canada	51605 CODI Semiconductor Inc. Kenilworth, New Jersey
29907 Omega Engineering Inc. Stamford, Connecticut	32767 Griffith Plastics Corp. Burlingame, California	37942 Mallory Capacitor Corp. Sub of Emhart Industries Indianapolis, Indiana	51642 Centre Engineering Inc. State College, Pennsylvania
30035 Jolo Industries Inc. Garden Grove, California	32879 Advanced Mechanical Components Northridge, California	39003 Maxim Industries Middleboro, Massachusetts	51791 Statek Corp. Orange, California
30146 Symbex Corp. Painesville, Ohio	32897 Murata Erie North America Inc. Cardisle Operations Cardisle, Pennsylvania	40402 Roderstein Electronics Inc. Statesville, North Carolina	51984 NEC America Inc. Falls Church, Virginia
30148 AB Enterprise Inc. Ahoskie, North Carolina	32997 Bourns Inc. Trimpot Div. Riverside, California	42498 National Radio Melrose, Massachusetts	52063 Exar Integrated Systems Sunnyvale, California
30161 Aavid Engineering Inc. Laconia, New Hampshire	33096 Colorado Crystal Corp. Loveland, Colorado	43543 Nytronics Inc.(Now 53342)	52072 Circuit Assembly Corp. Irvine, California
30315 Itron Corp. San Diego, California	33173 General Electric Co. Owensboro, Kentucky	44655 Ohmite Mfg. Co. Skokie, Illinois	52152 Minnesota Mining & Mfg. Saint Paul, Minnesota
30323 Illinois Tool Works Inc. Chicago, Illinois	33246 Epoxy Technology Inc. Billerica, Massachusetts	49671 RCA Corp. New York, New York	52333 API Electronics Haugpaug, Long Island, New York

Federal Supply Codes for Manufacturers (cont)

52361 Communication Systems Piscataway, New Jersey	54590 RCA Corp. Electronic Components Div. Cherry Hill, New Jersey	58104 Simco Atlanta, Georgia	64155 Linear Technology Milpitas, California
52525 Space-Lok Inc. Lerco Div. Burbank, California	55026 American Gage & Machine Co. Simpson Electric Co. Div. Elgin, Illinois	58474 Superior Electric Co. Bristol, Connecticut	64834 West M G Co. San Francisco, Calif.
52531 Hitachi Magnetics Edmore, Missouri	55112 Plessey Capacitors Inc. (Now 60935)	59124 KOA-Speer Electronics Inc. Bradford, Pennsylvania	65092 Sangamo Weston Inc. Weston Instruments Div. Newark, New Jersey
52745 Timco Los Angeles, California	55261 LSI Computer Systems Inc. Melville, New York	59640 Supertex Inc. Sunnyvale, California	65940 Rohm Corp & Whatney Irvine, California
52763 Stettner-Electronics Inc. Chattanooga, Tennessee	55285 Beroquist Co. Minneapolis, Minnesota	59660 Tusonix Inc. Tucson, Arizona	65964 Evovx Inc. Bannockburn, Illinois
52769 Sprague-Goodman Electronics Inc. Garden City Park, New York	55576 Synertek Santa Clara, California	59730 Thomas and Betts Corp. Iowa City, Iowa	66150 Entron Inc. Winslow Teltronics Div. Glendale, New York
52771 Monitern Corp. Amatrom Div. Santa Clara, California	55680 Michicon/America/Corp. Schaumburg, Illinois	59831 Semtronics Corp. Watchung, New Jersey	66608 Bering Industries Fremont, California
52840 Western Digital Corp. Costa Mesa, California	56282 Utek Systems Inc. Olathe, Kansas	60395 Xicor Inc. Milpitas, California	70290 Almetal Universal Joint Co. Cleveland, Ohio
53021 Sangamo Weston Inc. (See 06141)	56289 Sprague Electric Co. North Adams, Massachusetts	60399 Torin Engineered Blowers Div. of Clevepak Corp. Torrington, Connecticut	70485 Atlantic India Rubber Works Inc. Chicago, Illinois
53217 Technical Wire Products Inc. Santa Barbara, California	56365 Square D Co. Corporate Offices Palatine, Illinois	60705 Cera-Mite Corp. (formerly Sprague) Grafton, Wisconsin	70563 Amperite Company Union City, New Jersey
53342 Opt Industries Inc. Phillipsburg, New Jersey	56375 DAL Industries Inc. Wescorp Div. Mountain View, California	60935 Westlake Capacitor Inc. Tantalum Div. Greencastle, Indiana	70903 Belden Corp. Geneva, Illinois
53944 Glow-Lite Pauls Valley, Oklahoma	56481 Shugart Associates Sub of Xerox Corp. Sunnyvale, California	61804 M/A Com Inc. Burlington, Massachusetts	71002 Bimbach Co. Inc. Farmingdale, New York
54294 Shallcross Inc. Smithfield, North Carolina	56708 Zilog Inc. Campbell, California	61857 SAN-O Industrial Corp. Bohemia, Long Island, NY	71034 Bliley Electric Co. Erie, Pennsylvania
54453 Sullins Electronic Corp. San Marcos, California	56856 Vamistor Corp. of Tennessee Sevierville, Tennessee	61935 Schurter Inc. Petaluma, California	71183 Westinghouse Electric Corp. Bryant Div. Bridgeport, Connecticut
54473 Matsushita Electric Corp. (Panasonic) Secaucus, New Jersey	56880 Magnetics Inc. Baltimore, Maryland	62351 Apple Rubber Lancaster, New York	71400 Busaman Manufacturing Div. McGraw-Edison Co. St. Louis, Missouri
54583 TDK Garden City, New York	57026 Endicott Coil Co. Inc. Binghamton, New York	62793 Lear Siegler Inc. Energy Products Div. Santa Ana, California	71450 CTS Corp. Elkhart, Indiana
54869 Piherr International Corp. Arlington Heights, Illinois	57053 Gates Energy Products Denver, Ohio	63743 Ward Leonard Electric Co. Inc. Mount Vernon, New York	71468 ITT Cannon Div. of ITT Fountain Valley, California
54937 DeYoung Mfg. Bellevue, Washington	58014 Hitachi Magnalock Corp. (Now 12581)	64154 Lamb Industries Portland, Oregon	71482 General Instrument Corp. Clare Div. Chicago, Illinois

Federal Supply Codes for Manufacturers (cont)

71590 Mepco/Centralab A North American Philips Co. Fort Dodge, Iowa	73445 Amperex Electronic Corp. Hicksville, New York	75378 CTS Knights Inc. Sandwich, Illinois	79727 C - W Industries Southampton, Pennsylvania
71707 Coto Corp. Providence, Rhode Island	73559 Carlingswitch Inc. Hartford, Connecticut	75382 Kulka Electric Corp. (Now 83330) Mount Vernon, New York	79963 Zierick Mfg. Corp. Mount Kisco, New York
71744 General Instrument Corp. Lamp Div/Worldwide Chicago, Illinois	73586 Circle F Industries Trenton, New Jersey	75915 Tracor Littlefuse Des Plaines, Illinois	80009 Tektronix Beaverton, Oregon
71785 TRW Inc. Cinch Connector Div. Elk Grove Village, Illinois	73734 Federal Screw Products Inc. Chicago, Illinois	76854 Oak Switch Systems Inc. Crystal Lake, Illinois	80031 Mepco/Electra Inc. Morristown, New Jersey
71984 Dow Corning Corp. Midland, Michigan	73743 Fischer Special Mfg. Co. Cold Spring, Kentucky	77122 TRW Assemblies & Fasteners Group Fastener Div. Moutainside, New Jersey	80032 Ford Aerospace & Communications Corp. Western Development Laboratories Div. Palo Alto, California
72005 AMAX Specialty Metals Corp. Newark, New Jersey	73893 Microdot Mt. Clemens, Mississippi	77342 AMF Inc. Potter & Brumfield Div. Princeton, Indiana	80145 LFE Corp. Process Control Div. Clinton, Ohio
72136 Electro Motive Mfg. Corp. Florence, South Carolina	73899 JFD Electronic Components Div. of Murata Erie Oceanside, New York	77542 Ray-O-Vac Corp Madison, Wisconsin	80183 Sprague Products (Now 56289)
72228 AMCA International Corp. Continental Screw Div. New Bedford, Massachusetts	73905 FL Industries Inc. San Jose, California	77638 General Instrument Corp. Rectifier Div. Brooklyn, New York	80294 Boums Instruments Inc. Riverside, California
72259 Nytronics Inc. New York, New York	73949 Guardian Electric Mfg. Co. Chicago, Illinois	77900 Shakeproof Lock Washer Co. (Now 78189)	80583 Hammerlund Mfg. Co. Inc. Paramus, New Jersey
72619 Amperex Electronic Corp. Dialight Div. Brooklyn, New York	74199 Quam Nichols Co. Chicago, Illinois	77969 Rubbercraft Corp. of CA Ltd. Torrance, California	80640 Computer Products Inc. Stevens-Arnold Div. South Boston, Mass.
72653 G C Electronics Co. Div. of Hydrometals Inc. Rockford, Illinois	74217 Radio Switch Co. Marlboro, New Jersey	78189 Illinois Tool Works Inc. Shakeproof Div. Elgin, Illinois	81073 Grayhill Inc. La Grange, Illinois
72794 Dzus Fastner Co. Inc. West Islip, New York	74306 Piezo Crystal Co. Div. of PPA Industries Inc. Carlisle, Pennsylvania	78277 Sigma Instruments Inc. South Braintree, Mass.	81312 Litton Systems Inc. Winchester Electronics Div. Watertown, Connecticut
72928 Gulton Industries Inc. Gudeman Div. Chicago, Illinois	74542 Hoyt Elect.Instr. Works Inc. Penacook, New Hampshire	78290 Struthers Dunn Inc. Pitman, New Jersey	81439 Therm-O-Disc Inc. Mansfield, Ohio
72982 Murata Erie N. America Inc. Erie, Pennsylvania	74840 Illinois Capacitor Inc. Lincolnwood, Illinois	78553 Eaton Corp. Engineered Fastener Div. Cleveland, Ohio	81483 International Rectifier Corp. Los Angeles, California
73138 Beckman Industrial corp. Helipot Div. Fullerton, California	74970 Johnson EF Co. Waseca, Minnesota	78592 Stoeger Industries South Hackensack, New Jersey	81590 Korry Electronics Inc. Seattle, Washington
73168 Fenwal Inc. Ashland, Massachusetts	75042 TRW Inc. IRC Fixed Resistors Philadelphia, Pennsylvania	79136 Waldes Kohinoor Inc. Long Island City, New York	81741 Chicago Lock Co. Chicago, Illinois
73293 Hughes Aircraft Co. Electron Dynamics Div. Torrance, California	75297 Litton Systems Kester Solder Div. Chicago, Illinois	79497 Western Rubber Co. Goshen, Indiana	82227 Airpax Corp. Cheshire Div. Cheshire, Connecticut
	75376 Kurz-Kasch Inc. Dayton, Ohio		82240 Simmons Fastner Corp. Albany, New York

Federal Supply Codes for Manufacturers (cont)

82305 Palmer Electronics Corp. South Gate, California	84171 Arco Electronics Commack, New York	89536 John Fluke Mfg. Co., Inc. Everett, Washington	91802 Industrial Devices Inc. Edgewater, New Jersey
82389 Switchcraft Inc. Sub of Raytheon Co. Chicago, Illinois	84411 American Shizuki TRW Capacitors Div. Ogallala, Nebraska	89597 Fredericks Co. Huntingdon Valley, Penna.	91833 Keystone Electronics Corp. New York, New York
82415 Aipax Corp. Frederick Div. Frederick, Maryland	84613 FIC Corp. Rockville, Maryland	89709 Bunker Ramo-Eltra Corp. Amphenol Div. Broadview, Illinois	91836 King's Electronics Co. Inc. Tuckahoe, New York
82872 Roanwell Corp. New York, New York	84682 Essex Group Inc. Peabody, Massachusetts	89730 General Electric Lamp Div. Newark, New Jersey	91929 Honeywell Inc. Micro Switch Div. Freeport, Illinois
82877 Rotron Inc. Custom Div. Woodstock, New York	85367 Bearing Distributing Co. San Francisco, California	90201 Mallory Capacitor Co. Sub of Emhart Industries Inc. Indianapolis, Indiana	91934 Miller Electric Co. Woonsocket, Rhode Island
82879 ITT Royal Electric Div. Pawtucket, Rhode Island	85372 Bearing Sales Co. Los Angeles, California	90215 Best Stamp & Mfg. Co. Kansas City, Missouri	91984 Maida Development Co. Hampton, Virginia
83003 Varo Inc. Garland, Texas	85480 W. H. Brady Co. Industrial Product Milwaukee, Wisconsin	90303 Duracell Inc. Technical Sales & Marketing Bethel, Connecticut	91985 Norwalk Valve Co. S. Norwalk, Connecticut
83014 Hartwell Corp. Placentia, California	85932 Electro Film Inc. Valencia, California	91094 Essex Group Inc. Sufflex/IWP Div. Newmarket, New Hampshire	92914 Alpha Wire Corp. Elizabeth, New Jersey
83055 Signalite Fuse Co. (Now 71744)	86577 Precision Metal Products Co. Peabody, Massachusetts	91247 Illinois Transformer Co. Chicago, Illinois	93332 Sylvania Electric Products Semiconductor Products Div. Woburn, Massachusetts
83058 TRW Assemblies & Fasteners Group Fasteners Div. Cambridge, Massachusetts	86684 Radio Corp. of America (Now 54590)	91293 Johanson Mfg. Co. Boonton, New Jersey	94144 Raytheon Co. Microwave & Power Tube Div. Quincy, Massachusetts
83259 Parker-Hannifin Corp. O-Seal Div. Culver City, California	86928 Seastrom Mfg. Co. Inc. Glendale, California	91462 Alpha Industries Inc. Logansport, Indiana	94222 Southco Inc. Concordville, Pennsylvania
83298 Bendix Corp. Electric & Fluid Power Div. Eatonville, New Jersey	87034 Illuminated Products Inc. (Now 76854)	91502 Associated Machine Santa Clara, California	94988 Wagner Electric Corp. Sub of McGraw-Edison Co. Whippany, New Jersey
83315 Hubbell Corp. Mundelein, Illinois	88219 GNB Inc. Industrial Battery Div. Langhorne, Pennsylvania	91506 Augat Inc. Attleboro, Massachusetts	95146 Alco Electronic Products Inc. Switch Div. North Andover, Massachusetts
83330 Kulka Smith Inc. A North American Philips Co. Manasquan, New Jersey	88245 Winchester Electronics Litton Systems-Useco Div. Van Nuys, California	91507 Froeliger Machine Tool Co. Stockton, California	95263 Leecraft Mfg. Co. Long Island City, New York
83478 Rubbercraft Corp. of America West Haven, Connecticut	88486 Triangle PWC Inc. Jewitt City, Connecticut	91637 Dale Electronics Inc. Columbus, Nebraska	95275 Vitramon Inc. Bridgeport, Connecticut
83553 Associated Spring Bames Group Gardena, California	88690 Essex Group Inc. Wire Assembly Div. Dearborn, Michigan	91662 Elco Corp. A Gulf Western Mfg. Co. Connector Div. Huntingdon, Pennsylvania	95303 RCA Corp. Receiving Tube Div. Cincinnati, Ohio
83740 Union Carbide Corp. Battery Products Div. Danbury, Connecticut	89020 Amerace Corp. Buchanan Crimptool Products Div. Union, New Jersey	91737 ITT Cannon/Greomar (Now 08718)	95348 Gordo's Corp. Bloomfield, New Jersey
	89265 Potter-Brumfield (See 77342)		95354 Methode Mfg. Corp. Rolling Meadows, Illinois

Federal Supply Codes for Manufacturers (cont)

95573
Campion Laboratories Inc.
Detroit, Michigan

95712
Bendix Corp.
Electrical Comp. Div.
Franklin, Indiana

95987
Weckesser Co. Inc.
(Now 85480)

96733
SFE Technologies
San Fernando, California

96853
Gulton Industries Inc.
Measurement & Controls Div.
Manchester, New Hampshire

96881
Thomson Industries Inc.
Port Washington, New York

97525
EECO Inc.
Santa Ana, California

97540
Whitchall Electronics Corp.
Master Mobile Mounts Div.
Fort Meyers, Florida

97913
Industrial Electronic
Hardware Corp.
New York, New York

97945
Pennwalt Corp.
SS White Industrial Products
Piscataway, New Jersey

97966
CBS
Electronic Div.
Danvers, Massachusetts

98094
Machlett Laboratories Inc.
Santa Barbara, California

98159
Rubber-Teck Inc.
Gardena, California

98278
Malco A Microdot Co.
South Pasadena, California

98291
Sealectro Corp.
BICC Electronics
Trumbull, Connecticut

98372
Royal Industries Inc.(Now 62793)

98388
Lear Siegler Inc.
Accurate Products Div.
San Deigo, California

99120
Plastic Capacitors Inc.
Chicago, Illinois

99217
Bell Industries Inc.
Elect. Distributor Div.
Sunnyvale, California

99378
ATLIFE of Delaware Inc.
N. Andover, Massachusetts

99392
Mepco/Electra Inc.
Roxboro Div.
Roxboro, North Carolina

99515
Electron Products Inc.
Div. of American Capacitors
Duarte, California

99779
Bunker Ramo- Eltra Corp.
Barnes Div.
Lansdown, Pennsylvania

99800
American Precision Industries
Delevan Div.
East Aurora, New York

99942
Mepco/Centralab
A North American Philips Co.
Milwaukee, Wisconsin

TRANSFORMER CONNECTIONS
 (1) POWER ON
 (2) STANDBY
 (3) OVER CURRENT
 (4) HIGH VOLTAGE
 (5) LOW VOLTAGE

CHANGES
 (1) FOR S/N 811 UNLTD
 R106 REPLACED WITH BUSB WIRE
 R106 CHANGED FROM 40M TO 41M
 R107 DELETED
 R118 R221 & V201 ARE A MATCHED SET
 (2) FOR S/N 1073 AND ON
 R106 CHANGED FROM 2.1K TO 2.7K
 (3) FOR S/N APPROXIMATELY 1513 AND ON
 C207 CHANGED FROM 500PF TO 1.000PF
 C209 DELETED
 CR218 & CR217 ADDED

NOTES
 1. ALL CAPACITANCES IN MICROFARADS
 2. ALL RESISTANCES IN OHMS UNLESS
 OTHERWISE INDICATED WITH
 NUMBER ARE UNLIMITED
 3. INDICATES FACTORY MATCHED OR
 SELECTED COMPONENT

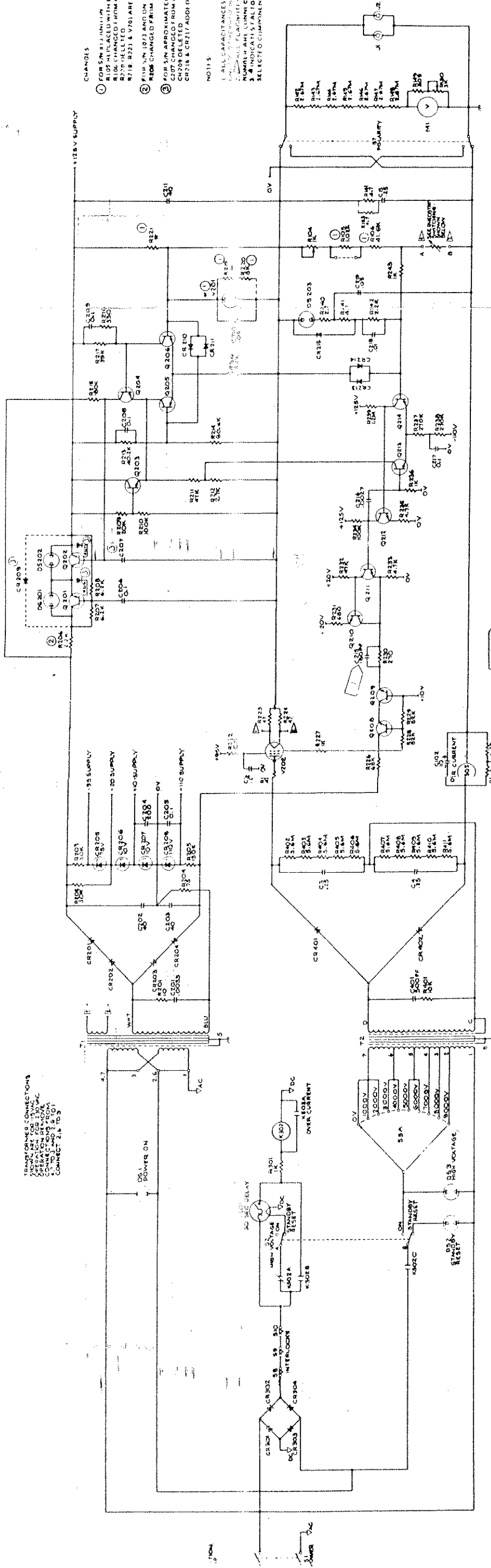

C215 (180PF) IS OPTIONAL (OR FACTORY SELECTED)
 C215 TO BE REMOVED IN FINAL TEST WHEN NECESSARY
 TO REDUCE OUTPUT NOISE LEVEL. (S/N APPROX.
 53400 AND ON)

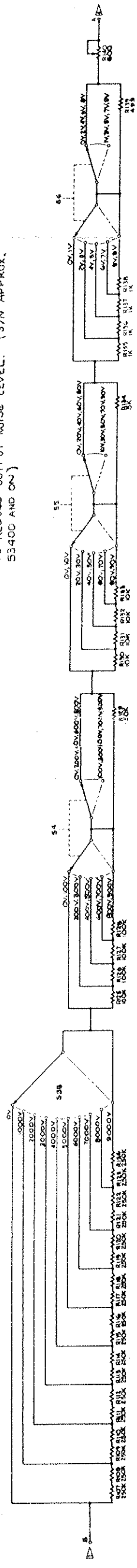

U.S. SALES OFFICE AREAS

AL, Huntsville

John Fluke Mfg. Co., Inc.
4920J Corporate Drive
Huntsville, AL 35805-6202
(205) 837-0581

AZ, Phoenix

John Fluke Mfg. Co., Inc.
2211 S. 48th Street
Suite B
Tempe, AZ 85282
(602) 438-8314

Tucson

(602) 790-9881

CA, Southern

John Fluke Mfg. Co., Inc.
P.O. Box 19676
Irvine, CA 92713-9676
16969 Von Karman
Suite 100
Irvine, CA 92714
(714) 863-9031

Burbank

John Fluke Mfg. Co., Inc.
2020 N. Lincoln Street
Burbank, CA 91504
(213) 849-7181

Northern

John Fluke Mfg. Co., Inc.
2300 Walsh Ave., Bldg. K
Santa Clara, CA 95051
(408) 727-0513

San Diego

(619) 292-7656

CO, Denver

John Fluke Mfg. Co., Inc.
14180 East Evans Ave.
Aurora, CO 80014
(303) 695-1000

CT, Hartford

John Fluke Mfg. Co., Inc.
Glen Locken East
41-C New London Turnpike
Glastonbury, CT 06033
(203) 659-3541

DC, Washington

(301) 770-1570

FL, Clearwater

(813) 799-0087

Miami

(305) 462-1380

Orlando

John Fluke Mfg. Co., Inc.
940 N. Fern Creek Ave.
Orlando, FL 32803
(305) 896-4881

Tampa

(813) 251-9211

GA, Atlanta

John Fluke Mfg. Co., Inc.
2700 Deik Rd., Suite 150
Marietta, GA 30067
(404) 953-4747

IL, Chicago

John Fluke Mfg. Co., Inc.
1150 West Euclid Ave.
Palatine, IL 60067
(312) 705-0500

IN, Indianapolis

John Fluke Mfg. Co., Inc.
8777 Purdue Rd.
Suite 101
Indianapolis, IN 46268
(317) 875-7870

LA, Baton Rouge

(504) 924-1203

New Orleans

(504) 455-0814

MA, Boston

John Fluke Mfg. Co., Inc.
Middlesex Tech Center
900 Middlesex Turnpike
Building 8
Billerica, MA 01821
(617) 663-2400

MD, Baltimore

(301) 792-7060

Rockville

John Fluke Mfg. Co., Inc.
5640 Fishers Lane
Rockville, MD 20852
(301) 770-1570

MI, Detroit

John Fluke Mfg. Co., Inc.
33031 Schoolcraft
Livonia, MI 48150
(313) 522-9140

MN, Bloomington

John Fluke Mfg. Co., Inc.
1801 E. 79th St., Suite 9
Bloomington, MN 55420
(612) 854-5526

MO, St. Louis

John Fluke Mfg. Co., Inc.
11756 Borman Drive
Suite 160
St. Louis, MO 63146
(314) 993-3805

NC, Greensboro

John Fluke Mfg. Co., Inc.
1310 Bearman Place
Greensboro, NC 27408
(919) 273-1918

NJ, Paramus

John Fluke Mfg. Co., Inc.
P.O. Box 930
Paramus, NJ 07653-0930
West 75 Century Road
Paramus, NJ 07652
(201) 262-9550

NM, Albuquerque

(505) 881-3550

NY, Rochester

John Fluke Mfg. Co., Inc.
4515 Culver Road
Rochester, NY 14622
(716) 323-1400

OH, Cleveland

John Fluke Mfg. Co., Inc.
7830 Freeway Circle
Middleburg Heights, OH 44130
(216) 234-4540

Dayton

John Fluke Mfg. Co., Inc.
5450 Far Hills Avenue
Suite 111
Kettering, OH 45429
(513) 436-2224

OK, Northeast

(918) 749-0190

OR, Portland

(503) 227-2042

PA, Philadelphia

John Fluke Mfg. Co., Inc.
200 Lindenwood Drive
Malvern, PA 19355
(215) 647-9550

Pittsburgh

(412) 261-5171

TX, Austin

(512) 459-3344

Dallas

John Fluke Mfg. Co., Inc.
1801 Royal Lane
Suite 307
Dallas, TX 75229
(214) 869-0311

El Paso

(915) 533-3508

Houston

(713) 240-5995

San Antonio

John Fluke Mfg. Co., Inc.
10417 Guilddate
San Antonio, TX 78216
(512) 340-0498

UT, Salt Lake City
(801) 268-9331

WA, Seattle

John Fluke Mfg. Co., Inc.
5020 148th Ave. N.E.
Suite #110
Redmond, WA 98052
(206) 881-6966

U.S. Government Specialists

Army (301) 770-1570, MD
(203) 837-0581, AL

Navy (714) 863-9031, CA
(301) 770-1570, MD

USAF (513) 436-2224, OH
(512) 340-2621, TX

Security (301) 770-1570, MD

Service Center Areas

CA, Burbank (213) 849-4641

CA, Santa Clara (408) 727-0513

CO, Denver (303) 695-1000

FL, Orlando (305) 896-4881

IL, Chicago (312) 705-0500

MD, Rockville (301) 770-1576

NJ, Paramus (201) 262-9550

TX, Dallas (214) 869-2848

WA, Everett (206) 356-5560

For more information on Fluke products or Sales Offices you may dial (800) 426-0361 toll-free in most of the U.S.A.
From Alaska, Hawaii, or Washington phone (206) 356-5400. From Canada and other countries phone (206) 356-5500.



John Fluke Mfg. Co., Inc., P.O. Box C9090, Everett, WA 98206
Fluke (Holland) B.V., P.O. Box 2269, 5600 CG, Eindhoven, The Netherlands. Phone (040) 458045
Litho in U.S.A. 11/87

INTERNATIONAL SALES OFFICES

Argentina •

Coasn S.A.
Virrey del Pino 4071 DPTO E-65
1430 CAP FED
Buenos Aires, Argentina
Tel: 54-1-552-5248
TLX: (390) 22284 COASN AR

Asia

Fluke Asia Ltd
Shun Tak Centre, Room 1501
200 Connaught Road
Central, Hong Kong
Tel: 852 5 482116
TLX: (780) 87058 FLUKE
FAX: (852) 5-479863

Australia •

Elmeasco Instruments Pty. Ltd.
P.O. Box 30
Concord, N.S.W. 2137
Australia
Tel: 61-2-736-2888
TLX: (790) 25887 A/B: ELSCOAA 25887
FAX: 61-2-733663

Elmeasco Instruments Pty. Ltd.
P.O. Box 623
12 Maroondah Highway
Ringwood, Victoria 3134
Australia
Tel: 61-3-879-2322
TLX: (790) 30418 A/B: ELTENTAA 30418
FAX: (61) (3) 879-4310

Elmeasco Instruments Pty. Ltd.
P.O. Box 274
Salisbury, Queensland 4107
Australia
Tel: 61-7-875-1444
TLX: (790) 44062 A/B: ELMQLDAA44062

Elmeasco Instruments Pty. Ltd.
P.O. Box 154
Prospect, South Australia 5082
Tel: 61-8-344-9000 TLX: (790) A/B 87519

Elmeasco Instruments Pty. Ltd.
P.O. Box 413
Scott House
46-48 Kings Park Road
West Perth, Western Australia 6005
Australia
Tel: 61-9-481-1500
TLX: (790) 94765 A/B: ASECSAA 94765
FAX: (61) (9) 322-2075

Austria •

Walter Rekirsch Elektronische
Geräte GmbH & Co.
Vertrieb KG
Obachgasse 28
1220 Vienna, Austria
Tel: 43-222-25-36-26
TLX: (847) 134759
FAX: 43-222-25-72-75

Bahrain •

Basma W.L.L.
P.O. Box 5701
Manama, Bahrain
Tel: 973-251364; TLX: (955) 9003
FAX: (965) 245218

Bangladesh •

Motherland Corporation
24 Hatkhola Road, Tikatuli
Dacca-3, Bangladesh
Tel: 257249
TLX: (950) 642022 PCO BJ
Cable: "MOTHERLAND" DACCA

Belgium •

N.V. Philips
Industrial & Electro-Acoustic Systems
5600 MD Eindhoven
The Netherlands
Tel: 040-785539
Tlx: 35000 phtc nl
Fax: 040-785651

Bolivia •

Coasin Bolivia S.R.L.
Casilla 7295
La Paz, Bolivia
Tel: 591-2-40962
TLX: (336) 3233 COALAP BV
Cable: COALAP

Brazil •

ATP, Hite Tek Eletrônica Ltda
Al. Amazonas 422
Alphaville, 06400, Barueri
São Paulo, Brazil
Tel: 55-11-421-5477
TLX: (391) 1171413 HITK BR

Brunei •

Rank O'Connor's SDN BHD
No. 8 Blok D
Sufri Shophouse Complex
Mile 1 Jalan Tutong
Bandar Seri Begawan
Negara Brunei Darussalam
Tel: 673-2-23109 or 23557
TLX: (799) BU 2265 RANKOC

Canada •

Fluke Electronics Canada Inc.
101, 1144 - 29th Avenue N.E
Calgary, Alberta T2E 7P1
Canada
Tel: (403) 291-5215
Fax: (403) 291-5219

Fluke Electronics Canada Inc.
400 Britannia Road East
Unit #1
Mississauga, Ontario L4Z 1X9
Tel: (416) 890-7600
Fax: (416) 890-6866

Fluke Electronics Canada Inc
1255 Trans Canada Hwy.
Suite 130
Dorval, Quebec
H9P 2V4 Canada
Tel: (514) 685-0022
TLX: (514) 685-0039

Fluke Electronics Canada Inc.
1690 Woodward Drive
Suite 216
Ottawa, Ontario
K2C 3R8 Canada
Tel: (613) 723-9453
Fax: (613) 723-9458

Chile •

Intronica Chile, Ltda.
Casilla 16228 (Mail)
Santiago 9, Chile
Tel: 56-2-2321886
TLX: (332) 346351 INTRON CK

China, Peoples Republic of •
Fluke International Corporation
P.O. Box 9085

Beijing
People's Republic of China
Tel: 86-01-65-7281
TLX: (716) 222237 FBSC CN
Instrimpex - Fluke Service Center
57, Xisi Dong Da Jie
Xicheng-qu
Beijing
Peoples Republic of China
Tel: 86-01-65-7281

Colombia •

Sistemas E Instrumentacion, Ltda.
Carrera 13, No. 37-43, Of. 401
Ap. Aereo 29583
Bogota DE, Colombia
Tel: 57-232-4532
TLX: (396) 45787 COASN CO

Cyprus •

Chris Radiovision, Ltd.
P.O. Box 1989
Nicosia, Cyprus
Tel: 357-21-66121; TLX: (826) 2395

Cyprus, Northern •

Ucok Buroteknik
2C & 2D Muftu Ziyai Street
Lefkosa, Northern Cyprus
Mersin 10, Turkey
Tel: 90-741-357-20-71777
TLX: (821) 57267

Czechoslovakia •

Amtest Associates, Ltd.
Amtest House
75-79 Guildford Street
Chertsey, Surrey KT16 9AS
England
Tel: 44-9328-68355
TLX: (851) 928855 AMTEST G
Fax: 44-9328-61919

Denmark •

Tjgr Olsen A/S
(Løfferup Byvej 222
2750 Ballerup
Drumsk
Tel: 45-2-658111
TLX: (855) 35293 TOAS DK

Eastern European Countries •

Amtest Associates, Ltd.
Amtest House
75-79 Guildford Street
Chertsey, Surrey KT16 9AS
England
Tel: 44-9328-68355
TLX: (851) 928855 AMTEST G
Fax: 44-9328-61919
German Branch Office
Amtest Associates, Ltd
Zugspitzstrasse 2A
P.O. Box 1107
8011 Vaterstetten
West Germany
Tel: 49-81-067117; TLX: (841) 528332

Ecuador •

Proteco Coasin Cia., Ltda.
P.O. Box 228-A
Ave. 12 de Octubre 2285
y Orellana
Quito, Ecuador
Tel: 593-2-529684
TLX: (393) 22085 ESIND

Egypt

Electronic Engineering Liaison Office
P.O. Box 2891 Horreya
11361 Heliopolis, Cairo
Egypt
Tel: 20-2-695705; TLX: (927) 22782

England

N.V. Philips
Industrial & Electro-Acoustic Systems
5600 MD Eindhoven
The Netherlands
Tel: 040-785539
Tlx: 35000 phtc nl
Fax: 040-785651

Fiji •

Awa New Zealand Limited
37 Freeston Road
Walu Bay, P.O. Box 858
Suva, Fiji
Tel: 679-312079; TLX: (792) FJ2347
FAX: 679-314379

Finland •

Instrumentarium Elektronika
P.O. Box 64
02631 Espoo 63
Finland
Tel: 358-0-5281
TLX: (857) 124426 HAVUL SF
FAX: (358) 0-5021073
Teletex: (857) 8-100155 INSTRUE

France •

M.B. Electronique S.A.
606, Rue Fourney
P.O. Box 31
78530 BUC, France
Tel: 33-1-39-56-81-31
TLX: (842) 695414
Fax: (33) (1) 3956-53-44

German Branch Office

Amtest Associates, Ltd.
Zugspitzstrasse 2A
P.O. Box 1107
8011 Vaterstetten
West Germany
Tel: 49-81-067117
TLX: (841) 528332

Germany, West

N.V. Philips
Industrial & Electro-Acoustic Systems
5600 MD Eindhoven
The Netherlands
Tel: 040-785539
Tlx: 35000 phtc nl
Fax: 040-785651

Greece

Hellenic Scientific Representations Ltd.
11, Vrassida Street
Athens 612, Greece
Tel: 30-1-7211140; TLX: (863) 219330

Hong Kong •

Sammet & Co (HK) Ltd
18th Floor, Great Eagle Centre
23 Harbour Road
Wanchai, Hong Kong
Tel: 852-5-8330-222
TLX: (780) 74766 SCHMC HX
FAX: 852-5-8918754

India •

Hinditron Services Pvt. Ltd
69/A.L. Jagmohandas Marg
Bombay 400 006, India
Tel: 91-22-8121316, 8125344
TLX: (953) 1175326 HSPL IN
Bangalore Office
Hinditron Services Pvt. Ltd
8th Main Road
33/44A Raj Mahal Vilas Extension
Bangalore 560 080, India
Tel: 91-812-363139
TLX: (953) 08452741
Cable: TEKHIND BANGALORE

Calcutta Office

Hinditron Services Pvt. Ltd.
5th Floor, Castle House
5/1A, Hungerford St.
Calcutta 700 017, India
Tel: 91-33-432628
TLX: (953) 214153

New Delhi Sales
Hinditron Services Pvt. Ltd
204-206 Hemkunt Tower
98 Nehru Place
New Delhi, 110019, India
Tel: 91 (11) 6410380 or 6414493
TLX: (953) 3161458 HSPL IN

New Delhi Service

Hinditron Services Pvt., Ltd.
Field Service Center
15, Community Centre
Panchshila Park
New Delhi 110 017, India
Tel: 91 011 6433675

Cable: Tekcentre Delhi
Hyderabad Office
Hinditron Services Pvt. Ltd.
Field Service Center
Emerald Complex, 5th Floor
1-7-264
114 Sarojini Devi Road
Secunderabad 500 003, India
Tel: 91 842 821117
TLX: (953) 04256973 HSPL IN

Indonesia •

P.T. Lamda Triguna
P.O. Box 6/JATJG
Jakarta, 13001
Indonesia
Tel: 62 21 8195365
TLX: (796) 46171 LAYARIA

Iran •

Arma Baynemeteli Co., Ltd.
P.O. Box 951570
Pasdaran-Tehran
Tel: 98-21-248717; TLX: (951) 213648

Ireland

N.V. Philips
Industrial & Electro-Acoustic Systems
5600 MD Eindhoven
The Netherlands
Tel: 040-785539
Tlx: 35000 phtc nl
Fax: 040-785651

Israel •

R.D.T. Electronics Engineering Ltd.
P.O. Box 43137
Tel Aviv 61430
Israel
Tel: (3) 972-3-483211
TLX: (922) 371452 RDT IL
Fax: 972-3-492190

Italy •

Sistrel S.p.A.
Via le Erminio Spalla 41
00142 Rome, Italy
Tel: 39-6-504-1367; TLX: (843) 625857
Fax: (39) 6-504137



John Fluke Mfg. Co., Inc. / PO Box C9090 / Everett, WA 98206 / (206) 356 5400

Litho in U.S.A. 11/87

Milan Office
Sistref S.p.A.
Via Pelizza da Volpedo 59
20092 Cinisello Balsamo
Milan, Italy
Tel: 39-2-6181893, TLX: (843) 334643
Fax: (39) 2-6182440

Naples Office
Sistref S.p.A.
Via Cintia
Parco S. Paolo 35
80126 Naples, Italy
Tel: 39-81-7678700
Fax: (39) 81-7661361

Japan •
John Fluke Mfg. Co., Inc.
Japan Branch
Sumitomo Higashi Shinbashi Bldg.
1-1-11 Hamamatsucho
Minato-ku, Tokyo 105, Japan
Tel: 81-3-434-0181
TLX: (781) 2424331 FLUK JPY
FAX: 81-3-434-0170
Osaka Sales Office
John Fluke Mfg. Co., Inc.
Japan Branch
Katsushige Building
2-45 Kohraibashi
Higashi-ku, Osaka 541
Japan
Tel: 81-6-229-0871 FAX: 81-6-229-1098

Korea, Republic of •
Myoung Corporation
Yeo Eui Do P.O. Box 14
Seoul, Korea
Tel: 82-2-784-9942 MYOUNG
TLX: (787) K24283
FAX: (82) 2-784-2387

Kuwait •
Al Bahar International Group
P.O. Box 26672 Safat
13127 Safat, Kuwait
Kuwait, Arabian Gulf
Tel: 965-848601, 847598
TLX: (959) 44822

Lebanon and Jordan •
Mabek (Electronics Division)
P.O. Box 13-5657
Beirut, Lebanon
Tel: 812523
TLX: (923) 22889 LIBANK LE

Malaysia •
Mecomb Malaysia Sdn Bhd
P.O. Box 24
46700 Petaling Jaya, Selangor, Malaysia
Tel: 60-3-774-3422
TLX: (784) MA37764 MECOMB
Fax: (6) 03-774-3414

Malta •
Fabian Enterprises
20, Msida Road
Gzira, Malta
Tel: 513283/40216, TLX: (838) 1837

Mexico •
Mexicana de Electronica
Industrial, S.A. (Mixel)
Diagonal No. 27
Entre Calle de Eugenia Y Ave
Colonia del Valle
C.P. 03100, Mexico
Tel: (905) 660-4323
TLX: (383) 1771038 FAIRME
Executone De Monterrey, S.A.
Ave. Gonzalitos NTE 545
Monterrey N.L., Mexico
Tel: 90-5-480400, 472625
TLX: (383) 382659

Morocco •
Oussama S.A.
Angle Boulevard Emile Zola et
Rue Reithel
P.O. Box 2007 Casa
Casablanca
Morocco
Tel: 212-24-13-38, TLX: (933) 28879 M

Nepal •
Associated Enterprises
GPO Box 790, Pyaphai Tole
Kathmandu, Nepal
Tel: 13868, TLX: (947) 2568 (ASOENT NP)

Netherlands
N.V. Philips
Industrial & Electro-Acoustic Systems
5600 MD Eindhoven
The Netherlands
Tel: 040-785539
Tlx: 35000 phtc nl
Fax: 040-785651

New Zealand •
Auckland Office
Northrop Instruments & Systems, Ltd.
459 Khyber Pass Road
Private Bag, Newmarket
Auckland 1, New Zealand
Tel: 64-9-501-801, 501-219
TLX: (791) 21570
FAX: 64-9-543430

Wellington Office
Northrop Instruments & Systems Ltd.
Information Technology Group
First Floor, Northrop Bldg.
189-191 Willis Street
P.O. Box 2406
Wellington, New Zealand
Tel: 64-4-856-658
TLX: (791) 3380

Christchurch Office
Northrop Instruments & Systems Ltd.
Information Technology Group
110 Mandeville Street
P.O. Box 8388
Christchurch, New Zealand
Tel: 64-3-488-874
TLX: (791) 4801

Norway •
Morgensterne & Co A/S
Konghellegate 3
P.O. Box 6688, Rodelokka
Oslo 5, Norway
Tel: (2) 356110, TLX: (856) 71719

Oman •
OHI Telecommunications LLC
P.O. Box 889
Muscat, Oman
Tel: 968-603606
TLX: (926) 5052 TELECOM ON

Pakistan •
International Operations (PAK), Ltd.
505 Muhammadi House
H. Chundrigar Road
P.O. Box 5323, Karachi, Pakistan
Tel: 92-21-221127, TLX: (952) 24494 PIO PK

Peru •
Importaciones y Representaciones
Electronicas S.A.
Avda. Franklin D. Roosevelt 105
Lima 1, Peru
Tel: 51-14-28-8650
TLX: (394) 25663 PE IREING

Philippines, Republic of •
Spark Radio & Electronics, Inc.
Greenhills P.O. Box 610
San Juan, Metro Manila, Zip 3113
Philippines
Tel: 63-2-775192, 704096
TLX: (722 or 732) 27901 RLA PH

Portugal •
Decada Espectral
Equipamentos de Electronica
Av. Bombeiros Voluntarios
Lote 102B, Miraflores/Alges
1495 Lisbon, Portugal
Tel: 351-1-4103420, TLX: (832) 15515

Romania •
Amtest Associates Ltd.
Amtest House
75-79 Guildford Street
Chertsey, Surrey KT16 9AS
England
Tel: 44-9328-68355, TLX: (851) 928855
FAX: 44-9328-61919

Saudi Arabia •
Electronic Equipment Marketing Co.
P.O. Box 3750
Riyadh, Saudi Arabia
Tel: 966-1-477-1650
TLX: (928) 401120 ZUHAIR SJ

Scotland
N.V. Philips
Industrial & Electro-Acoustic Systems
5600 MD Eindhoven
The Netherlands
Tel: 040-785539
Tlx: 35000 phtc nl
Fax: 040-785651

Singapore, Republic of •
Rank O'Connor's (PTE) Ltd.
O'Connor House
98 Pasir Panjang Road
Singapore 0511
Republic of Singapore
Tel: 65-4737944, TLX: (786) RS21023 OCONSIN
FAX: 4724508 CABLE CINECOM SINGAPORE

South Africa •
Protea PNI
P.O. Box 39127
Bramley 2018
Republic of South Africa
Tel: 27-11-786-3647
TLX: (960) 4-24409 SA
FAX: 27-11-786-1807

Spain •
ESSA
Equipos y Sistemas S.A.
C/Apolonio Morales, 13-B
Madrid 16, Spain
Tel: 34-1-458-0150
TLX: (831) 42856 EYS E

Sri Lanka •
Computerlink Data Systems, Ltd.
331 Union Place
Colombo 2, Sri Lanka
Tel: 94-1-28641
TLX: (954) 22455 COLINK CE

Sweden
N.V. Philips
Industrial & Electro-Acoustic Systems
5600 MD Eindhoven
The Netherlands
Tel: 040-785539
Tlx: 35000 phtc nl
Fax: 040-785651

Switzerland •
Traco Electronic AG
Jenatschstrasse 1
8002 Zurich
Switzerland
Tel: 41-1-201-0711
TLX: (845) 815570 TRCOCH

Syria •
Mabek (Electronics Division)
P.O. Box 4238
Damascus, Syria

Taiwan •
Schmidt Electronics Corp.
5th Fl, Cathay Min Sheng
Commercial Building,
344 Min Sheng East Road
Taipei Taiwan R.O.C.
Tel: 886-2-501-3468
TLX: (785) 11111 SCHMIDT
Fax: (886) 2-502-9692

Thailand •
Measuretronix Ltd.
2102/63 Ramkamhaeng Rd.
Huamark Bangkok 10240
Thailand
Tel: 66 (2) 3742516, 3741632
TLX: (788) 82796 HUAMARK TH

Tunisia •
Selep S.A.R.L.
6, Rue de Sparte
Tunis - 1000 RP
Tunisia
Tel: 216-1-248093, TLX: (934) 13030

Turkey •
Erkman Elektronik Aletler
Ticaret Anonim Sirketi
Necatibey Cad 92/3
Karakoy, Istanbul, Turkey
Tel: 90 (11) 441546, TLX: (821) 24399

United Arab Emirates •
Harris Al-Afaq, Ltd
P.O. Box 8141
Kamal Hamza Bldg.
Traffic Police Road
Dubai, U.A.E.
Tel: 971-4-283625
TLX: (958) 48168 AFAQEM
Al-Sanani Cen. Trad. Est.
P.O. Box 7187
Abu-Dhabi, U.A.E.
Tel: 971-2-821370, TLX: (958) 23966

Uruguay •
Coasin Uruguay S.A.
Casilla de Correo 1400
Libertad 2529
Montevideo, Uruguay
Tel: 598-2-789204, 789015
TLX: (398) UY23010 COAUR

USSR
Amtest Associates Ltd.
Amtest House
75-79 Guildford Street
Chertsey, Surrey KT16 9AS
England
Tel: 44-9328-68355, TLX: (851) 928855
FAX: 44-9328-61919

Venezuela •
Coasin C.A.
Calle 9 Con Calle 4, Edif Edinorbu
Apartado de Correos NR-70,136
Los Ruices
Caracas 1070-A, Venezuela
Tel: 58 (2) 241-03-09
TLX: (395) 21027 EMVEN VC

Yugoslavia •
Amtest Associates Ltd.
Amtest House
75-79 Guildford Street
Chertsey, Surrey KT16 9AS
England
Tel: 44-9328-68355, TLX: (851) 928855
FAX: 44-9328-61919

• **Supplied and Supported by** —
Fluke (Holland) B.V.
P.O. Box 2269
5600 CG Eindhoven
The Netherlands
Tel: (040) 45805, TLX: (844) 51846
FAX: 31-40-457515

• **Supplied and Supported by** —
Fluke International Corporation
P.O. Box C9090
Everett, WA 98206 U.S.A.
Tel: (206) 356-5500
TLX: 185103 FLUKE UT
FAX: 206-356-5116

The following countries are
represented by:
Fluke (Holland) B.V.
P.O. Box 2269
5600 CG Eindhoven
The Netherlands
Tel: (040) 45805, TLX: 51846
FAX: 31-40-457515

Abu Dhabi	Mauritania
Afghanistan	Menorca
Albania	Mongolia
Algeria	Niger
Angola	Nigeria
Benin	Qatar
Bornholm	Rodhos
Botswana	Russia
Chad	Sardinia
Corsica	Saudia Arabia
Czechoslovakia	Scotland
Dubai	Senegal
Ethiopia	Sierra Leone
Guinea	Somalia
Ibiza	Togo
Iceland	Upper Volta
Iraq	Wales
Kuwait	Wstn Sahara
Liberia	Yemen
Libya	Zaire
Luxembourg	Zambia
Maderia	Zimbabwe
Mailorca	

FLUKE

TECHNICAL SERVICE CENTERS

U.S.A.

CA, Burbank

John Fluke Mfg. Co., Inc.
Tel: (213) 849-4641

CA, Santa Clara

John Fluke Mfg. Co., Inc.
(408) 727-8121

CO, Denver

John Fluke Mfg. Co., Inc.
(303) 695-1000

FL, Orlando

John Fluke Mfg. Co., Inc.
(305) 896-4881

IL, Palatine

John Fluke Mfg. Co., Inc.
(312) 705-0500

MD, Rockville

John Fluke Mfg. Co., Inc.
(301) 770-1576

NJ, Paramus

John Fluke Mfg. Co., Inc.
(201) 262-9550

TX, Dallas

John Fluke Mfg. Co., Inc.
(214) 869-0311

WA, Seattle

John Fluke Mfg. Co., Inc.
(206) 356-5560

Other Countries

Argentina, Buenos Aires

Coasin S.A.
Tel: 552-5248
TLX: (390) 22284

Australia, Brisbane

Elmeasco Instruments Pty. Ltd.
Tel: 552-5248

Australia, Concord

Elmeasco Instruments Pty. Ltd.
Tel: 736-2888
TLX: (790) AA25887

Australia, Ringwood

Elmeasco Instruments Pty. Ltd.
Tel: 879-2322
TLX: (790) AA36206

Austria, Vienna

Walter Rekersch
Elektronische Gerate GmbH & Co
Tel: 253626
TLX: (847) 134759

Belgium, Brussels

Fluke (Belgium) NV/SA
Tel: 2164090
TLX: (846) 26312

Brazil, Sao Paulo

Hi-Tek Electronica Ltda.
Tel: 421-5477
TLX: (1391) 11/1413

Canada, Calgary

Fluke Electronics Canada Inc.
Tel: (403) 291-5215
Fax: (403) 291-5219

Canada, Mississauga

Fluke Electronics Canada Inc.
Tel: (416) 890-7600
Fax: (416) 890-6866

Canada, Montreal

Fluke Electronics Canada Inc.
Tel: (514) 685-0022
Fax: (514) 685-0039

Canada, Ottawa

Fluke Electronics Canada Inc.
Tel: (613) 723-9453
Fax: (613) 723-9458

Chile, Santiago

Intronica Chile Ltda
Tel: 232 1886
TLX: (332) 346351

China, Peoples Republic of

Instrimpex - Fluke Service Center
Tel: 65-7281

Colombia, Bogota

Sistemas E Instrumentacion, Ltda
Tel: 232-4532
TLX: (396) 45787

Denmark, Bailerup

Tage Olsson A/S
Tel: 658111
TLX: (855) 35293

Ecuador, Quito

Proteco Coasin Cia., Ltda
Tel: 526759
TLX: (393) 2865

Egypt and Sudan

Electronic Engineering Liaison Ofc
Tel: 2455705
TLX: (927) 22782

England, Chertsey, Surrey

Amtest Associates, Ltd
Tel: 68355

England, Watford, Herts

Fluke (Great Britain) Ltd
Tel: 40511
TLX: (851) 934583

Finland

Instrumentarium Elektronikka
Tel: 358-0-5281
TLX: (857) 124426

France

M.B. Electronique S.A.
Tel: 1-39-56-81-31
TLX: (842) 695414

Greece, Athens

Hellenic Scientific Representations
Tel: 7211140
TLX: (863) 219330

Hong Kong, Wanchai

Schmidt & Co (H.K.) Ltd.
Tel: 8330-222
TLX: (780) 74766

India, Bangalore

Hinditron Services Pvt. Ltd.
Tel: 363159
TLX: (953) 845741

India, Bombay

Hinditron Services Pvt. Ltd.
Tel: 6300043
TLX: (953) 11-72247

India, New Delhi

Hinditron Services Pvt. Ltd.
Tel: 6433675
TLX: (953) 316458

India, Secunderbad

Hinditron Services Pvt. Ltd.
Tel: 821117
TLX: (953) 1556973

Indonesia, Jakarta Pusat

PT Lamda Triguna
Tel: 8195365
TLX: 46171 LAYARIA

Israel, Tel Aviv

R.D.T. Electronics Engineering Ltd.
Tel: 483211
TLX: (922) 371452

Italy, Milan

Sistrel S.p.A.
Tel: 6181893
TLX: (843) 334643

Japan, Tokyo

John Fluke Mfg. Co., Inc.
Japan Branch
Tel: 434-0181
TLX: (781) 242-4331

Korea, Republic of

Myoung Corp
Tel: 784-9942
TLX: MYOUNG K24283

Malaysia, Selangor

Mecomb Malaysia Sdn. Bhd.
Tel: 3-743422
TLX: (784) MA37764

Mexico

Mexicana de Electronica
Industrial, S.A. (Mexel)
Tel: 5-660-4323
TLX: (383) 1771038

Netherlands, Tilburg

Fluke (Nederland) B.V.
Tel: 352455
TLX: (844) 52683

New Zealand, Auckland

Northrop Instruments
& Systems Ltd.
Tel: 501-801
TLX: (791) NZ21570

New Zealand, Wellington

Northrop Instruments
& Systems Ltd.
Tel: 856-658
TLX: (791) NZ33380

Norway, Oslo

Morgenstjerne & Co. A/S
Tel: 356110
TLX: (856) 71719

Pakistan, Karachi

International Operations (PAK), Ltd
Tel: 221127, 239052
TLX: (952) 24494

Peru, Lima

Importaciones Y Representaciones
Electronicas S.A.
Tel: 288650
TLX: (394) 25663

Philippines

Spark Radio & Electronics Corp.
Tel: 2-775192
TLX: (722) 27901

Portugal, Lisboa

Equipamentos de Electronica e
Cientificos, S.A.R.L.
Tel: 2103420
TLX: (832) 15515

Republic of Singapore

Rank O'Connor's (PTE) Limited
Tel: 4737944
TLX: (786) RS21023

Republic of South Africa, Bramley

Protea PNI
Tel: 11-786-3647
TLX: (960) 4-24409

Spain, Madrid

Equipos y Sistemas S.A.
Tel: 458-0150
TLX: (831) 42856

Sweden, Vallingby

Kaliber AB
Tel: 380350
TLX: (854) 14077

Switzerland, Zurich

Traco Electronic AG
Tel: 2010711
TLX: (845) 425570

Taiwan, Taipei

Schmidt Electronics Corp.
Tel: 5013468
TLX: (785) 11111

Thailand, Bangkok

Measuretronix Ltd.
Tel: 374-2516
TLX: (788) 82796

Turkey, Istanbul

Erkman Elektronik Aletler
Tel: 441546
TLX: (821) 24399

Uruguay, Montevideo

Coasin Uruguay S.A.
Tel: 789015
TLX: (398) UY23010

Venezuela, Caracas

Coasin C.A.
Tel: 241-0309
TLX: (395) 21027

West Germany, Ismaning/Munich

Fluke (Deutschland) GmbH
Tel: 9605240
TLX: (841) 0522472



John Fluke Mfg. Co., Inc., P.O. Box C9090, Everett, WA 98206

Fluke (Holland) B.V., P.O. Box 2269, 5600 CG, Eindhoven, The Netherlands. Phone (040) 458045

Litho in U.S.A. 11/87