

T.O. 33A1-12-1198-1

8025A
MULTIMETER

Instruction Manual



16 JULY 1984

8025A

MULTIMETER

Instruction Manual

P/N 659995
MAY 1984

©1984 John Fluke Mfg. Co., Inc. All rights reserved. Litho in U.S.A.



Section 1

Introduction and Specifications

1-1. INTRODUCTION

The 8025A is a rugged, water and chemical-resistant multimeter suitable for use in harsh industrial and military environments. It was designed for MIL-T-28800 Type II, Class 2, Style A instrument applications.

The Model 8025A combines the performance and accuracy of a digital meter with the speed and dynamic measurement capability of an analog meter. The 3200-count, digital display offers better resolution than a conventional 3-1/2 digit, 2000-count display, and the 31-segment analog bar-graph display provides quick and easy dynamic measurement indications. In addition, a unique software

Touch-Hold mode allows you to watch the probes and the circuit during critical measurements. The Touch-Hold mode locks the measurement into the display for viewing and automatically updates the display when a new measurement is taken. Model 8025A features include:

- 3200-Count Digital Display: Provides improved accuracy and resolution over a conventional 2000-count (3-1/2 digit) DMM.
- 31-Segment Analog Bar Graph Display: Allows quicker, easier dynamic measurements; capacitor checking, peaking, nulling, zero adjustments, etc. Analog bar graph updates 10 times faster than the digital display.

- Fast Autoranging: Simplifies and speeds meter use. Automatically selects proper measurement range. Manual range can be selected.
- Audible Continuity/Diode Test: Wiring, diode, and transistor tests can be performed quickly without viewing the display.
- Software Touch Hold: Using standard test leads, the 8025A captures a measurement, beeps, locks the measurement in the display for viewing, then automatically updates when a new measurement is taken. This feature allows the user to watch the probes and circuit when necessary, then look at the display after the measurement is complete.
- Rugged, Sealed Construction: The case is sealed to resist water, dirt, and contaminants.
- Safety Features: Extensive overload protection, high energy fuses for all current ranges, non-metallic case and bail, recessed input jacks, safety-designed test leads, and no fuses to replace for voltage and resistance overloads.
- Battery Life: Typically over 1000 hours

- Low Power Resistance Measurement: Allows in-circuit resistance measurements without turning on diodes or transistors.

1-2. ACCESSORIES

Fluke DMM accessories (listed in Table 1-1) are designed to increase the measurement capabilities of your instrument. Whether you are measuring voltage, current, resistance, or temperature, Fluke DMM accessories help you do the job quickly and accurately.

With our complete family of probes, you can measure ac current to 600A, temperature to 150 degrees Celsius, and voltage to 40 kV. The C25 soft carrying case is available in addition to the standard C20 hard case to help protect your instrument from drops, bumps, and spills. Fluke test leads simplify circuit connections and let you probe hard-to-reach places.

1-3. SPECIFICATIONS

Specifications for the 8025A are given in Table 1-2. Unless otherwise stated, the basic electrical specifications given are defined for the temperature range of 18 degrees Celsius to 28 degrees Celsius and relative humidity of up to 95% for 1 year after calibration.

Table 1-1. Accessories

MODEL NUMBER	DESCRIPTION
TL70	Replacement test leads. Feature right-angle, safety-designed input connectors and pin-tip size probes.
AC70	Two red and two black slip-on, insulated alligator clips compatible with the TL70 or other pin-tip size probes.
Y8134	Deluxe test lead kit. Features interchangeable tips and two test-tip probes, two alligator clips, two large spade-lug tips, and one spring-loaded hook-tip probe.
Y8140	Slim-Flex test leads. Adjustable length, flexible and insulated steel-needle test leads. Sharp needle point will pierce varnish and thin insulations. Fits into small places.
C20	Hard carrying case. Protects against rough handling and bad weather. Includes accessory storage compartment.
C25	Soft carrying case. Thickly padded vinyl with tough exterior and interior and heavy-duty zipper. Holds DMM and test leads. Includes combination belt loop carrying strap.
80K-6	High voltage probe (divide-by-1000 resistive divider) 0 to 6000V dc or peak ac (0 to 60 Hz).
80K-40	High voltage probe (divide-by-1000 resistive divider) 40,000V dc or peak ac (0 to 60 Hz).

Table 1-1. Accessories (cont)

MODEL NUMBER	DESCRIPTION
Y8100	200A DC/AC clamp-on current probe. Uses Hall effect to measure dc or ac current without electrical contact. Battery powered. 0 to 1 kHz. 0.75 inch (19 mm) jaw opening.
Y8101	AC clamp-on current probe. 1A to 150A, 48 Hz to 1 kHz. Divide-by-1000 current transformer. 0.43 inch (11 mm) jaw opening.
80i-400	AC clamp-on current probe, 1A to 400A, 48 Hz to 1 kHz (10A resolution above 320A with 8025A). Divide-by-1000 current transformer. 1.18 inch by 1.97 inch (30 x 50 mm) jaw opening.
80i-600	AC clamp-on current probe, 1A to 600A, 30 Hz to 1 kHz (10A resolution above 320A with 8025A). Divide-by-1000 current transformer. 2.0 inch (50.8 mm) jaw opening.
83RF	Radio frequency probe. 100 kHz to 100 MHz, 0.25V to 30V rms.
85RF	Radio frequency probe. 100 kHz to 500 MHz, 0.25V to 30V rms.
80T-150C	Temperature Probe (°C). P-N junction sensor, 350V dc or peak ac isolation, chemical-resistant housing. Minus 50°C to plus 150°C, 0.1°C resolution. Ideal for temperature measurements on circuit boards.
80T-150F	Temperature Probe (°F). P-N junction sensor, 350V dc or peak ac isolation, chemical-resistant housing. Minus 58°F to plus 302°F, 0.1°F resolution. Ideal for temperature measurements on circuit boards.

Table 1-2. Specifications

DISPLAY	Liquid crystal, multiplexed drive
Digital Display	3200 counts plus polarity indication, updated 2 times per second
Analog Display	31-segment bar graph plus polarity indication, updated 25 times per second
Annunciators	k, M, (Ω), ($\text{M}\Omega$), ($\text{k}\Omega$), ($\text{M}\Omega$), range indicators (3, 30, 300), nS (nanosiemens)
DC VOLTAGE MEASUREMENT	
Accuracy	$\pm(0.2\%$ of reading, +1 digit)
Ranges	320.0 mV (100 μ V resolution) 3.200V (1 mV resolution) 32.00V (10 mV resolution) 320.0V (100 mV resolution) 1000V (1V resolution)
Input Resistance	10-megohms nominal
Normal Mode Rejection Ratio	>60 dB @ 50 Hz and 60 Hz

Table 1-2. Specifications (cont)

Common Mode Rejection Ratio	>120 dB @ dc, 50 Hz and 60 Hz with 1 kilohm or less unbalance	
Overload Protection	1000V rms (500V rms on 320 mV range)	
AC VOLTAGE MEASUREMENT		
Accuracy	40 Hz to 2 kHz: $\pm(0.5\%$ of reading + 3 digits)	
(320.0 mV-320.0V range)	2 kHz to 10 kHz: $\pm(2\%$ of reading +3 digits)	
	10 kHz to 30 kHz: $\pm(4\%$ of reading +10 digits)	
Accuracy (1000V range)	40 Hz to 2 kHz: $\pm(1\%$ of reading + 3 digits)	
	2 kHz to 10 kHz: $\pm(3\%$ of reading +3 digits)	
Ranges	320.0 mV	(100 μ V resolution)
	3.200V	(1 mV resolution)
	32.00V	(10 mV resolution)
	320.0V	(100 mV resolution)
	1000V	(1V resolution)
Conversion Type	Ac coupled, average sensing, calibrated to read rms value of sinewave	
Input Impedance	10-megohms nominal in parallel with <100 pf	
Common Mode Rejection Ratio	>60 dB, dc to 60 Hz, 1 kilohm or less unbalance	

Table 1-2. Specifications (cont)

Overload Protection	100V rms (500V rms on 320 mV range); 10^7 Volt-Hertz product maximum
AC AND DC CURRENT	
AC Accuracy	$\pm(1.5\%$ of reading +2 digits)
DC Accuracy	$\pm(0.75\%$ of reading + 2 digits)
Ranges	320.0 μ A (0.1 μ A resolution) 3200 μ A (1 μ A resolution) 32.00mA (10 μ A resolution) 320.0 mA (100 μ A resolution) 10.00A (10 mA resolution)
Typical Full Scale Burden	320.0 μ A range: 160 mV
Voltage	3200 μ A range: 1.6V 32.00 mA range: 180 mV 320.0 mA range: 1.8V 10.00A range: 0.5V
Overload Protection	μ A/mA ranges: 630 mA/250V fuse in series with 3A/600V fuse 10.00A range: 20A/600V fuse

Table 1-2. Specifications (cont)

RESISTANCE MEASUREMENT	
Accuracy	320.0 ohm range: $\pm(0.3\%$ of reading +2 digits) 3.200k to 3.200M ranges: $\pm(0.2\%$ of reading +1 digit) 32.00M range: $\pm(1\%$ of reading +1 digit) 32.00 nS range: $\pm(2\%$ of reading +10% digits)
Ranges	320.0 ohm (0.1 ohm resolution) 3.200 kilohm (1 ohm resolution) 32.00 kilohm (10 ohm resolution) 320.0 kilohm (100 ohm resolution) 3.200 megohm (1 kilohm resolution) 32.00 megohm (10 kilohm resolution) 32.00 nS (0.01 nS resolution) (manual ranging only)
Overload Protection	500V rms
Full Scale Voltage	<420 mV up to 3.2 megohm; <1.3V up to 32 megohm
Open Circuit Voltage	<2.8V (-15 to 55°C)

Table 1-2. Specifications (cont)

DIODE TEST AND CONTINUITY

Diode Test Indication	Displays voltage drop; 0.5 mA nominal test current at 0.6V; 2.08V full scale
Continuity Indication	Continuous audible tone for test resistance below 150 ohms. Momentary click for test voltage dropping below 0.7V (typical silicon diode threshold)
Open Circuit Voltage	<3.3V (-15 to 55°C)

ENVIRONMENTAL SPECIFICATIONS

Temperature	Operating: -15 to 55°C Storage: -55 to 85°C
Temperature Coefficient	0.1 x the applicable accuracy specification per °C (for temperature <18°C or >28°C)
Shock, Vibration, Humidity And Water Resistance	Per MIL-T-28800 for a Style A, Class 2 Instrument.

Table 1-2. Specifications (cont)

GENERAL SPECIFICATIONS	
Maximum Voltage	1000V applied to any terminal with respect to earth ground
Power Requirements	Single 9V alkaline battery (NEDA 1604)
Battery Life	>1000 hours typical (alkaline). Battery symbol first displayed when at least 60 hours of battery life remains
Instrument Size	5.6 cm H x 9.5 cm W x 20.3 cm L (2.2 in H x 3.75 in W x 8 in L)
C20 Hard Case Size	10.2 cm H x 15.2 cm W x 33.0 cm L (including handle) (4.0 in H x 6.0 in W x 13.0 in L)
Weight	0.75 kg (1.6 lb) 8025A alone 1.5 kg (3.2 lb) with case and accessories
Safety	Protection Class II as defined in IEC 348 and ANSI C39.5.

Section 2 Operation

2-1. INTRODUCTION

This section describes how to make measurements with the 8025A. Even though you may have used a multimeter before, we suggest that you take the time to read this material carefully so you can take full advantage of the numerous 8025A features.

2-2. UNPACKING THE INSTRUMENT

The 8025A was shipped with two test leads (one red and one black), two alligator clips (one red and one black), a 9V alkaline battery (installed), this instruction manual, and a Model C20 Ruggedized Hard Case. Check the shipment carefully and immediately contact the place of purchase if anything is missing or damaged in shipment.

If reshipment is necessary, please use the original shipping container. If the original container is not available, be sure that adequate protection is provided to prevent damage during shipment. It is recommended that the instrument be surrounded by at least 3-inches of shock-absorbing material in the shipping container.

2-3. BATTERY INSTALLATION OR REPLACEMENT

A single, common, inexpensive 9V-battery (NEDA 1604) supplies power to operate the 8025A. The instrument is shipped with the battery installed. Typical battery life (using an alkaline battery) will exceed 1000 hours of use. The battery symbol on the display will come on when at least 60

8025A

hours of battery life remain. Use the following procedure to replace the battery.

WARNING

TO AVOID ELECTRICAL SHOCK, REMOVE THE TEST LEADS AND ANY INPUT SIGNALS BEFORE REPLACING THE BATTERY.

Refer to Figure 2-1, and use the following procedure to install or replace the 8025A battery.

1. Turn the rotary switch to OFF, and remove the test leads from the 8025A.
2. Lift the instrument stand on the back of the 8025A, then remove the four black, #6 X 32, Pozi-drive® screws from the battery door.
3. Pull the battery compartment straight out from the back of the 8025A. (A thumb-slot in the side of the battery compartment cover facilitates removal.)
4. Remove the battery from the battery holder, then disconnect the battery connector.

5. Snap the battery connector to the terminals on the new battery, then slide the battery into the battery compartment holder. Slip each battery lead into the slot in the holder as shown in Figure 2-1.

6. Slide the battery compartment back into the back of the 8025A, then replace the four black, #6 X 32, Pozi-drive® screws removed in step 2.

2-4. FUSE TEST

Use the following procedure to check for a defective fuse.

1. Turn the function selector switch to the ohms position.
2. Connect a test lead from the volts/ohms/diode test input jack to the amps (A) input jack.
3. The display should indicate between 0.1 ohm and 0.3 ohm.
4. Move one end of the test lead from the amps (A) input jack to the milliamp/microamp (mA/uA) input jack.

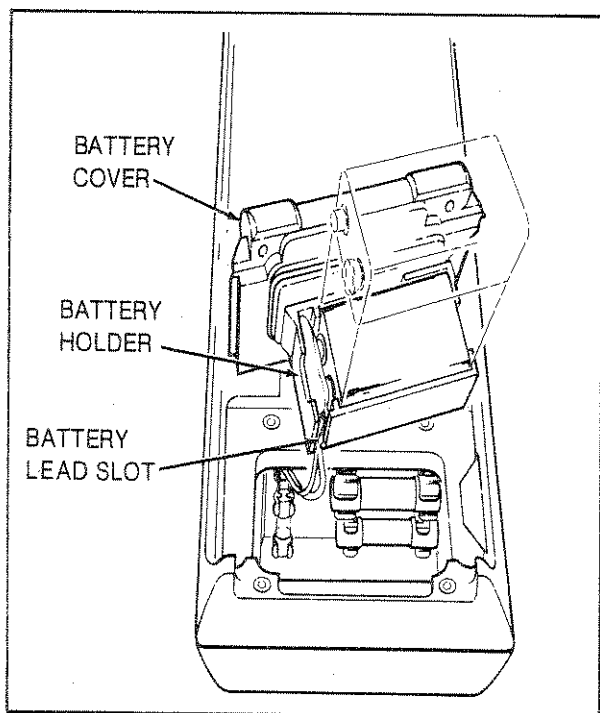

Figure 2-1. Battery Installation

5. The display should indicate between 5.3 ohms and 6.0 ohms.
6. If either of the above display indications is OL (overload), replace the appropriate fuse.

2-5. FUSE REPLACEMENT

There are three fuses mounted on the inside of the battery compartment. Fuse F1 (which protects the $\mu\text{A}/\text{mA}$ current input from very high energy overloads) is the lower of the two horizontally mounted fuses. The fuse mounted vertically is F2 (in series with F1). The upper one of the two horizontally mounted fuses is F3, which protects the 10A current input. A spare fuse to replace fuse F2 is located under the battery, between the battery holder and the battery compartment cover. Refer to Figure 2-2, and use the following procedure to check or replace the 8025A fuses.

1. Perform steps 1 through 3 of the battery replacement procedure.
2. Remove the defective fuse (or check continuity through the suspected fuse), and if necessary install a new fuse of the same size and rating.
3. Reinstall the battery compartment as instructed in step 6 of the battery replacement procedure.

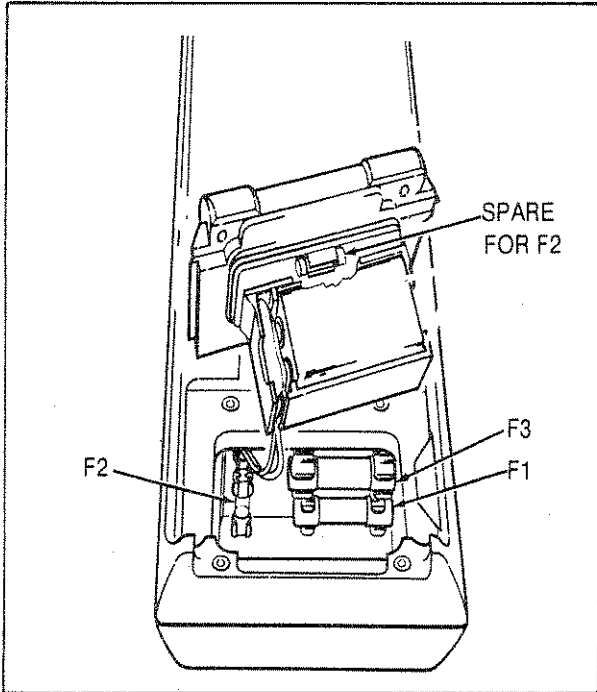

Figure 2-2. Fuse Replacement

2-6. PHYSICAL FEATURES

Before you begin using the Fluke 8025A, we suggest you take a few minutes to familiarize yourself with the instrument. All externally accessible features are shown in Figure 2-3 and described in Table 2-1. The front panel and display are also described in the following paragraphs.

All controls and connectors are located on the 8025A front panel, beneath the display. The centrally-located rotary switch is used to select various measurement functions. The RANGE and HOLD push buttons located above the rotary switch select the manual range mode and the touch-hold mode; the connectors located below the rotary switch provide input connections for the various types of measurements.

2-7. Display

Display information consists of four functional categories: the digital display, the annunciators, the bar graph display, and the range indicator. Measurement results are displayed on the 3200-count LCD digital display (refer to Figure 2-4). There are three full decimal digits, a partial leading digit, a minus sign, and three decimal points in the digital display. The digital display is updated approximately 2 times per second. The decimal point is positioned automatically for each measurement range. The partial leading digit can

display only the digits 1, 2, and 3; a leading 0 is not displayed by the leading digit. If the input is overrange, the display indicates an overload condition by displaying the letters OL.

Several display annunciators are used to distinguish between ohms, kilohms, and megohms in the ohms function and to supply information about battery condition and operating mode. The annunciators and their functions are as follows:



When first displayed, it indicates that remaining battery life is at least 60 hours.

Mk Ω

The Ω is displayed when the ohms function is selected. The M and k annunciators indicate the megohm or kilohm range.

nS

The nanosiemens (nS) annunciator is displayed when the top range of the resistance function is selected using manual ranging only. Megohms equals 1000 divided by nanosiemens. The Ω is not displayed with nS.



Indicates that the manual-ranging mode is in use.



Indicates that the touch-hold mode is in use.

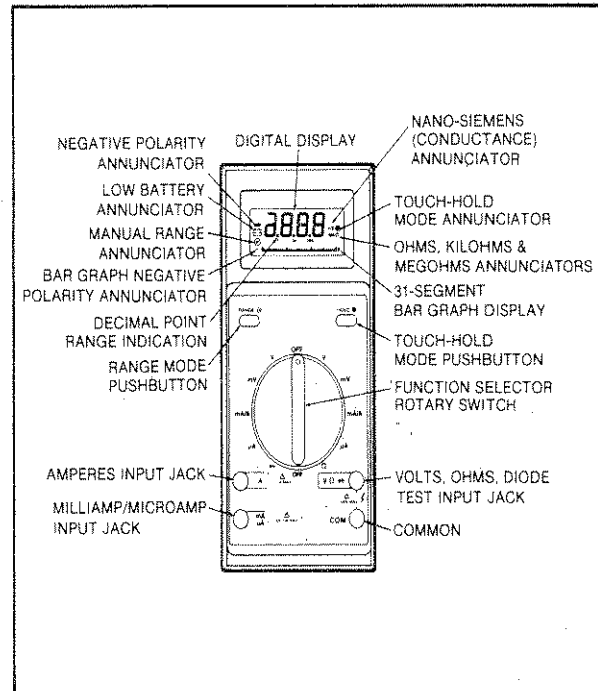

Figure 2-3. 8025A Features

Table 2-1. 8025A Features

FEATURES	DESCRIPTION
Digital Display	Displays input data in the 3200 count display, with automatic decimal point positioning. The leading zero is suppressed for the most significant digit.
Touch-Hold Mode Annunciator	Touch-Hold Mode Annunciator is displayed when the touch-hold mode is in use.
Resistance Annunciators	The appropriate annunciator is displayed for the resistance range in use.
Bar Graph Display	Analog representation of input data composed of 31 segments which illuminate starting from the left as the input increases.
Touch-Hold Mode Pushbutton	Press momentarily to enter touch-hold mode, press again to manually update indication, press and hold for 2 seconds to exit touch-hold mode.
Function Selector Rotary Switch	Turn to select any of ten different functions, or off. Functions marked with a straight line are dc functions; those marked with a ~ are ac functions.
Volt, Ohms, Diode Test Input Jack	Input jack used in conjunction with the volts, mV (ac or dc), ohms, or diode test position of the function selector rotary switch.
Common Jack	Common or return connection used for all measurements.

Table 2-1. 8025A Features (cont)

FEATURES	DESCRIPTION
Milliamp/Microamp Input Jack	Used as input connection for current measurements up to 320 mA (ac or dc) with the function selector rotary switch in the mA or μ A position.
Amperes Input Jack	Used as input connection for current measurements up to 10A with the function selector rotary switch in the mA/A position (ac or dc).
Manual Range Mode Pushbutton	Push once to enter manual range mode, press again to increment range, press and hold for 2 seconds to return to autorange.
Manual Range Annunciator	The manual range annunciator is displayed when the 8025A is in the manual range mode. Absence of the indicator implies autorange mode in use.
Decimal Point/Range Indicator	Decimal point position and the digits (3,30,300) under the decimal point indicate range in use.
Low Battery Annunciator	At least 60 hours of battery life remain when first displayed. Battery voltage is tested each time the function switch is moved to a new position.
Auto Polarity	Automatically displays positive or negative polarity inputs and (—) indicates negative polarity for digital and bar graph displays.
Conductance Range Annunciator	Top range of the resistance function is the conductance range. Displays conductance in nS (nanosiemens).

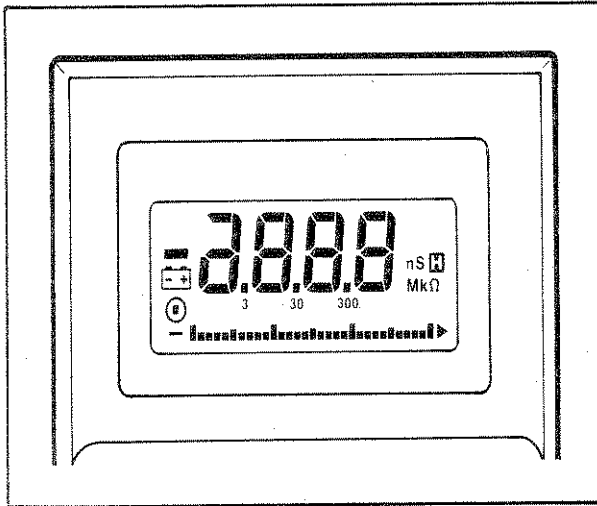

Figure 2-4. Display

The analog bar graph is located just below the digital display. The analog bar graph display consists of a 31-segment bar graph which indicates the absolute value of the input by displaying successive segments, starting from the left-most segment. A minus annunciator is located at the left end of the bar graph. The analog bar graph is updated 10

times as often as the digital display. If an overrange condition should occur, the bar graph will display all segments plus an overrange arrow.

The range indicators are located between the analog bar graph and the digital display. A 3, 30, or 300 range indicator is displayed just below the decimal point in the digital display. The number displayed indicates the range in use for each of the decimal point positions.

2-8. Audible Indicator

The range indicators are located between the analog bar graph and the digital display. A 3, 30, or 300 range indicator is displayed just below the decimal point in the digital display. The number displayed indicates the range in use for each of the decimal point positions. No decimal point is displayed in the 1000V or 3200 μ A range.

2-9. POWER-UP SELF TEST

When the function switch is moved to any position from the OFF position, the 8025A performs a power-up self test. All LCD segments are switched on while the test is being performed (about 1 second), then the unit commences normal operation. In addition to the power-up self tests, a battery test cycle is performed at power up and each time the operator selects a different function with the rotary switch. If

the battery voltage is below 6.3V, $\pm 0.3V$, the low battery annunciator will come on and remain on until a subsequent battery test determines that the battery voltage is above the 6.3V threshold (i.e. the battery recovers or is replaced).

If either the HOLD or RANGE push button is depressed (> 1 second) while the function switch is turned from OFF to any ON position, one of two extended modes will be entered. If the HOLD push button is depressed (> 1 second) while the function switch is moved from OFF to any ON position, the touch-hold mode will only update to a new reading when the HOLD push button is pressed. Automatic touch-hold updates are defeated. This is useful when you want to take a reading at a specific time and hold it. If the RANGE push button is depressed (> 1 second) while the function switch is moved from OFF to any ON position, the 8025A defaults to manual ranging. The 8025A may be returned to autorange mode by pressing the RANGE button for approximately 2 seconds.

2-10. OPERATION

The following paragraphs describe the various functions and modes in which the 8025A may be operated. Operation of each function and mode is summarized in Table 2-2 for reference, and discussed more fully in the following paragraphs. Mode selection and operation are discussed

first, then function selection and operation. Two mode push buttons are provided on the 8025A: RANGE & HOLD.

2-11. Range

The RANGE push button may be used to initiate the manual range operating mode, change ranges while in the manual mode, and return to the autorange mode. The RANGE push button must be pressed for greater than 1 second to exit the manual range mode. The HOLD push button can be used to initiate the touch-hold mode, manually update the touch-hold reading, and exit the touch-hold mode. The HOLD push button must be pressed for greater than 2 seconds to exit the touch-hold mode. Touch-hold can be used in either the manual or autorange mode.

Upon power-up, the 8025A initializes in the autorange mode. In autorange, the 8025A automatically increments through the available ranges for the function selected and selects the appropriate range for the measurement being taken. If the function selected has only one range, then the Ⓜ symbol is displayed. The operating range in use is indicated by the decimal point position and range indicator in the display, and in the Ohms function by the presence of the M or k annunciators. There is no annunciator for the autorange mode; the absence of the manual range annunciator Ⓜ indicates that the instrument is in the autorange mode.

Table 2-2. Summary of Operating Functions and Ranges





FUNCTION & MODE	INPUT TERMINALS	RANGES AND DECIMAL POINT POSITIONS
Volts dc, auto- range	V Ω  COM	3.2 Volts (x.xxx), 32 Volts (xx.xx) 320 Volts (xxx.x), 1000 Volts (xxxx)
Volts dc, manual range	V Ω  COM	3.2 Volts (x.xxx), 32 Volts (xx.xx) 320 Volts (xxx.x), 1000 Volts (xxxx)
Millivolts dc	V Ω  COM	320 mV (xxx.x)
Milliamps dc, autorange	mA/ μ A, COM	32 mA (xx.xx), 320 mA (xxx.x)
Milliamps dc, manual range	mA/ μ A, COM	32 mA (xx.xx), 320 mA (xxx.x)
Amps dc	A, COM	10 A (xx.xx)
Microamps dc, autorange	mA/ μ A, COM	320 μ A (xxx.x), 3200 μ A (xxxx)
Microamps dc, manual range	mA/ μ A, COM	320 μ A (xxx.x), 3200 μ A (xxxx)
Volts ac, auto- range	V Ω  COM	3.2 Volts (x.xxx), 32 Volts (xx.xx) 320 Volts (xxx.x), 1000 Volts (xxxx)

Table 2-2. Summary of Operating Functions and Ranges (cont)



FUNCTION & MODE	INPUT TERMINALS	RANGES AND DECIMAL POINT POSITIONS
Volts ac, manual range	V Ω  COM	3.2 Volts (x.xxx), 32 Volts (xx.xx) 320 Volts (xxx.x), 1000 Volts (xxxx)
Millivolts ac	V Ω  COM	320 mV (xxx.x)
Milliamps ac, autorange	mA/ μ A, COM	32 mA (xx.xx), 320 mA (xxx.x)
Milliamps ac, manual range	mA/ μ A, COM	32 mA (xx.xx), 320 mA (xxx.x)
Amps ac	A, COM	10 A (xx.xx)
Microamps ac, autorange	mA/ μ A, COM	320 μ A (xxx.x), 3200 μ A (xxxx)
Microamps ac, manual range	mA/ μ A, COM	320 μ A (xxx.x), 3200 μ A (xxxx)
Diode test/continuity	V Ω  COM	0 to +2.08V (x.xxx) (Beeper clicks as input descends through 0.7V; beeps constantly at 0.1V (~ 150 Ω) or less).

Table 2-2. Summary of Operating Functions and Ranges (cont)

FUNCTION & MODE	INPUT TERMINALS	RANGES AND DECIMAL POINT POSITIONS
Resistance, autorange	V Ω \rightarrow COM	320 ohms (xxx.x Ω), 3.2 kilohms (x.xxx k Ω) 32 kilohms (xx.xx k Ω) 320 kilohms (xxx.x k Ω) 3.2 megohms (x.xxx M Ω) 32 megohms (xx.xx M Ω)
Resistance and Conductance manual range	V Ω \rightarrow COM	320 ohms (xxx.x Ω) 3.2 kilohms (x.xxx k Ω) 32 kilohms (xx.xx k Ω) 320 kilohms (xxx.x k Ω) 3.2 megohms (x.xxx M Ω) 32 megohms (xx.xxx M Ω) 32 nS (xx.xx nS) Conductance range can only be entered using manual range selection.

To initiate the manual range mode, push the RANGE push button momentarily, then release it. The beeper will click and the manual range annunciator (M) will be displayed when the 8025A enters the manual range mode. Once in the manual range mode, the 8025A will increment one range each time the push button is pressed and increment to the lowest range upon exiting the highest range. If a function that has only a single range is selected, the 8025A will display the manual range annunciator (M). To return the 8025A to autoranging, press the RANGE push button and hold it in for approximately two seconds; when the beeper clicks the second time, the 8025A has returned to autorange, and the manual range annunciator will no longer be displayed. If you select a different function with the rotary switch while in the manual range mode, the 8025A automatically switches back to autorange (if possible) upon entering the new function.

2-12. Hold

In the touch-hold mode, operators can make a measurement in a circuit that is difficult, delicate, or hazardous to reach without taking their eyes from the test leads. The 8025A beeper indicates when a stable measurement is held in the display, then the operator can look at the measurement when convenient. Momentarily pressing the HOLD push button initiates the touch-hold mode.

While in the touch-hold mode, the display automatically updates each time a new, stable measurement (more than one bar graph segment of change) within bar graph resolution is available. The new measurement is displayed and the beeper beeps when the display updates. The beep can alert the operator that the signal has changed. The display can be manually updated at any time by pressing the HOLD push button momentarily. To exit the touch-hold mode, press the HOLD push button for a period of approximately 2 seconds (the beeper will click, beep, then click again as the 8025A exits the touch-hold mode).

2-13. Function Selection

A single rotary switch is used to select all 8025A functions. The position of the rotary function switch indicates the function in use. In addition, the ohms function displays an annunciator on the digital display. Each of the 8025A functions is discussed in the following paragraphs. Functions available and indicated by the function switch are:

Volts dc	Volts ac
Millivolts dc	Millivolts ac
Milliamps/Amps dc	Milliamps/Amps ac
Microamps dc	Microamps ac
Diode test	Ohms

8025A

Two additional functions are available. They are audible continuity and conductance. Audible continuity operates with the function selector switch in the diode test position. The conductance (nS) function operates with the function switch in the ohms position, and can only be entered through manual range selection.

2-14. VOLTS DC

Input voltages between -1000 and +1000V dc can be measured using the Volts dc function. Turn the function selector rotary switch to the position to select Volts dc.

Several ranges are available in the Volts dc function, and the decimal point/range indicator in the display indicates the range currently in use. The ranges available for the Volts dc function are:

RANGE	DISPLAY
3.200 Volts	x.xxx
32.00 Volts	xx.xx
320.0 Volts	xxx.x
1000 Volts	xxxx

2-15. MILLIVOLTS DC

Input voltages between -320 and +320 mV dc can be measured using the Millivolts dc function. Turn the function

2-14

selector rotary switch to the $\overline{\text{mV}}$ position to select millivolts dc. Only one range is available in the Millivolts dc function: 320 mV (decimal point position xxx.x).

2-16. MILLIAMPS/AMPS DC

Two different input jacks are used in conjunction with the $\overline{\text{mA/A}}$ position of the function selector rotary switch. The input jack in use determines whether the 8025A is measuring milliamps or amps. If the milliamp (marked $\overline{\text{mA}}/\mu\text{A}$) jack is in use with the function switch in the $\overline{\text{mA/A}}$ position, measurements between -320 and +320 mA are possible. If the ampere (marked A) jack is in use, intermittent display values up to 20A are possible. The 8025A input circuitry is limited to a maximum input of 10 amperes continuously. Again, the decimal point/range indicators indicate the range in use (xx.xx=32 mA or 10A range and xxx.x=320.0 mA range).

2-17. MICROAMPS DC

Turning the function selector rotary switch to the $\overline{\mu\text{A}}$ position selects the microamps dc function. Input current between -3200 μA and +3200 μA can be measured in the microamps dc function, using the mA/ μA input jack. Two ranges are available: 320.0 μA (display=xxx.x) and 3200 μA (display=xxxx).

2-18. VOLTS AC

Measurements between 0 and 1000V ac may be taken with the function selector in the \tilde{V} position and the red probe in the V (omega, diode) input jack. The minus sign is disabled in this mode and the decimal point/range indicators in the display indicate the range in use. The following ranges are available in the Volts ac function.

RANGE	DISPLAY
3.200 Volts	x.xxx
32.00 Volts	xx.xx
320.0 Volts	xxx.x
1000 Volts	xxxx

2-19. MILLIVOLTS AC

Turn the function selector rotary switch to the \tilde{mV} position to select the Millivolts ac function. Only one range is available with the 8025A in the Millivolts ac function: 0 to 320.0 millivolts (display=xxx.x). The minus sign is disabled in this function.

2-20. MILLIAMPS/AMPS AC

Two different input jacks are used in conjunction with the $\tilde{mA/A}$ position of the function selector rotary switch. The input jack in use determines whether the 8025A is measuring

milliamps or amps. If the milliamp (marked mA/ μ A) jack is in use, measurements between 0 and 320.0 mA are possible. If the ampere (marked A) jack is in use, intermittent display values of 20 A are possible. The 8025A input circuitry is limited to a maximum input of 10 amperes continuously. Again, the decimal point/range indicators indicate the range in use (xx.xx=32.00 mA or 10A range and xxx.x=320.0 μ A or 320.0 mA range).

2-21. MICROAMPS AC

Turning the function selector rotary switch to the $\tilde{\mu A}$ position selects the microamps ac function. Input current up to 3200 μ A can be measured in the microamps ac function, using the mA/ μ A input jack. Two ranges are available: 320.0 μ A (display=xxx.x) and 3200 μ A (display=xxxx). The minus sign is disabled in the microamps ac function.

2-22. RESISTANCE/CONDUCTANCE

Turning the function selector rotary switch to the Ω position selects the resistance function. The Ω annunciator is displayed when the 8025A enters the resistance function, and either the k or M annunciator is displayed when appropriate for the range in use.

The uppermost range of the Ω position is conductance (nS), and it can only be entered using the manual range mode. To

8025A

enter the conductance (nS) range, select the resistance function, open the test leads, and press the RANGE push button twice. When the 8025A enters the conductance range, the nanosiemens (nS) annunciator is displayed and the Ω annunciator is switched off. Megohms equal 1000 divided by nanosiemens. The following ranges are available in the resistance/conductance function.

RANGE	DISPLAY
320.0 ohms	xxx.x Ω
3.200 kilohms	x.xxx k Ω
32.00 kilohms	xx.xx k Ω
320.0 kilohms	xxx.x k Ω
3.200 megohms	x.xxx M Ω
32.00 megohms	xx.xx M Ω
32.00 nS	xx.xx nS

In the diode test function, the beeper produces a continuous tone if the voltage drop is less than 0.1V (150 ohms), and the beeper beeps when the voltage drop descends through the 0.7V threshold.

2-23. DIODE TEST

Turn the function selector rotary switch to the (||||| \rightarrow) position to initiate the diode or continuity test function. In diode test, there is only one range: 0 to +2.08 volts. The voltage measured is produced by a current output from the meter across the resistance of the device being tested. Open circuit conditions produce an overload, or out-of-limits (OL) indication.

Section 3 Applications

3-1. INTRODUCTION

Some common 8025A applications are presented in this section. The applications included in this section demonstrate possible uses for the various 8025A features, and they provide examples of operation to supplement the operating instructions in Section 2.

3-2. MULTIMETER SAFETY

Fluke multimeters are designed for safe, convenient operation. A few precautions and the proper operating procedures assure many years of safe, efficient service from the 8025A. The following safe practices and proper operating procedures should be followed when using any multimeter.

- Inspect the test leads for insulation damage or exposed metal. Damaged leads should be replaced.
- Reduce the risk of accidental contact by using leads with shrouded connectors and finger guards.
- Check the continuity of the test leads.
- Be certain the digital multimeter (DMM) itself is in good operating condition. During the continuity test, a meter reading that goes from overload (OL) to 0 generally means the circuitry is working properly.
- Select the proper function and range for your measurement.

- Electrically disconnect the positive, or hot, test lead before disconnecting the common test lead.
- Insulate yourself from ground using an insulating floor mat. If possible, use only one hand in taking measurements, keeping the other hand in your pocket to avoid accidentally allowing current to travel through your body.
- Follow all equipment safety procedures. Disconnect the input power and discharge all high-voltage capacitors through a protective impedance before testing with the multimeter.
- When working with equipment that contains a cathode ray tube (CRT), wear safety glasses and protective clothing to avoid injuries in the event of CRT implosion.
- Avoid working alone.
- When using a current shunt, turn the power off before connecting the multimeter in the circuit. Overloading a current shunt will cause excessive heat.
- If the current in the circuit is greater than 10 amps, use clamp-on probes for maximum protection.
- When measuring transformer secondary or motor winding current, check the DMM fuses first. An open fuse will allow high voltage buildup, which is potentially hazardous.
- When working with automotive circuits, be aware of danger from high voltage (up to 30,000V peak) and the fire hazard from gasoline fumes or leakage.

3-3. INTERNATIONAL ELECTRICAL SYMBOLS

The symbols shown in Figure 3-1 are used to denote certain functions or conditions pertaining to multimeter operation.

3-4. MEASUREMENT TECHNIQUES

The following paragraphs offer techniques that improve the measurement accuracy of the 8025A. While these techniques are in general use throughout the electronics industry, these paragraphs offer specific information for use with the 8025A.

3-5. AC Measurement











The 8025A ac ranges employ an average responding ac converter. This means that the unit measures the average value of the input and displays it as an equivalent rms value for a sine wave. As a result, measurement errors are





introduced when the input waveform is distorted (non-sinusoidal). The amount of error depends upon the amount of distortion. Figure 3-2 shows the relationship between sine, square, and triangular waveforms, and the required conversion factors. Multiply the display value by the conversion factor to calculate the true voltage or current. Example: To calculate the peak-to-peak value of a square wave, multiply the displayed value by 1.8.

3-6. Voltage, AC/DC

There are five ac voltage ranges and five dc voltage ranges available on the 8025A. All ranges present an input impedance of approximately 10 megohms in parallel with less than 100 pF. When making measurements, be careful not to exceed the overload limits as defined in Table 1-2, the Specifications table.

Measurement errors, due to circuit loading, can result when making either ac or dc voltage measurements on circuits with high source resistance. However, in most cases the error is negligible (0.1% or less) as long as the source resistance of the measurement circuit is 10 kilohms or less. If circuit loading does present a problem, the percentage of error can be calculated using the appropriate formula from Figure 3-3.

	OFF (power) SWITCH POSITION		DANGEROUS VOLTAGE
	ON (power) SWITCH POSITION		GROUND
	AC-ALTERNATING CURRENT		SEE EXPLANATION IN MANUAL
	DC-DIRECT CURRENT		DOUBLE INSULATION (Protection Class II)
	EITHER DC OR AC		FUSE

				
Underwriters Laboratories, Inc. U.S.A.	Factory Mutual Research Corp. U.S.A.	Canadian Standards Association, Canada	Technischer Überwachungsverein Rheinland, Germany	Verband Deutscher Elektrotechniker (VDE) Germany



UL recognition mark

Figure 3-1. International Electrical Symbols







INPUT WAVEFORM	DISPLAY MULTIPLIER FOR MEASUREMENT CONVERSION				INPUT WAVEFORM	DISPLAY MULTIPLIER FOR MEASUREMENT CONVERSION			
	PK-PK	0-PK	RMS	AVG		PK-PK	0-PK	RMS	AVG
SINE 	2.828	1.414	1.000	0.900	RECTIFIED SQUARE 	1.800	1.800	1.272	0.900
RECTIFIED SINE (FULL WAVE) 	1.414	1.414	1.000	0.900	RECTANGULAR PULSE $D=X/Y$ 	$0.9/D$	$0.9/D$	$0.9/D^{1/2}$	$0.9D$
RECTIFIED SINE (HALF WAVE) 	2.828	2.828	1.414	0.900	TRIANGLE SAWTOOTH 	3.600	1.800	1.038	0.900
SQUARE 	1.800	0.900	0.900	0.900					

Figure 3-2. Waveform Conversion .

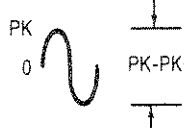
1. DC VOLTAGE MEASUREMENTS

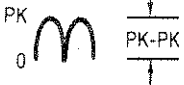
$$\text{Loading Error in \%} = 100 \times R_s \div (R_s + 10^7)$$

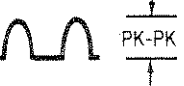
Where: R_s = Source resistance in ohms of circuit being measured.

2. AC VOLTAGE MEASUREMENTS

First, determine input impedance, as follows:

$$Z_{in} = \frac{10^7}{\sqrt{1 + (2\pi F \cdot R_{in} \cdot C)^2}}$$

Where: Z_{in} = effective input impedance

R_{in} = 10^7 ohms

C_{in} = 100×10^{-12} Farads

F = frequency in Hz

Then, determine source loading error as follows:
(Vector algebra required)

$$\text{Loading Error in \%} = \frac{100 \times Z_s}{R_s + Z_{in}}$$

Where: Z_s = source impedance

Z_{in} = input impedance (calculated)

R_s = source resistance

3-7. Current, AC/DC

WARNING

INSTRUMENT DAMAGE AND OPERATOR INJURY MAY RESULT IF THE FUSE BLOWS WHILE CURRENT IS BEING MEASURED IN A CIRCUIT WHICH EXHIBITS AN OPEN CIRCUIT VOLTAGE GREATER THAN 600V. DO NOT ATTEMPT AN IN-CIRCUIT CURRENT MEASUREMENT WHERE THE POTENTIAL IS GREATER THEN 600V DC OR RMS AC.

Five ac and five dc current ranges are available on the 8025A. All current ranges are fuse protected. If a fuse opens, refer to the fuse replacement procedures given in Section 2 of this manual.

3-8. Current Measurement Error Calculations

Full scale burden voltage (voltage drop across the fuse and current shunt) is given for each range in the Specifications (Table 1-2) in Section 1 of this manual. The burden voltage drops can affect the accuracy of a current measurement if the current source is unregulated and the shunt plus fuse resistance represents a significant portion (1/1000 or more) of the source resistance. If burden voltage does present a problem, the percentage of error can be calculated using the

Figure 3-3. Voltage Measurement Error Calculations

8025A

formula in Figure 3-4. Approximate terminal resistances for the current ranges are: 0.05 ohms for A, 5.5 ohms for mA, and 500 ohms for μ A.

3-9. Resistance Measurements

CAUTION

Turn test circuit power off and discharge all capacitors before attempting in-circuit resistance measurements.

There are six resistance measurement ranges in the 8025A and a conductance measurement range. All ranges employ a two-wire measurement technique. As a result, test lead resistance may influence measurement accuracy on the 320-ohm range. To determine the error, short the test leads together and read the lead resistance. Correct the measurement by subtracting the lead resistance from the measurement. The error is generally on the order of 0.1 to 0.2 ohms for a standard pair of test leads.

Some in-circuit resistance measurements can be made using any range up to, but not including, the 32-megohm range. The full-scale measurement voltage produced on the ranges below 32 megohms does not strongly bias silicon diode emitter-base junctions in the forward direction, so

resistance measurements often may be taken without removing diodes and transistors from the circuit. Use the highest range you can (below 32.00 megohm) to minimize the possibility of turning on diodes or transistor junctions. Full scale measurement voltage in the 32-megohm range does strongly forward bias a diode or transistor.

3-10. Diode Test and Continuity

In diode test, there is only one range: 0 to +2.08 volts. The voltage is developed across the component(s) under test by a test current output from the 8025A. Voltages greater than the high limit produce an overload (OL) condition, and negative inputs produce a negative indication (they are not suppressed). In the diode test function, the beeper produces a continuous tone if the input is less than 0.1V, and the beeper beeps once when the input descends through the 0.7V threshold.

Audible continuity testing is also performed with the function selector switch in the diode test/continuity position. A continuous tone sounds for test resistances below approximately 150 ohms. An intermittent connection produces erratic beeps, and can be a valuable troubleshooting aid. Erratic beeps can also occur, due to environmental noise, if a test value is very close to the threshold (150 ohms).

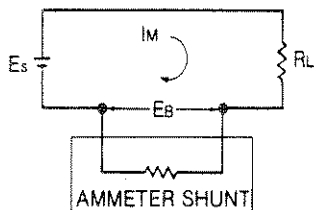

E_S = Source voltage

R_L = Load resistance + Source resistance

I_M = Measured current (display reading in mA)

E_B = Burden voltage (calculated), i.e., Display reading expressed as a % of full-scale ($100 \times \frac{\text{READING}}{\text{FULL-SCALE}}$) times full-scale burden voltage for selected range. See Table:

RANGE	TYPICAL BURDEN VOLTAGE
320 μ A	0.16V
3200 μ A	1.6V
32 mA	.18V
320 mA	1.8V
10A	0.5V

Maximum current error due to Burden Voltage

$$IN \% = 100 \times \frac{E_B}{E_S - E_B}$$

$$IN \text{ mA} = \frac{E_B \times I_M}{E_S - E_B}$$

Example: $E_S = 15V$, $R_L = 50\Omega$, $I_M = 270 \text{ mA}$.

$$E_B = 100 \times \frac{270}{320} \times 1.8 \text{ (from Table)} =$$

$$84.4\% \times 1.8 = 1.519V$$

$$\text{Error in \%} = 100 \frac{1.519}{15 - 1.519} = 100 \frac{1.519}{13.481} = 11.3\%$$

Increase displayed current by 11.3% to obtain true current

$$\text{Error in mA} = \frac{1.519 \times 270}{15 - 1.519} = \frac{410}{13.481} = 30.41 \text{ mA}$$

Increase displayed current by 30 mA to obtain true current.

Figure 3-4. Current Measurement Error Calculations

3-11. Conductance

Conductance measurement is performed with the function selector switch in the ohms function. The conductance range can only be entered using manual range selection; autorange can not enter the conductance range. The conductance range can be used both to measure conductance (the inverse of resistance) and to measure very high resistances (greater than 31 megohms).

Ordinarily, high value resistance measurements are plagued by noise, and require careful shielding. Normal precautions should be taken when measuring resistance in terms of conductance, for measurements up to 10,000 megohms. Conductance measurements are displayed in nanosiemens (nS). Calculate megohms to be equal to 1000 divided by the nanosiemens displayed (1000/nS is equivalent to megohms). Example: 2 nS converts to 500 megohms (1000/2).

3-12. Leakage Testing

The conductance range effectively extends the resistance measurement capability of the 8025A to the point where it can provide useful leakage measurements on passive components. For example, the operator can detect leaky

diodes, cables, connectors, printed circuit boards, etc. In all cases, the test voltage is less than 2V dc.

Leakage testing on purely resistive components such as cables and printed circuit boards is straightforward. Select the ohms function and manually increment the range to conductance (nS). Connect the test leads to the test points on the unit under test, and read the leakage in terms of conductance.

NOTE

There is normally a small residual reading with open test leads in the conductance range. To ensure accurate measurements, connect clean test leads to the 8025A, and (with the leads open) read the residual leakage in nanosiemens. Correct subsequent measurements by subtracting the residual from the readings. (Fingerprints or other contamination on the DMM pcb may also cause residual conductance readings.)

Diode leakage tests require that the diode junction be reverse biased when being measured. This is accomplished by connecting the anode of the diode to the COMMON input

terminal and the cathode (ring) of the diode to the volts/ohms/diode test terminal. Leakage at the test voltage being applied can then be read in terms of conductance.

3-13. ANALOG BAR GRAPH APPLICATIONS

A unique, and possibly unfamiliar, feature of the 8025A is the analog bar graph display. The following paragraphs provide examples of usage and applications for the analog bar graph.

3-14. Viewing The Analog Bar Graph

In looking at the analog bar graph, notice that it is composed of segments that simulate an analog needle. The bar graph performs the same function as an analog meter needle, but it eliminates the mechanical distortion inherent in needle movement. In fact, the analog bar graph is updated approximately 25 times per second, allowing it to represent input signal characteristics more faithfully than a VOM (volt-ohmmeter) needle.

A negative (-) annunciator is displayed at the left end of the bar graph when taking a reverse polarity dc measurement. Assume that a slowly varying dc voltage is the input signal. As the input goes more positive (from zero), a bar graph segment is displayed, and additional segments are displayed

from left to right, to indicate the input level as it increases. Now, assume that the input level slowly decreases. Fewer bar graph segments are displayed as the signal decreases, then the - annunciator flashes as the signal level passes through 0. As the signal goes more negative, the - annunciator is displayed, and additional bar graph segments are displayed from left to right, indicating a more negative input signal.

Note that every fifth segment of the bar graph is slightly larger than those in between, and every tenth segment is larger yet. The first bar is an indication of 20 counts. These larger segments provide a quick reference for bar graph indications. The largest segments (every tenth segment) divide the display into thirds. Thus, if the bar graph indicates 11 segments on the 32.00V range, the input voltage is 10 volts; if the bar graph indicates 11 segments on the 320.0V range, the input voltage is 100 volts. If the input equals or exceeds 3000 counts on the range selected, the bar graph displays an arrow at the far right of the display, then the 8025A automatically switches to the next higher range if the input equals or exceeds 3260 counts. If the 8025A is in the manual range mode, the overrange arrow is displayed until the operator manually selects a range appropriate for the input value.

3-15. Using The Analog Bar Graph

The analog bar graph is most useful in making adjustments and performing limited diagnostics. Bar graph response is fast and precise, so it can be used to easily reach a setting within a few percent of the final adjustment. With a traditional D'Arsonval meter movement, undershooting or overshooting the desired adjustment is much more likely. The bar graph can be used to make rough adjustments quickly, then the 3200-count digital display can be used for final adjustment.

The analog bar graph is useful for performing limited diagnostics in applications where rapidly fluctuating signal levels cause the flashing digits of a digital display to be useless. Like the traditional VOM needle, the analog bar graph excels at displaying trends, or slowly changing signals. In addition, autoranging on the 8025A allows monitoring the signal change through changing ranges; something not possible with a traditional analog VOM.

Many diagnostic routines using the bar graph require practice. The operator is looking for good or bad signal patterns that occur over some span of time. Capacitance checks and noisy resistance measurements create such patterns. Therefore, familiarity with analog bar graph

response and movement is necessary to accurately interpret a signal pattern. Compare the bar graph response when making measurements on a known-good unit to the bar graph response when making measurements on a faulty unit.

3-16. Specific Applications--Nulling

The 8025A bar graph is ideal for nulling adjustments. As an adjustment approaches zero, fewer bar graph segments are displayed, then no bar graph segments are displayed. The - annunciator flickers when the input level is within 2 counts of zero. The flickering null indication is displayed every time the input approaches zero or swings from one polarity to the other. The operator merely watches for the - annunciator indication, then reverses the direction of the adjustment when the polarity sign is displayed. In one or two passes, a near-zero input level is possible, then the digital display can be used for exact zero adjustment.

When using an analog VOM without a center scale, the operator must manually switch the polarity between each adjustment. Also, with the traditional analog VOM, there is no digital display to use for fine adjustment after the analog needle is at zero.

3-17. Specific Applications--Contact Bounce

When subject to vibration, relay contacts may begin to bounce open. Checking for this intermittent problem is a routine troubleshooting measure associated with many types of equipment, including computers. Since the bounce problem will worsen as the relay fatigues, early diagnosis is important.

When the contact bounces open, its resistance value changes momentarily from zero to infinity and back. Ordinary hand-held DMMs take more than 300 milliseconds to update their displays--much too long to detect a brief contact bounce. A traditional VOM needle will move slightly at the instant of contact bounce, but the inertia of the needle movement dampens the response.

The 8025A analog bar graph, however, will display at least one segment the moment the contact opens. The bar graph can detect contact bounce as brief as 0.2 milliseconds, while most analog needle movements require a 3 millisecond opening before they will respond.

Since the analog bar graph is ten times more sensitive to erratic signals than most analog needle movements, the bar graph can detect faulty contacts earlier than ever before.

And the severity of the problem is indicated by counting the number of displayed segments.

3-18. Specific Applications--Checking Capacitors

Volt-ohm meters are often used as simple capacitor checkers. In the capacitor kick test, the needle of the VOM in the resistance mode moves quickly from open (infinite ohms) toward short (zero ohms) as the capacitor is placed across the VOM input. The VOM battery charges the capacitor and the needle slowly moves back to the open (infinite ohms) position. The higher resistance ranges offer increased sensitivity for checking smaller capacitors.

The 8025A analog bar graph can make similar checks in the resistance function, even in the autoranging mode. As a capacitor is placed across the inputs, the analog bar graph quickly shortens, then rapidly down-ranges, depending on the size of the capacitor. As the capacitor charges, the bar graph slowly extends back to its full 31-segment length, up-ranging if necessary. For capacitors as small as 0.02 μF , only the 30-megohm range is involved. The last few segments blink off, then back on.

In a fixed range (using manual range mode), the time it takes for the bar graph to extend from zero to full scale indicates

8025A

the approximate capacitance value. Table 3-1 gives typical capacitance values for various charge times on different resistance ranges.

3-19. Specific Applications--Noisy Resistance Measurements

In the past, only the traditional analog VOM has been useful for resistance measurements in the presence of line voltage noise (50 or 60 Hz). Most digital multimeters are so sensitive they can not tolerate as much as 50 mV of line noise while making resistance measurements; their digital displays become unreadable due to the line noise. On the other hand, because of the mechanical inertia of the analog needle, the noise alternately pulls the needle to the left and then to the right, averaging out any movement and leaving a fairly stable resistance reading.

The 8025A resistance measurement circuit is designed to tolerate ac noise far better than the usual DMM. Readable 2-kilohm readings can be obtained even in the presence of 1V ac noise. Readings of 1-megohm may be obtained with up to 2V ac noise. The noise appears as about 50 digits of change and an oscillating bar graph.

Table 3-1. Capacitance Vs. Time to Full Scale

Resistance Range	320Ω	3.2kΩ	32kΩ	320kΩ	3.2MΩ	32MΩ
Capacitance Value						
10,000 μF	4 sec	33 sec	5 min	ext	ext	ext
1,000 μF	blink	4 sec	30 sec	ext	ext	ext
100 μF	nil	blink	4 sec	32 sec	ext	ext
10 μF	nil	nil	blink	4 sec	30 sec	ext
1 μF	nil	nil	nil	blink	3 sec	19 sec
0.1 μF	nil	nil	nil	nil	blink	2 sec
0.02 μF	nil	nil	nil	nil	nil	blink
ext = extended time, nil = no indication						