

8505A

Digital Multimeter

Instruction Manual

P/N 638841
MARCH 1983 REV 1, 3/86
©1986, John Fluke Mfg. Co., Inc. All Rights Reserved. Litho in U.S.A.



Section 1

Introduction & Specifications

1-1. INTRODUCTION

1-2. This eight-section manual provides comprehensive information for installing, operating and maintaining your Fluke digital multimeter. Complete descriptions and instructions are included for the instrument mainframe, for all modules necessary in making dc volts measurements, and for any optional modules ordered with the instrument. Appropriate sectionalized information is also included with any optional modules subsequently ordered and may be inserted in Section 6.

1-3. DESCRIPTION

1-4. The multimeter features 6-1/2 digit resolution, full annunciation and simplicity of operation. Modular construction, microprocessor control, and a bus structure provide excellent flexibility. Memory programming from the front panel (or through a remote interface) controls all measurement parameters, mathematic operations and special operations. An averaging mode is available to automatically optimize display resolution and stability for each function and range. The standard hardware configuration allows for measurement of dc volts in five ranges with 100 nV resolution on the lowest range. Optional modules are available for ac volts (four ranges), ac or dc current (five ranges), and resistance (eight ranges) in two-wire or four-wire arrangements.

1-5. Modular Construction

1-6. Considerable versatility is realized through unique construction. All active components are contained in modules which plug into a mainframe motherboard. This module-motherboard mating, combined with bus architecture and microprocessor control, yields both ease of option selection and reduced downtime.

NOTE

The A3 Isolator PCB is standard in the 8505A. This assembly is documented in Section 6 of this manual as Option -08A.

1-7. Microprocessor Control

1-8. All modules function under direct control of a microprocessor based controller. Each module is addressed by the controller as virtual memory. External reference values and offsets can be applied separately, stored in memory, and automatically used as factors in all subsequent readings. Digital filtering utilizes averaged samples for each reading.

1-9. Software Calibration

1-10. The 8505A features microprocessor-controlled calibration of all ranges and functions. Any range can be calibrated using a reference input of any known value from 60% of range to full scale. Software calibration can be performed using front-panel or remote control, allowing recertification without opening the case or removing the multimeter from the system.

1-11. Recirculating Remainder A/D Conversion

1-12. The multimeter adapts Fluke's patented recirculating remainder (R^2) A/D conversion technique to microprocessor control. This combination provides fast, accurate, linear measurements and long-term stability.

1-13. Options and Accessories

1-14. Remote interfaces, ac converters, a current converter, and an ohms converter are among the numerous options and accessories available for use with the multimeter. Refer to Tables 1-1 and 1-2 for complete listings. AC conversion can be accomplished with either the AC Averaging module (Option 01) or the RMS module (Option 09A). Any one of the three Remote Interface modules (Option 05, 06, or 07) can be installed at one time.

1-15. SPECIFICATIONS

1-16. Mainframe specifications with dc volts and dc ratio measurement capability are presented in Table 1-3. Optional function specifications are supplied with the respective option modules and included in Section 6.

Table 1-1. Options

OPTION NO.	NAME	NOTES
01	AC/DC Converter (Averaging)	1, 3
02A	Ohms Converter	
03	Current Shunts	3
05	IEEE Standard 488-1975 Interface	2
06	Bit Serial Asynchronous Interface	2
07	Parallel Interface	2
09A	AC/DC Converter (True RMS)	1, 3
<p>1) Options 01 and 09A cannot be installed simultaneously.</p> <p>2) Only one of Options 05, 06, and 07 can be installed at any time.</p> <p>3) For the ac portion of Option 03 to operate, either Option 01 or 09A must be installed.</p>		

Table 1-2. Accessories

MODEL OR PART NO.	NAME
M04-205-600	5¼-inch Rack Adapter
M00-260-610	18-inch Rack Slides
M00-280-610	24-inch Rack Slides
80K-6	High Voltage Probe
80K-40	High Voltage Probe
83RF	High Frequency Probe
85RF	High Frequency Probe
Y8001	IEEE Std. Cable, 1 Meter Length
Y8002	IEEE Std. Cable, 2 Meter Length
Y8003	IEEE Std. Cable, 4 Meter Length
MIS-7011K*	Extender Card
MIS-7190K*	Static Controller
MIS-7191K*	Test Module
MIS-7013K*	Bus Interconnect and Monitor
*For use during service or repair.	

Table 1-3. Specifications

GENERAL SPECIFICATIONS	
Dimensions	10.8 cm High x 43.2 cm Wide x 42.5 cm Long (4.25 in High x 17 in Wide x 16.75 in Long) (See Figure 1-1)
Weight	
BASIC	10 kg (22 lbs)
FULLY LOADED	12 kg (26 lbs)
Operating Power	
VOLTAGE	100V ac, 120V ac, 220V ac, or 240V ac (±10%)
BASIC INSTRUMENT POWER	12 watts
FULLY LOADED POWER	24 watts
FREQUENCY	47 Hz to 63 Hz (400 Hz available on request)
Warm-Up	2 hours to rate accuracy
Shock and Vibration	Meets requirements of MIL-T-28800 for type III, class 5, style E equipment.
Temperature Range	
OPERATING	0°C to 50°C
NON-OPERATING	-40°C to 70°C
Humidity Range	
0°C TO 18°C	80% RH
18°C TO 40°C	75% RH
40°C TO 50°C	45% RH
Maximum Terminal Voltage	
LO TO GUARD	127V rms
GUARD TO CHASSIS	500V rms
HI SENSE TO HI SOURCE	127V rms
LO SENSE TO LO SOURCE	127V rms
HI SENSE TO LO SENSE	1000V rms or 1200V dc
HI SOURCE TO LO SOURCE	280V rms

Table 1-3. Specifications (cont)

DC VOLTAGE**Input Characteristics**

RANGE	FULL SCALE 6½ DIGITS	RESOLUTION		INPUT RESISTANCE
		7½ DIGITS*	6½ DIGITS	
100 mV	200.0000 mV	—	100 nV	>10,000MΩ
1V	2.000000V	—	1 μV	>10,000MΩ
10V	20.00000V	1 μV	10 μV	>10,000MΩ
100V	128.0000V	—	100 μV	10MΩ
1000V	1200.000V	—	1 mV	10MΩ

*7½-digit resolution: In AVG operating mode.

Accuracy

DC VOLTS: ±(% of Reading + Number of Counts)				
RANGE	24-HOUR 23°C ±1°C ¹		90-DAY 23°C ±5°C	
	OPERATING MODE		OPERATING MODE	
	NORM	AVG	NORM	AVG ³
100 mV	0.0018 + 15	0.0010 + 8	0.0025 + 40	0.0020 + 8
1V	0.0008 + 7	0.0005 + 4	0.0015 + 8	0.0012 + 6
10V	0.0006 or 6*	0.0005 or 50 ^{2*}	0.0010 + 8	0.0008 + 60 ²
100V	0.0010 + 6	0.0005 + 5	0.0018 + 8	0.0015 + 6
1000V	0.0008 + 6	0.0005 + 5	0.0018 + 8	0.0015 + 6

*Whichever is greater

>90-Day: 23°C ±5°C

Add to the 90-day specification per month the following % of Reading and Number of Counts.

RANGE	OPERATING MODE	
	NORM	AVG ³
100 mV	0.00017 + 5.6	0.0001 + 0.1
1V	0.0001 + 0.1	0.0001 + 0.1
10V	0.0001 + 0.1	0.00008 + 1 ²
100V	0.00013 + 0.1	0.0001 + 0.1
1000V	0.00013 + 0.1	0.0001 + 0.1

NOTES:¹Relative to calibration standards, 4-hour warm-up, within 1 hour of dc zero. After software calibration, add the following to the 24 hour accuracy specification:

TIME SINCE INTERNAL (HARDWARE) CALIBRATION	NUMBER OF COUNTS*
<30 Days	0
<90 Days	1
<1 Year	2
>1 Year	3

*With 6½-digit display. For 7½-digits, multiply Number of Counts by 10.

²7½-digit mode of operation.³After 4-hour warm-up, within 1 hour of dc zero.

Table 1-3. Specifications (cont)

Operating CharacteristicsTEMPERATURE COEFFICIENT: \pm (% of Reading + Number of Counts)/ $^{\circ}$ C

RANGE	0 $^{\circ}$ C TO 18 $^{\circ}$ C AND 28 $^{\circ}$ C TO 50 $^{\circ}$ C
100 mV	0.0003 + 5
1V	0.0003 + 1
10V	0.0002 + 0.5*
100V	0.0003 + 1
1000V	0.0003 + 0.5

*Multiply Number of Counts by 10 for AVG operating mode (7½-digit).

INPUT BIAS CURRENT

AT TIME OF ADJUSTMENT	1-YEAR 23 $^{\circ}$ C \pm 1 $^{\circ}$ C	TEMPERATURE COEFFICIENT
< \pm 5 pA	< \pm 30 pA	< \pm 1 pA/ $^{\circ}$ C

ZERO STABILITY Less than 5 μ V for 90 days after a four-hour warm-up. Front panel pushbutton zero is provided for permanent storage of a zero correction for each range. Zero may be turned off at any time.

MAXIMUM INPUT VOLTAGE \pm 1200V dc or 1000V rms ac to 60 Hz, or 1400V peak above 60 Hz may be applied continuously to any dc range without permanent damage. Maximum common mode rate of voltage rise is 1000V / μ sec.

ANALOG SETTLLING TIME

FILTER MODE	FILTER COMMAND	TO 0.01% OF STEP CHANGE	TO 0.001% OF STEP CHANGE
Bypassed	F1	2 ms	20 ms
Fast	F0 or F3	40 ms	50 ms
Slow	F or F2	400 ms	500 ms

DIGITIZING TIME

Line Synchronous For 2 0 to 2 17 samples per reading digitizing time is from 4 ms to 9 minutes 6 seconds using a 60 Hz ac line with times increasing 20% using a 50 Hz ac line. Selectable in 18 binary steps.

Line Asynchronous 2 ms. (In 3 byte binary mode with dc zero, offset, limits and calibration factors turned off.)

NOISE REJECTION

Normal Mode Rejection

LINE FREQUENCY	FILTER MODE	4 SAMPLES/ READING	32 SAMPLES/ READING	128 SAMPLES/ READING
50 hertz	Fast	60 dB	70 dB	75 dB
50 hertz	Slow	85 dB	90 dB	95 dB
60 hertz	Fast	60 dB	70 dB	75 dB
60 hertz	Slow	90 dB	95 dB	100 dB

Common Mode Rejection 160 dB at 60 hertz with 1 k Ω in series with either lead, and 4 samples or more per reading. Greater than or equal to 100 dB with less than 4 samples per reading.

Table 1-3. Specifications (cont)

DC RATIO**Accuracy**

EXTERNAL REFERENCE VOLTAGE*	ACCURACY ¹
$\pm 20V$ to $\pm 40V$	$\pm(A + B + 0.001\%)$
$\pm V_{min}$ to $\pm 20V$	$\pm(A + B + (0.02\% / V_{xref}))$

*Maximum External Reference Voltage = $\pm 40V$ between External Reference HI and LO terminals, providing neither terminal is greater than $\pm 20V$ relative to the Sense LO or Ohms Guard² terminals.

Operating Characteristics

INPUT IMPEDANCE	External Reference HI or LO $>10,000\text{ M}\Omega$ relative to Ohms Guard ² or Sense LO.
BIAS CURRENT	External Reference HI or LO relative to Ohms Guard ² or Sense LO $<5\text{ nA}$.
SOURCE IMPEDANCE	Resistive Unbalance (External Reference HI to LO) $<4\text{ k}\Omega$. Total Resistance to Sense LO from either External Reference HI or LO $<20\text{ k}\Omega$.
MAXIMUM OVERLOAD VOLTAGE ...	$\pm 180V$ dc or peak ac (relative to Ohms Guard ² or Sense LO). $\pm 360V$ dc or peak ac (External Reference HI to LO).

NOISE REJECTION

INPUT TERMINALS	NORMAL MODE	COMMON MODE
Sense	Same as dc volts	Same as dc volts
External Reference	line frequency and 2x line frequency $>100\text{ dB}$	line frequency and 2x line frequency $>75\text{ dB}$

RESPONSE TIME

Analog Settling Time

FILTER MODE	FILTER COMMAND	TO 0.01% OF STEP CHANGE	TO 0.001% OF STEP CHANGE
Bypassed	F1	2 ms	20 ms
Fast	F0 or F3	40 ms	50 ms
Slow	F or F2	400 ms	500 ms

NOTES: (DC Ratio)

¹A = 10V dc range accuracy for the appropriate period of time.

B = Input signal function and range accuracy for the appropriate period of time.

V_{min} = Minimum allowable External Reference Voltage = $\pm 0.0001V$, or $V_{input} / 10^9$ (whichever is greater).

$|V_{xref}|$ = Absolute value of the External Reference Voltage

²Ohms Guard is available through the rear input.

Table 1-3. Specifications (cont)

DC RATIO (cont)

Operating Characteristics (cont)

Digitizing Time For 2^9 to 2^{17} samples per reading digitizing time is from 196 ms to 9 minutes 6 seconds using a 60 Hz ac line with times increasing 20% using a 50 Hz ac line. Selectable in 18 binary steps.

MAXIMUM RATIO DISPLAY +1.00000 E±9

EXTERNAL TRIGGER INPUT

Polarity May be wired internally for either rising or falling edge. Factory wired for falling edge.

High Level +4.3V (minimum)

Low Level +0.7V (maximum)

Pulse Width 10 μ s (minimum)

Connector BNC with the outer shell at interface common

Maximum Input ± 30 V

Maximum Shell to Ground Voltage ± 30 V

SCAN ADVANCE OUTPUT

Polarity Positive

High Level >+4V (TTL High)

Low Level <+0.7V (TTL Low)

Pulse Width 3 μ s (minimum)

Connector BNC with the outer shell at interface common

Maximum Shell to Ground Voltage ± 30 V

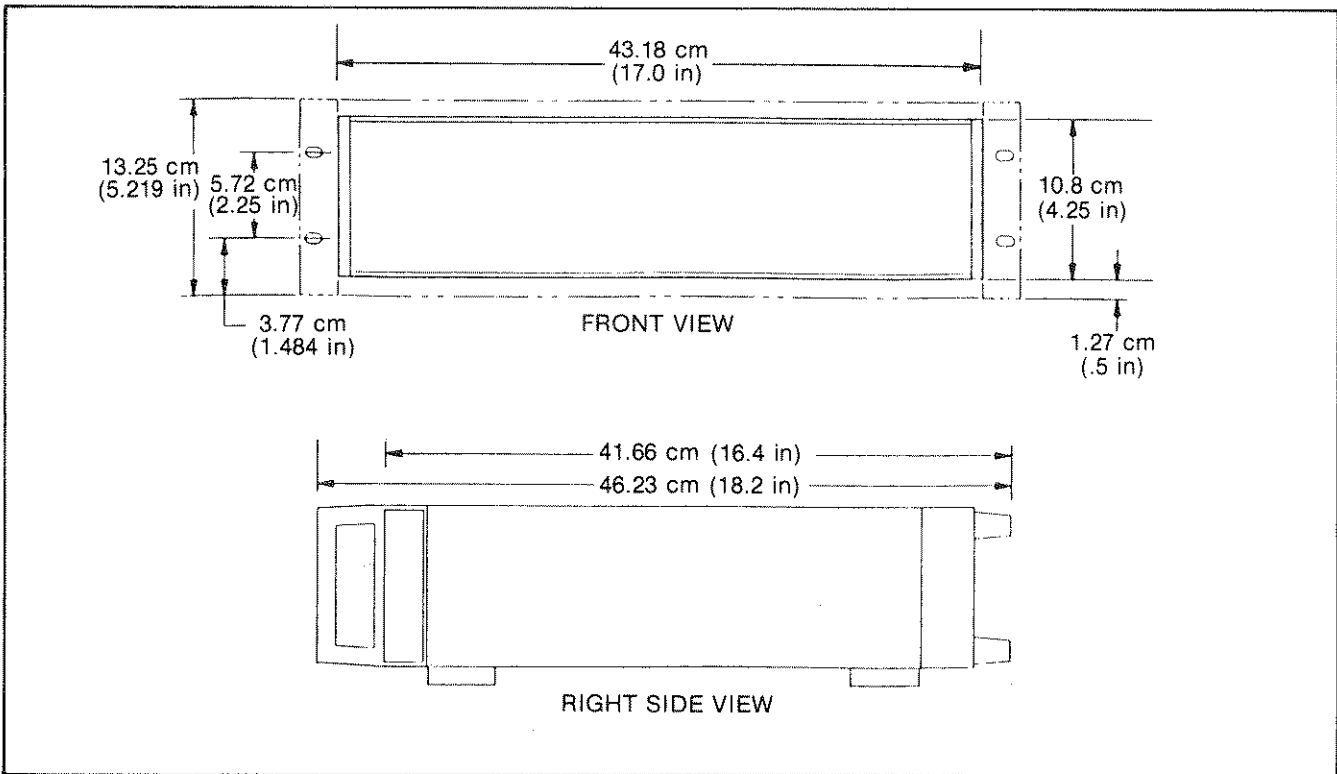

Figure 1-1. Dimension Drawing

Section 2

Operating Instructions

2-1. INTRODUCTION

2-2. Installation and operation of the multimeter are explained in this section. These instructions should be read thoroughly prior to multimeter operation. Once a familiarization with the instrument is achieved, parts of this section will serve as a quick reference. Explanations and applications are provided for all standard functions and operations. Should any difficulties arise, contact your nearest Fluke Sales Representative (listed in Section 7) or the John Fluke Mfg. Co., Inc.; P.O. Box C9090; Everett, WA. 98206; tel. (206) 342-6300).

2-3. SHIPPING INFORMATION

2-4. The multimeter is packaged and shipped in a foam-packed container. Upon receipt of the instrument, a thorough inspection should be made to reveal any possible shipping damage. Special instructions for inspection and claims are included with the shipping container.

2-5. If reshipment is necessary, the original container should be used. If the original container is not available, a new container can be obtained from John Fluke Mfg. Co., Inc. Please reference the instrument model number when requesting a new shipping container.

2-6. INSTALLATION

2-7. Non-marring feet and a tilt-down bail arrangement are installed on the instrument for field or bench use. A rack-mounting kit and rack slides are available for use with the standard 19-inch equipment racks. Information regarding installation and rack-mounting accessories is contained in Section 6.

2-8. The multimeter operates from 100, 120, 220, or 240V ac ($\pm 10\%$) at 50 or 60 Hz. Line voltage selection must be verified before the power cord is connected. This verification procedure is explained in Section 4.

WARNING

TO AVOID ELECTRICAL SHOCK, PROPERLY GROUND THE CHASSIS. A GROUND CONNECTION IS PROVIDED ON THE THREE-PRONG POWER CONNECTOR. IF PROPER GROUND IN YOUR POWER SYSTEM IS IN DOUBT, MAKE A SEPARATE GROUND CONNECTION TO THE REAR PANEL CHASSIS BINDING POST. OTHERWISE, THE POSSIBILITY OF ELECTRICAL SHOCK MAY EXIST IF HIGH VOLTAGE IS MEASURED WITH THE LEADS REVERSED (INPUT HI GROUNDED).

2-9. OPERATING FEATURES

2-10. Front and rear panel features are illustrated in Figure 2-1 and described in Table 2-1. Use this information for initial familiarization with the multimeter. A full explanation of all features is presented later in this section.

2-11. OPERATING NOTES

2-12. Input Power

2-13. A binding post on the rear panel has been provided as an earth ground connection. Line voltage selection (100, 120, 220, or 240V ac) is explained in Section 4. With the exception of proportionately slower reading rates and filter time-outs, operation at 50 Hz is identical to that at 60 Hz.

2-14. The line fuse (0.5A MDL Slow Blow for 100 or 120V ac, or 0.25 MDL Slow Blow for 220 or 240V ac) is located on the lower right side of the rear panel (in the heat sink). The current and ohms protection fuse (1.5A AGC) is located in the lower right-hand corner of the front panel for front input connections and on the left side of the rear panel (as seen from the rear) for rear input connections. Refer to Fuse Replacement in Section 4 before replacing any fuse.

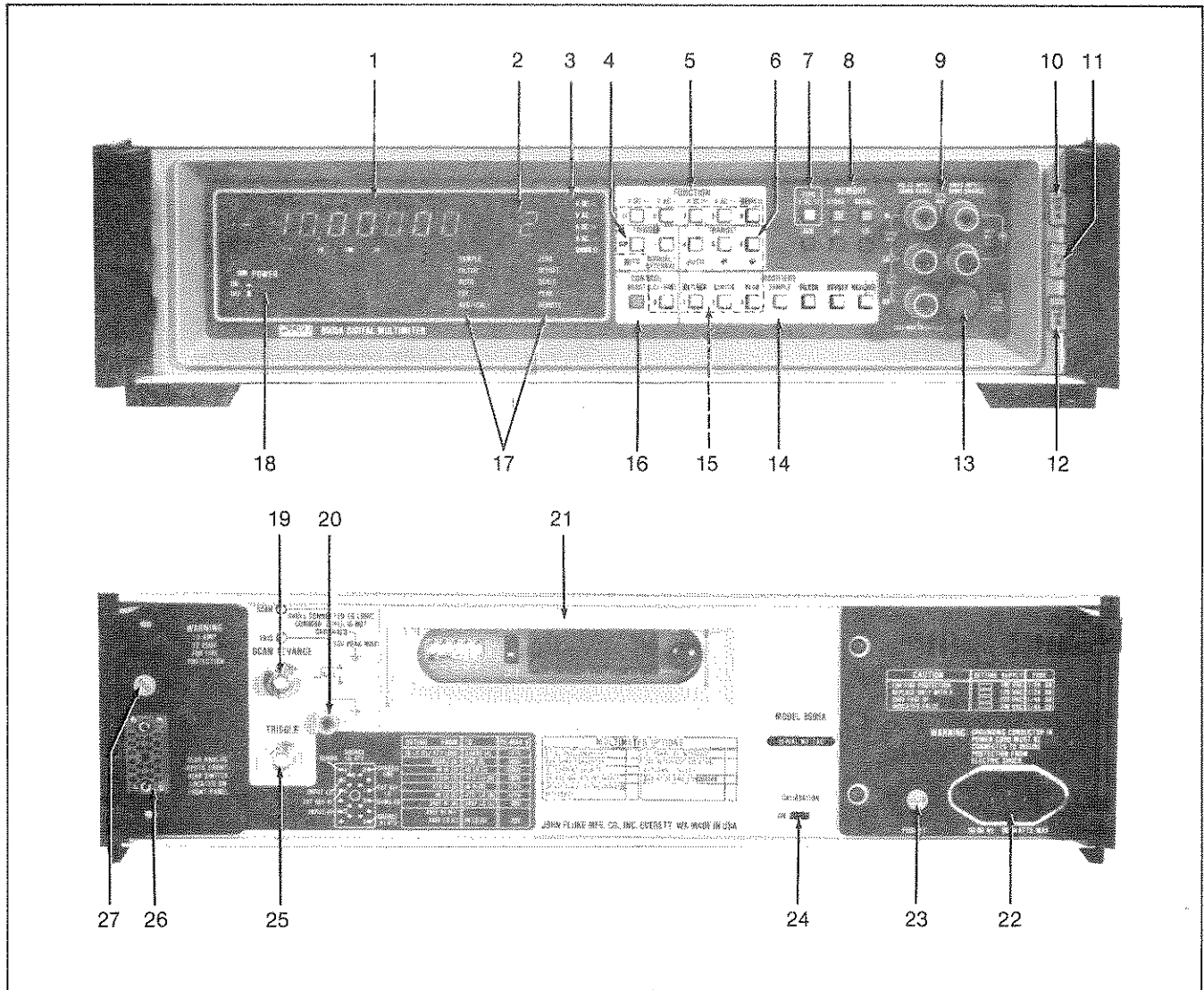

Figure 2-1. Controls, Indicators, and Connectors

Table 2-1. Controls, Indicators, and Connectors

ITEM	NAME	DESCRIPTION
1	Mantissa Field	Displays 5½, 6½ or 7½ digits with polarity and decimal point. Also displays errors and warnings, prompts, numerics, recalled values, and limits indications.
2	Exponent Field	Polarity and value of exponent shown for engineering notation of display value. In Averaging or Calibration mode, the exponent may be used as an extra digit of resolution.
3	Function Annunciators	Annunciator lights to indicate function selection. V DC and V AC annunciators will both light when respective functions are simultaneously selected and the RMS Converter is installed.
4	TRIGGER Push Buttons	TRIGGER push buttons used to select continuous (AUTO) or individual (MANUAL/EXTERNAL) measurement triggers.

Table 2-1. Controls, Indicators, and Connectors (cont)

ITEM	NAME	DESCRIPTION
5	FUNCTION Push Buttons	Used to select any of six measurement functions: voltage (V DC, V AC, or V DC and V AC), current (A DC or A AC), or resistance (OHMS).
6	RANGE Push Buttons	AUTO toggles into/out of Autoranging mode, changing range only when necessary. The up/down buttons exit Autoranging and increase/decrease one range with first use, step up/down one range with each additional use.
7	ZERO Push Button	Used to toggle into/out of the Zero mode (V DC or OHMS only). A new zero value is stored each time the mode is entered. This value is applied to the selected range and to all higher ranges within the same function. Also used to recall zero values. Refer to text for use with Calibration Memory.
8	MEMORY Push Buttons	STORE is used to initiate memory entry for displayed values or numeric entries. RECALL commands display of a memory value. HI and LO are used when storing or recalling limits, or when recalling peak values.
	Average Push Button	AVG toggles into/out of Averaging mode.
9	Input Terminals	Measurement connection terminals.
10	Guard Selector	GUARD is connected to SENSE LO when disengaged (out); GUARD is floated to allow external connection when engaged (in).
11	Ohms Selector	Push in for 4-wire ohms measurement using OHMS SENSE (HI, LO) and OHMS SOURCE (HI, LO) terminals. Push again to disengage for 2-wire ohms measurements using OHMS SENSE (HI, LO) terminals.
12	Rear Input Selector	Push in to connect rear analog input terminals and disconnect front terminals. Push again to disengage, reconnecting front terminals and disconnecting rear terminals. Position of the switch can be sensed remotely.
13	Current/Ohms Fuse	Use AGC 1.5A.
14	MODIFIERS Push Buttons	SAMPLE and FILTER modify the manner in which a reading is taken (measurement parameters). EXT REF, OFFSET, and SCALING modify the reading value (mathematic operations). LIMITS and PEAK modify the usage of the measurement value (special operations).
15	Numeric Entry Push Buttons	When enabled by initially pushing the STORE button, these push buttons can be used to enter numerics, exponents and related polarity signs.
16	CONTROL Push Buttons	<p>RESET initiates a power-up reset.</p> <p>LCL/RMT usage depends on the remote interface in use:</p> <ol style="list-style-type: none"> a. If the IEEE Interface (-05) is used, LCL/RMT toggles from remote to local, but not from local to remote. b. If the Bit Serial (-06) or Parallel (-07) Interface is used, LCL/RMT toggles between local and remote.

Table 2-1. Controls, Indicators, and Connectors (cont)

ITEM	NAME	DESCRIPTION
17	Status Annunciators	SAMPLE flashes to show a new reading in progress. FILTER lights whenever slow filter is selected. AUTO lights for Autoranging. EXT lights when External Reference is enabled (disables Scaling). AVG/CAL lights (steady) for Averaging or flashes for Calibration mode. ZERO lights when a V DC or OHMS zero correction value is in use. OFFSET lights when Offset mode is enabled. SCALE lights when Scaling mode is selected (disables Ext Ref). PEAK lights when Peak mode is enabled. REMOTE lights when the multimeter is controlled through a remote interface.
18	POWER Switch	Push ON/push OFF. The Calibration switch (item 24) must be off before cycling power on or off.
19	Scan Advance Output	TTL compatible output signals to external scanner (50-ohm output impedance).
20	Chassis Ground	Binding post for ground connections.
21	Remote Interface Access Port	Connector on optional remote interface module accessible here.
22	Power Connector	Three-prong connector accepting line cord with ground wire.
23	Line Fuse	Use ½A Slow Blow for 100 or 120V ac, ¼A Slow Blow for 220 or 240V ac. Refer to Fuse Replacement in Section 4.
24	Calibration Switch	Activates Calibration mode (AVG/CAL) annunciator flashes).
25	External Trigger Input	Enabled by front panel MANUAL/EXTERNAL push button.
26	Rear Analog Input Connection	Alternate connections for all front panel inputs — enabled when Rear Input Selector on front panel is pushed in. EXT REF HI and LO inputs are also included, but are not switched by the Rear Input Selector.
27	Rear Input Fuse	Use AGC 1.5A.

2-15. Required Hardware

2-16. The multimeter must be equipped with the following modules for standard operation (dc volts).

1. Controller (blank display if not installed)
2. Active Filter (Error 2 if not installed)
3. A/D Converter (Error 5 if not installed)
4. Isolator (Error 9 at power-up if not installed)

2-17. Additional modules are necessary when using the multimeter in ac volts, dc current, ac current, or resistance

functions or for remote control. Separate modules for averaging ac or rms ac measurements are available; only one of these modules may be installed at one time. If it is necessary to check, install or replace modules, refer to Module Installation and Removal procedures in Section 4.

2-18. An "Error 9" indication appears in the multimeter display whenever an optional function is selected and the respective function module is faulty or missing. At power-up, the multimeter identifies all installed options by displaying "CXXXXXX" ("X" = Option number). An "8" in the exponent display identifies an installed Isolator.

2-19. Power-Up Configuration

2-20. At power initialization, or whenever the RESET button is pushed, the multimeter assumes the power-up configuration. Basically, the instrument assumes the V DC function with all modes and values disabled. The power-up configuration is fully defined in Table 2-2.

2-21. Display

2-22. MEASUREMENT READING

2-23. The measurement display consists of mantissa and exponent fields. The mantissa presents polarity, 5-1/2, 6-1/2, or 7-1/2 digit resolution (range and function dependent) and automatic decimal placement. In addition, the mantissa displays numeric storing entries, recalled values, error and warning information, and interactive programming information (prompts). Decimal point positions are labeled (1, 10, 100, 1k) to correspond with range settings (as defined in Figure 2-3).

2-24. When very large or small readings are displayed, the exponent field is also used to maintain maximum

resolution. A negative or positive exponent field polarity indicates multiplication of the mantissa by the displayed power of ten (-3 means .001, +3 means 1000). Exponent values of -6, -3, +3, or +6 are available for displayed readings. Additional exponents of -9 and +9 are available for offset and scaling numeric entries.

2-25. When the Averaging mode is selected, the exponent may serve as an additional digit of resolution. When the Limits mode is selected, the entire measurement display is devoted to an indication of HI, LO, or PASS.

2-26. ANNUNCIATORS

2-27. Any valid function selection causes one of the function annunciators (V DC, V AC, A DC, A AC, OHMS) to light. The V DC annunciator normally lights in the power-up or reset configuration. However, if the DC Signal Conditioner module is faulty or not installed and a functional RMS Converter module is installed, power-up or reset causes the V AC annunciator to light. Two function annunciators (V DC and V AC) light when

Table 2-2. Default Configurations

Function	POWER-UP OR RESET		SELECTION OF NEW FUNCTION (1)	
	CONDITION	DISPLAY	CONDITION	DISPLAY
	DC Volts	V DC on	New Function	VDC,VAC,ADC, AAC or OHMS on
Range	1000V Manual	AUTO off	Autoranging	AUTO on
Trigger	Auto	SAMPLE flashes	Retains Previous Trigger Mode	SAMPLE flashing or off
Filter	F0	FILTER off	Retains Previous Filter Mode (2)	FILTER on or off
Sample	7	SAMPLE flashes	Retains Previous Sample Setting (2)	SAMPLE flashes
Offset	Off, Value 0	OFFSET off	Off, retains value	OFFSET off
Scaling	Off, Value 1	SCALE off	Off, retains value	SCALE off
External Reference	Off, Note 3	EXT REF off	Off, retains last value	EXT REF off
Limits	Off, Value 0	Normal Display	Off, retains last value	Normal Display
Peak	Off	PEAK off	Off, retains last values	PEAK off
Averaging	Off	AVG/(CAL) not on steady	Off (2)	AVG/(CAL) not on steady
Zero	On, Cal Memory Values	ZERO on	Retains mode values and state (4)	ZERO on (VDC,OHMS) or off
Calibration Mode	Note 4		Note 4	
Notes:				
1. Re-selection of the same function sets autoranging (AUTO on), but retains all other mode values and states.				
2. Disabling Average mode (by changing to a new function) sets filter mode F0 and sample setting 7. If the same function is re-selected, the state of Average mode is not changed, and the existing filter mode and sample setting are retained.				
3. The External Reference value is initialized to the multimeter software number whenever power-up or reset occurs. RECALL EXT REF can then be used to display this number. Any subsequent activation of External Reference mode replaces the software number with the actual external reference value.				
4. The Calibration mode state is on or off solely dependent on the position of the rear panel Calibration Switch. Do not cycle power on or off with this switch ON.				
Calibration mode entries are applied to the reading as follows:				
a. Gain correction factors are always applied (Calibration mode on or off).				
b. Zero values are applied whenever Zero mode is on or off (Calibration mode on or off, VDC or OHMS selected). However, the zero values used depend on the Calibration mode state.				
Modes			Zero applied	
Cal mode on, zero off			Nothing	
Cal mode on, zero on			Permanent Zero	
Cal mode off, zero off			Permanent Zero	
Cal mode off, zero on			Permanent Zero and Temporary Zero	

the V DC and V AC push buttons are pressed simultaneously and the RMS AC Converter module is installed.

2-28. Status annunciators light to signify various modes of operation. Annunciators (as defined in parentheses) light when any of the following modes are enabled: Peak (PEAK), Scaling (SCALE), or External Reference (EXT), Averaging (AVG/CAL), Offset (OFFSET), Autoranging (AUTO), or V DC/Ohms Zero (ZERO). The FILTER annunciator lights (steadily) whenever the slow filter is selected. The SAMPLE annunciator flashes at the reading (display update) rate for sample settings from 0 through 7. The flash rate for setting 0, 1, or 2 is very rapid: SAMPLE appears steadily on. For sample settings from 8 through 17, the SAMPLE annunciator flashes at the sample setting 7 rate only. Since these higher sample settings may require considerable time for a display update, this feature is necessary to insure that the operator is aware of a reading in progress. With a distinctive display of HI, LO, or PASS, the Limits mode requires no separate status annunciator.

2-29. OVERRANGE INDICATION

2-30. The measurement display presents a distinct indication when overrange inputs are detected. An input voltage exceeding the full scale value for the range selected causes HHHHHH to flash. Overage points for each range are defined in Table 2-3.

2-31. WARNING INDICATION

2-32. When in the Scaling, External Reference, Offset or Limits mode, there may be no readily discernible display of the true measurement value. Therefore, a single H is flashed in the exponent display when the voltage is 30V or higher at either the front panel input connections or the rear panel external reference terminals.

NOTE

Flashing indicators in the digit or exponent display are a warning only; they have no effect on instrument operation.

2-33. ERROR CODES

2-34. Error codes offer considerable help in identifying improper procedures or equipment configurations. These codes are explained in Table 2-4.

2-35. INTERACTIVE PROGRAMMING INFORMATION

2-36. The multimeter displays prompting messages during STORE and RECALL operations. Whenever the STORE button is pushed, the display responds with "?". The operator may now designate either the displayed value or keystroked numerics as the programming entry. If the displayed reading is being stored, pushing the appropriate terminator button (FILTER, SAMPLE, SCALING, HI OR LO - for LIMITS or OFFSET)

Table 2-3. Measurement Ranges

FUNCTION	DECIMAL POINT POSITION FOR RANGE INDICATED				EXP	OVERRANGE	UNDERRANGE	DIGITS
	1	10	100	1k				
V DC			100 mV		-3	200 mV	—	6½
	1V	10V	100V	1000V		2V	.17V	6½
V AC	1V	10V	100V	1000V		20V	1.7V	6½
						128V	12V	6½
A AC	1 mA	10 mA	100 mA		-6	1200V	120V	6½
	1A				-3	2.5V	—	5½
A DC	1 mA	100 µA	100 mA		-3	20V	1.875V	5½
	1A	10 mA			-3	160V	15V	5½
OHMS		10	100		-3	1000V	120V	5½
	1K	10K	100k		+3	312.5 µA	—	5½
					+3	2.5 mA	234 µA	5½
	1M	10M	100M		+3	20 mA	1.875 mA	5½
					+6	160 mA	15 mA	5½
					+6	1.28 mA	120 mA	5½
					+6	250 µA	—	5½
					+6	2 mA	187 µA	5½
					+6	16 mA	1.5 mA	5½
					+6	128 mA	12 mA	5½
					+6	1.28A	124 mA	5½
					+6	20Ω	—	5½
					+6	200Ω	18Ω	5½
					+6	2 kΩ	180Ω	6½
					+6	25 kΩ	1.8 kΩ	6½
					+6	250 kΩ	18 kΩ	6½
					+6	4.1 MΩ	180 kΩ	5½
					+6	35 MΩ	1.8 MΩ	5½
					+6	265 MΩ	18 MΩ	5½
					+6			5½

Table 2-4. Error Codes

MOMENTARY ERROR CONDITIONS

(The reading in progress is aborted, but multimeter operation is automatically restored with the next trigger. The function annunciator remains on during a momentary error condition.)

CODE	FAULT	SOLUTION
Error 0	V DC/Ohm Zero, zero attempted in wrong function (not V DC or OHMS) or an overrange has been entered.	Check function. Only V DC and OHMS are permissible.
Error 1	Store attempted during overload condition.	Change to higher range or (if storing cal correction factors) use lower value source.
Error 6	Display overflow error.	Check offset and scaling values.
Error 7	External Reference error - voltage on one input exceeds 20V dc.	Revise external reference input.
Error 8	Controller module is faulty.	Power off; replace controller module.
Error b	Illegal push button sequence in Calibration mode.	Wait till display clears. Use correct sequence.
Error C	Invalid push-button sequence, or illegal value entered.	Wait till display clears. Use correct sequence or value within limits.
Error d	Calibration Memory faulty or not installed. Occurs when storing into, or recalling from, Calibration Memory, or at power-up.	Replace or install Calibration Memory chip.
Error F	Cal Memory check-sum problem.	Try new power-up. If necessary, reprogram Cal Memory. Replacement of Calibration Memory may be required.
Error H	Ohms connection problem.	Verify that all connections are proper. Check input fuses. Check input lead polarity in four-terminal connections.

LATCHING ERROR CONDITIONS

(A valid function must be selected to restore multimeter operation. All function annunciators are off during a latching error condition.)

Error	System error, usually appears at power-up or reset.	Repeat power-up or reset.
Error 2	Filter module faulty or not installed.	Power off; replace or install filter module.
Error 3	DC Signal Conditioner module faulty or not installed.	Power off; replace or install DC Signal Conditioner module.
Error 4	OHMS, A DC, or A AC error.	Check for improper input level. Check function causing error indication. Applicable module may need replacement or installation.
Error 5	Analog to Digital Converter Module error.	Power off; replace or install Analog to Digital Converter module.
Error 9	Function selection error. The function module selected is faulty or not installed. V DC problem causes Error 3.	Select valid function to clear error condition. Power off; replace or install appropriate module.
Error E	More than one ac converter, or the wrong ac converter, is installed. Also appears when Calibration Memory module is installed.	Power off, remove one ac converter, or install correct converter, or remove the Calibration Memory module (the multimeter uses a separate Calibration Memory as part of the Controller).

completes the operation. The multimeter adopts both the mode specified with the terminator and the value previously displayed. If keystroked numerics are being stored, the multimeter displays the digits as they are entered from the front panel. Once all numbers for a particular mode are entered, the appropriate terminator button is pushed. For either method, the display now resumes the measurement reading function or, if HI or LO were specified as the terminator, begins reading HI, LO, or PASS.

2-37. The RECALL button commands a display of a stored factor or value. The procedure requires the following two steps when recalling the offset value, the scaling factor, the filter mode, the sample setting, or the zero value:

1. Push the RECALL button (display responds with "?").
2. Push the appropriate terminator button (OFFSET, SCALING, FILTER, SAMPLE or ZERO). The respective value is displayed as long as the terminator button is held depressed. Once the terminator button is released, the multimeter resumes operation; no mode or value is changed.

2-38. The following three push button steps are required to recall a limit or peak value.

1. Push RECALL (display responds with "?").
2. Then specify whether upper or lower limit or peak is desired by pushing HI or LO (display responds with "YES?").
3. Finally, push the appropriate terminator button (LIMITS or PEAK).

2-39. Front Panel Push Buttons

2-40. The multimeter employs 25 color-coded push buttons on the front panel. Most of the push buttons control more than one function. For example, many mode control push buttons also serve as numeric entry push buttons when used during a store operation. The number of keystrokes required for any operation is kept to a minimum. Refer to Figure 2-2 for a description of each push button and, where applicable, examples of typical programming operations.

2-41. Operation of the multimeter is straightforward. Preset measurement configurations are made at power-up, reset, or function selection. Programmed values are retained whenever the range or function is changed. Desired mode changes are made independently following a programming hierarchy of:

1. Measurement Parameters
2. Mathematic Operations
3. Special Operations

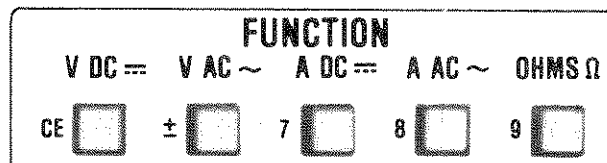

The FUNCTION push buttons allow selection of the analog measurement function. Available functions include: dc volts (V DC), ac volts (V AC), dc current (A DC), ac current (A AC), and resistance (OHMS — two wire or four wire).

V DC



Push V DC for dc voltage measurements with 6½-digit resolution (V DC annunciator lights). This function is standard for the multimeter (no optional module required). Five ranges are available: 1000V, 100V, 10V, 1V, and 100 mV.

V AC



Push V AC for ac voltage measurements with 5½-digit resolution (V AC annunciator lights). This function can be used with either the -01 Averaging Converter or the -09A RMS Converter. Four ranges are available: 1000V, 100V, 10V, and 1V.

A DC



Push A DC for dc current measurements with 5½-digit resolution (A DC annunciator lights). This function can be used with the -03 Current Shunts module installed. Five ranges are available: 1A, 100 mA, 10 mA, 1 mA, and 100 μA.

A AC



Push A AC for ac current measurements with 5½-digit resolution (A AC annunciator lights). This function can be used when the -03 Current Shunts module and either the -01 Averaging Converter or the -09A RMS Converter is installed. Available ranges are identical to those in the A DC function.

Figure 2-2. Front Panel Push Buttons

OHMS

Select the OHMS function to make resistance measurements (OHMS annunciator lights). The -02A Ohms Converter must be installed. Eight resistance ranges are available: 100 M Ω , 10 M Ω , 1 M Ω , 100k Ω , 10 k Ω , 1 k Ω , 100 Ω and 10 Ω .

NOTE

Either two-wire or four-wire resistance measurements can be made. Refer to Measurement Terminals and Controls.

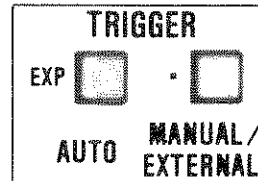
**AUTO**

The AUTO (trigger) push button selects the Auto Trigger mode. A flashing SAMPLE annunciator verifies Auto Trigger operation.

Initial use of the MANUAL/EXTERNAL push button disables the Auto Trigger mode (SAMPLE annunciator stops flashing), enables the front panel Manual Triggering mode, and arms the External Triggering mode. Each succeeding use of the MANUAL/EXTERNAL push button triggers a new measurement: any reading already in progress is aborted and the new reading begun immediately. The SAMPLE annunciator verifies that a measurement has been triggered by flashing once, or several times (if the sample-per-reading setting is greater than 7, 2 exponent 7 = 128 samples). An external trigger applied through the rear panel external trigger jack similarly commands a new reading. An external trigger applied simultaneously with a front panel manual trigger will be ignored. AUTO must be pushed to reenter the Auto Triggering mode.

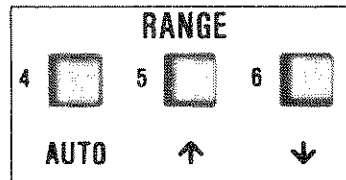
**MANUAL/
EXTERNAL****AUTO**

AUTO RANGE toggles into/out of the Autoranging mode, changing the existing range if necessary. When enabled (AUTO annunciator lighted), Autoranging automatically selects a range that displays the measurement with maximum resolution.



Each use of this manual ranging push button selects the next higher available range. If AUTO RANGE was previously activated, use of the uprange push button toggles out of Autoranging (AUTO annunciator off) and steps to the next higher range. No range change is effected if the multimeter is already in the highest range.



Use of the down-range push button causes the multimeter to toggle out of Autoranging (AUTO annunciator off) and assume the next lower available range. Each successive use of the down-range button selects the next lower range. This push button has no effect once the multimeter is in the lowest available range.

Figure 2-2. Front Panel Push Buttons (cont)

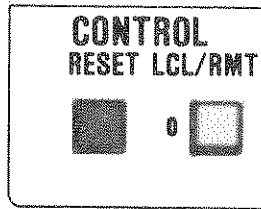
**RESET**

CAREFUL: The RESET push button is powerful: all modes and stored values (other than calibration factors) are lost if RESET is pressed. Once RESET is used, the multimeter assumes the Power-Up configuration (without actual power loss). Temporary zero values are replaced with zero values stored in Calibration Memory.

LCL/RMT

Depending on the remote interface being used, pushing the LCL/RMT button may cause one of three multimeter responses.

- 1.) If the -05 IEEE Interface is installed, LCL/RMT may be used to command local (front panel) control only if the multimeter is already in remote (REMOTE annunciator lighted). The push button has no effect if the multimeter is already in local.
- 2.) If the -06 Bit Serial Interface or the -07 Parallel Interface is installed, LCL/RMT may be used to toggle into/out of local control at any time.
- 3.) If no remote interface is installed, use of LCL/RMT causes a latching error condition.

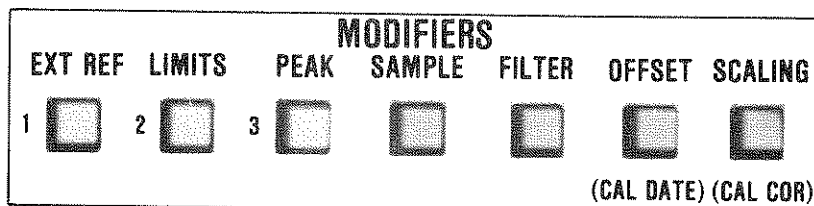
**EXT REF**

The EXT REF button toggles into/out of the External Reference mode. Either External Reference or Scaling may be enabled: selection of one mode disables the other. After power-up or reset, RECALL EXT REF can be used to identify the software version.

NOTE

The external reference voltage, applied through the rear input connector, can be read in the display while EXT REF is held depressed.

LIMITS

The LIMITS push button toggles into/out of the Limits mode without changing stored limits values. A display of HI, LO, or PASS denotes use of the Limits mode.

PEAK

The PEAK push button toggles into/out of the Peak mode. While in the Peak mode (PEAK annunciator lighted), a continually updated record of the highest and lowest reading values is stored. These values are also held in memory after the mode is disabled. Reentry into the PEAK mode erases previously recorded values and begins a new recording.

SAMPLE

Different reading rates can be specified by selecting the number of samples averaged per measurement. There are two methods for making this selection.

- 1.) The SAMPLE button can be pushed to toggle between two commonly used reading rates: slow (1.9 readings-per-second, SAMPLE annunciator flashes slowly) and fast (7.5 readings-per-second, SAMPLE annunciator flashes rapidly).

Figure 2-2. Front Panel Push Buttons (cont)

- 2.) Any of 18 different reading rates can be specified using the following push button sequence:

STORE (0-17) SAMPLE

The SAMPLE annunciator now flashes at a specified rate. For settings of 0-7, this rate is the reading rate. For the slower settings of 8-17, a single rate is preset to indicate a reading in progress.

FILTER



Two methods are available for filter selection.

- 1.) By toggling the FILTER push button, the operator can select mode F (no mode number) or F0 (mode number 0).
- 2.) The following sequence can be used to select any of the five filter modes:

STORE (mode number) FILTER

MODE NUMBER	FILTER	TIMEOUT	FILTER LED
(blank)	slow	none	on
0	fast	none	off
1	bypass	none	off
2	slow	550 ms	on
3	fast	50 ms	off

(No Mode Number is used for slow filter without timeout. Push STORE FILTER.)

OFFSET



The OFFSET push button can be used to toggle into/out of the Offset mode (OFFSET annunciator lights). Two methods are available for simultaneously entering an offset value and activating the Offset mode.

- 1.) A numeric value may be entered using a store sequence. For example, store an offset of 1.25 as follows:

STORE 1 . 2 5 OFFSET

- 2.) A displayed reading can be stored as the offset value. Use the following sequence:

STORE OFFSET

NOTE

In some instances, the displayed value may not be an appropriate offset value. For example, if the displayed value is being used to zero the multimeter, it is important to verify that no other mathematic operations are in effect. In such a case, check that OFFSET, SCALING, and EXT REF annunciators are all off before storing a new offset value.

Figure 2-2. Front Panel Push Buttons (cont)

(CAL DATE)



When the multimeter is in the Calibration Mode (AVG/(CAL) annunciator flashes), the (CAL DATE) push button is used to enter six digits which either denote the date or identify the multimeter by number. Refer to Calibration Mode later in this section.

SCALING



The SCALING push button can be used to toggle into/out of the Scaling mode without affecting any scaling value already stored. Either of the following two methods can be used to store a new scaling factor and enable the Scaling mode:

NOTE

Verify that the displayed value is the desired scaling value. Any mathematic operations (SCALING, EXT REF, OFFSET) already in effect must be cancelled if the actual measurement is desired as the scaling value. To cancel any of these modes, toggle SCALING, EXT REF, or OFFSET and verify that the respective annunciators are dark.

1. Use the following sequence to store the display as a scaling factor:

STORE SCALING

2. Numeric entry scaling factors must be programmed using the following procedure:

STORE (numerics) SCALING

With either method, the Scaling mode is entered with the initial use of the SCALING button.

(CAL COR)



The (CAL COR) push button is used when storing calibration factors for each function and range, or when recalling uncorrected readings. Refer to Calibration Mode later in this section.

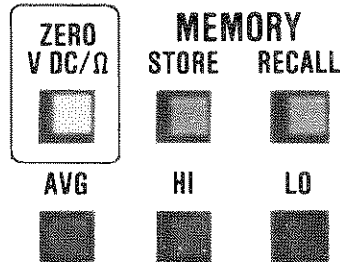

STORE



STORE is used as a first step in programming certain measurement parameters, mathematic operations, or special operations. STORE is the only push button that can activate the numeric entry keys. The multimeter prompts the second step by displaying "?". Following is a list of STORE operations:

Measurement Parameters:

	0-17	SAMPLE
STORE	0,1,2,3 or blank	FILTER

Figure 2-2. Front Panel Push Buttons (cont)

Mathematic Operations:

To store the displayed value as an offset or scaling value and enter the respective mode:

STORE { OFFSET
SCALING

To store a numeric entry as an offset or scaling value and enter the respective mode:

STORE (numerics) { OFFSET
SCALING

Special Operations:

To store the displayed value as a high or low limit and enter the Limits mode:

STORE { HI
LO

To store a numeric entry as a high or low limit and enter the Limits mode:

STORE (numerics) { HI
LO

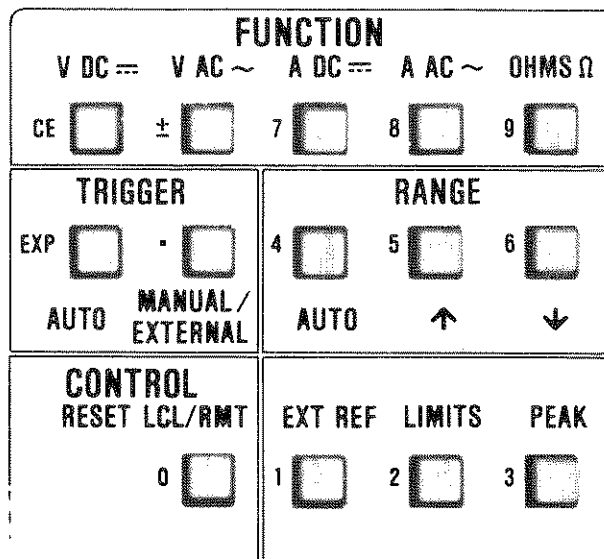

The multimeter utilizes fourteen dual purpose push buttons as numeric entry keys. When programming sample settings or filter modes, a one- or two-digit entry is necessary. When programming limits, or scaling and offset values, a longer entry may be required. Therefore, the following sequence is available:

Mantissa Field: enter a maximum of seven digits, with decimal point. Toggle polarity (\pm) button as required.

Exponent Field: push EXP button, then enter a single digit exponent. Toggle the polarity button again to set the exponent polarity.

Use the CE push button at any time prior to the terminator (last button in a store numeric sequence) to clear all numerics and revert to a "?" display. Fresh numerics may then be entered immediately.

Figure 2-2. Front Panel Push Buttons (cont)

RECALL



The RECALL push button can be pressed to recall and display values stored in the Limits, Peak, Scaling, Offset, Zero, External Reference, Sample or Filter modes. For recall of uncorrected readings, dates and identifiers, refer to Calibration Mode later in this section. No stored value is affected during the RECALL operation. The recalled value will be displayed as long as the last push button in the sequence is held depressed.

To recall measurement parameters:



To recall mathematic operation values:

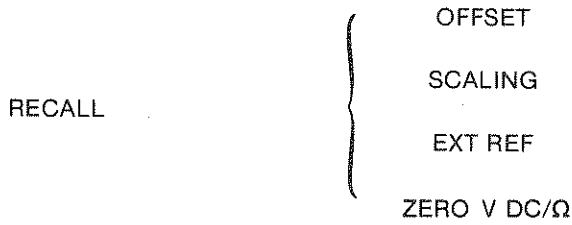

To recall a special operation value:

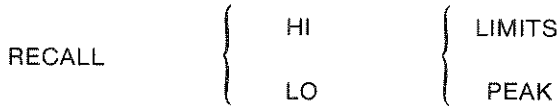

**ZERO
V DC/Ω**



The ZERO push button can be used to store a dc volts zero (any range) or ohms zero (any range). The zero value stored is also applied on all higher ranges in the same function. For discrete zero values on each range, zero must be stored sequentially on each range (from lowest to highest). With the initial button push, a new zero value is stored and the mode is enabled (ZERO annunciator on). Pushing ZERO a second time disables the mode, but retains the previous value. A new zero value is stored each time Zero mode is enabled. Refer to text for use with Calibration mode.

AVG



The AVG push button can be used to optimize sample and filter factors for each function and range combination. A stable reading is thereby assured. An additional digit (using the exponent display) is available in 10V dc range when in the Averaging mode.

HI



LO



The HI and LO push buttons are used to store or recall limit values and for recall only of peak values. Refer to STORE and RECALL push button descriptions for the applicable sequence.

Figure 2-2. Front Panel Push Buttons (cont)

2-42. Measurement parameters (range, sample, filter, trigger, averaging, zero) define all operations that affect the resolution, stability, and accuracy of the reading. For example, the range is specified to position the decimal point, and the filter mode may be changed to improve noise rejection.

2-43. Mathematic operations (External Reference or Scaling, Offset) alter the reading to operator requirements. For example, when Offset is used, only the difference between the reading and the offset value is displayed.

2-44. Special operations (limits, peak) specify how the reading is used. For example, Peak mode can be used to continuously update a record of the highest and lowest readings, or Limits mode may be used for a HI, LO, PASS display of the measurement reading. A comprehensive setup routine is summarized in Figure 2-3. All or part of this routine can be used to establish or change measurement parameters, mathematic operations, or special operations.

2-45. Error codes usually identify any programming problem and specify a solution (refer to Table 2-4). A numeric entry may be aborted at any time prior to termination by pushing the CE button. The multimeter responds by displaying "?": another numeric entry may now be made, or the displayed value may be stored by pushing the desired terminator button. A store or recall operation can be entirely aborted prior to execution by pressing STORE or RECALL a second time. The multimeter reverts to its state prior to the store or recall once a momentary Error C condition elapses.

NOTE

Errors due to thermal emf's should be considered when making low level, high resolution measurements. Thermal emf's (voltages produced by temperature differences between contacts of two dissimilar metals or by temperature gradients along a length of material) may cause differences of several microvolts. The use of low emf, shielded cables with copper spade lugs is recommended to minimize thermal emf errors.

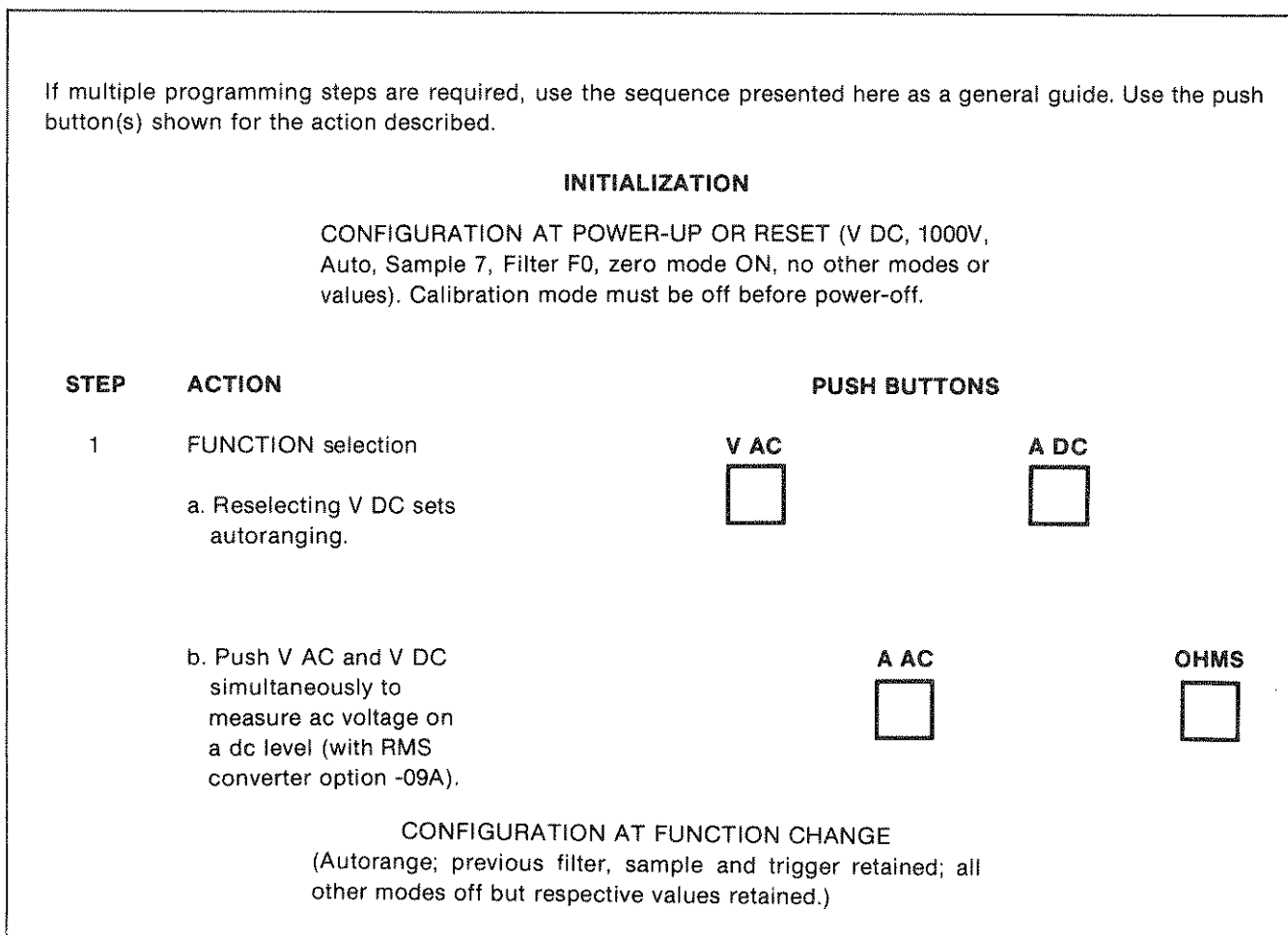

Figure 2-3. Programming Hierarchy

MEASUREMENT PARAMETERS

Measurement parameters establish reading resolution, noise rejection, stability and accuracy.

2 TRIGGER selection

a. If in manual, change to auto



AUTO

b. If in AUTO, change to manual



**MANUAL/
EXTERNAL**

c. Manual triggers

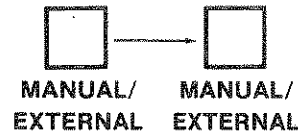

3 RANGE selection

a. Toggle into/out of autoranging



AUTO AUTO

b. Select manual ranging, step to next higher, lower range.



c. Continue stepping to available higher, (lower) ranges.

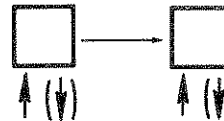

4 Reading Rate Selection

a. Toggle between sample settings 5 (2 exp 5 = 32) and 7 (2 exp 7 = 128)

SAMPLE SAMPLE



b. Select any sample setting from 0 (2 exp 0 = 1) to 17 (2 exp 17 = 131,072)

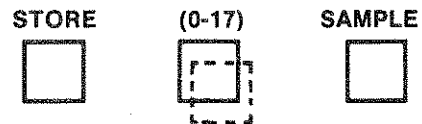
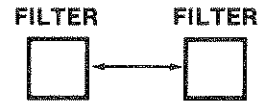
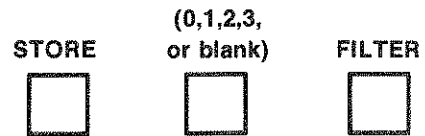

Figure 2-3. Programming Hierarchy (cont)

- 5 FILTER selection
- a. Toggle between filter F (slow) and F0 (fast)



- b. Select filter F, F0, F1, F2, or F3.



- 6 Averaging: toggle on/off (presets filter, sample)



- 7 V DC/OHMS Zero: toggle on/off (V DC or OHMS only). New zero stored each time mode is enabled. Refer to text for use with Calibration mode.



MATHEMATIC OPERATIONS

Stop here if only a direct measurement reading is desired. Further steps yield ratio, deviation, percentage variation and other special readings.

Refer to Applications in this Section for examples.

NOTE

Scaling (or External Reference) is applied first. The result of this operation is then offset.

- 8 SCALING selection (disables External Reference)

- a. Store displayed value, enter Scaling mode



- b. Store numeric value (non-zero), enter Scaling mode.

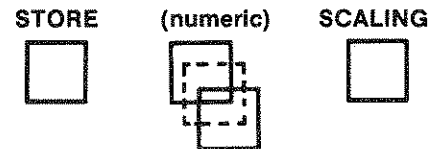

- c. Toggle into/out of Scaling mode while retaining value.

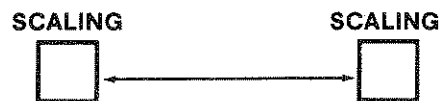
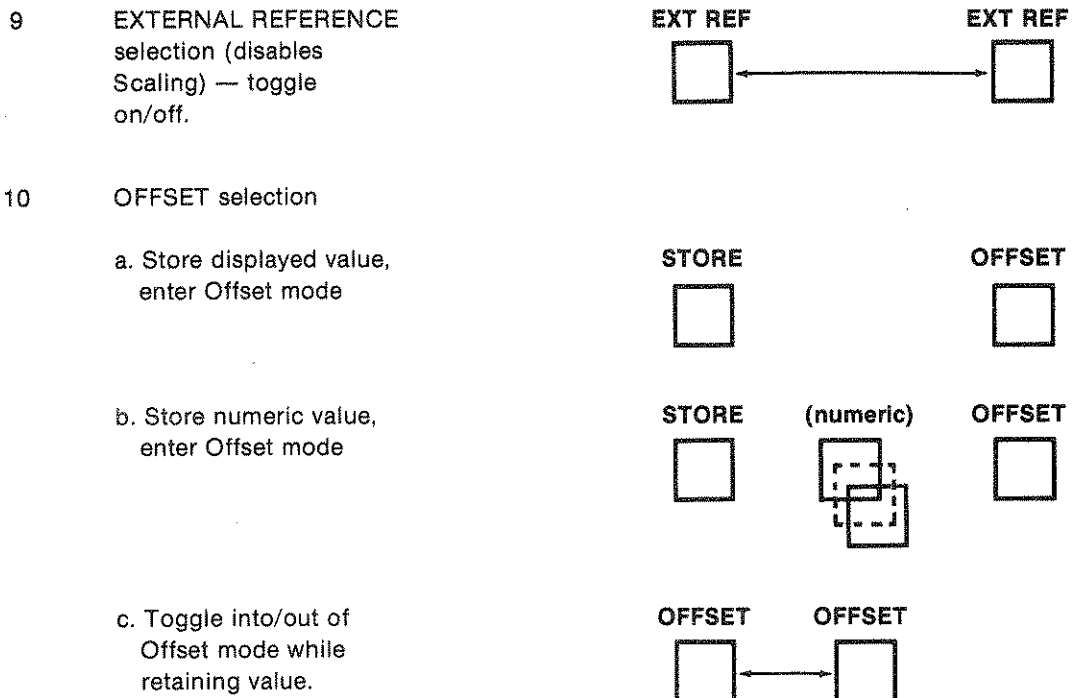

Figure 2-3. Programming Hierarchy (cont)



SPECIAL OPERATIONS

Use the reading, as modified by any math operations, for comparison with set limits, or record the reading maximum deviations.

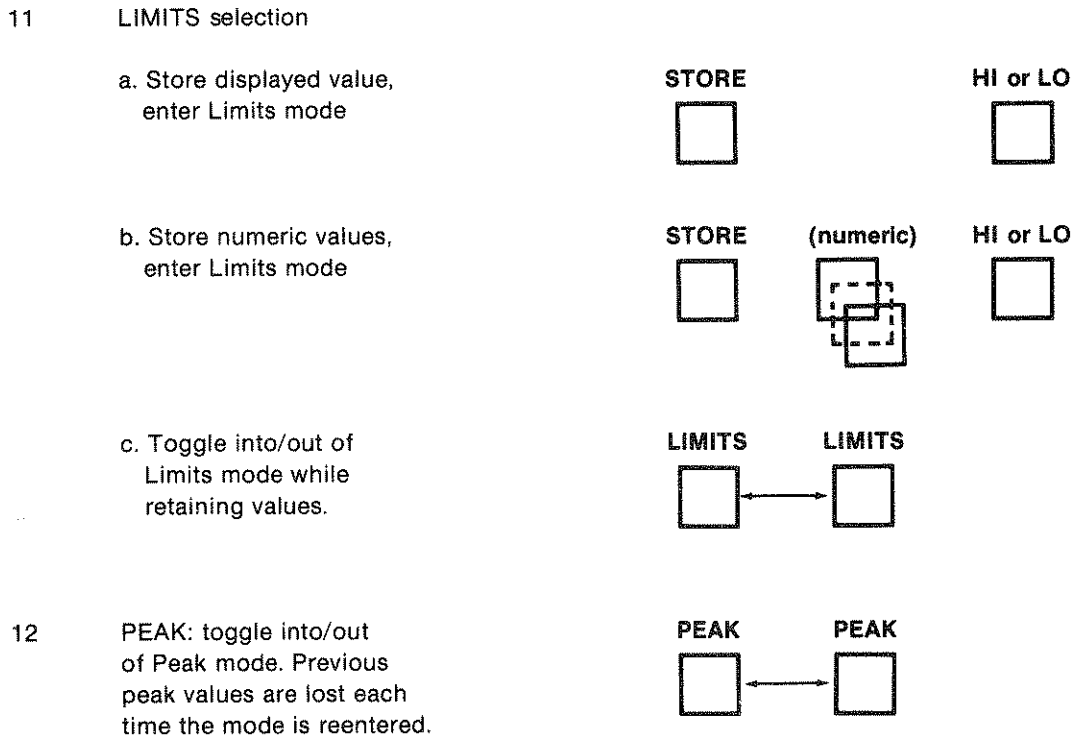

Figure 2-3. Programming Hierarchy (cont)

2-46. Measurement Terminals and Controls**2-47. GUARDING****2-48. General**

2-49. Guarding may be used to reduce noise and improve accuracy. Common mode voltages, resulting from currents and voltage drops between two points otherwise electrically common, may cause significant errors. Proper use of a floating, guarded multimeter minimizes these errors.

2-50. Generally, guarding should be employed where long signal leads are used, when signal source impedance is high, when making measurements near high-level radiated noise (particularly at the power line frequency), or when making floating measurements.

NOTE

Errors due to thermal emf's should be considered when making low level, high resolution measurements. Thermal emf's (voltages produced by temperature differences between contacts of two dissimilar metals or by temperature gradients along a length of material) may cause differences of several microvolts. The use of low emf, shielded cables with copper spade lugs is recommended to minimize thermal emf errors.

2-51. Guard Selector

2-52. Correct use of the multimeter GUARD terminal both protects the instrument and provides more accurate readings. The EXT GD IN selector, when disengaged (out), enables the internal guard connection. In many cases accurate measurements may be made with the selector in this position (shown as A in Figure 2-4). Here, the difference in potential between multimeter ground and device ground is very small, or the measurement is not critical. When pushed in, the selector disables the internal guard connection and allows for external guard connections as shown in B and C of Figure 2-4. The connection shown in B is better than that in A, since some common mode current (I_{CM}) is shunted away from the source resistance. The connection shown in C is necessary when the source may not be capable of driving the guard. The buffer amplifier shown in C prevents this source loading. Practical considerations usually dictate which of the three connections is used.

2-53. Guard Terminal

2-54. Recommended guard terminal connections are illustrated in Figure 2-4. The potential between GUARD and chassis ground must not exceed 500V. The potential between SENSE LO and GUARD must not exceed 127V.

2-55. VOLTS INPUT/OHMS SENSE (HI and LO) TERMINALS

2-56. The VOLTS INPUT/OHMS SENSE terminals are used when making voltage (dc and/or ac) and

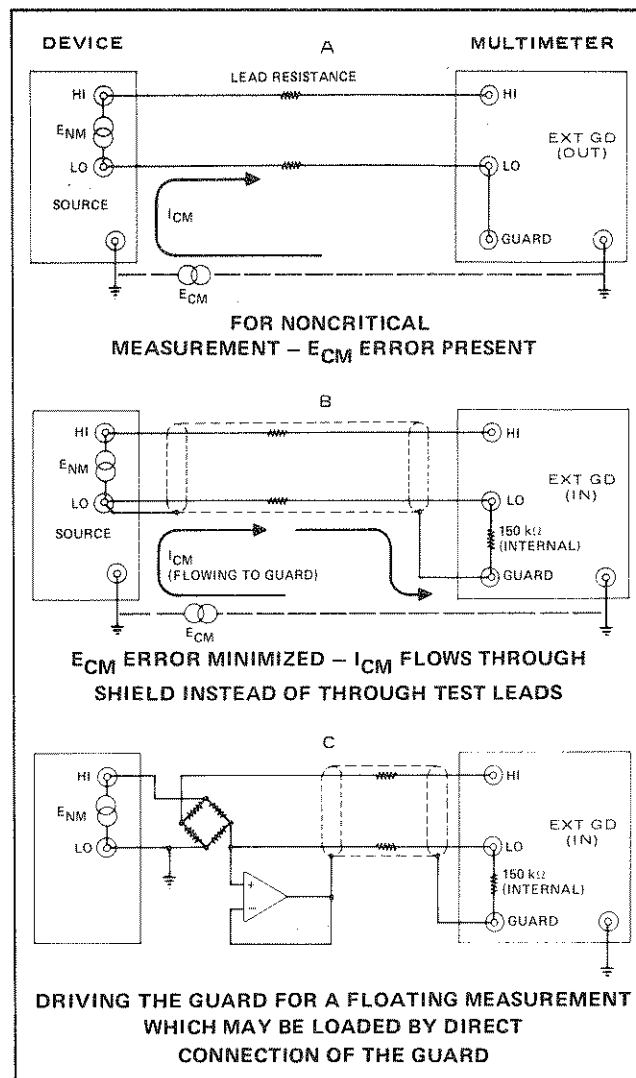
**Figure 2-4. Guard Connections**

resistance measurements. Connections are shown in Figure 2-5. The input on the HI terminal with respect to the LO terminal must not exceed 1000V. The LO to GUARD potential must not exceed 127V. These terminals are internally shorted to the AMPS INPUT/OHMS SOURCE terminals (HI to HI, LO to LO) when the Ohms Selector (4T OHMS IN) is in the disengaged (2-wire) position.

NOTE

In OHMS measurements, the voltage at the SENSE INPUT terminals is sampled before the Ohms Converter (Option 02) is connected. No connection is made if excessive voltage ($\pm 10V$ dc) is present.

2-57. AMPS INPUT/OHMS SOURCE (HI and LO) TERMINALS

2-58. The AMPS INPUT/OHMS SOURCE terminals are used when making current (A DC or A AC) or four-wire resistance (OHMS) measurements. The potential between SOURCE HI and SOURCE LO must not

exceed 280V. The potential between SOURCE HI and SENSE HI, or between SOURCE LO and SENSE LO must not exceed 127V.

NOTE

In current measurements, the voltage at the input terminals is sampled before the Current Shunts module (Option 03) is connected. No connection is made if excessive voltage (± 45 V dc) is present.

2-59. OHMS SELECTOR

2-60. When engaged (in), the Ohms Selector isolates SENSE HI from SOURCE HI and SENSE LO from SOURCE LO; four-wire resistance measurements can then be made. When disengaged (out), SENSE HI is connected to SOURCE HI and SENSE LO is connected to SOURCE LO for two-wire resistance measurements. Refer to Figure 2-5. Note that this control should be in the disengaged (out) position only when two-wire resistance measurements are being made. The Ohms Selector has no control of the rear inputs (a four-wire configuration is preset).

2-61. REAR INPUT SELECTOR

2-62. When pushed in, the Rear Input Selector disconnects the front panel inputs and connects the rear input connector. The Ohms Selector and Guard Selector have no effect when rear inputs are enabled. The state of the Rear Input Selector can be sensed remotely through any of the remote interface options.

2-63. Function

2-64. Selection of a new function automatically cancels any previously selected function and places the multimeter in the function change configuration. If the same function is successively selected, the multimeter assumes the Autoranging mode, but retains all other modes and values existing prior to the reselection. A valid new function selection is verified when the appropriate display annunciator(s) lights (V DC, V AC, A DC, A AC, OHMS, or V DC + V AC). An invalid function selection occurs whenever the necessary analog measurement module is not installed or is faulty; either ERROR 9 or ERROR 3 appears in the display in such cases. Once an invalid function has been selected, the multimeter ignores all other push buttons until a valid function is selected.

2-65. Measurement Parameters

2-66. SAMPLING

2-67. The multimeter averages a number of samples for each reading (display update). Noise rejection is influenced by the number of samples-per-reading and by the filter selection. Each sample-per-reading setting yields a specific processing time. Additional processing time is necessary when mathematic operations (such as OFFSET or SCALING) are involved. Samples taken are synchronous to the line frequency for local operation. Synchronous or asynchronous operation can be specified remotely.

2-68. Sample settings are specified as exponents of two. For example, the SAMPLE push button can be used individually to toggle between settings 5 (2 exponent 5 = 32 samples-per-reading) and 7 (2 exponent 7 = 128 samples-per-reading). Further, any sample setting (exponent of 2) from 0 through 17 may be made using the STORE (numeric) SAMPLE sequence. If a setting of 0 through 6 is in effect when SAMPLE is toggled, the multimeter assumes setting 7. A previous setting of 7 through 17 is changed to 5 when SAMPLE is toggled.

2-69. The SAMPLE annunciator is controlled by both the sample setting and the trigger. At sample settings from 0 through 7, SAMPLE flashes once for each triggered reading. The rapid reading rate at 0 or 1 setting yields an apparent steady indication. At sample settings 8 through 17, the flash rate is preset to that of setting 7. This feature insures a reliable reading-in-progress indication at these slower reading rates.

2-70. TRIGGERING

2-71. Each new measurement is initiated with a trigger. In auto triggering, each trigger is generated internally at the end of the required reading time. Triggers may also be applied locally (from the front panel) or remotely.

2-72. Auto trigger commands a continuously updated reading. The frequency of this updating is influenced by the number of samples-per-reading and by any extra processing time required by mathematic operations. The SAMPLE annunciator flashes to indicate the triggering of a new reading.

2-73. Local triggers can be manually commanded from the front panel. The duration of each reading is determined in the same manner as the auto triggers (samples, mathematics). Each use of the MANUAL/EXTERNAL push button commands an immediate response from the multimeter; any reading already in progress is aborted and a new reading begun. During any manually triggered reading, use of any other push button halts the multimeter; a new trigger must then be entered. Conversely, between manually triggered readings, the multimeter is inhibited; no display update or SAMPLE annunciation is evident. During this interval, any measurement parameter, mathematic operation, or special operation may be entered, but is not initiated until the next manual trigger is entered.

2-74. External triggers are applied through the rear panel TRIGGER jack. A local trigger manually applied from the front panel overrides a simultaneously applied external trigger.

2-75. FILTERING

2-76. Two analog filters are available: either one of these, or filter bypass, may be selected. The slow filter provides better normal mode rejection. The fast filter allows for faster instrument settling while still providing a degree of noise rejection. Whenever a filter is used, a

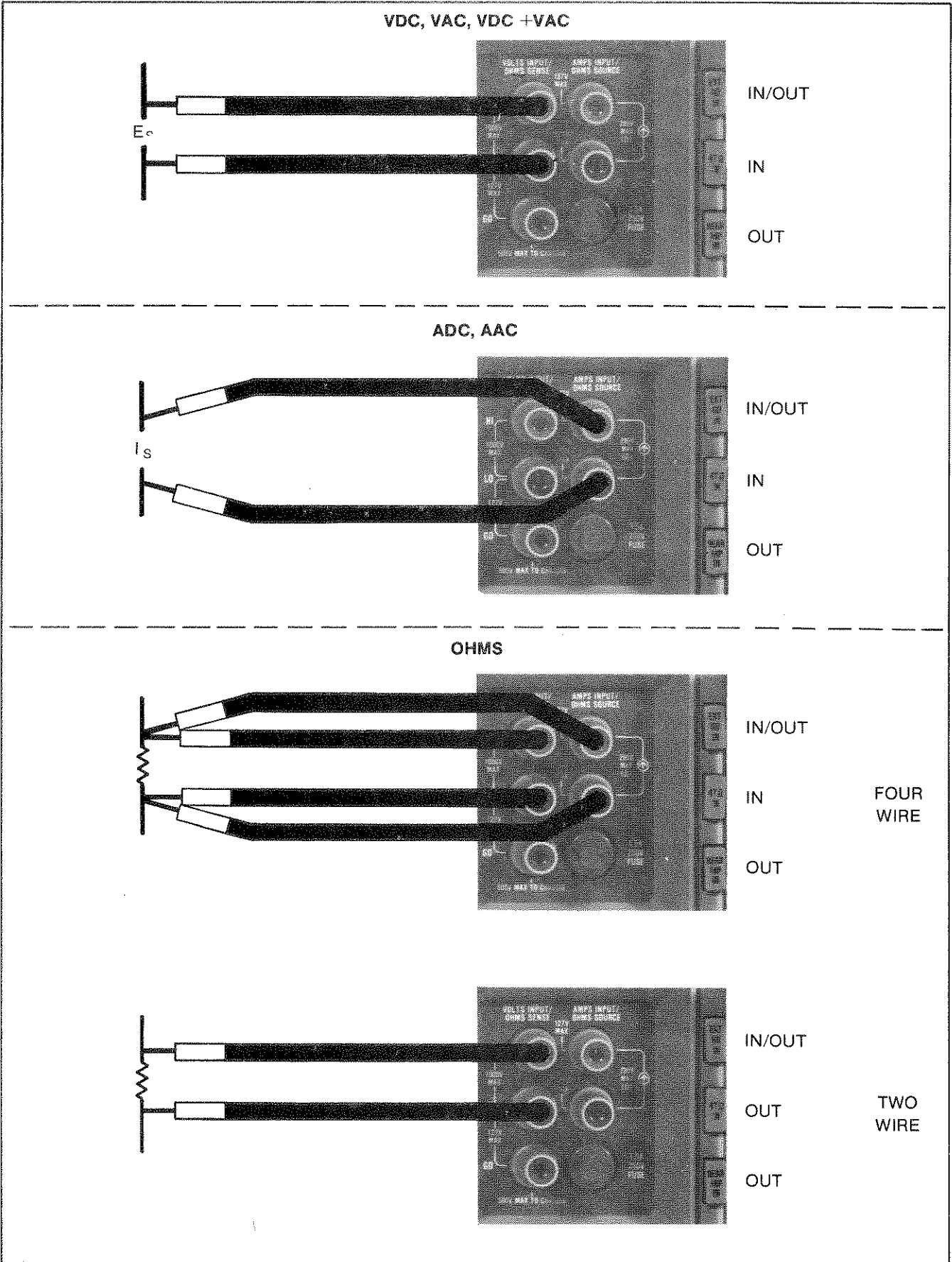

Figure 2-5. Measurement Connections

timeout (for settling delay) may also be inserted before each reading. No filtering is available for the external reference input.

2-77. Two methods of filter selection are available. Selection of any mode (F, F0, F1, F2, F3) is possible using the STORE (numeric) FILTER sequence. The FILTER push button by itself toggles between modes F and F0. The slow filter (F) is always selected when a toggle is performed with a fast filter (F0, F1, or F3) in effect. The fast filter (F0) is always selected when a slow filter (F or F2) is in effect. Mode F0 is preselected at power-up or reset.

2-78. AVERAGING

2-79. The Averaging mode presets the sample setting to 10 and the filter mode to F to provide optimum stability and resolution throughout the range of inputs. Subsequent FILTER or SAMPLE selection may jeopardize this intended optimization. Therefore, sample settings less than 10 cause the multimeter to exit the Averaging mode. Filter mode F2 can also be specified while in the Averaging mode. Selection of any filter other than F or F2 is accepted by the multimeter, but causes deactivation of Averaging mode.

2-80. The Averaging mode can be used to improve display stability (reduce rattle) in all ranges and to increase display resolution in certain ranges. Preset resolutions used for standard operation and for the Average mode are summarized in Table 2-5.

2-81. RANGE

2-82. Ranges available in each function are summarized in Table 2-3. A power-up or reset condition sets the multimeter in the 1000V range, Autoranging disabled. Each function selection enables Autoranging (AUTO annunciator on). In Autoranging, the multimeter selects the range offering maximum resolution for the measured value. The AUTO (range) push button toggles Autoranging mode on or off. When toggling off, no range change is effected. Either of the up/down push buttons select manual ranging and step up/down one range when initially used. Each subsequent use steps to the next higher/lower range (if available).

2-83. V DC AND OHMS ZERO

2-84. In VDC or OHMS, internal dc drift may be corrected by zeroing. If Calibration mode is off, the values are stored in a temporary memory and do not affect Calibration Memory entries. The value stored at a zero input level is used as a zero correction for the selected range and for all higher ranges in the same function. Separate zero values for each range can thereby be stored by starting with the lowest range and working up. Calibration Memory values are automatically loaded into the temporary memory when power-up or reset occurs. The Temporary memory values are reset to zero when power-up or reset occurs. In this case, each zero value stored does not affect values on any other range.

Table 2-5. Resolution

	RANGE	NORMAL DIGITS	AVERAGING DIGITS
V DC	100 mV	6½	6½
	1V	6½	6½
	10V	6½	7½
	100V	6½	6½
	1000V	6½	6½
V AC, OR V AC + V DC	1V	5½	6½
	10V	5½	6½
	100V	5½	6½
	1000V	5½	6½
A DC or A AC	100 µA	5½	6½(5½A AC)
	1 mA	5½	6½
	10 mA	5½	6½
	100 mA	5½	6½
	1A	5½	6½
OHMS	10Ω	5½	6½
	100Ω	5½	6½
	1 kΩ	6½	6½
	10 kΩ	6½	6½
	100 kΩ	6½	6½
	1 MΩ	5½	6½
	10 MΩ	5½	6½
100 MΩ	5½	6½	

2-85. Good quality, low thermal shorting bars (not shorted test leads) must be applied between INPUT HI and LO terminals during the zero operation. Initial use of the ZERO V DC/OHMS push button stores the zero correction value and activates the Zero mode (ZERO annunciator lights). Pressing ZERO V DC/OHMS a second time deactivates the Zero mode (ZERO annunciator goes off). A new zero value is entered each time the mode is enabled. Scaling and offset values are ignored in the stored correction value. Attempting to store zero in an illegal function (A DC, A AC, or V AC) results in an Error 0 indication. Exiting the zeroed function deactivates the Zero mode, but retains the stored values. Upon reentering the zeroed function, Zero mode and the old value are automatically restored. The zero value can be recalled for the selected range and function (VDC or OHMS).

2-86. Mathematic Operations

2-87. Mathematic operations can be specified to change the measured value (as influenced by measurement parameters) before it is actually displayed. Ratio, deviation, percentage variation and other mathematically manipulated displays are thereby possible. Scaling (or External Reference) can be used to divide the measured

value and display the ratio. An offset value can be subtracted from the measured value to display only the deviation. Scaling (or External Reference) and Offset can be used in combination to display percentage variation. Examples of such operations are given under Applications later in this section.

2-88. Use of mathematic operations is expressed in the following formula:

$$\text{DISPLAY} = \frac{\text{MEASURED VALUE}}{\text{SCALING}} - \text{OFFSET}$$

(OR EXTERNAL REFERENCE)

Measured value in this formula refers to the measurement as influenced by all selected measurement parameters. This value is subject to the following function-dependent considerations.

1. V DC function: measured value is the measured voltage less V DC Zero when the Zero mode is used.
2. OHMS function: measured value is obtained after any applicable OHMS Zero is applied.

2-89. SCALING

2-90. The Scaling mode divides the measured value (after application of V DC or OHMS zero) by a known amount and displays the quotient. Ratios, percentage deviations, or input/output relationships can thereby be displayed. The scaling divisor may be a previously displayed and stored value, or any non-zero numeric entry from $+10^9$ to $+10^{-9}$ and from -10^9 to -10^{-9} . When compared to External Reference, Scaling offers a much wider range. Only one scaling factor may be stored at a time.

2-91. Storing the displayed value as a scaling factor warrants a word of caution: insure that the displayed value is the true original display by first toggling out of Scaling and Offset modes (respective annunciators off). No stored scaling or offset value is lost in this manner. To store the desired display, push STORE SCALING.

NOTE

If the multimeter is in both Scaling and Offset modes, the scaling value is applied before the offset value.

2-92. EXTERNAL REFERENCE

2-93. Scaling and External Reference modes are mutually exclusive: selection of either mode automatically disables the other. The external reference value (always measured as a dc voltage) is applied as an unswitched input through the rear input connector.

2-94. Immediately after a power-up or reset, RECALL EXT REF can be used to verify the software version number. The first subsequent use of EXT REF to activate

External Reference mode disables this software identification feature. When toggling into the mode, the reference voltage is displayed as long as the EXT REF button is depressed. The EXT annunciator is lighted when the mode is enabled.

2-95. The applied External Reference voltage may be a maximum of $\pm 20\text{V}$ dc on either high or low input with respect to VOLTS INPUT LO. The voltage between External Reference high and low may not exceed 40V dc. The minimum acceptable External Reference voltage is the greater of $\pm 100\text{ uV}$ or a value found with the following formula:

$$V_{\text{min}} = \frac{\pm V_{\text{in}}}{10^9}$$

2-96. Normally, the External Reference low terminal is tied to VOLTS INPUT LO. In any event, the resistance between either External Reference terminal and VOLTS INPUT LO should be less than 20 kilohms. A reading rate of eight samples-per-reading and filter bypass are specified for each External Reference input.

2-97. OFFSET

2-98. In Offset mode, the display represents only the deviation from a stored offset value. Measurements of stability of analog variation are thereby possible. The multimeter automatically subtracts a programmed numeric (or previously stored display value) from the measurement and displays the result. No increase in resolution is displayed while in the Offset mode. One value (whether a numeric or a previous display) may be stored at a time. Programmed numerics may range from $+10^9$ to -10^9 (excluding 0). The stored offset value may be recalled at any time.

2-99. Special Operations

2-100. PEAK

2-101. The highest and lowest deviations in the displayed value may be recorded in the Peak mode. Measurement stability may thereby be checked over a period of time. The PEAK push button toggles into/out of the Peak mode. High and low Peak values may be recalled any time without exiting the Peak mode or interrupting further peak recording. The following sequence is used:

RECALL HI PEAK

RECALL LO PEAK

The high or low peak value is latched in the display as long as the PEAK button is held depressed.

2-102. Exiting the Peak mode (toggle PEAK once) halts further peak recording, but does not erase previously recorded high and low values. A multimeter function change disables Peak mode and retains peak values. At any time, reentry into the Peak mode (toggle Peak again)

erases previously recorded values. Both Peak mode and peak values are lost during a Power-Up or Reset condition.

2-103. LIMITS

2-104. The Limits mode may be employed to display a pass-fail indication of measurement values. The mode is entered when a single high or low limit value is stored, or when the LIMITS button is pushed. A second store sequence must be used if both high and low limits are desired. Either the normally displayed value or programmed numerics may be used for the limit values. For example, high and low limits of 12.05 and 11.95 would be programmed as follows:

```
STORE 1 2 . 0 5 HI
```

```
STORE 1 1 . 9 5 LO
```

In this example, the multimeter enters the Limits mode when either the HI or LO button is first pushed. Mode entry is verified by a display of HI, LO, or PASS. In this case, readings higher than 12.05 yield a HI display, readings lower than 11.95 yield LO, and all other readings yield PASS. The limit value(s) are compared to the now transparent display reading with all other parameters and operations still in effect.

2-105. A display reading can also be stored as a limit value. Use the following sequence:

```
STORE HI (or LO)
```

2-106. Use of Limits mode does not interrupt other uses of the multimeter. No measurement parameter or mathematic operation is changed: The other special operation (Peak) may be used simultaneously with Limits mode. Any of the measurement parameters or operations may be enabled, changed, or recalled while in the Limits mode: the display responds in the normal fashion during this process and automatically reverts to limits indications once the process is complete. Limits values may be recalled at any time (Limits mode enabled or disabled). The recall sequence does not change the state of the Limits mode. The following recall sequence is used:

```
RECALL HI LIMITS
```

```
RECALL LO LIMITS
```

The recalled value is latched in the display as long as the LIMITS button is held depressed.

2-107. Pushing the LIMITS button toggles the multimeter into or out of the Limits mode whether or not limits values have been entered. A function change disables the Limits mode, but retains any existing limit values. Once stored, limits values are retained during all but Power-Up and Reset sequences.

2-108. Remote Control

2-109. The multimeter may be equipped with any of three remote interface modules. These modules are fully explained in Section 6. When the -05 IEEE Interface is installed, the front panel LCL/RMT push button can be used to enable local control, but cannot be used to enable remote control. Remote control can only be commanded from the remote location with this interface.

2-110. The LCL/RMT push button may be used to toggle into/out of remote control when either the -06 Bit Serial or the -07 Parallel Interface is installed. Whenever the multimeter is in remote control, whether commanded locally or from the remote, the REMOTE annunciator is lighted.

2-111. When in remote, only the POWER push button remains operational at all times. The LCL/RMT push button may remain operational, but is disabled by a local lockout or display off command from the remote (refer to Section 6). A power interruption returns the multimeter to local control.

2-112. Calibration Mode

2-113. DESCRIPTION

2-114. The rear panel calibration switch is used to enable or disable the Calibration mode (remove calibration seal for access). The AVG/(CAL) annunciator flashes when the Calibration mode is enabled, or is lit steadily when the Averaging mode is enabled. Regular multimeter operation is significantly altered while in the Calibration mode:

1. Power must not be cycled on or off when the Calibration mode is activated (rear panel Calibration Switch on).
2. Overrange conditions no longer cause a special flashing "HHHHHH" indication.
3. Averaging mode is locked out: the Calibration and Averaging modes are mutually exclusive. However, pushing the AVG button when Calibration mode is on does enable or disable latching error indications.
4. All mathematic operations and special operations are disabled.
5. 7-1/2 digits are displayed on 10V dc range and 6-1/2 digits are displayed on all other functions and ranges. A sign (\pm) is displayed for all functions to facilitate potentiometer adjustment.
6. Calibration correction factors (for each range in V DC, A DC, OHMS, and for VAC ranges at a frequency of interest) and the calibration date may be stored.

2-115. Hardware calibration is facilitated while in Calibration mode. Enhanced resolution allows for more precise potentiometer adjustment during hardware calibration. With no mathematic operations allowed, the display represents the true input value.

2-116. Troubleshooting is also aided by using the Calibration mode. Latching errors can be disabled to allow special module configurations.

CAUTION

Latching errors are intended for multimeter protection and must not be disabled during normal operation or calibration. Refer to Troubleshooting in Section 4.

2-117. USE

2-118. The multimeter uses three calibration controls: the rear panel calibration switch, and the front panel (CAL DATE) and (CAL COR) push buttons. The rear panel calibration switch activates the Calibration mode and enables use of the (CAL COR) and (CAL DATE) push buttons. Store operations with these two push buttons are used for software calibration and are explained in Appendix 7B. Recall operations can be performed at any time and are explained in the following paragraphs.

2-119. The (CAL DATE) push button can be used in all functions to recall a six digit number. This number may signify the calibration date. For example, a recalled 02 18 83 would signify February 18, 1983. Alternately, the six digits may be used to identify the multimeter.

2-120. To recall the six digit date (or identifier) while in the Calibration mode, push RECALL (CAL DATE). If the multimeter is not in the Calibration mode, the six digit date (or identifier) can be recalled using RECALL LO (CAL DATE).

2-121. The (CAL COR) push button may be used to recall the uncorrected reading when the multimeter is in the Calibration mode, use:

RECALL (CAL COR)

The uncorrected reading can also be recalled when the multimeter is not in the Calibration mode. Use the following sequence:

RECALL LO (CAL COR)

2-122. Scan Advance

2-123. The multimeter outputs a sync signal during each measurement sequence. This signal occurs after the measurement is complete, but before a new trigger is accepted. The sync signal thereby allows for faster bus communications by advancing a scanner before a new reading is triggered. The signal (positive going TTL, 3 microsecond pulse width, 50-ohm output impedance) is available at a BNC connector on the multimeter rear panel.

2-124. Systems Use

2-125. The availability of optional interface modules makes the multimeter adaptable to a large variety of digital systems. Operating and programming instructions related to remote operation are included with the appropriate optional module.

2-126. OPERATION

2-127. Initial Turn-On

2-128. Before initial turn-on, check that the line voltage specified on the rear panel sticker (near the line fuse) agrees with the line voltage actually being used. If there is any doubt concerning the line voltage setting, refer to Line Voltage Selection in Section 4. Also verify that the Calibration switch is off. Once these verifications have been made, connect the power cord and push the POWER button to ON.

2-129. The multimeter identifies its own software and hardware at initial turn-on. Software is identified with a display of "HI - Y.Y.Y", where "Y" represents the software version in use. Hardware is then identified with a display of "CXXXXX", where "X" signifies any installed options by number.

2-130. Power-up (reset) configuration is now established. The function is set for V DC, the 1000V range is set, along with filter F0, sample 7, auto trigger, zero mode on, and local operation. All other modes and values are disabled. The multimeter may now be programmed as described in this Section. A two-hour warm-up insures rated accuracy. Better accuracies can be obtained in the Average mode after a four-hour warm-up.

2-131. Measurement Instructions

2-132. Use the following procedures when making measurements from the front panel:

1. Remove multimeter inputs.
2. Select the desired function.
3. Referring to Figure 2-3, set measurement parameters.
4. Further programming from the front panel is often not necessary. If no mathematic operation or special operations are desired, proceed to Step 6.
5. If mathematic or special operations are desired, refer again to the guidelines in Figure 2-3.
6. Position the measurement terminal controls (right of terminals) as required. The Rear Input Selector must be disengaged (out) if the front panel inputs are being used. The Ohms Selector must be engaged (in) when four-wire resistance measurements are being made. The Guard Selector is normally left disengaged (out) for non-critical measurements. Refer to Measurement Terminals and Controls in this Section for other uses of these selectors.

7. Depending on the function selected, make the measurement connection illustrated in Figure 2-5.

examples to aid in familiarization with the multimeter. If the applications are duplicated, modes or values already programmed could interfere with the expected instrument response. Therefore, a power-up or reset instrument configuration is a precondition.

2-133. APPLICATIONS

2-134. Specific applications using the multimeter are presented in Table 2-6. The applications may be used as

Table 2-6. Applications

STORING A DISPLAYED VALUE	
STORE	$\left\{ \begin{array}{l} \text{OFFSET} \\ \text{SCALING} \\ \text{HI} \\ \text{LO} \end{array} \right.$
APPLICATION 1	
REQUIREMENT:	Monitor the stability of a power supply in terms of its deviation in volts from a present output of +5.03V.
METHOD:	<p>Store the present output as an offset. Press:</p> <p>STORE → OFFSET</p> <p>Offset is now enabled. The multimeter will read only the deviation from +5.03V.</p>
APPLICATION 2	
REQUIREMENT:	Monitor the stability of a power supply as a decimal ratio to its present reading of -20.08V. DC zeroing appears to be necessary.
METHOD:	<p>Perform V DC Zeroing for internal drift. Apply low thermal short between INPUT HI and LO (at the terminals). Press:</p> <p style="text-align: center;">ZERO VDC/Ω</p> <p>The value stored will be displayed as long as ZERO VDC/Ω is held depressed. Release of the switch will activate the Zero mode. Revise terminal interconnections for dc volts measurements. Connect the dc voltage.</p> <p>Apply power supply reading of -20.08V as a scaling factor. Press:</p> <p style="text-align: center;">STORE → SCALING</p> <p>Display will now yield the ratio of subsequent readings to the scaling factor, e.g., an input of 22.08V yields a ratio of:</p> $\frac{22.088}{20.08} = 1:1$
STORING A NUMERIC ENTRY	
STORE	$\left\{ \begin{array}{l} \text{→ 0 - 17 → SAMPLE} \\ \text{→ -,0,1,2,3 → FILTER} \\ \text{→ (VALUE) → } \left\{ \begin{array}{l} \text{OFFSET} \\ \text{SCALING} \\ \text{HI} \\ \text{LO} \end{array} \right. \end{array} \right.$

Table 2-6. Applications (cont)

APPLICATION 3	
REQUIREMENT:	Identify the power supplies that have a tolerance of $15V \pm 100 \text{ mV}$.
METHOD:	Set high and low limits. Press: STORE → 1 → 5 → . → 1 → HI STORE → 1 → 4 → . → 9 → LO The multimeter will now display "HI," "LO", or "PASS" for each power supply.
APPLICATION 4	
REQUIREMENT:	For a group of 20V power supplies, determine the deviation in volts.
METHOD:	Offset the displayed reading by 20. Press: STORE → 2 → 0 → OFFSET Any value displayed now will equal the deviation from 20V.
APPLICATION 5	
REQUIREMENT:	Display the input error voltage for an operational amplifier by measuring the dc output error. Gain = 2.6847×10^4 .
METHOD:	Divide the measured dc output error by a scaling factor (the op amp gain). Press: STORE → 2 → . → 6 → 8 → 4 7 → EXP → 4 → SCALING The multimeter will now divide the measured input by the gain of the op amp and display the input error voltage.
APPLICATION 6	
REQUIREMENT:	Make a series of measurements in a noisy environment. Speed of measurement is not important. Display only the deviation in volts.
METHOD:	Allow for extra settling between readings: Press: STORE → 3 → FILTER Increase digital filtering (average more samples per reading). Press: STORE → 9 → SAMPLE Offset by the nominal output (e.g., 15V). Press: STORE → 1 → 5 → OFFSET

Table 2-6. Applications (cont)

RECALLING	
RECALL →	{ OFFSET ZERO VDC/ Ω EXT REF SAMPLE SCALING FILTER { HI } → { LO } PEAK LIMIT
APPLICATION 7	
REQUIREMENT:	Determine the highest and lowest readings encountered in measuring a group of 28V power supplies.
METHOD:	Press PEAK to record measurement extremes. Use a manual trigger for each measurement. When required measurements are complete, use the following sequence to recall high and low values. Press: RECALL → LO → PEAK RECALL → HI → PEAK (Hold PEAK in to read the recorded values.)

Section 2A Remote Programming Commands

2A-1. INTRODUCTION

2A-2. This section documents remote operation of the multimeter with any of the following interface modules installed:

1. IEEE-488 Interface (Option -05)
2. Bit Serial Interface (Option -06)
3. Parallel Interface (Option -07)

2A-3. Basic remote operation for 8500 series multimeters is detailed in Table 2A-1. These operating features are generally compatible with the 8505A and

8506A multimeters. Table 2A-2 details additional remote operating features available with the 8505A and 8506A only.

2A-4. General information, theory of operation, maintenance information, parts lists, and schematic diagrams for each of the three remote interfaces are presented in Section 6 of this manual.

2A-5. Software calibration for each function can be accomplished locally or remotely. Complete software calibration information is presented in Appendix 7B of this manual.

Table 2A-1. Programming Instructions

The programming instructions in this table pertain to the 8500 Series Digital Multimeters with the IEEE-488 Interface (Option -05), the Bit Serial Interface (Option -06) or the Parallel Interface (Option -07) installed. Features and instructions unique to the DMM model or to the interface used will be identified in the following manner:

1. 8500A or 8502A: the symbol ◆ will denote an explanation applicable to one DMM model only. The software version incorporated in the DMM may also be mentioned for further identification. To verify the software version incorporated in your instrument, observe the display indication at power on or reset. For example, in the 8502A, "HI-2.0.2" will appear in the display for models with software version 2.0.2.
2. -05, -06, or -07 Interface Options: the symbol ● will be used with a feature or instruction unique to a particular Interface.

INITIALIZATION

When power is applied, or the Reset character (*) is transmitted, the instrument assumes a preset default condition. This condition is defined by the following remote codes:

<u>REMOTE CODE</u>	<u>COMMAND</u>
V	Volts DC
R4	1000V range
◆ S5 (8500A)	2 ⁵ Samples per Reading
◆ S7 (8502A)	2 ⁷ Samples per Reading
F0	Fast Filter, Timeout Disabled (Panel Indicator OFF)
X0	External Reference/Scaling Disabled
P0	Offset Feature Disabled
U0	Limits-Peak Value Storage Disabled
T0	Single Reading Line Synchronous
B0	Single Character ASCII Format
D0	Front Panel Display Active
L0	Deactivate Local Lockout
J0	Deactivate Line Feed Suppression
M0	Enable Cal Memory Factors
◆ Q0 (8502A)	Disable External Trigger
◆ W (8502A)	No Delay
● Y0 (-06 Option only)	Echo mode off (Bit Serial IF)

In addition, the following instrument states are assumed at power on or Reset:

Remote/Local	Local
Offset	Zeroed
V dc Zero	Zeroed or *
Ohms Zero	Zeroed or *
Cal Memory Factors	*
Peak Values	Cleared
Limits Values	Zeroed
Ext. Ref/Scaling Values	1
● 8/16 Bit Mode (-07 Option only)	8 Bit

*Retained if Cal Memory Option -04 installed

Table 2A-1. Programming Instructions (cont)

PROGRAM SEQUENCE

When equipped with a remote interface option, the instrument is programmed through a sequence of commands ("command string") that will determine range, function, reading rate, etc. Examples of 5 possible command strings are:

1.

V	A	R	2	S	5	F	?

Table 2A-1. Programming Instructions (cont)

All command string characters transmitted via the remote interface must be ASCII 7-bit upper case characters. A command string is a sequence of 1 to 31 characters. (For the 8505A and 8506A, a command string may have up to 59 characters.) Characters are classified as immediate, command or termination. The instrument may be placed in Remote mode by transmitting any character that the instrument will recognize from the remote controlling terminal.

- With the IEEE Interface installed, the REMOTE switch can only be used to select local mode if already in Remote.

REMOTE is the only front panel switch to remain active when in REMOTE mode; REMOTE may, however, be locked out by the local lockout command.

IMMEDIATE CHARACTERS

There are 5 immediate characters; each of these may be executed at any time and does not require a termination character.



Reset

This immediate character will reset the instrument to the conditions described under INITIALIZATION.

- ◆ When transmitted, the reset character must not be followed by any other character for 3 seconds with the 8502A (2 seconds with the 8500A). Any carriage return or line feed following the reset character must be suppressed. The remote interface will be unable to accept programming characters during this time.



Halt

The halt character is used to terminate the continuous mode and cause the instrument to wait for a command string. No other characters should precede the halt character if continuous mode is in effect. Upon receipt of the halt character, the transmission of readings is terminated immediately. The following trigger mode transitions will occur when halt is used:

From: Continuous Line Synchronous
To: Single Reading Line Synchronous

From: Continuous Asynchronous
To: Single Reading Asynchronous



Go To Local - Lock Out Remote

- This character will command the instrument (Options -06 or -07 only) to enter local mode of operation and lock out the remote interface.
- The Remote mode may then be reentered by pressing the front panel REMOTE switch (for Option -06, -07). The Remote mode may not be reentered from the front panel when using the IEEE-488 Interface (Option -05).

Table 2A-1. Programming Instructions (cont)

#

Go To Local-Lock Out Remote (cont)

The state of the instrument, when changing from remote to local operation will be modified as follows:

1. Ohms fast mode will be ignored.
- ◆ 2. Scaling mode will not be in effect (8500A only).
- ◆ 3. If the high averaged samples per reading rate was in effect, the samples per reading will be set to 2⁷ (8500A only).

The state of the instrument when changing from local to remote operation will be modified as follows:

1. Ohms fast mode (Z1) and continuous reading mode will be resumed if the DMM was in either mode when placed into local.
2. Any error that occurred during local operation will be stored and available for recall.

!

High Speed Reading Mode

- The "!" character can be used with the Parallel Interface (Option -07) (and with the IEEE-488 Interface Option -05 in the 8502A only). The High Speed Reading mode provides a shortened 3-byte binary two's complement format response representing the input to the DMM's A/D Converter. Speeds up to 500 readings per second are possible in this mode of operation.

True readings can be computed from this response using range and function dependent factors (refer to Fluke Application Bulletin 25).

The High Speed Reading mode is suited to systems with very fast processors, to use with stored readings, or to applications not requiring direct numeric conversions (e.g., zero crossings or large deviations from a nominal value).

- ◆ Use of the "!" character will place the DMM in the High Speed Reading mode and trigger the first reading. Subsequent readings can be triggered by sending the "?" character. In addition, for the 8502A equipped with the -08A Option, subsequent readings can be triggered by sending the TTL pulse with the External Triggering Mode ("Q" or "Q1"). The High Speed Reading mode can be aborted at any time by transmitting a character other than "?" when a reading is to be triggered. The character sent in this case will do nothing more than cause the DMM to exit the High Speed Reading mode.

Table 2A-1. Programming Instructions (cont)

Voltage and Current Reading in "I"

The response data from the DMM will be in 3-byte format, as shown below, for each voltage or current reading. The first byte of this response contains sign and error bits, an implied binary point, and an implied scale factor of ten. Bytes 2 and 3 further define the reading. If the reading is negative, the sign bits will equal "1", and all three bytes must be two's complemented before conversion. If the error bit is equal to the complement of the sign bit, an error is defined.

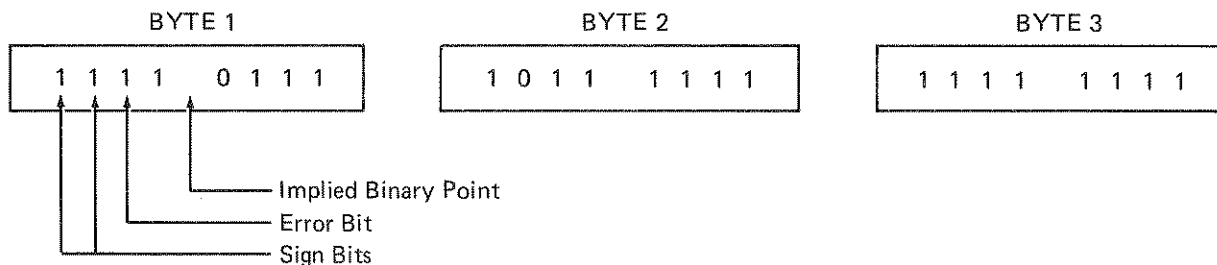

In this example, the sign bits are "1" and the reading is negative. Since the complement of the sign bit does not equal the error bit ("1"), no error is defined.

To convert the response in this example, the two's complement must first be formed.

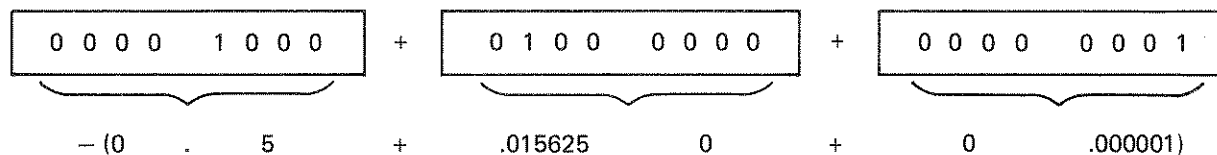

= 0.515626 X 10 (the implied scale factor)

Further conversion to calculate the true reading R_t necessitates multiplication of the A/D Converter reading (R_{AD}) by the scale factor for the instrument's range and function.

$$[R_t = R_{AD} \times \text{Scale Factor}]$$

Ohms Readings in "I"

The procedure for measuring ohms in High Speed Reading mode is more complex. High Speed Ohms readings differ from Fast Ohms (Z1) readings; when using the "I" character, the DMM will not compute the true reading. This conversion must be performed by the user. Up to 500 readings a second are possible when using High Speed Ohms. Refer to OPERATING NOTES, provided with Option -05 and -07 for High Speed Ohms Reading procedures.

/ 8/16 Bit Toggle

The "/" character is used to toggle between the 8-bit and the 16-bit mode. When this character is used to toggle from one mode to another, the immediate and/or termination character must be placed in the least significant byte (LSB) of the programming word.

Table 2A-1. Programming Instructions (cont)

TERMINATION CHARACTERS

Termination characters cause the execution of a command string. They are normally placed at the end of each programming statement.

<div style="border: 1px solid black; border-radius: 50%; width: 30px; height: 30px; display: flex; align-items: center; justify-content: center;">\$</div>	Clear the Command String	<ul style="list-style-type: none"> ● (Normally used only with the Bit-Serial Interface -06 Option.)
<p>This character is used to erase an incorrect programming entry from the command string buffer, deleting all characters issued back to, but not including, the preceding termination character. A new command string is then needed to modify the state of the instrument.</p>		
<div style="border: 1px solid black; border-radius: 50%; width: 30px; height: 30px; display: flex; align-items: center; justify-content: center;">,</div>	Execute the Command String	<p>This character is used to cause the execution of the previous command string. The instrument will then be in the defined state only; the character will not trigger a reading or produce a response from the instrument. When programming a string of characters, it is recommended that the execute character be used at frequent intervals; if an error is made, the string need then be cleared only back to the last execute character. This execute character is also required if a command string longer than 31 characters is used.</p>
<div style="border: 1px solid black; border-radius: 50%; width: 30px; height: 30px; display: flex; align-items: center; justify-content: center;">?</div>	Execute the Command String and Trigger	<p>This character will cause three actions: any previously entered command string will be executed, a reading will be taken, and that reading will be transmitted through the remote interface. If a command string was not entered immediately preceding this character, the instrument will take and transmit a reading in the last defined state.</p> <p>An exception occurs when a command string containing a "Get" command has been entered; the instrument will then respond with the value or status that was requested by the command string (no reading will be triggered).</p> <p>When issuing a program string terminated by the "?" character, the "CR" and/or "LF" delimiter characters should be, but do not have to be suppressed. If an error occurs during the reading, a single "0", followed by a "CR", will be transmitted. At this point, status should be requested to determine the cause of the error.</p>
<div style="border: 1px solid black; border-radius: 50%; width: 30px; height: 30px; display: flex; align-items: center; justify-content: center;">@</div>	Execute, Trigger, and Interrupt when Ready	<p>This character is used to trigger a reading and generate an interrupt when the reading is complete.</p>

Table 2A-1. Programming Instructions (cont)

@ Execute, Trigger, and Interrupt when Ready (cont)

- To provide the interrupt, the Bit-Serial Interface (Option -06) and the Parallel Interface (Option -07) transmit a single "CR". The IEEE-488 Interface (Option -05) provides an interrupt by generating a service request (SRQ).

The reading triggered by the "@" character can be obtained by inserting a "G" (get) command in the following command string (terminated by a "?").

The "@" character and the IEEE-488 Bus command "Group Execute Trigger" perform the same function.

COMMAND CHARACTERS

Command characters are classified within the following five groups:

1. FUNCTION
2. RANGE
3. MODIFIERS
4. CONTROL
5. MEMORY

FUNCTION COMMAND CHARACTERS

There are 7 function command characters. Whenever one of these characters is used, the state of the instrument will be changed as follows:

RANGE	Auto
MODIFIERS	Offset, Scaling, Limits, Peaks modes are turned off; stored values for these modes are retained.
MEMORY, CONTROL	Unchanged

If a function is selected requiring an optional module which is not loaded, the function of the instrument will be undefined, and the error code will be set to 19.

V DC Volts

V A AC Volts

C DC Coupled AC Volts

I DC Current

I A AC Current

Table 2A-1. Programming Instructions (cont)

Z Ohms

Z 1 Fast Ohms

The Z1 character will place the instrument into the ohms function and the fast ohms mode. In normal ohms operation, the unknown resistor value R_x is computed from the following measurements:

V1-V2: the voltage across an internal precision resistor (R_r)

V0: the voltage across the unknown resistor (R_x).

The value of R_x is then computed with Ohm's Law:

$$R_x = R_r \frac{V_0}{V_1 - V_2}$$

Fast Ohms mode differs in that the value of $\frac{R_r}{(V_1 - V_2)}$ is stored as a constant. The instrument will find R_x by measuring V0 and multiplying this constant. The constant will change with a function change, range change or overload condition.

NOTE

Fast ohms ("Z1") differs from HIGH SPEED READING ("!"). When using "!" for ohms measurement, R_x is not computed by the DMM.

RANGE COMMAND CHARACTERS

The nine range commands specify the following maximum values by function.

	DC VOLTS	VA or C AC VOLTS	I or IA DC or AC CURRENT	Z or Z1 OHMS
R	Auto	Auto	Auto	Auto
R 0	312 mV	Auto	312 μ A	31.25 Ω
R 1	2.5V	2.5V	2.5 mA	250 Ω
R 2	20V	20V	20 mA	2 k Ω
R 3	160V	160V	160 mA	32 k Ω
R 4	1200V	1000V	1.28A	256 k Ω
R 5	Auto	Auto	Auto	4.096 M Ω
R 6	Auto	Auto	Auto	32.768 M Ω
R 7	Auto	Auto	Auto	262.144 M Ω

Table 2A-1. Programming Instructions (cont)

MODIFIER COMMAND CHARACTERS

SAMPLES PER READING COMMAND CHARACTERS

The modifier command character "S" or "H" specifies the number of samples taken per reading. The times shown for these characters are approximate digitizing times per reading for 60 Hz line synchronous operation in dc volts, ac volts or current function.

S	0	$2^0 = 1$ Sample/Reading (4 ms)
S	1	$2^1 = 2$ Samples/Reading (8 ms)
S	2	$2^2 = 4$ Samples/Reading (17 ms)
S	3	$2^3 = 8$ Samples/Reading (33 ms)
S	4	$2^4 = 16$ Samples/Reading (67 ms)
S	5	$2^5 = 32$ Samples/Reading (134 ms)
S	6	$2^6 = 64$ Samples/Reading (267 ms)
S	7	$2^7 = 128$ Samples/Reading (534 ms)
H	0	$2^8 = 256$ Samples/Reading (1.1s)
H	1	$2^9 = 512$ Samples/Reading (2.1s)
H	2	$2^{10} = 1,024$ Samples/Reading (4.3s)
H	3	$2^{11} = 2,048$ Samples/Reading (8.5s)
H	4	$2^{12} = 4,096$ Samples/Reading (17.1s)
H	5	$2^{13} = 8,192$ Samples/Reading (34.1s)
H	6	$2^{14} = 16,384$ Samples/Reading (68.3s)
H	7	$2^{15} = 32,768$ Samples/Reading (137s)
H	8	$2^{16} = 65,536$ Samples/Reading (273s)
H	9	$2^{17} = 131,072$ Samples/Reading (546s)

Table 2A-1. Programming Instructions (cont)

FILTER COMMAND CHARACTERS

The "F" character is used to specify the type of filtering and the enabling of a time-out (for the filter settling time). This time-out causes a delay between a trigger command received and the actual reading taken. In the continuous trigger modes, the time-out will occur before each reading is initiated. The following "F" modifier command characters are used:

F		Slow filter, time-out disabled.
F	0	Fast filter, time-out disabled.
F	1	Bypass filter.
F	2	Slow filter, time-out enabled (approximately 500 ms).
F	3	Fast filter, time-out enabled (approximately 50 ms).

TRIGGER COMMAND CHARACTERS

The "T" characters specify the instrument's trigger mode. These characters determine whether samples taken are line synchronous (every 4 or 5 ms) or line asynchronous (approximately every 1.7 ms), whether single or continuous readings are to be taken.

T		Continuous reading mode/line synchronized.
T	0	Single reading mode/line synchronized.
T	1	Continuous reading mode/line asynchronous.
T	2	Single reading mode/line asynchronous.

NOTE

When line asynchronous modes are selected, the display will be turned off to save time; the front panel switches are then ignored.

- ◆ When in the continuous mode, any character (except "% HALT) will be ignored by the instrument (8502A).

When in the Single Reading mode ("T0" or "T2"), and IEEE Group Execute Trigger command, a "?" or "@" character, or a TTL trigger (for the 8502A-08A) must be sent for each reading.

With the Continuous Reading mode ("T" or "T1"), use of the "GET" command, "?", "@" or a TTL trigger will start continuous readings.

Table 2A-1. Programming Instructions (cont)

When each reading is accepted by the instrument controller, the next reading will be started. An exception to this sequence occurs in the "J1" Suppress Output mode; the next reading will now be taken immediately, without waiting for the output to the controller.

NOTE

The front panel display does not update in this mode unless the controller asks for a reading.

Use of the "%" character will halt the Continuous Reading mode and cycle the unit back to the Single Reading mode.

OFFSET COMMAND CHARACTERS

The "P" command characters specify whether an offset will be subtracted from a reading. The offset value may be entered by storing either a previous reading or a numerically entered offset.

- ◆ When storing readings, the 8500A will store the unprocessed reading, and the 8502A will store the displayed value.

Offset values may range from $\pm 1 \times 10^9$ to $\pm 1 \times 10^{-9}$ (including 0.0).

P Offset subtracted (ON).

P 0 Offset not subtracted (OFF).

EXTERNAL REFERENCE AND SCALING COMMAND CHARACTERS

The "X" command characters select External Reference or Scaling mode. Either mode is valid for any function and range. In External Reference mode, readings are divided by the signed magnitude of the external reference voltage. In Scaling mode, readings are divided by a numerically entered scale factor or by a previously read value.

X External Reference On, Scaling Off

The "X" External Reference mode uses the external reference voltage (V_{xref}) to divide the measured voltage. V_{xref} is measured during each reading cycle.

- ◆ Minimum $V_{xref} = \pm 0.0001V$ or the input divided by the maximum display with the volts range, whichever is greater (8500A only).
- ◆ For the 8502A, the minimum V_{xref} is the input divided by 10^9 .

Maximum $V_{xref} = \pm 40V$ between Ext Ref Hi and Lo terminals, providing neither terminal is greater than $\pm 20V$ relative to the Sense Lo or Ohms Guard Terminals.

Table 2A-1. Programming Instructions (cont)

X 0 External Reference Off,
Scaling Off

X 1 External Reference Off,
Scaling On

The "X1" Scaling mode will divide all readings by a previously taken external reference voltage or by a previously entered numeric scale factor. The read valued may not be used as a scaling factor.

NOTE

The 8502A can store the external reference voltage and the numerical scale factor separately. The 8500A can only store one or the other, not both.

- ◆ Minimum scaling factor = the same as the minimum Vxref, for the 8500A.
- ◆ For the 8502A minimum = 10^{-9} . Factors less than this will be set to 0, which is not a valid scale factor.

Maximum scaling factor = ± 100 (8500A), or Input/Max Scale factor $< 10^{-9}$ (8502A).

NOTE

The "X" and "X1" modes are mutually exclusive.

LIMITS AND PEAKS COMMAND CHARACTERS

The "U" command characters specify selection of Limits or Peaks modes.

U Limits Testing On

When this command character is sent, each instrument reading is compared to upper and lower limits. Limit values must be entered separately with a keep command (refer to KEEP COMMAND CHARACTERS). The output format from the instrument (when given a "G" command) is as follows:

- "0" is transmitted for a reading within limits.
- "1" is transmitted for a reading greater than the upper limit.
- "-1" is transmitted for a reading less than the lower limit.
- "2" is transmitted if an error occurs (e.g., overranging).

U 0 Disable Limits and
Peak Mode(s)

U 1 Save Highest and Lowest
Values (Peaks On)

Previous peak values are erased from memory whenever the "U1" command character is programmed.

Table 2A-1. Programming Instructions (cont)

U 1

Save Highest and Lowest Values (Peaks On) (cont)

◆ For the 8500A, storage of limit and peak values are mutually exclusive. For the 8502A, limit and peak values can be held in memory simultaneously.

NOTE

Limits are applied after all other modifier operations (Scaling, Offset, etc.) have been performed.

CONTROL COMMAND CHARACTERS

Output Format

The "B" characters activate binary or ASCII output format.

B

Single Byte Binary Format

B 0

Single Byte ASCII Format

B 1

Binary 16-Bit Parallel

B 2

16-Bit Parallel

"B1", "B2" used with Paralled ASCII Interface (Option -07) only.

The front panel DMM display is turned on when the ASCII mode is entered and off when the binary mode is entered.

The Binary Output Format

The binary output format consists of five bytes. The first four bytes comprise a 32-bit binary two's complement fixed point number. An implied binary point for this number is located between the first and second bytes. The first 8-bit byte thus serves as the integer portion. The 24 bits of the next 3 bytes serve as the binary fraction. Additionally, since this format cannot be used to hold the entire range of possible values for the DMM, a fifth byte is used as an exponent. This exponent is a two's complement binary number representing the decimal exponent of the binary fixed point number defined by the first 4 bytes. An exception occurs in Limits testing; the response will then be single byte binary two's complement number.

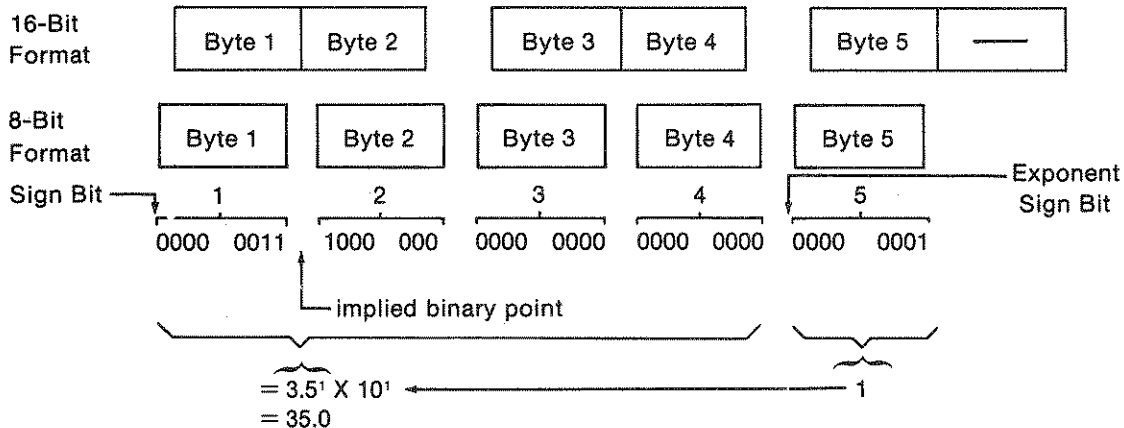

Table 2A-1. Programming Instructions (cont)

NOTE

In dc volts and ac volts, the exponent is always 1.
 In dc and ac current, the exponent is always -2.
 The exponent is range dependent in ohms function (1 for ohm ranges, 4 for kohm ranges, and 7 for Mohm ranges).

Errors will be indicated by 5 bytes of 0.

ASCII Data Output Format

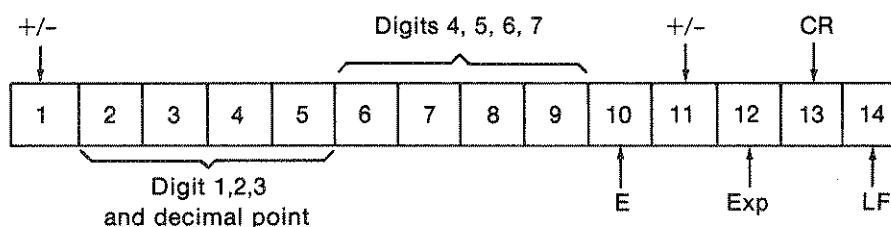

The seventh digit in the ASCII format corresponds to the "Cal" or HIRES digit of the front panel display. In some ranges and functions (e.g., 100 mV dc) this digit is permanently zeroed since it exceeds the resolution of the instrument. (When in the "Cal" or HIRES mode, the front panel will display the value of the reading rounded to six significant digits.)

DISPLAY CONTROL

The "D" command characters turn the DMM front panel display on or off.

D Display Off
D O Display On

When the "D0" command is used, the instrument will no longer interrogate any of the front panel switches (local lockout). The display will be turned On when the ASCII output format is commanded.

LOCAL LOCKOUT CONTROL

The "L" command characters select the local lockout condition, in which the display remains activated while none of the front panel switches affect the instrument.

L Local Lockout On
L O Local Lockout Off

ECHO COMMAND CHARACTERS

● (used with Bit Serial Option -06 only)

Y ECHO ON (Full-Duplex)
Y O ECHO OFF (Half-Duplex)

Table 2A-1. Programming Instructions (cont)

LINE FEED CONTROL COMMAND CHARACTERS

<div style="border: 1px solid black; border-radius: 50%; width: 30px; height: 30px; display: flex; align-items: center; justify-content: center; margin-bottom: 10px;">J</div>	Suppress Line Feed Character	This character suppresses the LF character normally sent at the end of a response line.
<div style="border: 1px solid black; border-radius: 50%; width: 30px; height: 30px; display: flex; align-items: center; justify-content: center; margin-bottom: 10px;">J</div> <div style="border: 1px solid black; border-radius: 50%; width: 30px; height: 30px; display: flex; align-items: center; justify-content: center; margin-left: 10px;">0</div>	Transmit Line Feed Character	This character disables the "J" character; the "LF" character will be sent.
<div style="border: 1px solid black; border-radius: 50%; width: 30px; height: 30px; display: flex; align-items: center; justify-content: center; margin-bottom: 10px;">J</div> <div style="border: 1px solid black; border-radius: 50%; width: 30px; height: 30px; display: flex; align-items: center; justify-content: center; margin-left: 10px;">1</div>	Suppress Output of Readings	◆ In the 8500A, use of J1 will suppress all output from the DMM. In the 8502A, use of J1 will suppress output with the following exceptions: Service Request (SRQ), status, recalled values. While in the J1 mode, use of the recall command "G ?" will retrieve a reading. Use of "J" or "J0" will exit the "J1" mode.

CALIBRATION CONSTANT

When the Calibration Memory (Option -04) module is installed, the "M" character will inhibit the adjustment of readings by the Calibration Memory correction factor. A slight increase in the speed of readings will result.

<div style="border: 1px solid black; border-radius: 50%; width: 30px; height: 30px; display: flex; align-items: center; justify-content: center; margin-bottom: 10px;">M</div>	Inhibit Calibration Memory Factors
<div style="border: 1px solid black; border-radius: 50%; width: 30px; height: 30px; display: flex; align-items: center; justify-content: center; margin-bottom: 10px;">M</div> <div style="border: 1px solid black; border-radius: 50%; width: 30px; height: 30px; display: flex; align-items: center; justify-content: center; margin-left: 10px;">0</div>	Enable Calibration Memory Factors

TRIGGER COMMAND CHARACTERS

◆ This set of command characters is available for the 8502A with the Isolator Option -08A.

<div style="border: 1px solid black; border-radius: 50%; width: 30px; height: 30px; display: flex; align-items: center; justify-content: center; margin-bottom: 10px;">Q</div>	Activate External Triggering Mode, Interrupt when Ready	This character enables the External Triggering mode. Any external TTL trigger then initiates a reading and interrupts when ready (SRQ).
<div style="border: 1px solid black; border-radius: 50%; width: 30px; height: 30px; display: flex; align-items: center; justify-content: center; margin-bottom: 10px;">Q</div> <div style="border: 1px solid black; border-radius: 50%; width: 30px; height: 30px; display: flex; align-items: center; justify-content: center; margin-left: 10px;">0</div>	Deactivate External Triggering Mode	
<div style="border: 1px solid black; border-radius: 50%; width: 30px; height: 30px; display: flex; align-items: center; justify-content: center; margin-bottom: 10px;">Q</div> <div style="border: 1px solid black; border-radius: 50%; width: 30px; height: 30px; display: flex; align-items: center; justify-content: center; margin-left: 10px;">1</div>	Activate External Triggering Mode, Transmit when Ready	The Q1 character also enables External Triggering mode. Any external TTL trigger initiates and transmits a reading.

NOTE

The "?" and "@" characters remain operative during External Triggering.

Table 2A-1. Programming Instructions (cont)

◆ EXTERNAL TRIGGER DELAY COMMAND CHARACTERS
(-08A with 8502A only)

The "W" command characters select the amount of delay between the external trigger signal and the initiation of the reading.

W	No Delay		
W	0		2.083 ms
W	1		4.166 ms
W	2		8.332 ms
W	3		16.66 ms
W	4		33.33 ms
W	5		66.66 ms
W	6		133.3 ms
W	7		266.6 ms
W	8		533.2 ms
W	9		1.066s
W	1	0	2.133s
W	1	1	4.266s
W	1	2	8.532s
W	1	3	17.06s
W	1	4	34.13s
W	1	5	68.26s

Table 2A-1. Programming Instructions (cont)

MEMORY COMMAND CHARACTERS

STORE

The "K" (Keep) command characters specify the storing of a reading or numeric entry.

K Store Last Reading as Offset ◆ The 8500A will store the unprocessed reading, whereas the 8502A will store the displayed reading.

K 0 Store Last Voltage Taken as VDC Zero (on R0 Only)

K 1 Store Last Reading as Ohms Zero (on R0 Only)

K N P Store Numeric Value Following as Offset

K N X Store Numeric Value Following as Scaling Factor
(Note: The read value may not be stored as a Scaling Factor.)

K N U Store Numeric Value Following as Upper Limit

K N L Store Numeric Value Following as Lower Limit

Offsets, Scaling Factors, Upper and Lower Limits may be entered via the "KN" command characters, followed by one of the modifier characters "P", "X", "U" or "L" and the numeric value (on ASCII string of numeric characters, and optional sign, decimal point and signed decimal exponent digit in "E" notation).

Examples of legal numeric strings are:

K N P 1 0

Keep Numeric offset of 10.0

K N X 1 0 . 3 E - 1

Keep numeric scaling factor of 10.3×10^{-1} or 1.03

K N U 7 . 6 E 4

Keep numeric upper limit of 7.6×10^4

K N L - 1 2 3 . 4 5 6 E + 0

Keep numeric lower limit of -123.456

Table 2A-1. Programming Instructions (cont)

An example of an illegal numeric string is:

(K) (N) (X) (2) (.) (0) (E) (-) (1) (3)

Exponent is limited to one signed integer digit, in this case the exponent would be -1 and the "3" would be ignored.

NOTE

Numeric entries are limited to the maximum display value. These values are:

+1.00000 E +9 to +1.00000 E -9, and -1.00000 E -9 to -1.00000 E +9

Numbers less the $\pm 1.00000 E -9$ are treated as zero.

RECALL

The "G" (Get) command characters specify the recall of a reading, a numeric entry or a status. Each "Get" command must be followed by a "?" termination character. The following memory "Get" commands may be used:

(G) Recall Previous Reading and Send on Next Trigger

(G) (0) Recall DC Zero and Send on Next Trigger

(G) (1) Recall Status and Send on Next Trigger

Status information from the DMM may be obtained with the command character "G1?". The status response will be returned in the following seven character format.

Error Codes

1	2					
---	---	--	--	--	--	--

Characters 1 and 2 define error code status. Each error code contains two digits: those codes with a zero for the first digit are related to remote operation only. All other codes contain the same second digit as the DMM's front panel error codes.

- 00 No Error
- 06 System Error
- 07 Illegal Numeric Entry
- 08 Remote Command String Error
- 09 Remote Overrange
- 10 V DC Zero/Ohms Zero Error
- ◆ 11 Offset Error (8500A) Store during Overrange (8502A)

Table 2A-1. Programming Instructions (cont)

Error Codes (cont)

- 12 Filter Module Faulty or not installed
- 13 DC Signal Conditioner Module Faulty or not installed
- 14 Excessive voltage present at terminals for Ohms/Current Measurement
- 15 Fast A/D Converter Faulty or not installed
- 16 Numeric Display Overflow
- 17 Magnitude of External Reference Input >20V
- 18 Controller Module Faulty
- 19 Function Module selected not installed

Range Codes

		3				
--	--	---	--	--	--	--

The third character of the status response contains the following range information:

- 0 100 mV dc, 100 μ A, 10 Ω
- 1 1V dc, 1V ac, 1 mA, 100 Ω
- 2 10V dc, 10V ac, 10 mA, 1k Ω
- 3 100V dc, 100V ac, 100 mA, 10 k Ω
- 4 1000V dc, 1000V ac, 1A, 100 k Ω
- 5 1 M Ω
- 6 10 M Ω
- 7 100 M Ω

Sample Codes

			4			
--	--	--	---	--	--	--

The fourth status response character contains sample information identified by the following codes:

- 0 1 Sample per Reading
- 1 2 Samples per Reading
- 2 4 Samples per Reading
- 3 8 Samples per Reading
- 4 16 Samples per Reading
- 5 32 Samples per Reading
- 6 64 Samples per Reading
- 7 128 Samples per Reading or Greater

Function Codes

				5	<CR>	<LF>
--	--	--	--	---	------	------

The fifth response character identifies function:

- 0 DC Volts
- 1 AC Volts
- 2 DC Amps
- 3 AC Amps
- 4 Ohms
- 5 DC Coupled AC Volts
- 7 Function Not Defined

Table 2A-1. Programming Instructions (cont)

G N P Recall Offset and Send on Next Trigger

◆ **G N X** Recall External Ref or Scaling Factor and Send on Next Trigger (8500A)
Recall Scaling Factor (8502A)

◆ **G N R** Recall External Reference Factor and Send on Next Trigger (8502A)

G N U Recall Upper and Send on Next Trigger

G N L Recall Lower Limit and Send on Next Trigger

NOTE

The instrument will replay to "GNU" or "GNL" by transmitting the stored limit value.

G N Q Recall Lowest (Peak) Value Found and Send on Next Trigger

G N W Recall Highest (Peak) Value Found and Send on Next Trigger

Table 2A-2. Programming Instructions (8505A, 8506A)

The following discussion relates remote operation features available with the 8505A and the 8506A to existing documentation for remote operation of the 8500 series multimeters. The additional features for the 8505A and the 8506A are presented in this discussion in the same sequence as they would appear in the "Programming Instructions" table (Table 2A-1).

Most of the items documented in this table supplement features available with the 8502A and 8502A/AT. Incompatibilities have been kept to a minimum. Therefore, programs designed for the 8502A are generally compatible with the 8505A and the 8506A, and 8502A/AT programs are generally compatible with the 8506A. The few areas that are not compatible are briefly described below. Refer to appropriate areas in this table for a more detailed description.

1. High Speed Mode (!): Some High Speed mode scaling factors have been changed. Also, use of the reset command (*) causes the multimeter to both exit High Speed mode and perform a normal reset.
2. Range Commands: Full scale points and autoranging points have been changed in several instances.
3. Store Zero Commands (K0, K1): In the 8505A/8506A, the temporary zero correction values are set to 0 when the instrument is reset or powered up (similar to the 8502A without the calibration memory option). In the 8502A with the calibration memory option, resetting the instrument does NOT clear the stored zeros.

INITIALIZATION

CAUTION

Interruption of input power could affect Calibration Memory entries when the multimeter is in Calibration mode. Do not cycle input power to the multimeter when Calibration mode is activated. If power is ON, verify that the AVG/(CAL) annunciator is not flashing before cycling power to OFF. From the remote, Calibration mode status can be verified with the G5 command (response of 0 = mode off, response of 1 = mode on). If power is OFF, verify that the rear panel Calibration switch is off before cycling power to ON.

Both the 8505A and the 8506A assume the same configuration at power up as that described for 8502A, with the following exceptions:

1. The Average mode is disabled (OO).
2. Calibration Memory factors are retained at all times. These factors include zero corrections for each range in dc volts and ohms functions, gain corrections for each range in each function, and the calibration date (or instrument identification) number.
3. External Reference at power up or reset is used as temporary storage for the multimeter software version number. The GNR command can then be used to recall this number. Any use of the X command subsequent to power-up or reset replaces this number with the value applied at the external reference inputs.
4. Zero mode is enabled with all temporary zero correction values set to 0.

HIGH SPEED MODE

Selection of the High Speed mode sets the following conditions:

1. The "!" command both enters the High Speed mode and triggers a reading.
2. Use of any character (or bit pattern) other than "?" causes the multimeter to exit the High Speed mode. Use of "*" causes the multimeter to both exit the High Speed mode and perform a normal reset. The character used to exit High Speed mode must be sent by itself. Any commands to be executed after exiting High Speed mode must be sent in a separate transmission (i.e., in a separate statement in the instrument controller program).
3. Selection of High Speed mode specifies the binary output format. Any previously selected output format is restored once High Speed mode is exited.
4. The multimeter front panel display is blank while High Speed mode is on. The previously selected display mode is restored once High Speed mode is exited.

Table 2A-2. Programming Instructions (8505A, 8506A) (cont)

5. High Speed mode specifies asynchronous, single trigger mode (T2). The previously selected trigger mode is restored once High Speed mode is exited.

The high speed reading mode ("I") cannot be used for any ac volts function (normal, enhanced, or high accuracy) with the 8506A.

Voltage and Current Reading in "I"

The following scale factors are used:

FUNCTION	UNITS	RANGE				
		0	1	2	3	4
DC Volts (V)	V	1/100*	1/10*	1	64/10*	64
DC Amps (I)	mA	-1/80*	-1/10*	-8/10*	-64/10*	-512*
AC Volts (8505A only)	V	n/a	1/8	1	8	64
AC Amps (8505A only)	mA	1/64	1/8	1	8	64

*Differs from 8502A

FUNCTION COMMAND CHARACTERS

The 8505A uses the same function command characters as those listed. The "C" command (dc coupled ac volts) can only be used when the True-RMS Converter (Option -09A) is installed. When an 8505A function is changed, the multimeter is configured as follows:

1. If the same function is re-selected, the multimeter assumes autoranging and retains all other existing modes and stored values.
2. If a new function is selected, the following configuration is set:
 - a. Autoranging (R) is set.
 - b. The existing trigger mode, sample, and filter are retained. However, if Average mode was previously on, it is turned off, sample is set to S7 and filter is set to F0.
 - c. Offset, External Reference, Scaling, Limits, and Peaks are turned off (P0, X0, U0 respectively), with all respective values retained.
 - d. Zero mode is toggled off if a function other than dc volts (V) or ohms (Z) is selected. If dc volts (V) or ohms (Z) is reselected, the Zero mode state (on or off) is restored to that in effect the last time the function was selected. The values of the temporary zeros are stored until the instrument is reset or powered off, or until new temporary zeros are stored.
 - e. Calibration mode is on or off (as determined by the Calibration Switch setting) and gain correction factors are enabled (M0).

When an 8506A function is changed, the multimeter assumes a configuration defined by the variety of both old and new functions. One variety includes dc volts (V), ohms (Z), and dc amps (I). The second variety includes all ac volts functions (VA, VA1, VA2, C, C1, and C2). Four types of configuration change are therefore possible. Each of these changes resembles that detailed above for the 8505A, with the following exceptions:

1. Initial function was V, Z, or I — New function is V, Z, or I:

The 8505A configuration is used.

Table 2A-2. Programming Instructions (8505A, 8506A) (cont)

2. Initial function was V, Z, or I — New function is ac or ac+dc volts:
 - a. Filter mode off (F0) is set.
 - b. No sample setting is allowed.
 - c. Zero mode is off.
3. Initial function was ac or ac+dc volts — New function is V, Z, or I:
 - a. Filter mode on (F) or off (F0) is retained.
 - b. Sample S7 is set.
4. Initial function was ac volts — New function is ac volts:
 - a. If the initial and new functions are both ac volts (or both ac+dc volts), manual ranging mode is retained at the same range, or autoranging is retained (starting at the same range).
 - b. If the change is between an ac volts function (VA, VA1, VA2) and an ac+dc volts function (C, C1, C2), autoranging is automatically enabled.
 - c. For all types of change (ac to ac, ac+dc to ac, ac to ac+dc, or ac+dc to ac+dc), Averaging mode (extended resolution) and all other modes and values are retained. No sample change is allowed in any 8506A ac volts function.

The following commands are used when initially selecting an 8506A ac volts function:

1. V A : V AC Normal
2. V A 1 : V AC Enhanced
3. V A 2 : V AC High Accuracy
4. C : V AC Normal (DC Coupled)
5. C 1 : V AC Enhanced (DC Coupled)
6. C 2 : V AC High Accuracy (DC Coupled)

NOTE

AC volts function commands used with the 8502A/AT are compatible with the 8506A. However, the six function commands mentioned above allow for faster, direct entry into the desired 8506A ac volts mode.

If the 8506A is already in an ac volts function, an abbreviated command can be used when selecting either of the other two ac volts functions. When selecting between ac or dc coupling for ac volts, the full command string mentioned above must be used. The abbreviated commands are as follows:

1. S 0 : V AC Normal
2. S 1 : V AC Enhanced
3. S 2 : V AC High Accuracy

Table 2A-2. Programming Instructions (8505A, 8506A) (cont)

RANGE COMMAND CHARACTERS

The nine range commands used with the 8505A or 8506A specify the full scale values by function as follows:

	DC VOLTS (V)	AC VOLTS	AC VOLTS	DC AMPS (I)	AC AMPS (IA)	OHMS (Z or Z1)
		8505A	8506A		8505A	
R	Auto	Auto	Auto	Auto	Auto	Auto
R 0	200 mV	Auto	125 mV	250 μ A	312.5 μ A	20 ohms
R 1	2V	2.5V	400 mV	2.0 mA	2.5 mA	200 ohms
R 2	20V	20V	1.25V	16 mA	20 mA	2 kohms
R 3	128V	160V	4V	128 mA	160 mA	20 kohms
R 4	1200V	1000V	12.5V	1.28A	1.28A	200 kohms
R 5	Auto	Auto	40V	Auto	Auto	4.1 Mohms
R 6	Auto	Auto	125V	Auto	Auto	35 Mohms
R 7	Auto	Auto	600V	Auto	Auto	265 Mohms

Resolution available for remote readings is as follows:

FUNCTION	RANGE	ASCII DIGITS*	
		STANDARD MODE	AVERAGING OR CALIBRATION MODE
DC Volts (V)	100 mV (R0)	6½ (5½)	6½
	1V (R1)	6½	6½
	10V (R2)	6½	7½
	100V (R3)	6½	6½
	1000V (R4)	6½	6½
Ohms (Z)	10 ohms (R0)	6½	6½
	100 ohms (R1)	6½	6½
	1 kohm (R2)	6½	6½
	10 kohms (R3)	6½	6½
	100 kohms (R4)	6½	6½
	1 Mohm (R5)	6½	6½
	10 Mohms (R6)	6½	6½
100 Mohms (R7)	6½	6½	
DC Amps (I)	100 μ A (R0)	6½ (5½)	6½
	1 mA (R1)	6½	6½
	10 mA (R2)	6½	6½
	100 mA (R3)	6½	6½
	1A (R4)	6½	6½
AC Amps (8505A only)	100 μ A (R0)	5½	5½
	1 mA (R1)	6½	6½
	10 mA (R2)	6½	6½
	100 mA (R3)	6½	6½
	1A (R4)	6½	6½
AC Volts (VA) or AC + DC (C) (8505A only)	1V (R1)	6½	6½
	10V (R2)	6½	6½
	100V (R3)	6½	6½
	1000V (R4)	6½	6½

Table 2A-2. Programming Instructions (8505A, 8506A) (cont)

FUNCTION	RANGE	ASCII DIGITS*	
		STANDARD MODE	AVERAGING OR CALIBRATION MODE
AC Volts (VA, VA1, VA2) or AC + DC (C, C1, C2) (8506A only)	100 mV (R0)	6½ (5½)	6½
	300 mV (R1)	6½ (5½)	6½
	1V (R2)	6½	6½
	3V (R3)	6½	6½
	10V (R4)	6½	6½
	30V (R5)	6½	6½
	100V (R6)	6½	6½
	500V (R7)	6½	6½

*Resolution in binary mode is generally the same as in ASCII mode. Differing resolution in binary mode is shown in parentheses.

SAMPLES PER READING COMMAND CHARACTERS

Use of the sample commands is modified as follows:

1. With the 8505A, samples-per reading can be set with command S, followed by one or two digits (0-17). Digits greater than 17 cause a command string error (08). The H command can still be used, but the multimeter recognizes only one following digit (0-9, corresponding to S8 through S17 respectively).
2. With the 8506A (dc volts, ohms, dc amps only), samples-per-reading can be commanded in the manner described above.
3. With the 8506A set for ac volts, no sample changes are allowed. Therefore, commands S0 through S17 (or H0 through H9) cannot be used for sample settings when the 8506A is set for ac volts normal, enhanced, or high accuracy. However, the first three commands (S0, S1, S2) are used when commanding ac volts functions as follows:
 - a. S0 commands ac volts normal. When initially commanding an ac volts function, only VA (for ac coupling) or C (for dc coupling) need be used. When the multimeter is already set for either of the other two ac volts functions, ac volts normal can be selected by using S0 only.
 - b. S1 commands ac volts enhanced. When initially commanding an ac volts function, VA1 (for ac coupling) or C1 (for dc coupling) must be used. when the multimeter is already set for either of the other two ac volts functions, ac volts enhanced can be selected by using S1 only.
 - c. S2 commands ac volts high accuracy. When initially commanding an ac volts function, VA2 (for ac coupling) or C2 (for dc coupling) must be used. when the multimeter is already set for either of the other two ac volts functions, ac volts high accuracy can be selected by using S2 only.

FILTER COMMAND CHARACTERS

Any filter command is acceptable for the 8505A or the 8506A (in V, Z, or I only). However, when Average mode is enabled, filter F is initially selected and can only be changed to F2 or re-selected. Any other filter selection (F0, F1, or F3), while accepted by the multimeter, sets the Average mode disabled and the sample at S7.

When the 8506A is in an ac volts function, only filter F0 (set at new function selection) or F (subsequently selected for inputs less than 40 Hz) is allowed.

TRIGGER COMMAND CHARACTERS

When the multimeter (8505A or 8506A) is in a continuous trigger mode (T or T1), the reset command (*) causes a normal multimeter reset. All other commands are buffered and examined only when the halt command (%) is sent.

Table 2A-2. Programming Instructions (8505A, 8506A) (cont)

With any trigger mode, no command string is examined until the existing reading or recalled value is returned. Any reading or recall value commanded (but not yet returned) can be discarded by sending the halt (%) command. If a continuous trigger mode (T or T1) is in effect when (%) is sent, the multimeter configuration is changed to single trigger mode (T0 or T2), and any buffered commands (with a terminating character) are executed.

AVERAGING COMMAND CHARACTERS

With the 8505A (all functions) and the 8506A (dc volts, ohms, dc amps only), the "O" character is used to command a preset sample and filter combination for each function and range to optimize accuracy and stability. Averaging also provides an extra digit of resolution in several ranges (as defined under RANGE COMMAND CHARACTERS). The following commands are available:

1. O: Averaging mode enabled.
2. O0: Average mode disabled.

Enabling of Average mode in the situations defined above sets the multimeter to sample S10 and filter F. With Average mode enabled, samples S11-S17 or filter F2 can also be selected. Disabling of Average mode changes the sample and filter again and occurs under any of the following circumstances:

1. Command O0 is sent. Averaging mode is disabled. The sample is set to S7 and the filter is set to F0.
2. The function is changed. The sample is set to S7 and the filter is set to F0. If an ac volts function is initially selected with the 8506A, only filter F0 is set. If a change is made between 8506A ac volts functions (VA, VA1, VA2, C, C1, C2), Averaging (extended resolution) is retained.
3. A sample or filter not allowed in Average mode is commanded. If S0-S9 is commanded, Average mode is disabled, the new sample setting is accepted and the filter is set to F0. If a filter other than F or F2 is selected, Average mode is disabled, the new filter is accepted and the sample is set to S7.

With the 8506A set for any of the ac volts functions, Average mode is not available. However, the O or O0 command can still be used to enable or disable extended resolution (as defined under RANGE COMMAND CHARACTERS). In this situation, only the sample and filter restrictions defined by the 8506A ac volts functions are applicable. No sample change can be made. Only filter F0 or F (for input signals less than 40 Hz) can be selected. If a sample change is attempted or an unallowed filter is commanded, a momentary error is set and extended resolution is retained. Extended resolution in 8506A ac volts functions is disabled if the O0 command is sent. If a change is made between ac volts functions, extended resolution is retained with the existing filter mode. If dc volts, ohms, or dc amps is selected, extended resolution (Average mode) is disabled, the filter is not changed, and the sample is set to S7.

Whenever the "O" character is used (8505A or 8506A - any function), the multimeter responds with the following output format:

BINARY OUTPUT FORMAT

16-Bit Format (B1):

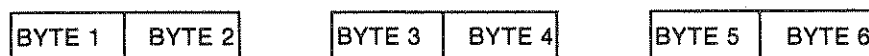

8-Bit Format (B):



Example:

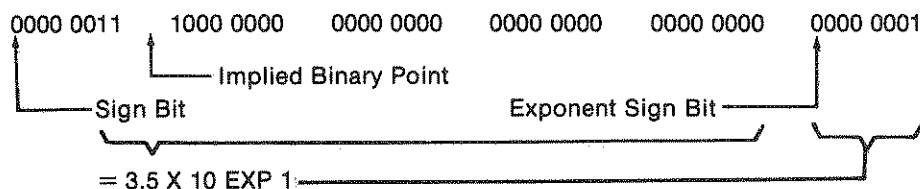
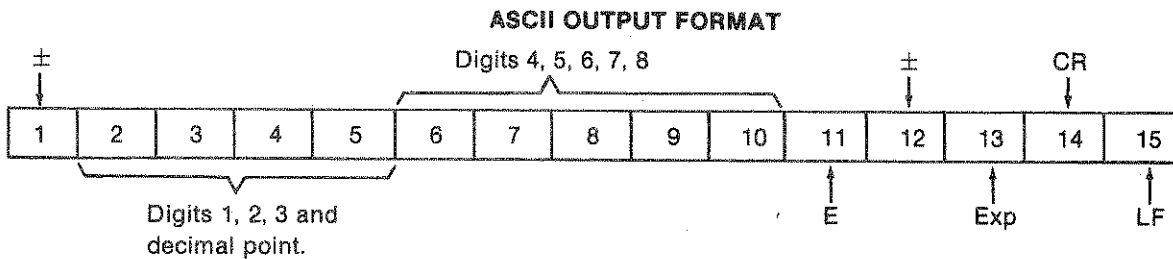

Table 2A-2. Programming Instructions (8505A, 8506A) (cont)



OFFSET COMMAND CHARACTERS

When storing the previous reading as an offset, both the 8505A and the 8506A use the displayed value in the same manner as does the 8502A.

LIMITS AND PEAKS COMMAND CHARACTERS

When Limits testing is enabled (U), an error is identified by either of the following responses:

1. The standard error response message (programmed with the K3 command) is normally returned.
2. If no such standard error response message has been programmed since the last power-up or reset, a "2" is returned to identify an error occurring during limits testing.

CONTROL COMMAND CHARACTERS

ASCII Data Output Format

Digit 7 is used with the 8505A and 8506A whenever 6½ digits of resolution are available. If 5½ digits are available, digit 7 is not needed and is consequently set to 0.

CALIBRATION CONSTANT

The Calibration Memory is a standard feature of the 8505A and 8506A. Therefore, the M and M0 commands may be used at any time to inhibit or enable all Calibration Memory gain correction factors:

M: inhibit all calibration gain correction factors.

M0: enable calibration gain correction factors.

The M1 and M2 commands may be used to inhibit or enable the temporary zero correction factors stored with the K0 and K1 commands (V DC and OHMS only). This has the same effect as turning the Zero mode off and on with the ZERO push button, except the M2 command does not store zeros:

M1: inhibit zero correction values (turn Zero mode off).

M2: enable zero correction values (turn Zero mode on).

The temporary zero correction factors are applied in dc volts (V) or ohms (Z) whenever the M2 command is in effect (i.e., whenever Zero mode is on). When the multimeter is powered-up or reset, the Zero mode is turned on and the temporary zero correction factors are reset to 0. During normal operation (Calibration mode off), the "permanent" zero correction factors in Calibration Memory are always in effect, and are not affected by the M1 and M2 commands.

Calibration Memory allows for software calibration of all functions and is fully described in Appendix 7B. Although software calibration procedures are not discussed here, the following considerations must be observed if Calibration mode is turned on (the Calibration mode is enabled or disabled with the rear panel Calibration Switch when the multimeter is in local control):

1. Calibration correction factors are always applied to readings unless the M command is sent. This is true whether Calibration mode is on or off.
2. When Calibration mode is on, the M1 and M2 commands enable and disable the "permanent" zero correction factors stored in Calibration Memory. Temporary zeros are not used in Calibration mode.
3. When Calibration mode is on, the resolution available for each range and function is the same as for Average mode (refer to RANGE COMMAND CHARACTERS).

Table 2A-2. Programming Instructions (8505A, 8506A) (cont)

MEMORY COMMAND CHARACTERS

STORE

Commands K0 (store dc volts zero) and K1 (store ohms zero) can be used with either the 8505A or the 8506A. However, the zero value is stored in the following new fashion:

1. If Calibration mode is on (G5 response = 1), any zero value entered with the K0 or K1 command is stored directly in the Calibration Memory and retained until a new value is stored during Calibration mode on. Software calibration uses this procedure and is fully described in Appendix 7B.
2. If Calibration mode is off (G5 response = 0), any zero value entered with the K0 or K1 command is stored in a separate, temporary memory. These values do not affect the values stored in Calibration Memory. The temporary zero values are retained and applied to subsequent readings until the multimeter is powered-off or reset. The temporary zero values are all reset to 0 at power-up or reset.
3. Whenever the K0 or K1 command is used (Calibration mode on or off), a separate zero value can be stored for each range.
 - a. If Calibration mode is on, the zero value is stored for the range selected without affecting the value for any other range.
 - b. If Calibration mode is off, any zero value stored is applied to the existing range and all higher ranges in the same function. Therefore, separate values for each range can be entered by using K0 (or K1) sequentially for each range (from lowest to highest).

The following additional store commands are available for the 8505A or the 8506A:

1. **K N G** : Keep gain correction on this range. This command is used when storing calibration gain correction factors with Calibration mode on. Software Calibration (Appendix 7B) deals with this procedure in detail.
2. **K N D** : Keep the following six digits as the calibration date or the multimeter identification. Any value totaling 999999 or less can be entered (with Calibration mode on). Zeros are not suppressed if less than six digits are entered. The full procedure is defined in Software Calibration (Appendix 7B).
3. **K 3** : Keep the error response message. This command allows the operator to specify the response for an error condition. These characters (instead of the actual reading) are then automatically returned whenever an error condition occurs. For example, the word ERROR or an obviously illegal response value (such as 1E20) can be programmed as the error response message. The desired response must be reprogrammed after a power-up or reset condition occurs. The multimeter returns 0 as the error message if no other message has been programmed. The actual error can only be identified as the first and second characters of the G1 (Get Status) response. The following rules must be followed when making the K3 entry:
 - a. A maximum of any 15 characters (excepting immediate and termination characters) can be programmed following the K3 command. Spaces can be used as part of the 15 character total. Characters in excess of 15 are ignored by the multimeter and do not cause an error condition.
 - b. Nulls are discarded and not stored. Nulls are not counted for the 15 character limit.
 - c. Any immediate character (including termination characters) terminates and executes the string normally.
 - d. The \$ command is an immediate character only when used with the Bit Serial Interface (Option -06). With the IEEE-488 Interface (Option -05) or Parallel Interface (Option -07), \$ is not an immediate character and can be used as part of the K3 command string.

Table 2A-2. Programming Instructions (8505A, 8506A) (cont)

- e. The # command is an immediate character only when used with the Bit Serial Interface (Option -06) or the Parallel Interface (Option -07). With the IEEE-488 Interface (Option -05), the # command is not an immediate character and can be used as part of the K3 command string.
4. **K 4 G 1** : Clear all of Calibration Memory. If it is necessary to clear all calibration factors (as in a check sum error 25 condition or prior to hardware calibration of all functions), the K4G1 command string can be used. Depending on the number of entries being cleared, several seconds may be necessary to complete this operation. Completion of this comprehensive clearing operation is verified by return of the status response.

CAUTION

If any interrupting command is sent immediately after K4 (and before G1), the comprehensive clearing operation may be interrupted prior to completion. A check sum (error 25) condition would then be set. Do not send any interrupting command (Immediate characters, reset, etc.) between K4 and G1.

5. **K 2** : Store previous reading as scaling factor.

RECALL**Recall DC Zero (G0)**

The G0 command (recall dc zero and send on next trigger) operates in the following fashion for either the 8505A or the 8506A:

1. The multimeter can store separate dc zero values for each range. If G0 is used when dc volts function is selected, the dc zero recalled is the value for the range selected. If G0 is used when any other function is selected, the dc zero recalled is the value for the 100 mV range only.
2. The multimeter can store both non-volatile ("permanent") and temporary dc zero values. Which values are recalled depends on the state of the Calibration mode at the time G0 is used. When Calibration mode is on, the zero values recalled are the permanent values, which are stored in Calibration Memory. When Calibration mode is off, the zero values recalled are the temporary values, which are stored in a separate, temporary memory. The temporary zero values are reset to 0 when the multimeter is powered-up or reset.

Recall Status (G1)

The first two digits of the G1 response (error codes) are identified in two steps. The first step involves a user-programmed error message that is returned whenever an error condition has been generated. This message is stored in an error response buffer and serves only as a "flag" that an error exists. It does not identify the error. An error message is programmed with the K3 command, followed by any combination of up to 15 characters. For example, an obviously illegal multimeter response of 1E20 could be specified as the error message. If no such special message has been programmed, a returned "0" is used. In any case, this message alone is returned whenever an error condition has been generated and a response from the multimeter has been commanded. The error message may be returned repeatedly. This depends on the type of error condition generated (momentary or latching) and subsequent corrective actions. The following rules apply:

1. Each momentary error condition generates only one error message.
2. A latching error condition, if not corrected, generates repeated errors. Therefore, the error message is returned for each attempted reading.

For the second step, the G1 (get status) command must be sent. The first and second characters of the status response then identify the error condition by number. This two-digit error code is stored in a separate error condition buffer and is subject to the following rules:

1. A single two-digit error code can occupy the error buffer.
2. If a multiple error condition exists, only the last error to have been generated is stored in the error buffer.

Table 2A-2. Programming Instructions (8505A, 8506A) (cont)

3. The error buffer is cleared (set to 00) when either of the following actions occurs:
 - a. The G1 command is sent. The error is returned in the status response, and the buffer is reset to 00. If the error still exists, a new reading must be triggered to reload the error buffer (and return the error message). If another G1 command is sent before a new reading is triggered, no error (00) is identified in the response.
 - b. A valid reading is triggered. The reading is returned and the buffer is reset to 00.

The multimeter employs both momentary and latching errors. A momentary error in the buffer can be cleared by sending the G1 command or by triggering a valid reading. If the momentary error does not reoccur, further multimeter operation is not impeded. A latching error, if not corrected, does impede further multimeter operation by generating another error (and returning the error message) each time a reading is triggered. Clearing the error buffer by sending G1 does not affect this impediment. Latching errors include 12, 13, 14, 15, 19, and 24.

A momentary error condition is illustrated in the following example. Assume that 1V dc is applied to a multimeter configured for dc volts. The following sequence of commands is sent: VR0? KG1? R1? The first command (VR0?) triggers an overrange, causing the error message to be returned. The second command (KG1?) attempts to store this overrange as an offset, loads momentary error 11 into the error buffer, and returns 11 (the most recent error to be generated) in the status response. The third command (R1?) triggers and returns a valid reading and resets the error buffer to 00.

A latching error condition is encountered in the following example. Assume that the multimeter is configured for dc volts (V), but not dc current measurement (I), and 1V dc is applied to the inputs. The following sequence of commands is sent: IR1? G1? ? V? The first command (IR1?) triggers an invalid reading, loads the error buffer with latching error 19, and causes the error message to be returned. The second command (G1?) returns 19 as the first two characters of the status response and resets the error buffer to 00. The third command (?) triggers another invalid reading, loads the error buffer with 19 again, and returns the error message. The fourth command (V?) is valid. Therefore, the actual reading is returned, and the error buffer is reset to 00.

NOTE

Latching errors are enabled at all times (Calibration mode on or off) when remote operation is in use. However, latching errors can be disabled locally (with Calibration mode on). This procedure is intended for use during troubleshooting only. Do not attempt to disable latching errors at any other time.

The following additional error conditions can occupy the error buffer for either the 8505A or the 8506A:

1. 23 : The Calibration Memory is faulty or not installed.
2. 24 : Illegal module configuration.
This error occurs at power-up or reset. It may mean that a Calibration Memory module is installed. The 8505A and 8506A do not use a separate module for calibration memory entries (calibration memory is a standard part of the Controller module). If a Calibration Memory module is installed, it must be removed. Also, error 24 may mean that the wrong ac converter configuration is installed. The 8505A uses either the -01 Option or the -09A Option (not both). The 8506A uses only the Thermal True-RMS Converter. If an illegal ac converter is installed, it must be removed. If the illegal configuration is not corrected, the error buffer is cleared (G1 sent), and a valid function is subsequently selected, the illegal module configuration does not interrupt further multimeter operation. However, if both ac converters (-01 and -09A) are installed in the 8505A, the ac volts command (VA or C) causes selection of the -09A converter only.
3. 25 : The Calibration Memory check sum is wrong.
This error condition may occur when applying power, when storing into Calibration Memory, or when recalling a Calibration Memory entry. It may be caused by an inadvertent cycling of power when the multimeter is in the Calibration mode. Ensure that Calibration mode is off, then try re-initializing power to the multimeter. If error 25 remains, it may be necessary to first clear, and then re-enter, all correction factors, zero values, and the calibration date (or instrument identification number). If error 25 recurs during the clearing procedure or during any subsequent programming attempt, the Calibration Memory may be faulty.

Table 2A-2. Programming Instructions (8505A, 8506A) (cont)

4. 27 : Ohms input problem
Error 27 can occur under any of the following circumstances:
- At least one ohms input connection is open.
 - An input polarity reversal has been made in four-terminal connections.
 - An input protection fuse is bad. For input connections at either the front panel terminals or through the rear input connector, any of the input fuses on the Front/Rear Switch PCB could be bad. Either the front or rear current/ohms fuse could also cause this error condition.

The third character of the G 1 (recall status) response is modified when used with the 8506A in an ac volts function. The third character (range codes) is then defined as follows:

0	100 mV	3	3V	6	100V
1	300 mV	4	10V	7	500V
2	1V	5	30V		

The fifth character (function codes) of the response to G1 is modified for the 8506A. Since ac current cannot be measured with the 8506A, the fifth character cannot be defined as "3". Further, if the fifth character is a "1" (ac volts) or a "5" (dc coupled ac volts), the specific ac volts function must also be identified. Since sample codes are not used in 8506A ac volts functions, the fourth character (Sample) is utilized to define whether normal mode (fourth character = 0), enhanced mode (1), or high accuracy mode (2) is selected.

Additional Recall Commands

The following additional recall commands are available with either the 8505A or the 8506A:

- G 2 : Recall multimeter configuration and send on next trigger. This recall command is useful in determining the multimeter type and identification number, verifying the installed modules prior to a performance test or calibration, and identifying the cause of an error 24 (illegal module configuration). A 22-character response identifies the multimeter and its hardware configuration as follows:
 - Characters 1-5: the model number (e.g. 8506A)
 - Characters 6-8: a special number (or blank)
 - Character 9: a colon (:)
 - Characters 10-22: 13 characters identifying the loaded modules.

D : DC Signal Conditioner
 F : Active Filter
 C : A/D Converter
 1 : Averaging AC Converter (Option -01)
 2 : Ohms Converter (Option -02A)
 3 : Current Converter (Option -03)
 4 : Not used (always = -)
 5 : IEEE-488 Interface (Option -05)
 6 : Bit Serial Interface (Option -06)
 7 : Parallel Interface (Option -07)
 8 : Isolator
 9 : True-RMS Converter (Option -09A)
 A : Thermal True-RMS Converter

Table 2A-2. Programming Instructions (8505A, 8506A) (cont)

Any module not installed is noted with a (-) in the response. For the 8505A, a response of DFC12---78-- would signify a standard dc volts configuration (DFC) with the Isolator (8) and options for averaging ac (1), ohms (2), and parallel interfacing (7). For the 8506A, a response of DFC--3-5--8-A would identify a standard dc volts (DFC) with the Isolator (8) and thermal true-rms volts (A) configuration with options for dc current (3), and IEEE-488 interfacing (5). Modules allowed in either instrument are defined as follows:

POSSIBLE CONFIGURATION	ALLOWED CONFIGURATION (S = standard, O = optional, N = not allowed, - = not used)	
	8505A	8506A
D	S	S
F	S	S
C	S	S
1	O (1)	N
2	O	O (2)
3	O (1)	O (2)
4	-	-
5	O (3)	O (3)
6	O (3)	O (3)
7	O (3)	9 (3)
8	S (3)	S (3)
9	O (1)	B
A	N	S

NOTES:

(1) 8505A AC Volts (VA) uses either Averaging (Option -01) or True-RMS (Option -09A) converter. 8505A AC Amps (IA) uses Current Converter (Option -03) and either ac converter. If both ac converters are installed with ac volts or ac amps selected, the True-RMS converter (Option -09A) is used.

(2) 8506A can use either the Ohms Converter (Option -01A) or the Current Converter (Option -03) — not both.

(3) 8505A and 8506A: only one interface (Option -05, -06, or -07) can be installed at one time.

2. G3: recall front/rear input selector status on next trigger. Response is as follows:

0 (rear inputs)
1 (front inputs)

3. G 4 : recall the calibration date (or instrument identifying) number. Response includes six digits with no leading zero suppression. If the Calibration Memory is not installed, the response is 0 0 0 0 0 0, and no error is generated.
4. G 5 : recall Calibration mode status. A returned 0 identifies Calibration mode off, and a returned 1 identifies Calibration mode on.
5. G 6 : recall Ohms zero value and send on next trigger. If G6 is sent when the Ohms function is selected, the zero value for the range selected is returned. If any other function is selected when G6 is sent, the zero value for the 10 ohm range (R0) is returned.

If any unspecified G command is attempted (such as G7), the multimeter assumes that G (recall previous reading and send on next trigger) has been sent.

