

895A

DC Differential
Voltmeter

WARRANTY

Notwithstanding any provision of any agreement the following warranty is exclusive:

The JOHN FLUKE MFG. CO., INC., warrants each instrument it manufactures to be free from defects in material and workmanship under normal use and service for the period of 1 year from date of purchase. This warranty extends only to the original purchaser. This warranty shall not apply to fuses, disposable batteries (rechargeable type batteries are warranted for 90 days), or any product or parts which have been subject to misuse, neglect, accident, or abnormal conditions of operations.

In the event of failure of a product covered by this warranty, John Fluke Mfg. Co., Inc., will repair and calibrate an instrument returned to an authorized Service Facility within 1 year of the original purchase; provided the warrantor's examination discloses to its satisfaction that the product was defective. The warrantor may, at its option, replace the product in lieu of repair. With regard to any instrument returned within 1 year of the original purchase, said repairs or replacement will be made without charge. If the failure has been caused by misuse, neglect, accident, or abnormal conditions of operations, repairs will be billed at a nominal cost. In such case, an estimate will be submitted before work is started, if requested.

THE FOREGOING WARRANTY IS IN LIEU OF ALL OTHER WARRANTIES, EXPRESS OR IMPLIED, INCLUDING BUT NOT LIMITED TO ANY IMPLIED WARRANTY OF MERCHANTABILITY, FITNESS, OR ADEQUACY FOR ANY PARTICULAR PURPOSE OR USE. JOHN FLUKE MFG. CO., INC., SHALL NOT BE LIABLE FOR ANY SPECIAL, INCIDENTAL, OR CONSEQUENTIAL DAMAGES, WHETHER IN CONTRACT, TORT, OR OTHERWISE.

If any failure occurs, the following steps should be taken:

1. Notify the JOHN FLUKE MFG. CO., INC., or nearest Service facility, giving full details of the difficulty, and include the model number, type number, and serial number. On receipt of this information, service data, or shipping instructions will be forwarded to you.
2. On receipt of the shipping instructions, forward the instrument, transportation prepaid. Repairs will be made at the Service Facility and the instrument returned, transportation prepaid.

SHIPPING TO MANUFACTURER FOR REPAIR OR ADJUSTMENT

All shipments of JOHN FLUKE MFG. CO., INC., instruments should be made via United Parcel Service or "Best Way" prepaid. The instrument should be shipped in the original packing carton; or if it is not available, use any suitable container that is rigid and of adequate size. If a substitute container is used, the instrument should be wrapped in paper and surrounded with at least four inches of excelsior or similar shock-absorbing material.

CLAIM FOR DAMAGE IN SHIPMENT TO ORIGINAL PURCHASER

The instrument should be thoroughly inspected immediately upon original delivery to purchaser. All material in the container should be checked against the enclosed packing list. The manufacturer will not be responsible for shortages against the packing sheet unless notified immediately. If the instrument is damaged in any way, a claim should be filed with the carrier immediately. (To obtain a quotation to repair shipment damage, contact the nearest Fluke Technical Center.) Final claim and negotiations with the carrier must be completed by the customer.

The JOHN FLUKE MFG. CO., INC., will be happy to answer all applications or use questions, which will enhance your use of this instrument. Please address your requests or correspondence to: JOHN FLUKE MFG. CO., INC., P.O. BOX C9090, EVERETT, WASHINGTON 98206, ATTN: Sales Dept. For European Customers: Fluke (Holland) B.V., P.O. Box 5053, 5004 EB, Tilburg, The Netherlands.

*For European customers, Air Freight prepaid.

John Fluke Mfg. Co., Inc., P.O. Box C9090, Everett, Washington 98206

Table of Contents

SECTION	TITLE	PAGE
1	INTRODUCTION AND SPECIFICATIONS	1-1
	1-1. Introduction	1-1
	1-6. Input Power	1-1
	1-8. Receiving Inspection	1-1
	1-10. Specifications	1-2
2	OPERATING INSTRUCTIONS	2-1
	2-1. Function of Controls, Terminals and Indicators	2-1
	2-3. Preliminary Operation	2-1
	2-4. Zeroing Instructions	2-1
	2-6. Operation as a Differential Voltmeter	2-1
	2-7. Operation as a Conventional Voltmeter	2-3
	2-9. Measurement of Voltage Excursions About a Nominal Value	2-3
	2-10. Use with a Recorder	2-4
	2-12. Measurement of High Resistance	2-4
	2-15. Use as a Ratiometer	2-5
	2-17. Notes on Operation	2-6
3	THEORY OF OPERATION	
	3-1. Introduction	3-1
	3-7. Circuit Descriptions	3-2
4	MAINTENANCE	4-1
	4-1. Introduction	4-1
	4-3. Test Equipment Required	4-1
	4-5. Periodic Maintenance	4-1
	4-8. Performance Testing	4-1
	4-15. Calibration	4-4
	4-26. Corrective Maintenance	4-5

(continued page ii)

TABLE OF CONTENTS, *continued*

SECTION	TITLE	PAGE
5	LIST OF REPLACEABLE PARTS	5-1
	5-1. Introduction	5-1
	5-3. Columnar Information	5-1
	5-4. How to Obtain Parts	5-1
	5-7. Abbreviations and Symbols	5-2
	5-8. Serial Number Effectivity	5-21
6	ACCESSORIES	6-1
	6-1. Precision Voltage Dividers	6-1
	6-2. Isolation Amplifier	6-2
7	GENERAL INFORMATION	7-1
8	SCHEMATIC DIAGRAM	8-1

List of Illustrations

FIGURE	TITLE	PAGE
Frontispiece	Model 895A DC Differential Voltmeter	iii
2-1.	Location of Controls, Terminals, and Indicators	2-2
2-2.	Function of Controls, Terminals, and Indicators (Sheet 1 of 2)	2-2
2-2.	Function of Controls, Terminals, and Indicators (Sheet 2 of 2)	2-3
2-3.	TVM Ranges	2-3
2-4.	Measurement of Resistance	2-4
2-5.	Resistance Measurement Ranges	2-5
2-6.	Measurement of Resistance Ratios	2-6
2-7.	Off-Null Input Resistance	2-7
3-1.	Model 895A Block Diagram	3-1
3-2.	+1100 Volt Reference Supply	3-4
4-1.	Test Equipment Required	4-2
4-2.	Setting for Null Detector Check	4-3
4-3.	Source for Test Voltages	4-3
4-4.	Troubleshooting Chart	4-6
4-5.	Transistor Voltage Chart	4-7
4-6.	Kelvin-Varley Divider Test	4-9
4-7.	Kelvin-Varley Divider Error Limits	4-10
4-8.	Kelvin-Varley Calibration Circuit	4-11
4-9.	Calibration Adjustment Limits	4-11

(continued page iv)

LIST OF ILLUSTRATIONS, *continued*

SECTION	TITLE	PAGE
5-1.	Final Assembly	5-3
5-2.	Chassis Assembly	5-5
5-3.	Front Panel Assembly	5-6
5-4.	Switch Assembly	5-7
5-5.	Reference Supply Board Assembly (Sheet 1 of 2)	5-10
5-5.	Reference Supply Board Assembly (Sheet 2 of 2)	5-11
5-6.	Zener Diode Oven Assembly	5-12
5-7.	Null Detector Board Assembly	5-15
5-8.	Kelvin-Varley Board Assembly	5-18
5-9.	High Voltage Board Assembly	5-20

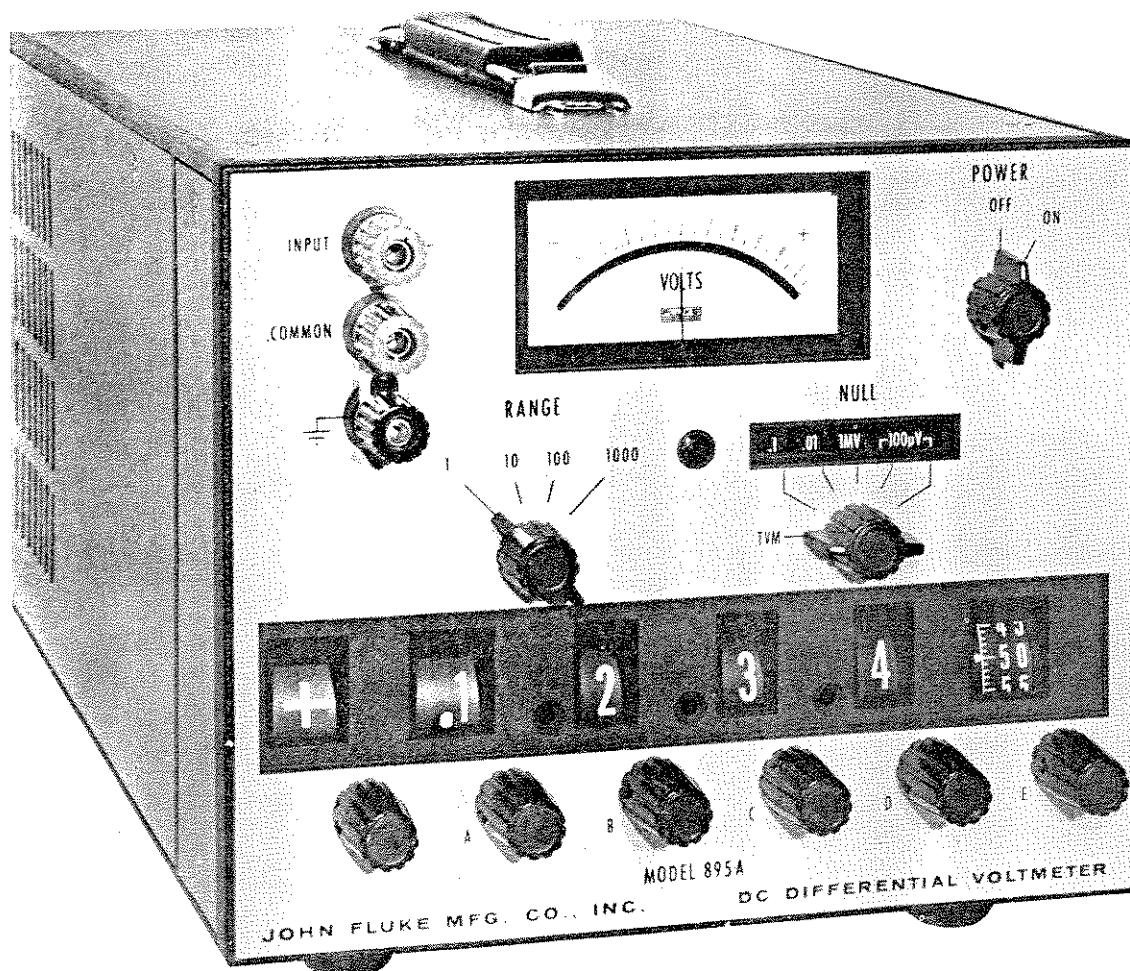

MODEL 895A DC DIFFERENTIAL VOLTMETER

Section 1

Introduction & Specifications

1-1. INTRODUCTION

1-2. The 895A DC Differential Voltmeter is half-rack size, and is equipped with resilient feet and tilt-up bail for field or bench use. A single instrument may be mounted in a standard 19 inch rack with metal handle-rack adapter kit 881A-102. Two half-rack size instruments may be mounted side-by-side with metal handle-rack adapter kit 881A-103.

1-3. The 895A can be used as: (a) A conventional voltmeter for rapid determination of dc voltages from 0 to ± 1100 volts to within $\pm 3\%$ of range setting. (b) A differential voltmeter for precise measurement of dc voltages of 0 to ± 1100 volts to within $\pm (0.0025\%$ of input + 0.0001% of range + 5 uv). (c) A ratiometer for accurately determining the ratio of two voltages, and (d) A megohmmeter for measurement of resistance from 0.1 megohm to 10,000,000 megohms with a typical accuracy of $\pm 5\%$. The instrument can be used to indicate voltage excursions about a nominal value. One feature that should be emphasized is that no current is drawn from the unknown voltage source, when the voltmeter is at null, at up to 1100 volts. Thus, the determination of the unknown potential is independent of its source resistance.

1-4. Leakage resistance of the 895A to ground is 100 megohms. The instrument contains a polarity switch for convenience in measuring positive or negative voltages, or in using the instrument as a ratiometer. A grounded recorder output is included for monitoring the voltage being measured. Shock, vibration, humidity, and tem-

perature testing verify a design that will provide years of hard use under severe environmental conditions.

1-5. When used as a differential voltmeter, the 895A operates on the potentiometric principle. An unknown voltage is measured by comparing it to a known reference voltage with the aid of a null detector. An accurate standard for measurement is provided by an 1100 volt reference supply containing a pair of temperature-controlled zener diodes. A five-dial Kelvin-Varley voltage divider attenuates the reference voltage as necessary to obtain a null condition. The unknown voltage is then indicated by the setting of the voltage readout dials.

1-6. INPUT POWER

1-7. The 895A is usually supplied with the primary windings of the power transformer connected in parallel for operation from 115 volts ac. Upon request, the instrument will be supplied with the primary windings connected in series for operation from 230 volts. If it becomes desirable to convert from one operating voltage to the other, refer to the schematic diagram, and to the instruction decal on the power transformer.

1-8. RECEIVING INSPECTION

1-9. This instrument has been thoroughly tested and inspected before being shipped from the factory. Immediately after receiving the instrument, carefully inspect for damage which may have occurred in shipment. If any damage is noted, follow the instructions outlined in the warranty page at the back of this manual.

1-10. SPECIFICATIONS

DIFFERENTIAL VOLTMETER

ABSOLUTE ACCURACY: $\pm(0.0025\%$ of input $+0.0001\%$ of range $+ 5 \text{ uv}$) from 0 to $\pm 1100 \text{ vdc}$ at $23(\pm 1)^\circ \text{C}$ (nominal calibration temperature), less than 70% relative humidity.

$\pm(0.005\%$ of input $+ 5 \text{ uv}$) from 0 to $\pm 1100 \text{ vdc}$, within the temperature range of 16°C to 32°C (60°F to 90°F), less than 70% relative humidity. Derate accuracy outside this temperature range at $0.00035\%/^\circ \text{C}$ to limits of 0°C and 50°C .

NOTE: Through error analysis studies into total instrument stability taking into account the documented stabilities of individual components and utilizing probability and statistical methods, indicate that typical instrument stability (defined as a specification met by 80% to 90% of all instruments) is 20 ppm (0.002%) peak-to-peak per year. An instrument so categorized need be calibrated only once per year to meet all specifications. Additional stability data upon request.

INPUT AND NULL RANGES:

Input Range (volts)	Null Ranges (volts)
1	.1, .01, .001, .0001
10	1, .1, .01, .001, .0001
100	10, 1, .1, .01, .001
1000	100, 10, 1, .1, .01

NOTE: Each input range and each null range has 10% overvoltage capability.

INPUT RESISTANCE: Infinite at null from 0 to $\pm 1100 \text{ vdc}$.

VOLTAGE DIAL RESOLUTION:

Input Range (volts)	Resolution	
	ppm of range	voltage
1	1	1 uv
10	1	10 uv
100	1	100 uv
1000	1	1 mv

METER RESOLUTION:

Null Range (volts)	Resolution
.0001	1 uv
.001	10 uv
.01	100 uv
.1	1 mv
1	10 mv
10	100 mv
100	1 v

CONVENTIONAL VOLTMETER

ACCURACY: $\pm 3\%$ of range.

RANGES:

Input Range (volts)	Input Resistance (megohms)
1000-0-1000	100
100-0-100	100
10-0-10	100
1-0-1	100
*.1-0-.1	100
*.01-0-.01	10
*.001-0-.001	1
*.0001-0-.0001	1

NOTE: 10% overranging on each range.
*These ranges are obtained by using null ranges with the readout dials set to zero.

RATIOMETER

The RATIO position of the polarity switch places the Kelvin-Varley divider across the rear panel binding posts for connection to external reference input voltage. The null detector remains connected between the front panel input and the Kelvin-Varley output. At null, the readout dial setting indicates the decimal ratio of the front panel input voltage to the rear panel reference input voltage. When the instrument is used as a ratiometer, the 10 position of the first readout dial is shorted out, providing a setting of .9999100 for unity ratio. The decimal point is always located in front of the first dial.

RATIO: Zero to unity (six-digit readout).

REFERENCE INPUT VOLTAGE: 0 to ± 1000 vdc with no power derating over entire range.

RATIO ACCURACY: $\pm 0.0012\%$ of setting at 0.1 ratio and above. $\pm 0.00012\%$ terminal linearity below 0.1 ratio.

TEMPERATURE COEFFICIENT OF RATIO: 0.0001% of setting/ $^{\circ}$ C above 0.1 ratio. 0.00001% terminal linearity/ $^{\circ}$ C below 0.1 ratio.

GENERAL

REGULATION OF REFERENCE SUPPLY: 0.0002% for a 10% line voltage change.

STABILITY OF REFERENCE SUPPLY: 0.0005% peak-to-peak per hour. 0.0008% peak-to-peak per day. 0.0013% peak-to-peak per sixty days.

STABILITY OF METER ZERO (includes noise): ± 2 uv for a 10% line voltage change on most sensitive (0.0001 v)null range.

KELVIN-VARLEY DIVIDER ACCURACY: $\pm 0.0012\%$ of setting from 1/10 full scale to full scale. $\pm 0.00012\%$ terminal linearity below 1/10 full scale.

REFERENCE ELEMENT: Temperature compensated Zener diodes.

WARM-UP TIME: 30 minutes.

RECORDER/ISOLATION AMPLIFIER OUTPUT: Adjustable from 0 to 0.5 v minimum for end-scale meter deflection, source resistance 5K to 8K, linearity better than $\pm 0.5\%$ of end-scale. Gain as an isolation amplifier is (0.5 v/null-range sensitivity).

POLARITY: Front panel switch selects +dc, -dc, and ratio.

DC COMMON MODE REJECTION: 140 db or 0.1 uv/volt of common mode voltage.

AC COMMON MODE REJECTION: 140 db at 50, 60, and 120 Hz; 120 db at 400 Hz and 1000 Hz.

OPERATING TEMPERATURE RANGE: 0° C to 50° C (32° F to 122° F). See Accuracy.

HUMIDITY: Within specifications up to 70% relative humidity.

STORAGE TEMPERATURE RANGE: -40° C to $+70^{\circ}$ C (-40° F to 158° F).

SHOCK: Meets requirements of MIL-T-945A and MIL-S-901B.

VIBRATION: Meets requirements of MIL-T-945A.

INPUT POWER: 115/230 vac $\pm 10\%$, 50 to 1000 Hz, 15 watts, 20 VA.

SIZE: 7" high x 8-1/2" wide x 14-3/4" deep.

WEIGHT: 16 lbs.



static awareness



A Message From
John Fluke Mfg. Co., Inc.

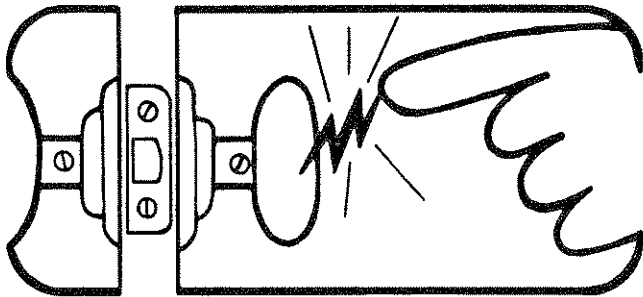

Some semiconductors and custom IC's can be damaged by electrostatic discharge during handling. This notice explains how you can minimize the chances of destroying such devices by:

1. Knowing that there is a problem.
2. Learning the guidelines for handling them.
3. Using the procedures, and packaging and bench techniques that are recommended.

The Static Sensitive (S.S.) devices are identified in the Fluke technical manual parts list with the symbol



The following practices should be followed to minimize damage to S.S. devices.

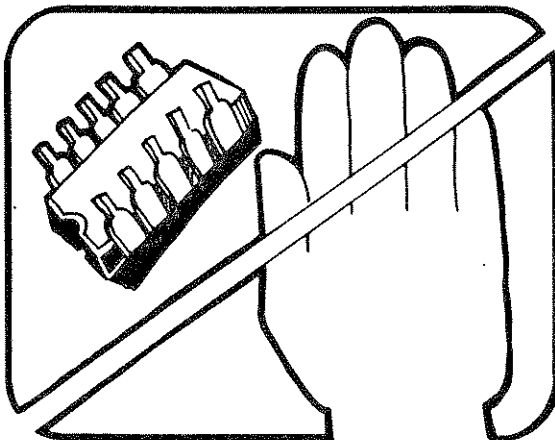

1. MINIMIZE HANDLING

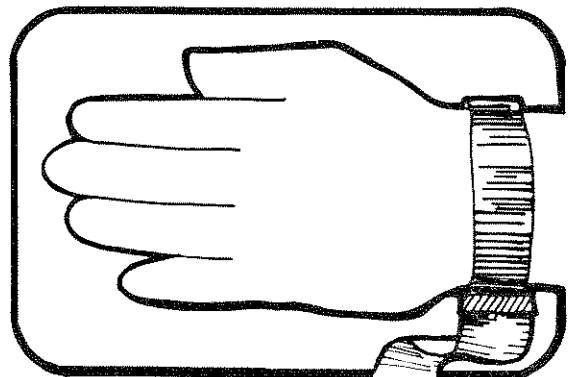

3. DISCHARGE PERSONAL STATIC BEFORE HANDLING DEVICES. USE A HIGH RESISTANCE GROUNDING WRIST STRAP.

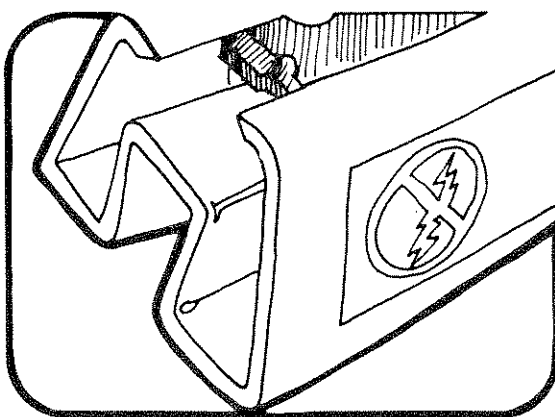

2. KEEP PARTS IN ORIGINAL CONTAINERS UNTIL READY FOR USE.

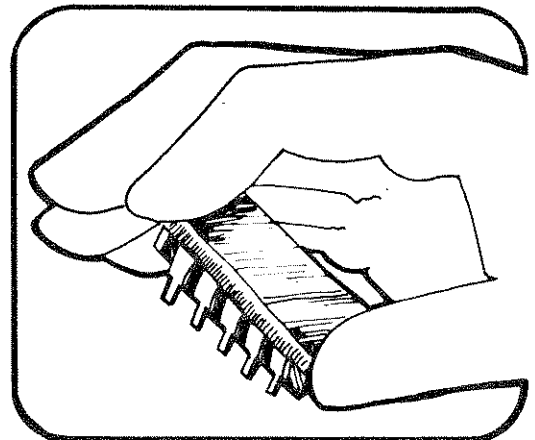

4. HANDLE S.S. DEVICES BY THE BODY

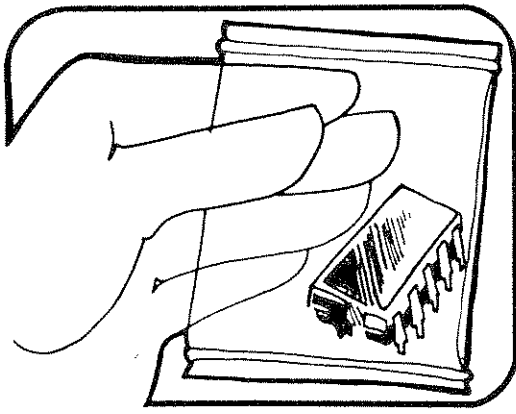

5. USE STATIC SHIELDING CONTAINERS FOR HANDLING AND TRANSPORT

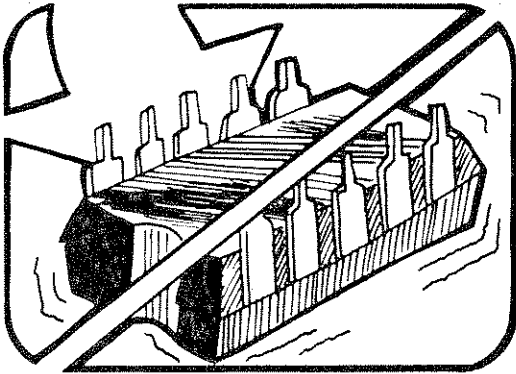

6. DO NOT SLIDE S.S. DEVICES OVER ANY SURFACE

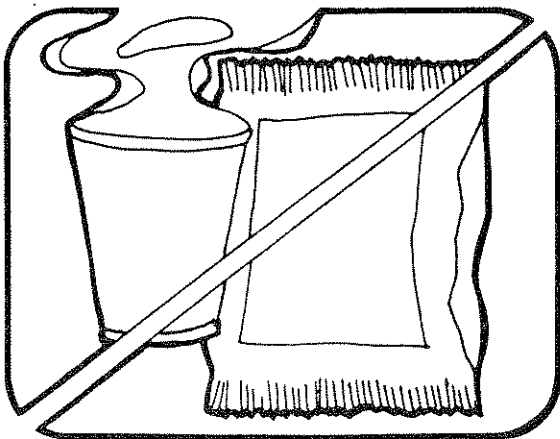

7. AVOID PLASTIC, VINYL AND STYROFOAM® IN WORK AREA

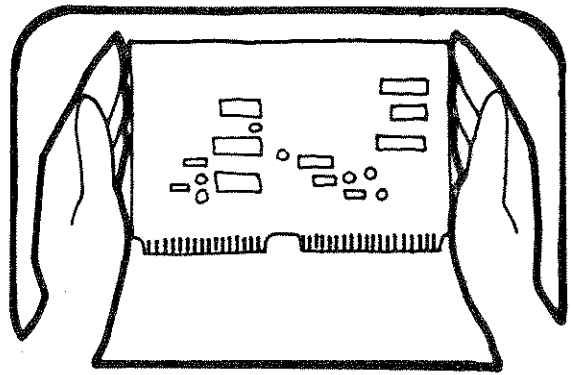

8. WHEN REMOVING PLUG-IN ASSEMBLIES, HANDLE ONLY BY NON-CONDUCTIVE EDGES AND NEVER TOUCH OPEN EDGE CONNECTOR EXCEPT AT STATIC-FREE WORK STATION. PLACING SHORTING STRIPS ON EDGE CONNECTOR HELPS TO PROTECT INSTALLED SS DEVICES.

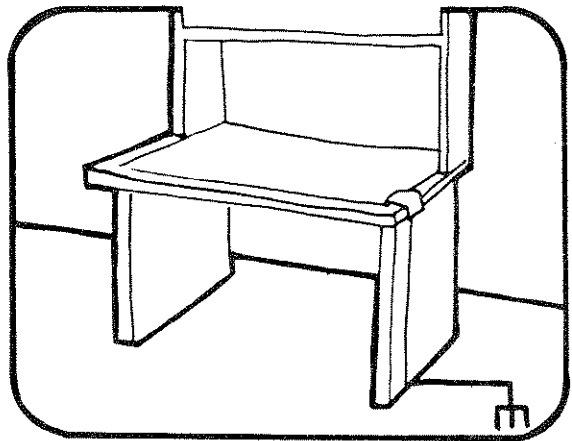

- 9. HANDLE S.S. DEVICES ONLY AT A STATIC-FREE WORK STATION
- 10. ONLY ANTI-STATIC TYPE SOLDER-SUCKERS SHOULD BE USED.
- 11. ONLY GROUNDED TIP SOLDERING IRONS SHOULD BE USED.

A complete line of static shielding bags and accessories is available from Fluke Parts Department, Telephone 800-526-4731 or write to:

JOHN FLUKE MFG. CO., INC.
 PARTS DEPT. M/S 86
 9028 EVERGREEN WAY
 EVERETT, WA 98204

PORTIONS REPRINTED
 WITH PERMISSION FROM TEKTRONIX, INC.
 AND GENERAL DYNAMICS, POMONA DIV.

Section 2

Operating Instructions

2-1. FUNCTION OF CONTROLS, TERMINALS AND INDICATORS

2-2. The location, reference designation, and a functional description of the external controls, terminals, and indicators on the 895A DC Differential Voltmeter are given in Figures 2-1 and 2-2.

2-3. PRELIMINARY OPERATION

- a. Mechanically zero the meter with the adjustment screw on the front panel. If the instrument has been operating, it must be shut off for at least three minutes prior to this adjustment.
- b. Connect the power plug to a 115 volt ac power source, or to 230 volts ac if the instrument is so wired.

WARNING!

The round pin on the polarized three-prong plug connects the instrument case to power system ground. Use a three-to-two pin adapter when connecting to a two-contact outlet. For personnel safety, connect the short lead from the adapter to a high-quality ground.

- c. Set the switches on the 895A as follows:

RANGE	1000
NULL	TVM
Polarity	+
Voltage readout dials	000000

- d. Set the POWER switch to ON, and allow a warmup period of 30 minutes for best accuracy. A warmup period of 10 minutes is sufficient for an accuracy of $\pm 0.005\%$.

2-4. ZEROING INSTRUCTIONS

2-5. It may be necessary to adjust the internal meter zero control. This will usually be done at more frequent

intervals than instrument calibration. Proceed as follows:

- a. Mechanically zero the meter with the adjustment screw on the front panel. The instrument must be shut off for at least three minutes prior to this adjustment, and the internal meter terminals must be shorted together.
- b. Set the switches on the 895A as follows:

RANGE	1
NULL	100 UV
Polarity	+
Voltage readout dials	000000

- c. Remove the top/rear dust cover.
- d. Short the INPUT and COMMON posts with a piece of copper wire.
- e. Adjust R204, if necessary, for zero meter deflection.
- f. Set the polarity switch to -. If the meter zero changes by more than ± 2 microvolts, readjustment of R204 is necessary.
- g. Remove the short from the INPUT and COMMON post, and replace the top/rear dust cover.

2-6. OPERATION AS A DIFFERENTIAL VOLTMETER

- a. Perform preliminary operation according to paragraph 2-3.
- b. Connect the unknown voltage between the INPUT and COMMON posts. If one side is grounded, always connect it to the COMMON post.
- c. If meter deflects to the left, the polarity of the unknown voltage is negative. Turn polarity switch to the negative position. The meter will deflect to the right.
- d. Turn RANGE switch to lowest range that will permit on-scale meter deflection, and note the approximate value of unknown voltage.
- e. Noting the position of the decimal point, set the five voltage readout dials to the approximate voltage determined in step d. For example, if the approximate voltage was 35 volts, the decimal point will be between the B and C readout dials. Therefore, set dial A to 3, and set dial B to 5.

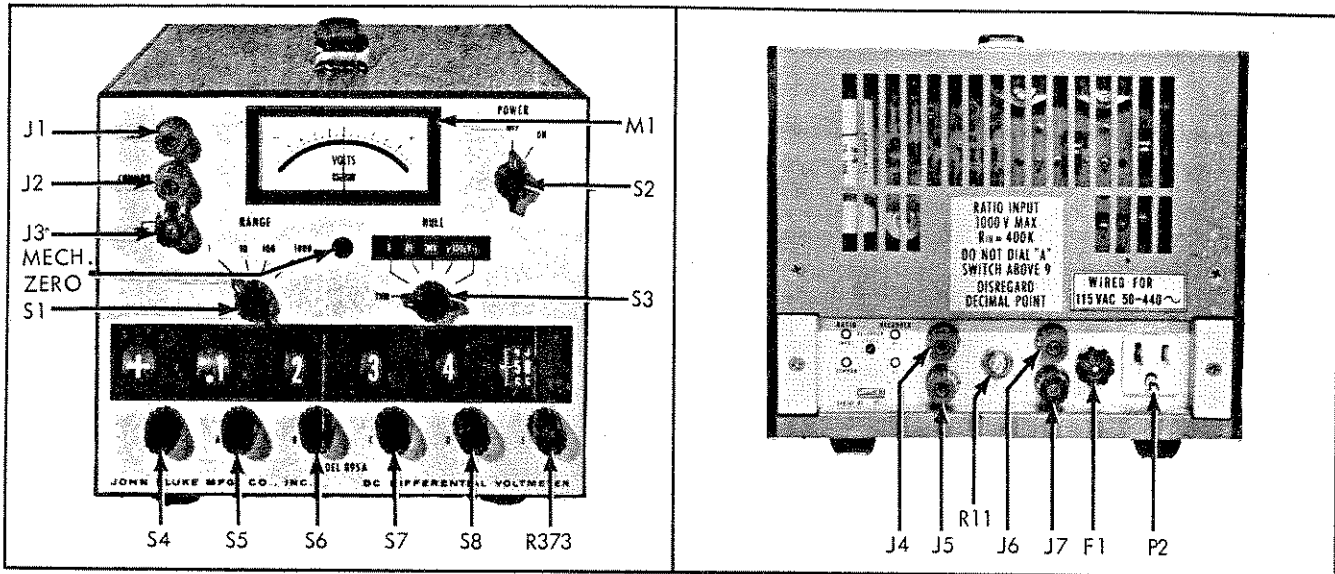

Figure 2-1. LOCATION OF CONTROLS, TERMINALS, AND INDICATORS

CONTROL, TERMINAL, OR INDICATOR	REFERENCE DESIGNATION	FUNCTION
INPUT and COMMON terminals	J1, J2	Provided for connecting the dc voltage to be measured.
Chassis ground terminal	J3	Provided for grounding purposes. A 0.047 uf capacitor, C1, and a 100M resistor, R1, are connected from the COMMON binding post to the chassis ground post. The INPUT post should never be connected to the chassis ground terminal, J3. Since the instrument is equipped with a three-wire line cord with the third wire connected to the chassis, the circuit should be checked for conflicts in grounding before connecting the COMMON post to the chassis ground post.
POWER switch	S2	The POWER switch applies ac line voltage to the primary circuit of the power transformer, T1, when set from OFF to ON
RANGE switch	S1	Selects the desired voltage range, changes null ranges appearing in the null window, and positions the decimal point of the voltage readout dials. When set to 1 or 10, this switch also open-circuits the primary of T2, which deactivates the 1100 volt reference supply.
NULL switch	S3	Sets the instrument for either conventional voltmeter operation, or differential voltmeter operation. The null ranges represent the full-scale difference between the unknown voltage and the internal reference voltage set by the voltage readout dials.
Voltage readout dials A, B, C, D, and E	S5, S6, S7, S8, & R373	Provides an in-line readout of the amount of internal reference voltage necessary to equal the unknown voltage.
Polarity switch	S4	Changes the polarity of the internal reference supply to match the polarity of the unknown voltage. The + position indicates that the INPUT post is positive with respect to the COMMON post. This switch also selects RATIO operation of the instrument and simultaneously deactivates the 1100V reference supply.

Figure 2-2. FUNCTION OF CONTROLS, TERMINALS, AND INDICATORS (Sheet 1 of 2)

CONTROL, TERMINAL, OR INDICATOR	REFERENCE DESIGNATION	FUNCTION
Mechanical zero control	none	Sets meter to zero mechanically. This adjustment should be used only after the instrument has been off for at least three minutes, or if the internal meter terminals are shorted.
Meter	M1	Indicates the unknown voltage when the instrument is in the TVM mode, and indicates the difference between the unknown and the internal reference voltage when the instrument is in the differential (null) mode.
RATIO terminals	J4, J5	Used to connect the external reference voltage to the 895A when making voltage ratio measurements.
RECORDER terminals	J6, J7	Provided for connecting a recorder to record meter deflection. Also used as the output terminals when the instrument is used as an isolation amplifier.
RECORDER LEVEL adjustment	R11	Varies the output voltage at the RECORDER output posts from 0 to at least 0.5 volt for full-scale meter deflection.
Line cord plug	P2	Provided for attaching the separable line cord.
Fuse	F1	Protects the instrument against excessive current.

Figure 2-2. FUNCTION OF CONTROLS, TERMINALS, AND INDICATORS (Sheet 2 of 2)

f. Set the NULL switch from TVM to the first null position for the range being used, and adjust the readout dials for zero meter deflection.

WARNING!

When the NULL switch is set to a null range, the voltage indicated by the readout dials is applied to the INPUT post. Consequently, a maximum voltage of 1100 volts with a source impedance of 10M, can appear at this binding post. Avoid contact with the INPUT post when the RANGE switch is set to 100, or to 1000.

g. Adjust the readout dials for zero meter deflection in successively more sensitive null ranges. When the meter needle deflects to the right, the magnitude of the voltage under measurement is greater than the voltage set on the readout dials. When deflection is to the left, the voltage under measurement is less than the voltage set on the readout dials.

h. When the meter is at null on the most sensitive null range, the unknown voltage equals the value set on the five readout dials.

2-7. OPERATION AS A CONVENTIONAL VOLTMETER

2-8. The instrument can be used as a conventional 3% voltmeter by setting the NULL switch to the TVM position. Full-scale ranges are 1, 10, 100, and 1000 volts. Additional ranges can be made available for measuring low-level voltages, by converting the null ranges to conventional voltmeter ranges, through setting the voltage readout dials to zero.

a. Perform preliminary operation according to paragraph 2-3.

b. Refer to Figure 2-3, and select the full-scale voltage range desired. If the approximate value of voltage being measured is unknown, select the 1000 volt range initially. Set the RANGE switch, NULL switch, and voltage readout dials according to Figure 2-3 for the range selected.

c. Connect the voltage to be measured between the INPUT and COMMON posts. If one side is grounded, always connect it to the COMMON post.

d. Voltage is indicated by the deflection of the panel meter. Meter deflection to the right when the polarity switch is set to positive indicates that the unknown voltage is of positive polarity.

2-9. MEASUREMENT OF VOLTAGE EXCURSIONS ABOUT A NOMINAL VALUE

a. Perform preliminary operation according to paragraph 2-3.

FULL SCALE DEFLECTION (volts)	RANGE SWITCH (volts)	NULL SWITCH	VOLTAGE DIALS
1000-0-1000	1000	TVM	No effect
100-0-100	100	TVM	No effect
10-0-10	10	TVM	No effect
1-0-1	1	TVM	No effect
0.1-0-0.1	1	.1	All zero
0.01-0-0.01	1	.01	All zero
0.001-0-0.001	1	1 MV	All zero
0.0001-0-0.0001	1	100 UV	All zero

Figure 2-3. TVM RANGES

b. Connect the voltage to be measured between the INPUT and COMMON posts. If one side is grounded, always connect it to the COMMON post. Deflection to the left indicates the voltage is of negative polarity; set the polarity switch to negative. Meter will deflect to the right.

c. Set the RANGE switch to the lowest range which will permit on-scale meter deflection, and note the nominal value of voltage indicated.

d. Set the five voltage readout dials to the nominal voltage determined in step c.

e. Turn the NULL switch from TVM to the highest null sensitivity possible, while retaining voltage excursions on the meter scale.

f. Voltage excursions are indicated by the meter. Note that full-scale right and left meter deflection is equal to the null range being used (disregarding 10% over-ranging). Meter deflection to the right indicates that the voltage being measured has increased above the nominal value set on the readout dials. Deflection to the left indicates that the voltage has, of course, decreased below the nominal value.

2-10. USE WITH A RECORDER

2-11. A recorder may be used with the 895A to record deflection of the panel meter. Since one side of the RECORDER output is grounded, the isolation characteristics of the recorder used is not important. Proceed as follows:

a. Connect the RECORDER terminals to the input terminals of the recorder.

b. Perform the preliminary operation according to paragraph 2-3.

c. Short the INPUT and COMMON posts.

d. Set the switches on the 895A as follows:

RANGE	10
NULL	1
Polarity	+
Voltage readout dials	1.000000

e. The meter will indicate full scale (-1.0). This provides up to 0.5 volts dc at the RECORDER output terminals, depending on the setting of the RECORDER LEVEL control.

f. Adjust the RECORDER LEVEL control until recorder deflection is as desired for full-scale deflection of the 895A panel meter.

g. Remove the short between the INPUT and COMMON posts.

h. Connect the voltage to be monitored to the INPUT and COMMON posts. The voltmeter and recorder are ready for use. Proceed according to paragraph 2-9.

2-12. MEASUREMENT OF HIGH RESISTANCE

2-13. One of the applications of the 895A is the use of the instrument for rapid measurements of high resistance from 0.1 megohm to 10,000,000 megohms with a typical accuracy of 5%. Because of the 1100 volt reference supply, the instrument can be used for resistance measurements at up to 1100 volts dc, in four ranges of 1, 10, 100, and 1000 volts. The following general equation, derived from Figure 2-4, can be used to compute

2-4

the resistance of an unknown connected to the input binding posts.

$$R_x = R_i \left(\frac{E}{E_m} - 1 \right)$$

where:

R_x = the unknown resistance in megohms

E = the voltage indicated by the readout dials

E_m = the voltage indicated by the panel meter

R_i = the input resistance of the null detector in megohms. R_i varies according to null sensitivity, as shown in paragraph 1-10.

2-14. To measure unknown resistance, proceed as follows:

a. Perform preliminary operation according to paragraph 2-3.

b. Connect the unknown resistance between the INPUT and COMMON posts. Use short, isolated leads to prevent measuring the leakage resistance between leads.

c. Refer to Figure 2-5, and set the RANGE switch and NULL switch according to the range of test voltage and unknown resistance.

d. Set the readout dials to the desired test voltage.

e. For full-scale meter deflection (-1.0) with full range input, determine the unknown resistance according to Figure 2-5. If the meter does not deflect full-scale, or if the readout dials are not set to maximum, the following corrections are necessary:

(1) For less than full-scale meter deflection, divide resistance given in Figure 2-5 by the decimal fraction of meter reading, where full-scale deflection = 1.0. For example, if the meter deflects to mid-scale, the resistance indicated for full-scale deflection must be divided by 0.5.

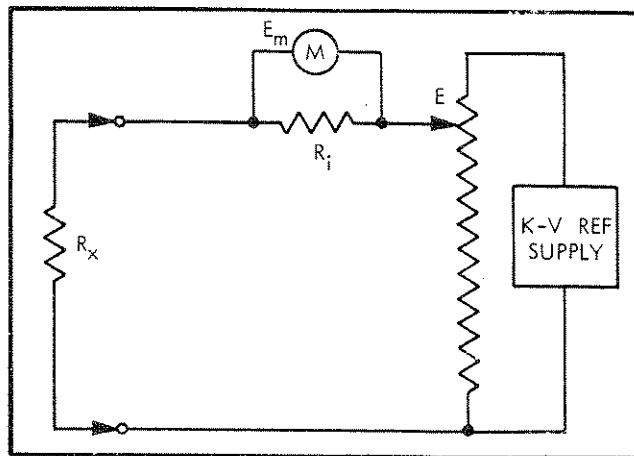

Figure 2-4. MEASUREMENT OF RESISTANCE

INPUT RANGE USED	NULL RANGE USED	UNKNOWN RESISTANCE AT FULL-SCALE (-1.0) DEFLECTION WITH FULL RANGE INPUT
1	.1, .01, 1 MV	10^9 ohms, approximately
	100 UV	10^{10} ohms
10	1	10^9 ohms, approximately
	.1, .01, 1 MV	10^{10} ohms
	100 UV	10^{11} ohms
100	10	10^9 ohms, approximately
	1	10^{10} ohms
	.1, .01, 1 MV	10^{11} ohms
1000	100	10^9 ohms, approximately
	10	10^{10} ohms
	1	10^{11} ohms
	.1, .01	10^{12} ohms

Figure 2-5. RESISTANCE MEASUREMENT RANGES

(2) If the readout dials are not dialed up to full range, multiply the resistance given in Figure 2-5 by the ratio of dialed voltage to range voltage. For example, if the readout dials are set to .50000, multiply the resistance indicated for full-range voltage by 0.5.

2-15. USE AS A RATIOMETER

2-16. The 895A can be used for determining resistance ratios and voltage ratios. When used for measuring voltage ratios, the two voltages must have a common ground, and, of course, be of the same polarity. When the 895A is used as a ratiometer, the internal high voltage reference supply is shut off. The 10% over-ranging capability of the Kelvin-Varley divider is also removed, providing a ten-step divider, with a maximum setting of .9999100. Ratio accuracy of the 895A is $\pm 0.0012\%$ of setting for ratios between 0.1 and 1. To measure voltage ratios, proceed as follows:

- Perform the preliminary operation of paragraph 2-3.
- Connect the lower of the two voltages to the INPUT and COMMON posts. Connect the higher of the two voltages to the RATIO terminals on the back panel. Please note that the lower RATIO terminal is the common terminal.
- Set the RANGE switch and the NULL switch as appropriate for the input voltage used. The position of the NULL switch determines full-scale sensitivity of the meter. Consequently, use reduced meter sensitivity initially.

d. Set the readout dials to 000000, and set the polarity switch to RATIO.

e. Adjust the readout dials for zero meter deflection in successively more sensitive null ranges. The final setting will indicate the ratio of the front panel input to the rear panel input. Note that the decimal point is always in front of dial A, regardless of the setting of the RANGE switch. Do not use the 10 position of dial A.

2-17. To measure resistance ratios, proceed as follows:

- Perform the preliminary operation of paragraph 2-3.
- The equipment connection is illustrated in Figure 2-6. The output of the test divider is applied to the INPUT post, and the input terminals of the test divider, and output of the power source, are connected to the RATIO terminals.
- Set the power source to the desired divider voltage.

CAUTION!

Do not exceed 1000 volts input into the Kelvin-Varley divider, as damage to the resistors may result.

d. Set the RANGE switch and NULL switch as appropriate for the input voltage used. The position of the NULL switch determines full-scale sensitivity of the

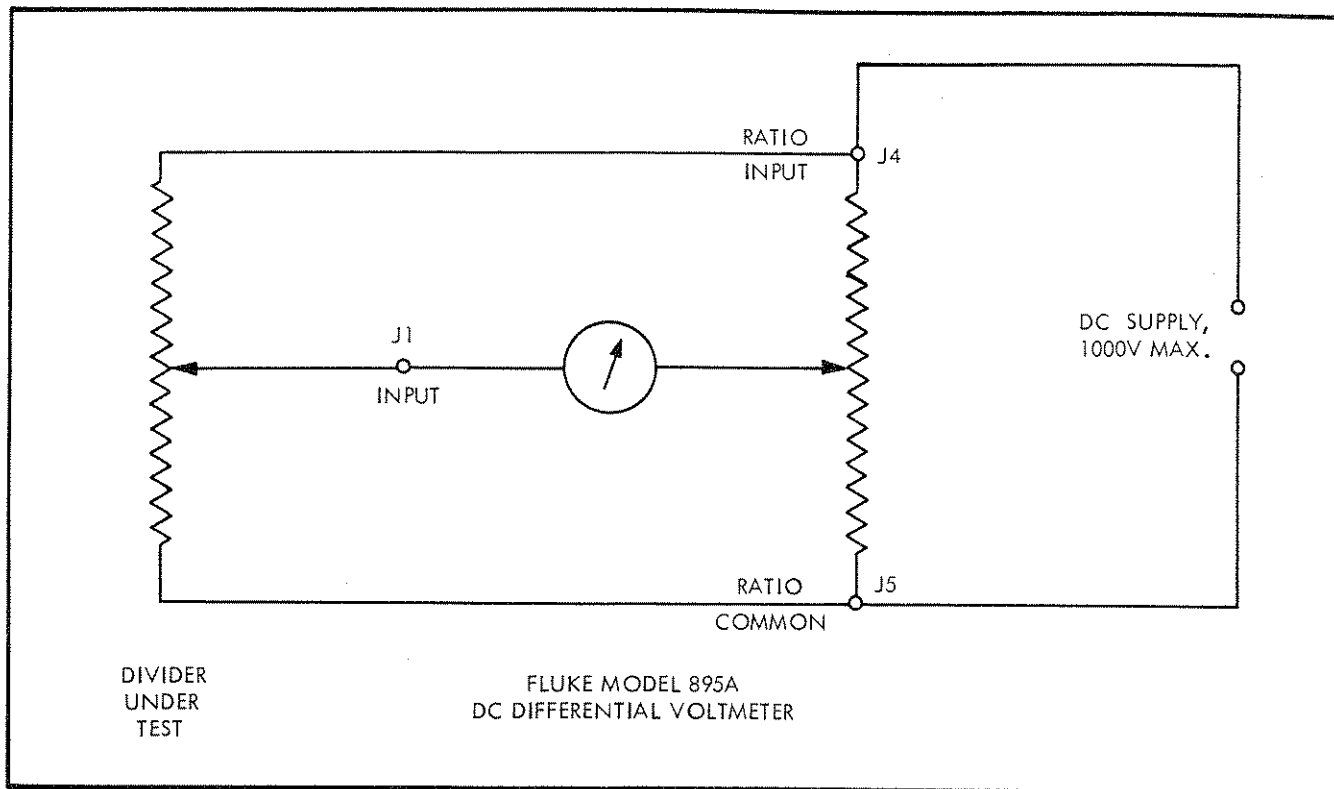

Figure 2-6. MEASUREMENT OF RESISTANCE RATIOS

meter. Consequently, use reduced meter sensitivity initially.

- e. Set the polarity switch to **RATIO**.
- f. Set the readout dials of the 895A and of the test divider to the desired point.
- g. Deflection of the panel meter can be reduced in either one of two ways:
 - (1) By adjusting the appropriate calibration control in the test divider, or
 - (2) By adjusting the readout dials on the 895A, and obtaining a table of corrections for the test divider.

In either case, increase the sensitivity of the null detector as null is approached.

2-17. NOTES ON OPERATION

2-18. OFF-NUL INPUT IMPEDANCE

2-19. Input resistance of the 895A is infinite at null, since no current flows from the source being measured. However, a small current does flow from the unknown when the meter is deflected from null. Figure 2-7 is a graph of the apparent dc input resistance when the meter is off null. For example, when the meter is deflected 10% of full-scale on the 1 mv null range, the input resistance of the instrument is 10^{10} ohms per volt of input, or 10^{11} ohms for an input voltage of 10 volts.

2-20. GROUND LOOP CURRENTS

2-21. A potential difference often exists between different points on power system grounds. Consequently,

current may flow from the power system ground through the voltmeter and the equipment being measured and back to the power system ground. Ground loop currents should be avoided for maximum measurement accuracy. To prevent ground loop currents when the system being measured is grounded, do not connect the **COMMON** post to the chassis ground post.

2-22. USE OF SHORTING LINK

2-23. A 0.047 uf capacitor, C1, and 100M resistor, R1, are connected from the **COMMON** binding post to the chassis ground binding post, which reduces the effect of circulating ac currents from the transformer. In some cases, it is possible for C1 to acquire a charge of up to 1.5 volts dc due to leakage. Capacitor C1 will also become charged when making measurements in the presence of common mode voltages, which may cause a measurement error not exceeding 0.1 uv per volt of common mode voltage. The shorting link should be connected between the **COMMON** and ground binding posts to short out any common mode voltage present, provided, of course, the common-to-ground portion of the circuit under measurement is not adversely affected by such a short-circuit.

2-24. EFFECT OF AC COMPONENTS

2-25. Occasionally an ac component may be present on the dc being measured. A double-section, low-pass filter, R202, C202, R203, and C203, at the input of the null detector attenuates any ac component by 50 db, or about 300 to 1. At lower frequencies, this low-pass filter is less effective, and the ac component may be

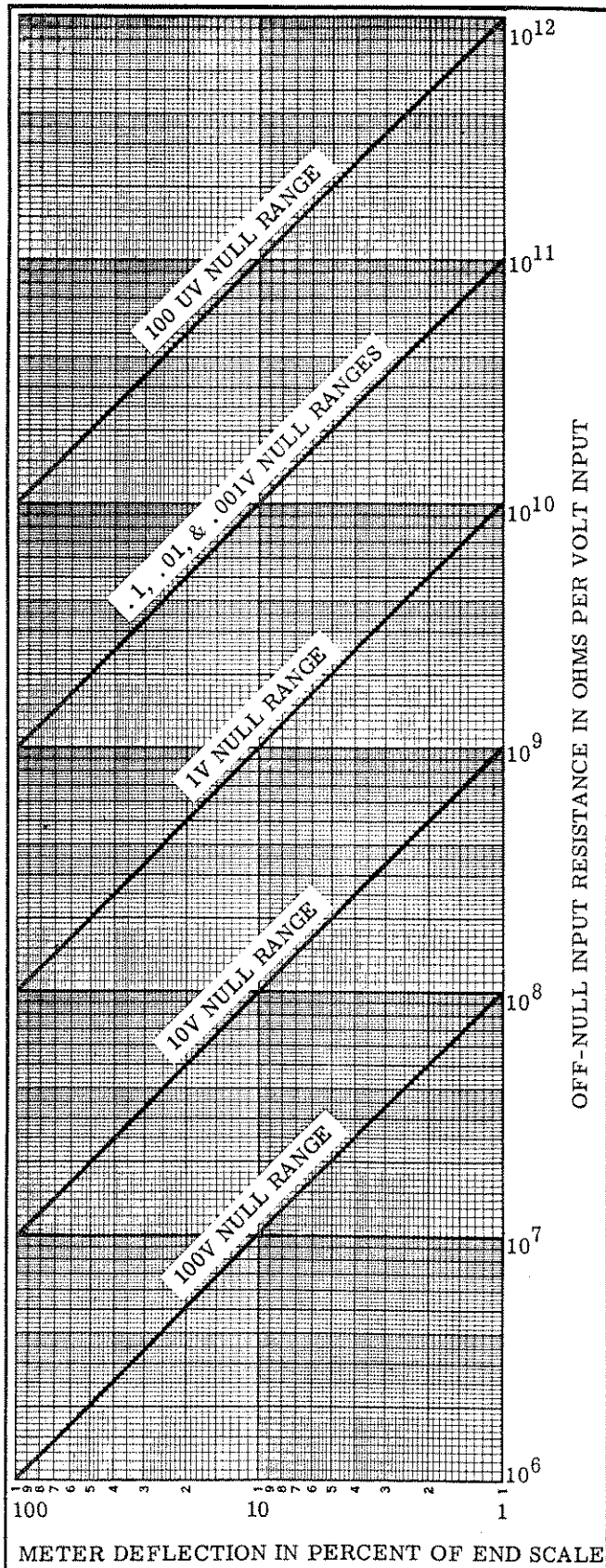

Figure 2-7. OFF-NULL INPUT RESISTANCE

significant. The only ac component that will reduce measurement accuracy is one that either starts to saturate the null detector, or one that is very close to a multiple or submultiple of the chopper frequency of 84 Hertz. The null detector is more sensitive to the latter. However, if harmonics of the chopper frequency are affecting the null detector the meter will oscillate at the difference frequency. For all practical purposes, no trouble should be encountered above a hundred Hertz. If ac components that affect accuracy are ever encountered, additional filtering at the input of the instrument will be necessary. For alternating current of a single frequency, a twin-T filter is effective, and has low total series resistance. For an alternating current of various frequencies, an ordinary low-pass filter can be used. In either case, the filter should be constructed of high-quality capacitors having leakage resistance of at least 10^{12} ohms.

2-26. EFFECT OF DC COMMON MODE VOLTAGE

2-27. DC common mode errors are caused partly by leakage currents passing through ground loops. Care has been taken in the design and construction of the instrument to isolate the circuitry from chassis ground. Accurate dc measurements can be made with the 895A in the presence of common mode voltages of up to 1000 volts dc. The dc common mode rejection is at least 140 db (10,000,000 to 1), or 0.1 microvolt or error per common-mode volt, up to 70% relative humidity. Since the leakage resistance varies inversely with humidity, the dc common mode error is typically much less at lower relative humidity. If the common mode voltage is greater than 50 volts, the measurement should be made several minutes after hookup for best accuracy. This is due to the time required to charge stray capacitance through the extremely high leakage resistance to ground.

2-28. MEASUREMENT OF NEGATIVE VOLTAGES

2-29. Because of the polarity switch, voltage which is negative with respect to common, as well as positive voltage, may be measured with equal facility. If the INPUT binding post is connected to ground, either at the front panel or at the source being measured, the accuracy of the voltmeter may be reduced. If the unknown voltage is grounded, always connect the grounded side to the COMMON post, and use the polarity switch to obtain the proper result.

Section 3

Theory of Operation

3-1. INTRODUCTION

3-2. GENERAL

3-3. A block diagram for the 895A DC Differential Voltmeter is given in Figure 3-1. Additional detail is

contained in the functional schematic in the back of this manual. The schematic is intended to aid in understanding circuit theory and in troubleshooting. The signal flow is from left to right and the components are arranged functionally.

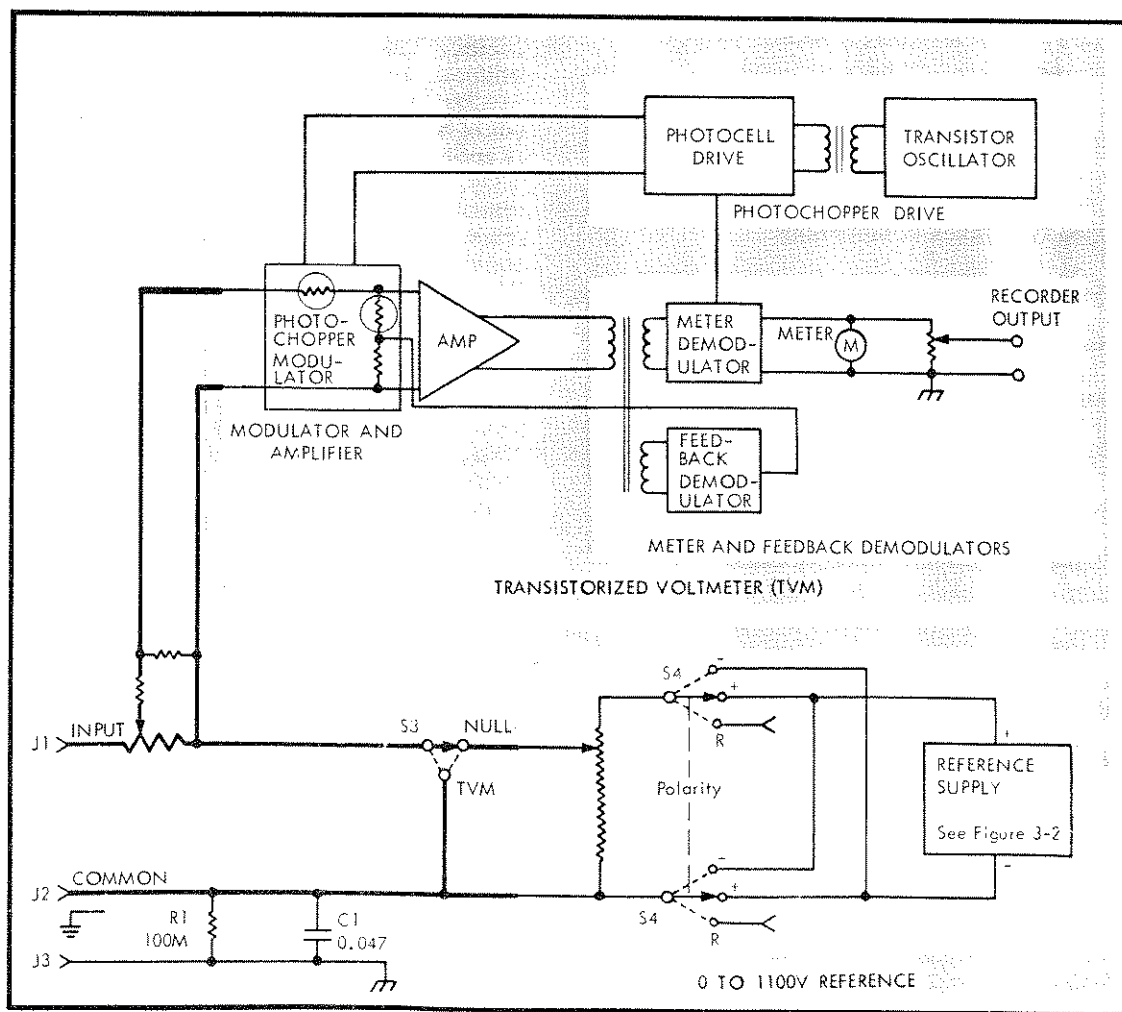

Figure 3-1. MODEL 895A BLOCK DIAGRAM

3-4. The overall operation of the instrument may be summarized as follows. For direct measurement of an unknown voltage, the unknown is connected directly to the attenuator of the transistorized voltmeter (tvm). Since the voltage required for full-scale deflection of the tvn is either 1 millivolt or 100 microvolts, the tvn attenuator reduces the input voltage as necessary. The value of the unknown is indicated by deflection of the panel meter. For null measurement of the unknown, it is connected in opposition to an internal reference voltage of 0 to 1100 volts, and the tvn is used as a null detector between the two voltages. The reference voltage is then adjusted with the Kelvin-Varley voltage dials until the internal voltage equals the unknown, as indicated by zero deflection of the null detector. The unknown is then indicated by the setting of the Kelvin-Varley dials.

3-5. INPUT RESISTANCE OF INSTRUMENT

3-6. The input resistance of the 895A is determined by dividing the unknown terminal voltage by the current drawn from the unknown. The current drawn from the unknown is equal to the difference between the unknown terminal voltage and the internal reference voltage, divided by the resistance of the tvn attenuator. The equation for input resistance can therefore be written as:

$$R_{in} = \frac{E_u}{I_u} = \frac{E_u R_a}{|E_u - E|} = \frac{E_s (R_a + R_s)}{|E_s - E|} - R_s$$

Where:

R_{in} = input resistance of voltmeter

I_u = current drawn from unknown

E_s = source voltage of unknown

R_s = source resistance of unknown

E_u = $E_s - I_u R_s$ = terminal voltage of unknown

R_a = input resistance of tvn attenuator

E = voltage indicated by voltage readout dials

$| \quad |$ = absolute value (magnitude only)

Thus, the input resistance is essentially infinite at null (leakage resistance across the input is approximately 10^{14} ohms) when E is equal to E_u and E_s .

3-7. CIRCUIT DESCRIPTIONS

3-8. DC TRANSISTORIZED VOLTMETER

3-9. INTRODUCTION. The dc transistorized voltmeter (tvm) is composed of a tvn attenuator and a null detector. The primary part of the tvn is the null detector, in which the dc signal is modulated by a photo-chopper, amplified by a five-stage amplifier, rectified by a phase-sensitive demodulator, and filtered to produce a dc output. Transformer coupling is used to isolate the dc meter/recorder output from the floating null detector

circuitry. Negative feedback makes the null detector insensitive to gain variations of individual transistors. The panel meter has tautband suspension, which eliminates the stickiness associated with pivot-jewel meters.

3-10. NULL-DETECTOR. The null detector is a current feedback amplifier that drives a zero center meter. The feedback voltage is the voltage drop across R208 caused by a portion of the output current. At the input to the 895A null detector, R202, C202, R203, and C203 form a double-section, low-pass filter that reduces any ac component present on the dc voltage being measured. The difference between the voltage appearing at the output of the filter and the voltage across feedback resistor R208 is converted to a square wave by PC201 and PC202, an 84 Hz photo-chopper. The effect of a negative input voltage is to shift the phase of the square wave by 180° . Thus, by using a phase-sensitive demodulator, the polarity of the input voltage is reconstructed in the meter drive circuit. The alternating voltage created by PC201 and PC202 is amplified by a five-stage amplifier. Transistors Q201, Q202, and Q203 are common-emitter amplifiers having negative feedback. Transistor Q204 is a common-emitter amplifier which drives the push-pull pair Q205 and Q206. The output from the push-pull pair is applied to the primary of transformer T201. Transformer T201, which provides isolation between the null detector and the grounded recorder output, has two secondary windings, one of which is connected to null detector common, the other winding being connected to chassis common. The output of the winding that is connected to chassis common is applied to a phase-sensitive demodulator, Q209 and Q210. The square-wave drive for this demodulator is from a winding connected to chassis ground on the drive transformer, T101. The polarity of the square wave out of the transformer permits conduction of Q209 or Q210 during alternate halves of the square-wave cycle. Since the phasing of the square wave through the null detector depends on the polarity of the input voltage, then either Q209 or Q210 conducts, depending on the polarity of the input. Conduction of Q209 or Q210 tends to drive current through the meter in opposite directions. Thus, the meter and recorder output are driven according to the polarity as well as the magnitude of the unknown voltage.

3-11. The output of the secondary winding that is connected to null detector common is applied to another phase-sensitive demodulator, Q207 and Q208. The square-wave drive for these transistors is obtained from a winding that is connected to null detector common on T101. This phase-sensitive demodulator operates identically to Q209 and Q210. The output from Q207 and Q208 is filtered and fed back to R208 at the input of the null detector for gain stabilization.

3-12. The null detector has a basic sensitivity of 1 mv, except for the most sensitive null ranges on the 1 and 10 volt ranges, in which the sensitivity of the null detector is increased to 100 uv.

3-13. TVM ATTENUATOR. For null measurements the voltage difference of the unknown voltage minus the reference voltage is divided down as necessary by positions on the tvn attenuator as selected by null switch sections

S3E, S3G, S3K, and S3I, which provides the basic null detector input of 1 millivolt.

3-14. **CHOPPER DRIVE CIRCUIT.** The chopper drive circuit provides ac drive for the photo-chopper modulator and for the phase-sensitive demodulators. Auxiliary voltages for the null detector are also obtained from the chopper drive circuit. The chopper drive is essentially a transformer-coupled multivibrator Q109 and Q110. Assume that Q110 has been conducting, and Q109 turns on. Conduction of Q109 applies approximately +18 volts between pins 1 and 2 of T101, which induces a voltage between pins 4 and 5. The secondary winding of pins 4 and 5 is connected between the bases of Q109 and Q110. The two windings are phased so that the voltage between pins 4 and 5, approximately 12 volts, adds to the voltage at the base of Q109, which is effectively clamped at +18 volts. The resulting voltage biases Q110 off. After Q110 is biased off, capacitor C112 begins to discharge through R145 and R146. When the voltage across C112 approaches zero volts, Q110 begins to turn on, and the preceding cycle is repeated with Q110 conducting. Resistor R146 is used for frequency adjustment.

3-15. AC voltage for the +17 volt, +10 volt, and -17 volt auxiliary supplies is obtained from one winding of T101. Diodes CR206 and CR207, and capacitors C214 and C215, form two half-wave rectifiers. Regulation of the +10 volt supply is provided by zener diode CR203. Illumination for the photo-choppers PC201 and PC202 is also obtained from the same winding of T101, through CR204, CR205, DS201, and DS202. Diodes CR204 and CR205 permit conduction of DS201 and DS202 on alternate half-cycles of the 84 Hz wave, thus illuminating PC201 and PC202 alternately. Since the resistance of the photocell decreases several times when illuminated, the result is the same as that of a mechanical chopper. Lamp DS202 also drives the photocell chopper PC101 in the reference supply.

3-16. **EFFECT OF AC COMPONENTS.** The low-pass filter at the input of the chopper-amplifier will attenuate any ac component present on the dc being measured. The magnitude of the ac voltage appearing at the output of the filter depends on both its amplitude and frequency before filtering. The only ac voltage that will reduce the accuracy of the 895A is one that either saturates the null detector or beats with the chopper frequency. Since the voltage required for saturation is greater than that required for beating, the null detector is most sensitive to an ac voltage having a frequency that is a submultiple or a low multiple of the chopper frequency. However, this is easy to detect, because the meter will oscillate at the difference frequency. For all practical purposes, no trouble should be encountered above a hundred Hz. If low-frequency ac components that affect accuracy ever occur, additional filtering as outlined in the operating instructions will eliminate the problem.

3-17. **RECORDER OUTPUT.** A recorder output directly proportional to meter deflection is provided by R11 and R12. The RECORDER LEVEL control, R11, provides for adjusting the recorder output voltage to at least ± 0.5 volt at full-scale meter deflection (± 1.0). The recorder output is driven by the same demodulator that drives the panel meter. The low side of the RECORDER output is connected to chassis ground.

3-18. 0 TO 1100 VOLT REFERENCE

3-19. **GENERAL.** In making differential voltage measurements, an internal reference voltage is nulled directly against the unknown voltage. The extremely accurate reference voltage required is obtained from the 0 to +1100 volt reference voltage, which is composed of a +11 volt reference voltage, a +1100 volt reference voltage, a range divider, a five-decade Kelvin-Varley divider, and a polarity switch. The 0 to 1100 volt reference supply is represented in Figures 3-1 and 3-2.

3-20. **+11 VOLT REFERENCE.** A +18 volt power supply uses diode CR101 and filter capacitor C101 to supply unregulated dc voltage to series pass transistor Q101. The +18 volts is regulated by comparing a sample of the output voltage, tapped off divider string R103, R104, and R105, with the voltage from zener reference diodes CR104 and CR105, in a two-stage differential amplifier. Transistor Q102 is a dual transistor, having matched current gain and matched ΔV_{be} , which insures minimum voltage change due to temperature in the +18 volt reference voltage. The output from Q102, which is proportional to the difference between the two inputs, is applied to a second stage of differential amplification, Q103 and Q104. The output from Q103 is applied to the base of series pass transistor Q101. The action of the differential amplifier is to adjust the voltage drop across the series pass transistor so as to maintain the two inputs into the differential amplifier at an equal voltage. Thus, the differential amplifier maintains a constant output voltage. The +18 volt output provides operating current for the chopper drive multivibrator, base drive to Q402, collector voltage for Q405, Q406, Q105 through Q107, and supplies a constant current through R111 to its own Zener reference diodes, CR104 and CR105.

3-21. For instrument serial numbers 147 and on, zener diodes CR104 and CR105 are enclosed in a proportionally-controlled oven, Q111, Q112, Q113, and associated components. The oven heater is R147. Transistors Q112 and Q113 are connected as a differential amplifier, with the base voltage of Q113 fixed by R153 and R154. The base voltage of Q112 is set by R150 and R155. Since R155 is temperature-sensitive, the base voltage of Q112 varies inversely with temperature. The output from the collector of Q112, which is proportional to the difference between the base voltages of Q112 and Q113, is applied to the base of Q111 and controls the conduction of Q111, which controls heater current. For example, as the oven temperature increases, the resistance of R155 decreases. This causes a more positive output from the collector of Q112, which reduces the conduction of Q111, thus reducing current through the heater R147, and decreasing heating of R147.

3-22. **+1100 VOLT REFERENCE.** A block diagram of the +1100 volt reference supply is given in Figure 3-2. The overall operation of the +1100 volt reference supply is similar to that of an operational amplifier with negative feedback. A differential amplifier controls the output voltage, by controlling the conduction of the series pass transistors Q401 through Q404. As shown in Figure 3-2, the common of the differential amplifier is connected to the +1100 volt output bus. The other differential amplifier input is connected through a chopper-

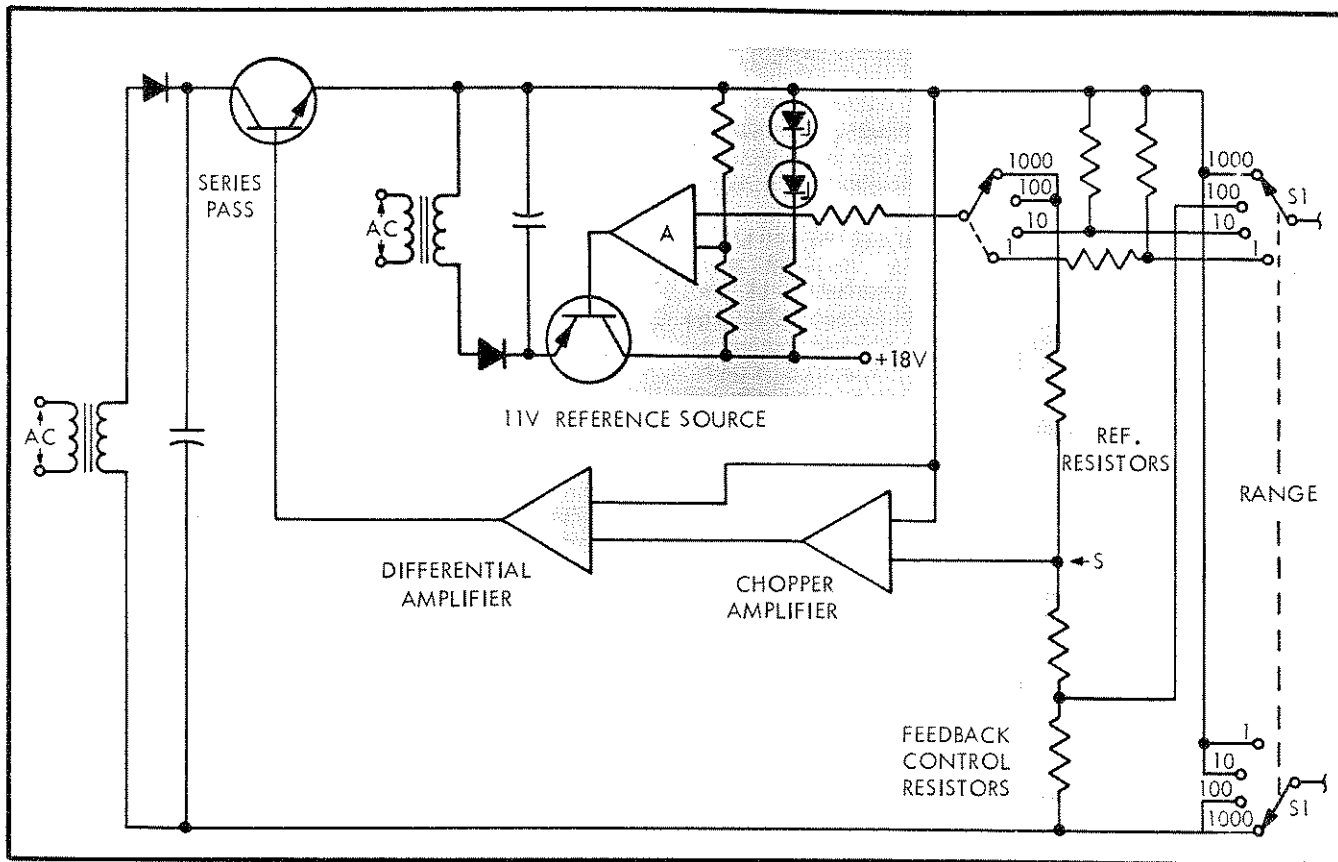

Figure 3-2. +1100 VOLT REFERENCE SUPPLY

stabilizing amplifier to point S, the summing junction of the feedback voltage-determining resistors and the reference resistors. The action of the differential amplifier is to control the conduction of the series pass transistors so that the difference between the two inputs of the differential amplifier is zero, which means that both inputs are at +1100 volts. Since the reference voltage of +11 volts is constant, the current through the reference resistors R121 and R122 is also constant, and the output voltage is equal to the voltage drop across the feedback resistors R123 through R130.

3-23. Chopper Stabilizing Amplifier. An unregulated, filtered, +1600 volts dc is provided by half-wave rectifier CR401, and capacitors C401 through C404. Transistors Q401, Q402, Q403 and Q404 are the series regulating transistors. The difference between the +1100 volt reference voltage and the voltage at summing point S, which is the error signal, is converted to a square wave by PC101, a photocell. Drive for the photocell is obtained from DS202. The resulting square wave is amplified by Q105, Q106, and Q107, which are direct-coupled amplifiers having a common emitter feedback resistor. Transistor Q108 demodulates the amplified signal, the base drive of Q108 being obtained from the 84 Hz oscillator. The amplified, demodulated dc error signal is applied to the base of Q406. The base of Q405 is maintained at approximately +1100 volts. The amplified error signal varies the collector current of Q406 proportionally to the variation in the +1100 volt output.

The base current of Q403 thus varies inversely to any deviation of the reference voltage from +1100 volts, and controls the conduction of Q404 so as to regulate the +1100 volt output.

3-24. Transistors Q401 and Q402 are preregulators for Q404, which make possible a more constant collector voltage for Q404. Resistors R406 and R408 set the base voltage of Q401, and the collector voltage of Q402, at approximately one-half of the total voltage appearing across Q401 and Q402. The base of Q402 is connected to +18 volts, thus requiring Q401 and Q402 to preregulate the rectified dc voltage.

3-25. The output of the +1100 volt reference supply is connected to the input of the Kelvin-Varley divider on the 1000 volt range. For the 100 volt range, the Kelvin-Varley divider is connected in parallel with part of the feedback (control resistor) string, and is not connected directly across the output. Bleeder resistors R421 through R424 are used to provide a constant load for the +1100 volt supply when the 100 volt range is being used.

3-26. RANGE DIVIDER. In the 10 volt range, the zener reference voltage from CR104 and CR105 is connected to the Kelvin-Varley divider through resistors R113, R114, and R115, which reduce the zener reference voltage to 11 volts at the input of the Kelvin-Varley divider. In the 1 volt range, resistors R116, R117, R118, and R120 reduce the reference voltage to 1.1 volts.

In the 100 and 1000 volt ranges, the +11 volt reference voltage is used as a reference for the +1100 volt supply, as described in paragraphs 3-22 through 3-25.

3-27. **KELVIN-VARLEY DIVIDER.** The five-decade Kelvin-Varley divider, composed of resistors R301 through R373, is capable of dividing the reference voltage into 1, 100,000 equal increments, thus providing the extremely accurate reference voltage required. The decades are adjusted by voltage dials A through E. The first decade has twelve 40K resistors (composed of two 20K resistors plus a 10 ohm trimmer in each position, except for the first two positions which also have a 2 ohm trimmer). Two of these resistors are shunted by the 80K total resistance of the second decade. Between the two wipers of S5 there is therefore a total resistance of 40K (80K in parallel with 80K). Thus, the first decade divides the voltage across it into eleven equal parts, with one of the parts appearing across the two shunted resistors. Similarly, the voltage across the second, third, and fourth decades is divided into 10 equal parts. The last decade with its associated shunt resistance is a variable resistor which sets the last two digits. The Kelvin-Varley resistors are matched for resistance tolerance and temperature coefficient, thus providing an overall accuracy of $\pm 0.0012\%$ of setting from 1/10 of full-scale to full-scale.

3-28. **ADJUSTMENTS.** Variable resistor R105 is used during calibration to set the low-voltage reference supply to +18 volts. This adjustment should have to be repeated only when a component of the reference supply is replaced. The voltage from the zener reference diodes is reduced to +11 volts at the input of the Kelvin-Varley divider by adjusting R114 and R115. Variable resistors R117 and R118 are then adjusted for 1.1 volts at the input of the Kelvin-Varley divider for the 1 volt range. Resistor R130 is used to set the +1100 volt reference voltage, and resistor R129 is used to set the 110 volt reference voltage, in the high voltage reference supply. The trimmer resistors in the first Kelvin-Varley decade should require adjustment only after a component in the Kelvin-Varley divider has been replaced.

3-29. **POLARITY SWITCH.** The polarity switch, S4, reverses the reference voltage connection with respect to the Kelvin-Varley divider input, for measuring negative voltages. Note that a 0.047 uf capacitor, C1, and a 100M resistor, R1, are connected from the COMMON post to the chassis ground post to reduce the effect of circulating ac currents. If the instrument did not contain a polarity switch, the grounded side of a negative voltage would have to be connected to the INPUT terminal, which would place C1 across the input. The polarity switch prevents this occurrence, and provides equal convenience and accuracy in measuring positive and negative voltages.

Section 4

Maintenance

4-1. INTRODUCTION

4-2. Maintenance of the 895A DC Differential Voltmeter should consist primarily of occasional cleaning and calibration. To determine if the instrument is operating within specifications, its performance can be tested by using the performance tests in this section. Information on troubleshooting is also included.

4-3. TEST EQUIPMENT REQUIRED

4-4. Figure 4-1 is a list of the test equipment recommended for performance testing, calibration, and troubleshooting. If the recommended equipment is not available, other equipment which meets the required specifications may be used.

4-5. PERIODIC MAINTENANCE

4-6. Periodic maintenance consists primarily of occasional cleaning to remove dust, grease, and other contamination. Special care has been taken to prevent leakage across critical switch wafers, areas of some printed circuit boards, and from the printed circuit boards to chassis ground. The power, range, null, polarity, and voltage readout dial switches are vacuum impregnated with polybutane oil. These switches are also isolated from the chassis with Lexan spacers. The printed circuit boards are coated with a moisture sealant and are isolated from chassis ground by means of polyethylene grommets.

4-7. Clean the instrument as follows:

CAUTION!

Avoid touching the polyethylene grommets. Contamination can cause excessive electrical leakage.

- a. Remove accumulations of dust and other foreign matter with low-pressure, clean, dry air. Pay particular attention to the input binding posts, binding post wiring, switches, and polyethylene grommets.
- b. Clean the polyethylene grommets, binding posts, and front panel with anhydrous ethyl alcohol, or an aerosol can of Freon TF Degreaser (Miller-Stephenson Chemical Co., Inc.) and, if necessary, a clean cloth or cotton swab.

CAUTION!

Do not use Metriclene, acetone, lacquer thinner, or any ketone, since they will react with the Lexan switch rotors. Also, be careful not to saturate the switch contacts, which have been lubricated for life.

c. When necessary, clean all exposed dielectric surfaces of switches with denatured alcohol, using a small, stiff-bristled brush which has been wrapped with a clean cloth to prevent saturating the switch contacts.

d. After cleaning, recoat the exposed switch insulating material with Oronite 8E polybutane oil. This prevents leakage due to moisture on these surfaces.

4-8. PERFORMANCE TESTING

4-9. GENERAL

4-10. The following tests are designed to compare the instrument's performance with the specifications. The tests may be used during routine maintenance, and for receiving inspection. Performance should be tested just before calibration of the instrument, which provides a valuable history of the instruments characteristics. Just prior to calibration, the instrument should be within specifications; if not, troubleshooting should first be performed to correct the cause of the error. Localizing the problem to a particular area of the instrument may be done by an analysis of the performance test results.

4-11. NULL DETECTOR SENSITIVITY TEST

4-12. The null detector is tested in this procedure by using the instrument's internal reference supply and Kelvin-Varley divider. If the instrument fails to pass this test, it may be due to a faulty reference supply or Kelvin-Varley divider. In this case, measuring a known voltage in the tvn mode will indicate if the null detector is operating correctly. Proceed as follows:

- a. Set meter to zero with mechanical zero control.
- b. Set POWER switch to ON and allow the instrument to warmup for 5 minutes.
- c. Set polarity switch to +.
- d. Short INPUT post to COMMON post.
- e. Set switches on voltmeter as shown in Figure 4-2. The meter should indicate within ± 1.5 small scale divisions ($\pm 3\%$ of null range) of the values shown in Figure 4-2.
- f. Remove the short between the INPUT and COMMON posts.

RECOMMENDED EQUIPMENT	SPECIFICATIONS REQUIRED	USE
VTVM, RCA Voltohmyst, or equivalent, or VOM, Triplett Model 630-M, or equivalent (Battery operation aids convenience.)	Range: 0 to 500 vdc, 0 to 300 vac Accuracy: $\pm 3\%$ dc, $\pm 5\%$ ac Input Impedance: 10M, 5 pf dc 1M, 100 pf ac	CORRECTIVE MAINTENANCE Voltage Level Measurements Reference Voltage Regulation
Autotransformer, General Radio Model W5MT3 Variac (W5HMT for 230 volt instruments).	103 to 127 volts (207 to 253 volts for 230 volt instruments.)	CORRECTIVE MAINTENANCE Reference Voltage Regulation
DC Differential Voltmeter, Fluke Model 871A, or equivalent.	Range: 10 to 1100 vdc Accuracy: $\pm 0.02\%$ Null Range: 10 mv, minimum	CORRECTIVE MAINTENANCE Reference Voltage Regulation
Standard Cell Bank, Guildline Instruments Model MB3, or equivalent.	Accuracy: 0.0005%	PERFORMANCE TESTING Differential Measurement Test CALIBRATION CORRECTIVE MAINTENANCE Common Mode Test
DC Power Supply, Fluke Model 412B, or equivalent.	Output Voltage: 1 to 1100 vdc Output Current: 2 ma Stability: $\pm 0.005\%$ per hour Resolution: 5 mv	PERFORMANCE TESTING Differential Measurement Test CALIBRATION CORRECTIVE MAINTENANCE Common Mode Test Kelvin-Varley Divider Test Kelvin-Varley Divider Adjustment
Null Detector, Fluke Model 845A, or equivalent.	Range: 1 uv to 1 mv end scale.	PERFORMANCE TESTING Differential Measurement Test CALIBRATION CORRECTIVE MAINTENANCE Kelvin-Varley Divider Test Kelvin-Varley Divider Adjustment
Kelvin-Varley Divider, Fluke Model 720A, or equivalent.	Ratio Accuracy: 0.1 ppm from 1/10 full-scale to full-scale.	PERFORMANCE TESTING Differential Measurement Test CORRECTIVE MAINTENANCE Kelvin-Varley Divider Test Kelvin-Varley Divider Adjustment.
Lead Compensator, Fluke Model 721A, or equivalent.	Resolution: 0.0001 ohms Divider Ratios: 0.1 to 1	CORRECTIVE MAINTENANCE Kelvin-Varley Divider Test Kelvin-Varley Divider Adjustment
Counter, Hewlett-Packard Model 5211A, or equivalent.	Count: 84 Hz, $\pm 1\%$	CORRECTIVE MAINTENANCE Photochopper Frequency Adjustment
Reference Voltage Divider, Fluke Model 750A, calibrated every 30 days to maintain an accuracy of $\pm 0.0006\%$, or equivalent.	Output Voltage: 1, 10, 100, and 1000 volts dc. Accuracy: Calibrated to $\pm 0.0006\%$ + 2 uv.	PERFORMANCE TESTING Differential Measurement Test CALIBRATION

Figure 4-1. TEST EQUIPMENT REQUIRED

VOLTMETER SWITCH SETTINGS			METER INDICATION
RANGE	NULL	VOLTAGE READOUT DIALS A B C D E	
10	1.0	1.0 0 0 0 0	-1.0
10	.1	0.1 0 0 0 0	-1.0
10	.01	0.0 1 0 0 0	-1.0
10	.001	0.0 0 1 0 0	-1.0
1	.1	1 0 0 0 0	-1.0
1	.01	0 1 0 0 0	-1.0
1	.001	0 0 1 0 0	-1.0
1	.0001	0 0 0 1 0	-1.0
100	10	1 0 0 0 0	-1.0
100	1	0 1 0 0 0	-1.0
100	.1	0 0 1 0 0	-1.0
100	.01	0 0 0 1 0	-1.0
1000	100	1 0 0 0 0	-1.0
1000	10	0 1 0 0 0	-1.0
1000	1	0 0 1 0 0	-1.0
1000	.1	0 0 0 1 0	-1.0
10	1	0.1 0 0 0 0	-0.1
10	1	0.2 0 0 0 0	-0.2
10	1	0.3 0 0 0 0	-0.3
10	1	0.4 0 0 0 0	-0.4
10	1	0.5 0 0 0 0	-0.5
10	1	0.6 0 0 0 0	-0.6
10	1	0.7 0 0 0 0	-0.7
10	1	0.8 0 0 0 0	-0.8
10	1	0.9 0 0 0 0	-0.9
10	1	1.0 0 0 0 0	-1.0
10	1	1.1 0 0 0 0	-1.1

Figure 4-2. SETTING FOR NULL DETECTOR CHECK

4-13. DIFFERENTIAL MEASUREMENT TEST

4-14. The following procedure tests the instrument at 10%, 50%, and 100% of full-scale. This method tests the accuracy of the instrument with a minimum number of measurements. Proceed as follows:

a. Set the meter to zero with the mechanical zero control.

b. Set the POWER switch to ON, and if necessary allow the voltmeter to warmup to equilibrium temperature (about 5 minutes).

c. Connect the necessary equipment to provide dc voltages of 1, 5, and 10 volts at an accuracy of at least $\pm(0.001\% + 2 \text{ uv})$. Proceed as follows:

(1) Equipment connection is illustrated in Figure 4-3. Connect the 845A to the null detector terminals of the 750A, and connect a standard cell to the standard cell terminals of the 750A.

CAUTION!

Be sure the 412B high voltage switch is set to off.

(2) Connect the 412B to the input voltage terminals of the 750A.

(3) Turn on all equipment and allow it to warmup for about 30 minutes.

(4) Set the standard cell voltage dials on the 750A to the correct standard cell voltage.

(5) Set the input voltage switch on the 750A to 1000 volts.

(6) Set the voltage dials on the 412B to 1000, and set the high voltage switch to on.

(7) Set the 845A to 100 microvolt sensitivity.

(8) Adjust the voltage dials on the 412B and the coarse and fine dials on the 750A for a null in successively more sensitive null ranges of the 845A. Final null should be on the 10 microvolt range. Zero the 845A as necessary.

(9) Voltages of 1, 5, and 10 volts are available at the output voltage terminals of the 750A when the output voltage switch is set to the desired position.

d. Zero the null detector of the 895A as follows:

(1) Connect the 895A ground post to line ground.

(2) Short the INPUT and COMMON posts.

(3) Set the switches on the 895A as follows:

RANGE	1
NULL	100 UV
Polarity	+
Voltage readout dials	zero

(4) If necessary, null the panel meter for both polarities of input voltage by adjusting electronic zero resistor R204. The top cover must be removed to gain access to this resistor.

(5) Remove the short between the INPUT and COMMON posts.

e. Set the NULL switch to .1, and set the voltage dials to 1.000000.

f. Apply 1 volt dc $\pm(0.001\% + 2 \text{ uv})$ between the INPUT and COMMON posts.

g. Adjust the voltage readout dials for zero meter deflection in successively more sensitive null ranges. Final readout dial setting should be between .999969 and 1.000031.

h. Set RANGE switch to 10, NULL switch to 1, and voltage readout dials to 5.00000.

i. Apply 5 volts dc $\pm(0.001\% + 2 \text{ uv})$ between the INPUT and COMMON posts.

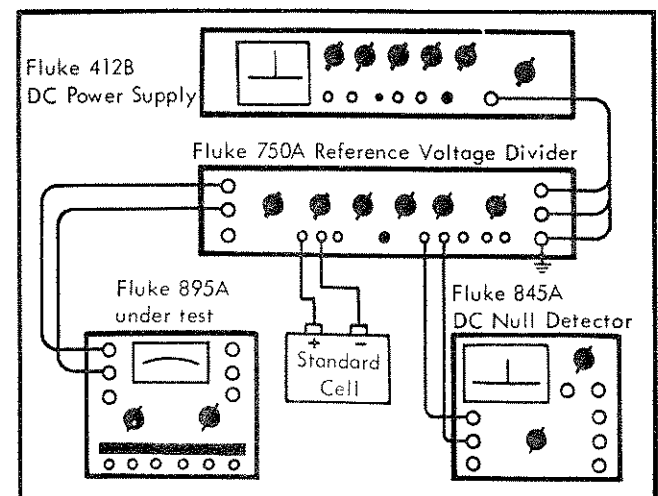

Figure 4-3. SOURCE FOR TEST VOLTAGES

j. Adjust voltage readout dials for zero meter deflection in successively more sensitive null ranges. Final readout dial setting should be between 4.99986 and 5.00014.

k. With the NULL switch at 1, set the voltage readout dials to 10.00000.

l. Apply 10 volts dc $\pm(0.001\% + 2 \text{ uv})$ between the INPUT and COMMON posts.

m. Adjust the voltage readout dials for zero meter deflection in successively more sensitive null ranges. Final readout dial setting should be between 9.99974 and 10.00026.

4-15. CALIBRATION

4-16. GENERAL

4-17. It is recommended that the instrument be calibrated every sixty days to maintain an accuracy of $\pm(0.005\% + 5 \text{ uv})$ between 16°C and 32°C (60°F and 90°F), at less than 70% relative humidity. For applications requiring an accuracy of $\pm(0.0025\%$ of input + 0.0001% of range + 5 uv) at $23 (\pm 1)^\circ\text{C}$, ($73.4 (\pm 1.8)^\circ\text{F}$), less than 70% relative humidity, it is recommended that the instrument be calibrated every thirty days. Calibration should be accomplished in a draft-free area with an ambient temperature of $23 (\pm 1)^\circ\text{C}$, at less than 50% relative humidity, and with a constant line voltage.

4-18. The calibration procedure consists of six parts: Equipment Setup, Null Detector Calibration, 10 Volt Range Calibration, 1 Volt Range Calibration, 100 Volt Range Calibration, and 1000 Volt Range Calibration. Calibration is usually done in the given sequence. The recommended equipment and the specifications required are shown in Figure 4-1. All calibration controls are identified inside the instrument.

4-19. EQUIPMENT SETUP

4-20. To provide the necessary calibration voltages, perform step c. of paragraph 4-14.

4-21. NULL DETECTOR CALIBRATION

a. Set switches on 895A as follows:

RANGE	1
NULL	100 UV
Polarity	+
Voltage readout dials	zero

b. Short the INPUT and COMMON posts with a piece of copper wire.

c. Adjust R204 for zero meter deflection.

d. Set the polarity switch to -. If meter zero changes position by more than 2 microvolts, readjustment of R204 is necessary.

4-4

e. Set switches on 895A as follows:

RANGE	1
NULL	.1
Polarity	+
Voltage readout dials	<u>.100000</u>

f. Adjust R224 for full-scale deflection of the panel meter (-1.0).

g. Set switches on 895A as follows:

RANGE	1
NULL	100 UV
Polarity	+
Voltage readout dials	<u>.000100</u>

h. Adjust R228 for full-scale meter deflection to the left (-1.0).

i. Remove the short from the INPUT and COMMON posts.

4-22. 10 VOLT RANGE CALIBRATION

Note!

The 10 volt range must be calibrated before attempting calibration of the 1 volt, 100 volt, or 1000 volt ranges. To prevent possible error due to leakage, use an insulated screwdriver to adjust R115, R117, R129, and R130.

a. Set switches on 895A as follows:

RANGE	10
NULL	1 MV
Polarity	+
Voltage readout dials	<u>10.00000</u>

b. Apply 10 volts dc $\pm(0.001\% + 2 \text{ uv})$ between the INPUT and COMMON posts.

c. Adjust R115 for zero meter deflection in the 1 MV null range. Resistor R114 may be adjusted if there is insufficient range in R115.

d. Set the voltage readout dials to 9.999100, with 10 volts dc applied as in step b. Deflection of the panel meter must be less than ± 70 microvolts.

4-23. 1 VOLT RANGE CALIBRATION

a. Set switches on 895A as follows:

RANGE	1
NULL	100 UV
Polarity	+
Voltage readout dials	<u>1.000000</u>

b. Apply 1 volt dc $\pm(0.001\% + 2 \text{ uv})$ between the INPUT and COMMON posts.

c. Adjust R117 for zero meter deflection in the 100 UV null range. Resistor R118 may be adjusted if there is insufficient range in R117.

4-24. 100 VOLT RANGE CALIBRATION

WARNING

When the RANGE switch is set to 100 volts or to 1000 volts, potentials within the instrument can approach 1600 volts dc. Avoid contact with the High Voltage Reference Board (895A-404) and with the Null Detector (895A-402), except for R129 and R130 on 895A-404.

- a. Set switches on 895A as follows:

RANGE	100
NULL	.01
Polarity	+
Voltage readout dials	<u>100.0000</u>

b. After five minutes, apply 100 volts dc ($\pm 0.001\%$) between the INPUT and COMMON posts.

c. Adjust R129 for zero meter deflection in the .01 volt null range.

4-25. 1000 VOLT RANGE CALIBRATION

- a. Set switches on 895A as follows:

RANGE	1000
NULL	.1
Polarity	+
Voltage readout dials	<u>1000.000</u>

b. Apply 1000 volts dc ($\pm 0.001\%$) between the INPUT and COMMON posts.

c. Adjust R130 for zero meter deflection in the .1 volt null range. If the meter oscillates at a beat frequency, readjust the chopper frequency according to paragraph 4-36.

4-26. CORRECTIVE MAINTENANCE

4-27. GENERAL

4-28. If the 895A does not perform correctly before or after calibration, the information given here may be used as a guide for locating and correcting the source of trouble. The equipment required for maintaining the instrument is given in Figure 4-1.

4-29. TROUBLESHOOTING

4-30. The purpose of troubleshooting is to quickly and accurately correct the cause of defective operation. Thus, servicing should begin with an attempt to localize the general area of malfunction. By performing a complete performance test, as outlined in paragraph 4-8, the trouble may be isolated to the null detector, reference supply, or Kelvin-Varley divider. The causes and remedies of some of the more common troubles that might occur are listed in the troubleshooting chart, Figure 4-4. However, an understanding of the theory of operation and frequent reference to the schematic diagram is the best way to locate the cause of any malfunction.

4-31. VISUAL INSPECTION. Trouble can sometimes be found by a thorough visual inspection. Look for:

- Accumulations of dirt, dust, moisture, or grease. Remove contamination as outlined in paragraph 4-5.
- Scorched or burned parts. Damage of this type is usually due to a defective component. Determine the cause of damage before replacing the overheated part.

CAUTION!

Avoid touching the polyethylene grommets. Contamination can cause excessive electrical leakage.

- Cracks, cuts, and other damage to the polyethylene grommets. Replace grommets, using a plastic bag over the hand to prevent contamination.
- Loose or intermittent connections.

4-32. MEASURING VOLTAGE LEVELS. When the trouble has been localized to a circuit, the defective part may be isolated in some cases by voltage level measurements at the transistor terminals. Pin voltage of the transistors is listed in Figure 4-5. When measuring pin voltages on printed circuit boards, use a sharp probe and press firmly while rotating the probe to break through the moisture-proof coating. Measurements that differ widely from those listed in the transistor voltage chart can be used to trace the trouble to a specific part.

WARNING!

When measuring voltages, care should be exercised to prevent momentary short circuits, which could damage transistors. With the polarity switch set to -, as recommended, some transistor pin voltages approach 500 volts dc; with the polarity switch set to +, and the RANGE switch set to 100 or 1000, some transistor voltages, and the case of some resistors, approach +1100 volts dc. Do not measure pin voltages in the positive polarity, and avoid accidental contact with transistor cases.

4-33. TROUBLESHOOTING TESTS. The following tests can be used to determine correct operation of specific portions of the instrument.

4-34. Reference Supply Voltages. Test the reference supply voltages for accuracy and line regulation as follows:

- Connect the autotransformer to the line, and connect the voltmeter to the output of the autotransformer. Set the autotransformer for 115 volts output (or 230 volts for 230 volt instrument).
- Set the POWER switch to ON.
- Set the NULL switch to TVM; set the polarity switch to +; and set the RANGE switch to 10.
- Connect a differential voltmeter between test point 101 (TP101) and TP105. The voltmeter should indicate +26 (± 3) volts dc.
- Connect the differential voltmeter between TP102 and TP105. The voltmeter should indicate -20 (± 2) volts dc.

SYMPTOM	PROBABLE CAUSE	REMEDY
+18 volt reference supply low	Q101 defective	Replace
	R103, R104 defective	Check and replace if necessary
	Q102, Q103, or Q104 defective	Check and replace if necessary
Zener reference voltage incorrect or noisy	Incorrect Zener current	Check R111
	Incorrect operation of Zener oven.	Establish correct operating potentials of 10-15 volts across R147, and 4 volts across R115, in 25° C ambient.
+1100 volt reference supply incorrect or noisy	R414 out of adjustment	Set R414 while observing waveform at TP108. Adjust R414 for minimum signal amplitude.
	Noisy chopper amplifier	Check DS202 for erratic operation. Replace if necessary.
+110 volt reference supply incorrect or noisy	C115 leaking or shorted	Replace if necessary.
Incorrect null sensitivity	Input divider resistor short or open	Check R2 through R10.
Null Detector inoperative (+17 volt supply low)	Shorted Q205 or Q206	Replace
Null Detector noisy	Erratic operation of DS201, DS202	Replace if neon flicker is observed
	Multivibrator frequency out of adjustment	Readjust multivibrator frequency according to paragraph 4-36. Check C112.
	Contamination of null detector input	Check protective coating of PC201, PC202, C201, C202, CR201, and CR202.
Drift of reference supply evidenced by null detector meter drift when measuring a stable voltage	Faulty reference supply.	Measure stability of reference supply according to paragraph 4-40.
Meter rattle or drift	Moisture, dirt, or other contamination on printed circuit boards or switches	Clean instrument according to paragraph 4-7.
Measurements are out of tolerance on every range when Kelvin-Varley divider is dialed to any setting other than <u>10999100</u> .	Kelvin-Varley divider out of adjustment, or one of the resistors out of tolerance.	Check accuracy of Kelvin-Varley divider using paragraph 4-42. If Kelvin-Varley is out of tolerance, first adjust divider according to paragraph 4-43. If divider cannot be adjusted, use data obtained from paragraph 4-42 and 4-43 to isolate the defective resistor.
Meter cannot be adjusted for zero	Chopper drive not symmetrical.	Readjust photochopper drive circuit according to paragraph 4-36.
	CR201 or CR202 defective	Check and replace if necessary.
Meter oscillates during measurement.	Chopper drive circuit out of adjustment.	Adjust photochopper drive circuit according to paragraph 4-36.

Figure 4-4. TROUBLESHOOTING CHART

TRANSISTOR	EMITTER (vdc)	BASE (vdc)	COLLECTOR (vdc)
Q101	+ 26.4 ①	+ 25.5	+ 18.0 ②
Q102A	+ 11.9	+ 12.5	+ 15.5
Q102B	+ 11.9	+ 12.5	+ 15.5
Q103	+ 15.0	+ 15.5	+ 25.5
Q104	+ 15.0	+ 15.5	+ 18.0
Q105	+ 15.0	- 0.02	+ 0.04
Q106	- 0.48	+ 0.04	+ 0.11
Q107	- 0.48	+ 0.11	+ 8.3
Q108	+ 0.05	- 0.43	0
Q109	+ 17.5	+ 22.2	+ 0.8
Q110	+ 17.5	+ 21.8	+ 0.5
Q111	+ 16.0	+ 15.5	+ 2.0
Q112	- 7.9	- 7.3	+ 14.1
Q113	- 7.9	- 7.2	+ 3.2
Q201	- 0.48	0	- 0.01
Q202	- 0.48	- 0.02	+ 0.05
Q203	- 0.48	+ 0.04	+ 7.6
Q204	0	+ 0.57	+ 6.0
Q205	+ 6.1	+ 6.0	+ 14.0
Q206	+ 6.1	+ 5.9	0
Q207	0	- 9.3	0
Q208	0	+ 7.2	0
Q209	0	+ 5.5	0
Q210	0	- 5.6	0
Q401	+251	+241	+452
Q402	+ 17.0	+ 17.6	+251
Q403	+ 0.61	+ 1.07	+ 17.1
Q404	0	+ 0.61	+ 17.1
Q405	- 0.51	- 0.03	+ 4.3
Q406	- 0.50	0	+ 1.08

The above operating voltage levels are measured under the following conditions: (a) Polarity switch set to -, Null switch set to TVM, Readout dials set to 000000, Range switch set to 10 for measuring null detector voltages, and to 1000 for measuring other voltages. (b) Line voltage at 115/230 volts ac, 50 to 440 Hz. (c) All voltages measured with a 3%, 10 megohm voltmeter from specified terminal to common of the circuit being measured. The COMMON post is reference supply-null detector common when in TVM mode or when in a NULL mode with all readout dials set to 0. (d) Some voltages may vary as much as 20%, however, bias voltages (difference between emitter and base voltages) should remain approximately the same. NOTES: ① Emitter of Q101 should be between +23 and +29 vdc for 115/230 vac line operation. ② Collector of Q101 should be between +17.9 and +18.1 vdc as measured with a VTVM.

Figure 4-5. TRANSISTOR VOLTAGE CHART

f. Connect the differential voltmeter between TP103 and TP105.

g. Set the voltmeter to differentially measure +18.0 volts dc.

h. If necessary, adjust R105 so that the voltmeter indicates +18.0 (± 0.1) volts dc.

Note!

If R105 is adjusted, it will be necessary to recalibrate the 10 volt range according to paragraph 4-22.

i. Set the autotransformer for 103 volts output (207 volts if the instrument is wired for 230 volt operation), and adjust the differential voltmeter for zero meter deflection.

j. Set the autotransformer for 127 volts output (253 volts for 230 volt instruments). The voltage change indicated by the differential voltmeter should not exceed 800 microvolts.

k. Connect the differential voltmeter between TP407 and TP408.

l. Set the RANGE switch to 1000, and set the polarity switch to -.

m. The differential voltmeter should indicate -1100 (± 33) volts dc.

n. Set the autotransformer for 103 volts output (207 volts for 230 volt instruments), and adjust the differential voltmeter for zero meter deflection.

o. Set the autotransformer for 127 volts output (253 volts for 230 volt instruments). The voltage change indicated by the differential voltmeter should not exceed 3 millivolts.

4-35. Meter Rattle Test. Proceed as follows:

- a. Set the switches on the 895A as follows:

RANGE	1
NULL	100 UV
Voltage readout dials	zero

b. Set the POWER switch to ON, and allow the instrument to warmup for about 5 minutes.

c. Short the INPUT and COMMON posts. Random deflection of the meter needle should be less than 1 small division peak-to-peak in both polarities. If rattle is excessive, check the photo-chopper drive circuit.

4-36. Adjustment of Photo-chopper Frequency. The photo-chopper frequency may require adjustment if a part in the circuit is replaced, if there is difficulty in zeroing the meter, or if the meter oscillates due to the relationship of line frequency with the photo-chopper frequency. Proceed as follows:

- Set the POWER switch to ON.
- Set the RANGE switch to TVM, and set the polarity switch to +.
- Connect a counter between TP105 and TP110.
- Adjust R146 so that the counter indicates a frequency of 84 (± 1) Hz.

4-37. Null Detector Supply Voltages.

- Connect the voltmeter between TP201 and TP202.
- Set the POWER switch to ON.
- The voltmeter should indicate +17 (± 3) volts dc.
- Connect the voltmeter between TP201 and TP203.
- The voltmeter should indicate -17 (± 3) volts dc.
- Connect the voltmeter between TP105 and TP205. The voltmeter should indicate +5.5 (± 1.5) volts dc.

4-38. Line Regulation.

a. Connect the autotransformer to the line, and connect the voltmeter to the output of the autotransformer. Set the autotransformer for 103 volts output (207 volts for 230 volt instruments).

- b. Set the switches on the 895A as follows:

RANGE	1
NULL	100 UV
Voltage readout dials	zero
Polarity	+

- Short the INPUT and COMMON posts.
- Set the autotransformer for 127 volts output (253 volts for 230 volt instruments). The change in deflection of the panel meter should not exceed 2 microvolts.

4-39. Chopper Amplifier Operation.

- a. Set switches on 895A as follows:

RANGE	1000
NULL	1 MV
Polarity	-
Voltage readout dials	zero

b. Connect the differential voltmeter between TP105 and TP107. The voltmeter should indicate +9 (± 2) volts dc.

c. Connect the differential voltmeter between TP105 and TP109. Adjust R414, if necessary, so that the voltmeter indicates a minimum, and no greater than ± 1 millivolt.

4-40. Reference Supply Stability.

a. Using the 1 volt range and positive polarity, measure the voltage of a standard cell.

b. After a minimum time period of 8 hours, repeat step a.

c. After an additional 8 hours, repeat step a.

d. If the difference between the voltages measured in steps a., b., and c. exceeds 9 microvolts, either the reference supply or the reference zener diodes, CR104 and CR105, are unstable.

4-41. Common-Mode Measurement Test. If the instrument is suspected of making incorrect measurements in the presence of common-mode voltages, perform the following test:

a. Measure the voltage of a standard cell, using the 1 volt range and positive polarity. The standard cell must not be grounded.

b. Disconnect the shorting link, and connect 500 volts dc from the chassis ground post to the COMMON post, and wait for 3 minutes.

c. Measure the standard cell voltage. If the two measurements differ by more than 50 microvolts, there is excess electrical leakage to ground. Clean the instrument according to paragraph 4-5.

4-42. Kelvin-Varley Divider Test. The Kelvin-Varley test requires connections to the Kelvin-Varley divider inside the instrument, and requires a considerable amount of time. Therefore, this test should be performed only if the differential measurement test (paragraph 4-13) indicates there is a problem, or if the Kelvin-Varley divider has been adjusted (paragraph 4-43). Proceed as follows:

a. Set the POWER switch to OFF, and set the NULL switch to TVM.

b. Disconnect the 895A from line power.

c. Remove bottom panel and top panel.

d. Locate high input wire (wire from point 13, or R301, on Kelvin-Varley board to polarity switch S4), high output wire (wire from R373 to null switch S3), and input-output common wire (point 1 on Kelvin-Varley board).

CAUTION!

Be sure that the 412B high voltage switch is set to off.

e. Connect the equipment as shown in Figure 4-6.
f. Turn on all equipment and allow it to warmup for about 30 minutes.

g. Set voltage dials on 412B for an output of 33.0 volts dc.

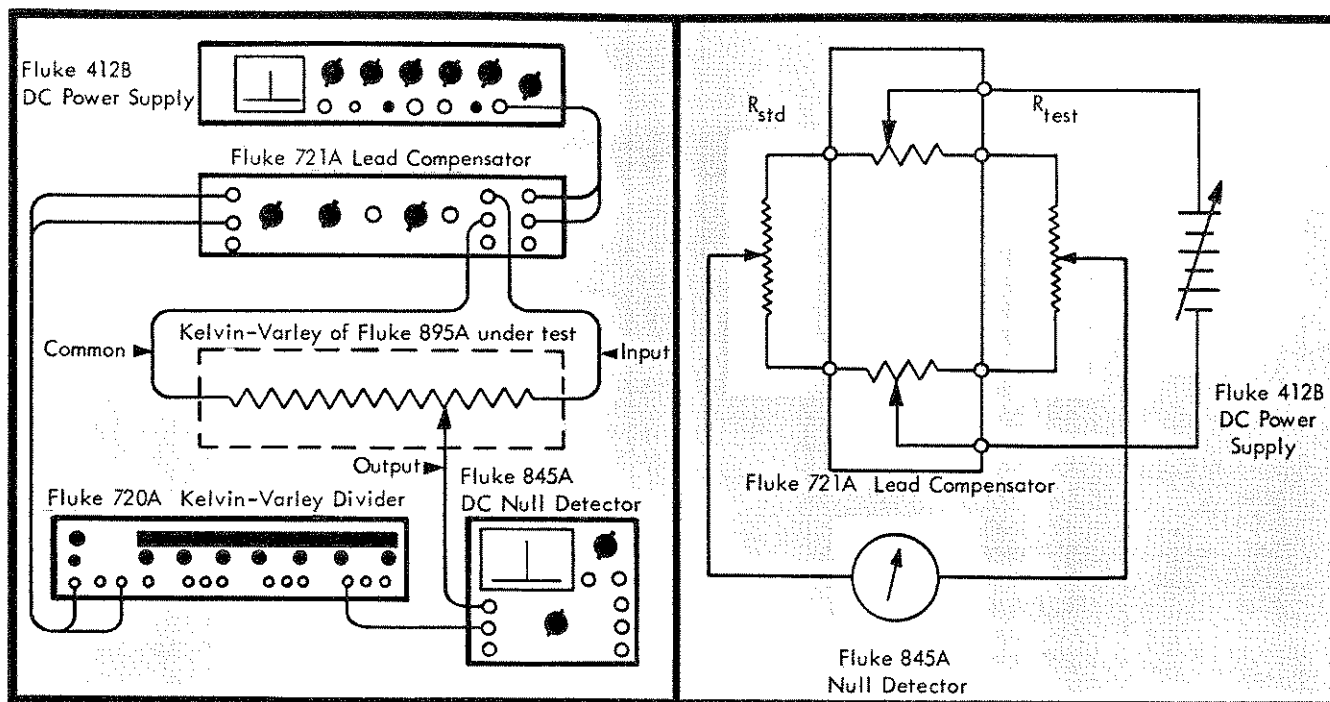

Figure 4-6. KELVIN-VARLEY DIVIDER TEST

- h. Set 895A voltage readout dials to 000000, and set 720A dials to 0000000.
- i. Set 845A to 10 microvolts.
- j. Set mode switch of 721A to R_{std} R_{test} .
- k. Set 721A voltage switch to off.
- l. Zero 845A Null Detector.
- m. Set 721A voltage switch to on.
- n. Adjust low balance controls of 721A for a null on 845A.
- o. Set 895A voltage dials to 10999100, and set 720A dials to 109999910.
- p. Set 721A voltage switch to off.
- q. Zero 845A Null Detector
- r. Set 721A voltage switch to on.
- s. Adjust high balance controls on 721A for a null on 845A.
- t. Set 845A Null Detector to 300 microvolts sensitivity, and change to 100 microvolts if required.
- u. Set 895A voltage readout dials and 720A readout dials to the first positions shown in Figure 4-7. The 845A Null Detector indication should be less than the listed deviation.
- v. Repeat step u. for the remaining switch positions shown in Figure 4-7. If the Kelvin-Varley divider is out of tolerance between settings of 1000000 and 0999100, readjust according to paragraph 4-43.

4-43. Kelvin-Varley Divider Adjustment. The first deck of the Kelvin-Varley divider can be adjusted after a resistor has been replaced, or if the Kelvin-Varley divider test (paragraph 4-42) indicates that the Kelvin-Varley divider is out of tolerance. Proceed as follows:

- a. Set the POWER switch to OFF, set the NULL switch to TVM, and set the polarity switch to +.
- b. Disconnect the 895A from line power.
- c. Remove the bottom cover of the instrument.

- d. Open the jumper on the Kelvin-Varley board marked "x". Also unsolder high input wire of Kelvin-Varley divider (wire from point 13 to switch section S4D).
- e. Connect the equipment as shown in Figure 4-8. Points A, C, & D are identified on the Kelvin-Varley board.
- f. Turn on all equipment, and allow it to warmup for a minimum of 30 minutes.
- g. Set the 720A readout dials to .6666667.
- h. Set the 412B output for 150 (± 0.40) volts dc, as follows:

CAUTION!

To prevent possible damage to the 725A Kelvin-Varley resistors, do not apply more than 150 volts dc to the test circuit.

- (1) Set the 412B power switch to on.
 - (2) Set the 412B high voltage switch to standby/reset.
 - (3) Set the 412B polarity switch to +.
 - (4) Set the 412B output voltage dials for an output voltage of 150 volts.
- i. Connect the low-thermal shorting jumper between points 2 and 3 on the copper side of the printed circuit board.
 - j. Set the 845A to the operate position and 10 micro-volt range, and zero the meter.
 - k. Set the 412B high voltage switch from standby/reset to on.
 - l. Adjust R335 (adjustment B) so that the 845A indicates 0 ± 50 microvolts. Resistor R336 (adjustment A) may be adjusted if there is insufficient range in R335.
 - m. Set the 412B high voltage switch to standby/reset.
 - n. Reconnect the shorting jumper between points 1 and 2.

895A Voltage Dial Settings	Standard Divider Settings	Maximum Deviation (± microvolts for input voltage of 33.0 vdc)	895A Voltage Dial Settings	Standard Divider Settings	Maximum Deviation (± microvolts for input voltage of 33.0 vdc)
1000000	10000000	360	007000	0070000	36
9999100	10000000	360	0069100	0070000	36
900000	9000000	324	006000	0060000	36
8999100	9000000	324	0059100	0060000	36
800000	8000000	288	005000	0050000	36
7999100	8000000	288	0049100	0050000	36
700000	7000000	252	004000	0040000	36
6999100	7000000	252	0039100	0040000	36
600000	6000000	216	003000	0030000	36
5999100	6000000	216	0029100	0030000	36
500000	5000000	180	002000	0020000	36
4999100	5000000	180	0019100	0020000	36
400000	4000000	144	001000	0010000	36
3999100	4000000	144	0009100	0010000	36
300000	3000000	108	000900	0009000	36
2999100	3000000	108	0008100	0009000	36
200000	2000000	72	000800	0008000	36
1999100	2000000	72	0007100	0008000	36
100000	1000000	36	000700	0007000	36
0999100	1000000	36	0006100	0007000	36
090000	0900000	36	000600	0006000	36
0899100	0900000	36	0005100	0006000	36
080000	0800000	36	000500	0005000	36
0799100	0800000	36	0004100	0005000	36
070000	0700000	36	000400	0004000	36
0699100	0700000	36	0003100	0004000	36
060000	0600000	36	000300	0003000	36
0599100	0600000	36	0002100	0003000	36
050000	0500000	36	000200	0002000	36
0499100	0500000	36	0001100	0002000	36
040000	0400000	36	000100	0001000	36
0399100	0400000	36	0000100	0001000	36
030000	0300000	36	000090	0000900	36
0299100	0300000	36	000080	0000800	36
020000	0200000	36	000070	0000700	36
0199100	0200000	36	000060	0000600	36
010000	0100000	36	000050	0000500	36
0099100	0100000	36	000040	0000400	36
009000	0090000	36	000030	0000300	36
0089100	0090000	36	000020	0000200	36
008000	0080000	36	000010	0000100	36
0079100	0080000	36	000000	0000000	0

Figure 4-7. KELVIN-VARLEY DIVIDER ERROR LIMITS

- o. Set the 412B high voltage switch to on.
- p. Adjust R334 (adjustment D) so that the 845A indicates 0 ± 50 microvolts. Resistor R333 (adjustment C) may be adjusted if there is insufficient range in R334.
- q. Set the 412B high voltage switch to standby/reset.
- r. Repeat steps n. through q., using the 895A dial settings, shorted test points, adjustments, and tolerances given in Figure 4-9.
- s. Disconnect the test equipment, and resolder jumper "x" between points A and C on the Kelvin-Varley circuit board.

4-44. MECHANICAL DRUM ADJUSTMENTS

4-45. Occasionally the need may arise to align the polarity switch drum or one of the voltage dial drums in the readout windows. Also, if the drive gear on a switch or dial shaft is no longer in line with the drum shaft, the gears may bind as the dials are turned. Proceed as follows:

- a. Remove both side front-covers and the bottom cover from 895A.

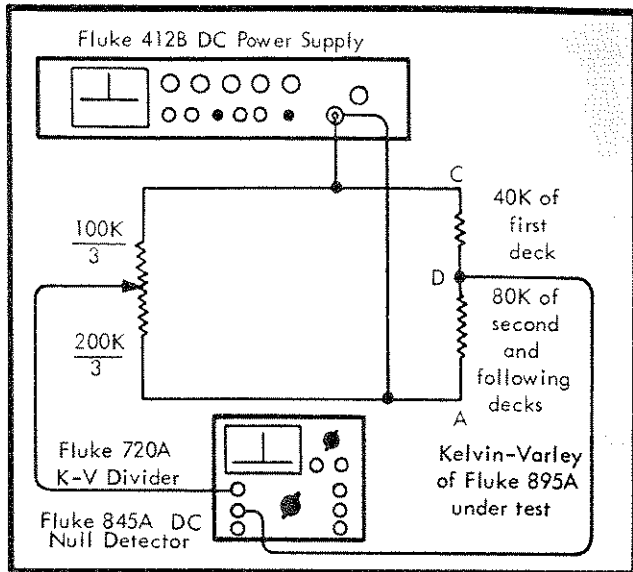

Figure 4-8. KELVIN-VARLEY CALIBRATION CIRCUIT

- b. Stand instrument on rear.
- c. Make sure that drive gear on polarity switch shaft and drive gear on shaft of voltage dial E are in line with drum shaft. If not, loosen set screw of drive gear with a 1/16" hex key and align drive gear with drum shaft.
- d. Loosen adjusting bracket at left side of instrument and position drum shaft up or down until there is just discernible backlash. That is, until polarity drum just moves when rotated with a finger without moving drive gear on polarity switch shaft.

- e. Loosen adjusting bracket at right side of instrument and position drum shaft up or down until there is just discernible backlash for drum of voltage dial E.
- f. Turn polarity switch and all voltage dials fully counterclock wise.
- g. Loosen set screw of drive gear for drum being aligned and slide drive gear toward back of instrument.

Note!

See step 1. for adjustment of voltage dial E.

- h. Insert finger through window and hold drum being aligned in desired position.
- i. Insert hex key into set screw of drive gear and lift drive gear into place allowing it to turn counter clockwise as the teeth mesh.
- j. When drive gear is in line with drum shaft tighten set screw.
- k. Check character alignment in window. If necessary, loosen set screw and rotate drive gear slightly for final adjustment.
- l. To align drum for voltage dial E, loosen set screw of drive gear and slide toward rear of instrument.
- m. Insert hex key into set screw of drive gear and lift drive gear into alignment with drive shaft while noting how much drum turns.
- n. Slide drive gear toward rear of instrument.
- o. Position drum so that 00 position will line up with pointer when gear is raised into position.
- p. Raise drive gear into alignment with drum shaft and position 00 in line with pointer by rotating drive gear slightly before tightening set screw.

895A Readout Dials	Shorted Test Points	Adjustment	845A Indication For 150V Input
.0	2 to 3	R135 & R136 R133 & R134	0 ± 50 UV
.0	1 to 2		0 ± 50 UV
.2	4 to 5	R130 R127	0 ±150 UV
.2	3 to 4		0 ±150 UV
.4	6 to 7	R124 R121	0 ±150 UV
.4	5 to 6		0 ±150 UV
.6	8 to 9	R118 R115	0 ±150 UV
.6	7 to 8		0 ±150 UV
.8	10 to 11	R112 R109	0 ±150 UV
.8	9 to 10		0 ±150 UV
1.0	12 to 13	R106 R103	0 ±150 UV
1.0	11 to 12		0 ±150UV

Figure 4-9. CALIBRATION ADJUSTMENT LIMITS

Section 5

List of Replaceable Parts

5-1. INTRODUCTION

5-2. This section contains complete descriptions of those parts one might normally expect to replace during the life of the instrument. The first listing is a breakdown of all of the major assemblies in the instrument. Subsequent listings itemize the components in each assembly. Every listing is accompanied by an illustration identifying each component in the listing. Assemblies and subassemblies are identified in both the list and the illustration with a reference designation beginning with the letter A, (e.g., A1, A100, A201, etc.). Components are identified by the schematic diagram reference designation (e.g. R1, C107, DS1). Parts not appearing on the schematic diagram are identified by a number of the same series as the other parts of the assembly (e.g. 8, 103, 209).

5-3. COLUMNAR INFORMATION

a. The REF DESIG column indexes the item description to the associated illustration. In general the reference designations are listed in alpha-numeric order. Subassemblies of minor proportions are sometimes listed with the assembly of which they are a part. In this case, the reference designations for the components of the subassembly may appear out of order.

b. The DESCRIPTION column describes the salient characteristics of the component. Indentation of the item description indicates the relationship to other assemblies, components, etc. See Abbreviations and Symbols, paragraph 5-7, next page.

c. The ten-digit part number by which the item is identified at the John Fluke Mfg. Co. is listed in the FLUKE PART NO column. Use this number when ordering parts from the factory or authorized representatives.

d. The Federal Supply Code for the item manufacturer is listed in the MFR column. An abbreviated list of Federal Supply Codes is included in the Appendix.

e. The part number which uniquely identifies the item to the original manufacturer is listed in the MFR PART NO column. If a component must be ordered by description, the type number is listed.

f. The TOT QTY column lists the total quantity of the item used in the instrument. Second and subsequent listing of the same item are referenced to the first listing with the abbreviation REF. In the case of optional

subassemblies, plug ins, etc. that are not always part of the instrument, the TOT QTY column lists the total quantity of the item in that particular assembly.

g. Entries in the REC QTY column indicate the recommended number of spare parts necessary to support one to five instruments for a period of two years. This list presumes an availability of common electronic parts at the maintenance site. For maintenance for one year or more at an isolated site, it is recommended that at least one of every part in the instrument be stocked.

h. The USE CODE column identifies certain parts which have been added, deleted or modified during the production of the instrument. Each part for which a Use Code has been assigned may be identified with a particular instrument serial number by consulting the Serial Number Effectivity List. As Use Codes are added to the list, the TOT QTY column listings are changed to reflect the most current information. Sometimes when a part is changed, the new part can and should be used as a replacement for the original part. In this event a parenthetical note is added in the DESCRIPTION column.

5-4. HOW TO OBTAIN PARTS

5-5. Standard components have been used wherever possible. Thus, most parts can be obtained locally. However, parts may be ordered directly from the manufacturer's part number. Or they may be ordered from the John Fluke Mfg. Co factory or authorized representative. In the event the part you order has been replaced by a new or improved part, the replacement will be accompanied by an explanatory note and installation instructions, if necessary.

5-6. You can insure prompt and efficient handling of your order to the John Fluke Mfg. Co. if you include the following information:

- a. Instrument model and serial number.
- b. Component description.
- c. Component reference designation.
- d. John Fluke Mfg. Co. part number.

If you must order structural parts not listed in the parts list, describe the part as completely as possible. A sketch of the part showing its location to other parts of the instrument is usually most helpful.

5-8. SERIAL NUMBER EFFECTIVITY

5-9. A Use Code column is provided to identify certain parts that have been added, deleted, or modified during production of the 895A. Each part for which a use code has been assigned may be identified with a particular instrument serial number by consulting the Use Code Effectivity List below. All parts with no code are used on all instruments with serial numbers above 123. New codes will be added as required by instrument changes.

USE CODE

EFFECTIVITY

No Code	Model 895A serial number 123 and on.
A	Model 895A serial number 123 thru 146.
B	Model 895A serial number 147 and on. Model 896A serial number 123 and on.
C	Model 895A serial number 123 thru 142.
D	Model 895A serial number 143 and on. Model 896A serial number 123 and on.
E	Model 895A serial number 123 thru 282.
F	Model 895A serial number 283 and on. Model 896A serial number 123 and on.
G	Model 895A serial number 123 thru 338.
H	Model 895A serial number 339 and on. Model 896A serial number 123 and on.
I	Model 895A serial number 123 thru 472.
J	Model 895A serial number 473 and on. Model 896A serial number 123 and on.
K	Model 895A serial number 147 thru 472.
L	Model 895A serial number 123 thru 520.
M	Model 895A serial number 521 and on. Model 896A serial number 123 and on.
N	Model 895A serial number 123 thru 262. Model 896A serial number 123 thru 242.
O	Model 895A serial number 673 and on. Model 896A serial number 243 and on.
P	Model 896A serial number 328 and on.

REF DESIG	DESCRIPTION	STOCK NO	MFR	MFR PART NO	TOT QTY	REC QTY	USE CODE
	FINAL ASSEMBLY-Figure 5-1						
A1	Chassis Assembly (see Figure 5-2)						
A2	Front Panel Assembly (see Figure 5-3)						
A3	Switch Assembly (see Figure 5-4)						
A100	Reference Supply Board Assembly (see Figure 5-5)	1702-196170 (895A-401)	89536	1702-196170	1		
A200	Null Detector Board Assembly (see Figure 5-7)	1702-196188 (895A-402)	89536	1702-196118	1		
A300	Kelvin-Varley Board Assembly (see Figure 5-8)	5111-196196 (895A-403)	89536	5111-196196	1		
A400	High Voltage Board Assembly (see Figure 5-9)	1702-196204 (895A-404)	89536	1702-196204	1		

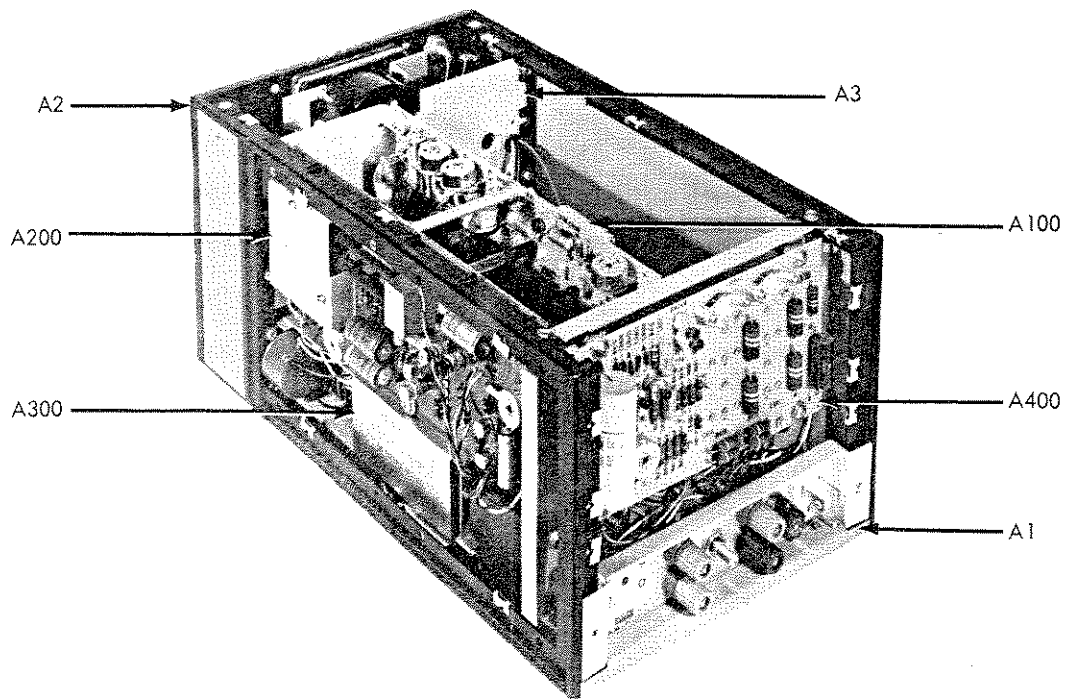

Figure 5-1. FINAL ASSEMBLY

REF DESIG	DESCRIPTION	STOCK NO	MFR	MFR PART NO	TOT QTY	REC QTY	USE CODE
A1	CHASSIS ASSEMBLY-Figure 5-2						
F1	Fuse, Type AGC, 1/2 amp	5101-153858	71400	Type AGC	1		C
	Fuse, Type AGC, 3/4 amp 115V operation (not illustrated)	5101-109249	71400	Type AGC	1		D
	Fuse, Type AGC, 1/4 amp 230V operation (not illustrated)	5101-109314	71400	Type AGC	1		
J4, J5	Binding post, red	2811-149856	58474	BHB-10208G22	5		
J6	Binding post, red	2811-142976	58474	DF31RC	1		I
J6	Binding post, red	2811-149856	58474	BHB-10208G22	REF		J
J7	Binding post, black	2811-142984	58474	DF31BC	2		I
J7	Binding post, black	2811-149864	58474	BHB-10208G21	2		J
J8, P1	Line Cord Assembly	6005-161638	91934	107-1, SVT	1		
P2	Plug, 3 prong	2109-160275	73586	M-1548-GS	1		
R11	Res, var, comp, 10K \pm 20%, 1/2W	4701-162800	12697	Series 37	1		
R12	Res, comp, 3.9K \pm 10%, 1/2W (not illustrated)	4704-161406	01121	EB3921	1		
R13	Res, metal clad, 1.3K \pm 5%, 25W	4706-196782	00213	3225M	1		
R14, R15	Res, comp, 1K \pm 5%, 1/4W	4704-148023	01121	CB1025	2		
T1	Transformer, power	5600-167783	89536	5600-167783	1		
T2	Transformer, high voltage	5600-192617	89536	5600-192617	1		
1	Cover, bottom	3156-196733	89536	3156-196733	1		
2	Cover, side	3156-162164	89536	3156-162164	2		
3	Cover, side, rear	3156-162172	89536	3156-162172	2		
4	Cover, top	3156-196758	89536	3156-196758	1		
5	Drum Assembly, polarity	2403-162883	89536	2403-162883	1		
6	Drum Assembly, 0-10	2403-162891	89536	2403-162891	4		
7	Drum Assembly, 00-100	2403-162909	89536	2403-162909	1		
8	Fuseholder	2102-160846	75915	34-2004	1		
9	Gear, nylon	3155-154682	89536	3155-154682	6		
10	Handle	2404-101857	12136	919-415-173	1		
11	High voltage shield	3156-196113	89536	3156-196113	1		
12	Rod, light	3800-168047	89536	3800-168047	3		
13	Rubber foot (not illustrated)	2819-103309	83478	9102-W	4		
14	Tilt stand	3153-163386	89536	3153-163386	1		

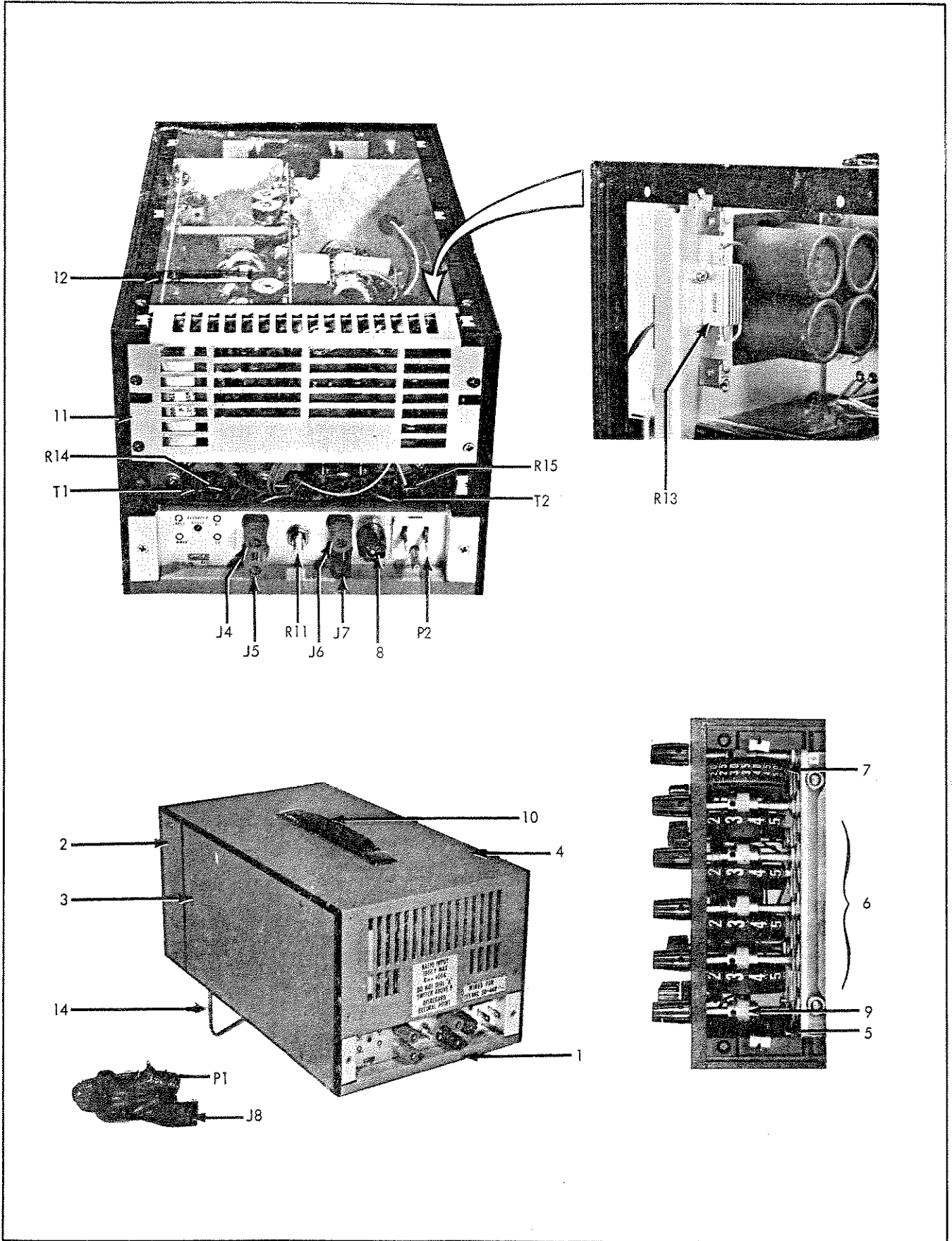

Figure 5-2. CHASSIS ASSEMBLY

REF DESIG	DESCRIPTION	STOCK NO	MFR	MFR PART NO	TOT QTY	REC QTY	USE CODE
A2	FRONT PANEL ASSEMBLY-Figure 5-3						
C1	Cap, mylar, 0.047 uf $\pm 20\%$, 1200V	1507-182683	84411	JF-37	1		
J1, J2	Binding Post, red	2811-149856	58474	BHB-10208G22	REF		
J3	Binding Post, black	2811-142984	58474	DF31BC	REF		I
J3	Binding Post, black	2811-149864	58474	BHB-10208G21	REF		J
M1	Meter Assembly	2901-203422	89536	2901-203422	1		
R1	Res, comp, 100M $\pm 10\%$, 1/2W	4704-190520	01121	EB1071	1		
15	Bushing	2502-160499	89536	2505-160499	9		
16	Front Panel	1406-162289	89536	1406-162289	1		
17	Knob	2405-158949	89536	2405-158949	6		
18	Knob, bar	2405-158956	89536	2405-158956	3		
19	Shutter	3156-180737	89536	3156-180737	1		
20	Shorting link	2811-101220	24655	938L	1		

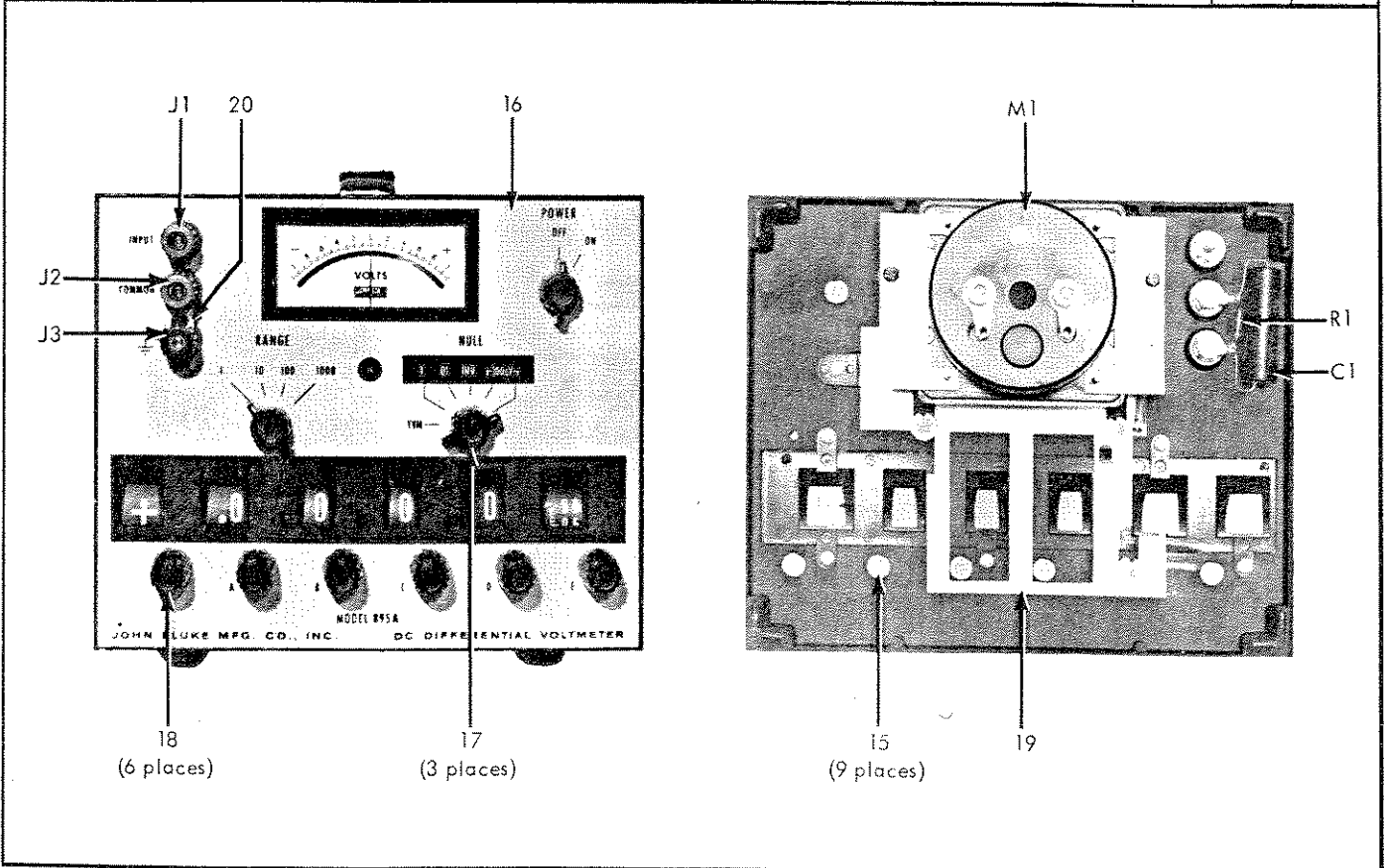

Figure 5-3. FRONT PANEL ASSEMBLY

REF DESIG	DESCRIPTION	STOCK NO	MFR	MFR PART NO	TOT QTY	REC QTY	USE CODE
A3	SWITCH ASSEMBLY - Figure 5-4						
C2	Cap, mylar, 1.0 uf $\pm 20\%$, 200V	1507-106450	84411	Type X663F	1		
C3	Cap, mylar, 1.0 uf $\pm 20\%$, 120V	1507-193748	84411	JF-11	1		
R2-R4	Res, car flm, 30M $\pm 1\%$, 1W	4703-188391	91673	Type DC-1	3		
R5	Res, car flm, 9M $\pm 1/2\%$, 1W	4703-107557	12400	Type C13	1		
R6	Res, car flm, 900K $\pm 1/2\%$, 1W	4703-192328	12400	Type C13	1		
R7	Res, car flm, 90K $\pm 1/2\%$, 1/2W	4703-107292	12400	Type C12	1		
R8	Res, car flm, 9K $\pm 1/2\%$, 1/2W	4703-107250	12400	Type C12	1		
R9	Res, car flm, 900 Ω $\pm 1/2\%$, 1/2W	4703-107771	12400	Type C12	1		
R10	Res, car flm, 100 Ω $\pm 1/2\%$, 1/2W	4703-107730	12400	Type C12	1		
S1	Switch, rotary, RANGE	5105-196915	89536	5105-196915	1		
S2	Switch, rotary, POWER	5105-180679	89536	5105-180679	1		
S3	Switch, rotary, NULL	5105-196923	89536	5105-196923	1		
S4	Switch, rotary, POLARITY	5105-196873	89536	5105-196873	1		

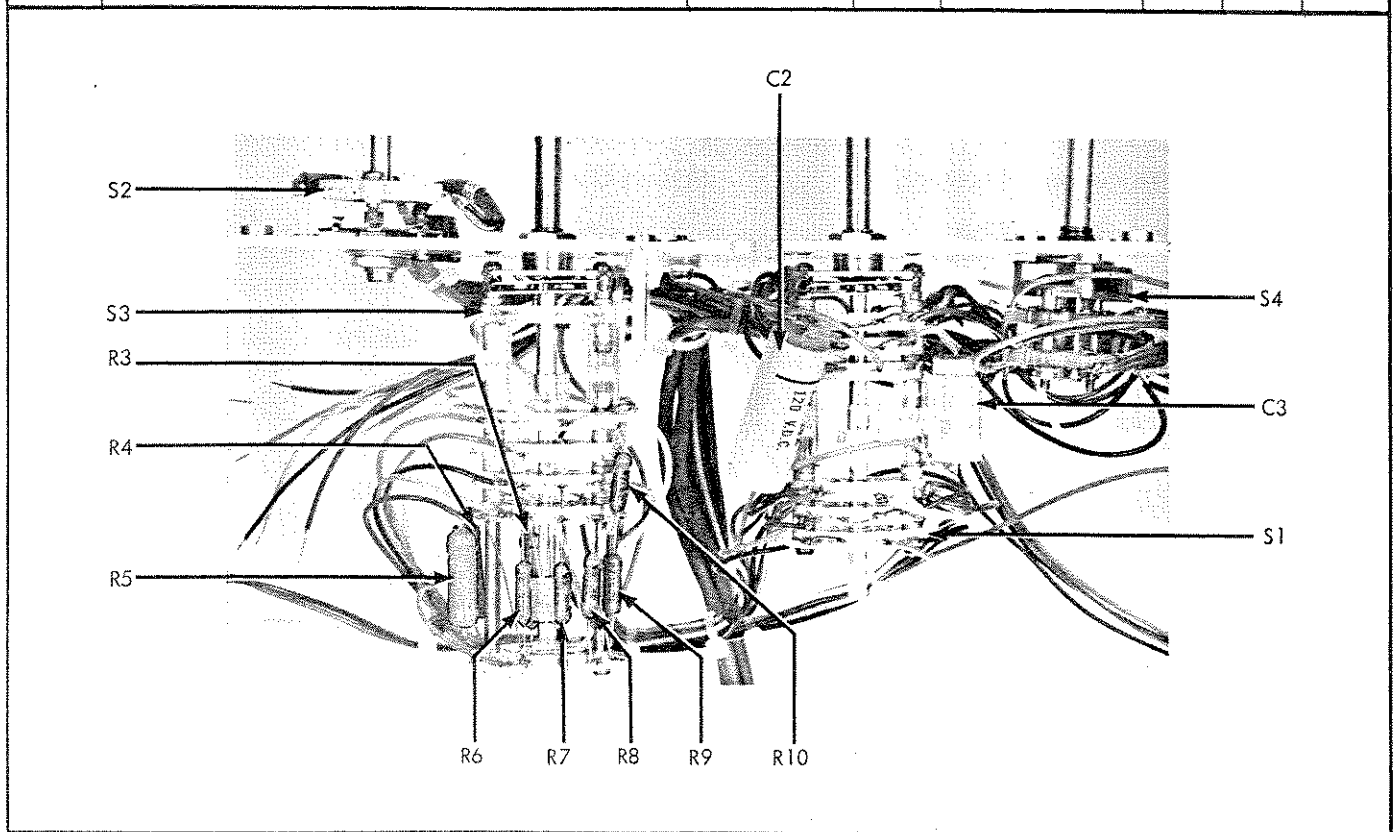













Figure 5-4. SWITCH ASSEMBLY

REF DESIG	DESCRIPTION	STOCK NO	MFR	MFR PART NO	TOT QTY	REC QTY	USE CODE
A100	REFERENCE SUPPLY BOARD ASSEMBLY Figure 5-5	1702-196170 (895A-401)	89536	1702-196170	REF		
A101	Zener-Diode Oven Assembly (see Figure 5-6)	1702-206334 (895A-415)	89536	1702-206334	1		B
C101	Cap, elect, 250 uf -10/+50%, 40V	1502-178616	73445	C437ARG250	1		
C102	Cap, elect, 20 uf -10/+75%, 50V	1502-106229	56289	30D206G050DC4	2		
C103	Cap, mylar, 0.022 uf \pm 10%, 80V	1507-159400	56289	192P2239R8	1		
C104	Cap, mylar, 0.22 uf \pm 10%, 75V	1507-159392	56289	192P2249R8	5		
C105	Cap, plstc, 0.22 uf \pm 20%, 200V	1507-200584	84411	JF-39	1		
C106, C107	Cap, mylar, 0.047 uf \pm 10%, 80V	1507-195099	56289	192P4739R8	2		
C108	Cap, cer, 500 pf \pm 10%, 1,000V	1501-105692	56289	C067B102E501K	3		
C109	Cap, elect, 1,250 uf -10/+50%, 4V	1502-166330	73445	C437ARB1250	2		
C110	Cap, elect, 2 uf -10/+75%, 50V	1502-105197	56289	30D205G050BA4	1		
C111	Cap, elect, 20 uf -10/+75%, 50V	1502-106229	56289	30D206G050DC4	REF		
C112	Cap, mylar, 0.22 uf \pm 10%, 75V	1507-159392	56289	192P2249R8	REF		
CR101, CR102	Diode, Internat Rect. Type 4D4	4802-180240	81483	4D4	10		
CR103	Diode, zener, 20V, Type 1N968A	4803-113340	07910	1N968A	1		
CR104, CR105	Diode, zener						A
CR106, CR107	Diode, specially treated	4802-180885	89536	4802-180885	4		
CR108	Diode, Type 1N456A	4802-190272	93332	1N456A	1		
PC101	Photo cell, factory treated	3700-200261	89536	3700-200261	1		
PC101	Photo cell, factory selected & treated	3700-256784	89536	3700-256784	1		
Q101	Tstr, Totorola Type MPS3638	4805-169375	04713	MPS3638	2		
Q101	Tstr, Type 2N4126	4805-215897	04713	2N4126	1		H
Q102	Tstr, dual matched pair	4805-182246	89536	4805-182246	1		
Q103 thru Q107	Tstr, Type 2N3565	4805-177105	07263	2N3565	9		
Q108	Tstr, Motorola Type MPS3638	4805-169375	04713	MPS3638	1		
Q109, Q110	Tstr, T. I. Type GA2817	4805-182600	01295	GA2817	2		
R101	Res, comp, 1.2K \pm 10%, 1/2W	4704-108803	01121	EB1221	1		
R102	Res, comp, 1M \pm 10%, 1/2W	4704-108134	01121	EB1051	4		G
R102	Res, comp, 3.9K \pm 5%, 1/2W	4704-180596	01121	EB3925	1		H

REF DESIG	DESCRIPTION	STOCK NO	MFR	MFR PART NO	TOT QTY	REC QTY	USE CODE
R103	Res, WW, factory selected						
R104	Res, WW, factory selected						
R105	Res, var, WW, 500Ω ±10%, 1-1/4W	4702-113258	71450	Type 110	1		
R106	Res, met flm, 17.8K ±1%, 1/2W	4705-162545	12400	Type CEC-TO	3		G
R106	Res, met flm, 34K ±1%, 1/2W	4705-151241	12400	Type CEC-TO	2		H
R107	Res, met flm, 17.8K ±1%, 1/2W	4705-162545	12400	Type CEC-TO	1		
R108	Res, met flm, 47.5K ±1%, 1/2W	4705-148908	12400	Type CEC-TO	1		
R109	Res, met flm, 17.8K ±1%, 1/2W	4705-162545	12400	Type CEC-TO	REF		G
R109	Res, met flm, 34K ±1%, 1/2W	4705-151241	12400	Type CEC-TO	REF		H
R110	Res, comp, 5.6K ±10%, 1/2W	4704-108324	01121	EB5621	1		
R111	Res, WW, factory selected						
R112	Res, comp, 33Ω ±10%, 1/2W	4704-108456	01121	EB3301	1		
R113	Res, WW, factory selected						
R114	Res, var, WW, 10Ω ±10%, 1-1/4W	4702-112672	71450	Type 110	14		
R115	Res, var, WW, 2Ω ±10%, 2W	4702-193243	71450	115 Special	2		
R116	Res, WW, factory matched						
R117	Res, var, WW, 2Ω ±10%, 2W	4702-193243	71450	115 Special	REF		
R118	Res, var, WW, 10Ω ±10%, 1-1/4W	4702-112672	71450	Type 110	REF		
R119	Res, WW, factory selected						
R120	Res, WW, factory matched						
R121, R122	Res, WW, factory matched						
R123 thru R126	Res, WW, factory matched						
R127	Res, WW, factory matched						
R128	Res, WW, factory matched						
R129, R130	Res, var, cer met, 1K ±20%, 3/4W	4701-190538	73138	75P-RIK	2		
R131	Res, comp, 150K ±5%, 1/4W	4704-182212	01121	CB1545	1		
R132	Res, comp, 330K ±5%, 1/4W (underneath C107)	4704-192948	01121	CB3345	1		
R133	Res, comp, 1M ±5%, 1/4W	4704-182204	01121	CB1055	2		
R134	Res, comp, 10M ±10%, 1/2W	4704-108142	01121	EB1061	1		
R135	Res, comp, 1M ±10%, 1/2W	4704-108134	01121	EB1051	3		
R136	Res, comp, 20K ±5%, 1/2W	4704-109041	01121	EB2035	1		

REF DESIG	DESCRIPTION	STOCK NO	MFR	MFR PART NO	TOT QTY	REC QTY	USE CODE
R137	Res, comp, 43K $\pm 5\%$, 1/2W	4704-188797	01121	EB4335	1		
R138	Res, comp, 3 Ω $\pm 5\%$, 1/2W	4704-188771	01121	EB30G5	1		
R139	Res, comp, 2K $\pm 5\%$, 1/2W	4704-169854	01121	EB2025	1		
R140, R141	Res, comp, 39K $\pm 10\%$, 1/2W	4704-108555	01121	EB3931	2		
R142	Res, comp, 15K $\pm 10\%$, 1/2W	4704-108530	01121	EB1531	1		
R143	Res, comp, 10 Ω $\pm 10\%$, 1/2W	4704-108092	01121	EB1001	3		
R144, R145	Res, comp, 27K $\pm 10\%$, 1/2W	4704-108878	01121	EB2731	2		
R146	Res, var, WW, 10K $\pm 10\%$, 1-1/4W	4702-162115	71450	Type 110	1		
T101	Transformer, Auxiliary	5600-195941	89536	5600-195941	1		L
T101	Transformer, Auxiliary	5600-244756	89536	5600-244756	1		M
100	Polyethelene grommet, 3/8" x 1/4"	2807-171876	89536	2807-171876	20		

- 1 If replacement is required, replace with complete Zener-Resistor Set, part number 4807-196261.
- 2 This resistor is factory selected for each instrument. When ordering, include all information stamped on this resistor.
- 3 If replacement is required, replace with complete 1 Volt Divider Set, part number 4710-196279.
- 4 If replacement is required, replace with complete Feedback Set, part number 4710-196287.

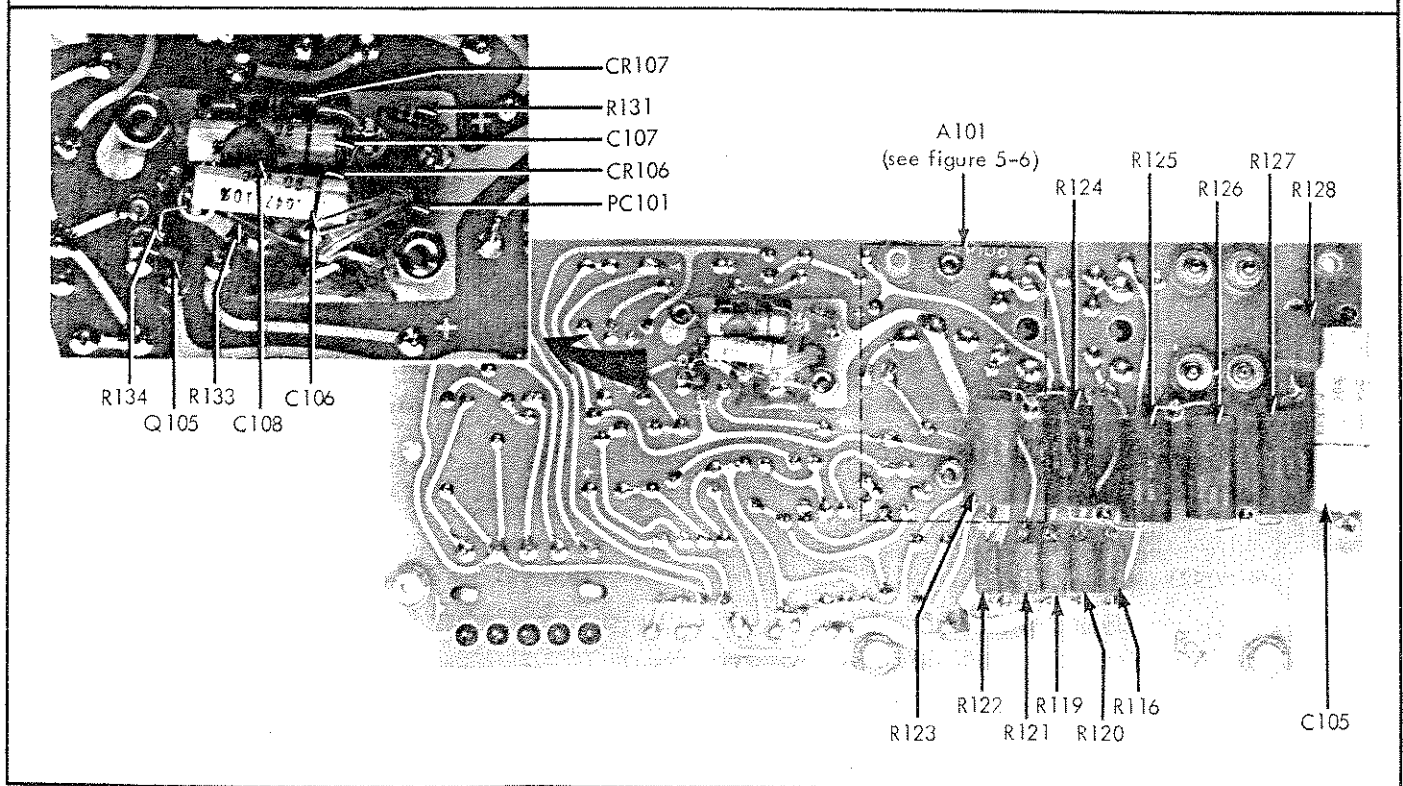

Figure 5-5. REFERENCE SUPPLY BOARD ASSEMBLY (Sheet 1 of 2)

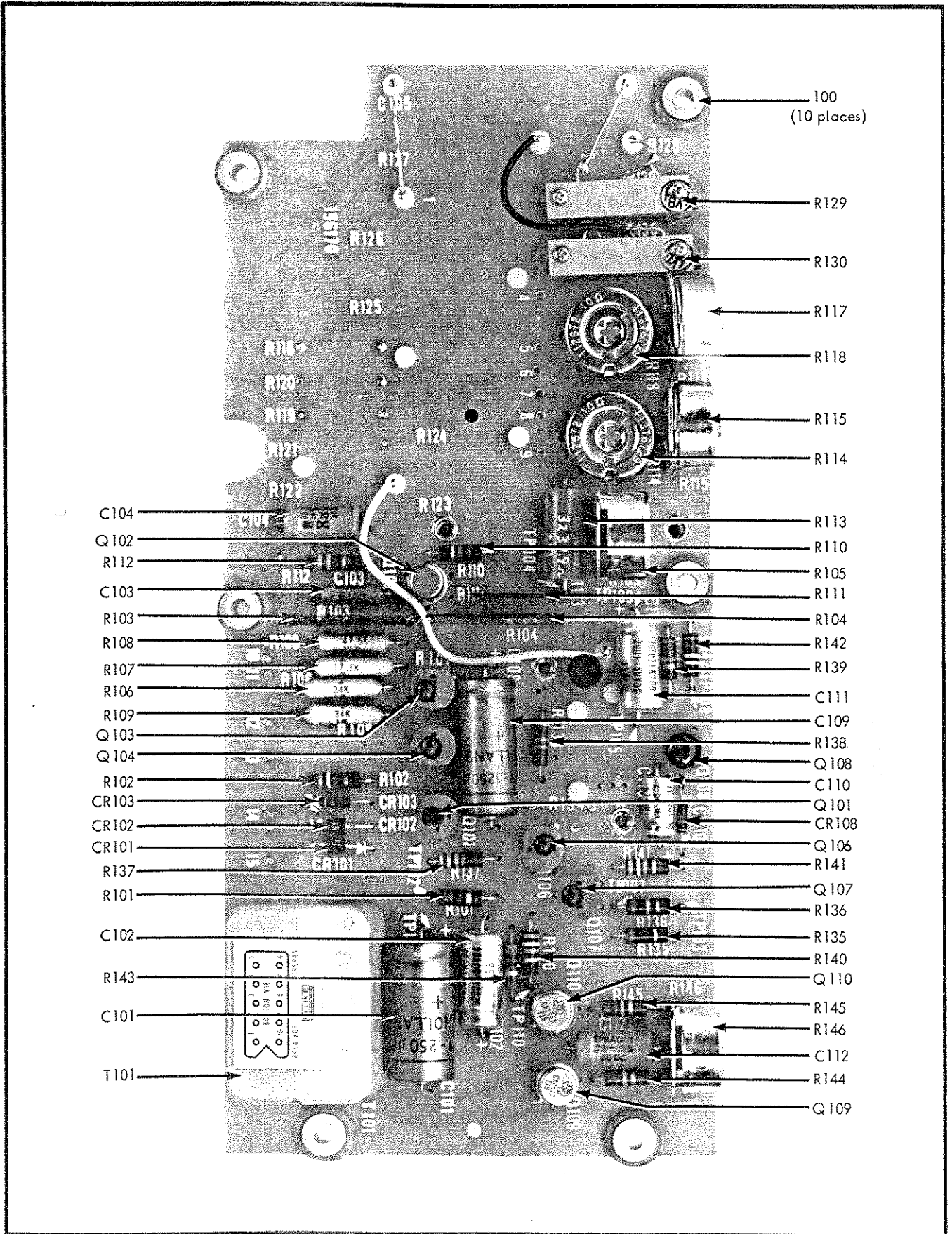

Figure 5-5. REFERENCE SUPPLY BOARD ASSEMBLY (Sheet 2 of 2)

REF DESIG	DESCRIPTION	STOCK NO	MFR	MFR PART NO	TOT QTY	REC QTY	USE CODE
	The Zener Diode Oven Assembly was used from serial number 147 and on only.						
A101	ZENER DIODE OVEN ASSEMBLY Figure 5-6	1702-206334 (895A-415)	89536	1702-206334	REF		B
A102	Zener Diode Oven	5301-206318	89536	5301-206318	1		B
CR104, CR105	Diode, zener, factory selected (not illustrated)	▷					B
R147	Res, factory selected (not illustrated)	▷					B
R155	Thermistor, factory selected (not illustrated)	▷					B
C113	Cap, cer, 0.01 uf ±20%, 100v	1501-149153	56289	C023B101F103M	1		J
Q111	Tstr, Motorola Type SM4144	4805-190389	04713	SM4144	1		B
Q112, Q113	Tstr, Type 2N3391	4805-168708	03508	2N3391	5		B
R148, R149	Res, comp, 3.9K ±5%, 1/4W	4704-148064	01121	CB3925	3		B
R150	Res, met flm, 66.5K ±1%, 1/2W	4705-187955	12400	Type CEC-TO	2		B
R151	Res, comp, 2.7K ±5%, 1/4W	4704-170720	01121	CB2725	1		B
R152	Res, comp, 3.9K ±5%, 1/4W	4704-148064	01121	CB3925	REF		B
R153	Res, met flm, 66.5K ±1%, 1/2W	4705-187955	12400	Type CEC-TO	REF		B
R154	Res, met flm, 19.6K ±1%, 1/2W	4705-159640	12400	Type CEC-TO	1		K
R154	Res, met flm, 15.8K ±1%, 1/2W	4705-171983	12400	Type CEC-TO	1		J

▷ If replacement is required, replace with complete Zener Diode Oven, part number 5301-206318.

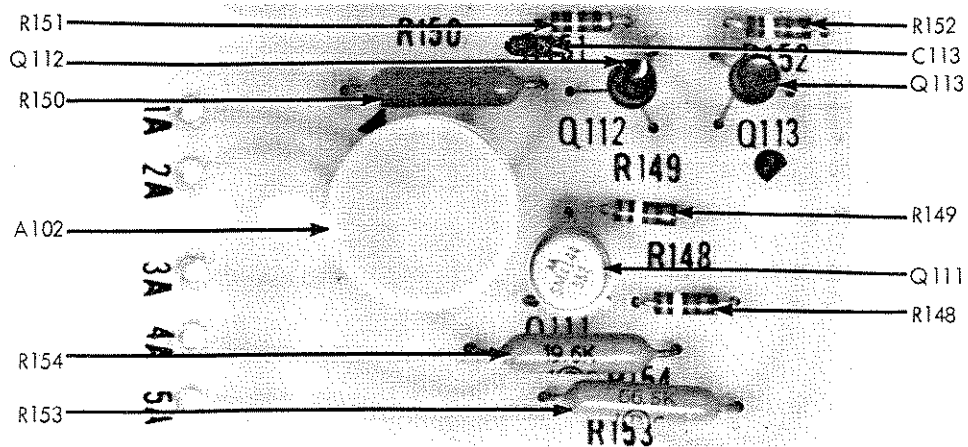

Figure 5-6. ZENER DIODE OVEN ASSEMBLY

REF DESIG	DESCRIPTION	STOCK NO	MFR	MFR PART NO	TOT QTY	REC QTY	USE CODE
A200	NULL DETECTOR BOARD ASSEMBLY Figure 5-7	1702-196188 (895A-402)	89536	1702-196188	REF		
C201, C202	Cap, 0.22 uf, 100V, factory treated	1507-167734	89536	1507-167734	2		
C203	Cap, 0.1 uf, 100V, factory treated	1507-167742	89536	1507-167742	1		
C204	Cap, elect, 400 uf -10/+50%, 25V	1502-168153	73445	C437ARF400	3		
C205	Cap, plstc, 0.047 uf \pm 20%, 100V	1507-106096	84411	663UW47301	1		
C206	Cap, cer, 500 pf \pm 10%, 1,000V	1501-105692	56289	C067B102E501K	REF		
C207	Cap, elect, 1,250 uf -10/+50%, 4V	1502-166330	73445	C437ARB1250	REF		
C208	Cap, mylar, 0.22 uf \pm 10%, 57V	1507-159392	56289	19P2249R8	REF		
C209	Cap, cer, 500 pf \pm 10%, 1,000V	1501-105692	56289	C067B102E501K	REF		
C210	Cap, elect, 50 uf -10/+50%, 25V	1502-168823	73445	C426ARF50	1		
C211	Cap, elect, 640 uf -10/+50%, 6.4V	1502-178608	73445	C437ARC640	1		I
C211	Cap, elect, 500 uf -10/+50%, 10V	1502-245589	88419	BRNP500-10	2		J
C212	Cap, elect, 400 uf -10/+50%, 25V	1502-168153	73445	C437ARF400	REF		I
C212	Cap, elect, 500 uf -10/+50%, 10V	1502-245589	88419	BRNP500-10	REF		J
C213	Cap, mylar, 0.1 uf \pm 10%, 200V	1507-106013	56289	192P10492	1		
C214, C215	Cap, elect, 400 uf -10/+50%, 25V	1502-168153	73445	C437ARF400	REF		
CR201, CR202	Diode, factory treated	4802-180885	89536	4802-180885	REF		
CR203	Diode, zener, Type 1N759	4803-159780	07910	1N759	1		
CR204- CR207	Diode, Internat Rect. Type 4D4	4802-180240	81483	4D4	REF		
DS201, DS202	Lamp, neon, Type NE-2U	3902-162602	33173	NE-2U	2		
PC201, PC202	Photocell, factory treated	3700-200287	89536	3700-200287	2		N
PC201, PC202	Photocell, factory selected & tested	3700-256776	89536	3700-256776	1 pr.		O
Q201	Tstr, factory tested	4805-198812	89536	4805-198812	1		
Q202- Q204	Tstr, Type 2N3391	4805-168708	03508	2N3391	REF		
Q205	Tstr, Type 2N1304	4805-117127	01295	2N1304	1		
Q206	Tstr, Type 2N1307	4805-148643	01295	2N1307	1		
Q207	Tstr, T.I. Type GA2875	4805-182691	01295	GA2875	2		
Q208, Q209	Tstr, T.I. Type GA2877	4805-182709	01295	GA2877	2		
Q210	Tstr, T.I. Type GA2875	4805-182691	01295	GA2875	REF		

REF DESIG	DESCRIPTION	STOCK NO	MFR	MFR PART NO	TOT QTY	REC QTY	USE CODE
R201	Res, comp, 270K $\pm 10\%$, 2W	4702-110023	01121	HB2741	1		
R202	Res, comp, 180K $\pm 5\%$, 1/4W	4704-193441	01121	CB1845	1		
R203	Res, comp, 100K $\pm 5\%$, 1/4W	4704-148189	01121	CB1045	1		
R204	Res, var, comp, 100K $\pm 20\%$, 1/4W	4701-163873	71450	UPE200	1		
R205	Res, comp, 560K $\pm 10\%$, 1/2W	4704-108795	01121	EB5641	1		
R206	Res, comp, 680K $\pm 10\%$, 1/2W	4704-108340	01121	EB6841	1		
R207	Res, comp, 47K $\pm 10\%$, 1/2W	4704-108480	01121	EB4731	4		
R208	Res, met flm, 10 Ω $\pm 1\%$, 1/2W	4705-151043	12400	Type CEC-TO	1		
R209	Res, comp, 1M $\pm 5\%$, 1/4W	4704-182204	01121	CB1055	REF		
R210	Res, comp, 6.8M $\pm 10\%$, 1/2W	4704-108662	01121	EB6851	1		
R211	Res, comp, 1.5M $\pm 10\%$, 1/2W	4704-108175	01121	EB1551	2		
R212	Res, comp, 47K $\pm 10\%$, 1/2W	4704-108480	01121	EB4731	REF		
R213	Res, comp, 4.7 Ω $\pm 10\%$, 1/2W	4704-165746	01121	EB47G1	1		
R214	Res, comp, 180K $\pm 10\%$, 1/2W	4704-108431	01121	EB1841	1		
R215	Res, comp, 5.6M $\pm 10\%$, 1/2W	4704-178558	01121	EB5651	1		
R216	Res, comp, 10K $\pm 10\%$, 1/2W	4704-108118	01121	EB1031	2		
R217	Res, comp, 1M $\pm 10\%$, 1/2W	4704-108134	01121	EB1051	REF		
R218	Res, comp, 47K $\pm 10\%$, 1/2W	4704-108480	01121	EB4731	REF		
R219, R220	Res, comp, 22K $\pm 10\%$, 1/2W	4704-108209	01121	EB2231	2		
R221	Res, comp, 220 Ω $\pm 10\%$, 1/2W	4704-108191	01121	EB2211	1		I
R221	Res, comp, 10 Ω $\pm 10\%$, 1/2W	4704-108092	01121	EB1001	REF		J
R222	Res, met flm, 4.99K $\pm 1\%$, 1/2W	4705-148890	12400	Type CEC-TO	2		E
R222	Res, met flm, 4.42K $\pm 1\%$, 1/2W	4705-218628	12400	Type CEC-TO	1		F
R223	Res, met flm, 42.2k $\pm 1\%$, 1/2W	4705-182501	12400	Type CEC-TO	1		
R224	Res, var, WW, 1K $\pm 20\%$, 1-1/4W	4702-111575	71450	Type 110	1		
R225	Res, comp, 33 Ω $\pm 10\%$, 1/2W	4704-108456	01121	EB3301	REF		I
R225	Res, comp, 220 Ω $\pm 10\%$, 1/2W	4704-108191	01121	EB2211	1		J
R226, R227	Res, comp, 12K $\pm 10\%$, 1/2W	4704-108977	01121	EB1231	2		
R228	Res, var, WW, 10K $\pm 20\%$, 1-1/4W	4702-112862	71450	Type 110	1		
R229	Res, met flm, 49.9K $\pm 1\%$, 1/2W	4705-182980	12400	Type CEC-TO	1		
R230	Res, met flm, 4.99K $\pm 1\%$, 1/2W	4705-148890	12400	Type CEC-TO	1		

REF DESIG	DESCRIPTION	STOCK NO	MFR	MFR PART NO	TOT QTY	REC QTY	USE CODE
R231	Res, comp, 47K ±10%, 1/2W	4704-108480	01121	EB4731	REF		
T201	Transformer, Auxiliary	5602-195958	89536	5602-195958	1		
200	Polyethelene grommet, 3/8" x 1/4"	2807-171876	89536	2807-171876	REF		
201	Rod, light	3800-168047	89536	3800-168047	REF		
202	Shield, input (not illustrated)	3156-196097	89536	3156-196097	1		

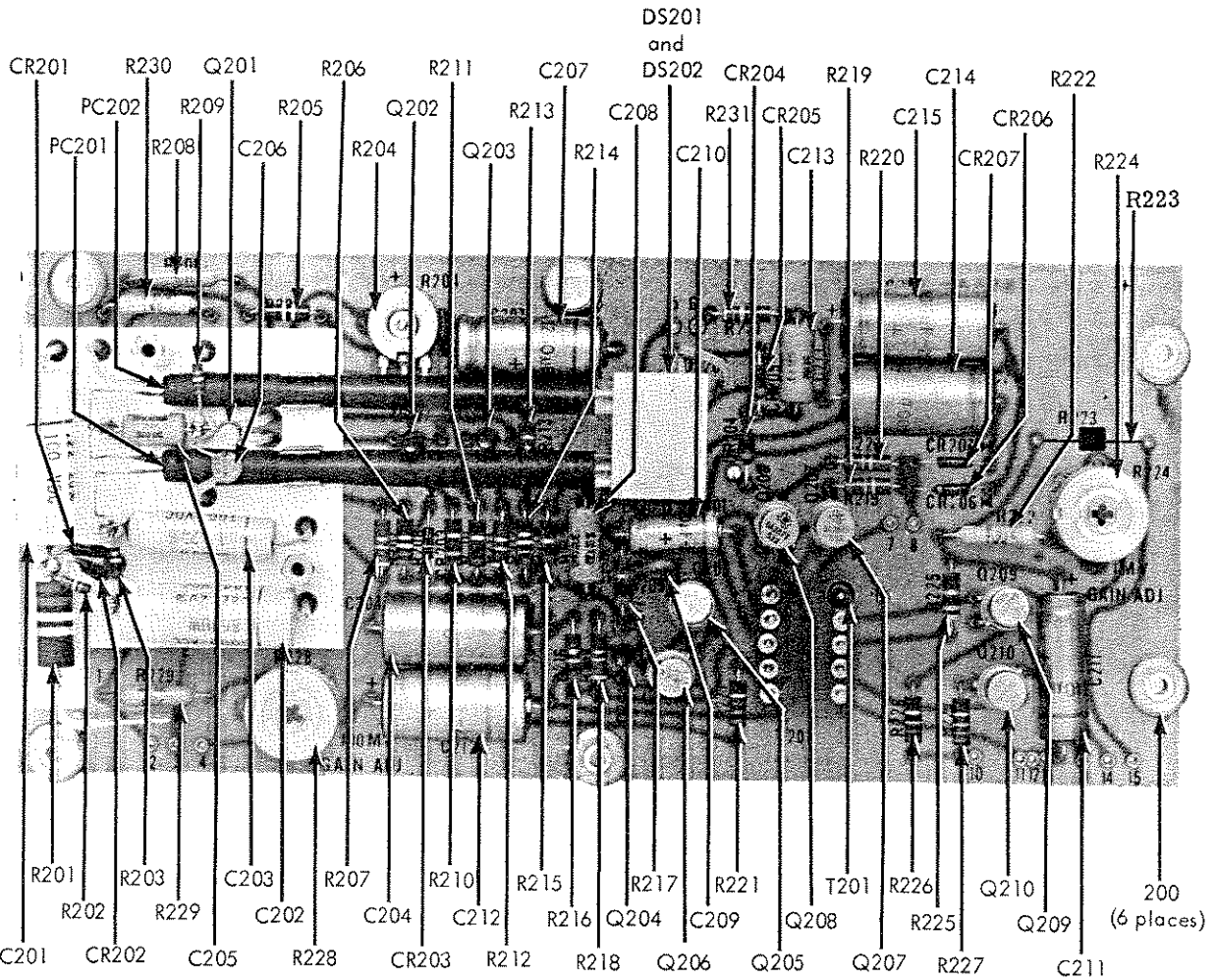





















Figure 5-7. NULL DETECTOR BOARD ASSEMBLY

REF DESIG	DESCRIPTION	STOCK NO	MFR	MFR PART NO	TOT QTY	REC QTY	USE CODE
A300	KELVIN-VARLEY BOARD ASSEMBLY Figure 5-8	5111-196196 (895A-403)	89536	5111-196196	REF		
R301, R302	Res, WW, 20K \pm 0.005%, 1W						
R303	Res, var, WW, 10 Ω \pm 10%, 1-1/4W	4702-112672	71450	Type 110	REF		
R304, R305	Res, WW, 20K, \pm 0.005%, 1W						
R306	Res, var, WW, 10 Ω \pm 10%, 1-1/4W	4702-112672	71450	Type 110	REF		
R307, R308	Res, WW, 20K \pm 0.005%, 1W						
R309	Res, var, WW, 10 Ω \pm 10%, 1-1/4W	4702-112672	71450	Type 110	REF		
R310, R311	Res, WW, 20K \pm 0.005%, 1W						
R312	Res, var, WW, 10 Ω \pm 10%, 1-1/4W	4702-112672	71450	Type 110	REF		
R313, R314	Res, WW, 20K \pm 0.005%, 1W						
R315	Res, var, WW, 10 Ω \pm 10%, 1-1/4W	4702-112672	71450	Type 110	REF		
R316, R317	Res, WW, 20K \pm 0.005%, 1W						
R318	Res, var, WW, 10 Ω \pm 10%, 1-1/4W	4702-112672	71450	Type 110	REF		
R319, R320	Res, WW, 20K \pm 0.005%, 1W						
R321	Res, var, WW, 10 Ω \pm 10%, 1-1/4W	4702-112672	71450	Type 110	REF		
R322, R323	Res, WW, 20K \pm 0.005%, 1W						
R324	Res, var, WW, 10 Ω \pm 10%, 1-1/4W	4702-112672	71450	Type 110	REF		
R325, R326	Res, WW, 20K \pm 0.005%, 1W						
R327	Res, var, WW, 10 Ω \pm 10%, 1-1/4W	4702-112672	71450	Type 110	REF		
R328, R329	Res, WW, 20K \pm 0.005%, 1W						
R330	Res, var, WW, 10 Ω \pm 10%, 1-1/4W	4702-112672	71450	Type 110	REF		
R331, R332	Res, WW, 20K \pm 0.005%, 1W						
R333	Res, var, WW, 10 Ω \pm 10%, 1-1/4W	4702-112672	71450	Type 110	REF		
R334, R335	Res, var, WW, 2 Ω \pm 10%, 2W	4702-182410	89536	4702-182410	2		
R336	Res, var, WW, 10 Ω \pm 10%, 1-1/4W	4702-112672	71450	Type 110	REF		

REF DESIG	DESCRIPTION	STOCK NO	MFR	MFR PART NO	TOT QTY	REC QTY	USE CODE
R337, R338	Res, WW, 20K \pm 0.005%, 1W						
R339 To R349	Res, WW, 8K \pm 0.005%, 1/2W						
R350 To R360	Res, WW, 1.6K \pm 0.005%, 1/8W						
R361 To R371	Res, WW, 320 Ω \pm 0.02%, 1/8W						
R372	Res, WW, 860.2 Ω \pm 0.05%, 1/2W (not illustrated)	4707-192591	89536	4707-192591	1		
R373	Res, var, WW, 2.5K \pm 0.5%	4711-163154	89536	4711-163154	1		
S5	Switch, rotary, 2 pol, 11 pos, 2 sections	5105-162644	89536	5105-162644	1		
S6	Switch, rotary, 2 pol, 10 pos, 2 section	5105-162636	89536	5105-162636	2		
S7	Switch, rotary, 2 pol, 10 pos, 2 section	5105-162651	89536	5105-162651	1		
S8	Switch, rotary, 2 pol, 10 pos, 2 section	5105-162636	89536	5105-162636	REF		

-  R301 through R338 are factory matched in pairs (R301/R302, R304/R305, etc.) for resistance, tolerance, and temperature coefficient. If replacement becomes necessary, replace in pairs only. When ordering, supply all markings on the old pair of resistors.
-  R339 through R349 are factory matched according to resistance, tolerance, temperature coefficient, and the resistance of R301/R302, R304/R305, etc. When ordering, supply all markings on the old resistor.
-  R350 through R360 are factory matched according to resistance, tolerance, and the resistance of R339 through R349. When ordering, supply all markings on the old resistor.
-  R361 through R371 are factory matched according to resistance, tolerance and the resistance of R350 through R360. When ordering, supply all markings on the old resistor.

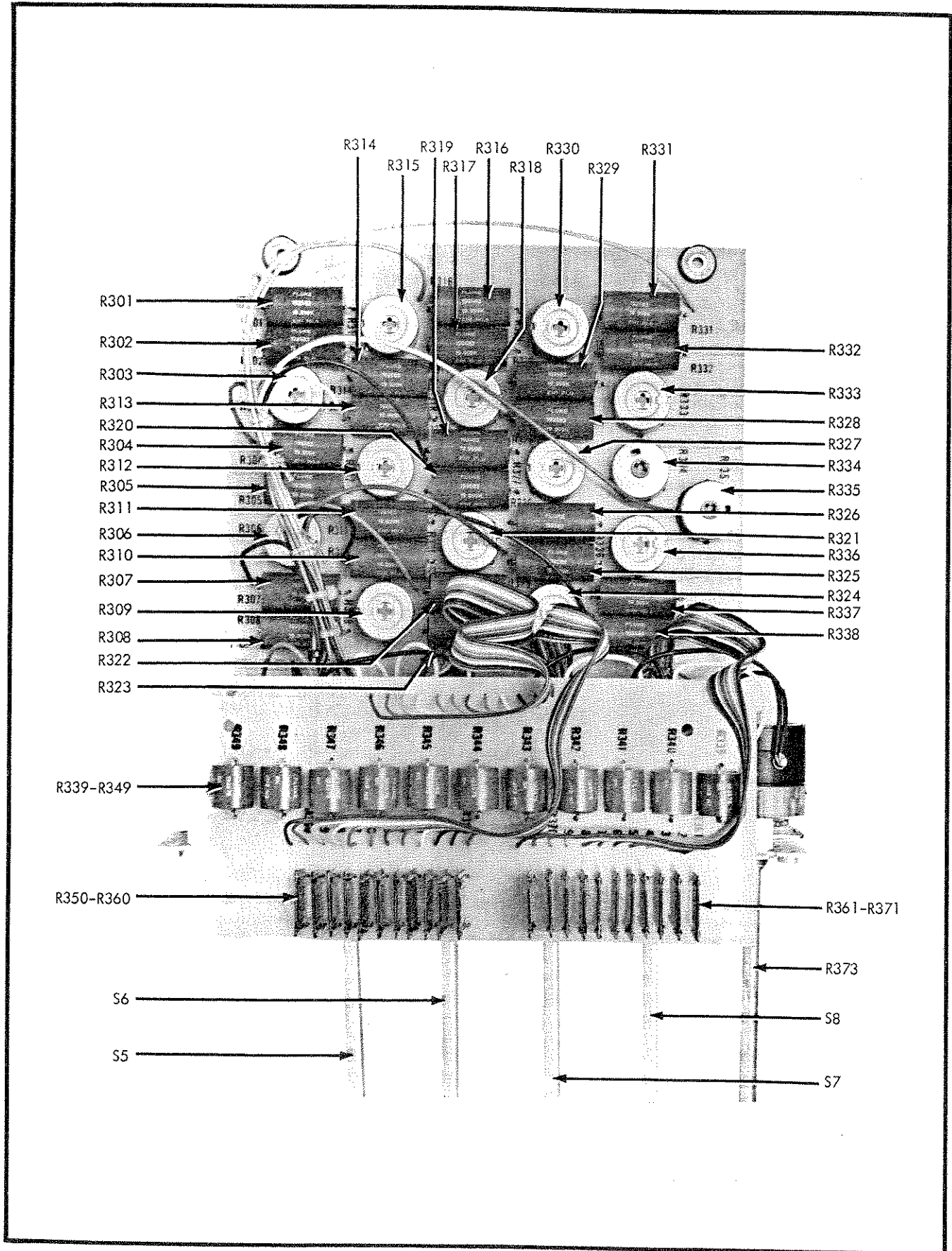

Figure 5-8. KELVIN-VARLEY BOARD ASSEMBLY

REF DESIG	DESCRIPTION	STOCK NO	MFR	MFR PART NO	TOT QTY	REC QTY	USE CODE
A 400	HIGH VOLTAGE BOARD ASSEMBLY Figure 5-9	1702-196204 (895A-404)	89536	1702-196204	REF		
C401 To C404	Cap, elect, 20 uf -10/+100%, 500V	1502-105932	56289	Type 66D	4		
C405	Cap, polystrene, 0.25 uf $\pm 10\%$, 1, 200V	1507-183616	84411	JF6	1		
C406, C407	Cap, mylar, 0.22 uf $\pm 10\%$, 75V	1507-159392	56289	192P2249R8	REF		
CR401	Diode, rectifier, Varo Type 7715-4	4801-182238	83003	7715-4	1		
CR402	Diode, Type 1N4822	4802-112383	05277	1N4822	1		
CR403 To CR406	Diode, Internat. Rect. Type 4D4	4802-180240	81483	4D4	REF		
Q401, Q402	Tstr, Radio Corp. Type 40424	4805-178525	95303	40424	2		
Q403 To Q406	Tstr, Type 2N3565	4805-177105	07263	2N3565	REF		
R401 To R404	Res, comp, 220K $\pm 10\%$, 2W	4704-110197	01121	HB2241	4		
R405	Res, comp, 15K $\pm 10\%$, 1W	4704-109421	01121	GB1531	1		
R406	Res, comp, 750K $\pm 5\%$, 1/2W	4704-188789	01121	EB7545	1		
R407	Res, comp, 10K $\pm 10\%$, 1/2W	4704-108118	01121	EB1031	REF		
R408	Res, comp, 1M $\pm 10\%$, 1/2W	4704-108134	01121	EB1051	REF		
R409	Res, comp, 8.2K $\pm 10\%$, 1/2W	4704-109017	01121	EB8221	1		
R410	Res, comp, 470K $\pm 10\%$, 1/2W	4704-108290	01121	EB4741	1		
R411	Res, comp, 10 Ω $\pm 10\%$, 1/2W	4704-108092	01121	EB1001	REF		
R412	Res, comp, 1.2M $\pm 10\%$, 1/2W	4704-108407	01121	EB1251	1		
R413	Res, comp, 2.7K $\pm 10\%$, 1/2W	4704-108837	01121	EB2721	2		
R414	Res, var, 6K $\pm 5\%$, 1-1/4W	4702-113209	71450	Type 110	1		
R415 To R417	Res, comp, 18M $\pm 10\%$, 1/2W	4704-108985	01121	EB1861	3		
R418	Res, comp, 1.5M $\pm 10\%$, 1/2W	4704-108175	01121	EB1551	REF		

REF DESIG	DESCRIPTION	STOCK NO	MFR	MFR PART NO	TOT QTY	REC QTY	USE CODE
R419	Res, comp, 2.7K ±10%, 1/2W	4704-108837	01121	EB2721	REF		
R420	Res, comp, 220K ±10%, 1/2W	4704-108217	01121	EB2241	1		
R421 To R424	Res, comp, 110K ±5%, 1W	4704-187674	01121	GB1145	4		
400	Polyethelene grommet, 3/8" x 1/4" (not illustrated)	2807-171876	89536	2807-171876	REF		

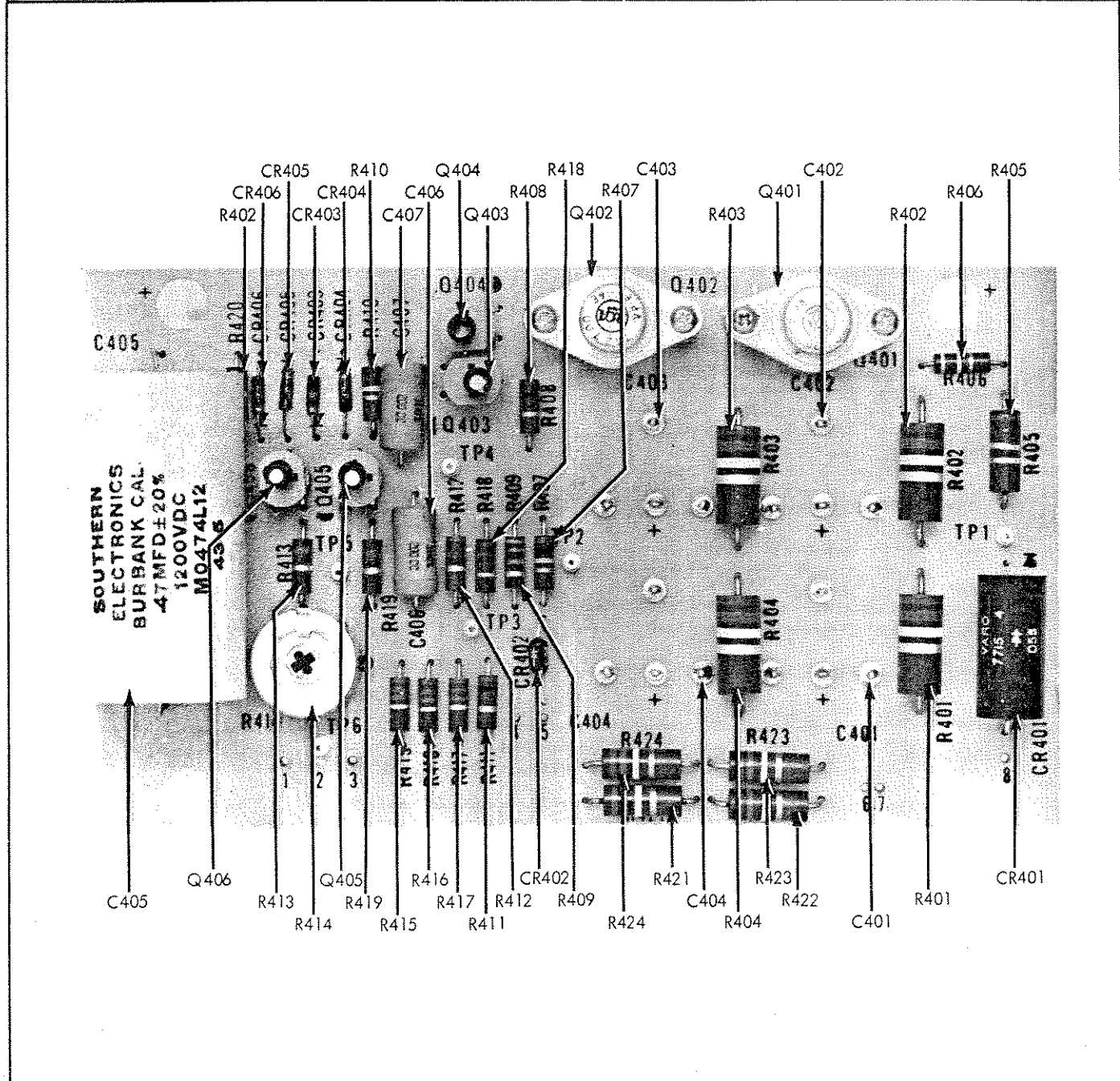

Figure 5-9. HIGH VOLTAGE BOARD ASSEMBLY

Section 7

General Information

7-1. This section of the manual contains generalized user information as well as supplemental information to the List of Replaceable Parts contained in Section 5.

Federal Supply Codes for Manufacturers

D9816 Westermann Wilhelm Augusta-Anlage Mannheim-Nackarau Germany	01101 Wabash Inc (Formerly Wabash Magnetics) Wabash, IN	02697 Parker-Hannifin Corp. O-Ring Div Lexington, KY	04423 Telonic Berkley Inc. Laguna Beach, CA
S0482 Sony Corp. Tokyo, Japan	01121 Allen Bradley Co. Milwaukee, WI	02735 RCA-Solid State Div. Somerville, NJ	04713 Motorola Inc. Semiconductor Group Phoenix, AZ
S3774 Oshino Electric Lamp Works Tokyo, Japan	01281 TRW Electronics & Defense Sector RF Devices Lawndale, CA	02768 ITW (IL Tool Works) Fastex Division Des Plaines, IL	04946 Standard Wire and Cable Rancho Dominguez, CA
0AD86 IN General El Paso, TX	01295 TX Instruments Inc. Semiconductor Group Dallas, TX	02799 Arco Electronics Inc. Chatsworth, CA	05173 General Radio NY, NY. Replaced by:
0AE89 Autosplice Inc. Woodside, NY	01526 Genicom Waynesboro, VA	03296 Nylon Molding Corp. Monrovia, CA	24655 Genrad, INC. Concord, MA
0BW21 Nortake Co. Inc. Burlington, MA	01537 Motorola Communications & Electronics Inc. Franklin Park, IL	03445 Lercion Electronics Inc Burbank, CA	05236 Jonathan Mfg. Co. Fullerton, CA
0ANF0 Topaz Semiconductor Inc San Jose, CA	01686 RCL Electronics/Shalleross Inc. Electro Components Div. Manchester, NH	03508 General Electric Co. Semiconductor Products & Batteries Auburn, NY	05245 Corcom Inc. Libertyville, IL
0DSM7 Conductive (Pkg) Containers Inc. Brookfield, WI	01884 Sprague Electric Co. (Now 56289)	03797 Sprisco Technology Corp. Eltronics Div. Rancho Dominguez, CA	05276 ITT Pomona Electronics Div. Pomona, CA
OCLN7 Emhart Fastening Group Shelton, CT	01961 Varian Associates Inc. Pulse Engineering Div. Conroy, CT	03877 Gilbert Engineering Co. Inc Incon Sub of Transatron Electronic Corp. Glendale, AZ	05277 Westinghouse Elec. Corp. Semiconductor Div. Youngwood, PA
0FB81 S-Mos Systems Inc. San Jose, CA	01963 Cherry Electrical Products Corp Waukegan, IL	03888 KDI Electronics Inc. Pyrofilm Div. Whippany, NJ	05347 Ultronix Inc Grand Junction, CO
0FFP1 Eveready LTD Ever Ready Special Battery Div. Dawley Telford Salop UK	02111 Spectrol Electronics Corp. City of Industry, CA	03911 Clairex Corp. Clairex Electronics Div. Mount Vernon, NY	05397 Union Carbide Corp. Materials Systems Div. Cleveland, OH
00199 Marcon Electronics Corp Keamy, NJ	02114 Amperex Electronic Corp. Ferrox Cube Div. Saugerties, NY	03980 Muirhead Inc. Mountainside, NJ	05571 Sprague Electric Co. (Now 56289)
00213 Nytronics Comp. Group Inc. Darrington, NC	02131 General Instrument Corp. Government Systems Div. Westwood, MA	04009 Cooper Industries, Inc. Arrow Hart Div. Hartford, CT	05574 Viking Connectors Inc Sub of Criton Corp. Chatsworth, CA
00327 Welwyn International Inc. Westlake, OH	02395 Sonar Radio Corp. Hollywood, FL	04217 Essex International Inc. Wire & Cable Div. Anaheim, CA	05791 LYN-TRON Burbank, CA
00656 Aerovox Corp. New Bedford, MA	02533 Leigh Instruments Ltd. Frequency Control Div. Don Mills, Ontario, Canada	04221 Midland-Ross Corp. Midtex Div. N. Mankato, MN	05820 EG & G Wakefield Engineering Wakefield, MA
00686 Film Capacitors Inc. Passaic, NJ	02606 Fenwal Labs Division of Travenal Labs Morton Grove, IL	04222 AVX Corp. AVX Ceramics Div. Myrtle Beach, SC	05839 Advance Electrical Chicago, IL
00779 AMP, Inc. Harrisburg, Pennsylvania	02660 Bunker Ramo-Eltra Corp. Amphenol NA Div. Broadview, IL	05972 Loctite Corp. Newington, CT	

Federal Supply Codes for Manufacturers (cont)

06001 General Electric Co. Electric Capacitor Product Section Columbia, SC	07047 Ross Milton Co., The Southampton, PA	08111 MF Electronics New Rochelle, NY	1B715 (United Shoe & Nylock Corp) -Nylock Fastener Corp.- Paramus, NJ
06141 Fairchild Weston Systems Inc. Data Systems Div. Sarasota, FL	07138 Westinghouse Electric Corp. Industrial & Government Tube Div. Horseheads, NY	08235 Industro Transistor Corp. Long Island City, NY	10059 Barker Engineering Corp. Kenilworth, NJ
06192 La Deau Mfg. Co. Glendale, CA	07233 Benchmark Technology Inc. City of Industry, CA	08261 Spectra-Strip An Eltra Co. Garden Grove, CA	10389 IL Tool Works Inc. Licon Div. Chicago, IL
06229 Electrovert Inc. Elmsford, NY	07239 Biddle Instruments Blue Bell, PA	08445 Electri-Cord Mfg., Inc Westfield, PA	11236 CTS Corp. Resistor Products Div. Berne, IN
06383 Panduit Corp. Tinley Park, IL	07256 Silicon Transistor Corp. Sub of BBF Inc. Chelmsford, MA	08530 Reliance Mica Corp. Brooklyn, NY	11237 CTS Corp of CA Electro Mechanical Div. Paso Robles, CA
06473 Bunker Ramo Corp. Amphenol NA Div. SAMS Operation Chatsworth, CA	07261 Avnet Corp. Culver City, CA	08718 ITT Cannon Electric Phoenix Div. Phoenix, AZ	11295 ECM Motor Co. Schaumburg, IL
06540 Mite Corp Amatorm-Electrical Div	07263 Fairchild Semiconductor North American Sales Ridgeview, CT	08806 General Electric Co. Minature Lamp Products Cleveland, OH	11358 Columbia Broadcasting System CBS Electronic Div. Newburyport, MA
06555 Beede Electrical Instrument Penacook, NH	07344 Bircher Co. Inc., The Rochester, NY	08863 Nylomatic Fallsington, PA	11403 Vacuum Can Co. Best Coffee Maker Div. Chicago, IL
06665 Precision Monolithics Sub of Bourns Inc. Santa Clara, CA	07374 Optron Corp Woodbridge, CT	08988 Skottie Electronics Inc. Archbald, PA	11502 (can also use 35009) TRW Inc. TRW Resistive Products Div. Boone, NC
06666 General Devices Co. Inc. INpolis, IN	07557 Campion Co. Inc. Philadelphia, PA	09021 Aircro Inc. Aircro Electronics Bradford, PA	11503 Keystone Columbia Inc. Freemont, IN
06739 Electron Corp. Littleton, CO	07597 Bumdy Corp. Tape/Cable Div. Rochester, NY	09023 Cornell-Dublier Electronics Fuquay-Varina, NC	11532 Teledyne Relays Teledyne Industries Inc. Hawthome, CA
06743 Gould Inc. Foil Div. Eastlake, OH	07716 TRW Inc. (Can use 11502) IRC Fixed Resistors/ Burlington Burlington, VT	09214 General Electric Co. Semiconductor Products Dept. Aubum, NY	11711 General Instrument Corp. Rectifier Div. Hicksville, NY
06751 Components Inc. Sensor Div. Phoenix, AZ	07792 Lerma Engineering Corp. Northampton, MA	09353 C and K Components Inc. Newton, MA	11726 Qualidyne Corp. Santa Clara, CA
06776 Robinson Nugent Inc. New Albany, IN	07810 Bock Corp. Madison, WI	09423 Scientific Components Inc. Santa Barbara, CA	12014 Chicago Rivet & Machine Co. Naperville, IL
06915 Richco Plastic Co. Chicago, IL	07910 Teledyne Semiconductor Mtn. View, CA	09922 Bumdy Corp. Norwalk, CT	12020 Ovenaire Div. of Electronic Technologies Charlottesville, VA
06961 Vemitron Corp. Piezo Electric Div. Bedford, OH	07933 Raytheon Co. Semiconductor Div. Mountain View, CA	09969 Dale Electronics Inc. Yankton, SD	12038 Simco (Div of Ransburg Corp) Hatfield, PA
06980 EIMAC (See Varian) San Carlos, CA	08FG6 Calmos Systems Inc. Kanata, Ont. Canada	09975 Burroughs Corp. Electronics Components Detroit, MI	12040 National Semiconductor Corp. Danbury, CT
	080A9 Dallas Semiconductor Dallas, TX	1A791 LFE Electronics Danvers, MA	

Federal Supply Codes for Manufacturers (cont)

12060 Diodes Inc. Northridge, CA	13050 Potter Co. Wesson, MS	14704 Crydom Controls (Division of Int Rectifier) El Segundo, CA	16473 Cambridge Scientific Industries Div. of Chemed Corp. Cambridge, MD
12136 PHC Industries Inc. Formerly Philadelphia Handle Co. Camden, NJ	13103 Thermalloy Co., Inc. Dallas, TX	14752 Electro Cube Inc. San Gabriel, CA	16733 Cablewave Systems Inc. North Haven, CT
12300 AMF Canada Ltd. Potter-Bramfield Guelph, Ontario, Canada	13327 Solitron Devices Inc. Tappan, NY	14936 General Instrument Corp. Discrete Semi Conductor Div. Hicksville, NY	16742 Paramount Plastics Fabncators Inc. Downey, CA
12323 Practical Automation Inc. Shelton, CT	13511 Bunker-Ramo Corp. Amphenol Cadre Div. Los Gatos, CA	14949 Trompeter Electronics Chatsworth, CA	16758 General Motors Corp. Delco Electronics Div. Kokomo, IN
12327 Freeway Corp. Cleveland, OH	13606 Sprague Electric Co. (Use 56289)	15412 Amtron Midlothian, IL	17069 Circuit Structures Lab Burbank, CA
12406 Elpac Electronics Inc. Santa Ana, CA	13689 SPS Technologies Inc. Hatfield, NJ	15542 Scientific Components Corp. Mini-Circuits Laboratory Div. Brooklyn, NY	17117 Electronic Molding Corp. Woonsocket, RI
12443 Budd Co.,The Plastics Products Div. Phoenixville, PA	13764 Micro Plastics Flippin, AZ	15636 Elec-Trol Inc. Saugus, CA	17338 High Pressure Eng. Co. Inc. OK City, OK
12581 Hitachi Metals International Ltd. Hitachi Magna-Lock Div. Big Rapids, MO	13919 Burr-Brown Research Corp. Tucson, AZ	15782 Bausch & Lomb Inc. Graphics & Control Div. Austin, TX	17504 Aluminum Filter Co. Carpinteria, CA
12615 US Terminals Inc. Cincinnati, OH	14099 Semtech Corp. Newbury Park, CA	15801 Fenwal Eletronics Inc. Div. of Kidde Inc. Framingham, MA	17545 Atlantic Semiconductors Inc. Asbury Park, NJ
12617 Hamlin Inc. LaKe Mills, WI	14140 McGray-Edison Co. Commercial Development Div. Manchester, NH	15818 Teledyne Inc. Co. Teledyne Semiconductor Div. Mountain View, CA	17745 Angstrom Precision, Inc. Hagerstown, MD
12673 Wesco Electrical Greenfield, MA	14189 Ortronics, Inc. Orlando, FL	15849 Useco Inc. (Now 88245)	17856 Siliconix Inc. Santa Clara, CA
12697 Clarostat Mfg. Co. Inc. Dover, NH	14193 Cal-R-Inc. Santa Monica, CA	15898 International Business Machines Corp. Essex Junction, VT	18178 E G & Gvactee Inc. St. Louis, MO
12749 James Electronic Inc. Chicago, IL	14301 Anderson Electronics Hollidaysburg, PA	16068 International Diode Div. Harrison, NJ	18235 KRI/Bantry Components Inc. Manchester, NH
12856 MicroMetals Inc. Anaheim, CA	14329 Wells Electronics Inc. South Bend, IN	16162 MMI Southfield, MI	18310 Concord Electronics New York, NY
12881 Metex Corp. Edison, NJ	14482 Watkins-Johnson Co. Palo Alto, CA	16245 Conap Inc. Olean, NY	18324 Signetics Corp. Sacramento, CA
12895 Cleveland Electric Motor Co. Cleveland, OH	14552 Microsemi Corp. (Formerly Micro-Semiconductor) Santa Ana, CA	16258 Space-Lok Inc. Burbank, CA	18377 Parlex Corp. Methuen, MA
12954 Microsemi Corp. Components Group Scottsdale, AZ	14604 Elmwood Sensors, Inc Pawtucket, RI	16258 Space-Lok Inc. Burbank, CA	18520 Sharp Electronics Corp. Paramus, NJ
12969 Unitrode Corp. Lexington, MA	14655 Cornell-Dublier Electronics Div. of Federal Pacific Electric Co. Govt Cont Dept. Newark, NJ	16352 Codi Corp. Linden, NJ	18542 Wabash Inc. Wabash Relay & Electronics Div. Wabash, IN

Federal Supply Codes for Manufacturers (cont)

18565 Chomerics Inc. Woburn, MA	2Y384 North American Philips Lighting Corp. Van Wert, OH	23732 Tracor Applied Sciences Inc. Rockville, MD	26402 Lumex Inc. Bayshore, NY
18612 Vishay Intertechnology Inc. Vishay Resistor Products Group Malvern, PA	20584 Enochs Mfg. Inc. INpolis, IN	23880 Stanford Applied Engineering Santa Clara, CA	26629 Frequency Sources Inc. Sources Div. Chelmsford, MA
18632 Norton-Chemplast Santa Monica, CA	20891 Cosar Corp. Dallas, TX	23936 William J. Purdy Co. Pamotor Div. Burlingame, CA	26806 American Zettler Inc. Irvine, CA
18677 Scanbe Mfg. Co. Div. of Zero Corp. El Monte, CA	21317 Electronics Applications Co. El Monte, CA	24347 Penn Engineering Co. S. El Monte, CA	27014 National Semiconductor Corp. Santa Clara, CA
18736 Voltronics Corp. East Hanover, NJ	21604 Buckeye Stamping Co. Columbus, OH	24355 Analog Devices Inc. Norwood, MA	27167 Corning Glass Works Corning Electronics Wilmington, NC
18786 Micro-Power Long Island City, NY	21845 Solitron Devices Inc. Semiconductor Group Riviera Beach, FL	24444 General Semiconductor Industries, Inc. Tempe, AZ	27264 Molex Inc. Lisle, IL
18927 GTE Products Corp. Precision Material Products Business Parts Div. Titusville, PA	21847 Aertech Now TRW Microwave Inc. Sunnyvale, CA	24546 Bradford Electronics Bradford, PA	27440 Industrial Screw Products Los Angeles, CA
19080 Robinson Electronics Inc. San Luis Obispo, CA	21962 Vectron Corp. Replaced by: S.W. Electronics	24618 Transcon Mfg. Now: D.J. Associates Inc.	27494 Staffall, Inc. Providence, RI
19112 Garry Corp. Langhorne, PA	22526 DuPont, El DeNemours & Co. Inc. DuPont Connector Systems Advanced Products Div. New Cumberland, PA	24655 Genrad Inc. (Replaced General Radio 05173) Concord, MA	27745 Associated Spring Barnes Group Inc. Syracuse, NY
19315 Bendix Corp., The Navigation & Control Group Terboro, NJ	22626 Micro Semiconductor (Now 14552)	24759 Lenox-Fugle Electronics Inc. South Plainfield, NJ	27918 Component Parts Corp. Bellmore, NY
19451 Perine Machine Tool Corp. Kent, WA	22670 GM Nameplate Seattle, WA	24796 AMF Inc. Potter & Brumfield Div. San Juan Capistrano, CA	27956 Relcom (Now 14482)
19482 Delta Electronics Alexandria, VA	22767 ITT Semiconductors Palo Alto, CA	24931 Specialty Connector Co. Greenwood, IN	28175 Alpha Metals Chicago, IL
19613 MN Mining & Mfg. Co. Textool Products Dept. Electronic Product Div. Irving, TX	22784 Palmer Inc. Cleveland, OH	24995 ECS Grants Pass, OR	28198 Positronic Industries Springfield, MO
19647 Caddock Electronics Inc. Riverside, CA	23050 Product Comp. Corp. Mount Vernon, NY	25088 Siemen Corp. Isilen, NJ	28213 MN Mining & Mfg. Co. Consumer Products Div. 3M Center Saint Paul, MN
19701 Mepco/Centralab Inc. A. N. American Philips Co. Mineral Wells, TX	23223 CTS Microelectronics Lafayette, NY	25099 Cascade Gasket Kent, WA	28309 Kaiser Minette, AL
2B178 Wire Products Cleveland, OH	23237 I.R.C., Inc. Microcircuits Division Philadelphia, PA	25403 Amperex Electronic Corp. Semiconductor & Micro-Circuit Div. Slatersville, RI	28425 Serv-O-Link Eulless, TX
2K262 Boyd Corporation Portland, OR	23302 S.W. Electronics & Mfg. Corp. Cherry Hill, NJ	25435 Moldtronics, Inc Downers Grove, IL	28478 Deltron Corporation Deltron Controls Div. Milwaukee, WI
	23730 Mark Eyelet and Stamping Inc. Wolcott, CT	25706 Dabum Electronic & Cable Corp. Norwood, NJ	28480 Hewlett Packard Co. Corporate HQ Palo Alto, CA

Federal Supply Codes for Manufacturers (cont)

28484 Emerson Electric Co. Gearmaster Div. McHenry, IL	31433 Kemet Electronics Corp. Simpsonville, NC	33246 Epoxy Technology Inc. Billerica, MA	36701 Van Waters & Rogers Valley Field, Quebec, Canada
28520 Heyco Molded Products Kenilworth, NJ	31448 Army Safeguard Logistics Command Huntsville, AL	33292 Pioneer Sterilized Wiping Cloth Co. Portland, OR	37942 Mallory Capacitor Corp. Sub of Emhart Industries INpolis, IN
28932 Lumax Industrials, Inc Altoona, PA	31471 Gould Inc Semiconductor Div Santa Clara, CA	33297 NEC Electronics USA Inc. Electronic Arrays Inc. Div. Mountain View, CA	39003 Maxim Industries Middleboro, MA
29083 Monsanto Co. Santa Clara, CA	31522 Metal Masters Inc. Baldwin, MS	33919 Nortek Inc. Cranston, RI	4F434 Plastic Sales Los Angeles, CA
29604 Stackpole Components Co. Raleigh, NC	31746 Cannon Electric Woodbury, TN	34114 Oak Industries Rancho Bernardo, CA	40402 Roderstein Electronics Inc. Statesville, NC
29907 Omega Engineering Inc. Stamford, CT	31827 Budwig Ramona, CA	34263 CTS Electronics Corp. Brownsville, TX	42498 National Radio Melrose, MA
3D536 Aimco Inc. Seattle, WA	31918 ITT-Schadow Eden Prairie, MN	34333 Silicon General Inc. Garden Grove, CA	43543 Nytronics Inc. (Now 53342)
30035 Jolo Industries Inc. Garden Grove, CA	32293 Intersil Cupertino, CA	34335 Advanced Micro Devices (AMD) Sunnyvale, CA	43744 Panasonic Industrial Co. San Antonio, TX
30045 Solid Power Corp. Farmingdale, NY	32539 Mura Corp. Westbury, Long Island, N.Y.	34359 MN Mining & Mfg. Co. Commercial Office Supply Div. Saint Paul, MN	43791 Datron Systems Wilkes Barre, PA
30146 Symbex Corp. Painesville, OH	32559 Bivar Santa Ana, CA	34371 Harris Corp. Harris Semiconductor Products Group Melbourne, FL	44655 Ohmite Mfg. Co. Skokie, IL
30148 AB Enterprise Inc. Ahoskie, NC	32719 Siltronics Santa Ana, CA	34576 Rockwell International Corp. Newport Beach, CA	47001 Lumberg Inc. Richmond, VA
30161 Aavid Engineering Inc. Laconia, NH	32767 Griffith Plastics Corp. Burlingame, CA	34641 Instrument Specialties Eulless, TX	47379 ISOCOM Campbell, CA
30315 Itron Corp. San Diego, CA	32879 Advanced Mechanical Components Northridge, CA	34649 Intel Corp. Santa Clara, CA	49569 IDT (International Development & Trade) Dallas, TX
30323 IL Tool Works Inc. Chicago, IL	32897 Murata Erie North America Inc. Carlisle Operations Carlisle, Pennsylvania	34802 Electromotive Inc. Kenilworth, NJ	49671 RCA Corp. New York, NY
30800 General Instrument Corp. Capacitor Div. Hicksville, NY	32997 Boums Inc. Trimpot Div. Riverside, CA	34848 Hartwell Special Products Placentia, CA	49956 Raytheon Company Executive Offices Lexington, MA
30838 Fastec Chicago, ILL	33025 M/A ComOmni Spectra, Inc. (Replacing Omni Spectra) Microwave Subsystems Div. Tempe, AZ	35009 Renfrew Electric Co. Ltd. IRC Div. Toronto, Ontario, Canada	5D590 Mostek Corp. Replaced by: SGS Thompson Microelec- tronics
31019 Solid State Scientific Inc. Willow Grove, PA	33096 CO Crystal Corp. Loveland, CO	35986 Amrad Melrose Park, IL	5F520 Panel Components Corp. Santa Rosa, CA
31091 Alpha Industries Inc. Microelectronics Div. Hatfield, PA	33173 General Electric Co. Owensboro, KY	36665 Mitel Corp. Kanata, Ontario, Canada	5P575 Nobel Electronics Suffern, NY
31323 Metro Supply Company Sacramento, CA			5W664 NDK Div. of Nihon Dempa Kogyo LTD Lynchburg, VA

Federal Supply Codes for Manufacturers (cont)

5U802 Dennison Mfg. Co. Framingham, MA	51499 Amuron Corp. Boston, MA	52840 Western Digital Corp. Costa Mesa, CA	54937 DeYoung Mfg. Bellevue, WA
50088 SGS - Thomson Microelectronics Inc. Carrollton, TX	51506 Accurate Screw Machine Co. (ASMCO) Nutley, NJ	53021 Sangamo Weston Inc. (See 06141)	54590 RCA Corp. Electronic Components Div. Cherry Hill, NJ
50120 Eagle-Picher Industries Inc. Electronics Div. CO Springs, CO	51605 CODI Semiconductor Inc. Kenilworth, NJ	53036 Textool Co. Houston, TX	55026 American Gage & Machine Co. Simpson Electric Co. Div. Elgin, IL
50157 Midwest Components Inc. Muskegon, MS	51642 Centre Engineering Inc. State College, PA	53184 Xciton Corp. Lathan, NY	55112 Plessey Capacitors Inc. (Now 60935)
50356 Teac Corp. of America Industrial Products Div Montebello, CA	51705 ICO/Rally Palo alto, CA	53217 Technical Wire Products Inc. Santa Barbara, CA	55261 LSI Computer Systems Inc. Melville, NY
50364 MMI, Inc. (Monolithic Memories Inc) Military Products Div. Santa Clara, CA	51791 Statek Corp. Orange, CA	53342 Opt Industries Inc. Phillipsburg, NJ	55285 Berequist Co. Minneapolis, MN
50472 Metal Masters, Inc. City of Industry, CA	51984 NEC America Inc. Falls Church, VA	53673 Thompson CSF Components Corp. (Semiconductor Div) Conaga Park, CA	55322 Samtech Inc. New Albany, IN
50541 Hypertronics Corp. Hudson, MA	52063 Exar Integrated Systems Sunnyvale, CA	53718 Airmold/W. R. Grese & Co. Roanoke Rapids, NC	55408 STI-CO Industries Co Buffalo, NY
50558 Electronic Concepts, Inc. Eatontown, NJ	52072 Circuit Assembly Corp. Irvine, CA	53848 Standard Microsystems Hauppauge, NY	55464 Central Semiconductor Corp. Hauppauge, NY
50579 Litronix Inc. Cupertino, CA	52152 MN Mining & Mfg. Saint Paul, MN	53894 AHAM Inc. RanchoCA, CA	55557 Microwave Diode Corp. W. Stewartown, NH
50891 Semiconductor Technology Stuart, FL	52333 API Electronics Hauppauge, Long Island, NY	53944 Glow-Lite Pauls Valley, OK	55566 R A F Electronic Hardware Inc. Seymour, CT
50934 Tran-Tec Corp Columbus, NE	52361 Communication Systems Piscataway, NJ	54178 Plasmetex Industries Inc. San Marcos, CA	55576 Synertek Santa Clara, CA
51167 Aries Electronics Inc. Frenchtown, NJ	52500 Amphenol, RF Operations Burlington, MA	54294 Shallcross Inc. Smithfield, NC	55680 Nichicon/America/Corp. Schaumburg, IL
51284 Mos Technology Norristown, PA	52525 Space-Lok Inc. Lercro Div. Burbank, CA	54453 Sullins Electronic Corp. San Marcos, CA	55943 D J Associates, Inc (Replaced Transcon Mfg.-24618) Fort Smith, AZ
51249 Heyman Mfg. Co. Cleveland, OH	52531 Hitachi Magnetics Edmore, MO	54473 Matsushita Electric Corp. (Panasonic) Secaucus, NJ	56282 Utek Systems Inc. Olathe, KS
51372 Verbatim Corp. Sunnyvale, CA	52745 Timco Los Angeles, CA	54492 Cinch Clamp Co., Inc. Santa Rosa, CA	56289 Sprague Electric Co. North Adams, MA
51398 MUPAC Corp. Brockton, MA	52763 Stettner-Electronics Inc. Chattanooga, TN	54583 TDK Garden City, NY	56365 Square D Co. Corporate Offices Palatine, IL
51406 Murata Erie, No. America Inc. (Also see 72982) Marietta, GA	52769 Sprague-Goodman Electronics Inc. Garden City Park, NY	54590 RCA Corp Distribution & Special Products Cherry Hill, NY	56375 WESCORP Div. Dal Industries Inc Mountain View, CA
	52771 Moniterm Corp. Amatrom Div. Santa Clara, CA	54869 Pifer International Corp. Arlington Heights, IL	

Federal Supply Codes for Manufacturers (cont)

56481 Shugart Associates Sub of Xerox Corp. Sunnyvale, CA	59610 Souriau Inc Valencia, CA	60911 Inmos Corp. CO Springs, CO	64537 KDI Electronics Whippany, NJ
56637 RCD Components Inc. Manchester, NH	59635 HV Component Associates Howell, NJ	60935 Westlake Capacitor Inc. Tantalum Div. Greencastle, IN	64782 Precision Control Mfg. Inc. Bellevue, WA
56708 Zilog Inc. Campbell, CA	59640 Supertex Inc. Sunnyvale, CA	60958 ACIC Intercomp Wire & Cable Div. Hayesville, NC	64834 West M G Co. San Francisco, CA
56856 Vamistor Corp. of TN Sevierville, TN	59660 Tusonix Inc. Tucson, AZ	61271 Fujitsu Microelectronics Inc San Jose, CA	64961 Electronic Hardware LTD North Hollywood, CA
56880 Magnetics Inc. Baltimore, MD	59730 Thomas and Betts Corp. IA City, IA	61394 SEEQ Technology Inc. San Jose, CA	65092 Sangamo Weston Inc. Weston Instruments Div. Newark, NJ
57026 Endicott Coil Co. Inc. Binghamton, NY	59831 Semtronics Corp. Watchung, NJ	61429 Fox Electronics Cape Coral, FL	65786 Cypress Semi San Jose, CA
57053 Gates Energy Products Denver, CO	61053: American Components Inc. an Insilco Co. RPC Div. Hayesville, NC	61529 Aromat Corp. New Providence, NJ	65940 Rohm Corp & Whatney Irvine, CA
57170 Cambridge Thermionic Cambridge, MA Replaced by: 71279 Interconnection Products Inc.	6L611 Allen, Robert G. Inc. Van Nuys, CA	61752 IR-ONICS Inc Warwick, RI	65964 Evox Inc. Bannockburn, IL
57668 R-ohm Corp Irvine, CA	6U850 Burgess Switch Co., Inc Northbrook, IL	61772 Integrated Device Technology Santa Clara, CA	66150 Entron Inc. Winslow Teltronics Div. Glendale, NY
57962 SGS - Thomson Microelectronics Inc Montgomeryville, PA	6U095 AMD Enterprises, Inc. Roswell, GA	61802 Toshiba Houston, TX	66302 VLSI Technology Inc. San Jose, CA
58014 Hitachi Magnalock Corp. (Now 12581)	6X403 SGS/ATES Semiconductor Corp. INpolis, IN	61857 SAN-O Industrial Corp. Bohemia, Long Island, NY	66419 Exei San Jose, CA
58104 Simco Atlanta, GA	6Y440 Micon Technology Inc. Boise, ID	61935 Schurter Inc. Petaluma, CA	66450 Dyna-Tech Electronics, Inc Walled Lake, MI
58364 BYCAP Inc. Chicago, IL	60046 Power Dynamics Inc West Orange, NJ	62351 Apple Rubber Lancaster, NY	66608 Bering Industries Freemont, CA
58451 Precision Lamp Cotat, CA	60197 Precicontact Inc. Langhorne, PA	62643 United Chemicon Rosemont, IL	66891 BKC International Electronics Lawrence, MA
58474 Superior Electric Co. Bristol, CT	60386 Squires Electronics Inc Cornelius, OR	62712 Seiko Instruments Torrance, CA	66958 SGS Semiconductor Corp. Phoenix, AZ
58614 Communications Instruments Inc. Fairview, NC	60395 Xicor Inc. Milpitas, CA	62793 Lear Siegler Inc. Energy Products Div. Santa Ana, CA	66967 Powerex Inc Auburn, NY
59124 KOA-Spacer Electronics Inc. Bristol, PA	60399 Torin Engineered Blowers Div. of Clevepak Corp. Torrington, CT	63743 Ward Leonard Electric Co.Inc. Mount Vernon, NY	67183 Altera Santa Clara, CA
59422 Holmberg Electronics Irvine, CA	60496 Micrel Inc. Sunnyvale, CA	64154 Lamb Industries Portland, OR	68919 WIMA % Harry Levinson Co. Seattle, WA
	60705 Cera-Mite Corp. (formerly Sprague) Grafton, WI	64155 Linear Technology Milpitas, CA	

Federal Supply Codes for Manufacturers (cont)

7F361 Richmond-Division of Dixico % Zellerbach Paper Co. Seattle, WA	71468 ITT Cannon Div. of ITT Fountain Valley, CA	73138 Beckman Industrial corp. Helipot Div. Fullerton, CA	75042 TRW Inc. IRC Fixed Resistors Philadelphia, PA
7F844 Moore Business Forms, Inc Seattle, WA	71482 General Instrument Corp. Clare Div. Chicago, IL	73168 Fenwal Inc. Ashland, MA	75297 Kester Solder Div. Litton Systems, Inc Des Plaines, IL
7G902 Textron Inc. Carnar Div. Rockford, IL	71590 Mepco/Centralab A North American Philips Co. Fort Dodge, IA	73293 Hughes Aircraft Co. Electron Dynamics Div. Torrance, CA	75376 Kurz-Kasch Inc. Dayton, OH
7I395 Universal Plastics Welshpool, WA	71707 Coto Corp. Providence, RI	73445 Ampere Electronic Corp. Hicksville, NY	75378 CTS Knights Inc. Sandwich, IL
7J696 AMD Plastics East Lake, OH	71744 General Instrument Corp. Lamp Div/Worldwide Chicago, IL	73559 Carlingswitch Inc. Hartford, CT	75382 Kulka Electric Corp. (Now 83330) Mount Vernon, NY
7K354 Omni Spectra Inc Los Altos, CA	71785 TRW Inc. Cinch Connector Div. Elk Grove Village, IL	73586 Circle F Industries Trenton, NJ	75569 Performance Semiconductor Corp. Sunnyvale, CA
7Z884 ALPS Seattle, WA	71984 Dow Corning Corp. Midland, MI	73734 Federal Screw Products Inc. Chicago, IL	75915 Littelfuse Tracor (Formerly: Tracor-Littelfuse) Des Plaines, IL
7X634 Duracell USA Div. of Dart & Kraft Inc. Valdese, NC	72005 AMAX Specialty Metals Corp. Newark, NJ	73743 Fischer Special Mfg. Co. Cold Spring, KY	76854 Oak Switch Systems Inc. Crystal Lake, IL
70290 Almetal Universal Joint Co. Cleveland, OH	72136 Electro Motive Mfg. Corp. Florence, NC	73893 Microdot Mt. Clemens, MS	77122 TRW Assemblies & Fasteners Group Fastener Div. Moutainside, NJ
70485 Atlantic India Rubber Works Inc. Chicago, IL	72228 AMCA International Corp. Continental Screw Div. New Bedford, MA	73899 JFD Electronic Components Div. of Murata Erie Oceanside, NY	77342 AMF Inc. Potter & Brumfield Div. Princeton, IN
70563 Amperite Company Union City, NJ	72259 Nytronics Inc. New York, NY	73905 FL Industries Inc. San Jose, CA	77542 Ray-O-Vac Corp Madison, WI
70903 Cooper-Belden Corp. Geneva, IL	72619 Amperex Electronic Corp. Dialight Div. Brooklyn, NY	73949 Guardian Electric Mfg. Co. Chicago, IL	77638 General Instrument Corp. Rectifier Div. Brooklyn, NY
71002 Bimbach Co. Inc. Farmingdale, NY	72653 G C Electronics Co. Div. of Hydrometals Inc. Rockford, IL	74199 Quam Nichols Co. Chicago, IL	77900 Shakeproof Lock Washer Co. (Now 78189)
71034 Bliley Electric Co. Eric, PA	72794 Dzus Fastner Co. Inc. West Islip, NY	74217 Radio Switch Co. Marlboro, NJ	77969 Rubbercraft Corp. of CA Ltd. Torrance, CA
71183 Westinghouse Electric Corp. Bryant Div. Bridgeport, CT	72928 Gulton Industries Inc. Gudeman Div. Chicago, IL	74445 Holo-Krome Co. Elmwood, CT	78189 IL Tool Works Inc. Shakeproof Div. Elgin, IL
71279 Interconnection Products Inc. Formerly Midland-Ross Cambion Div. Santa Ana, CA	72962 Elastic Stop Nut Div. of Hayward Industries Union, NJ	74542 Hoyt Elect. Instr. Works Inc. Penacook, NH	78277 Sigma Instruments Inc. South Braintree, MA
71400 Bussman Manufacturing Div. McGraw-Edison Co. St. Louis, MO	72982 Erie Specialty Products, Inc Formerly: Murata Erie Erie, PA	74840 IL Capacitor Inc. Lincolnwood, IL	78290 Struthers Dunn Inc. Pitman, NJ
71450 CTS Corp. Elkhart, IN		74970 Johnson EF Co. Waseca, MN	78553 Eaton Corp. Engineered Fastener Div. Cleveland, OH

Federal Supply Codes for Manufacturers (cont)

78592 Stoeger Industries South Hackensack, NJ	81439 Therm-O-Disc Inc. Mansfield, OH	83315 Hubbell Corp. Mundelein, IL	87034 Illuminated Products Inc. (Now 76854)
79497 Western Rubber Co. Goshen, IN	81483 International Rectifier Corp. Los Angeles, CA	83330 Kulka Smith Inc. A North American Philips Co. Manasquan, NJ	87516 Standard Crystal KS City, KS
79727 C - W Industries Southampton, PA	81590 Korry Electronics Inc. Seattle, WA	83478 Rubbercraft Corp. of America West Haven, CT	88044 Aeronautical Standards Group Dept. of Navy & Air Force
79963 Zierick Mfg. Corp. Mount Kisco, NY	81741 Chicago Lock Co. Chicago, IL	83553 Associated Spring Barnes Group Gardena, CA	88219 GNB Inc. Industrial Battery Div. Langhorne, PA
8C798 Ken-Tronics, Inc. Milan, IL	82227 Aipax Corp. Cheshire Div. Cheshire, CT	83740 Union Carbide Corp. Battery Products Div. Danbury, CT	88245 Winchester Electronics Litton Systems-Useco Div. Van Nuys, CA
8D528 Baumgartens Atlanta, GA	82240 Simmons Fastner Corp. Albany, NY	84171 Arco Electronics Commack, NY	88486 Triangle PWC Inc. Jewitt City, CT
8F330 Eaton Corp. Cutler Hammer Product Sales Office Mountain View, CA	82305 Palmer Electronics Corp. South Gate, CA	84411 American Shizuki TRW Capacitors Div. Ogallala, NE	88690 Essex Group Inc. Wire Assembly Div. Dearborn, MI
8T100 Tellabs Inc. Naperville, IL	82389 Switchcraft Inc. Sub of Raytheon Co. Chicago, IL	84613 FIC Corp. Rockville, MD	88786 Atlantic India Rubber Co. Goshen, IN
80009 Tektronix Beaverton, OR	82415 Aipax Corp Frederick Div. Frederick, MD	84682 Essex Group Inc. Peabody, MA	88978 Philips (Now Fluke) Mahwah, NJ
80031 Mepco/Electra Inc. Morristown, NJ	82872 Roanwell Corp. New York, NY	84830 Lee Spring Co. Inc Brooklyn, NY	89020 Amerace Corp. Buchanan Crumptool Products Div. Union, NJ
80032 Ford Aerospace & Communications Corp. Western Development Laboratories Div. Palo Alto, CA	82877 Rotron Inc. Custom Div. Woodstock, NY	85367 Bearing Distributing Co. San Francisco, CA	89265 Potter-Brumfield (See 77342)
80145 LFE Corp. Process Control Div. Clinton, OH	82879 IFT Royal Electric Div. Pawtucket, RI	85372 Bearing Sales Co. Los Angeles, CA	89462 Waldes Truarc, Inc. Long Island, NY
80183 Sprague Products (Now 56289)	83003 Varo Inc. Garland, TX	85480 W. H. Brady Co. Industrial Product Milwaukee, WI	89536 John Fluke Mfg. Co., Inc. Everett, WA
80294 Boums Instruments Inc. Riverside, CA	83014 Hartwell Corp. Placentia, CA	85840 Brady WH Co Industrial Products Div Milwaukee, WI	89597 Fredericks Co. Huntingdon Valley, PA
80583 Hammerlund Mfg. Co. Inc. Paramus, NJ	83055 Signalite Fuse Co. (Now 71744)	85932 Electro Film Inc. Valencia, CA	89709 Bunker Ramo-Eltra Corp. Amphenol Div. Broadview, IL
80640 Computer Products Inc. Stevens-Arnold Div. South Boston, MA	83058 TRW Assemblies & Fasteners Group Fasteners Div. Cambridge, MA	86577 Precision Metal Products Co. Peabody, MA	89730 General Electric Lamp Div. Newark, NJ
81073 Grayhill Inc. La Grange, IL	83259 Parker-Hannifin Corp. O-Seal Div. Culver City, CA	86684 Radio Corp. of America (Now 54590)	9R216 Data Composition Svc, Inc Laurie, MD
81312 Litton Systems Inc. Winchester Electronics Div. Watertown, CT	83298 Bendix Corp. Electric & Fluid Power Div. Eatonsville, NJ	86928 Seastrom Mfg. Co. Inc. Glendale, CA	9S171 Port Plastics Tukwila, WA

Federal Supply Codes for Manufacturers (cont)

9W423 Amatom El Mont, CA	91934 Miller Electric Co. Woonsocket, RI	95573 Campion Laboratories Inc. Detroit, MI	98278 Malco A Microdot Co. South Pasadena, CA
90201 Mallory Capacitor Co. Sub of Emhart Industries Inc. Indianapolis, IN	91967 National Tel-Tronics Div. of electro Audio Dynamics Inc Meadville, PA	95712 Bendix Corp. Electrical Comp. Div. Franklin, IN	98291 Sealectro Corp. BICC Electronics Trumbull, CT
90215 Best Stamp & Mfg. Co. KS City, MO	91984 Maida Development Co. Hampton, VA	95987 Weckesser Co. Inc. (Now 85480)	98372 Royal Industries Inc. (Now 62793)
90303 Duracell Inc. Technical Sales & Marketing Bethel, CT	91985 Norwalk Valve Co. S. Norwalk, CT	96733 SFE Technologies San Fernando, CA	98388 Lear Siegler Inc. Accurate Products Div. San Deigo, CA
91094 Essex Group Inc. Suflex/IWP Div. Newmarket, NH	92218 Wakefield Corp., The Wakefield, ME	96853 Gulton Industries Inc. Measurement & Controls Div. Manchester, NH	98978 IERC (International Electronic Research Corp.) Burbank, CA
91247 IL Transformer Co. Chicago, IL	92527 VTC Inc. Bloomington, MN	96881 Thomson Industries Inc. Port WA, NY	99120 Plastic Capacitors Inc. Chicago, IL
91293 Johanson Mfg. Co. Boonton, NJ	92607 Tensolite Co. Div. of Carlisle Corp. Buchanan, NY	97464 Industrial Retainer Ring Irvington, NJ	99217 Bell Industries Inc. Elect. Distributor Div. Sunnyvale, CA
91462 Alpha Industries Inc. Logansport, IN	92914 Alpha Wire Corp. Elizabeth, NJ	97525 EECO Inc. Santa Ana, CA	99378 ATLEE of DE Inc. N. Andover, MA
91502 Associated Machine Santa Clara, CA	93332 Sylvania Electric Products Semiconductor Products Div. Wobum, MA	97540 Whitehall Electronics Corp. Master Mobile Mounts Div. Fort Meyers, FL	99392 Mepco/Electra Inc. Roxboro Div. Roxboro, NC
91506 Augat Alcoswitch N. Andover, MA	94144 Raytheon Co. Microwave & Power Tube Div. Quincy, MA	97913 Industrial Electronic Hardware Corp. NY, NY	99515 Electron Products Inc. Div. of American Capacitors Duarte, CA
91507 Froeliger Machine Tool Co. Stockton, CA	94222 Southco Inc. Concordville, PA	97945 Pennwalt Corp. SS White Industrial Products Piscataway, NJ	99779 Bunker Ramo- Eltra Corp. Barnes Div. Lansdown, PA
91637 Dale Electronics Inc. Columbus, NE	94988 Wagner Electric Corp. Sub of McGraw-Edison Co. Whippany, NJ	97966 CBS Electronic Div. Danvers, MA	99800 American Precision Industries Delevan Div. East Aurora, NY
91662 Elco Corp. A Gulf Western Mfg. Co. Connector Div. Huntingdon, PA	95146 Alco Electronic Products Inc. Switch Div. North Andover, MA	98094 Machlett Laboratories Inc. Santa Barbara, CA	99942 Mepco/Centralab A North American Philips Co. Milwaukee, WI
91737 ITT Cannon/Gremar (Now 08718)	95263 Leecraft Mfg. Co. Long Island City, NY	98159 Rubber-Teck Inc. Gardena, CA	
91802 Industrial Devices Inc. Edgewater, NJ	95275 Vitramon Inc. Bridgeport, CT		
91833 Keystone Electronics Corp. NY, NY	95303 RCA Corp. Receiving Tube Div. Cincinnati, OH		
91836 King's Electronics Co. Inc. Tuckahoe, NY	95348 Gordo's Corp. Bloomfield, NJ		
91929 Honeywell Inc. Micro Switch Div. Freeport, IL	95354 Methode Mfg. Corp. Rolling Meadows, IL		

U.S. Service Locations

California
Fluke Technical Center
15969 Von Karman Avenue
Suite 100
Irvine, CA 92714
Tel: (714) 863-9031

Fluke Technical Center
46610 Landing Parkway
Fremont, CA 94538
Tel: (415) 651-5112

Colorado
Fluke Technical Center
14180 East Evans Avenue
Aurora, CO 80014
Tel: (303) 695-1171

Florida
Fluke Technical Center
940 N. Fern Creek Avenue
Orlando, FL 32803
Tel: (407) 896-4881

Illinois
Fluke Technical Center
1150 W. Euclid Ave.
Palatine, IL 60067
Tel: (312) 705-0500

Maryland
Fluke Technical Center
5640 Fishers Lane
Rockville, MD 20852
Tel: (301) 770-1576

New Jersey
Fluke Technical Center
East 66 Midland Avenue
Paramus, NJ 07652-0930
Tel: (201) 599-9500

Texas
Fluke Technical Center
1801 Royal Lane, Suite 307
Dallas, TX 75229
Tel: (214) 869-2848

Washington
Fluke Technical Center
John Fluke Mfg. Co., Inc.
1420 75th St. S.W.
M/S 6-30
Everett, WA 98203
Tel: (206) 356-5560

International

Argentina
Coasin S.A.
Virrey del Pino 4071 DPTO E-65
1430 CAP FED
Buenos Aires
Tel: 54 1 522-5248

Australia
Philips Customer Support
Scientific and Industrial
23 Lakeside Drive
Tally Ho Technology Park
East Burwood
Victoria 3151

Australia
Philips Customer Support
Scientific & Industrial
25-27 Paul St. North
North Ryde N.S.W. 2113
Tel: 61 02 888 8222

Austria
Oesterreichische Philips Industrie
Unternehmensbereich Prof. Systeme
Triesterstrasse 66
Postfach 217
A-1101 Wein
Tel: 43 222-60101, x1388

Belgium
Philips & MBL Associated S.A.
Scientific & Industrial Equip. Div
Service Department.
80 Rue des deux Gares B-1070
Brussels
Tel: 32 2 525 6111

Brazil
Hi-Tek Electronica Ltda.
Al. Amazonas 422, Alphaville
CEP 06400 Barueri
Sao Paulo
Tel: 55 11 421-5477

Canada
Fluke Electronics Canada Inc.
400 Britannia Rd. East, Unit #1
Mississauga
Ontario L4Z 1X9
Tel: 416-890-7600

Chile
Intronica Chile Ltda.
Casilla 16228
Santiago 9
Tel: 56 2 2321886, 2324308

China
Fluke International Corp.
P.O. Box 9085
Beijing
Tel: 86 01 512-3436

Colombia
Sistemas E. Instrumentacion, Ltda.
Carrera 13, No. 37-43, Of. 401
Ap. Aereo 29583
Bogota DE
Tel: 57 232-4532

Denmark
Philips A/S
Technical Service I & E
Strandlodsvej 1A
PO Box 1919
DK-2300
Copenhagen S
Tel: 45 1 572222

Ecuador
Proteco Coasin Cia., Ltda.
P.O. Box 228-A
Ave. 12 de Octubre
2285 y Orellana
Quito
Tel: 593 2 529684

Egypt
Philips Egypt
10, Abdel Rahman el Rafei st.
el. Mohandessin
P.O. Box 242
Dokki Cairo
Tel: 20-2-490922

England
Philips Scientific
Test & Measuring Division
Colonial Way
Watford
Hertfordshire WD2 4TT
Tel: 44 923-40511

Finland
Oy Philips AB
Central Service
Sinikallontie 1-3
P.O. Box 11
SF-02630 ESPOO
Tel: 358-0-52572

France
S.A. Philips Industrielle
et Commerciale,
Science et Industry
105 Rue de Paris Bp 62
93002 Bobigny, Cedex
Tel: 33-1-4942-8040

Germany (F.R.G.)
Philips GmbH
Service fuer FLUKE - Produkte
Department VSF
Oskar-Messter-Strasse 18
D-8045 Ismaning/Munich,
West Germany
Tel: 49 089 9605-239

Greece
Philips S.A. Hellenique
15, 25th March Street
177 78 Tavros
10210 Athens
Tel: 30 1 4894911

Hong Kong
Schmidt & Co (H.K.) Ltd.
18/FL., Great Eagle Centre
23 Harbour Road
Wanchai
Tel: 852 5 8330222

India
Hinditron Services Pvt. Ltd
1st Floor, 17-B,
Mahal Industrial Estate
Mahakali Road, Andheri East
Bombay 400 093
Tel: 91 22 6300043

Hinditron Services Pvt. Inc.
33/44A Raj Mahal Villas Extn.
8th Main Road
Bangalore 560 080
Tel: 91 812 363139

Hinditron Services Pvt. Ltd.
Field Service Center
Emerald Complex 1-7-264
5th Floor
114 Sarojini Devi Road
Secunderabad 500 003
Tel: 08 42-821117

Hinditron Services Pvt. Ltd.
15 Community Centre
Panchshila Park
New Delhi 110 017
Tel: 011-6433675

Indonesia
P.T. Lamda Triguna
P.O. Box 6/JATJG
Jakarta 13001
Tel: (021) 8195365

Israel
R.D.T. Electronics Engineering, Ltd.
P.O. Box 43137
Tel Aviv 61430
Tel: 972 3 483211

Italy
Philips S.p.A.
Sezione I&E / T&M
Viale Elvezia 2
2005 Monza
Tel: 39 39 3635342

Japan
John Fluke Mfg. Co., Inc.
Japan Branch
Sumitomo Higashi Shinbashi Bldg.
1-1-11 Hamamatsucho
Minato-ku
Tokyo 105
Tel: 81 3 434-0181

Korea
Myoung Corporation
Yeo Eui Do P.O. Box 14
Seoul 150
Tel: 82 2 784-9942

Malaysia
Mecomb Malaysia Sdn. Bhd.
P.O. Box 24
46700 Petaling Jaya
Selangor
Tel: 60 3 774-3422

Mexico
Mexel Servicios en Computacion
Instrumentacion y Perifericos
Blvd. Adolfo Lopez Mateos No. 163
Col. Mixcoac
Mexico D.F.
Tel: 52-5-563-5411

Netherlands
Philips Nederland
Test & Meetapparaten Div.
Postbus 115
5000 AC Tilburg
Tel: 31-13-352445

New Zealand

Philips Customer Support
Scientific & Industrial Division
2 Wagener Place
Mt. Albert
Auckland
Tel: 64 9 894-160

Norway

Morgenstjerne & Co. A/S
Konghellegate 3
P.O. Box 6688, Rodelokka
Oslo 5
Tel: 47 2 356110

Pakistan

International Operations (PAK) Ltd.
505 Muhammadi House
I.I. Chundrigar Road
P.O. Box 5323
Karachi
Tel: 92 21 221127, 239052

Peru

Importaciones & Representaciones
Electronicas S.A.
Avad Franklin D. Roosevelt 105
Lima 1
Tel: 51 14 288650

Philippines

Spark Radio & ElectronicS Inc.
Greenhills, P.O. Box 610
San Juan, Metro-Manila Zip 3113
Tel: 63-2-775192

Portugal

Decada Espectral
Equipmentos de Elec. e Cientificos
Av. Bomberos Voluntarios
Lote 102B, Miraflores/Alges
1495 Lisboa
Tel: 351 1 410-3420

Singapore

Rank O'Connor's Singapore (PTE) Ltd.
98 Pasir Panjang Road
Singapore 0511
Tel: 65 4737944

South Africa

South African Philips (Pty) Ltd.
Service Department
195 Main Rd
Martindale, Johannesburg, 2092
Tel: 27 11 470-5255

Spain

Philips Iberica S.A.E.
Depto. Tecnico Instrumentacion
c/Martinez Villergas 2
28027 Madrid
Tel: 34 1 4042200

Sweden

Philips Kistaindustrier AB
Customer Support
Borgarfjordsgatan 16
S-16493 Kista

Switzerland

Philips A.G.
Technischer Kundendienst
Postfach 670
Allmendstrasse 140
CH-8027 Zurich
Tel: 41 1 482211

Taiwan

Schmidt Electronics Corp.
5th Floor, Cathay Min Sheng
Commercial Building,
344 Min Sheng East Road
Taipei
Tel: 886 2501-3468

Thailand

Measuretronix Ltd.
2102/63 Ramkamhaeng Rd.
Bangkok 10240
Tel: 66 2 374-2516, 374-1632

Turkey

Turk Philips Ticaret A.S.
Inonu Caddesi 78/80
Posta Kutusu 504-Beyoglu
Istanbul
Tel: 90 1 1435891

Uruguay

Coasin Uruguay S.A.
Casilla de Correo 1400
Libertad 2525
Montevideo
Tel: 598-2-789015

Venezuela

Coasin C.A.
Calle 9 Con Calle 4, Edif. Edinurbi
Apartado de Correos Nr-70-136
Los Ruices
Caracas 1070-A
Tel: 58 2 241-0309, 241-1248

West Germany

Philips GmbH
Department VSF
Service fuer FLUKE - Produkte
Oskar - Messter - Strasse 18
D-8045 Ismaning / Munich
Tel: 49 089 9605-260

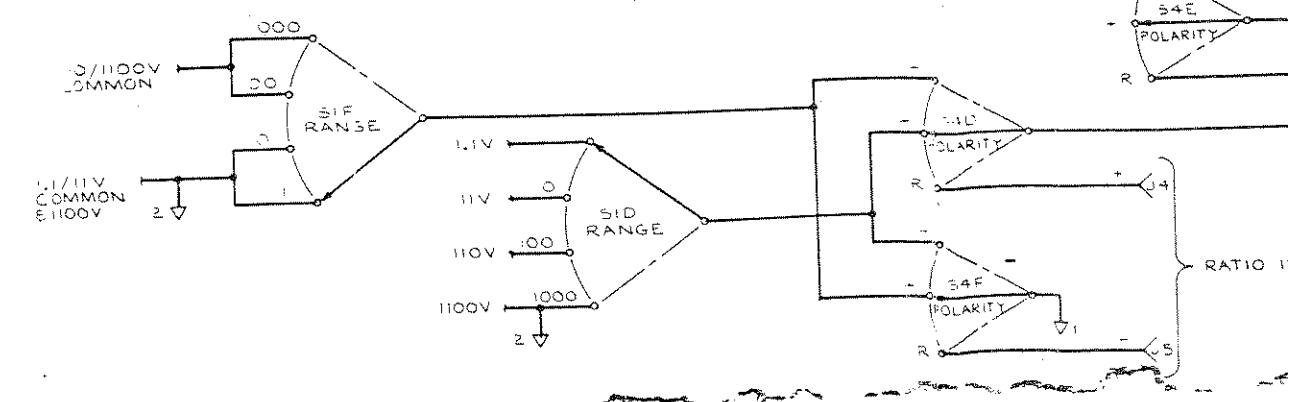
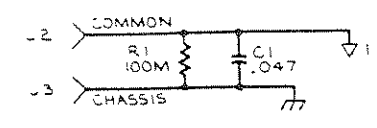
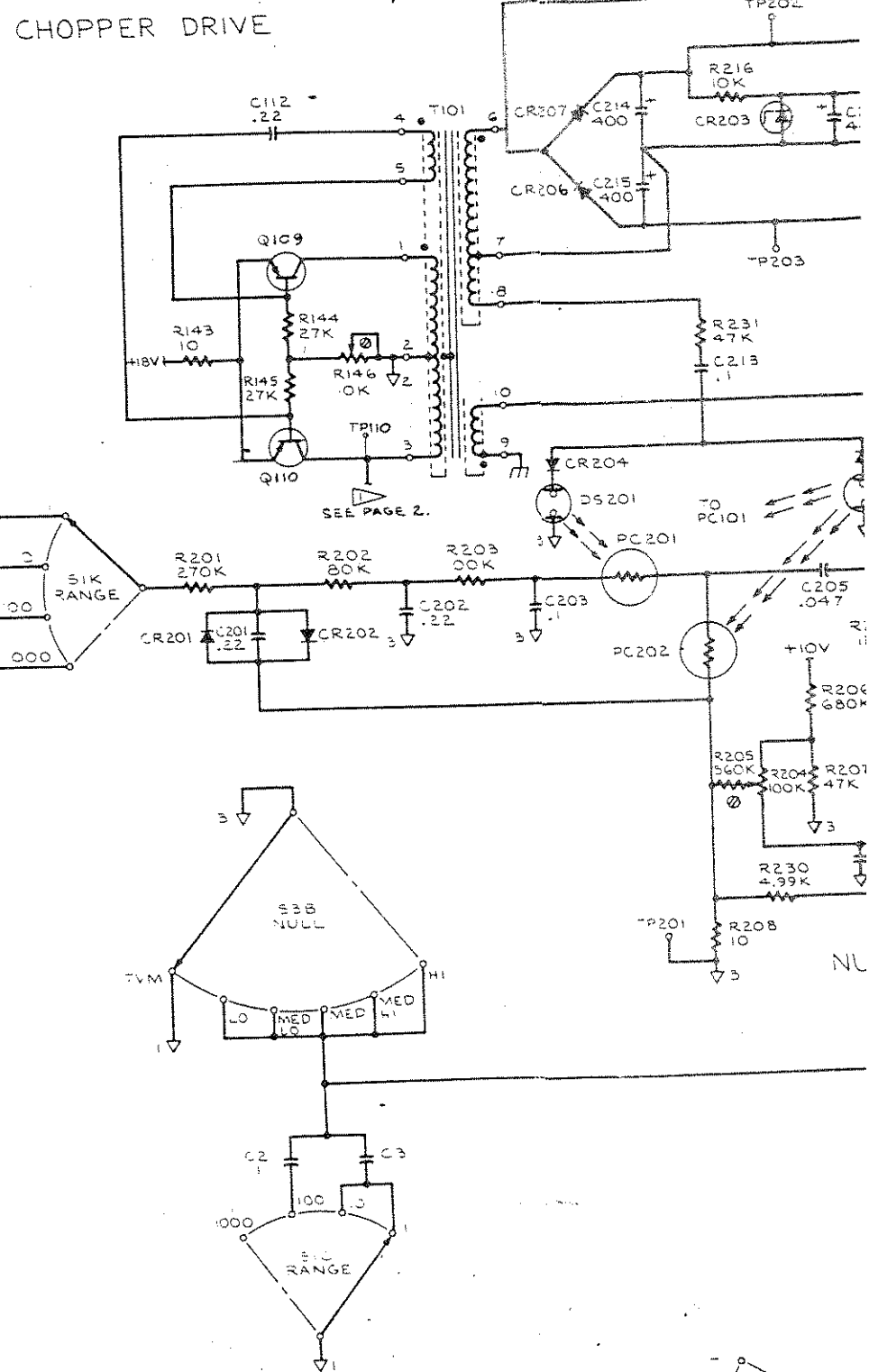
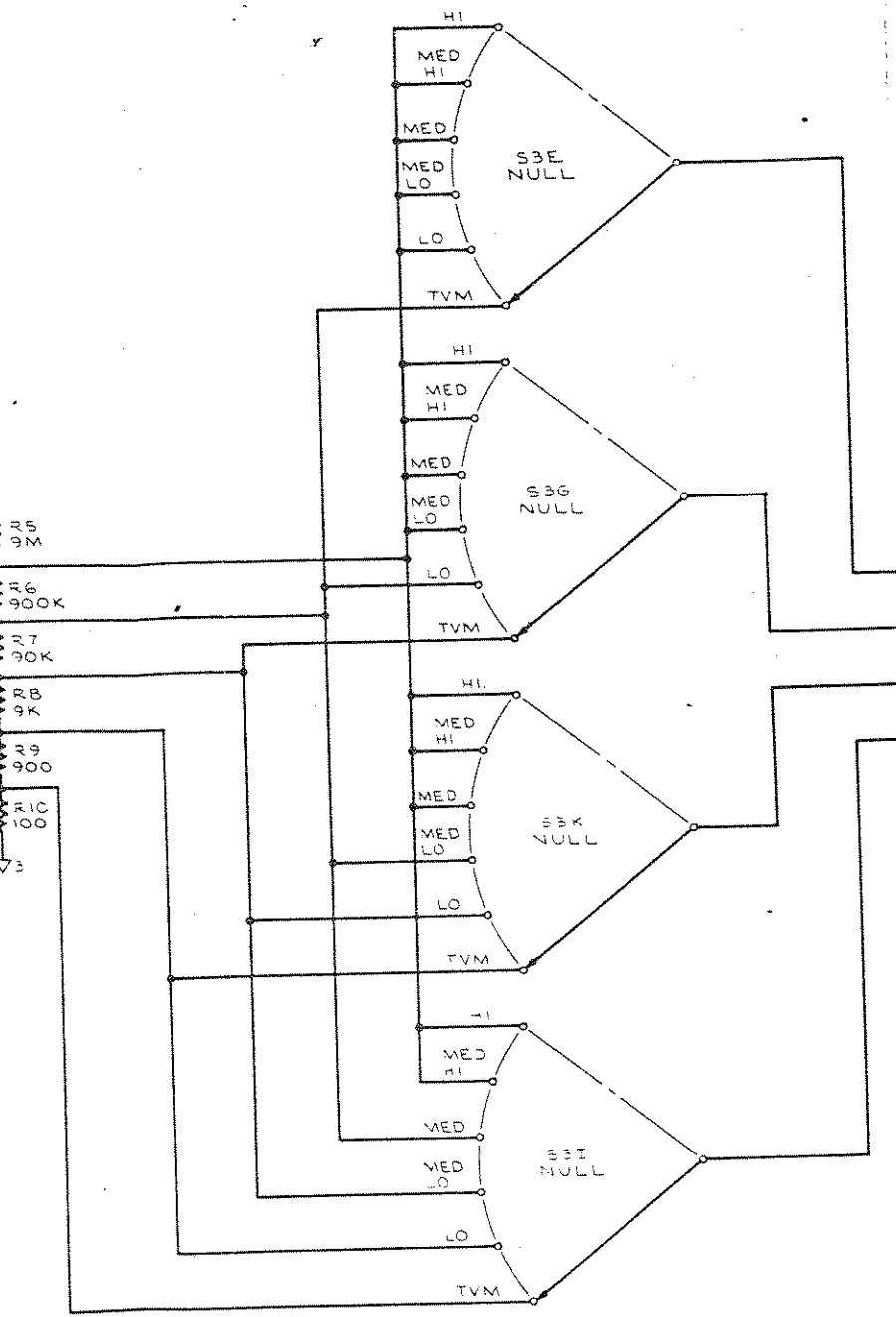
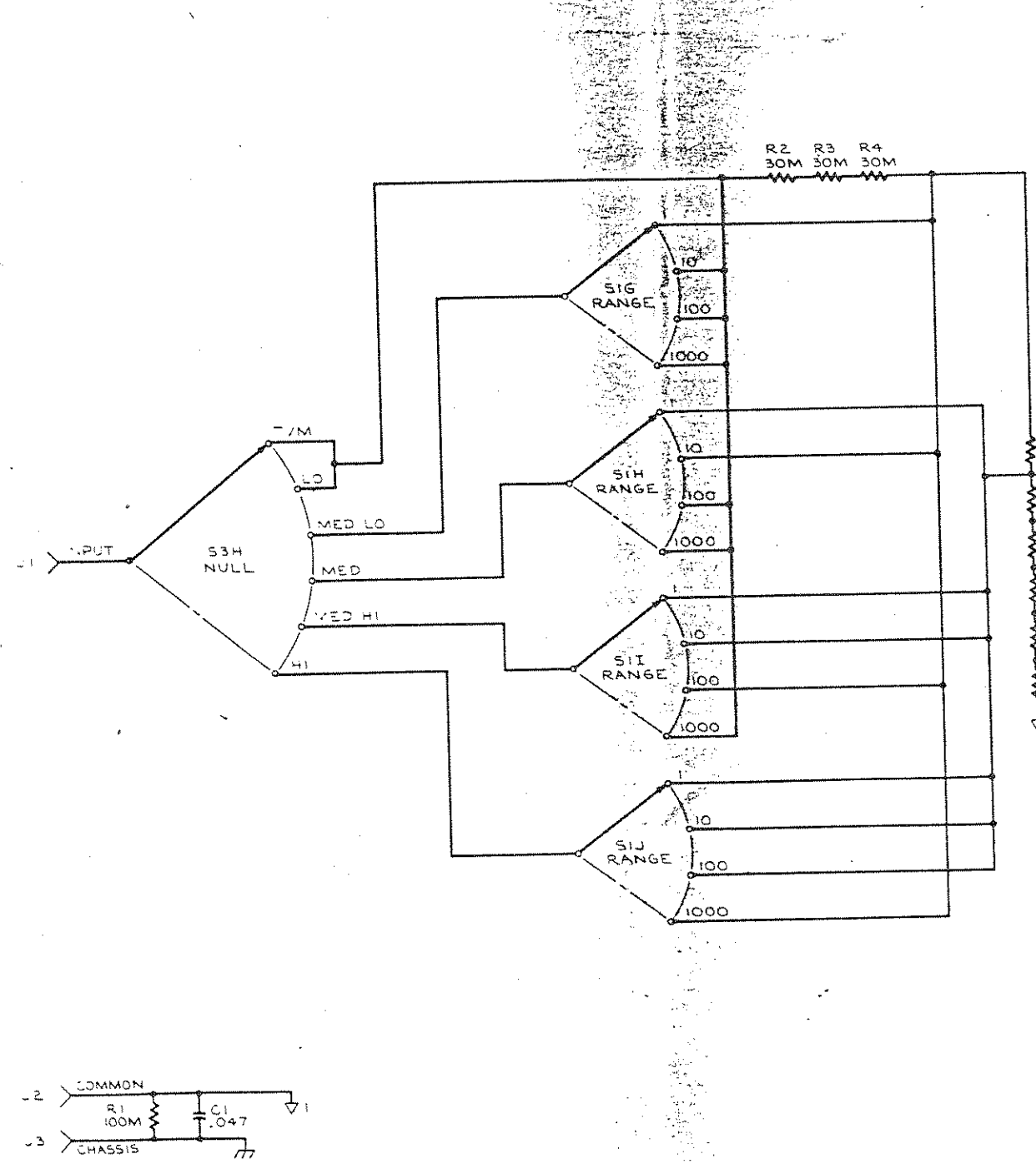

CHOPPER DRIVE

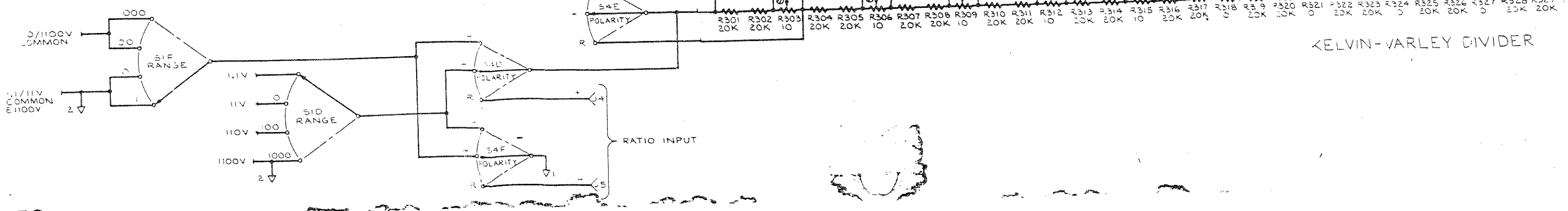
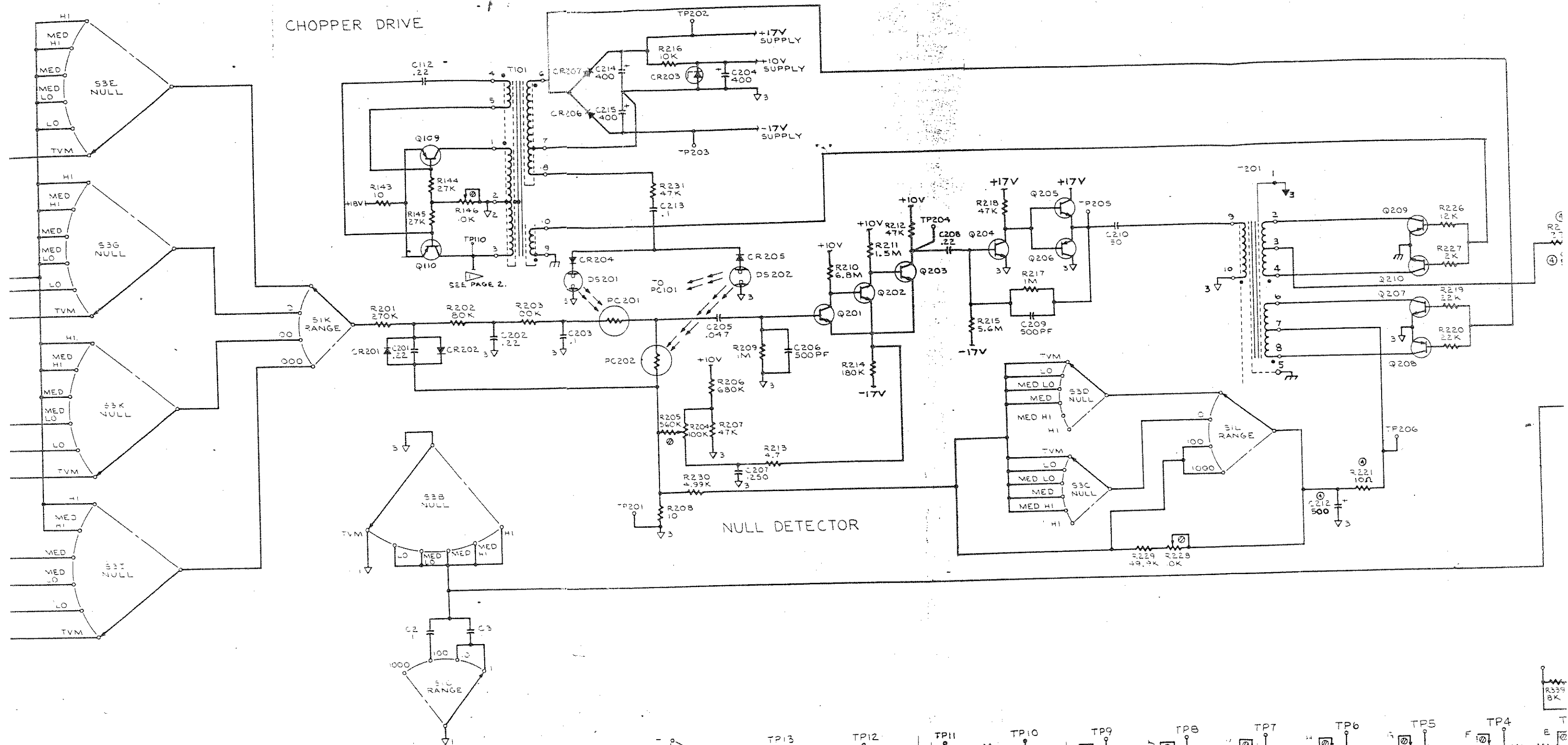

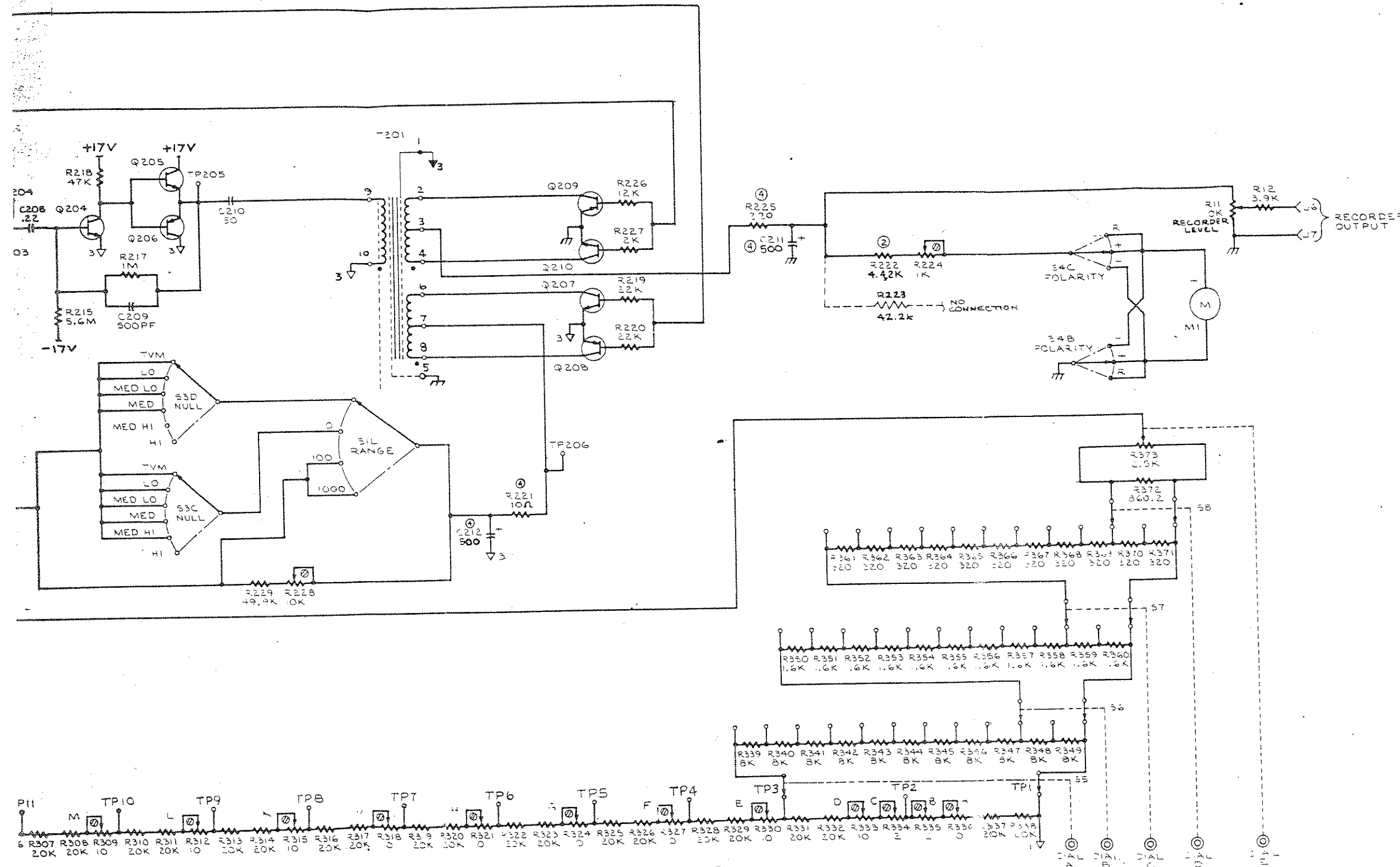

INPUT RANGE	NULL RANGE				
	LO	MED LO	MED	MED HI	HI
1	100 MV	10 MV	1 MV	100 μV	100 μV
10	1	100 MV	10 MV	1 MV	100 μV
100	10	1	100 MV	10 MV	1 MV
1000	100	1	1	100 MV	10 MV

- CHANGES:
- ① FOR SER. NO. 123 THRU 146
OVEN CIRCUIT NOT USED
 - ② FOR SER. NO. 123 THRU 282
R222 WAS 4.99K
 - ③ FOR SER. NO. 123 THRU 338
R102 WAS 1M
R106, R109 WERE 17.8K
 - ④ FOR SER. NO. 123 THRU 472
C211 WAS 640 uF
C212 WAS 400 uF
C113 WAS NOT USED
R154 WAS 19.6K
R221 WAS 220Ω
R225 WAS 33Ω

- REFERENCE DESIGNATIONS:
- C1-3, 101-112, 201-218, 401-407
 - CR101-108, 201-207, 401-406
 - DS201-202
 - F1
 - J1-8
 - M1
 - P1-2
 - PC101, 201-202
 - Q101-113, 201-210, 401-406
 - R1-19, 101-155, 201-231, 301-373, 401-424
 - S1-5
 - T1-2, 101, 201
 - TP101-110, 201-206, 401-408

- NOTES:
- ⊙ INDICATES INTERNAL ADJUSTMENT
 - ▷ ALL FLAG NOTES WITH THE SAME NUMBER ARE CONNECTED
 - ⊥ INPUT COMMON
 - ⊥ 1.1/11V COMMON & 1100V REFERENCE
 - ⊥ NULL DETECTOR COMMON
 - ⊥ CHASSIS GROUND

KELVIN-VARLEY DIVIDER

FUNCTIONAL SCHEMATIC

SCHEMATIC NO. 1 DC VOLTMETER & KELVIN VARLEY DIVIDER

DIFFERENTIAL VOLTMETER

MODEL 895A

MODEL 895A SER. NO. 123 & ON

FLUKE JOHN FLUKE MFG CO., INC.
P.O. Box 7428 Seattle, Washington 98122

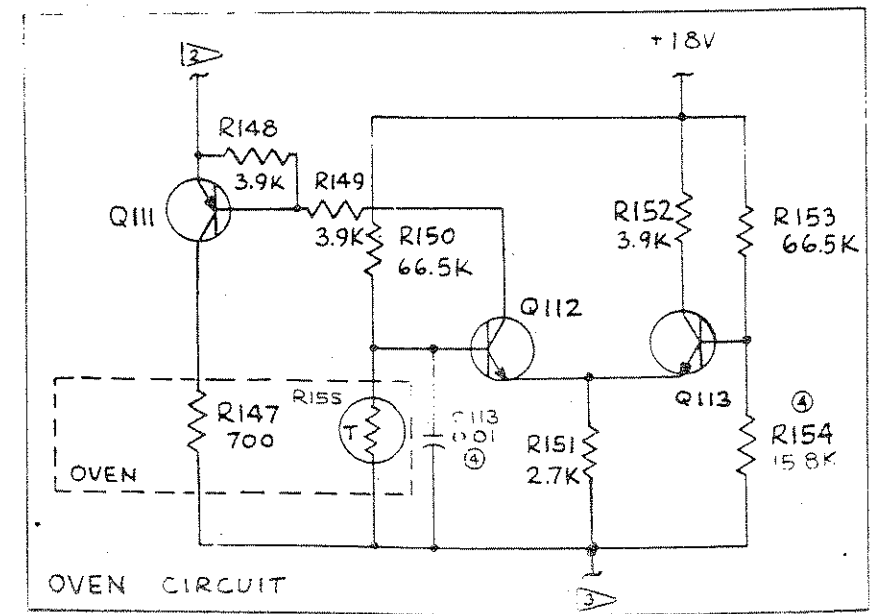
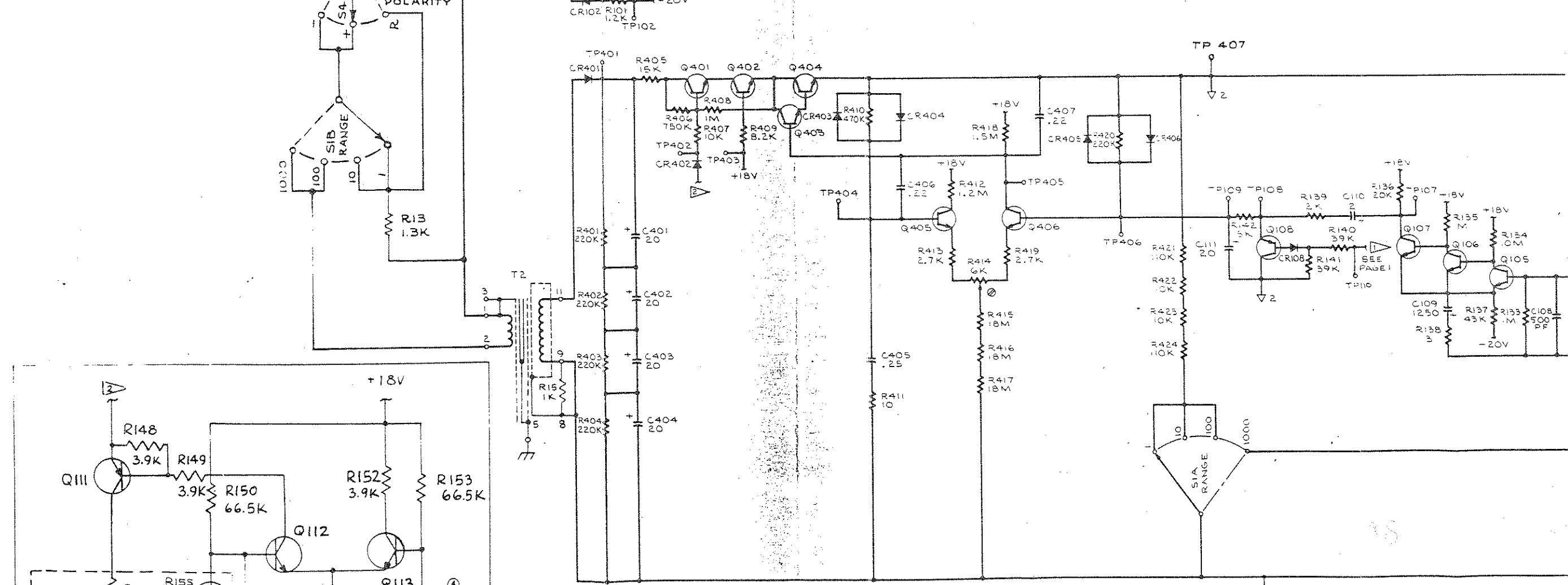
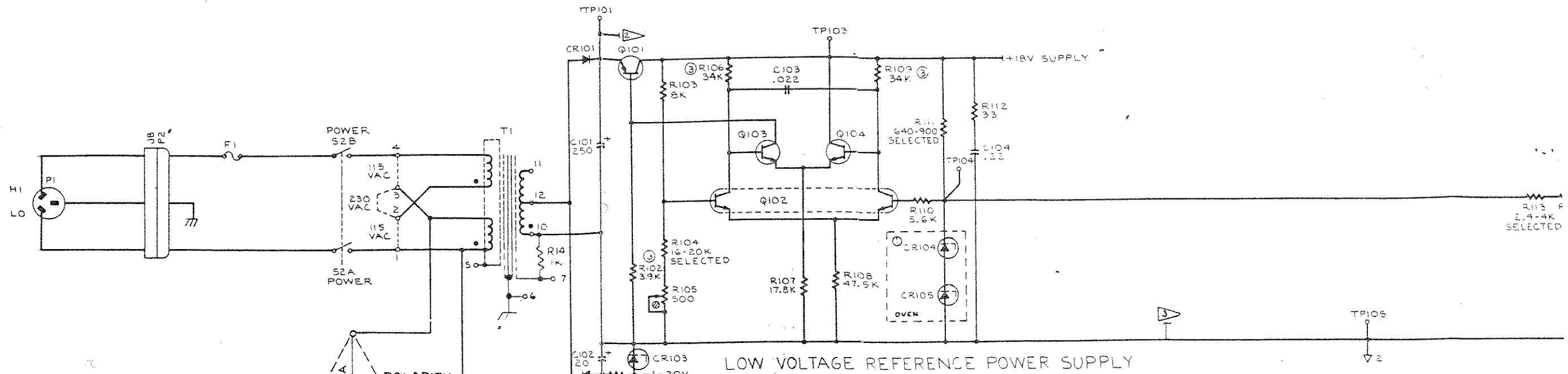

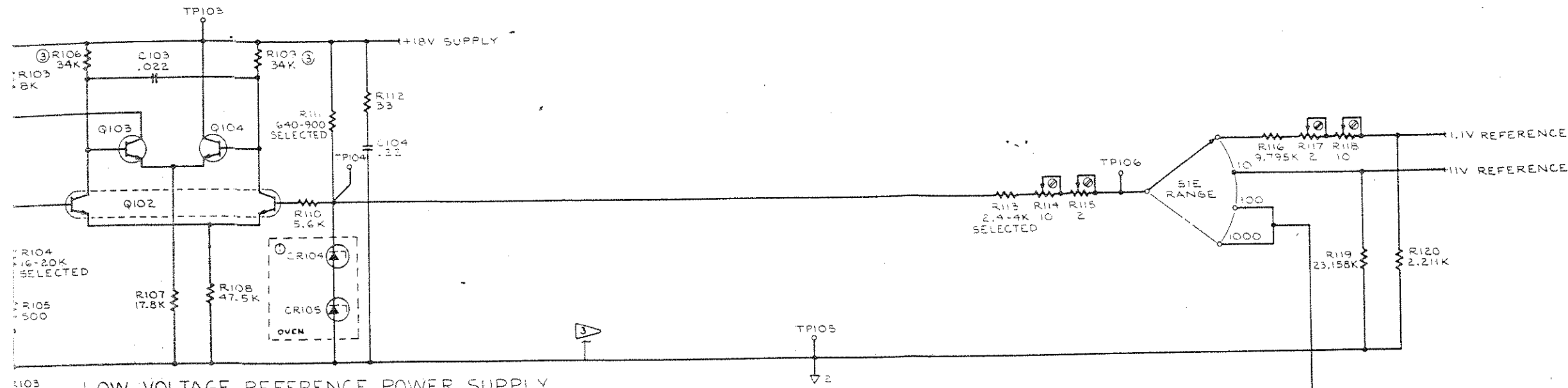

LOW VOLTAGE REFERENCE POWER SUPPLY

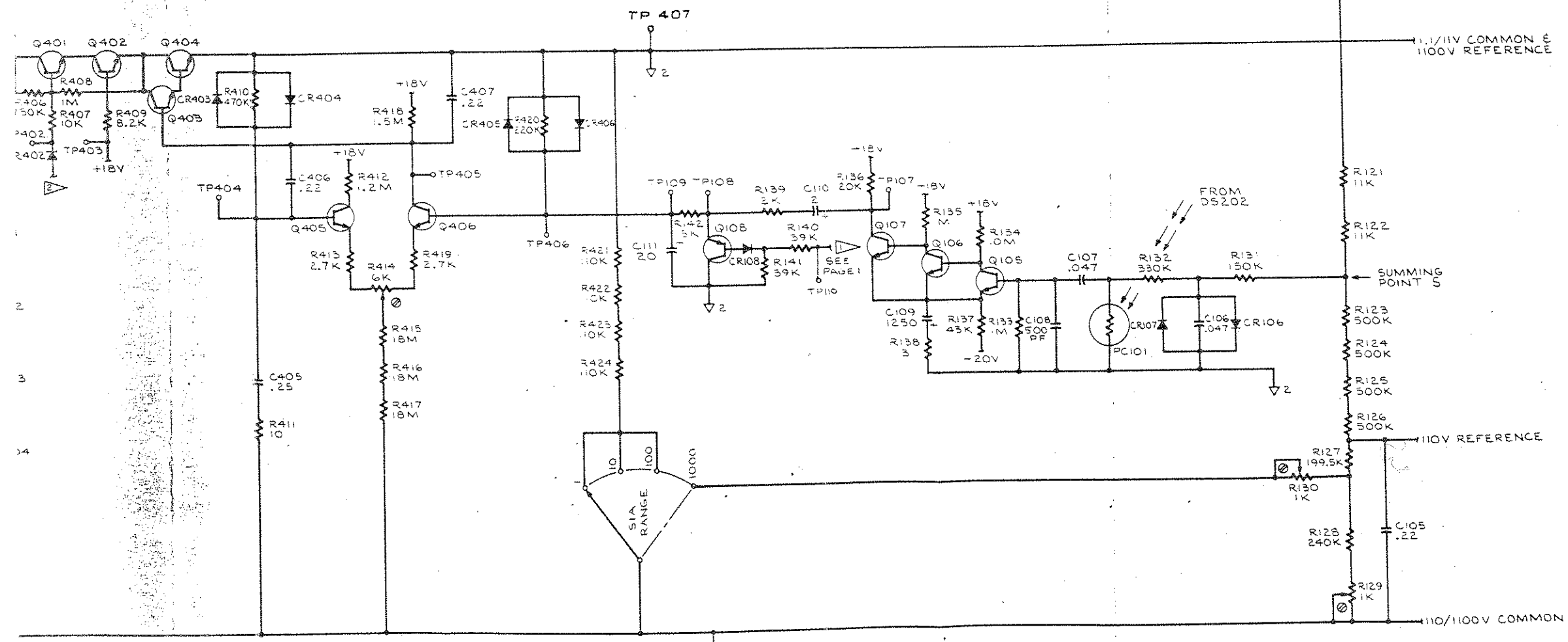

HIGH VOLTAGE REFERENCE POWER SUPPLY

CHANGES:
SEE SCHEMATIC NO. 1

FUNCTIONAL SCHEMATIC	
SCHEMATIC NO. 2	REFERENCE SUPPLY
DIFFERENTIAL VOLTMETER	
MODEL 895A	
MODEL 895A SER. NO. 123 & ON	
JOHN FLUKE MFG. CO., INC. P.O. Box 7428 Seattle, Washington 98133	