



7020/7040 THEBES® Therapy Beam Evaluation System



FLUKE®

Biomedical

37-705 VeriDose® PDMQC System



7600 Double Check® Pro Daily Check Device

Radiation Oncology Product Catalog

2007/2008

Fluke Biomedical.
*The accuracy you need
from a company you can trust.*



05-433 PRIMALERT® 10 Teletherapy Radiation Monitor



35040 Advanced Therapy Dosimeter (ATD)

2007/2008

Providing solutions, not just products

Today, biomed, physicists, RSO's, other medical personnel must meet increasing regulatory pressures, higher quality standards, and rapid technological growth, while performing their work faster and more efficiently than ever. Fluke Biomedical provides a diverse range of software and hardware tools to meet today's challenges.

Service

Fluke Biomedical is dedicated to providing the best service within the healthcare industry. Equipped with the best-credentialed facilities, onsite experts, and full asset-management capabilities, Fluke Biomedical's service team is always on call to take care of its customers. Fluke Biomedical's world-class staff leads the industry in post- and pre-sale support, including helping customers choose the best products and accessories for their needs, technical support, product calibration, and repairs.

Regulatory compliance

Fluke Biomedical is a major force in the industry and, like its parent company Fluke, is a leader in quality. Fluke Biomedical operates to the most rigorous standards in the industry, including compliance with ISO 9001:2000, ISO 13485:2003, FDA/QSR as applicable, and NRC/Part 50, Appendix B/Part 21 and adheres to ISO 17025:2005, ANSI Z540, Mammography MQSA and CNSC. Many of the Fluke Biomedical products are CE-marked and CSA-certified. In addition, the Global Calibration Laboratory holds its NVLAP certification and is traceable to both the NIST & PTB.

Legacy

You may be familiar with some of our legacy brand names, including:

- Victoreen®
- Nuclear Associates
- Keithley
- Metron
- DNI Nevada
- Bio-Tek Instruments

Fluke Biomedical has taken the best elements and products of these former brands and have incorporated them into the Fluke Biomedical culture and product line available today.

Our newest catalog

Thank you for requesting our Radiation Oncology catalog. Within these pages, you will find solutions to manage your quality assurance and maintain a safe, regulatory-compliant facility in the radiation oncology physics field.

If you are interested in receiving catalogs or information about any of Fluke Biomedical's other product-lines, please visit www.flukebiomedical.com/catalog.

Catalogs are available for the following product lines:

- Biomedical Test
- Diagnostic Imaging QA
- Radiation Safety
- Service

About Fluke Biomedical

Fluke Biomedical leads the world in the manufacture of biomedical test and simulation products, including standalone electrical safety testers to fully integrated and automated performance testing and documentation systems. Fluke Biomedical also provides some of the most trusted and accurate radiation safety, medical imaging, and oncology quality-assurance solutions for regulatory compliance.

About Fluke Corporation

Fluke Biomedical is a division of Fluke Corporation. Fluke Corporation is the world leader in the manufacture, distribution, and service of electronic test tools and software and is a wholly owned subsidiary of Danaher Corporation (NYSE:DHR).

Contents

Linear Accelerator Quality Assurance Instruments

7020/7040 THEBES® II Therapy Beam Evaluation System	4
7020SW THEBES® II Level II Software (Contour Manager Version 2.0).....	6
35040 Advanced Therapy Dosimeter.....	8
7304 3D ARM Scanning System	10
37-705 VeriDose® PDMQC System.....	11
30-471 VeriDose® Solid-State Diode Detectors	12
37-720 Dual-Diode Dosimeter Patient Dose Monitor.....	13
37-105 mobileMOSFET Wireless Dose Verification System	14
7600 Double Check® Pro Daily Check Device.....	16
05-433 PRIMALERT® 10 Teletherapy Radiation Monitor	17
37-731 Precision Isocentric QC Beam-Checker II	18
37-001 TEL-ALIGN™ Teletherapy Alignment Gauge.....	19
37-013 GARD™ Geometric Accuracy Radiotherapy Device	20

Radiation Oncology Chambers

30-331 Advanced Markus™ Electron Ionization Chamber, 0.02 cm ³ , waterproof.....	21
30-351 Farmer-Type Ionization Chamber, 0.6 cm ³ , waterproof.....	22
30-344 Semiflex™ Ionization Chamber, 0.125 cm ³ , waterproof.....	24
30-316 Semiflex™ Ionization Chamber, 0.3 cm ³ , waterproof.....	26
30-353 PinPoint™ Ionization Chamber, 0.015 cm ³ , waterproof	28
30-332 Roos™ Electron Ionization Chamber, 0.35 cm ³ , waterproof.....	30
30-329 Markus™ Electron Ionization Chamber, 0.055 cm ³ , waterproof.....	32
30-355 Extension Cable Reel for Ionization Chambers	34

Phantoms and Accessories

74-6 Series Plastic Water™.....	35
74-0 Series IMRT Phantoms: Thorax, Homogeneous, Advanced Pelvic 3D, and Head and Neck	36
76-417 CT Simulation Phantom	41
76-462 Electron Density Phantom	42
37-020 Oakton® Temperature Compensated Barometers	43
07-405 NIST Traceable Digital Thermometer	43

Fluke Biomedical
6045 Cochran Road
Cleveland, OH 44139-3303 U.S.A.

Fluke Biomedical Europe AS
Vegamot 8, N-7048 Trondheim,
Norway

For more information, contact us

In the U.S.A. (800) 850-4608 or
Fax (440) 349-2307

In Europe/M-East/Africa
+47 73954700 or

Fax +47 73954701

From other countries

+1 (440) 248-9300 or

Fax +1 (440) 349-2307

Email:

sales@flukebiomedical.com

Web access:

www.flukebiomedical.com

Service Center

1-800-850-4608 ext. 2564

Email:

globalcal@flukebiomedical.com

Repair/Calibration

instructions:

Request a SRA (Service Return

Authorization) by calling

440-498-2564 or emailing

globalcal@flukebiomedical.com.

Shipping instructions will be provided when you receive your SRA.

7020 and 7040

THEBES® II Therapy Beam Evaluation System



The THEBES II* (THERapy Beam Evaluation System) consists of a linear ion chamber array, electrometer, communicator, THEBES II Contour Manager software, wall mount power supply, interconnecting cable, and carrying case. An acrylic base plate that holds the ion chamber array and build up plates are also provided. The linear ion chamber array is permanently connected to the electrometer by a 1.5 m shielded multiconductor cable to eliminate radiation damage to the electrometer. The THEBES II linear ion chamber array is a waterproof,



linear array of 47 ion chambers on 0.5 cm centers. The total active length of the array is 23.42 cm. The THEBES II communicator provides power and the communication interface for the THEBES II electrometer. THEBES II Contour Manager Software is a Windows based application that acquires beam contour data from the detector array and displays it graphically.

The THEBES II is used to perform linear accelerator quality assurance using physicist-preferred air ion chamber technology for dose measurement, avoiding the ion transport issue of the competing liquid chamber technology and radiation damage issues of diode detectors. The detector array consists of 47 waterproof air ion chambers in a linear array. Two detector arrays are being offered: 7020 with 47 ion chambers on a 0.5 cm pitch (23.42 cm total active length) and 7040 with 47 ion chambers on a 1 cm pitch (46.88 cm total active length). The software performs beam contour analysis such as flatness and symmetry. Beam contour data is saved in an Access compatible database, facilitating daily, weekly, and yearly checks, aiding in following the guidelines in TG-40 and TG-51.

*US Patent No. 6,885,007.

Key features

- Linear array of 47 air ion chambers
- 0.5 cm spacing for 7020
- 1.0 cm spacing for 7040
- Central axis chamber
- Waterproof and vented
- Simultaneously checks symmetry, flatness, light field vs. radiation field coincidence, field size, beam center, penumbra, constancy, and integrated
- Real-time dose maps for service and setup
- No electronics in or near the beam
- Windows® applications software

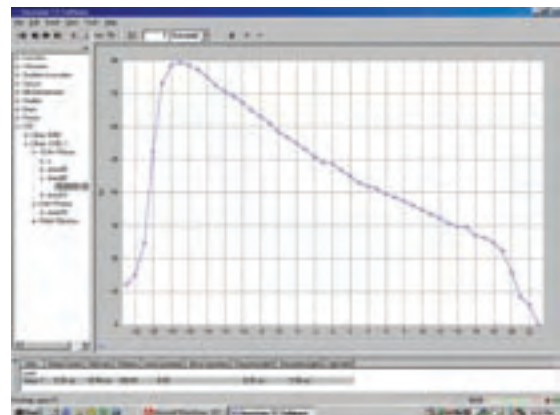

60 degree dynamic wedge

Elsos Philips Service, Trenčín

7020 and 7040

THEBES® II Therapy
Beam Evaluation System

Specifications

Linear ion chamber array	
Detector type	Ionization chambers, waterproof and vented
Number of detectors	47
Dimensions (WxDxH)	7020: 6.2 cm x 30.2 cm x 3.7 cm 7040: 6.2 cm x 53.5 cm x 3.7 cm
Active area	7020: 1.0 cm x 23.42 cm (23 cm center to center) 7040: 0.88 cm x 46.88 cm (46 cm center to center)
Detector spacing	7020: 0.5 cm 7040: 1.0 cm
Inherent buildup	0.5 cm polystyrene, .02 cm polycarbonate
Inherent backscatter	Without mounting plate: 0.3 cm acrylic With mounting plate: 0.3 cm acrylic, 1.0 cm acrylic
Radiation detected	Photons: ⁶⁰ Co to 25 MV Electrons: 6 to 25 MeV
Beam limits	Maximum dose/pulse: 12.5 mGy per pulse Maximum pulse rate: 1000 pulses per second Maximum continuous dose rate: 500 cGy/min
Ion chamber dimensions (WxDxH)	7020: 0.42 cm x 0.95 cm x 0.50 cm 7040: 0.88 cm x 0.88 cm x 0.50 cm
Ion chamber nominal volume	7020: 0.17 cm ³ 7040: 0.36 cm ³
Ion chamber alignment	± 0.3 mm chamber outline on top of array in all axes
Nominal bias voltage	-300 V
Weight	0.34 kg (0.75 lb)
Electrometer	
Number of channels	48
Amplifiers	Non-multiplexed, low leakage, mosfet operational amplifier
Array scan time	1.1 ms
Frame rate	5 frames/sec
Status indicators	4
Dimensions (WxDxH)	10.9 cm x 21.6 cm x 3.2 cm
Communicator	
Computer interface	RS-232, DB-9 connector
Power requirements	12 V dc, 1 A
Communication interface	Connector: RJ-45 Baud rate: 57.6 K
Dimensions (WxDxH)	4.2 cm x 8.8 cm x 2 cm
System	
Power requirements	Input: 120 V ac, 60 Hz, 22 W Output: 12 V dc, 1 A
Computer requirements	Computer IBM® compatible PC, Intel® Pentium® 90 or higher with at least one unused COM port
Operating system	Microsoft Windows XP®, 2000
Hard disk space	64 MB of available space
Mounting plate dimensions (WxDxT)	7020: 22.8 cm x 30.5 cm x 2.5 cm 7040: 22.8 cm x 53.8 cm x 2.5 cm
Calibration	Accuracy: 2 % Reproducibility: 1 % Long term stability: 1 % Linearity: 1 %
Environmental	Operating temperature: 10 °C to 40 °C (50 °F to 104 °F) Storage temperature: -25 °C to +65 °C (-13 °F to +149 °F) Relative humidity: 20 % to 75 %, non-condensing
Weight	10 kg (21 lb)

Optional accessories

57-051 Lead Foil for TG-51,
1 mm x 20 cm²

7020

7020BP95 9.5 cm Buildup Plates
7020AA ARM 3D Watertank
Adapter

7020MA Multidata Watertank
Adapter

7020WDA Wellhöfer (Dovetail)
Watertank Adapter

7020WPA Wellhöfer Blue (Pin)
Watertank Adapter

7020VA Tray Adapter Kit, Varian
Type 3

7020EA Tray Adapter Kit, Elekta

7020SA Tray Adapter Kit,
Siemens

7040

7040BP95 9.5 cm Buildup Plates
7040VA Tray Adapter Kit,
Varian Type 3

7040EA Tray Adapter Kit, Elekta

7040SA Tray Adapter Kit,
Siemens

Included accessories

AC adapters, specify with order

14-328 110 V ac 12 V dc
1000 mA USA, Japan

14-401 230 V ac 12 V dc
1000 mA, Europe

14-414 230 V ac 12 V dc
1000 mA, UK

14-414 and 14-416 adapter
230 V ac 12 V dc 1000 mA,
Australia

7020

7020CBL Communication Cable,
23 m (75 ft)

7020TER Terminator, 120 Ω

7020COM Communicator

7020BP10 1 cm Buildup Plate

7020BP25 2.5 cm Buildup Plate

7040

7040CBL Communication Cable,
23 m (75 ft)

7040TER Terminator, 120 Ω

7040COM Communicator

7040BP10 1 cm Buildup Plate

7040BP25 2.5 cm Buildup Plate

Ordering information

7020 THEBES II 20 cm Field
Size Array

7040 THEBES II 40 cm Field
Size Array

7020SW

THEBES® II Level II Software
(Contour Manager Version 2.0)

Specifications

DICOM	Allows the user to export an exposure profile (integrated dose) to a DICOM enabled device. The user may open an exposure, and then export the dose data to a DICOM compatible file
New calculations Includes calculations from various vendors for symmetry and flatness:	
Flatness: Percent value, calculated as follows	Default method (TG-45, Siemens): Flatness = (MAX - MIN) / (MAX + MIN) * 100 %
	Where the MAX is the maximum value of a chamber in the specified field region
	The MIN is the minimum value of a chamber in the specified field region
	The AVERAGE is the arithmetic average value for MAX and MIN
Flatness: Percent value, calculated as follows	Varian Method: Flatness = (MAX MIN) / Central Axis Dose
	This provides the total error. To report as ± error limits, divide by 2
Mirror symmetry (Varian)	Percent value, the maximum symmetry error in the specified field region. The mirror symmetry value of one pair of chambers is calculated as $MSYMi = (Vj - Vi) / Vi * 100$ Where MSYMi is the symmetry value of one pair of chambers. Vi is the value of the chamber i on the right side. Vj is the value of its mirror chamber on the left side. After calculating the mirror symmetry of all chamber pairs in the Field Region, the software finds the maximum value and its corresponding chamber on the right side. Mirror symmetry is reported as total error.
Area symmetry (Siemens, IEC)	Percent value, the difference between the area under the right half of the beam curve and area under the left half. A positive Area Symmetry means that the right half is greater. A negative value means that the left half is greater. It is calculated as $ASYM = (RightArea - LeftArea) / (RightArea + LeftArea) * 200$ The RightArea and the LeftArea are calculated by trapezoidal integration of the measured data points
Percent depth dose	Percent depth dose is a graph of output vs. depth in water. After each exposure the chamber array is moved to a different depth and another exposure is taken. The results are graphed and saved for trend analysis.
Wedge angle—dynamic wedge	Calculates the angle of the profile using the following equation: $Wedge\ Angle = \tan^{-1} (Ddose/width) / (Ddose/depth)$
Field size factor	$Central\ Axis\ Dose\ (fs1) / Central\ Axis\ Dose\ (fs2)$ Field size (fs) is the only change
Wedge factor—dynamic wedge	$Central\ Axis\ Dose\ (1) / Central\ Axis\ Dose\ (2)$ The first exposure is open. The second exposure contains a wedge.
Enhanced scale factors	The user has the ability to modify (calibrate) the output of the THEBES II hardware through the use of scale factors (correction factors). The scale factors are multiplied by the THEBES II output. The default scale factor is 1. A number of methods are provided: 'Direct modification on the main chart and a scale factors dialog. For the direct method the user simply drags a data point to modify the scale factors.
Calculation window customization	Allows the user to customize the data in the calculation window similar to Windows Explorer. Allows the user to display any detail about the exposure (i.e. name, collimator settings, calculations, SSD, just whatever). The selection(s) must be saved between sessions.
ZOOM	Provides an obvious ZOOM function, in which the user may click and drag on the chart view to modify the display.
Disable individual channels	User may disable any channel of the THEBES II hardware in case a channel is not working properly.

Ordering information

7020SW THEBES II Level II
Software, Version 2.0

35040

Advanced Therapy
Dosimeter

The 35040 Advanced Therapy Dosimeter (ATD) is a reference grade instrument used to measure the charge and current from ion chambers in Radiation Therapy, and provides bias voltage for all commonly used chambers. Front panel controls select ion chamber calibration factors, facilitate entry of temperature and pressure values for air density correction, allow bias voltage selection, threshold level, timer control, and choice of display screens. The user-customized display screens can simultaneously show dose, exposure time, dose rate, effective exposure time, average current/rate, accumulated charge/dose, bias voltage, leakage, and other important information that ensures the validity of the instrument. The customization software allows design of 16 screens that display conditions, parameters, values and text. Up to 32 chamber factors, 11 bias voltages can be programmed. It is PC compatible and connects via a RS-232 cable. The user can customize the display for basic use or for specialized applications such as brachy therapy. The Advanced Therapy Dosimeter exceeds the recommendations of calibration laboratories for leakage, linearity, and stability by a wide margin. This instrument raises the standard of Radiation Therapy measurements.

Key features

- Wide measurement range, up to 1.000 μA and 19.999 mC for HDR Brachy therapy applications
- Automatic reset and hold of measured values between exposures
- Front panel adjustment of exposure threshold and user disable of threshold to permit manual operation
- Thirty-two ion chamber calibration factors
- Automatic power-down after user specified time period, when operating from battery supply
- Annunciators warn of low battery, low bias, and operational errors
- Large capacity battery provides eight hours of continuous operation; fast recharge in less than three hours, even during operation
- AC line operation over the range 100 V ac to 240 V ac and 47 Hz to 63 Hz without operator intervention
- Charge and current calibration factors entered by calibration laboratories at user's option

35040

Advanced Therapy
Dosimeter

Specifications

Charge full scale	Charge sensitivity	Current* full scale	Current* sensitivity
200.00 pC	0.01 pC	200.0 pA	0.1 pA
2.0000 nC	0.0001 nC	2.000 nA	0.001 nA
20.0000 nC	0.001 nC	20.00 nA	0.01 nA
200.00 nC	0.01 nC	200.0 nA	0.1 nA
2.0000 µC	0.0001 µC	1.000 µA	0.001 µA
20.000 µC	0.001 µC		
200.00 µC	0.01 µC		
2.0000 mC	0.0001 mC		
20.000 mC	0.001 mC		

*Average current is displayed with ten times greater resolution.

Effective exposure time ranges	
Full scale range	Display resolution
59.99 s	0.01 s
5 hr 33 min 19.9 s	0.1 s

Stability	Designed for ultra long-term stability error of approximately 0.1 % per five years
Leakage	Virtually removes effects of total system leakage during measurement. Uncorrected leakage < 10 fA over temperature range
Linearity	Maximum non-linearity variation from straight line of 0.1 % of all charge and current ranges
Resolution	0.005 % of range (4.5 digits) for charge, dose, average rate and average current; 0.05 % of range (3.5 digits) for current and rate
Warm-up	Fully meets specifications within five minutes of applying power
Measurement accuracy	18 °C to 28 °C (64 °F to 82 °F); charge ± (0.20 % reading plus two counts); current ± (0.20 % reading plus two counts)
Bias	Eleven user-programmable steps from -500 to +500 V in 0.1 volt increments; accuracy ± 0.3 V for loads < 0.2 mA; front panel selectable
Ion chamber calibration factors	Thirty-two user-programmable calibration factors; front panel selectable
Display units	All practical radiation and electrical units
RS-232 computer configuration	For customizing and data transfer
Power requirements	Internal lead acid battery; Integral charger operates 100 V ac to 240 V ac (47 Hz to 63 Hz)
Connectors	Triax BNC front/rear 35040; Triax TNC front/rear 35040TNC
Dimensions (WxDxH)	21.6 cm x 26 cm x 8.9 cm (9.4 in x 10 in x 4 in)
Weight	4.6 kg (10 lb)

Optional accessories

37780 Carrying Case

86120 Extension Cable, 20 ft, Triax BNC to BNC

30-356 BNC to TNC Converter

External chamber accessories

30-344 Semiflex™ Ionization Chamber, 0.125 cm³, Waterproof

30-316 Semiflex™ Ionization Chamber, 0.3 cm³, Waterproof

30-353 PinPoint™ Ionization Chamber, 0.015 cm³, Waterproof

30-332 Roos™ Electron Ionization Chamber, 0.35 cm³, Waterproof

30-353 Advanced Markus™ Electron Ionization Chamber, 0.02 cm³, Waterproof

Ordering information

35040 Advanced Therapy Dosimeter

35040TNC Advanced Therapy Dosimeter, TNC option

7304

3D ARM Scanning System

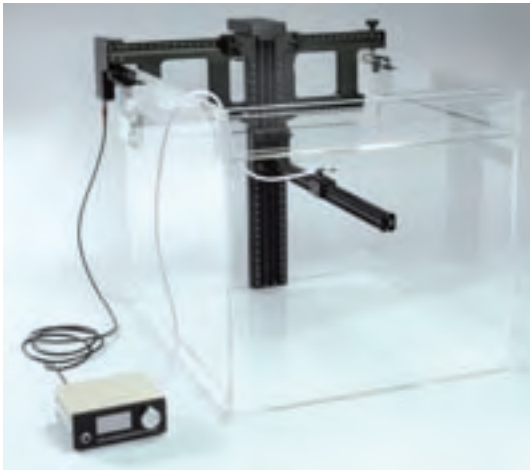

The 7304 3D ARM Scanning System is the most efficient and accurate water phantom available on the market today. All the components of the ARM scanner are either anodized aluminum or stainless steel, eliminating problems with corrosion. As a result, distilled or undistilled water can be used.

High-precision lead screws drive the scanner, which is a superior design to timing belts. This design allows a precision of better than 0.1 mm for all axes. Stepping motors drive the

lead screws and a combination of software and firmware allows scanning with either stepping or continuous motion.

The controller is housed in a convenient (LxWxH) 18 cm x 18 cm x 6 cm package. Dual amplifier, channel, and A/D converters are located inside the microprocessor, which controls the entire system. All electronics stay in the room and are connected to the remote computer via a thin serial line.

The hardware design allows the three modules of the 3D scanner to be assembled or disassembled in less than five minutes. Leveling is achieved by leveling the scanner to the water (not the tank) either electronically or by mechanically adjusting just two points.

Key features

- Setup time is less than five minutes
- Included software with Home Reset, Auto Center, and Continuous Scanning features to boost efficiency
- 0.1 mm positioning accuracy coupled with 0.1 mm sampling provide extremely accurate results
- Auto-Center function automatically finds center of radiation field, saving valuable time
- Firmware and software allows use of stepping motors in continuous-motion mode
- Sampling rates of 0.1 mm, 0.2 mm, and 0.5 mm using the unique high-resolution mode
- > 41,000 samples-per-step assists in low-signal situations using electron beams
- Included software allows scanning without a reference for very small fields
- May be used with alternate detectors: THEBES® II 47 ion chamber array, as well as diodes; integration software available for full compatibility with THEBES II

Specifications

Scanner components material	Anodized aluminum or stainless steel
Water tank material	Acrylic
Water tank dimensions (LxWxH)	62 cm x 62 cm x 54 cm
Water tank scanning area (LxWxH)	50 cm x 50 cm x 40 cm
Water tank capacity	Maximum water volume and weight 175 liters, 175 Kilos
Axes	All driven by lead screw for accuracy
Positioning accuracy	0.1 mm
Measurement accuracy	0.5 %, except for radial motion
Leveling	Levels the scanner, not the water tank
Portability	The scanner assembles/disassembles in approx. 5 minutes
Perpendicularity	± 0.15 degrees
Interface	All major treatment planning systems
Software	All conventional protocols, TG-21 and TG-51 with complete analysis of parameters for photons and electrons. Tables of Percentage Depth Dose (PDD), Tissue Max Ratio (TMR), and Tissue Phantom Ratio (TPR). Compatible with Windows® 2000, Windows XP®
Shipping information (LxWxH)	4 cartons. Lift table: 20 in x 36 in x 48 in, 265 lb; Tank: 33 in x 32 in x 28 in, 75 lb; Scanner case, box, cables, chamber, misc.: 39 in x 35 in x 19 in, 114 lb; Submersible pump and hose: 16 in x 16 in x 11 in, 11 lb

Optional accessories

- 7305** Lift table for the ARM 3D scanning system
- 7303-CHEXR** ARM holder for Exradin A14 and A12 ion chambers
- 7303-CHFT06** ARM holder for Farmer type 0.6 cc ion chamber
- 7303-CH01** ARM holder for PTW 0.125 cc, PTW 0.3 cc, Exradin 0.125 cc ion chambers
- 7303-MPP** ARM holder for Markus Parallel Plate ion chamber
- 7307** Training to support water tank implementation
- 7308** Software interface for 7304 connection to THEBES II
- 7020** THEBES II 47 ion chamber array
- 57-051** Lead foil for TG-51, 1 mm x 20 cm²

Ordering information

7304 Scanner, Water Tank and Software

Else Philips Service, Trenčín

37-705

VeriDose®
PDMQC System

Our innovation and leading-edge technology combines the powerful performance capabilities of patient dose monitoring and linear accelerator quality control into one compact, easy-to-use product. We give you this powerful combination of technology and versatility for a lower price than you would expect to pay for one unit alone.

Use VeriDose PDMQC as a patient dose monitor and when needed, just simply plug in the VeriDose QC Module and VeriDose PDMQC is transformed into a precision linear accelerator quality control device.

Specifications

Electrometer	
Input circuitry	Five electrometer channels with digital zeroing and gain control; bi-polar
Rate range	1.0 to 1000 cGy/min
Dose range	0.1 to 1000 cGy
Sensitivity adjustment	0.1 to 10 nC/cGy
Display	240 x 64 dot LCD. 8 lines x 40 characters, with CCF backlight
Clock	Real time clock, battery operated, US or European format
Alarm	User-selectable level for each channel
User controls	On-Off switch, 5-column select soft-keys for control functions, scroll-up, scroll-down, and enter key for data entry
User setup parameters	Stored in nonvolatile, battery-backup RAM
Computer interface	RS-232, 19.2 BAUD, 8, N, 1 Data format: standard decimal points or Euro-commas
Printer interface	Parallel, selectable drivers for LaserJet in ASCII format only
Environmental	Storage temperature: 0 °C to 70 °C (32 °F to 158 °F) Operating temperature: 10 °C to 30 °C (50 °F to 86 °F) Relative humidity: 5 % to 95 %, non-condensing
Power requirements	120 V ac, 60 Hz or 230 V ac, 50 Hz to 12 V dc @ 1A AC adapter, UL, CSA, CE
Dimensions (WxDxH)	22.9 cm x 21.6 cm x 6.4 cm (9 in x 8.5 in x 2.5 in) (EMI shielded)
Weight	1.2 kg (2.5 lb)
Phantom	
Detector	Five diode detectors
Energy range	Photon: 4 MV to 25 MV Electron: 5 MeV to 25 MeV
Sensitive volume	0.25 mm ³
Sensitivity	1.5 nC/cGy
Diode polarity	Negative
Rad damage at 10 kGy	< 15 %
Detector configuration	Flatness/Symmetry One central axis. Four orthogonally-positioned at 8 cm off central axis in the transverse and radial dimensions. Off-axis detectors are positioned at 80 % of field size for flatness and symmetry measurements Energy constancy Detector depth positions: 4.5, 12.5 and 20.5 cm
Interface cable	15 m (50 ft)
Buildup	1.9 cm acrylic (2.3 g/cm ²)
Dimensions (WxDxH)	25 cm x 25 cm x 3.8 cm (9.85 in x 9.85 in x 1.5 in)
Weight	11.6 kg (5.25 lb)

Key features

- Measures beam constancy, flatness, and symmetry
- Two systems in one
- Accurate to within 1 % or better
- Measurements and updates are provided in real time.
- Automatically adjusts the proper offset voltage for each detector, resulting in up to ten times less drift than other products
- VeriDose PDMQC stores up to 25 separate calibration sets. (A calibration set can be created for up to five diodes at a time.)
- In vivo measurements with the VeriDose PDMQC as a patient dose monitor are reimbursable under CPT-4 Section 77331 Special Dosimetry
- When interfaced with a standard printer, you can print patient treatment dose reports, date and time of the procedure, diode detector group and serial number

Optional accessories

- 37-705-2100 VeriDose Excel Add-In Software, CD, 32 bit version
- 30-492-1000 Diode Holder, with five slots
- 30-492-5200 Calibration Jig, with six slots
- 30-471 VeriDose Solid-State Diode Detectors (see next page for diode specifications)

Ordering information

- 37-705 VeriDose V Electrometer
- 37-705-7777 VeriDose PDMQC System, consists of electrometer, Excel add-in software, and VeriDose PDMQC Phantom

30-471

VeriDose® Solid-State Diode Detectors



Using the VeriDose Patient Dose Monitor Quality Control (PDMQC) System or the VeriDose V Patient Dose Monitor in conjunction with VeriDose Solid-State Diode Detectors, you can verify the given dose quickly and accurately during treatment, thus



avoiding potential misadministration of radiation.

VeriDose Solid-State Diode Detectors are silicon-based radiation detectors that utilize a p-n junction. These rugged diodes are encased within a biocompatible polystyrene material. A low noise coaxial cable with BNC connectors is used to connect the diode to an electrometer. When attached to an electrometer, these diodes provide enhanced sensitivity and instantaneous response time.

- Optimized for use with all Fluke Biomedical's Patient Dose Monitors and high-quality medical-grade ionization chamber electrometers
- All diodes are supplied with a noncrimp repairable cable with a coax BNC connector

Key features

- Designed to provide superior response, reliability, and performance
- Long-lifetime diodes. Tested to 2×10^6 cGy in a high-energy electron beam, the most damaging radiation
- Very low dose rate and temperature dependence
- Hemispherical shape improves isotropic response and reduces angular and field-size dependencies
- Waterproof design with appropriate buildup for all clinical photon and electron energies
- Flat bottom permits secure, easy placement on the patient
- Dose rate independent
- Responds to photons and electrons
- Responds to dose rates of 1.0 to 1000 cGy/min
- Can be used on continuous (^{60}Co) x-ray beams, pulsed (linear-accelerator) x-ray beams, and electron beams

Specifications

Photon and electron diode detectors	
Nominal sensitivity	1.5 nC/cGy
Sensitivity volume	0.25 mm ³
Output polarity	Positive/Negative
Linearity	< 0.1 % for dose ranges from 0.01 to 10 Gy; < 0.1 % for dose rates 3 to 5 Gy/min
Reproducibility	0.2 %
Angular dependence	< 2 % ± 60° for lower energy diodes (30-471 and 30-472); < 2 % ± 10°; < 5 % ± 60° (for higher energy photon diodes and electron diodes)
Sensitivity loss at 10 kGy	< 15 %
Cable length	3 m (10 ft)
Dimensions	8 mm Ø
Weight	42 gm

Model	Range	Polarity/Color	Buildup	Buildup (g/cm ²)	Electrometer
30-471	1 mV to 4 mV	Positive/Blue	Cu	0.732	37-720
30-471-8000	1 mV to 4 mV	Negative/Blue			37-705
30-472	5 mV to 11 mV	Positive/Yellow	Cu	1.359	37-720
30-472-8000	5 mV to 11 mV	Negative/Yellow			37-705
30-473	12 mV to 17 mV	Positive/Red	W	2.606	37-720
30-473-8000	12 mV to 17 mV	Negative/Red			37-705
30-474	18 mV to 25 mV	Positive/Green	W	3.574	37-720
30-474-8000	18 mV to 25 mV	Negative/Green			37-705
30-475	5 mV to 25 MeV	Positive/Grey		0.284	37-720
30-475-8000	5 mV to 25 MeV	Negative/Grey			37-705

Optional accessories

88-490 Diode Extension Cable, 9 m (30 ft)

88-490-1000 Diode Extension Cable, 3 m (10 ft)

Ordering information

30-471 VeriDose Diode, 1-4 mV Photons, Positive Polarity, Blue

30-471-8000 VeriDose Diode, 1-4 mV Photons, Negative Polarity, Blue

30-472 VeriDose Diode, 5-11 mV Photons, Positive Polarity, Yellow

30-472-8000 VeriDose Diode, 5-11 mV Photons, Negative Polarity, Yellow

30-473 VeriDose Diode, 12-17 mV Photons, Positive Polarity, Red

30-473-8000 VeriDose Diode, 12-17 mV Photons, Negative Polarity, Red

30-474 VeriDose Diode, 18-25 mV Photons, Positive Polarity, Green

30-474-8000 VeriDose Diode, 18-25 mV Photons, Negative Polarity, Green

30-475 VeriDose Diode, 5-25 MeV Electrons, Positive Polarity, Grey

30-475 VeriDose Diode, 5-25 MeV Electrons, Negative Polarity, Grey

Also Philips Service, Trenčín

37-720

Dual-Diode Dosimeter
Patient Dose Monitor

Excessive radiation exposure (misadministration) to the patient is always a matter of concern in radiation therapy. The Dual-Diode Dosimeter eliminates this concern by providing a dosimetry system specifically designed to verify the amount of radiation received by the patient during treatment.

Measurements are presented on a large digital display with a range of 0 to 2000 Rad or Rad/minute. The electrometer accepts either one or two diode detectors, which are selected using a front-panel switch. Calibration and zero adjustments, as well as dose or dose rate selection, are all readily accessible on the front panel. While the Dual-Diode Dosimeter is not intended as a primary calibration device, it can also be used to accurately determine therapy machine output.

Specifications

Accuracy	± 5 %
Reproducibility	± 5 %
Range	0 to 2000 Rad or Rad/minute
Readout	0.5 inch high digits on display
Front controls	On/Off, Dose/Rate, Detector A/Detector B, reset, Trimpots for Zero, and Calibration for Detectors A and B
Rear connections	Detector A and B input
Power requirements	9 V battery or equivalent
Dimensions (WxDxH)	15.24 cm x 16.51 cm x 7 cm (6 in x 6.5 in x 2.75 in)
Weight	0.9 kg (2 lb)

Key features

- Provides instant patient data on radiation exposure to sensitive organs and rapid checks of equipment output
- Prevents the potential for misadministration
- Battery operated
- Provides instantaneous readings on the radiation dose being delivered to the patient
- Designed for use with positive polarity diodes only

Optional accessories

30-492 Diode Detector Holder; 7 in x 7 in x 0.5 in thick clear acrylic plate routed to hold six diodes in a level, reproducible position during field measurements

Ordering information

37-720 Dual-Diode Dosimeter Patient Dose Monitor

37-105

mobileMOSFET Wireless Dose Verification System



Key features

- Small, isotropic, direct read dose verification system
- One to five dosimeters or one linear array
- Accurate, non-shielding
- Brachytherapy, IMRT
- Radiosurgery, TBI (total body irradiation), diagnostic x-ray
- Reader houses wireless transceiver
- Bluetooth® technology
- IMRT QA and phantom work
- Brachytherapy
- IGRT/tomotherapy
- Intracavitary measurement

37-105 mobileMOSFET Dose Verification System takes MOSFET Dosimetry to the next level. The mobileMOSFET is a portable, easy to use, seamlessly integrated system that simplifies dosimetry and minimizes QA time, making it ideal for a busy Radiotherapy center. For example, one Reader Module can be easily shared between multiple treatment rooms (with LAN connections and additional transceivers).

This new wireless system is entirely software driven allowing for remote control of one or more systems from a PC. The system consists of Remote Monitoring Dose Verification Software, wall-mounted Bluetooth Wireless Transceiver, and a small Reader Module that acts as a channel between the MOSFET and software and provides a final dose report for patient records. Up to five MOSFETs or one Linear Five Array can be plugged into one module. This provides easy mobility within the treatment room. The PC is online with the Reader Module and dose is obtained in real-time.

Specifications

MOSFET Sensitivity		
Under full build-up	1 mV/cGy on standard bias	
	2.7 mV/cGy on high sensitivity bias (Higher sensitivities available)	
Under x-ray energies	9 mV/R on high sensitivity bias	
Dose	Bias supply	
	Standard	High
200 cGy	< 2 %	< 0.8 %
100 cGy	< 3 %	< 1.2 %
20 cGy	< 8 %	< 3 %

System dose-to-dose reproducibility at 1 σ

37-105

mobileMOSFET Wireless Dose Verification System

Specifications

Software

Interactive, 2-way on-line communication between a PC and the reader module
Dose obtained in real-time
Able to perform all dose data measurements with a few mouse clicks
Calibration feature enables quick and easy calibration of the MOSFETs
Capability to assign Calibration Factors, Correction Factors and Target Dose to each MOSFET
Final dose and percent deviation from target are automatically calculated
Export to MS Excel and MS Word
Set interval read times to sample multiple doses during treatment (automatic or manual control)
With multiple systems and transceivers, one PC can read MOSFETs in multiple treatment rooms simultaneously
Patient records can be saved, imported, and printed
Final dose report provided

Hardware

Wireless transceiver: Bluetooth transceiver (wall mounted)
Reader module: Small size (17.8 cm x 15.9 cm x 4.2 cm)
Wireless (up to 10 m), portable and mobile
Contains reader, Bluetooth transceiver, dual bias supply settings (high and standard), ports for 5 MOSFETs and 1 linear array
One reader module can be used for 1 to 5 MOSFETs or one linear array
Battery operated (rechargeable; > 20 hours of typical use)
Built-in smart charger (< 3 hours)
Up to 40 MOSFETs can be read on-line with additional systems and transceivers
Portability between multiple treatment rooms

The MOSFET dosimeter

One dosimeter/ calibration factor for all photon and electron modalities
Isotropic ($\pm 2\%$ for 360°)
Active region of 0.2 mm x 0.2 mm
Permits pinpoint measurement without patient shielding
Dose-rate and temperature independent
Unobtrusive in procedures
Lightweight and flexible
Multiple dosimeter capability with one reader
Standard MOSFET is 2 mm wide
microMOSFET is 1 mm wide
Linear 5ive Array: 5 dose points on one flex

Included accessories

- 37-105-1000 Wireless Transceiver Bluetooth wall mount
- 37-105-2000 Cable, RS-232, 15 m (50 ft)
- 37-105-3000 Software License for mobileMOSFET Remote Monitoring Dose Verification
- 37-100-1005 MOSFET Dosimeters with Radiopaque Marker, package of five

Ordering information

- 37-105 mobileMOSFET Wireless Dose Verification System
- 37-105-LA5 mobileMOSFET Wireless Dose Verification System with Linear 5ive MOSFET Array

Optional accessories

- 37-100-1003 MOSFET Dosimeters with Reinforcement, package of five
- 37-100-1004 MOSFET Dosimeters with Reinforcement, package of two
- 37-100-1005 MOSFET Dosimeters with Radiopaque Marker, package of five
- 37-100-1006 MOSFET Dosimeters with Radiopaque Marker, package of two
- 37-102-1003 High Sensitivity MOSFET Dosimeters with Reinforcement, package of five
- 37-102-1004 High Sensitivity MOSFET Dosimeters with Reinforcement, package of two
- 37-102-1005 High Sensitivity MOSFET Dosimeters with Radiopaque Marker, package of five
- 37-102-1006 High Sensitivity MOSFET Dosimeters with Radiopaque Marker, package of two
- 37-103-1003 microMOSFET Dosimeters with Reinforcement, package of five
- 37-103-1004 microMOSFET Dosimeters with Reinforcement, package of two
- 37-103-1005 microMOSFET Dosimeters with Radiopaque Marker, package of five
- 37-103-1006 microMOSFET Dosimeters with Radiopaque Marker, package of two
- 37-103-1007 MOSFET Dosimeters (5 pack) - customized with 10 ft cables
- 37-104-1003 High Sensitivity microMOSFET Dosimeters with Reinforcement, package of five
- 37-104-1004 High Sensitivity microMOSFET Dosimeters with Reinforcement, package of two
- 37-104-1005 High Sensitivity microMOSFET Dosimeters with Radiopaque Marker, package of five
- 37-104-1006 High Sensitivity microMOSFET Dosimeters with Radiopaque Marker, package of two
- 37-105-1000 Wireless Transceiver Blue Tooth wall mount
- 37-105-1001 (LAN) Local Area Network adapter for the 37-105-100
- 37-105-1002 LAN and Blue Tooth Wireless Transceiver Package
- 37-100-3012 Build-up Cap, 1 cm, package of one
- 37-100-3002 Build-up Cap, 1 cm, package of five
- 37-100-3009 Build-up Cap, 1.5 cm, package of one
- 37-100-3004 Build-up Cap, 1.5 cm, package of five
- 37-100-3011 Build-up Cap, 2 cm, package of one
- 37-100-3006 Build-up Cap, 2 cm, package of five
- 37-100-3007 Build-up Caps, 3 pack: 1, 1.5 and 2 cm
- 37-100-4000 XWU-IMRT Phantom, for a minimum of 9 dose points and film (only to be used with the MOSFET System)
- 37-105-4000 Linear 5ive MOSFET Array (5 MOSFETS on one flex array)

7600

Double Check® Pro
Daily Check Device

The 7600 Double Check Pro is a portable, easy-to-use, daily check device for therapy beam quality assurance. Ten ion chambers are positioned to simultaneously check beam constancy, symmetry, flatness, and energy constancy. Nine ion chambers are used for verification of flatness, symmetry, and dose constancy while a special

filtered ion chamber provides energy constancy information. The bright color LCD touch screen display and the user interface, make the unit easy-to-use. Internal and external Flash memory along with several different computer interfaces allow flexible measurement storage, comparison and archival record keeping.

The Double Check Pro consists of a detector array and software for performing linear accelerator quality assurance using physicist preferred air ion chamber technology for dose measurement, avoiding the radiation damage issues of diode detectors. Windows® CE based software acquires beam profile data from the detector array. The beam profile is displayed numerically or graphically. Beam profile analysis such as flatness and symmetry is performed and is saved in a database resident on the unit, facilitating daily, weekly, yearly checks, aiding in following the guidelines in TG-40. The data is also available for correlation to TG-51 data.

Specifications

Display	
Dot pixels	320 x 3 [RGB] (w) x 240
Dot size (WxH)	0.10 mm x 0.34 mm
Dot pitch (WxH)	0.12 mm x 0.36 mm
Viewing area (WxH)	122.0 mm x 92.0 mm
LCD type	F-STN/color-mode/transmissive
Backlight	Cold cathode fluorescent lamp
Detector	
Material	Acrylic
Standard field size	20 cm x 20 cm or 10 cm x 10 cm
External chamber cavity	Side cavity provided for farmer-type ion chamber (0.6 cc), allowing central axis calibration
Ion chamber buildup (all chambers)	5 mm acrylic, 0.28 mm polycarbonate; 0.8 mm polyethylene
Ion chambers	Ten air vented
Ion chamber configuration	One central axis; four 4 cm off-axis; four 8 cm off-axis; energy constancy chamber for external filters @ 9 cm off-axis
Ion chamber nominal bias voltage	300 V dc
Ion chamber diameter/volume	1.27 cm/0.65 cc
System	
Dose range	50 to 1000 rad/min; 0.50 Gy to 10 Gy/min
Beam type energy	Photons: 2 mV to 25 mV Electrons: 2 MeV to 25 MeV
Operating temperature	Minimum 10 °C, maximum 40 °C
Dimensions (WxDxH)	23 cm x 47.9 cm x 5.8 cm (9 in x 18.9 in x 2.3 in)
Weight	2.88 kg (6.34 lb)

Key features

- Daily check device including 10 air-vented ion chambers
- Efficient workload planning
- Wireless state-of-the-art communications (optional)
- Limitless data storage
- User-friendly interface
- Thorough data analysis
- Automatic atmospheric beam corrections
- Flexible weekly scheduling
- User created protocols
- Tabular or graphical data presentation
- Large, bright, easy-to-use color touch screen

Optional accessories

- 7600KBD** Compact Keyboard, USB
- 7600CAB** 23 m (75 ft) Communications Cable includes ethernet crossover RJ-45
- 7600WCF** Wireless Compact Flash Card, 802.11b
- 7600CFM** Compact Flash Memory Card, 256 MB
- 7600WR** Wireless Router, 802.11b
- 7600WLS** Victoreen Double Check Pro Wireless Kit. Includes Wireless Compact Flash Card, 802.11b; Wireless Router, 802.11b; and 23 m (75 ft) Communications Cable

Included accessories

- 7600USB** USB Cable, 6 ft
- 7200-50** Stainless Steel Filter Set: 0.46, 0.61, 0.76, 0.91, 1.5, 1.9, 3.0, 3.6, 5.0, 10, 15, 30 mm
- 171063** Buildup Plates, 1 cm, 3 each
- 7600AC** Universal 6 V dc AC Adapter

Ordering information

- 7600** Double Check Pro Daily Check Device
- Elso Philips Service, Trenčín

05-433

PRIMALERT® 10 Teletherapy Radiation Monitor



The 05-433 PRIMALERT® 10 Teletherapy Radiation Monitor is a compact monitor that responds to scatter radiation and can be mounted anywhere in the treatment room. A pair of bright red lamps on the instrument face flash a warning when the source is exposed, and will continue to flash, until



safe conditions are re-established. The flashing green Operation Indicator light indicates continuous monitoring of background radiation and provides visible indication that the instrument is functioning. PRIMALERT® 10 comes with a self-stick wall-mounting bracket and an ac adaptor/power converter.

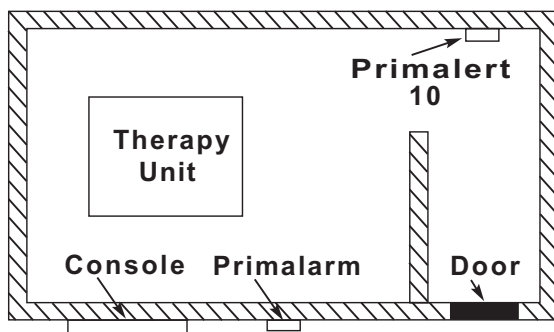

Key features

- Flashing lights indicate source is exposed
- Line-operated
- Optimized for use with Primapak II Backup Battery Pack

Optional accessories

62-103 Check Source, 137Cs, 10 µCi. Flat Disc, 1 inch diameter

05-441 Primapak II Backup Battery Pack, 110 V

05-434 Primalarm Remote Alarm

Available ac adapters for 05-441 (specify with order)

14-102 110 V ac, 12 V dc 500 mA, USA, Japan

14-103 230 V ac, 12 V dc 500 mA, Europe

14-104 230 V ac, 12 V dc 580 mA, UK

14-105 230 V ac, 12 V dc 580 mA, Australia

Available ac adapters for 05-434 (specify with order)

14-314 110 V ac 12 V dc, 500 mA, USA, Japan

14-400 230 V ac 12 V dc, 500 mA, Europe

14-417 230 V ac 12 V dc, 580 mA, UK

14-436 230 V ac 12 V dc, 580 mA Australia

Specifications

05-433 PRIMALERT® 10 Teletherapy Radiation Monitor	
Detector	Energy-compensated GM tube
Accuracy	± 20 % from 60 keV to 2 MeV
Alarm trip level	Switch-selectable at 2.5 or 20 mR/hr
Alarm	Two flashing red lamps with a 180° field of view. Alarm ceases when radiation falls below trip level
Power requirements	Line-operated with UL-listed converter (105 to 125 V ac, 60 Hz to 12 V dc). Also can be powered by Primapak II
Dimensions (HxWxT)	15.24 cm x 8.89 cm x 3.81 cm (6 in x 3.5 in x 1.5 in)
Weight	0.91 kg (2 lb)
05-434 PRIMALARM™ Remote Alarm	
Alarm trip level	Controlled by PRIMALERT 10
Alarms	Two flashing red lamps with a 180° field of view. The aural alarm is switch-selectable.
Power requirements	Line-operated with UL-listed converter. Also can be powered by PRIMAPAK II (05-441). 220 V with optional converter
Dimensions (HxWxT)	15.24 cm x 8.89 cm x 3.81 cm (6 in x 3.5 in x 1.5 in)
Weight	0.45 kg (1 lb)
05-441 PRIMAPAK II Backup Battery Pack	
Dimensions (HxWxT)	15.24 cm x 11.43 cm x 7 cm (6 in x 4.5 in x 2.75 in)
Weight	1.8 kg (4.5 lb)

Ordering information

05-433 PRIMALERT 10 Teletherapy Radiation Monitor

Available ac adapters for 05-433 (specify with order)

14-314 110 V ac, 12 V dc 500 mA, USA, Japan

14-400 230 V ac, 12 V dc 500 mA, Europe

14-417 230 V ac, 12 V dc 580 mA, UK

14-436 230 V ac, 12 V dc 580 mA, Australia

37-731

Precision Isocentric
QC Beam-Checker II

This precision quality control tool is ideal for daily, weekly and monthly quality control assessments of all mechanical and geometrical parameters of linear accelerators or teletherapy units.

The Precision Isocentric Beam Checker II consists of a large opaque acrylic screen backed by a secondary plate, both supported by two uprights. The screen is inscribed with lines precisely defining the corners, edges and

center of the screen's 10 cm x 10 cm and 20 cm x 20 cm fields. Intersecting center lines are inscribed with short lines spaced 1 cm apart. The screen can rotate about its axis in increments of 45°. Tungsten markers of 2 mm in diameter are embedded in the center and corners of the fields.

A 10 in x 12 in ready-pack film can be sandwiched between the two plates. When exposed, the tungsten markers project a sharp image on the film, thus eliminating the inaccuracy and need to prick holes into the film.

The device's acrylic base-plate has an attached bubble level and non-slip leveling legs that allow it to be quickly and conveniently set up for use.

Key features

For checks of:

- Radiation and light-field congruence
- Collimator isocentricity
- Collimator field-size accuracy
- Gantry isocentricity
- Table isocentricity
- ODI accuracy
- Isocenter rotational stability
- Laser alignments

Specifications

Material	White and clear acrylics
Markers	Tungsten spheres; 2 mm Ø
Screen dimensions	30.5 cm x 30.5 cm (12 in x 12 in)
Overall dimensions (WxDxH)	15.2 cm x 45.7 cm x 33 cm (6 in x 18 in x 13 in)
Weight	2.7 kg (6.1 lb)

Ordering information

37-731 Precision Isocentric QC
Beam-Checker II

Else Philips Service, Trenčín

37-001

TEL-ALIGN™ Teletherapy Alignment Gauge*



Accuracy begins with beam alignment. It is impossible to deliver the carefully calculated plan if the beam position is not verified. TEL-ALIGN verifies the coincidence of the light and radiation fields and checks the isocenter variation and the optical back pointer when the gantry is rotated $\pm 90^\circ$.

TEL-ALIGN consists of a rectangular plastic base with a removable vertical scale. The top surface of the base contains lead markers that form

a square (10 cm x 10 cm) for visualization on film. A crosshair in the center of the square lines up with two additional sets of crosshairs, one on each outer edge of the base.

The vertical scale is placed on the base to check the optical distance indicator, or a film can be placed under the base to check the light field versus the radiation field. By rotating the gantry angle at $\pm 90^\circ$, the isocenter variation and optical back pointer are also checked. If adjustment of machine geometry is needed, it can be done quickly and easily, with the TEL-ALIGN Teletherapy Alignment Gauge in place.

Key features

Permits checks of:

- Optical distance indicator (over a 15 cm range)
- Collimator and central crosshair
- Head rotation and pitch
- Isocenter variation
- Side lights and optical back pointer
- Light field vs. radiation field

Specifications

Dimensions (WxDxH)	Base: 14 cm x 18 cm x 2 cm (5.51 in x 7.09 in x 0.79 in)
	Vertical scale: 18 cm (7.09 in)
Weight	0.91 kg (2 lb)

Ordering information

37-001 TEL-ALIGN Teletherapy Alignment Gauge

* Designed and developed by the Medical Physics Department, Memorial Sloan Kettering Hospital, New York, NY 10021.

37-013

GARD™ (Geometric Accuracy Radiotherapy Device)

The GARD* (geometric accuracy radiotherapy device) is designed to fit into the shadow tray of the therapy machine, providing a fixed reference point for all measurements. This helps to eliminate errors associated with using independent devices for each geometric parameter.

The Gard very precisely measures, gantry and collimator angle indicators; Oight and radiation fird coincidence; Optical distance indicator and laser alignment.

Key features

- Geometric accuracy reproducibility device
- Designed to verify geometric accuracy of linear accelerators and simulators
- Provides quick visual verifications
- Helps eliminate errors
- Custom manufactured to fit any machine

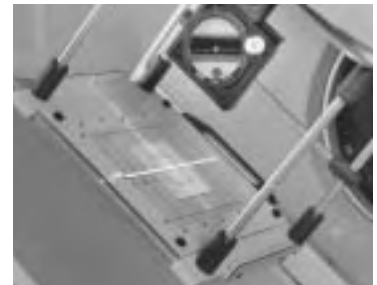

Digital angle indicator alignment

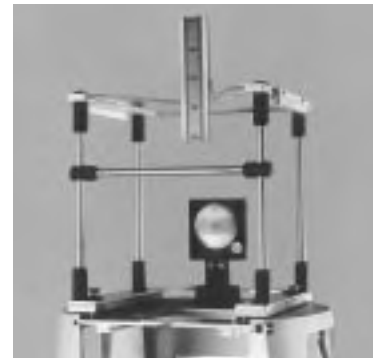

Optical distance indicator test

Specifications

Goniometer accuracy/ resolution	0.1°
Optical distance indicator resolution	1.0 mm
Field size indicators	5 cm x 5 cm, 10 cm x 10 cm, 15 cm x 15 cm, 20 cm x 20 cm
Dimensions (WxDxH)	13.5 cm x 13.5 cm x 14.5 cm
Weight	4.3 kg (9.5 lb)

Alignment Tool	
Optical distances	5 cm steps to 40 cm
Material	White plastic w/mat finish and black dots
Ball pointer	12 inch L with 1/16 inch Ø ball
Rod clamp base	13 cm x 10 cm x 0.50 inch zinc plated steel with rubber feet
Height	43 cm (17 in)
Weight	1.8 kg (4 lb)

* Designed by A. Kalend, Ph.D., and L. Reinstein, Ph.D., State University of New York at Stony Brook.

Optional accessories

37-013-2000 Film Cassette, 8 in x 10 in
37-013-1300 Optical Distance Verification and Alignment Tool

Included accessories

One 8 x 10 inch film cassette

Ordering information

37-013 GARD. Custom-manufactured to fit the shadow tray of any therapy machine. Specify manufacturer's model number when ordering.

Elsø Philips Service, Trenčín

30-331

Advanced Markus™ Electron Ionization Chamber, 0.02 cc³, Waterproof



The 0.02 cc Advanced Markus Chamber is our newest development in plane-parallel electron ion chambers. This chamber combines the advantages of both Roos™ and Markus chamber types into one truly exceptional plane-parallel electron chamber. Developed for relative and absolute electron dosimetry in water or solid type phantoms, the advanced design of this chamber makes it possible to perform absolute electron dosimetry without perturbation effects.

This chamber is designed in strict accordance with the recommendations of IEC 60731 and it is waterproof. Since the outer shape is identical to that of the Markus chamber, all existing Markus chamber phantom plates and adapters can be used with the Advanced Markus chamber. The small sensitive volume makes this chamber ideal for dose distribution measurements in a water phantom, giving a good spatial resolution. An improved design of the guard ring reduces the influence of scattered radiation from the housing, and makes it possible to perform absolute electron dosimetry without perturbation effects.

Key features

- Vented sensitive volume of 0.02 cc
- Same dimensions as the Markus chamber

Specifications

Type of product	Vented plane-parallel chamber type 34045 with guard ring
Application	Dose and dose rate measurements in high-energy electron beams
Measuring quantities and units	Absorbed dose to water (Gy); absorbed dose rate to water (Gy/min)
Radiation quality	Electrons 2 to 45 MeV
Response	670 pC/Gy
Sensitive volume	0.02 cm ³
Directional dependence	The deviation of the response following tilting of the chamber by up to 10° is smaller than 0.1 %
Entrance window	Polyethylene (CH ₂) foil with 0.03 mm thickness
Electrode	Acrylic (PMMA), graphite coated 5 mm Ø
Area density	2.5 mg/cm ²
Reference point	Center of entrance foil
Chamber voltage	Maximum 400 V
Leakage current	± 4 fA
Cable leakage	Less than or equal to 1 pC/(Gy · cm)
Ion collection time	150 V 44 µs 300 V 22 µs 400 V 17 µs
Range of temperature	10 °C to 40 °C, 50 °F to 104 °F
Range of relative humidity	10 % to 80 %, max 20 g/m ³
Range of air pressure	700 to 1060 hPa
Temperature equilibrium	2 to 3 min/K
Pressure equilibrium	Less than or equal to 10 s

Included accessories

BNC Triax connector and PMMA buildup cap

Ordering information

30-331 Advanced Markus Electron Ionization Chamber, 0.02 cm³, Waterproof

Other types of triaxial cable connectors available

30-351

Farmer-Type Ionization Chamber,
0.6 cc³, Waterproof

The waterproof 0.6 cc ionization chamber is designed for absolute dosimetry in radiation therapy. Since the chamber is waterproof, it may be used in water phantoms and does not require a protective sleeve. It is rugged in construction and has a PMMA/graphite thimble and an aluminum electrode. This chamber includes a 10 m (33 ft) cable, BNC Triax connector, and a PMMA buildup cap.

Key features

- Completely waterproof, does not require protective sleeve
- Can be safely used in water phantoms and solid state phantoms
- Open volume, vented at connector
- Fully guarded up to the measuring volume
- Touchable parts free of high voltage
- Extension cables up to 100 meters in length are available

Specifications

Volume	0.6 cm ³
Response	$2 \cdot 10^{-8}$ C/Gy
Leakage	$\pm 4 \cdot 10^{-15}$ A
Polarizing voltage	Maximum 500 V
Cable length	10 m (33 ft)
Cable leakage	10^{-12} C/(Gy · cm)
Wall material	PMMA (C ₅ H ₈ O ₂), Graphite (C)
Wall density	1.19 gm/cm ³ (PMMA), 1.85 gm/cm ³ (C)
Wall thickness	0.335 mm PMMA, 0.09 mm C
Area density	56.5 mg/cm ²
Electrode	Aluminum, 1.1 mm Ø, 21.2 mm long
Nominal useful range	30 keV to 50 MeV
Range of temperature	10 °C to 40 °C
Range of relative humidity	10 % to 80 %
Ion collection time	300 V 0.18 ms
	400 V 0.14 ms
	500 V 0.11 ms

Saturation behavior	Polarizing voltage	99.0 % saturation	99.5 % saturation
Maximum dose rate at continuous irradiation	300 V	5.70 Gy/s	2.80 Gy/s
	400 V	10.00 Gy/s	5.00 Gy/s
	500 V	16.00 Gy/s	7.80 Gy/s
Maximum dose rate per irradiation pulse	300 V	0.69 mGy	0.34 mGy
	400 V	0.91 mGy	0.46 mGy
	500 V	1.14 mGy	0.57 mGy

30-351

Farmer-Type Ionization Chamber, 0.6 cc³, Waterproof

Diagram (Approximate dimensions in mm, drawing not to scale)

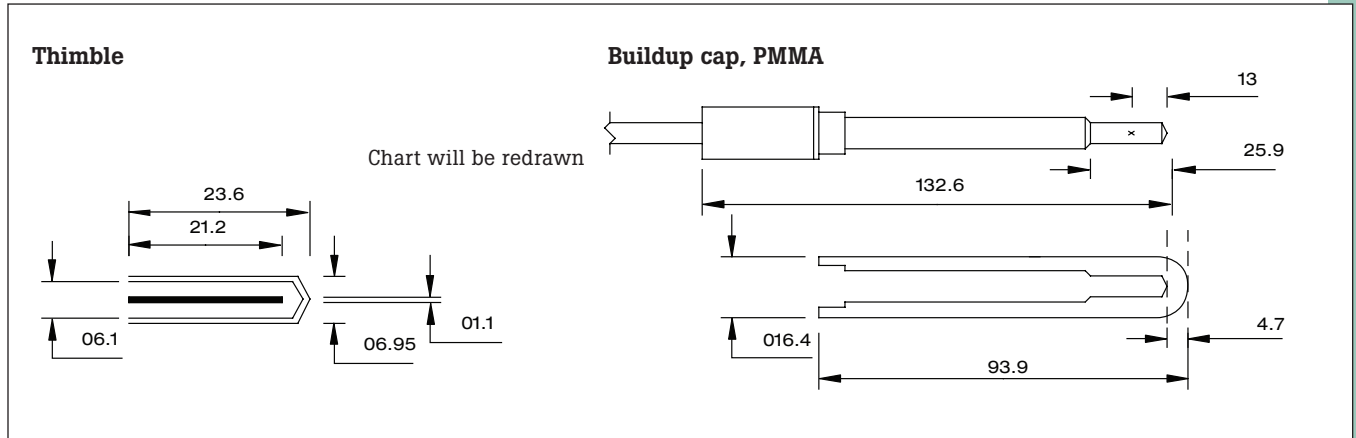

Energy dependence

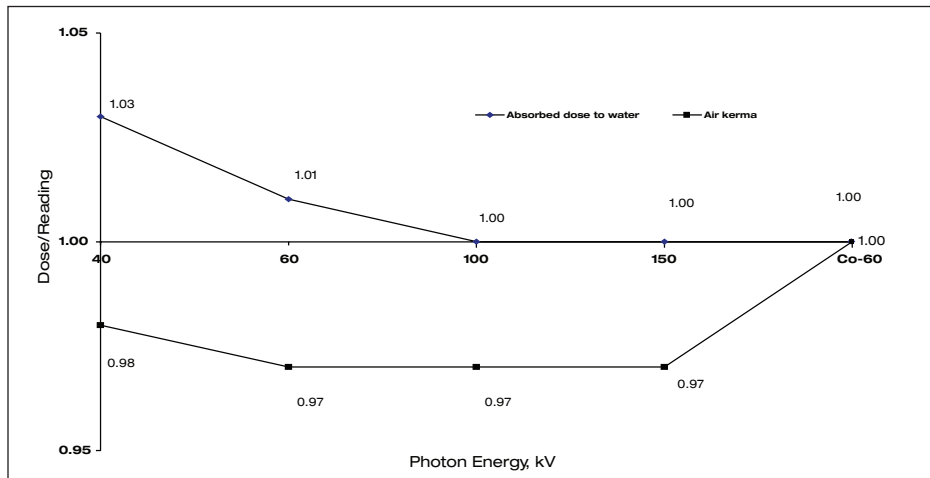

Directional dependence

in Air												
Reading/Dose, %	6°	12°	18°	24°	30°	60°	90°	120°	150°	162°	174°	180°
70 kV	20	48	69	81	88	99	100	100	98	96	91	88
140 kV	36	66	82	90	94	100	100	100	100	98	96	94
280 kV	57	80	90	94	96	100	100	100	100	99	98	97
Co-60	67	85	91	95	97	100	100	100	100	99	99	98

in PMMA												
Reading/Dose, %	6°	12°	18°	24°	30°	60°	90°	120°	150°	162°	174°	180°
70 kV	78	88	96	100	101	100	100	100	100	101	102	102
140 kV	90	97	101	102	103	101	100	100	99	100	102	102
280 kV	100	102	103	103	103	101	100	100	100	101	102	102
Co-60	102	101	101	101	101	100	100	100	101	102	102	102

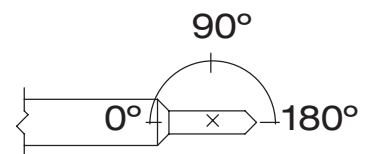

Included accessories
BNC Triax connector and PMMA buildup cap

Ordering information
30-351 Farmer-Type Ionization Chamber, 0.6 cm³, Waterproof
Other types of triaxial cable connectors available

30-344

Semiflex™ Ionization Chamber,
0.125 cc³, Waterproof

The 0.125 cc ionization chamber type is designed for measurements in the beam of high energy photon and electron fields. The chamber is waterproof and is used mainly for relative measurements in a water phantom or in an air scanner. The measuring volume is approximately spherical resulting in a flat energy response over an angle of 160° and a uniform spatial resolution, in all three axes,

during measurements in a phantom. The chamber includes a 1.3 m (4.3 ft) cable, BNC Triax connector, PMMA buildup cap, and a short 36 mm rigid stem for easy mounting.

Key features

- Suitable for use in water phantoms or solid state phantoms
- Measuring volume is fully vented via the connector
- Fully guarded up to measuring volume
- Touchable parts free of high voltage
- Extension cables up to 100 meters in length are available

Specifications

Volume	0.125 cm ³
Response	4 • 10 ⁻⁹ C/Gy
Leakage	± 4 • 10 ⁻¹⁵ A
Polarizing voltage	Maximum 500 V
Cable length	1.3 m (4.3 ft)
Cable leakage	10 ⁻¹² C/(Gy • cm)
Wall material	PMMA (C ₅ H ₈ O ₂), Graphite (C)
Wall density	1.19 gm/cm ³ (PMMA), 0.82 gm/cm ³ (C)
Wall thickness	0.55 mm PMMA, 0.15 mm C
Area density	78 mg/cm ²
Electrode	Aluminum, 1.0 mm Ø, 5.0 mm long
Nominal useful range	30 keV to 50 MeV
Range of temperature	10 °C to 40 °C
Range of relative humidity	10 % to 80 %
Ion collection time	300 V 0.14 ms
	400 V 0.10 ms
	500 V 0.08 ms

Saturation behavior	Polarizing voltage	99.0 % saturation	99.5 % saturation
Maximum dose rate at continuous irradiation	300 V	5.6 Gy/s	2.8 Gy/s
	400 V	10.0 Gy/s	5.0 Gy/s
	500 V	15.0 Gy/s	7.5 Gy/s
Maximum dose rate per irradiation pulse	300 V	0.7 mGy	0.4 mGy
	400 V	1.0 mGy	0.5 mGy
	500 V	1.2 mGy	0.6 mGy

30-344

Semiflex™ Ionization Chamber, 0.125 cc³, Waterproof

Diagram (Approximate dimensions in mm, drawing not to scale)

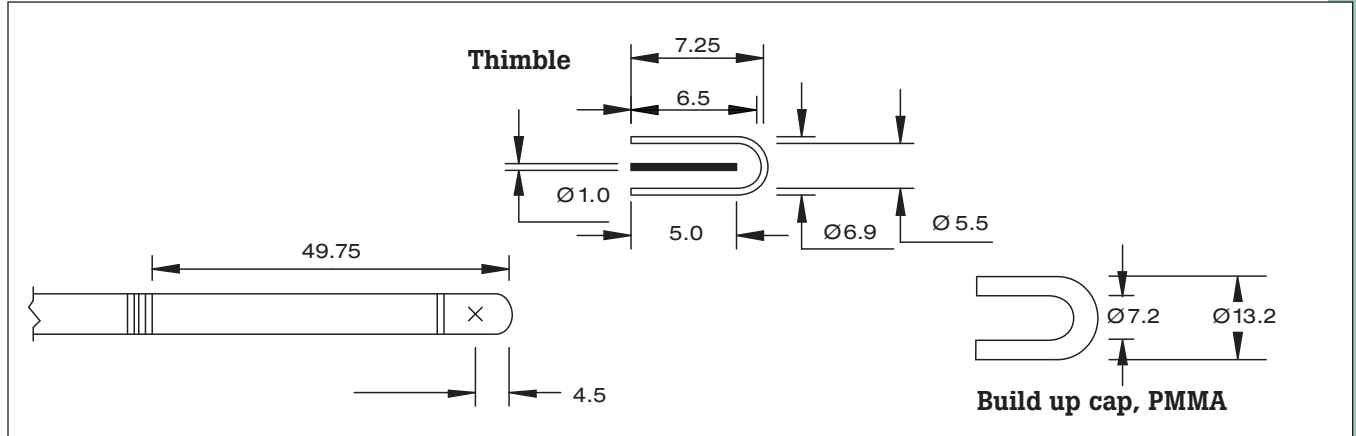

Energy dependence

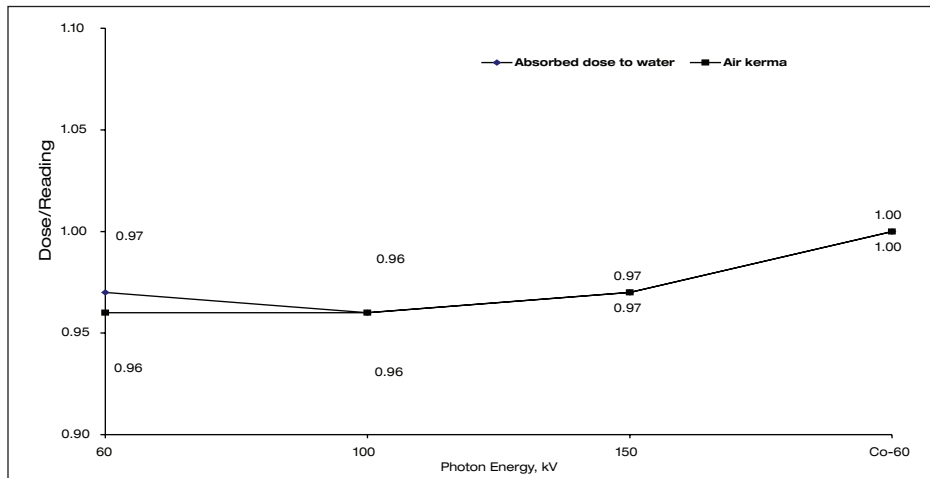

Directional dependence

in Air												
Reading/Dose, %	6°	12°	18°	24°	30°	60°	90°	120°	150°	162°	174°	180°
100 kV	3	20	44	67	80	97	100	99	96	95	94	93
140 kV	10	32	55	76	87	99	100	99	97	97	96	96
280 kV	33	62	78	87	93	99	100	101	101	101	100	100
Co-60	79	89	93	95	97	100	100	100	100	100	100	100

in PMMA												
Reading/Dose, %	6°	12°	18°	24°	30°	60°	90°	120°	150°	162°	174°	180°
100 kV	56	63	71	81	88	98	100	100	100	100	100	100
140 kV	58	68	77	87	93	99	100	100	100	100	100	100
280 kV	67	83	91	95	97	99	100	101	101	101	101	100
Co-60	85	95	99	100	100	100	100	100	100	100	100	100

100 kV, 0.17 mm Cu HVL; 140 kV, 0.49 mm Cu HVL; 280 kV, 3.4 mm Cu HVL

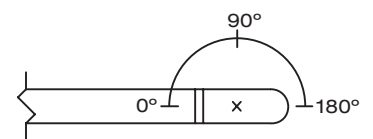

Included accessories

BNC Triax connector, PMMA buildup cap, and 36 mm rigid stem for mounting

Ordering information

30-344 Semiflex Ionization Chamber, 0.125 cm³, Waterproof
Other types of triaxial cable connectors available

30-316

Semiflex™ Ionization Chamber,
0.3 cc³, Waterproof

The 0.3 cc ionization chamber is designed for measurements in the useful beam of high energy photon and electron fields. The chamber is waterproof and is used mainly for relative measurements in a water phantom or in an air scanner. The measuring volume is open to the surrounding air via the 1.3 m (4.3 ft) cable and BNC Triax connector. This chamber has a short rigid stem for easy mounting, includes a PMMA buildup cap, and is type tested by PTB Braunschweig.

Key features

- Suitable for use in water phantoms or solid state phantoms
- Measuring volume is fully vented the connector
- Fully guarded up to measuring volume
- Touchable parts free of high voltage
- Extension cables up to 100 meters length are available

Specifications

Volume	0.3 cm ³
Response	1 • 10 ⁻⁸ C/Gy
Leakage	± 4 • 10 ⁻¹⁵ A
Polarizing voltage	Maximum 500 V
Cable length	1.3 m (4.3 ft)
Cable leakage	10 ⁻¹² C/(Gy • cm)
Wall material	PMMA (C ₅ H ₈ O ₂)
Wall density	1.19 gm/cm ³ (PMMA)
Wall thickness	0.7 mm PMMA
Area density	83.3 mg/cm ²
Electrode	Aluminum, graphite coated, 1.0 mm Ø, 14.25 mm long
Nominal useful range	30 keV to 50 MeV
Range of temperature	10 °C to 40 °C
Range of relative humidity	20 % to 75 %
Ion collection time	300 V 0.10 ms
	400 V 0.08 ms
	500 V 0.06 ms

Saturation behavior	Polarizing voltage	99.0 % saturation	99.5 % saturation
Maximum dose rate at continuous irradiation	300 V	17.0 Gy/s	8.5 Gy/s
	400 V	30.0 Gy/s	15.0 Gy/s
	500 V	45.0 Gy/s	23.0 Gy/s
Maximum dose rate per irradiation pulse	300 V	1.0 mGy	0.4 mGy
	400 V	1.3 mGy	0.5 mGy
	500 V	1.7 mGy	0.7 mGy

30-316

Semiflex™ Ionization Chamber, 0.3 cc³, Waterproof

Diagram (Approximate dimensions in mm, drawing not to scale)

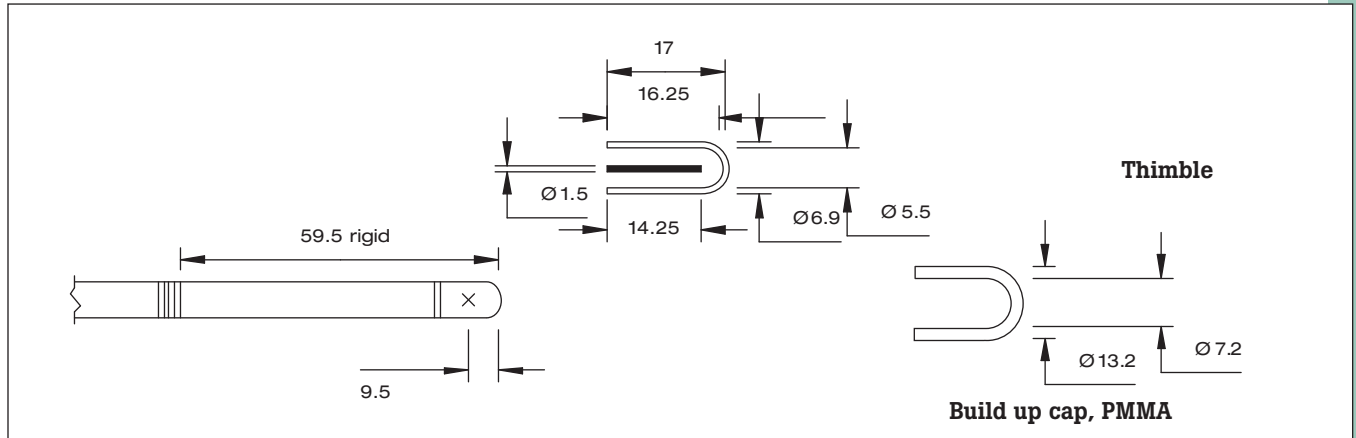

Energy dependence

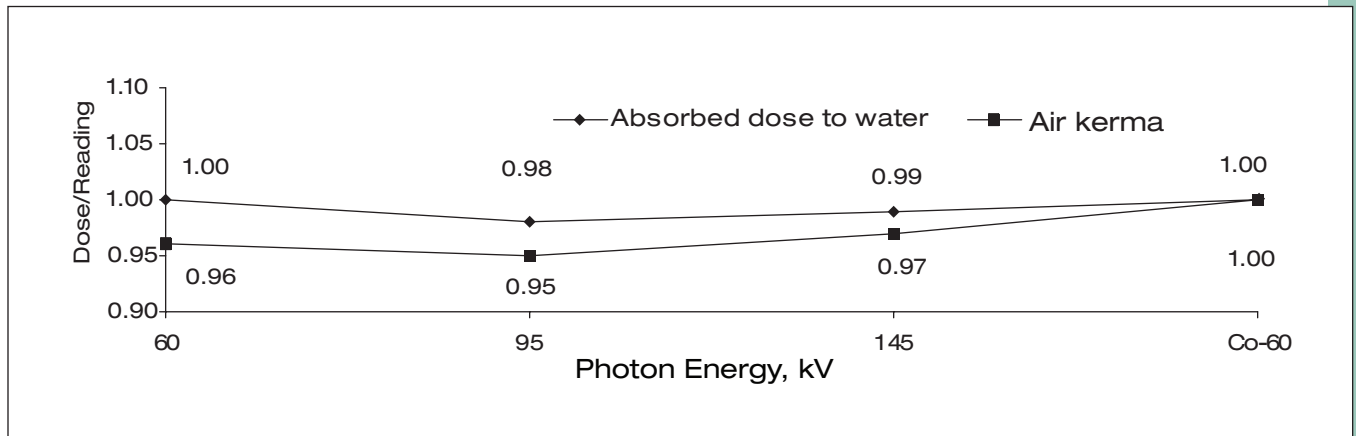

Directional dependence

in Air												
Reading/ Dose, %	6°	12°	18°	24°	30°	60°	90°	120°	150°	162°	174°	180°
70 kV	44.1	65.6	80.2	87.5	92.5	99.7	100.0	99.6	96.1	93.0	88.7	85.4
140 kV	68.7	82.9	92.2	95.0	97.4	99.7	100.0	99.4	97.7	96.5	94.5	91.0
280 kV	79.9	87.1	93.1	95.5	97.5	99.5	100.0	99.7	98.5	97.4	96.1	94.9
Co-60	83.2	91.1	94.6	96.0	97.1	99.4	100.0	99.4	97.5	96.8	96.0	94.6

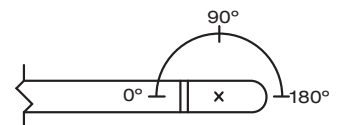

in PMMA												
Reading/ Dose, %	6°	12°	18°	24°	30°	60°	90°	120°	150°	162°	174°	180°
70 kV	97.2	104.3	106.4	105.9	105.4	103.0	100.0	97.8	98.1	98.8	99.4	97.1
140 kV	109.0	108.0	106.9	106.1	105.3	101.8	100.0	98.8	98.9	99.6	100.3	99.8
280 kV	111.3	107.1	105.0	104.2	103.3	101.2	100.0	99.4	100.0	100.6	101.2	100.6
Co-60	104.0	106.4	104.6	104.0	103.5	101.1	100.0	99.9	100.8	101.3	101.8	101.0

Included accessories

BNC Triax connector, PMMA buildup cap, and rigid stem for mounting

Ordering information

30-316 Semiflex Ionization Chamber, 0.3 cm³, Waterproof, Other types of triaxial cable connectors available

30-353

PinPoint™ Ionization Chamber, 0.015 cc³, Waterproof



The 0.015 cc PinPoint ionization chamber is specifically designed for stereotactic field measurements. PinPoint is a waterproof cylindrical ion chamber ideally suited to perform relative measurements in water phantoms or solid-state phantoms when superior spatial resolution is required. The chamber is fully guarded up to its measuring volume and open to the surrounding air via its 4.3 ft (1.3 m) cable and BNC Triax connector. PinPoint has a short rigid stem for mounting and includes a PMMA buildup cap.

Key features

- Specifically designed for stereotactic field measurements
- Completely waterproof
- 0.015 cc volume
- 2 mm active diameter
- 5 mm active length
- Directional dependence is better than 0.5 % when tilting the chamber by $\pm 20^\circ$
- Open volume, vented
- Fully guarded up to measuring volume
- All touchable parts are fully insulated from high voltage

Specifications

Volume	0.015 cm ³
Response	$4 \cdot 10^{-10}$ C/Gy
Leakage	$\pm 4 \cdot 10^{-15}$ A
Polarizing voltage	Maximum 400 V
Cable length	1.3 m (4.3 ft)
Cable leakage	10^{-12} C/(Gy · cm)
Wall material	PMMA (C ₅ H ₈ O ₂), Graphite (C)
Wall density	1.19 gm/cm ³ (PMMA), 0.82 gm/cm ³ (C)
Wall thickness	0.56 mm PMMA, 0.15 mm C
Area density	79 mg/cm ²
Electrode	Steel, 0.18 mm Ø, 4.5 mm long
Nominal useful range	⁶⁰ Co to 50 mV
Range of temperature	10 °C to 40 °C
Range of relative humidity	10 % to 80 %
Ion collection time	100 V 80 µs
	200 V 40 µs
	300 V 20 µs

Saturation behavior	Polarizing voltage	99.0 % saturation	99.5 % saturation
Maximum dose rate at continuous irradiation	400 V	580 Gy/s	1,160 Gy/s
Maximum dose rate per irradiation pulse	400 V		7 mGy

30-353

PinPoint™ Ionization Chamber, 0.015 cc³, Waterproof

Diagram (Approximate dimensions in mm, drawing not to scale)

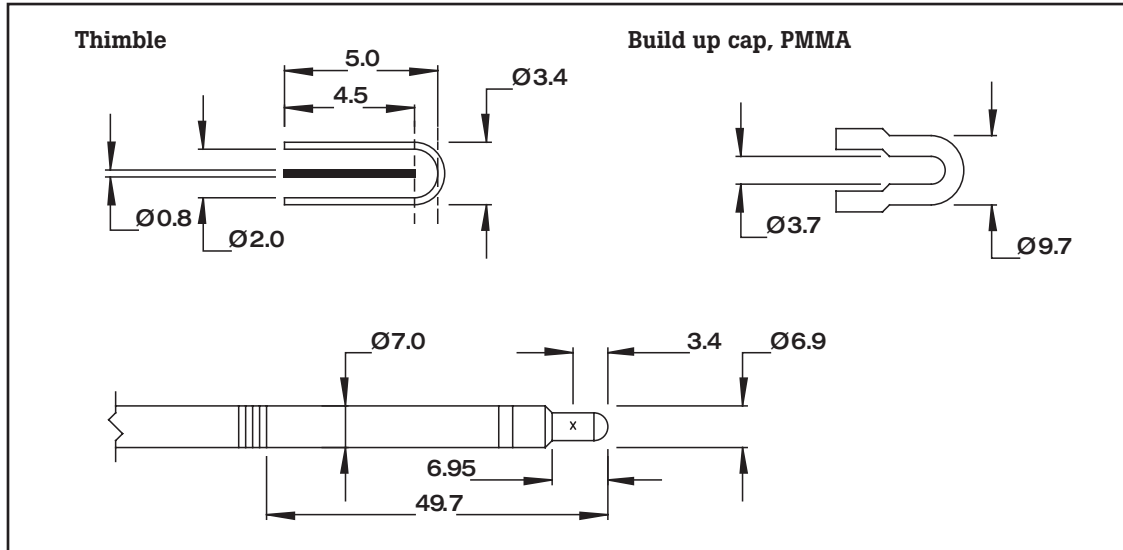

Spatial resolution

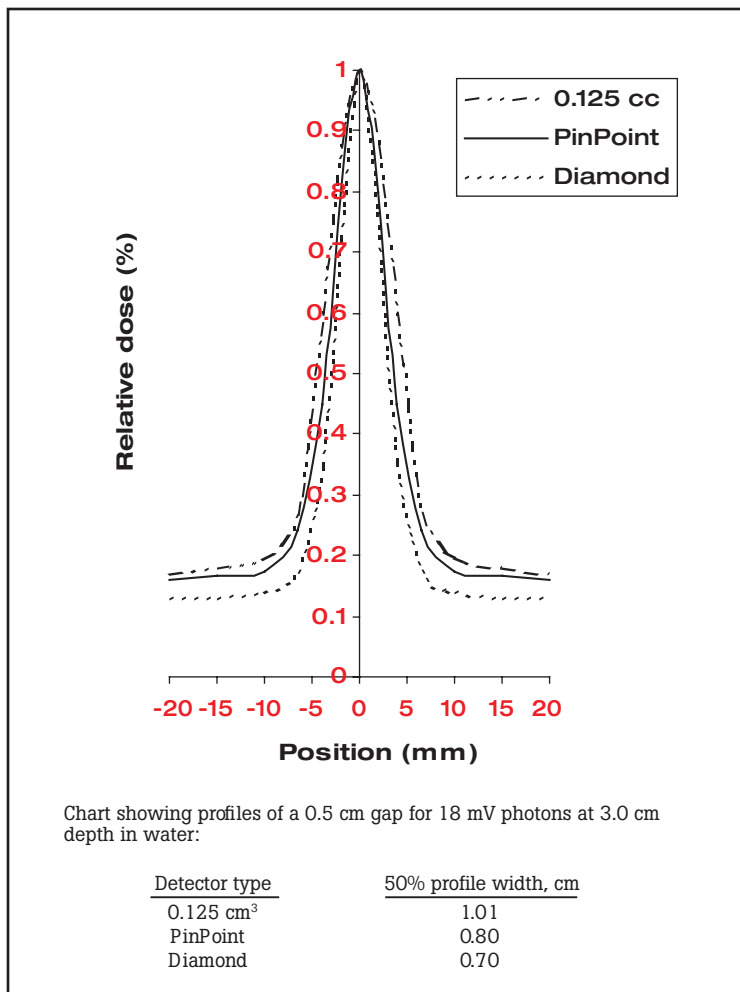

Included accessories

BNC Triax connector, PMMA buildup cap, and 33 mm rigid stem for mounting

Ordering information

30-353 PinPoint Ionization Chamber, 0.015 cm³, Waterproof
Other types of triaxial cable connectors available

30-332

Roos™ Electron Ionization Chamber, 0.35 cc³, Waterproof



The 30-332 Roos chamber, a development from Dr. Roos of PTB-Braunschweig, is used as a standard chamber for electron dosimetry. This chamber has a very wide guard ring to exclude any perturbation effect, even at low electron energies. The polarity effect is negligible. Energy dependence is only influenced by the stopping power correction, a type dependent correction is not necessary. The chamber is waterproof and vented through

the connection cable. Roos includes a 1.08 m (3.5 ft) cable and BNC Triax connector.

Key features

- Designed as a standard chamber for electron dosimetry
- Wide guard ring excludes perturbation effects, even at low electron energies
- Negligible polarity effect, < 0.5 % at 10 MeV
- Energy dependence is only influenced by the stopping power correction, a type dependent correction is not necessary
- Completely waterproof
- Ideal for use in water phantoms or suitable solid state phantoms
- Open volume, vented

Specifications

Volume	0.35 cm ³
Response	1 • 10 ⁻⁸ C/Gy
Leakage	± 4 • 10 ⁻¹⁵ A
Polarizing voltage	100 V recommended, maximum 400 V
Cable length	1.08 m (3.5 ft)
Cable leakage	3.5 • 10 ⁻¹² C/(Gy • cm)
Wall material	Acrylic (C ₅ H ₈ O ₂)
Wall density	1.19 gm/cm ³
Wall thickness	1.0 mm
Area density	119 mg/cm ²
Electrode	Acrylic, graphite coated, 15 mm Ø
Guard ring	4 mm wide
Nominal useful range	2 MeV to 25 MeV
Range of temperature	10 °C to 40 °C
Range of relative humidity	10 % to 80 %
Ion collection time	100 V: 0.37 ms
	200 V: 0.13 ms
	300 V: 0.07 ms

Saturation behavior	Polarizing voltage	99.0 % saturation	99.5 % saturation
Maximum dose rate at continuous irradiation	100 V	2.6 Gy/s	1.3 Gy/s
	200 V	11.0 Gy/s	5.2 Gy/s
	400 V	42.0 Gy/s	21.0 Gy/s
Maximum dose rate per irradiation pulse	100 V	0.5 mGy	0.2 mGy
	200 V	0.9 mGy	0.5 mGy
	400 V	1.9 mGy	0.9 mGy

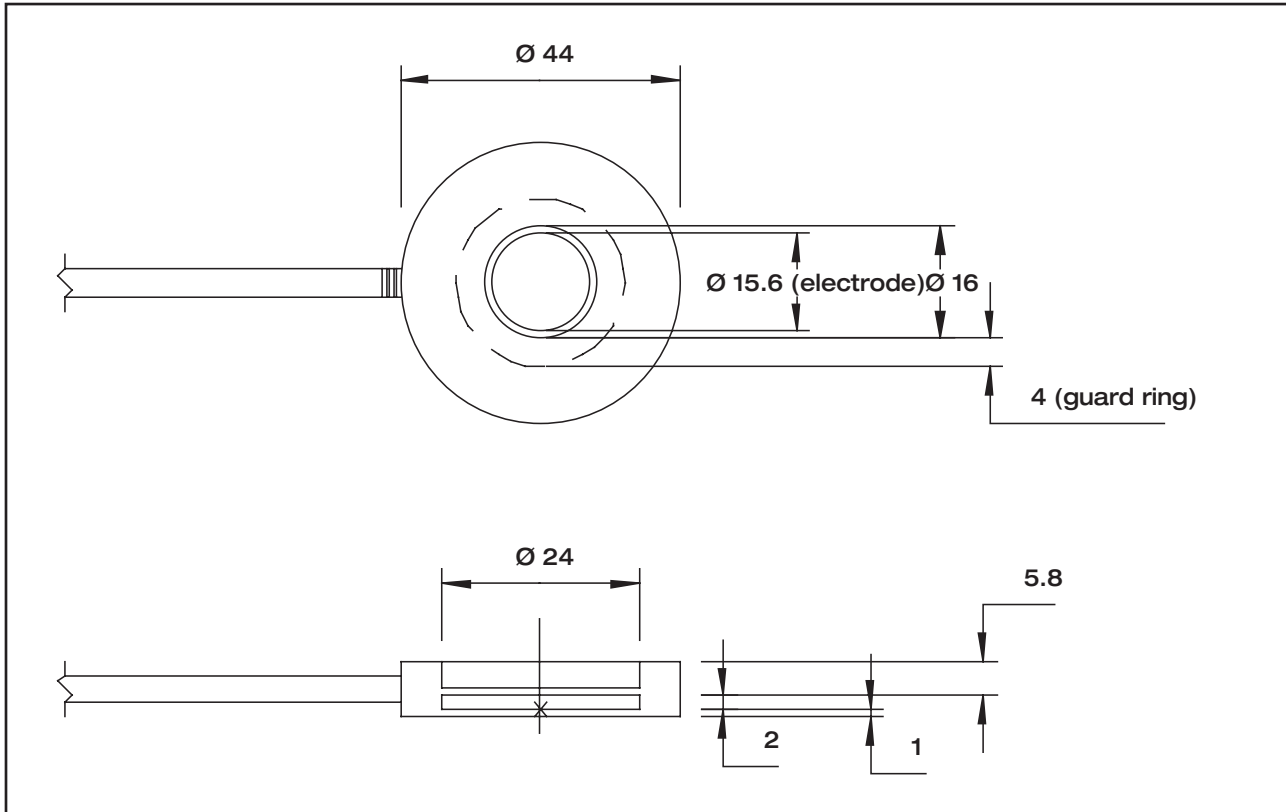
30-332**Roos™ Electron Ionization Chamber,
0.35 cc³, Waterproof****Diagram** (Approximate dimensions in mm, drawing not to scale)**Directional dependence**

The deviation of the response following tilting of the chamber by up to 10° at 6 and 20 MeV, at the dose maximum in water, is less than 0.1 %.

Included accessories

BNC Triax connector

Ordering information

30-332 Roos Electron Ionization Chamber, 0.35 cm³, Waterproof

Other types of triaxial cable connectors available

30-329

Markus™ Electron Ionization Chamber, 0.055 cc³, Waterproof



The Markus chamber is the very first chamber specifically designed for electron dosimetry. The chamber may be used for measurements in water phantoms or solid state phantoms. A PMMA waterproofing cap, 0.87 mm thick (equivalent to 1 mm of water), and an annulus, for solid state phantom measurements, are included. The chamber's small measuring volume makes it ideal for electron measurements when very high spatial resolution is required. The diaphragm front

allows measurements in the buildup region of electron fields to a depth of virtually zero. Markus includes a 1.05 m (3.4 ft) cable and BNC Triax connector.

Key features

- Suitable for use in solid phantoms and water phantoms
- Vented measuring volume
- Fully guarded up to measuring volume
- All touchable parts fully insulated from high voltage
- Extension cables up to 100 meters in length are available

Specifications

Volume	0.055 cm ³
Response	2 · 10 ⁻⁹ C/Gy
Leakage	± 2 · 10 ⁻¹⁶ A
Polarizing voltage	300 V recommended, 400 V maximum
Cable length	1.05 m (3.4 ft)
Cable leakage	3.5 · 10 ⁻¹² C/(Gy · cm)
Wall material	Polyethylene CH ₂
Membrane thickness	0.03 mm
Area thickness	2.5 mg/cm ²
Electrode	Acrylic, graphite coated, 5.3 mm Ø
Nominal useful range	2 to 45 MeV
Range of temperature	10 °C to 40 °C
Range of relative humidity	10 % to 80 %
Ion collection time	150 V: 0.20 ms 300 V: 0.09 ms 400 V: 0.07 ms

Saturation behavior	Polarizing voltage	99 % saturation	99.5 % saturation
Maximum dose rate at continuous irradiation	100 V	5.9 Gy/s	2.9 Gy/s
	200 V	24 Gy/s	12 Gy/s
	400 V	42 Gy/s	21 Gy/s
Maximum dose rate per irradiation pulse	100 V	0.7 mGy	0.4 mGy
	200 V	1.4 mGy	0.7 mGy
	400 V	1.9 mGy	0.9 mGy

30-329

Markus™ Electron Ionization Chamber, 0.055 cc³, Waterproof

Diagram dependence (The values given in the diagrams are typical for the construction)

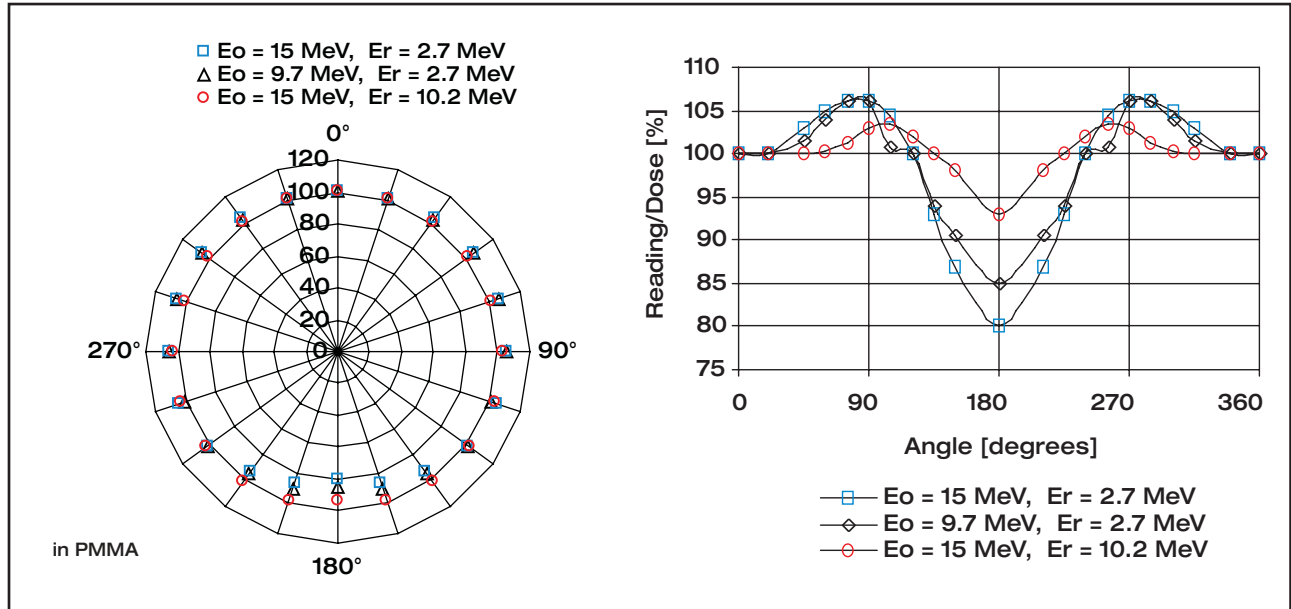
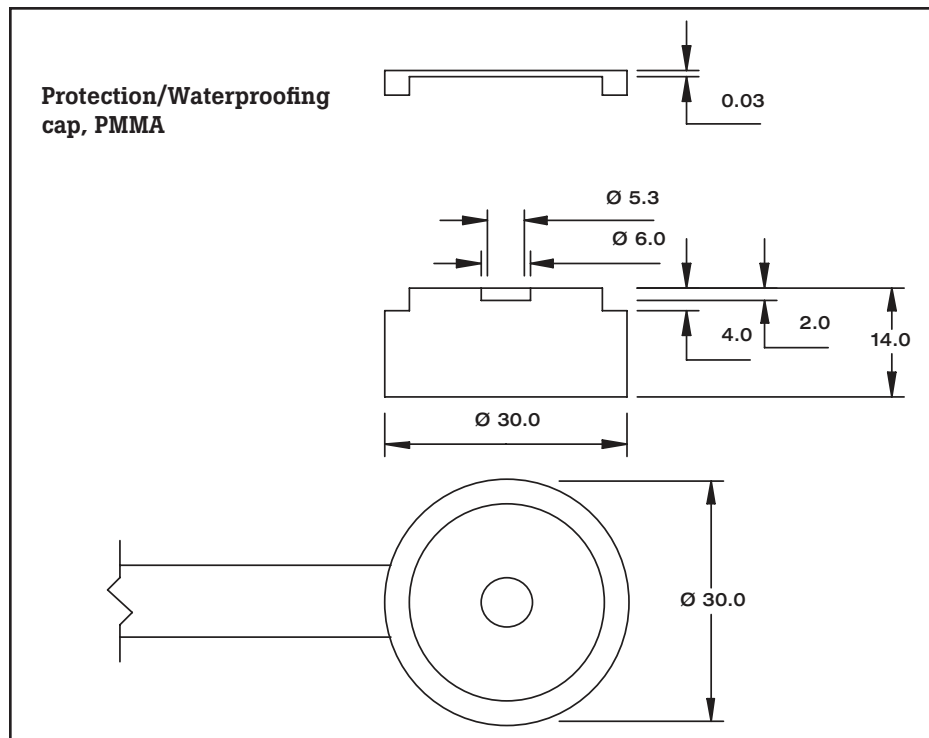

Diagram (Approximate dimensions in mm, drawing not to scale)



Included accessories

BNC Triax connector and PMMA buildup cap

Ordering information

30-329 Markus Electron Ionization Chamber, 0.055 cm³, Waterproof

Other types of triaxial cable connectors available

30-355

Extension Cable Reel for Ionization Chambers



The 30-355 cable reel offers a great convenience in winding and storage of extension cables. This cable reel will extend the life of a cable significantly by eliminating kinks and providing protection during storage. Only as much cable as needed has to be reeled out at any time. A cable reel will accommodate a white extension cable up to 50 meters in length or a grey cable up to 20 meters. Either gender may be specified at the hub, depending on whether the

cable reel will be kept at the electrometer (male connector at the hub) or inside the treatment room (female connector at the hub).

Key features

- Prevents tangled, loose, or misplaced triaxial-connector cables
- A must for every therapy department

Specifications

Dimensions (Ø x h)	21.5 cm x 7.5 cm (8.5 in x 3.0 in)
Weight	1 lb to 3 lb (depending on the cable length)

Ordering information

30-355 Extension Cable Reel for Ionization Chambers

Elsco Philips Service, Trenčín

74-6 Series

Plastic Water™



Plastic Water is a unique, solid phantom material that will change the way you perform high-energy calibration in both electron and photon radiation oncology. With Plastic Water, you'll achieve the results you want without spending extra time, effort or money. Plastic Water is virtually identical to water in dosimetric properties, but easier to use.

With plastic water, you'll be able to calibrate photon and electron beams within 0.5 % of true water dose, and do it quickly, easily and cost-effectively.

Is compatible with a variety of chambers, making it the most versatile solid phantom material available. (Custom cavities are available to accommodate any ion chamber on the market; simply provide detailed drawings when ordering).

Key features

- Agrees with true water within 0.5 % ± 0.04 % above 7 MeV
- Won't break or crack, even under impact
- Provides the closest dosimetry characteristics to natural water, over the entire oncology energy range
- Allows for easy and accurate calibration and energy checks
- Needs no correction factors, making it fast, easy and convenient to use
- Is available in a wide range of thicknesses, starting as low as 0.1 cm, to meet all of your calibration needs

Specifications

Material	Epoxy
Thickness tolerances	± 0.01 cm
Density	1.02 gm/cc

Individual slab thicknesses, model numbers, and sizes

Thickness (cm)	30 cm x 30 cm	30 cm x 30 cm drilled	40 cm x 40 cm	40 cm x 40 cm drilled
	Model	Model	Model	Model
0.5	74-602	N/A	74-602-4040	N/A
1.0	74-603	N/A	74-603-4040	N/A
2.0	74-604	74-604-D*	74-604-4040	74-604-4040-D*
3.0	74-605	74-605-D*	74-605-4040	74-605-4040-D*
4.0	74-606	74-606-D*	74-606-4040	74-606-4040-D*
5.0	74-609	74-609-D*	74-609-4040	74-609-4040-D*
6.0	74-610	74-610-D*	74-610-4040	74-610-4040-D*
7.0	74-611	74-611-D*	74-611-4040	74-611-4040-D*

Plastic Water Set #3 (74-615)

- 5.5 MeV electron and photon calibrations, and photon beam energy checks
- 30 cm x 30 cm
- Weight of set: 21.4 kg (47 lb)

Individual slab thicknesses, model numbers, and sizes

Qty.	Thickness (cm)	Qty.	Thickness (cm)
1	0.1	2	2.0
2	0.2	1	4.0
1	0.5	1	3.0
1	1.0	1	6.0
1*	2.0		

* Drilled for chamber

Ordering information

74-602 Plastic Water,
 74-602-4040 Plastic Water
 74-603 Plastic Water,
 74-603-4040 Plastic Water
 74-604 Plastic Water
 74-604-D Plastic Water
 74-604-4040 Plastic Water
 74-604-4040-D Plastic Water
 74-605 Plastic Water
 74-605-D Plastic Water
 74-605-4040 Plastic Water
 74-605-4040-D Plastic Water
 74-606 Plastic Water
 74-606-D Plastic Water
 74-606-4040 Plastic Water
 74-606-4040-D Plastic Water
 74-609 Plastic Water
 74-60-D Plastic Water
 74-60-4040 Plastic Water
 74-60-4040-D Plastic Water
 74-610 Plastic Water
 74-610-D Plastic Water
 74-610-4040 Plastic Water
 74-610-4040-D Plastic Water
 74-611 Plastic Water
 74-611-D Plastic Water
 74-611-4040 Plastic Water
 74-611-4040-D Plastic Water
 74-615 Plastic Water Set #3

Plastic Water drilling and etching charge

74-619-1000 Plastic Water plug for any cavity drilled
 74-620 Etching on Plastic Water
 74-630 Any addition cavity drilled in any Plastic Water slab

Film dosimetry cassettes

74-607 Plastic Water Film Cassette, 8 in x 10 in
 74-607-1012 Plastic Water Film Cassette, 10 in x 12 in

74-007, 74-008 and 74-034

IMRT Phantoms



Advanced Pelvic 3D
74-034



Homogeneous
74-008



Thorax
74-007

The IMRT (Intensity-Modulated Radiotherapy) Phantom for Film and Ion Chamber Dosimetry is designed to address the complex issues surrounding commissioning and comparison of treatment planning systems while providing a simple yet reliable method for verification of individual patient plans and delivery. The phantoms are elliptical in shape. They are a reasonable representation of human anatomy in size and proportion. The phantoms are manufactured from a unique proprietary material that faithfully mimics water within 1 % from 50 keV to 25 MeV. The phantoms also support radiographic or GAFCHROMIC® film at mid-plane in the phantom for analysis of dose distributions. Optional inserts are available to support a variety of other detectors including TLD's, MOSFET, and diodes. The surfaces of the phantoms are etched for ease of laser alignment, and CT markers ensure accurate film to plan registration.

Key features

- Check 2D or 3D dose distributions
- Point dose measurements in multiple planes
- Calibrate film with ion chamber
- Quickly verify individual patient treatment plans
- Correlate CT units to electron density

Electron density reference inserts

	Density	Electron density per cc x 10 ²³	Electron density relative to H ₂ O
H ₂ O	1.00	3.34	1.000
Lung	0.21	0.69	0.207
Bone	1.60	5.03	1.506
Muscle	1.06	3.48	1.042
Adipose	0.96	3.17	0.949
Plastic Water® —diagnostic/ therapy range	1.04	3.35	1.003

Ordering information

74-008 IMRT Phantom,
Homogeneous
74-007 IMRT Phantom, Thorax
74-034 IMRT Phantom,
Advanced Pelvic 3D

Else Philips Service, Trenčín

74-007, 74-008 and 74-034

IMRT Phantoms

Specifications Homogeneous (74-008)

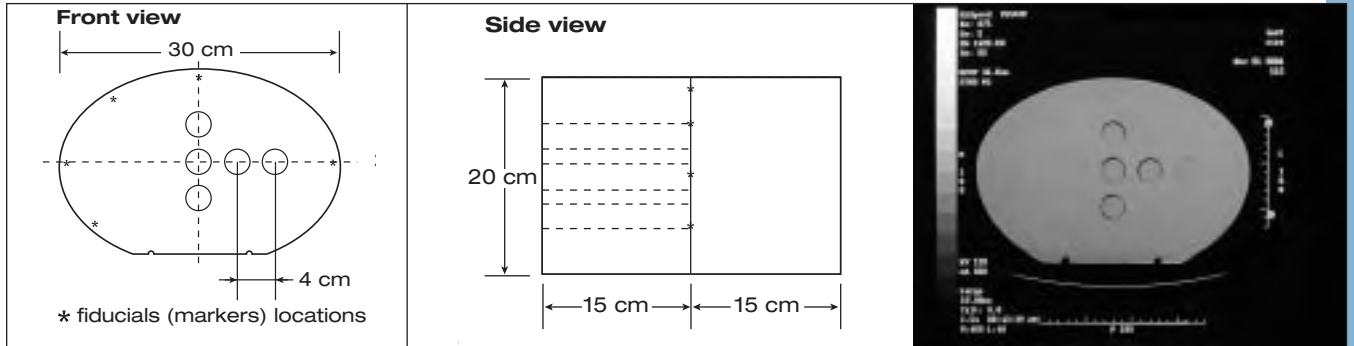

Specifications Thorax (74-007)

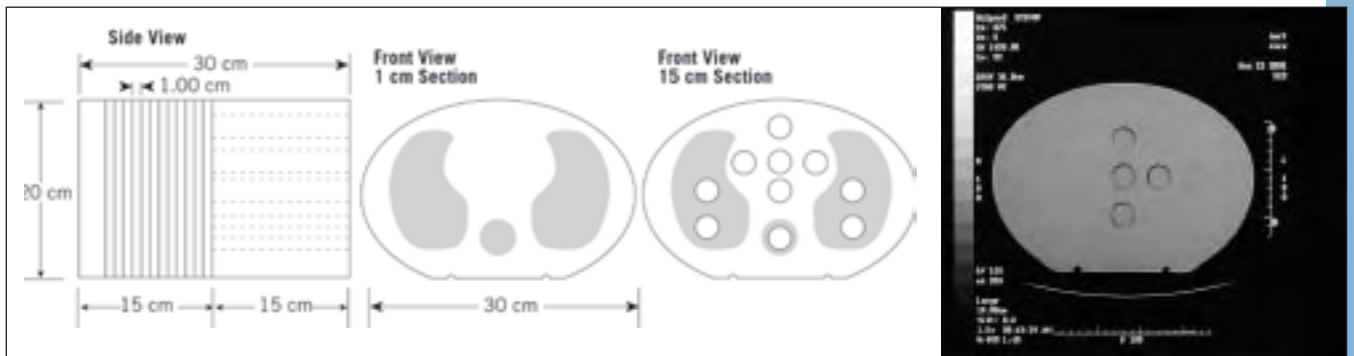

Specifications Advanced Pelvic 3D (74-034)

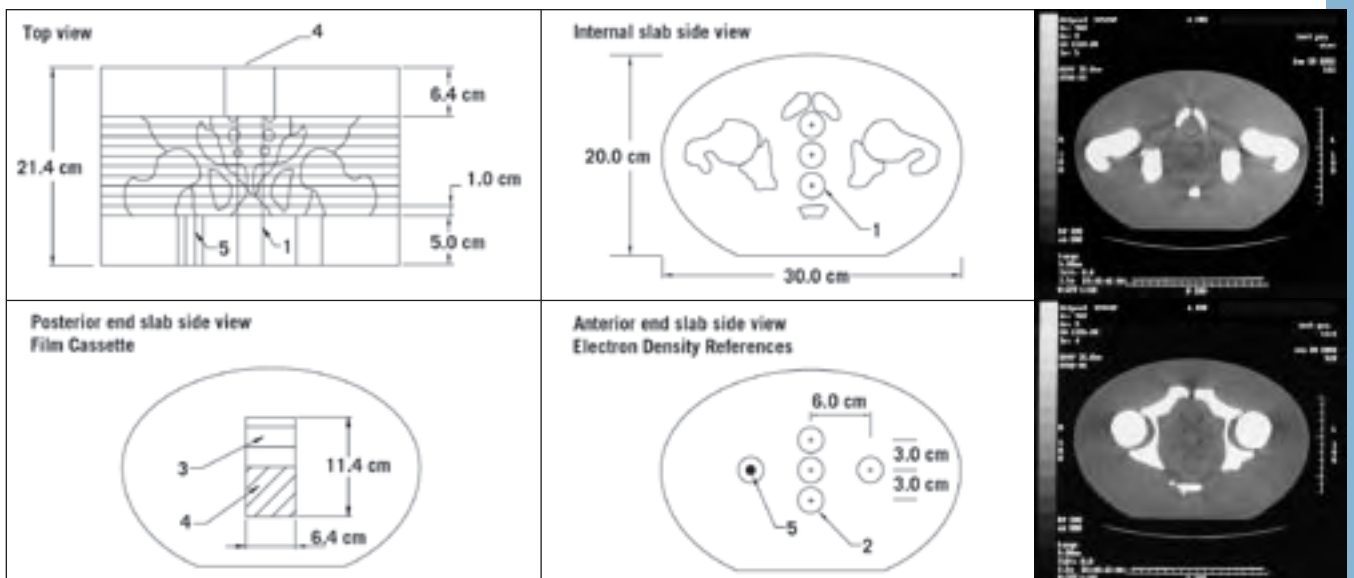

- 1 Holes plugged with rods (diameter 2.5 cm)
- 2 Holes for electron density inserts
- 3 Spacers
- 4 Film stack (cube 2.5 inches)
- 5 Bone core (diameter 1 cm in water background)

74-007, 74-008 and 74-034

IMRT Phantoms

Rod with ion chamber cavities

Rods with chamber cavities are included with each phantom. See specific phantom description for details. The rods are 1 inch in diameter and are 15 cm long. They are available in water, bone, or lung equivalent material. Should your chamber not be listed below, contact Fluke Biomedical for assistance. When ordering, specify part number and cavity code. (Example: 74-024-501)

Cavity code	Accommodates
501	0.6 cm ³ Farmer-type Chambers without buildup cap, PTW, Nuclear Enterprise (NE)
502	0.6 cm ³ Farmer-type chambers with buildup cap, PTW, Nuclear Enterprise (NE)
506	Capintec PR-06G with buildup cap
507	Capintec PR-06C without buildup cap
511A	Nuclear Enterprise (NE) 2533 without buildup cap
511B	PTW N31003 0.3 cm ³ without buildup cap
511C	PTW N31002 0.125 cm ³ without buildup cap
513	Exradin A-12
515	Exradin T-14 Microchamber
517	0.2 cm ³ Farmer-type Chamber without buildup cap
518	PTW 31006 without buildup cap
520	PTW 23331 without buildup cap
521	Wellhöfer IC3
522	Nuclear Enterprise (NE) 2611A without buildup cap
523	Fluke Biomedical 550-6A Ion Chamber with buildup cap (X-10)
524	Fluke Biomedical 550-6A Ion Chamber without buildup cap
525	Wellhöfer IC15 Ion Chamber without buildup cap
526	Capintec PR-06G without buildup cap
527	Wellhöfer IC70 with buildup cap
528	Exradin 14SL
531	Exradin 1SL
532	Wellhöfer CC13/IC10
533	Wellhöfer CC01

Optional accessories

74-012 Single Breast Attachment

89-002 Foam Lined Carrying Case

74-015 CT to Film Fiducial Markers

74-028 Electron Density Reference Plugs (set of 4: lung, bone, muscle, adipose)

74-013 Film Stack for Small Volume 3D Image Reconstruction

74-014 Gel Dosimetry Cassette

74-017 Homogeneous Section that accommodates 74-013 or 74-014 cassettes

74-018 Thorax Region Section that accommodates 74-013 or 74-014 cassettes

74-019 Pelvic Region Section that accommodates 74-013 or 74-014 cassettes

74-020 Bone Equivalent Rod Insert with Ion Chamber Cavity, 15 cm long

74-022 Lung Equivalent Rod Insert with Ion Chamber Cavity, 15 cm long

74-024 Water Equivalent Rod Insert with Ion Chamber Cavity, 15 cm long

74-011 Water Equivalent Rod Inserts (5 cm) for TLD's (set of 5)

74-016 Holding Device

74-010 Alignment Device
Custom accessories are available for diodes, MOSFET, and other detectors. Contact Fluke Biomedical for more information.

Ordering information

Homogeneous includes (74-008)

- (2) Tissue Equivalent Sections, one drilled to accommodate rod inserts, 15 cm thick
- (5) **74-015** CT to Film Fiducial Markers
- (5) Water Equivalent Rod Inserts, 15 cm long
- (1) **74-024** Water Equivalent Rod Insert with Ion Chamber Cavity, 15 cm long
- (1) **74-010** Alignment Device
- (1) **74-016** Holding Device

Thorax includes (74-007)

- (1) Thorax Region Section drilled to accommodate rod inserts, 15 cm thick
- (12) Thorax Region Sections, 1 cm thick
- (1) End Section, approx. 2 cm thick
- (1) **74-024** Water Equivalent Rod Insert with Ion Chamber Cavity, 15 cm long
- (1) **74-010** Alignment Device
- (1) **74-016** Holding Device
- (1) **74-020** Bone Equivalent Rod Insert with Ion Chamber Cavity, 15 cm long
- (1) **74-022** Lung Equivalent Rod Insert with Ion Chamber Cavity, 15 cm long
- (5) Water Equivalent Rod Inserts, 15 cm long
- (1) Bone Equivalent Rod Insert, 15 cm long
- (4) Lung Equivalent Rod Inserts, 15 cm long

Advanced Pelvic 3D includes (74-034)

- (1) Tissue Equivalent Electron Density Reference Section with interchangeable inserts, 5 cm thick
- (10) Contiguous 3D Pelvic Sections each drilled to accommodate rod inserts, 1 cm thick
- (1) **74-017** Homogeneous Section that accommodates 74-013 or 74-014 cassettes
- (1) **74-024** Water Equivalent Rod Insert with Ion Chamber Cavity, 15 cm long
- (5) Water Equivalent Rod Inserts, 2.5 cm \varnothing x 5 cm long
- (1) **74-010** Alignment Device
- (1) **74-016** Holding Device
- (4) Electron Density Reference Plugs (set of 4: lung, bone, muscle, adipose)
- (1) Section for Electron Density Reference plugs, 5 cm thick

Elseo Philips Service, Trenčín

74-001

IMRT Phantom Head and Neck



The 74-001 IMRT phantom is designed to address the complex issues surrounding commissioning and comparison of treatment planning systems and verification of individual patient plans and delivery.

The phantom is circular in shape, approximates the size of an average patient, and is manufactured from unique proprietary materials that faithfully mimic bone and water within 1 % from 50 keV to 25 MeV. This enables thorough analysis of both the treatment planning and delivery systems.

Tissue equivalent interchangeable rod inserts for ionization chambers allow for point dose measurements in multiple planes in the phantom and film calibration. The phantom also supports film dosimetry with not only standard radiographic films but also GAFCHROMIC® media. Optional inserts are available to support a variety of other detectors including TLD's, MOSFET, and diodes.

The 74-001 accommodates one Ready Pack 10 in x 12 in film in transverse orientation, two radiochromic or radiographic 10 cm x 10 cm films in transverse orientation and/or a stack or thirteen radiochromic pre-cut to 63.5 mm x 63.5 mm in three different orientations.

The 74-001 includes five different Electron Density reference plugs that can be interchanged in five separate locations within the phantom. The surface of the phantom is etched with grooves to ensure proper orientation of the CT slices and accurate film to plan registration. An optional cranial bone ring is also available.

Key features

- Verify heterogeneity corrections
- Correlate CT units to electron density
- Check dose distributions in sensitive areas
- Check depth doses and absolute dose
- Measure 2D and 3D isodoses
- Verify individual patient treatment plans
- Calibrate film with ion chamber

Electron density reference inserts

	Density	Electron density per cc x 10 ²³	Electron density relative to H ₂ O
H ₂ O	1.00	3.34	1.000
Lung	0.21	0.69	0.207
Bone	1.60	5.03	1.506
Muscle	1.06	3.48	1.042
Adipose	0.96	3.17	0.949
Plastic Water® - diagnostic/therapy range	1.04	3.35	1.003

74-001

IMRT Phantom Head and Neck

Specifications

Phantom front view

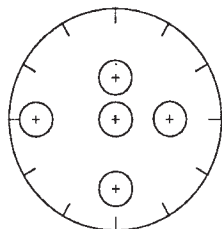

Cavity slab front view

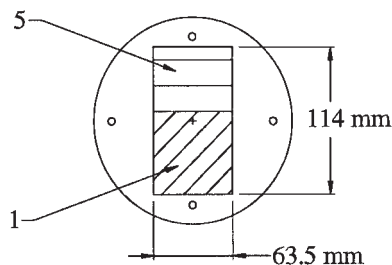

Film dosimetry slab front view Side view

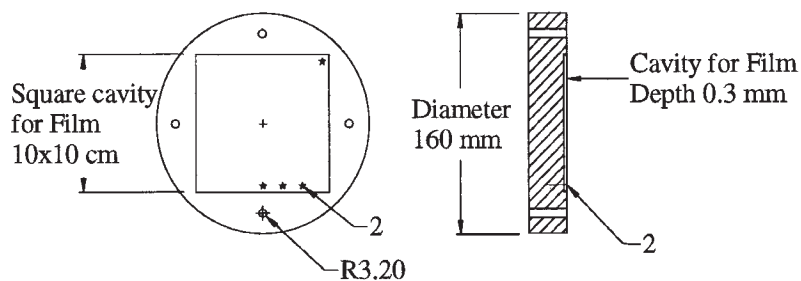

Phantom side view

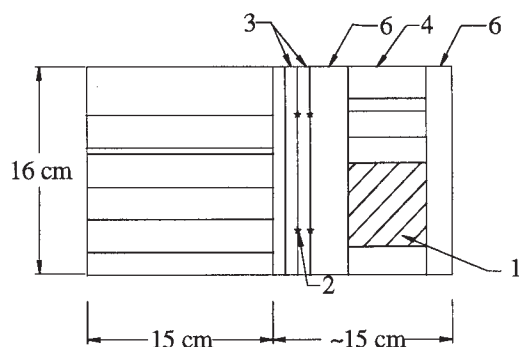

1 Film stack or gel cassette 2 Fiducial markers 3 Two 1 cm slabs for film dosimetry
4 Cavity slab 5 1 and 2 cm spacers for film stack positioning 6 2 and 1 cm spacer slabs

Optional accessories

74-011 Water Equivalent Rod Inserts (5 cm) for TLD's (set of 5)
74-014 Gel Dosimetry Cassette
74-028 Electron Density Reference Plugs (set of 4: lung, bone, muscle, adipose)

Included accessories

(1) Water Equivalent Homogeneous Section drilled to accommodate rod inserts, 15 cm thick
(1) Cavity Slab to accommodate Film Stack or Gel Cassette, 6.4 cm
(2) Film Slabs, 1 cm, Film Cavity 10 x 10 cm
(1) 74-013 Film Stack for Small Volume 3-D Image Reconstruction
(2) 74-015 CT to Film Fiducial Markers in Film Slabs
(2) Spacer Slabs, 1 cm
(1) Spacer Slab, 2 cm
(1) 74-020 Bone Equivalent Rod Insert with Ion Chamber Cavity, 15 cm long
(1) 74-024 Water Equivalent Rod Insert with Ion Chamber Cavity, 15 cm long
(2) End Slabs
(5) Water Equivalent Rod Inserts, 15 cm long
(1) Bone Equivalent Rod Insert, 15 cm long
(1) 74-010 Alignment Device
(1) 74-016 Holding Device

Rod with ion chamber cavities

See page 40 for ordering details.

Ordering information

74-001 IMRT Phantom;
Head and Neck

Else Philips Service, Trenčín

76-417

CT Simulation Phantom



A CT simulator consists of a dedicated, fast CT scanner (often a spiral scanner), a virtual simulator (a set of computer software), and a laser marking device to mark the center of target volume. Therefore, methods of designing and implementing quality control procedures must include quality control on each segment of the process.

Quality control of a virtual simulator is a very complex issue and difficult to verify, due to the nature of software quality. Since geometrical planning is the core of CT simulation, periodic quality control is essential for maintaining

optimum image quality and patient care. Hence, the quality control of a virtual simulator consists of testing every segment of the software for possible flaws. The test should include imaging parameters such as low contrast resolution and high contrast detect ability of a DRR.

Various 3D treatment planning systems can also generate DRR. Hence, the quality control of DRR generation needs to be addressed. This versatile phantom provides essential quality control tools for geometrical 3D treatment planning systems and imaging tools for CT-simulation as well, which are capable of generating DRR for portal design.

Key features

- Designed for use with spiral CT scanners and may be used with conventional scanners
- Simplifies quality control for the radiology physicist and radiation oncology physicist
- Verifies the accuracy of the digitally reconstructed radiograph (DRR) reconstruction for 3D treatment planning systems

References

1. K.P., McGee, I.J. Das, "Commissioning Acceptance Testing and Quality Assurance of a CT Simulator," in A Practical Guide to CT Simulation," L.R. Coia, T.E. Schultheiss, and G.E. Hanks, eds. (Madison, WI.: Advanced Medical Publishing, 1995), 39-50.
2. K.P., McGee, I.J. Das, C. Sims, "Evaluation of Digitally Reconstructed Radiographs (DRRs) Used for Clinical Radiotherapy: A Phantom Study," Medical Physics, 22 (1995), 1815-1827. Request Reprint No. 638B.

Phantom sections

Material	Acrylic
Dimensions	15 cm x 15 cm (5.906 in x 5.906 in)
Weight	4.19 kg (9.24 lb)

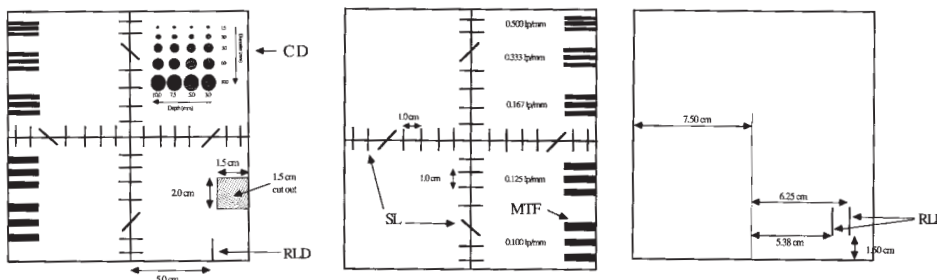

Schematic representation of the phantom developed to evaluate DRRs: (a) Top face of the DRR phantom showing the contrast-detail, MTF, ray line divergence (RLD), and spatial linearity (SL) test patterns. (b) Side face of the phantom showing the MTF and SL test pattern. (c) shows the third face of the phantom containing the RLD pattern. The two lines represent the rods embedded at distances of 5.38 cm and 6.25 cm from the central axis of the phantom.

Ordering information
76-417 CT Simulation Phantom

76-462

Electron
Density Phantom

The Electron Density Phantom (76-462) is used in CT (computed tomography) treatment planning. The accuracy of radiation oncology treatment planning systems is heavily dependent upon precise CT analysis of the patient anatomy which is to be irradiated. Physicists performing treatment planning need accurate tools to evaluate CT scan data, correct for inhomogeneities and to document the relationship between CT number and tissue electron density. The Electron Density Phantom is designed to meet this requirement.

Key features

- Can be configured to simulate head or abdomen
- Manufactured from durable epoxy
- Tissue-equivalent plugs can be positioned at 17 different locations within the scan field
- Special marker plugs enable quick assessment of distance registration
- All material accurately simulate indicated tissue within the diagnostic energy range
- Includes a rugged carrying case

Specifications

	Electron density phantom components	Head insert components	Physical density	Electron density per cc x 10 ²³	Electron density relative to H ₂ O
Phantom head	1	1			
Phantom body (water equivalent)	1	0			
Inserts					
Syringe H ₂ O	1	1	1	3.34	1
Lung (inhale)	2	1	0.195	0.634	0.19
Lung (exhale)	2	1	0.495	1.632	0.489
Breast (50/50)	2	1	0.991	3.261	0.976
Dense bone, 800 mg/cc HA H ₂ O with 10 mm dia rod	2	1	1.609	5.052	1.512
Trabecular bone	2	1	1.161	3.73	1.117
Liver	2	1	1.071	3.516	1.052
Muscle	2	1	1.062	3.483	1.043
Adipose	2	1	0.967	3.18	0.952
Distance Marker	2	2	1.007		

Material	Epoxy resin
Weight	6.8 kg (15 lb)

Included accessories

Carrying case

Ordering information

76-462 Electron Density Phantom

Elsco Philips Service, Trenčín

37-020 and 07-405

Barometers and NIST Traceable Digital Thermometer



37-020 Oakton® Temperature Compensated Barometers

The 37-020 is ideal for easy, accurate, on-site pressure readings. Oakton Temperature Compensated Barometers measure atmospheric pressure in millibar (mbar) and inches Hg or mm Hg. Barometers also monitor temperature and provide temperature compensation with a built-in bimetal thermometer. Barometers are encased in brass with bezel for wall mounting.

07-405 NIST Traceable Digital Thermometer

The NIST Traceable Digital Thermometer is a rugged, low-cost, lollipop-type, wide-range digital thermometer to replace hazardous mercury units. It employs micro-electronics for reliability and utilizes a liquid crystal display for accurate reading. It features an easy-to-read heads-up display. The reading updates every second, and at the touch of a button, the memory recalls highest and lowest readings. The 20 cm long stainless steel stem is impervious to acids, bases, and solvents. The thermometer includes a NIST traceable calibration certificate.

Specifications

37-020 Oakton Temperature Compensated Barometers	
Parameter	Atmospheric pressure, temperature
Range	Atmospheric pressure: 930 mbar to 1070 mbar 37-020: 27.5 in to 31.6 in Hg 37-020-2200: 698 mm to 802 mm Hg Temperature: -10 °C to 50 °C (14 °F to 122 °F)
Resolution*	Atmospheric pressure: 1 mbar 37-020: 0.1 in Hg 37-020-2200: 1 mm Hg Temperature: 1.0 °C (1.0 °F)
Accuracy	Atmospheric pressure: ± 1 mbar 37-020: ± 0.03 in Hg 37-020-2200: ± 1 mm Hg Temperature: ± 1 °C (± 1.8 °F)
Dimensions (DxØ)	5 cm x 15.5 cm (2 in x 6.1 in)
Weight	1.4 kg (3 lb)

*Altitude resolution for 37-020-220 is 1 meter from -500 m to 1000 m, 2 meters from 1001 m to 7000 m. The standard 37-020 has a resolution of 0.9 °F (± 0.5 °C)

07-405 NIST Traceable Digital Thermometer	
Range	-50 °C to 300 °C (-58 °F to 572 °F)
Accuracy	Within ± 0.2 °C, from -20 °C to 100 °C
Resolution	0.1 °C between -20 °C to 200 °C
Display	3.50 digit LCD, 6.35 mm high digits
Dial diameter	38 mm
Display update	1 second
Probe	Stainless steel stem, 3.2 mm Ø x 20.3 cm
Power	Type 389 1.5 V silver oxide battery (included)
Battery life	One year continuous operation
Weight	23 g

Ordering information

37-020 Oakton Temperature Compensated Barometer, measures in mbar and inches Hg
37-020-2200 Oakton Temperature Compensated Barometer, measures in mbar and mm Hg
07-405 NIST Traceable Digital Thermometer

Publications

The following Fluke Biomedical catalogs are also available



Fluke Biomedical Diagnostic Imaging QA

The Diagnostic Imaging QA catalog is a comprehensive source book of solutions for the Imaging QA Technologist, Physicist, Biomedical/Clinical Engineer, or Service Engineer. The catalog contains information about the test devices, phantoms, and accessories needed to manage diagnostic imaging QA and maintain regulatory-compliance.

Order the Diagnostic Imaging QA catalog online by visiting www.flukebiomedical.com/catalogs



Fluke Biomedical Radiation Safety

The Radiation Safety catalog highlights devices used to measure radiation levels, manage regulatory QA requirements, and aide in radiation emergencies. These devices are intended for Radiation Safety Officers (RSOs), Health Physicists, Emergency Responders and other radiation-minded professionals. The catalog contains information about a variety of survey meters and probes, area monitors, and other radiation-monitoring accessories.

Order the Radiation Safety catalog online by visiting www.flukebiomedical.com/catalogs



Fluke Biomedical Test

The Biomedical Test catalog emphasizes the complete line of biomedical test and simulation products for Biomedical/Clinical Engineers and Technicians. The catalog contains information about Fluke Biomedical's test and simulation products, including standalone electrical safety testers, patient simulators, and performance analyzers, as well as fully integrated and automated performance-testing and documentation systems.

Order the Biomedical Test catalog online by visiting www.flukebiomedical.com/catalogs

Your authorized Fluke distributor



riešenia na presné meranie™

Elso Philips Service; tel: +421 32 6582410
email: elso@elso.sk; web: www.elso.sk

Fluke Biomedical.

*The accuracy you need
from a company you can trust.*

Fluke Biomedical
6045 Cochran Road
Cleveland, OH 44139-3303 U.S.A.

Fluke Biomedical Europe AS
Vegamot 8, N-7048 Trondheim, Norway

For more information, contact us

In the U.S.A. (800) 850-4608 or
Fax (440) 349-2307

In Europe/M-East/Africa +47 73954700 or
Fax +47 73954701

From other countries +1 (440) 248-9300 or
Fax +1 (440) 349-2307

Email: sales@flukebiomedical.com

Web access: www.flukebiomedical.com

©2007 Fluke Biomedical.

All OEM company trademarks are implied.
Specifications subject to change without notice.
Printed in U.S.A. 9/2007 3037447 C-EN Rev A