





**FLUKE**®

**Hart Scientific**®

Now you can measure, graph, and record three sensor types anywhere... with the new 1523/24 Reference Thermometers from Fluke's Hart Scientific division that are easy to use and offer top accuracy:

- PRTs:  $\pm 0.011\text{ }^{\circ}\text{C}$
- Thermocouples:  $\pm 0.24\text{ }^{\circ}\text{C}$
- Thermistors:  $\pm 0.002\text{ }^{\circ}\text{C}$

Plus the 1524 offers two channels, 15,000 points logged, and more.

See page 58 for more information.

**Finally, a reference thermometer as versatile as you are**

*Fluke. Keeping your world up and running.\**



**FLUKE**®

**Hart Scientific**®

**914X Series Field Metrology Wells deliver maximum portability, speed, and accuracy at a minimum price**

The 914X family from Fluke's Hart Scientific division lightens your field calibration workload at every turn. Their compact size and weight make them the most portable field calibrators in their class. Fast heating and cooling plus automated and documented calibrations save time. Plus the built-in reference thermometer, two measurement channels, and 24 V loop power supply ensure top accuracy.

See page 144 for more information.

**Best in Field.**

*Fluke. Keeping your world up and running.\**



**FLUKE**®

**Hart Scientific**®

Now it's easy to increase your IR temperature measurement accuracy with the new 4180/81 Precision Infrared Calibrators from Fluke's Hart Scientific division. Their accredited radiometric calibrations ensure meaningful, consistent measurements. And the large 152 mm (6 in) target helps eliminate errors. You easily get fast, accurate results for temperature ranges from  $-15\text{ }^{\circ}\text{C}$  to  $120\text{ }^{\circ}\text{C}$  (4180) or from  $35\text{ }^{\circ}\text{C}$  to  $500\text{ }^{\circ}\text{C}$  (4181).

See page 171 for more information.

**When was the last time you calibrated your IR thermometers?**

*Fluke. Keeping your world up and running.\**



**FLUKE**®

**Hart Scientific**®

**Get high accuracy and reliable data storage with the 1620A DewK Thermo-Hygrometer.**

The DewK measures temperature to  $\pm 0.125\text{ }^{\circ}\text{C}$  and RH to  $\pm 1.5\%$  on two channels, and displays them on a big, clear screen. Ethernet, wireless (optional), RS-232, and the optional Logware III software will allow you to network as many DewKs as you'd like. And it stores years' worth of readings internally, or directly to a computer. Even your auditor will love it.

See page 63 for more information.

**Paper chart or state-of-the-art?**



*Fluke. Keeping your world up and running.\**



# Table of Contents

## Primary standards selection guide . . . . . 4

Why buy primary standards from Hart? . . . . .	6
Quartz-sheath SPRTs . . . . .	8
Working standard SPRT . . . . .	10
Extended range metal-sheath SPRT . . . . .	11
Glass capsule SPRTs . . . . .	12
Annealing furnace . . . . .	13
Triple point of water cells . . . . .	14
TPW maintenance bath . . . . .	17
<i>Use TPW and ratio method to improve SPRT stability and accuracy.</i> . . . . .	18
DC bridge . . . . .	20
<i>Why use Fluke metal freeze-point cells?</i> . . . . .	21
ITS-90 fixed-point cells . . . . .	23
ITS-90 fixed-point cells . . . . .	24
<i>Traceability and thermometric fixed-point cells</i> . . . . .	26
Freeze-point furnaces . . . . .	28
Mini fixed-point cells . . . . .	30
Mini TPW maintenance apparatus . . . . .	32
Gallium cell maintenance apparatus . . . . .	33
Mini fixed-point cell furnace . . . . .	34
LN <sub>2</sub> comparison calibrators . . . . .	35
DC resistance standards . . . . .	36
Standard AC/DC resistors . . . . .	37

## Thermometer readout selection guide . . . . . 38

Super-Thermometer readouts . . . . .	40
<i>Evaluating calibration system accuracy</i> . . . . .	44
<i>International Temperature Scale of 1990 (ITS-90) quick reference.</i> . . . . .	45
<i>PRT temperature vs. resistance table</i> . . . . .	46
<i>Thermocouple EMF and sensitivity chart</i> . . . . .	47
The Black Stack thermometer readout . . . . .	48
Tweener thermometer readouts . . . . .	56
Handheld thermometer readouts . . . . .	58
Reference multimeter . . . . .	62
The DewK thermo-hygrometer . . . . .	63

## Thermometer probe selection guide . . . . . 66

How accurate is that probe? . . . . .	67
Secondary standard PRTs . . . . .	68
Ultra high-temp PRT . . . . .	69
Secondary reference temperature standards . . . . .	70
Secondary PRT with calibration options . . . . .	72
5616 secondary reference PRT . . . . .	74
<i>Sensible temperature specifications</i> . . . . .	76
Small diameter industrial PRT . . . . .	77
Precision freezer PRT . . . . .	78
Precision industrial PRTs . . . . .	79
Fast response PRTs . . . . .	80
<i>What are stem conduction errors and how can they create errors in calibration?</i> . . . . .	81
Thermistor standards probes . . . . .	82
Secondary reference thermistor probes . . . . .	84
<i>Thermistors: the under appreciated temperature standards</i> . . . . .	86
<i>Thermocouples 101... or, maybe... 401!</i> . . . . .	88
Type R and S thermocouple standards . . . . .	90
<i>Reference table: letter-designated thermocouple tolerances.</i> . . . . .	91
<i>Temperature conversion table</i> . . . . .	92
<i>Why did my temperature sensor fail calibration?</i> . . . . .	93

## Software selection guide . . . . . 96

Interface-it . . . . .	96
MET/TEMP II . . . . .	97
TableWare . . . . .	100
LogWare and LogWare II . . . . .	101
LogWare III . . . . .	102
<i>Establishing traceability</i> . . . . .	103

## Bath selection guide . . . . . 104

<i>Buying the right bath</i> . . . . .	106
Deep-well compact baths . . . . .	108
Compact baths . . . . .	110
<i>Why a Hart bath?</i> . . . . .	112
Really cold baths . . . . .	114
Cold baths . . . . .	116
Hot baths . . . . .	118
Really hot bath . . . . .	120
Bath accessories . . . . .	121
Deep-well baths . . . . .	122
Resistor baths . . . . .	124
Constant temperature ice bath . . . . .	126
<i>Avoid water problems in cold baths</i> . . . . .	127
Bath fluids . . . . .	128
Controller for Rosemount-designed baths . . . . .	132
Benchtop controllers . . . . .	133

## Industrial calibrator selection guide . . . . . 134

<i>Selecting an industrial temperature calibrator</i> . . . . .	136
Metrology Well calibrators . . . . .	139
Field Metrology Wells . . . . .	144
<i>Understanding the uncertainties associated with Metrology Wells</i> . . . . .	149
Micro-Baths . . . . .	152
<i>Eliminating sensor errors in loop calibrations</i> . . . . .	154
Field dry-wells . . . . .	156
<i>A few dry-well dos and don'ts...</i> . . . . .	158
Industrial dual-block calibrator . . . . .	160
High-accuracy dual-well calibrator . . . . .	162
Handheld dry-wells . . . . .	164
Portable lab dry-well . . . . .	166
Thermocouple furnace . . . . .	167
Thermocouple calibration furnace . . . . .	168
Zero-point dry-well . . . . .	170
4180 series precision infrared calibrators . . . . .	171
Portable IR calibrators . . . . .	174
Surface calibrator . . . . .	176

## Other neat stuff selection guide . . . . . 177

External battery pack . . . . .	177
Benchtop temperature/humidity generator . . . . .	178
<i>On rutabagas and their origins...</i> . . . . .	180
Hart Scientific temperature seminars . . . . .	181
<i>NVLAP accreditation at Hart.</i> . . . . .	184
Calibration services . . . . .	186
<i>Guidelines for Hart product specifications</i> . . . . .	194
Hart Service . . . . .	195
How to order . . . . .	195

# Primary standards selection guide

## SPRTs

Model	$R_{TPW}$	Range	Page
5681	25.5 $\Omega$	-200 °C to 670 °C	8
5683	25.5 $\Omega$	-200 °C to 480 °C	
5684	0.25 $\Omega$	0 °C to 1070 °C	
5685	2.5 $\Omega$	0 °C to 1070 °C	
5698	25.5 $\Omega$	-200 °C to 670 °C	
5699	25.5 $\Omega$	-200 °C to 670 °C	11
5686	25.5 $\Omega$	-260 °C to 232 °C	12
5695	25.5 $\Omega$	-200 °C to 500 °C	

## Fixed-point cells

Model	Description	Temperature	Page	
5901A-G	TPW Cell, 12 mm ID with handle, glass shell	0.01 °C	14	
5901A-Q	TPW Cell, 12 mm ID with handle, quartz shell	0.01 °C		
5901C-G	TPW Cell, 13.6 mm ID with handle, glass shell	0.01 °C		
5901C-Q	TPW Cell, 14.4 mm ID with handle, quartz shell	0.01 °C		
5901D-G	TPW Cell, 12 mm ID, glass shell	0.01 °C		
5901D-Q	TPW Cell, 12 mm ID, quartz shell	0.01 °C		
5901B-G	TPW Cell, mini, glass shell	0.01 °C		
5900	TP Mercury, SST	-38.8344 °C		23
5904	Freezing Point of Indium	156.5985 °C		
5905	Freezing Point of Tin	231.928 °C		
5906	Freezing Point of Zinc	419.527 °C		
5907	Freezing Point of Aluminum	660.323 °C		
5908	Freezing Point of Silver	961.78 °C		
5909	Freezing Point of Copper	1084.62 °C		
5924	Open Freezing Point of Indium	156.5985 °C		
5925	Open Freezing Point of Tin	231.928 °C		
5926	Open Freezing Point of Zinc	419.527 °C		
5927A-L	Open Freezing Point of Aluminum, Long	660.323 °C		
5927A-S	Open Freezing Point of Aluminum, Short	660.323 °C		
5928	Open Freezing Point of Silver	961.78 °C		
5929	Open Freezing Point of Copper	1084.62 °C		
5943	Melting Point of Gallium, SST	29.7646 °C		
5914A	Mini Freezing Point of Indium	156.5985 °C	30	
5915A	Mini Freezing Point of Tin	231.928 °C		
5916A	Mini Freezing Point of Zinc	419.527 °C		
5917A	Mini Freezing Point of Aluminum	660.323 °C		
5918A	Mini Freezing Point of Silver	961.78 °C		
5919A	Mini Freezing Point of Copper	1084.62 °C		
5944	Mini Freezing Point of Indium	156.5985 °C		
5945	Mini Freezing Point of Tin	231.928 °C		
5946	Mini Freezing Point of Zinc	419.527 °C		
5947	Mini Freezing Point of Aluminum	660.323 °C		



# Primary standards selection guide

## Apparatus

Model	Features/Use	Page
7012	Maintains: triple point of water and gallium cells. Comparisons: -10 °C to 110 °C.	116
7037	Maintains: triple point of water and gallium cells. Comparisons: -40 °C to 110 °C.	
7312	Maintains: two TPW cells. Compact size, runs quietly. Comparisons: -5 °C to 110 °C.	17
7341	Maintains: triple point of mercury cell. Comparisons: -45 °C to 150 °C.	108
9210	Maintains: mini triple point of water and mini gallium cells. Comparisons: -10 °C to 125 °C.	32
9230	Maintains: stainless steel gallium cell. Comparisons: 15 °C to 35 °C.	33
9260	Maintains: indium, tin, zinc, and aluminum cells. Comparisons: 50 °C to 680 °C.	34
9114	Maintains: indium, tin, zinc, and aluminum cells. Comparisons: 100 °C to 680 °C.	28
9115A	Maintains: aluminum and silver cells. Comparisons: 550 °C to 1000 °C.	
9116A	Maintains: aluminum, silver, gold, and copper cells. Comparisons: 400 °C to 1100 °C.	
9117	Anneals SPRTs, HTPRTs, and thermocouples to 1100 °C. Protects them against contamination from metal ions.	13

## Boiling point of liquid nitrogen

7196	Affordable substitute for a triple point of argon system. Provides for low-temperature comparison calibrations at approximately -196 °C with uncertainties of 2 mK.	35
------	---	----

## Resistance bridge

5581	0.1 ppm accuracy for calibration of standard resistors and SPRTs. 13:1 measurement ratio allows resolution to 0.001 mK.	18
1590	1 ppm accuracy for calibration of SPRTs and thermistors.	40

## Standard resistors

742A	Excellent performance without oil or air baths. Values from 10 ohm to 100 megohm.	36
5430	Highest stability oil-filled resistors (< 2 ppm/year drift). AC cal uncertainty to 3 ppm.	37

# Why buy primary standards from Hart?

Setting up a primary temperature standards lab is no small project. Decisions must be made about temperature range, uncertainty requirements, the types of standards you need, and the companies that can supply your standards. Whose products are reliable? Which company backs up its performance claims? Who provides after-sale support and training? Who really demonstrates the most integrity throughout your ownership experience? After all, substantial investments are being made, and in many cases the credibility of your lab can be affected by the outcome.

So why does Hart Scientific claim to be the world's best supplier of primary temperature standards? Because our products have been tested over and over again by national labs around the world and proven to outperform their specs. Because the people who design and build primary temperature standards at Hart have been designing and building primary temperature standards longer than any other supplier in the world. We not only manufacture primary standards, we perform basic research and innovate with new primary standards designs. No one else offers the high-quality training and post-sale support that we do. No one!

## Metal fixed-point cells

For realizing the ITS-90 temperature scale, Hart's metal fixed-point cells provide performance you can trust, and we supply the data with each cell to prove it. Hart's fixed-point cells benefit from more than 20 years of experience in research, design, and manufacturing. Three types of cells are available: traditional size cells, "mini" quartz cells, and new "mini" metal-cased cells. All three provide outstanding performance.

Each Hart cell is carefully assembled, tested, and supplied with an assay of metal-sample purity. Every traditional-size cell further undergoes more rigorous testing to a CCT-based procedure in our NVLAP-accredited lab, where we realize at least three freezing curves and perform a detailed "slope analysis" to confirm cell purity. If you'd like this more thorough "slope analysis" for a "mini" quartz cell or new "mini" metal-cased cell, we offer that as an option. And if you still want more, we can also supply comparison data with our own reference cells that have been independently tested at NIST.

No other commercial company has as much experience in the development of fixed-point cells as Hart does. Hart's own Xumo Li was a key contributor to the



development of the ITS-90 scale. That's one reason you'll find Hart cells in many of the national metrology institutes around the world.

## Water triple point cells

Like our metal fixed-point cells, Hart's triple point of water cells come in traditional and "mini" quartz sizes, as well as small stainless steel, which can be realized in a dry-well calibrator. Our traditional cells have been tested at NIST (see chart on facing page) and are within a few microkelvin of NIST's cells.

If you're new to primary temperature standards and are considering a water triple point cell, one of our cells is sure to meet your requirements. We offer training through our seminars, insurance for our glass cells, and our stainless steel cell just can't be broken!

## Maintenance apparatus

Maintaining fixed-point cells requires high-stability apparatus with tight

gradient control so plateaus last longer and your work is more productive. Every Hart maintenance apparatus, including our metrology furnaces and fluid baths, uses temperature controllers designed and manufactured by Hart. These controllers are widely recognized for their unmatched stability and uniformity control.

For metal fixed-point cells, choose from one-zone, three-zone, or heat-pipe furnaces for regular or mini cells. Optional equilibration blocks fit into the furnaces for annealing and comparison calibrations. Don't let the competition try to tell you that a furnace fitted with process controllers can provide the same performance as a furnace fitted with controllers designed specifically for high-stability temperature control. With a Hart furnace you'll get longer cell plateaus with smaller gradients than you will from any other furnace on the market.

# Why buy primary standards from Hart?

## SPRTs

SPRTs are the only acceptable ITS-90 interpolation devices from the triple point of hydrogen (13.8033 K) to the freezing point of silver (961.78 °C). While most SPRT manufacturers lost their design capabilities years ago, Hart continues to develop new innovative designs with the lowest drift rates.

Hart manufactures quartz SPRTs in four different temperature ranges, including capsule SPRTs for low temperatures, an ultra-stable SPRT for the range to 480 °C, and a new “working-standard” SPRT for the range to 660 °C. Our metal-sheath SPRTs include a 25.5-ohm, contamination-resistant SPRT. Hart SPRTs are the standards of choice for many national metrology institutes around the world.

## Thermometry

Traditionally, SPRT measurements have been made using expensive, difficult-to-use bridges. If you need 1 ppm accuracy, there’s nothing that provides a better price/performance ratio than Hart’s 1590 Super-Thermometer. The 1590 Super-Thermometer provides bridge accuracy at a fraction of the cost and provides a multitude of features that improve your productivity. With a Super-Thermometer, there is virtually no learning curve. It’s so easy to use that you’ll be making measurements within minutes after switching it on.

If you truly need 0.1 ppm performance, the 5581 MIL Bridge offers conventional DC measurement for a wide range. It’s perfect for temperature metrology work and for labs looking to combine temperature with electrical resistance standards.



Mingjian Zhao, Hart’s director of Primary Standards Engineering.

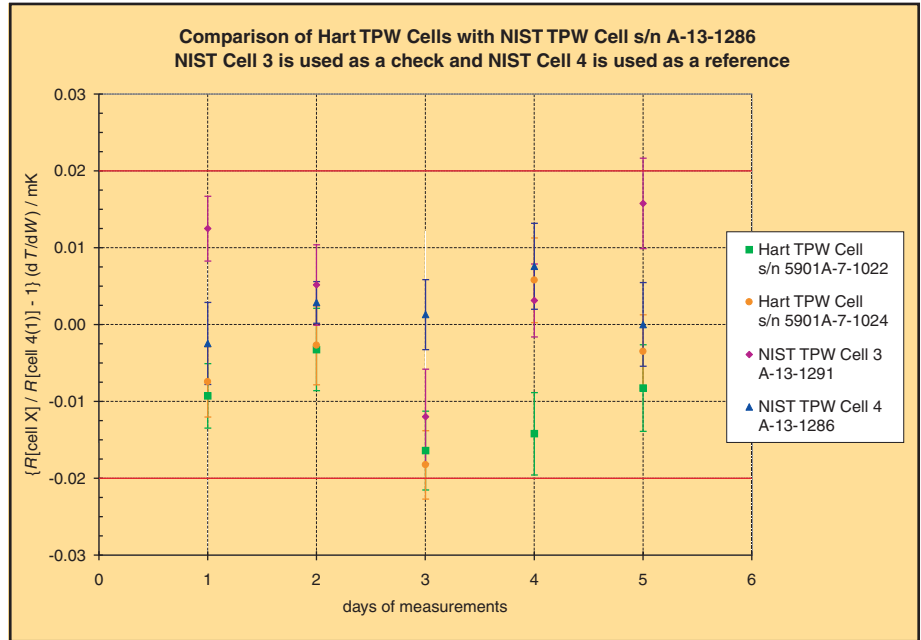

## Training

Once you’ve determined which primary standards products you need and you’ve made a major investment, what about training and after-sales support? Hart’s temperature school offers a fun and unique seminar that provides all the answers to your toughest questions. Our 2½-day “Realizing and Approximating ITS-90” seminar provides all the theory and some first-rate practical, hands-on experience to get you started. You’ll learn some key temperature theory from former national lab scientists and take part in practical experiments with our lab staff. If you want more, talk to us about individual ITS-90 training, where you can work alongside our cal lab staff in Hart’s primary standards lab, performing practical realizations on the cells that you just purchased.

We’ve been making and using primary temperature standards for many years, and we understand the issues you face in your lab. Our own lab is accredited (NVLAP lab code 200348-0) and our uncertainties are among the best in the world. When you buy primary standards, don’t compromise the quality of the products, the reputation of your supplier, or the level of service and training they can provide.



# Quartz-sheath SPRTs



- Drift rates as low as 0.0005 K
- Proprietary gas mixture ensures high stability
- Most experienced SPRT design team in the business

Choosing the right platinum thermometer as your primary standard may be the most critical purchase decision in your lab. Unfortunately, other manufacturers are pretty secretive about how their SPRTs are made. They won't tell you much more than you can already see by looking at one. Many of the leaders of a few decades ago have lost their original craftsmen and design scientists. Hart Scientific has one of only a few active SPRT design groups in the world today.

So how do you know you're making the best purchase? Self-proclaimed expertise shouldn't convince you. You should expect some sound evidence that the company is qualified in the ongoing science of SPRT development. At Hart, we'll tell you how we make an SPRT. We'll let you talk to the people here who design, build, and calibrate SPRTs. Finally, when you buy one, if you don't like it, we'll take it back and return your money.

Hart has four quartz-sheath SPRTs, covering the ITS-90 range of  $-200\text{ }^{\circ}\text{C}$  to  $1070\text{ }^{\circ}\text{C}$ . The 5681 is used from  $-200\text{ }^{\circ}\text{C}$  to the aluminum point at  $660.323\text{ }^{\circ}\text{C}$ . The 5683 is used from  $-200\text{ }^{\circ}\text{C}$  to  $480\text{ }^{\circ}\text{C}$  with greater long term stability. The 5684 and

the 5685 cover higher temperatures up to  $1070\text{ }^{\circ}\text{C}$  and can be calibrated at the silver point.

Yes, they have all the features you would expect in a world-class SPRT. They have gold-plated spade lugs, a strain-relieved four-wire cable, convection prevention disks, the finest quartz glass available, delustered stems, and the purest platinum wire available.

The purity of a thermometer's platinum wire is critical to meeting ITS-90 requirements. Platinum resistance is measured by the resistance ratio "W" at specified ITS-90 fixed points. Maintaining that purity over the life of the thermometer impacts long-term stability. The quartz glass tube of the SPRT should be properly sealed to prevent contamination of the platinum wire. Others use mechanical assemblies and epoxy seals. These introduce additional materials to the thermometer's internal environment and can be prone to mechanical failure, risking exposure of the platinum to impurities.

Theoretically, the best seal would be a direct seal between the quartz glass and the platinum wire. However, the quartz glass used in thermometer sheaths has a

very small coefficient of expansion while platinum has a much larger coefficient of expansion. If you simply sealed the sheath's glass to the platinum wire, these different rates of expansion would result in a poor seal as the assembly is exposed to changing temperatures.

We've figured out a way to match the expansion coefficients of the glass sheath and the platinum wires. We do it by creating a graduating seal that's made of 18 separate pieces of glass, each with a different coefficient of expansion. The expansion and contraction rate of the innermost piece of glass matches that of the platinum, resulting in an overall seal that prevents gas leakage and impurity penetration for at least 20 years.

Fusing each piece of glass to the next is a painstaking process. Sure it costs us extra, but the results are worth it!

There's more!

We use only pure quartz glass materials for the cross frames, disks, and tubes. We don't use mica or ceramic materials. Additionally, we have a special glass-treating process to increase the resistance of the quartz to devitrification and remove more impurities than the typical cleaning process.

We've done some research to find the best-performing balance of argon to oxygen in the tube. Some oxygen in the sheath is necessary to minimize the danger of the platinum being poisoned by foreign metals at high temperatures, but too much oxygen at temperatures below  $500\text{ }^{\circ}\text{C}$  accelerates the oxidation process affecting the integrity of the platinum. We've got a balance that provides exactly the right protection for the platinum.

Each of these seemingly small things adds up to better uncertainties and less drift.

## 5681: $-200\text{ }^{\circ}\text{C}$ to $670\text{ }^{\circ}\text{C}$

This 25-ohm thermometer is the workhorse of the ITS-90 ranges. It can be calibrated for any of the subranges from the triple point of argon to the freezing point of aluminum. The 5681 meets the ITS-90 requirements for resistance ratios as follows:

$$W(302.9146\text{ K}) \geq 1.11807$$

and

$$W(234.3156\text{ K}) \leq 0.844235$$

## 5683: $-200\text{ }^{\circ}\text{C}$ to $480\text{ }^{\circ}\text{C}$

While SPRTs traditionally cover temperatures to the aluminum point ( $660\text{ }^{\circ}\text{C}$ ), most measurements occur between  $-100\text{ }^{\circ}\text{C}$  and  $420\text{ }^{\circ}\text{C}$ . The 5683 SPRT covers this range and more, from  $-200\text{ }^{\circ}\text{C}$  to  $480\text{ }^{\circ}\text{C}$ , and does so with long-term stabilities that

# Quartz-sheath SPRTs

Specifications	5681	5683	5684	5685
Temperature Range	-200 °C to 670 °C	-200 °C to 480 °C	0 °C to 1070 °C	0 °C to 1070 °C
Nominal $R_{TPW}$	25.5 $\Omega$		0.25 $\Omega$	2.5 $\Omega$
Current	1 mA		10 mA or 14.14 mA	3 or 5 mA
Resistance Ratio	W(302.9146 K) $\geq$ 1.11807 and W(234.3156 K) $\leq$ 0.844235		W(302.9146 K) $\geq$ 1.11807 and W(1234.93 K) $\geq$ 4.2844	
Sensitivity	0.1 $\Omega$ /°C		0.001 $\Omega$ /°C	0.01 $\Omega$ /°C
Drift Rate	< 0.002 °C/100 hours at 661 °C (typically < 0.001 °C)	< 0.001 °C/100 hours at 480 °C (0.0005 °C typical)	< 0.003 °C/100 hours at 1070 °C (typically < 0.001 °C)	
Self-heating at TPW	< 0.002 °C under 1 mA current		< 0.002 °C under 10 mA current	< 0.002 °C under 3 mA current
Reproducibility	$\pm$ 0.001 °C or better	$\pm$ 0.00075 °C or better	$\pm$ 0.0015 °C or better	
$R_{TPW}$ drift after Thermal Cycling	< 0.00075 °C	< 0.0005 °C	< 0.001 °C	
Sensor Support	Quartz glass cross		Quartz glass strip with notches	Quartz glass cross
Diameter of Sensor Pt Wire	0.07 mm (0.003 in)		0.4 mm (0.016 in)	0.2 mm (0.008 in)
Protective Sheath	Quartz glass, Diameter: 7 mm (0.28 in), Length: 520 mm (20.5 in)		Quartz glass, Diameter: 7 mm (0.28 in), Length: 680 mm (26.8 in)	

extended range SPRTs can't match. Typical drift is less than 0.5 mK after 100 hours at 480 °C.

### 5684 and 5685: 0 °C to 1070 °C

ITS-90 extended the use of the platinum thermometer from 630 °C to 962 °C. The 0.25-ohm HTPRT sensor uses a strip-shaped support made from high-purity quartz glass. The 2.5-ohm model uses a quartz glass cross frame. Stability after thermal cycling is excellent, and the design is reasonably tolerant of vibration. Choose from 0.25-ohm or 2.5-ohm

nominal  $R_{TPW}$  values. In addition to meeting the resistance ratio requirements shown above, these thermometers meet the following additional criterion:

$$W(1234.93 \text{ K}) \geq 4.2844$$

These glass probes really are a notch above the rest!

### Ordering Information

**5681-S** SPRT 25.5  $\Omega$ , 670 °C<sup>1</sup>

**5683-S** SPRT 25.5  $\Omega$ , 480 °C<sup>1</sup>, Ultrastable

**5684-S** SPRT 0.25  $\Omega$ , 1070 °C<sup>1</sup>

**5685-S** SPRT 2.5  $\Omega$ , 1070 °C<sup>1</sup>

<sup>1</sup>Maple carrying case included

See page 186 for SPRT calibration options.

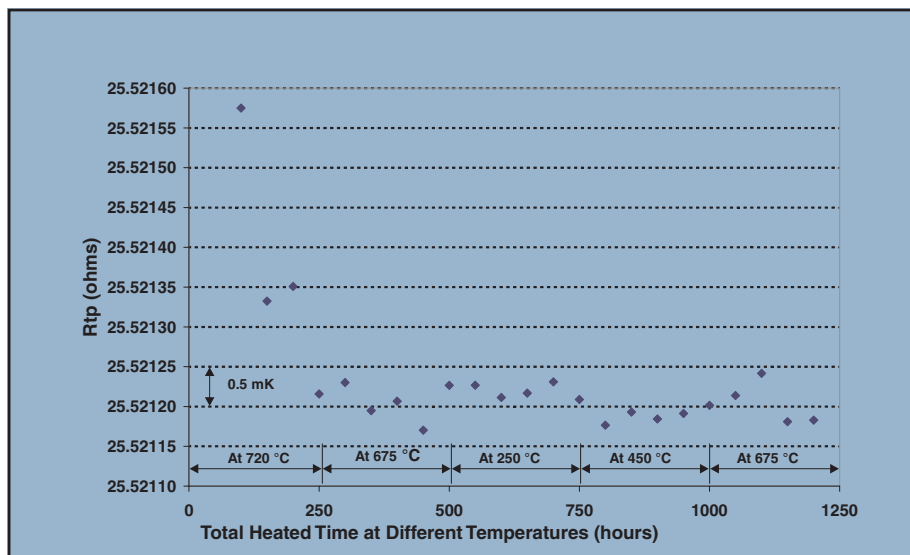

A typical stability graph of a 5681 SPRT (#71122). Units are calibrated or shipped to customers after about 250 hours of annealing.

### Maximize your SPRT's performance

Amazingly high accuracies can be obtained from a good SPRT if it is handled correctly. Expanded uncertainties as low as a few tenths of a millikelvin at 0 °C are possible provided you do the following:

- Avoid physical shock or vibration to your SPRT. An SPRT is a delicate instrument, highly susceptible to mishandling.
- Make a measurement at the triple point of water after each measurement. Use the resistance ratio (W) rather than the absolute resistance to calculate the temperature.
- Measure at two different input currents and extrapolate the results to determine the value at zero power. This will eliminate the often-ignored effects of self-heating.



# Working standard SPRT



- Fully conforms to ITS-90 SPRT guidelines
- Drift rate typically less than 0.003 °C
- Multiple calibration options by fixed point
- Unmatched performance-to-price-ratio

SPRTs. Art or science? It takes, in fact, quite a bit of both. The one thing *not* involved is mystery. That's why Hart SPRTs always include detailed published specifications, including drift rates.

Our newest SPRT is no exception. It was designed by the same Hart metrologists who have created a dozen different SPRT designs used in national labs around the world. And it performs just like we say it does.

The 5698 Working Standard SPRT is a true SPRT. It meets the ITS-90 ratio requirements for SPRTs and includes a Hart-designed, completely strain-free platinum sensor. With a 485-mm quartz sheath, this 25-ohm SPRT covers a temperature range from -200 °C to 670 °C. Long-term drift, which we define as the change in output resistance at the triple point of water after 100 hours at 670 °C, is (after converting to temperature) less than 6 mK—typically less than 3 mK.

The 5698 is the perfect companion to a Hart Super-Thermometer such as the 1590, which reads 25-ohm SPRTs to within 1 mK at 0 °C and includes a number of convenient features for working with SPRTs. Requiring 1 mA of excitation current, the 5698 can also be used easily with a Hart *Black Stack*, or even a Chub-E4 Thermometer.

If you need your SPRT calibrated by a reputable calibration lab, we offer appropriate calibration options by fixed-point in

our NVLAP-accredited lab. Our calibration prices are as reasonable as our instrument prices, so you get maximum value from your SPRT.

Why buy critical temperature standards from companies unwilling to publish complete specifications? At Hart, we not only provide excellent post-purchase support so you have the best possible ownership experience, we also provide you all the information we can *before* you purchase—including detailed performance specifications.

## Not all platinum is the same

Platinum resistance thermometers (PRTs) are made from a variety of platinum sensor wire. The differences in the wire affect the thermometers' performance. The two most important variations are purity and thickness.

According to IPTS-68 requirements, platinum purity was measured by its "alpha," or average change of resistance per degree. Alpha 0.00385 was common for industrial thermometers, and alpha 0.003925 was common for SPRTs. ITS-90, in contrast, measures platinum quality with ratios ( $W$ ) of their resistance at certain fixed points (gallium, mercury, and/or silver) to their resistance at the triple point of water ( $R_{TPW}$ ). Those meeting the ITS-90-specified ratios are considered SPRT quality.

## Specifications

Temperature Range	-200 °C to 670 °C
Nominal $R_{TPW}$	25.5Ω (± 0.5Ω)
Current	1.0 mA
Resistance Ratios	$W(234.315K) \leq 0.844235$ $W(302.9146K) \geq 1.11807$
Sensitivity	0.1Ω/ °C
Drift Rate	< 0.006 °C/100 hours at max temperature (typically < 0.003 °C)
Self-heating at TPW	< 0.002 °C under 1 mA current
Reproducibility	± 0.0015 °C or better
$R_{TPW}$ Drift After Thermal Cycling	< 0.001 °C
Diameter of Pt Sensor Wire	0.07 mm (0.003 in)
Protective Sheath	Quartz Glass Diameter: 7 mm (0.28 in) Length: 485 mm (19.1 in)
Lead Wires	Four sensor wires

## Ordering Information

**5698-25** 25Ω Working Standard SPRT<sup>†</sup>

<sup>†</sup>Maple carrying case included

See page 186 for SPRT calibration options.

Maybe there is some art mixed with our science. But that doesn't mean we keep secrets. Trust your lab standards to Hart Scientific.

The thickness of the platinum wire affects its resistance and is indicated by a nominal resistance value at the triple point of water. The thicker the wire, the lower its nominal resistance. 100 ohms at  $R_{TPW}$  is common for industrial sensors, and 25 ohms at  $R_{TPW}$  is typical for SPRTs.

Which is best for your application? All things equal, lower resistance PRTs are generally more stable because of their thicker sensor wire. However, low-resistance PRTs require higher resolution readout devices to handle the small changes in resistance per degree. The advantages gained by using low-resistance PRTs are not significant in most applications. If they're needed, however, be sure you have the right device to read them. (See Hart readouts on page 38.)



# Extended range metal-sheath SPRT



- Measures temperatures as high as 670 °C
- Inconel and platinum sheaths guard against contamination
- Less than 8 mK/year drift
- Fifth wire provides shielded ground

SPRTs designed by Hart Scientific are known for their outstanding reliability and minimal long-term drift. They have been calibrated by national (and other primary) laboratories and proven repeatedly to outperform competitive models. Now Hart's 5699 Extended Range Metal-Sheath SPRT combines all the advantages of a Hart-designed sensor with the protective sheathing materials that allow your SPRT to be used in virtually any furnace or bath with temperatures as high as 670 °C.

Designed and manufactured by our primary standards metrologists, the strain-free sensing element in the 5699 meets all ITS-90 requirements for SPRTs and minimizes long-term drift.

After one year of regular usage, drift is less than 0.008 °C (< 0.003 °C is typical). Even lower drift rates are possible depending on care and handling. A fifth wire for grounding is added to the four-wire sensor to help reduce electrical noise, particularly for ac measurements. Finally, you can get an improved version of an old industry-standard Inconel-sheathed SPRT.

The 5699 is constructed with a 0.219-inch-diameter Inconel sheath for high durability and fast response times. Inside the sheath, the sensing element is protected by a thin platinum housing that shields the sensor from contamination from free-floating metal ions found within metal

environments at high temperatures. Reduced contamination means a low drift rate—even after hours of use in metal-block furnaces at high temperatures.

If you choose not to calibrate the 5699 yourself, a wide variety of options is conveniently available from Hart's own primary standards laboratory, including fixed-point calibrations covering any range between -200 °C and 661 °C.

At Hart, we use SPRTs every day. We design them, build them, calibrate them, use them as standards, and know what it takes to make a reliably performing instrument. Why buy from anyone else?

## Specifications

Temperature Range	-200 °C to 670 °C
Nominal $R_{TPW}$	25.5 $\Omega$ ( $\pm$ 0.5 $\Omega$ )
Current	1 mA
Resistance Ratio	W(302.9146 K) $\geq$ 1.11807 W(234.3156 K) $\leq$ 0.844235
Sensitivity	0.1 $\Omega$ / °C
Drift Rate	< 0.008 °C/year (< 0.003 °C/year typical)
Repeatability	< 1 mK
Self-heating at TPW	< 0.001 °C under 1 mA current
Reproducibility	$\pm$ 0.001 °C or better
$R_{TPW}$ Drift After Thermal Cycling	< 0.001 °C
Diameter of Pt Sensor Wire	0.07 mm (0.003 in)
Lead Wires	Four sensor wires plus grounding wire
Protective Sheath	Inconel Diameter: 5.56 mm $\pm$ 0.13 mm (0.219 in $\pm$ 0.005 in) Length: 482 mm (19 in)
Insulation Resistance	> 100 M $\Omega$ at 661 °C > 1000 M $\Omega$ at 20 °C

## Ordering Information

**5699-S** Extended Range Metal-Sheath SPRT<sup>†</sup>

<sup>†</sup>Maple carrying case included

See page 186 for SPRT calibration options.  
See page 38 for optional readouts.

# Glass capsule SPRTs



- Temperatures from  $-260\text{ }^{\circ}\text{C}$  (13K) to  $232\text{ }^{\circ}\text{C}$
- Stability typically  $0.001\text{ }^{\circ}\text{C}$  over a  $100\text{ }^{\circ}\text{C}$  range
- Miniature capsule package eliminates stem conduction

Sometimes you would like to make SPRT measurements but traditional SPRTs are too long or awkward for a particular application. Our miniature glass capsule SPRTs are perfect for cryogenics, calorimetry, and other metrology work requiring small SPRTs.

These are true SPRTs. The high-purity platinum wire is hand-wound on a glass cross frame in a strain-free design. The glass capsule is designed to match the thermal expansion of the platinum wire to ensure a true seal at all operating temperatures. The capsules are pressure sealed and come protected in their own maple cases. Both models comply completely with ITS-90 requirements for platinum

purity including the following resistance ratio:

$$W(302.9146\text{K}) \geq 1.11807$$

and

$$W(234.3156\text{K}) \leq 0.844235$$

The 5686 covers temperatures from  $-260\text{ }^{\circ}\text{C}$  to  $232\text{ }^{\circ}\text{C}$ , so it's perfect for cryogenic applications. It is 5.8 mm (.23 inches) in diameter and 56 mm (2.2 inches) long.

These SPRTs are small but meet customary SPRT performance for reproducibility, reliability, and stability.

## Specifications

Temperature Range	$-260\text{ }^{\circ}\text{C}$ to $232\text{ }^{\circ}\text{C}$ (13 K to 505 K)
Nominal $R_{TPW}$	$25.5\ \Omega$
Resistance Ratio	$W(302.9146\text{ K}) \geq 1.11807$ $W(234.3156\text{ K}) \leq 0.844235$
Drift Rate	$< 0.005\text{ }^{\circ}\text{C}$ per year over the entire range
Self-heating at TPW	$< 0.002\text{ }^{\circ}\text{C}$ under 1 mA current
Reproducibility	$\pm 0.001\text{ }^{\circ}\text{C}$ or better
$R_{TPW}$ Drift After Thermal Cycling	$< 0.001\text{ }^{\circ}\text{C}$
Filling Gas	helium
Lead Wires	Four platinum wires, 30 mm long (1.18 in)
Size	5.8 mm dia. x 56 mm long (0.23 x 2.2 in)

## Ordering Information

**5686-B** Glass Capsule SPRT,  $-260\text{ }^{\circ}\text{C}$  to  $232\text{ }^{\circ}\text{C}$ <sup>1</sup>

<sup>1</sup>Maple carrying case included

See page 186 for SPRT calibration options.

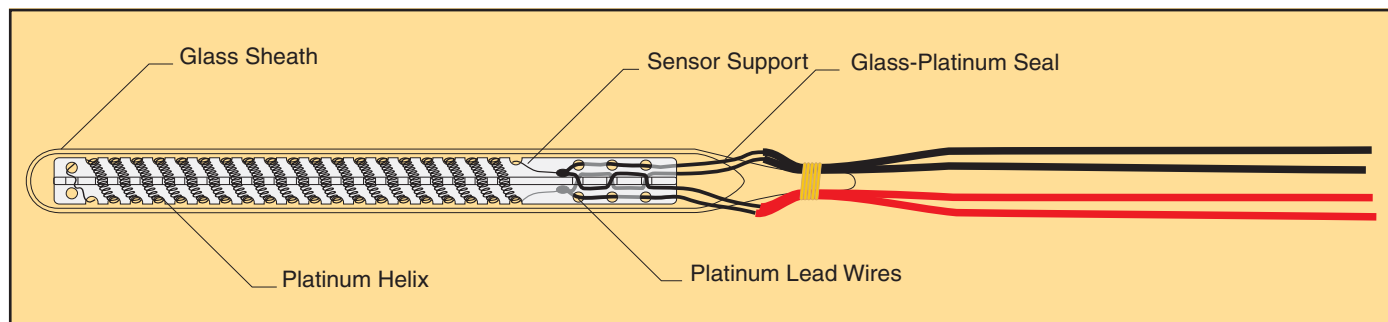

# Annealing furnace



- Guards against contamination
- Anneals both SPRTs and HTPRTs
- Fully programmable

You've spent some serious money to equip your lab with some of the finest SPRTs in the world because they're the most accurate temperature measurement instruments you can buy. Now that you've got them, part of your job is to keep them performing at their highest levels. You can do that with a Hart 9117 Annealing Furnace.

All HTPRTs and SPRTs are subject to mechanical shock no matter how carefully you handle them. This shock changes the resistance characteristics of the platinum and shows up as temperature measurement errors. Annealing relieves the stress on the platinum sensor caused by mechanical shock and is recommended prior to any calibration of an SPRT.

In addition to removing mechanical strain, annealing also removes the oxidation from sensors that have been used for

long periods at temperatures between 200 °C and 500 °C. Oxidation impacts the purity of the element and therefore the accuracy of temperature readings. Oxide is easily removed by annealing at 670 °C for one or two hours.

During the annealing process, contamination must be controlled. At temperatures above 500 °C, the lattice structure of a quartz sheath is transparent to metal ions. The thermometer must be cleaned and all contaminating materials removed from its sheath. Annealing should only be done in a furnace that's designed to avoid emitting metal ions during its heating cycle. Hart solves this problem in its 9117 furnace by using an alumina block that is specially designed to guard against contamination.

The furnace also has a programmable controller specifically designed for the annealing process.

As a manufacturer of SPRTs, Hart metrologists understand every aspect of SPRT use and calibration procedures, including the annealing process. We use this furnace in our own lab, so we know exactly how well it works.

## Specifications

<b>Temperature Range</b>	300 °C to 1100 °C
<b>Stability</b>	± 0.5 °C
<b>Uniformity</b>	± 0.5 °C at 670 °C (over bottom 76 mm [3 in])
<b>Power</b>	230 V ac (± 10 %), 50/60 Hz, 12 A, 2500 W
<b>Display Resolution</b>	0.1 °C below 1000 °C 1 °C above 1000 °C
<b>Display Accuracy</b>	± 5 °C
<b>Thermal Wells</b>	Five: 8 mm diameter x 430 mm long (0.31 x 16.9 in)
<b>Controller</b>	PID, ramp and soak programmable, thermocouple sensor
<b>Over-Temp Protection</b>	Separate circuit protects furnace from exceeding rated temperature limit
<b>Exterior Dimensions (HxWxD)</b>	863 x 343 x 343 mm (34 x 13.5 x 13.5 in)
<b>Weight</b>	28 kg (61 lb)
<b>Communications</b>	RS-232

## Ordering Information

- 9117** Annealing Furnace (includes 2129 Alumina Block)
- 2129** Spare Alumina Block, 5 wells
- 2125-C** IEEE-488 Interface (RS-232 to IEEE-488 converter box)



# Triple point of water cells



- Easy-to-use, inexpensive standard with uncertainty better than  $\pm 0.0001\text{ }^{\circ}\text{C}$
- Four sizes and two shells (glass and quartz) to choose from
- Isotopic composition of Vienna Standard Mean Ocean Water

The triple point of water (TPW) is not only the most accurate and fundamental temperature standard available, it's also one of the least expensive and simplest to use.

## Water cells are essential!

Triple point of water cells fill four critical purposes. First, they provide the most reliable way to identify unacceptable thermometer drift between calibrations—including immediately after a calibration if the thermometer has been shipped. Interim checks are critical for maintaining confidence in thermometer readings between calibrations. Second, they provide a critical calibration point with unequaled uncertainties.

Third, for users who characterize probes using ratios (that is, they use the

ratios of the resistances at various ITS-90 fixed points to the resistance of the thermometer at the triple point of water, indicated by "W"), interim checks at the triple point of water allow for quick and easy updates to the characterizations of critical thermometer standards, which can be used to extend calibration intervals.

And lastly, the triple point of water is where the practical temperature scale (ITS-90) and the thermodynamic temperature scale meet, since the triple point of water is assigned the value 273.16 K (0.01  $^{\circ}\text{C}$ ) by the ITS-90 and the Kelvin is defined as 1/273.16 of the thermodynamic temperature of the triple point of water.

Good triple point of water cells contain only pure water and pure water vapor.

(There is almost no residual air left in them.) When a portion of the water is frozen correctly and water coexists within the cell in its three phases, the "triple point of water" is realized. Hart water cells achieve this temperature with expanded uncertainties of less than 0.0001  $^{\circ}\text{C}$  and reproducibilities within 0.00002  $^{\circ}\text{C}$ .

In simple terms, water cells are made from just glass and water, but there's much more to it than that! For starters, that's not just *any* water in there.

## Heavy water

Hart cells contain carefully and repetitively distilled ocean water and are meticulously evacuated and sealed to maintain an isotopic composition nearly identical to the international standard, "Vienna Standard Mean Ocean Water," or "VSMOW."

The oxygen atoms found in most water are predominantly comprised of eight protons and eight neutrons ( $^{16}\text{O}$ ). Some oxygen atoms, however, have an extra neutron ( $^{17}\text{O}$ ) or two ( $^{18}\text{O}$ ). Similarly, the hydrogen atoms in water normally contain only a single proton ( $^1\text{H}$ ), but sometimes contain a neutron also ( $^2\text{H}$ ), resulting in "heavy" water. These isotopes coexist in varying proportions in ocean water, polar water, and continental water, with ocean water being the heaviest.

The ITS-90 recommends that water cells be made from water with "substantially the isotopic composition of ocean water." Research has shown that TPW errors associated with isotopic composition can be as large as 0.00025  $^{\circ}\text{C}$ . The uncertainty contribution due to the effect of deviation from VSMOW in Hart cells is less than  $\pm 0.000007\text{ }^{\circ}\text{C}$ . That's seven microkelvin!

Hart offers two options for verifying the isotopic composition of any purchased water cell, both at nominal costs. We can submit a sample of water taken from your own cell to a testing laboratory (*after* it was completely manufactured, so you get a valid comparison) and give you the test report. Or, we can send that water sample to you in a sealed ampoule for you to conduct your own tests. We can even provide multiple samples from the same cell (virtually as many as you'd like) so you can check for changes over time.

## Impurities

Further, the potential for errors due to water impurity is even greater than the errors from isotopic composition. Hart cells undergo multiple distillation processes and utilize special techniques to retain water purity. Among other things, our primary

# Triple point of water cells

standards scientists are able to connect quartz cells directly to the glass distillation system without using coupling hardware that may invite contamination.

## Glass vs. quartz

Most Hart water cells may either be purchased with borosilicate glass or with fused silica ("quartz") housings. What's the difference? Glass is less expensive than quartz, but it's also more porous, allowing impurities to pass through it over time. Research indicates that glass cells generally drift about 0.000006 °C per year while quartz cells drift less.

## Many sizes

Hart cells come in four general sizes. Models 5901A, 5901C, and 5901D each come in either quartz or glass shells and include 265 mm of thermometer immersion depth. The primary difference between these models (other than the arm on the 5901A) is the inside diameter of the probe well. (See chart on page 16 and note that the inside diameter of the 5901C cells varies with the shell material). A variety of baths is available, which can maintain the triple point within these cells for many weeks. Accredited (NVLAP) test certificates are available with any cell under our Model 1904-TPW.

5901A cells include an arm that can be used as a handle, a hook, or a McLeod gauge to demonstrate how much residual air is trapped in the cell. Carefully developed manufacturing processes at Hart keep the air bubble in a quartz cell as small as the air bubble in glass cells.

A fourth size, the 5901B cell, comes in a glass version and is significantly smaller than the other cells. It is designed for use in our Model 9210 Maintenance Apparatus, which automates the realization and maintenance of the TPW. The 9210-5901B combination is perfect for both calibrating thermometers and providing periodic checks of sensor drift.

## Accessories

For simplest realization of the TPW in our larger cells, the Model 2031A "Quick Stick" Immersion Freezer uses dry ice and alcohol to facilitate rapid formation of an ice mantle within the cell without requiring constant intervention while the mantle forms.

For best results, use a 3901 bushing with your triple point of water cell. A bushing is used to improve the thermal contact between your SPRT and the ice mantle of your water triple point cell. Be sure to choose a bushing that matches the inner diameter of the reentrant well of the cell and the outer diameter of the SPRT. Additionally, a small piece of foam (<0.5 cm) may be placed beneath the bushing to isolate it from the bottom of the cell which research has shown is slightly colder than the rest of the cell.

Insurance is also available for each water cell purchased from Hart. Water cells are not difficult to handle nor is the TPW difficult to realize, but they are delicate and accidents do happen. For a nominal fee, we'll insure your cell in one-year increments. If something goes wrong, just let us know and we'll replace your cell. No questions asked.

## Ordering Information

<b>5901A-G</b>	TPW Cell, 12 mm ID with handle, glass shell
<b>5901A-Q</b>	TPW Cell, 12 mm ID with handle, quartz shell
<b>5901C-G</b>	TPW Cell, 13.6 mm ID, glass shell
<b>5901C-Q</b>	TPW Cell, 14.4 mm ID, quartz shell
<b>5901D-G</b>	TPW Cell, 12 mm ID, glass shell
<b>5901D-Q</b>	TPW Cell, 12 mm ID, quartz shell
<b>5901B-G</b>	TPW Cell, mini, glass shell
<b>7012</b>	TPW Maintenance Bath (maintains four cells)
<b>7312</b>	TPW Maintenance Bath (maintains two cells)
<b>9210</b>	TPW (5901B-G) Maintenance Apparatus
<b>2028</b>	Dewar (for TPW ice bath)
<b>2031A</b>	"Quick Stick" Immersion Freezer
<b>1904-TPW</b>	Accredited Cell Intercomparison
<b>INSU-5901</b>	TPW Cell Insurance, one-year
<b>5901-ITST</b>	Isotopic Composition Analysis, TPW Cell
<b>5901-SMPL</b>	Water Sample, TPW Cell (comes in a sealed glass ampoule)
<b>3901-11</b>	TPW Bushing, 5901/5901A to 7.5 mm
<b>3901-12</b>	TPW Bushing, 5901/5901A to 5.56 mm (7/32 in)
<b>3901-13</b>	TPW Bushing, 5901/5901A to 6.35 mm (1/4 in)
<b>3901-21</b>	TPW Bushing, 5901C to 7.5 mm
<b>3901-22</b>	TPW Bushing, 5901C to 5.56 mm (7/32 in)
<b>3901-23</b>	TPW Bushing, 5901C to 6.35 mm (1/4 in)



The 2028 Dewar has inside dimensions of 20 cm by 50 cm (7.75 in x 19.5 in), and outside dimensions of 25 cm by 61 cm (9.75 in x 24 in).



Accessories like the "Quick Stick" Immersion Freezer and 3901 bushings add simpler realization and improved thermal contact.

# Triple point of water cells

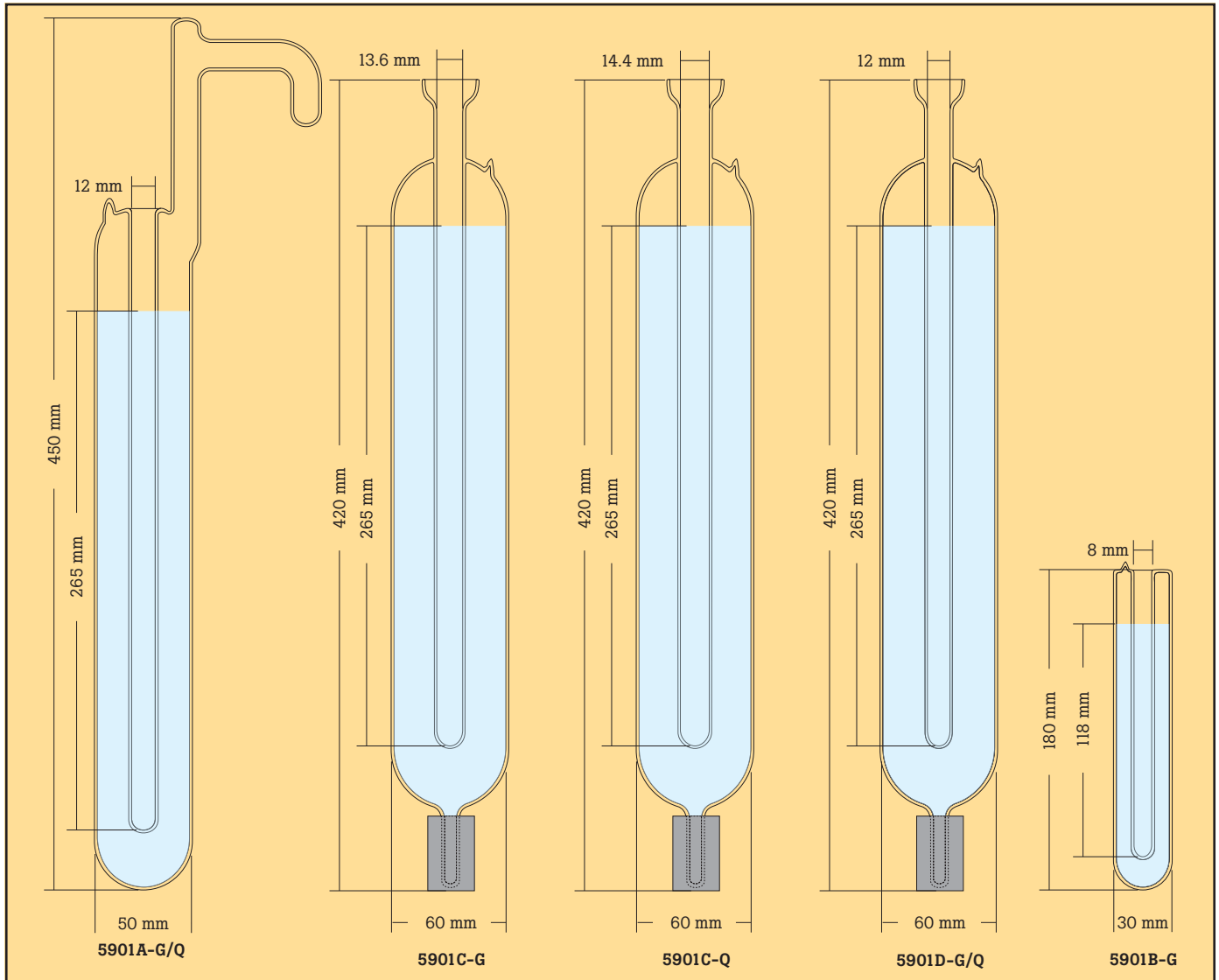

## Specifications

	5901A-G	5901A-Q	5901C-G	5901C-Q	5901D-G	5901D-Q	5901B-G
<b>Expanded Uncertainty (k=2)</b>	$< 0.0001\text{ }^{\circ}\text{C}$						$< 0.0002\text{ }^{\circ}\text{C}$
<b>Reproducibility</b>	$0.00002\text{ }^{\circ}\text{C}$						$0.00005\text{ }^{\circ}\text{C}$
<b>Dimensions</b>	50 mm OD 12 mm ID 450 mm long		60 mm OD 13.6 mm ID 420 mm long	60 mm OD 14.4 mm ID 420 mm long		60 mm OD 12 mm ID 420 mm long	30 mm OD 8 mm ID 180 mm long
<b>Immersion Depth (water surface to well bottom)</b>	265 mm						118 mm
<b>Material</b>	Borosilicate Glass	Fused Silica (Quartz)	Borosilicate Glass	Fused Silica (Quartz)	Borosilicate Glass	Fused Silica (Quartz)	Borosilicate Glass
<b>Water Source</b>	Ocean						
$\delta\text{D}_{\text{VSMOW}}$	$\pm 10\text{ }^{\circ}\text{‰}$ ( $\pm 1\%$ )						$\pm 20\text{ }^{\circ}\text{‰}$
$\delta^{18}\text{O}_{\text{VSMOW}}$	$\pm 1.5\text{ }^{\circ}\text{‰}$ ( $\pm 0.15\%$ )						$\pm 3\text{ }^{\circ}\text{‰}$
<b>Effect of Deviation from VSMOW</b>	$\pm 7\text{ }\mu\text{K}$						$\pm 14\text{ }\mu\text{K}$



# TPW maintenance bath



- Maintains TPW cells for up to two months
- Optional immersion freezer for simple cell freezing
- Independent cutout circuit protects cells from breaking

For frequent use of traditional-size triple point of water cells, nothing helps save you time and hassle like a good maintenance bath. The 7312 Triple Point of Water Maintenance Bath keeps your cells up and running reliably for weeks at a time—even during heavy usage—and comes at a price you'll love.

The 7312 accommodates two TPW cells and includes three pre-cool wells for properly cooling probes prior to measurements within the cells. Stability and uniformity are each better than  $\pm 0.006$  °C, so your cells stay usable for up to eight weeks. Whatever method you use for building your ice mantles, you can be assured they'll last in a 7312 bath.

An independent safety circuit protects your water cells from freezing and breaking by monitoring the temperature of the bath and shutting down its refrigeration system should the bath controller fail. Noise-reduction techniques in the manufacturing process ensure your bath doesn't add excessive noise to your lab.

With a temperature range from  $-5$  °C to  $110$  °C, this bath can also be used for comparison calibrations—particularly of long-stem probes—or maintenance of gallium cells. An optional gallium cell holding fixture fits two cells, which, in a 7312 bath, can maintain their melting plateaus for up to two weeks.

In fact, the 7312 is available with a time-saving 2031A "Quick Stick" Immersion Freezer so you can build your ice mantles quickly and hands-free. Just fill the 2031A's condensing reservoir with dry-ice and alcohol, insert it into the cell, and get some other work done while your ice mantle forms in less than an hour. (Alternatively, LN<sub>2</sub> may be used.)

If you're using traditional-size TPW cells, don't take the time to create an ice mantle only to watch it melt quickly as it sits in a bucket of ice. Maintain your cells the right way in a Hart 7312 TPW Maintenance Bath.

## Specifications

Range	$-5$ °C to $110$ °C
Stability	$\pm 0.001$ °C at $0$ °C (alcohol-water mix) $\pm 0.004$ °C at $30$ °C (alcohol-water mix)
Uniformity	$\pm 0.003$ °C at $0$ °C (alcohol-water mix) $\pm 0.006$ °C at $30$ °C (alcohol-water mix)
TPW Duration	Six weeks, typical (assumes correctly formed ice mantle)
Set-Point Accuracy	$\pm 0.05$ °C at $0$ °C
Set-Point Repeatability	$\pm 0.01$ °C
Display Resolution	$\pm 0.01$ °C
Set-Point Resolution	$\pm 0.002$ °C; $0.00003$ °C in high-resolution mode
Access Opening	121 x 97 mm (4.75 x 3.8 in)
Immersion Depth	496 mm (19.5 in)
Volume	19 liters (5 gallons)
Communications	RS-232 included
Power	115 V ac ( $\pm 10$ %), 60 Hz or 230 V ac ( $\pm 10$ %), 50 Hz, specify
Size (HxWxD)	819 x 305 x 622 mm (12 x 24.5 x 32.25 in)
Weight	34 kg (75 lb)

## Ordering Information

7312	TPW Maintenance Bath (includes TPW Holding Fixture, MPGa Holding Fixture, and RS-232 Interface)
2001-IEEE	Interface, IEEE-488
2031A	"Quick Stick" Immersion Freezer



Hart's 2031A "Quick Stick" Immersion Freezer offers unmatched convenience and simplicity in forming the triple point of water ice mantle.

# Use TPW and ratio method to improve SPRT stability and accuracy

Reprinted from *Random News*

## Introduction

The Standard Platinum Resistance Thermometer (SPRT) is the most accurate thermometer in the extended temperature range from  $-259\text{ }^{\circ}\text{C}$  to  $962\text{ }^{\circ}\text{C}$ . The uncertainty of an SPRT can be as low as a few tenths of a millikelvin (mK).

More and more metrologists are using SPRTs as reference standards to calibrate other types of thermometers or to achieve a high level of accuracy for any reason. However, the handling and use of an SPRT is as important to achieving a high level of accuracy as the design and performance of the SPRT itself. Several types of errors can corrupt SPRT measurements.

Sometimes absolute resistance is used to calculate temperature instead of the resistance ratio. When absolute resistance is substituted for the resistance ratio, errors of more than 10 mK at  $660\text{ }^{\circ}\text{C}$  are common. In addition, even when the correct measurement and calculations are made, the resistance of the SPRT in the triple point of water should be determined immediately after a high accuracy measurement is made with the thermometer.

The triple point of water measurement is often overlooked but is vital to accuracy. The relationship of the triple point of water measurement to SPRT accuracy is explained with a few key points.

## TPW and accuracy

In general, SPRTs have excellent stability; however, a small drift in resistance might happen now and then, especially after transportation, thermal cycling, or accidental rough handling. A change as low as 1 ppm in resistance at about  $660\text{ }^{\circ}\text{C}$  (the freezing point of aluminum) will be equivalent to a change of 1.1 mK in temperature. The stability required of a high-quality standard resistor is about 1 ppm. The working and environmental conditions normally associated with a standard resistor are much better than the conditions usually found when working with an SPRT. So a few ppm of stability might be the best we can expect for most SPRTs.

The ratio of two resistances of an SPRT based on two temperatures is much more stable than the stability expected when an absolute resistance at a single fixed temperature is used. For example, using only the freezing point of silver as a reference point over a six year time frame, an SPRT exhibited a change of 5 ppm in its resistance [1]; this is equivalent to a change of 7.5 mK in temperature. On the other hand, the change in the resistance ratio,

$$W(961.78\text{ }^{\circ}\text{C}) = R(961.78\text{ }^{\circ}\text{C})/R(0.01\text{ }^{\circ}\text{C})$$

was within 1 ppm (a change of 2 mK in temperature) across the same six-year period. This explains why the resistance ratio  $W(t)$  is specified by the International Temperature Scales since 1960 instead of the absolute resistance  $R(t)$ .

The best method for accomplishing this ratio is to use the Triple Point of Water as the second temperature because of its excellent stability and simplicity. It has been specified as a reference point for SPRTs since 1960 [2]. Thus, the highest SPRT accuracy possible is achieved when the resistance of an SPRT at the triple point of

water ( $R_{tp}$ ) is made immediately after a measurement at any other temperature.

Use of the ratio method also reduces system error introduced by any electronic readout. This reduction in system error is important because as little as 0.7 PPM of error in resistance will cause an error of 1 mK in temperature at  $962\text{ }^{\circ}\text{C}$  (see table below).

## Frequency of $R_{tp}$ measurement

When accuracy requirements don't extend to the highest levels,  $R_{tp}$  may need measuring only once a day, every few days, or at some other suitable interval. How frequently  $R_{tp}$  needs measuring depends on several factors, such as acceptable

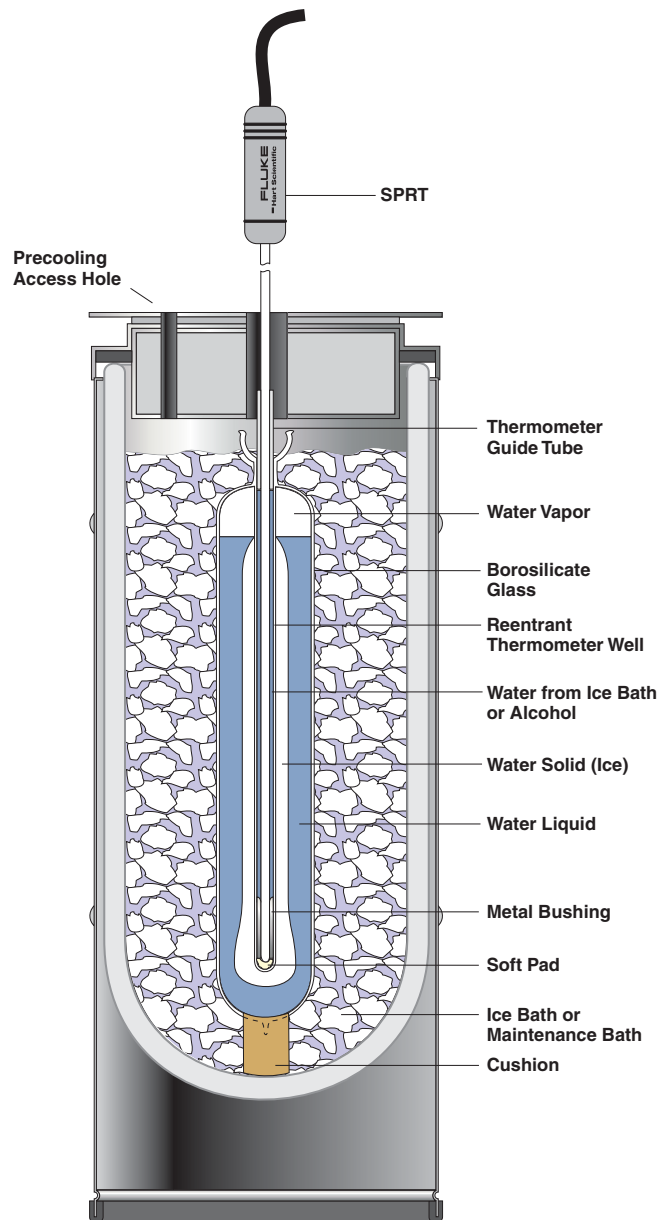

# Use TPW and ratio method to improve SPRT stability and accuracy

uncertainty, the stability of the SPRT, the measuring temperature range, and the working conditions. If the required uncertainty is 1 mk or so,  $R_{tp}$  measurement should follow each  $R_t$  measurement. If accuracy requirements are 20 mk or more in a temperature range lower than 420 °C and the SPRT used is quite stable, the  $R_{tp}$  might be measured once a week. The stability over time of each SPRT must be measured, even when using SPRTs manufactured in the same lot from the same supplier.

When temperature measurements are higher than 800 °C, it is better to measure the  $R_{tp}$  as soon as the SPRT cools down to room temperature. Whenever possible, an SPRT should cool down to at least 500 °C with a low cooling rate (about 100 °C per hour). Otherwise, the SPRT should be annealed before making a measurement at the triple point of water.

A suitable annealing procedure is a two-hour anneal at 700 °C at the end of which the SPRT is allowed to cool to 450 °C over a period of about two and one half hours. After this initial cooling period, the SPRT can cool quickly to room temperature. Fast cooling from high temperatures above 500 °C may cause significant increases in  $R_{tp}$  because of the quenching-in effect on lattice defects found in platinum wire. This increase of  $R_{tp}$  could be as large as 30 mk.

## Can the $R_{tp}$ given in the "NIST Calibration Report" be used to calculate the ratio?

Some metrologists may feel the  $R_{tp}$  measured by NIST is more accurate than that measured in their own lab, so they prefer to use the value for  $R_{tp}$  given in the "NIST Calibration Report" to calculate the resistance ratio in the interpolation equation. While it's true that the accuracy of NIST's measurements are generally much better than those done in other labs, the  $R_{tp}$  of your SPRT may have changed during

transportation, so it should be measured again in your own lab. Furthermore, the  $R_{tp}$  should be measured using the same instrument and time frame as the  $R_t$  to reduce system error with the readout included in the measuring procedure. It is important to always use the same readout instrument to measure both  $R_t$  and  $R_{tp}$ .

## Avoiding mechanical strain and the annealing procedure

An SPRT is a delicate instrument. Shock, vibration, or any other form of acceleration may cause strains that change its temperature-resistance characteristics. Even a light tap, which can easily happen when an SPRT is put into or taken out of a furnace or a triple point of water cell, may cause a change in  $R_{tp}$  as high as 1 mk. Careless handling of an SPRT over the course of a year has resulted in  $R_{tp}$  increases equivalent to 0.1 °C.

Annealing at 660 °C for an hour will relieve most of the strains caused by minor shocks and nearly restore the  $R_{tp}$  to its original value. If the maximum temperature limit for an SPRT is lower than 660 °C, it should be annealed at its maximum temperature. Such an annealing procedure is always advisable after any type of transportation.

The annealing furnace should be very clean and free of metals, such as copper, iron, and nickel. SPRTs are contaminated when they are annealed in furnaces containing a nickel block, even when the SPRTs were separated from the nickel block by quartz sheaths [ 3 ]. Well designed, clean annealing furnaces are important for quality measurements with SPRTs.

## Conclusions

SPRTs are among the finest temperature measuring devices known. However, high accuracy comes at a price and not just in terms of money. Patience, care and proper

procedures are major factors in producing high quality measurements.

Support instruments such as triple point of water cells are inexpensive and simple to use. Annealing is a well understood process. Uncompromised measurements are possible in almost every laboratory situation.

## References

- 1, Li, Xumo et al, Realization of the International Temperature Scale of 1990 between 0 °C and 961.78 °C at NIM, "Temperature, Its Measurement and Control in Science and Industry," Volume 6, Part 1, p. 193 (1992).
- 2, CGPM (1960): Comptes Rendus des Seances de la Onzieme Conference Generale des Poids et Mesures, pp. 124-133.
- 3, Li, Xumo et al, A New Type of High Temperature Platinum Resistance Thermometer, Metrologie, 18 (1982), p. 203.

Temperature (°C)	The temperature error caused by an error of 1 PPM in resistance measurement (mK)	The resistance error equivalent to an error of 1 mK in temperature (PPM)
-200	0.04	25.4
-100	0.14	6.9
0.01	0.25	4.0
232	0.51	2.0
420	0.74	1.4
660	1.1	0.9
962	1.5	0.7



# DC bridge



- Measurement uncertainty to  $\pm 0.025$  mK
- Uses conventional standard resistors

Several companies manufacture high quality resistance bridges for both AC and DC applications that can take measurements at the 0.1 ppm level. Research has shown that all of them compensate well for any theoretical inaccuracies predicted in their design.

We like the MI bridge because we feel confident about its measurements, and its software gives us more information than we can get from the other instruments. While it's true we do use the other bridges for certain functions we undertake in our lab, including some experimental testing, we use the MI bridge every day for fixed-point calibrations of SPRTs.

The 5581 Bridge performs a true auto-balancing procedure to nine significant digits. As the check proceeds, the bridge steps through an internal comparison of the transformer's windings, the results of which are recorded to track its performance over time.

Another function of this bridge is its real-time uncertainty analysis program. In this mode, you enter external uncertainty factors such as the uncertainty of your resistor, and the 5581 combines your information with its own uncertainties to

compute a system uncertainty for your measurement.

The optional Windows<sup>®</sup> compatible control software offers history logging and regression analysis, along with uncertainty analysis and the auto-self-check feature. The program also calculates standard deviations if you need them. You can enter coefficients for your SPRT and read temperature rather than resistance.

Of course, if you prefer, you can operate the bridge manually. The choice is yours, but either way you'll find this to be a great bridge to use.

## The DC Advantage

AC bridges are more susceptible to electrical interference than DC bridges. Therefore, when AC furnaces are used, DC bridges are preferred. The likelihood of electrical interference increases at temperatures above the freezing point of Aluminum (660.323 °C), because the insulation resistance of the furnace and the SPRT decline significantly.

## Specifications

Specifications	
<b>Bridge</b>	
<b>Range/Accuracy</b>	-0.001 $\Omega$ to 0.01 $\Omega$ : < 5 ppm 0.01 $\Omega$ to 0.1 $\Omega$ : < 0.5 ppm 0.1 $\Omega$ to 1 $\Omega$ : < 0.1 ppm 0.1 $\Omega$ to 10 K $\Omega$ : < 0.1 ppm 10 K $\Omega$ to 10 M $\Omega$ : < 0.2 ppm
<b>Linearity</b>	0.01 ppm
<b>Max Ratio</b>	13:1
<b>Test Currents</b>	10 $\mu$ A to 150 mA, 30-Volt compliance
<b>Current Reversal</b>	Automatic 4 to 1000 seconds
<b>Power</b>	100, 120, 220, and 240 V ( $\pm 10$ %), 47-63 Hz, 180 VA
<b>Weight</b>	60 lb (27.3 kg)
<b>Dimensions (WxHxD)</b>	432 x 279 x 381 mm (17 x 11 x 15 in)
<b>Scanner</b>	
<b>Inputs</b>	20/10
<b>Operation</b>	Matrix
<b>Thermal EMFs</b>	< 500 nanovolts
<b>Error Contribution</b>	< 20 nanovolts
<b>Contact Ratings</b>	Relay 2-coil latching
<b>Max Carrying Current</b>	2 A (ac/dc) (optional 30 A)
<b>Contact Resistance</b>	< 0.007 $\Omega$
<b>Insulation Resistance</b>	> 10 <sup>12</sup> $\Omega$
<b>Inputs and Outputs</b>	Tellurium Copper (rear panel)
<b>IEEE-488</b>	24-pin IEEE-488
<b>Weight</b>	<b>5313-001:</b> 18 kg (40 lb) <b>5313-002:</b> 9 kg (20 lb)
<b>Dimensions (WxHxD)</b>	<b>5313-001:</b> 432 x 279 x 381 mm (17 x 11 x 15 in) <b>5313-002:</b> 127 mm H (5 in)

## Ordering Information

<b>5581</b>	MI Bridge
<b>5313-001</b>	Scanner, 20 channels
<b>5313-002</b>	Scanner, 10 channels
<b>5313-003</b>	IOTech 488 Interface Card
<b>5313-004</b>	Windows Software

# Why use Fluke metal freeze-point cells?

By now you've probably been preparing budgets for the new primary standards you need in your lab. Well, you've come to the right place because we've got a complete line of the best metal freeze-point cells you can buy.

Fluke scientists have designed and tested metal freeze-point cells for many years. Not only do we manufacture all the major freeze-points, our metrologists have written extensively on the theory and use of cells and have created new designs covering a range of applications no other company can match. They can answer every question you have on freeze-points and explain how we have handled the radiation losses along the well, minimized possible stem error and made pressure corrections for the highest possible measurement accuracy.

Pure metals melt and freeze at a unique temperature through a process involving the absorption, or liberation, of the latent heat of fusion. If 100% pure metals were available, each cell of a particular type would melt and freeze at its exact theoretical temperature, but since 100% pure metal is not possible, cells vary slightly from their theoretical absolute.

The best freeze-point cells are the ones that get very close to their theoretical freezing temperature and provide a temperature plateau that's stable and long lasting for calibration work. Changes as small as 0.01 mK (0.00001°C) are measurable, so cell uncertainty is definable. Fluke cells come very, very close to the absolute theoretical limits possible with today's material science. We use 99.9999% pure metal. Six 9s purity is as good as it gets. Some manufacturers may use five 9s. Make sure they specify purity on their quotations.

The shape of the curve generated by freezing a fixed-point cell tells a lot about the purity of the metal. Unlike most manufacturers we provide certificates for each metal fixed-point cell at no extra charge. The certificates we provide include three graphs of full plateaus, as measured by a bridge and SPRT, and a calculated purity for the metal sample. Exceptions include gallium cells (extremely long plateaus), gold and copper cells (SPRT temperature range exceeded).

We test each cell three times so that we can evaluate the stability of the plateau. This provides evidence that the cell is good and that the metal sample is not being contaminated over time. Some examples of freezing curves from Fluke fixed-point cells are pictured below. The

Substance	Impurity Level	Deviation from Pure Liquidus Point	Achievable Plateau Length
Mercury	99.999999 %	-0.002 mK	30 hours
Gallium	99.99999 %	-0.014 mK	14 days
Indium	99.9999 %	-0.24 mK	25 hours
Tin	99.9999 %	-0.30 mK	25 hours
Zinc	99.9999 %	-0.54 mK	25 hours
Aluminum	99.9999 %	-0.67 mK	20 hours
Silver	99.9999 %	-1.12 mK	20 hours

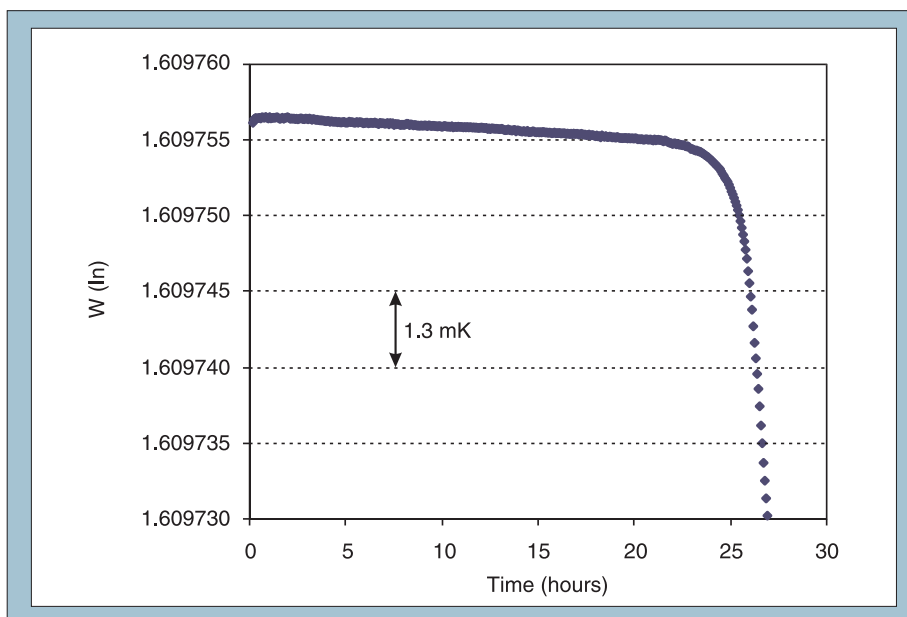

Sample freezing curve for 5904 indium cell

graphs also demonstrate the length of Fluke fixed-point cell freezing plateaus.

Freezing plateau length provides another quality measure for comparing fixed-point cells. The longer the plateau, the better the cell and the more cost-effective it is to use. As indicated in the table, Fluke metal fixed-points have plateaus that range from 20 hours to 14 days depending on the type of cell. No other producer of fixed-points beats the performance of a Fluke fixed-point cell.

Further proof of cell performance is available through our accredited cell certification service (NVLAP Lab Code 200348-0). This service is a rigorous test that involves repeatedly testing the melting and freezing plateaus of the fixed-point cell and then comparing the thermodynamic temperature to that of a NIST-certified reference cell. The result is a highly-qualified primary standard

instrument with a certificate traceable to national and international standards.

All freeze-point cells have to be used and maintained in specially-designed freeze-point furnaces. Furnaces come in a variety of temperature ranges, and each one must have a very uniform temperature region for the freezing and melting process. High accuracy is achieved by the formation of two liquid-solid interfaces during freezing. One interface should be adjacent to the inner surface of the crucible, and the other should be on the outer surface of the central well, which is the closest point to the thermometer.

A very thin solid shell should form on the central well, and the concentration of impurity in this thin shell should be much lower than the average impurity in the core metal. The temperature on the second liquid-solid interface should be very close to that found in a 100% pure metal under ideal conditions.

# Why use Fluke metal freeze-point cells?

Fluke's freeze-point furnaces provide the proper temperature, stability and uniformity to create the longest, most stable temperature plateau possible.

The immersion depth of a thermometer in the liquid metal (the distance from the surface of the liquid metal to the middle point of the thermometer's sensor) is approximately 180 mm in cells made by Fluke. The outside diameter of each cell is 48 mm, the thermometer well is 8 mm and cell length is 290 mm.

Cells are delicate and must be handled with extreme care. Fluke provides special storage cases, gloves for handling and complete care instructions. Cells are hand carried rather than shipped to ensure complete integrity of measurements.

The performance of every Fluke cell is guaranteed. When you call, ask about our temperature calibration school where you can learn more about the theory and operation of all metal freeze-point cells. We'll answer every question you have and help solve any problem you encounter. We use metal freeze-point cells in our lab every day, and our metrologists have decades of experience with them.

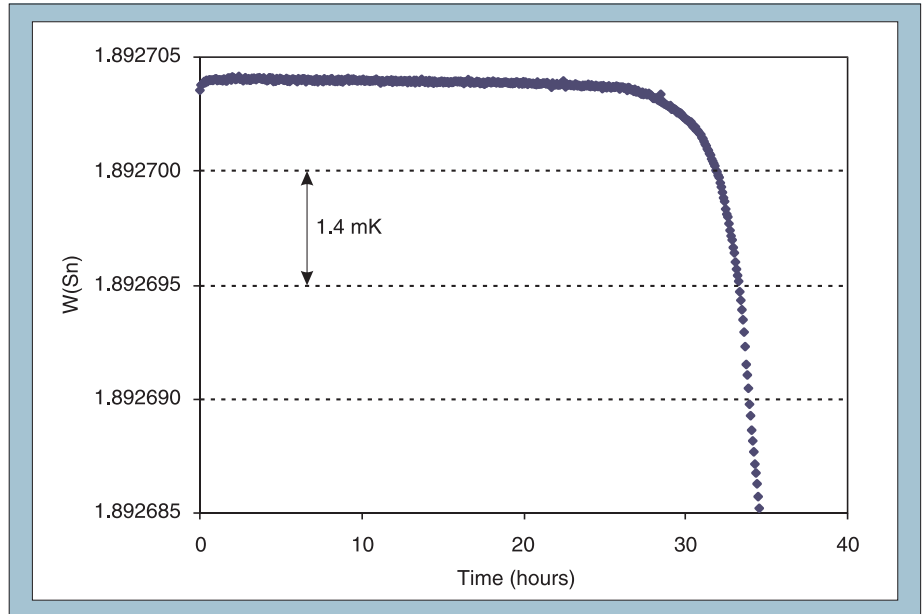

Sample freezing curve for 5905 tin cell.

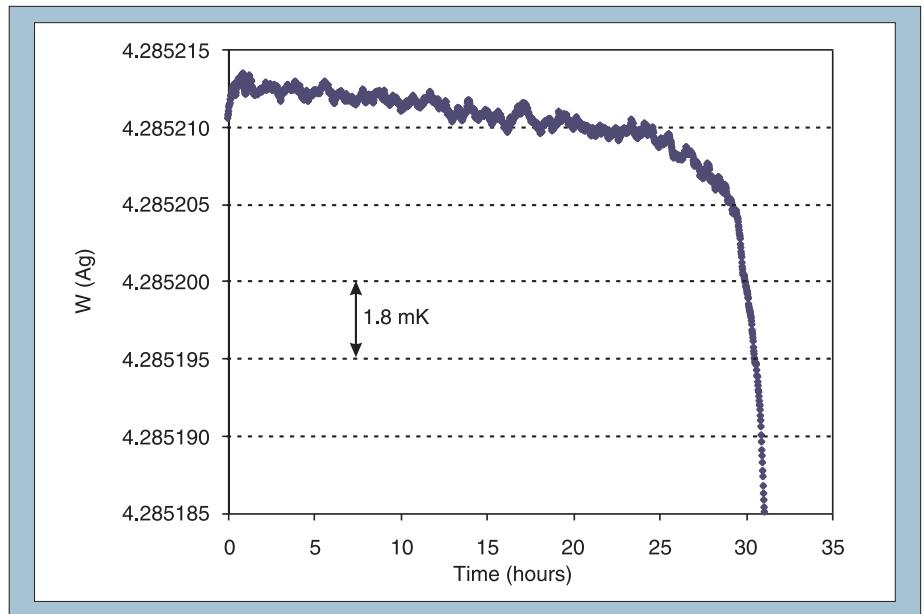

Sample freezing curve for 5908 silver cell.



# ITS-90 fixed-point cells



- Best cell uncertainties commercially available
- Every ITS-90 fixed point available from mercury to copper
- Plateaus last days (gallium for weeks and TPW for months)
- Manufactured and tested by Hart's primary standards scientists

Hart scientists have designed and tested ITS-90 fixed-point cells for many years. Not only do we manufacture all the major fixed points, our metrologists have written extensively on the theory and use of cells and have created new designs covering a range of applications no other company can match.

Our testing of fixed-point cells is also unmatched. The scope of our accreditation includes the testing of ITS-90 fixed-point cells. Each cell may be purchased with this intercomparison option, which includes comparing the equilibrium value of your cell against that of a reference Hart cell.

## Traditional freeze-point cells

If you want true primary temperature standards capability, you want metal freeze-point cells that are very close to the theoretical freezing temperature and provide plateaus that are both stable and long lasting.

Hart's metal freeze-point cells are the culmination of more than 20 years of primary standards experience. No other company has as much experience in the development of metal fixed-point cells as Hart. That's why you'll find Hart cells in

many national metrology institutes around the world.

Each Hart cell is carefully constructed in our ultra-clean, state-of-the-art lab, using high-density, high-purity graphite crucibles containing metal samples with purity of at least 99.9999 % (six 9s) and, in many cases, 99.99999 % (seven 9s). The crucible is enclosed within a sealed quartz glass envelope that is evacuated and back-filled with high-purity argon gas. A special sealing technique is used to seal the cell at the freezing point. We measure and record for you the precise pressure of the argon gas to ensure the most accurate corrections for pressure.

Once manufactured, all Hart cells are tested and supplied with an assay of metal-sample purity. Every traditional size ITS-90 cell further undergoes more rigorous testing in our primary standards lab where we realize melt-freeze curves and perform a detailed "slope analysis" to confirm cell purity. If you want more data, we'll give you an optional intercomparison with our own reference cells.

## Gallium cells

Gallium cells are a great reference for validation of instruments subject to drift (like SPRTs), and they're important for calibrating sensors used near room or body temperatures, in environmental monitoring, and in life sciences applications.

Hart's 5943 Gallium Cell is sealed in a stainless steel envelope. High purity gallium (99.99999 %) is enclosed in a plastic and metal shell. The stainless steel container is then filled with pure argon gas at one standard atmosphere at the melting-point temperature.

Gallium expands by 3.1 % when it freezes requiring the cell to have flexible walls. Unlike some manufacturers' cells, which are made from PTFE enclosure materials, our cells don't need pumping and refilling because they're not gas permeable. In fact, we guarantee our cells will maintain their uncertainty of < 0.1 mK for at least five years. Realization and maintenance of the cell is automated with our 9230 Maintenance Apparatus (see page 33). This apparatus will provide melting plateaus up to eight days and a convenient control to automatically achieve a new melt plateau each week with an investment of just five minutes. Never has the maintenance of a world-class gallium cell been easier.

## Water cells

While simple ice baths are often used as a calibration point at 0 °C, their limitations include gradients, purity problems, repeatability issues, and variances in construction and measurement techniques. Triple point of water cells not only solve these problems; they represent the most used temperature on the ITS-90, and they're inexpensive to own and use.

Hart makes three traditional-size TPW cells (see page 14) that have been repeatedly proven in national labs to surpass their published uncertainty specification of  $\pm 0.0001$  °C. Ice mantles may be formed using dry ice, LN<sub>2</sub>, or immersion freezers and can last for up to two months when maintained in our 7012 or 7312 baths.

## Open metal cells

Made from the same materials and with the same manufacturing techniques as their sealed counterparts, Hart's new series of "open" metal fixed-point cells include a high quality valve for connecting to a precision pressure-handling system within your lab. Using such a system, the cell can be evacuated, charged, and purged several times with a pure inert

# ITS-90 fixed-point cells

## Specifications

Model	Fixed Point	Style	Assigned Value (°C)	Outside Diameter	Inside Diameter	Total Outside Cell Height	Depth <sup>†</sup>	Cell Uncertainty (mK, k=2)	Certification (mK, k=2) <sup>†</sup>
5900	Mercury	Stainless Steel	-38.8344	31.8 mm	8.0 mm	417.6 mm	208 mm	0.2	0.25
5904	Indium	Traditional Quartz Glass	156.5985	48 mm	8 mm	282 mm	195 mm	0.7	0.7
5905	Tin	Traditional Quartz Glass	231.928	48 mm	8 mm	282 mm	195 mm	0.5	0.8
5906	Zinc	Traditional Quartz Glass	419.527	48 mm	8 mm	282 mm	195 mm	0.9	1.0
5907	Aluminum	Traditional Quartz Glass	660.323	48 mm	8 mm	282 mm	195 mm	1.3	1.8
5908	Silver	Traditional Quartz Glass	961.78	48 mm	8 mm	282 mm	195 mm	2.4	4.5
5909	Copper	Traditional Quartz Glass	1084.62	48 mm	8 mm	282 mm	195 mm	10.1	12.0
5924	Indium	Open Quartz Glass	156.5985	50 mm	8 mm	596 mm	195 mm	0.7	0.7
5925	Tin	Open Quartz Glass	231.928	50 mm	8 mm	596 mm	195 mm	0.5	0.8
5926	Zinc	Open Quartz Glass	419.527	50 mm	8 mm	596 mm	195 mm	0.9	1.0
5927A-L	Aluminum	Open Quartz Glass (long)	660.323	50 mm	8 mm	696 mm	195 mm	1.3	1.8
5927A-S	Aluminum	Open Quartz Glass (short)	660.323	50 mm	8 mm	596 mm	195 mm	1.3	1.8
5928	Silver	Open Quartz Glass	961.78	50 mm	8 mm	696 mm	195 mm	2.4	4.5
5929	Copper	Open Quartz Glass	1084.62	50 mm	8 mm	696 mm	195 mm	10	12.0
5943	Gallium	Stainless Steel	29.7646	38.1 mm	8.2 mm	250 mm	168 mm	0.1	0.1

<sup>†</sup>Certifications at lower uncertainties are available for national laboratories.

<sup>†</sup>Depth is measured from the bottom of the thermometer well to the top of the pure reference material.

gas, then charged again to a regulated pressure level while measurements are made with the cell.

Once assembled and tested, each Hart ITS-90 open cell further undergoes more rigorous testing in our lab, unlike cells from some manufacturers who provide their open cells as a kit of parts, without any test data.

Because open cells allow users to measure the pressure within the cell, uncertainties due to pressure corrections may be minimized. Use of open cells is now being suggested by the CCT, and open cells can be used for demanding temperature-versus-pressure applications, as well as precision SPRT calibrations.

The height of these cells has been extended to allow easy access to the gas valve while the cells are in use. Pure quartz-wool insulation and four high-purity graphite discs prevent heat loss from the metal sample to the pressure regulation system while optimizing vertical temperature gradients within the cell. Each cell has an outside diameter of 50 mm (2

inches) and a height of 600 mm (23.5 inches)—(silver and copper cells are 700 mm [27.6 inches] tall).

When it comes to primary temperature standards, Hart supplies more equipment than all of our competitors combined. If your goal is to reduce uncertainty, start by

buying from the company that supports its products better than any other metrology company in the world. Why trust your primary standards to any other company?

## Ordering Information

<b>5900</b>	Mercury Cell, Stainless Steel	<b>5924</b>	Indium Cell, Open Quartz Glass
<b>5904</b>	Indium Cell, Traditional Quartz Glass	<b>5925</b>	Tin Cell, Open Quartz Glass
<b>5905</b>	Tin Cell, Traditional Quartz Glass	<b>5926</b>	Zinc Cell, Open Quartz Glass
<b>5906</b>	Zinc Cell, Traditional Quartz Glass	<b>5927A-L</b>	Aluminum Cell, Open Quartz Glass, Long
<b>5907</b>	Aluminum Cell, Traditional Quartz Glass	<b>5927A-S</b>	Aluminum Cell, Open Quartz Glass, Short
<b>5908</b>	Silver Cell, Traditional Quartz Glass	<b>5928</b>	Silver Cell, Open Quartz Glass
<b>5909</b>	Copper Cell, Traditional Quartz Glass	<b>5929</b>	Copper Cell, Open Quartz Glass
		<b>5943</b>	Gallium Cell, Metal Cased
		<b>2068-D</b>	Stand, Fixed-Point Cell, Black Delron

# ITS-90 fixed-point cells

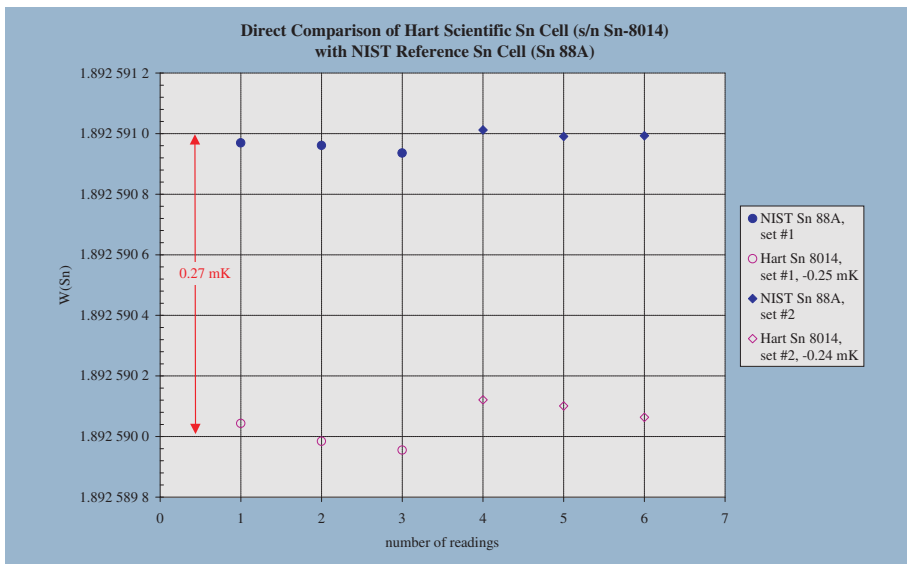
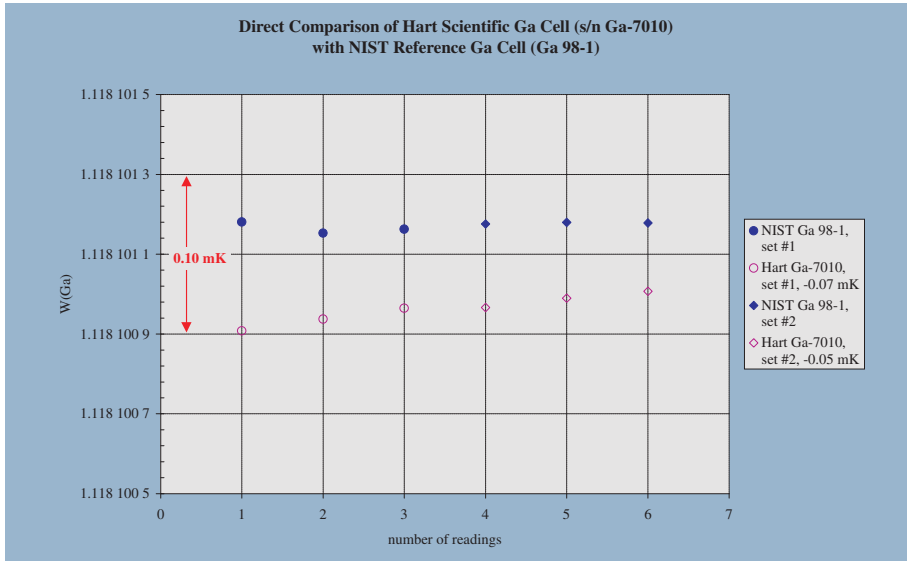

Open cells allow users to minimize the uncertainty from pressure corrections by regulating cell pressures themselves.

## What is the uncertainty of my cell?

Fixed-point cells are standards which embody reproducible physical phenomena. The uncertainty associated with these standards can be viewed in two ways.

The first way is based on the purity of the constituent components only. Unfortunately, most of the assays provided by manufacturers of pure metals are not of sufficient quality to make a determination of the purity of the supplied metal to the level of uncertainty required. To be used in realizing the ITS-90, it would typically be necessary to have a high quality traceable assay capable of verifying 99.9999% purity or better. Even with an assay, additional evidence of the purity is necessary. This

evidence includes an analysis of the slope of the freezing and melting curves and a comparison against another cell which makes similar or better claims of purity. Finally, because the temperature of a fixed point cell is defined at one atmosphere, pressure traceability is required as well.

The second approach to fixed-point uncertainties is similar but shifts the emphasis away from the traceable assay and derives its traceability through inter-comparison with another traceable fixed-point cell. In this case, the assay and the slope analysis become the supporting evidence for the observed difference against the traceable cell. This second approach represents actual

observed performance in a laboratory rather than unproved claims and weakly justified hopes. This approach is particularly important with sealed cells because there is no way to verify the pressure within a sealed cell after it has been sealed.

Hart's published specs are guaranteed and can be verified through an optional accredited certification in our primary temperature lab. Are the values assigned to your fixed-point cells traceable?



# Traceability and thermometric fixed-point cells

Reprinted from *Random News*

## What is an intrinsic standard?

Intrinsic standards are defined by the NCSL as “standard(s) recognized as having or realizing, under prescribed conditions of use and intended application, an assigned value the basis of which is an inherent physical constant or an inherent and stable physical property.” Thermometric fixed-point cells are included in the NCSL “Catalog of Intrinsic and Derived Standards.” Some other well-known intrinsic standards include the Josephson-array voltage standard, the Quantum Hall resistance standard, and the Cesium atomic frequency standard.

The definitions themselves do not directly address the issues of uncertainty, traceability, or accreditation. However, in the case of thermometric fixed points, these issues are covered in the notes to the definition. The notes indicate that the value is assigned by consensus and need not be established through calibration. The uncertainty is said to have two fundamental components: (a) that associated with its consensus value, and (b) that associated with its construction and application. Traceability and stability are said to be established through verification at appropriate intervals. Verification can either be based upon application of a consensus approved test method or through intercomparison. Furthermore, the intercomparison may be accomplished with standards in a local quality control system or external standards including national and international standards.

## Do fixed-point cells fit the definition?

The basic parameter of the cell, the phase transition, is believed to be an inherent and stable physical property of the cell when used under prescribed conditions. The generally accepted values for the temperatures of the phase transitions along with corrections due to pressure and



Sealed metal freeze-point cells

hydrostatic head are assigned by the ITS-90, the current temperature scale adopted by the BIPM. From the values given and by taking a few measurements, the theoretical temperature of the phase transition can be calculated. Also defined by the ITS-90 is the intended application, namely, as defining thermometric fixed points to be used in conjunction with an appropriate interpolation instrument and associated equations. Finally, the conditions of use are described by supplementary information to the ITS-90 as well as a significant body of literature. Although not everyone agrees on the exact procedures, for the most part, they are quite well understood and accepted. It appears, then, that fixed-

point cells can indeed be considered intrinsic standards.

However, several issues arise: First, the ITS-90 discusses fixed points based on phase transitions of pure substances. An ideal substance behaves differently than the real materials that we are able to obtain. The departure depends on the impurity content of the sample once it is assembled into a cell. For very highly pure materials, the slope of the plateau can be used to approximately determine the purity, but the absolute temperature remains difficult to predict. Second, the ITS-90 does not directly specify an optimum cell design, furnace or cryostat design, or minimum purity requirements. Quite to the contrary, many designs and options are

Issue	Verification via SPRT	Verification via Industry Intercomparison	NIST MAP	Cell Certification
Uncertainty for Cells	maybe	no	maybe	yes
Traceability for Cells	maybe	no	maybe	yes
Laboratory Apparatus	yes	yes	yes	maybe
Laboratory Equipment	yes	yes	yes	maybe
SPRT Calibration	no	maybe	yes	no
Procedure Evaluation	maybe	maybe	yes	no
Computation Evaluation	no	maybe	yes	no

# Traceability and thermometric fixed-point cells

presented in the literature. Although experimental results may suggest one design over another, the conclusions regarding uncertainty are not always clear. Third, the measurement results obtained from a cell are highly dependent upon experimental conditions. Having a good cell is only part of the exercise. Fourth, since a thermometer always measures its own temperature, the thermometer must be able to come to thermal equilibrium with the cell. This is affected by the cell, its apparatus, the thermometer, and the technique used to realize the phase transition. Finally, since we wish to perform traceable calibrations, knowing only the theoretical temperature is not adequate.

## To certify or not to certify?

So, how do we demonstrate that our cells embody the ITS-90 definitions and how do we establish traceability? Before we tackle those points, there are three issues that we must consider. First, whatever method we choose, we must perform a robust uncertainty analysis on our measurements. The uncertainty associated with the temperature of the phase transition is only one component among many that should be considered. Second, statistical process control (SPC) is critical whenever the measurement relies upon physical processes (such as the realization of a phase transition). Through SPC, we can quantify the repeatability of our process and show that the test experiment represents the process. Third, although SPRTs and sealed cells can be used as transfer standards, intercomparison of fixed-point cells over long distances is problematic.

That having been said, the simplest method is to perform measurements in your cells using a calibrated SPRT. If the uncertainty of the measurement is sufficiently small, the temperature can then be shown to be within the estimated uncertainty based upon the theoretical considerations of the cell construction. In the case of low purity cells (five 9s or lower), it may be appropriate to “assign” a temperature and uncertainty to the realization obtained from the cell. These methods may be considered the least robust and will typically result in the largest uncertainties, but they can be shown to be traceable determinations.

A similar but more complicated method is to intercompare calibration results with peer laboratories or a reference laboratory using a suitable transfer standard. Although this type of analysis cannot directly “certify” the performance of a fixed-point cell, it will show your laboratory’s



Water triple point cells

capability to calibrate SPRTs using them. In many cases, this is what you are attempting to illustrate. A well-designed intercomparison will evaluate the results of the calibration, the raw and intermediate data, and the computations. Much insight can be obtained from such scrutiny. NIST offers a measurement assurance program (MAP) to satisfy this need.

Finally, the cells can be tested by an experienced laboratory that has the capability to provide traceable results with uncertainties in the neighborhood of your requirements. If the laboratory performing the test is using its own equipment and apparatus, this type of test will show the performance of the cell only. Additional experiment and uncertainty evaluation may be required for use in your laboratory. Also, this method will not illustrate your laboratory’s ability to use the cells properly. The major advantage of this method is that it can provide the lowest overall uncertainty. Often, this is referred to as “direct comparison.”

## So, what should we do?

At one time, it was considered acceptable to use a fixed-point cell with plateau analysis to show that the cell was behaving itself. This approach has proven to be inadequate as our understanding evolves and we try to improve our laboratories. Moreover, laboratory accreditation requires that we follow rigorous procedures in evaluating our uncertainties. If our uncertainties approach National Metrology Institute level, our data and analysis must justify this. And, the fixed-point cell is a critical component in the uncertainty evaluation. The intrinsic standard argument provided by the NCSL does state that some level of intercomparison is necessary.

Presumably, the NCSL expects the intercomparison to be appropriate to the uncertainty claimed and based on the most current practices.

We must choose the method that makes economic sense and that satisfies our requirements. For example, if we are calibrating secondary PRTs using mini fixed-point cells, we may be justified in using a calibrated SPRT to verify the performance of our cells. Many laboratories (several accredited) use this method with success. Traceability can easily be demonstrated and the uncertainty analysis is straightforward. On the other hand, if we have spent tens of thousands of dollars on a system to calibrate SPRTs and these SPRTs are used for critical measurements, the NIST MAP program is a very good option, provided we qualify. Finally, if we wish to provide cell certifications, we will require a set of certified reference cells along with a robust uncertainty evaluation. At Hart, we use a combination of all three methods.

## Conclusion and recommendations

So, are fixed point cells intrinsic standards or certified artifacts? It really doesn’t matter. Both viewpoints require testing and traceability. Both approaches require rigorous uncertainty analysis that must satisfy the scrutiny of our accreditation assessors, our customers, and our peers. And each perspective can be logically justified. At Hart, we treat some as intrinsic standards and others as certified artifacts. Our uncertainty analyses are as rigorous as we can make them and we welcome comment from our peers. Additionally, the NIST thermometry staff is available to assist in the development of uncertainty budgets, meeting traceability and accreditation requirements, as well as unique testing requirements. Finally, we use the approach that will result in the lowest uncertainties for a given set of equipment and techniques. After all, isn’t that what it’s all about?

# Freeze-point furnaces



- Designed for long plateaus
- Automated controllers, RS-232 included
- Top access to high-stability Hart controllers
- External cooling coils

Several companies manufacture freeze-point furnaces. Most of these furnaces are of adequate theoretical design and of reasonable quality. Most are priced similarly. However, there is a difference that can't be seen from specifications or price, and that's how well the furnace performs with the freeze-point cells they're designed to maintain.

Establishing and maintaining a freeze-point plateau is what these furnaces are supposed to be about. Nothing they do is more important than this performance issue.

Hart Scientific makes three freeze-point furnaces that, when combined with Hart freeze-point cells, produce the longest plateaus in the industry. A Hart furnace and cell can establish plateaus that range from 24 to 40 hours or more.

Fixed-point furnaces can also be used for comparison calibrations and for annealing. In these processes, stability and uniformity are very important, and nothing speaks more about stability and uniformity than the length of the plateaus produced

by the furnace. No other furnace beats a Hart furnace where it counts.

All three of these furnaces have external cooling coils for circulation of tap water at less than 60 PSIG and approximately 0.4 GPM to reduce heat load to the lab. They also come with RS-232 ports and have equilibration blocks available for comparison calibrations. IEEE-488 interface packages are also available, if that's your preference.

One of Hart's three fixed-point furnace models will meet your needs. Remember, the length of the plateau is the best measure of a furnace's performance. Call us for performance data on actual cell freezes and test data on furnace gradients.

## 9114

This furnace has a range of 100 °C to 680 °C, which includes the indium, tin, zinc, and aluminum fixed points, all in one furnace.

The 9114 furnace has an inlet for use of clean dry air or inert gas to initiate the

supercool of a tin cell. Other furnaces require the user to remove the hot and fragile tin cell from the furnace by hand before cooling. In a Hart furnace, you simply turn on your gas, monitor your cell during its supercool, and turn the gas off when the freeze begins.

The 9114 is a three-zone furnace with the best in Hart digital controller technology. Hart designs and builds proprietary controllers that have a reputation of being the best in the business. All of our fixed-point furnaces use them to achieve excellent stability and uniformity.

For easy access and visibility, all three zones are controlled from the top of the unit. The primary controller can be set in 0.01 °C increments, and actual temperature is readable to two decimal places.

The freezing and melting process can be automated using eight preset, user-programmable temperature settings. The top and bottom zones are slaved to the primary zone using differential thermocouples. A high-temperature PRT acts as the main control sensor for the best accuracy, sensitivity, and repeatability.

## 9115A

The 9115A Sodium Heat Pipe Furnace is specifically designed for maintenance of aluminum and silver freeze-point cells.

It has a temperature range of 550 °C to 1000 °C with gradients of less than  $\pm 0.1$  °C throughout. The sodium heat-pipe design provides a simple, yet uniform, single heating zone that ensures very uniform changes in states during heating and cooling.

Melting, freeze initiation, and plateau control for a variety of freeze-point cells are possible by entering up to eight set-points, ramp rates, and soak times. The controller displays temperature in degrees C or F, and temperature feedback is done via a thermocouple. Freeze-point plateaus of 8 to 10 hours are typical, and 24 hours are possible under controlled conditions.

External cooling coils are included for circulation of tap water to reduce chassis temperature and heat load to the lab. Temperature cutouts protect your SPRTs and the furnace from exposure to excessive temperatures.

## 9116A

The Hart Scientific 9116A Furnace has a temperature range of 550 °C to 1100 °C and is designed for use in achieving aluminum, silver, or copper freezing point measurements. An advanced high temperature Sodium heat pipe extends usage to more than 1000 hours at 1100 °C and



# Freeze-point furnaces

Specifications	9114	9115A	9116A
Temperature Range	100 °C to 680 °C	550 °C to 1000 °C	550 °C to 1100 °C
Temperature Stability	± 0.03 °C	± 0.25 °C	± 0.15 °C
Temperature Uniformity	± 0.05 °C (± 0.1 °C in the pre-heat well)	+0.1 °C from bottom of well to 100 mm (3.94 in)	± 0.05 °C
Set-Point Accuracy	± 0.5 °C	± 3.0 °C	
Set-Point Resolution	0.01 °C	0.1 °C	
Display Resolution	0.01 °C	0.1 °C below 1000 °C 1 °C above 1000 °C	
Thermal Safety Cutout Accuracy	± 5 °C	± 10 °C	
Heater Power	End Zones: 1000 W each (at 230 V ac nominal) Primary Zone: 1500 W	2500 W	
Exterior Dimensions (HxWxD)	838 x 610 x 406 mm (33 x 24 x 16 in)		
Power Requirements	230 V ac (± 10 %), 50/60 Hz, 1 Phase, 22 A maximum		
Weight	92 kg (203 lb)	82 kg (180 lb)	82 kg (180 lb)

5000 hours at 982 °C. The heater is embedded in a fiber ceramic insulating block. A hollow section through the center contains the heat pipe.

The minimum working temperature of the Sodium heat pipe is about 500 °C. Above that temperature, the sodium circulates throughout the tube providing a uniform temperature zone for freezing point measurements. With uniformity of ± 0.05 °C, zone adjustments are eliminated simplifying installation and increasing throughput.

The uniform temperature is maintained over the full length of the metal freeze point cell. A programmable temperature controller simplifies freeze initiation, melting and plateau control. Control stability is ± 0.15 °C, the best in the industry, enabling extension of freezing plateaus of quality fixed point cells for up to 20 hours and longer. For compatibility with automation programs, plateaus may be controlled through standard RS-232 and optional IEEE-488 PC interfaces.

## Ordering Information

<b>9114</b>	Metrology Furnace (includes Cell Support Container)
<b>2125</b>	IEEE-488 Interface (9114 only)
<b>2126</b>	Comparison Block, 9114
<b>2940-9114</b>	Cell Support Container, 9114
<b>2127-9114</b>	Alumina Block, 9114
<b>2941</b>	Mini Freeze-Point Cell Basket Adapter
<b>9115A</b>	Sodium Heat Pipe Furnace (includes Cell Support Container)
<b>2940-CC</b>	Cell Support Container, 9115A, 9116A
<b>9116A</b>	Three-Zone Freeze-Point Furnace (includes Cell Support Container)
<b>2127-CB</b>	Block, Ceramic, Non-contaminating, 9115A/9116A



Protect platinum thermometers from metal ion contamination with a low-cost alumina block.

## Specifications - 2127

Dimensions	<b>2127-9114:</b> 54 x 510 mm (2 x 20 in)
Wells	Three: 8 mm ID x 488 mm (0.31 x 19.2 in)
Immersion Protection	Last 156 mm (6.1 in) in alumina
Well-to-Well Uniformity	10 mK at 660 °C in 9114
Temperature Range	Up to 1100 °C

# Mini fixed-point cells



- Lower uncertainties than comparison calibrations
- All ITS-90 fixed points from TPW to copper
- Reduced equipment and annual recalibration costs

If cuteness were reason enough to buy a product, Hart's Mini Fixed-Point Cells would win you over easily. But there's a much better reason to buy them: they give you the least expensive, easiest-to-use fixed-point standards for your lab.

Mini cells eliminate the need for comparison calibrations. Temperatures of fixed-point cells are constant and intrinsic, so only the electrical parameters of the sensor under calibration need to be read. If you're calibrating industrial thermometers, thermocouples, or thermistors and want the most accurate calibration possible, these mini cells will give it to you. If you need a wide range of temperatures, mini cells cover the triple point of water (0.01 °C) and every ITS-90 point from indium (156.5985 °C) to copper (1084.62 °C).

## Fixed-points made simple

With mini cells, realization and maintenance are simple. Mini TPW cells can be automatically realized and maintained in our 9210 Maintenance Apparatus (page 30). Realizing the triple point of water takes only five minutes, but the plateaus last all day.

The realization and maintenance of indium, tin, zinc, and aluminum cells are likewise automated through our 9260 Mini Fixed-Point Cell Furnace (page 34). Work with them at their designated freeze point, or use them at their melting point to simplify the calibration process even further. We published a paper, "The Comparison Between the Freezing Point and Melting Point of Tin," to help you understand and benefit from the easier procedure of using the melting point of your standard.

These mini cells are made from the same materials and with the same procedures as their full-size counterparts. In fact, they can achieve nearly the same uncertainty levels as Hart's traditional fixed-point cells. Probes as short as 229 mm (9 in) work with these cells. The specifications table (at right) gives you the immersion depth and uncertainty for each cell.

In addition to high-accuracy calibrations of RTDs and PRTs, these cells are perfect for validating the accuracy of SPRTs. If you're doing comparison calibrations with SPRTs, then you know the importance of occasionally checking their accuracy between their own recalibrations. Because these cells are easy to use

and maintain, verification checks are simple and convenient.

## Metal-cased cells

Metal-cased cells can also be used in the 9260 maintenance furnace. Because they use stainless steel cases, these cells are easier to use and transport without the same risk of breakage. You'll notice that we have designed the metal cased cells with more immersion depth to give even better uncertainty too!

You'll find these cells easier to use than you expect. You can have a free copy of Xumo Li's paper comparing freeze-point measurements with melting-point measurements, and if you want a high level of training in using metal freeze-point cells, you can attend one of Hart's in-depth training classes held in our lab in Utah.

## Ordering Information

5901B-G	TPW Cell, Mini, Glass Shell
5914A	Mini Quartz Indium Cell
5915A	Mini Quartz Tin Cell
5916A	Mini Quartz Zinc Cell
5917A	Mini Quartz Aluminum Cell
5918A	Mini Quartz Silver Cell
5919A	Mini Quartz Copper Cell
5944	Mini Metal Cased Indium Cell
5945	Mini Metal Cased Tin Cell
5946	Mini Metal Cased Zinc Cell
5947	Mini Metal Cased Aluminum Cell
9210	Mini TPW Maintenance Apparatus (see page 30)
9260	Mini Fixed-Point Furnace (for In, Sn, Zn, Al cells—see page 34)

# Mini fixed-point cells

## Specifications

Model Number	Fixed-Point	Temperature (°C)	Outside Diameter	Inside Diameter	Total Cell Height	Immersion Depth <sup>1</sup>	Uncertainty (mK) k=2	
							Cell Only <sup>2</sup>	Simple Realization <sup>2</sup>
5901B-G	Water T. P.	0.01	30 mm	8 mm	170 mm	117 mm	0.2	0.5
5914A	Indium F. P.	156.5985	43 mm	8 mm	214 mm	140 mm	1.0	2.0
5915A	Tin F. P.	231.928	43 mm	8 mm	214 mm	140 mm	1.4	3.0
5916A	Zinc F. P.	419.527	43 mm	8 mm	214 mm	140 mm	1.6	4.0
5917A	Aluminum F. P.	660.323	43 mm	8 mm	214 mm	140 mm	4.0	10.0
5918A	Silver F. P.	961.78	43 mm	8 mm	214 mm	140 mm	7.0	n/a
5919A	Copper F. P.	1084.62	43 mm	8 mm	214 mm	140 mm	15.0	n/a
5944	Indium F. P.	156.5985	41.3 mm	7.8 mm	222 mm	156 mm	0.7	1.4
5945	Tin F. P.	231.928	41.3 mm	7.8 mm	222 mm	156 mm	0.8	1.6
5946	Zinc F. P.	419.527	41.3 mm	7.8 mm	222 mm	156 mm	1.0	2.0
5947	Aluminum F. P.	660.323	41.3 mm	7.8 mm	222 mm	156 mm	2.0	4.0

<sup>1</sup>Distance from the bottom of the central well to the surface of the pure metal.

<sup>2</sup>"Cell Only" refers to the expanded uncertainty of the cell when realized by traditional methods and maintained using traditional maintenance devices. "Simple Realization" refers to the expanded uncertainty of the cell when realized using practical methods (melting points instead of freezing points or slush ice instead of an ice mantle, for example) and maintained using Hart's 9210 and 9260 mini cell maintenance apparatus.

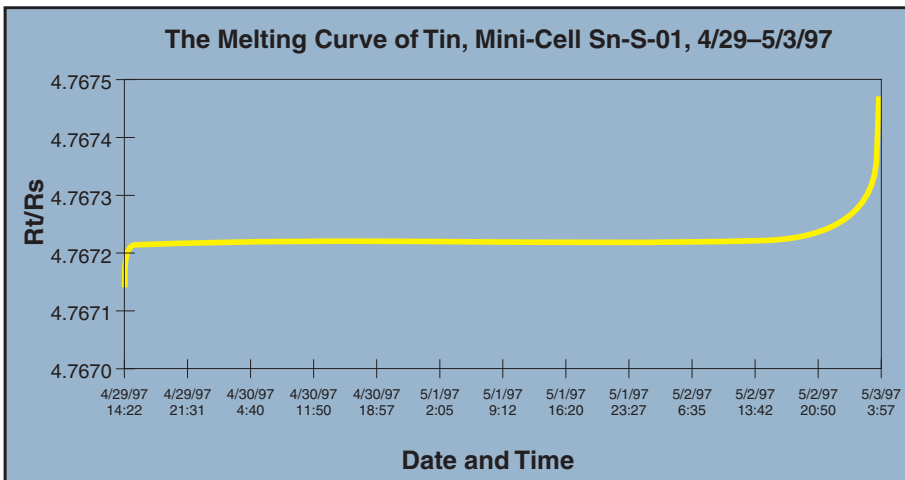
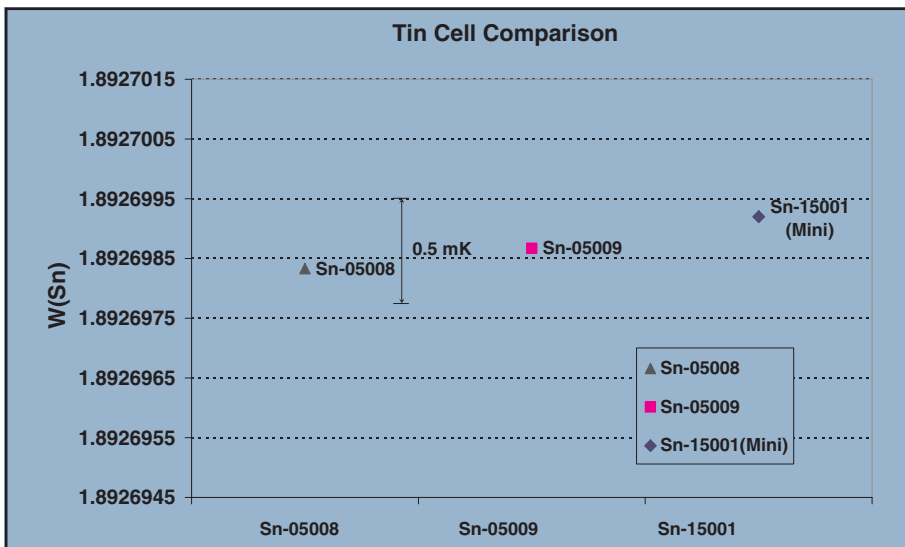



# Mini TPW maintenance apparatus



- Easy preprogrammed realization
- Inexpensive fixed-point solution
- Training takes just a few hours

If the reason you don't use fixed-point cells is because they're too expensive or too difficult to use, you haven't heard of Hart's mini fixed-point apparatus.

The triple point of water (0.01 °C) is one of the most important temperatures on the ITS-90. Unfortunately, realizing and maintaining triple point of water cells hasn't always been convenient or cost-effective.

Because ITS-90 calibrations require frequent measurements at the triple point of water, and because the triple point of water is often used as a statistical check against the drift of a temperature standard, it is important to be able to realize and maintain well-constructed triple point of water cells easily.

Hart's 9210 TPW Maintenance Apparatus provides built-in programming for the simple supercool-and-shake realization and maintenance of our 5901B Mini TPW Cell. Simply insert the cell, enter the "freeze" mode through the front-panel buttons, have your morning cup of coffee, and when the 9210 audibly alerts you,

remove the Mini TPW Cell and give it a shake to initiate freezing a portion of the water. Re-insert the cell, change the program mode to "maintain," and you've got 0.01 °C for the rest of the day with uncertainty of only  $\pm 0.0005$  °C.

Precision-machined thermal blocks can also be used to take advantage of the excellent stability and uniformity of the 9210 for performing comparison calibrations. Multi-hole and custom blocks are available with 178 mm (7 in) depths.

## Specifications

Temperature Range	-10 °C to 125 °C
Ambient Operating Range	5 °C to 45 °C
Stability	$\pm 0.02$ °C
Vertical Gradient	$\pm 0.05$ °C over 100 mm at 0 °C
Plateau Duration	6-10 hours, typical
Resolution	0.01 ° (0.001 ° in program mode)
Display Scale	°C or °F, switchable
Immersion Depth	171 mm (6.75 in) in optional comparison block
Stabilization Time	15 minutes nominal
Preheat Wells	3 wells (for 3.18, 6.35, or 7.01 mm probes [0.125, 0.25, 0.276 in])
Fault Protection	Adjustable software cutout using control probe; separate circuit thermocouple cutout for maximum instrument temperature
Display Accuracy	$\pm 0.25$ °C
Comparison Block	Three multi-hole blocks, blanks, and custom blocks available
Well-to-Well Gradient (in comparison block)	$\pm 0.02$ °C
Heating Time	Ambient to 100 °C: 45 min.
Cooling Time	Ambient to -5 °C: 25 min.
Comm.	RS-232 included
Power Requirements	115 V ac ( $\pm 10$ %), 60 Hz, 1.5 A, or 230 V ac ( $\pm 10$ %), 50 Hz, 0.75 A, 170 W
Exterior Dimensions (HxWxD)	489 x 222 x 260 mm (19.25 x 8.75 x 10.25 in)
Weight	7 kg (15.5 lb) with block

## Ordering Information

9210	Mini TPW Maintenance Apparatus	3110-3	Comparison Insert B, 2 holes at 4.76 mm (3/16 in), 2 at 6.35 mm (1/4 in), and 2 at 9.5 mm (3/8 in)
5901B	Mini TPW Cell	3110-4	Comparison Insert C, 6 holes at 6.35 mm (1/4 in)
1904-TPW	Accredited Cell Intercomparison		<i>Call for other comparison insert options.</i>
3110-1	Comparison Insert, Blank		
3110-2	Comparison Insert A, holes at 1.6 mm, 3.2 mm, 4.76 mm, 6.35 mm, 9.5 mm, and 12.7 mm (1/16, 1/8, 3/16, 1/4, 3/8, and 1/2 in)		

# Gallium cell maintenance apparatus



- One week plateau duration
- No hassle automatic realizations
- Used daily in our Primary Lab

The gallium melting point (29.7646 °C) is a critical temperature. Thermometers used in life science, environmental monitoring, and many other applications depend on it for accurate calibrations. Lab standards rely on it as an ITS-90 check standard and as a means of measuring drift between calibrations. Hart Scientific now makes it easy to use.

The new 9230 Gallium Maintenance System works with Hart's Model 5943 Stainless Steel Gallium Cell to provide melting plateaus that last a week, with results approaching what can be achieved in a Hart maintenance bath. Not a day. Not a day-and-a-half. One week.

The Model 5943 Stainless Steel Gallium Cell holds a gallium sample that is 99.99999+ % pure. The gallium is sealed in a Teflon envelope in a high purity argon atmosphere, which is itself sealed inside a stainless steel housing. This double-sealing method reduces leaching into the gallium sample and ensures a life of ten years or longer for the cell.

## Specifications

Temperature Range	15 °C to 35 °C
Ambient Operating Range	18 °C to 28 °C
Stability	± 0.02 °C
Vertical Gradient	< 0.03 °C over six inches during cell maintenance
Plateau Duration	Five days, typical
Resolution	0.01 ° (0.001 ° in program mode)
Display Scale	°C or °F, switchable
Immersion Depth	220 mm (8.75 in) in gallium cell
Stabilization Time	Preprogrammed
Preheat Wells	2
Fault Protection	Heating/cooling rate cutout
Display Accuracy	± 0.05 °C at 29.76 °C
Comparison Block	Contact Hart
Well-to-Well Gradient (in comparison block)	n/a
Heating Time	Preprogrammed
Cooling Time	Preprogrammed
Comm.	RS-232 included
Power Requirements	115 V ac (± 10 %), 60 Hz, 1.0 A, or 230 V ac (± 10 %), 50 Hz, 0.65 A, 175 W
Exterior Dimensions (HxWxD )	489 x 222 x 260 mm (19.25 x 8.75 x 10.25 in)
Weight	8.2 kg (18 lb) without cell

## Ordering Information

9230	Gallium Cell Maintenance Apparatus
5943	Stainless Steel Gallium Cell
1904-Ga	Accredited Cell Intercomparison

# Mini fixed-point cell furnace



- Good introduction to fixed-point calibration
- User friendly and inexpensive

Hart's 9260 Mini Fixed-Point Cell Furnace provides a fixed-point system that cuts in half the financial investment required to do fixed-point calibrations and virtually all the time and training required by traditional systems.

This furnace costs less than half of a large furnace and works with indium, tin, zinc, and aluminum cells to cover all ITS-90 fixed points from 156.5985 °C to 660.323 °C. The cells themselves, using a smaller volume of 99.9999 % pure metal, also cost much less. But cost is only a part of the issue.

The 9260 makes using fixed points easy. Simply insert the cell at the end of the day and let it sit overnight. The next morning, initialize the built-in software routine for your specific cell. Come back in an hour, verify the stability of the cell, and you can take measurements for the rest of the day from a near-perfect temperature source!

The built-in software lets you choose between using melting-point curves or freezing-point curves for each metal. The ITS-90 calls for freezing points, but melting points are easier to realize, and the difference in

uncertainty (less than 2 mK for most applications) is generally insignificant.

Comparison blocks are also available for the 9260 for high-precision comparison calibrations at high temperatures. Two blocks are available with a variety of pre-drilled wells in addition to blank or custom blocks. Well depth is 229 mm (9 in).

Specifications	
Temperature Range	50 °C to 680 °C
Ambient Operating Range	5 °C to 45 °C
Stability	± 0.03 °C to 300 °C ± 0.05 °C above 300 °C
Vertical Gradient	Top and bottom zones adjustable by offset
Plateau Duration	6–10 hours typical
Resolution	0.01 °
Display Scale	°C or °F, switchable
Immersion Depth	229 mm (9 in)
Stabilization Time	15 minutes nominal
Preheat Wells	2
Fault Protection	Sensor burnout and short protection, over-temperature thermal cutout
Display Accuracy	± 0.2 °C to 300 °C ± 0.3 °C to 450 °C ± 0.5 °C to 680 °C
Comparison Block	Two multi-hole blocks, blanks, and custom blocks available
Well-to-Well Gradient (in comparison block)	± 0.02 °C
Heating Time	1.25 hrs. from 25 °C to 680 °C
Cooling Time	10.5 hrs. from 680 °C to 100 °C
Comm.	RS-232 included
Power Requirements	115 V ac (± 10 %), 60 Hz, 11 A, or 230 V ac (± 10 %), 50 Hz, 6 A, specify, 1200 W
Exterior Dimensions (HxWxD)	489 x 222 x 260 mm (19.25 x 8.75 x 10.25 in)
Weight	20.5 kg (45 lb) with block

## Ordering Information

9260	Mini Fixed-Point Furnace	2942-9260	Container, SST Mini-Cell Support, 9260
5914A	Mini Quartz Indium Cell	1904-X	Accredited Cell Intercomparison
5915A	Mini Quartz Tin Cell	3160-1	Comparison Insert, Blank
5916A	Mini Quartz Zinc Cell	3160-2	Comparison Insert, 7 holes at 6.35 mm (1/4 in)
5917A	Mini Quartz Aluminum Cell	3160-3	Comparison Insert, 2 holes at 3.2 mm (1/8 in), 2 at 4.76 mm (3/16 in), 2 at 6.35 mm (1/4 in), 2 at 9 mm (9/32 in), and 2 at 9.5 mm (3/8 in)
5944	Metal Cased Mini Indium Cell		<i>Call for other comparison insert options.</i>
5945	Metal Cased Mini Tin Cell		
5946	Metal Cased Mini Zinc Cell		
5947	Metal Cased Mini Aluminum Cell		
2940-9260	Container, Mini-Cell Support, 9260		



# LN<sub>2</sub> comparison calibrators

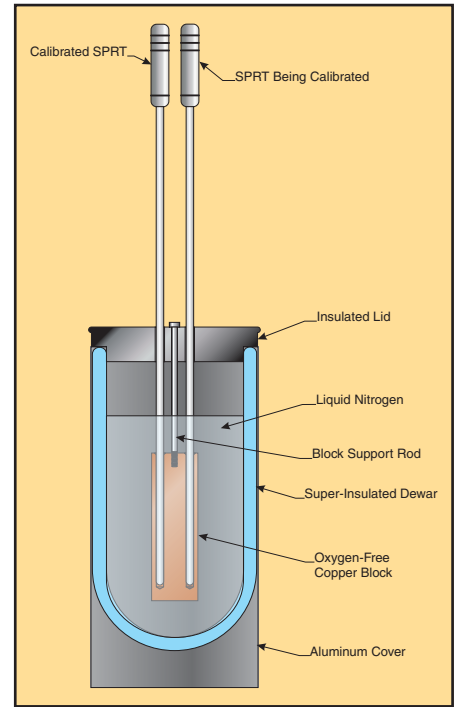

- Low-cost calibrations to -196 °C
- Simple to use
- Uncertainty less than 2 mK

While there is a difference between the nominal boiling point of nitrogen (-196 °C) and the argon triple point (-189.3442 °C), the difference can be corrected for mathematically, and an uncertainty of less than 2 mK from the actual argon triple point is achievable.

Hart's LN<sub>2</sub> Comparison Calibrators consist of a super-insulated glass dewar, a high-purity copper block, and a precision-fit lid. The dewar is filled with LN<sub>2</sub> and the copper block is suspended in it; an SPRT is inserted into the block and a calibration

is performed against your own calibrated SPRT. The Model 7196-4 includes four 8 mm (0.315 in) wells. The 7196-13 includes five 8 mm (0.315 in) wells and eight 6.35 mm (0.25 in) wells.

Hart's LN<sub>2</sub> Comparison Calibrators are neither expensive nor complicated to use. If you need supporting data or would like to discuss the theory of operating an LN<sub>2</sub> Comparison Calibrator, call Hart Scientific today. (Or come to one of our training courses, and we'll show you.)

## Specifications

<b>Temperature</b>	Nominal -196 °C depending on atmospheric pressure
<b>Thermal Wells</b>	<b>7196-4:</b> four 8 mm (0.32 in) I.D. wells <b>7196-13:</b> five 8 mm (0.32 in) I.D. wells, eight 6.35 mm (0.25 in) I.D. wells <b>Both blocks:</b> 275 mm immersion from top of lid to bottom of well, 150 mm immersion into copper block
<b>Dimensions</b>	180 mm O.D. x 385 mm high
<b>Stability</b>	Typically better than 2 mK/20 min
<b>Uniformity</b>	< 0.4 mK between holes
<b>Volume</b>	3.5 liters of liquid nitrogen
<b>Evaporation</b>	Approx. 25 mm (1 in) per 45 minutes

## Ordering Information

- 7196-4** LN<sub>2</sub> Comparison Calibrator, 4 holes
- 7196-13** LN<sub>2</sub> Comparison Calibrator, 13 holes

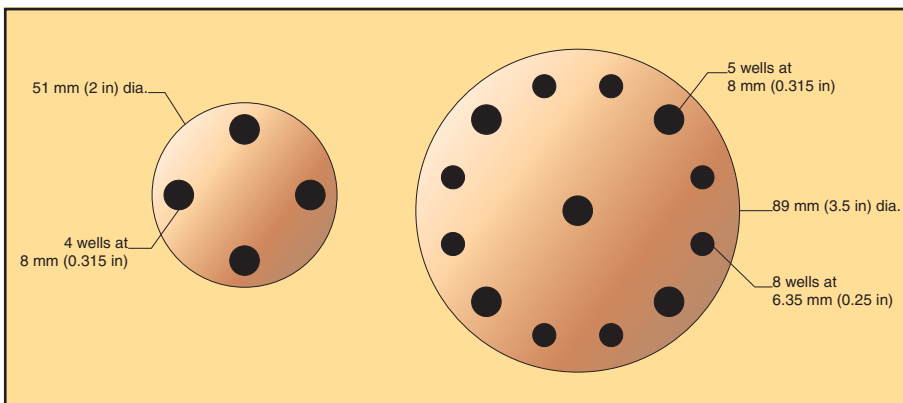

# DC resistance standards



- Convenient air resistors don't require oil or air baths
- Calibrate resistance thermometers and other devices
- Includes NIST-traceable calibration data with uncertainty to 1 ppm
- Easily transported for on-site resistance calibration

Do you need high-accuracy working standards for precise, on-site resistance calibrations? If you'd like to avoid maintaining traditional standard resistors in oil baths, Hart has a complete assortment of DC air resistors manufactured by Fluke, with Fluke's proprietary tellurium-copper five-way binding posts.

The Fluke 742A Series covers values from 1 ohm all the way to 100 megohm. These are the finest-quality air resistors you can buy. They're durable, easy to maintain, and easy to use. Their excellent temperature stability allows them to be used from 18 °C to 28 °C with typically less than 2 ppm degradation. Using the

calibration table supplied with the standards, which lists corrections in 0.5 °C increments, this uncertainty can be reduced.

Care has been taken to reduce resistance changes brought about by thermal and mechanical shock. Retrace (shift in resistance) is typically less than 2 ppm after cycling between 0 °C and 40 °C.

Each of these resistors comes with a NVLAP-accredited report of calibration from Fluke. Accredited recalibrations are available from either Fluke or Hart.

## Ordering Information

742A-1	Resistor, DC Standard, 1Ω
742A-10	Resistor, DC Standard, 10Ω
742A-25	Resistor, DC Standard, 25Ω
742A-100	Resistor, DC Standard, 100Ω
742A-1K	Resistor, DC Standard, 1 KΩ
742A-10K	Resistor, DC Standard, 10 KΩ
742A-100K	Resistor, DC Standard, 100 KΩ
742A-1M	Resistor, DC Standard, 1 MΩ
742A-10M	Resistor, DC Standard, 10 MΩ
742A-7002	Transit Case
1960	Cal, DC Standard Resistor

## Specifications

Model	Nominal Value Ω	Stability, ppm 6 Months	Stability, ppm 12 Months	Max Change, ppm from 23 °C ± 5 °C (± ppm)	Calibration Uncertainty, ± ppm
742A-1	1	5	8	3.0	1.0
742A-10	10	5	8	3.0	1.0
742A-25	25	5	8	3.0	1.0
742A-100	100	4	6	3.0	1.0
742A-1K	1K	4	6	2.0	1.5
742A-10K	10K	2.5	4	1.5	1.0
742A-100K	100K	4	6	2.0	2.5
742A-1M	1M	6	8	2.0	5.0
742A-10M	10M	6	9	3.0	10.0

# Standard AC/DC resistors



- Long-term stability better than 2 ppm/year (< 1 ppm typical)
- Traceable AC and DC calibrations available
- National lab design proven for more than 25 years

National laboratories around the world have long relied on the standard AC/DC resistors manufactured by Tinsley. Whether they're used in thermometry or electrical applications—with AC or DC bridges—these resistors perform better than any other AC/DC resistors available.

Six resistors in Hart's 5430 series cover resistance values from 1 ohm to 10,000 ohms. Each one has an actual resistance within 10 ppm of its nominal value and holds its resistance within 2 ppm per year.

Each resistor comes with a Tinsley certificate on AC performance, traceable to NPL in the UK, including calibration uncertainty of 3 ppm. Additionally, Hart can provide an optional DC certificate, traceable to NIST and NVLAP accredited, with uncertainty below 1 ppm.

Designed originally by a national lab, Tinsley resistors are bifilar wound to minimize reactance and are filled with oil to minimize both time- and temperature-caused instabilities. AC/DC transfer error at 90 Hz is only 1 ppm.

For maintaining your oil resistors, Hart provides baths that range from 51- to 167-liter capacity with enough inside shelf space to maintain all your standard

resistors. Our 7009, 7015, and 7108 models maintain your resistors with exceptional stability (see page 124).

In our lab, we use both AC and DC bridges in addition to Super-Thermometers. We calibrate SPRTs in fixed points, and we calibrate reference resistors. We use standard resistors every day, and we understand the value of being able to rely on resistors that won't drift. Tinsley makes the best AC/DC resistors around, and Hart makes the best maintenance baths. Ask people who know. Then don't compromise.

## Specifications

<b>Tolerance</b>	10 ppm
<b>Calibration Uncertainty</b>	AC: 3 ppm (10 KΩ: 4 ppm) DC: 1 ppm (optional)
<b>Long-Term Stability</b>	2 ppm/year
<b>Temperature Coefficient</b>	2 ppm/°C
<b>Recommended Current</b>	1 Ω: 100 mA 10 Ω: 32 mA 25 Ω: 20 mA 100 Ω: 10 mA 1 KΩ: 3 mA 10 KΩ: 1 mA
<b>Maximum Current</b>	1 Ω: 1 A 10 Ω: 320 mA 25 Ω: 200 mA 100 Ω: 100 mA 1 KΩ: 32 mA 10 KΩ: 10 ma
<b>AC/DC Transfer Error (at 90 Hz)</b>	0.1 ppm

## Ordering Information

<b>5430-1</b>	Resistor, AC/DC Standard, 1Ω
<b>5430-10</b>	Resistor, AC/DC Standard, 10Ω
<b>5430-25</b>	Resistor, AC/DC Standard, 25Ω
<b>5430-100</b>	Resistor, AC/DC Standard, 100Ω
<b>5430-200</b>	Resistor, AC/DC Standard, 200Ω
<b>5430-400</b>	Resistor, AC/DC Standard, 400Ω
<b>5430-1K</b>	Resistor, AC/DC Standard, 1 KΩ
<b>5430-10K</b>	Resistor, AC/DC Standard, 10 KΩ
<b>1960</b>	Cal, DC Standard Resistor

See page 124 for standard resistor maintenance bath options.



# Thermometer readout selection guide

## Readouts

Model	Probe Types	Accuracy at 0 °C	Features	Page
1575A	SPRTs, PRTs, Thermistors	± 0.001 °C	4 ppm accuracy; resolution to 0.0001 °C for SPRTs and 0.00001 °C for thermistors; 2 channels; add 10 more channels with a mux.	40
1590	SPRTs, PRTs Thermistors	± 0.00025 °C	1 ppm accuracy; patented DWF connectors; color display; add up to 50 channels with muxes.	
1560	Accepts any combination of the modules below; all are easily added to and removed from the 1560 base.			48
2560	SPRTs, PRTs	± 0.005 °C	2 channels of 25Ω or 100Ω PRTs.	
2561	HTPRTs	± 0.013 °C	2 channels to 1200 °C.	
2562	PRTs	± 0.01 °C	8 channels of 2-, 3-, or 4-wire RTDs.	
2563	Thermistors	± 0.0013 °C	2 channels of resolution to 0.0001 °C.	
2564	Thermistors	± 0.0025 °C	8 channels for data acquisition.	
2565	Thermocouples	± 0.05 °C	Reads most TC types with 0.0001 mV resolution.	
2566	Thermocouples	± 0.1 °C	Reads any combination up to 12 channels of virtually any type of TC.	
2567	1000Ω PRTs	± 0.006	2 channels of high-resistance PRTs.	
2568	1000Ω PRTs	± 0.01	8 channels of high-resistance PRTs.	
1529	PRTs, Thermistors, Thermocouples	± 0.006 °C (PRT)	Four channels can all be measured simultaneously; battery-powered; logs up to 8,000 readings; flexible display.	53
1502A	PRTs	± 0.006 °C	Resolution of 0.001 °C and accuracy to match; uses ITS-90, IPTS-68, CVD, or DIN (IEC 751) conversions.	56
1504	Thermistors	± 0.002 °C	Reads thermistors from 0 to 500 KΩ; uses Steinhart-Hart and CVD.	
1523	PRTs, Thermistors, Thermocouples	± 0.002 °C	Battery-powered, handheld thermometer; INFO-CON connector reads coefficients without programming; saves 25 readings on demand; graphs trends.	58
1524	PRTs, Thermistors, Thermocouples	± 0.002 °C	Same as 1523 but with inputs for two thermometers; logs up to 15,000 readings and stores 25 more on demand	

## Thermo-hygrometer

Model	Product	Features	Page
1620A	The "DewK" Thermo-Hygrometer	Two channels measure ambient temperature to ± 0.125 °C and % RH to ± 1.5 % RH. Onboard memory holds up to two years of time/date-stamped readings. Visual and audio alarms. Detachable sensors contain their own calibration data for easy recalibrations. Wired and wireless networking options.	63

## Reference multimeter

Model	Product	Features	Page
8508A	Fluke Reference Multimeter	True ohms measurement. 20 amp current measurement. Stores up to 100 PRT coefficients.	62

# Choosing the right temperature readout

When you're performing temperature calibrations, the right choice of readout for your reference probe and units under test is critical. Consider the following:

## Accuracy

Most readout devices for resistance thermometers provide a specification in parts per million (ppm), ohms, and/or temperature. Converting ohms or ppm to temperature depends on the thermometer being used. For a 100Ω probe, 0.001Ω equals 0.0025 °C at 0 °C. One ppm would be the same as 0.1 mΩ or 0.25 mK. You should note whether the specification is "of reading" or "of full range." One ppm of reading at 100Ω is 0.1 mΩ. However, 1 ppm of full range, where full range is 400Ω, is 0.4 mΩ.

When reviewing accuracy specifications, remember the readout uncertainty can be a small contribution to total uncertainty and that it may not make economic sense to buy the lowest uncertainty readout. A 0.1 ppm bridge may cost \$50,000, whereas a 1 ppm Super-Thermometer costs less than half that. Yet the bridge offers very little improvement—in this case, 0.000006 °C (see below).

## Measurement errors

When making high-accuracy resistance measurements, be sure the readout is eliminating thermal EMF errors within the measurement system. A common technique for removing EMF errors uses a switched DC or low-frequency AC current supply.

## Resolution

Having 0.001 ° resolution does not mean the unit is accurate to 0.001 °. In general, a readout accurate to 0.01 ° should have a resolution of at least 0.001 °. Display resolution is important when detecting small temperature changes—for example, when monitoring the stability of a calibration bath.

## Linearity

Most manufacturers provide an accuracy specification at one temperature (typically 0 °C), but it's important to know the accuracy over your working range. The accuracy of the readout will vary depending on the measurement. The uncertainty could be larger at the temperature you're measuring than it is at 0 °C. Be sure the manufacturer provides an accuracy specification that covers your working range.

## Stability

Stability is important, since you'll be making measurements in a wide variety of ambient conditions and over varying lengths of time. Be sure to review the temperature coefficient and long-term stability specifications. Make sure the variations in your ambient conditions will not affect the readout's accuracy. Be wary of the supplier who quotes "zero drift" specifications. Every readout has at least one drift component.

## Calibration

Some readout specifications state "no recalibration necessary." However, ISO guides require the calibration of all measuring equipment. Look for a readout that can be calibrated through its front panel without special software. Also avoid readouts that still use manual potentiometer adjustments or that need to be returned to the factory for recalibration. Most DC readouts are calibrated using high-stability DC standard resistors. Calibration of AC readouts is more complicated, requiring a reference inductive voltage divider and accurate AC standard resistors.

## Traceability

Traceability of DC readout measurements is extremely simple through well-established DC resistance standards. Traceability of measurements from AC readouts and bridges is more problematic. Many countries have no established AC resistance

traceability. Most countries that have traceable AC measurements rely on AC resistors calibrated with 10 times the uncertainty of the readout or bridge, which significantly increases the system measurement uncertainty.

## Convenience features

Because the push for increased productivity is endless, you'll need a readout with as many time-saving features as possible. Some important ones to look for are direct display in temperature rather than just raw resistance or voltage, acceptance of a wide variety of thermometer types, ease of use for a short learning curve, channel expansion capability through multiplexers, and digital interface (and software) options that allow for automation of measurements and calibrations.

Sources of Uncertainty Comparison Calibration of PRTs from -196 °C to 420 °C	Super-Thermometer	Bridge
SPRT	0.001000 °C	0.001000 °C
1 ppm Super-Thermometer (1 ppm)	0.000250 °C	n/a
0.1 ppm Bridge	n/a	0.000025 °C
Bath Uniformity / Stability	0.005000 °C	0.005000 °C
Estimated Total Uncertainty (k=2)*	<b>0.005105 °C</b>	<b>0.005099 °C</b>
*RSS, assuming uncertainty components were statistically evaluated.		

So, for a mere additional \$50,000 you can buy a bridge and improve your system uncertainty by a whopping 0.000006 °C. We suggest you stick with a Super-Thermometer and treat your boss to dinner with the money you save.

# Super-Thermometer readouts



- Accuracy to 4 ppm (0.001 °C) or 1 ppm (0.00025 °C)
- Bridge-level performance at less than half the cost
- Accepts 0.25-ohm through 100-ohm SPRTs plus thermistors
- Includes all temperature functions and stores setups

Hart's Super-Thermometers are recognized in metrology laboratories around the world for their ease of use and reliable accuracy. The Model 1575A Super-Thermometer is accurate to 0.001 °C. The Model 1590 Super-Thermometer II is accurate to 0.00025 °C, or 1 ppm.

Both Super-Thermometers are perfectly suited for SPRT calibrations. These are the best lab instruments to take advantage of SPRT accuracy. They're easy to use, they read temperature directly, they have automated data collection, they automatically calculate constants for ITS-90, and both of them are priced at less than half the price of the competitors' resistance bridges.

Of course, there's more.

## Bridges

Resistance bridges are one of the most expensive pieces of lab equipment you can buy. Most sell for \$30,000 to \$50,000. The resistance bridge market is very small, and there's hardly any competition. There's nothing to control the price except your willingness to pay.

Resistance bridges are difficult to use. Their learning curve is long and complex,

which means you'll spend plenty of time learning to master one. Time spent learning costs you money, and costs multiply if you have to train other people!

So why buy a bridge if you have a legitimate alternative?

If 1 ppm accuracy gets the job done, the easiest and cheapest way to do it is with one of Hart's Super-Thermometers.

## 1575A

The 1575A Super-Thermometer is a best-selling thermometer because of its ease of use, high accuracy, built-in software, and reasonable price. Temperature is read directly on the display in your choice of scales. There are no manual resistance-to-temperature conversions. Resistance is converted to temperature for you using the ITS-90 algorithm in any one of the instrument's ranges. Up to 16 independent sets of probe characterizations can be stored in the 1575A's memory. Switch SPRTs and simply call up its reference identification number. Forget the extensive, time-consuming setup required by resistance bridges. Read the features common to

both units and you'll understand why each is a great buy.

## 1590

The 1590 Super-Thermometer II has all of the features of the 1575A, plus it has the unbeatable accuracy of 1 ppm and a color screen that tilts to create the best viewing angles. With all of these features, it's still less than half the price of a bridge.

In many labs with standards that require the use of bridges, Super-Thermometers have been accepted as an alternative to bridges because they are a combination of bridge technology and microprocessor-based solid-state electronics—and they're much easier to use.

Both Hart Super-Thermometers come with an accredited calibration.

## Accuracy

The typical benchtop thermometer has an error level 5 to 10 times larger than the Super-Thermometer, and 20 to 40 times higher than a Super-Thermometer II. With common 25- or 100-ohm SPRTs, the 1575A Super-Thermometer achieves  $\pm 0.002$  °C accuracy and  $\pm 0.001$  °C accuracy with a calibrated external standard resistor. The 1590 Super-Thermometer II is even better with  $\pm 0.00025$  °C accuracy.

ITS-90 specifies the use of 2.5-ohm and 0.25-ohm SPRTs as high-temperature standards up to the silver point (962 °C).



# Super-Thermometer readouts

This very small resistance is difficult to measure and is commonly done only with resistance bridges. The Super-Thermometers address ITS-90 problems directly and are absolutely the most cost-effective solution available.

In addition, resolution with a 25-ohm SPRT is 0.0001 °C. Comparison calibrations or calibrations against primary standard fixed points are easily performed. Both instruments have two channels for handling two probes at once. Display and record actual temperatures or choose to read the difference between the two directly from the screen.

Both Super-Thermometers have their own on-board resistors. Each is a high-stability, low thermal coefficient, four-terminal resistor for each of the resistance ranges of the thermometer: 0.25 ohms, 2.5 ohms, 10 ohms, 25 ohms, 100 ohms, and thermistor ranges. Resistors are housed in an internal temperature-controlled oven. Can it get any better?

Well, actually it does.

## DWF connectors

Hart's patented Model 2392 DWF Connector is unique in the industry (U.S. Patent 5,964,625). Each one is machined from solid brass and then plated with gold. DWF Connectors accept banana plugs, spade connectors, or bare wires. Banana plugs are inserted in the top. Bare wires go in one of the four side holes and are held in place by a spring-loaded pressure plate. Spade connectors are inserted between the top of the connector and pressure plate and are held in place the same as bare wire. The connections are solid and difficult to dislodge. Bare wire and spade connectors require nothing more than pushing the DWF Connector in. There's nothing to screw down or tighten.



Hart's patented DWF Connectors—so easy to use you'll never want to use anything else.

## Other features

Super-Thermometers convert resistance to temperature using your choice of ITS-90 or IPTS-68. ITS-90 requires no conversions; just enter your coefficients directly. For IPTS-68 enter R<sub>0</sub>, ALPHA, DELTA, A<sub>4</sub>, and C<sub>4</sub>. Temperature can be converted from IPTS-68 to ITS-90 automatically at your request. Calendar-Van Dusen equations are also provided in an automated mode.

Thermistor probes are characterized by coefficients of a logarithmic polynomial. Save money and use low-cost, rugged thermistor standards for ± 0.001 °C accuracy in the low-temperature regions. Other thermometers don't do all this.

Measurements can be displayed as temperatures in °C, K, or °F and as resistance in ohms or a ratio of probe resistance to reference resistance. The current source is controllable between 0.001 mA and 15 mA with a resolution of 0.2 %. Integration time and digital filtering are programmable to optimize resolution, stability, and response.

Datalogging and memory functions store measurements, and each thermometer has its own 3.5-inch disc drive for archiving data. The display is a backlit LCD for visual display of information. It has an RS-232, an IEEE-488, and a parallel printer port.

These Super-Thermometers are based on DC electronics, thus eliminating the problems with national lab certification for AC bridges and the removal of quadrature interference from AC-heated fixed-point furnaces. Read about the complete *Theory of Operation of Hart Super-Thermometers* at [www.hartscientific.com](http://www.hartscientific.com)

## Multiplexers

If two channels aren't enough, add 10 more with a Mighty-Mux featuring Hart's handy DWF connectors. In fact, add up to 50 more channels to the 1590.

The Model 2575 provides 10 more channels for use with a 1575. For the 1590, the Model 2590 Mighty-Mux II has a cascading ability that lets you have up to 50 channels by chaining more than one Mux together, and you can now set continuous constant current levels on each channel to avoid self-heating effects. Whatever your application, a Mighty-Mux will make it easier and more efficient.

Both units have low thermal EMF relays that are hermetically sealed and magnetically shielded. You're making true four-wire measurements with a floating guard and support for up to 20 mA of drive current.



Add 10 channels to a 1575A Super-Thermometer with a 2575 Mighty-Mux. Or add up to 50 channels to a 1590 Super Thermometer II with 10-channel 2590 Mighty-Mux II multiplexers.

## Super-Thermometers vs. digital multimeters

Good eight-and-a-half-digit multimeters might give you accuracy to ± 0.005 °C in the resistance measurement. However, DMMs require separate high-stability current sources, and you have to make EMF offsets, worry about a scheme to switch between forward and reverse current during the measurement, and devise a switch to get a second channel for an external standard resistor.

Once you've done all of this, you still have to convert resistance to temperature with tedious manual calculations.

Super-Thermometers do all of this automatically.

## Super-Thermometers vs. everything else

There really isn't anything else to compare to the 1590 and 1575A. No other readout is this easy to use. You'll be doing calibrations with it the first day you receive it, not the first day after the training program is over.

## Ordering Information

1575A	Super-Thermometer
2575	Multiplexer, 1575
1590	Super-Thermometer II
2590	Multiplexer, 1590
742A-25	Standard DC Resistor, 25Ω
742A-100	Standard DC Resistor, 100Ω

# Super-Thermometer readouts

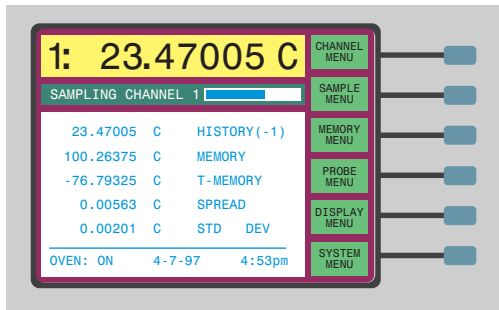

## Customize your display

The graphic screen is easily modified to include information that fits your application or preferences. Under the display menu you select up to five lines of on-screen information from 19 different options including:

T-MEMORY	Current value minus the value in memory
T(1) - T(2)	Channel one minus channel two
MAXIMUM	Peak reading since last reset
MINIMUM	Lowest value since last reset
SPREAD	Maximum difference between readings
AVERAGE	Computes average of previous samples
STD DEV	Computes standard deviation of previous samples

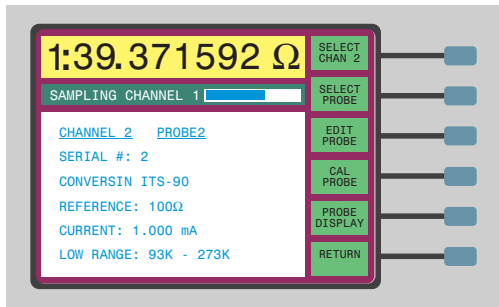

## Probe setup

Each probe's information is identified by its unique serial number for assignment to a specific channel. You select the desired resistance-to-temperature conversion formula, set the probe constants, and select the reference resistor and the drive current. A total of 16 probe setups are stored in internal memory. An unlimited number can be stored to disk and selected when needed. After a probe's information is entered the first time, the Super-Thermometer is immediately set to match that probe by simply selecting the probe's serial number.

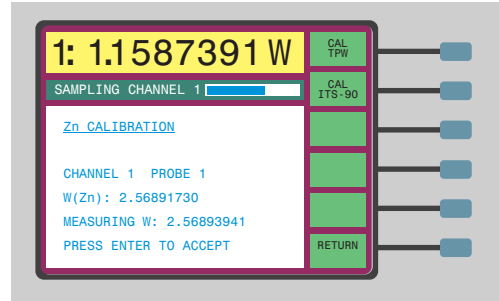

## Automatic calculation of constants

The Super-Thermometers automatically calculate the required constants for the ITS-90 temperature conversion. Connect your uncalibrated standards probe to the 1590, measure the resistance at the fixed-points or against a calibrated standard, and the 1590 stores the resistance readings and automatically derives the correct constants. You don't need a calculator and a pad of paper. The Super-Thermometers enter the constants directly to the probe setup, saving you time and preventing error in the manual entry of constants.

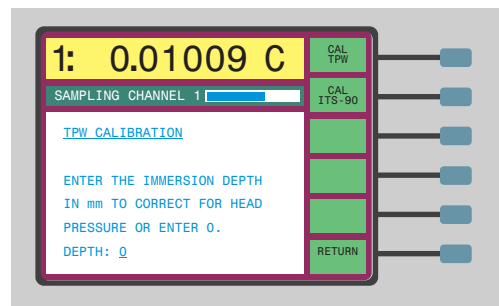

## The triple point of water

Take a reading in the TPW cell just prior to each new measurement. The Super-Thermometers store the current  $R_{TPW}$  value and reference it during the conversion from resistance to temperature. This eliminates two sources of measurement error. The drift of  $R_{TPW}$  in the SPRT is removed, and the error of the on-board reference resistors is canceled. For convenience and maximum precision, you can even enter the immersion depth of your SPRT in the cell to correct for hydrostatic head.

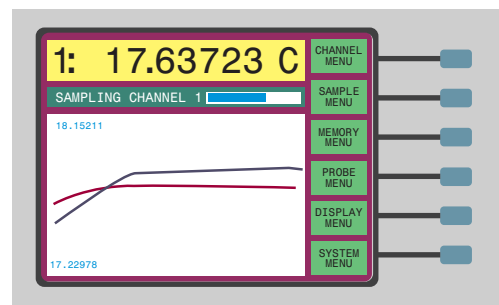

## Graphing feature

The Super-Thermometers feature real-time, on-scale graphing for monitoring fluid bath stabilization or realizing metal fixed-point plateaus. Simply monitor the graph for stability on one or multiple channels and take your readings in resistance, temperature, or the ratio to the triple point of water. The 3.5-inch disc drive stores readings in an ASCII format for spreadsheet or graphing use. Graphing resolution limits can be manually entered, or maximum resolution is automatically set as the readings stabilize over time. Temperature measurement labs save time by not monitoring or taking data every few seconds.

# Super-Thermometer readouts

Specifications	1575A			1590		
	Nominal Resistance	Accuracy (of indicated value)	Equivalent Temp. Value, at 0 °C	Nominal Resistance	Accuracy (of indicated value)	Equivalent Temp. Value, at 0 °C
Transfer Accuracy (using external reference resistor)	0.25 Ω	40 ppm	0.01 °C	0.25 Ω	20 ppm	0.005 °C
	2.5 Ω	20 ppm	0.005 °C	2.5 Ω	5 ppm	0.00125 °C
	25 Ω	4 ppm	0.001 °C	25 Ω	1 ppm	0.00025 °C
	100 Ω	4 ppm	0.001 °C	100 Ω	1 ppm	0.00025 °C
	10 KΩ	10 ppm	0.00025 °C (thermistor at 25 °C)	10 KΩ	5 ppm	0.000125 °C (thermistor at 25 °C)
Absolute Accuracy (using internal reference resistor)	0.25 Ω	100 ppm	0.025 °C	0.25 Ω	40 ppm	0.01 °C
	2.5 Ω	40 ppm	0.01 °C	2.5 Ω	20 ppm	0.005 °C
	25 Ω	8 ppm	0.002 °C	25 Ω	6 ppm	0.0015 °C
	100 Ω	8 ppm	0.002 °C	100 Ω	6 ppm	0.0015 °C
	10 KΩ	20 ppm	0.0005 °C (thermistor at 25 °C)	10 KΩ	10 ppm	0.00025 °C (thermistor at 25 °C)
Typical Resolution	0.25 Ω	10 ppm	0.0025 °C	0.25 Ω	10 ppm	0.0025 °C
	2.5 Ω	5 ppm	0.00125 °C	2.5 Ω	2 ppm	0.0005 °C
	25 Ω	1 ppm	0.00025 °C	25 Ω	0.5 ppm	0.000125 °C
	100 Ω	1 ppm	0.00025 °C	100 Ω	0.5 ppm	0.000125 °C
	10 KΩ	3 ppm	0.000075 °C (thermistor at 25 °C)	10 KΩ	2 ppm	0.00005 °C (thermistor at 25 °C)
Resistance Range	0 Ω to 500 KΩ					
Internal Reference Resistors	1 Ω, 10 Ω, 100 Ω, 10 KΩ					
Minimum Measurement Period	2 seconds					
Current Source	0.001 mA to 20 mA, programmable					
Analog Output	-5 to +5 V					
Display	Monochrome LCD with CCFT backlight			Color LCD with CCFT backlight		
Power	100–125/200–250 V ac (user switchable), 50/60 Hz, 1 A					
Size/Weight	178 mm H x 516 mm W x 320 mm D (7.0 x 20.3 x 12.6 in) / 16 kg (35 lb)					
Calibration	Includes NIST-traceable accredited calibration					

## Specifications - Multiplexers

Channels	<b>2575:</b> 10 <b>2590:</b> 10 per unit, cascade up to 5 units for 50 channels
Connector	4-wire plug, floating guard
Terminals	Gold-plated Hart DWF Connectors
Relays	Low thermal EMF, hermetically sealed, magnetically shielded
Contact Resistance	< 0.1Ω
Isolation	1 x 10 <sup>12</sup> between relay legs
Channel Selection	Manual or auto
Current Capability	20 mA
Current Levels	<b>1575A:</b> Current on active channel only <b>1590:</b> Standby current 1 mA, 0.5 mA, or 10 μA on all channels
Power	Via connection to 1575A or 1590
Size (HxWxD)	178 x 516 x 320 mm (7 x 20.3 x 12.6 in)



# Evaluating calibration system accuracy

Is your calibration system accurate enough?

Obviously, a measurement device such as a PRT can be no more accurate than the system used to calibrate it. You wouldn't use a dry-well and a hand-held multimeter to calibrate an SPRT, right? After listing the factors that contribute error to a PRT (which might include drift, hysteresis, repeatability, resistance shunting, and others in addition to the calibration uncertainty), it is clear that the accuracy of the calibration system must be much better than the desired accuracy of the PRT. But exactly how accurate does it need to be?

## Test uncertainty ratio

Ideally, metrologists evaluate all the sources of uncertainty, including uncertainty in calibration, and make sure the combined uncertainty is within the limits required for the application. However, this approach might require too much effort, and in many cases some of the sources of error, or values for their uncertainties, cannot be known.

For an alternative, we might assume that the calibration uncertainty should be less than some particular fraction of the specification—below an established *test uncertainty ratio* (TUR). This approach is quite simple and is widely used. A commonly used TUR, as given by the ANSI/NCSL Z540 standard, is 4 to 1, meaning the uncertainty of the system used to calibrate a measurement device should be no greater than 25 % of the desired accuracy of the device. So, if we want a PRT to be accurate to  $\pm 0.1\text{ }^\circ\text{C}$ , its calibration should have an uncertainty of  $\pm 0.025\text{ }^\circ\text{C}$  or better.

## Uncertainty components

Once we've established a required uncertainty for our calibration system, how do we determine if our system meets this requirement? What we first need to do is list all the sources of uncertainty, and then assign reasonable values to them. Some of the uncertainties that might apply in a PRT calibration system would be those associated with the reference thermometer calibration, reference thermometer stability, thermometer readouts, bath uniformity, immersion effects, electrical and thermal noise (including bath stability), and day-to-day process variations.

Some of these can be evaluated statistically, by making repeated measurements and calculating the standard deviation of the measurements. This is often designated as a *type A* evaluation. Others might just be

assumed from the best information available, such as manufacturer's specifications. This is a *type B* evaluation.

## Readout uncertainty

Readout uncertainty is often simply obtained from the manufacturer's specifications. But what do we do if the readout's specs are in resistance and we need an uncertainty in terms of temperature? We have to do a little conversion by dividing the resistance spec by the slope of the PRT's resistance-temperature curve.

Suppose we are using a readout that has a spec of 6 ppm (of reading) and we are measuring a temperature near  $420\text{ }^\circ\text{C}$  with a  $100\text{ }\Omega$  PRT. The resistance at this temperature would be about  $257\text{ }\Omega$ , and from the T vs. R table for the PRT we see that the resistance changes about  $0.35\text{ }\Omega/^\circ\text{C}$  near  $420\text{ }^\circ\text{C}$ . So, the spec of the readout converted to temperature for this measurement is

$$u(\text{readout}) = \frac{(6 \cdot 10^{-6})(257\Omega)}{0.35\text{ }\Omega/^\circ\text{C}} = 0.0044\text{ }^\circ\text{C}$$

The same type of calculation can be used for thermocouples, using a readout's voltage accuracy spec and the thermocouple's T vs. mV slope at the measured temperature. However, with a thermocouple we also need to consider the uncertainty of the reference junction temperature, along with the T vs. mV slopes at the measured temperature and the reference junction temperature.

Now, with no information that indicates otherwise, we should assume that the error from the readout is equally likely to be anywhere within the specification—that is, it follows a uniform distribution. To be able to compare and combine uncertainty components, they must all be stated as standard deviations. To convert the spec of the readout (now in terms of temperature) to an equivalent standard deviation, we divide by  $\sqrt{3}$ , which makes  $0.0025\text{ }^\circ\text{C}$  for the PRT readout example above.

## Combining uncertainties

With a list of uncertainties, we can now combine them to get the uncertainty of our calibration system. The easiest way to combine them would be to simply add them up. However, this would give us a number that is probably much larger than the actual uncertainty. If our uncertainty components are independent, the correct way to combine them is using the root-sum-squares formula:

$$u(\text{system}) = \sqrt{u_a^2 + u_b^2 + u_c^2 + \dots}$$

This will give us the best estimate of the standard deviation of the total error in our calibration system. But then we'll want to apply a *coverage factor*. We don't want the error in our system to be within our limits just *some* of the time, but we'd rather it be within the limits *most* of the time. So we would multiply the standard uncertainty by a coverage factor  $k$ , such as  $k=2$ , to give an *expanded uncertainty*. The components of uncertainty and the resulting expanded uncertainty for a typical PRT calibration system are shown in the table below.

## Uncertainties for a PRT calibration system, at $420\text{ }^\circ\text{C}$

Reference SPRT calibration	0.0030 $^\circ\text{C}$
Reference SPRT stability	0.0005 $^\circ\text{C}$
Thermometer readout, SPRT	0.0025 $^\circ\text{C}$
Thermometer readout, PRT	0.0025 $^\circ\text{C}$
Bath uniformity	0.0025 $^\circ\text{C}$
Immersion effects	0.0015 $^\circ\text{C}$
Thermal (bath stability) and electrical noise	0.0006 $^\circ\text{C}$
Process variability	0.0030 $^\circ\text{C}$
Combined and expanded uncertainty, $k=2$	0.0126 $^\circ\text{C}$

For further information on evaluating uncertainty, recommended sources are ISO *Guide to the Expression of Uncertainty in Measurement* or ANSI/NCSLI *U.S. Guide to the Expression of Uncertainty in Measurement* and ISO/IEC 17025. You might also consider attending one of our seminars, where we spend time discussing uncertainty in measurements and allow you to have all your questions answered.

# International Temperature Scale of 1990 (ITS-90) quick reference

## ITS-90 fixed point chart (Table 1)

$T_{90}$  refers to ITS-90 temperature. For the official text and defining equations of the ITS-90 go to [www.BIPM.org](http://www.BIPM.org).

$W_{T90}$  is the ratio of the value of a probes resistance at one temperature to its resistance at the triple point of water.

$$W_{T90} = \frac{R(T_{90})}{R(0.010^{\circ}C)}$$

$R(T_{90})$  = Probe resistance at temperature  $T_{90}$

$W_{T90}$  = resistance ratio at temperature  $T_{90}$

$R(0.010^{\circ}C)$  = Resistance at the triple point of water ( $R_{TPW}$ )

PT100 refers to a platinum resistance thermometer with a nominal resistance at the triple point of water of 100  $\Omega$ ; PT.25 refers to an SPRT with a nominal resistance of 0.25  $\Omega$  at the triple point of water

## ITS-90 subrange chart (Table 2)

$\Delta W$  = Deviation of resistance ratio from the ITS-90 Reference function

$$\Delta W(T) = W_{T90}(T) - W_{ITS-90Ref}(T)$$

The ITS-90 uses two reference function equations for platinum resistance thermometers. One for the above zero subranges and one for below zero. Subrange 5 extends across both reference functions.

Table 1 ITS-90 fixed point chart

Substance	$T_{90}$		Resistance ( $\Omega$ )						$W_{T90}$ (ratio)
	$^{\circ}C$	K	$\alpha=0.00385$			$\alpha=0.003926$			ITS-90 Reference Function
			PT100	PT100	PT25	PT10	PT2.5	PT.25	
Argon Triple Point	-189.3442	83.8058	23.11	21.59	5.40	-	-	-	0.21585975
Mercury Triple Point	-38.8344	234.3156	84.73	84.41	21.10	-	-	-	0.84414211
Water Triple Point	0.010	273.1600	100.00	100.00	25.00	10.00	2.50	0.25	1.00000000
Gallium Melting Point	29.7646	302.9146	111.58	111.81	27.95	11.18	2.80	0.28	1.11813889
Indium Freezing Point	156.5985	429.7485	159.79	160.98	40.25	16.10	4.02	0.40	1.60980185
Tin Freezing Point	231.928	505.0780	187.54	189.28	47.32	18.93	4.73	0.47	1.89279768
Zinc Freezing Point	419.527	692.6770	253.80	256.89	64.22	25.69	6.42	0.64	2.56891730
Aluminum Freezing Point	660.323	933.4730	332.89	337.60	84.40	33.76	8.44	0.84	3.37600860

Table 2 ITS-90 subrange chart

Subrange	Temperature Range	Coefficients	ITS-90 Fixed Points	Calibration equation (deviation function)
4	-189.3442 to 0.01 $^{\circ}C$	$a_4, b_4$	Argon, Mercury, Water	$\Delta W = a_4(W-1) + b_4(W-1)\ln(W)$
5	-38.8344 to 29.7646 $^{\circ}C$	$a_5, b_5$	Mercury, Water, Gallium	$\Delta W = a_5(W-1) + b_5(W-1)^2$
6	0 $^{\circ}C$ to 961.78 $^{\circ}C$	$a_6, b_6, c_6, d_6$	Water, Tin, Zinc, Aluminum, Silver	$\Delta W = a_6(W-1) + b_6(W-1)^2 + c_6(W-1)^3 + d_6[W(T) - W(660.323^{\circ}C)]^2$ , $d_6 = 0$ when $T < 660.323^{\circ}C$
7	0 $^{\circ}C$ to 660.323 $^{\circ}C$	$a_7, b_7, c_7$	Water, Tin, Zinc, Aluminum	$\Delta W = a_7(W-1) + b_7(W-1)^2 + c_7(W-1)^3$
8	0 $^{\circ}C$ to 419.527 $^{\circ}C$	$a_8, b_8$	Water, Tin, Zinc	$\Delta W = a_8(W-1) + b_8(W-1)^2$
9	0 $^{\circ}C$ to 231.928 $^{\circ}C$	$a_9, b_9$	Water, Indium, Tin	$\Delta W = a_9(W-1) + b_9(W-1)^2$
10	0 $^{\circ}C$ to 156.5985 $^{\circ}C$	$a_{10}$	Water, Indium	$\Delta W = a_{10}(W-1)$
11	0 $^{\circ}C$ to 29.7646 $^{\circ}C$	$a_{11}$	Water, Gallium	$\Delta W = a_{11}(W-1)$

# PRT temperature vs. resistance table

## How to use this chart to calculate equivalent temperature accuracy

A PRT readout's accuracy is specified in ohms. The equivalent temperature accuracy depends on both the resistance and temperature sensitivity of the PRT at temperature (T). Use this chart to estimate PRT resistance and sensitivity, for specific temperatures and PRT types. First, select the row (T) with the temperature you are interested in and the columns with the desired PRT type. For each PRT type, the first column contains the PRT resistance reading at specified temperatures and the second column contains the associated temperature sensitivity. Readout resistance accuracy at a specified temperature depends on the resistance reading of the PRT, found in the first column for each PRT type. Equivalent temperature accuracy depends on the resistance

accuracy and also the sensitivity (dR/dT) found in column two for each PRT type. First, calculate resistance accuracy and then divide by the PRT temperature sensitivity (dR/dT) to convert accuracy from units of resistance to units of temperature.

**EXAMPLE:** The Black Stack 2560 module has an accuracy of 25 ppm and model 5626 is a PT100 (100 Ω PRT) meeting the platinum purity requirements of the ITS-90 ( $\alpha = 0.003926$ ).

From the table: at 600 °C, a PT100 with  $\alpha = 0.003926$  would have resistance close to 318.04 and its sensitivity would be 0.33 Ω/°C, so the equivalent temperature accuracy would be calculated:  

$$= \pm (25\text{ppm})(\text{resistance})/(\text{sensitivity})$$

$$= \pm (25\text{ppm})(318.04)/(0.33 \text{ } \Omega/\text{ } ^\circ\text{C}) = (25/1000000)(318.04)/(0.33)$$

$$= \pm 0.024 \text{ } ^\circ\text{C}.$$

T	PT100 $\alpha=0.00385$		PT100 $\alpha=0.003926$		PT25 $\alpha=0.003926$		PT10 $\alpha=0.003926$		ITS-90 Reference Function	
	R	dR/dT	R	dR/dT	R	dR/dT	R	dR/dT	W	dW/dT
-200	18.52	0.43	16.98	0.43	4.24	0.11			0.16975189	0.00430
-180	27.10	0.43	25.64	0.43	6.41	0.11			0.25642164	0.00434
-160	35.54	0.42	34.26	0.43	8.57	0.11			0.34263838	0.00428
-140	43.88	0.41	42.76	0.42	10.69	0.11			0.42764804	0.00422
-120	52.11	0.41	51.15	0.42	12.79	0.10			0.51154679	0.00417
-100	60.26	0.41	59.45	0.41	14.86	0.10			0.59454082	0.00413
-80	68.33	0.40	67.68	0.41	16.92	0.10			0.67679040	0.00410
-60	76.33	0.40	75.84	0.41	18.96	0.10			0.75839970	0.00407
-40	84.27	0.40	83.94	0.40	20.99	0.10			0.83943592	0.00404
-20	92.16	0.39	91.99	0.40	23.00	0.10			0.91994588	0.00401
0	100.00	0.39	100.00	0.40	25.00	0.10	10.00	0.040	0.99996011	0.00399
20	107.79	0.39	107.95	0.40	26.99	0.10	10.79	0.040	1.07948751	0.00396
40	115.54	0.39	115.85	0.39	28.96	0.10	11.59	0.039	1.15853017	0.00394
60	123.24	0.38	123.71	0.39	30.93	0.10	12.37	0.039	1.23709064	0.00392
80	130.90	0.38	131.52	0.39	32.88	0.10	13.15	0.039	1.31517094	0.00389
100	138.51	0.38	139.28	0.39	34.82	0.10	13.93	0.039	1.39277281	0.00387
120	146.07	0.38	146.99	0.38	36.75	0.10	14.70	0.038	1.46989789	0.00384
140	153.58	0.37	154.65	0.38	38.66	0.10	15.47	0.038	1.54654781	0.00382
160	161.05	0.37	162.27	0.38	40.57	0.09	16.23	0.038	1.62272420	0.00380
180	168.48	0.37	169.84	0.38	42.46	0.09	16.98	0.038	1.69842880	0.00377
200	175.86	0.37	177.37	0.37	44.34	0.09	17.74	0.037	1.77366331	0.00375
220	183.19	0.37	184.84	0.37	46.21	0.09	18.48	0.037	1.84842945	0.00373
240	190.47	0.36	192.27	0.37	48.07	0.09	19.23	0.037	1.92272884	0.00370
260	197.71	0.36	199.66	0.37	49.91	0.09	19.97	0.037	1.99656298	0.00368
280	204.90	0.36	206.99	0.37	51.75	0.09	20.70	0.037	2.06993313	0.00366
300	212.05	0.36	214.28	0.36	53.57	0.09	21.43	0.036	2.14284029	0.00363
320	219.15	0.35	221.53	0.36	55.38	0.09	22.15	0.036	2.21528514	0.00361
340	226.21	0.35	228.73	0.36	57.18	0.09	22.87	0.036	2.28726797	0.00359
360	233.21	0.35	235.88	0.36	58.97	0.09	23.59	0.036	2.35878867	0.00357
380	240.18	0.35	242.98	0.35	60.75	0.09	24.30	0.035	2.42984670	0.00354
400	247.09	0.34	250.04	0.35	62.51	0.09	25.00	0.035	2.50044110	0.00352
420	253.96	0.34	257.06	0.35	64.26	0.09	25.71	0.035	2.57057048	0.00350
440	260.78	0.34	264.02	0.35	66.01	0.09	26.40	0.035	2.64023304	0.00347
460	267.56	0.34	270.94	0.34	67.74	0.09	27.09	0.034	2.70942664	0.00345
480	274.29	0.34	277.81	0.34	69.45	0.09	27.78	0.034	2.77814885	0.00342
500	280.98	0.33	284.64	0.34	71.16	0.08	28.46	0.034	2.84639697	0.00340
520			291.42	0.34	72.85	0.08	29.14	0.034	2.91416813	0.00338
540			298.15	0.34	74.54	0.08	29.81	0.034	2.98145939	0.00335
560			304.83	0.33	76.21	0.08	30.48	0.033	3.04826779	0.00333
580			311.46	0.33	77.86	0.08	31.15	0.033	3.11459044	0.00330
600			318.04	0.33	79.51	0.08	31.80	0.033	3.18042462	0.00328
700							35.02	0.032	3.50219482	0.00316
800							38.12	0.030	3.81156573	0.00303
900							41.09	0.029	4.10872717	0.00291
1000							43.94	0.028	4.39418009	0.00280



# Thermocouple EMF and sensitivity chart

## How to use this chart to calculate equivalent temperature accuracy

Thermocouple readout accuracy is specified in either millivolts (mV) or microvolts (µV). Equivalent temperature accuracy depends on both the voltage and temperature sensitivity of the thermocouple at temperature (T). Use this chart to estimate thermocouple voltage and sensitivity, for specific temperatures and thermocouple types. First, select the row (T) with the temperature you are interested in and the columns for the desired thermocouple type. The first column contains the thermocouple voltage reading (µV) and the second column contains the sensitivity. Equivalent temperature accuracy depends on the readout's voltage accuracy and also the thermocouple sensitivity (dV/dT) found in column two for each thermocouple type. First, calculate readout voltage accuracy then divide by the thermocouple temperature sensitivity (dV/dT) to convert to units of temperature.

**EXAMPLE 1:** The Black Stack 2565 module has an accuracy of ± 0.002 mV (the same as ± 2 µV). For a Type K thermocouple at 600 °C the sensitivity is 43 µV/°C, so the equivalent temperature accuracy would be calculated: ± 2 µV/(43 µV/°C) = ± 0.047 °C.

**EXAMPLE 2:** The Black Stack 2565 module reference junction compensation (RJC) is ± 0.05 °C. When RJC is used, multiply the RJC accuracy by the thermocouple sensitivity at room temperature. Then divide the result by the thermocouple sensitivity at the measurement temperature. From the chart a Type K thermocouple's sensitivities are 40 µV/°C at 25 °C (room temperature) and 43 µV/°C at 600 °C. Then, for a measurement at 600 °C the RJC effect on measurement accuracy is: (± 0.05 °C)(40)/(43)= ± 0.047 °C.

This number should be combined with the result from example 1 by root sum squares for a total readout measurement accuracy of ±0.066 °C.

T (°C)	T		J		E		K		N		R		S		B	
	µV	µV/°C	µV	µV/°C	µV	µV/°C	µV	µV/°C	µV	µV/°C	µV	µV/°C	µV	µV/°C	µV	µV/°C
-200	-5603.0	15.7	-7890.5	21.7	-8824.6	25.0	-5891.4	15.2	-3990.4	9.9						
-150	-4648.5	22.3	-6499.8	33.0	-7279.3	36.1	-4912.7	23.5	-3336.3	16.0						
-100	-3378.6	28.3	-4632.5	41.0	-5237.2	45.1	-3553.6	30.4	-2406.8	20.9						
-50	-1819.0	33.8	-2431.3	46.6	-2787.2	52.5	-1889.4	35.8	-1268.6	24.3	-226.5	3.7	-235.6	3.9		
0	0.0	38.7	0.0	50.4	0.0	58.6	0.0	39.4	0.0	26.1	0.0	5.3	0.0	5.4		
25	992.0	40.6	1277.3	51.7	1495.1	60.9	1000.2	40.5	658.6	26.8	140.6	5.9	142.6	6.0		
50	2035.7	42.8	2585.3	52.8	3047.6	63.2	2023.1	41.2	1339.8	27.7	296.5	6.5	298.9	6.5		
100	4278.5	46.7	5268.9	54.4	6318.9	67.5	4096.2	41.4	2774.1	29.6	647.4	7.5	645.9	7.3		
150	6704.1	50.1	8009.9	55.2	9788.8	71.1	6138.3	40.3	4301.8	31.4	1041.0	8.2	1029.4	8.0		
200	9288.1	53.1	10778.7	55.5	13421.3	74.0	8138.5	40.0	5913.4	33.0	1468.6	8.8	1440.8	8.5		
250	12013.4	55.8	13555.2	55.5	17180.6	76.2	10153.4	40.7	7597.0	34.3	1923.4	9.3	1873.6	8.8		
300	14861.9	58.1	16327.2	55.4	21036.2	77.9	12208.6	41.4	9341.2	35.4	2400.6	9.7	2323.0	9.1		
350	17818.7	60.1	19090.5	55.2	24964.4	79.1	14293.1	41.9	11136.2	36.3	2896.2	10.1	2785.8	9.4		
400	20872.0	61.8	21848.1	55.2	28946.0	80.0	16397.1	42.2	12973.7	37.1	3407.7	10.4	3259.4	9.6		
450			24610.1	55.4	32964.7	80.6	18515.8	42.5	14846.4	37.8	3933.1	10.6	3742.2	9.7		
500			27392.6	56.0	37005.4	80.9	20644.3	42.6	16747.9	38.3	4471.3	10.9	4233.3	9.9		
550			30216.1	57.0	41052.8	80.9	22776.4	42.6	18672.0	38.7	5021.5	11.1	4732.2	10.1		
600			33102.4	58.5	45093.4	80.7	24905.5	42.5	20613.1	39.0	5583.5	11.4	5238.7	10.2		
650			36070.7	60.3	49115.7	80.2	27024.9	42.3	22566.2	39.1	6157.2	11.6	5753.0	10.4		
700			39131.8	62.1	53112.4	79.7	29129.0	41.9	24526.7	39.3	6742.7	11.8	6275.2	10.5		
750			42280.5	63.7	57080.1	79.1	31213.5	41.5	26490.5	39.3	7340.3	12.1	6805.8	10.7		
800			45494.4	64.6	61017.4	78.4	33275.4	41.0	28454.5	39.3	7949.8	12.3	7345.0	10.9		
850			48714.9	64.0	64921.8	77.7	35313.1	40.5	30415.6	39.2	8571.4	12.5	7892.8	11.0		
900			51877.3	62.5	68786.6	76.8	37325.9	40.0	32371.3	39.0	9204.9	12.8	8449.2	11.2	3956.9	8.4
950			54955.8	60.7	72602.7	75.8	39313.5	39.5	34318.8	38.9	9849.8	13.0	9014.1	11.4	4386.8	8.8
1000			57953.4	59.3	76372.8	75.2	41275.6	39.0	36255.5	38.6	10506.0	13.2	9587.1	11.5	4834.3	9.1
1050			60890.3	58.3			43211.2	38.4	38179.0	38.3	11172.8	13.4	10168.0	11.7	5298.8	9.5
1100			63792.2	57.8			45118.7	37.9	40086.6	38.0	11849.6	13.6	10756.5	11.8	5779.5	9.8
1150			66679.0	57.6			46995.5	37.2	41976.4	37.6	12535.2	13.8	11351.1	11.9	6275.6	10.1
1200			69553.2	57.2			48838.2	36.5	43846.4	37.2	13228.0	13.9	11950.5	12.0	6786.4	10.4
1250							50643.9	35.7	45693.9	36.7	13926.3	14.0	12553.6	12.1	7311.0	10.6
1300							52410.3	34.9	47512.8	36.0	14628.7	14.1	13159.1	12.1	7848.2	10.9
1350							54137.7	34.2			15333.8	14.1	13765.8	12.1	8397.1	11.1
1400							54886.4	33.9			16040.1	14.1	14372.6	12.1	8956.2	11.3
1450											16746.2	14.1	14978.3	12.1	9524.1	11.4
1500											17450.7	14.1	15581.7	12.0	10099.1	11.6
1550											18152.1	14.0	16181.6	12.0	10679.3	11.6
1600											18848.9	13.9	16776.8	11.9	11263.0	11.7
1650											19539.8	13.7	17366.3	11.7	11848.1	11.7
1700											20221.7	13.5	17947.3	11.5	12432.5	11.7
1750											20877.0	12.7	18503.3	10.7	13014.3	11.6
1800															13591.3	11.5

# The *Black Stack* thermometer readout



- Reads SPRTs, RTDs, thermistors, and thermocouples
- Any configuration you like up to eight modules
- High-accuracy reference thermometer (to  $\pm 0.0013\text{ }^{\circ}\text{C}$ )
- Automates precision data acquisition

Hart's *Black Stack* thermometer has established itself as one of the most versatile, cost-effective, and accurate readouts in the world.

Nothing about this instrument says ordinary. Traditionally, thermometers were square boxes configured to do one particular job—such as read a calibrated PRT. However, if you also wanted to measure thermistors, you had to buy another instrument that could do this specific task. Some thermometers can do multiple jobs, but they're expensive, complex, and difficult to use. You're paying for functions you don't need and may never use. The *Black Stack* solves these problems and more.

The 1560 *Black Stack* can be any kind of thermometer you want it to be, and it works in three distinctive ways.

It's a reference thermometer with a NIST traceable calibration; it's an automated calibration system reading your reference probe and sensors you're testing;

or it's a high-accuracy data acquisition system. And it does these functions better than any other thermometer currently on the market.

The *Stack* consists of up to eight different modules that fit together to do any type of thermometry you choose. You can buy all of them, or any combination of them, and change the *Stack* and its functions anytime you want. Each module stacks behind the preceding one, and when you add a module, the *Stack's* software automatically reconfigures itself to include all of the new functions supplied by that module. There's nothing to take apart. No boards need to be installed. There's no software to load, and nothing has to be calibrated. Just stack a new module onto the back of the previous modules and you're ready to use the *Black Stack* and all of its remarkable features.

Hart's 9935 LogWare II makes the *Black Stack* an even more powerful data

acquisition tool. LogWare II provides graphical and statistical analysis of each channel you're measuring (up to 96 with the *Black Stack*). And with alarms that can be customized, delayed start times, and selectable logging intervals, LogWare II turns the *Black Stack* into the most powerful temperature data acquisition tool on the market. (See page 101.)

## The base unit

The *Stack* starts with a base module. It consists of two parts: a display with the main processor and a power supply. The base module supplies power, communication management, and software coordination for all of the other modules. It has the display, control buttons, and RS-232 port built-in.

Each base module can handle eight thermometer modules stacked behind it with a maximum of 96 sensor inputs. The base module never needs calibration and performs its own diagnostic self-test each time it powers up. The thermometer characteristics of each base module are defined by the thermometry modules stacked behind it.



# The *Black Stack* thermometer readout

## The modules

There are nine thermometry modules: an SPRT module, a high-temp PRT module, a PRT scanner module, a standards thermistor module, a thermocouple scanner module, a thermistor scanner module, a precision thermocouple module, and two 1000-ohm PRT modules.

Each module has its own processor and connects to the stack on a proprietary digital bus. Each retains its own calibration data and performs all analog measurement functions within the module.

### SPRT module 2560

The SPRT module reads 10-ohm, 25-ohm, and 100-ohm four-wire RTDs, PRTs, and SPRTs with very high accuracy. It turns the *Stack* into a first-rate reference thermometer with an accuracy to  $\pm 0.005$  °C.

The 2560 has two input channels so you can collect data with two reference sensors, or you can do comparison calibrations of one sensor against a calibrated reference sensor.

Temperature conversion features include direct resistance measurement, ITS-90, W(T90), IPTS-68, Callendar-Van Dusen, or an RTD polynomial conversion. The user-changeable default values for the CVD conversion fit the 100-ohm, 0.00385 ALPHA sensor described by IEC-751.

The SPRT modules can be used one at a time or combined together in any combination for reading up to 16 different reference thermometers. If you stack an SPRT module with a scanner module, you can test multiple sensors against your reference. Unlike other competitive instruments, our PRT Scanner Module operates with or without the two-channel SPRT module. If you can think of a way to use a reference thermometer, you can do it with the *Stack*.

### High-temp PRT module 2561

This module reads 2.5-ohm and 0.25-ohm four-wire HTPRTs and RTDs. The complete resistance range covers up to 5-ohm sensors with applications as high as 1200 °C. The temperature conversion features are the same as for the SPRT module, and like the SPRT module, the connectors are gold plated.

### PRT scanner 2562

This module reads eight channels of two-, three-, or four-wire 100-ohm PRTs or RTDs. The accuracy is  $\pm 0.01$  °C at 0 °C for calibration of industrial sensors. The common industrial RTD can be read with the default values in the CVD temperature



Each module connects and disconnects easily from the Black Stack with just two screws.

conversion for fast setup of industrial applications, or you can enter individual probe constants for higher accuracy data acquisition.

### Standards thermistor module 2563

Special low-drift thermistors are becoming increasingly popular as reference probes in applications with modest temperature ranges up to 100 °C. This module has a temperature accuracy of  $\pm 0.0013$  °C at 0 °C with a resolution of 0.0001 °C.

The 2563 Thermistor Module has two input channels. It displays direct resistance in ohms or converts directly to a temperature readout using either the Steinhart-Hart equation or a higher-order polynomial.

### Thermistor scanner module 2564

This module is usable with any type of thermistor but has eight channels instead of the two channels found on the Standards Thermistor Module and operates with or without the Standards Thermistor Module. This module's accuracy is  $\pm 0.0025$  °C at 0 °C for all eight channels.

The eight channels make the 2564 module an excellent data acquisition tool. It can be used in research work or for verification of biomedical equipment such as DNA sequencing apparatus.

### Precision thermocouple module 2565

This precision thermocouple module reads any type of thermocouple, including type S platinum thermocouples and gold-platinum thermocouples for standards work. This two-channel module has internal reference junction compensation, or you can use an external source for even greater accuracy.

All the standard ANSI thermocouple types are preprogrammed; however, you can choose a conversion method and then

enter the probe characteristics of your sensor, creating a system-calibrated channel. The 2565 module accepts up to three calibration points for error adjustment in the individual sensor.

A polynomial interpolation function calculates the points between your measurements.

Type R, type S, and gold-platinum conversions accept complete polynomial calibration coefficients. Additionally, a thermocouple conversion function calculates temperature by interpolating from a table. You enter the temperature in degrees C and the corresponding voltage for your specific sensor from 1 to 10 temperatures. Interpolation is performed between the entered points.

### Thermocouple scanner module 2566

This module has 12 channels and reads K, J, T, S, R, B, E, and N thermocouples. (Support for C and U type thermocouples is available. Download the application note *Using Hart Readouts with Tungsten-Rhenium and other Thermocouples* from [www.hartscientific.com](http://www.hartscientific.com).) Each channel can be set to read a different type of thermocouple. All temperature readings are performed in exactly the same manner as with the 2565 module.

The connectors on the scanner module are special dual connectors that accept both the common miniature and standard thermocouple connectors. If you want to use screw terminals, use the appropriately-sized connector with the hood removed.

### 1000-ohm PRT modules 2567 and 2568

For 1000-ohm PRTs, these modules provide all the same great features as the 2560 and 2562 Modules. The



# The *Black Stack* thermometer readout



The *Black Stack* is the perfect foundation to build a totally automated calibration system with Hart heat sources and 9938 MET/TEMP II software (see page 97). No programming or system design nightmares.

two-channel 2567 Module has a resistance range of 0 to 4000 ohms and is accurate to  $\pm 0.006$  °C at 0 °C. The 2568 Module reads up to eight 1000-ohm PRTs and at 0 °C is accurate to  $\pm 0.01$  °C. Don't use an ohmmeter or multimeter to read your 1000-ohm PRTs when you can use a *Black Stack* loaded with convenient temperature functions.

## Extended communications module 3560

Need more communications options? The 3560 module adds an IEEE-488 (GPIB) interface, a Centronics printer interface, and analog output via a DC signal ( $\pm 1.25$  VDC).

## Features common to all modules

The 1560 *Black Stack* is an incredible thermometer. You buy only the modules you need for the work you are doing. If your work changes, simply order the modules with the functions you need and slip them onto the back of the *Stack*. Your thermometer changes its software, display, and method of operation to match the new functions you've added.

Remember, you never have to open the case to add modules. There's no software to load. It's all automatic.

Each module stores its own calibration internally, so you can add or change modules without recalibrating the whole stack. Module calibration is digital and is performed manually through the base's front panel or over the RS-232 link. If your lab has the capability, you can calibrate modules yourself. If not, send them to us with or without your base unit and we'll

recalibrate them. Hart calibrations are accredited.

The LCD screen has multiple methods of displaying data, including a graphical strip chart recorder. The graphical capability of the *Black Stack* makes testing temperature stability easier than ever. Vertical scaling and graph resolution are automatic.

The *Stack* has high-accuracy, two-channel capability or multi-channel functionality if you need it. Its memory stores the most recent 1000 readings, or you can send your data to your PC through the RS-232 port. Each data point is time and date stamped. An IEEE-488 port is optional.

With the *Black Stack* you can read data almost anyway you like—in ohms, millivolts, or temperature, according to your application and preference.

Remember, this thermometer's calibration is traceable to NIST. Its accuracy is as high as  $\pm 0.0013$  °C, depending on the module and sensor you're using.

## Hey! Why did you make it look like that?!

We get asked this question a lot! There are several reasons for the shape of the *Black Stack*.

When we started the design process on the *Black Stack*, we wanted a unique instrument that was a true technological leap in thermometry. Incremental improvements are okay sometimes, but if you're going to lead the industry, you might as well go out and lead it.

Here are some of the design criteria we started with. The new thermometer had to be capable of transforming itself into any kind of thermometry instrument the customer wanted, and it had to do this without having to open the box, replace boards, or set up anything. All connections needed to be easily accessible from the front of the instrument, with no connectors on the front panel. The front panel had to be easy to read, with all features including programming done on the front panel, and the programming taking advantage of the graphical capability of the display. The software had to be as creative and as versatile as the instrument. It had to be easy to use and, if at all possible, even fun to use. And finally, it had to be very accurate.

The shape of the *Black Stack* facilitates the function and usability of the instrument. And it is unbelievably functional and fun to use.

The only way you'll truly understand what we're talking about is to get one and try it. Hundreds of customers, including many national standards labs, already have it!

# The *Black Stack* thermometer readout

## Specifications

### Model 1560 Base Unit

Power: 100 to 240 V ac, 50 or 60 Hz, nominal; Attachable Modules: up to 8; Display: 4.25 in x 2.25 in LCD graphics, LED backlight, adjustable contrast and brightness; Automatic Input Sequencing: 1 to 96 channels; Communications: RS-232; Non-volatile Memory: channel sequence, probe coefficients; Minimum Sample Time: 2 seconds.

### Extended Communication Module 3560

The Extended Communication Module adds additional communication interface capability to the system. This module includes a GPIB (IEEE-488) interface, Centronics printer interface, and analog output. The GPIB interface connects the 1560 to a GPIB bus. GPIB can be used to control any function of the 1560 and read measurement data. The printer interface allows the 1560 to send measurement data directly to a printer. The analog output sources a DC signal ( $\pm 1.25$  VDC) corresponding to the value of a measurement.

### Resistance modules

Input Channels	Resistance Range	Basic Resistance Accuracy	Resistance Resolution	Temperature Range	Equivalent Temperature Accuracy <sup>†</sup>	Temperature Resolution	Excitation Current
----------------	------------------	---------------------------	-----------------------	-------------------	--	------------------------	--------------------

#### SPRT Module 2560

2	0 $\Omega$ to 400 $\Omega$	$\pm 20$ ppm of reading (0.0005 $\Omega$ at 25 $\Omega$ , 0.002 $\Omega$ at 100 $\Omega$ )	0.0001 $\Omega$	-260 $^{\circ}\text{C}$ to 962 $^{\circ}\text{C}$	$\pm 0.005$ $^{\circ}\text{C}$ at 0 $^{\circ}\text{C}$ $\pm 0.007$ $^{\circ}\text{C}$ at 100 $^{\circ}\text{C}$	0.0001 $^{\circ}\text{C}$	1.0 mA, 1.4 mA
---	----------------------------	--	-----------------	--	--	---------------------------	-------------------

#### High-Temp PRT Module 2561

2	0 $\Omega$ to 25 $\Omega$	$\pm 50$ ppm of reading (0.00013 $\Omega$ at 2.5 $\Omega$ )	0.00001 $\Omega$	0 $^{\circ}\text{C}$ to 1200 $^{\circ}\text{C}$	$\pm 0.013$ $^{\circ}\text{C}$ at 0 $^{\circ}\text{C}$ $\pm 0.018$ $^{\circ}\text{C}$ at 100 $^{\circ}\text{C}$	0.001 $^{\circ}\text{C}$	3.0 mA, 5.0 mA
---	---------------------------	--	------------------	--	--	--------------------------	-------------------

#### PRT Scanner 2562

8	0 $\Omega$ to 400 $\Omega$	$\pm 40$ ppm of reading (0.004 $\Omega$ at 100 $\Omega$ )	0.0001 $\Omega$	-200 $^{\circ}\text{C}$ to 850 $^{\circ}\text{C}$	$\pm 0.01$ $^{\circ}\text{C}$ at 0 $^{\circ}\text{C}$ $\pm 0.014$ $^{\circ}\text{C}$ at 100 $^{\circ}\text{C}$	0.0001 $^{\circ}\text{C}$	1.0 mA, 1.4 mA
---	----------------------------	--	-----------------	--	---	---------------------------	-------------------

#### Standards Thermistor Module 2563

2	0 $\Omega$ to 1 M $\Omega$	$\pm 50$ ppm of reading (0.5 $\Omega$ at 10 K $\Omega$ )	0.1 $\Omega$	-60 $^{\circ}\text{C}$ to 260 $^{\circ}\text{C}$	$\pm 0.0013$ $^{\circ}\text{C}$ at 0 $^{\circ}\text{C}$ $\pm 0.0015$ $^{\circ}\text{C}$ at 75 $^{\circ}\text{C}$	0.0001 $^{\circ}\text{C}$	2 $\mu\text{A}$ , 10 $\mu\text{A}$
---	----------------------------	---	--------------	---	---	---------------------------	---------------------------------------

#### Thermistor Scanner 2564

8	0 $\Omega$ to 1 M $\Omega$	$\pm 100$ ppm of reading (1 $\Omega$ at 10 K $\Omega$ )	0.1 $\Omega$	-60 $^{\circ}\text{C}$ to 260 $^{\circ}\text{C}$	$\pm 0.0025$ $^{\circ}\text{C}$ at 0 $^{\circ}\text{C}$ $\pm 0.003$ $^{\circ}\text{C}$ at 75 $^{\circ}\text{C}$	0.0001 $^{\circ}\text{C}$	2 $\mu\text{A}$ , 10 $\mu\text{A}$
---	----------------------------	--	--------------	---	--	---------------------------	---------------------------------------

#### 1000 $\Omega$ PRT Module 2567

2	0 $\Omega$ to 4 K $\Omega$	$\pm 25$ ppm of reading (0.025 $\Omega$ at 1 K $\Omega$ )	0.001 $\Omega$	-260 $^{\circ}\text{C}$ to 962 $^{\circ}\text{C}$	$\pm 0.006$ $^{\circ}\text{C}$ at 0 $^{\circ}\text{C}$ $\pm 0.009$ $^{\circ}\text{C}$ at 100 $^{\circ}\text{C}$	0.0001 $^{\circ}\text{C}$	1.0 mA, 1.4 mA
---	----------------------------	--	----------------	--	--	---------------------------	-------------------

#### 1000 $\Omega$ PRT Scanner 2568

8	0 $\Omega$ to 4 K $\Omega$	$\pm 40$ ppm of reading (0.04 $\Omega$ at 1 K $\Omega$ )	0.001 $\Omega$	-200 $^{\circ}\text{C}$ to 850 $^{\circ}\text{C}$	$\pm 0.01$ $^{\circ}\text{C}$ at 0 $^{\circ}\text{C}$ $\pm 0.014$ $^{\circ}\text{C}$ at 100 $^{\circ}\text{C}$	0.0001 $^{\circ}\text{C}$	0.1 mA, 0.05 mA
---	----------------------------	---	----------------	--	---	---------------------------	--------------------

### Thermocouple modules

Input Channels	Millivolt Range	Millivolt Accuracy	Millivolt Resolution	Temperature Accuracy, <sup>†</sup> Ext. CJC	Temperature Accuracy, <sup>†</sup> Int. CJC	Temperature Resolution
----------------	-----------------	--------------------	----------------------	---	---	------------------------

#### Precision Thermocouple Module 2565

2	-10 to 100 mV	$\pm 0.002$ mV	0.0001 mV	$\pm 0.05$ $^{\circ}\text{C}$	$\pm 0.1$ $^{\circ}\text{C}$	0.001 $^{\circ}\text{C}$
---	---------------	----------------	-----------	-------------------------------	------------------------------	--------------------------

#### Thermocouple Scanner 2566

12	-10 to 100 mV	$\pm 0.004$ mV	0.0001 mV	$\pm 0.1$ $^{\circ}\text{C}$	$\pm 0.3$ $^{\circ}\text{C}$	0.001 $^{\circ}\text{C}$
----	---------------	----------------	-----------	------------------------------	------------------------------	--------------------------

<sup>†</sup>Temperature accuracy depends on probe type and temperature.

# The *Black Stack* thermometer readout

## Ordering Information

1560	Black Stack Readout Base Unit
2560	SPRT Module, 25 $\Omega$ and 100 $\Omega$ , 2-channel
2561	High-Temp PRT Module, 0.25 $\Omega$ to 5 $\Omega$ , 2-channel
2562	PRT Scanner Module, 8-channel
2563	Standards Thermistor Module, 2-channel
2564	Thermistor Scanner Module, 8-channel
2565	Precision Thermocouple Module, 2-channel
2566	Thermocouple Scanner Module, 12-channel
2567	SPRT Module, 1000 $\Omega$ , 2-channel
2568	PRT Scanner Module, 8-channel, 1000 $\Omega$
3560	Extended Communications Module
9935-S	LogWare II, Multi Channel, Single User
9935-M	LogWare II, Multi Channel, Multi User
9302	Case (holds 1560 and up to five modules)

## Probes

5610-6-X	Thermistor Probe (0.125 in dia x 6 in), 0 $^{\circ}\text{C}$ to 100 $^{\circ}\text{C}$
5610-9-X	Thermistor Probe (0.125 in dia x 9 in), 0 $^{\circ}\text{C}$ to 100 $^{\circ}\text{C}$
5642-X	Standards Thermistor Probe
5615-6-X	Secondary Standard PRT, (0.188 x 6.0 in), -200 to 300 $^{\circ}\text{C}$
5615-9-X	Secondary Standard PRT, (0.188 x 9.0 in), -200 to 420 $^{\circ}\text{C}$
5615-12-X	Secondary Standard PRT, (0.250 x 12.0 in), -200 to 420 $^{\circ}\text{C}$
5626-12-X	Secondary Standard PRT (0.25 in dia x 12 in), 100 $\Omega$ , -200 $^{\circ}\text{C}$ to 661 $^{\circ}\text{C}$
5628-12-X	Secondary Standard PRT (0.25 in dia x 12 in), 25 $\Omega$ , -200 $^{\circ}\text{C}$ to 661 $^{\circ}\text{C}$
5628-15-X	Secondary Standard PRT (0.25 in dia x 15 in), 25 $\Omega$ , -200 $^{\circ}\text{C}$ to 661 $^{\circ}\text{C}$

X = termination. Specify "B" (bare wire), "D" (5-pin DIN for Tweener Thermometers), "G" (gold pins), "I" (INFO-CON for 1521 or 1522 Handheld Thermometers), "J" (banana jacks), "L" (mini spade lugs), "M" (mini banana jacks), or "S" (spade lugs).

See pages 66 to 90 for more probes.

## Spare connector kits

2380-X	Miniature Thermocouple Connector, 12 pcs. (X = TC type. Choose from K, T, J, E, R, S, N, or U)
2381-X	Standard Thermocouple Connector, 12 pcs. (X = TC type. Choose from K, T, J, E, R, S, N, or U)
2382	RTD/Thermistor Connector, 8 pcs. (Fits 2562, 2564, and 2568 modules)

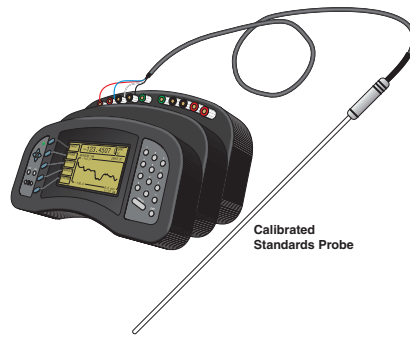

Calibrated Standards Probe

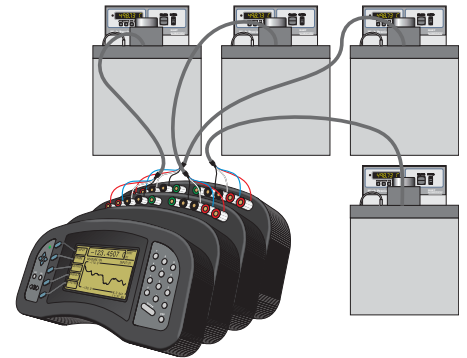

### The Black Stack as a High-Accuracy Reference Thermometer

Use the Black Stack with a calibrated standards probe. Using multiple modules, you can have one instrument read a standards probe in each bath or furnace in your lab.

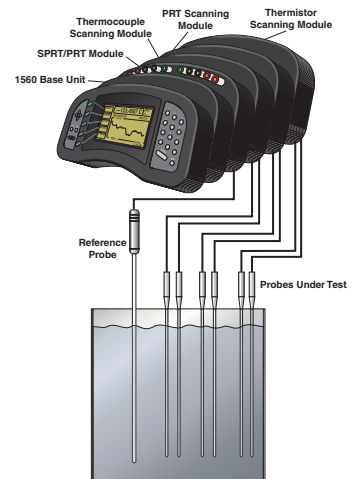
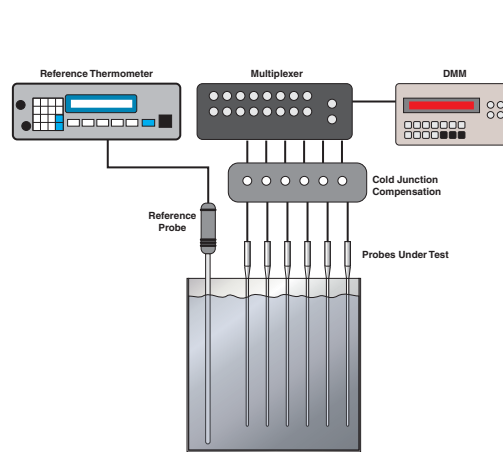

### The Black Stack as an Automated Calibration System

The 1560 reads sensors under calibration. Traditional techniques require a reference thermometer, digital multimeter, scanner, and cold junction compensation for thermocouples. With the Black Stack, one instrument does the whole job.

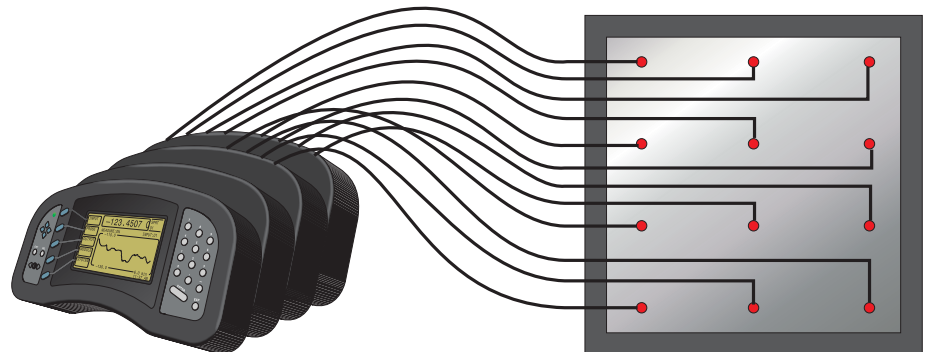

### The Black Stack as a High-Accuracy Data Acquisition System

Use the 1560 in research work or critical production roles. With calibrated probes attached, the 1560 calibrates or verifies the performance of ovens, incubators, DNA sequencers, baths, or process equipment.



# Chub-E4 thermometer readout



- Four channels for PRTs, thermistors, and thermocouples
- Displays eight user-selected data fields from any channel
- Logs up to 8,000 readings with date and time stamps
- Battery provides eight hours of continuous operation

So you need multiple channels, battery power, outstanding accuracy, and the ability to read many different sensor types—but you don't need all the power of a 1 ppm Super-Thermometer. We have the answer for you.

Hart's 1529 Chub-E4 Thermometer gives you four channels, three major sensor types, lab-quality accuracy, and a ton of great features, all at a price you'll love.

## Inputs

The Chub-E4 has four inputs for reading four different sensors simultaneously, and we'll configure those inputs in any of three different ways according to your preference. Choose four channels of thermocouple inputs, four channels of PRT/thermistor inputs, or two channels of each. With this thermometer, reading thermocouples, PRTs, and thermistors accurately from the same device is no problem.

100-ohm, 25-ohm, or 10-ohm PRTs and RTDs are read using ITS-90, IEC-751

(DIN), or Callendar-Van Dusen conversion methods. Typical accuracies include  $\pm 0.004$  °C at  $-100$  °C and  $\pm 0.009$  °C at  $100$  °C. Thermistor readings are converted using the Steinhart-Hart polynomial or standard YSI-400 curve and are as accurate as  $\pm 0.0025$  °C at  $25$  °C with resolution of  $0.0001$  °.

Thermocouple inputs read all the common thermocouple types, including B, E, J, K, N, R, S, T, and Au-Pt, and allow you to choose between internal and external reference junction compensation. Typical accuracy for a type J thermocouple at  $600$  °C is  $\pm 0.35$  °C using internal reference junction compensation and not including the thermocouple. (Support for C and U type thermocouples is available. Download the application note *Using Hart Readouts with Tungsten-Rhenium and other Thermocouples* from [www.hartscientific.com](http://www.hartscientific.com).)

PRTs and thermistors connect easily to the 1529 using Hart's patented mini DWF connectors, which accept bare wire, spade

lug, or mini banana plug terminations. Thermocouples connect using standard or miniature terminations. Measurements are taken each second and can be taken simultaneously or sequentially. A special high-speed mode allows measurements on one channel to be taken at the rate of 10 per second.

## Display

If you think three sensor types and four inputs sounds versatile, wait until you see the display panel on the Chub-E4. Displaying measurements in °C, °F, K, ohms, or millivolts and choosing temperature resolution from 0.01 to 0.0001 are just the beginning.

You can also select any eight items from our long list of displayable data fields to view on-screen. Choose statistical functions such as averages, standard deviations, and spreads; choose probe information such as probe type and serial number; choose T1-T2 functions using inputs from any two channels; or choose utility functions such as the date, time, and battery power level. You can even save up to 10 screen configurations for easy recall.

The push of a single front-panel button also brings up a simple menu system

# Chub-E4 thermometer readout

to easily guide you through all the internal setup and memory options of the 1529. Probe coefficients, sample intervals, communication settings, password settings, and a host of other functions are all easily accessible.

## Communications

The memory and communications capabilities of the Chub-E4 make it perfect for benchtop thermometry, on-site measurements, lab calibration work, and remote data logging. Optional software packages from Hart make this one of the most powerful thermometers on the market.

With battery power and memory to store up to 8,000 measurements (including date and time stamps) at user-selected intervals, the 1529 has plenty of data logging capability. Store 100 individual measurements or any number of automatic log sessions (up to 8,000 readings), each tagged with an identifying session label. Fourteen different logging intervals may be selected, from 0.1 second to 60 minutes.

With Hart's 9935 LogWare II (page 101), data may be quickly downloaded to your PC for complete graphical and statistical analysis. Separate log sessions may even be automatically downloaded to separate files based on session labels. With this software, the 1529 can even be used for real-time data logging. Log four channels at once directly to your PC with virtually no limit to the number of data points you take. You can analyze data, set alarm events, and even set delayed start and stop times.

With MET/TEMP II software, the Chub-E4 may be integrated into a completely automated calibration system. Use one input for your reference thermometer and calibrate up to three other thermometers automatically (see page 97). An RS-232 port is standard on every unit. An IEEE-488 port is optional.

## More great features

Did we forget some aspect of versatility on this thermometer? No!

The 1529 runs on AC power from 100 to 240 volts, DC power from 12 to 16 volts, or off its internal nickel-metal-hydride battery for eight hours between charging. The standard battery charges in less than three hours and lasts through 500 charge/recharge cycles.

If you want to rack-mount your Chub-E4, we've even got a rack-mount kit for you.

This unit fits on your benchtop, in your instrument rack, and even in your hand.

Of course, all the reference thermometers you might need for your 1529 are

available from Hart, including secondary standard PRTs, standard thermistors, and noble-metal thermocouples.



The diagram shows the front panel of the Chub-E4 thermometer. On the left, there is a power switch labeled 'POWER', a battery charging indicator labeled 'CHARGING' with a '1 AMP 14.5-16 V' specification, an RS-232 port, and an optional IEEE-488 port. A label at the bottom left indicates 'FUSES INTERNAL - 1 A T 125 V'. On the right, there are four channels of input terminals labeled 'CHANNEL CONFIGURATION' with sub-labels 'CH1', 'CH2', 'CH3', and 'CH4'. Each channel has two terminals. Below the input terminals are two pairs of banana plug receptacles. The diagram illustrates three different input configurations: 2 PRT/Thermistor and 2 TC or 4 PRT/Thermistor, and Thermocouple receptacles.

Choose from three combinations of inputs: 2 PRT/Thermistor and 2 TC or 4 PRT/Thermistor or 4 TC.

PRTs and thermistors connect easily with Hart's patented mini-DWF connectors, which accept bare wire, spade lug, or banana plug terminations.

The Chub-E4 reads 2-, 3-, or 4-wire PRTs with either 25- or 100-ohm nominal resistance values. A grounding terminal is also included.

Thermocouple receptacles accept both standard and miniature connectors. The Chub-E4 reads thermocouple types B, E, J, K, N, R, S, T, and Au-PT.

# Chub-E4 thermometer readout

Specifications	PRT / RTD	Thermistor	Thermocouple
Inputs	2 channels PRT/thermistor and 2 channels TC, or 4 channels PRT/thermistor, or 4 channels TC, specify when ordering; PRT/thermistor channels accept 2, 3, or 4 wires; TC inputs accept B, E, J, K, N, R, S, T, and Au-Pt TC types. (Support for C and U type thermocouples is available. Download the application note <i>Using Hart Readouts with Tungsten-Rhenium and other Thermocouples</i> from <a href="http://www.hartscientific.com">www.hartscientific.com</a> .)		
Temperature Range	-189 °C to 960 °C	-50 °C to 150 °C	-270 °C to 1800 °C
Measurement Range	0 to 400 Ω	0 to 500 KΩ	-10 to 100 mV
Characterizations	ITS-90, IEC-751 (DIN "385"), Callendar-Van Dusen	Steinhart-Hart, YSI-400	NIST Monograph 175, 3-point deviation function applied to NIST 175, 6th-order polynomial
Temperature Accuracy (meter only)	± 0.004 °C at -100 °C ± 0.006 °C at 0 °C ± 0.009 °C at 100 °C ± 0.012 °C at 200 °C ± 0.018 °C at 400 °C ± 0.024 °C at 600 °C	± 0.0025 °C at 0 °C ± 0.0025 °C at 25 °C ± 0.004 °C at 50 °C ± 0.010 °C at 75 °C ± 0.025 °C at 100 °C	Ext. RJC Int. RJC B at 1000 °C ± 0.6 °C ± 0.6 °C E at 600 °C ± 0.07 °C ± 0.25 °C J at 600 °C ± 0.1 °C ± 0.35 °C K at 600 °C ± 0.15 °C ± 0.4 °C N at 600 °C ± 0.15 °C ± 0.3 °C R at 1000 °C ± 0.4 °C ± 0.5 °C S at 1000 °C ± 0.5 °C ± 0.6 °C T at 200 °C ± 0.1 °C ± 0.3 °C
Temperature Resolution	0.001 °	0.0001 °	0.01 to 0.001 °
Resistance/Voltage Accuracy	0 Ω to 20 Ω: ± 0.0005 Ω 20 Ω to 400 Ω: ± 25 ppm of rdg.	0 Ω to 5 KΩ: ± 0.5 Ω 5 KΩ to 200 KΩ: ± 100 ppm of rdg. 200 KΩ to 500 KΩ ± 300 ppm of rdg.	-10 to 50 mV: ± 0.005 mV 50 to 100 mV: ± 100 ppm of rdg. (Internal RJC: ± 0.25 °C)
Operating Range	16 °C to 30 °C		
Measurement Interval	0.1 second to 1 hour; inputs may be read sequentially or simultaneously at 1 second or greater interval		
Excitation Current	1 mA, reversing	2 and 10 μA, automatically selected	n/a
Display	33 x 127 mm (1.3 x 5 in) backlit LCD graphical display		
Display Units	°C, °F, K, Ω, KΩ, mV		
Data Logging	Up to 8,000 time- and date-stamped measurements can be logged		
Logging Intervals	0.1, 0.2, 0.5, 1, 2, 5, 10, 30, or 60 seconds; 2, 5, 10, 30, or 60 minutes		
Averaging	Moving average of most recent 2 to 10 readings, user selectable		
Probe Connection	Patented DWF Connectors accept mini spade lug, bare-wire, or mini banana plug terminations	Universal receptacle accepts miniature and standard TC connectors	
Communications	RS-232 included, IEEE-488 (GPIB) optional		
AC Power	100–240 V ac, 50–60 Hz, 0.4 A		
DC Power	12–16 VDC, 0.5 A (battery charges during operation from 14.5 to 16V DC, 1.0A)		
Battery	NiMH, 8 hours of operation typical without backlight, 3 hours to charge, 500 cycles		
Size (HxWxD)	102 x 191 x 208 mm (4.0 x 7.5 x 8.2 in)		
Weight	2 kg (4.5 lb)		
Probes from Hart	See pages 66 to 90		
Calibration	Accredited NIST-traceable resistance calibration and NIST-traceable voltage calibration provided		

## Ordering Information

1529	Chub-E4 Thermometer, 2 TC and 2 PRT/Thermistor inputs	2513-1529	Rack-Mount Kit
1529-R	Chub-E4 Thermometer, 4 PRT/Thermistor inputs	9935-S	LogWare II, Multi Channel, Single User
1529-T	Chub-E4 Thermometer, 4 TC inputs	9935-M	LogWare II, Multi Channel, Multi User
2506-1529	IEEE Option	2362	Spare AC Adapter, 15 V
9322	Rugged Carrying Case, holds 1529 and four probes up to 12" long		



# Tweener thermometer readouts



- Two Tweeners to choose from—reading PRTs or thermistors
- Battery packs available
- Best price/performance package

One of Hart's best-selling products is the Tweener thermometer, and there's a reason. No other company, not one, has a thermometer that comes close to the performance and features of the Tweener for anywhere near its price.

## 1502A Tweener PRT Readout

The 1502A Tweener features accuracy up to  $\pm 0.006$  °C (the 1504 is even more accurate, up to  $\pm 0.002$  °C). In addition, it reads 100-ohm, 25-ohm, and 10-ohm probes, has a resolution of 0.001 °C across its entire range, and is the smallest unit in its class. It also has an optional battery pack for completely portable operation.

Each Tweener is programmable to match a probe's constants for maximum linearity and accuracy. All probe constants and coefficients are programmed through simple, front-panel keystrokes. Temperature is displayed in °C, °F, K, or resistance in ohms.

The 1502A accurately measures the resistance of the probe and then converts the resistance to a temperature value using its built-in algorithms.

For convenience, the 1502A reads the common industrial grade IEC-751 or "385" ALPHA RTD without any programming. Enter the actual RO and ALPHA of the individual probe for increased accuracy. For maximum accuracy, use the ITS-90 formulas. The Tweener accepts the subranges 4 and 6 through 11.

ITS-90 formulas reside in the Tweener's firmware. If your probe has been calibrated for any of the above subranges of the ITS-90, you simply enter the coefficients directly into your Tweener.

Each thermometer comes complete with an RS-232 interface for automation of temperature data collection, calibrations, or process control functions. An IEEE-488 interface is available as an option.

The 1502A is calibrated digitally using the front-panel buttons. You never have to open the box to calibrate it. This calibration protocol further reduces the cost of the 1502A. It goes where you go and works the way you want it to.

## 1504 Tweener Thermistor Readout

If you need more accuracy in a limited temperature range, the Model 1504 Tweener gives it to you as a thermistor readout. Thermistors are less fragile than PRTs and less likely to be impacted by mechanical shock. Thermistors are more sensitive to temperature, have faster response times, and come in many shapes for different applications.

Typical accuracy of a 1504 is  $\pm 0.002$  °C with a resolution of 0.0001 °C.

## Software

With our 9934 LogWare, both Tweener models may be used for real-time data acquisition. Collect data and analyze it

graphically or statistically. Additionally, Tweeners may be used as reference thermometers with our MET/TEMP II software. (See our software section starting on page 96.)

## Battery option

If you need to take your work on the road, order Model 9320A battery pack and get 36 hours between charges.

## Calibration choices

Each Tweener and its accompanying probe (sold separately) have their own individual calibration reports. Overall system error can be calculated from the individual errors, rendering the added cost of system data unnecessary. However, for those requiring it, system data is available at two or more temperatures of your choice. (See calibration options on page 186.)



The thermistor version of the "Tweener" gives you more variety in sensor configurations and even higher accuracy over a limited temperature range.

# Tweener thermometer readouts

Specifications	1502A	1504
Temperature Range †	-200 °C to 962 °C (-328 °F to 1764 °F)	Any thermistor range
Resistance Range	0 Ω to 400 Ω, auto-ranging	0 Ω to 1 MΩ, auto-ranging
Probe	Nominal R <sub>TPW</sub> : 10 Ω to 100 Ω RTD, PRT, or SPRT	Thermistors
Characterizations	ITS-90 subranges 4, 6, 7, 8, 9, 10, and 11 IPTS-68: R <sub>0</sub> , α, δ, a <sub>4</sub> , and c <sub>4</sub> Callendar-Van Dusen: R <sub>0</sub> , α, δ, and β	Steinhart-Hart thermistor polynomial Callendar-Van Dusen: R <sub>0</sub> , α, δ, and β
Resistance Accuracy (ppm of reading) (1 yr)	0 Ω to 20 Ω: 0.0005 Ω 20 Ω to 400 Ω: 25 ppm	0 Ω to 5 KΩ: 0.5 Ω 5 KΩ to 200 KΩ: 100 ppm 200 KΩ to 1 MΩ: 300 ppm
Temperature Accuracy †	± 0.004 °C at -100 °C ± 0.006 °C at 0 °C ± 0.009 °C at 100 °C ± 0.012 °C at 200 °C ± 0.018 °C at 400 °C ± 0.024 °C at 600 °C	± 0.002 °C at 0 °C ± 0.002 °C at 25 °C ± 0.004 °C at 50 °C ± 0.010 °C at 75 °C ± 0.020 °C at 100 °C (Using 10 KΩ thermistor sensor, α=0.04. Does not include probe uncertainty or characterization errors.)
Operating Temperature Range—Full Accuracy	16 °C to 30 °C	13 °C to 33 °C
Resistance Resolution	0 Ω to 20 Ω: 0.0001 Ω 20 Ω to 400 Ω: 0.001 Ω	0 Ω to 10 KΩ: 0.01 Ω 10 KΩ to 100 KΩ: 0.1 Ω 100 KΩ to 1 MΩ: 1 Ω
Temperature Resolution	0.001 °C	0.0001 °C
Excitation Current	0.5 and 1 mA, user selectable, 2 Hz	2 and 10 μA, automatically selected
Measurement Period	1 second	
Digital Filter	Exponential, 0 to 60 seconds time constant (user selectable)	
Probe Connection	4-wire with shield, 5-pin DIN connector	
Communications	RS-232 serial standard IEEE-488 (GPIB) optional	
Display	8-digit, 7-segment, yellow-green LED; 0.5-inch-high characters	
Power	115 V ac (± 10 %), 50/60 Hz, 1 A, max 230 V ac (± 10 %), 50/60 Hz, 1 A, nominal, specify	
Size (HxWxD)	61 x 143 x 181mm (2.4 x 5.6 x 7.1 in)	
Weight	1.0 kg (2.2 lb)	
Calibration	Accredited NIST-traceable calibration provided	
Probes from Hart	See pages 68 to 80	See pages 82 to 85

†Temperature ranges and accuracy may be limited by the sensor you use.

## Ordering Information

1502A	Tweener PRT Readout	1935	System Cal Report, Thermistors (see pages 186 to 189)
1504	Tweener Thermistor Readout	1930	System Cal Report, PRT (see pages 186 to 189)
2505	Spare Connector		
2506	IEEE Option		
2508	Serial Cable Kit		
9934-S	LogWare, Single Channel, Single User		<i>See pages 66 to 90 for a selection of probes to use with Tweeners and other Hart readouts.</i>
9934-M	LogWare, Single Channel, Multi User		
9320A	External Battery Pack, 115 V ac		
9301	Carrying Case, fits Tweener and 12 in probe		

# Handheld thermometer readouts



## Finally, a reference thermometer as versatile as you are

The new 1523/24 Reference Thermometers from Fluke's Hart Scientific division measure, graph, and record PRTs, thermocouples, and thermistors. These new thermometer readouts deliver high accuracy, wide measurement range, logging, and trending, all in a handheld tool you can take anywhere.

The 1523/24 lets you handle field applications, laboratory measurements, and data logging with ease. And with the dual channel measurement capabilities of the model 1524, you can do twice the work in half the time.

## Make accurate, consistent measurement...anywhere

You need accuracy for compliance, product yields, energy savings, and consistent results. The 1523/24 uses current reversal, a technique used in high-end instruments that eliminates thermal EMFs, for precision temperature measurements. Specifications are guaranteed from  $-10^{\circ}\text{C}$  to  $60^{\circ}\text{C}$  ambient. Special precision resistors and a highly stable reference voltage source keep 1523/24 accuracy virtually insensitive to environmental temperature.

Like all Fluke handheld tools, the 1523/24 Reference Thermometers endure rigorous testing in temperature extremes and under harsh conditions of vibration, so you can take it with confidence

## Measure, graph and record three sensor types with one tool

### High accuracy

- PRTs: up to  $\pm 0.011^{\circ}\text{C}$
- Thermocouples: up to  $\pm 0.24^{\circ}\text{C}$
- Precision thermistors:  $\pm 0.002^{\circ}\text{C}$

### Two models

- **1523:** Single channel standard model with memory for 25 readings
- **1524:** Two channels: memory for logging 15,000 measurements; real-time clock for time and date stamps

anywhere you need to go. An optional magnetic hanger allows you to hang the thermometer for easy viewing while freeing your hands to focus on the job.

## Monitor trends in the lab or in the field

See trends graphically on the 1523/24 thermometer's 128x64-backlit LCD display. You can change the graph's resolution at the touch of a button. Now it is easy to see when the temperature is stable (without statistics or long delays) or to monitor processes over time to verify correct operation.

Hold readings on the display at the touch of a button, or document up to 25 readings and associated statistics for easy retrieval. Statistics include the average maximum and minimum values, and the standard deviation. View them through the display or by uploading it to a PC via RS-232 connection and 9940 I/O Toolkit software, included free. To monitor and log more data over time, use a PC and optional LogWare II software.

RS-232-to-USB adapters are available for those who prefer USB connectors. Battery power lasts at least 20 hours on three AA batteries, or use the dc power adapter for extended periods of measurement. Power saving features can be enabled or disabled for longer battery life or greater convenience.

## INFO-CON connectors ensure correct temperature conversion

Inside the INFO-CON, a memory chip keeps calibration information for the attached probe. Simply plugging in the



# Handheld thermometer readouts

FLUKE®

Hart Scientific®

## Two models let you make the best choice for your application

### 1523 single-channel thermometer

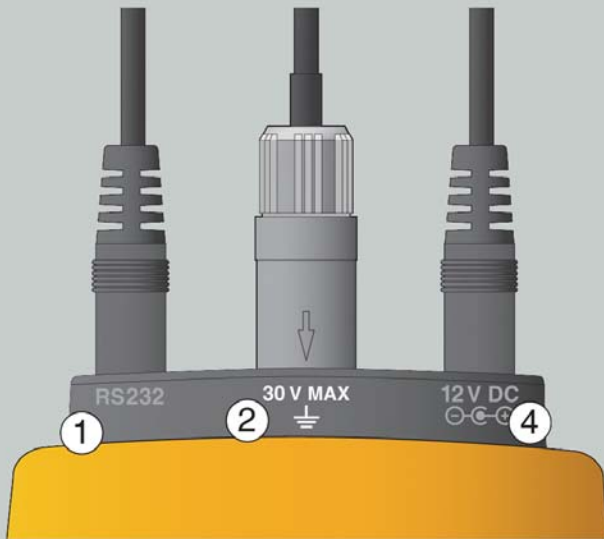

### 1524 two-channel thermometer

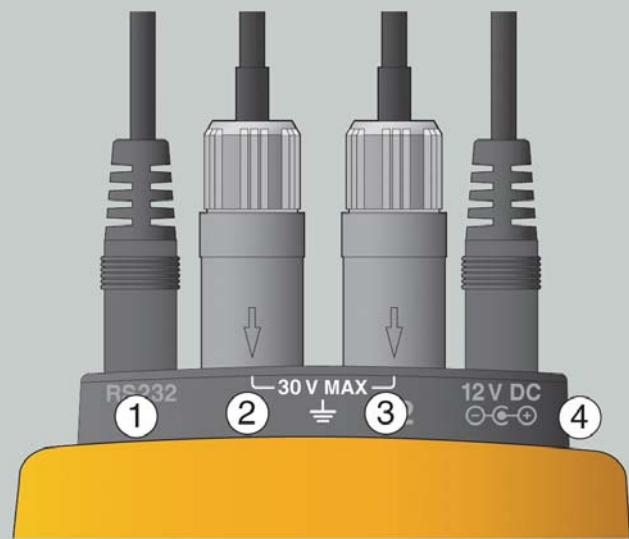

- 1 RS-232 serial interface connector. For PC communications, uploading and downloading data from memory and from the probe INFO-CON connectors.
- 2 Sensor connector (PRT, thermocouple, or thermistor)
- 4 External power adapter connection, for continuous use without changing batteries. Alternatively, 3 AA batteries will last more than 20 hours in the field.

The 1523 Reference Thermometers are versatile single-channel thermometers that measure, graph and record three sensor types with one tool. Support for PRTs/RTDs, thermocouples, and thermistors provide flexibility to choose the right probe for the job.

- 1 RS-232 serial interface connector
- 2 Channel 1 sensor connector (PRT, thermocouple, and thermistor)
- 3 Channel 2 sensor connector (PRT, and thermistor)
- 4 External power adapter connection

The new 1524 Reference Thermometers help you do twice the work in half the time. Two channels and three sensor types and high-speed measurement make you more productive and make model 1524 the one reference thermometer you need to own. It has all the features of the 1523, and it's a data logger too. A real-time clock and memory for 15,000 time and date stamped measurements mean everything you are going to need is in this package. Log up to three times per second, or once every hour or other options in between. Download the data to a PC for analysis when you need it.

probe uploads the information to the readout. The connector transfers this information to the 1523/24 automatically, ensuring the correct temperature conversion for accurate, hassle-free measurements.

Probes may be locked by password to specific channels and readouts for security or for system calibration traceability. Plug any thermocouple with

mini-thermocouple jacks into an optional universal thermocouple adapter for convenient measurement. Each thermocouple adapter or standard connector supports reference junction compensation (RJC) with its own internal precision thermistor.

# Handheld thermometer readouts

Specifications	1523	1524
Input channels	1	2
Resolution	PRTs and thermistors: 0.001 ° thermocouples: 0.01 °	
Logging	25 readings with statistics	25 readings with statistics 15,000 time and date stamped
Sample interval (normal)	1 second	1 second (simultaneous measurement)
Typical sample interval (fast mode)*	0.3 seconds	
Sensor types	PRTs, RTDs, thermistors, and thermocouples	
Thermocouple types	C, E, J, K, L, M, N, T, U, B, R, S	
Statistics	Maximum, minimum, average, standard deviation	
Trending	Scale: ± 10 °C (18 °F), ± 1 °C (1.8 °F), ± 0.1 °C (0.18 °F), ± 0.01 °C (0.018 °F), 10 minutes of real-time data	
Power requirements	3 AA alkaline batteries, 12 V dc universal power supply	
Battery life	20 hr	
Size (HxWxD)	96 mm x 200 mm x 47 mm (3.75 in x 7.9 in x 1.86 in)	
Weight	0.65 kg (1.4 lb)	
Computer interface	RS-232, 9940 I/O ToolKit software included	
Safety	EN61010-1:2001, CAN/CSA C22.2 No. 61010.1-04	
Environmental conditions for best accuracy: 13 °C to 33 °C (55.4 °F to 91.4 °F)		
Millivolt range and accuracy	-10 mV to 75 mV, ± (0.005 % + 5 µV)	
Internal reference junction compensation	± 0.2 °C (± 0.36 °F)	
Resistance range and accuracy	0 Ω to 400 Ω ± (0.004 % + 0.002 Ω) 200 Ω to 50 kΩ ± (0.01 % + 0.5 Ω) 50 kΩ to 500 kΩ ± (0.03 %)	
Temperature coefficient, voltage: -10 °C to 13 °C, +33 °C to 60 °C (14 °F to 55.4 °F, 91.4 °F to 140 °F)	± (0.001 %/°C + 1 mV/°C)	
Temperature coefficient, resistance: -10 °C to 13 °C, +33 °C to 60 °C (14 °F to 55.4 °F, 91.4 °F to 140 °F)	0.0008 %/°C + 0.0004 Ω (0 Ω to 400 Ω) 0.002 %/°C + 0.1 Ω (0 Ω to 50 kΩ) 0.06 %/°C + 0.1 Ω (50 kΩ to 500 kΩ)	
Excitation current, resistance	1 mA (0 Ω to 400 Ω) 10 µA (0 Ω to 50 kΩ) 2 µA (50 kΩ to 500 kΩ)	

\*See technical manual for sample interval details by sensor type and number of inputs.

Accuracies of selected readout/probe combinations (± °C)				
Temperature	5616-12	5615-6	5627A-12	5610-9
-200 °C (-328 °F)	0.014	0.025	0.027	n/a
0 °C (32 °F)	0.021	0.021	0.049	0.009
100 °C (212 °F)	0.027	0.028	0.065	0.03
300 °C (572 °F)	0.040	0.043	0.103	n/a
420 °C (788 °F)	0.050	n/a	0.130	n/a

Includes readout accuracy, probe calibration, and probe drift

Equivalent temperature accuracies for selected sensors derived from primary specifications (Ω, mV)

Temperature, thermocouples		
Type	Range	Measure accuracies
J	-200 °C to 0 °C (-328 °F to 32 °F)	0.52 °C (0.94 °F)
	0 °C to 1200 °C (32 °F to 2192 °F)	0.23 °C (0.41 °F)
T	-200 °C to 0 °C (-328 °F to 32 °F)	0.60 °C (1.08 °F)
	0 °C to 400 °C (32 °F to 752 °F)	0.25 °C (0.45 °F)
K	-200 °C to 0 °C (-328 °F to 32 °F)	± 0.61 °C (± 1.10 °F)
	0 °C to 1370 °C (32 °F to 2498 °F)	± 0.24 °C (± 0.43 °F)
R	-20 °C to 0 °C (4 °F to 32 °F)	± 1.09 °C (± 1.96 °F)
	0 °C to 500 °C (32 °F to 932 °F)	± 0.97 °C (± 1.71 °F)
	500 °C to 1750 °C (932 °F to 3182 °F)	± 0.49 °C (± 0.88 °F)
S	-20 °C to 0 °C (4 °F to 32 °F)	± 1.05 °C (± 1.89 °F)
	0 °C to 500 °C (32 °F to 932 °F)	± 0.95 °C (± 1.71 °F)
	500 °C to 1750 °C (932 °F to 3182 °F)	± 0.56 °C (± 1.01 °F)

Accuracies are based on internal reference junction compensation. Refer to technical manual for greatly improved accuracies using external reference junctions.

Temperature, RTD Ranges, and Accuracies (ITS-90)	
Accuracy ± °C	
± 0.011 at -100 °C	
± 0.015 at 0 °C	
± 0.019 at 100 °C	
± 0.023 at 200 °C	
± 0.031 at 400 °C	
± 0.039 at 600 °C	
Resolution: 0.001 °C (0.001 °F)	

Temperature, Thermistor	
Accuracy ± °C	
± 0.002 at 0 °C	
± 0.003 at 25 °C	
± 0.006 at 50 °C	
± 0.014 at 75 °C	
± 0.030 at 100 °C	
Resolution: 0.001 °C (0.001 °F)	

Based on a 10 kΩ (at 25 °C) thermistor with a beta value of 4000 Ω. See technical manual for details.

# Handheld thermometer readouts

## Ordering Information

<b>1523<sup>†</sup></b>	Reference Thermometer, Handheld, 1 Channel
<b>1524<sup>†</sup></b>	Reference Thermometer, Handheld, 2 Channel, Data Logger
<b>1523-P1</b>	1523 Bundled with 5616 PRT [-200 °C to 420 °C (-328 °F to 788 °F)], NIST Traceable Calibration, 100 ohm, 6.35 mm x 305 mm (1/4 in x 12 in)], Universal TC INFO-CON Connector, TPAK, and Case
<b>1523-P2</b>	1523 Bundled with 5628 PRT [-200 °C to 660 °C (-328 °F to 1220 °F)], Accredited Calibration, 25 ohm, 6.35 mm x 305 mm (1/4 in x 12 in)], Universal TC INFO-CON Connector, TPAK, and Case
<b>1523-P3</b>	1523 Bundled with 5627A PRT [-200 °C to 420 °C (-328 °F to 788 °F)], Accredited Calibration, 100 ohm, 6.35 mm x 305 mm (1/4 in x 12 in)], Universal TC INFO-CON Connector, TPAK, and Case
<b>1524-P1</b>	1524 Bundled with 5616 PRT, Universal TC INFO-CON Connector, TPAK, and Case
<b>1524-P2</b>	1524 Bundled with 5628 PRT, Universal TC INFO-CON Connector, TPAK, and Case
<b>1524-P3</b>	1524 Bundled with 5627A PRT, Universal TC INFO-CON Connector, TPAK, and Case

<sup>†</sup>Requires an optional probe

## Calibration options

<b>1523-CAL</b>	1523 Accredited Calibration
<b>1524-CAL</b>	1524 Accredited Calibration
<b>1929-2</b>	System Verification, PRT with Readout, Accredited
<b>1929-5</b>	System Verification, Thermistor with Readout, Accredited
<b>1930</b>	System Calibration, PRT with Readout, Accredited
<b>1935</b>	System Calibration, Thermistor with Readout, Accredited
<b>1925-A</b>	Accredited Thermistor Calibration, 0 °C to 100 °C (23 °F to 212 °F)

## Included accessories

NIST traceable certificate of calibration, users guide, CD-ROM (contains technical manual), 12 V dc universal power supply, RS-232 cable, 9940 I/O Toolkit software

## Optional accessories

<b>5610-9-P</b>	Probe, Precision Thermistor, Stainless Steel, 3.18 mm x 228.6 mm (1/8 in x 9 in), 0 °C to 100 °C (32 °F to 212 °F), NIST traceable calibration
<b>5615-6-P</b>	Probe, PRT, 100 ohm, 4.76 mm x 152.4 mm (3/16 in x 6 in), -200 °C to 300 °C (-328 °F to 572 °F), Accredited Calibration
<b>5609-9BND-P</b>	Probe, PRT, 100 ohm, 6.35 mm x 381 mm (1/4 in x 15 in), 90° bend at 9 in, -200 °C to 660 °C (-328 °F to 1220 °F), Requires Calibration (i.e. 1924-4-7)
<b>FLK80P1</b>	80PK-1, Probe, Thermocouple, Beaded Type K
<b>FLK80P3</b>	80PK-3A, Probe, Thermocouple, Surface Measurement Type K
<b>9935-S</b>	Software, LogWare II, Single User
<b>1523-CASE</b>	Case, 1523/1524 Readout and Probe Carrying
<b>FLUKETPAK</b>	TPAK, Meter Hanging Kit
<b>2373-LPRT</b>	Adapter, INFO-CON (152X) to Mini Grabbers (4-wire)
<b>2373-LTC</b>	Adapter, INFO-CON (152X) to Universal TC (TC)
<b>2384-P</b>	INFO-CON (152X) Connector, PRT (Gray Cap), Spare
<b>2384-T</b>	INFO-CON (152X) Connector, TC (Blue Cap), Spare

## Recommended Accessories

A wide array of accessories is available to help you maximize productivity, but the following are essential for most users.



Calibrated Temperature Sensors



TPAK Magnetic Hanger



Probe and Readout Case



Universal Thermocouple Adapter



Universal RTD Adapter



# Reference multimeter



- True Ohms measurement
- 20 amp current measurement
- Stores up to 100 PRT coefficients

At last, now there's a meter designed specifically for the measurement challenges faced by metrologists. The Fluke 8508A Reference Multimeter is simply the best you can buy. Not only does it provide the performance required for complex measurement tasks, it is also extremely easy to use. Moreover, it is specified in a way that lets you really understand the uncertainties of the measurements you make.

## Accuracy and stability

The Fluke 8508A features 8.5 digit resolution, exceptional linearity, and extremely low noise and stability, producing superior accuracy specifications as low as 3 ppm over one year. But measurements need to be repeatable, and the 8508A delivers that as well, with 24-hour stability as low as 0.5 ppm and a 20-minute stability of 0.16 ppm. This stability is maintained over a wide operating temperature range and achieved without requiring routine auto-cal or self-calibration, which can compromise measurement traceability and history. What's more, Fluke publishes a detailed 8508A Extended Specifications Brochure on [www.fluke.com](http://www.fluke.com) that specifies in absolute and relative terms, allowing you to replace Fluke's calibration uncertainty with those that represent traceability available locally.

## Functional and versatile

The Fluke 8508A lets you handle a wide range of applications and achieve your measurement requirements with a single instrument. In addition to AC and DC voltage, AC and DC current, resistance and frequency, the 8508A also includes a host of other features designed to increase the range of measurements you can make. True Ohms measurement using current reversal techniques improves the accuracy of your resistance measurements. The PRT temperature readout extends the 8508A's functionality into precision temperature metrology. The Lo Current Ohms feature reduces measurement errors due to self-heating within the device being measured. A dual input channel ratio feature, under GPIB control, enables the 8508A to be used as a simple, fast, automated transfer standard. High current measurement (up to 20 A) extends the operational range to address your multi-product calibrator workload. Up to 200 V compliance on resistance ranges gives you greater scope to measure high resistances with greater accuracy.

## Easy to use

A clear control structure with Dual Paramatrix™ LCD displays and context-sensitive menus provides an intuitive interface that makes the 8508A easy to use.

The menu structures have been designed especially for metrology applications, so you can focus on getting the best possible measurements without needing to work through complex sequential or multi-instrument setups, or having to repeatedly reference supporting documentation.

## Specifications

<b>DC Voltage</b>	0 to $\pm 1050$ V 1 Year Spec: $\pm 3$ ppm of rdg <sup>†</sup>
<b>AC Voltage</b>	2 mV to 1050 V, 1 Hz to 1 MHz 1 Year Spec: $\pm 65$ ppm of rdg <sup>†</sup>
<b>DC Current</b>	0 to $\pm 20$ A 1 Year Spec: $\pm 12$ ppm of rdg <sup>†</sup>
<b>AC Current</b>	2 $\mu$ A to 20 A, 1 Hz to 100 kHz 1 Year Spec: $\pm 200$ ppm of rdg <sup>†</sup>
<b>Resistance</b>	0 to 20 G $\Omega$ , $\pm 7.5$ ppm of rdg
<b>Power</b>	Voltage: 90–130 V or 180–260 V Frequency: 47–63 Hz Consumption: 37 VA
<b>Weight</b>	11.5 kg 25.5 lb(l)
<b>Size (HxWxD)</b>	88 x 427 x 487 mm (3.5 x 16.8 x 19.2 in)

<sup>†</sup>Best guaranteed specification within measurement category.

## Ordering Information

<b>8508A</b>	Reference Multimeter
<b>8508A/01</b>	Reference Multimeter with Front and Rear 4 mm binding posts and rear input ratio measurement
<b>8508ALEAD</b>	Lead kit including two pairs of 1 m six-wire PTFe cable terminated with gold flashed spaces connectors and 4 mm plugs
<b>5626-15-S</b>	Secondary PRT
<b>5699-S</b>	Extended Range PRT
<b>Y8508</b>	Rack-Mount Kit
<b>Y8508S</b>	Rack-Mount Slide Kit

# The DewK thermo-hygrometer



- Superior accuracy
- Network enabled
- Powerful logging and analysis tools
- Two interchangeable calibrated sensors
- Huge memory
- Upgraded software

Two years ago the 1620 DewK revolutionized environmental monitoring for calibration labs, but it just got better. Wait until you hear about the 1620A!

Now you can easily monitor and record conditions throughout your entire facility with the DewK's new Ethernet and wireless connections, and set your upgraded LogWare III software to notify you immediately of changing conditions.

You'll still have the superior convenience, dependability, and NIST-traceable accuracy of a 1620, but your 1620A will give you the added accessibility and peace of mind you've been looking for.

## Accuracy

Two types of sensors are available from Hart, and the DewK may be originally purchased with either one. The high-accuracy sensor ("H" model) reads temperature to  $\pm 0.125$  °C over a calibrated range of 16 °C to 24 °C. Relative humidity readings are to  $\pm 1.5$  % RH from 20 % RH to 70 % RH.

The standard-accuracy sensor ("S" model) reads temperature to  $\pm 0.25$  °C over its calibrated range of 15 °C to 35 °C. Relative humidity readings are to  $\pm 2$  % RH from 20 % RH to 70 % RH.

All DewK sensors come with NVLAP accredited certificates of calibration for both temperature and humidity, complete with data and NIST traceability. Hart provides exceptional uncertainties, including total test uncertainty ratios better than 3:1 for both temperature and relative humidity—even for the high-accuracy sensors!

Both sensors can also measure temperature below their respective calibrated ranges to 0 °C and above their respective calibrated ranges to 50 °C with typical accuracy of  $\pm 0.5$  °C. And RH readings from 0 % RH to 20 % RH and from 70 % RH to 100 % RH are typically within  $\pm 3$  % RH.

## Ethernet and wireless capability

The DewK gives you all the communications options you expect, and then some. With its built-in Ethernet RJ45 jack,

multiple DewKs can be monitored from the same screen using our new LogWare III client-server software. Ethernet also gives you the possibility for remote connectivity over the internet, so you can monitor critical conditions while you're away.

Cables running along the floor can be a safety hazard, and cables hanging from the ceiling and walls are an eyesore. With the DewK, your wireless dreams will come true when you connect your computer through an RF modem up to 100 ft away, without the clutter of all the extra cables!

Finally, if you need a printout, send data to a printer through the RS-232 interface in real time.

## Math and statistical functions

In addition to temperature and humidity, the DewK calculates dew point, heat index, and rates of change for both temperature and humidity, without the need to buy additional software. Min, max, and a variety of other statistics are also calculated and can be shown on-screen. Daily summary statistics, including min, max, and maximum rates of change are stored for the most recent sixty days.

## Calibrated sensors

With the DewK you get two for the price of one. Having inputs for two sensors, each measuring both temperature and relative humidity, one DewK can monitor two locations at the same time. Both sensors can be run via extension cables to remote locations up to 100 feet away, or one sensor can be directly mounted to the top of the DewK.

Each sensor is calibrated for both temperature and humidity at Fluke's Hart Scientific Division. The calibration constants assigned to the sensors reside in a memory chip located inside the sensor housing, so sensors may be used interchangeably between different DewKs, and the recalibration of sensors doesn't require an accompanying DewK.

Sensors may also be assigned a unique identifier (up to 16 characters) to facilitate record keeping by matching the sensor identifier with the collected data. Each DewK ships with one sensor, with additional sensors available from Hart. Spare sensors may also be purchased as a kit, which includes a case for the sensor, a wall mounting bracket, and a 25-foot extension cable.

## Memory

The DewK has enough on-board memory to store up to 400,000 date- and time-stamped data points. That's two years'



# The DewK thermo-hygrometer

worth of data for both measurements from two sensors if readings are taken every ten minutes!

## Alarms and battery backup

Alarm settings can be set up quickly in the DewK based on temperature, the rate of change in temperature, RH, the rate of change in RH, and instrument fault conditions. Alarms can be both visual (flashing display) and audible (beeping). Likewise, alarm settings can be set up and events triggered in LogWare III. The DewK is also equipped with a 0 to 12 volt alarm output that can trigger a process control system.

A backup battery shuts down the DewK's display but maintains measurements for up to 16 hours in the event of a power failure.

## One very cool display

Want to view data from across the room? Want to view data from two temperature and two humidity inputs simultaneously? Want to view data graphically, statistically, or both? At the same time?! The DewK does everything you could want—or at least everything we could think of. Up to sixteen different display setups can be stored and recalled at the touch of a single button. And all 16 can be easily modified, so you get exactly what you want.

## Confidence

Fluke's Hart Scientific Division supplies the world's finest measurement laboratories with world-class temperature standards. We not only measure temperature and humidity better than anybody, we make temperature measurements functional and productive.

Don't compromise on your lab standards. Measure with confidence. Partner with Hart Scientific.

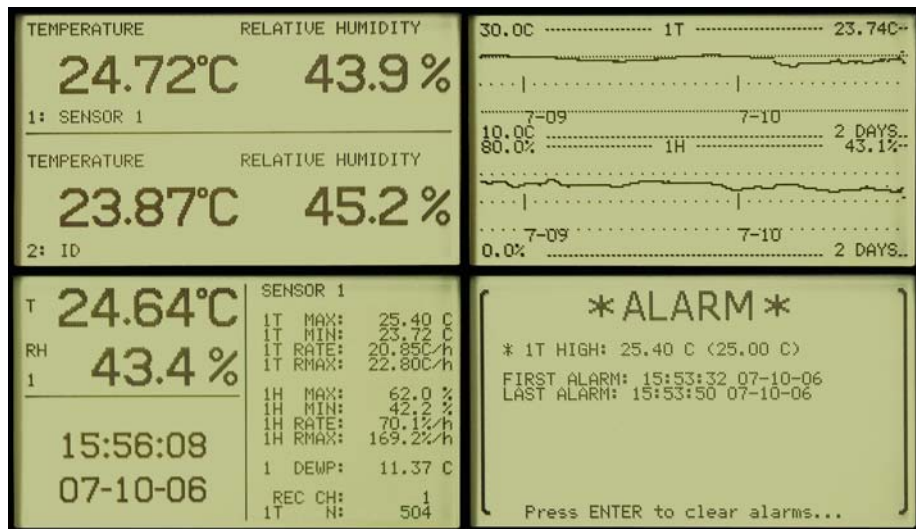

The DewK lets you view data just about any way you like it. Both graphical data and statistical data can be shown for temperature and humidity from one or two inputs. Modifying any of the standard screens is easily done, so you see exactly what you want—no more, no less.

## LogWare III

If you really want to get the most out of your DewK, LogWare III is an investment worth every penny. As client-server or stand-alone software, it remotely monitors and logs an unlimited number of concurrent log sessions into a single database. That means data from many DewKs can be managed in real time via Ethernet, RS-232, or wireless connections.

LogWare III allows you to customize your graph trace color, alarms, and statistics as you go. You can start/stop log sessions and modify sample intervals from your computer.

LogWare III supports "hot-swapping," which allows you to remove and replace sensors without shutting down the log session. LogWare III also supports security features such as passwords for individual users or groups/teams, a built-in administrator account, pre-defined user groups, and customizable permissions.

Never again be the last to know about a problem. Customizable e-mail settings allow you to send e-mails to designated recipients, including cell phones and PDA's, when a log session begins, ends, or is aborted; when the DewK's battery is low; when a sensor calibration is due; or when a temperature/humidity alarm is exceeded.

If you cannot be reached via email, you can always arrange to be paged instead. Data stored on the DewK can be imported into the software, which is a handy feature when power outages disable the network.

Are you ready for a deep dive into your data? Historical data can be viewed by sensor (model/serial number) location, or log session and displayed in a spreadsheet-style grid. Logged data can also be exported to HTML, RTF or ASCII text for use in your analytical software, or simply print historical data and graphs.

Customizable graphs in LogWare III with zooming capability are an easy way to analyze your data history, and data points that need to be explained can be highlighted, annotated, and referred to later. LogWare III statistics include min, max, spread, average, and standard deviation functions, and printed reports keep track of the number of temperature and humidity measurements that were found to be out of tolerance.

For previously stored data, LogWare allows on-screen viewing of raw data. It also exports data easily to file formats that can be viewed in Excel or other common spreadsheet and database programs. It's hard to say which is more versatile: the DewK or LogWare III. This could well be the *amazingest* combination we've ever produced!

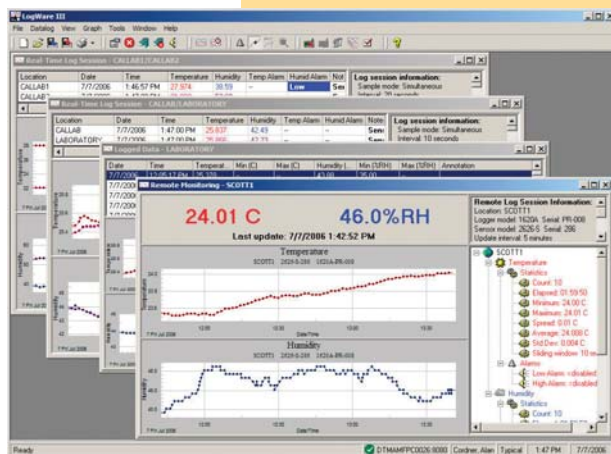



# The DewK thermo-hygrometer

Specifications	
Operating Range	0 °C to 50 °C (32 °F to 122 °F); 0 % RH to 100 % RH
Calibrated Temperature Accuracy ("H" Model)	± 0.125 °C from 16 °C to 24 °C (± 0.225 °F from 60.8 °F to 75.2 °F)
Calibrated temperature Accuracy ("S" Model)	± 0.25 °C from 15 °C to 35 °C (± 0.45 °F from 59 °F to 95 °F)
Calibrated RH Accuracy ("H" Model)	± 1.5 % RH from 20 % RH to 70 % RH
Calibrated RH Accuracy ("S" Model)	± 2 % RH from 20 % RH to 70 % RH
Expected Extrapolated Performance (Uncertified)	± 0.5 °C (± 0.9 °F) outside calibrated range ± 3 % RH outside calibrated range
Delta Temperature Accuracy	± 0.025 °C for ± 1 ° changes within 15 °C to 35 °C (± 0.045 °F for ± 1 ° changes within 59 °F to 95 °F)
Temperature Resolution	User selectable up to 0.001 °C/°F on front-panel display (0.01° recorded)
Delta Humidity Accuracy	± 1.0 % RH for ± 5 % changes within 20 % RH to 70 % RH
RH Resolution	User selectable up to 0.01 % on front-panel display (0.1 % recorded)
Inputs	Up to two sensors, measure temperature and relative humidity, detachable, cable-extendable, interchangeable, self-contained calibrations, may be assigned unique 16-character identifications
Display	240 x 128 graphics monochrome LCD, displays password-protected temperature/humidity data graphically, numerically, and statistically (one or both channels); 16 pre-defined, user-changeable screen setups
Memory	400,000 typical individual date/time-stamped readings
Alarms	Password-protected visual, audible, and external alarms for temperature, temperature rate, RH, RH rate, and fault conditions
Alarm Port Output	2.5 mm two-conductor subminiature plug, 0 V normal, 11 to 12 V active, sources up to 20 mA
Connectivity	Ethernet, RS-232, RF (optional)
Ethernet	RJ45 jack, 10 Base-T or 100 Base-TX; static or dynamic (DHCP client) IP address assignment
Web Page	Embedded web page interface features: instrument identification, measurements, password-protected terminal page; can be disabled
Wireless Option	<i>Requires wireless modem.</i> 802.15.4 (underlies Zigbee), 2.4 GHz frequency, 1 mW transmit power, 30 m (100 ft) typical unobstructed range; can be disabled
Mounting	Wall mounted (hardware included) or set on a bench top
Power	12 V dc from external 100 to 240 V dc power supply
Battery Backup	Standard 9 V battery enables continued measuring during power disruptions
Size (DewK) ( HxWxD )	125 mm x 211 mm x 51 mm (4.9 x 8.3 x 2.0 in)
Size (Sensors) ( LxDia )	79 mm x 19 mm (3.1 x 0.75 in)
Weight	0.7 kg (1.5 lb)
Calibration	Certificate of NIST-traceable NVLAP accredited temperature and humidity calibration included; As Found and As Left data supplied at three temperature points and three humidity points each at 20 °C (68 °F); Complies with NCSL/ISO/IEC 17025:2000 and ANSI/NCSL Z540-1-1994
Log Ware III (Optional Software)	Requirements include: Microsoft® Windows® 2000 (SP4) or XP (SP2) operating system, IBM compatible Intel Pentium® IV 1 GHz PC processor or better, 512 Mb RAM (1Gb or more recommended), 200 Mb HDD space for installation (additional free space recommended for data storage), CD-ROM drive for installation

## Ordering Information

<b>1622A-H</b>	The "DewK" Thermo-Hygrometer, USB Wireless High-Accuracy Value Kit (includes 1621A-H Value Kit, 2633-RF, and 2633-USB)
<b>1621A-H</b>	The "DewK" Thermo-Hygrometer, High-Accuracy Value Kit (includes 1620A-H and 2627-H below, and 9936A LogWare III single-PC license)
<b>1620A-H</b>	The "DewK" Thermo-Hygrometer, High-Accuracy (includes one high-accuracy sensor, wall mount bracket, and RS-232 cable)
<b>1622A-S</b>	The "DewK" Thermo-Hygrometer, USB Wireless Standard-Accuracy Value Kit (includes 1621A-S Value Kit, 2633-RF, and 2633-USB)
<b>1621A-S</b>	The "DewK" Thermo-Hygrometer, Standard-Accuracy Value Kit (includes 1620A-S and 2627-S below, and 9936A LogWare III single-PC license)
<b>1620A-S</b>	The "DewK" Thermo-Hygrometer, Standard-Accuracy (includes one standard-accuracy sensor, wall mount bracket, and RS-232 cable)
<b>2626-H</b>	Spare Sensor, high-accuracy
<b>2627-H</b>	Spare Sensor Kit (includes high-accuracy sensor, sensor case, sensor wall mount bracket, and 7.6 m [25 ft] extension cable)
<b>2626-S</b>	Spare Sensor, standard-accuracy
<b>2627-S</b>	Spare Sensor Kit, (includes standard-accuracy sensor, sensor case, sensor wall mount bracket, and 7.6 m [25 ft] extension cable)
<b>2633-RF</b>	Wireless Option (requires wireless modem)
<b>2633-USB</b>	Wireless Modem, USB to wireless
<b>2633-232</b>	Wireless Modem, RS-232 to wireless
<b>2628</b>	Cable, Sensor Extension, 7.6 m (25 ft)
<b>2629</b>	Cable, Sensor Extension, 15.2 m (50 ft)
<b>9328</b>	Protective Case for 1620A and two sensors
<b>2607</b>	Protective Case for spare sensor
<b>2361</b>	Spare Power Supply, 100 to 240 V ac
<b>9936A</b>	LogWare III Software (Single License) <i>For more ordering information on 9936A LogWare III license and upgrade options see page 102.</i>

# Thermometer probe selection guide

## PRTs

Model	Range	Size	Calibration Uncertainty <sup>†</sup>	Page
<b>Secondary Standards PRTs</b>				
5626	-200 °C to 661 °C	305 or 381 x 6.35 mm (12 or 15 x 0.25 in)	± 0.004 °C at 0 °C	68
5628	-200 °C to 661 °C	305 or 381 x 6.35 mm (12 or 15 x 0.25 in)	± 0.004 °C at 0 °C	
5624 High Temperature PRT	0 °C to 1000 °C	508 x 6.35 mm (20 x 0.25 in)	± 0.004 °C at 0 °C	69
<b>Secondary Reference PRTs</b>				
5615-6	-200 °C to 300 °C	152 x 4.76 mm (6 x 0.188 in)	± 0.010 °C at 0 °C	70
5615-9	-200 °C to 300 °C	229 x 4.7 mm (9 x 0.188 in)	± 0.010 °C at 0 °C	
5615-12	-200 °C to 420 °C	305 x 6.35 mm (12 x 0.25 in)	± 0.010 °C at 0 °C	
<b>Secondary PRT with calibration options</b>				
5608-9, -12	-200 °C to 500 °C	9, 12 in x 1/8 in	± 0.01 °C at 0 °C	72
5609-12, -15, -20	-200 °C to 670 °C	12, 15, 20 in x 1/4 in	± 0.01 °C at 0 °C	
5609-300, -400, -500	-200 °C to 670 °C	300, 400, 500 mm x 6 mm	± 0.01 °C at 0 °C	
<b>Secondary Reference PRT</b>				
5616-12	-200 °C to 420 °C	298 x 6.35 mm (11.75 x 0.25 in)	± 0.01 °C at 0 °C	74
<b>Small Diameter Industrial PRTs</b>				
5618B-6	-200 °C to 300 °C	152 x 3.2 mm (6 x 0.125 in)	± 0.010 °C at 0 °C	73
5618B-9	-200 °C to 500 °C	229 x 3.2 mm (9 x 0.125 in)	± 0.010 °C at 0 °C	
5618B-12	-200 °C to 500 °C	305 x 3.2 mm (12 x 0.125 in)	± 0.010 °C at 0 °C	
<b>Precision Freezer PRT</b>				
5623B	-200 °C to 156 °C	152 x 6.35 mm (6 x 0.25 in)	± 0.010 °C at 0 °C	78
<b>Precision Industrial PRTs</b>				
5627A-6	-200 °C to 300 °C	152 x 4.7 mm (6 x 0.187 in)	± 0.025 °C at 0 °C	79
5627A-9	-200 °C to 300 °C	229 x 4.7 mm (9 x 0.187 in)	± 0.025 °C at 0 °C	
5627A-12	-200 °C to 420 °C	305 x 6.35 mm (12 x 0.25 in)	± 0.025 °C at 0 °C	
<b>Fast Response PRTs</b>				
5622-05	-200 °C to 350 °C	100 x 0.5 mm	± 0.040 °C at 0 °C	80
5622-10	-200 °C to 350 °C	100 x 1.0 mm	± 0.040 °C at 0 °C	
5622-16	-200 °C to 350 °C	200 x 1.6 mm	± 0.040 °C at 0 °C	
5622-32	-200 °C to 350 °C	200 x 3.2 mm	± 0.040 °C at 0 °C	
<b>Thermistors</b>				
<b>Thermistor Standards</b>				
5640	0 °C to 60 °C	229 x 6.35 mm (9 x 0.25 in)	± 0.0015 °C	82
5641	0 °C to 60 °C	114 x 3.2 mm (4.5 x 0.125 in)	± 0.001 °C	
5642	0 °C to 60 °C	229 x 3.2 mm (9 x 0.125 in)	± 0.001 °C	
5643	0 °C to 100 °C	114 x 3.2 mm (4.5 x 0.125 in)	± 0.0025 °C	
5644	0 °C to 100 °C	229 x 3.2 mm (9 x 0.125 in)	± 0.0025 °C	
<b>Secondary Thermistor Probes</b>				
5610	0 °C to 100 °C	152 or 229 x 3.2 mm (6 or 9 x 0.125 in)	± 0.01 °C	84
5611A	0 °C to 100 °C	1.5 mm (0.06 in) tip dia.	± 0.01 °C	
5611T	0 °C to 100 °C	28 x 3 mm (1.1 x 0.12 in)	± 0.01 °C	
5665	0 °C to 100 °C	76 x 3.2 mm (3 x 0.125 in)	± 0.01 °C	
<b>Thermocouples</b>				
<b>Type R and S Thermocouple Standards</b>				
5649/5650-20	0 °C to 1450 °C	508 x 6.35 mm (20 x 0.25 in)	± 0.7 °C at 1100 °C	90
5649/5650-20C	0 °C to 1450 °C	508 x 6.35 mm (20 x 0.25 in)	± 0.7 °C at 1100 °C	
5649/5650-25	0 °C to 1450 °C	635 x 6.35 mm (20 x 0.25 in)	± 0.7 °C at 1100 °C	
5649/5650-25C	0 °C to 1450 °C	635 x 6.35 mm (20 x 0.25 in)	± 0.7 °C at 1100 °C	
<b>Other</b>				
Glass Thermometers	-38 °C to 405 °C -36 °F to 761 °F	381 mm (15 in) length	0.1 °C Divisions 0.2 °F Divisions	

<sup>†</sup>Calibration uncertainty includes short-term repeatability. It does not include long-term drift.

# How accurate is that probe?

At Hart, we field inquiries every day about reference thermometers. Inevitably, as a particular thermometer is discussed, the same bottom-line question is asked: "How accurate is it?"

This important question deserves a complete answer, so here are five things to consider.

## Calibration

One of the most important contributors to the accuracy of your reference thermometer is the way it was calibrated. Not all calibrations are equal.

Calibrations by fixed points are generally better than calibrations by comparison. Calibrations limited to a narrow temperature range are better than calibrations done over a needlessly wide range. Calibrations by people who know what they're doing are better than calibrations by people who don't.

Your calibration should describe the method used, state the uncertainty or test-uncertainty-ratio of the calibration, include a calibration report that meets your quality standards and demonstrates traceability to a national laboratory, and be done by an accredited lab or company you trust. The uncertainty of your probe's own calibration is the first element of accuracy to consider.

## Short-term stability (repeatability)

Just because your thermometer has been well calibrated doesn't mean it repeats each identical measurement perfectly. Limitations on the abilities and physical purity of the sensing element and other materials used in the construction of the thermometer prohibit perfect repeatability.

Different types of thermometers made by different manufacturers have varying susceptibilities to errors from hysteresis, oxidation, and other sources of instability. Thermocouples, for example, are inherently less repeatable than reference-grade thermistors. Strain-free SPRTs are more repeatable than industrial RTDs. The point is that short-term instabilities cannot be "calibrated out" and must be considered as an additional source of uncertainty.

## Long-term stability (drift)

Long-term stability, or "drift," is a critical specification for any reference thermometer. Many causes of short-term instability grow worse as a thermometer's thermal history increases. Normal wear and tear takes its toll on even the best sensing elements and affects their output. It's important to note that "normal wear and tear," in this case, should be defined in the specification.

For example, a drift specification may be stated as "less than 2 mK after 100 hours at 661 °C" (such as on page 9) or as " $\pm 0.025$  °C at 0 °C per year maximum, when used periodically to 400 °C" (such as on page 70). If your intended use of the thermometer is more or less strenuous than what the manufacturer states, you may anticipate correspondingly more or less drift.

Many causes of long-term drift can be periodically addressed and, to some extent, removed. The effects of oxidation, for example, can be largely removed by occasional annealing at high temperatures. Annealing, itself, however, adds more high-temperature history to the sensor and should not be done needlessly. One of the reasons the drift specification is so important is that it helps identify how long you can use your thermometer between recalibrations. Be wary of suppliers who don't provide a drift specification.

## Usage

You won't find a specification to account for all the ways a reference thermometer can be misused (or even abused), but in evaluating specifications it must be understood that the manufacturer has made assumptions regarding how its instrument will be used. At Hart, we tend to write "looser" specifications to allow for instruments being used in less ideal conditions than those under which we use them. Not every manufacturer does so.

Typical examples of misuse include inadequate immersion depth, subjection to mechanical or thermal shock, inadequate thermal contact against the subject being measured, use outside the specified temperature range, and extended use at extreme ends of the temperature range. Before assuming your thermometer will perform the way the manufacturer says it will, satisfy yourself that it will be used within the manufacturer's intended parameters.

## Display accuracy

The uncertainty of the thermometer's readout device (bridge, DMM, *Black Stack*, etc.) must be added to the uncertainty of the actual thermometer when considering total accuracy. No electrical thermometer (PRT, thermistor, thermocouple, etc.) generates a direct temperature reading. The resistance or voltage must always be interpreted (and usually fitted to an equation), and there are always errors inherent in this process.

## In the final analysis...

Accuracy is closely related to confidence, and confidence can be enhanced by following a few simple guidelines: consider all the appropriate performance specifications, use the thermometer correctly and carefully, and recalibrate it soon to verify its performance. As recalibrations yield positive results and confidence in an instrument grows, calibration intervals can be extended and maintenance costs decreased. If you're buying from the right manufacturer and handling your thermometer correctly, you'll find it not uncommon to experience much better results than what the manufacturer has specified.



# Secondary standard PRTs



- Range to 661 °C
- Calibrated accuracy of  $\pm 0.006$  °C at 0 °C
- $R_{TPW}$  drift < 20mK after 500 hours at 661 °C

Hart's high-temp secondary standards fill the gap between affordable, but temperature-limited secondary PRTs and more expensive, highly accurate SPRTs.

If you're using block calibrators, furnaces, or temperature points above normal PRT temperatures (420 °C), then these two PRTs are for you. The 5626 is nominally 100 $\Omega$  and the 5628 is nominally 25.5 $\Omega$ . Both instruments have a temperature range of -200 °C to 661 °C. They make great working or check standards for calibration work up to the aluminum point.

Using a regular PRT at temperatures above 500 °C exposes the platinum to contamination. If the PRT is used as a reference or calibration standard, contamination is a major problem. SPRTs, which are

more expensive and delicate, can handle the higher temperatures, but with greater risk to the instrument due to shock, contamination, or mishandling. The 5626 and 5628 are designed to reduce the contamination risk through the use of internal protection while not impairing performance.

In addition to the right measurement performance and durability, a PRT for secondary applications should be priced affordably. Hart's new PRTs are inexpensive and come with an accredited calibration. The calibration comes complete with ITS-90 constants and a resistance-versus-temperature table.

Check the temperature range, check the stability, check the price! Who else

gives you this much quality, performance, and value for your money? No one!

## Specifications

<b>Temperature Range</b>	-200 °C to 661 °C
<b>Handle Temp.</b>	0 °C to 80 °C
<b><math>R_{TPW}</math></b>	<b>5626:</b> 100 $\Omega$ ( $\pm 1$ $\Omega$ ) <b>5628:</b> 25.5 $\Omega$ ( $\pm 0.5$ $\Omega$ )
<b>W(Ga)</b>	$\geq 1.11807$
<b>Calibrated Accuracy<sup>†</sup> (k=2)</b>	$\pm 0.006$ °C at -200 °C $\pm 0.006$ °C at 0 °C $\pm 0.015$ °C at 420 °C $\pm 0.022$ °C at 661 °C
<b>Stability</b>	<b>5626:</b> $\pm 0.003$ °C <b>5628:</b> $\pm 0.002$ °C
<b>Long-Term Drift (k-2)</b>	<b>5626:</b> < 0.006 °C/100 hours at 661 °C <b>5628:</b> < 0.004 °C/100 hours at 661 °C
<b>Immersion</b>	At least 12.7 cm (5 in) recommended
<b>Sheath</b>	Inconel™ 600
<b>Lead Wires</b>	4-wire Super-Flex PVC, 22 AGW
<b>Termination</b>	Gold-plated spade lugs, or specify
<b>Size</b>	6.35 mm dia. x 305 mm, 381 mm, or 508 mm (0.25 x 12, 15, or 20 in) standard, custom lengths available
<b>Calibration</b>	Accredited calibration from Fluke Hart Scientific

<sup>†</sup>Includes calibration and 100 hr drift

## Ordering Information

<b>5626-12-X</b>	High-temp PRT, 100 $\Omega$ , 305 mm (12 in)
<b>5626-15-X</b>	High-temp PRT, 100 $\Omega$ , 381 mm (15 in)
<b>5626-20-X</b>	High-temp PRT, 100 $\Omega$ , 508 mm (20 in)
<b>5628-12-X</b>	High-temp PRT, 25.5 $\Omega$ , 305 mm (12 in)
<b>5628-15-X</b>	High-temp PRT, 25.5 $\Omega$ , 381 mm (15 in)
<b>5628-20-X</b>	High-temp PRT, 25.5 $\Omega$ , 508 mm (20 in)
<b>2609</b>	Spare Case

Appropriate case included with purchase of 5626 or 5628 PRT.

X = termination. Specify "A" (INFO-CON for 914X), "B" (bare wire), "D" (5-pin DIN for Tweener Thermometers), "G" (gold pins), "I" (INFO-CON for 1521 or 1522), "J" (banana plugs), "L" (mini spade lugs), "M" (mini banana plugs), "P" (INFO-CON for 1523 or 1524), or "S" (spade lugs).

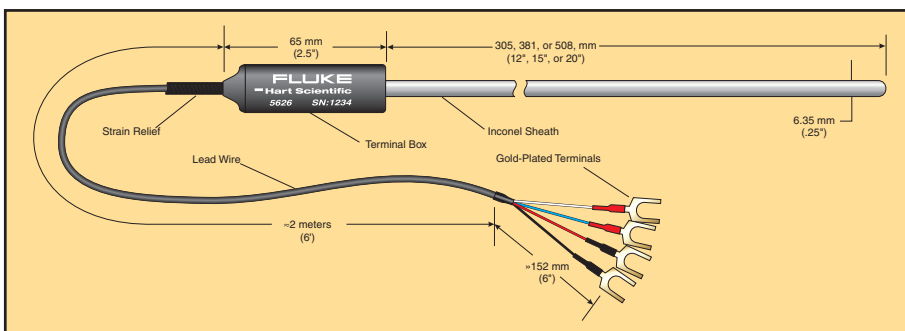

# Ultra high-temp PRT



- Temperature range of 0 °C to 1000 °C
- Calibrated accuracy of ± 0.006 °C at 0 °C
- Long-term drift of 0.01 °C at 0 °C after 100 hours at 1000 °C
- Designed by Hart's primary standards design team

At Hart, we receive many requests for precision PRT accuracy at thermocouple temperatures. Until now metrologist have settled for expensive, high-temperature SPRTs or inaccurate thermocouples for high-temperature measurement.

We're pleased to introduce the world's finest high-temperature secondary PRT, our Model 5624.

Ideal for use as a reference thermometer in high-temperature furnaces, the 5624 can reach a temperature of 1000 °C with long-term drift at 0 °C of only 10 mK! Due to Hart Scientific's proprietary sensor

design, this PRT has short-term stability of 5 mK, and an immersion requirement of less than 153 mm (6 in) at 700 °C.

The 5624 is assembled in an alumina sheath that is 508 mm (20 in) long and 6.35 mm (0.25 in) in diameter. Several termination configurations can be selected to match different thermometer readouts. Each 5624 comes with a NIST-traceable, NVLAP-accredited (lab code 200348-0) fixed-point calibration from 0 °C to 962 °C. That's a *fixed-point* calibration! The 5624 also comes in a protective carrying case.

## Specifications

<b>Range</b>	0 °C to 1000 °C
<b>Calibration Uncertainty</b>	± 0.004 °C at 0 °C ± 0.020 °C at 962 °C
<b>Long-term Drift (R<sub>tpw</sub>) (k=2)</b>	<0.01 °C at 0 °C/100 hours at 1000 °C <0.06 °C at 0 °C/1000 hours at 1000 °C
<b>Calibrated Accuracy † (k=2)</b>	± 0.006 °C at 0 °C ± 0.031 °C at 660 °C ± 0.041 °C at 961 °C
<b>Short-term Stability</b>	± 0.005 °C
<b>Immersion</b>	<153 mm (6 in) at 700 °C
<b>R<sub>tpw</sub></b>	10 ohm (± 0.1 ohm)
<b>Hysteresis</b>	<0.005 °C from 0 °C to 1000 °C
<b>Thermocycling</b>	<0.01 °C, 10 cycles from 0 to 1000 °C
<b>Current</b>	1 mA
<b>Size</b>	6.35 mm (0.25 in) O.D.
<b>Length</b>	508 mm (20 in)
<b>Sheath Material</b>	Alumina
<b>Calibration</b>	Included 1913-6 fixed-point calibration

†Includes calibration and 100 hr drift

## Ordering Information

**5624-20-X** Probe, 1000 °C, 10 ohm PRT, 6.35 mm x 508 mm (0.25 in x 20 in), (includes 2609 case)

*X = termination. Specify "A" (INFO-CON for 914X), "B" (bare wire), "D" (5-pin DIN for Tweener Thermometers), "G" (gold pins), "I" (INFO-CON for 1521 or 1522), "J" (banana plugs), "L" (mini spade lugs), "M" (mini banana plugs), "P" (INFO-CON for 1523 or 1524), or "S" (spade lugs).*

**1913-6** Cal, SPRT by Fixed Point, 0 °C to 962 °C

**2609** Case, PRT, Plastic



# Secondary reference temperature standards



- Affordable wide-range accuracy
- Calibrated accuracy  $\pm 0.012$  °C at 0 °C
- Reference-grade platinum sensing element
- NVLAP-accredited calibration included, lab code 200706-0

For years, you've relied on our 5612, 5613, and 5614 Secondary Reference Probes. These field-durable, lab-accurate PRTs have been replaced by the 5615, which comes with a NVLAP accredited calibration.

The 5615-12 is a Platinum Resistance Thermometer (PRT) with an Inconel™ 600 sheath that's 305 mm (12 in) long and 6.35 mm (0.250 in) in diameter. It is a secondary reference temperature standard designed to bridge the gap between the highest laboratory standards and industrial or second-tier lab locations. It has accuracy of  $\pm 0.012$  °C at 0.01 °C.

The element is constructed of reference-grade platinum wire (99.999 % pure) for excellent stability. The wire is wound in a coil and placed in a mandrel where it's uniformly supported in a manner that virtually eliminates hysteresis. The electrical configuration is a four-wire current-potential hookup that eliminates the effects of lead-wire resistance.

These Inconel™-sheathed probes have a fully supported sensing element, making them more durable than SPRTs. The element is protected in an ultrahigh-purity

ceramic case with a hermetic glass seal to improve output stability by locking out moisture and contaminants.

This probe comes calibrated with ITS-90 coefficients, making it compatible with many excellent readout devices, including Hart's 1529 Chub-E4, 1560 *Black Stack*, and 1502A Tweener. It bridges the gap between a 100-ohm industrial RTD and an SPRT.

For those needing faster thermal response, or where diameter and immersion depth are problems, order the 5615-9 or 5615-6. These probes are excellent reference probes for comparison calibrations in a Hart dry-well. The sheaths of the 5615-6 and 5615-9 are 4.76 mm (0.188 in) in diameter.

A printout of sensor resistance is provided in 1 °C increments for each probe. The 5615-9 and 5615-12 are calibrated from -196 °C to 420 °C. The 5615-6 is calibrated to 300 °C.

We've tested many of the probes on the market. We've used them in our manufacturing facility and tested them in the lab, and this is an excellent secondary

standards PRT. Other instruments on the market are priced much higher, have lower stability, or are of lower quality. Remember, these are reliable instruments and each probe comes with its own individual NVLAP-accredited calibration, lab code 200706-0.

## Ordering Information

<b>5615-6-X</b>	Secondary Standard PRT, 4.76 mm x 152 mm (0.188 x 6.0 in), -200 °C to 300 °C
<b>5615-9-X</b>	Secondary Standard PRT, 4.76 mm x 229 mm (0.188 x 9.0 in), -200 °C to 420 °C
<b>5615-12-X</b>	Secondary Standard PRT, 6.35 mm x 305 mm (0.250 x 12.0 in), -200 °C to 420 °C
<b>2601</b>	Probe Carrying Case

*X = termination. Specify "A" (INFO-CON for 914X), "B" (bare wire), "D" (5-pin DIN for Tweener Thermometers), "G" (gold pins), "I" (INFO-CON for 1521 or 1522), "J" (banana plugs), "L" (mini spade lugs), "M" (mini banana plugs), "P" (INFO-CON for 1523 or 1524), or "S" (spade lugs).*



# Secondary reference temperature standards

Specifications	
Temperature range	5615-12 and 5615-9: -200 °C to 420 °C 5615-6: -200 °C to 300 °C
Nominal resistance at 0 °C	100 Ω ± 0.10 Ω
Temperature coefficient	0.0039250 Ω/Ω/°C
Accuracy <sup>[1]</sup>	± 0.024 °C at -200 °C ± 0.012 °C at 0 °C ± 0.035 °C at 420 °C
Short-term repeatability <sup>[2]</sup>	± 0.009 °C at 0.010 °C
Drift <sup>[3]</sup>	± 0.007 °C at 0.010 °C
Sensor length	28 mm (1.1 in)
Sensor location	6.9 mm ± 3.3 mm from tip (0.27 in ± 0.13 in)
Sheath diameter tolerance	± 0.127 mm (± 0.005 in)
Sheath material	Inconel™ 600
Minimum insulation resistance	1000 MΩ at 23 °C
Transition junction temperature range <sup>[4]</sup>	-50 °C to 200 °C
Transition junction dimensions	71 mm x 13 mm dia (2.8 in x 0.5 in)
Maximum immersion length	5615-6: 102 mm (4 in) 5615-9: 178 mm (7 in) 5615-12: 254 mm (10 in)
Response time <sup>[5]</sup>	9 seconds typical
Self heating (in 0 °C bath)	50 mW/°C
Lead-wire cable type	Teflon™ insulated with Teflon™ jacket, 22 AWG
Lead-wire length	183 cm (72 in)
Lead-wire temperature range	-50 °C to 200 °C
Calibration	NVLAP-accredited calibration included, lab code 200706-0. Please see calibration uncertainty table and its explanation of changeable uncertainties.

<sup>[1]</sup>Includes calibration and 100 hr drift (k=2)

<sup>[2]</sup>Three thermal cycles from min to max temp, includes hysteresis, 95 % confidence (k=2)

<sup>[3]</sup>After 100 hrs at max temp, 95 % confidence (k=2)

<sup>[4]</sup>Temperatures outside this range will cause irreparable damage. For best performance, transition junction should not be too hot to touch.

<sup>[5]</sup>Per ASTM E 644

NVLAP <sup>†</sup> Calibration Uncertainty	
Temperature	Expanded Uncertainty (k=2)
-196 °C	0.024 °C
-38 °C	0.011 °C
0 °C	0.010 °C
200 °C	0.018 °C
420 °C <sup>‡</sup>	0.029 °C

**Note:** Calibration uncertainties depend on the uncertainties of the lab performing the calibration. Subsequent calibrations of this probe performed with different processes, at different facilities, or with changed uncertainty statements may state different uncertainties.  
<sup>†</sup>Lab code 200706-0  
<sup>‡</sup>5615-6 excluded

## Interim checks save trouble later

You spend good money getting your reference standards calibrated. How can you be sure that they continue to measure accurately prior to their next calibration? One way is to periodically compare them to other reference standards with higher accuracy. Such a test is called an interim check.

An interim check that most of us are familiar with is the use of a water triple

point cell to check the stability of a PRT. The ISO 17025 suggests the use of interim checks as a quality safeguard. Do this regularly, keep good records, and you may improve your accuracy by more than a factor of 10. And if you find a problem, you'll be glad you found it sooner rather than later!

# Secondary PRT with calibration options

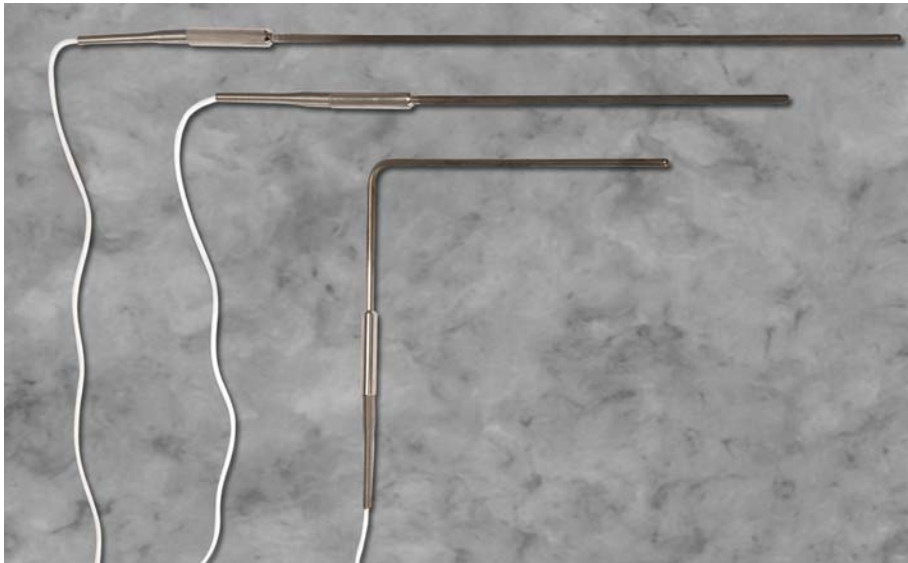

- **5608:** -200 °C to 500 °C (80 mm minimum immersion)
- **5609:** -200 °C to 670 °C (100 mm minimum immersion)
- $\pm 0.008$  °C relative accuracy at 0 °C
- Calibration not included, NVLAP-accredited calibration optional, lab code 200348-0

If you want a very stable thermometer from -200 °C to 670 °C and are particular about the calibration, then look no further than our 5609 Secondary Reference PRT. Its short-term stability at the triple point of water is only  $\pm 7$  mK and its one-quarter inch (6.23mm) diameter lets you get accurate measurements in only 100 mm of immersion. The 5608 is also a  $\pm 7$  mK probe at the triple point of water, but its one-eighth inch (3.18 mm) diameter gets you accurate measurements from -200 °C to 500 °C with only 80mm (3.1 in) of immersion. With multiple sheath length options on both of these probes, you can find the dimensions that are just right for your specific application.

The 5608 comes with a one-eighth inch (3.18 mm) diameter sheath in lengths of 9 inches or 12 inches. The 5609 comes with a one-quarter inch (6.35 mm) diameter sheath in lengths of 12 inches, 15 inches, and 20 inches; or with a 6 mm diameter in lengths of 300 mm, 400 mm, or 500 mm.

When looking for improved response time and reduced stem effect in shallow immersion, look for small diameter probes, because the measurement error called stem effect is caused by the diameter of the stem rather than the length of the stem.

Both of these probes have Inconel™ sheaths and are made using a special

manufacturing process, giving them great precision over a wide temperature range. The sensors for these probes are reference-grade platinum and feature four-wire connections with less noisy measurements than two-wire counterparts.

These probes come with a certificate of compliance to ensure they meet their specifications. If you'd like, you can also order a NVLAP-accredited calibration from our laboratory, lab code 200348-0. On the report of calibration, you'll get the test data and the ITS90 calibration coefficients that you can easily input into any Hart thermometer. If you order your probe with an INFO-CON connector, we'll program the coefficients directly into your connector, which loads the coefficients for you when you plug it into our 1522 Handheld Thermometer.

Call today for your free quote.

## Ordering Information

<b>5608-9-X</b>	Secondary Reference PRT, 9 in x 1/8 in, -200 to 500 °C
<b>5608-12-X</b>	Secondary Reference PRT, 12 in x 1/8 in, -200 to 500 °C
<b>5609-12-X</b>	Secondary Reference PRT, 12 in x 1/4 in, -200 to 670 °C
<b>5609-15-X</b>	Secondary Reference PRT, 15 in x 1/4 in, -200 to 670 °C
<b>5609-20-X</b>	Secondary Reference PRT, 20 in x 1/4 in, -200 to 670 °C
<b>5609-300-X</b>	Secondary Reference PRT, 300 mm x 6 mm, -200 to 670 °C
<b>5609-400-X</b>	Secondary Reference PRT, 400 mm x 6 mm, -200 to 670 °C
<b>5609-500-X</b>	Secondary Reference PRT, 500 mm x 6 mm, -200 to 670 °C
<b>5609-9BND-X</b>	Secondary Reference PRT, 15 in x 1/4 in, 9 in bend, -200 °C to 670 °C
<b>1922-4-R</b>	PRT (5608) Calibration, -200 °C to 500 °C, NVLAP Accredited
<b>1923-4-7</b>	PRT (5609) Calibration, -200 °C to 660 °C, NVLAP Accredited
<b>1924-4-7</b>	PRT (5609-9BND) Calibration, -200 °C to 660 °C, NIST-traceable
<b>1930</b>	Precision Digital Thermometer System Calibration by Comparison, NVLAP-accredited, lab code 200348-0
<b>2601</b>	Plastic PRT Case, for models ending -9, -12, and -300
<b>2609</b>	Plastic PRT Case, for models ending -15, -20, -400, and -500

*X = termination. Specify "A" (INFO-CON for 914X), "B" (bare wire), "D" (5-pin DIN for Tweener Thermometers), "G" (gold pins), "I" (INFO-CON for 1521 or 1522), "J" (banana plugs), "L" (mini spade lugs), "M" (mini banana plugs), "P" (INFO-CON for 1523 or 1524), or "S" (spade lugs).*

# Secondary PRT with calibration options

Specifications	
Temperature range	5608: -200 °C to 500 °C 5609: -200 °C to 670 °C
Nominal resistance at 0.01 °C	100 Ω ± 0.5 Ω
Temperature coefficient	0.0039250 Ω/Ω/°C
Relative Accuracy <sup>[1]</sup>	± 0.007 °C at -200 °C ± 0.008 °C at 0 °C ± 0.020 °C at 420 °C ± 0.027 °C at 660 °C
Short-term repeatability <sup>[2]</sup>	± 0.007 °C at 0.010 °C ± 0.013 °C at max temp
Drift <sup>[3]</sup>	± 0.01 °C at 0.010 °C ± 0.02 °C at max temp
Hysteresis	± 0.01 °C maximum
Sensor length	30 mm ± 5 mm (1.2 in ± 0.2 in)
Sensor location	3 mm ± 1 mm from tip (0.1 in ± 0.1 in)
Sheath material	Inconel™ 600
Minimum insulation resistance	5608: 500 MΩ at 23 °C, 20 MΩ at 500 °C 5609: 500 MΩ at 23 °C, 10 MΩ at 670 °C
Transition junction temperature range <sup>[4]</sup>	-50 °C to 200 °C
Transition junction dimensions	71 mm x 12.5 mm (2.8 in x 0.49 in)
Minimum immersion length <sup>[5]</sup> (<5 mK error)	5608: 80 mm (3.1 in) 5609: 100 mm (3.9 in)
Maximum immersion length	305 mm (12 in)
Response time <sup>[5]</sup>	5608: 9 seconds typical 5609: 12 seconds typical
Self heating (in 0 °C bath)	5608: 75 mW/°C 5609: 50 mW/°C
Lead-wire cable type	Teflon,™ 24 AWG
Lead-wire length	1.8 m (6 ft)
Lead-wire temperature range	-50 °C to 250 °C
Calibration	Calibration not included; NVLAP-accredited calibration optional, lab code 200348-0. Please see calibration uncertainty table and its explanation of changeable uncertainties.

<sup>[1]</sup>Includes short-term repeatability and 100 hr drift. Calibration will add additional uncertainties.

<sup>[2]</sup>Three thermal cycles from min to max temp, includes hysteresis, 95 % confidence (k=2)

<sup>[3]</sup>After 100 hours at max temp, 95 % confidence (k=2)

<sup>[4]</sup>Temperatures outside this range will cause irreparable damage. For best performance, transition junction should not be too hot to touch.

<sup>[5]</sup>Per ASTM E 644

Calibration Uncertainty for optional NVLAP-accredited <sup>†</sup> calibration

Temperature	Expanded Uncertainty (k=2)
-200 °C	0.025 °C
-100 °C	0.025 °C
-40 °C	0.025 °C
0 °C	0.025 °C
156 °C	0.025 °C
230 °C	0.030 °C
420 °C	0.045 °C
660 °C	0.050 °C

**Note:** Calibration uncertainties depend on the uncertainties of the lab performing the calibration. Subsequent calibrations of this probe performed with different processes, at different facilities, or with changed uncertainty statements may state different uncertainties. <sup>†</sup>Lab code 200348-0



# 5616 secondary reference PRT



- Temperature range:  $-200\text{ }^{\circ}\text{C}$  to  $420\text{ }^{\circ}\text{C}$
- Excellent stability:  $\pm 10\text{ mK}$
- Calibrated accuracy  $\pm 0.011\text{ }^{\circ}\text{C}$  at  $0\text{ }^{\circ}\text{C}$
- NIST-traceable calibration included

You won't find another NIST-traceable reference temperature sensor that matches the accuracy and temperature range of the 5616 for the same price.

The 5616-12 is a 100-ohm platinum resistance thermometer (PRT) with excellent short-term repeatability and comes with an unaccredited NIST-traceable calibration.

The temperature range of the 5616 covers  $-200\text{ }^{\circ}\text{C}$  to  $420\text{ }^{\circ}\text{C}$ , and its high-purity platinum element and durability make it great for calibrating in the lab or in the field. When choosing a reference with a platinum element, there are two things you want to look at carefully: the short-term repeatability and the long-term drift. When PRTs are thermally cycled over their temperature range as they would be during a calibration, their resistance at the triple point of water can move up and down within an expected range. Hart Scientific defines this range (called "short-term repeatability") as the repeatability at the triple point of water during three thermal cycles. 5616s are among the best performing in their class with short-term repeatability better than  $\pm 0.010\text{ }^{\circ}\text{C}$  ( $\pm 0.004\text{ }^{\circ}\text{C}$  is typical). In addition, the

5616's drift is  $\pm 0.007\text{ }^{\circ}\text{C}$  at the triple point of water when exposed up to its maximum temperature ( $420\text{ }^{\circ}\text{C}$ ) for 100 hours. These specifications are given at  $k=2$  and therefore include a 95 % confidence level.

The 5616's sealed INCONEL® 600 sheath is 298 mm (11.75 in) long and 6.35 mm (0.250 in) in diameter. The probe's Teflon®-jacketed cable is made of silver plated copper that ends with four-wire leads, which eliminate the effects of lead-wire resistance on measurements.

Use the 5616 with Hart's 1560 Black Stack, 1529 Chub-E4, or 1502A Tweener thermometer readouts.

Each sensor comes with a manufacturer's report of calibration. The report includes the expanded uncertainty ( $k=2$ ) at seven calibration temperature points, ITS-90 calibration coefficients, and a temperature vs. resistance table presented in  $1\text{ }^{\circ}\text{C}$  increments.

Compare the 5616 to other Secondary Reference PRTs. You'll like its price, but you'll love its performance.

## Ordering Information

**5616-12-X** Secondary Reference PRT, 6.35 mm x 298 mm (0.250 x 11.75 in),  $-200$  to  $420\text{ }^{\circ}\text{C}$

**2601** Probe Carrying Case

*X = termination. Specify "A" (INFO-CON for 914X), "B" (bare wire), "D" (5-pin DIN for Tweener Thermometers), "G" (gold pins), "I" (INFO-CON for 1521 or 1522), "J" (banana plugs), "L" (mini spade lugs), "M" (mini banana plugs), "P" (INFO-CON for 1523 or 1524), or "S" (spade lugs).*

# 5616 secondary reference PRT

Specifications	
Parameter	Value
Temperature range	-200 °C to 420 °C
Nominal resistance at 0.01 °C	100 Ω ± 0.5 Ω
Temperature coefficient	0.003925 Ω/Ω/°C nominal
Calibrated Accuracy <sup>[1]</sup> (k=2)	± 0.012 °C at -200 °C ± 0.011 °C at 0 °C ± 0.028 °C at 420 °C
Short-term repeatability <sup>[2]</sup>	± 0.007 °C at 0.010 °C
Drift <sup>[3]</sup>	± 0.007 °C at 0.010 °C
Hysteresis	± 0.010 °C maximum
Sensor length	50.8 mm (2.0 in)
Sensor location	9.5 mm ± 3.2 mm from tip (0.375 in ± 0.125 in)
Sheath diameter tolerance	± 0.08 mm (± 0.003 in)
Sheath material	INCONEL® 600
Minimum insulation resistance	500 MW at 23 °C
Transition junction temperature range <sup>[4]</sup>	-50 °C to 150 °C (see footnote)
Transition junction dimensions	76.2 mm x 9.5 mm (3.00 in x 0.375 in)
Minimum immersion length[5] (< 5 mK error)	102 mm (4.0 in)
Maximum immersion length	254 mm (10 in)
Response time <sup>[5]</sup>	8 seconds typical
Self heating (in 0 °C bath)	60 mW/°C
Lead-wire cable type	Teflon®-jacketed cable, Teflon® insulated conductors, 24 AWG stranded, silver plated copper
Lead-wire length	182.9 cm ± 2.5 cm (72.0 in ± 1.0 in)
Lead-wire temperature range	-50 °C to 150 °C
Calibration	NIST-traceable calibration

Calibration Uncertainty	
Temperature	Expanded Uncertainty (k=2)
-197 °C	0.012 °C
-80 °C	0.012 °C
-38 °C	0.011 °C
0 °C	0.009 °C
156 °C	0.011 °C
230 °C	0.013 °C
420 °C	0.021 °C

**Note:** Laboratories may periodically reevaluate their uncertainties. Calibration uncertainties depend on the calibration process, the standards used, and the instrument performance.

<sup>[1]</sup>Includes calibration uncertainty and 100 hr drift.

<sup>[2]</sup>Three thermal cycles from min to max temp, includes hysteresis, 95 % confidence (k=2)

<sup>[3]</sup>After 100 hrs at max temp, 95 % confidence (k=2)

<sup>[4]</sup>Temperatures outside this range will cause irreparable damage. For best performance, transition junction should not be too hot to touch.

<sup>[5]</sup>Per ASTM E 644

# Sensible temperature specifications

## Based on an article from *Random News*

Specifications are used to quantify the performance of platinum resistance thermometers (PRTs) and are often the main determinant in the customer's probe choice. Therefore marketers sometimes use a tactic called "specmanship" to artificially enhance their PRT's performance. "Specmanship" is defined as presenting instrument specifications in a misleading fashion. PRT specmanship can come in many forms. Here are some of the most common we see in the temperature world:

### Incomplete specifications

Completeness means providing all the information necessary for a user to form proper expectations of PRTs performance over its intended range and for its intended purpose. A specification only given at one temperature point gives little indication of the PRT's performance over its full range.

It is usually not practical to define specifications in every detail at every increment over its range (or for every imaginable application). However, this is no excuse for intentionally omitting or relocating critical specifications in an effort to give a false impression of performance. Make sure specifications provide all the information needed to adequately predict performance over your intended range of use.

Drift is more important than many people realize, and they often fail to give it the consideration it deserves. The amount your probe drifts affects how often it must be recalibrated. Drift can be monitored by periodically measuring the probe's resistance shift at the triple point of water (TPW), or 0.01 °C.

### Misuse of "typical" and "best performance"

Unfortunately, manufacturers are not bound by a common standard defining how to derive or present specifications. Ideally, manufacturers are adequately conservative when publishing specifications so that actual performance is better than the stated specifications. This should be done not only to provide a high level of confidence to the user when they validate the PRT's performance, but also to account for applications that may not be "typical" or that don't fit the "best performance" criteria.

It is important to realize that when a manufacturer qualifies a specification with the words like "typical", "as good as" or "depends on actual use" that they are not guaranteeing the specification. This is not

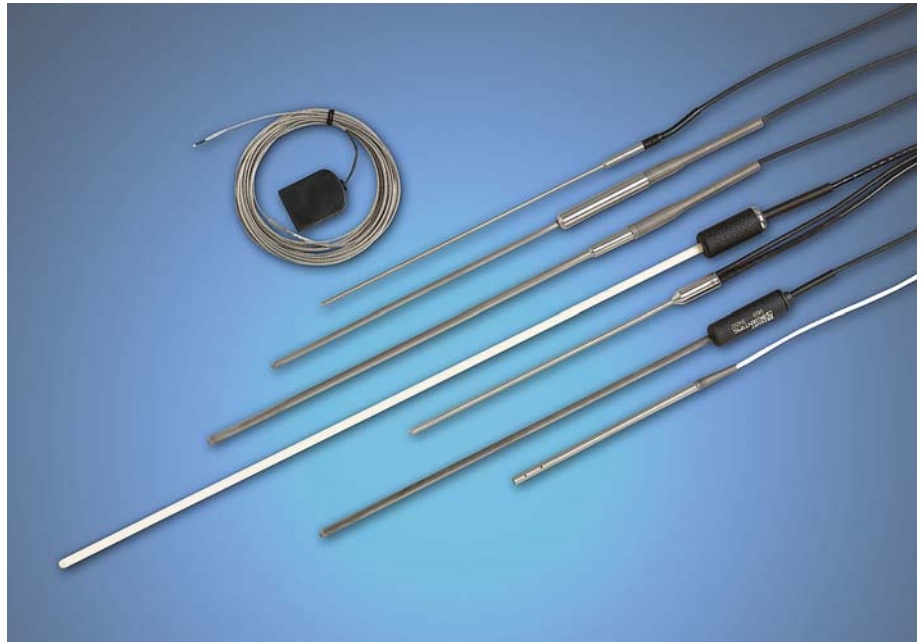

to say that such terms may never be used. The term "typical" may be used in literature to give users a general indication of performance on non-critical specifications that have several variables. For example, the term "typical" can provide the user with an indication of performance when that performance is more within the user's control than the manufacturer's.

However use of such terms may be an indication that inadequate testing has been performed, or that an attempt is being made to exaggerate the actual performance of the majority of instruments being produced. These terms and others like them may be stated so the manufacturer may publish the most attractive specification possible while trying to build a defensible position for when the probe does not perform to the stated specification. Don't be fooled by exaggerated performance specifications. Ask for a guarantee.

### Declaring specifications that are difficult to interpret or apply

Not enough can be said for clearly stated specifications that are easy to interpret and apply. Some specmanship artisans ambiguously represent specifications so customers are left to their own interpretation of the specification and how to apply it. Once a customer has clarified the "true" meaning, he or she often finds the specification is not based on the general application—thus, rendering it useless. Properly

written specifications should therefore apply to the anticipated application.

If you ever see a specification that you do not understand, please ask. Otherwise, you may be misunderstanding a critical part of your probe's performance.

### Conclusion

Specmanship exists in the temperature calibration market today. We suggest a thorough examination of PRT specifications on completeness and application use. We understand that thorough specifications can be challenging to develop, but we excuse no one, including ourselves. If you see a chance for us to improve the presentation of our specifications, please let us know!



# Small diameter industrial PRT



- Small diameter sheath, 3.2mm (0.125 in)
- Excellent stability
- Includes ITS-90 coefficients
- NVLAP-accredited calibration from -200 °C to 500 °C, lab code 200706-0

For secondary level performance with full ITS-90 calibration, Hart's 5618B series PRTs are an excellent choice for critical temperature measurements. Featuring a 3.2 mm diameter (1/8 in) sheath, these industrial standards probes have reduced response time without compromising precision. This small diameter 5618B probe works well in many applications where immersion depth is limited. Larger diameter probes give more measurement error in short immersion depth applications because they conduct more heat between ambient and the sensor.

With each probe you will receive a full NVLAP-accredited calibration report, lab code 200706-0. On the report you'll get the test data and the ITS-90 calibration coefficients that you can easily input into your Hart thermometer. If you are using a Handheld Thermometer readout, we'll program the coefficients directly into your INFO-CON connector.

The 5618B is also a great probe to use for calibrating your Hart 9132 or 9133 infrared calibrators. In fact, these IR black

body heat sources were designed to be calibrated with this type of probe. Now you can calibrate these targets in your own lab!

For use from -200 °C to 500 °C (the six-inch model goes to 300 °C), you won't find a better industrial standard in this configuration than our 5618B. We recommend using the 5618B PRTs with the 1523, 1524, 1502A, 1529, or 1560 thermometer readouts.

## Ordering Information

<b>5618B-12-X</b>	305 mm (12 in) Small Diameter Probe
<b>5618B-9-X</b>	229 mm (9 in) Small Diameter Probe
<b>5618B-6-X</b>	152 mm (6 in) Small Diameter Probe
<b>2601</b>	Probe Carrying Case

*X = termination. Specify "A" (INFO-CON for 914X), "B" (bare wire), "D" (5-pin DIN for Tweener Thermometers), "G" (gold pins), "T" (INFO-CON for 1521 or 1522), "J" (banana plugs), "L" (mini spade lugs), "M" (mini banana plugs), "P" (INFO-CON for 1523 or 1524), or "S" (spade lugs).*

Specifications	
<b>Resistance</b>	Nominal 100 Ω at 0 °C
<b>Temperature Coefficient</b>	0.003923 Ω/Ω/ °C nominal
<b>Temperature Range</b>	-200 °C to 500 °C (-200 °C to 300 °C for 5618B-6-X)
<b>Drift Rate</b>	± 0.1 °C when used periodically to 500 °C
<b>Sheath Material</b>	316 SST
<b>Leads</b>	22 AWG Teflon, 6'
<b>Termination</b>	Specify
<b>Hysteresis</b>	Less than 0.01 °C at 0 °C when using -196 °C and 420 °C as the end points.
<b>Time Constant</b>	Four seconds maximum for 63.2 % response to step change in water moving at 3 fps.
<b>Thermal EMF</b>	Less than 25 mV at 420 °C
<b>Calibration</b>	Includes manufacturer's NVLAP-accredited calibration w/ITS-90 coefficients, R vs. T values in 1 °C increments, lab code 200706-0
<b>Size</b>	<b>5618B-12:</b> 305 mm L x 3.2 mm dia. (12 x 1/8 in) <b>5618B-9:</b> 229 mm L x 3.2 mm dia. (9 x 1/8 in) <b>5618B-6:</b> 152 mm L x 3.2 mm dia. (6 x 1/8 in)
<b>Calibrated Accuracy † (k=2)</b>	± 0.026 °C at -200 °C ± 0.066 °C at 0 °C ± 0.219 °C at 500 °C

†Includes calibration uncertainty and drift specification.

NVLAP † Calibration Uncertainty	
Temperature	Expanded Uncertainty (k=2)
-196 °C	0.024 °C
-38 °C	0.011 °C
0 °C	0.010 °C
200 °C	0.018 °C
420 °C ‡	0.029 °C

**Note:** Calibration uncertainties depend on the uncertainties of the lab performing the calibration. Subsequent calibrations of this probe performed with different processes, at different facilities, or with changed uncertainty statements may state different uncertainties.  
 †Lab code 200706-0  
 ‡300 °C for 5618B-6

# Precision freezer PRT



- Fully immersible probe assembly to  $-100\text{ }^{\circ}\text{C}$
- NVLAP-accredited calibration, lab code 200706-0
- Accuracy to  $\pm 0.05\text{ }^{\circ}\text{C}$  over the full range

If you need a precision measurement at low temperatures, do not look any further than Hart Scientific.

The 5623B, precision “freezer probe,” is specially sealed from the sensing element to the end of the probe cable, preventing ingress of moisture when exposed to temperatures as low as  $-100\text{ }^{\circ}\text{C}$ . The entire assembly withstands temperatures over its full range ( $-100\text{ }^{\circ}\text{C}$  to  $156\text{ }^{\circ}\text{C}$ ), which is ideal for verification of freezers or autoclaves where a thermo-well isn’t available. The 5623B assembly can be fully immersed in fluids when the application may require use in a liquid bath. The 5623B is available in a 6.35 mm (0.25 in) dia.  $\times$  125 mm (6 in) long Inconel™ sheath. With calibration uncertainty of only  $\pm 0.010\text{ }^{\circ}\text{C}$  at  $0\text{ }^{\circ}\text{C}$ , the 5623B is just right as a secondary standard for calibration of other process sensors.

Most Hart Scientific readouts make an excellent companion for the 5623B. We recommend the use of the 1523, 1524, 1502A, 1529, or 1560 thermometer readouts.

With each 5623B, you receive a full NVLAP-accredited calibration report, lab code 200706-0. This report includes test data and ITS-90 calibration coefficients to enter into your Hart Scientific thermometer readout.

## Specifications

<b>Resistance</b>	Nominal $100\ \Omega$ ( $\pm 0.1\ \Omega$ )
<b>Temperature Coefficient</b>	$0.003925\ \Omega/\Omega/^{\circ}\text{C}$ nominal
<b>Temperature Range</b>	$-100\text{ }^{\circ}\text{C}$ to $156\text{ }^{\circ}\text{C}$
<b>Transition Temperature</b>	$-100\text{ }^{\circ}\text{C}$ to $156\text{ }^{\circ}\text{C}$
<b>Drift Rate</b>	$\pm 0.01\text{ }^{\circ}\text{C}$ per year maximum at $0\text{ }^{\circ}\text{C}$ , when used periodically at max temperature
<b>Sheath Material</b>	Inconel™ 600
<b>Leads</b>	Teflon™-insulated, silver-plated stranded copper, 22 AWG.
<b>Termination</b>	Specify. See ordering information.
<b>Calibration</b>	Includes manufacturer’s NVLAP-accredited, lab code 200706-0, calibration and table with R vs. T values in $1\text{ }^{\circ}\text{C}$ increments from $-80\text{ }^{\circ}\text{C}$ to $156\text{ }^{\circ}\text{C}$ . ITS-90 coefficients included.
<b>Calibrated Accuracy<sup>†</sup> (<math>k=2</math>)</b>	$\pm 0.05\text{ }^{\circ}\text{C}$ over the full range
<b>Cable Length</b>	6.1 meters (20 ft)
<b>Size</b>	6.35 mm (0.25 in) dia. $\times$ 152 mm (6 in)

<sup>†</sup>Includes calibration uncertainty and drift.

## Ordering Information

**5623B-6-X** Freezer Probe, RTD 6.35 mm dia.  $\times$  152 mm (1/4 in  $\times$  6 in),  $-100\text{ }^{\circ}\text{C}$  to  $156\text{ }^{\circ}\text{C}$

**2601** Probe Carrying Case

*X = termination. Specify “A” (INFO-CON for 914X), “B” (bare wire), “D” (5-pin DIN for Tweener Thermometers), “G” (gold pins), “I” (INFO-CON for 1521 or 1522), “J” (banana plugs), “L” (mini spade lugs), “M” (mini banana plugs), “P” (INFO-CON for 1523 or 1524), or “S” (spade lugs).*



# Precision industrial PRTs



- Vibration and shock resistant
- 19 mm (3/4-inch) bend radius for increased durability
- NVLAP-accredited calibration included, lab code 200706-0

When buying a PRT, performance isn't the only criterion you need to look at. The real issues are price-to-accuracy and price-to-durability ratios.

5627A probes have a temperature range up to 420 °C and an accuracy as good as ± 0.025 °C. They come in three different lengths. (Both six- and nine-inch models cover -200 °C to 300 °C.) Each instrument is shipped with its ITS-90 coefficients and a calibration table in 1 °C increments.

One of the best features of this sensor is that it conforms to the standard 385 curve, letting you use your DIN/IEC RTD meters fully. Why use a probe that's less accurate than your meter?

The 5627A is manufactured using a coil suspension element design for increased shock and vibration resistance. It has a mineral-insulated sheath with a minimum bend radius of 19 mm (3/4-inch) for flexibility and durability. (Bend, if any, should be specified at time of order.)

Six- and nine-inch 5627As are calibrated at -196 °C, -38 °C, 0 °C, 200 °C, and 300 °C. For 12-inch versions the point at 300 °C is replaced by a calibration point at 420 °C.

Each probe is individually calibrated and includes a NVLAP-accredited report of calibration from the manufacturer, lab code 200706-0.

This probe is an excellent value. It has the price-to-accuracy and price-to-durability ratios you should demand in every PRT you buy!

## Ordering Information

- 5627A-6-X** Secondary PRT, 152 mm x 4.7 mm (6 x 3/16 in), -200 °C to 300 °C
- 5627A-9-X** Secondary PRT, 229 mm x 4.7 mm (9 x 3/16 in), -200 °C to 300 °C
- 5627A-12-X** Secondary PRT, 305 mm x 6.35 mm (12 x 1/4 in), -200 °C to 420 °C

**2601** Probe Carrying Case

*X = termination. Specify "A" (INFO-CON for 914X), "B" (bare wire), "D" (5-pin DIN for Tweener Thermometers), "G" (gold pins), "I" (INFO-CON for 1521 or 1522), "J" (banana plugs), "L" (mini spade lugs), "M" (mini banana plugs), "P" (INFO-CON for 1523 or 1524), or "S" (spade lugs).*

## Specifications

<b>Resistance</b>	Nominal 100Ω
<b>Temperature Coefficient</b>	0.00385 Ω/Ω/ °C nominal
<b>Temperature Range</b>	-200 °C to 420 °C (5627A-6 and 5627A-9 to 300 °C; transition and cable temperature: 0 °C to 150 °C)
<b>Drift Rate (k=2)</b>	± 0.04 °C at 0 °C after 100 hours at 420 °C
<b>Sheath Material</b>	316 Stainless Steel
<b>Leads</b>	Teflon™-insulated, nickel-plated stranded copper, 22 AWG
<b>Termination</b>	Specify. See Ordering Information.
<b>Time Constant</b>	Four seconds maximum for 63.2 % response to step change in water moving at 3 fps.
<b>Bending Radius</b>	Sheath may be ordered with a bend on a minimum radius of 19 mm (3/4 in) except for 50 mm (2 in) area of sheath near tip. (Hart lab requires 20 cm [8 in] of unbent sheath to re-calibrate.)
<b>Calibration</b>	Includes manufacturer's NVLAP-accredited (lab code 200706-0) calibration and table with R vs. T values in 1 °C increments from -196 °C to 500 °C (to 300 °C for 5627A-6 and 5627A-9). ITS-90 coefficients included.
<b>Immersion</b>	At least 100 mm (4 in) recommended
<b>Calibrated Accuracy † (k=2)</b>	± 0.026 °C at -196 °C ± 0.046 °C at 0 °C ± 0.077 °C at 200 °C ± 0.124 °C at 420 °C
<b>Size</b>	<b>5627A-12:</b> 305 mm x 6.35 mm (12 in x 1/4 in) <b>5627A-9:</b> 229 mm x 4.7 mm (9 in x 3/16 in) <b>5627A-6:</b> 152 mm x 4.7 mm (6 in x 3/16 in)

†Includes calibration uncertainty and 100 hr drift.



# Fast response PRTs

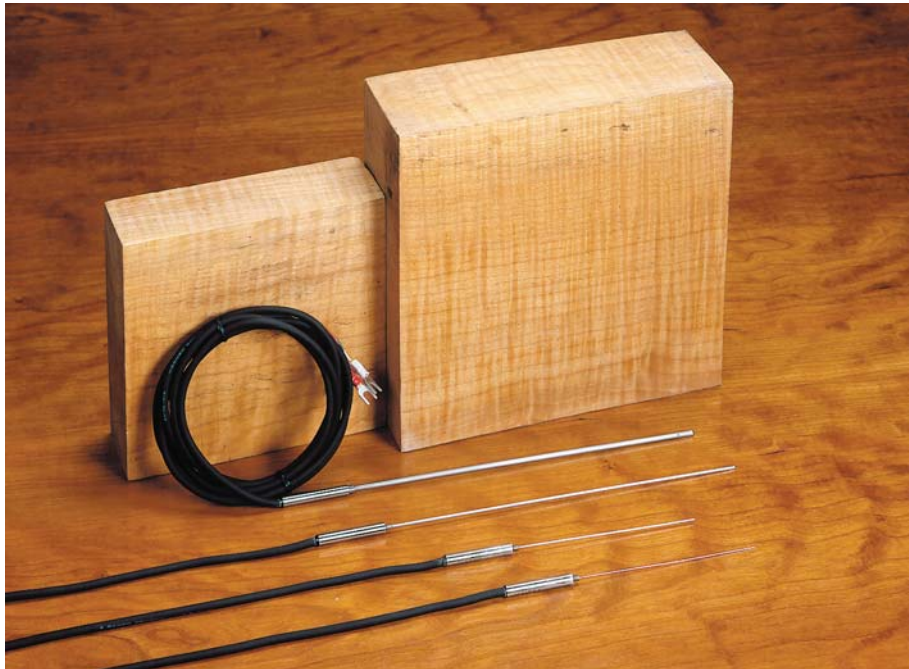

- Time constants as fast as 0.4 seconds
- Available as DIN/IEC Class A PRTs or with NVLAP-accredited calibration, lab code 200348-0
- Small probe diameters ranging from 0.5 mm to 3.2 mm

For special temperature measurement applications requiring fast response or short immersion over a wide temperature range, Hart's new 5622 series PRTs are the perfect solution.

Made by Netsushin, one of the world's leading PRT manufacturers, this series includes four models with stainless steel sheaths ranging from 0.5 to 3.2 mm (0.02 to 0.125 in) in diameter. Because these high-quality wire-wound sensors come in small packages, heat transfer to the sensors occurs quickly. Time constants from 0 °C to 100 °C are as fast as 0.4 seconds.

Immersion requirements for these probes is also a plus, ranging from just 10 mm to 64 mm (0.4 to 2.5 inch), depending on the model. Getting into shallow or tight places is not a problem. And because these probes can handle temperatures from -200 °C to 350 °C, they're more versatile than most thermistors.

5622 PRTs come with two calibration options. Uncalibrated, each of these probes conforms to DIN/IEC Class A requirements with accuracy of  $\pm 0.15$  °C at 0 °C and  $\pm 0.55$  °C at 200 °C and -200 °C. Alternatively, any 5622 PRT may be purchased with a 1923-4-N ITS-90 NVLAP-accredited comparison calibration (lab

code 200348-0) that includes seven points from -197 °C to 300 °C. With calibration, short-term accuracies are achieved as good as  $\pm 0.04$  °C at 0 °C.

Readout options for the Model 5622 PRTs include Hart's Little Lord Kelvin and Little Lord Logger Handheld Thermometers (page 58) as well as the 1502A Tweener Thermometer (page 56). Each of these readouts will read your PRT as a standard DIN/IEC probe or as an individually calibrated PRT.

Whatever your thermometry requirements are, come to Hart. No one else offers a wider range of standards-quality reference thermometers than Hart.

## Specifications

<b>Temperature Range</b>	-200 °C to 350 °C
<b>Nominal <math>R_{TPW}</math></b>	100 $\Omega$
<b>Sensor</b>	Four "385" platinum wires
<b>Calibrated Probe Accuracy (includes calibration uncertainty and short-term stability)</b>	<b>5622-05 and 5622-10:</b> $\pm 0.04$ °C at -200 °C $\pm 0.04$ °C at 0 °C $\pm 0.09$ °C at 200 °C $\pm 0.09$ °C at 300 °C <b>5622-16 and 5622-32:</b> $\pm 0.04$ °C at -200 °C $\pm 0.04$ °C at 0 °C $\pm 0.045$ °C at 200 °C $\pm 0.055$ °C at 300 °C
<b>Uncalibrated DIN/IEC Conformity</b>	DIN/IEC Class A; $\pm 0.15$ °C at 0 °C
<b>Time Constant (63.2 %)</b>	From 0 °C to 100 °C: <b>5622-05:</b> 0.4 seconds <b>5622-10:</b> 1.5 seconds <b>5622-16:</b> 3.0 seconds <b>5622-32:</b> 10 seconds (90 %)
<b>Immersion Depth</b>	<b>5622-05:</b> 10 mm (0.4 in) <b>5622-10:</b> 20 mm (0.8 in) <b>5622-16:</b> 32 mm (1.25 in) <b>5622-32:</b> 64 mm (2.5 in)
<b>Thermal EMF</b>	20 mV at 350 °C
<b>Sheath</b>	316 SST <b>5622-05:</b> 100 x 0.5 mm (4 x 0.02 in) <b>5622-10:</b> 100 x 1.0 mm (4 x 0.04 in) <b>5622-16:</b> 200 x 1.6 mm (8 x 0.06 in) <b>5622-32:</b> 200 x 3.2 mm (8 x 0.13 in)
<b>Cable</b>	PVC, 4-wire cable, 2 meters long, 90 °C max temp

## Ordering Information

<b>5622-05-X</b>	Fast Response PRT, 0.5 mm (0.02 in)
<b>5622-10-X</b>	Fast Response PRT, 1.0 mm (0.04 in)
<b>5622-16-X</b>	Fast Response PRT, 1.6 mm (0.06 in)
<b>5622-32-X</b>	Fast Response PRT, 3.2 mm (0.13 in)
<i>(All models come without calibration unless calibration purchased separately.)</i>	
<b>1923-4-N</b>	NVLAP-accredited Calibration, PRT Comparison, -196 °C to 300 °C, lab code 200348-0
<b>2601</b>	Probe Carrying Case

X = termination. Specify "A" (INFO-CON for 914X), "B" (bare wire), "D" (5-pin DIN for Tweener Thermometers), "G" (gold pins), "I" (INFO-CON for 1521 or 1522), "J" (banana plugs), "L" (mini spade lugs), "M" (mini banana plugs), "P" (INFO-CON for 1523 or 1524), or "S" (spade lugs).

# What are stem conduction errors and how can they create errors in calibration?

## Reprinted from *Random News*

Stem conduction is heat conduction along the length of a thermometer. When the heat source temperature and the handle, or cable end, of the thermometer are at different temperatures, stem conduction happens. This difference produces a sensor reading that's different from the actual heat source temperature. Two thermometers side by side in the same heat source with stems made of different materials may read two different temperatures.

The following chart illustrates the stem conduction effect. Five different, but high quality, thermometers were tested in a liquid bath at 80 °C. The test was performed by immersing each of the thermometers to a specific depth. Since each thermometer or probe had design differences, including the length of sensor and the diameter, the immersion was adjusted for those variables.

*Immersion Depth = Sensor Length + X Diameters*

Temperatures were normalized at *SL + 20 Diameters*.

The results show that thermometers 1 and 2 read nearly the same temperature values for each depth, while thermometers 3, 4, and 5 read very different temperatures with less immersion depth. This illustrates stem conduction effects. This simple test has many implications for the work you do. How much immersion depth do you need for your sensors?

## Factors that impact stem conduction error

Remember the heat conduction formula:

$$Q = (K \times A \times \Delta T) / d$$

*Q* = heat, *K* = thermal conductance factor, *A* = cross sectional area, *Delta T* is the temperature difference between the

sensor and ambient, and *d* is the immersion depth. Knowing that an increase of *Q* will increase the error of the measurement, consider each of the components of this equation.

### Thermal conductance factor

A high thermal resistance (hence low conductance value) helps to isolate the temperature sensor against the conduction of heat to the ambient air (or vice-versa). The material type and diameter of lead wires, the sheath thickness, and materials of construction all factor into this. The copper lead of a type T thermocouple is clearly a high thermal conductor for a given diameter of wire and may need to be compensated for in some way.

Probe 5 in our test had a heavy walled sheath. The effect of the heat conducted along this sheath contributed to the errors. A related factor for quartz sheaths is light piping.

### Cross sectional area

Whatever the heat conduction coefficient of the stem material, the bigger the cross-sectional area of the stem, the more heat conduction, and the greater the error. Using the diameter to determine immersion depth helps compensate for this. However, a calibration comparison of two thermometers of vastly different stem diameters may actually require the smaller one to be placed at the same depth as the larger one so both sensors are at the same temperature. Labs calibrating short, large diameter sensors find it very difficult to obtain a high accuracy calibration because of the dominating effect of stem conduction.

### Delta T

Delta T refers to the temperature difference between the heat source and the ambient temperature. Calibrations are usually made over wide temperature

ranges. Stem conduction errors increase directly with this temperature difference as our equation suggests.

### Depth

Many factors influence the errors related to stem conduction but few are as easy to control as depth. The equation shows that the other effects can be reduced by increasing the value of immersion depth. Immerse the thermometer as far as possible while still keeping all the test and reference sensors as close together as practical. Remember not to cook the connection or handle end of the thermometer.

In our example, we used a liquid bath for our heat source. If you're using a dry-well or furnace, stem conduction errors are greater and more difficult to manage.

The formula given in this brief, simple discussion of stem conduction error can be used as a general rule-of-thumb for figuring immersion depth. You should do some similar experiments with your own sensors to establish their stem conduction errors. Thermometers with low stem conduction errors make good references for checking the uniformity of heat sources.

Temperature error at 80 °C due to stem conduction, degrees C

Depth	Probe 1 SPRT, Inconel Sheath, 5.5 mm Dia 50 mm SL	Probe 2 SPRT, Quartz Sheath, 7 mm Dia 29 mm SL	Probe 3 SPRT, Inconel Sheath, 6.3 mm Dia. 29 mm SL	Probe 4 Secondary, Inconel Sheath, 6.3 mm Dia. 41 mm SL	Probe 5 Secondary, Inconel Sheath, 6.3 mm Dia. 38 mm SL
SL+20D	0	0	0	0	0
SL+17.5D	0	0	-0.001	-0.002	-0.002
SL+15D	0	0	-0.005	-0.003	-0.003
SL+12.5D	-0.002	-0.002	-0.010	-0.005	-0.005
SL+10D	-0.002	-0.001	-0.015	-0.010	-0.050
SL+7.5D	-0.004	-0.003	-0.020	-0.050	-0.100
SL+5D	-0.007	-0.005	-0.050	-0.130	-0.430



# Thermistor standards probes



- Accuracy to  $\pm 0.002\text{ }^{\circ}\text{C}$
- Affordable system accuracy to  $\pm 0.004\text{ }^{\circ}\text{C}$  or better
- NIST-traceable calibration included from manufacturer; accredited Hart calibration optional

If you want a high-accuracy probe with excellent stability at a great price, the Model 5640-series Thermistor Standards Probes give you all three in a great package. Why pay for an SPRT when you can get  $\pm 0.001\text{ }^{\circ}\text{C}$  accuracy from  $0\text{ }^{\circ}\text{C}$  to  $60\text{ }^{\circ}\text{C}$  in a calibrated thermistor probe for about one-third the cost of an uncalibrated SPRT alone?

Each probe uses an ultra-stable glass thermistor enclosed in a thin-wall stainless steel tube. The basic semiconductor element is a bead of manganese, nickel, and cobalt oxides mounted on  $0.1\text{ mm}$  platinum wires. For long-term stability, the thermistor is aged at various temperatures for 16 weeks. During the aging process, verification of the probe's stability is done to ensure performance to published specs.

The 5640, 5641, and 5642 thermistor probes are designed for the temperature range of  $0\text{ }^{\circ}\text{C}$  to  $60\text{ }^{\circ}\text{C}$ . The 5643 and 5644

probes span the  $0\text{ }^{\circ}\text{C}$  to  $100\text{ }^{\circ}\text{C}$  temperature range. They offer stability of either  $\pm 0.002\text{ }^{\circ}\text{C}$  or  $\pm 0.005\text{ }^{\circ}\text{C}$ . These stability levels are guaranteed for one full year.

Precision calibration, traceable to NIST, is provided with each probe. A computer-generated table in increments of  $0.01\text{ }^{\circ}\text{C}$  is furnished with each calibration based on the formula:

$$R = \exp\left(A + \frac{B}{T} + \frac{C}{T^2} + \frac{D}{T^3}\right)$$

The constants for the formula are obtained from a polynomial regression performed on the calibration data obtained. Over the range of  $0\text{ }^{\circ}\text{C}$  to  $60\text{ }^{\circ}\text{C}$ , calibration is performed at the triple point of water ( $0.01\text{ }^{\circ}\text{C}$ ) and  $15\text{ }^{\circ}\text{C}$ ,  $25\text{ }^{\circ}\text{C}$ ,  $30\text{ }^{\circ}\text{C}$ ,  $37\text{ }^{\circ}\text{C}$ ,  $50\text{ }^{\circ}\text{C}$  and  $60\text{ }^{\circ}\text{C}$ . For the  $0\text{ }^{\circ}\text{C}$  to  $100\text{ }^{\circ}\text{C}$  temperature range, the additional calibration points of  $80\text{ }^{\circ}\text{C}$  and  $100\text{ }^{\circ}\text{C}$  are used.

Each probe is individually calibrated and includes a report of calibration from the manufacturer. Contact Hart for calibration in Hart's NVLAP accredited lab.

Thermistor standards are rugged, precision sensors suitable for use as secondary or working temperature standards for laboratory metrology applications. Because they generally are not affected by shock and vibration, you can use them in the most difficult field environments without worrying about calibration integrity.

Combine these probes with Hart's 1560 *Black Stack* thermometer to read directly in  $^{\circ}\text{C}$ ,  $^{\circ}\text{F}$ , or K. This combination gives you resolution of  $0.0001$  degrees and total system accuracy is better than  $\pm 0.004\text{ }^{\circ}\text{C}$ .

Compare the cost of a 5640 calibrated probe and a *Black Stack* thermometer to the cost of one uncalibrated SPRT. Between  $0\text{ }^{\circ}\text{C}$  and  $100\text{ }^{\circ}\text{C}$ , nothing beats the value of the 5640 Series Thermistors.



# Thermistor standards probes

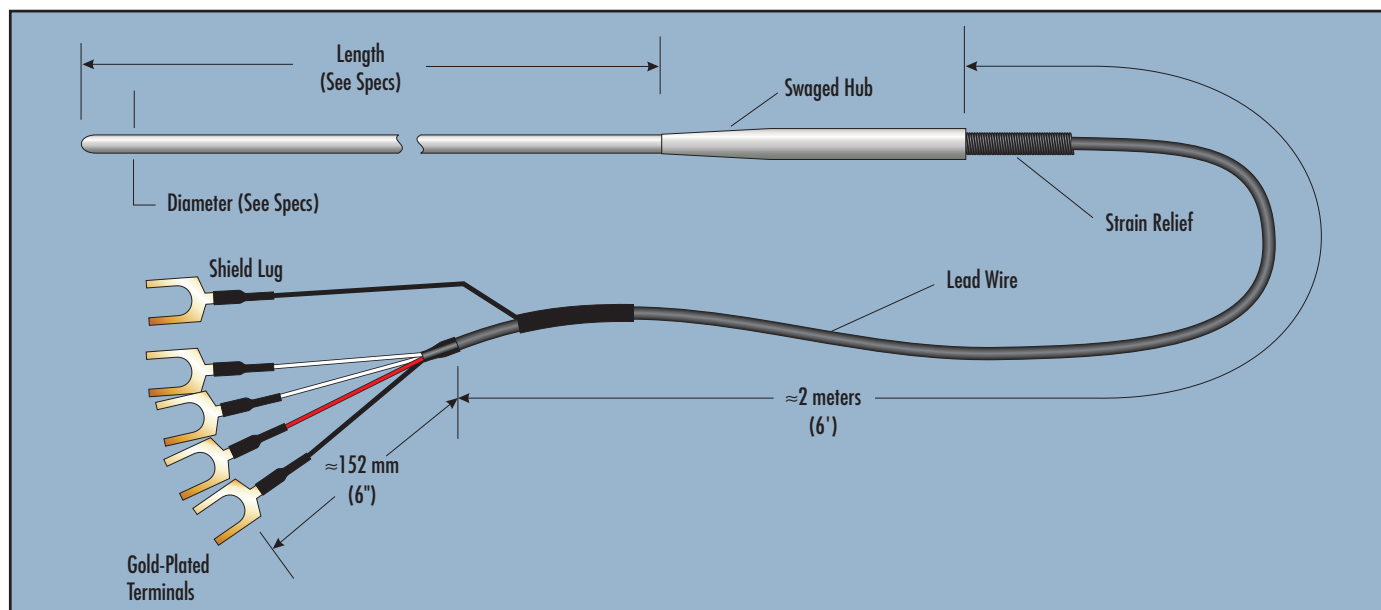

## Specifications

Model	Diameter x Length	Range	Drift °C/Year	Accuracy (Mfr.) <sup>1</sup>		Wires	Nominal Resistance at 25 °C
				0–60 °C	60–100 °C		
5640	6.35 x 229 mm (0.25 x 9 in)	0 °C–60 °C	± 0.005 °C	± 0.0015 °C	n/a	4	4.4 kΩ
5641	3.18 x 114 mm (0.125 x 4.5 in)	0 °C–60 °C	± 0.002 °C	± 0.001 °C	n/a	4	5 kΩ
5642	3.18 x 229 mm (0.125 x 9 in)	0 °C–60 °C	± 0.002 °C	± 0.001 °C	n/a	4	4 kΩ
5643	3.18 x 114 mm (0.125 x 4.5 in)	0 °C–100 °C	± 0.005 °C	± 0.0015 °C	± 0.0025 °C	4	10 kΩ
5644	3.18 x 229 mm (0.125 x 9 in)	0 °C–100 °C	± 0.005 °C	± 0.0015 °C	± 0.0025 °C	4	10 kΩ

<sup>1</sup>Does not include long-term drift, resistance traceability adds additional ± 0.0025 %.

## Ordering Information

<b>5640-X</b>	Standards Thermistor Probe
<b>5641-X</b>	Standards Thermistor Probe
<b>5642-X</b>	Standards Thermistor Probe
<b>5643-X</b>	Standards Thermistor Probe
<b>5644-X</b>	Standards Thermistor Probe

X = termination. Specify "B" (bare wire), "D" (5-pin DIN for Tweener Thermometers), "G" (gold pins), "I" (INFO-CON for 1521 or 1522), "J" (banana plugs), "L" (mini spade lugs), "M" (mini banana plugs), "P" (INFO-CON for 1523 or 1524), or "S" (spade lugs).

## Thermistors make great reference thermometers!

Contrary to some traditional belief, reference-grade thermistors do indeed make great temperature standards. Consider:

- **Stability.** Today's glass-encapsulated thermistors are well sealed to prevent sensor oxidation and drift. In fact, standards-level thermistors usually won't drift more than a few millidegrees in a year.
- **Accuracy.** Thermistors are easier (than PRTs) to read accurately because of their larger base resistance and large change in resistance-per-degree. It's common to get meaningful and repeatable readings from a thermistor with resolution of 0.0001 °C.
- **Durability.** While a bare thermistor bead can be fairly delicate, a properly constructed stainless steel-sheathed thermistor probe can be more rugged than a PRT or SPRT.

For about the same cost of a secondary level PRT, you can buy a well-calibrated standards thermistor probe with accuracy and stability that rivals an SPRT. You can also save wear and tear on your SPRT by using a thermistor over the 0 °C to 100 °C temperature range.

See the article *Thermistors: the under appreciated temperature standards* on page 86 for a more detailed examination on this subject.

# Secondary reference thermistor probes



- Short-term accuracy to  $\pm 0.01$  °C; one-year drift  $< \pm 0.01$  °C
- Accredited NVLAP calibration optional
- Flexible Teflon and silicone coated fast-response models
- Rugged polished stainless steel sheaths

Hundreds of thousands of thermistors are sold every year, but only a few have the stability necessary for use as high-accuracy thermometry standards. If you're looking for economical lab-grade thermistor probes for accurate work across a narrow temperature range, Hart's Secondary Reference Series thermistor probes are the best you can buy.

These thermistors are available in a variety of sheath materials appropriate for your specific application. In addition to our metal-sheathed probes, we offer flexible Teflon encapsulated and silicone coated thermistors that have smaller tips and can measure those places where even a metal-sheathed thermistor can't reach.

## Teflon encapsulated thermistor

The 5611T is an especially versatile Teflon coated thermistor probe. With a Teflon encapsulated tip that is just 3 mm (0.12 in) in diameter and a Teflon coating that makes it impervious to most liquids, the Teflon Probe is handy for measuring in a wide variety of applications, including biopharmaceuticals. It's even immersible to nearly 20 feet and flexible enough that you could roll it up into a ball in your hand if you wanted to!

The 5611T's thermistor bead is encapsulated in a Mylar sleeve that is encapsulated inside a Teflon sleeve. The Teflon sleeve is

then melted around the Teflon-insulated cable, forming a moisture-proof seal.

## Stainless steel sheathed thermistors

Our stainless steel metal-sheath probes include our 5610-6 and 5610-9 immersion probes, as well as our 5665 fully immersible probe. These probes are great for measuring in air, liquid or soil.

## Silicone coated thermistor

With a diameter at the tip of just 1.5 mm (0.06 in), the 5611A's tip has the smallest diameter of any of our secondary reference thermistors and can fit nearly anywhere. Its faster response time, flexible sheath, and silicone coating make the 5611A great for use in many applications. However, applications involving silicone oil could damage the thermistor and should be avoided.

## Higher performance

All of Hart's secondary reference thermistors have small diameters and very small sensing elements, which means they require far less immersion than a PRT to avoid errors caused by stem effect. Self heating is usually negligible, giving them an advantage when taking measurements in air. Their small size also improves response time, allowing measurements to be taken more quickly.

If your application involves frequent handling, you'll be especially interested to

know thermistors are less susceptible to mechanical shock than PRTs. The bottom line may be better accuracy in fieldwork.

Additionally, higher base resistance and larger resistance coefficients make it easier to achieve precision readings with thermistors, so better resolution and accuracy are possible for a lower cost. All of these thermistors have a negative temperature coefficient of resistance (NTC). For additional information about thermistors, please see "Thermistors: the under-appreciated temperature standards" on page 86.)

## Readouts

These probes come in a complete assembly ready for use, and each works well with the uncertainties of our thermometer readouts: the 1504 Tweener, the 1523 and 1524 Handheld Thermometers, the 1529 Chub-E4, the 1560 *Black Stack*, and the 1575A and 1590 Super-Thermometers.

These probes provide most accurate readings when coupled with a 2563 Standards Thermistor Module or 1590 Super-Thermometer, but they are most portable when used with a handheld Reference Thermometer.

## Calibrated accuracy

What's more, the Secondary Reference Series Thermistors are accurate to  $\pm 0.01$  °C and cover the temperature range of 0 °C to 100 °C. They come with a NIST-traceable calibration and a resistance-versus-temperature table printed in 0.1 °C increments that can be interpolated to 0.0001 °C. NVLAP accredited calibrations as single thermistors or as systems combined with their readouts, are also available.

No other sensors can match the accuracy and price combination of these high-accuracy thermistor probes. Try one and you'll agree.

# Secondary reference thermistor probes

## Specifications

<b>Resistance</b>	Nominal 10,000 Ω at 25 °C
<b>Range</b>	0 °C to 100 °C
<b>Calibration</b>	R vs. T table with 0.1 °C increments, interpolation equation furnished
<b>Calibration Uncertainty</b>	Table and equation are accurate to ± 0.01 °C Optional accredited <sup>†</sup> calibration uncertainties ± 0.006 °C
<b>Drift</b>	Better than ± 0.01 °C per year (k=3)
<b>Repeatability</b>	Better than ± 0.005 °C
<b>Size and Construction</b>	See illustrations below.
<b>Termination</b>	Specify when ordering.

<sup>†</sup>NVLAP Lab Code 200348-0

## Ordering Information

<b>5610-6-X</b>	152 mm (6 in) Immersion Probe
<b>5610-9-X</b>	229 mm (9 in) Immersion Probe
<b>5611A-11X</b>	Silicone-Bead Probe
<b>5611T-X</b>	Teflon Probe
<b>5665-X</b>	Miniature Immersion Probe
<b>1925-A</b>	Calibration, 100 ° span, 6 points over span, NVLAP-accredited
<b>1935-A</b>	System calibration, 100 ° span, 6 points over span, NVLAP-accredited
<b>2601</b>	Probe Carrying Case

*X = termination. Specify "B" (bare wire), "D" (5-pin DIN for Tweener Thermometers), "G" (gold pins), "I" (INFO-CON for 1521 or 1522), "J" (banana plugs), "L" (mini spade lugs), "M" (mini banana plugs), "P" (INFO-CON for 1523 or 1524), or "S" (spade lugs).*

**5610 Stainless Steel Immersion Probe**

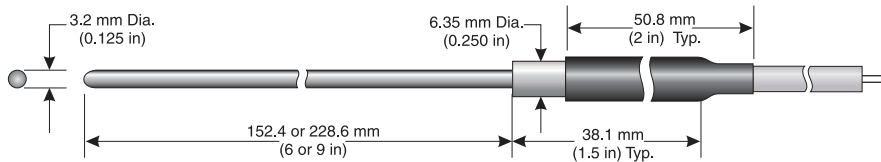

**5611A Silicone-Bead Probe**

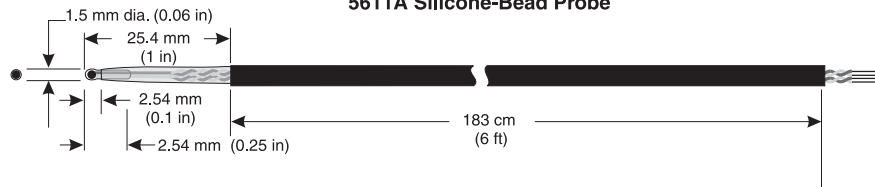

**5611T Teflon Probe**

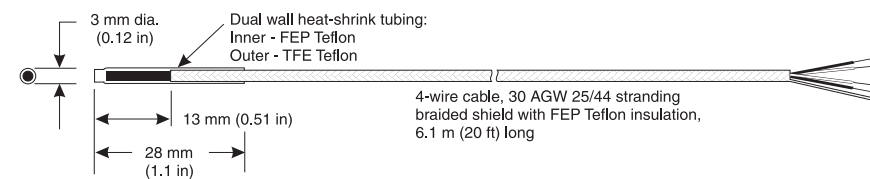

**5665 Stainless Steel Miniature Immersion Probe**

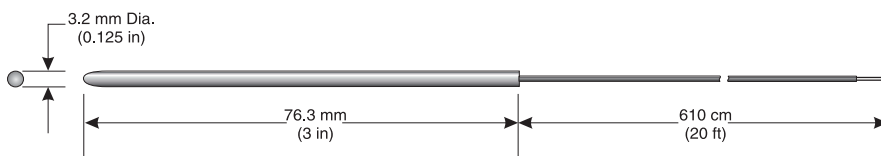

## Handle your probe correctly

Good thermometer handling procedures help maintain calibration accuracy. Here are a few pointers.

### Don't

- Don't subject a PRT to physical shock or vibration.
- Don't bend a probe that is not designed for bending.
- Don't subject a thermometer to sudden extreme temperature changes.
- Don't install compression fittings on a probe sheath.
- Don't subject a thermometer to temperatures outside its range.
- Don't subject a thermometer's transition junction, handle, or lead wires to temperatures outside their ranges (which likely differ from the thermometer's range).
- Don't immerse the probe past the bottom of its handle.

### Do

- Do immerse a probe to at least its minimum immersion depth.
- Do allow the thermometer time to stabilize before taking readings.
- Do use the proper current to prevent self-heating errors.
- Do check your probe's  $R_{TPW}$  value frequently.
- Do test the shunt resistance of your probe periodically. (Shunt resistance is the resistance between the probe sensor and the probe sheath.)



# Thermistors: the under appreciated temperature standards

## Reprinted from *Random News*

Thermistors don't make good temperature standards? Yes they do. You've probably seen sensor comparison charts published by magazines and probe manufacturers. They're typically found in articles and application notes intended to help you select the correct sensor for various applications. In thermistor charts you regularly find the authors listing poor linearity and poor long-term stability as disadvantages. These are the reasons you most often hear repeated when someone believes a thermistor isn't a good thermometry standard.

### Linearity

Let's look at non-linearity first. With today's powerful microprocessor-based readouts, non-linearity isn't really an issue. As long as the resistance vs. temperature curve of the sensor is very predictable, or repeatable, the sensor can make accurate measurements when used with a readout designed to deal with the non-linearity. The Steinhart-Hart equation or resistance look-up tables are commonly used by instruments to accurately convert resistance to temperature.

### Stability

Poor long-term stability has been the main concern about thermistors. Changes in the physical composition of the semiconductor can result in either an increase or a decrease in the resistance of the thermistor. Oxidation of the semiconductor materials contributes to this change. For example, a common additive in thermistors is copper oxide, which has poor stability in the presence of oxygen. Problems with changing contact resistance sometimes result from thermal stress or insufficient strain relief between the thermistor body and its leads.

While these potential problems occasionally occur in the lower-cost thermistor devices, they are not common in thermistors which are hermetically sealed in glass. Sealing the thermistor eliminates oxygen transfer to the semiconductor and

prevents resistance shifts. The rate at which the resistivity of a thermistor will change in the presence of oxygen increases with increasing temperature. Consequently, the use of a hermetic seal permits operation of the bead at higher temperatures. The glass seal also provides an adequate strain relief for the lead-to-ceramic contact on many thermistor styles.

### NBS Study

Between 1974 and 1976, the National Bureau of Standards conducted a study on the stability of thermistors. The results demonstrated no significant drift for bead-in-glass thermistors. Non-glass-sealed disk type thermistors showed definite drift that increased as the test temperature increased. Later, J.A. Wise of the National Institute of Standards and Technology conducted another investigation that was published at the Seventh International Temperature Symposium in Toronto. Her study included newer, glass-sealed disk thermistors, as well as bead-in-glass thermistors. This time, the disk type fared nearly as well as the bead type.

These extensive studies conclude that a super-stable glass-sealed thermistor will typically drift only 0.001 °C to 0.002 °C per year. This level of stability is comparable, and, in fact better, than some SPRTs on the market today. However, a calibrated reference probe made with this type of thermistor costs between \$500 and \$1400 depending on its range and stability. An uncalibrated SPRT costs about \$3,000. The thermistor probe is priced at the same level as a secondary PRT probe while delivering 10 to 20 times better annual stability.

Though many applications may not require high stability performance and many thermistors may not be suitable for standards thermometry, this does not mean all thermistors are not suitable. The same is true for platinum resistance thermometers. Most industrial RTDs are not suitable for standards work. This doesn't mean

that a properly constructed PRT or SPRT is a bad standard.

### Durability

Another interesting point is the fragility of the sensor. Sometimes thermistors are criticized as being too fragile. While a bare bead thermistor is fairly delicate, a properly constructed stainless steel-sheathed probe is surprisingly rugged when compared to a PRT or SPRT. The platinum resistance element in an SPRT or PRT is far more susceptible to mechanical shock than its thermistor counterpart. While the bumps and taps of everyday handling can impact the strain relief and contact resistance of the PRT, the same level of mechanical shock will not change the base resistance in a thermistor probe. The thermistor is recommended where frequent handling is expected.

### Temperature range

The only real limitation of thermistors in metrology applications is temperature range. Currently, the most common ranges for super-stable thermistors suitable for metrology lie between 0 °C and 110 °C. Of course, a large percentage of all measurement applications fall between these two temperatures. An excellent strategy is to use a thermistor for work in this range and a PRT for work beyond that range. This reduces the handling of the PRT and the likelihood that a shift in base resistance will occur.

### Other advantages

Thermistors typically have larger base resistance and resistance change-per-degree than PRTs. This makes it easier to read their resistance precisely. It also contributes to a thermistor's ability to provide better resolution than a PRT. It is common to get meaningful and repeatable readings of temperature change to 5 places past the decimal.

The size of a thermistor bead is also considerably smaller than the size of a PRT. In a stainless steel sheath, the

Thermometer readouts							
Model	ASL F250	Hart 1504 Tweener	Hart 1560 Black Stack	ASL F700	Hart 1575 Super-Thermometer	Hart 1590 Super-Thermometer	ASL F18
Thermistors?	No <sup>†</sup>	Yes	Yes	No <sup>†</sup>	Yes	Yes	No <sup>†</sup>
Meter Accuracy at 25 °C	± 0.01 °C	± 0.003 °C	± 0.0013 °C	± 0.001 °C	± 0.00025 °C	± 0.000125 °C	± 0.0001 °C
Resolution	0.001 °C	0.0001 °C	0.0001 °C	0.00025 °C	0.000075 °C	0.00005 °C	0.0001 °C

<sup>†</sup>We realize this chart compares apples to oranges. That's because our competitors don't make thermistor readouts. So, to be fair, we've shown the best published specs from the closest competition. All their specs assume a 25Ω or 100Ω platinum resistance thermometer.

## Thermistors: the under appreciated temperature standards

thermistor is much less affected by stem-conduction than a PRT. In many applications, a large PRT probe is simply too large. For example, the testing or calibration of biomedical devices and analytical instruments frequently requires a sensor smaller than even the bare PRT element, not to mention its tubular packaging. Off-the-shelf thermistor standards are available in diameters of only 1.8 mm (0.07 in) with small gauge leads. Tremendous flexibility is possible in custom packaging thermistors for surface, air, and liquid measurements.

While Hart manufactures reference PRTs and SPRTs, we do not make thermistors. Still, we feel it's important to promote their virtues because their unique advantages can contribute significantly to metrology and calibration work. For this reason, each of Hart's thermometer readouts is available with the ability to read thermistors. When you're considering the purchase of a readout, check into the possibility of reading thermistors. If the salesman tells you a thermistor isn't a good standard, you've just had a good indication of the company's credibility.



Hart's 1504 Tweener reads thermistors accurately to  $\pm 0.003$  °C.

# Thermocouples 101... or, maybe... 401!

## Reprinted from *Random News*

Thermocouples are the most commonly used temperature sensors in the world. If you're a thermocouple user, particularly of reference thermocouples, there are a few things you should know. It is easy to be led into believing that accurate measurements with a thermocouple (two dissimilar pieces of wire joined together at a common junction) are as simple to get as reading a number off a digital display.

Thermocouples react to temperature gradients by generating a voltage. The accuracy of converting that voltage into a temperature is determined by the condition of the thermocouple, the measurement technique used, the characteristics (or "type") of the thermocouple, and its calibration.

### If you don't know how a thermocouple senses temperature, you probably make mistakes in using them.

The junction between the two dissimilar metals of a thermocouple does not produce the voltage that is measured across the ends of its lead wires. Thermocouples use the relationship between temperature and electricity that was first observed in 1821 by Thomas Seebeck. The so-called "Seebeck effect," which describes how thermal energy is converted into electrical energy, does not require two dissimilar metals to be joined together.

Consider two parallel, electrically unconnected wires that are each extending from left to right. The first wire is pure platinum, and the second is a platinum-rhodium alloy. If the temperature at the left end of the wires is different from the temperature at the right end of the wires, then there is an electric potential difference (voltage) between the left and right ends of the wires. However, the voltage across the pure platinum will be different than the voltage across the platinum alloy. For a single wire, we call this voltage the absolute Seebeck emf. In practice, this voltage can never be measured directly. However, once an electrical connection is made, for example, by making a junction at the right end by touching the two wires together (see the schematic drawings), what is known as a thermocouple is produced. Then, the potential difference measured across the open ends, on the left, depends on the temperature difference between the right and left ends of the thermocouple. If the voltage and reference temperature on the left is known, then the measurement temperature on the right can be calculated. Yet, without an

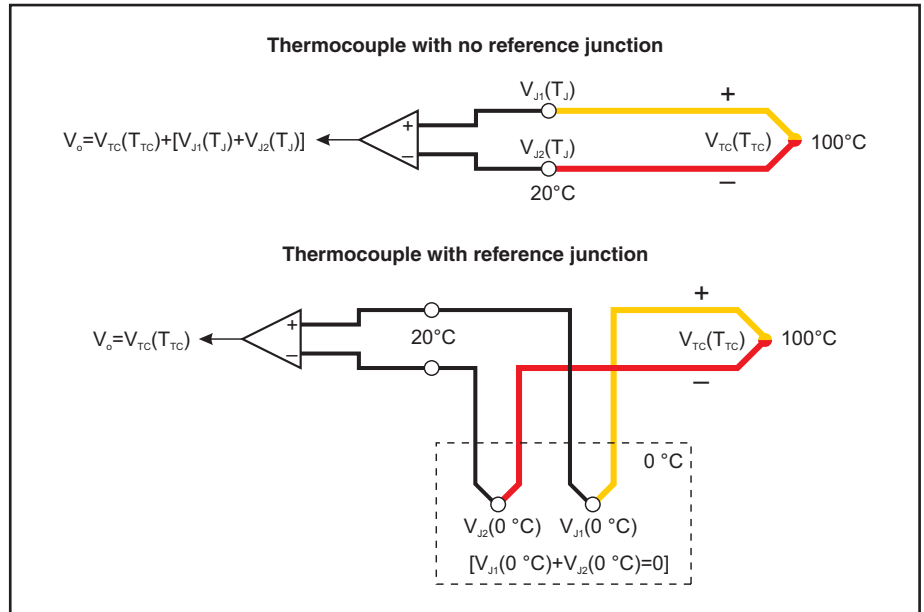

Electrical schematic drawings of thermocouples with and without a reference junction.

accurate reference temperature, making huge measurement errors is as easy as reading numbers off a digital display!

### If you don't know what a reference junction is, you need to find out.

There are a number of ways to obtain an accurate reference temperature. The exact manner chosen depends on the desired accuracy, budget, available equipment, and expertise of the user.

On one end of the thermocouple is the measurement junction; the reference junction (if there is one) is on the other end. Generally, a reference junction consists of two copper or platinum wires (with very similar absolute Seebeck emfs) that are electrically connected to the thermocouple. The reference junction is usually placed in an ice bath, which keeps it at a constant known temperature of  $0.000^\circ C \pm 0.002^\circ C$  if you're following the ASTM procedure E 563-97 for constructing a proper ice bath. Voltage measurements are then taken across the copper wires, which now reside at a known temperature, rather than at the thermocouple wires.

If a thermocouple does not have a reference junction, it is necessary to use some sort of electronic reference junction compensation (RJC—or "CJC" for "cold junction compensation"). The meter measures the temperature at the "cold" end of the thermocouple. From this temperature, a voltage offset is calculated. The voltage offset is then added to the voltage

measured by the meter and the total voltage is used to calculate the temperature. You may have to choose how the readout or simulator device generates this offset. The wrong choice could mean an error as large as  $25^\circ C$ .

### Isn't "homogeneity" a property of milk?

Imperfections in thermocouple wire may produce undesired results in temperature measurements. Thermocouple wires that are free from these imperfections are called homogenous. This means that the composition of the wire is exactly the same from end to end. A new thermocouple ought to be homogenous. An old thermocouple may not be. Thermocouples attached to extension wires are not homogenous and the practice of adding extension wires, for laboratory calibrations, should be avoided. Thermocouple wire that has been kinked or exposed to temperatures, pressures, or chemical environments for which they are not designed may also behave unpredictably because of reductions in homogeneity. However, if a thermocouple is not homogenous (i.e. where a reference junction has been soldered to it) and the temperature is kept constant along the heterogeneous section (i.e. the reference junction is placed in an ice bath), then the previously described errors will be greatly minimized.

Manufacturers of thermocouples usually anneal new thermocouple wire electrically to relieve the mechanical strain introduced



# Thermocouples 101... or, maybe... 401!

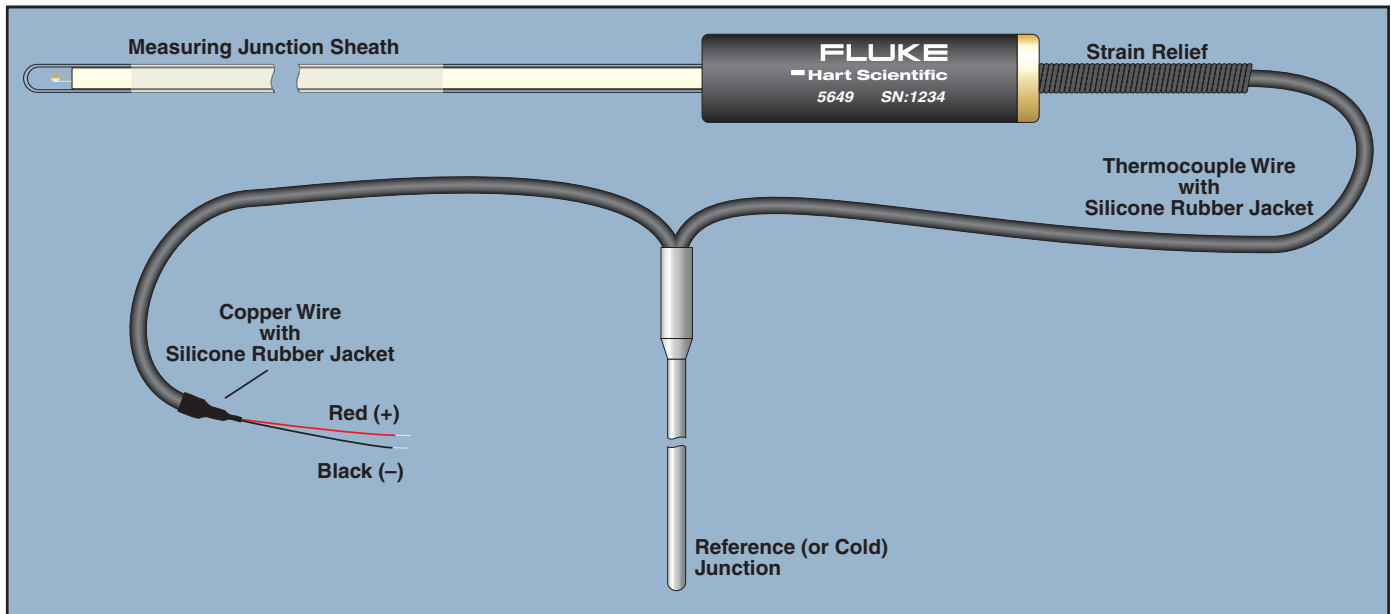

Typical thermocouple construction with a reference or cold junction.

during manufacturing. Also, it is not unusual for laboratories to anneal thermocouples before attempting an accurate calibration. No one knows for sure whether annealing will help when other factors such as contamination have affected homogeneity.

If annealing cannot restore a thermocouple to a homogeneous state, then it should be replaced rather than recalibrated. Homogeneity is often the leading source of error in thermocouple measurements and the leading reason the thermocouple should be thrown away. The lifetime of a thermocouple is affected by its time exposed to extreme temperatures, quenching, vacuum, harsh chemical environments, and mechanical work on the wires.

Be sure to use the correct type and gauge of thermocouple for your application. For example, certain types of thermocouples may be better suited for a particular chemical environment than others. Noble metal thermocouples will make the best reference thermocouples because of their stability over time compared to other thermocouples. A large diameter thermocouple will last longer at elevated temperatures, but a smaller diameter thermocouple will experience less immersion related error.

## To sheath or not to sheath?

Some thermocouples come with a sheath. Sheaths may be ceramic, glass, or metal. The purpose of a sheath is to protect the

thermocouple from its environment. Sheaths do not improve performance, and, in fact, thermocouples with sheaths are less responsive and require more immersion than do similar unsheathed thermocouples. However, using a sheath is preferred to contaminating or mechanically damaging a thermocouple and is therefore a good choice for many applications.

## To calibrate or replace?

Thermocouple types are defined by a particular emf-temperature relationship within a specified limit of error. However, they can be calibrated to achieve results that are more accurate. When a manufacturer makes a set of thermocouples from a particular batch of wire, a sample from that group may be calibrated as representative of the entire group. Individual thermocouple calibrations may achieve more accurate results than a batch calibration.

Thermocouples may be calibrated in a laboratory or in situ. In situ calibrations are recommended for base metal thermocouples. That is because when they are used in a particular application, errors due to changes in the properties of the thermocouple occur that are difficult to reproduce in a laboratory. An in situ calibration is performed using a new thermocouple while the old thermocouple is still in use. Once located side by side, the difference in the indications of the two thermocouples (old and new) allows the

user to determine the tolerance status of the old thermocouple.

Of course, taking everything into consideration, the decision to replace or recalibrate a thermocouple (and how often to recalibrate) is ultimately yours—you being most familiar with its behavior during actual usage conditions.

# Type R and S thermocouple standards



- Designed by Hart's primary standards design team
- Two sizes available, each with or without reference junction
- Uncalibrated accuracy is the greater of  $\pm 0.6^\circ\text{C}$  or  $\pm 0.1\%$  of reading

Made from the finest platinum and platinum-rhodium alloy, the Type R and Type S Thermocouples cover a temperature range of  $0^\circ\text{C}$  to  $1450^\circ\text{C}$  with uncertainties as good as  $0.15^\circ\text{C}$  over most of that range. With four different models for each type, we have the thermocouple to fit your application.

The measuring junction of both the 5649 and the 5650 is encased in a 0.25-inch (6.35 mm) alumina sheath that can be ordered in lengths of 20 or 25 inches (50.8 or 63.5 cm) to fit the specific requirements of your application. A reference, or "cold," junction may also be ordered. The reference junction uses a stainless steel sheath and is 8.25 inches long (21 cm) by 0.188 inches in diameter (4.8 mm). The thin diameter minimizes the immersion depth needed, but the extra length ensures you can get all the immersion you like.

Special tin-plated, solid-copper connecting wires with ultra-low EMF properties are used to help retain the integrity of your measurement junction where the probe attaches to your micro voltmeter or Hart *Black Stack*.

Each probe comes from a spool of wire that has been sample tested using fixed-point standards to ensure uncertainties less than  $0.5^\circ\text{C}$  up to  $1100^\circ\text{C}$ . From  $1100^\circ\text{C}$  to  $1450^\circ\text{C}$ , the uncertainty increases linearly to  $3.0^\circ\text{C}$ . If you need greater accuracy, order an individual calibration with fixed-point standards to reduce uncertainties to  $\pm 0.15^\circ\text{C}$  up to  $962^\circ\text{C}$ ,  $\pm 0.25^\circ\text{C}$  up to  $1100^\circ\text{C}$ , and increasing linearly to  $\pm 2.0^\circ\text{C}$  at  $1450^\circ\text{C}$ .

The probe assembly can be easily disassembled for performing your own bare-wire calibrations.

## Specifications

<b>Range</b>	$0^\circ\text{C}$ to $1450^\circ\text{C}$
<b>Type</b>	Platinum/13 % Rhodium vs. platinum (type R) Platinum/10 % Rhodium vs. platinum (type S)
<b>Calibration</b>	Optional fixed point calibration uncertainties ( $k=2$ ): $\pm 0.15^\circ\text{C}$ up to $962^\circ\text{C}$ , increasing linearly to $\pm 2.0^\circ\text{C}$ at $1450^\circ\text{C}$
<b>Hot Junction Sheath Dimensions</b>	6.35 mm (0.25 in) diameter; see Ordering Information for lengths
<b>Reference Junction Sheath Dimensions</b>	4.8 mm dia. x 210 mm long (0.188 x 8.25 in)
<b>Long-Term Stability</b>	$\pm 0.5^\circ\text{C}$ to $1100^\circ\text{C}$ $\pm 2.0^\circ\text{C}$ to $1450^\circ\text{C}$ (over one year depending on usage)
<b>Short-Term Stabilities</b>	$\pm 0.2^\circ\text{C}$ to $1100^\circ\text{C}$ $\pm 0.6^\circ\text{C}$ to $1450^\circ\text{C}$
<b>Immersion</b>	At least 152 mm (6 in) recommended
<b>Protective Case</b>	Model 2609 case included
<b>Weight</b>	1 kg (2 lb)

## Ordering Information

<b>5649-20-X</b>	Type R TC, 508 mm (20 in)
<b>5649-20CX</b>	Type R TC, 508 mm (20 in), with reference junction
<b>5649-25-X</b>	Type R TC, 635 mm (25 in)
<b>5649-25CX</b>	Type R TC, 635 mm (25 in), with reference junction
<b>5650-20-X</b>	Type S TC, 508 mm (20 in)
<b>5650-20CX</b>	Type S TC, 508 mm (20 in), with reference junction
<b>5650-25-X</b>	Type S TC, 635 mm (25 in)
<b>5650-25CX</b>	Type S TC, 635 mm (25 in), with reference junction

*X = termination. Specify "B" (bare wire), "W" (generic copper-to-copper TC connector), "R" (standard Type R/S TC connector), or "T" (INFO-CON for 1523 and 1524). Models with reference junctions should not specify "R" and models without reference junctions should not specify "W".*

**1918-B** Four-point calibration by fixed point (Sn, Zn, Al, Ag). Extrapolated to  $1450^\circ\text{C}$ .

*Note: Calibration uncertainty for individually calibrated 5650s by fixed point is  $\pm 0.25^\circ\text{C}$  below  $1100^\circ\text{C}$  and  $\pm 2.0^\circ\text{C}$  above  $1100^\circ\text{C}$ . 2609 case included with new models.*

**2609** Spare Case (for 635 mm [25 in] long TC)



# Reference table: letter-designated thermocouple tolerances

This table indicates tolerances on initial values of electromotive force versus temperature for letter designated thermocouples types listed in NIST monograph 175. They apply only to new thermocouple wire. Properties of thermocouple wire will change

with time and use. Due to changes in homogeneity, calibration of used thermocouples unless performed in-situ may yield irrelevant results. All tolerances are in degrees Celsius and a reference junction temperature of 0 °C (32 °F) is assumed.

T (°C)	Standard Tolerances							Special Tolerances					
	T	J	E	K	N	R or S	B	T	J	E	K or N	R or S	B
-200	± 3.0		± 2.0	± 4.0									
-150	± 2.3		± 1.7	± 3.0									
-100	± 1.5		± 1.7	± 2.2									
-50	± 1.0		± 1.7	± 2.2									
0	± 1.0	± 2.2	± 1.7	± 2.2	± 2.2	± 1.5		± 0.5	± 1.1	± 1.0	± 1.1	± 0.6	
50	± 1.0	± 2.2	± 1.7	± 2.2	± 2.2	± 1.5		± 0.5	± 1.1	± 1.1	± 1.1	± 0.6	
100	± 1.0	± 2.2	± 1.7	± 2.2	± 2.2	± 1.5		± 0.5	± 1.1	± 1.2	± 1.1	± 0.6	
150	± 1.1	± 2.2	± 1.7	± 2.2	± 2.2	± 1.5		± 0.6	± 1.1	± 1.3	± 1.1	± 0.6	
200	± 1.5	± 2.2	± 1.7	± 2.2	± 2.2	± 1.5		± 0.8	± 1.1	± 1.4	± 1.1	± 0.6	
250	± 1.9	± 2.2	± 1.7	± 2.2	± 2.2	± 1.5		± 1.0	± 1.1	± 1.5	± 1.1	± 0.6	
300	± 2.3	± 2.3	± 1.7	± 2.3	± 2.3	± 1.5		± 1.2	± 1.2	± 1.2	± 1.2	± 0.6	
350	± 2.6	± 2.6	± 1.8	± 2.6	± 2.6	± 1.5		± 1.4	± 1.4	± 1.4	± 1.4	± 0.6	
400		± 3.0	± 2.0	± 3.0	± 3.0	± 1.5			± 1.6	± 1.6	± 1.6	± 0.6	
450		± 3.4	± 2.3	± 3.4	± 3.4	± 1.5			± 1.8	± 1.8	± 1.8	± 0.6	
500		± 3.8	± 2.5	± 3.8	± 3.8	± 1.5			± 2.0	± 2.0	± 2.0	± 0.6	
550		± 4.1	± 2.8	± 4.1	± 4.1	± 1.5			± 2.2	± 2.2	± 2.2	± 0.6	
600		± 4.5	± 3.0	± 4.5	± 4.5	± 1.5			± 2.4	± 2.4	± 2.4	± 0.6	
650		± 4.9	± 3.3	± 4.9	± 4.9	± 1.6			± 2.6	± 2.6	± 2.6	± 0.7	
700		± 5.3	± 3.5	± 5.3	± 5.3	± 1.8			± 2.8	± 2.8	± 2.8	± 0.7	
750		± 5.6	± 3.8	± 5.6	± 5.6	± 1.9			± 3.0	± 3.0	± 3.0	± 0.8	
800			± 4.0	± 6.0	± 6.0	± 2.0				± 3.2	± 3.2	± 0.8	
850			± 4.3	± 6.4	± 6.4	± 2.1				± 3.4	± 3.4	± 0.9	
900			± 4.5	± 6.8	± 6.8	± 2.3	± 4.5			± 3.6	± 3.6	± 0.9	± 2.3
950				± 7.1	± 7.1	± 2.4	± 4.8				± 3.8	± 1.0	± 2.4
1000				± 7.5	± 7.5	± 2.5	± 5.0				± 4.0	± 1.0	± 2.5
1050				± 7.9	± 7.9	± 2.6	± 5.3				± 4.2	± 1.1	± 2.6
1100				± 8.3	± 8.3	± 2.8	± 5.5				± 4.4	± 1.1	± 2.8
1150				± 8.6	± 8.6	± 2.9	± 5.8				± 4.6	± 1.2	± 2.9
1200				± 9.0	± 9.0	± 3.0	± 6.0				± 4.8	± 1.2	± 3.0
1250				± 9.4	± 9.4	± 3.1	± 6.3				± 5.0	± 1.3	± 3.1
1300						± 3.3	± 6.5					± 1.3	± 3.3
1350						± 3.4	± 6.8					± 1.4	± 3.4
1400						± 3.5	± 7.0					± 1.4	± 3.5
1450						± 3.6	± 7.3					± 1.5	± 3.6
1500							± 7.5						± 3.8
1550							± 7.8						± 3.9
1600							± 8.0						± 4.0
1650							± 8.3						± 4.1
1700							± 8.5						± 4.3



# Temperature conversion table

To convert a temperature from Celsius to another temperature scale, first find the Celsius temperature in the left column and look up the Fahrenheit or Kelvin temperature in the adjacent columns.

$$^{\circ}\text{C} = 5/9 (^{\circ}\text{F} - 32)$$

$$^{\circ}\text{F} = 9/5^{\circ}\text{C} + 32$$

$$\text{Kelvin} = ^{\circ}\text{C} + 273.15$$

$^{\circ}\text{C}$	$^{\circ}\text{F}$	K	$^{\circ}\text{C}$	$^{\circ}\text{F}$	K	$^{\circ}\text{C}$	$^{\circ}\text{F}$	K	$^{\circ}\text{C}$	$^{\circ}\text{F}$	K	$^{\circ}\text{C}$	$^{\circ}\text{F}$	K
-200	-328	73.15	170	338	443.15	540	1004	813.15	910	1670	1183.15	1280	2336	1553.15
-195	-319	78.15	175	347	448.15	545	1013	818.15	915	1679	1188.15	1285	2345	1558.15
-190	-310	83.15	180	356	453.15	550	1022	823.15	920	1688	1193.15	1290	2354	1563.15
-185	-301	88.15	185	365	458.15	555	1031	828.15	925	1697	1198.15	1295	2363	1568.15
-180	-292	93.15	190	374	463.15	560	1040	833.15	930	1706	1203.15	1300	2372	1573.15
-175	-283	98.15	195	383	468.15	565	1049	838.15	935	1715	1208.15	1305	2381	1578.15
-170	-274	103.15	200	392	473.15	570	1058	843.15	940	1724	1213.15	1310	2390	1583.15
-165	-265	108.15	205	401	478.15	575	1067	848.15	945	1733	1218.15	1315	2399	1588.15
-160	-256	113.15	210	410	483.15	580	1076	853.15	950	1742	1223.15	1320	2408	1593.15
-155	-247	118.15	215	419	488.15	585	1085	858.15	955	1751	1228.15	1325	2417	1598.15
-150	-238	123.15	220	428	493.15	590	1094	863.15	960	1760	1233.15	1330	2426	1603.15
-145	-229	128.15	225	437	498.15	595	1103	868.15	965	1769	1238.15	1335	2435	1608.15
-140	-220	133.15	230	446	503.15	600	1112	873.15	970	1778	1243.15	1340	2444	1613.15
-135	-211	138.15	235	455	508.15	605	1121	878.15	975	1787	1248.15	1345	2453	1618.15
-130	-202	143.15	240	464	513.15	610	1130	883.15	980	1796	1253.15	1350	2462	1623.15
-125	-193	148.15	245	473	518.15	615	1139	888.15	985	1805	1258.15	1355	2471	1628.15
-120	-184	153.15	250	482	523.15	620	1148	893.15	990	1814	1263.15	1360	2480	1633.15
-115	-175	158.15	255	491	528.15	625	1157	898.15	995	1823	1268.15	1365	2489	1638.15
-110	-166	163.15	260	500	533.15	630	1166	903.15	1000	1832	1273.15	1370	2498	1643.15
-105	-157	168.15	265	509	538.15	635	1175	908.15	1005	1841	1278.15	1375	2507	1648.15
-100	-148	173.15	270	518	543.15	640	1184	913.15	1010	1850	1283.15	1380	2516	1653.15
-95	-139	178.15	275	527	548.15	645	1193	918.15	1015	1859	1288.15	1385	2525	1658.15
-90	-130	183.15	280	536	553.15	650	1202	923.15	1020	1868	1293.15	1390	2534	1663.15
-85	-121	188.15	285	545	558.15	655	1211	928.15	1025	1877	1298.15	1395	2543	1668.15
-80	-112	193.15	290	554	563.15	660	1220	933.15	1030	1886	1303.15	1400	2552	1673.15
-75	-103	198.15	295	563	568.15	665	1229	938.15	1035	1895	1308.15	1405	2561	1678.15
-70	-94	203.15	300	572	573.15	670	1238	943.15	1040	1904	1313.15	1410	2570	1683.15
-65	-85	208.15	305	581	578.15	675	1247	948.15	1045	1913	1318.15	1415	2579	1688.15
-60	-76	213.15	310	590	583.15	680	1256	953.15	1050	1922	1323.15	1420	2588	1693.15
-55	-67	218.15	315	599	588.15	685	1265	958.15	1055	1931	1328.15	1425	2597	1698.15
-50	-58	223.15	320	608	593.15	690	1274	963.15	1060	1940	1333.15	1430	2606	1703.15
-45	-49	228.15	325	617	598.15	695	1283	968.15	1065	1949	1338.15	1435	2615	1708.15
-40	-40	233.15	330	626	603.15	700	1292	973.15	1070	1958	1343.15	1440	2624	1713.15
-35	-31	238.15	335	635	608.15	705	1301	978.15	1075	1967	1348.15	1445	2633	1718.15
-30	-22	243.15	340	644	613.15	710	1310	983.15	1080	1976	1353.15	1450	2642	1723.15
-25	-13	248.15	345	653	618.15	715	1319	988.15	1085	1985	1358.15	1455	2651	1728.15
-20	-4	253.15	350	662	623.15	720	1328	993.15	1090	1994	1363.15	1460	2660	1733.15
-15	5	258.15	355	671	628.15	725	1337	998.15	1095	2003	1368.15	1465	2669	1738.15
-10	14	263.15	360	680	633.15	730	1346	1003.15	1100	2012	1373.15	1470	2678	1743.15
-5	23	268.15	365	689	638.15	735	1355	1008.15	1105	2021	1378.15	1475	2687	1748.15
0	32	273.15	370	698	643.15	740	1364	1013.15	1110	2030	1383.15	1480	2696	1753.15
5	41	278.15	375	707	648.15	745	1373	1018.15	1115	2039	1388.15	1485	2705	1758.15
10	50	283.15	380	716	653.15	750	1382	1023.15	1120	2048	1393.15	1490	2714	1763.15
15	59	288.15	385	725	658.15	755	1391	1028.15	1125	2057	1398.15	1495	2723	1768.15
20	68	293.15	390	734	663.15	760	1400	1033.15	1130	2066	1403.15	1500	2732	1773.15
25	77	298.15	395	743	668.15	765	1409	1038.15	1135	2075	1408.15	1510	2750	1783.15
30	86	303.15	400	752	673.15	770	1418	1043.15	1140	2084	1413.15	1520	2768	1793.15
35	95	308.15	405	761	678.15	775	1427	1048.15	1145	2093	1418.15	1530	2786	1803.15
40	104	313.15	410	770	683.15	780	1436	1053.15	1150	2102	1423.15	1540	2804	1813.15
45	113	318.15	415	779	688.15	785	1445	1058.15	1155	2111	1428.15	1550	2822	1823.15
50	122	323.15	420	788	693.15	790	1454	1063.15	1160	2120	1433.15	1560	2840	1833.15
55	131	328.15	425	797	698.15	795	1463	1068.15	1165	2129	1438.15	1570	2858	1843.15
60	140	333.15	430	806	703.15	800	1472	1073.15	1170	2138	1443.15	1580	2876	1853.15
65	149	338.15	435	815	708.15	805	1481	1078.15	1175	2147	1448.15	1590	2894	1863.15
70	158	343.15	440	824	713.15	810	1490	1083.15	1180	2156	1453.15	1600	2912	1873.15
75	167	348.15	445	833	718.15	815	1499	1088.15	1185	2165	1458.15	1610	2930	1883.15
80	176	353.15	450	842	723.15	820	1508	1093.15	1190	2174	1463.15	1620	2948	1893.15
85	185	358.15	455	851	728.15	825	1517	1098.15	1195	2183	1468.15	1630	2966	1903.15
90	194	363.15	460	860	733.15	830	1526	1103.15	1200	2192	1473.15	1640	2984	1913.15
95	203	368.15	465	869	738.15	835	1535	1108.15	1205	2201	1478.15	1650	3002	1923.15
100	212	373.15	470	878	743.15	840	1544	1113.15	1210	2210	1483.15	1660	3020	1933.15
105	221	378.15	475	887	748.15	845	1553	1118.15	1215	2219	1488.15	1670	3038	1943.15
110	230	383.15	480	896	753.15	850	1562	1123.15	1220	2228	1493.15	1680	3056	1953.15
115	239	388.15	485	905	758.15	855	1571	1128.15	1225	2237	1498.15	1690	3074	1963.15
120	248	393.15	490	914	763.15	860	1580	1133.15	1230	2246	1503.15	1700	3092	1973.15
125	257	398.15	495	923	768.15	865	1589	1138.15	1235	2255	1508.15	1710	3110	1983.15
130	266	403.15	500	932	773.15	870	1598	1143.15	1240	2264	1513.15	1720	3128	1993.15
135	275	408.15	505	941	778.15	875	1607	1148.15	1245	2273	1518.15	1730	3146	2003.15
140	284	413.15	510	950	783.15	880	1616	1153.15	1250	2282	1523.15	1740	3164	2013.15
145	293	418.15	515	959	788.15	885	1625	1158.15	1255	2291	1528.15	1750	3182	2023.15
150	302	423.15	520	968	793.15	890	1634	1163.15	1260	2300	1533.15	1760	3200	2033.15
155	311	428.15	525	977	798.15	895	1643	1168.15	1265	2309	1538.15	1770	3218	2043.15
160	320	433.15	530	986	803.15	900	1652	1173.15	1270	2318	1543.15	1780	3236	2053.15
165	329	438.15	535	995	808.15	905	1661	1178.15	1275	2327	1548.15	1790	3254	2063.15

# Why did my temperature sensor fail calibration?

Temperature is the most commonly measured parameter in the world. Temperature sensors are used in instruments designed for measuring temperature. To be accurate, all temperature sensors must be calibrated against a known standard. Only short-term stability is checked during calibration. Long term stability should be monitored and determined by the user.

Occasionally, a temperature sensor might fail during calibration. This can happen even though the temperature sensor seemed to be functioning properly prior to sending it in for calibration. This article gives some basic reasons for temperature sensor failures and offers some suggestions to ensure their accuracy and maximize their useable life. In addition, some background knowledge is given on each temperature sensor type, including basic characteristics and their limitations.

## Common temperature sensor types

Thermistors, platinum resistance thermometers (PRTs), and thermocouples are the instruments of choice for most temperature measurement applications. Each has specific characteristics and limitations. Normally, these instruments are reliable and give years of trouble-free service. Mistreating them, however, greatly affects their accuracy and useful life. Therefore, it's imperative that they be handled and used properly. To do so, you must understand how they operate and what their limitations are.

### Thermistors

Thermistors are among the most robust of all temperature sensors. They are constructed of a solid state device that acts like a variable resistor. As the temperature changes, so does its resistance. These devices have excellent sensitivity and accuracy. They come in a wide range of resistance values. They have excellent long term drift characteristics and are not shock sensitive, nor do they suffer from other concerns that other thermometer types may have. Because they are not shock sensitive, their calibrations generally are not affected by minor vibration, being bumped or dropped. However, their temperature ranges are usually limited to 100 °C span.

### Platinum resistance thermometers (PRTs)

PRTs are perhaps the most versatile of all temperature sensors because of their wide temperature range and high accuracy. Most are usable from -196 °C to 420 °C, with a few exceptions that reach up to 500 °C or even higher. This, of course,



depends on individual model specifications and their respective calibrations.

Even though PRTs are highly accurate and cover a wide temperature range, they do have limitations. Unlike thermistors, PRTs are subject to changes in calibration if the platinum wire is contaminated, exposed to vibration, bumped or dropped (see photo next page). Changes in calibration through these processes are

cumulative. Therefore, great care must be taken when handling and using PRTs.

### Thermocouples

Base metal thermocouples have advantages in that they have a very broad temperature range and are low in cost. Their disadvantages include relatively low accuracy and, at very high temperatures, they are susceptible to inhomogeneity. Nobel metal thermocouples have a very broad

# Why did my temperature sensor fail calibration?



Damaged coils from a dropped sensor.

temperature range with higher accuracy, but they cost more. Like base metal thermocouples, they are also susceptible to inhomogeneity.

## Causes of failure during calibration

### Self-heating in thermistors and PRTs

When thermistors and PRTs are calibrated, a nominal excitation current is applied. The amount of current that's required is generally stated on the calibration report or manufacturer's specifications.

We learn from Ohms Law that when a current flows through a resistor, power is dissipated ( $I^2R$ ). This power causes the sensor to heat; which is known as "self-heating." When the temperature sensor is calibrated, its self-heating has been accounted for.

When using either sensor type, be sure to set the readout for the proper excitation current. Too little or too much current will cause measurement errors. These sensors can even be damaged if too much current is applied.

Some readouts will automatically choose the proper current when either "thermistor" or "PRT" is selected. Others may need to be set manually. The settings are generally in the probe setup menu. If you select the current manually, always

refer to the thermometer's specifications or calibration report for the proper current.

### Low insulation resistance and leakage currents

Low insulation resistance is sometimes referred to as shunt resistance, because current is allowed to flow outside of the measurement circuit. Electrically, it is like putting another resistance in parallel with the sensor. When low insulation resistance occurs, too often the transition junction temperature has become too hot. (The hub should not be so hot that it is painful to touch.)

Additionally, low insulation resistance may result if the sheath has been bent, or if the seal has been compromised, allowing moisture to reach the sensor and lead wires. This problem usually can be avoided through proper use and handling (see resistance illustration).

### Transition junctions

Thermistors and PRTs generally have transition junctions. The transition junction is where the cable lead wires connect to the sensor lead wires. The lead wires will either be soldered or spot welded. If they are soldered and the junction gets too hot, the solder will melt, causing an open or intermittent condition.

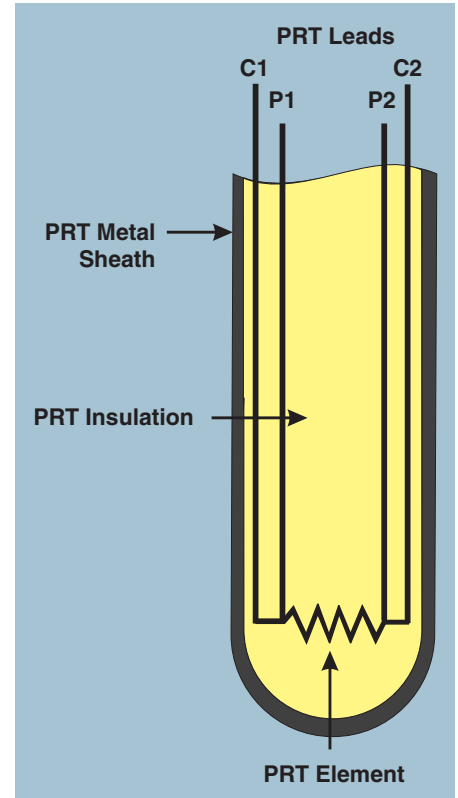

The resistance of the insulation between the metal sheath and any of the four PTR leads prevents leakage currents.

Usually, the junction is sealed with epoxy to keep out moisture and other contaminants. If the seal is subjected to temperatures that are beyond what the epoxy can handle, the seal may crack. This allows moisture and other contaminants to penetrate the seal and reach the lead wires and sensor. Moisture accumulation is most noticeable when the temperature sensor is left to soak at temperatures below ambient or if the ambient humidity is high.

PRTs are often packed with powdered insulative material. This material makes the PRT less susceptible to stress caused by mechanical shock. Unless a good seal exists, at low temperatures the insulation absorbs moisture from the air. Moisture or other contaminants create errors in the measurements and cause the temperature sensor to fail calibration. Trapped moisture can also present a safety concern. If the insulation has absorbed a lot of moisture and the temperature sensor is put into a high temperature heat source, the moisture will turn to steam, possibly causing the seal to blow or rupture the sheath.



# Why did my temperature sensor fail calibration?

## Broken or intermittent lead wires

If the temperature sensor cable is pulled, overworked or stressed, the lead wires may break, causing an open or an intermittent connection. On occasion, open or intermittent sensor or sensor lead wires may occur. Some intermittent events are not noticeable until the temperature sensor is heated, causing the wire to expand and separate.

Even if great care has been taken to prevent broken or intermittent connections, they still may occur given enough time and use. The repeated expansion and contraction of the lead and sensor wires may eventually take its toll, causing the wire to break.

## Contamination

Contamination can be caused by chemicals, metal ions or oxidation.

Chemical contamination can occur in PRTs if a liquid reaches the lead or sensor wires. This can change the purity of the platinum, which alters its electrical characteristics. Any changes in the purity will be permanent.

Metal Ion contamination of platinum wire usually occurs at 600 °C and higher. Because PRT sensors are manufactured using high purity platinum wire, they are the most susceptible to this type of contamination. Metal ion contamination is not reversible and will cause a PRT to constantly drift upwards in temperature. This is particularly noticeable in a triple-point-of-water cell, where the reference temperature is extremely stable. When a PRT is manufactured for extremely high temperatures, it's constructed in such a way that the sensor is protected from ion contamination.

Temperature sensor sheaths are usually sealed to guard against contamination. Both industrial and secondary temperature sensors are not evacuated before being sealed. Generally, therefore, there will be some dry air inside them. When they are exposed to various temperatures, oxidation can form on the surface of the wire. Oxidation primarily affects temperature sensors whose sensing elements contain platinum wire. Oxidation causes an increase in RTPW (resistance at the water triple point) in metallic RTDs. Fortunately, oxidation can be removed by annealing the RTD, using the manufacturer's recommended temperature and procedure. Before and after annealing, compare the temperature sensor with a standard of superior accuracy such as a triple point of water cell. This allows you to determine whether the procedure was

successful, and it helps you keep a history of the temperature sensor's performance.

## Hysteresis and non-repeatability

Hysteresis is a condition in which temperature sensor's readings lag behind or appear to have a "memory" effect as the thermometer is moved through a sequential range of temperatures. Measured values depend on the previous temperature in which the sensor or wire was exposed. If a temperature sensor is taken through a range of temperatures for the first time—let's say, from cold to hot—it will follow a particular curve. If the measurements are repeated in the reverse order, (hot to cold in our example), a thermometer that has a hysteresis problem will have an offset from the previous set of measurements. If repeated, the amount of offset may not always be the same.

Hysteresis does not occur with undamaged standard platinum resistance thermometers (SPRTs), because SPRTs are designed to be strain free. PRTs that are designed to be rugged, however, do not have a strain-free design and have at least some hysteresis. Moisture ingress, or moisture penetrating inside the temperature sensor, causes hysteresis in RTDs of any type.

## Inhomogeneity

When a thermocouple is used at high temperatures, its wire may become contaminated. This causes the local Seebeck coefficient of the wire to change from its initial state. In other words, this alters the sensitivity of the wire to changes in temperature. However, the temperature exposure and contamination may not be uniform along the length of the thermocouple. The Seebeck coefficient then becomes a function of position along the thermocouple. This leads to measurement errors that depend on the temperature profile the thermocouple is exposed to all along the length of the thermocouple, and not just the temperature at the measurement junction.

## Short term stability

Measurement repeatability is a term than can be used many different ways. It should be defined by the person using the term. It often refers to the RTPW repeatability during a segment of thermal cycling or a calibration process.

When a temperature sensor fails to meet its short term stability specification, it means the deviation between measurements at a particular temperature is outside its specification. This could be caused by a large standard deviation or by

readings that continually drift in one direction. Potential causes for short-term stability problems include moisture, contamination, strain, leakage current, mechanical shock and inhomogeneity.

## Ways to help prevent temperature sensor failure

To avoid contamination, take proper precautions when using temperature sensors in harsh environments. Do not subject the transition junction to higher or lower temperatures than the epoxy seal or transition junction can handle. Refer to the temperature sensor's specifications or contact the temperature sensor manufacturer for the transition junction temperature specification. If there is a possibility that the transition junction could be exposed to high or even marginally high temperatures, a heat shield or heat sink is recommended.

## Other ways to help prevent failure:

- Do not drop, bump, or vibrate a PRT.
- Never bend a sheath that isn't designed to be bent. Even slight bends may adversely affect the calibration or temperature sensor life.
- Never submerge the transition junction into a liquid.
- Never exceed the temperature specification of the temperature sensor.
- Do not soak temperature sensors for long periods of time, particularly at temperatures where oxidation is likely to occur.
- Do not pull or overly strain the temperature sensor cable.
- If a temperature sensor requires annealing, use recommended temperatures and techniques. Afterwards, always verify the temperature sensors accuracy by comparing it against a primary standard.
- Periodically compare the temperature sensor's accuracy to a primary standard, such as a water-triple-point cell or a calibrated SPRT (standard platinum resistance thermometer)

# Software selection guide

Model	Name	Description	Page
9930	Interface- <i>it</i>	Windows-based interface to all Hart dry-wells and baths that include an RS-232 port (virtually all units). Provides access to all controller functions and the ability to graphically monitor the temperature displayed on the heat source.	96
9938	MET/TEMP II	Complete calibration system software. Communicates with Hart thermometers & heat sources to control & take readings. Generates calibration constants and reference tables. Now works with Fluke MET/TRACK!	97
9933	TableWare	Generates calibration constants and reference tables based on calibration data entered by the user.	100
9934	LogWare	Turns any 1-channel Hart thermometer readout (1523, 1502A, 1504, etc.) into a real-time data logger. Includes flexible graphing functions as well as statistics for logged data. Also provides programming, downloading, and data analysis tool for Hart logging thermometers.	101
9935	LogWare II	Graphical data analysis software for multi-channel thermometers (1529, 1560, 1575A, 1590). Works in real-time or from downloaded data sets.	
9936A	LogWare III	Database-oriented real-time temperature and humidity logging software for the 1620/5020A and 1620A "DewK" Thermo-hygrometers. Also includes tools for downloading, importing, exporting, and analyzing logged data.	102

## Interface-*it*

- Free with nearly every Hart heat source
- Provides PC access to Hart controller functions
- Graphically displays heat source temperatures

The Hart Scientific 9930 Interface-*it* software package and a serial cable are included with almost every Hart dry-well and bath that has an RS-232 interface. The 9930 lets you use your own PC to access many of the instrument's functions including set-points, temperature units,

scan functions, ramp and soak program (if included in dry-well's or bath's firmware), duty cycle, proportional band, and more! Calibration constants can also be accessed, but access can be limited using a password.

Interface-*it* also lets you log readings to a text file, and perform fully automated thermal switch tests with dry-wells that support this feature. Interface-*it* can do this and more, all from your PC! You have probably seen so-called automation software packages from other companies with fewer features than you get with our free Interface-*it* software.

Don't have an RS-232 (COM) port on your computer? No problem. Using a USB to RS-232 converter, you can add a virtual COM port to any computer. Contact an Application Specialist for more details and recommendations.

Interface-*it* is free software. New updates are always posted on our web site and can be downloaded and installed in a few minutes. Remember to check our web site regularly to obtain the latest version of the software including known bug fixes, new features, and support for new instruments.

If you need more features, such as fully automated sensor calibration or data logging software, check out our entire list of functional logging and calibration software.

### Ordering Information

9930	Interface- <i>it</i> Software
2383	USB to RS-232 Adapter

# MET/TEMP II

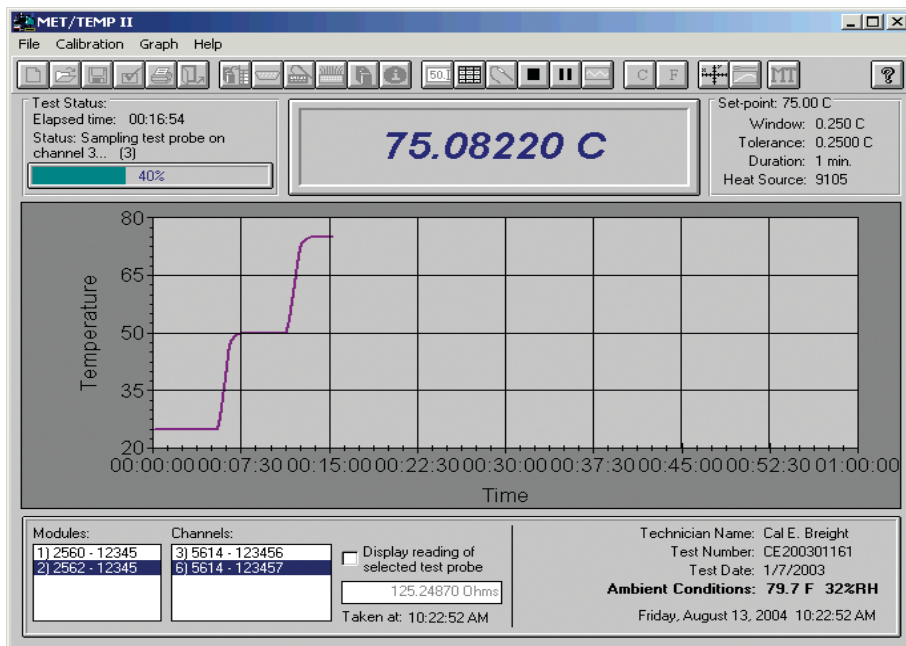

- Fully automated calibration of RTDs, TCs, thermistors, and many heat sources
- Calibrates up to 100 sensors at up to 40 points
- Performs coefficient calculations and generates tables and reports
- Includes optional integration with Fluke's MET/TRACK® database

Few things matter in your work more than productivity. And few things can help make you more productive than well-written automation software. We've got the world's best temperature calibration automation software—exactly what you need to be productive. It's Windows® based and it's easy to use.

You may be familiar with the Hart automation software duo *Calibrate-it* and *Generate-it*. Now both come in a single package. We call it MET/TEMP II! Written by the same Hart Scientific temperature experts that brought you the original *Calibrate-it* and *Generate-it* software, this new package interfaces with Fluke's MET/TRACK software—the industry standard for asset management. Calibrating sensors manually is expensive because of labor costs. It takes roughly four hours to calibrate a sensor at three points, then another hour on top of that for paperwork to document the temperature data and to create the certificate. This is much too time-consuming. Now there's a better way.

With MET/TEMP II, you simply place your test sensors in a heat source, connect

them to a readout, enter your setup information, and start the test. Sometime later, hit your print button, take the reports out of your printer, sign them, and ship the sensors back to your customer. Your customers will love the fast turnaround.

It's your choice. Spend four hours the old way and handle everything manually, or fifteen minutes with our software and have plenty of time to read your e-mail.

This software package tests thermocouples (all types), RTDs, SPRTs, thermistors, and even liquid-in-glass thermometers (LIGs). Virtually any sensor with a resistance or voltage output can be tested, up to 100 sensors at a time. They don't even have to be the same type. You can select as few as 1 or as many as 40 temperatures at which to test your sensors. Nobody makes more ultra-stable heat sources and thermometer readouts for temperature calibration work than Hart Scientific. MET/TEMP II can use nearly every one of them. You don't need to worry about special software drivers for each different piece of equipment. Just plug and play.

Use MET/TEMP II with these instruments:

### Thermometer readouts

- 1590 Super-Thermometer II (With up to five 2590 Mighty-Mux II's optional)
- 1575A Super-Thermometer (2575 Mighty-Mux optional)
- 1560 *Black Stack* (with any combination of modules)
- 1529 Chub-E4 Readout
- 1502, 1503, 1504 Tweener Readouts
- 1523, 1524 Handheld Readouts
- Fluke Hydra series dataloggers

### Heat sources

- All Hart baths with RS-232
- All Hart dry-wells with RS-232, including 9112 & 9114 furnaces
- All Hart Metrology Wells
- Fluke dry-block models 514, 515, 517, 518
- Any other heat source (temperatures must be set manually)

Did we mention that MET/TEMP II also works with the Fluke Hydra Series II data loggers?

You can even calibrate heat sources such as Hart dry-wells and micro-baths with this software.

A new feature now allows MET/TEMP II to interface with the 1620A "DewK" Thermo-Hyrometer to record ambient temperature and humidity conditions during the test process.

MET/TEMP II also lets you perform semi-automated fixed-point calibrations. The software allows you to program soak times in the cell before taking readings. You may even mix fixed points with comparison points in the same calibration. Of course, we also include fixed-point information on the new report layout.

If you use the 1560 *Black Stack*, you can simultaneously calibrate up to 64 RTDs, 64 thermistors, 96 thermocouples, or any combination. That's a lot of sensors.

MET/TEMP II allows you to track the model and serial numbers, calibration and due dates of all test equipment and sensors under test. Optionally, this data may be synchronized with information in your MET/TRACK database. MET/TEMP II also stores customer names and addresses for printing on reports.

With MET/TEMP II, you make your own choices regarding precision and throughput. When setting up tests, you specify the required stability level at each set-point to ensure that readings are taken only under the conditions you require. You'll get the



# MET/TEMP II

exact level of precision you want based on the equipment you have and the calibration time you set

MET/TEMP II will interface with MET/TRACK to record calibration and maintenance history, traceability information, and even the location of your thermometer readouts and heat sources. Use it with MET/TRACK and watch your productivity take a big step up.

Calibration reports are automatically created from your setup data and test results. Each report conforms completely to the requirements of ANSI/NCSL Z540-1. It's fast, it's accurate, and it's complete. MET/TEMP II even allows you to print your company's logo on the report!

This is true Windows® software. It runs on Windows® 9x/ME/2000/NT/XP and includes a context-sensitive online help system. Just click the help button (or press F1) from any screen and you'll get the information you need. When you experience the interface of this software, you'll agree nothing could be easier.

The MET/TEMP II Coefficients and Tables application (formerly Generate-it) is included and contains utilities for data analysis. It can calculate coefficients and residuals for each sensor tested. Tables can be generated with temperature versus-resistance, temperature-versus-ratio, or temperature-versus-EMF data. Each table can be generated in °C, °F, or K and in increments from 0.01 to 100.

For PRTs, MET/TEMP II can calculate coefficients for ITS-90, IPTS-68, Callendar-Van Dusen, and polynomial functions. For thermistors, it can calculate coefficients for polynomial functions, including Steinhart-Hart. Thermocouple coefficients can be calculated for types B, E, J, K, N, R, S, T, and AuPt. This software even allows you to verify that the



MET/TEMP II software can be used with any Hart thermometer readout, and it controls any combination of Hart dry-wells and baths. Choose from more than 9 readouts and 40 heat sources to calibrate up to 100 sensors automatically. Whether you need 1 mK accuracy for advanced metrology work or 1 °C accuracy for industrial sensors, Hart has the equipment to fit your application. It also provides quick and accurate generation of sensor coefficients and tables.

appropriate temperatures are used to calculate coefficients.

Need subranges in ITS-90? No problem. Want to print tables for any temperature range and in any incremental amounts? No problem. Need to generate formatted reports that conform to ANSI/NCSL Z540-1 with your own logo? No problem.

Data can also be exported to spreadsheets or other statistical analysis software as comma-delimited or tab-delimited text. MET/TEMP II does all of that and more, but best of all it does it automatically.

There's not much you could ever want to do that this package won't do. This is real calibration software, not merely a data acquisition package with a fancy name!

Other software packages work with one or two instruments; they won't control the wide variety of heat sources our software does. Other software doesn't fully automate the calibration process.

Control dry-wells, baths, readouts, and the entire calibration process. Store data on test equipment and on sensors under test.

When you've got more work to do than you can do in a 12-hour day, and you still need some time to visit accounting to straighten out a few things, MET/TEMP II will take care of business for you. Go home. Spend some time with your kids. Play a game of golf. It's your choice how you spend your time!

MET/TEMP II can do all of this using a single RS-232 (COM) port. Hardware is

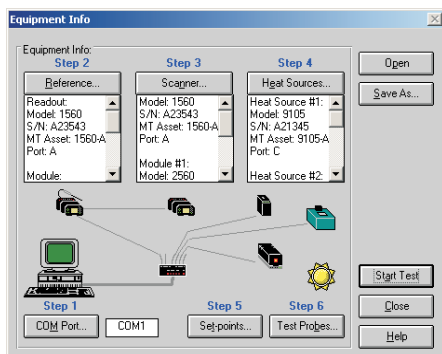

Instrument configuration screen.

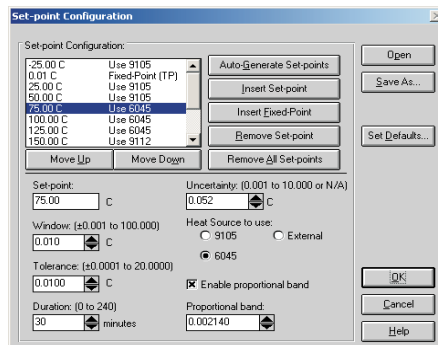

Set-point configuration screen.

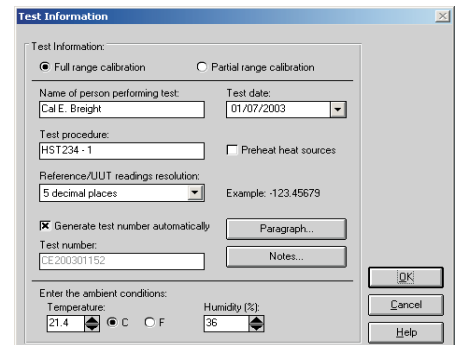

Test information screen.

# MET/TEMP II

included to connect up to 6 interfaced instruments to the PC. Additional null-modem cables are required to connect instruments to the hardware (not included). Don't forget to order additional cables! Don't have an RS-232 (COM) port on your computer? No problem. Using a USB to RS-232 converter, you can add a virtual COM port to any computer. Contact an Application Specialist for more details and recommendations.

In order to interface MET/TEMP II with the MET/TRACK database, you must have MET/TRACK v7.01 or later and you must purchase and apply a MET/TEMP II license to the MET/TRACK database (sold separately).

Download a free working demo version from our web site today! Remember to check our web site regularly to obtain the latest Service Releases and updates for the software including known bug fixes, new features, and support for new instruments. Updates are always posted on our web site and can typically be downloaded and installed in a few minutes.

## Ordering Information

- 9938** MET/TEMP II Software (package includes CD-ROM, RS-232 multiplexer box, adapter, and PC cable)
- LIC-9938** MET/TRACK License
- 2383** USB to RS-232 Adapter

## Application note (literature code 3084747):

**Calculating calibration uncertainties in an automated temperature calibration system**

Automation makes calibration easy. Now we do the same for uncertainty analysis.



Go to [www.hartscientific.com/publications](http://www.hartscientific.com/publications) for a detailed application note.

## Report of Calibration

Report No: CE200206126-002  
Page 1 of 1

Temp Tech Co.  
105 Celcius Drive  
Out Town, USA  
34567-8998

Model: 5614 Serial: 365232 Description: Probe, Secondary Standard	Customer: Our Customer One Customer Way Technology Drive Any Town, USA 23456
Calibration Range: Full Received Condition: New Current: 1.0 mA Procedure: HST000 - 0	

The above referenced instrument was calibrated by direct measurement of generated temperatures using the reference standards listed in the "Test Equipment" table at the bottom of this report. The internal calibration coefficients and the data obtained are shown on page 2. A Test Uncertainty Ratio (TUR) of at least 4:1 was maintained unless otherwise indicated. This calibration is traceable to NIST or natural physical constants and is in compliance with ANSI/NCSL Z540-1 and MIL-STD 45662A.

Nominal (Set-point) (C)	Actual Value (Reference) (C)	UUT (Test Sensor) (Ohms)	Measurement Uncertainty (C)	Method of Realization
-25.00	-24.9697	89.2564	0.050	COMP
0.01	0.0100	100.0235	0.010	TP
25.00	25.0155	110.2354	0.050	COMP
50.00	49.9895	123.5642	0.050	COMP
75.00	75.0045	132.2514	0.050	COMP
100.00	99.9692	138.2563	0.050	COMP
125.00	124.9835	145.0251	0.050	COMP

## Test Equipment

Manufacturer	Model	Description	Serial Number	Recall Date
Hart Scientific, Inc.	1529	"Chub-E4" Thermometer 2-RTD/2-TC	A23564	6/30/2002
Hart Scientific, Inc.	5614	Secondary Reference Temperature Std., 1/4" x 12"	360984	1/17/2003
Hart Scientific, Inc.	5901	TPW	123456	2/1/2003
Hart Scientific, Inc.	9105	Drywell, Low-Temperature	A23765	NCR

Notes: This test was performed in accordance with the test procedure indicated above.

Calibration Date: 6/3/2002  
Recall Date: 6/3/2003  
Temperature: 21 C  
Humidity: 25%  
Customer Order: 54543-544S

Technician: \_\_\_\_\_  
Cal E. Breight

Approved By: \_\_\_\_\_

*This report shall not be reproduced except in full without written approval of Temp Tech Co..*

MET/TEMP II software creates test reports that fully comply with ANSI/NCSL Z540-1 requirements. Among the features included in each report are report numbers, pagination, test procedure numbers, test data, stated uncertainties, and test results shown as tolerances. Two locations are also available on the report for special notes.

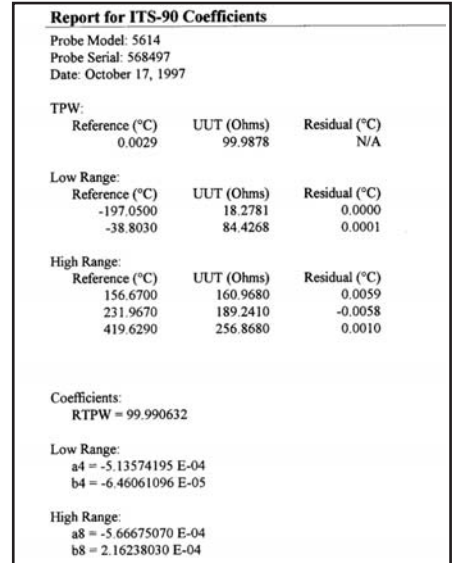
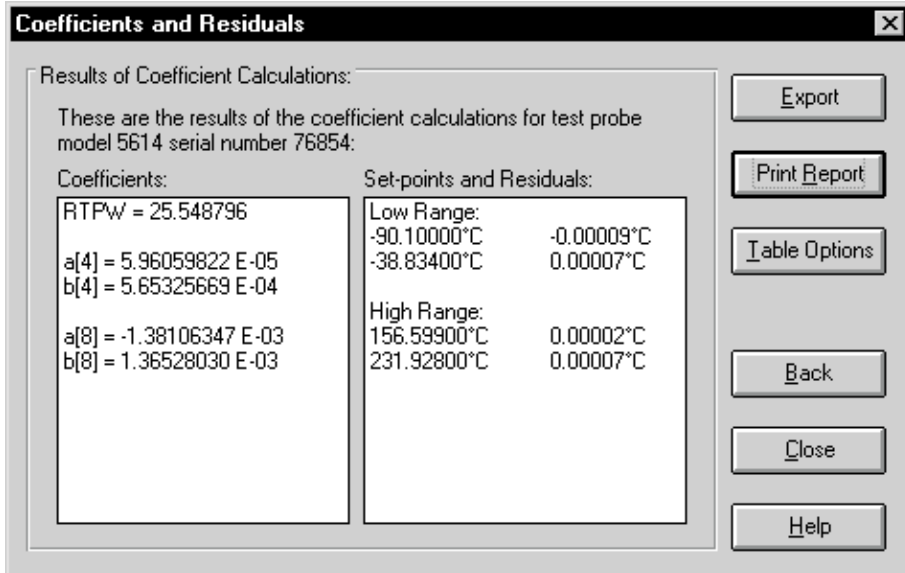

- Calculates coefficients for RTDs, thermistors, and thermocouples
- Generates three types of temperature tables
- Easy-to-use, time-saving interface
- Outputs to ASCII text file or printed report

Okay, you know about the benefits of our MET/TEMP II software, but you didn't order your Hart instruments with RS-232 ports, or maybe you've made the mistake of buying less capable products.

Well, you don't need to worry, because we've got something for you, too! Our TableWare software package does almost everything that MET/TEMP II's Coefficients and Tables Application does, but allows you to manually enter the data. It still saves you time and money on your calculations, so it's a great buy.

TableWare calculates coefficients for RTDs, thermistors, and thermocouples. It supports ITS-90, IPTS-68, Callendar-Van Dusen, and polynomial equations, including standard thermocouple types. It calculates coefficients using either direct or over-determined solutions and calculates residuals at each data point.

TableWare also generates temperature-versus-resistance, temperature-versus-ratio, and temperature-versus-EMF tables at increments down to 0.01. And it includes functions for importing and exporting data and tables for use with other data analysis programs.

You simply enter or import the raw resistance or voltage data from your calibrations. TableWare generates coefficients, calculates residual values, and generates useful tables.

TableWare is reasonably priced and works the way you do.

## Ordering Information

- |             |                       |
|-------------|-----------------------|
| <b>9933</b> | TableWare Software    |
| <b>2383</b> | USB to RS-232 Adapter |

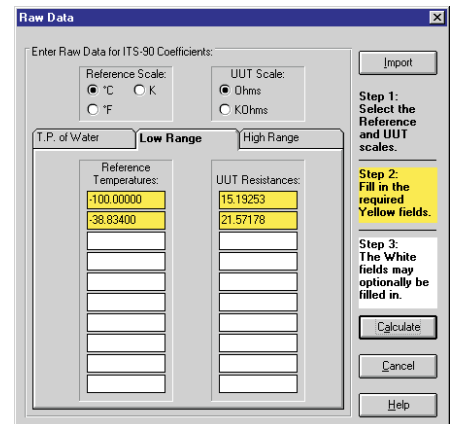

Input screen.



# LogWare and LogWare II

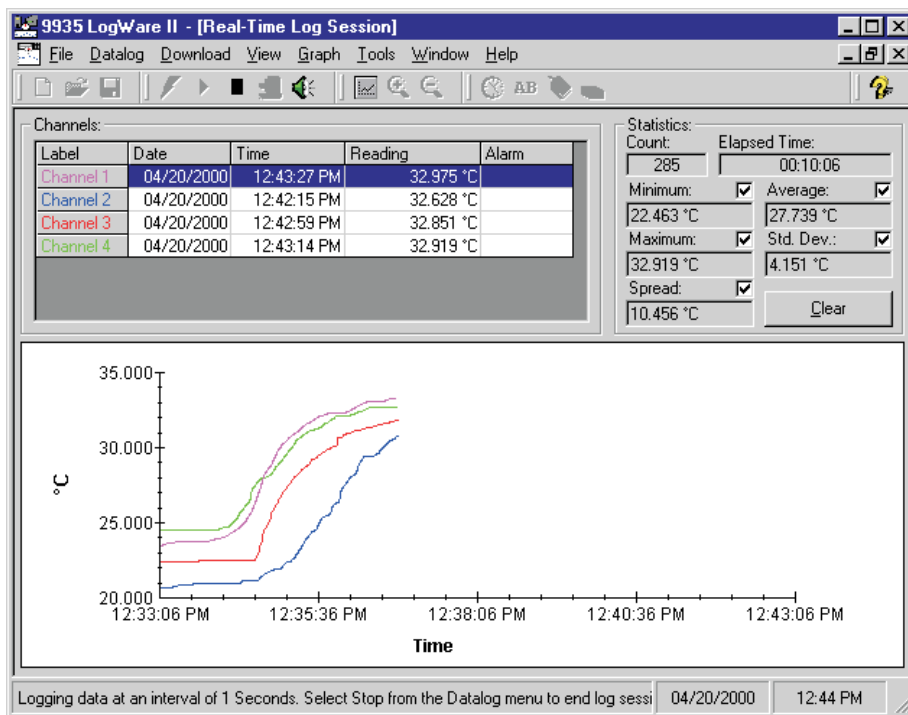

Both readouts store thousands of data points in multiple log sessions. LogWare lets you download your data into individual log sessions and view each one separately.

Store readings from your freezers, ovens, chambers, and anywhere else you need to record temperature, bring it back to your PC (through a standard serial cable or infrared dongle), and LogWare will separate each log session into individual data sets. You don't have to load the text file into your spreadsheet and try to figure out which data points went with which log session. LogWare does all that for you.

LogWare also gives you the ability to make configuration changes to your thermometer readout. Program your probe coefficients, write calibration data to your meter, set password-protected parameters, and access other tools specific to your thermometer readout all from your PC.

Get the most out of your readout with LogWare. If you don't agree this is the best temperature acquisition system for your application, send it back and we'll refund your money. Buy it today and try it out at no risk.

- Turns any Hart thermometer readout into a real-time data logger
- Calculates statistics and displays customized graphs
- User-selectable alarms, delayed start times, and sample intervals
- Two versions for single-channel or multi-channel thermometer readouts

Turn any Hart thermometer readout into a real-time data logger with one of Hart's LogWare software packages. Whether you use our 9934 LogWare with a single-channel thermometer readout or 9935 LogWare II with one of Hart's multi-channel readouts, you'll agree that this is the

easiest data acquisition program you've ever used.

LogWare lets you acquire data to your PC graphically and store it to a text file. It also performs statistical functions automatically on each data set.

LogWare was designed specifically for temperature data acquisition. Set high and low alarm conditions, program a delayed start time, store a data log for a fixed number of readings or length of time, program the acquisition interval from 1 second to 24 hours, and let the software record the data you need the way you need it.

During a log session you can view the data in a time/temperature trend graph while the data points are stored to a file on your PC. Output the graph to your printer, view the test points from a spreadsheet, or review the pertinent log statistics once your log is completed. With LogWare II you can collect and view data from up to 96 probes.

With Hart's 1524 Reference Thermometer and 1529 Chub-E4 thermometer readouts, there's even more you can do.

## Ordering Information

9934-S	LogWare, Single Channel, Single User
9934-M	LogWare, Single Channel, Multi User
9935-S	LogWare II, Multi Channel, Single User
9935-M	LogWare II, Multi Channel, Multi User
2383	USB to RS-232 Adapter

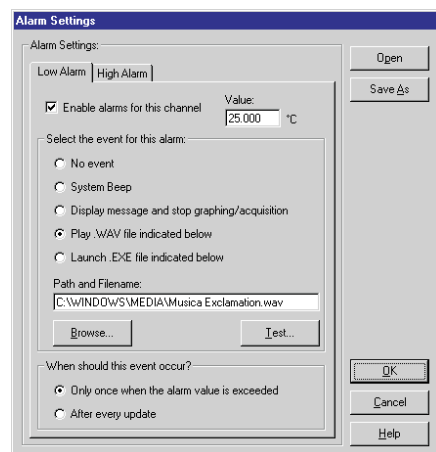

Alarm settings screen.

# LogWare III

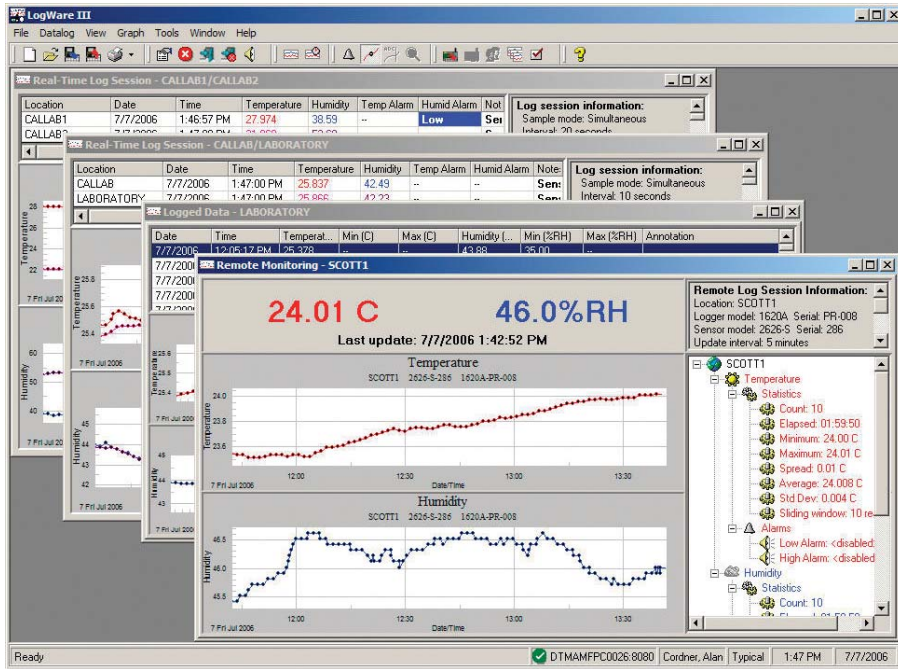

- Supports Ethernet, 802.15.4 wireless, and RS-232 communication
- Contacts users via email to PDAs and cell phones
- Shows real-time or historical data using customized graphs
- Seamlessly integrates with MET/CAL® software

LogWare III is a Windows® application that retrieves, stores, and analyzes data from the Hart's 1620A "DewK" Thermo-Hygrometer. As client-server or stand-alone software, it remotely monitors and logs an unlimited number of concurrent log sessions into a single database. That means data from many DewKs can be managed in real time via Ethernet, RS-232, or wireless connections.

Data may be logged from one or both of a DewK's sensors, providing up to two temperature and two humidity inputs for each DewK.

LogWare III allows you to customize your graph trace color, alarms, and statistics as you go. You can start/stop log sessions and modify sample intervals from your computer.

LogWare III supports "hot-swapping," allowing you to remove and replace sensors without shutting down the log session. LogWare III also supports security features such as passwords for individual users or groups/teams, a built-in administrator account, pre-defined user groups, and customizable permissions to ensure the integrity of all stored data.

Never again be the last to know about a problem. Customizable email settings allow you to send emails to designated recipients, including cell phones and PDA's, when a log session begins, ends, or is aborted; when the DewK's battery is low; when a sensor calibration is due; or when a temperature/humidity alarm is exceeded.

If you cannot be reached via email, you can always arrange to be paged instead. Data stored on the DewK can be imported into the software, which is a handy feature when power outages disable the network.

Are you ready for a deep dive into your data? Historical data can be viewed by sensor (model/serial number) location, or log session and displayed in a spreadsheet-style grid.

Logged data can also be exported to HTML, RTF, or ASCII text for use in your analytical software, or simply print historical data and graphs.

Customizable graphs in LogWare III with zooming capability are an easy way to analyze your data history, and data points that need to be explained can be highlighted, annotated, and referred to later. LogWare III statistics include min, max, spread, average, and standard deviation functions, and printed reports keep track of the number of temperature and humidity measurements that were found to be out of tolerance.

## Ordering information

- 9936A** LogWare III Software (Single License)
- 9936A-L1**<sup>†</sup> Additional 1-Pack License, LogWare III Software
- 9936A-L5**<sup>†</sup> Additional 5-Pack License, LogWare III Software
- 9936A-L10**<sup>†</sup> Additional 10-Pack License, LogWare III Software
- 9936A-LST**<sup>†</sup> Additional Site License, LogWare III Software
- 9936A-UPG** 9936A Software Upgrade from version 1.x

<sup>†</sup>Additional licences require the purchase and installation of 9936A single license.

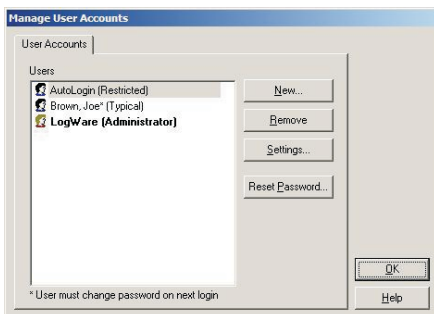

Manage user accounts

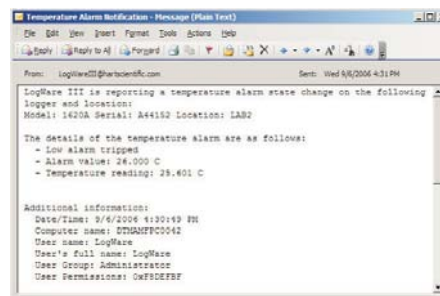

Temperature alarm e-mail

## Establishing traceability

### Reprinted from *Random News*

Prior to the start of any Olympic Games, a flame is passed from torch to torch in an unbroken chain from Athens, Greece, to the hosting country. Similarly, you can imagine a value from a standard at a national laboratory transferred in an unbroken chain of comparisons from one reference standard to another until the value from the national standard has been transferred to a device in your own laboratory.

Traceability is defined as the "property of the result of a measurement or the value of a standard whereby it can be related to stated references, usually national or international standards, through an unbroken chain of comparisons all having stated uncertainties." (Quite a mouthful for some of us!) For purposes of addressing our myth, we point out two critical parts of this definition: "an unbroken chain of comparisons" (as illustrated by the Olympic flame) and "having stated uncertainties."

The ISO Guide to the Expression of Uncertainty in Measurement (the "GUM") gives general rules for expressing uncertainties and says that any documentation supporting a claim of traceability for a measurement result should include explicitly stated uncertainties. Therefore, claims of traceability and uncertainty calculations are inseparable.

But be aware: it is the responsibility of the person or lab making the claim of traceability to be able to support that claim. It's not the responsibility of the national lab. Traceability cannot be achieved simply by following a particular procedure or by using a certain piece of equipment. Nor does sending equipment to a national or accredited lab guarantee traceability.

NIST, for example, says, "Although the measurement results in a calibration or measurement certificate can be considered to be 'certified' by NIST to be traceable to NIST reference standards at the time the measurements were performed, NIST cannot 'certify' that those measurement results are valid after an instrument or artifact or reference material has left NIST" (from NIST web site, emphasis added). NIST clearly makes the point that the responsibility of verifying the continuing

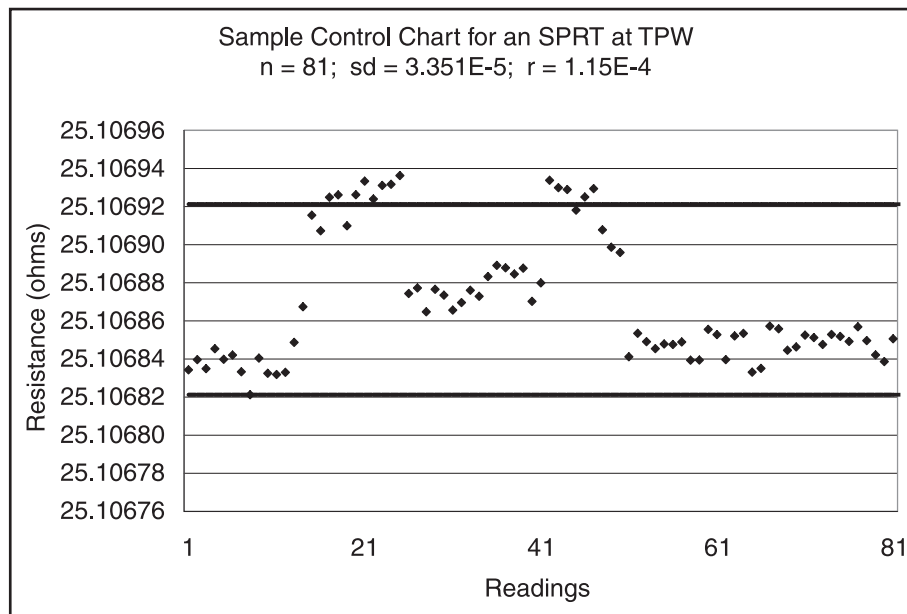

validity of a result of a measurement belongs to the user of that result.

So how do you "verify continuing validity" and ensure traceability? NIST recommends establishing your own measurement assurance program, or "MAP." A MAP involves characterizing the transfer instrument, standard, or system for which traceability is desired and establishing measurement assurance charts (indicating associated values and uncertainties.)

Take the example of a system in which calibrations of PRTs are performed in a bath using an SPRT as the reference thermometer. The SPRT might be characterized by monitoring its triple point of water value before and after each use of the SPRT. Using this data, you can establish a measurement assurance chart that would allow trends to be analyzed and any changes in the characteristics of the reference to be captured.

At the same time, incorporate a check standard into the measurement process. A measurement assurance chart characterizing the measurement system would allow the tracking of any changes in the system and the quantification of uncertainties in the system.

With this MAP in place and the system and transfer standard both characterized, you are now in a position to send your reference out for calibration. When it returns with its new calibration certificate, you are able to quantifiably verify the integrity of your calibration and measurement system by continuing your MAP. This provides support to your claim of traceable measurement results. (After all, how can you claim traceability if you can't prove that your standard is behaving the same now as it was at the time it was calibrated?)

Your analysis of the data collected in a MAP should include an evaluation of the uncertainty associated with your measurement results and any changes that may have occurred to the transfer standard during use (in our example, an SPRT).

For traceability to exist, many believe that a transfer instrument, standard, or system must continually produce results, that demonstrate a consistently quantifiable uncertainty. A measurement assurance program is the tool for the job. It may seem like a large investment of time and resources, but the investment is small compared to the cost of a recall or the loss of a customer.



# Bath selection guide

## Compact series

Model	Range	Stability	Depth	Features	Page
6330	35 °C to 300 °C	± 0.005 °C at 100 °C ± 0.015 °C at 300 °C	234 mm 9.25 in	Small benchtop footprint. Optional cart includes storage space.	110
7320	-20 °C to 150 °C	± 0.005 °C at -20 °C ± 0.005 °C at 25 °C	234 mm 9.25 in	Small 9.2-liter (2.4-gallon) tank. Uniformity ± 0.005 °C.	
7340	-40 °C to 150 °C	± 0.005 °C at -40 °C ± 0.005 °C at 25 °C	234 mm 9.25 in	Low temperature calibrations. Metrology-level performance.	
7380	-80 °C to 100 °C	± 0.006 °C at -80 °C ± 0.010 °C at 0 °C	178 mm 7 in	Achieves -80 °C in less than 130 minutes. Quiet operation.	
7312	-5 °C to 110 °C	± 0.001 °C at 0 °C	496 mm 19.5 in	Maintains two TPW cells. Compact, quiet.	17
6331	40 °C to 300 °C	± 0.007 °C at 100 °C ± 0.015 °C at 300 °C	457 mm 18 in	18 in of depth with just 16 liters of fluid. RS-232 included.	108
7321	-20 °C to 150 °C	± 0.005 °C at -20 °C ± 0.005 °C at 25 °C	457 mm 18 in	Perfect for LIG thermometers with optional kit. Quiet operation.	
7341	-45 °C to 150 °C	± 0.005 °C at -40 °C ± 0.005 °C at 25 °C	457 mm 18 in	Fast temperature changes. Access opening accommodates many thermometers.	
7381	-80 °C to 110 °C	± 0.006 °C at -80 °C ± 0.005 °C at 0 °C	457 mm 18 in	Stability of ± 0.006 °C or better over full range. Compatible with MET/TEMP II software.	

## Standard baths

Model	Range	Stability	Depth	Features	Page
7060	-60 °C to 110 °C	± 0.0025 °C at -60 °C ± 0.0015 °C at 25 °C	305 mm 12 in	Reaches -60 °C with standard refrigeration.	114
7080	-80 °C to 110 °C	± 0.0025 °C at -80 °C ± 0.0015 °C at 25 °C	305 mm 12 in	Best combination of stability and ultra low temperatures.	
7100	-100 °C to 110 °C	± 0.008 °C at -100 °C	337 mm 13.25 in	No external cooling for -100 °C.	
7008	-5 °C to 110 °C	± 0.0007 °C at 25 °C	331 mm 13 in	Large tank for larger mass immersion. Maintains standard resistors.	116
7011	-10 °C to 110 °C	± 0.0008 °C at 0 °C ± 0.0008 °C at 25 °C	305 mm 12 in	Self-contained refrigeration. Best-priced ultra stable, cooled bath.	
7012	-10 °C to 110 °C	± 0.0008 °C at 0 °C ± 0.0008 °C at 25 °C	457 mm 18 in	Maintains up to 4 WTP cells for weeks. Large access: 162 x 292 mm (6.3 in x 11.5 in).	
7037	-40 °C to 110 °C	± 0.002 °C at -40 °C ± 0.0015 °C at 25 °C	457 mm 18 in	Lowest-temperature deep-well bath. Mercury cell maintenance bath.	
7040	-40 °C to 110 °C	± 0.002 °C at -40 °C ± 0.0015 °C at 25 °C	305 mm 12 in	Self-contained single-stage refrigeration. Digital controller.	
6020	40 °C to 300 °C	± 0.001 °C at 40 °C ± 0.005 °C at 300 °C	305 mm 12 in	Broad range to 300 °C. Optional RS-232 and IEEE-488 interface.	118
6022	40 °C to 300 °C	± 0.001 °C at 40 °C ± 0.005 °C at 300 °C	464 mm 18.25 in	Deep tank for SPRT or LIG thermometers. Optional fluid level adapter.	
6024	40 °C to 300 °C	± 0.001 °C at 40 °C ± 0.005 °C at 300 °C	337 mm 13.25 in	Larger access opening and tank size for higher throughput.	
6050H	180 °C to 550 °C	± 0.002 °C at 200 °C ± 0.007 °C at 500 °C	305 mm 12 in	Better stability than sand baths. High temperatures, low gradients.	120

# Bath selection guide

## Special application

Model	Range	Stability	Depth	Features	Page
6054	50 °C to 300 °C	± 0.003 °C at 100 °C ± 0.005 °C at 300 °C	610 mm 24 in	Maintains constant fluid level.	122
6055	200 °C to 550 °C	± 0.003 °C at 200 °C ± 0.01 °C at 550 °C	432 mm 17 in	Includes LIG sighting channel.	
7007	-5 °C to 110 °C	± 0.001 °C at 0 °C ± 0.003 °C at 100 °C	610 mm 24 in	Large, 7-inch-diameter working space.	
7009	0 °C to 110 °C	± 0.0007 °C at 25 °C	331 mm 13 in	Largest capacity with 4.8-cubic foot (167-liter) working area and 0.7 mK stability.	124
7015	0 °C to 110 °C	± 0.0007 °C at 25 °C	331 mm 13 in	Ultrastable for maintaining resistors. Large access and workspace. Splash- and spill-resistant lid.	
7108	20 °C to 30 °C	± 0.004 °C	203 mm 8 in	Peltier cooling means no compressor and quieter performance. Maintains standard resistors.	
7911A2	0 °C	± 0.002 °C	203 mm 8 in	Easy and affordable zero-point source for calibrating temperature sensors.	126

## Other

Item	Description	Page
Bath Accessories	Stands, rods, and clamps to suspend and support your probes and thermometers	121
Bath Fluids	Silicone oils, salt, and cold fluids in convenient, small quantities.	128
Rosemount Bath Controllers	Model 7900 controller designed by Hart integrates the features of Hart's 2100 controller and can be used in place of the Rosemount 915 controller with Rosemount-designed baths.	132
Hart Bath Controllers	Model 2100 and 2200 controllers can be integrated with homemade baths or other heat sources to achieve performance levels approaching Hart baths.	133

Note: See page 152 for portable Micro-Baths.

## Buying the right bath

During a European trip we visited a lab struggling through the lab accreditation process. The hold-up was their bath. They had already tested baths from two manufacturers. The first bath didn't meet specs and the maker would not rectify the situation, so the bath was returned. The second bath maker delivered a working bath, but when the accreditation auditor tested the bath he downgraded the lab's accuracy class because they couldn't meet the required stability and uniformity levels.

Most bath manufacturers tell you as little as possible about their baths' performance. In fact, one of our competitors used to tell people that high bath stability wasn't even necessary for accurate calibrations. Some still don't publish stability specs, and some are so elusive about the meaning of their specs that you can only conclude they've got something to hide.

### Lab accreditation

Accreditation guidelines published by NVLAP specify that the temperature stability and uniformity of the bath fluid should be at least *10 times better* than the required uncertainty of the sensor being calibrated. If you're testing a sensor with a modest specification of  $\pm 0.1$  °F over its whole range, your bath must be stable and uniform to  $\pm 0.01$  °F. Translated to Celsius, this figure becomes  $\pm 0.005$  °C, and you find yourself in need of a bath with performance to the third decimal place *at each of the temperatures you must test*. Several issues are involved in selecting a bath, and each item impacts your calibrations.

### Stability

Stability is a measure of the bath's control performance. How well does it maintain a constant temperature? Short-term instability is normally seen as an oscillation around the control point with its peaks defined in a "2-sigma" or " $\pm$ " statement. If the temperature of the bath fluid is changing during your measurements, you can't get reliable calibration results. Short-term stability is therefore absolutely crucial. Ask about short-term stability and define short-term as lasting at least 15 minutes. Less than that can prove very frustrating.

Long-term stability (over several hours, days, or weeks) is a convenience issue. If your work requires an exact or absolute value, say 25.000 °C, and the bath has long-term drift, you must readjust the control set-point and wait for equilibration (attainment of short-term stability) before each use. So you really need to know both

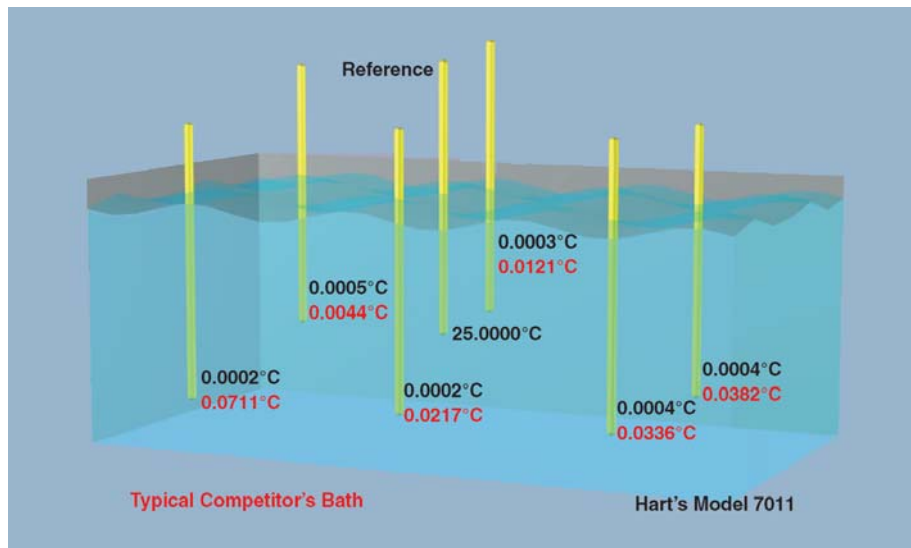

Deviations from a central reference temperature taken in water with a 1/4-inch-diameter PRT at 25 °C.

short-term and long-term stability before you know if a bath will meet your needs. Long-term instability normally takes the form of drift in a single direction, but in some baths it may be seen as a long-term oscillation.

A bath's stability will vary at different temperatures. Most baths perform best at temperatures close to ambient. The colder or hotter the set-point, the less stability. Too many sellers give you only one spec at or near ambient. Some give a single stability spec and don't ever mention that it applies only to one temperature or a narrow range. Ask about stability over the whole range that interests you.

Bath fluid also affects stability. The higher a fluid's viscosity and the lower its heat capacity, the larger the effect on stability. In addition to asking the temperature, ask what fluid was used when the spec was taken. For example, at 37 °C a bath will be more stable with water as the medium. If you're going to use oil, expect somewhat larger instability. If your oil has high viscosity at 37 °C, expect even greater degradation in stability.

### Uniformity

A bath can have good stability but poor uniformity. The bath must be homogenous in temperature throughout the test zone where you'll make your comparison measurements. When you place two or more thermometers in the fluid, they should be at the same temperature during your measurement. The uniformity spec defines the peak value for this error source. The more

probes you're testing, the larger the test zone, and the more important uniformity becomes.

Uniformity depends mostly on the mixing of the bath fluid. Does the bath use a circulator pump for mixing? If it does, are there thermal flow patterns in the bath that interfere with uniformity? Ask about both vertical and horizontal gradients.

In a laminar flow bath (one where the fluid is stirred in a circular pattern), there may be no horizontal gradient, but because the fluid is not mixed vertically, there are gradients between different depths in the bath. This is a problem if your reference probe and the probes under test are not the same length. For example, if you're testing 3-inch-long probes and your standard is a 19-inch SPRT, you've got a problem. You can only immerse the test probes to 3 inches, but if you immerse the SPRT to only 3 inches you don't have sufficient depth to avoid stem effects and light piping that will affect the measurement made by the SPRT. If you properly immerse the SPRT and your bath suffers from vertical gradients, you won't be measuring the temperature at the 3-inch depth of your probes under test.

### Equilibration blocks

Accreditation guidelines recommend the use of a metal equilibration block to improve short-term stability during the measurement. It's certainly true that a block can increase the stability of your measurements.



## Buying the right bath

However, a block can be inconvenient. The fixed location and diameter of its holes eliminate the flexibility of a bath to readily test any size or shape of thermometer. You'll need a new block for each probe type. Placing the probes in the block and the block in the bath is somewhat less convenient than simply dipping the probes directly in the liquid. Blocks also oxidize, and silicone oil will thicken and stick in the bottom of the holes. Regular cleaning is required to ensure continued performance levels. If you're testing many probes at a time, a block may not even work for you. It would be difficult to construct a block to properly test 20 thermometers at a time.

Evaluate your bath purchase on specifications taken directly in the bath's fluid. If you're given performance graphs, ask if a block was used. In your lab you can always add a block for the most critical measurements. Remember: *the bath that performs the best without a block will also be the bath that performs the best with a block.*

### Temperature range

The advertised temperature range of a bath is not necessarily the practical usable range. For example, a bath with a published range of  $-80\text{ }^{\circ}\text{C}$  to  $150\text{ }^{\circ}\text{C}$  can be a bit misleading. The bath may operate over that temperature range, but currently there's no fluid to match that whole range. Those fluids that perform best at  $-80\text{ }^{\circ}\text{C}$  will evaporate too rapidly long before they get to  $100\text{ }^{\circ}\text{C}$ , much less  $150\text{ }^{\circ}\text{C}$ .

An oil bath with an advertised range of  $35\text{ }^{\circ}\text{C}$  to  $300\text{ }^{\circ}\text{C}$  will be limited by the silicone oil you put in it. A good  $300\text{ }^{\circ}\text{C}$  oil will be too viscous to deliver good performance below about  $80\text{ }^{\circ}\text{C}$ , so with that fluid the bath's range is  $80\text{ }^{\circ}\text{C}$  to  $300\text{ }^{\circ}\text{C}$ . In another example, a Hart salt bath works quite well at  $40\text{ }^{\circ}\text{C}$  with the right fluid. But salt is molten only above  $150\text{ }^{\circ}\text{C}$ .

In addition to fluid, other factors mechanically limit a bath's range. These include refrigeration, insulation, heater types, and other design issues. Refrigeration gases break down above  $150\text{ }^{\circ}\text{C}$ , thus limiting the life of the system. If a refrigerated bath is advertised with a higher range, ask if you must remove the cooling coil above a certain temperature. Some baths are advertised with ranges from  $-80\text{ }^{\circ}\text{C}$  to  $300\text{ }^{\circ}\text{C}$  in a single bath. However, the refrigeration gases or coils must be removed before going to the higher end of the temperature range.

We could probably design a single bath that could operate from  $-100\text{ }^{\circ}\text{C}$  to  $500\text{ }^{\circ}\text{C}$ .

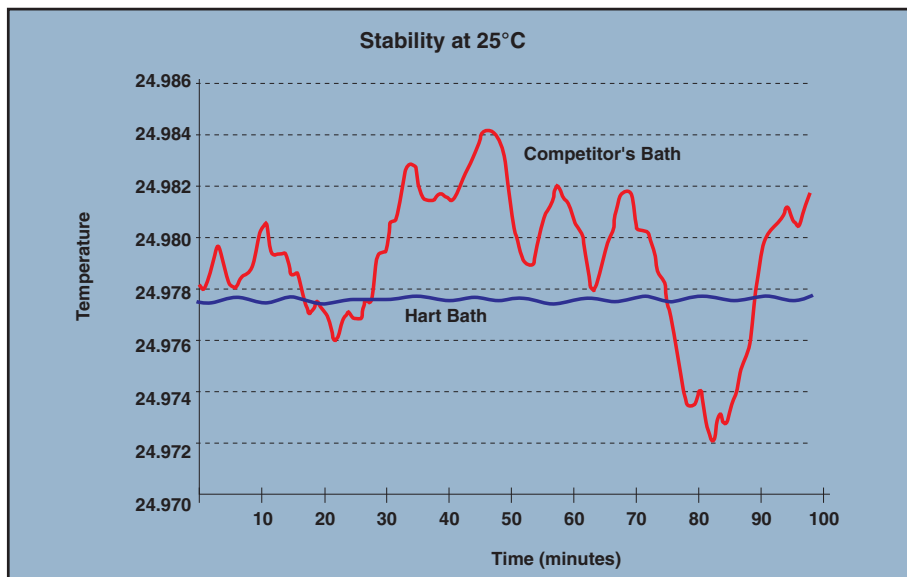

Hart baths can achieve stability better than 1 mK for extended periods of time.

Besides the high price for such a bath, there would be no point. You would have to drain, clean, and refill the bath at least three times during a calibration run in order to cover that range. The best solution to cover  $-100\text{ }^{\circ}\text{C}$  to  $500\text{ }^{\circ}\text{C}$  is at least three baths with three different fluids. This way each bath design is optimized for performance in the range of the fluid you would use. You'll get the best stability and uniformity while tripling your throughput.

### Can you ask too many questions?

It's not likely that a manufacturer will have a test file covering every temperature and fluid combination that interests you, but you can look for representative numbers. How many numbers will they give you? The more the better.

If a salesman says his bath's stability spec of  $\pm 0.005\text{ }^{\circ}\text{C}$  applies to the whole range, ask for a graph at several temperatures. If you're buying a bath for use at  $300\text{ }^{\circ}\text{C}$  and the maker can't give you performance data above  $100\text{ }^{\circ}\text{C}$ , you need to be skeptical.

If a salesman talks about "calibration accuracy" instead of bath performance, ask for specific stability and uniformity data taken in the bath fluid. Finally, ask for a money-back guarantee of the performance. If you can't get what you need from the bath when it's in your lab, you need to know your supplier will be there for you.

### Bath fluid affects performance

Hart determines its bath specifications by using selected fluids for particular temperatures. Your application, however, may require different fluids over different temperatures. Considering that fluid characteristics change with temperature, some care must be taken to apply general specifications to your own application.

For example, Hart often uses water to spec baths at  $25\text{ }^{\circ}\text{C}$ . The properties of viscosity, thermal conductivity, and heat capacity make water an ideal fluid at  $25\text{ }^{\circ}\text{C}$ . However, if you want to cover a range from  $-5\text{ }^{\circ}\text{C}$  to  $110\text{ }^{\circ}\text{C}$ , water just won't work. Hart's 5010 silicone oil fluid will more than adequately cover that range, but it may not perform as well as water at  $25\text{ }^{\circ}\text{C}$ . Carefully testing the fluid you use over the range you use can tell you what you need to know for your uncertainty budget.

# Deep-well compact baths



- 457 mm (18 in) of depth with just 15.9 liters (4.2 gal) of fluid
- Perfect for liquid-in-glass thermometers with optional LIG kit
- Fast, quiet, compact (yet deep!), and economical

Need a bath with a lot of immersion depth, great stability, and a low price tag? How about one that minimizes fluid costs, changes temperatures quickly, and runs quietly?

Hart's new Deep-Well Compact Bath series features four models covering temperatures from  $-80\text{ }^{\circ}\text{C}$  to  $300\text{ }^{\circ}\text{C}$ .

Each model includes a 457 mm (18-inch) deep tank to accommodate long-stem PRTs, SPRTs, and liquid-in-glass (LIG) thermometers. Access openings are 120 by 172 mm (4.7 in by 6.8 in) so you can calibrate many thermometers simultaneously. Yet only 15.9 liters (4.2 gallons) of fluid are needed to get all the benefits Deep-Well Compact Baths offer.

Using Hart's own best-in-class temperature controller, these baths deliver the performance you need for confidence in your calibrations. The 7381 ( $-80\text{ }^{\circ}\text{C}$  to  $110\text{ }^{\circ}\text{C}$ ) features both stability and uniformity better

than  $\pm 0.007\text{ }^{\circ}\text{C}$  over its entire range. The 7341 and 7321 ( $-45\text{ }^{\circ}\text{C}$  to  $150\text{ }^{\circ}\text{C}$  and  $-20\text{ }^{\circ}\text{C}$  to  $150\text{ }^{\circ}\text{C}$ , respectively) are stable to  $\pm 0.005\text{ }^{\circ}\text{C}$  and uniform to  $\pm 0.007\text{ }^{\circ}\text{C}$  at temperatures below ambient. And finally, the 6331 provides stability and uniformity from  $\pm 0.007\text{ }^{\circ}\text{C}$  to  $\pm 0.025\text{ }^{\circ}\text{C}$  over its range from  $40\text{ }^{\circ}\text{C}$  to  $300\text{ }^{\circ}\text{C}$ .

Be sure to understand the performance of the temperature calibration equipment you buy. Some manufacturers offer only limited (and often difficult to interpret) specifications. The table at right includes stability and uniformity values for the entire range of each bath—and tells you what fluid we used in the measurements. If that's still not enough, give us a call and we'll be happy to explain anything—and share data with you.

Hart's control system automatically adds refrigeration when you need to cool down quickly, and shuts down

refrigeration when you need to heat up quickly. For maximum stability, refrigeration levels are automatically balanced to match the set-point temperature you're working at.

Connect any of these baths to a Hart thermometer readout and Hart's industry-leading MET/TEMP II temperature calibration software, and you'll be performing automated probe calibrations within minutes from switch-on.

Want to optimize your bath for calibrating liquid-in-glass thermometers? Simple. With the optional LIG Thermometer Calibration Kit, you get an easy-to-install fluid level adapter tube that raises the meniscus of the bath fluid to within about 12 mm (0.5 in) of the top surface of the bath itself. The kit also includes a thermometer carousel that fits onto the top of the fluid level adapter tube and holds up to ten LIG thermometers in place. A magnifying scope (8X) is also available that mounts to the front of any Deep-Well Compact Bath so you can clearly see the liquid level of your thermometer against its temperature scale.

Like all Hart baths, these units come with a report of test that includes one hour of stability data and a verification of set-point accuracy. A convenient overflow reservoir captures any excess fluid resulting from fluid expansion, allowing the trapped fluid to be reused following subsequent fluid contraction. A drain is also provided for easily emptying the bath's tank when needed.



The 2019-DCB Liquid-in-Glass Thermometer Calibration Kit includes a carousel which holds up to 10 thermometers and an adapter tube which raises the bath fluid level to within 5–15 mm of the thermometers' readings. The 2069 Magnifier Scope mounts easily to the front of any Deep-Well Compact Bath to provide magnification of 8X or greater.

# Deep-well compact baths

Specifications	6331	7321	7341	7381
<b>Range</b>	35 °C to 300 °C	-20 °C to 150 °C	-45 °C to 150 °C	-80 °C to 110 °C
<b>Stability</b>	± 0.007 °C at 100 °C (oil 5012) ± 0.010 °C at 200 °C (oil 5017) ± 0.015 °C at 300 °C (oil 5017)	± 0.005°C at -20°C (ethanol) ± 0.005°C at 25°C (water) ± 0.007°C at 150°C (oil 5012)	± 0.005°C at -45°C (ethanol) ± 0.005°C at 25°C (water) ± 0.007°C at 150°C (oil 5012)	± 0.006°C at -80°C (ethanol) ± 0.005°C at 0°C (ethanol) ± 0.005°C at 100°C (oil 5012)
<b>Uniformity</b>	± 0.007 °C at 100 °C (oil 5012) ± 0.017 °C at 200 °C (oil 5017) ± 0.025 °C at 300 °C (oil 5017)	± 0.007 °C at -20 °C (ethanol) ± 0.007 °C at 25 °C (water) ± 0.010°C at 150 °C (oil 5012)	± 0.007 °C at -45 °C (ethanol) ± 0.007 °C at 25 °C (water) ± 0.010 °C at 150 °C (oil 5012)	± 0.007 °C at -80 °C (ethanol) ± 0.007 °C at 0 °C (ethanol) ± 0.007 °C at 100 °C (oil 5012)
<b>Heating Time †</b>	130 minutes, from 40 °C to 300 °C (oil 5017)	120 minutes, from 25 °C to 150 °C (oil 5012)	120 minutes, from 25 °C to 150 °C (oil 5012)	60 minutes, from 25 °C to 100 °C (oil 5012)
<b>Cooling Time †</b>	14 hours, from 300 °C to 100 °C (oil 5017)	110 minutes, from 25 °C to -20 °C (ethanol)	130 minutes, from 25°C to -45°C (ethanol)	210 minutes, from 25 °C to -80 °C (ethanol)
<b>Stabilization Time</b>	15–20 minutes			
<b>Temperature Setting</b>	Digital display with push-button data entry			
<b>Set-Point Resolution</b>	0.01 °; 0.00018 ° in high-resolution mode			
<b>Display Resolution</b>	0.01 °			
<b>Digital Setting Accuracy</b>	± 1 °C			
<b>Digital Setting Repeatability</b>	± 0.01 °C			
<b>Access Opening</b>	120 x 172 mm (4.7 x 6.8 in)			
<b>Depth</b>	457 mm (18 in) without Liquid-in-Glass Thermometer Cal Kit 482 mm (19 in) with Liquid-in-Glass Thermometer Cal Kit			
<b>Wetted Parts</b>	304 stainless steel			
<b>Power†</b>	115 V ac (± 10 %), 50/60 Hz, 14.8 A or 230 V ac (± 10 %), 50/60 Hz, 7.4 A, specify	115 V ac (± 10 %), 60 Hz, 14 A or 230 V ac (± 10 %), 50 Hz, 7 A, specify	115 V ac (± 10 %), 60 Hz, 16 A or 230 V ac (± 10 %), 50 Hz, 8 A, specify	230 V ac (± 10 %), 50 or 60 Hz, specify, 10 A
<b>Volume</b>	15.9 liters (4.2 gal)			
<b>Size (HxWxD)</b>	1067 x 356 x 788 mm (940 mm from floor to tank access opening) [42 x 14 x 31 in (37 in from floor to tank access opening)]			
<b>Weight</b>	41 kg (90 lb)	62 kg (137 lb)	68 kg (150 lb)	91 kg (200 lb)
<b>Automation Package</b>	Interface- <i>it</i> software and RS-232 included (IEEE-488 optional)			

†Rated at nominal 115 V (or optional 230 V)

## Ordering Information

<b>6331</b>	Deep-Well Compact Bath, 40 °C to 300 °C	<b>2019-DCB</b>	Liquid-in-Glass Thermometer Calibration Kit (includes bath adapter tube and thermometer carousel)
<b>7321</b>	Deep-Well Compact Bath, -20 °C to 150 °C	<b>2069</b>	8X Magnifier Scope, with mounts
<b>7341</b>	Deep-Well Compact Bath, -45 °C to 150 °C	<b>2001-IEEE</b>	IEEE-488 Interface
<b>7381</b>	Deep-Well Compact Bath, -80 °C to 110 °C	<b>2027-DCBW</b>	TPW Holding Fixture (7321, 7341, 7381)
<b>2012-DCB</b>	Spare Access Cover, Plastic, 7321, 7341, 7381	<b>2027-DCBM</b>	Mercury TP Holding Fixture (7341)
<b>2020-6331</b>	Spare Access Cover, Stainless Steel, 6331		



# Compact baths



- Stability and uniformity each better than  $\pm 0.008$  °C
- Metrology-level performance in lab-friendly sizes
- Convenient use on benchtops or on matching carts

When you only need a circulator or utility bath to control a process within a few degrees or to maintain biological test samples, talk to a utility bath manufacturer. But when you're doing precision thermometer testing, and stability and uniformity are critical to the success of your work, talk to us.

Hart Scientific has been making the world's best-performing temperature baths for almost two decades. With our proven heating/cooling designs and hybrid analog-digital controller, Hart baths apply the most effective technologies that are commercially feasible. These four compact baths are no exception.

## 6330

This bath delivers all the high temperatures you need up to 300 °C. With stability and uniformity at 300 °C better than  $\pm 0.015$  °C and  $\pm 0.020$  °C respectively, calibrations can easily be performed at this high temperature with total uncertainty better than  $\pm 0.05$  °C. At lower temperatures, stability and uniformity are even better.

The 6330 is only 12 inches wide and less than 19 inches tall, so it fits easily onto a benchtop without consuming precious space. An optional cart with casters and a storage area raises the 6330 to a convenient height when used on a floor and provides an extra cabinet for lab supplies. With built-in handles, it even lifts easily onto and off of its cart or benchtop. No matter where you want to use this bath—or even if you want to move it around—the 6330 gets there hassle-free.

## 7320 and 7340

Also featuring large work areas, our Model 7320 and 7340 baths cover your needs for low temperature calibrations. The 7320 covers a range from  $-20$  °C to 150 °C and the 7340 reaches even colder temperatures to  $-40$  °C. Below 0 °C, these baths maintain an impressive stability of  $\pm 0.005$  °C with uniformities better than  $\pm 0.006$  °C. No utility bath performs as well as Hart's compact baths below 0 °C or at critical room and body temperatures—or even at important higher temperatures such as 100 °C and 122 °C.

## 7380

For ultracold temperatures, the 7380 reaches  $-80$  °C quickly and maintains a two-sigma stability of  $\pm 0.006$  °C when it gets there. The 7380 is a true metrology bath, not a chiller or circulator. With uniformity to  $\pm 0.008$  °C, comparison calibration of temperature devices can be performed with high precision.

Each bath includes an RS-232 serial interface and our Model 9930 Interface-it software for controlling your bath from a PC. With a Hart Scientific thermometer readout, such as a *Black Stack*, and our MET/TEMP II software, automated calibrations can run unattended.

Hart Scientific doesn't make chillers, circulators, or so-called utility baths, and utility bath manufacturers don't make metrology baths. Use the right tools for your work and reap the best possible results. Baths from Hart Scientific are the most stable and uniform of any you'll find. They'll give you results no other bath can.



With an optional floor cart (including locking casters), your bath can easily be moved to any place you need it. (Available for the 6330, 7320, or 7340. Casters included on the 7380.)

# Compact baths

Specifications	6330	7320	7340	7380
<b>Range</b>	35 °C to 300 °C	-20 °C to 150 °C	-40 °C to 150 °C	-80 °C to 100 °C
<b>Stability</b>	± 0.005 °C at 100 °C (oil 5012) ± 0.010 °C at 200 °C (oil 5017) ± 0.015 °C at 300 °C (oil 5017)	± 0.005 °C at -20 °C (ethanol) ± 0.005 °C at 25 °C (water) ± 0.007 °C at 150 °C (oil 5012)	± 0.005 °C at -40 °C (ethanol) ± 0.005 °C at 25 °C (water) ± 0.007 °C at 150 °C (oil 5012)	± 0.006 °C at -80 °C (ethanol) ± 0.010 °C at 0 °C (ethanol) ± 0.010 °C at 100 °C (oil 5012)
<b>Uniformity</b>	± 0.007 °C at 100 °C (oil 5012) ± 0.015 °C at 200 °C (oil 5017) ± 0.020 °C at 300 °C (oil 5017)	± 0.005 °C at -20 °C (ethanol) ± 0.005 °C at 25 °C (water) ± 0.010 °C at 150 °C (oil 5012)	± 0.006 °C at -40 °C (ethanol) ± 0.005 °C at 25 °C (water) ± 0.010 °C at 150 °C (oil 5012)	± 0.008 °C at -80 °C (ethanol) ± 0.012 °C at 0 °C (ethanol) ± 0.012 °C at 100 °C (oil 5012)
<b>Heating Time †</b>	250 minutes, from 35 °C to 300 °C (oil 5017)	80 minutes, from 25 °C to 150 °C (oil 5012)	60 minutes, from 25 °C to 150 °C (oil 5012)	25 minutes, from 25 °C to 100 °C (oil 5010)
<b>Cooling Time</b>	n/a	100 minutes, from 25 °C to -20 °C (oil 5012)	110 minutes, from 25 °C to -40 °C (ethanol)	130 minutes, from 25 °C to -80 °C (ethanol)
<b>Stabilization Time</b>	15–20 minutes			
<b>Temperature Setting</b>	Digital display with push-button data entry			
<b>Set-Point Resolution</b>	0.01°; 0.00018° in high-resolution mode			0.01°
<b>Display Resolution</b>	0.01 °			
<b>Digital Setting Accuracy</b>	± 0.5 °C			
<b>Digital Setting Repeatability</b>	± 0.01 °C			
<b>Access Opening</b>	94 x 172 mm (3.7 x 6.8 in)			86 x 114 mm (3.25 x 4.5 in)
<b>Working Area</b>	81 x 133 mm (3.2 x 5.25 in)			86 x 114 mm (3 x 4 in)
<b>Depth</b>	234 mm (9.25 in)			178 mm (7 in)
<b>Wetted Parts</b>	304 stainless steel			
<b>Power</b>	115 V ac (±10 %), 50/60 Hz, 7 A or 230 V ac (±10 %), 50/60 Hz, 3.5 A, specify	115 V ac (±10 %), 60 Hz, 15 A or 230 V ac (±10 %), 50 Hz, 8 A, specify, 1400 VA		115 V ac (±10 %) 60 Hz, 16 A or 230 V ac (±10 %), 50 Hz, 8 A, specify
<b>Volume</b>	9.2 liters (2.4 gal)			4 liters (1 gal)
<b>Size (WxDxH)</b>	305 x 546 x 470 mm (12 x 21.5 x 18.5 in) off cart; 305 x 546 x 819 mm (12 x 21.5 x 32.25 in) on cart	305 x 622 x 584 mm (12 x 24.5 x 23 in) off cart; 305 x 622 x 819 mm (12 x 24.5 x 32.25 in) on cart		305 x 610 x 762 mm (12 x 24 x 30 in)
<b>Weight</b>	19 kg (42 lb)	35.4 kg (78 lb)		52 kg (115 lb)
<b>Automation Package</b>	Interface-it software and RS-232 included (IEEE-488 optional)			

†Rated at nominal 115 V (or optional 230 V)

## Ordering Information

<b>6330</b>	Compact Bath, 35 °C to 300 °C	<b>2076-7320</b>	Floor Cart, 7320/7340 (height: 229 mm [9 in])	<b>7380</b>	Compact Bath, -80 °C to 100 °C
<b>2020-6330</b>	Spare Access Cover, SST, 6330	<b>2001-IEEE</b>	IEEE-488 Interface	<b>2020-7380</b>	Spare Access Cover, SST, 7380
<b>2076-6330</b>	Floor Cart, 6330 (height: 343 mm [13.5 in])	<b>7340</b>	Compact Bath, -40 °C to 150 °C	<b>2125-C</b>	IEEE-488 Interface (RS-232 to IEEE-488 converter box)
<b>2001-IEEE</b>	IEEE-488 Interface	<b>2020-7320</b>	Spare Access Cover, SST, 7320/7340		
<b>7320</b>	Compact Bath, -20 °C to 150 °C	<b>2076-7320</b>	Floor Cart, 7320/7340 (height: 229 mm [9 in])		
<b>2020-7320</b>	Spare Access Cover, SST, 7320/7340	<b>2001-IEEE</b>	IEEE-488 Interface		

# Why a Hart bath?

Fluke's Hart Scientific division is the recognized leader in the design and manufacture of temperature calibration baths, with more Hart baths in calibration laboratories worldwide than any other bath supplier. We've achieved this position through delivering baths with a measurable difference. Hart baths were designed specifically for metrology, not adaptations of equipment designed for biology and chemistry laboratories. Hart baths provide performance you can trust and here's why.

## Range of baths

Four types of baths are available: standard baths, compact baths, deep-immersion compact baths, and standard resistor baths. The wide range of baths means you'll absolutely find a bath to meet your application needs and your budget, whether you're working in a primary standards laboratory or an industrial workshop.



Standard baths, a favorite with National Metrology Institutes (NMI), are available for the range  $-100\text{ }^{\circ}\text{C}$  to  $550\text{ }^{\circ}\text{C}$  and offer milli-Kelvin stability and uniformity. Hart standard baths have larger well openings than other baths. This makes them an excellent choice for sensor manufacturers and others that test large batches of sensors or special probes of unusual size and shape.

If you don't need the performance of a Hart standard bath, the Hart compact baths are the perfect alternative with ranges from  $-80\text{ }^{\circ}\text{C}$  to  $300\text{ }^{\circ}\text{C}$ , more portability, and smaller fluid volumes. The deep-immersion versions offer a full 457 mm (18 in) of immersion depth with an optional fluid-level adaptor for calibration of total and partial-immersion liquid-in-glass thermometers.

For maintaining your standard resistors for electrical or temperature calibration work, a Hart resistor bath will provide unmatched stability and uniformity and a



large working volume, up to 27.5 in x 22 in x 13 in.

## Controllers

The first step in evaluating a bath is to look at its temperature controller. We designed our own proprietary control technology to deliver stability to  $\pm 0.0001\text{ }^{\circ}\text{C}$  with user convenience and productivity features. Our hybrid analog and digital design is unique. Set-point resolution is  $0.01\text{ }^{\circ}\text{C}$  ( $0.002\text{ }^{\circ}\text{C}$  on some models), and our "Super-Tweak" resolution mode offsets the set-point so you can adjust the bath set-point to  $0.00018\text{ }^{\circ}\text{C}$ ! If you need a bath set to exactly  $25.000\text{ }^{\circ}\text{C}$ , a Hart bath gets you there with less effort than any other bath. Eight of your most frequently used

set-point temperatures are stored for quick recall and faster bath setup. Temperature can be easily switched between Celsius and Fahrenheit. Safety cutout temperatures are also set on the LED display.

Hart baths are each fitted with a high-stability PRT or thermistor as the control sensor. Our controller uses special noise-rejection techniques to allow us to measure the very tiny resistance changes required for this level of bath stability. In this design we use current reversal techniques to cancel thermal EMF measurement errors. Custom, high-precision, low-coefficient resistors aid the short- and long-term stability of the temperature setting, and advanced filtering techniques force out line noise along with stray EMI and RFI.

A proportional, integrating control function directs power to the bath heaters. Factory tuning eliminates most overshoot and allows the bath to achieve maximum stability within 10 to 15 minutes after reaching the set-point temperature.

Other bath manufacturers use off-the-shelf process controllers, which just plain can't provide the low-noise, low-resistance measurement necessary for milli-Kelvin stability and uniformity over a bath's working range.

## Automation

For improved productivity, automation is essential. You can select from an RS-232 interface or IEEE-488. The RS-232 packages come complete with 9930 Interface-it software so you can immediately start controlling your bath from a PC without any software programming skills.

With optional 9938 MET/TEMP II software, connect any Hart bath with an RS-232 interface to a Hart thermometer read-out and you can perform fully automated probe calibrations.





## Why a Hart bath?

Hart's compact baths use an automatic control for refrigeration power. However, the higher performance standard baths use a heating/cooling equilibrium design that's unique in the industry. A manual valve adjusts the cooling power to properly balance the refrigeration against the active control of the resistance heaters. Hart's standard bath interface packages include automated valves to make these adjustments automatically by your PC.

### Heat-port technology

A major factor in Hart's standard bath performance is our heat-port technology. The cooling coil and the heater are sandwiched to the outside of the bath's stainless steel tank. The tank bottom becomes the heat port with most of the heat entering and exiting the bath through a single location. Providing well-designed insulation around the tank minimizes other heat leaks.

### Mixing

For mixing the bath fluid, Hart uses a carefully balanced stirring mechanism. The number of propellers and the pitch of the blades are adjusted to thoroughly mix the bath medium and eliminate both horizontal and vertical gradients. We don't use circulating pumps because the tubular inlet and outlet design cause thermal-flow patterns in the bath that create unnecessary gradients. Our mixing scheme and the size and shape of our tanks all combine to deliver great performance.

All our baths use tanks made of heavy-gauge stainless steel that is fabricated and welded in our own factory so we can control quality. After more than 20 years we haven't had a single Hart bath weld develop a leak.

### Maintenance

Hart baths are easy to maintain because our stirrer motors last longer and there are no pumps to unclog or repair. Our tanks are easier to clean because they allow



100% drainage of bath fluid. Since the stirrer motors are direct drive, you won't have to buy a supply of belts just to perform your calibrations.

These are the reasons we sell more temperature calibration baths than anybody else. And remember, if you don't find a bath in the catalog to meet your exact needs, talk to us. Chances are we've built one.

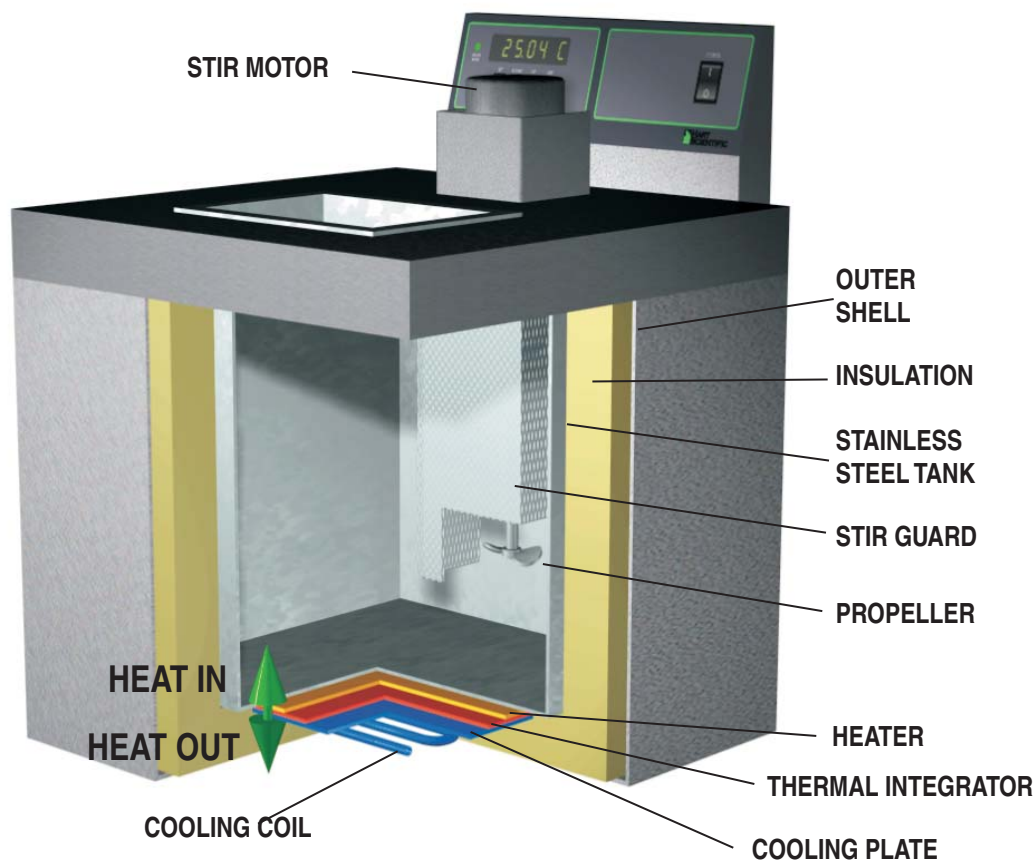

"Standard Bath" construction.

# Really cold baths



- Self-contained refrigeration—no LN<sub>2</sub> or chiller required
- Temperatures as low as -100 °C in real metrology baths
- Best stability and uniformity available at -60 °C and below
- Large working areas for increased throughput

Do you need a bath that chills below -40 °C to temperatures as low as -60 °C or even -100 °C? Would you like a bath that reaches those temperatures without using any external coolants? Hart has a variety of baths that meet these temperature requirements and give you the best stability in the industry.

These baths are completely self-contained. They require no auxiliary cooling fluids or devices to achieve their set-point temperatures. Using Hart's unique "heat-port" design, stability at -100 °C is  $\pm 0.008$  °C. No other company makes a bath that can match a Hart bath's performance, and Hart baths are backed by our guarantee that if they don't perform exactly the way we say they will, we'll

take them back. No arguments. No ifs, ands, or buts.

Automate each of these baths with an interface package and Hart's 9930 Interface-*it* software. If you want to completely automate the entire calibration process, see the description of Hart's MET/TEMP II software package on page 97.

Forget commodity-like utility baths! They're not designed for high performance calibration needs. And be careful of companies that advertise performance specifications they don't meet. It's easy to write down numbers; it's more difficult to meet them with an instrument.

Remember, if our baths don't perform the way we say they will, just send them back. Our equipment won't disappoint you.

## Ordering Information

7060	Standard Bath, -60 °C to 110 °C
7080	Standard Bath, -80 °C to 110 °C
7100	Standard Bath, -100 °C to 110 °C
2001-7060	Automation Package for 7060
2001-7080	Automation Package for 7080
2001-7100	Automation Package for 7100
2001-IEEE	Add for IEEE-488 (requires Automation Package)
2010	Access Cover, 127 x 254 mm (5 x 10 in), Lexan
2007	Access Cover, 127 x 254 mm (5 x 10 in), Stainless Steel
2016-7060	Fluid Level Adapter, 7060
2016-7080	Fluid Level Adapter, 7080
2019-7100	Fluid Level Adapter, 7100
2069	8X Magnifier Scope, with mounts

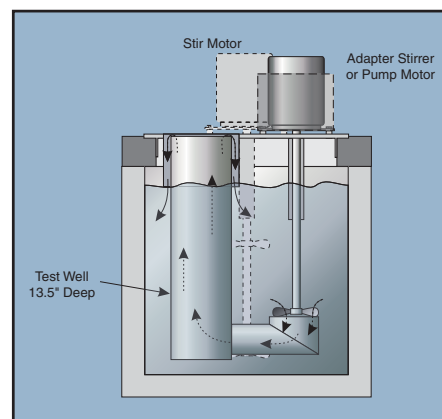

The 2016 fluid level adapter circulates fluid to the top of the bath access to give as much immersion as possible for LIG thermometers.

# Really cold baths

Specifications	7060	7080	7100
Range	-60 °C to 110 °C	-80 °C to 110 °C	-100 °C to 110 °C
Stability	± 0.0025 °C at -60 °C (methanol) ± 0.002 °C at 0 °C (methanol) ± 0.0015 °C at 25 °C (water) ± 0.003 °C at 100 °C (oil 5012)	± 0.0025 °C at -80 °C (methanol) ± 0.0015 °C at 0 °C (methanol) ± 0.0015 °C at 25 °C (water) ± 0.003 °C at 100 °C (oil 5012)	± 0.008 °C at -100 °C (methanol)
Uniformity	± 0.005 °C at -60 °C (methanol) ± 0.005 °C at 0 °C (methanol) ± 0.003 °C at 25 °C (water) ± 0.005 °C at 100 °C (oil 5012)	± 0.007 °C at -80 °C (methanol) ± 0.005 °C at 0 °C (methanol) ± 0.003 °C at 25 °C (water) ± 0.005 °C at 100 °C (oil 5012)	± 0.005 °C at -100 °C (methanol)
Temperature Setting	Digital display with push-button data entry		
Set-Point Resolution	0.01 °C; high-resolution mode, 0.00007 °C		
Display Resolution	0.01 °C		
Digital Setting Accuracy	± 1 °C		
Digital Setting Repeatability	± 0.01 °C		
Heaters	500 and 1000 Watts	350 and 700 Watts	
Access Opening	127 x 254 mm (5 x 10 in)	98 mm diameter (3.8 in)	
Depth	305 mm (12 in)	406 mm (16 in)	
Wetted Parts	304 stainless steel		
Power	230 V ac (± 10 %), 50 or 60 Hz, 13 A, single phase, specify frequency	230 V ac (± 10 %), 50 or 60 Hz, 12 A, specify frequency	
Volume	27 liters (7.2 gallons)	18 liters (4.8 gallons)	
Weight	159 kg (350 lb)	182 kg (400 lb)	
Size (HxWxD)	1168 x 775 x 483 mm (46 x 30.5 x 19 in)	1270 x 813 x 483 mm (50 x 32 x 19 in)	
Automation Package	Interface-it software and an RS-232 computer interface are available for setting the bath temperature via an external computer. For IEEE-488, add 2001-IEEE to the automation package.		

## Periodic bath testing

All calibration apparatus should either be tested or calibrated. Calibration baths are no different. Although the accuracy is often of secondary importance, bath instability and non-uniformity directly affect calibration uncertainties.

To ensure continued performance, these bath characteristics should be tested periodically. The tests should be carried out at all

temperatures commonly used and under typical conditions.

Additionally, since the goal of the tests is to determine the contribution to uncertainty, these tests should be conducted only over the "calibration zone" used in your process, not over the entire zone available. The tests can be conducted with several sensors or with a single sensor moved from one location to the next.

Map the differences and include them in your uncertainty analysis. In most cases, with a Hart bath, the values observed will be significantly smaller than the published specifications.



# Cold baths



- Stability to  $\pm 0.0007$  °C
- Best digital temperature controller available
- “Super Tweak” function provides set-point resolution to 0.00003 °C
- Excellent for maintaining fixed-point cells

Hart Scientific’s temperature calibration baths are known around the world as the best calibration baths made. If you’re looking for a cold bath, no one gives you more choices than Hart.

These five baths operate at temperatures as low as  $-40$  °C, and each one is built using CFC-free refrigerants. Hart’s proprietary controller design and unique tank construction produce bath stabilities to  $\pm 0.001$  °C or better. These baths are so stable and uniform that national labs use them for comparison calibrations and fixed-point cell maintenance.

Each bath (except the 7011) is fully automatable with a bath interface package and Hart’s MET/TEMP II automation software package described on page 97. When we

automate a bath, we automate it completely with computer-controlled solenoid valves for precision balancing of the heating and cooling system. MET/TEMP II performs all calibration tasks automatically, using your PC.

With a Hart cold bath, you can forget external coolants. Internal refrigeration systems are all that’s needed to reach each bath’s coldest temperature. Most cold baths may be ordered with an optional pumping lid for supplying external cooling requirements.

Each bath has unique characteristics that make it perfect for specific jobs. Some baths are excellent for SPRTs, some are great with thermistors, and some are perfect for maintaining triple point of water cells. A 7008IR bath can even be used

to maintain the temperature of a blackbody cone.

Regardless of your application, Hart has a bath that gets the job done, and done better than anyone else can do it. Call us today and tell us about your application.



*This Hart Model 7008-IR features a NIST-designed cone-shaped target.*

# Cold baths

Specifications	7008	7040	7037	7012	7011
<b>Range</b>	-5 °C to 110 °C	-40 °C to 110 °C		-10 °C to 110 °C	
<b>Stability</b>	± 0.0007 °C at 25 °C (water) ± 0.001 °C at 25 °C (mineral oil)	± 0.002 °C at -40 °C (ethanol) ± 0.0015 °C at 25 °C (water) ± 0.003 °C at 100 °C (oil 5012)		± 0.0008 °C at 0 °C (ethanol) ± 0.0008 °C at 25 °C (water) ± 0.003 °C at 100 °C (oil 5012)	
<b>Uniformity</b>	± 0.003 °C at 25 °C (water) ± 0.004 °C at 25 °C (mineral oil)	± 0.004 °C at -40 °C (ethanol) ± 0.002 °C at 25 °C (water) ± 0.004 °C at 100 °C (oil 5012)		± 0.003 °C at 0 °C (ethanol) ± 0.002 °C at 25 °C (water) ± 0.004 °C at 100 °C (oil 5012)	
<b>Temperature Setting</b>	Digital display with push-button data entry				
<b>Set-Point Resolution</b>	0.002 °C; high-resolution mode, 0.00003 °C	0.01 °C; high-resolution mode, 0.00007 °C		0.002 °C; high-resolution mode, 0.00003 °C	
<b>Display Resolution</b>	0.01 °C				
<b>Digital Setting Accuracy</b>	± 1 °C				
<b>Digital Setting Repeatability</b>	± 0.01 °C			± 0.005 °C	
<b>Heaters</b>	500 and 1000 Watts				
<b>Access Opening (call for customs)</b>	324 x 184 mm (12.75 x 7.25 in)	127 x 254 mm (5 x 10 in)	162 x 292 mm (6.38 x 11.5 in)		127 x 254 mm (5 x 10 in)
<b>Depth</b>	331 mm (13 in)	305 mm (12 in)	457 mm (18 in)		305 mm (12 in)
<b>Wetted Parts</b>	304 stainless steel				
<b>Power</b>	115 V ac (± 10 %), 60 Hz, 14 A or 230 V ac, 50 or 60 Hz, 8 A, specify	115 V ac (± 10 %), 60 Hz, 16 A or 230 V ac (± 10 %), 50 or 60 Hz, 9 A (specify voltage and frequency)		115 V ac (± 10 %), 60 Hz, 14 A or 230 V ac (± 10 %), 50 Hz, 7 A, specify	
<b>Volume</b>	42 liters (11.2 gal)	27 liters (7.2 gal)	42 liters (11.2 gal)		27 liters (7.2 gal)
<b>Weight</b>	61 kg (135 lb)	63.5 kg (140 lb)	68 kg (150 lb)		56.7 kg (125 lb)
<b>Size (HxWxD)</b>	610 x 775 x 483 mm (24 x 30.5 x 19 in)	622 x 768 x 483 mm (24.5 x 30.25 x 19 in)	775 x 768 x 483 mm (30.5 x 30.25 x 19 in)	762 x 686 x 401 mm (30 x 27 x 15.8 in)	559 x 686 x 401 mm (22 x 27 x 15.8 in)
<b>Automation Package</b>	Interface- <i>it</i> software and RS-232 computer interface are available for setting the bath temperature via an external computer. For IEEE-488, add the 2001-IEEE to the automation package. (Interfaces not available for Model 7011.)				

## Ordering Information

<b>7008</b>	Standard Bath, -5 °C to 110 °C, high capacity	<b>2010</b>	Access Cover, 127 x 254 mm (5 x 10 in), Lexan (7011, 7040)	<b>2027-5901</b>	TPW Holding Fixture (7012, 7037)
<b>7011</b>	Standard Bath, -10 °C to 110 °C	<b>2010-5</b>	Access Cover, 162 x 292 mm (6.38 x 11.5 in), Lexan (7037)	<b>2069</b>	8X Magnifier Scope, with mounts
<b>7012</b>	Standard Bath, -10 °C to 110 °C, deep	<b>2011</b>	Access Cover, 184 x 324 mm (7.25 x 12.75 in), Lexan (7008)	<b>7008IR</b>	7008, modified to accept an IR cone
<b>7037</b>	Standard Bath, -40 °C to 110 °C, deep	<b>2016-7008</b>	Fluid Level Adapter, 7008	<b>2033</b>	IR Cone (NIST design)
<b>7040</b>	Standard Bath, -40 °C to 110 °C	<b>2016-7011</b>	Fluid Level Adapter, 7011		
		<b>2016-7012</b>	Fluid Level Adapter, 7012		
		<b>2016-7037</b>	Fluid Level Adapter, 7037		
<b>2001-IEEE</b>	Add for IEEE-488 (requires Automation Package)	<b>2016-7040</b>	Fluid Level Adapter, 7040		
<b>2007</b>	Access Cover, 127 x 254 mm (5 x 10 in), Stainless Steel (7011, 7040)	<b>2071</b>	Bath Cart, 7011, 7012 (312 mm [12.3 in] H)		
		<b>2073</b>	Bath Cart, 7008, 7037, 7040 (216 mm [8.5 in] H)		

# Hot baths



- Large-capacity tanks for higher productivity
- Calibrations up to 300 °C
- Built-in cooling coils for extended low range
- Stability to  $\pm 0.001$  °C

Comparison calibrations require a heat source that's stable and uniform, and for moderately high temperatures nothing provides a better heat source than a Hart oil bath.

Hart oil baths are stable to  $\pm 0.001$  °C and do not require calibration blocks or use of special calibration techniques to achieve that stability. The specifications of all Hart baths are "true" specifications representing the performance you can expect to achieve in your lab under your operating conditions. Other companies advertise specs that they know you will never see in your lab. When their baths fail to perform, they blame it on you.

Hart baths are built using a unique tank design that guarantees the best uniformity

possible in a liquid bath. This, coupled with the industry's best-selling digital bath controller, achieves uncompromised performance and ease of use.

Not only does Hart's digital controller have features like its "Super-Tweak" high-resolution mode so you can dial in the exact temperatures you want, it also lets you completely automate the calibration process using your PC and Hart's 9938 MET/TEMP II software (see page 97).

You'll love these baths, and once you've got one you'll never buy anything else. There's a bath to match any temperature range, depth, price, and performance you need.

## Uncertainty evaluation and statistical process control with a bath

Considerable emphasis is placed on uncertainty analysis and statistical process control (SPC) in the calibration lab. If you're using a calibration bath in your process, you may be wondering how to include the bath in the process evaluation. Basically, there are three approaches.

The first is to "calibrate" the bath to ensure that it meets published specifications and include the published specifications with the "type B" uncertainties in your evaluation just as you might do with any other instrument.

The second approach is to thoroughly test the bath stability and uniformity, perform statistical analysis of the results' uncertainties, and include the results with the "type A" uncertainties in your evaluation. This is often a better method and will provide more realistic results.

The third avenue is to use a "check standard" instrument in the process in such a way that the bath characteristics are included in the check-standard data, which is evaluated statistically and included with the "type A" evaluation. This approach is somewhat more time-consuming but will provide realistic results. When used in conjunction with the second method above, the best results will be obtained.



# Hot baths

Specifications	6020	6022	6024
Range	40 °C to 300 °C†		
Stability	± 0.001 °C at 40 °C (water) ± 0.003 °C at 100 °C (oil 5012) ± 0.005 °C at 300 °C (oil 5017)		
Uniformity	± 0.002 °C at 40 °C (water) ± 0.004 °C at 100 °C (oil 5012) ± 0.012 °C at 300 °C (oil 5017)		
Temperature Setting	Digital display with push-button data entry		
Set-Point Resolution	0.01 °C; high-resolution mode, 0.00018 °C		
Display Temperature Resolution	0.01 °C		
Digital Setting Accuracy	± 1 °C		
Digital Setting Repeatability	± 0.02 °C		
Heaters	350 and 1050 watts		
Access Opening (call for custom openings)	127 x 254 mm (5 x 10 in)		184 x 324 mm (7.25 x 12.75 in)
Depth	305 mm (12 in)	464 mm (18.25 in)	337 mm (13.25 in)
Wetted Parts	304 stainless steel		
Power	115 V ac (± 10 %), 50/60 Hz, 10 A or 230 V ac (± 10 %), 50/60 Hz, 5 A, specify		
Volume	27 liters (7.2 gallons)	42 liters (11.2 gallons)	
Weight	32 kg (70 lb)	36 kg (80 lb)	
Size (HxWxD)	648 x 406 x 508 mm (25.5 x 16 x 20 in)	813 x 406 x 508 mm (32 x 16 x 20 in)	699 x 483 x 584 mm (27.5 x 19 x 23 in)
Automation Package	Interface- <i>it</i> software and RS-232 computer interface are available for setting bath temperature via remote computer. For IEEE-488, add the 2001-IEEE to the automation package.		

†External cooling required for operation below 40 °C. Cooling coils are built into the bath walls. Tubing ports are accessible at the back of the bath for circulating chilled fluid or shop air to boost cooling.

## Ordering Information

<b>6020</b>	Standard Bath, 40 °C to 300 °C	<b>2007</b>	Access Cover, 127 x 254 mm (5 x 10 in), SST (6020, 6022)	<b>2023</b>	Fast-Start Heater, 419 mm (16.5 in) (6022)
<b>6022</b>	Standard Bath, 40 °C to 300 °C, deep	<b>2009</b>	Access Cover, 184 x 324 mm (7.25 x 12.75 in), Stainless Steel (6024)	<b>2069</b>	8X Magnifier Scope, with mounts
<b>6024</b>	Standard Bath, 40 °C to 300 °C, high capacity	<b>2070</b>	Bath Cart, 6020, 6022 (312 mm [12.3 in] H)		
<b>2001-6020</b>	Automation Package for 6020	<b>2072-2450</b>	Bath Cart, 6024 (216 mm [8.5 in] H)		
<b>2001-6022</b>	Automation Package for 6022				
<b>2001-6024</b>	Automation Package for 6024				
<b>2001-IEEE</b>	Add for IEEE-488 (requires Automation Package)				

# Really hot bath



- Eliminates messy sand baths
- Electronically adjustable temperature cutouts
- Stability of  $\pm 0.008$  °C at 550 °C

You'll find more Hart baths in national calibration labs than any other brand, and there's a reason for that. No one else can match the stability, uniformity, and performance of a Hart bath, and we absolutely guarantee it.

This model is designed for high-temperature work—up to 550 °C. Most labs use this as a salt bath for calibration of thermocouples, RTDs, and SPRTs. In fact, this bath is so good you can even do comparison calibrations of SPRTs with it. The bath is stable to  $\pm 0.005$  °C or better at 300 °C.

Hart is the only company that offers complete automated calibration software packages that work with the bath interface option. Our optional software is not just a data acquisition package; it actually controls the calibration, including bath temperatures.

Choose the model that most closely matches your needs. These baths are compatible with salt for higher temperatures and also with oils for lower temperatures.

Hart sells a complete selection of salt and fluids for your bath. You can find these on page 128. Salt baths offer better performance and less mess than sand baths. SPRT comparison calibrations in a sand bath aren't reliable the way they are in a Hart salt bath.

All options, including the automation interface package, are available for the 6050H. It is the finest-quality salt bath you can buy!

If you need to reach the maximum temperature possible in a salt bath, the Hart 6050H goes to 550 °C and is 10 to 100 times more stable than alternative calibration devices.

It is 305 mm (12 in) deep and has a 127 x 254 mm (5 x 10 in) well opening for easy access. Ports in the rear of the bath access cooling coils if you want to cool the bath rapidly with external fluids.

## Specifications

<b>Range</b>	180 °C to 550 °C
<b>Stability</b>	$\pm 0.002$ °C at 200 °C (salt) $\pm 0.004$ °C at 300 °C (salt) $\pm 0.008$ °C at 550 °C (salt)
<b>Uniformity</b>	$\pm 0.005$ °C at 200 °C (salt) $\pm 0.020$ °C at 550 °C (salt)
<b>Temperature Setting</b>	Digital display with push-button data entry
<b>Set-Point Resolution</b>	0.01 °C; high-resolution mode, 0.00018 °C
<b>Display Temperature Resolution</b>	0.01 °C
<b>Digital Setting Accuracy</b>	$\pm 1$ °C
<b>Digital Setting Repeatability</b>	$\pm 0.02$ °C
<b>Heaters</b>	400, 1200, and 2000 Watts
<b>Access Opening</b>	127 x 254 mm (5 x 10 in)
<b>Depth</b>	305 mm (12")
<b>Wetted Parts</b>	304 stainless steel
<b>Power</b>	230 V ac ( $\pm 10$ %), 50/60 Hz, 10 A
<b>Volume</b>	27 liters (7.1 gal), requires 50 kg (112 lb) of bath salt
<b>Weight</b>	82 kg (180 lb)
<b>Size (HxWxD)</b>	724 x 518 x 622 mm (28.5 x 20.4 x 24.5 in)
<b>Automation Package</b>	Interface- <i>it</i> software and RS-232 computer interface are available for setting bath temperature via remote computer. For IEEE-488, add the 2001-IEEE to the automation package.

## Ordering Information

<b>6050H</b>	Standard Bath, 60 °C to 550 °C (includes cart)
<b>2001-6050</b>	Automation Package for 6050H
<b>2001-IEEE</b>	Add for IEEE-488 (requires Automation Package)
<b>2014</b>	Spare Access Cover
<b>5001</b>	Bath Salt, 56.8 kg (125 lb)
<b>2023</b>	Fast-Start Heater, 419 mm (16.5 in)

# Bath accessories

## Mechanical support for probes

When setting up a new calibration bath, you need a way to suspend your probes in the bath fluid. We recommend our modular mechanical support systems. Made of fine-quality steel and machined parts, these support components combine in hundreds of ways to solve almost any probe suspension problem.

### Single probe kit

Our single probe kit is a good way to get started. It has one medium clamp, one 10-inch rod, one bosshead, and one V-base for holding one probe. (See photo below.)

### Economy kit

Our economy kit includes two V-bases, one 29-inch stainless steel rod, two 23-inch rods, five bossheads, two micro-clamps, and one medium clamp. This will build a bench-mounted frame for suspending one rod and three clamps over a bath opening. Simply add to your setup as needed. Choose from any of the listed accessories.

### Individual hardware

Our selection of clamps and stands provides a simple way to hold probes and thermometers in baths during calibration. System components can be assembled in a number of ways to suit individual needs. Select clamps, rods, bossheads, and bases to fit your individual needs.



Single Probe Kit.

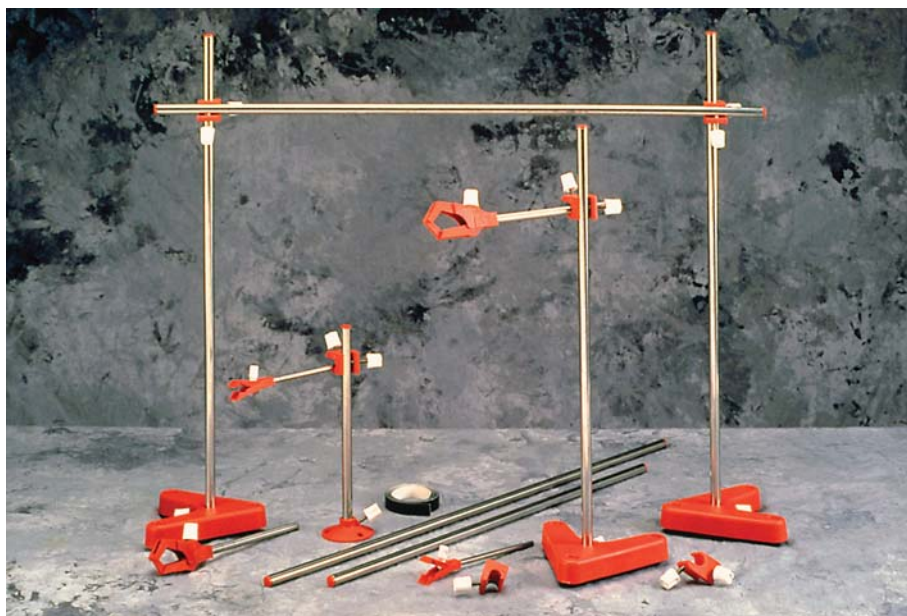

## Ordering Information

Selected kits		Model
<b>Single probe kit</b>	Includes: 1 medium clamp, 1 10-inch rod, 1 bosshead, and 1 V-base	<b>2051</b>
<b>Economy kit</b>	Includes: 2 V-bases, 1 29-inch stainless steel rod, 2 23-inch rods, 5 bossheads, 2 micro-clamps, and 1 medium clamp	<b>2050</b>
Individual hardware		
<b>Micro-clamps</b>	Holds thermometers and probes with diameters to 0.75 inch.	<b>2055</b> (Pkg. of 2)
<b>Medium clamp</b>	Holds diameters up to 1.75 inches.	<b>2056</b> (Pkg. of 1)
<b>Non-slip tape</b>	Increases grip on clamps and bossheads.	<b>2057</b> (1 roll)
<b>Stainless steel rods</b>	Used to assemble supports, frameworks, or scaffolds.	<b>2058</b> 10" (Pkg. of 1)
		<b>2059</b> 20" (Pkg. of 1)
		<b>2060</b> 23" (Pkg. of 1)
		<b>2061</b> 29" (Pkg. of 1)
<b>Bossheads</b>	Clamps two rods at right angles. Also attaches clamps to rods.	<b>2062</b> (Pkg. of 5)
<b>Screw bases</b>	Holds one rod and is screwed to the surface of your bench or bath lid. 2.5-inch-diameter base; screws included.	<b>2063</b> (Pkg. of 4)
<b>V-base</b>	Holds one rod. Weighted for excellent stability. 2.2 pounds (1 kg).	<b>2064</b> (Pkg. of 1)
<b>Large V-base</b>	Same as above but larger. Recommended for holding SPRTs and large probes. 4.4 pounds (2 kg). (May be too large for some baths.)	<b>2065</b> (Pkg. of 1)



# Deep-well baths



- Constant liquid levels through concentric-tube design
- Special design for sighting LIG thermometers
- Depth up to 24 inches (61 cm)
- Optional interface packages control all settings

The Hart Models 7007, 6054, and 6055 have extra-deep wells for use with liquid-in-glass thermometers, SPRT calibrations, or other thermometry work requiring extra tank depth. They were originally designed for NIST.

Well depths vary from 17 to 24 inches to eliminate stem conduction effects in probes that require more than 12 inches of immersion. Originally developed for a national standards lab, these baths are optimized for the visual calibration of liquid-in-glass thermometers.

The 7007 is designed for the temperature range of  $-5^{\circ}\text{C}$  to  $110^{\circ}\text{C}$ , has built-in refrigeration, is 24 inches deep, and comes with a removable polycarbonate

cover. The 6054 covers the temperature range of  $50^{\circ}\text{C}$  to  $300^{\circ}\text{C}$ , is also 24 inches deep, and comes with a removable stainless steel cover. The 6055 is engineered for the temperature range of  $200^{\circ}\text{C}$  to  $550^{\circ}\text{C}$  with salt and is 17 inches deep. Specific size differences and various specifications are shown in the comparison table.

The Model 6055, operating up to  $550^{\circ}\text{C}$ , uses molten salts with a pumping system for maintaining the necessary consistent fluid level required for liquid-in-glass thermometer calibrations. A viewing channel is built into the stainless steel top cover for a clear visual path to your glass thermometers.

The 6055 also has an optional thermometer carousel for holding several glass thermometers in the correct calibration position without exposing them to the hot salts in the bath. The Model 2018 Carousel is completely constructed of stainless steel and has an elevated handle for rotating your thermometers to the viewing position.

These deep-well baths are built to the same performance standards as all Hart baths, which means you can't find another bath that has better stability or uniformity.

## Ordering Information

7007	Refrigerated Deep-Well Bath
6054	Mid-Range Deep-Well Bath
6055	Hi-Temp Deep-Well Bath
2001-7007	Automation Package for 7007
2001-6054	Automation Package for 6054
2001-6055	Automation Package for 6055
2001-IEEE	Add for IEEE-488 (requires Automation Package)
2018	Carousel Holding Fixture for 6055
2069	LIG Telescope with Mounting, 8X magnification



Model 2018 carousel for protecting your glass thermometers.

# Deep-well baths

Specifications	7007	6054	6055
Range	-5 °C to 110 °C	50 °C to 300 °C	200 °C to 550 °C
Stability	± 0.001 °C at 0 °C (ethanol) ± 0.003 °C at 100 °C (oil 5012)	± 0.003 °C at 100 °C (oil 5012) ± 0.005 °C at 300 °C (oil 5017)	± 0.003 °C at 200 °C (salt) ± 0.01 °C at 550 °C (salt)
Uniformity	± 0.004 °C at 0 °C (ethanol) ± 0.007 °C at 100 °C (oil 5012)	± 0.007 °C at 100 °C (oil 5012) ± 0.015 °C at 300 °C (oil 5017)	± 0.005 °C at 200 °C (salt) ± 0.010 °C at 550 °C (salt)
Temperature Setting	Digital display with push-button data entry		
Set-Point Resolution	0.002 °C, high res. 0.00003 °C	0.01 °C, high res. 0.00018 °C	
Display Temperature Resolution	0.01 °C		
Digital Setting Accuracy	± 1 °C		
Digital Setting Repeatability	± 0.005 °C	± 0.01 °C	
Heaters	250 to 1000 W	250 to 1000 W	260 to 2080 W
Working Area	178 mm dia. (7 in)	196 mm dia. (7.7 in)	107 mm dia. (4.2 in)
Depth	610 mm (24 in) deep	610 mm deep (24 in)	432 mm deep (17 in)
Wetted Parts	304 stainless steel		
Power	230 V ac (± 10 %), 50 or 60 Hz, 15 A (Specify frequency, contact Hart if CE mark required.)	230 V ac (± 10 %), 50/60 Hz, 15 A max	230 V ac (± 10 %), 50/60 Hz, 15 A
Volume	42 liters (11.2 gal)	50 liters (13.2 gal)	19.8 liters (5.2 gal, 43 kg [95 lb] of bath salt)
Size (DxWxH)	470 x 775 x 194 mm to working surface (18.5 x 30.5 x 47 in), 1397 mm (55 in) to top of stir motor, 914 mm (36 in) to control panel	572 x 762 x 1219 mm to working surface (22.5 x 30 x 48 in), 1422 mm (56 in) to top of stir motor box, 914 mm (36 in) to control panel	572 x 775 x 1219 mm to working surface (22.5 x 30.5 x 48 in), 1524 mm (60 in) to top of stir motor box, 914 mm (36 in) to control panel
Distance from Line of Sight to Top of Fluid	9.5 mm (3/8 in)	15.9 mm (5/8 in)	
Automation Package	Interface-it software and RS-232 computer interface are available for setting bath temperature via remote computer. For IEEE-488, add the 2001-IEEE to the automaton package.		
Weight	70.8 kg (156 lb)		

## Viscosity matters

Viscosity is a measure of resistance to fluid flow. The temperature homogeneity, or uniformity, within a bath is directly related to the ability of the stirrer to circulate the fluid around the tank. Any resistance to that fluid circulation will impede the mixing and transfer of heat throughout the bath that is necessary to establish temperature uniformity.

In general, the lower the viscosity, the better. Kinematic viscosity is measured in centistokes (cs). Water at 20 °C has a viscosity of about 1 cs. A viscosity of less than 10 cs will give good performance. As a rule of thumb, as viscosities approach 50 cs (less for a Micro-Bath), uniformity in particular can be degraded. Keeping probes close together can stretch the useful viscosity range of a fluid.

# Resistor baths



- Three size options for any quantity of resistors
- Stability to  $\pm 0.0007$  °C
- Set-point resolution to  $0.00003$  °C
- Minimal long-term drift

Regardless of the size and number of standard resistors you have to maintain, Hart has a bath that will do the job for you. Choose one of the three models described here or call us for information on other sizes.

Like all Hart baths, these resistor baths have unbeatable stability and uniformity. No other baths limit long-term and short-term drift—as well as gradients—better than these baths. Hart's proprietary controller senses temperature changes as small as  $0.00001$  °C. This controller is the industry's best-selling temperature calibration controller for bath retrofits because it improves the stability of almost every other poorly performing bath. So why not buy the best to begin with?

Each bath can be delivered with any size resistor rack you want (a standard model is included with each bath), and the Model 7015 has several other special features that make your work easier.

## 7015

The 7015 has a 95-liter tank and a temperature range of 0 °C to 50 °C. It's stable to  $\pm 0.0007$  °C.

It has a one-piece stainless steel lid designed to drain spills and splashes back into the bath as you remove resistors. It has a large access opening to make handling large resistors, like the Thomas design standard resistors, easier. The tank has an electrically isolated resistor shelf.

This is truly a quality resistor bath, and it's backed by Hart's industry-leading service.

## 7009

This is a large bath with a tank  $27\frac{1}{2}$  inches long by 22 inches wide. It has a temperature range of 0 °C to 50 °C and a stability of  $\pm 0.0007$  °C.

For a bath this size and with these specs, it is priced extremely well. The Model 7009's large tank can handle many resistors of any size.

## 7108

This is the quietest resistor bath you've ever heard. The 7108 uses thermoelectric (Peltier) modules to provide heating and cooling over its range from 20 °C to 30 °C. Without a compressor, noise is dramatically reduced. Power requirements are also lower, so you save money running the bath and add less heat load to your lab.



# Resistor baths

Specifications	7015	7009	7108
Range	0 °C to 50 °C†	0 °C to 50 °C†	20 °C to 30 °C
Stability at 25 °C	± 0.0007 °C (water) ± 0.001 °C (mineral oil 5011)		± 0.002 °C (water) ± 0.004 °C (mineral oil 5011)
Uniformity	± 0.003 °C at 25 °C (water) ± 0.005 °C at 25 °C (mineral oil 5011)		± 0.005 °C (water) ± 0.008 °C (mineral oil 5011)
Temperature Setting	Digital display with push-button data entry		
Set-Point Resolution	0.001 °C; high-resolution mode, 0.00003 °C		
Display Resolution	0.01 °C		
Digital Setting Accuracy	± 1 °C		± 0.5 °C
Digital Setting Repeatability	± 0.01 °C		
Heaters	500 and 1000 Watts		Peltier heating/cooling
Cooling Capacity	100 to 200 Watts		100 W in ambient 23 °C
Access Opening	699 x 279 mm (27.5 x 11 in)	699 x 559 mm (27.5 x 22 in)	356 x 356 mm (14 x 14 in)
Bath Chamber Dimensions ( HxWxD ) (unobstructed space)	699 x 279 x 330 mm (27.5 x 11 x 13 in)	669 x 559 x 330 mm (27.5 x 22 x 13 in)	355 x 203 x 355 mm (14 x 8 x 14 in)
Depth	330 mm (13 in)		203 mm (8 in)
Wetted Parts	304 stainless steel		Tank: 304 stainless steel Resistor rack: hard-anodized, perforated aluminum
Safety Cutout	Factory-set high temperature		n/a
Power	115 V ac (± 10 %), 60 Hz, 15 A or 230 V ac, 50 or 60 Hz, 8 A, specify	230 V ac (± 10 %), 50 or 60 Hz, 12 A (specify frequency)	115 V ac (± 10 %), 50/60 Hz, 3 A or 230 V ac (± 10 %), 50/60 Hz, 1.6 A, specify
Volume	95 liters (25 gallons)	167 liters (44 gallons)	51 liters (13.2 gallons)
Weight	141 kg (310 lb)	150 kg (330 lb)	35 kg (75 lb)
Size ( HxWxD )	1219 x 1118 x 559 mm (48 x 44 x 22 in)	1092 x 1130 x 864 mm (43 x 44.5 x 34 in)	489 x 413 x 635 mm (19.25 x 22 x 25 in)
Automation Package	Interface- <i>it</i> software and RS-232 computer interface are available for setting the bath temperature via an external computer. (Both come standard with a 7108.) For IEEE-488, add the 2001-IEEE to the automation package.		

†Although the 7015 and 7009 baths are capable of reaching higher temperatures, they are designed for use with standard resistors. Therefore, the soft cutout of the instrument has been set at the factory to 50 °C to protect standard resistors placed in the bath.

With a 51-liter (13.2-gal) tank, the 7108 holds plenty of resistors. A large 14" x 14" (356 x 356 mm) access opening allows you to easily move resistors in and out of the bath. A resistor rack comes with each unit that fits across the bottom of the tank. Made from hard-anodized perforated aluminum, this rack maintains the necessary electrical isolation between your resistors.

Hart baths have been used in primary temperature and electrical labs for years. Why shouldn't they be? They're the most stable baths in the world. Now they're even better. Try one.

## Ordering Information

<b>7015</b>	Resistor Bath
<b>7009</b>	Resistor Bath, high capacity
<b>7108</b>	Resistor Bath, Peltier-cooled, includes RS-232
<b>2001-7015</b>	Automation Package for 7015
<b>2001-7009</b>	Automation Package for 7009
<b>2001-IEEE</b>	Add for IEEE-488 (requires Automation Package)
<b>5011-18.9L</b>	Fluid, Mineral Oil, 18.9 L (5 gal.)
<b>5011-3.8L</b>	Fluid, Mineral Oil, 3.8 L (1 gal.)

## Improving uniformity performance

Want to reduce your bath uncertainties? Non-uniformity can be a significant factor in calibration uncertainty. Our uniformity specs cover the entire working volume of the bath. The "working volume" is typically one inch from all of the walls and three inches below the fluid surface.

For better results, keep your probes close together and adequately immersed. Bath uniformity is better within a small portion of the bath than it is over the entire working volume. Leave about one-half inch of space around each probe to permit adequate fluid flow. Any more than that is unnecessary.

# Constant temperature ice bath



- Lower uncertainty zero-point (to  $\pm 0.002$  °C uniformity)
- Affordable—amazing price for this uniformity and stability
- Many probes can be checked/calibrated at once

Take a look at this easy and affordable zero-point source for calibrating temperature sensors—the Hart Scientific 7911A2 Constant Temperature Ice Bath.

Now you can attain lower uncertainties from a simple ice bath. Most people don't realize just how much uncertainty a stationary ice mixture in a typical ice bath can have. Pockets of non-uniform temperature will wreak havoc on your calibration uncertainties. With a stirred ice bath, the uniformity and stability can easily drop to  $\pm 0.002$  °C. Now that's more like it!

The 7911A2 has a 5-liter tank with a depth of 12 inches. This gives you an optimal calibration zone of 2.5" diameter by 8" deep—enough space to calibrate several probes at once, including odd-shaped or short probes. Think how many thermocouple cold junctions you could put in this bath!

As with all Hart products, the model 7911A2 Constant Temperature Ice Bath is manufactured according to a proven design using the best components.

The vacuum-insulated stainless steel dewar is used to give your ice-point realization longevity (a well-prepared ice bath can be used for several hours without attention).

We use a Rosemount-designed "flow chute" stirring mechanism to saturate the bath water with air as it stirs. Having the same concentration of air in the mixture each time increases the repeatability of the ice point.

Using pure distilled or demineralized water for bath fluid and ice, you'll consistently produce a 0 °C calibration environment with up to  $\pm 0.002$  °C accuracy.

For thermometer calibrations or for a thermocouple cold junction temperature source, if you want the best ice bath results, use the best equipment available—get the Hart 7911A2.

## Specifications

<b>Uniformity</b>	$\pm 0.002$ °C†
<b>Stability</b>	$\pm 0.002$ °C†
<b>Optimal Temp. Zone</b>	64 mm dia. x 203 mm D (2.5 x 8 in)
<b>Size</b>	185 mm dia. x 490 mm D (7 x 19 in)
<b>Tank Capacity</b>	5 Liters, 150 mm dia. x 300 mm D (6 x 12 in)
<b>Weight</b>	13.5 lb (6.1 kg)
<b>Power</b>	115 V ac ( $\pm 10$ %), 60 Hz, 1 A or 230 V ac ( $\pm 10$ %), 50 Hz, 0.5 A

†based on a properly made ice bath mixture

## Ordering Information

**7911A2** Constant Temperature Ice Bath

## Preparing an ice bath

You wouldn't think that making a good, repeatable ice bath would be a difficult thing. Well, it's not if you follow some simple procedures, which you can find in the ASTM Standard Practice E563. Those are too detailed to cite here, but here are some quick thoughts:

- By always following the same procedure and using the same source for both water and ice, you'll improve the repeatability of the temperature you achieve.
- Remember that any impurities in the ice and water you use will affect the ice bath temperature. Pure distilled, demineralized, or deionized water is recommended for realizing the true ice point temperature, 0 °C.
- Be sure to keep your bath container clean by rinsing it with pure water.

## Avoid water problems in cold baths

### Reprinted from *Random News*

Halocarbon, methanol, ethanol, silicone oils, ethylene glycol, and Fluorinert are common bath fluids used at cold temperatures. Under ideal conditions, they make excellent heat transfer fluids for calibrations. But how are their heat transfer characteristics affected by water and how does this occur?

When a bath is operated at low temperatures, moisture condenses on exposed cold metal surfaces. This moisture accumulates until gravity causes it to run or drip into the bath fluid. Water may also be absorbed directly into the fluid from the surrounding air, particularly when ambient conditions are high in humidity.

Small amounts of water in most bath fluids will usually not affect the bath's performance in any noticeable way. However, as more water accumulates, the bath's performance will deteriorate. The water converts to small ice crystals, the viscosity of the fluid increases, and the result is a degradation in the stability and uniformity characteristics of the bath. Obviously, this is a bigger problem in areas with higher humidity.

Condensed moisture affects various fluids in different ways. For example, ethylene glycol (mixed in a 1:1 ratio with water) is the least affected by an increase in water content. Alcohols such as ethanol or methanol absorb water and have a high tolerance for moisture in the short term, but will exhibit poorer performance as water content continues to increase.

Silicone oils, on the other hand, do not absorb water at all, which can allow excessive water to freeze on exposed cold metal surfaces. When this occurs, the oil is somewhat protected, but a new problem arises when the ice formations act as a thermal barrier or insulator and the conductive characteristics of the bath's walls are compromised. This can result in a bath failing to reach its lowest rated temperatures and, in severe cases, can impede or even completely stop the stirring of the fluid.

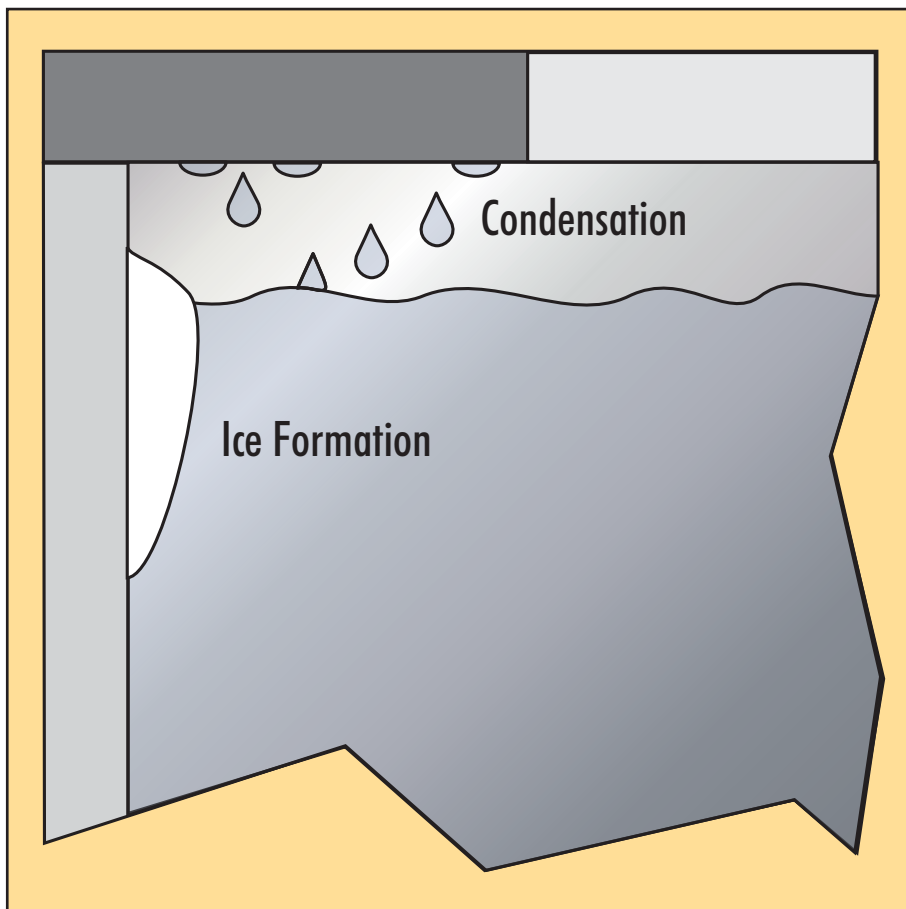

So, what to do? Here are a few suggestions:

- Always keep the bath's access cover in place, especially when operating the bath below room temperature. The idea here is to prevent the wet room air from circulating throughout the tank area and depositing its moisture in the bath.
- If the bath is equipped with a rubber fill-hole stopper, a hole may be drilled through the stopper through which a metal tube can be inserted to supply dry air or nitrogen. The pressure

should be adjusted just enough to maintain a positive pressure flow.

- With oils, the water can be boiled off periodically at 100°C.
- Alcohols must simply be replaced when they become saturated with water.

Maintaining the bath fluid (by keeping it as dry and clean as possible) and following moisture prevention techniques will help ensure your bath keeps running at top performance.



# Bath fluids



The bad news is there's a lot to know about selecting a proper bath fluid—and there's a lot to understand about how to correctly use it. The good news is we're in our fourth decade of working with a very wide variety of fluids and we've already done a lot of the homework for you!

On the following pages you'll find a list of fluids (including granular bath salt) offered by Hart Scientific. We offer most of them in a variety of different container sizes, so please select the packaging you prefer. (If you order 100 liters in a one-liter size, you'll get 100 separately packaged liters.) You'll also find a chart, which graphically indicates usable ranges and some other important facts about each fluid.

First, though, let's get you acquainted with some of the important things to know about selecting and using various bath fluids.

## Usable range

Hart Scientific defines the "usable range" of a bath fluid as the range of temperatures over which a fluid can safely provide a good environment in which to compare thermometers. The ranges we define for each fluid may be different than what the

manufacturers of those fluids specify. That's simply because we're taking the application (thermometer testing in baths) into account.

Range can be limited by viscosity, flash points, freeze points, boiling points, evaporation rates, propensity to gel (or polymerize), etc. Safety-related issues should never be discounted.

Unfortunately, no magic fluid exists to cover extremely wide temperature ranges. We wish one did! Most fluids cover smaller ranges than we'd like. Ideally, you have a separate bath for every common temperature point you use – to eliminate fluid changes and time for baths to change temperature and to maximize throughput.

## Viscosity

Viscosity is a measure of a fluid's resistance to flow—we often think of it simply as "thickness." Kinematic viscosity is the ratio of absolute viscosity to density and is measured in "stokes" (at a specific temperature), which are commonly divided by 100 to give us more helpful "centistokes." The higher the number of centistokes, the more viscous (or thick) a fluid is. Viscosity is always stated at a specific temperature

(often at 25 °C) and increases as the fluid's temperature decreases (and vice versa).

Bath fluids which are too viscous create strain on stirring and pumping mechanisms and don't adequately transfer heat uniformly from temperature sources to thermometers.

Hart recommends using fluids with less than 50 centistokes viscosity, which is reflected in the usable ranges we state for each fluid. Less than 10 centistokes viscosity, however, is ideal. Low-uncertainty calibrations require a homogeneous temperature within the "calibration zone" of a bath. High-viscosity fluids promote unwanted temperature gradients.

## Flash points

This is the temperature at which an adequate mixture of fluid vapor and air will ignite if in the presence of a spark or flame. (The vapor may even stop burning if the flame is removed.)

There are two ways to measure flash points. With the "open cup" method, neither the fluid nor the air around it is enclosed, so there is a higher ratio of air to fluid vapor. With the "closed cup" method, the fluid, fluid vapor, and air are enclosed. Closed cup flash points are typically lower than open cup flash points.

Also, fluid manufacturers list flash points in various places. On MSDS, the flash point is often given non-specifically to fit into a classification scheme used for hazard control. Actual product specification sheets usually give more specific information. For example, the flash point of one silicone oil is listed on its MSDS as "> 101.1 °C," whereas a more specific "211 °C cc" is listed on its specification sheet.

For Hart fluids that have flash points, we list the closed cup method and limit the upper end of the fluid's range to slightly below the flash point.

## Heat capacity

Specific heat is the amount of heat required to raise the temperature of a unit of a substance by 1 °C. The higher the heat capacity, the more difficult it is to raise a fluid's temperature, therefore it is both slower and more stable.

## Thermal conductivity

Thermal conductivity is a fluid's ability to transfer heat from one molecule to another. The better the heat transfer, the quicker the fluid will heat or cool. Better thermal conduction improves bath uniformity.

# Bath fluids

## Expansion

All fluids have a coefficient of thermal expansion. This coefficient tells how much a fluid's volume will change (expand or contract) with changes in temperature. Fluid expansion has important ramifications for safety, cleanliness, and care of equipment. If baths are filled too high with a fluid at a low temperature and then heated without regard to volume increase, they can obviously spill. Also, if the fluid in a bath is allowed to run too low, it can leave bath heaters exposed, which can damage them.

## Specific gravity

The specific gravity is the ratio of a fluid's density to that of water. The higher the specific gravity, the more dense (and heavy) a fluid is. If the fluid is too heavy, it may not work well in a bath equipped with a pump mechanism or circulator.

## Vapor pressure

Vapor pressure is (at least for our purposes here) the temperature at which the rate of evaporation of that fluid equals the rate at which the fluid's vapor is condensing back into the fluid—i.e. the two are at equilibrium. Raising the temperature increases a fluid's vapor pressure over ambient pressure, thereby driving vapor into the air.

Fluids that have low vapor pressures (such as alcohols and water) evaporate quickly and require frequent replenishment. Furthermore, rapid evaporation at the fluid surface has a cooling effect on the fluid, making temperature control more difficult, especially with an uncovered bath. Such fluids generally are only suitable for low temperature use. In some cases, vapors in the air can provide a health hazard and should be carefully vented.

## Gelling (polymerization)

Here's an area that can get people into trouble! Given enough time, temperature, and catalysts, silicone oils will eventually polymerize. That is, they'll suddenly turn into a molasses-like "goop," doubling in volume and making an unpleasant mess.

Oxidation is the root cause. While silicone oils may be used safely to near their flash points, susceptibility to polymerization increases with use above their oxidation points, which we list for each silicone oil.

To delay polymerization, limit a bath's time above a fluid's oxidation point, have it idle below its vapor point when not being used, keep contaminants out of the oil (including salts, other oils, and oxidizers),

and change your oil if it becomes too dark, too viscous, or too unstable in temperature.

## Water

There are a few things to understand about water in non-water baths. First, never introduce water into a salt or hot oil bath as this can be extremely dangerous.

Second, water may condense in an oil bath being used at low temperatures, particularly where there is high ambient humidity. The water can freeze to cooling surfaces and cause bad stirring conditions. Occasionally the water needs to be boiled off.

Lastly, alcohols absorb water. This isn't all bad. In fact 5 % water in methanol will allow methanol to be used at -100 °C. Also, water that is absorbed will not freeze onto cooling surfaces. However, when too much water is absorbed, the alcohol becomes saturated and a slurry forms, impeding stability and uniformity. At that point, the fluid needs to be changed.

## Ventilation

Always use good ventilation with baths that will prevent bath users from breathing fumes from bath fluids. Suction devices that open near the bath's access opening and exit out of doors are best. Oil vapor can settle on the surfaces of the eyes which causes some discomfort. Silicone oils can create benzene and formaldehyde

as they break down at high temperatures—i.e. at about the flash point or above. Keep baths sealed up as much as possible to prevent fumes from coming into the work space. This will help with safety but will also increase the lifetime of the oil and improve performance of the bath.

## Safety

Nothing is more important when working around a bath than to follow good safety practices. Here are some important recommendations:

- Always wear appropriate personal protective equipment. This may include gloves, aprons, and face shields of adequate covering and material for the temperatures being worked with.
- Understand the fluids you're using. MSDS sheets from manufacturers can be very helpful. Product specification sheets from manufacturers often include helpful information not in the MSDS.
- Ventilate appropriately, as mentioned above.
- Never mix fluids or put any chemicals into the fluid.
- Never put anything into bath fluid which could potentially cause a physical or chemical reaction.
- Never allow water to come into contact with hot salts or oils. (If a fire-

## Specifications

Model #	Fluid	Usable Range <sup>§</sup>	FlashPoint <sup>†</sup>
5019	Halocarbon 0.8 Cold Bath Fluid	-100 °C to 70 °C	n/a
5022	Dynalene HF/LO*	-65 °C to 58 °C	60 °C
5023	HFE Cold Bath Fluid	-75 °C to 100 °C	n/a
5020	Ethylene Glycol (Mix 1:1 with water)	-30 °C to 90 °C	n/a
5010	Silicone Oil Type 200.05	-40 °C to 130 °C	133 °C
5012	Silicone Oil Type 200.10	-30 °C to 209 °C	211 °C
5013	Silicone Oil Type 200.20	10 °C to 230 °C	232 °C
5014	Silicone Oil Type 200.50	30 °C to 278 °C	280 °C
5017	Silicone Oil Type 710	80 °C to 300 °C	302 °C
5011	Mineral Oil	10 °C to 175 °C	177 °C
5001	Bath Salt, 125 lb <sup>‡</sup> Potassium Nitrate 53 % Sodium Nitrite 40 % Sodium Nitrate 7 %	180 °C to 550 °C	n/a

<sup>§</sup>Atmospheric pressure affects the usable ranges of some fluids. The temperatures quoted are at sea level.

<sup>†</sup>Flash point is the temperature at which a vapor (not the fluid) will ignite if exposed to an open flame. When the flame is removed, the vapor will stop burning. (Open cup method.)

\*Electrical resistivity is greater than 20 MΩ-cm.

<sup>‡</sup>125 lb bath salt fills a 30-liter (7.9-gallon) tank.

Material Safety Data Sheets available at [www.hartscientific.com](http://www.hartscientific.com)

# Bath fluids

extinguishing sprinkler system is triggered and sends water into salt and hot oil baths, the situation can become literally explosive.)

- Only place clean thermometers into bath fluids.
- Never operate a bath on or around combustible materials. Keep the area around baths clean.
- Keep appropriate fire extinguishing equipment nearby.
- Ensure that all personnel who operate with or near baths understand the precautions that should be taken around them and how to deal with emergencies.
- Abide by federal, state, and local laws regarding the storage and disposal of hazardous or flammable bath fluids.
- Do not use or store bath salt in or around flammable materials. While Hart 5001 Bath Salt is not flammable, it supports combustion of other flammable materials such as wood or cardboard. Do not use bath salt for applications outside of thermometer calibrations.
- Avoid using fluids above their flash points. Special safety considerations should be used for alcohols since their flash points are typically below room temperatures.

## Ordering Information

### 5001 Bath Salt

**5001** Bath Salt, 125 lb (fills a 30 liter [7.9 gal] tank)

### 5010 Silicone Oil

**5010-1L** Silicone Oil Type 200.05, -40 °C to 130 °C, 1 liter (0.26 gal)

**5010-3.8L** Silicone Oil Type 200.05, -40 °C to 130 °C, 3.8 LITERS (1 GAL)

**5010-18.9L** Silicone Oil Type 200.05, -40 °C to 130 °C, 18.9 liters (5 gal)

### 5011 Mineral Oil

**5011-1L** Mineral Oil, 10 °C to 175 °C, 1 liter (0.26 gal)

**5011-3.8L** Mineral Oil, 10 °C to 175 °C, 3.8 liters (1 gal)

**5011-18.9L** Mineral Oil, 10 °C to 175 °C, 18.9 liters (5 gal)

### 5012 Silicone Oil

**5012-1L** Silicone Oil Type 200.10, -30 °C to 209 °C, 1 liter (0.26 gal)

**5012-3.8L** Silicone Oil Type 200.10, -30 °C to 209 °C, 3.8 liters (1 gal)

**5012-18.9L** Silicone Oil Type 200.10, -30 °C to 209 °C, 18.9 liters (5 gal)

### 5013 Silicone Oil

**5013-1L** Silicone Oil Type 200.20, 10 °C to 230 °C, 1 liter (0.26 gal)

**5013-3.8L** Silicone Oil Type 200.20, 10 °C to 230 °C, 3.8 liters (1 gal)

**5013-18.9L** Silicone Oil Type 200.20, 10 °C to 230 °C, 18.9 liters (5 gal)

### 5014 Silicone Oil

**5014-1L** Silicone Oil Type 200.50, 30 °C to 278 °C, 1 liter (0.26 gal)

**5014-3.8L** Silicone Oil Type 200.50, 30 °C to 278 °C, 3.8 liters (1 gal)

**5014-18.9L** Silicone Oil Type 200.50, 30 °C to 278 °C, 18.9 liters (5 gal)

### 5017 Silicone Oil

**5017-1L** Silicone Oil Type 710, 80 °C to 300 °C, 1 liter (0.26 gal)

**5017-3.8L** Silicone Oil Type 710, 80 °C to 300 °C, 3.8 liters (1 gal)

**5017-18.9L** Silicone Oil Type 710, 80 °C to 300 °C, 18.9 liters (5 gal)

### 5019 Halocarbon Fluid

**5019-1L** Halocarbon 0.8 Cold Bath Fluid, -100 °C to 70 °C, 1 liter (0.26 gal)

**5019-3.8L** Halocarbon 0.8 Cold Bath Fluid, -100 °C to 70 °C, 3.8 liters (1 gal)

**5019-18.9L** Halocarbon 0.8 Cold Bath Fluid, -100 °C to 70 °C, 18.9 liters (5 gal)

### 5020 Ethylene Glycol

**5020-1L** Ethylene Glycol (Mix 1:1 with Water), -30 °C to 90 °C, 1 liter (0.26 gal)

**5020-3.8L** Ethylene Glycol (Mix 1:1 with Water), -30 °C to 90 °C, 3.8 liters (1 gal)

**5020-18.9L** Ethylene Glycol (Mix 1:1 with Water), -30 °C to 90 °C, 18.9 liters (5 gal)

### 5022 Dynalene HF/LO Fluid

**5022-1L** Dynalene HF/LO, -65 °C to 58 °C, 1 liter (0.26 gal)

**5022-3.8L** Dynalene HF/LO, -65 °C to 58 °C, 3.8 liters (1 gal)

**5022-18.9L** Dynalene HF/LO, -65 °C to 58 °C, 18.9 liters (5 gal)

### 5023 HFE Cold Bath Fluid

**5023-1L** HFE Cold Bath Fluid, -75 °C to 100 °C, 1 liter (0.26 gal)

**5023-3.8L** HFE Cold Bath Fluid, -75 °C to 100 °C, 3 liters (1 gal)

**5023-18.9L** HFE Cold Bath Fluid, -75 °C to 100 °C, 18.9 liters (5 gal)



# Bath fluids

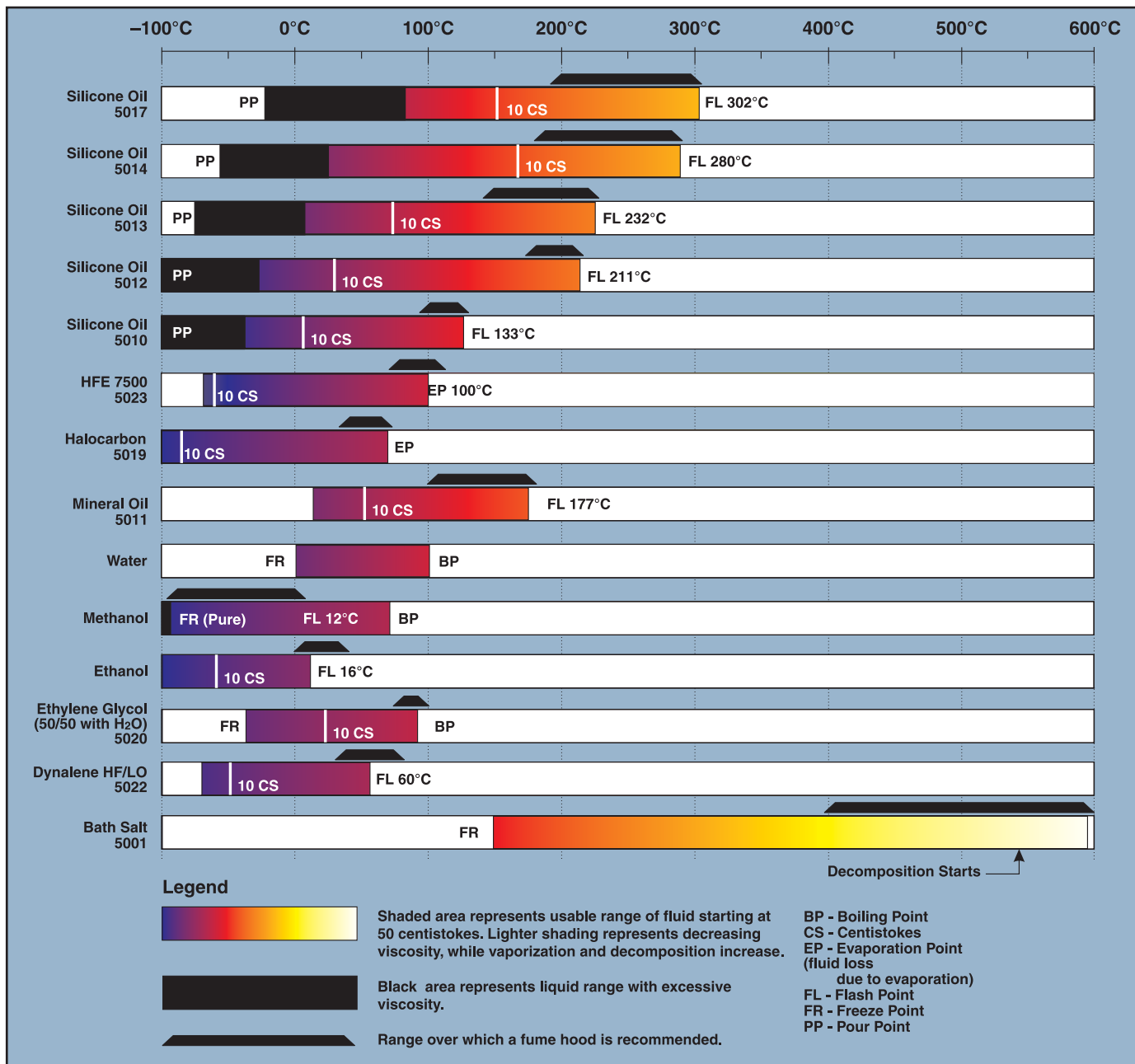

## Can't a single fluid cover my bath's entire range?

So, you want to cover the entire temperature range of your bath with one fluid? That would be nice. Unfortunately for all of us, this is often not possible.

All fluids have temperature range limits for a variety of reasons. The properties of certain fluids just don't hold still over temperature. Not only do you have problems with freezing and boiling, but viscosity

changes, evaporation, and flash points create limits for a fluid's useful temperature range.

The result is that one fluid may not cover the range you need within a single bath, leaving you with a choice between inconvenient fluid changes or multiple temperature-dedicated baths.

# Controller for Rosemount-designed baths



- All the features of the Hart 2100 Controller
- Installs easily
- Two independent over-temperature cutout circuits

Hart's bath controllers have long been recognized as the finest in the world. They're the most popular retrofit controller in the industry, and now they're available for Rosemount baths. The Model 7900 Controller installs easily and can replace the Rosemount Model 915 for all Rosemount bath models.

This controller uses the same circuitry as Hart's 2100 Controller to achieve long-lasting stabilities of  $\pm 0.001$  °C or better. Special noise-rejection techniques allow the 7900 to measure the very tiny resistance changes required for this level of stability. AC bridges are used within the controller to cancel thermal EMFs. Custom high-precision resistors contribute to short- and long-term stability and advanced filtering techniques force out troublesome line noise.

The Model 7900 includes a special circuit that monitors the controller's microprocessor and automatically resets it if its operations are interrupted. Two separate cutout systems are also included for keeping your bath's temperature within its normal range.

A software cutout uses an adjustable high-temperature limit that can be easily

accessed through the front panel and set to match the requirements of your bath fluid. Should the control sensor measure a temperature beyond this upper limit, heating is shut down. If the bath's temperature falls below its normal operating range, the heaters are turned on and the LN<sub>2</sub> cooling shut off. A second, independent hardware cutout monitors the bath's temperature with a thermocouple and shuts down all heating and LN<sub>2</sub> cooling if the bath's temperature rises above its range.

These cutout features, combined with the superior reliability and long-term stability performance of the 7900, allow you to run your system for as long as you like between shut-downs—365 days a year, if you wish. Your bath can be ready for you to take measurements the minute you walk into your lab each day.

## Specifications

Temperature Control Range	-100 °C to 550 °C
Optional Ranges	None
Stability	$\pm 0.003$ ( $\pm 0.001$ typical)
Stabilization Time	30 minutes
Display Accuracy	$\pm 1$ °C
Cooling Control	LN <sub>2</sub> – automatic
Heating Control	2-position, firmware or user controlled
Firmware High-Temp Cutout	Yes, volatile, programmable (independent of the controller)
Hardware High-Temp Cutout	Thermocouple controlled
Memory	Non-volatile; 8 programmable set-points, each with ramp and soak features
Programmable Soak Time	1 to 500 minutes
Control Sensor	100-ohm PRT; $\alpha = 0.00385$
Interface	RS-232 and IEEE standard
Software	Interface-it
Operating Temperature	5 °C to 50 °C
Operating Voltage	115 V ac ( $\pm 10$ %), 60 Hz
CE Mark	Contact Hart
Current Rating	20 amps max.
Dimensions (WxHxD)	311 x 114 x 279 mm (12.25 x 4.5 x 11 in)
Weight	4 kg (9 lb)
Installation	Freestanding or rack mounted with optional hardware

## Ordering Information

7900-B	Controller, Rosemount-Designed Baths, bottom stirred (includes control probe and thermocouple cutout)
7900-T	Controller, Rosemount-Designed Baths, top stirred (includes control probe and thermocouple cutout)

# Benchtop controllers



- Most stable temperature controllers available
- Resolution as high as 0.00018 °C
- RS-232 interface included for automating applications

It's no secret why Hart's temperature baths are the most stable baths in the world. In fact, right on page 112 of this catalog we explain that Hart baths use Hart temperature controllers, and they're flat out the best anywhere.

If you're using a homemade bath—or worse, a bath built by one of our competitors—there's a good chance you can drastically improve its performance by using one of Hart's two temperature controllers.

The 2100 controller can sense and respond to temperature changes as low as 0.00001 °C, which means you can enjoy stabilities better than ± 0.001 °C in a mechanically sound bath.

The 2100 has set-point resolution of 0.002 °C using a thermistor input and 0.01 °C using an RTD input. In high-resolution mode you can adjust the set-point in increments smaller than 0.0002 °C. Actual display resolution is 0.01 °C.

Power output is provided on a standard IEC female power receptacle. An auxiliary power output provides constant line voltage to equipment accessories such as stirrers.

The 2200 controller is smaller and lighter than the 2100 and uses an RTD input to provide stabilities as good as ± 0.015 °C. Resolution is 0.01 °C and temperature range is -100 °C to 800 °C.

If operated from any line power between 100 and 230 V ac, 50 or 60 Hz, the 2200 will supply up to 10 amps power output on a standard IEC female power receptacle.

Both models are programmed using the front-panel buttons and also come with an RS-232 interface.

Either of these benchtop controllers can turn an average temperature bath into a true calibration tool. Call us and tell us your application. We'll help you pick the best controller for your situation.

## Specifications

<b>Temperature Range</b>	<b>2100:</b> -100 °C to 670 °C <b>2200:</b> -100 °C to 800 °C
<b>Control Stability</b>	<b>2100:</b> ± 0.0005 °C to ± 0.002 °C <b>2200:</b> ± 0.005 °C to ± 0.02 °C (depends on system design)
<b>Display Accuracy<sup>†</sup> (with probes shown below)</b>	± 1.0 °C
<b>Display Resolution</b>	0.01 °
<b>Set-Point Resolution</b>	<b>2100:</b> 0.0002 ° in high-resolution mode <b>2200:</b> 0.01 °
<b>Auxiliary and Heater Output</b>	<b>2100:</b> 100–125 nominal V ac or 230 nominal V ac (internally switchable), 50/60 Hz, 10 A max. <b>2200:</b> 100–230 V ac, 50/60 Hz, 10 A max.
<b>Heater Output</b>	Solid-state relay
<b>Dimensions (HxWxD)</b>	<b>2100:</b> 72 x 172 x 250 mm (2.83 x 6.75 x 9.86 in) <b>2200:</b> 72 x 114 x 178 mm (2.85 x 4.5 x 7 in)
<b>Probes</b>	<b>2620:</b> RTD, 280 x 4.8 mm (11 x 0.187 in), -100 to 550 °C <b>2622:</b> RTD, 229 x 4.8 mm (9 x 0.187 in), -100 to 550 °C <b>2624:</b> RTD, 356 x 4.8 mm (14 x 0.187 in), -100 to 550 °C <b>2611:</b> Thermistor, 229 x 5.5 mm (9 x 0.218 in), -10 °C to 110 °C (2100 controller only) <b>5635:</b> Type K thermocouple, 406 x 4.7 mm (16 x 0.187 in), 1100 °C for cutout
<b>Automation Software</b>	Both models include Hart's 9930 Interface- <i>it</i> software package (see page 96)

<sup>†</sup>Performance is dependent on system design including the control sensor. Capabilities are based on factory observed performance.

## Ordering Information

<b>2100-P</b>	Controller, PRT
<b>2100-T</b>	Controller, Thermistor
<b>2200</b>	Controller, PRT
<b>2125</b>	IEEE-488 Interface (2100 only)
<b>2611</b>	Thermistor Probe
<b>5635-S</b>	Thermocouple Cutout Probe
<b>2620</b>	RTD Probe, 11 in
<b>2622</b>	RTD Probe, 9 in
<b>2624</b>	RTD Probe, 14 in



# Industrial calibrator selection guide

## Micro-Baths

Model	Range	Accuracy	Description/Features	Page
6102 Micro-Bath	35 °C to 200 °C (95 °F to 392 °F)	± 0.25 °C	World's smallest calibration bath. Stability to ± 0.02 °C. Stirred 2.5-inch-diameter tank.	152
7102 Micro-Bath	-5 °C to 125 °C (23 °F to 257 °F)	± 0.25 °C	Portable bath to -5 °C. No refrigeration—solid-state cooling. Stability to ± 0.015 °C.	
7103 Micro-Bath	-30 °C to 125 °C (-22 °F to 257 °F)	± 0.25 °C	Ultracold Micro-Bath reaches -30 °C. No refrigeration or external cooling needed. Stability to ± 0.03 °C.	

## Handheld dry-wells

Model	Range	Accuracy	Description/Features	Page
9100S Handheld Dry-Well	35 °C to 375 °C (95 °F to 707 °F)	± 0.25 °C at 100 °C ± 0.5 °C at 375 °C	World's smallest dry-well. Fixed block with 4-inch well depth. Four hole patterns available.	164
9102S Handheld Dry-Well	-10 °C to 122 °C (14 °F to 252 °F)	± 0.25 °C	Handheld unit cools to -10 °C. Two 0.5-inch-diameter, removable sleeves.	

## Field dry-wells

Model	Range	Accuracy	Description/Features	Page
9009 Dual-Block Calibrator	-15 °C to 350 °C (5 °F to 662 °F)	Cold block: ± 0.2 °C Hot block: ± 0.6 °C	Dual-block industrial dry-well. Each block has two wells with removable sleeves. Water- and air-tight enclosure.	160
9103 Field Dry-Well	-25 °C to 140 °C (-13 °F to 284 °F)	± 0.25 °C	Small, lightweight field calibrator reaches -25 °C. Stability to ± 0.02 °C. Calibrates up to six probes at once.	148
9140 Field Dry-Well	35 °C to 350 °C (95 °F to 662 °F)	± 0.5 °C	Portable field calibrator. Choose from four multi-hole, removable inserts.	
9141 Field Dry-Well	50 °C to 650 °C (122 °F to 1202 °F)	± 0.5 °C to 400 °C ± 1 °C to 650 °C	High-temp field calibrator. Interface- <i>it</i> software and RS-232 included. Extremely small and fast for temperature range.	
3125 Surface Calibrator	35 °C to 400 °C (95 °F to 752 °F)	± 0.5 °C to 200 °C ± 1.0 °C to 400 °C	Calibrates surface sensors. Plate stability of ± 0.3 °C.	176

## Precision Infrared Calibrators

Model	Range	Accuracy	Description/Features	Page
4180	-15 °C to 120 °C (5 °F to 248 °F)	± 0.40 °C at -15 °C ± 0.55 °C at 120 °C	Fast, portable and easy to use Correct target size for most thermometers	171
4181	35 °C to 500 °C (95 °F to 932 °F)	± 0.35 °C at 35 °C ± 1.60 °C at 500 °C	Calibration solutions from -15 °C to 500 °C (5 °F to 932 °F) Radiometrically calibrated for traceable and consistent results	

## Infrared calibrators

Model	Range	Accuracy	Description/Features	Page
9132	50 °C to 500 °C (122 °F to 932 °F)	± 0.5 °C at 100 °C ± 0.8 °C at 500 °C	Certifies most handheld pyrometers. Short heating and cooling times.	174
9133	-30 °C to 150 °C (-22 °F to 302 °F)	± 0.4 °C	Calibrates at cold temperatures. Gets to desired temperature quickly.	

# Industrial calibrator selection guide

## Metrology Wells

Model	Range	Accuracy	Description/Features	Page
9170	-45 °C to 140 °C (-49 °F to 284 °F)	± 0.1 °C	Best-performing industrial heat sources (accuracy, stability, uniformity) in the world.	139
9171	-30 °C to 155 °C (-22 °F to 311 °F)	± 0.1 °C	Immersion depth to 203 mm (8 in). Optional ITS-90 reference input reads PRTs to ± 0.006 °C.	
9172	35 °C to 425 °C (95 °F to 797 °F)	± 0.1 °C at 100 °C ± 0.15 °C at 225 °C ± 0.2 °C at 425 °C	Temperature range from -45 °C to 700 °C.	
9173	50 °C to 700 °C (122 °F to 1292 °F)	± 0.2 °C at 425 °C ± 0.25 °C at 660 °C		

## Field Metrology Wells

Model	Range	Accuracy	Description/Features	Page
9142	-25 °C to 150 °C (-13 °F to 302 °F)	± 0.2 °C Full Range	Lightweight, portable, and fast Cool to -25 °C in 15 minutes and heat to 660 °C in 15 minutes	144
9143	33 °C to 350 °C (91 °F to 662 °F)	± 0.2 °C Full Range	Built-in two-channel readout for PRT, RTD, thermocouple, 4-20 mA current	
9144	50 °C to 660 °C (122 °F to 1220 °F)	± 0.35 °C at 50 °C ± 0.35 °C at 420 °C ± 0.5 °C at 660 °C	True reference thermometry with accuracy to ± 0.01 °C On-board automation and documentation Metrology performance in accuracy, stability, uniformity, and loading	

## Zero point dry-well

Model	Range	Stability	Description/Features	Page
9101	0 °C (32 °F)	± 0.05 °C	Solid-state cooling. Replaces messy ice baths—easy to operate. Three wells, each 6 inches deep.	170

## Dual block dry-well

Model	Range	Stability	Description/Features	Page
9011 Hot Block	50 °C to 670 °C (122 °F to 1238 °F)	± 0.15 °C at 100 °C ± 0.65 °C at 600 °C	Combined ranges from -30 °C to 670 °C. 1 unit – 2 blocks.	162
Cold Block	-30 °C to 140 °C (-22 °F to 284 °F)	± 0.25 °C (insert wells) ± 0.65 °C (fixed wells)	Two independent temperature controllers (hot and cold side). Stability: ± 0.01 °C. Multi-hole inserts hold up to 8 probes at once.	

## Portable lab dry-wells

Model	Range	Stability	Description/Features	Page
9007	-40 °C to 140 °C (-40 °F to 284 °F)	± 0.15 °C	-40 °C with solid-state Peltier cooling. Rugged truck-, plane-, and sea-worthy enclosure.	166

## Furnaces

Model	Range	Stability	Description/Features	Page
9150 Thermo- couple Furnace	150 °C to 1200 °C (302 °F to 2192 °F)	± 0.5 °C	Benchtop thermocouple furnace. Interchangeable insert sleeves. Fast heating and cooling.	167
9112B Calibra- tion Furnace	300 °C to 1100 °C (572 °F to 2012 °F)	± 0.1 °C	Standard block fits five probes. Accommodates long probes. Gradients less than ± 0.3 °C at 1000 °C.	168

# Selecting an industrial temperature calibrator

Dozens of dry-well manufacturers around the world are producing hundreds of different models of dry-wells. How do you know which will perform best and which is best suited for your work? Here are ten important things to keep in mind.

## Understand your needs

The remaining nine items will be pretty worthless to you without this one. Dry-wells have many characteristics. For you to know which ones will be most important to you, you need to understand how you intend to use your dry-well.

Will it be in a lab environment or in the field? What temperatures will you need? What kind of throughput do you need? Do you want to maximize throughput through speed or through capacity? How accurate are the thermometers you'll be testing in your dry-well—i.e. how accurate does your dry-well need to be? Will you rely on the dry-well's display for a reference or will you use an external thermometer? How long are the thermometers you'll be placing inside the dry-well? Will you be calibrating short or odd-shaped sensors that are better served in a liquid bath? Will you wish to automate your dry-well calibrations? Et cetera.

## Temperature range

Ideally, your dry-wells cover all temperatures at which your thermometers need to be calibrated—with a little room to spare. If you have too much room to spare, you're probably over-spending. Be careful when evaluating low-limit specifications. “-40 °C” is not the same as “-40 °C below ambient.”

## Reliability

The more frequently you run your dry-well from one extreme end of its temperature range to the other, the shorter the life of your dry-well will be. This is especially true for “cold” dry-wells, which rely on thermo-electric cooling. The life of those devices is shortened by extreme cycling and by excessive use at the high end of the dry-well's range. If your application would require either of these usage patterns, consider an additional unit for high temperatures—or buy the extended warranty option.

Watch for blocks and inserts made from degradable material. Copper, for example, has great thermal properties—except that copper inserts oxidize rapidly and flake apart as a result of thermal history at extreme temperatures.



*A large variety of dry-well calibrators from which to choose may make finding the right one for your applications and use a little overwhelming. Read this article and find out what you should be considering for your next calibrator purchase.*

## Accuracy

Four things to know here. First, the internal control sensor in your dry-well (which feeds your dry-well's display) is fairly inexpensive and does not have the robust performance characteristics of a good reference thermistor or PRT (or noble-metal thermocouple, as the case may be). If it's an RTD (most are), it's subject to shift from mechanical shock and may exhibit poor hysteresis. On the other hand, it may be perfectly adequate for your application.

Second, the control sensor and display system were probably calibrated against a high-quality PRT. However, that PRT was inserted into a particular well at a particular depth and contains a particular sensor construction. The specific thermal and mechanical characteristics of that PRT (sensor length, sensor location, lead-wire conductivity, etc.) were essentially “calibrated into” your dry-well. So, unless you're calibrating an identically-constructed sensor inserted in the same place as the one that calibrated your dry-well, the accuracy of your display may not be quite what you think it is.

Third, external references are generally more accurate than internal references. External probes share with probes under test a more common “point of view” of a

block's temperature than does the internal control sensor. But beware of built-in electronics for external reference sensors and how they are specified. Many have poor resolution and do not accept calibration constants for specific reference thermometers. Be sure also to consider both the reference probe and the electronics that read it. A dry-well that has built-in electronics is probably only specifying the accuracy of reading the probe—not of the probe itself.

Fourth, there's a lot more to accuracy than the calibrated internal sensor or a calibrated external reference. You also need to consider—depending on your particular use of the dry-well—the next five items below (stability, axial gradients, radial gradients, loading effects, and hysteresis).

## Stability

The European Association of National Metrology Institutes, in their document EURAMET/Cg-13/V.01, defines “stability” as temperature variation “over a 30-minute period.” Be careful not to over-rely on your dry-well's display to indicate stability. The resolution of the display and the filtering techniques it uses may limit its ability to show instability. And the stability of the control sensor has limited



# Selecting an industrial temperature calibrator

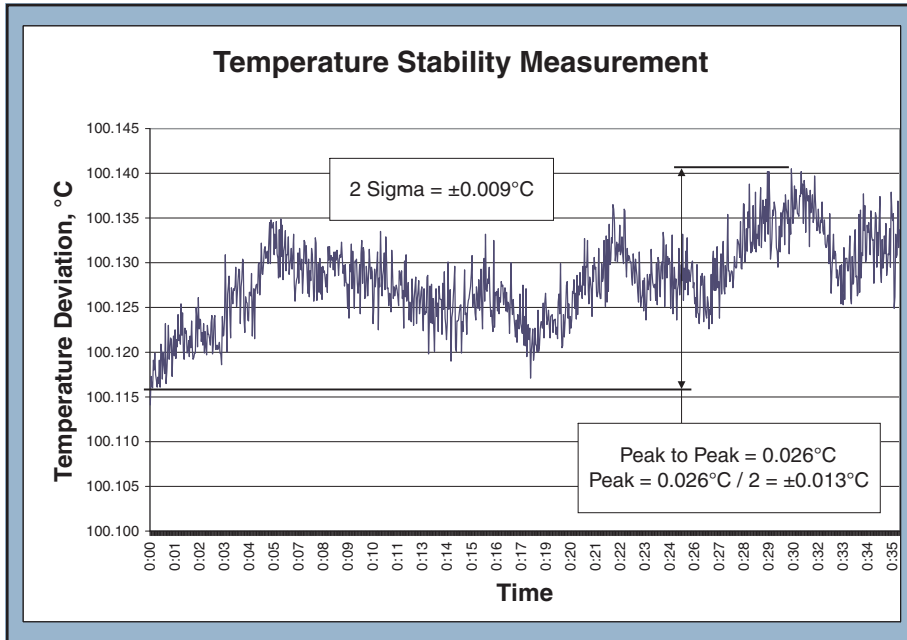

Don't be afraid to ask for stability information and documentation to help in your decision making.

relevance to the stability at the bottom of whatever well you're using.

Also, remember that long-term stability or "drift," in the control sensor requires the dry-well's display to be periodically re-calibrated. How long should you wait between re-calibrations? That depends on the dry-well and how it is used. The best advice is to start with short calibration intervals (3-6 months) and then to lengthen the intervals as the dry-well demonstrates ability to "hold" its calibration.

## Axial (or "vertical") gradients (sweet spots)

Because the top end of a dry-well is directly (or most closely) exposed to the ambient environment, the temperature at that end of the dry-well is closer to ambient temperature and less stable than is the bottom end of the well. It's just physics.

According to EA guidelines, dry-wells should have a "zone of sufficient temperature homogeneity of at least 40 mm (1.5 in) in length." Axial gradients create significant problems when comparing two probes inserted to different depths (should be avoided!), when comparing two probes at the same depth but with different sensor constructions, and when comparing to the displayed temperature a probe which is at a different depth or of a different construction than the probe used to calibrate the display.

Axial gradients can be minimized through design techniques such as block mass and depth, insulation, multiple-zone controlling, and use of profiled or imbalanced heating. It can also be

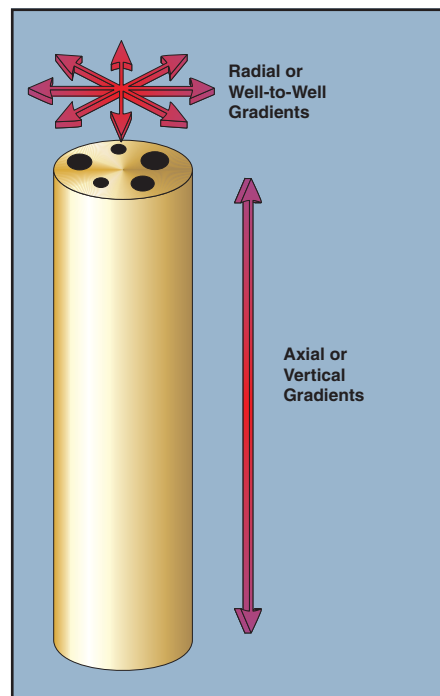

Axial and radial gradients are important considerations in your calibration process.

measured, though it is difficult to separate a measurement of vertical gradients from the stem effects inherent in the probe making the measurements.

## Radial (or "well-to-well") gradients

Radial gradients limit the usefulness of comparing a probe in one well to a probe in another well. While the control sensor of the dry-well is measuring temperature at one fixed location, temperatures may vary within different measuring wells due to variations in the distances between wells and heaters and in variations in hole patterns and how heat flows into and around those holes. In some cases, the temperature in a specific well may even differ depending on how the insert is rotated within the block. (To make sure we all understand terms the same way, "block" refers to the fixed mass of metal, usually containing or surrounded by heating elements; "insert" refers to a metal mass that is removable from the fixed block; and "well" or "hole" refers to the boring in either the insert or the well into which thermometers are introduced.)

To further complicate things, it is difficult to compare a probe of one diameter in one well against a probe of another diameter in another well. Probes with more thermal conductivity draw more influence from the ambient environment into the block. For that reason alone, large-diameter probes (10 mm [3/8 in] in diameter) are often ill-suited for calibration in dry-wells.

## Loading effects

Speaking of heat draw (or "heat suck" as we call it in Utah), the more probes that are inserted into a dry-well, the more heat that will be drawn away from or into the dry-well, depending on its temperature relative to ambient. The displays of dry-wells are typically calibrated when loaded with the one probe that is calibrating it. Adding more probes may cause a larger difference between the control sensor and any one of the probes inside the block. Such effects are easily measured by adding probes and noting the change in reading to the first probe. Design characteristics of dry-wells (block mass, well depth, insulation, and multiple-zone temperature control) can minimize loading effects, as can the use of small-diameter probes. The deeper a probe is inserted into a dry-well, the better also.

# Selecting an industrial temperature calibrator

## Hysteresis

Hysteresis is the difference in a dry-well's actual temperature resulting from the direction from which that temperature was approached. It is greatest at the mid-point of a dry-well's range. For example, a dry-well with a range of 35 °C to 600 °C will have a different temperature at 300 °C when 300 °C was approached from a colder temperature than when 300 °C was approached from a higher temperature. It is a characteristic of the internal control sensor used in the dry-well. The impact of this is eliminated when comparing a test probe to a reference probe, but should be understood when comparing against the unit's calibrated display.

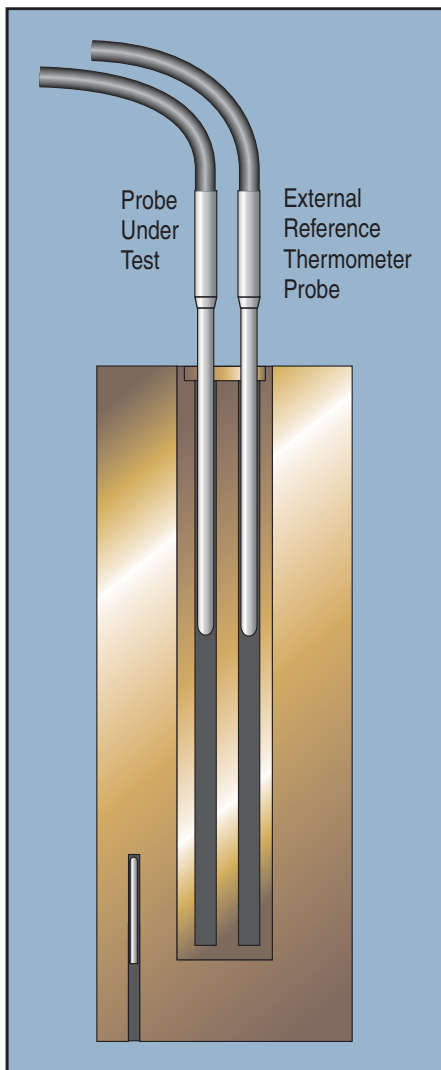

Maximum accuracy for short probes can be obtained by comparing to a similar probe at the same well depth.

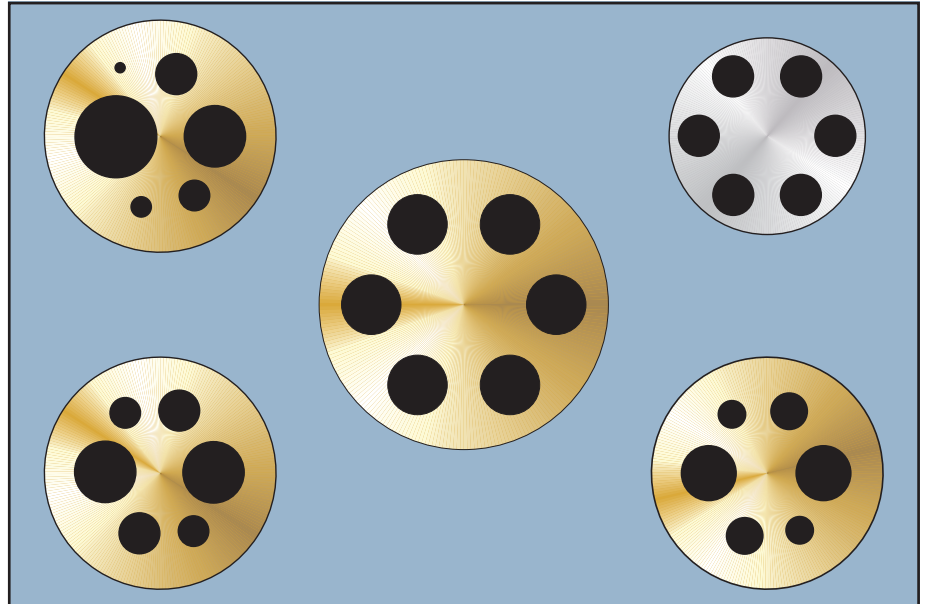

The availability of a variety of blocks or inserts can enhance the flexibility of your calibrator and allow for multiple calibrations at one time.

## Immersion depth

Probe immersion errors (or "stem conduction" errors) can be huge. They vary not only with the dry-well, but with the probe being placed in the dry-well. Different probes utilize different designs and construction techniques, including the size and location of the sensor within the probe assembly and the type and size of the lead wires used in the probe. Therefore different probes have different immersion characteristics. These characteristics can be tested by noting the change in readings from a probe at various depths within the same temperature.

Generally speaking, deeper wells do a better job of eliminating the "stem effects" in probes due to inadequate immersion. Separate "top zone" temperature control of a dry-well also helps minimize stem effect. If you use probes that are too short to adequately reach the homogeneous measurement zone (usually at the bottom) of the dry-well, consider using a bath instead. At a minimum, be sure to compare it to another probe inserted to the same depth in another well. (See illustration at left)

## Flexibility

Speed issues aside at the moment, the most "flexible" dry-wells provide for a removable, multi-hole

inserts can accommodate larger numbers of probes of varying sizes. Be sure when considering the number of wells in a block and the spacing between them, to consider the size of the hubs or handles of the probes that will be used inside the well. While it may appear that two probes can fit snugly near each other in a block or insert, their handles may actually get in the way of each other.

## Functionality

Size, weight, speed, and capacity all involve important tradeoffs—against each other—and against many of the performance characteristics just described. For example, a large, deep thermal mass may provide the most capacity, least gradients, and best stability, but it probably won't be very small, light, or fast. Generally speaking, the fastest, lightest dry-wells provide the poorest performance. High speed and high stability are also difficult to get in the same block design.

This is why it's important to understand how your dry-well will be used and the characteristics of the probes you'll be calibrating in it. In the end, it's those probes you'll be calibrating which should make the decision for you as to whether to use a bath, a metrology well, or a field dry-well.

# Metrology Well calibrators



- Best-performing industrial heat sources (accuracy, stability, uniformity) in the world
- Immersion depth to 203 mm (8 in)
- Optional ITS-90 reference input reads PRTs to  $\pm 0.006$  °C
- Temperature range from  $-45$  °C to  $700$  °C

Every once in a while, a new product comes around that changes the rules. It happened when we introduced handheld dry-wells. It happened when we introduced Micro-Baths. Now we've combined bath-level performance with dry-well functionality and legitimate reference thermometry to create Metrology Wells.

With groundbreaking new proprietary electronics from Fluke's Hart Scientific Division (patents pending), Metrology Wells let you bring lab-quality performance into whatever field environment you might work in. New analog and digital control techniques provide stability as good as  $\pm 0.005$  °C. And with dual-zone control,

axial (or "vertical") uniformity is as good as  $\pm 0.02$  °C over a 60 mm (2.36 in) zone. (That's 60 mm!) Such performance doesn't exist anywhere else outside of fluid baths.

In short, there are six critical components of performance in an industrial heat source (which the European metrology community explains, for example, in the document EURAMET/Cg-13/V.01): calibrated display accuracy, stability, axial (vertical) uniformity, radial (well-to-well) uniformity, impact from loading, and hysteresis. We added a seventh in the form of a *legitimate* reference thermometer input and created an entirely new product category: Metrology Wells.

(By the way, Metrology Wells are the only products on the market supported by published specifications addressing *every* performance category in the EA-10/13. Our specs aren't just hopes or guidelines. They apply to every Metrology Well we sell.)

## Display accuracy

Dry-wells are typically calibrated by inserting a calibrated PRT into one of the wells and making adjustments to the calibrator's internal control sensor based on the readings from the PRT. This has limited value because the unique characteristics of the reference PRT, which essentially become "calibrated into" the calibrator, are often quite different from the thermometers tested by the calibrator. This is complicated by the presence of significant thermal gradients in the block and inadequate sensor immersion into blocks that are simply too short.

Metrology Wells are different. Temperature gradients, loading effects, and hysteresis have been minimized to make the calibration of the display much more meaningful. We use only traceable, accredited PRTs to calibrate Metrology Wells and our proprietary electronics consistently demonstrate repeatable accuracy more than ten times better than our specs, which range from  $\pm 0.1$  °C at the most commonly used temperatures to  $\pm 0.25$  °C at  $661$  °C.

For even better accuracy, Metrology Wells may be ordered with built-in electronics for reading external PRTs with ITS-90 characterizations. (See sidebar, Built in Reference Thermometry, on page 140.)

## Stability

Heat sources from Hart have long been known as the most stable heat sources in the world. It only gets better with Metrology Wells. Both low-temperature units (Models 9170 and 9171) are stable to  $\pm 0.005$  °C over their full range. Even the  $700$  °C unit (Model 9173) achieves stability of  $\pm 0.03$  °C. Better stability can only be found in fluid baths and primary fixed-point devices. The "off-the-shelf controllers" used by most dry-well manufacturers simply can't provide this level of performance.

## Axial uniformity

The EURAMET document suggests that dry-wells should include a zone of maximum temperature homogeneity, which extends for 40 mm (1.54 in), usually at the bottom



# Metrology Well calibrators

## Built-in reference thermometry!

Fluke's Hart Scientific Division has been making the world's best thermometer readout devices for quite some time. Our Super-Thermometer, *Black Stack*, and Tweener thermometers are well-known everywhere. Now we're making our proprietary Tweener measurement circuitry available directly in a heat source—our new Metrology Wells.

This optionally built-in input accepts 100-, 25-, and 10-ohm PRTs. It reads thermometer probes accurately from  $\pm 0.006$  °C at 0 °C to  $\pm 0.027$  °C at 661 °C, not including errors from the probe. It is compatible with every PRT sold by Hart and connects to Metrology Wells via a 5-pin DIN connector.

of a well. Metrology Wells, however, combine our unique electronics with dual-zone control and more well depth than is found in dry-wells to provide homogeneous zones over 60 mm (2.36 in). Vertical gradients in these zones range from  $\pm 0.02$  °C at 0 °C to  $\pm 0.4$  °C at 700 °C.

What's more, Metrology Wells actually have these specifications published for each unit, and we stand by them. We even offer a specially-constructed PRT for testing axial uniformity (models 5662 and 5663).

## Radial uniformity

Radial uniformity is the difference in temperature between one well and another well. For poorly designed heat sources, or when large-diameter probes are used, these differences can be very large. For Metrology Wells, we define our specification as the largest temperature difference between the vertically homogeneous zones of any two wells that are each 6.4 mm (0.25 in) in diameter or smaller. The cold units (9170 and 9171) provide radial uniformity of  $\pm 0.01$  °C and the hot units (9172 and 9173) range from  $\pm 0.01$  °C to  $\pm 0.04$  °C (at 700 °C).

## Loading

Loading is defined as the change in temperature sensed by a reference thermometer inserted into the bottom of a well after the rest of the wells are filled with thermometers, too.

For Metrology Wells, loading effects are minimized for the same reasons that axial gradients are minimized. We use deeper

Two things dramatically differentiate the Tweener circuit from the measurement electronics built into many dry-wells. First, it accepts unique ITS-90 characterization coefficients from reference thermometers, which allow you to take full advantage of the accuracies of those thermometers. Second, it comes with a traceable, accredited calibration, providing you full confidence in the integrity of its measurements.

Nothing beats a Hart Metrology Well for industrial thermal performance. And nothing beats a Tweener measurement for built-in reference thermometry.

wells than found in dry-wells. And we utilize proprietary dual-zone controls. Loading effects are as minimal as  $\pm 0.005$  °C in the cold units.

## Hysteresis

Thermal hysteresis exists far more in internal control sensors than in good-quality reference PRTs. It is evidenced by the difference in two external measurements of the same set-point temperature when that temperature is approached from two different directions (hotter or colder) and is usually largest at the midpoint of a heat source's temperature range. It exists because control sensors are typically designed for ruggedness and do not have the "strain free" design characteristics of SPRTs, or even most PRTs. For Metrology Wells, hysteresis effects range from 0.025 °C to 0.07 °C.

## Immersion depth

Immersion depth matters. Not only does it help minimize axial gradient and loading effects, it helps address the unique immersion characteristics of each thermometer tested in the heat source. Those characteristics include the location and size of the actual sensor within the probe, the width and thermal mass of the probe, and the lead wires used to connect the sensor to the outside world. Metrology Wells feature well depths of 203 mm (8 in) in the Models 9171, 9172, and 9173. The Model 9170 is 160 mm (6.3 in) deep to facilitate temperature of  $-45$  °C.

## Other great features

A large LCD display, numeric keypad, and on-screen menus make use of Metrology Wells simple and intuitive. The display shows the block temperature, built-in reference thermometer temperature, cutout temperature, stability criteria, and ramp rate. The user interface can be configured to display in English, French, or Chinese.

All four models come with an RS-232 serial interface and the Model 9930, *Interface-it* software. All are also compatible with Model 9938 MET/TEMP II software for completely automated calibrations of RTDs, thermocouples, and thermistors.

Even without a PC, Metrology Wells have four different preprogrammed calibration tasks that allow up to eight temperature set points with "ramp and soak" times between each. There is an automated "switch test" protocol that zeros in on the "dead-band" for thermal switches. And a dedicated °C/°F button allows for easy switching of temperature units.

Any of six standard inserts may be ordered with each unit, accommodating a variety of metric- and imperial-sized probe diameters. (See illustration at right.) And Metrology Wells are small enough and light enough to go anywhere.

## 9170

The Model 9170 achieves the lowest temperatures of the series, reaching  $-45$  °C in normal room conditions. The 9170 is stable to  $\pm 0.005$  °C over its full temperature range (up to 140 °C) and has 160 mm (6.3 in) of immersion depth. With axial uniformity of  $\pm 0.02$  °C and radial uniformity of  $\pm 0.01$  °C, this model delivers exceptional uncertainty budgets and is perfect for a variety of pharmaceutical and other applications.

## 9171

If you need more depth, the Model 9171 provides 203 mm (8 in) of immersion over temperatures from  $-30$  °C all the way to 155 °C with full-range stability of  $\pm 0.005$  °C. Just like the 9170, this dry-well has exceptional axial and radial uniformity. The display of the 9171 is calibrated to an accuracy of  $\pm 0.1$  °C over its full range.

## 9172

The Model 9172 provides temperatures from 35 °C to 425 °C with a calibrated display accurate to  $\pm 0.2$  °C at 425 °C. In addition to exceptional accuracy, the 9172 is stable from  $\pm 0.005$  °C to  $\pm 0.01$  °C, depending on temperature.

# Metrology Well calibrators



The Metrology Well family consist of four models (Model 9170, 9171, 9172, and 9173) which, combined, cover a temperature range of -45 °C to 700 °C.

With 203 mm (8 in) of immersion, the 9172 significantly reduces stem conduction errors at high-temperatures.

## 9173

For work between 50 °C and 700 °C, the Model 9173 provides unmatched performance. The 9173 has a display accuracy of ± 0.25 °C at 700 °C and an immersion depth of 203 mm (8 in). Stability and uniformity performance of this unit are enough to dramatically reduce uncertainty budgets for calibrations of thermometers at high temperatures.

Of course, there's still a place in the world for dry-wells or "dry block" calibrators. In fact, Hart makes and will continue to make some of the best performing, portable, fast dry-wells in the world. There's still nothing better for a quick test of industrial temperature sensor performance.

We just can't resist the urge, though, to keep coming up with breakthrough product designs that can dramatically impact the ways people work and the results they see. For the absolute best performance in a portable temperature source, Metrology Wells raise the standard to an entirely new level.

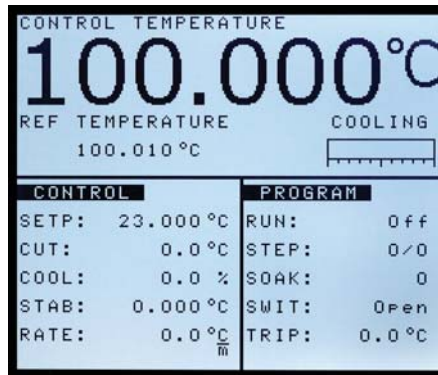

Metrology Well displays offer all the information needed to perform calibrations—control and reference probe temperatures, heating and cooling status, set-point temperature, stability criteria, and more.

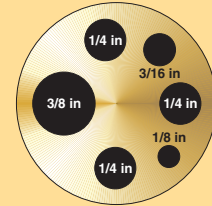

Insert "A"

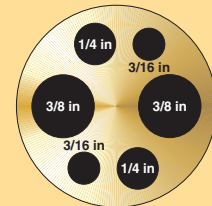

Insert "B"

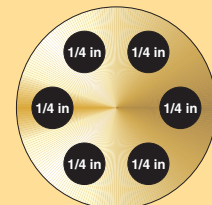

Insert "C"

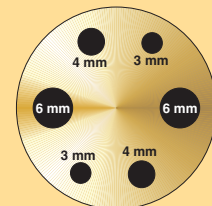

Insert "D"

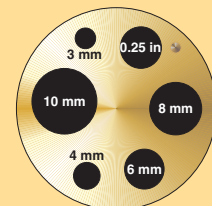

Insert "E"

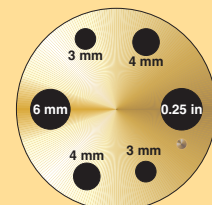

Insert "F"

# Metrology Well calibrators

Specifications	9170	9171	9172	9173
Range (at 23 °C ambient)	-45 °C to 140 °C (-49 °F to 284 °F)	-30 °C to 155 °C (-22 °F to 311 °F)	35 °C to 425 °C (95 °F to 797 °F)	50 °C to 700 °C <sup>†</sup> (122 °F to 1292 °F)
Display Accuracy	± 0.1 °C full range		± 0.1 °C: 35 °C to 100 °C ± 0.15 °C: 100 °C to 225 °C ± 0.2 °C: 225 °C to 425 °C	± 0.2 °C: 50 °C to 425 °C ± 0.25 °C: 425 °C to 660 °C
Stability	± 0.005 °C full range		± 0.005 °C: 35 °C to 100 °C ± 0.008 °C: 100 °C to 225 °C ± 0.01 °C: 225 °C to 425 °C	± 0.005 °C: 50 °C to 100 °C ± 0.01 °C: 100 °C to 425 °C ± 0.03 °C: 425 °C to 700 °C
Axial Uniformity (60 mm)	± 0.1 °C at -45 °C ± 0.04 °C at -35 °C ± 0.02 °C at 0 °C ± 0.07 °C at 140 °C	± 0.025 °C at -30 °C ± 0.02 °C at 0 °C ± 0.07 °C at 155 °C	± 0.05 °C: 35 °C to 100 °C ± 0.1 °C: 100 °C to 225 °C ± 0.2 °C: 225 °C to 425 °C	± 0.1 °C: 50 °C to 100 °C ± 0.25 °C: 100 °C to 425 °C ± 0.4 °C: 425 °C to 700 °C
Radial Uniformity	± 0.01 °C full range		± 0.01 °C: 35 °C to 100 °C ± 0.02 °C: 100 °C to 225 °C ± 0.025 °C: 225 °C to 425 °C	± 0.01 °C: 50 °C to 100 °C ± 0.025 °C: 100 °C to 425 °C ± 0.04 °C: 425 °C to 700 °C
Loading Effect (with a 6.35 mm reference probe and three 6.35 mm probes)	± 0.02 °C at -45 °C ± 0.005 °C at -35 °C ± 0.01 °C at 140 °C	± 0.005 °C at -30 °C ± 0.005 °C at 0 °C ± 0.01 °C at 155 °C	± 0.01 °C full range	± 0.02 °C at 425 °C ± 0.04 °C at 700 °C
Hysteresis	0.025 °C		0.04 °C	0.07 °C
Well Depth	160 mm (6.3 in)	203 mm (8 in)		
Resolution	0.001 °C			
Display	LCD, °C or °F, user-selectable			
Key Pad	Ten key with decimal and +/- button. Function keys, menu key, and °C / °F key.			
Cooling Time	44 min: 23 °C to -45 °C 19 min: 23 °C to -30 °C 19 min: 140 °C to 23 °C	30 min: 23 °C to -30 °C 25 min: 155 °C to 23 °C	220 min: 425 °C to 35 °C 100 min: 425 °C to 100 °C	235 min: 700 °C to 50 °C 153 min: 700 °C to 100 °C
Heating Time	32 min: 23 °C to 140 °C 45 min: -45 °C to 140 °C	44 min: 23 °C to 155 °C 56 min: -30 °C to 155 °C	27 min: 35 °C to 425 °C	46 min: 50 °C to 700 °C
Size (HxWxD)	366 x 203 x 323 mm (14.4 x 8 x 12.7 in)			
Weight	14.2 kg (31.5 lb)	15 kg (33 lb)	13.2 kg (29 lb)	15 kg (33 lb)
Power	115 V ac (± 10 %), or 230 V ac (± 10 %), 50/60 Hz, 550 W		115 V ac (± 10 %), or 230 V ac (± 10 %), 50/60 Hz, 1025 W	
Computer Interface	RS-232 Interface with 9930 Interface-it control software included			
Traceable Calibration (NIST)	Data at -45 °C, 0 °C, 50 °C, 100 °C, and 140 °C	Data at -30 °C, 0 °C, 50 °C, 100 °C, and 155 °C	Data at 100 °C, 150 °C, 250 °C, 350 °C, and 425 °C	Data at 100 °C, 200 °C, 350 °C, 500 °C, and 660 °C

<sup>†</sup>Calibrated to 660 °C; reference thermometer recommended at higher temperatures.

Specifications	Built-in Reference Input	
Temperature Range	-200 °C to 962 °C (-328 °F to 1764 °F)	
Resistance Range	0 Ω to 400 Ω, auto-ranging	
Characterizations	ITS-90 subranges 4, 6, 7, 8, 9, 10, and 11 Callendar-Van Dusen (CVD): $R_{\alpha}$ , $\alpha$ , $\beta$ , $\delta$	
Resistance Accuracy	0 Ω to 20 Ω: 0.0005 Ω 20 Ω to 400 Ω: 25 ppm	
Temperature Accuracy (does not include probe uncertainty)	<b>10 Ω PRTs:</b> ± 0.013 °C at 0 °C ± 0.014 °C at 155 °C ± 0.019 °C at 425 °C ± 0.028 °C at 700 °C	<b>25 Ω and 100 Ω PRTs:</b> ± 0.005 °C at -100 °C ± 0.007 °C at 0 °C ± 0.011 °C at 155 °C ± 0.013 °C at 225 °C ± 0.019 °C at 425 °C ± 0.027 °C at 661 °C
Resistance Resolution	0 Ω to 20 Ω: 0.0001 Ω 20 Ω to 400 Ω: 0.001 Ω	
Measurement Period	1 second	
Probe Connection	4-wire with shield, 5-pin DIN connector	
Calibration	NVLAP accredited (built-in reference input only), NIST-traceable calibration provided	



# Metrology Well calibrators

## Ordering Information - 9170

<b>9170-X</b>	Metrology Well, -45 °C to 140 °C, w/INSX
<b>9170-X-R</b>	Metrology Well, -45 °C to 140 °C, w/INSX, w/Built-In Reference
<b>9170-INSA</b>	Insert "A" 9170, Al, Misc Holes
<b>9170-INSB</b>	Insert "B" 9170, Al, Comparison Holes
<b>9170-INSC</b>	Insert "C" 9170, Al, 0.25-inch Holes
<b>9170-INSD</b>	Insert "D" 9170, Al, Metric Comparison Holes
<b>9170-INSE</b>	Insert "E" 9170, Al, Misc Metric Holes, w/0.25-inch Ref Hole
<b>9170-INSF</b>	Insert "F" 9170, Al, Metric Comparison Holes, w/0.25-inch Ref Hole
<b>9170-INSZ</b>	Insert "Z" 9170, Al, Blank

## Ordering Information - 9171

<b>9171-X</b>	Metrology Well, -30 °C to 155 °C, w/INSX
<b>9171-X-R</b>	Metrology Well, -30 °C to 155 °C, w/INSX, w/Built-In Reference
<b>9171-INSA</b>	Insert "A" 9171, Al, Misc Holes
<b>9171-INSB</b>	Insert "B" 9171, Al, Comparison Holes
<b>9171-INSC</b>	Insert "C" 9171, Al, 0.25-inch Holes
<b>9171-INSD</b>	Insert "D" 9171, Al, Comparison Metric Holes
<b>9171-INSE</b>	Insert "E" 9171, Al, Misc Metric Holes, w/0.25-inch Ref Hole
<b>9171-INSF</b>	Insert "F" 9171, Al, Metric Comparison Holes, w/0.25-inch Ref Hole
<b>9171-INSZ</b>	Insert "Z" 9171, Al, Blank

## Ordering Information - 9172

<b>9172-X</b>	Metrology Well, 35 °C to 425 °C, w/INSX
<b>9172-X-R</b>	Metrology Well, 35 °C to 425 °C, w/INSX, w/Built-In Reference
<b>9172-INSA</b>	Insert "A" 9172, Brass, Misc Holes
<b>9172-INSB</b>	Insert "B" 9172, Brass, Comparison Holes
<b>9172-INSC</b>	Insert "C" 9172, Brass, 0.25-inch Holes
<b>9172-INSD</b>	Insert "D" 9172, Brass, Metric Comparison Holes
<b>9172-INSE</b>	Insert "E" 9172, Brass, Misc Metric Holes, w/0.25-inch Ref Hole
<b>9172-INSF</b>	Insert "F" 9172, Brass, Metric Comparison Holes, w/0.25-inch Ref Hole
<b>9172-INSZ</b>	Insert "Z" 9172, Brass, Blank

## Ordering Information - 9173

<b>9173-X</b>	Metrology Well, 50 °C to 700 °C, w/INSX
<b>9173-X-R</b>	Metrology Well, 50 °C to 700 °C, w/INSX, w/Built-In Reference
<b>9173-INSA</b>	Insert "A" 9173, Al-Brnz, Misc Holes
<b>9173-INSB</b>	Insert "B" 9173, Al-Brnz, Comparison Holes
<b>9173-INSC</b>	Insert "C" 9173, Al-Brnz, 0.25-inch Holes
<b>9173-INSD</b>	Insert "D" 9173, Al-Brnz, Comparison Metric Holes
<b>9173-INSE</b>	Insert "E" 9173, Al-Brnz, Misc Metric Holes, w/0.25-inch Ref Hole
<b>9173-INSF</b>	Insert "F" 9173, Al-Brnz, Metric Comparison Holes, w/0.25-inch Ref Hole
<b>9173-INSZ</b>	Insert "Z" 9173, Al-Brnz, Blank

## All Metrology Wells

*X in the above model numbers to be replaced with A, B, C, D, E, or F as appropriate for the desired insert. See the illustration on page 141 and listing below.*

<b>9170-CASE</b>	Case, Carrying, 9170-3 Metrology Wells
<b>9170-DCAS</b>	Case, Transportation with Wheels, 9170-3 Metrology Wells

# Field Metrology Wells



- Lightweight, portable, and fast
- Cool to  $-25\text{ }^{\circ}\text{C}$  in 15 minutes and heat to  $660\text{ }^{\circ}\text{C}$  in 15 minutes
- Built-in two-channel readout for PRT, RTD, thermocouple, 4-20 mA current
- True reference thermometry with accuracy to  $\pm 0.01\text{ }^{\circ}\text{C}$
- On-board automation and documentation
- Metrology performance in accuracy, stability, uniformity, and loading

Recently, we introduced Metrology Wells, which provide the very best performance in portable temperature calibration. The new 914X Series Field Metrology Wells extend high performance to the industrial process environment by maximizing portability, speed, and functionality with little compromise to metrology performance.

Field Metrology Wells are packed with functionality and are remarkably easy to use. They are lightweight, small, and quick to reach temperature set points, yet they are stable, uniform, and accurate. These industrial temperature loop calibrators are perfect for performing transmitter loop calibrations, comparison calibrations, or simple checks of thermocouple sensors. With the “process” option, there is no need to carry additional tools into the field. This optional built-in two-channel readout reads resistance, voltage, and 4–20 mA current with 24 volt loop power. It also has on-board documentation. Combined, the three models (9142, 9143, and 9144—each with a “process” option) cover the wide range of  $-25\text{ }^{\circ}\text{C}$  to  $660\text{ }^{\circ}\text{C}$ .

## High performance for the industrial environment

Field Metrology Wells are designed for the industrial process environment. They weigh less than 8.2 kg (18 lb) and have a small footprint, which makes them easy to transport. Optimized for speed, Field Metrology Wells cool to  $-25\text{ }^{\circ}\text{C}$  in 15 minutes and heat to  $660\text{ }^{\circ}\text{C}$  in 15 minutes.

Field environment conditions are typically unstable, having wide temperature variations. Each Field Metrology Well has a built-in gradient-temperature compensation (patent pending) that adjusts control characteristics to ensure stable performance in unstable environments. In fact, all specifications are guaranteed over the environmental range of  $13\text{ }^{\circ}\text{C}$  to  $33\text{ }^{\circ}\text{C}$ .

## Built-in features to address large workloads and common applications

Whether you need to calibrate 4–20 mA transmitters or a simple thermostatic switch, a Field Metrology Well is the right

tool for the job. With three models covering the range of  $-25\text{ }^{\circ}\text{C}$  to  $660\text{ }^{\circ}\text{C}$ , this family of Metrology Wells calibrates a wide range of sensor types. The optional process version (models 914X-X-P) provides a built-in two-channel thermometer readout that measures PRTs, RTDs, thermocouples, and 4-20 mA transmitters which includes the 24 V loop supply to power the transmitter.

Each process version accepts an ITS-90 reference PRT. The built-in readout accuracy ranges from  $\pm 0.01\text{ }^{\circ}\text{C}$  to  $\pm 0.07\text{ }^{\circ}\text{C}$  depending on the measured temperature. Reference PRTs for Field Metrology Wells contain individual calibration constants that reside in a memory chip located inside the sensor housing, so sensors may be used interchangeably. The second channel is user-selectable for 2-, 3-, or 4-wire RTDs, thermocouples, or 4-20 mA transmitters. For comparison calibration, don't hassle with carrying multiple instruments to the field. Field Metrology Wells do it all as a single instrument.

Traditionally, calibrations of temperature transmitters have been performed on the measurement electronics, while the sensor remained uncalibrated. Studies have shown, however, that typically 75 % of the error in the transmitter system (transmitter electronics and temperature sensor) is in the sensing element. Thus, it becomes important to calibrate the whole loop—both electronics and sensor.

The process option of Field Metrology Wells makes transmitter loop calibrations easy. The transmitter sensor is placed in the well with the reference PRT and the transmitter electronics are connected to the front panel of the instrument. With 24 V loop power, you are able to power and measure the transmitter current while sourcing and measuring temperature in the Field Metrology Well. This allows for the measurement of as-found and as-left data in one self-contained calibration tool.

All Field Metrology Wells allow for two types of automated thermostatic switch test procedures—auto or manual setup. Auto setup requires the entry of only the nominal switch temperature. With this entry, it will run a 3-cycle calibration procedure and provide final results for the dead band temperature via the display. If you need to customize the ramp rate or run additional cycles, the manual setup allows you to program and run the procedure exactly how you would like. Both methods are fast and easy and make testing temperature switches a virtual joy!

# Field Metrology Wells

## Metrology performance for high-accuracy measurements

Unlike traditional dry-wells, Field Metrology Wells maximize speed and portability without compromising the six key metrology performance criteria laid out by the European Association of National Metrology Institutes: accuracy, stability, axial (vertical) uniformity, radial (well-to-well) uniformity, loading, and hysteresis. All criteria are important in ensuring accurate measurements in all calibration applications.

Field Metrology Well displays are calibrated with high-quality traceable and accredited PRTs. Each device (process and non-process versions) comes with an IEC-17025 NVLAP-accredited calibration certificate, which is backed by a robust uncertainty analysis that considers temperature gradients, loading effects, and hysteresis. The 9142 and 9143 have a display accuracy of  $\pm 0.2$  °C over their full range, and the 9144 display accuracy ranges from  $\pm 0.35$  °C at 420 °C to  $\pm 0.5$  °C at  $\pm 660$  °C. Each calibration is backed with a 4:1 test uncertainty ratio.

New control technology guarantees excellent performance in extreme environmental conditions. The 9142 is stable to  $\pm 0.01$  °C over its full range and the mid-range 9143 is stable from  $\pm 0.02$  °C at 33 °C and  $\pm 0.03$  °C at 350 °C. Even at 660 °C, the 9144 is stable to  $\pm 0.05$  °C. But this is not all! Thermal block characteristics provide radial (well-to-well) uniformity performance to  $\pm 0.01$  °C. Dual-zone control helps these tools achieve axial uniformity to  $\pm 0.05$  °C at 40 mm (1.6 in).

## Automation and documentation make each unit a turnkey solution

So you now have a precision calibration instrument that has field-ready characteristics, accredited metrology performance, built-in two-channel thermometry, and automation—what else could you ask for? How about all this and a turnkey solution that will automate and document the results?

The process versions of Field Metrology Wells have on-board non-volatile memory for documentation of up to 20 tests. Each test can be given a unique alphanumeric ID and will record block temperature, reference temperature, UUT values, error, date, and time. Each test can be easily viewed via the front panel or exported using Model 9930 Interface-it software, which is included with each shipment. Interface-it allows you to pull the raw data into a calibration report or an ASCII file.



*With the ability to measure a reference PRT, mA current, and source 24 V loop power, Field Metrology Wells can automate and save up to 20 different tests.*

## Operation is as easy as 1-2-3

You'll find Field Metrology Wells intuitive and easy to use. Each unit is equipped with a large, easy-to-read LCD display, function keys, and menu navigation

buttons. Its "SET PT." button makes it straightforward and simple to set the block temperature. Each product has a stability indicator that visually and audibly tells you the Field Metrology Wells is



# Field Metrology Wells

stable to the selectable criteria. Each unit offers pre-programmed calibration routines stored in memory for easy recall, and all inputs are easily accessible via the front panel of the instrument.

Never buy a temperature calibration tool from a company that only dabbles in metrology (or doesn't even know the word). Metrology Wells from Fluke are designed and manufactured by the same people who equip the calibration laboratories of the world's leading temperature scientists. These are the people around the world who decide what a Kelvin is! We know a thing or two more about temperature calibration than the vast majority of the world's dry-well suppliers. Yes, they can connect a piece of metal to a heater and a control sensor. But we invite you to compare all our specs against the few that they publish. (And by the way, we meet our specs!)



Field Metrology Wells are available in two versions for maximum speed and portability for the industrial environment. The standard version, pictured on the left, is our best field calibrator, and the process version, pictured on the right, is an all-in-one process calibration tool that reads electronic thermometers, automates calibration, and documents the results.

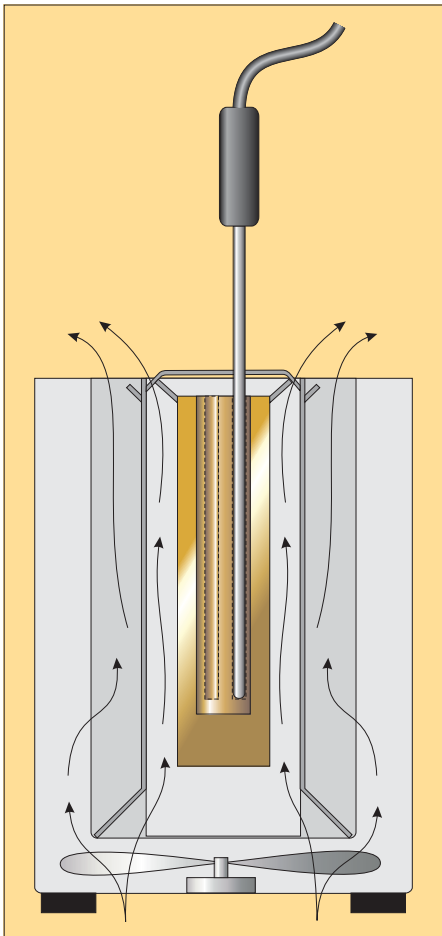

Simplified schematic illustrating the airflow design (patents applied for) to minimize potential heat damage to sensor handles and transition junctions.

# Field Metrology Wells

Base Unit Specifications			
	9142	9143	9144
Temperature Range at 23 °C	-25 °C to 150 °C (-13 °F to 302 °F)	33 °C to 350 °C (91 °F to 662 °F)	50 °C to 660 °C (122 °F to 1220 °F)
Display Accuracy	± 0.2 °C Full Range	± 0.2 °C Full Range	± 0.35 °C at 50 °C ± 0.35 °C at 420 °C ± 0.5 °C at 660 °C
Stability	± 0.01 °C Full Range	± 0.02 °C at 33 °C ± 0.02 °C at 200 °C ± 0.03 °C at 350 °C	± 0.03 °C at 50 °C ± 0.05 °C at 420 °C ± 0.05 °C at 660 °C
Axial Uniformity at 40 mm (1.6 in)	± 0.05 °C Full Range	± 0.04 °C at 33 °C ± 0.1 °C at 200 °C ± 0.2 °C at 350 °C	± 0.05 °C at 50 °C ± 0.35 °C at 420 °C ± 0.5 °C at 660 °C
Radial Uniformity	± 0.01 °C Full Range	± 0.01 °C at 33 °C ± 0.015 °C at 200 °C ± 0.02 °C at 350 °C	± 0.02 °C at 50 °C ± 0.05 °C at 420 °C ± 0.10 °C at 660 °C
Loading Effect (with a 6.35 mm reference probe and three 6.35 mm probes)	± 0.006 °C Full Range	± 0.015 °C Full Range	± 0.015 °C at 50 °C ± 0.025 °C at 420 °C ± 0.035 °C at 660 °C
Hysteresis	0.025 °C	0.03 °C	0.1 °C
Operating Conditions	0 °C to 50 °C, 0 % to 90 % RH (non-condensing)		
Environmental Conditions (for all specifications except temperature range)	13 °C to 33 °C		
Immersion (Well) Depth	150 mm (5.9 in)		
Insert OD	30 mm (1.18 in)	25.3 mm (1.00 in)	24.4 mm (0.96 in)
Heating Time	16 min: 23 °C to 140 °C 23 min: 23 °C to 150 °C 25 min: -25 °C to 150 °C	5 min: 33 °C to 350 °C	15 min: 50 °C to 660 °C
Cooling Time	15 min: 23 °C to -25 °C 25 min: 150 °C to -23 °C	32 min: 350 °C to 33 °C 14 min: 350 °C to 100 °C	35 min: 660 °C to 50 °C 25 min: 660 °C to 100 °C
Resolution	0.01 °		
Display	LCD, °C or °F user-selectable		
Size (H x W x D)	290 mm x 185 mm x 295 mm (11.4 x 7.3 x 11.6 in)		
Weight	8.16 kg (18 lb)	7.3 kg (16 lb)	7.7 kg (17 lb)
Power Requirements	100 V to 115 V (± 10 %) 50/60 Hz, 635 W 230 V (± 10 %) 50/60 Hz, 575 W	100 V to 115 V (± 10 %), 50/60 Hz, 1400 W 230 V (± 10 %), 50/60 Hz, 1800 W	
Computer Interface	RS-232 and 9930 Interface— <i>it</i> control software included		

-P Specifications	
Built-in Reference Thermometer Readout Accuracy (4-Wire Reference Probe) †	± 0.013 °C at -25 °C ± 0.015 °C at 0 °C ± 0.020 °C at 50 °C ± 0.025 °C at 150 °C ± 0.030 °C at 200 °C ± 0.040 °C at 350 °C ± 0.050 °C at 420 °C ± 0.070 °C at 660 °C
Reference Resistance Range	0 ohms to 400 ohms
Reference Resistance Accuracy ‡	0 ohms to 42 ohms: ± 0.0025 ohms 42 ohms to 400 ohms: ± 60 ppm of reading
Reference Characterizations	ITS-90, CVD, IEC-751, Resistance
Reference Measurement Capability	4-wire
Reference Probe Connection	6-pin Din with Infocon Technology
Built-in RTD Thermometer Readout Accuracy	NI-120: ± 0.015 °C at 0 °C PT-100 (385): ± 0.02 °C at 0 °C PT-100 (3926): ± 0.02 °C at 0 °C PT-100 (JIS): ± 0.02 °C at 0 °C
RTD Resistance Range	0 ohms to 400 ohm
RTD Resistance Accuracy ‡	0 ohms to 25 ohms: ± 0.002 ohms 25 ohms to 400 ohms: ± 80 ppm of reading
RTD Characterizations	PT-100 (385),(JIS),(3926), NI-120, Resistance
RTD Measurement Capability	4-wire RTD (2-,3-wire RTD w\ Jumpers only)
RTD Connection	4 terminal input
Built-in TC Thermometer Readout Accuracy	Type J: ± 0.7 °C at 660 °C Type K: ± 0.8 °C at 660 °C Type T: ± 0.8 °C at 400 °C Type E: ± 0.7 °C at 660 °C Type R: ± 1.4 °C at 660 °C Type S: ± 1.5 °C at 660 °C Type L: ± 0.7 °C at 660 °C Type N: ± 0.9 °C at 660 °C
TC Millivolt Range	-10 mV to 75 mV
Voltage Accuracy	0.025 % of reading + 0.01 mV
Internal Cold Junction Compensation Accuracy	± 0.35 °C (ambient of 13 °C to 33 °C)
TC Connection	Small connectors
Built-in mA Readout Accuracy	0.02 % of reading + 0.002 mA
mA Range	Cal 4-22 mA, Spec 4-24 mA
mA Connection	2 terminal input
Loop Power Function	24 V dc loop power
Built-in Electronics Temperature Coefficient (0 °C to 13 °C, 33 °C to 50 °C)	± 0.005 % of range per °C

†The temperature range may be limited by the reference probe connected to the readout. The Built-In Reference Thermometer Readout Accuracy does not include the sensor probe accuracy. It does not include the probe uncertainty or probe characterization errors.

‡Measurement accuracy specifications apply within the operating range and assume 4-wires for PRTs. With 3-wire RTDs add 0.05 ohms to the measurement accuracy plus the maximum possible difference between the resistances of the lead wires.

# Field Metrology Wells

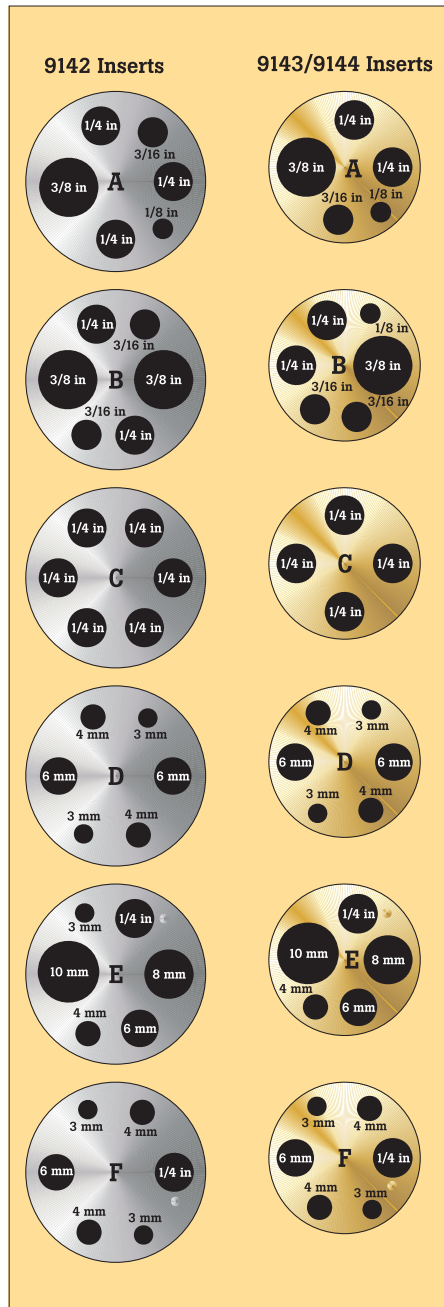

## Ordering Information

### Ordering Information for 9142

- 9142-X** Field Metrology Well, -25 °C to 150 °C, w/9142-INSX  
**9142-X-P** Field Metrology Well, -25 °C to 150 °C, w/9142-INSX, w/Process Electronics  
*X in the above model numbers to be replaced with A, B, C, D, E, or F as appropriate for the desired insert. See the inserts illustration and listing below.*
- 9142-INSA** Insert "A" 9142, Imperial Misc Holes  
**9142-INSB** Insert "B" 9142, Imperial Comparison Holes  
**9142-INSC** Insert "C" 9142, 0.25-inch Holes  
**9142-INSD** Insert "D" 9142, Metric Comparison Holes  
**9142-INSE** Insert "E" 9142, Metric Misc Holes w/0.25-inch Hole  
**9142-INSF** Insert "F" 9142, Metric Comparison Misc Holes w/0.25-inch Hole  
**9142-INSZ** Insert "Z" 9142, Blank

### Ordering Information for 9143

- 9143-X** Field Metrology Well, 33 °C to 350 °C, w/9143-INSX  
**9143-X-P** Field Metrology Well, 33 °C to 350 °C, w/9143-INSX, w/Process Electronics  
*X in the above model numbers to be replaced with A, B, C, D, E, or F as appropriate for the desired insert. See the inserts illustration and listing below.*
- 9143-INSA** Insert "A" 9143, Imperial Misc Holes  
**9143-INSB** Insert "B" 9143, Imperial Comparison Holes  
**9143-INSC** Insert "C" 9143, 0.25-inch Holes  
**9143-INSD** Insert "D" 9143, Metric Comparison Holes  
**9143-INSE** Insert "E" 9143, Metric Misc Holes w/0.25-inch Hole  
**9143-INSF** Insert "F" 9143, Metric Comparison Misc Holes w/0.25-inch Hole  
**9143-INSZ** Insert "Z" 9143, Blank

### Ordering Information for 9144

- 9144-X** Field Metrology Well, 50 °C to 660 °C, w/9144-INSX  
**9144-X-P** Field Metrology Well, 50 °C to 660 °C, w/9144-INSX, w/Process Electronics  
*X in the above model numbers to be replaced with A, B, C, D, E, or F as appropriate for the desired insert. See the inserts illustration and listing below.*
- 9144-INSA** Insert "A" 9144, Imperial Misc Holes  
**9144-INSB** Insert "B" 9144, Imperial Comparison Holes  
**9144-INSC** Insert "C" 9144, 0.25-inch Holes  
**9144-INSD** Insert "D" 9144, Metric Comparison Holes  
**9144-INSE** Insert "E" 9144, Metric Misc Holes w/0.25-inch Hole  
**9144-INSF** Insert "F" 9144, Metric Comparison Misc Holes w/0.25-inch Hole  
**9144-INSZ** Insert "Z" 9144, Blank

### Ordering Information for All Field Metrology Wells

- 9142-CASE** Carrying Case, 9142-4 Field Metrology Wells



## Understanding the uncertainties associated with Metrology Wells

### Introduction

Dry-well calibrators are stable heat sources used in process and laboratory environments for calibration of temperature sensors. All heat sources introduce measurement errors as a result of their mechanical design and thermodynamic properties. These effects can be quantified in an effort to determine the heat sources's contribution to the measurement uncertainty. Fluke's Hart Scientific Division has developed Metrology Wells to reduce the errors typically seen in the usage of dry-wells. Metrology Wells come with a calibrated control sensor and have an option for a built-in thermometer readout. The Metrology Well's uncertainty will significantly vary depending on mode of use. The uncertainties associated with each method of use are discussed. The purpose of this application note is to help technicians and metrologists understand and quantify the measurement uncertainty when using Metrology Wells.

### Uncertainties associated with the use of Metrology Well and its built-in reference thermometer input

Best performance is usually realized when Metrology Wells are used as stable heat sources and an external reference thermometer or the optional built-in reference thermometer input is used as the reference standard. Typically, the major sources of uncertainty are caused by imperfect axial and radial uniformity, loading, instability, stem conduction, reference thermometer accuracy, and unit under test characteristics.

#### Axial uniformity

Each Metrology Well insert (removable sleeve with several drilled wells) is exposed to ambient environment at the top end and to a controlled temperature along a portion of its length. The vertical gradient in the insert is termed "axial uniformity." Due to dissimilarities in construction and length of temperature sensing elements, one must consider the axial uniformity of Metrology Wells.

According to EA (European Accreditation) guideline 10/13, dry-wells should have a "zone of sufficient temperature homogeneity of 40 mm" from the bottom of

**Application Tip:** Axial uniformity errors can often be improved beyond the specification by aligning the centers of the sensing element of the reference probe and the UUT (see Figure 4).



the well. We recommend a zone of at least 60 mm to cover sensor lengths of the units under test (UUTs) and the reference standard, which often needs at least 50 mm

#### Radial uniformity

The thermal gradient from one well to another is referred to as radial uniformity. Measurement errors caused from imperfect radial uniformity are attributed to the distance between wells and heaters, the thermal properties of the insert material, and effects from uneven heat distribution caused by non symmetrical loading.

**Application Tip:** Best results are found when using a comparison insert (Insert B, D, or E) with a reference probe of the same diameter as the UUT and measuring directly across from the UUT.

#### Loading effect

The number of probes inserted into a Metrology Well impacts the amount of heat drawn away from or into a Metrology Well. This is referred to as "loading effect," which can be measured by inserting probes into wells and noting the change

# Understanding the uncertainties associated with Metrology Wells

in the reference reading. Metrology Well design characteristics, such as 203 mm (8 in) of immersion and dual-zone control, help minimize the loading error.

### Stability

Stability over time affects calibrations. EURAMET/Cg-13/V.01 defines stability as a temperature variation "over a 30-minute period." The Metrology Well display can help determine when stability is reached, but there can be a significant difference between the actual and indicated temperature during stabilization. The better practice is to rely on the display of the thermometer readout, which offers more resolution (see Figure 1).

### Stem conduction error

Stem conduction is heat flux along the length of the thermometer stem. This affects both the reference thermometer and the UUT (see Figure 2). Recommended depth of immersion for a probe is calculated as follows:  $[20 \times \text{probe OD}] + [\text{length of the sensor}]$  [see Figure 3]. Because Metrology Wells have deep immersion (160 mm [6.3 in] to 203 mm [8 in]), the error from stem conduction is usually a very small contributor to the over all uncertainty.

**Application Tip:** Stem conduction error can be determined by immersing the probe into a bath and noting its change in temperature when raised at set increments. This is the best practice in that each probe has unique characteristics that contribute to stem conduction and should be evaluated individually.

### Reference probe, thermometer readout, and UUT considerations

There are many other sources of uncertainty to consider that result from the use of a reference probe, reference readout, UUTs, and their readouts. These errors include reference probe and thermometer readout calibration uncertainty or accuracy, reference probe drift and hysteresis, reference probe self-heating, UUT short-term drift and hysteresis, and UUT readout accuracy. This paper does not go into detail on these contributors, but more information can be obtained by contacting Fluke's Hart Scientific Division at [www.hartscientific.com](http://www.hartscientific.com).

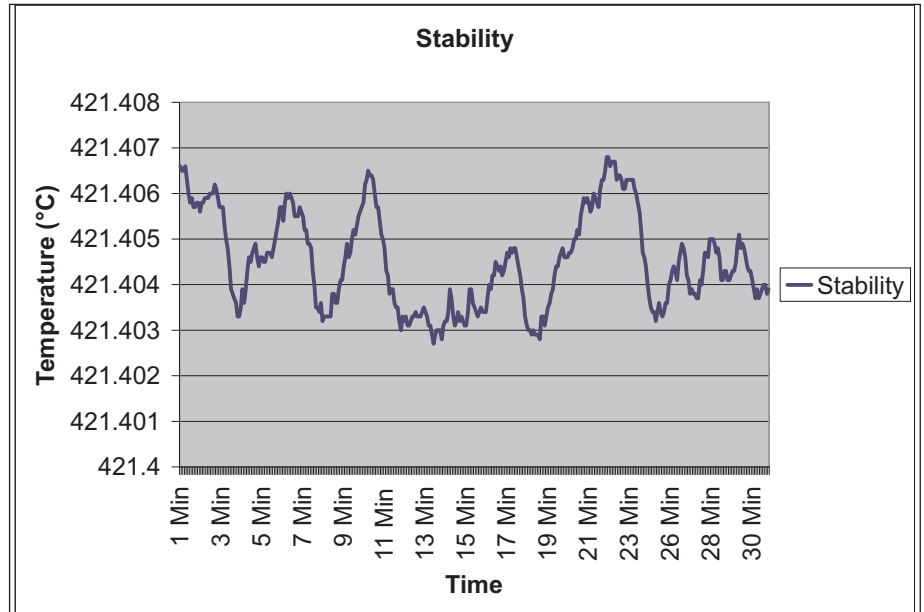

Figure 1. The Metrology Well display can help determine when stability is reached, but a better practice is to rely on the display of a reference thermometer with graphing functions (e.g. a 1523 Reference Thermometer).

### Uncertainties associated with the use of a Metrology Well and its calibrated control sensor

Metrology Well control sensors come calibrated with a traceable certificate of calibration and an accuracy statement which allows the display to be used as a reference standard. Many measurement errors contribute to the uncertainty when using the Metrology Well in this manner.

### Axial uniformity

The vertical gradients in Metrology Wells are more apparent when using the calibrated control sensor as the reference than when using the external reference thermometer. This is because it's not always practical to align the sensing elements of

the control sensor (which is fixed in the block) to the UUTs (see Figures 4 and 5).

### Radial uniformity

The calibrated control sensor is fixed in the block and is often not equidistant to the UUTs from the heaters. Thus, radial uniformity is a contributing factor and is considered.

### Loading effect

Errors from loading typically are much larger when using the control sensor as the reference standard as opposed to an external reference probe, because the control sensor is isolated in the block and does not compensate for the loading of the wells in the insert.

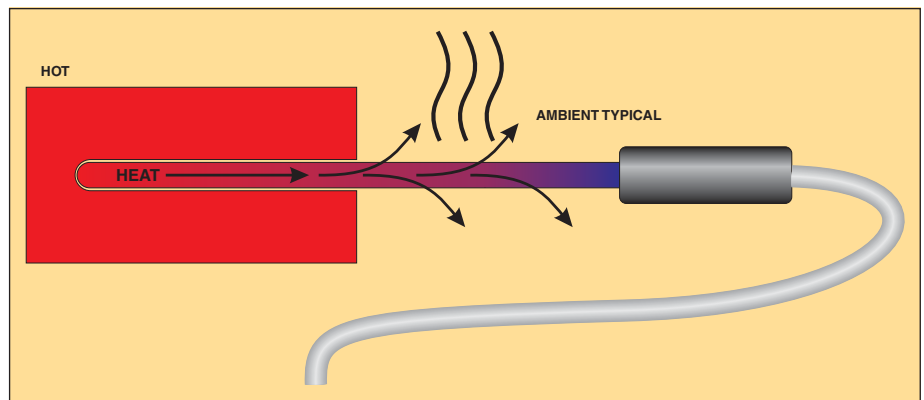

Figure 2. Stem conduction

# Understanding the uncertainties associated with Metrology Wells

## Short-term and long-term drift

Each Metrology Well control sensor has a short- and long-term drift associated with its use. Drift will vary depending on use and care of the Metrology Well. Sensor drift can be determined by regular calibration or intermediate checks at a fixed temperature.

## Hysteresis

Hysteresis is the difference in a Metrology Well's actual temperature resulting from the direction from which that temperature was approached. It is greatest at the midpoint of a Metrology Well's range.

## Control sensor calibration

Metrology Well control sensors are calibrated and come with NIST-traceable reports of calibration. The accuracy of the control sensor may vary from  $\pm 0.1\text{ }^{\circ}\text{C}$  to  $\pm 0.25\text{ }^{\circ}\text{C}$ . The calibrated display becomes most useful when it is used in the same way it was calibrated—when the 6.35 mm (0.25 in) hole is loaded with the UUT and readings are compared against the display temperature.

## Other considerations

The errors from short-term drift, hysteresis, and readout accuracy of the UUT apply in the same way as when a Metrology Well is used with an external reference.

For a complete article with example calculations go to [www.hartscientific.com/publications/](http://www.hartscientific.com/publications/)

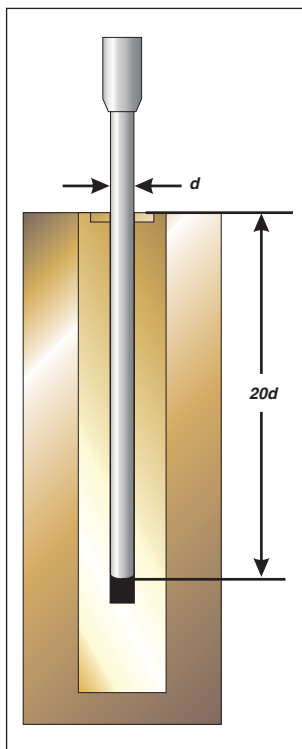

Figure 3. Recommended depth for probe immersion

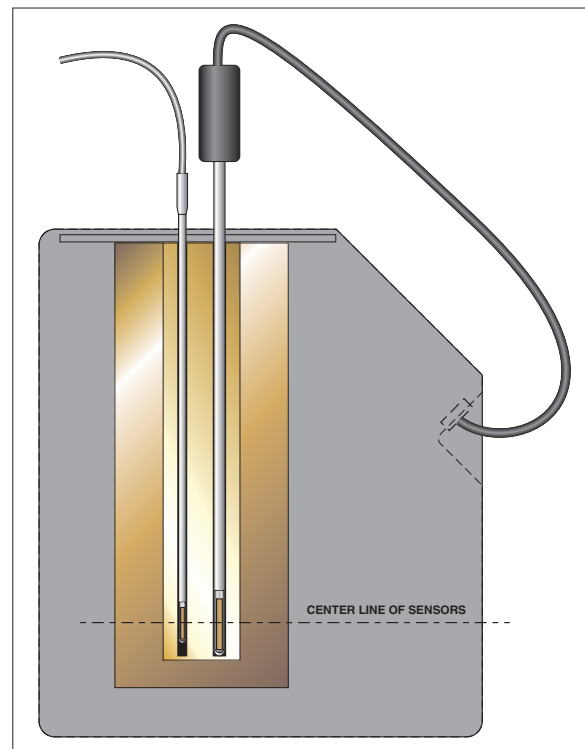

Figure 4. Aligning the centers of the sensing element of the reference probe and the UUT

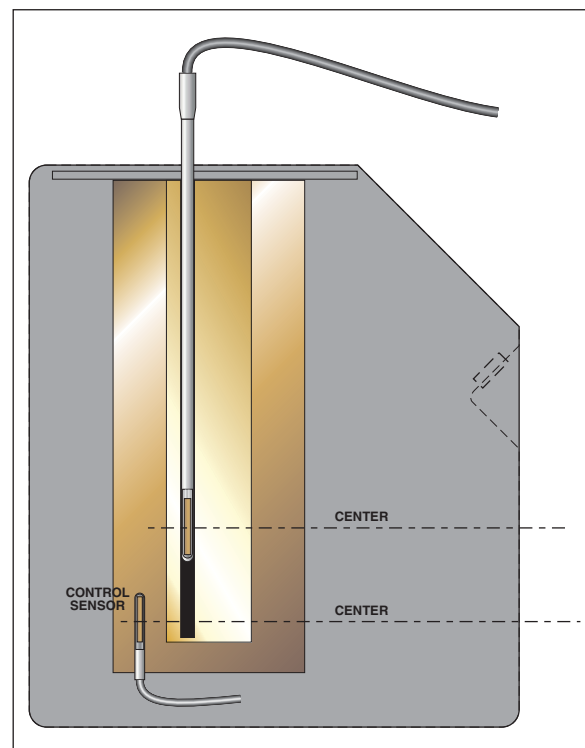

Figure 5. The vertical gradients in Metrology Wells are more apparent when using the calibrated control sensor as the reference.



# Micro-Baths



- World's smallest portable calibration baths
- Calibrates sensors of any size or shape
- Stability to  $\pm 0.015$  °C
- Ranges from  $-30$  °C to  $200$  °C

Need portability and extreme stability? Hart Micro-Baths have both. We invented the Micro-Bath. And, while many have tried to duplicate it, none of them use proprietary Hart Scientific controllers, so none of them deliver performance like a Hart bath. Micro-Baths can be used anywhere for any type of sensor. The 6102 weighs less than 4.5 kg (10 lb), with the fluid. It's lighter and smaller than most dry-wells, has a spill-proof lid, and is easier to carry than your lunch. You can take it where you need to go without carts or excessive effort. Micro-Baths can even be transported with the fluid in them.

Wherever you go with your Micro-Bath, you can count on its performance. Each model is stable to  $\pm 0.03$  °C or better, depending on the fluid you use. Uniformity is  $\pm 0.02$  °C or better for low uncertainties using a reference thermometer. Display accuracy has been improved to  $\pm 0.25$  °C for quick calibrations without a reference thermometer. In short, you get the stability and precision of a liquid bath in a dry-well-sized package. Don't be fooled by competitors who pour oil into a dry-well

and call it a bath. Hart Micro-Baths are maximized for true fluid-bath performance.

With a 48 mm (1.9-inch) diameter, 140 mm (5.5-inch) deep tank, a Micro-Bath can calibrate any type of sensor including short, square, or odd-shaped sensors. The problems of fit and immersion are virtually eliminated by using a fluid medium rather than a dry-block calibrator. Micro-Baths are perfect for liquid-in-glass and bimetal thermometers.

The 6102 has a temperature range from 35 °C to 200 °C, the 7102 covers  $-5$  °C to 125 °C, and the 7103 extends from  $-30$  °C to 125 °C. Stability, uniformity, and accuracy specifications cover the entire range for each bath, not just the best temperature.

All Micro-Baths have RS-232 ports, come with our Interface-*it* software, and can be used with Hart's MET/TEMP II software (described on page 97). Also included are contacts to calibrate a thermal switch, eight set-point memory storage, ramp-rate adjust, and over-temperature safety cutout.

You may have noticed we haven't touted our CFC-free refrigeration. Yes, cold Micro-Baths are CFC-free, and also compressor-free. That's right—no heavy, noisy compressor to lug around. We achieve our temperature range and stability with only one moving part. This means more durability and less weight.

Hart manufactures and sells temperature calibration baths of every size and shape, and now we have the smallest and lightest baths in the industry to go with the dozens of other models we make.

Look at the specs, price, and value of these portable instruments and you'll know why Hart Scientific is the number-one company in this business.

# Micro-Baths

Specifications	6102	7102	7103
<b>Range</b>	35 °C to 200 °C (95 °F to 392 °F)	-5 °C to 125 °C (23 °F to 257 °F)	-30 °C to 125 °C (-22 °F to 257 °F)
<b>Accuracy</b>	± 0.25 °C		
<b>Stability</b>	± 0.02 °C at 100 °C (oil 5013) ± 0.03 °C at 200 °C (oil 5013)	± 0.015 °C at -5 °C (oil 5010) ± 0.03 °C at 121 °C (oil 5010)	± 0.03 °C at -25 °C (oil 5010) ± 0.05 °C at 125 °C (oil 5010)
<b>Uniformity</b>	± 0.02 °C		
<b>Resolution</b>	0.01 °C/°F		
<b>Operating Temperature</b>	5 °C to 45 °C		
<b>Heating Time</b>	25 °C to 200 °C: 40 minutes	25 °C to 100 °C: 30 minutes	25 °C to 100 °C: 35 minutes
<b>Cooling Time</b>	200 °C to 100 °C: 35 minutes	25 °C to 0 °C: 30 minutes	25 °C to -25 °C: 45 minutes
<b>Well Size</b>	64 mm dia. x 140 mm deep (2.5 x 5.5 in) (working area is 48 mm [1.9 in] in diameter)		
<b>Size ( WxHxD )</b>	14 x 26 x 20 cm (5.5 x 10.38 x 8 in)	18 x 31 x 24 cm (7.2 x 12 x 9.5 in)	23 x 34 x 26 cm (9 x 13.2 x 10.5 in)
<b>Weight</b>	4.5 kg (10 lb) with fluid	6.8 kg (15 lb) with fluid	9.8 kg (22 lb) with fluid
<b>Volume</b>	0.75 L (1.6 pints)	0.75 L (1.6 pints)	1.0 L (2.11 pints)
<b>Power</b>	115 V ac (± 10 %), 2.3 A or 230 V ac (± 10 %), 1.1 A, switchable, 50/60 Hz, 270 W	115 V ac (± 10 %), 1.8 A or 230 V ac (± 10 %), 0.9 A, switchable, 50/60 Hz, 200 W	94-234 V ac (± 10 %), 50/60 Hz, 400 W
<b>Computer Interface</b>	RS-232 included with free Interface- <i>it</i> software		
<b>NIST-Traceable Calibration</b>	Data at 50 °C, 100 °C, 150 °C, and 200 °C	Data at -5 °C, 25 °C, 55 °C, 90 °C, and 121 °C	Data at -25 °C, 0 °C, 25 °C, 50 °C, 75 °C, 100 °C, and 125 °C

### Ordering Information - 6102

<b>6102</b>	Micro-Bath, 35 °C to 200 °C (includes a transport seal lid and a 2082-M test lid)
<b>2082-M</b>	Spare test lid
<b>2083</b>	76 mm (3 in) tank extension adapter (affects stability, uniformity, and range at extreme temperatures)
<b>5013-1L</b>	Silicone oil, type 200.20, 1 liter (usable range: 10 °C to 230 °C)
<b>9310</b>	Carrying Case
<b>3320</b>	Spare Stir Bar, Micro-Bath

### Ordering Information - 7102

<b>7102</b>	Micro-Bath, -5 °C to 125 °C (includes a transport seal lid and a 2082-P test lid)
<b>2082-P</b>	Spare test lid
<b>2083</b>	76 mm (3 in) tank extension adapter (affects stability, uniformity, and range at extreme temperatures)
<b>5010-1L</b>	Silicone oil, type 200.05, 1 liter (usable range: -40 °C to 130 °C)
<b>9311</b>	Carrying Case
<b>3320</b>	Spare Stir Bar, Micro-Bath

### Ordering Information - 7103

<b>7103</b>	Micro-Bath, -30 °C to 125 °C (includes a transport seal lid and a 2085 test lid)
<b>2085</b>	Spare test lid
<b>5010-1L</b>	Silicone oil, type 200.05, 1 liter (usable range: -40 °C to 130 °C)
<b>9317</b>	Carrying Case
<b>3320</b>	Spare Stir Bar, Micro-Bath

# Eliminating sensor errors in loop calibrations

## Calibrating a loop is more than just 4 mA to 20 mA—Eliminating sensor errors in loop calibrations

Temperature plays an important role in many industrial and commercial processes. Examples may include pharmaceutical sterilization, metal heat-treatment, cold storage verification, and atmospheric and oceanographic research. In all temperature measurement applications, the sensor strongly affects the results.

The majority of process temperature measurements are performed using a sensor, commonly an RTD or thermocouple, connected to a transmitter. See Figure 1 for a diagram of a typical temperature measurement system.

Traditional process verification only considers calibration of the transmitter—ignoring the sensor. Although this method is more time efficient and convenient than performing a loop calibration, traditional process verification leaves out the sensor which is the largest contributor of error.

Rosemount Inc. uses the following example to help customer's understand the significant performance improvement possible when using a calibrated sensor. The Model 644H Smart Temperature Transmitter uses a calibrated or matched sensor that has unique calibration constants which characterize its performance throughout its temperature range. Table 1 shows the difference in accuracy between two identical IEC751 Pt100 sensors and the only difference between the two sensors is the calibration of the probe.

Combining the capabilities of the Fluke 744 Documenting Process Calibrator with Hart Scientific's dry-wells or Micro-Baths gives you ability test the entire loop. Below are some examples of how to use this equipment to get the most out of your temperature measurement and control loop.

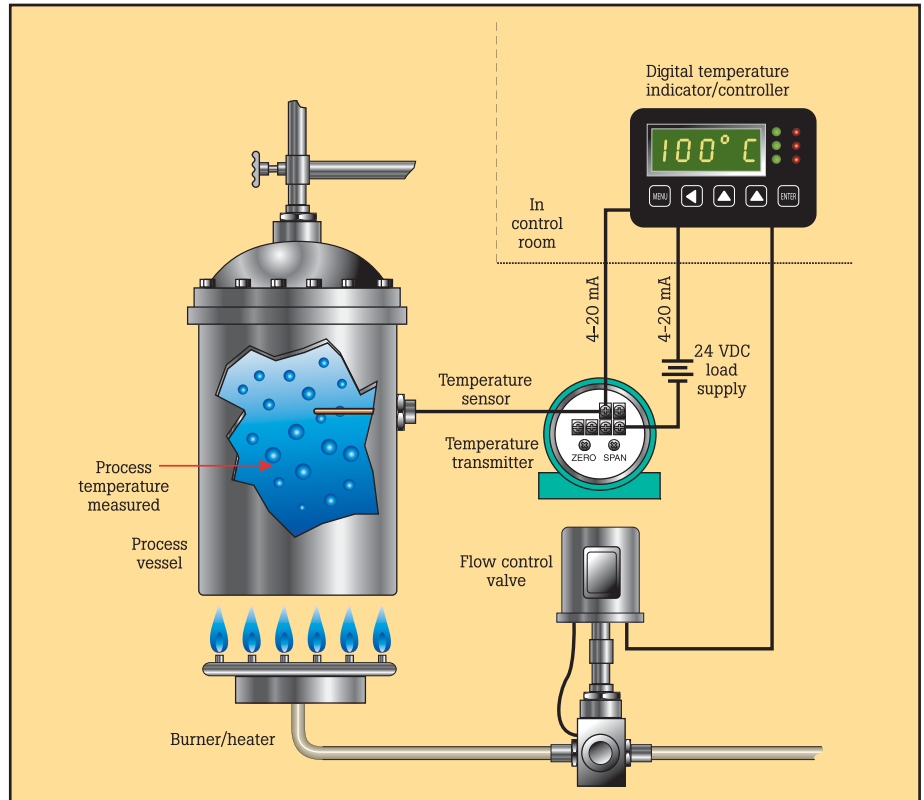

Figure 1. Diagram of a typical process temperature measurement system

Simply connect the Fluke 744 to a Hart Scientific dry-well or Micro-Bath by way of a serial RS-232 interface cable (part number 211108). The 744 will control the dry-well to easily source the desired temperature with a single button press. This connection is pictured in Figure 2 below.

### Calibrating and adjusting 4-20 mA transmitter loops

In many process applications, the instrumentation of choice for temperature

measurements is a transmitter that accepts the output from the temperature sensor and drives a 4-20 mA signal back to the PLC, DCS, or indicator. To test this type of measurement loop, the RTD sensor is removed from the process and inserted into the dry-block calibrator. The mA connections from the transmitter are connected directly to the Documenting

Table 1.

System Accuracy Comparison Measuring 150 °C Using A Pt100 (IEC751)		RTD with a transmitter Span of 0 to 200 °C	
Standard RTD		Characterized RTD	
Rosemount Model 644H	± 0.15 °C	Rosemount Model 644H	± 0.15 °C
Standard RTD	± 1.05 °C	Matched (Calibrated) RTD	± 0.18 °C
<b>Total System</b>	<b>± 1.06 °C</b>	<b>Total System</b>	<b>± 0.23 °C</b>
Total System Accuracy calculated using RSS statistical method			



Figure 2. Hart Scientific 9141 and Fluke 744 calibrating a 4-20 mA transmitter and temperature sensor.



# Eliminating sensor errors in loop calibrations

Process Calibrator. See Figure 2 for an example of this test configuration.

Once connections are made, you can use the Fluke 744 to set the test parameters for an automated test and collect as found data. Figure 3 gives an example of typical test data.

Loop 24V		
SOURCE	MEASURE	ERROR %
50.0 °C	49.87C	-0.13
75.1 °C	75.56C	0.40
100.0 °C	100.55C	0.55
125.2 °C	126.50C	1.30
150.0 °C	151.50C	1.50

Figure 3.

After collecting as found data, you can make an adjustment at the zero and span values to get the as left data. The zero (Lower Range Value, LRV) or span (Upper Range Value, URV) values are measured by the 744. If you're using a transmitter with HART communication capabilities, the 744 can allow you to make these adjustments directly. With an analog transmitter, you will need to mechanically adjust the zero and span when sourcing the appropriate temperature values.

## Calibrating and adjusting measurement systems using characterized sensors and calibration constants

More recent transmitter designs feature correction or linearization algorithms that can accommodate calibrated temperature sensors. For example, Platinum RTDs typically use the Callendar-Van Dusen (CVD) equation for linearizing the sensor's output. Another method of reducing uncertainty in measurement systems is to characterize the temperature sensor, calculate correction coefficients, and load these correction coefficients into the transmitter.

The Fluke 744 connected with a dry-well can collect the sensor resistance or voltage information to characterize the sensor. Hart Scientific's TableWare allows you to enter in the sensor data and calculates the calibration coefficients (see Figures 4 and 5). The coefficients calculated from TableWare are then entered into the

SOURCE	MEASURE	ERROR %
-24.5 °C	91.5 Ω	2.23
0.0 °C	101.1 Ω	-4.82
24.9 °C	110.8 Ω	-12.08
50.0 °C	120.6 Ω	-19.36
75.0 °C	130.2 Ω	-26.91

Figure 4.

The screenshot shows two windows from the TableWare software. The top window, 'Raw Data', prompts the user to 'Enter Raw Data for Callendar-Van Dusen Coefficients'. It has two columns: 'Reference Temperatures' and 'UUT Resistances'. The bottom window, 'Coefficients and Residuals', displays the results of the calculations for Model P1100, Serial No. 123456. It lists coefficients (R0, ALPHA, DELTA, BETA) and set-points with residuals.

Figure 5.

transmitter. The transmitter is able to linearize the data to match the characteristics of the probe.

## Summary

Using a dry-well in combination with a process calibrator allows measurement systems to be verified and adjusted to optimize measurement performance. By verifying the entire measurement system, unique characteristics of the sensor can be combined with the measurement electronics to minimize measurement error. This can result in a significant reduction in measurement errors. The Fluke 744 Documenting Process Calibrator combined with a Hart Scientific dry-well makes this process faster and easier.

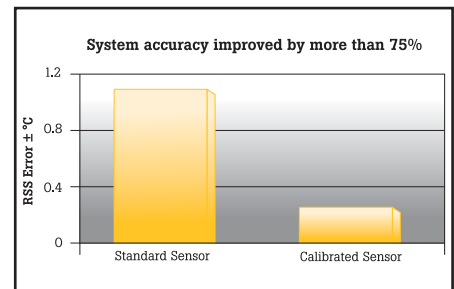

Figure 6.

# Field dry-wells



- Lightweight and very portable
- Accuracy to  $\pm 0.25$  °C
- RS-232 and Interface-*it* software included
- Easy to recalibrate

If you've been using dry-well calibrators for field work, you know there's a lot more to a dry-well than its temperature range and stability. Size, weight, speed, convenience, and software are also significant.

Field dry-wells need to be portable, flexible, and suitable for high-volume calibrations or certifications. If they're not, you'll soon forget about the great stuff the sales rep told you and realize what you've really bought.

At Hart Scientific, we use dry-wells every day in our manufacturing and

calibration work, and we know what makes a dry-well easy and productive to use—which is exactly how users describe our series of field dry-wells. These dry-wells work for you instead of the other way around.

These three units beat every other comparable dry-well in the industry in performance, size, weight, convenience, ease of calibration, software, and price. In addition, the heating and cooling rate of each of these dry-wells is adjustable from the front panel, thermal switches can be

checked for actuation testing, and multiple-hole inserts are available for a variety of probe sizes.

Hart dry-wells are easy to calibrate. You don't even have to open the case. This means less maintenance costs and less down time when they do need calibration.

Our Interface-*it* software lets you adjust set-points and ramp rates, log dry-well readings to a file, create an electronic strip chart, and perform thermal switch testing with data collection. The software is written for Windows and has a great graphical interface. Regardless of whether you want basic software or a completely automated calibration system, we've got what you want. Read about all our great packages starting on page 96.

Every dry-well we ship is tested at our factory, and every unit comes with a NIST-traceable calibration. There's no extra charge for the report, because we consider it an essential ingredient in our quality program. You shouldn't have to pay extra for calibration procedures we perform anyway.

## 9103

The 9103 covers below-ambient temperatures as low as  $-25$  °C. The 9103 is stable to  $\pm 0.02$  °C, and its display is calibrated to an accuracy of  $\pm 0.25$  °C at all temperatures within its range. In just eight minutes,  $0$  °C is reached, and  $100$  °C is reached in six minutes, so your time is spent calibrating—not waiting.

The 9103 reaches temperatures  $50$  °C below ambient, so  $-25$  °C is reached under normal ambient conditions. Our competitors like to advertise their units as reaching  $-45$  °C when they really mean  $-45$  °C below ambient, which typically means it will go to  $-20$  °C. Our unit does not require you to work in a walk-in freezer to achieve its full advertised range.

Choose one of three removable inserts sized for probes from  $1/16$  inch to  $1/2$

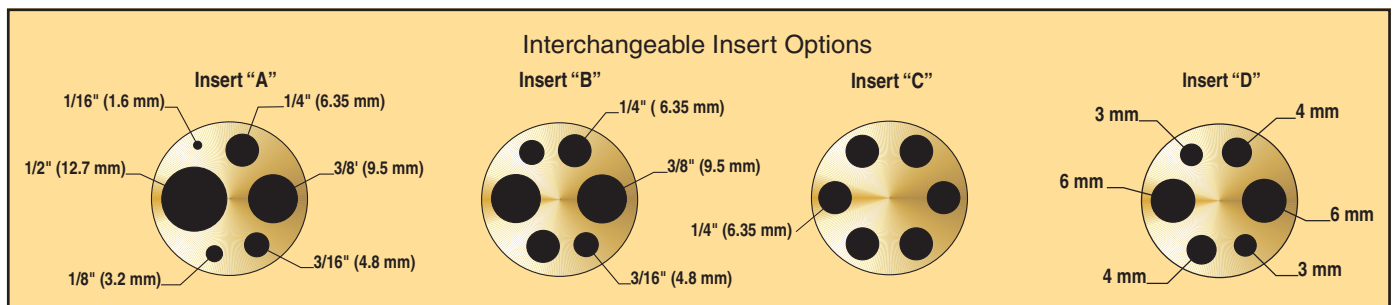

When ordering, replace the "X" in the model number with the appropriate insert letter. Order additional inserts as your applications require.

# Field dry-wells

Specifications	9103	9140	9141
Range	-25 °C to 140 °C (-13 °F to 284 °F) at 23 °C ambient	35 °C to 350 °C (95 °F to 662 °F)	50 °C to 650 °C (122 °F to 1202 °F)
Accuracy	± 0.25 °C (holes greater than 1/4" [6.35 mm]: ± 1 °C)	± 0.5 °C (holes greater than 1/4" [6.35 mm]: ± 1 °C)	± 0.5 °C to 400 °C; ± 1.0 °C to 650 °C (holes greater than 6.35 mm: ± 2 °C)
Stability	± 0.02 °C at -25 °C ± 0.04 °C at 140 °C	± 0.03 °C at 50 °C ± 0.05 °C at 350 °C	± 0.05 °C at 100 °C ± 0.12 °C at 500 °C ± 0.12 °C at 650 °C
Well-to-Well Uniformity	± 0.1 °C between similarly sized wells	± 0.1 °C with similarly sized wells	± 0.1 °C below 400 °C, ± 0.5 °C above 400 °C with similarly sized wells
Heating Times	18 minutes from ambient to 140 °C	12 minutes from ambient to 350 °C	12 minutes from ambient to 650 °C
Cooling Times	20 minutes from ambient to -25 °C	15 minutes from 350 °C to 100 °C	25 minutes from 650 °C to 100 °C
Stabilization Time	7 minutes		
Immersion Depth	124 mm (4.875")		
Inserts	Insert A, B, C, or D included (specify when ordering)		
Outside Insert Dimensions	31.8 mm dia. x 124 mm (1.25 x 4.88 in)		28.5 mm dia. x 124 mm (1.12 x 4.88 in)
Computer Interface	RS-232 included with free Interface-it software (Model 9930)		
Power	115 V ac (± 10 %), 1.3 A or 230 V ac (± 10 %), 0.7 A, switchable, 50/60 Hz, 150 W	115 V ac (± 10 %), 4.4 A or 230 V ac (± 10 %), 2.2 A, switchable, 50/60 Hz, 500 W	115 V ac (± 10 %), 8.8 A or 230 V ac (± 10 %), 4.4 A, switchable, 50/60 Hz, 1000 W
Size (WxHxD)	143 x 261 x 245 mm (5.63 x 10.25 x 9.63 in)	152 x 86 x 197 mm (6 x 3.375 x 7.75 in)	109 x 236 x 185 mm (4.3 x 9.3 x 7.3 in)
Weight	5.7 kg (12 lb)	2.7 kg (6 lb)	3.6 kg (8 lb)
NIST-Traceable Certificate	Data at -25 °C, 0 °C, 25 °C, 50 °C, 75 °C, 100 °C, and 140 °	Data at 50 °C, 100 °C, 150 °C, 200 °C, 250 °C, 300 °C, and 350 °C	Data at 100 °C, 200 °C, 300 °C, 400 °C, 500 °C, and 600 °C

inch in diameter. Insert A handles a full range of probe sizes with a single well of each size. Insert B features two wells each of 3/8, 1/4, and 3/16 inches in diameter for doing comparison calibrations. Insert C has six 1/4-inch-diameter wells for multiple probe calibrations, and Insert D has three pairs of metric sized wells.

## 9140

The 9140 has a temperature range of 35 °C to 350 °C, and it reaches its maximum temperature in 12 minutes. At six pounds, it's small enough to easily carry in one hand. It's truly a unique innovation in dry-wells.

The unit has a stability of ± 0.05 °C or better and a uniformity of at least 0.4 °C in the largest-diameter wells and 0.1 °C in the smaller wells. Despite its small size, this unit performs.

Use the display, calibrated to ± 0.5 °C, as your reference, or use an external thermometer for maximum calibration accuracy. With three removable inserts to choose from, the 9140 is as versatile as it is fast.

## 9141

Here's an upright unit you're going to love. It does calibrations up to 650 °C, weighs only eight pounds, and heats up to 650 °C in only 12 minutes—12! This dry-well does everything but get legs and walk to the job for you. (And we're working on one that does that too.)

This four-inch-wide dry-well is amazing. You can control all functions from the front panel or hook it up to your PC with its built-in RS-232 port. And just like the 9140, it works with all of our software described on page 96.

It has three removable well inserts available, an optional carrying case, a NIST-traceable calibration, and the best price in the industry.

## Ordering Information

- 9103-X** Dry-Well (specify X, X = A, B, C, or D included insert)
- 3103-1** Insert, blank
- 3103-2** Insert A
- 3103-3** Insert B
- 3103-4** Insert C
- 3103-6** Insert D
- 3103-Y** Insert, custom 9011/9103
- 9316** Rugged Carrying Case
- 9140-X** Dry-Well (specify X, X = A, B, C, or D included insert)
- 3140-1** Insert, blank
- 3140-2** Insert A
- 3140-3** Insert B
- 3140-4** Insert C
- 3140-6** Insert D
- 9308** Rugged Carrying Case
- 9141-X** Dry-Well (specify X, X = A, B, C, or D included insert)
- 3141-1** Insert, blank
- 3141-2** Insert A
- 3141-3** Insert B
- 3141-4** Insert C
- 3141-6** Insert D
- 9309** Rugged Carrying Case



# A few dry-well dos and don'ts...

## Reprinted from *Random News*

In the world of industrial temperature calibration, few instruments are as valuable as a good dry-well calibrator. Dry-wells offer portability, durability, accuracy, and stability for a wide range of industrial calibration applications. They are also very convenient, have a quick response, and are easy to use.

Because dry-wells can be so durable and reliable, we can sometimes forget how important it is to invest in their proper care and maintenance. A good dry-well calibrator can cost thousands of dollars to purchase, so a little time and effort to keep it in proper working condition is usually well worth it.

Over the years, our technicians have encountered odd cases of service and repair ranging from simple misunderstandings of how a dry-well works to complete misuse and abuse. The following list of Dos and Don'ts were derived from these actual cases, which we've lumped into five categories.

### First things first

#### Do...

... read the User Guide and become familiar with the instrument's features and controller settings. Features vary from one dry-well to another. You may

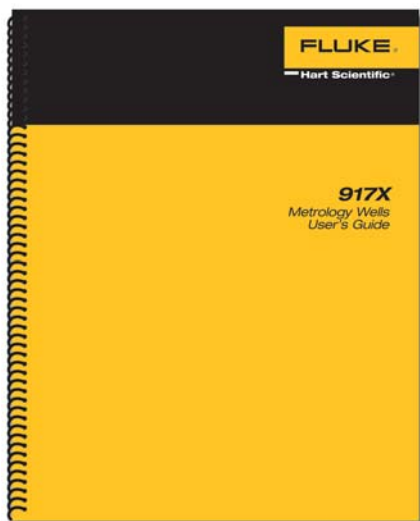

discover the dry-well can do things that may save you a lot of time.

...learn what "normal" operation of the dry-well is, so you can recognize whether it is acting "abnormal." Read the instrument's specifications to

understand the typical heating/cooling times, stability and accuracy specifications, typical overshoot, etc.

...verify the dry-well is in spec before using it, especially after it has been shipped, transported, or has been in storage for a long period of time.

... make periodic checks a part of your routine to ensure the dry-well is reading and controlling accurately.

...make sure the dry-well's calibration constants match the values listed on the most recent Report of Calibration if it does not appear to be in spec.

#### Don't...

...attempt to change any controller settings, such as Scan Rate, Proportional Band, Approach, and Cut-out, without understanding what affect they have on instrument performance.

...assume the dry-well readings are always correct (see "periodic checks" above). Even though they are very durable and reliable, dry-wells can go out of calibration if not handled or cared for properly.

### Use as intended

#### Do...

...use the correct voltage supply. Some dry-wells come with "universal" power supplies that can be used from 94 V ac to 230 V ac, but many are still dedicated to a single voltage.

...allow adequate ventilation and air flow around the dry-well, especially when operating at extreme temperatures. Placing other instruments or objects too close to the dry-well can cause inadequate air flow and prevent the dry-well from performing well.

...remove any ice/frost build-up regularly when operating at cold temperatures. Set the dry-well to a "hot" temperature regularly to evaporate any moisture that may be present in the wells.

#### Don't...

...attach external devices such as cooling fans in an attempt to improve performance. Changing the air flow may adversely affect the instrument's calibration and stability.

...run a dry-well at sub-freezing temperatures for extended periods of time (to prevent ice/frost build-up).

### Watch those inserts!

#### Do...

...clean any debris from sensors and inserts prior to inserting them into wells. Inserts are designed to fit snugly to maximize thermal conductivity. Even a very small particle can cause an insert to become stuck.

...regularly remove oxidation or other build-up from inserts and wells. Use a Scotch-Brite pad or other fine abrasive material to clean them.

...use the provided insert removal tool to remove inserts from the wells.

...use proper personal protective equipment when removing extremely hot or cold inserts.

...remove inserts and probes from the wells when storing the dry-well for long periods.

...remove and dispose of any thermal grease (if used) from inserts and wells frequently. (Note that dry-wells are designed to be used dry and the use of thermal grease is not recommended.) Thermal grease can break down in a short time and effectively glue the inserts to the well.

#### Don't...

...twist or rotate the dry-well's block to accommodate specific needs. This may cause the heater and/or internal sensor wires to break.

...drop, pound, or force inserts or sensors into the wells.

...introduce foreign objects into the wells, including food—yes, food.



...use inserts that are not made of the same type of metal as the block, unless specified by the manufacturer. Dissimilar metals expand and contract at different rates. Metals also melt at unique temperatures.

# A few dry-well dos and don'ts...

...attempt to use homemade inserts. Custom inserts are available and are relatively inexpensive.

...use oil or other fluids to attempt to increase thermal conductivity. Many dry-wells do not have sealed wells, and the fluids can leak into the dry-well and destroy the heaters, insulation, fans, and possibly the electronics.

## Transportation

### Do...

...use the handle provided to lift and carry the dry-well.



...remove inserts, external sensors, and other objects from the wells during transport.

...use adequate packaging materials when shipping the dry-well. Consider using a padded carrying case.

### Don't...

...drop, run over, or violently shake (or vibrate) the dry-well. Dry-wells may be durable, but don't push it (and remember, the internal control sensor is still subject to mechanical shock).

...immerse the dry-well in any fluids or liquids. It's a dry-well.

## Preventative maintenance and calibration

### Do...

...keep your dry-well clean. You can generally use compressed air to remove dust, dirt, and other debris from the fans, electronics, and the wells. Remember to protect yourself with appropriate clothing and eye protection.

...clean your inserts and wells regularly, as mentioned above.

...calibrate the dry-well on a regular interval, if required.

...contact the nearest service center for information on how to get your dry-well serviced and/or calibrated by trained, knowledgeable technicians.

### Don't...

...attempt to disassemble and repair the dry-well yourself. Most dry-wells contain non-serviceable parts.

...change the controller's calibration constants from the values indicated on the most recent Report of Calibration.

...attempt to perform a calibration without becoming familiar with how to do it or without the proper equipment. Read the appropriate sections of the User Guide for more information on performing calibrations.



# Industrial dual-block calibrator



- Temperatures from  $-15\text{ }^{\circ}\text{C}$  to  $350\text{ }^{\circ}\text{C}$  in one unit
- Two wells in each block for simultaneous comparison calibrations
- Rugged, lightweight, watertight enclosure

Hart's 9009 Industrial Dual-Block Calibrator lets you calibrate at hot and cold temperatures at the same time. Double your productivity or cut your calibration time in half—either way you look at it, your in-field temperature calibrations just got easier.

The 9009 includes two independently controlled temperature blocks. The hot block provides temperatures from  $50\text{ }^{\circ}\text{C}$  to  $350\text{ }^{\circ}\text{C}$ , while the cold block covers the range  $-15\text{ }^{\circ}\text{C}$  to  $110\text{ }^{\circ}\text{C}$ . Each block is controlled by a precision Hart Scientific temperature controller. These aren't some off-the-shelf controllers we glued into a box. These are Hart Scientific controllers from the leading temperature company in the world.

Each temperature block includes two wells with removable inserts. You can calibrate four probes at once, or you can calibrate two probes at the same time with an external reference (like Hart's 1521 Little Lord Kelvin Thermometer on page 58), or you can use the two temperature wells to get quick "zero" and "span" references for transmitter calibrations.

Need portability and durability? The 9009 is housed in a tough Pelican™ case that is both airtight and watertight. It's a small package weighing only 10 pounds, yet it fits everything you need, including a power cord and four extra inserts. Inserts are available to accommodate sensors of any size from  $1/16\text{''}$  (1.6 mm) to  $7/16\text{''}$  (11.1 mm). This rugged system can go anywhere.

Of course, the 9009 also delivers the performance you expect from a Hart Scientific temperature source. The cold block is calibrated to within  $\pm 0.2\text{ }^{\circ}\text{C}$  with stability of  $\pm 0.05\text{ }^{\circ}\text{C}$ . The hot block's display is accurate to  $\pm 0.6\text{ }^{\circ}\text{C}$  with stability of  $\pm 0.05\text{ }^{\circ}\text{C}$ . A NIST-traceable calibration is included for each of the two test blocks.

For use with automated systems, the 9009 comes with an RS-232 connection and our Model 9930 Interface-it software, which allows you to control and monitor temperatures from your PC. For completely automated calibrations, Hart's MET/TEMP II software (page 97) also integrates with the 9009.

Two blocks in one unit, a total range of  $-15\text{ }^{\circ}\text{C}$  to  $350\text{ }^{\circ}\text{C}$ , portability, durability, versatility, performance, and automation. Hart Scientific delivers it all.

The 9009 is built into a small, lightweight, rugged enclosure that holds everything you need and comes in black or yellow.

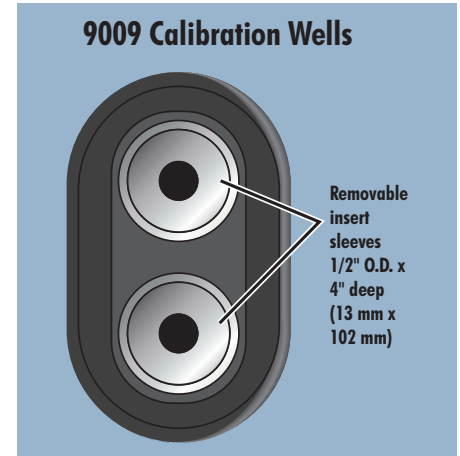

Each block contains two wells, which accept removable inserts. A  $1/4\text{''}$  and a  $3/16\text{''}$  insert are included for each block. Additional sizes (including custom sizes) are available.



# Industrial dual-block calibrator

Specifications	Hot Block	Cold Block
Range	50 °C to 350 °C (122 °F to 662 °F)	-15 °C to 110 °C (5 °F to 230 °F) (-8 °C [18 °F] with hot block at 350 °C [662 °F])
Accuracy	± 0.6 °C	± 0.2 °C
Stability	± 0.05 °C	
Well-to-Well Uniformity	± 0.1 °C	
Display Resolution	0.1 °	
Heating Times	30 minutes from 25 °C to 350 °C	15 minutes from 25 °C to 110 °C
Cooling Times	40 minutes from 350 °C to 100 °C	16 minutes from 25 °C to -15 °C
Stabilization Times	8 minutes	
Well Depth	4" (102 mm)	
Removable Inserts	Two 6.4 mm (1/4 in) and two 4.8 mm (3/16 in) inserts included; see Ordering Information for other available inserts	
Computer Interface	RS-232 included with free Interface-it software	
Power	115 V ac (± 10 %), 3 A, or 230 V ac (± 10 %), 2 A, specify, 50/60 Hz, 280 W	
Size (HxWxD)	178 x 267 x 248 mm (7 x 10.5 x 9.75 in)	
Weight	4.5 kg (10 lb)	
NIST-Traceable Calibration	Data at 50 °C, 100 °C, 150 °C, 200 °C, 250 °C, 300 °C, and 350 °C	Data at -8 °C, 0 °C, 25 °C, 50 °C, 75 °C, 100 °C, and 110 °C

## Ordering Information

9009-X	Industrial Dual-Block Dry-Well (X = case color. Specify "B" for black or "Y" for yellow.) Includes two 1/4 in (6.4 mm) and two 3/16 in (4.8 mm) inserts.
3102-0	Insert, Blank
3102-1	Insert, 1/16 in (1.6 mm)
3102-2	Insert, 1/8 in (3.2 mm)
3102-3	Insert, 3/16 in (4.8 mm)
3102-4	Insert, 1/4 in (6.4 mm)
3102-5	Insert, 5/16 in (7.9 mm)
3102-6	Insert, 3/8 in (9.5 mm)
3102-7	Insert, 7/16 in (11.1 mm)
3102-8	Insert, 5/32 in (4 mm)

## Maximum accuracy

To get the most accurate calibrations possible from a dry-well calibrator, you should use an external reference thermometer. If, however, you are *not* using an external reference, there are a few important things you should keep in mind.

First, you *are* using a reference. You're comparing the reading of your test probe against the display of the dry-well. The dry-well display is based on its own control sensor, usually located at the bottom of the well. Therefore, to make the best comparison, your test probe should be inserted to the same depth as the control sensor. This was the method used when the dry-well's display was calibrated at the factory.

Second, your test probe should fit snugly into one of the test wells. Again, this is how it was originally calibrated at the factory. If

your probe is too loose, thermal contact is poor and a large error has been introduced. Custom inserts are available to help solve this problem.

Third, you should not introduce fluids into the wells of a dry-block in an attempt to improve thermal contact. It is too dangerous. If thermal contact is so poor that you're thinking about doing this, consider buying a fluid bath instead. Micro-Baths are available that are just as portable and easy to use as dry-wells.

The point is that the accuracy specs of your dry-well are based upon how the manufacturer calibrates it. If you're relying on those specs, you need to use the dry-well the same way they do—with a good, snug fit at the bottom of the well.

# High-accuracy dual-well calibrator



- Combined ranges for calibrating from  $-30\text{ }^{\circ}\text{C}$  to  $670\text{ }^{\circ}\text{C}$ ; one unit—two blocks
- Two independent temperature controllers (hot and cold side)
- Stability to  $\pm 0.02\text{ }^{\circ}\text{C}$
- Multi-hole wells calibrate up to eight probes simultaneously

To give you the widest temperature range available in a dry-well calibrator, we've combined two of our most popular units. The 9011 allows temperature probes to be calibrated from  $-30\text{ }^{\circ}\text{C}$  to  $670\text{ }^{\circ}\text{C}$  in a single unit.

The 9011 features two independently controlled temperature wells, which makes calibrating RTDs and thermocouples faster than ever. While readings are being taken at one temperature, the other well can be ramping up or down to the next point. Checking the zero and span points of temperature transmitters is a breeze. The cold block can even be used as a zero-point reference for a thermocouple making measurements in the hot block.

The 9011 is a high-accuracy unit that is capable of laboratory as well as field calibrations. Stabilities to  $\pm 0.02\text{ }^{\circ}\text{C}$  are possible, and display accuracy is better than  $\pm 0.25\text{ }^{\circ}\text{C}$ . Using multi-hole interchangeable inserts, you can calibrate more probes at the same time. With a single RS-232 port for both wells, you

can automate your calibration work and be even more efficient. Add on Hart's 9938 MET/TEMP II software and totally automate your calibrations of RTDs, thermocouples, and thermistors.

Every dry-well we ship from the factory includes a full NIST-traceable calibration report with test data for each well at each point. There's no extra charge for the report or the test readings from your unit. We also include your choice of multi-hole inserts. If you don't find one that suits your applications, we'll provide a blank sleeve or have a custom one made.

At Hart, we continually develop new industrial calibration tools that make your work easier and better. We gave you the first handheld dry-well, the first Micro-Bath, and now we're giving you the widest ranging dry-well available. Whatever your temperature application, Hart has a solution.

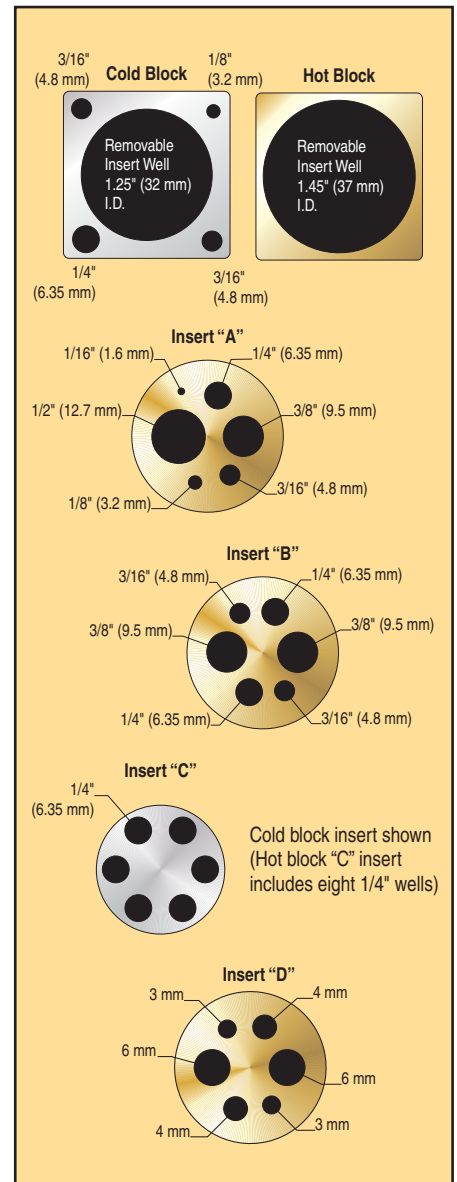

# High-accuracy dual-well calibrator

FLUKE®

Hart Scientific®

Specifications	Hot Block	Cold Block
Range	50 °C to 670 °C (122 °F to 1238 °F)	-30 °C to 140 °C (-22 °F to 284 °F)
Accuracy	± 0.2 °C at 50 °C ± 0.4 °C at 400 °C ± 0.65 °C at 600 °C	± 0.25 °C (insert wells) ± 0.65 °C (fixed wells)
Stability	± 0.02 °C at 100 °C ± 0.06 °C at 600 °C	± 0.02 °C at -30 °C ± 0.04 °C at 140 °C
Uniformity	± 0.2 °C (± 0.05 °C typical)	± 0.05 °C (insert wells) ± 0.25 °C (fixed wells)
Well Depth	152 mm (6 in)	124 mm (4.875 in)
Heating Time to Max.	30 minutes	15 minutes
Cooling Times	120 minutes from 660 °C to 100 °C	30 minutes from 140 °C to -30 °C
Well Inserts	1 interchangeable well accommodates multi-hole insert	1 interchangeable well accommodates multi-hole insert, plus four outer wells, 1/4", 3/16", 3/16", and 1/8"
Computer Interface	RS-232 interface included with Model 9930 Interface-it control software	
Power	115 V ac (± 10 %), 8.8 A or 230 V ac (± 10 %), 4.4 A, switchable, 50/60 Hz, 1150 W	
Size (HxWxD)	292 x 394 x 267 mm (11.5 x 15.5 x 10.5 in)	
Weight	16.4 kg (36 lb)	
NIST-Traceable Certificate (8 points)	Data at 50 °C, 100 °C, 200 °C, 300 °C, 400 °C, 500 °C, 600 °C, and 660 °C	Data at -30 °C, 0 °C, 25 °C, 50 °C, 75 °C, 100 °C, 125 °C, and 140 °C

## Ordering Information

- 9011-X High-Accuracy Dual-Well Calibrator (specify X, X = A, B, C, or D included insert)
- 3109-0 Insert, Blank (Hot Side)
- 3109-1 Insert A, Miscellaneous (Hot Side)
- 3109-2 Insert B, Comparison (Hot Side)
- 3109-3 Insert C, Eight 1/4 in Wells (Hot Side)
- 3109-4 Insert D, Comparison - Metric (Hot Side)
- 3103-1 Insert, Blank (Cold Side)
- 3103-2 Insert A, Miscellaneous (Cold Side)
- 3103-3 Insert B, Comparison (Cold Side)
- 3103-4 Insert C, Six 1/4 in Wells (Cold Side)
- 3103-6 Insert D, Comparison - Metric (Cold Side)
- 3103-Y Insert, custom 9011/9103
- 2125-C IEEE-488 Interface (RS-232 to IEEE-488 converter box)
- 9319 Large Instrument Case

## The sometimes subtle art of specsmanship

"Specsmanship" is the careful wording of performance specifications to provide the expectation of better performance than practically achievable. We see this often as we work with customers who are comparing our products against others. Hart's philosophy is to provide meaningful, clearly written specifications that provide verifiable and guaranteed performance. Unfortunately, all manufacturers don't seem to share our approach, particularly when it comes to heat sources such as baths and dry-wells. Here are some terms to watch out for:

**"Typical" or "best"** - While "typical" or "best" specifications may provide useful information, they offer no guarantee that the unit you buy is "typical" or capable of providing the "best" performance as listed. For calibration applications, worst-case or guaranteed performance specifications are required that include all natural variations in the product. "Typical" or "best" specifications are fine if accompanied by a guaranteed specification. If they're not, be sure you ask!

**"Relative" accuracy** - "Relative" accuracy specs attempt to remove errors associated with the test standards or reference thermometers used in a heat source. This assumes that references contribute no measurement errors—an impossibility! Some may argue that "relative" specs allow

the customer to add the error of their reference to obtain a complete specification unique to their situation. And we would agree, but the fact that the specification excludes these errors is too often relegated to the fine print and is simply misleading to less-informed readers. One thing's for sure. You can't directly compare "relative" specs to "absolute" specs, since the components of "relative" specs comprise a subset of the components of "absolute" specs.

**"Comprehensive evaluation reports"** - Evaluation reports are a very important method of determining the performance of a unit or sample of units. Evaluation reports can be misleading, however, if they are used to infer the performance of an entire population of instruments, or more importantly, the unit you are purchasing. Evaluation reports only provide information regarding the units that were evaluated and the conditions present during the evaluation. It takes extensive engineering analysis to use this information to produce a specification of performance that applies to all units being produced. Be sure whatever specs you rely on are the ones the manufacturer guarantees and will stand behind.

If you ever have a question about Hart's specifications, please talk to us and we'll gladly help you understand the performance you can expect from our products.



# Handheld dry-wells



- Smallest dry-wells in the world
- Proprietary Hart Scientific controller
- Accuracy to  $\pm 0.25$  °C, stability of  $\pm 0.05$  °C at 0 °C
- RS-232 interface with Hart Interface-*it* software

Hart's line of portable dry-wells is incredible. They're the smallest, lightest, and most portable dry-wells in the world. And now they're better than ever!

## 9100S Dry-Well

Since we introduced the world's first truly handheld dry-well, many have tried to duplicate it. Despite its small size (57 mm [2¼ in] high and 127 mm [5 in] wide) and light weight, the 9100S outperforms every dry-well in its class in the world.



Take the 9100S anywhere. It's the smallest dry-well in the world.

It's simple and convenient, too. Anyone can learn to use one in less than 15 minutes. It has a range to 375 °C (707 °F) and is perfect for checking RTDs, thermocouples, and small bimetal thermometers in the field.

Plug it in, switch it on, set the temperature with the front-panel buttons, and insert your probe into the properly sized well. Compare the reading of your device to the display temperature or to an external reference, and the difference is the error in your device. With a proprietary Hart Scientific temperature controller, the 9100S has a display resolution of 0.1 degrees. Display accuracy ranges from  $\pm 0.25$  °C to  $\pm 0.5$  °C and stability ranges from  $\pm 0.07$  °C to  $\pm 0.3$  °C, depending on set-point temperature.

## 9102S Dry-Well

For work in the temperature range of  $-10$  °C to 122 °C, Hart's Model 9102S dry-well is another first in the industry, featuring display accuracy of  $\pm 0.25$  °C.

This dry-well is only four inches high and six inches wide, achieves

temperatures as low as  $-10$  °C, includes a NIST-traceable calibration, and is stable to  $\pm 0.05$  °C. The Model 9102S is excellent for dial gauges, digital thermometers, bulb switches, and other sensors that need calibration below ambient.

The 9102S has two wells so you can use one for a reference thermometer to increase accuracy. Both wells are 12.7 mm (1/2 in) in diameter, and each has inserts available for almost any sensor size. The 9102S also has a battery pack option that gives you approximately four hours of field use when AC power is unavailable.

## Increase dry-well performance with a reference thermometer

To increase the performance of a block calibrator and the accuracy level of your calibrations, add a reference thermometer to your system. The Tweener Thermometers and Handheld Thermometers on pages 56–60 can bring your NIST-traceable uncertainty from  $\pm 0.5$  °C to  $\pm 0.05$  °C.

Using a comparison technique, users insert both the test and reference probe into the same block at the same time, which yields a much better calibration. Both probes, if inserted at the same depth with similar size and diameters, will be sensing more of the same temperature than a single probe inserted and compared to the sensor that feeds the display.

Tweener and Handheld Thermometers are used with a high-accuracy reference PRT or thermistor calibrated to the ITS-90 scale and included with a certificate and calibration coefficients.

We designed many of our field calibrators with removable insert sleeves that have multiple holes drilled for use with a reference thermometer system.

# Handheld dry-wells

Specifications	9100S	9102S
Range	35 °C to 375 °C (95 °F to 707 °F)	-10 °C to 122 °C (14 °F to 252 °F) at 23 °C ambient
Accuracy	± 0.25 °C at 50 °C; ± 0.25 °C at 100 °C; ± 0.5 °C at 375 °C	± 0.25 °C
Stability	± 0.07 °C at 50 °C; ± 0.1 °C at 100 °C; ± 0.3 °C at 375 °C	± 0.05 °C
Well-to-Well Uniformity	± 0.2 °C with sensors of similar size at equal depths within wells	
Heating Times	35 °C to 375 °C: 9.5 minutes	ambient to 100 °C: 10 minutes
Stabilization	5 minutes	7 minutes
Cooling Times	375 °C to 100 °C: 14 minutes	ambient to 0 °C: 10 minutes
Well Depth	102 mm (4 in); 1.6 mm (1/16 in) hole is 89 mm (3.5 in) deep	102 mm (4 in)
Removable Inserts	N/A	Available in sizes from 1.6 mm (1/16 in) to 11.1 mm (7/16 in) [6.4 mm (1/4 in) and 4.8 mm (3/16 in) included]
Power	115 V ac (± 10 %), 55–65 Hz, 1.5 A or 230 V ac (± 10 %), 0.8 A, 45–55 Hz, 175 W	94–234 V ac (± 10 %), 50/60 Hz, 60 W; or 12 VDC
Size (HxWxD)	57 x 125 x 150 mm (2.25 x 4.9 x 6.1 in)	99 x 140 x 175 mm (3.9 x 5.5 x 6.9 in)
Weight	1 kg (2 lb 3 oz)	1.8 kg (4 lb)
Computer Interface	RS-232 included with free Interface-it software	
NIST-Traceable Calibration	Data at 50 °C, 100 °C, 150 °C, 200 °C, 250 °C, 300 °C, and 375 °C	Data at -10 °C, 0 °C, 25 °C, 50 °C, 75 °C, 100 °C, and 122 °C

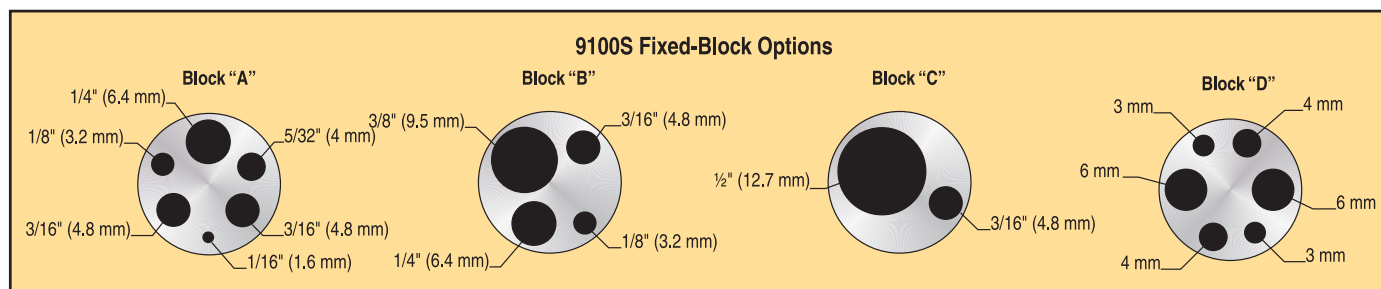

9100S fixed-block options. Order number 9100S-A, 9100S-B, 9100S-C, or 9100S-D for the desired block option.



9102S block configuration. Instrument includes 1/4" and 3/16" inserts. Order additional sizes as needed.

### Ordering Information - 9100S

- 9100S-A** HDRC Handheld Dry-Well A
- 9100S-B** HDRC Handheld Dry-Well B
- 9100S-C** HDRC Handheld Dry-Well C
- 9100S-D** HDRC Handheld Dry-Well D
- 9300** Rugged Carrying Case

### Ordering Information - 9102S

- 9102S** HDRC Handheld Dry-Well
- 3102-0** Insert, blank
- 3102-1** Insert, 1/16 in (1.6 mm)
- 3102-2** Insert, 1/8 in (3.2 mm)
- 3102-3** Insert, 3/16 in (4.8 mm)
- 3102-4** Insert, 1/4 in (6.4 mm)
- 3102-5** Insert, 5/16 in (7.9 mm)
- 3102-6** Insert, 3/8 in (9.5 mm)
- 3102-7** Insert, 7/16 in (11.1 mm)
- 3102-8** Insert, 5/32 in (4 mm)
- 9308** Carrying Case
- 9320A** External Battery Pack, 115 V ac

# Portable lab dry-well



- Designed for on-ship and on-the-go lab applications
- Covers  $-40\text{ }^{\circ}\text{C}$  to  $140\text{ }^{\circ}\text{C}$
- Includes three-inch and six-inch calibration zones

This calibrator, designed for the U.S. Navy, covers temperatures from  $-40\text{ }^{\circ}\text{C}$  to  $140\text{ }^{\circ}\text{C}$ , delivers the performance you'll only find in true lab standards, and comes in a totally portable case. If your work involves ocean vessels, aircraft, or service trucks, Hart's Portable Lab Dry-Well was designed for you.

The 9007 covers  $-40\text{ }^{\circ}\text{C}$  to  $140\text{ }^{\circ}\text{C}$ . No external cooling is needed, so you get  $-40\text{ }^{\circ}\text{C}$  in normal ambient. Set-point accuracy is  $\pm 0.15\text{ }^{\circ}\text{C}$  and stability is better than  $\pm 0.02\text{ }^{\circ}\text{C}$ .

This dry-well comes with a unique calibration at the full, six-inch depth of the well and at a three-inch depth for short

probes. Coefficients for each calibration are stored in the dry-well and can be easily selected from the top-panel control buttons to match the length of the probe being tested.

Encased in an all-aluminum enclosure that is durable, waterproof, and meets the standards of MIL-T-28800, the 9007 comes with both RS-232 and IEEE-488 interface connections. A wide variety of inserts are available covering probe diameters from 1/16 inch (1.6 mm) to 5/8 inch (15.9 mm).

## Specifications

<b>Range</b>	$-40\text{ }^{\circ}\text{C}$ to $140\text{ }^{\circ}\text{C}$ at $25\text{ }^{\circ}\text{C}$
<b>Accuracy</b>	$\pm 0.15\text{ }^{\circ}\text{C}$
<b>Stability</b>	$\pm 0.02\text{ }^{\circ}\text{C}$
<b>Heating Times</b>	$25\text{ }^{\circ}\text{C}$ to $140\text{ }^{\circ}\text{C}$ : 20 min.
<b>Cooling Times</b>	$25\text{ }^{\circ}\text{C}$ to $-40\text{ }^{\circ}\text{C}$ : 25 min.
<b>Stabilization</b>	10 minutes
<b>Test Wells</b>	19 mm dia. x 152 mm deep (3/4 x 6 in)
<b>Communications</b>	RS-232 and IEEE-488
<b>Enclosure</b>	Meets Type II, Class 3, Style D requirements of MIL-T-28800
<b>Power</b>	115 V ac ( $\pm 10\%$ ), 5 A or 230 V ac ( $\pm 10\%$ ), 2.4 A, switchable, 50/60 Hz, 560 W
<b>Size (HxWxD)</b>	35.1 x 27.4 x 42.9 cm (13.8 x 10.8 x 16.9 in)
<b>Weight</b>	16.3 kg (36 lb)
<b>NIST-Traceable Calibration</b>	Data at $-40\text{ }^{\circ}\text{C}$ , $0\text{ }^{\circ}\text{C}$ , $25\text{ }^{\circ}\text{C}$ , $75\text{ }^{\circ}\text{C}$ , and $140\text{ }^{\circ}\text{C}$

## Ordering Information

<b>9007</b>	Portable Lab Dry-Well, $-40\text{ }^{\circ}\text{C}$ to $140\text{ }^{\circ}\text{C}$ , 1/4 in (6.36 mm) insert
<b>3107-2000</b>	Blank insert
<b>3107-2063</b>	1/16 in Insert (1.6 mm)
<b>3107-2125</b>	1/8 in Insert (3.2 mm)
<b>3107-2156</b>	5/32 in Insert (4 mm)
<b>3107-2188</b>	3/16 in Insert (4.8 mm)
<b>3107-2250</b>	1/4 in Insert (6.35 mm)
<b>3107-2313</b>	5/16 in Insert (7.9 mm)
<b>3107-2375</b>	3/8 in Insert (9.5 mm)
<b>3107-2500</b>	1/2 in Insert (12.7 mm)
<b>3107-2625</b>	5/8 in Insert (15.9 mm)
<b>3107-2901</b>	1 User-Specified Hole
<b>3107-2902</b>	2 User-Specified Holes



# Thermocouple furnace



## Specifications

<b>Temperature Range</b>	150 °C to 1200 °C (302 °F to 2192 °F)
<b>Display Resolution</b>	0.1 ° to 999.9 ° 1 ° above 1000 °
<b>Stability</b>	± 0.5 °C
<b>Display Accuracy</b>	± 5 °C
<b>Well Diameter</b>	1.25 in (32 mm)
<b>Well Depth</b>	140 mm (5.5 in); (101 mm [4 in] removable insert plus 38 mm [1.5 in] insulator)
<b>Heating Time</b>	35 minutes to 1200 °C
<b>Cooling Time</b>	140 minutes with block
<b>Well-to-Well Uniformity</b>	± 2.5 °C (Insert "C" at 1200 °C)
<b>Stabilization</b>	20 minutes
<b>Power</b>	115 V ac (± 10 %), 10.5 A or 230 V ac (± 10 %), 5.2 A, switchable, 50/60 Hz, 1200 W
<b>Size (HxWxD)</b>	315 x 208 x 315 mm (12.4 x 8.2 x 12.4 in)
<b>Weight</b>	13 kg (28 lb)
<b>NIST-Traceable Calibration</b>	Data at 150 °C, 300 °C, 450 °C, 600 °C, 800 °C, 1000 °C, and 1200 °C

- Low-cost thermocouple furnace
- NIST-traceable calibration included
- RS-232 port standard

You told us you weren't satisfied with the competition's furnaces for checking industrial thermocouples. You said you wanted something new and more convenient to use—and you wanted it at a lower price than any other furnace available. Well, we've got what you asked for, and it's the Model 9150 Thermocouple Furnace from Hart Scientific.

With a stability of ± 0.5 °C, it has a temperature range to 1200 °C and a display accuracy of ± 5 °C across its entire range.

With interchangeable temperature blocks, you can check thermocouples as

small as 1/16 of an inch in diameter. The 9150 works with 115 or 230 V ac power.

The 9150 Thermocouple Furnace uses Hart's own microprocessor-based controller for great stability and set-point accuracy. It has a removable well insert for versatility. It has rapid cool-down and heat-up times. And it comes with an RS-232 port for connection to a PC.

You can now afford to check your thermocouples with this excellent cost-effective instrument. Why pay more for features you don't need and can't use? Each unit is factory-calibrated and comes with test data and a calibration traceable to NIST.

## Ordering Information

<b>9150-X</b>	Thermocouple Furnace (specify X, X = A, B, C, or D included insert)
<b>3150-2</b>	Insert A
<b>3150-3</b>	Insert B
<b>3150-4</b>	Insert C
<b>3150-6</b>	Insert D
<b>9315</b>	Rugged Carrying Case

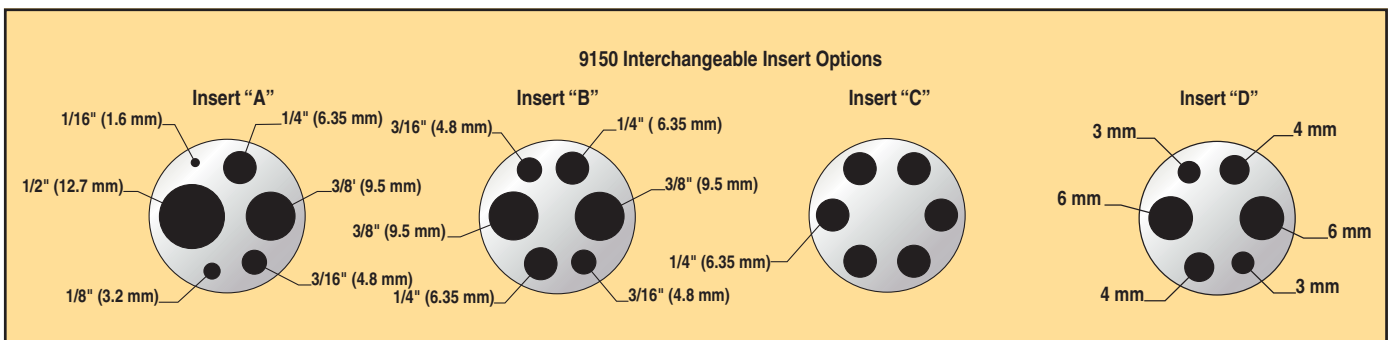

# Thermocouple calibration furnace



- Combined stability and uniformity better than  $\pm 0.4$  °C
- RS-232 serial interface standard
- High capacity for simultaneous comparison calibrations
- CE compliant

Need the most accurate thermocouple calibrations possible? The Hart Model 9112B Thermocouple Furnace gives you a broad temperature range to 1100 °C, stability up to  $\pm 0.05$  °C, and all at an excellent price. In addition, you can take advantage of optional MET/TEMP II software that completely automates the furnace and calibration processes.

Alternative calibration tools such as a sand bath or fluidized alumina bath have been used for calibrations up to 700 °C but with very poor comparative performance. Gradients of several degrees are common in a sand bath, along with poor stability, resulting in low-accuracy calibrations. Sand baths are also known to create a troublesome dust problem. Why buy poor performance and lab pollution?

Calibration furnaces are an excellent alternative to sand baths, especially for thermocouples, RTDs, and optical fiber probes. With a five-hole standard block and custom blocks available, the 9112B doesn't limit the size and shape of sensors you can calibrate the way other furnaces

do. In addition, most calibration furnaces have poor stability.

## Automation software

Hart's 9938 MET/TEMP II software lets you use your PC to automate your calibrations. Not only does the software operate the furnace, it also automates Hart readouts along with the calibration procedures. Read more about our software packages starting on page 96.

## Unique engineering

The 9112B employs a special heater design for temperature uniformity and rapid heat rates. The heaters are embedded in a refractory ceramic-fiber material, forming a two-piece heating assembly. A quartz tube lines the entire test zone of the furnace, insulating the isothermal block and your work from the high-power heater windings while supporting the block and further equalizing temperature distribution.

The isothermal block assembly is machined from a high-nickel-content alloy for good thermal conductivity and resistance to high-temperature oxidation. The

central block is sized for optimum balance between sufficient mass for good stability/uniformity and small enough mass for rapid heating/cooling and stabilization. The assembly makes use of two smaller alloy blocks as thermal barriers and heat sinks. Guide tubes connect the blocks and guide your probes to the heart of the block. A thermal shield at the front of the assembly prevents heat loss at the front of the furnace.

## Multiple probe calibrations

The standard furnace block accepts up to four probes under test and one reference probe. The four test holes take 1/4-inch-diameter probes, and the reference hole accepts the slightly larger and typical standard type S thermocouple or an SPRT. Custom isothermal blocks can handle a specific number of probes with different diameters and depths. Call our sales department for a custom quote.

## Microprocessor control

A microprocessor-based digital temperature controller makes set-point adjustments fast and easy. Both set and actual temperatures are simultaneously displayed for your convenience. A fast push-button adjustment is used for manual temperature settings. The controller is factory tuned for best performance between 300 °C and 1100 °C when the tuning function is set for automatic conformity to the set-point requirements. When using the furnace below 300 °C, controller adjustments are made to achieve high stability.

The isothermal block design and the controller auto-tuning combine to give you metrology-level performance. The "B" block delivers uniformity of  $\pm 0.1$  °C at the low end and  $\pm 0.3$  °C or better at the high-temperature end.

The stability figures quoted in our specification table are for mid-term to long-term stability. Short-term stability during a comparison calibration is even better.

Wide-range and high-temperature calibration work are now easier and more affordable due to Hart's innovative 9112B design. Thermocouples, RTDs, and other sensors are all calibrated with a greater level of confidence and accuracy.

# Thermocouple calibration furnace

## Specifications

<b>Range</b>	300 °C to 1100 °C (572 °F to 2012 °F)
<b>Stability</b>	± 0.05 °C at 300 °C ± 0.1 °C at 700 °C ± 0.1 °C at 1100 °C
<b>Uniformity</b>	± 0.05 °C at 300 °C ± 0.2 °C at 700 °C ± 0.3 °C at 1100 °C
<b>Heating Rates</b>	25 °C to 900 °C: 35 minutes 900 °C to 1100 °C: 3 hours
<b>Cooling Rates</b>	Nom. at 800 °C: ≥300 °C/hour Nom. at 600 °C: ≥180 °C/hour
<b>Stabilization Time</b>	Typically 2 hours midrange, slower at low-temperature end (4 hours), faster at high-temperature end
<b>Interface</b>	RS-232 included on all units
<b>Outside Dimensions (HxWxD)</b>	457 mm x 362 mm x 660 mm (18 in x 14.25 in x 26 in)
<b>Thermal Block</b>	406 mm (16 in) immersion; includes four wells at 6.35 mm (1/4 in) and one well at 7.11 mm (0.28 in)
<b>Weight</b>	33 kg (72.5 lb) with block
<b>Power</b>	230 V ac (± 10 %), 50/60 Hz, 20 A, 3700 W
<b>Heater</b>	3700 W
<b>NIST-Traceable Calibration</b>	Data at 420 °C

## Ordering Information

**9112B-B** Calibration Furnace (includes standard 406 mm [16 in] block)  
*Call for custom inserts.*

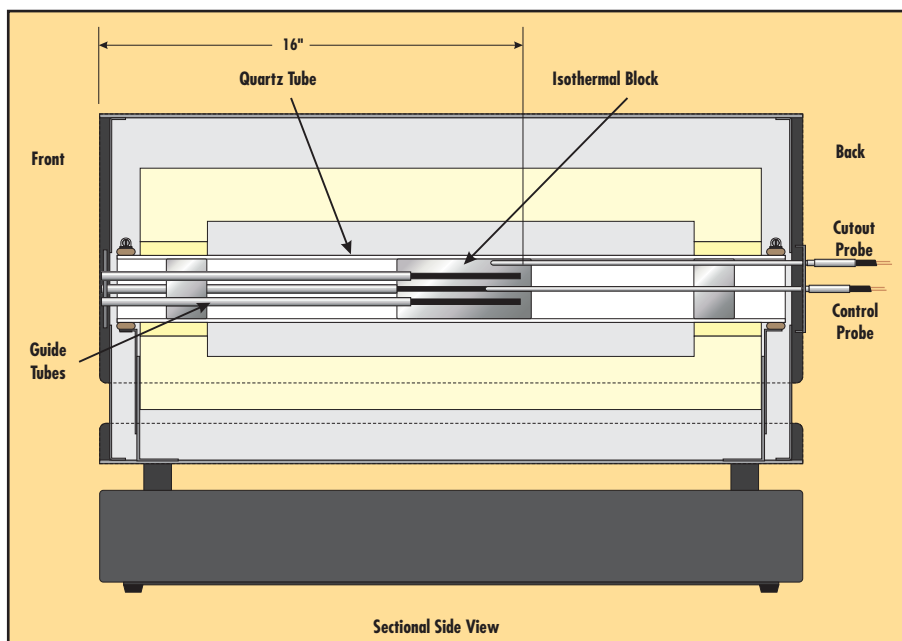



# Zero-point dry-well



- Bath-quality stability in a portable ice-point reference
- Easy recalibration for long-term reliability
- Ready light frees user's time and attention
- Solid-state cooling technology

Have you been thinking about buying a zero-point dry-well? Forget those ugly-looking units the competition makes. You can get a great looking and great performing zero-point dry-well from Hart Scientific.

The Hart 9101 has three test wells for inserting more than one probe at a time. All three wells are stable to  $\pm 0.005^\circ\text{C}$ . One well accommodates changeable inserts for varying probe diameters.

The Model 9101 takes advantage of the latest solid-state cooling technology rather than relying on older, less reliable sealed-water-cell devices. This eliminates the possibility that the sealed water cell will freeze and burst while transporting the unit to field locations. And our solid-state cooler is run by an adjustable electronic controller that can be recalibrated in your lab for convenient recertification. Simply place a certified standards thermometer in one of the wells and, if needed, tweak the 9101 controller until the standards thermometer reaches equilibrium at  $0^\circ\text{C}$ .

Since the unit is completely self-contained and doesn't require any user settings, you can run it on demand for

instant access to an accurate, traceable zero point. Set it up with the reference junction of a thermocouple for high-accuracy thermocouple measurements.

Less costly than refrigerated baths, more accurate and less problematic than ice baths, and more durable and better looking than competitive units using sealed-water cells, the Hart 9101 Zero-Point Dry-Well is a great choice for any calibration lab!

## Keep it clean!

Be sure to keep those dry-well inserts and blocks clean. They'll perform better and be easier to use (not to mention they'll look better). As needed, you should:

- Clean off any oxidation that has built up in the dry-well block or on an insert. Oxidation can make inserts difficult to remove. It can also cause probes not to fit properly. This oxidation occurs more rapidly at higher temperatures and in humid environments. It will clean up nicely with a Hart 2037 Dry-Well Cleaning Kit.
- Remove any foreign substances in the wells that can make operation difficult. Never intentionally put a foreign substance into a dry-well. Not only can you make probes and inserts difficult to remove, but you may also cause damage to the unit. If you're tempted to pour a fluid into a dry-well, stop. Give us a call and we'll set you up with a proper fluid bath.
- Clean probes before inserting them into the dry-well as a preventative measure.

## Specifications

<b>Temperature Range</b>	0 °C (32 °F)
<b>Stability</b>	$\pm 0.005^\circ\text{C}$
<b>Total Instrument Error</b>	$\pm 0.02^\circ\text{C}$ , typical; $\pm 0.05^\circ\text{C}$ max. (18–25 °C ambient)
<b>Stabilization Time</b>	Approx. 30 minutes (the ready lamp indicates stable control at $0^\circ\text{C}$ )
<b>Temperature Coefficient</b>	$\pm 0.005^\circ\text{C}/^\circ\text{C}$ amb.
<b>Size (HxWxD)</b>	311 x 216 x 146 mm (12.25 x 8.5 x 5.75 in)
<b>Power</b>	115 V ac ( $\pm 10\%$ ), 1 A or 230 V ac ( $\pm 10\%$ ), 0.5 A, 50/60 Hz, 125 W
<b>Well Dimensions</b>	2 wells 6.4 mm dia. x 152 mm D (0.25 x 6 in), 1 well 7 mm dia. x 152 mm D (0.28 x 6 in). Includes one set of telescoping inserts to provide various smaller diameters
<b>Weight</b>	5.4 kg (12 lb)
<b>NIST-Traceable Calibration</b>	Data at $0^\circ\text{C}$

## Ordering Information

<b>9101</b>	Zero-Point Dry-Well (includes one set of telescoping inserts to provide various smaller diameters)
<b>2130</b>	Spare Well-Sizing Tube Set
<b>9325</b>	Rugged Carrying Case

# 4180 series precision infrared calibrators

FLUKE®

Hart Scientific®



- Fast, portable and easy to use
- Correct target size for most thermometers
- Calibration solutions from -15 °C to 500 °C (5 °F to 932 °F)
- Radiometrically calibrated for traceable and consistent results

## Should your thermometer be calibrated by one of these?

Business decisions costing thousands of dollars are based on the results of your measurements, so they had better be right! It can be very expensive to shut down a line for repairs and maintenance, but it might be catastrophic if the shutdown is unplanned. To stand by your measurements with confidence, you should definitely have your thermometers calibrated.

## How to get consistent results:

Even those infrared thermometers that cannot be adjusted can benefit from a calibration that demonstrates the consistency and validity of your results. A trusted calibration means less worry, fewer questions and more time being productive. To get more reliable, traceable, and consistent results, buy a precision infrared calibrator from Fluke's Hart Scientific Division.

The 4180 Series of Precision Infrared Calibrators for infrared thermometers is fast, accurate, and easy to use. It comes

## Application note, (literature code 3187781):



## Infrared Temperature Calibration 101

Infrared temperature calibration is not so hard when you are on the right wave length. View the necessary information for spot on calibration.

Go to [www.hartscientific.com/publications](http://www.hartscientific.com/publications) for complete information.

# 4180 series precision infrared calibrators

## Common pitfalls in infrared thermometer calibration

- If the target size is too small, the thermometer will not read the right temperature. This problem, called size of source effect, is addressed by the large, 152.4 mm (six in) target of the 4180 series, which was designed to accommodate the field of view and calibration geometry requirements of certain common infrared thermometers used in the field, lab and process control.
- Some people are misled by the accuracy statements on IR calibrators because they are not familiar with the concept of

emissivity. Look for calibrators with a "radiometric calibration" so that accuracy will be straightforward and uncomplicated by emissivity-related errors.

For more information on emissivity, size of source effect and radiometric calibration, see Hart Scientific application note "Infrared Temperature Calibration 101" or choose a calibrator like the 4180 series that you know has already addressed all of these issues.

*Infrared thermometers have peripheral vision.*

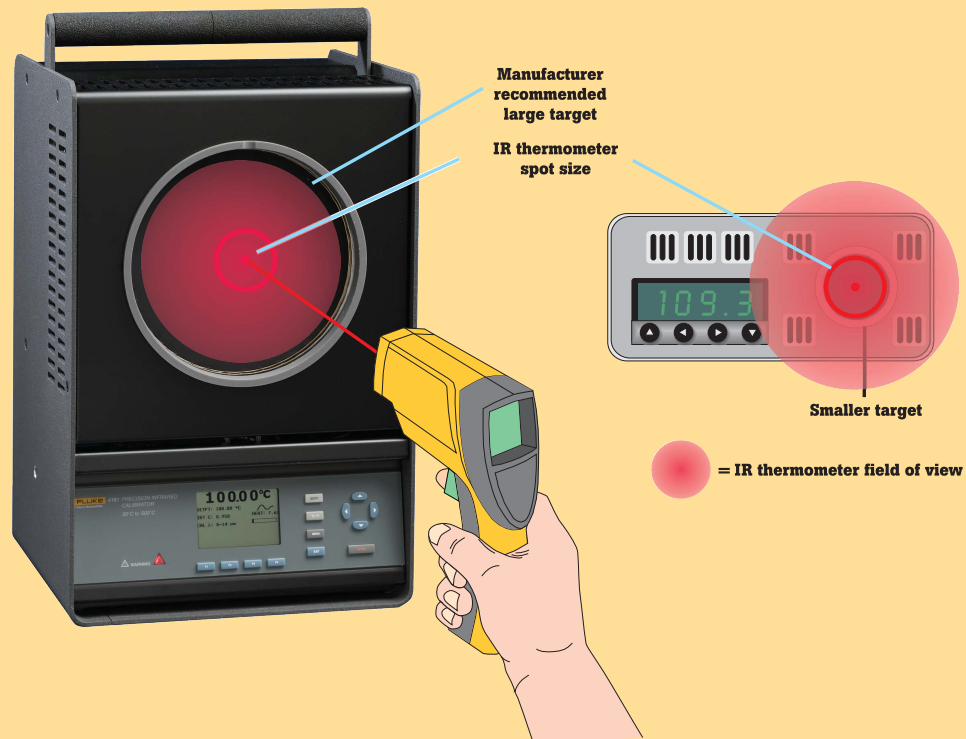

with an accredited calibration from one of the world's most trusted temperature calibration laboratories, sample calibration procedures for Fluke thermometers built right in and everything you need to get started making high-quality infrared thermometer calibrations. This is the perfect solution for any infrared thermometer within its temperature range.

The 4180 reaches temperatures from  $-15\text{ }^{\circ}\text{C}$  to  $120\text{ }^{\circ}\text{C}$  and the 4181 has a temperature range from  $35\text{ }^{\circ}\text{C}$  to  $500\text{ }^{\circ}\text{C}$ . Uniformity is important at these temperatures because an infrared thermometer will "see" the entire target when placed at the appropriate calibration distance.

In addition, with accuracies as good as  $\pm 0.35\text{ }^{\circ}\text{C}$ , the 4180 Series can meet its specifications without additional

emissivity-related corrections, leading to legitimate test uncertainty ratios (TUR) as good as 4:1. (See the sidebar below for information about common pitfalls in infrared calibrator accuracy and have a look at our Guide to Infrared Thermometer Calibration to get started quickly with your new calibrator.



# 4180 series precision infrared calibrators

FLUKE®

Hart Scientific®

Specifications	4180	4181
Temperature range (@ 23 °C ambient, 0.95 emissivity )	-15 °C to 120 °C (5 °F to 248 °F)	35 °C to 500 °C (95 °F to 932 °F)
Display accuracy <sup>1</sup>	± 0.40 °C at -15 °C ± 0.40 °C at 0 °C ± 0.50 °C at 50 °C ± 0.50 °C at 100 °C ± 0.55 °C at 120 °C	± 0.35 °C at 35 °C ± 0.50 °C at 100 °C ± 0.70 °C at 200 °C ± 1.20 °C at 350 °C ± 1.60 °C at 500 °C
Stability	± 0.10 °C at -15 °C ± 0.05 °C at 0 °C ± 0.10 °C at 120 °C	± 0.05 °C at 35 °C ± 0.20 °C at 200 °C ± 0.40 °C at 500 °C
Uniformity <sup>2</sup> (5.0 in dia of center of target)	± 0.15 °C at -15 °C ± 0.10 °C at 0 °C ± 0.25 °C at 120 °C	± 0.10 °C at 35 °C ± 0.50 °C at 200 °C ± 1.00 °C at 500 °C
Uniformity2 (2.0 in dia of center of target)	± 0.10 °C at -15 °C ± 0.10 °C at 0 °C ± 0.20 °C at 120 °C	± 0.10 °C at 35 °C ± 0.25 °C at 200 °C ± 0.50 °C at 500 °C
Heating time	15 min: -15 °C to 120 °C 14 min: 23 °C to 120 °C	20 min: 35 °C to 500 °C
Cooling time	15 min: 120 °C to 23 °C 20 min: 23 °C to -15 °C	100 min: 500 °C to 35 °C 40 min: 500 °C to 100 °C
Stabilization time	10 minutes	10 minutes
Nominal emissivity <sup>3</sup>	0.95	0.95
Thermometer emissivity compensation	0.9 to 1.0	
Target diameter	152.4 mm (6 in)	
Computer interface	RS-232	
Power	115 V ac (± 10%), 6.3 A, 50/60 Hz, 630 W 230 V ac (± 10%), 3.15 A, 50/60 Hz, 630 W	115 V ac (± 10%), 10 A, 50/60 Hz, 1000 W 230 V a (± 10%), 5 A, 50/60 Hz, 1000 W
Fuse(s)	115 V ac 6.3 A, 250 V, slow blow 230 V ac 3.15 A, 250 V, T	115 V ac 10 A, 250 V, fast blow 230 V ac 5 A, 250 V, F
Size (HxWxD)	356 mm x 241 mm x 216 mm (14 in x 9.5 in x 8.5 in)	356 mm x 241 mm x 216 mm (14 in x 9.5 in x 8.5 in)
Weight	9.1 kg (20 lb)	9.5 kg (21 lb)
Safety	EN 61010-1:2001, CAN/CSA C22.2 No. 61010.1-04	

<sup>1</sup>For 8 μm to 14 μm spectral band thermometers with emissivity set between 0.9 and 1.0

<sup>2</sup>The uniformity specification refers to how IR thermometers with different spot sizes both focused at the center of the target will measure the same temperature.

<sup>3</sup>The target has a nominal emissivity of 0.95, however it is radiometrically calibrated to minimize emissivity related uncertainties.

## Ordering information

- 4180** Precision Infrared Calibrator, -15 °C to 120 °C
- 4181** Precision Infrared Calibrator, 35 °C to 500 °C
- 4180-CASE** Carrying Case, 4180 or 4181
- 4180-APRT** 2-in Aperture, 4180 or 4181
- 4180-DCAS** Case, Transportation with wheels, 4180 or 4181

## Included accessories

Accredited radiometric calibration report, target cover, User Guide, Getting Started Guide, and 9930 Interface-it software with User Guide

# Portable IR calibrators



- Certify IR pyrometers from  $-30\text{ }^{\circ}\text{C}$  to  $500\text{ }^{\circ}\text{C}$  ( $-22\text{ }^{\circ}\text{F}$  to  $932\text{ }^{\circ}\text{F}$ )
- Large 57 mm (2.25 in) blackbody target
- RTD reference well for high precision
- Small, compact design

Whether you're using in-line or handheld infrared pyrometers, you need good calibration standards to verify their accuracy. Our new portable IR calibrators provide stable blackbody targets for calibrating noncontact IR thermometers from  $-30\text{ }^{\circ}\text{C}$  to  $500\text{ }^{\circ}\text{C}$ .

These new units feature a large, temperature controlled blackbody target with a diameter of 57 mm (2.25 in), which offers a large field of view area for optical variations in infrared thermometers. The emissivity of the isothermal target is set at 0.95 ( $\pm 0.02\%$ ), and the target temperature can be controlled in set-point increments of  $0.1\text{ }^{\circ}$  from  $-30\text{ }^{\circ}\text{C}$  to  $500\text{ }^{\circ}\text{C}$ .

For even higher precision, a well is located directly behind the blackbody surface for contact calibration of the blackbody.

These units are as easy to use as "point and shoot." Simply set the desired blackbody temperature from the convenient front panel control buttons, wait a few minutes for equilibrium, and point the gun at the target. The radiated energy from the blackbody is measured by your IR thermometer. Simply compare its reading

to the display on the blackbody and record the difference.

## 9132

For IR calibrations above normal ambient, the 9132 provides a stable blackbody target up to  $500\text{ }^{\circ}\text{C}$  ( $932\text{ }^{\circ}\text{F}$ ). With accuracy to  $\pm 0.5\text{ }^{\circ}\text{C}$  and stability to  $\pm 0.1\text{ }^{\circ}\text{C}$ , this new portable IR unit can certify most handheld pyrometers.

Short heating and cooling times mean you won't have to wait long to get your work done. From room temperature to  $500\text{ }^{\circ}\text{C}$  the 9132 will be stable within 30 minutes. You won't find a more compact IR calibrator.

## 9133

If you're calibrating IR guns at cold temperatures, you'll love our new 9133. With solid-state cooling technology, this new IR calibrator reaches  $-30\text{ }^{\circ}\text{C}$  ( $22\text{ }^{\circ}\text{F}$ ) in normal ambient conditions. With a conveniently located dry gas fitting on the front bezel, ice build up on the target can be avoided. At the upper end of its range, the 9133 provides stable temperatures to  $160\text{ }^{\circ}\text{C}$  ( $320\text{ }^{\circ}\text{F}$ ).

With heating and cooling times of about 15 minutes from ambient to either extreme, the 9133 gets you to temperature quickly and performs when it gets there. Compare your IR devices to the temperature display—it's factory calibrated to be within  $\pm 0.4\text{ }^{\circ}\text{C}$  ( $\pm 0.7\text{ }^{\circ}\text{F}$ ).

No other IR calibrators give you this level of precision in such compact packages. Whatever your temperature application, trust a Hart product to solve it.



Large target for calibrating all IR thermometer types.



The 9133 includes a quick-attach fitting on the front bezel for dry air purging, which eliminates ice buildup on the target.

# Portable IR calibrators

Specifications	9133	9132
Temperature Range	-30 °C to 150 °C at 23 °C ambient (-22 °F to 302 °F at 73 °F ambient)	50 °C to 500 °C (122°F to 932°F)
Accuracy	± 0.4 °C (± 0.72 °F)	± 0.5 °C at 100 °C (± 0.9°F at 212°F) ± 0.8 °C at 500 °C (± 1.4 °F at 932 °F)
Stability	± 0.1 °C (± 0.18 °F)	± 0.1°C at 100°C (± 0.18°F at 212°F) ± 0.3°C at 500°C (± 0.54°F at 932°F)
Target Size	57 mm (2.25 in)	
Target Emissivity	0.95 (± 0.02 from 8 to 14 μm)	
Resolution	0.1 °	
Heating Time	15 minutes (25 °C to 150 °C)	30 minutes (50 °C to 500 °C)
Cooling Time	15 minutes (25 °C to -20 °C)	30 minutes (500 °C to 100 °C)
Computer Interface	RS-232 I/O included with 9930 Interface-it software	
Power	115 V ac (± 10 %), 1.5 A, or 230 V ac (± 10 %), 1.0 A, switchable, 50/60 Hz, 200 W	115 V ac (± 10 %), 3 A or 230 V ac (± 10 %), 1.5 A, switchable, 50/60 Hz, 340 W
Size ( HxWxD )	152 x 286 x 267 mm (6 x 11.25 x 10.5 in)	102 x 152 x 178 mm (4 x 6 x 7 in )
Weight	4.6 kg (10 lb)	1.8 kg (4 lb)
NIST-Traceable Contact Calibration	Data at -30°C, 0°C, 25°C, 75°C, 100°C, 125°C, and 150°C	Data at 50°C, 100°C, 200°C, 250°C, 300°C, 400°C, and 500°C

## Ordering Information

- 9132** Portable IR Calibrator, 500 °C
- 9308** Rugged Carrying Case, 9132
  
- 9133** Portable IR Calibrator, -30 °C
- 9302** Rugged Carrying Case, 9133



# Surface calibrator



- Calibrates surface sensors up to 400 °C
- Uses Hart 2200 Controller for excellent accuracy and stability
- NIST-traceable calibration included

Surface probes are difficult to calibrate because it's hard to find a flat, heated surface that's stable and uniform. Hart's new Model 3125 Surface Dry-Well takes advantage of our proprietary Model 2200 Temperature Controller (page 133) and gives you the best possible conditions for calibrating surface sensors.

Why buy a non-temperature calibration device designed for test tube sterilization or PC board repair when you can have a true calibration instrument? The 3125 has a uniform surface temperature and reaches temperatures as high as 400 °C.

The test surface is milled aluminum for an absolutely smooth and true calibration work area with maximum thermal conductivity. The 12.25-square-inch test surface is large enough to calibrate more than one sensor at a time. The 3125 can be used with a reference surface sensor or PRT.

PRTs (3/16" diameter, such as the 5612 on page 70) may be inserted through a drilled hole into the center of the block for use as reference thermometers or for easy recalibration of the unit's display.

With an accuracy of  $\pm 0.5$  °C to 200 °C and  $\pm 1$  °C to 400 °C, you can calibrate almost any surface probe, thermistor, thin film sensor, RTD, thermocouple, ribbon sensor, or surface mount cutouts, fuses, and switches. Stability is within  $\pm 0.3$  °C at 400 °C and uniformity within the center three inches of the surface is  $\pm 0.6$  °C at 200 °C. Don't buy "make-do" hot plates when you can have a legitimate calibration tool.

## Specifications

<b>Temperature Range</b>	35 °C to 400 °C (95 °F to 752 °F)
<b>Display Accuracy</b>	$\pm 0.5$ °C to 200 °C $\pm 1.0$ °C to 400 °C
<b>Stability</b>	$\pm 0.2$ °C to 300 °C $\pm 0.3$ °C to 400 °C
<b>Resolution</b>	0.01 °
<b>Uniformity</b>	$\pm 0.3$ °C at 100 °C $\pm 0.6$ °C at 200 °C $\pm 0.9$ °C at 300 °C $\pm 1.4$ °C at 400 °C
<b>Heating Time</b>	25 °C to 400 °C: 22 minutes
<b>Cooling Time</b>	400 °C to 100 °C: 65 minutes
<b>Stabilization Time</b>	8 minutes
<b>Controller</b>	Hart Model 2200, microprocessor based, with RS-232 (see page 133)
<b>Readout</b>	°C or °F, switchable
<b>Sensor</b>	RTD, 100 $\Omega$
<b>Heater</b>	325-watt, solid-state controlled
<b>Surface Plate</b>	6061 aluminum; top surface machine finished to 0.0008 mm (0.000032 in), 96 mm (3.8 in) diameter accessible
<b>Power</b>	115 V ac ( $\pm 10$ %), 2.8 A or 230 V ac ( $\pm 10$ %), 1.4 A, specify, 50/60 Hz, 325 W
<b>Weight</b>	3.2 kg (7 lb) with 2200 Controller
<b>NIST-Traceable Calibration</b>	Data at 50 °C, 120 °C, 190 °C, 260 °C, 330 °C, and 400 °C

## Ordering Information

<b>3125</b>	Surface Calibrator, (includes detachable Hart Model 2200 Controller)
-------------	--

# Other neat stuff selection guide

## Cool lab products

Product	Features	Page
9320A Battery Pack	Provides 115 V ac or 12 V dc power portability	177
5121 Bench-Top Temperature /Humidity Generator	Full range accuracy $\pm 0.5$ %RH. Large working volume for optimal throughput. NIST-developed two-pressure principal.	178

## And there's more...

Seminars	Three seminars covering topics from industrial field calibrations to primary standards lab calibrations. Each course mixes lectures, demonstrations, hands-on exercises, and question/answer sessions. Instructors include leading metrology experts with a wide variety of applications experience.	181
Cal Lab Services	Calibration services for SPRTs, RTDs, thermocouples, and thermistors. Calibrations by fixed point and by comparison. Recalibrations of Hart dry-wells and thermometers.	186

# External battery pack



- Powers 115 V ac or 12 V dc products almost anywhere
- 3-digit battery status display
- Audible alarm signals overheat and under voltage conditions

Are you having trouble finding a power outlet? Hart's 9320A external battery pack solves your problem. Plug your 115 V ac or 12 V dc powered calibration equipment into the 9320A for hours of useful operation. Don't get caught half-way through your work, only to find your battery pack just ran out of power. With the 3-digit battery status display on the front of the 9320A, you'll know how

much time your battery's got even before you start the job. The 9320A comes with an ac charger that recharges the battery pack from a standard wall outlet, and a dc charging cable to recharge the unit from the battery of a truck or car. What's more, you'll also get jumper cables, a handy light, and an air compressor tool! Don't be sorry. Get a 9320A of your own.

### Ordering Information

9320A External Battery Pack

### Suggested Run Times

1502A Tweener	36 Hours
1523 1524	36 Hours
1529 Chub-E4 Run Time	16 Hours
1620A DewK Run Time	36 Hours
9102S Handheld Dry-Well Run Time	4 Hours

### Specifications

AC Output	115 $\pm$ 10 V ac RMS, 60 Hz $\pm$ 4 Hz
Internal Battery Voltage (nominal)	12 V dc
DC Power Socket (maximum continuous load)	12 A with automatic reset
Fuse (internal)	2 x 25 A or 1 x 50 A
Internal Battery Type	Sealed, AGM (absorbed glass mat) lead acid
Internal Battery Capacity (minimum)	20 Ah
Internal Battery CCA Rating	200 CCA
Operating Temperature Range	0 °C to 40 °C (32 °F to 104 °F)
Air Compressor Pressure	250 PSI
Nozzle Adapter (for air compressor)	Two nozzle adapters, one sports needle adapter
Size (HxWxD)	24.1 cm x 40.8 cm x 20.3 cm (9.5 x 16 x 8 in)
Weight	10.5 kg (23 lb)

# Benchtop temperature/humidity generator



- Full range accuracy  $\pm 0.5\%$  RH
- Large working volume for optimal throughput
- NIST-developed two-pressure principal
- RS-232 interface and ControLog automation software included

Tired of outsourcing your humidity calibrations? Why not buy a temperature/humidity generator and calibrate your humidity probes, data loggers, and chart recorders yourself? It's simple with the 5121 manufactured for Hart by Thunder Scientific. The 5121 is a self-contained generator that measures and controls humidity with high accuracy to  $\pm 0.5\%$  and a large working volume of 15" x 15" x 12" (381 x 381 x 305 mm). Not only does it calibrate humidity probes but also entire chart recorders, data-loggers, and hygrometers (if the probe is not detachable, which is often the case).

5121 uses a "two-pressure" generation principal, which was originally developed

by NIST and involves saturating a stream of air with water vapor at a known temperature and pressure. Relative humidity of the saturated air can be directly calculated through the following formula:

$$\%RH = \frac{f_s}{f_c} \cdot \frac{e_s}{e_c} \cdot \frac{P_c}{P_s} \cdot 100$$

To generate a known humidity, the 5121 controls the pressure ratio ( $P_c/P_s$ ), utilizing an enhancement factor ratio ( $f_s/f_c$ ) and the effective degree of saturation ( $e_s/e_c$ ).

Humidity generated by this method is only dependant upon precision measurements of temperature and pressure, so the

need to use an expensive chilled-mirror hygrometer as a reference is eliminated, reducing the cost of ownership. The 5121 generates RH with an accuracy of 0.5 % over the range  $-10\text{ }^\circ\text{C}$  to  $70\text{ }^\circ\text{C}$  and 10 %RH to 98 %RH. Chamber temperature accuracy is an amazing 0.06  $^\circ\text{C}$ . With this performance, you can calibrate ambient-measuring, temperature-probes!

To assist with your own calibration uncertainty analysis, be sure to visit the Hart website and download a copy of the 5121 series evaluation report that includes the detailed temperature and humidity uncertainty analysis.

How about operating the 5121? It's so easy you'll be performing humidity calibrations minutes from switch-on. The generator is supplied as standard with all the equipment you'll need. Simply connect the generator to a clean, oil-free air supply, fill up the water reservoir, and plug it in; then place your chart recorders, data-loggers, or humidity sensors into the chamber, close the door, and program the desired temperature and humidity through the easy-to-use front panel display. You'll quickly be at set point and recording your calibration data! The front panel display provides loads of useful information, including chamber humidity and flow rates, as well as the saturation and chamber temperatures and pressures.

If you're looking for improved productivity in your humidity calibrations, try ControLog™ software, which allows you to program a series of humidity and temperature set-points, and automatically steps through the set-points to maintain stable calibration conditions for defined periods of time. What could be easier?

The 5121 series is a favorite with many national labs around the world, all branches of the U.S. military, and most of the major humidity sensor manufacturers.

We use a 5121 at Hart for calibration support of our environmental monitoring systems around our cal labs and in manufacturing. It performs reliably day-in and day-out. In fact, we like our 5121 so much, we wanted to offer one to you. So, if you calibrate humidity systems, visit with Hart and check out the 5121. You'll be glad you did!



# Benchtop temperature/humidity generator

## Specifications

Relative Humidity Range	10 % to 98 %
Relative Humidity Resolution	0.02 %
Relative Humidity Accuracy	± 0.5 %
Chamber Temperature Range	-10 °C to 70 °C
Chamber Temperature Resolution	0.02 °
Chamber Temperature Uniformity	± 0.1 °C
Chamber Temperature Accuracy	0.06 °C
Gas Flow Rate Range	5 to 20 slpm
Gas Type	Air or Nitrogen
Heating/Cooling Rate	0.4 °C per minute
Interface	RS-232, Software ControLog™ and HumiCalc® included
Chamber Dimensions	381 x 381 x 305 mm (15 x 15 x 12 in)
Power, Chamber	100/120 V at 15 A, 50/60 Hz 200/240 V at 8 A, 50/60 Hz
Power, Compressor	100/120 V at 5 A, 50/60 Hz 200/240 V at 2.5 A, 50/60 Hz
Air Supply	Clean, oil-free, instrument air at 175 psiG and 20 slpm
Calibration	NIST traceable temperature & humidity calibration with certificate & data
Warranty	12-months, parts-and-labor

## Ordering Information

5121 Humidity Generator, 2500ST (LT)(TPA)

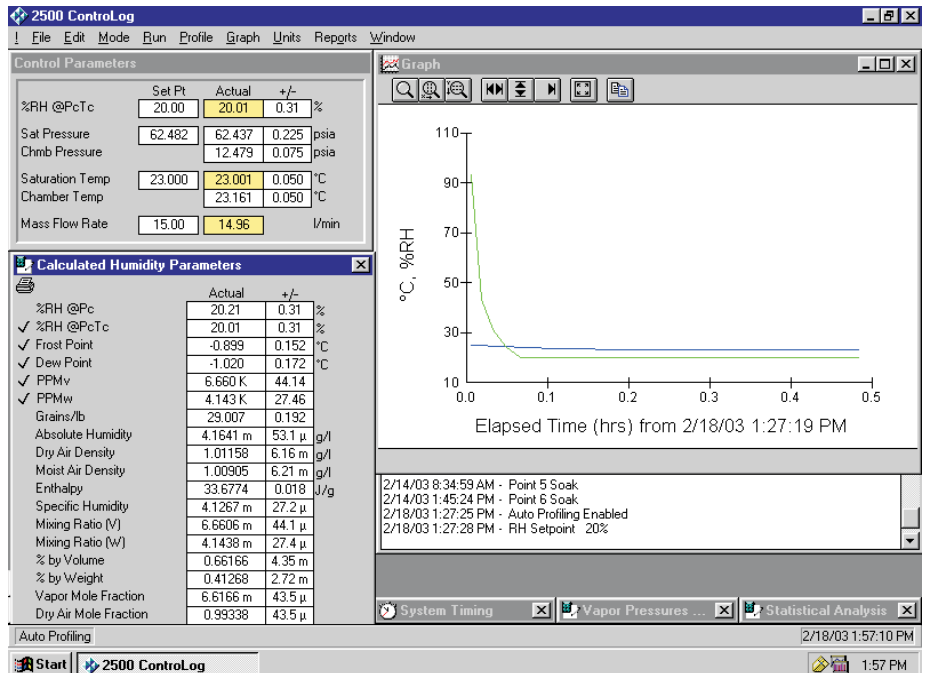

ControLog™ software can completely automate the operation of your 5121. Run a single set-point or quickly create a profile with a series of set-point/time values and let your 5121 run unattended. ControLog™ collects data and includes a report editor for semi-custom reports. It can operate your system in a variety of modes including %RH, Frost Point, Dew Point, PPMv, and PPMw.

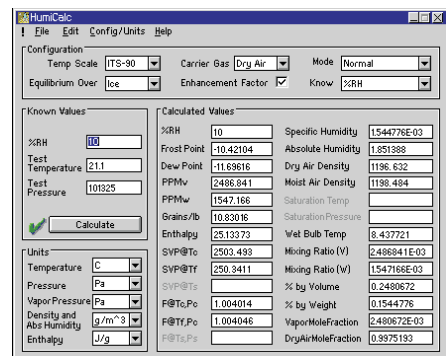

HumiCalc® software makes simple work of complex humidity conversions. A typical calculation requires only a temperature, a pressure, and one known humidity parameter. HumiCalc® then computes all the final humidity values for you and can export them to a spreadsheet.

## On rutabagas and their origins...

### Reprinted from *Random News*

Every now and again a new customer of ours comes across a reference in our literature to rutabagas and, after giving up on trying to find a connection between rutabagas and temperature calibration, asks us in desperation what it could possibly mean. So we figure it's time for a very brief history lesson.

Once upon a time, many years ago, a respected competitor of ours made a statement about temperature calibration being more than a business to them, it was their "hobby."

That got us thinking.

Would our customers prefer to work with temperature experts who seem virtually obsessed by their work? Or would they prefer temperature experts who can relate to them on common-sense issues and who are willing to discuss whether that last digit of resolution is really meaningful to their application or not?

Now, don't get me wrong. We love every milli- and micro-Kelvin we've ever met (and we strive to meet more every day), but we never want to get so wrapped up in them that we fail to respond to the needs of our customers—like wanting to talk to a helpful person on the phone or get a quick turnaround on a calibration. Or maybe have some decent equipment to work with so they can get their work done and enjoy getting to the end of the day.

So, we decided that farming was our hobby. And, since growing things in Utah isn't easy (there's a reason why most of the first people to get here kept going west!), we picked the hardiest piece of vegetation we could think of. Rutabagas are so tough, you probably couldn't get one through airport security these days. But that's not the point.



Rutabagas remind us that we're not the only ones in the world and we need to be good neighbors—down-to-earth, "everyday" kind of people—willing to be flexible, eager to help rather than just "sell," and capable of admitting when we're wrong (which we sometimes are).

And that's the history of it. We don't sprinkle rutabagas all over everything we do. But we keep them around enough to remind us that we serve the temperature community and don't try to run it.

Has it done any good? Well, You're the ultimate judge of that. For our part, we remain focused on being a customer-friendly, service-oriented business. We've added staff to our customer service and

applications groups, we've expanded (and are still expanding) our NVLAP-accredited calibration services, and we've brought our service turnaround times to an all-time best.

We hope the impact of those improvements is making your lives better. And that you'll tell us if it isn't. In the meantime, when you spot a rutabaga in our catalog or on our web site, just remember, that's our way of reminding ourselves that you come first. Because if we forget that, we're going to be spending more time growing rutabagas in the dessert than even we would like.

# Hart Scientific temperature seminars

Our seminars give you the skills you need to do your job better. The members of our faculty are the right people to learn from because they deal with tough temperature metrology questions on a daily basis. Whether you're a technician or a manager, these seminars will help you get ahead in your career. You'll love each of our courses: *Principles of Temperature Metrology*, *Advanced Topics in Temperature Metrology*, *Infrared Temperature Metrology*, and *Product Training*. Each course lasts two days. We sometimes offer two courses in the same week, so check our website to see if you can take two courses in just one visit: [www.hartscientific.com/seminars/index.htm](http://www.hartscientific.com/seminars/index.htm)

## Principles of Temperature Metrology

"It was one of the best training courses I have attended."

That's what Keith Decker from a company that is a leader in the development of innovative therapies for serious illnesses, had to say about our *Temperature Metrology* course. Come to our *Principles of Temperature Metrology* course to experience this training for yourself.

Topics for this course range from the selection and usage of calibration equipment to the theory behind good calibrations. This includes knowing how to use SPRTs and other high-accuracy standards and how to keep your working standards performing at their highest levels. Are you working on laboratory accreditation? In this course we also discuss accreditation and compliance, especially dealing with ISO 17025 issues.

Not only will we cover actual calibration techniques, we'll show you how various instruments such as readouts, dry-wells, and calibration baths work and the principles behind why they work the way they do. You'll learn to choose the most cost-effective approach for specific applications, and then we'll get into enough basic uncertainty analysis to get your feet wet.

This course lasts two days. We sometimes offer two courses in the same week, so check our website to see if you can take two courses in just one visit: [www.hartscientific.com/seminars/index.htm](http://www.hartscientific.com/seminars/index.htm)

## Advanced Topics in Temperature Metrology

It's one thing to follow a calibration procedure and quite another to design one or provide technical support when things go wrong. If you really need to get training

that can improve the way you work, attend our course *Advanced Topics in Temperature Metrology*. We've got the right faculty in place to answer all your toughest temperature questions. That's because they know the theory and practice of calibrating everything you see on a daily basis. Some of them even designed the stuff!

This course covers advanced temperature metrology topics, including instruction on the ITS-90, procedure design, mathematical models, and serious uncertainty analysis. Bring your questions; we'll answer them.

Attendees should have completed *Principles of Temperature Metrology* or its equivalent previously.

This course lasts two days. We sometimes offer two courses in the same week, so check our website to see if you can take two courses in just one visit: [www.hartscientific.com/seminars/index.htm](http://www.hartscientific.com/seminars/index.htm)

## Infrared Temperature Metrology

So your customers want to use their infrared thermometers and it's time to figure out how to deal with the mysteries of IR thermometer calibration. Unfortunately, books written on the subject of infrared thermometry might as well be written in a foreign language, so why not make it easy on yourself and hear it all explained in clear, understandable terms?

Our *Infrared Temperature Metrology* course covers the basics of using infrared thermometers, performing radiometric (IR) calibrations, and determining measurement uncertainties.

You'll get your questions answered about black bodies, grey bodies, size of source effect, emissivity, spot size, background temperature effects, and apparent



temperature, to name a few. We'll discuss what calibration means for infrared thermometers and how to do it right. Don't miss this chance to get ahead of the game on the next big thing in temperature calibration.

This course lasts two days. We sometimes offer two courses in the same week, so check our website to see if you can take two courses in just one visit: [www.hartscientific.com/seminars/index.htm](http://www.hartscientific.com/seminars/index.htm)

## Product Training

It's time to get the most out of your Hart products. While our seminars offer theory, demonstrations, hands-on exercises, and panel discussions, *Product Training* provides additional hands-on experience.

The course is broken into four sessions covering thermometers, baths, dry-wells, and software. These sessions offer the perfect opportunity to learn to maximize the advantages you get from Hart products. You will leave knowing exactly how to use your favorite temperature



# Hart Scientific temperature seminars

## Meet our faculty

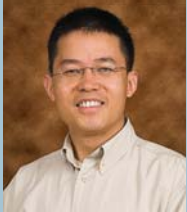

Mingjian Zhao came to us in 1994 from the National Institute of Metrology (NIM, China) where he worked as a researcher for seven years. He has published over 40 papers worldwide and has an MS degree in Thermal Physics from Harbin Institute of Technology (P. R. China). He is currently Hart's director of primary standards engineering and an expert in the design of thermometers and fixed points.



Tom Wiandt, Hart's director of metrology, has been with us since 1995. He has been key in achieving and maintaining our NVLAP accreditation in American Fork, Utah and UKAS accreditation in Norwich, England. His knowledge in temperature metrology is backed by his experience at Northrop Corporation, Southern California Edison, and the US Air Force. He is a frequent speaker at MSC, NCSLI, and international metrology organizations. He is currently the ASTM chair for committee E20.07, Fundamentals in Thermometry.



Mike Hirst, one of the original founders of Hart Scientific, has worked in the engineering of high-performance temperature sources since 1970, including dry-well calibrators, fixed-point furnaces, and baths. He received his BS degree in design technology from Brigham Young University.



Rick Walker has been with us since 1988 and has had a leading role in the development of a majority of Hart's thermometer readouts, including the Tweener, *Black Stack*, and Super-Thermometer. He holds an MS degree in electrical engineering.



Frank Liebmann has been with us since 2003. He is an expert in infrared temperature measurement and works as an engineer in the design of IR thermometer calibrators and other temperature calibration equipment. Frank has a BS in Electrical Engineering from the University of Utah.



Ron Ainsworth, marketing manager for Hart Scientific, was formerly the calibration laboratory manager and has been with the company since 1999. He holds a BS in Physics from Brigham Young University and has published his research through TEMPMEKO, the American Institute of Physics, and NCSLI, where he is also a section coordinator.

calibration products, how to achieve the best results from them, and how to get the most productivity out of your calibration work.

An experienced product group expert at Hart Scientific guides each product training session. Enrollment is limited and you're guaranteed to get all your questions answered.

Each session includes experience with a large number of products that represent Hart's entire line for that particular product group. In the thermometer session, for example, you'll get to work (and play) with a Little Lord Logger, a DewK, a Chub-E4, a *Black Stack*, and a Super-Thermometer. Likewise for the other sessions.

You just need to register to enjoy using the best temperature calibration products in the world. Try them out and you'll understand what we mean.

This course lasts two days. We sometimes offer two courses in the same week, so check our website to see if you can take two courses in just one visit: [www.hartscientific.com/seminars](http://www.hartscientific.com/seminars).

## How do I register?

Call us at...  
**(801) 763-1600**  
**(800) 438-4278**

Fax us at...  
**(801) 763-1010**

E-mail us at...  
**[seminars@hartscientific.com](mailto:seminars@hartscientific.com)**

or register online at...  
**[www.hartscientific.com](http://www.hartscientific.com)**

Remember, you can check our web site for dates and times of classes. Once you register, we'll send you the necessary visitor information on where to stay and how to get here. We're located just 40 minutes from Salt Lake City International Airport with plenty of inexpensive hotels nearby.

# Hart Scientific temperature seminars

## Principles of Temperature Metrology, course outline

A principles-based course in practical lab skills for comparison calibration of thermistors, RTDs, thermocouples, and other thermometers.

### Introduction to temperature

- ITS-90 and other temperature scales
- Traceability
- Uncertainty
- Calibration

### Temperature sensors, indicators, and sources

- Types (advantages/disadvantages)
- Characteristics
- Sources of error
- Effective (proper) use
- Evaluation

### Calibration systems

### Measurement techniques and procedures

### Uncertainty budgets

### Quality assurance

- Check standards
- Control charts
- ANSI/NCSL Z540
- ISO 17025
- Accreditation
- Audits
- Lab inter-comparison

Types (advantages/disadvantages)

Characteristics

Sources of error

Effective (proper) use

Evaluation

## Temperature Metrology, course outline

An intermediate course in practical lab skills for comparison calibration of thermistors, RTDs, thermocouples, and other thermometers.

### Introduction to temperature metrology

- Scales, ITS-90, and fixed points
- Uncertainty and traceability

### Thermometer types

- SPRTs, PRTs, RTDs, and thermistors
- Thermocouples—noble vs. base metal
- Liquid-in-Glass—procedures for accuracy
- Reference thermometers

### Components of uncertainty

- Heat sources
- Readouts

### Common calibration techniques

- Thermistors & PRTs
- Thermocouples—ASTM, spool testing
- LIG—ASTM—specific requirements

### Optimizing your measurement

- Test uncertainty ratios
- Error budgeting
- Profiling a heat source
- Mathematics

### Maintaining your standards

- Frequency of calibration
- Uncertainty analysis and SPC

### Compliance issues

- Reports, tables—pleasing the auditor
- ISO/IEC 17025, incorporating the new requirements

## Infrared Temperature Metrology, course outline

### IR thermometry theory

- What is radiation?
- IR spectrum
- Radiation equations
- Emissivity
- Gray bodies
- Size of source effect (SSE)
- Background temperature and effect

### Using the IR thermometer

- Spectral response
- Emissivity
- Spot size
- Background temperature and effect
- Imagers

### Using the IR calibrator

- Plates vs. cavities
- Emissivity (how to account for emissive effects)
- Reference IR thermometer
- IR calibrator specifications
- Spot size and target size
- Background temperature and effect
- Alignment

### Uncertainty budget

- Traceability
- Reference IR thermometer
- Measurement equation
- Accuracy
- Repeatability
- Elements of an IR uncertainty budget
- ASTM guidelines

## Product Training, course outline

### Bath training

- Profile a bath to minimize uncertainty
- Use different types of bath fluids
- Use Hart bath controllers
- Get the most from a reference thermometer

### You'll use...

- Deep-well Compact Baths
- Standard Baths

### Dry-Well Training

- Use all dry-well controller functions
- recalibrate your own dry-well
- Use a reference thermometer
- Maximize dry-well productivity

### You'll use...

- Metrology Wells
- Field Dry-Wells

### Thermometer training

- Use the menu systems for each readout
- Match a probe to a readout
- Select the best probe and handle it correctly
- Avoid calibration pitfalls
- Get the most productivity from your readout

### You'll use...

- 1524 Reference Thermometer
- 1529 Chub-E4
- 1620A DewK
- 1560 *Black Stack*
- 1590 Super-Thermometer II

### Software training

- Automate Control of your heat sources
- Automate calibrations entirely
- Generate probe data easily
- Log temperature data and analyze it

### You'll use...

- 9930 *Interface-it*
- 9938 *MET/TEMP II*
- 9933 *TableWare*
- 9935 *LogWare II*
- 9936A *LogWare III*

# NVLAP accreditation at Hart

In November 2000, Hart Scientific's temperature laboratory became officially accredited by the National Voluntary Laboratory Accreditation Program (NVLAP lab code 200348), which operates under the umbrella of NIST, the national metrology institute of the United States. Hart's lab accreditation was renewed for two years in early 2003. An abbreviated reproduction of our new scope of accreditation under ISO/IEC 17025 can be found on our web site at [www.hartscientific.com](http://www.hartscientific.com).

NVLAP has signed Mutual Recognition Arrangements (MRAs) with the Asia Pacific Laboratory Accreditation Cooperation (APLAC) and the International Laboratory Accreditation Cooperation (ILAC). Signatories to the ILAC agreement include most of the world's developed nations (see sidebar on following page). In short, Hart's lab is recognized as an accredited laboratory in most countries in the world.

## What is accreditation?

Accreditation is the unbiased assessment by a third party of a laboratory's quality program and technical capabilities. The third party assesses the laboratory against a recognized standard. In December 1999, the new standard, ISO/IEC 17025, "General Requirements for the Competence of Testing and Calibration Laboratories," was adopted and has now replaced ISO Guide 25 as the accepted standard for accredited test and measurement laboratories.

Accreditation indicates that a laboratory has demonstrated that it functions within the parameters of the standard. While accreditation is not a guarantee of a laboratory's performance, it does provide a means for determining the laboratory's competence to perform particular types of tests or calibrations. The technical evaluation during an accreditation includes a review (by experts in the relevant discipline) of calibration procedures, calibration standards, traceability, uncertainty analysis, actual results, and statistical process control.

Laboratory accreditation has been a requirement in many countries for years. Nationally recognized accreditation bodies have provided customers with confidence in calibration certificates and reports by employing generally established standards set by the European (CEN) or international (ISO) standardization bodies. Accreditation in the United States is voluntary. Nevertheless, as more companies become ISO 9000 certified, accreditation is becoming a more common practice in the United States.



## What is the scope of hart's accreditation?

The scope of Hart's accreditation is intended to satisfy the traceability and other requirements for ongoing company operations, research requirements, and customer support for both primary and secondary thermometry. In the United States, NVLAP and A2LA have already accredited hundreds of calibration laboratories. Hart's laboratory, however, is accredited for some of the lowest uncertainties of all commercial laboratories in the world. The following areas are included within Hart's scope of accreditation:

- Thermometric fixed-point cell certification
- SPRT calibration by fixed point
- Noble-metal thermocouple calibration by fixed point
- PRT calibration
- Thermistor calibration
- Reference resistor calibration (DC)
- Digital thermometer readout calibration
- Digital thermometer / probe system calibration

## What's in it for you?

First, since accreditation involves a third-party assessment of a laboratory's QA

program and technical capabilities, it provides an impartial viewpoint of the competency of the laboratory. It also provides an unbiased assessment of the laboratory's standards, procedures, personnel qualifications, and traceability to an appropriate national laboratory. In the United States, this means traceability of all standards to NIST. By showing traceability to NIST, we show traceability directly to the ITS-90. In short, accreditation offers a lab's customers a high level of confidence in its quality and technical abilities.

Second, because ISO 9000 includes calibration requirements, many companies include accreditation for calibration suppliers as a mandatory part of their QA system. Often, accredited suppliers need only remit a copy of their accreditation scope in order to become an approved vendor. This eliminates the need for time-consuming, expensive audits and other supplier evaluation methods. Further, in cases where customers' audits are still necessary, the audits run smoother when accredited suppliers are used.

Third, accreditation has benefits for international customers. All recognized accreditation bodies have adopted ISO/IEC 17025 as the basis for accreditation of calibration and testing laboratories. Because these accreditations are based on



# NVLAP accreditation at Hart

the same standards, countries may enter into MRAs whereby an accreditation body in one country recognizes the accreditations done by a fellow MRA signatory in another country. This has the effect of easing some of the barriers that have historically hindered the flow of calibrated instruments across borders.

## What's in it for us?

Customer demand for laboratory accreditation has been rising for years. With many companies requiring their calibration services suppliers to be accredited, this demand is starting to reach a critical level. By becoming accredited, Hart is better positioned to serve a wide variety of customers. Additionally, the time and costs associated with providing repetitive audits to numerous customers will decline with accreditation.

Perhaps the single greatest benefit of accreditation to Hart is the accreditation process itself. Hart employs some of the world's leading temperature metrologists. One such expert, Tom Wiandt, has done an outstanding job running our calibration



For the Scope of Accreditation Under NVLAP Lab Code 200348-0

lab since 1996. However, the opportunity to receive evaluation and criticism from industry peers is extremely valuable. Both the QA systems and the technical operating procedures were thoroughly examined. Issues were discussed and recommendations made and implemented. While the lab was already excellent, it is now the best it's ever been, and we have independent confirmation that we are qualified to do what we say we can do.

In the end, accreditation benefits both the accredited lab and its customers. Our processes and systems have been validated, our stated uncertainties scrutinized,

and our traceability examined. At the same time, customers' confidence in our lab's quality system and technical capabilities has been independently substantiated. The complete scope, ranges, and uncertainties of Hart's accreditation are available for review on our web site at [www.hartscientific.com](http://www.hartscientific.com).

Take a look. We make the world's finest temperature calibration equipment, and we know how to use it. We used it, in fact, to get our accreditation. Trust your critical calibration work to an accredited laboratory.

## Signatory organizations to the ILAC MRA

<b>Australia</b>	NATA	<a href="http://www.nata.asn.au">www.nata.asn.au</a>	<b>Japan</b>	JAB	<a href="http://www.jab.or.jp">www.jab.or.jp</a>
<b>Austria</b>	BMWA	<a href="mailto:guenter.friers@bmwa.gv.at">guenter.friers@bmwa.gv.at</a>	<b>Korea, Republic of</b>	KOLAS	<a href="http://kolas.ats.go.kr">kolas.ats.go.kr</a>
<b>Belgium</b>	BeltestOBE/BKO	<a href="http://BELTEST.fgov.be">BELTEST.fgov.be</a>	<b>Netherlands</b>	RvA	<a href="http://www.rva.nl">www.rva.nl</a>
<b>Brazil</b>	CGCRE	<a href="http://www.inmetro.gov.br">www.inmetro.gov.br</a>	<b>New Zealand</b>	IANZ	<a href="http://www.ianz.govt.nz">www.ianz.govt.nz</a>
<b>Canada</b>	SCC	<a href="http://www.scc.ca">www.scc.ca</a>	<b>Norway</b>	NA	<a href="http://www.justervesenet.no/na">www.justervesenet.no/na</a>
<b>China, Hong Kong</b>	HKAS	<a href="http://www.info.gov.hk/itc/hkas">www.info.gov.hk/itc/hkas</a>	<b>Portugal</b>	IPQ	<a href="http://www.ipq.pt">www.ipq.pt</a>
<b>China, People's Republic of</b>	CNAL	<a href="http://www.cnal.org.cn">www.cnal.org.cn</a>	<b>Singapore</b>	SAC	<a href="http://www.sac-ccreditation.org.sg">www.sac-ccreditation.org.sg</a>
<b>Chinese Taipei</b>	CNLA	<a href="http://www.cnla.org.tw">www.cnla.org.tw</a>	<b>Slovakia</b>	SNAS	<a href="http://www.snas.sk">www.snas.sk</a>
<b>Czech Republic</b>	CAI	<a href="http://www.cai.cz">www.cai.cz</a>	<b>South Africa</b>	SANAS	<a href="http://www.sanas.co.za">www.sanas.co.za</a>
<b>Denmark</b>	DANAK	<a href="http://www.danak.dk">www.danak.dk</a>	<b>Spain</b>	ENAC	<a href="http://www.enac.es">www.enac.es</a>
<b>Finland</b>	FINAS	<a href="http://www.finas.fi">www.finas.fi</a>	<b>Sweden</b>	Swedac	<a href="http://www.swedac.se">www.swedac.se</a>
<b>France</b>	COFRAC	<a href="http://www.cofrac.fr">www.cofrac.fr</a>	<b>Switzerland</b>	SAS	<a href="http://www.sas.ch">www.sas.ch</a>
<b>Germany</b>	DACH	<a href="mailto:dach@dach-gmbh.de">dach@dach-gmbh.de</a>	<b>Thailand</b>	TISI	<a href="http://www.tisi.go.th">www.tisi.go.th</a>
<b>Germany</b>	DAP	<a href="http://www.dap.de">www.dap.de</a>	<b>United Kingdom</b>	UKAS	<a href="http://www.ukas.com">www.ukas.com</a>
<b>Germany</b>	DAR	<a href="http://www.dar.bam.de">www.dar.bam.de</a>	<b>USA</b>	A2LA	<a href="http://www.a2la.org">www.a2la.org</a>
<b>Germany</b>	DASMIN	<a href="http://www.dasmin.de">www.dasmin.de</a>	<b>USA</b>	ICBO	<a href="http://www.icboes.org">www.icboes.org</a>
<b>Germany</b>	DATEch	<a href="http://www.datech.de">www.datech.de</a>	<b>USA</b>	NVLAP	<a href="http://www.nist.gov/nvlap">www.nist.gov/nvlap</a>
<b>Germany</b>	DKD	<a href="http://www.dkd.info">www.dkd.info</a>	<b>Viet Nam</b>	VILAS	<a href="http://vol.vnn.vn">vol.vnn.vn</a>
<b>India</b>	NABL	<a href="http://www.nabl-india.org">www.nabl-india.org</a>			
<b>Indonesia</b>	BSN	<a href="http://www.bsn.or.id">www.bsn.or.id</a>			
<b>Ireland</b>	NAB	<a href="http://www.nab.ie">www.nab.ie</a>			
<b>Israel</b>	ISRAC	<a href="http://www.israc.gov.il">www.israc.gov.il</a>			
<b>Italy</b>	SINAL	<a href="http://www.sinal.it">www.sinal.it</a>			
<b>Japan</b>	IAJapan	<a href="http://www.nite.go.jp">www.nite.go.jp</a>			

# Calibration services



Hart's American Fork calibration crew:

## American Fork, Utah lab

Hart's NVLAP accredited Metrology Laboratory (lab code 200348) in American Fork, Utah provides temperature calibrations from approximately  $-200\text{ }^{\circ}\text{C}$  to  $1000\text{ }^{\circ}\text{C}$  using fixed-point and comparison methods. Our accredited uncertainties are among the lowest commercially available anywhere in the world. Our prices are very competitive and our turn-around times are excellent. Our reports are comprehensive and include as-found and as-left data as well as pass/fail criteria (where applicable) and a concise statement of the method used. Calibrations performed at Hart are traceable to NIST and meet the new ISO 17025 requirements as described in the following pages.

For fixed-point calibrations, we use Hart fixed-point cells and apparatus, Hart SPRTs as check standards, and conventional DC bridges with DC standard resistors. Our fixed-point calibration procedures are based on CCT procedures, so you can be confident that the technique is current, correct, and thorough.

For comparison calibrations, we use Hart baths, Hart SPRTs, and Hart readouts. We use several different techniques to minimize uncertainties while maximizing efficiency to keep the costs as low as

possible without compromising quality. All Hart-manufactured instruments (except SPRTs and some thermocouples, which come uncalibrated) are certified before they are shipped to you. We don't simply provide a "certificate of conformance" with a couple of NIST numbers like some other manufacturers and then sock you with a high fee if you require a proper calibration. We are the laboratory of choice for many of our customers because they know that they can depend on us for correct, complete, and on-time calibrations at reasonable prices.

## Norwich, England lab

In 2003, after extensive planning and a significant capital investment, Hart Scientific opened a primary temperature calibration laboratory in Europe. This new lab in Norwich, England, will service the precision temperature calibration needs of customers in Europe, the Middle East, and Africa. The UK lab uses the same great Hart fixed point cells, furnaces, baths, and thermometers used in the American Fork, Utah lab. We even have similarly excellent metrology experts in this lab. Watch for us to also have UKAS accreditation here soon, with similar uncertainties to that of Hart's American Fork, Utah lab!

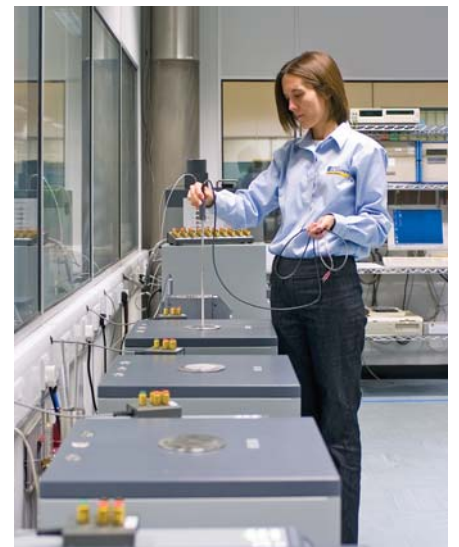

Alison Shrimpling manages Hart's new European Primary Temperature Laboratory in Norwich, UK.

# Calibration services

## SPRT calibration by ITS-90 fixed point NVLAP accredited

All calibrations in this section include the following: (1) calibration at two levels of current and extrapolation to zero power, (2) ITS-90 deviation function coefficients and interpolation tables for the nominal current calibration and the zero-power calibration in W vs.  $T_{90}$ , and (3) analysis for compliance to ITS-90 criteria for a standard interpolating instrument of the ITS-90. This represents our best measurement capability(BMC) for SPRTs. Recommended when you absolutely must have the best uncertainty possible. Only Excellent SPRTs qualify.

Order No.	Temperature	ITS-90		Temperature	Uncertainty (k=2)
		Subranges	Fixed Points Used		
1910-4-7	-200 °C to 660 °C	4, 7	comp at NBPLN2, TPHg, TPW, FPSn, FPZn, FPAI	-197 °C (LN)	0.60 mK
1910-4-8	-200 °C to 420 °C	4, 8	comp at NBPLN2, TPHg, TPW, FPSn, FPZn	-38.8344 °C (TPHg)	0.35 mK
1910-4-9	-200 °C to 232 °C	4, 9	comp at NBPLN2, TPHg, TPW, FPin, FPSn	0.010 °C (TPW)	0.20 mK
1910-5-7	-40 °C to 660 °C	5, 7	TPHg, TPW, MPGa, FPSn, FPZn, FPAI	29.7646 °C (MPGa)	0.35 mK
1910-5-10	-40 °C to 157 °C	5, 10	TPHg, TPW, MPGa, FPin	156.599 °C (FPIn)	0.70 mK
1910-7	0 °C to 660 °C	7	TPW, FPSn, FPZn, FPAI	231.928 °C (FPSn)	0.90 mK
1910-8	0 °C to 420 °C	8	TPW, FPSn, FPZn	419.527 °C (FPZn)	1.2 mK
				660.323 °C (FPAI)	2.0mK
				961.78 °C (FPAg)	8.0 mK

## SPRT calibration by ITS-90 fixed point NVLAP accredited

All calibrations in this section include the following: (1) calibration at two levels of current and extrapolation to zero power, (2) ITS-90 deviation function coefficients and interpolation tables for the nominal current calibration and the zero-power calibration W vs.  $T_{90}$ , and (3) analysis for compliance to ITS-90 criteria for a standard interpolating instrument of the ITS-90. Recommended for working standard SPRTs, when slightly larger uncertainties are acceptable.

Order No.	Temperature	ITS-90		Temperature	Uncertainty (k=2)
		Subranges	Fixed Points Used		
1911-4-7	-200 °C to 660 °C	4, 7	comp at NBPLN2, TPHg, TPW, FPSn, FPZn, FPAI	-197 °C (LN2)	1.0 mK
1911-4-8	-200 °C to 420 °C	4, 8	comp at NBPLN2, TPHg, TPW, FPSn, FPZn	-38.8344 °C (TPHg)	0.8 mK
1911-4-9	-200 °C to 232 °C	4, 9	comp at NBPLN2, TPHg, TPW, FPin, FPSn	0.010 °C (TPW)	0.5 mK
1911-5-7	-40 °C to 660 °C	5, 7	TPHg, TPW, MPGa, FPSn, FPZn, FPAI	29.7646 °C (MPGa)	0.8 mK
1911-5-10	-40 °C to 157 °C	5, 10	TPHg, TPW, MPGa, FPin	156.599 °C (FPIn)	1.5 mK
1911-6	0 °C to 961 °C	6	TPW, FPSn, FPZn, FPAI, FPAg	231.928 °C (FPSn)	1.5 mK
1911-7	0 °C to 660 °C	7	TPW, FPSn, FPZn, FPAI	419.527 °C (FPZn)	1.8 mK
1911-8	0 °C to 420 °C	8	TPW, FPSn, FPZn	660.323 °C (FPAI)	3.0 mK
				961.78 °C (FPAg)	10.0 mK

## SPRT calibration by ITS-90 fixed point NVLAP accredited

All calibrations in this section include the following: (1) ITS-90 deviation function coefficients and interpolation table for the nominal current calibration W vs.  $T_{90}$ , and (2) analysis for compliance to ITS-90 criteria for a standard interpolating instrument of the ITS-90. This larger uncertainty SPRT calibration is still better than most offered in the industry, and is easier on the wallet. Recommended for any SPRT.

Order No.	Temperature	ITS-90		Temperature	Uncertainty (k=2)
		Subranges	Fixed Points Used		
1912-4-7	-200 °C to 660 °C	4, 7	comp at NBPLN2, TPHg, TPW, FPSn, FPZn, FPAI	-197 °C (LN2)	2.0 mK
1912-4-8	-200 °C to 420 °C	4, 8	comp at NBPLN2, TPHg, TPW, FPSn, FPZn	-38.8344 °C (TPHg)	2.0 mK
1912-4-9	-200 °C to 232 °C	4, 9	comp at NBPLN2, TPHg, TPW, FPin, FPSn	0.010 °C (TPW)	2.0 mK
1912-5-8	-40 °C to 420 °C	5, 8	TPHg, TPW, MPGa, FPSn, FPZn	29.7646 °C (MPGa)	2.0 mK
1912-5-9	-40 °C to 232 °C	5, 9	TPHg, TPW, MPGa, FPin, FPSn	156.599 °C (FPIn)	3.0 mK
1912-5-10	-40 °C to 157 °C	5, 10	TPHg, TPW, MPGa, FPin	231.928 °C (FPSn)	4.0 mK
1912-7	0 °C to 660 °C	7	TPW, FPSn, FPZn, FPAI	419.527 °C (FPZn)	6.0 mK
1912-8	0 °C to 420 °C	8	TPW, FPSn, FPZn	660.323 °C (FPAI)	8.0 mK
				961.78 °C (FPAg)	10.0 mK

## Precision PRT calibration by ITS-90 fixed point NVLAP accredited

All calibrations in this section include the following: (1) ITS-90 deviation function coefficients and interpolation tables for the nominal current calibration in resistance vs.  $T_{90}$ . Recommended for high quality, secondary standard PRTs only. Hart models 5626, 5628, and 5624 qualify.

Order No.	Temperature	ITS-90		Temperature	Uncertainty (k=2)
		Subranges	Fixed Points Used		
1913-4-7	-200 °C to 660 °C	4, 7	-197 °C, -100 °C, TPHg, TPW, MPIn, MPSn, MPZn, MPAl	-197 °C (LN2)	6.0 mK
1913-4-8	-200 °C to 420 °C	4, 8	-197 °C, -100 °C, TPHg, TPW, MPIn, MPSn, MPZn	-100 °C	10.0 mK
1913-4-9	-200 °C to 232 °C	4, 9	-197 °C, -100 °C, TPHg, TPW, MPIn, MPSn	-38.8344 °C (TPHg)	6.0 mK
1913-5-8	-40 °C to 420 °C	5, 8	TPHg, TPW, MPIn, MPSn, MPZn	0.010 °C (TPW)	4.0 mK
1913-5-9	-40 °C to 232 °C	5, 9	TPHg, TPW, MPIn, MPSn	156.599 °C (MPIn)	6.0 mK
1913-6	0 °C to 961 °C	6	TPW, MPIn, MPSn, MPZn, MPAl, FPAg	231.928 °C (MPSn)	6.0 mK
1913-7	0 °C to 660 °C	7	TPW, MPIn, MPSn, MPZn, MPAl	419.527 °C (MPZn)	9.0 mK
1913-8	0 °C to 420 °C	8	TPW, MPIn, MPSn, MPZn	660.323 °C (MPAl)	14.0 mK
				961.78 °C (FPAg)	20.0 mK



# Calibration services

## Precision PRT calibration by comparison NVLAP accredited

All calibrations in this section include the following: (1) ITS-90 deviation function coefficients, and (2) interpolation table in 1-degree increments in terms of resistance vs. T90. Recommended for high quality, secondary standard PRTs, where higher uncertainty is acceptable. Hart models 5608, 5609, 5615, 5616, and 5618B qualify.

Order No.	Temperature	Comparison Points Used	Temperature	Uncertainty
1922-4-R	-200 °C to 500 °C	-197.0 °C, -100 °C, -38.8 °C, 0.01 °C, 156.6 °C, 231.9 °C, 419.5 °C, 500 °C	-200 °C	10 mK
1922-4-8	-200 °C to 420 °C	-197.0 °C, -100.0 °C, -38.8 °C, 0.01 °C, 156.6 °C, 231.9 °C, 419.5 °C	-100 to -50 °C	10 mK
1922-5-8	-40 °C to 420 °C	-38.8 °C, 0.01 °C, 156.6 °C, 231.9 °C, 419.5 °C	-50 to 0 °C	8 mK
1922-5-9	-40 °C to 232 °C	-38.8 °C, 0.01 °C, 156.6 °C, 231.9 °C	0.010 °C	6 mK
1922-R	0 °C to 500 °C	0.01 °C, 156.6 °C, 231.9 °C, 419.5 °C, 500 °C	0 to 200 °C	9 mK
1922-8	0 °C to 420 °C	0.01 °C, 156.6 °C, 231.9 °C, 419.5 °C	200 to 300 °C	12 mK
			300 to 400 °C	14 mK
			400 to 500 °C	16 mK

## PRT (RTD) calibration by comparison NVLAP accredited

All calibrations in this section include the following: (1) fitted results with an appropriate equation and (2) interpolation table in 1-degree increments in terms of resistance vs. T90. Recommended for all industrial level PRT (RTD) probes. Hart models 5627A, 5622, and 5618B qualify.

Order No.	Temperature	Comparison Points Used	Temperature	Uncertainty
1923-4-R	-200 °C to 500 °C	-197.0 °C, -100.0 °C, -38.8 °C, 0.01 °C, 156.6 °C, 231.9 °C, 419.5 °C, 500 °C	-200 °C	25 mK
1923-4-8	-200 °C to 420 °C	-197.0 °C, -100.0 °C, -38.8 °C, 0.01 °C, 156.6 °C, 231.9 °C, 419.5 °C	-100 to -50 °C	25 mK
1923-4-N	-200 °C to 300 °C	-197.0 °C, -100.0 °C, -38.8 °C, 0.01 °C, 156.6 °C, 231.9 °C, 300 °C	-50 to 0 °C	25 mK
1923-4-9	-200 °C to 232 °C	-197.0 °C, -100.0 °C, -38.8 °C, 0.01 °C, 156.6 °C, 231.9 °C	0.010 °C	25 mK
1923-5-8	-40 °C to 420 °C	-38.8 °C, 0.01 °C, 156.6 °C, 231.9 °C, 419.5 °C	0 to 100 °C	25 mK
1923-5-N	-40 °C to 300 °C	-38.8 °C, 0.01 °C, 156.6 °C, 231.9 °C, 300 °C	100 to 300 °C	30 mK
1923-5-9	-40 °C to 232 °C	-38.8 °C, 0.01 °C, 156.6 °C, 231.9 °C	300 to 420 °C	35 mK
1923-N	0 °C to 300 °C	0.01 °C, 156.6 °C, 231.9 °C, 300 °C	420 to 500 °C	45 mK
1923-9	0 °C to 232 °C	0.01 °C, 156.6 °C, 231.9 °C		
1923-10	0 °C to 157 °C	0.01 °C, 100 °C, 156.6 °C		

## Precision thermistor calibration by comparison NVLAP accredited

All calibrations in this section include the following: (1) polynomial solution with coefficients in Steinhart-Hart or third order, and (2) bound interpolation table in 0.01- or 0.1-degree increments (depending upon span of calibration) in terms of resistance vs. T90. Order the 1925-A for secondary thermistors with 100 °C range, like the Hart 5610 & 5611 probes. The 1925-B&C calibrations are recommended for very high accuracy thermistor standards like the Hart 5640-44 series probes.

Order No.	Temperature	Comparison Points Used	Uncertainty (k=2)
1925-A	100 °C span	6 points over span	6.0 mK
1925-B	60 °C span	7 points over span	2.0 mK
1925-C	100 °C span	11 points over span	2.5 mK
1925-D	10 °C span	4 points over span	6.0 mK

## Noble-metal thermocouple calibration by ITS-90 fixed point

NVLAP accredited

All calibrations in this section include the following: (1) ITS-90 polynomial coefficients in accordance with NIST Monograph 175, and (2) bound interpolation table in 1-degree increments in terms of EMF vs. T90. Recommended for high quality thermocouple standards. Order 1918-A for Au/Pt thermocouple standards, 1918-B for Type S and Type R standards.

Order No.	Temperature	Fixed Points Used	Uncertainty (k=2)	Extrapolated Uncertainty (k=2)
1918-B	0 °C to 1450 °C	FPSn, FPZn, FPAl, FPAg (Type S-R)	0.15 °C	2 °C

Requirements for thermocouples: Must have very clean, unbroken (even uncracked) sheaths, have at least 20" long sheath length, and have at least 36" lead length. Please call our customer service department for clarification if needed.

# Calibration services

## Precision digital thermometer system calibration by comparison NVLAP accredited

All calibrations in this section include as-found data, as-left system data, and adjustments. Systems are calibrated as systems and not as individual components (probe and readout). Uncertainties are similar to those listed on the opposite page, depending on the system being calibrated. Consult Hart's customer service group for temperature ranges not listed here. An additional fee is charged for non-standard temperature points requested.

Order No.	Temperature	Comparison Points Used
1930-4-R	-200 °C to 500 °C	-197.0 °C, -38.8 °C, 0.01 °C, 231.9 °C, 419.5 °C, 500.0 °C
1930-4-8	-200 °C to 420 °C	-197.0 °C, -38.8 °C, 0.01 °C, 231.9 °C, 419.5 °C
1930-D-8	-100 °C to 420 °C	-100.0 °C, -38.8 °C, 0.01 °C, 231.9 °C, 419.5 °C
1930-5-8	-40 °C to 420 °C	-38.8 °C, 0.01 °C, 231.9 °C, 419.5 °C
1930-5-9	-40 °C to 232 °C	-38.8 °C, 0.01 °C, 156.6 °C, 231.9 °C
1930-8	0 °C to 420 °C	0.01 °C, 231.9 °C, 419.5 °C
1935-A	100 °C span	6 points over span
1935-B	60 °C span	7 points over span
1935-C	100 °C span	11 points over span

## Fixed point cell direct comparison NVLAP accredited

Comparison to a Hart working standard fixed-point cell. A comprehensive calibration report is included. (For Best Measurement Capability comparisons, please call Hart.)

Order No.	ITS-90 Fixed Point Cell	Uncertainty (k=2)
1904-Hg	TPHg	0.25mK
1904-Tpw	TPW	0.10mK
1904-Ga	MPGa	0.10mK
1904-In	FPIIn	0.70mK
1904-Sn	FPSn	0.80mK
1904-Zn	FPZn	1.00mK
1904-Al	FPAI	1.80mK
1904-Ag	FPAg	4.50mK

## DC resistance calibration NVLAP accredited

Your DC resistors are compared to Hart's standard resistors. A comprehensive calibration report is included.

Order No.	Resistance Range	Uncertainty (k=2)
1960	1 - 10 Ohm	0.35 ppm
1960	10 - 100 Ohm	0.45 ppm
1960	100 - 1000 Ohm	0.60 ppm
1960	1000 - 10000 Ohm	0.70 ppm

## Humidity Sensor Calibration

All calibrations in this section are traceable to NIST and include certificates compliant with ANSI/NCSS Z540-1 and ISO Guide 17025. As-found data, as-left data, and adjustments are included.

Order No.	Temp. Points	RH Points
1980-A	1	3
1980-B	1	5
1980-C	3	5
1980-D	5	5

## Instrument Calibration

For recalibration of Hart Scientific thermometer readouts and dry-wells please call Hart Customer service. If you are calling from within the USA, please call toll free (800) 438-4278 or (888) 538-4278. If you are calling from outside of the USA please call (801) 763-1600. Calibration of Hart thermometer readouts fall within Hart's scope of accreditation.

## ISO 17025 triggers changes in calibration interval management

The ISO 17025 views calibration interval management as the responsibility of the customer rather than the calibration supplier. As a result, when you contact us to arrange for recalibration of your instruments, our customer service representative will ask you what interval you wish to set. If no interval is selected, the calibration report will show the due date as "Not Defined."

In the case of new instruments, we will set the initial interval based on manufacturer's recommendations (including our own if Hart is the manufacturer) unless we are instructed otherwise. Remember, although manufacturers may provide advice regarding calibration intervals, cal labs accredited under ISO 17025 may not. You have the choice and responsibility to determine the calibration cycle for your instruments.

## Should I get a "system" cal?

Traditionally, readouts and probes are calibrated individually. This is generally best because the instruments are specified individually, traceability is straightforward, and it permits interchangeability.

However, in some circumstances system calibrations can prove beneficial. For example, if the probe and readout are "married" and are both stable performers, it is often faster and cheaper to have them calibrated as a system rather than individually. As-found data is obtained in temperature units and traceability is established through the system. As long as interchangeability is not required, this approach can prove beneficial when used judiciously.

# Index

- I**
- 1502A Tweener PRT Readout . . . . . 57
  - 1504 Tweener Thermistor Readout . . . . . 57
  - 1523 Reference Thermometer, Handheld, 1 Channel . . . . . 61
  - 1523-CAL 1523 Accredited Calibration . . . . . 61
  - 1523-CASE Case, 1523/1524 Readout and Probe Carrying . . . . . 61
  - 1523-P1 1523 Bundled with 5616 PRT . . . . . 61
  - 1523-P2 1523 Bundled with 5628 PRT . . . . . 61
  - 1523-P3 1523 Bundled with 5627A PRT . . . . . 61
  - 1524 Reference Thermometer, Handheld, 2 Channel, Data Logger . . . . . 61
  - 1524-CAL 1524 Accredited Calibration . . . . . 61
  - 1524-P1 1524 Bundled with 5616 PRT . . . . . 61
  - 1524-P2 1524 Bundled with 5628 PRT . . . . . 61
  - 1524-P3 1524 Bundled with 5627A PRT . . . . . 61
  - 1529 Chub-E4 Thermometer, 2 TC and 2 PRT/Thermistor inputs . . . . . 55
  - 1529-R Chub-E4 Thermometer, 4 PRT/Thermistor inputs . . . . . 55
  - 1529-T Chub-E4 Thermometer, 4 TC inputs . . . . . 55
  - 1560 Black Stack Readout Base Unit . . . . . 52
  - 1575A Super-Thermometer . . . . . 41
  - 1590 Super-Thermometer II . . . . . 41
  - 1620A-H The "DewK" Thermo-Hygrometer, High-Accuracy . . . . . 65
  - 1620A-S The "DewK" Thermo-Hygrometer, Standard-Accuracy . . . . . 65
  - 1621A-H The "DewK" Thermo-Hygrometer, High-Accuracy Value Kit . . . . . 65
  - 1621A-S The "DewK" Thermo-Hygrometer, Standard-Accuracy Value Kit . . . . . 65
  - 1622A-H The "DewK" Thermo-Hygrometer, USB Wireless High-Accuracy Value Kit . . . . . 65
  - 1622A-S The "DewK" Thermo-Hygrometer, USB Wireless Standard-Accuracy Value Kit . . . . . 65
  - 1922-4-R PRT (5608) Calibration, -200 °C to 500 °C, NVLAP Accredited . . . . . 72
  - 1923-4-7 PRT (5609) Calibration, -200 °C to 660 °C, NVLAP Accredited . . . . . 72
  - 1924-4-7 PRT (5609-9BND) Calibration, -200 °C to 660 °C, NIST-traceable . . . . . 72
  - 1925-A Accredited Thermistor Calibration, 0 °C to 100 °C (23 °F to 212 °F) . . . . . 61
  - 1929-2 System Verification, PRT with Readout, Accredited . . . . . 61
  - 1929-5 System Verification, Thermistor with Readout, Accredited . . . . . 61
  - 1930 Precision Digital Thermometer System Calibration by Comparison . . . . . 72
  - 1930 System Calibration, PRT with Readout, Accredited . . . . . 61
  - 1935 System Calibration, Thermistor with Readout, Accredited . . . . . 61
  - 2001-6020 Automation Package for 6020 . . . . . 119
  - 2001-6022 Automation Package for 6022 . . . . . 119
  - 2001-6024 Automation Package for 6024 . . . . . 119
  - 2001-6050H Automation Package for 6050H . . . . . 120
  - 2001-6054 Automation Package for 6054 . . . . . 122
  - 2001-6055 Automation Package for 6055 . . . . . 122
  - 2001-7007 Automation Package for 7007 . . . . . 122
  - 2001-7009 Automation Package for 7009 . . . . . 125
  - 2001-7015 Automation Package for 7015 . . . . . 125
  - 2001-7060 Automation Package for 7060 . . . . . 114
  - 2001-7080 Automation Package for 7080 . . . . . 114
  - 2001-7100 Automation Package for 7100 . . . . . 114
  - 2001-IEEE Interface, IEEE-488 . . . . . 17, 109, 111, 114, 117, 119 - 120, 122, 125 . . . . .
  - 2007 Access Cover, 5 x 10 in, SST 114, 117, 119
  - 2009 Access Cover, 184 x 324 mm (7.25 x 12.75 in), Stainless Steel . . . . . 119
  - 2010 Access Cover, 5 x 10 in, Lexan . . . . . 114, 117
  - 2010-5 Access Cover, 6.38 x 11.5 in, Lexan (7037) . . . . . 117
  - 2011 Access Cover, 184 x 324 mm (7.25 x 12.75 in), Lexan . . . . . 117
  - 2012-DCB Spare Access Cover, Plastic, 7321, 7341, 7381 . . . . . 109
  - 2014 Spare Access Cover . . . . . 120
  - 2016-7008 Fluid Level Adapter, 7008 . . . . . 117
  - 2016-7011 Fluid Level Adapter, 701 . . . . . 117
  - 2016-7012 Fluid Level Adapter, 701 . . . . . 117
  - 2016-7037 Fluid Level Adapter, 7037 . . . . . 117
  - 2016-7040 Fluid Level Adapter, 7040 . . . . . 117
  - 2016-7060 Fluid Level Adapter, 7060 . . . . . 114
  - 2018 Carousel Holding Fixture for 6055 . . . . . 122
  - 2019-7080 Fluid Level Adapter, 7080 . . . . . 114
  - 2019-7100 Fluid Level Adapter, 7100 . . . . . 114
  - 2019-DCB Liquid-in-Glass Thermometer Calibration Kit . . . . . 109
  - 2020-6330 Spare Access Cover, SST, 6330 . . . . . 111
  - 2020-6331 Spare Access Cover, Stainless Steel, 6331 . . . . . 109
  - 2020-7320 Spare Access Cover, SST, 7320/7340 111 . . . . .
  - 2020-7380 Spare Access Cover, SST, 7380 . . . . . 111
  - 2023 Fast-Start Heater, 16.5 in . . . . . 119 - 120
  - 2027-5901 TPW Holding Fixture (7012, 7037) . . . . . 117
  - 2027-DCBM Mercury TP Holding Fixture (7341) . . . . . 109
  - 2027-DCBW TPW Holding Fixture (7321, 7341, 7381) . . . . . 109
  - 2028 Dewar (for TPW ice bath) . . . . . 15
  - 2031A "Quick Stick" Immersion Freezer . . . . . 15, 17
  - 2033 IR Cone (NIST design) . . . . . 117
  - 2068-D Stand, Fixed-Point Cell, Black Delron . . . . . 24
  - 2069 8X Magnifier Scope . . . . . 109, 114, 117, 119
  - 2069 LiG Telescope with Mounting, 8X magnification . . . . . 122
  - 2070 Bath Cart, 6020, 6022 (312 mm 12.3 in H) . . . . . 119
  - 2071 Bath Cart, 7011, 7012 (312 mm 12.3 in H) . . . . . 117
  - 2072 Bath Cart, 6024 (216 mm 8.5 in H) . . . . . 119
  - 2073 Bath Cart, 7008, 7037, 7040 (216 mm 8.5 in ) H . . . . . 117
  - 2076-6330 Floor Cart, 6330 (343 mm 13.5 in H) . . . . . 111
  - 2076-7320 Floor Cart, 7320/7340 (229 mm 9 in H) . . . . . 111
  - 2082-M Spare test lid . . . . . 153
  - 2082-P Spare test lid . . . . . 153
  - 2083 Tank extension adapter . . . . . 153
  - 2085 Spare test lid . . . . . 153
  - 2100-P Controller, PRT . . . . . 133
  - 2100-T Controller, Thermistor . . . . . 133
  - 2125 IEEE-488 Interface . . . . . 29, 133
  - 2125-C IEEE-488 Interface (RS-232 to IEEE-488 converter box) . . . . . 13, 111, 163
  - 2126 Comparison Block, 9114 . . . . . 29
  - 2127-9114 Alumina Block, 9114 . . . . . 29
  - 2127-CB Block, Ceramic, Non-contaminating, 9115A/9116A . . . . . 29
  - 2129 Spare Alumina Block, 5 wells . . . . . 13
  - 2130 Spare Well-Sizing Tube Set . . . . . 170
  - 2200-P Controller, PRT . . . . . 133
  - 2361 Spare Power Supply, 100 to 240 V ac . . . . . 65
  - 2362 Spare AC Adapter, 15 V . . . . . 55
  - 2373-KLTC Adapter, Lemo to Universal TC (TC) . . . . . 61
  - 2373-LPRT Adapter, Lemo to Mini Grabbers (4-wire) . . . . . 61
  - 2380-X Miniature Thermocouple Connector . . . . . 52
  - 2381-X Standard Thermocouple Connector . . . . . 52
  - 2382 RTD/Thermistor Connector . . . . . 52
  - 2383 USB to RS-232 Adapter . . . . . 96, 99 - 101
  - 2384-P INFO-CON Connector, PRT (Gray Cap), Spare . . . . . 61
  - 2384-T INFO-CON Connector, TC (Blue Cap), Spare . . . . . 61
  - 2505 Spare Connector . . . . . 57
  - 2506 IEEE Option . . . . . 57
  - 2506-1529 IEEE Option . . . . . 55
  - 2508 Serial Cable Kit . . . . . 57
  - 2513-1529 Rack-Mount Kit . . . . . 55
  - 2560 SPRT Module, 25Ω and 100Ω, 2-channel . . . . . 52
  - 2561 High-Temp PRT Module, 0.25Ω to 5Ω, 2-ch 52 . . . . .
  - 2562 PRT Scanner Module, 8-channel . . . . . 52
  - 2563 Standards Thermistor Module, 2-channel . . . . . 52
  - 2564 Thermistor Scanner Module, 8-channel . . . . . 52
  - 2565 Precision Thermocouple Module, 2-channel 52 . . . . .
  - 2566 Thermocouple Scanner Module, 12-channel . . . . . 52
  - 2567 SPRT Module, 1000Ω, 2-channel . . . . . 52
  - 2568 PRT Scanner Module, 8-channel, 1000Ω . . . . . 52
  - 2575 Multiplexer, 1575 . . . . . 41
  - 2590 Multiplexer, 1590 . . . . . 41
  - 2601 Plastic PRT Case . . . . . 72
  - 2601 Probe Carrying Case . . . . . 74, 77 - 80, 85
  - 2607 Protective Case for spare sensor . . . . . 65
  - 2609 Case, PRT, Plastic . . . . . 68 - 69, 90
  - 2609 Plastic PRT Case . . . . . 72
  - 2611 Thermistor Probe . . . . . 133
  - 2620 RTD Probe, 11 in . . . . . 133
  - 2622 RTD Probe, 9 in . . . . . 133
  - 2624 RTD Probe, 14 in . . . . . 133
  - 2626-H Spare Sensor, high-accuracy . . . . . 65
  - 2626-S Spare Sensor, standard-accuracy . . . . . 65
  - 2627-H Spare Sensor Kit, high-accuracy . . . . . 65
  - 2627-S Spare Sensor Kit, standard-accuracy . . . . . 65
  - 2628 Cable, Sensor Extension, 7.6 m (25 ft) . . . . . 65
  - 2629 Cable, Sensor Extension, 15.2 m (50 ft) . . . . . 65
  - 2633-232 Wireless Modem, RS-232 to wireless . . . . . 65
  - 2633-RF Wireless Option . . . . . 65
  - 2633-USB Wireless Modem, USB to wireless . . . . . 65
  - 2940-9114 Cell Support Container, 9114 . . . . . 29
  - 2940-9115 Cell Support Container, 9115 . . . . . 29
  - 2940-9260 Container, Mini-Cell Support, 9260 . . . . . 34
  - 2941 Mini Freeze-Point Cell Basket Adapter . . . . . 29
  - 2942-9260 Container, SST Mini-Cell Support, 9260 . . . . . 34
  - 3102-0 Insert, blank . . . . . 165
  - 3102-0 Insert, Blank . . . . . 161
  - 3102-1 Insert, 1/16 in (1.6 mm) . . . . . 161, 165
  - 3102-2 Insert, 1/8 in (3.2 mm) . . . . . 161, 165
  - 3102-3 Insert, 3/16 in (4.8 mm) . . . . . 161, 165
  - 3102-4 Insert, 1/4 in (6.4 mm) . . . . . 161, 165
  - 3102-5 Insert, 5/16 in (7.9 mm) . . . . . 161, 165
  - 3102-6 Insert, 3/8 in (9.5 mm) . . . . . 161, 165
  - 3102-7 Insert, 7/16 in (11.1 mm) . . . . . 161, 165
  - 3102-8 Insert, 5/32 in (4 mm) . . . . . 161, 165
  - 3103-1 Insert, blank . . . . . 157
  - 3103-1 Insert, Blank . . . . . 163
  - 3103-2 Insert A . . . . . 157, 163
  - 3103-3 Insert B . . . . . 157, 163



# Index

3103-4 Insert C. . . . .	157	5011-3.8L Fluid, Mineral Oil, 3.8 L (1 gal.) . . . . .	125	5626-20-X High-temp PRT, 100Ω, 508 mm (20 in). . . . .	68
3103-4 Insert C, Six 1/4 in Wells (Cold Side) . . . . .	163	5012 Silicone Oil Type 200.10 . . . . .	129	5627A-12-X Secondary PRT. . . . .	79
3103-6 Insert D, Comparison - Metric (Cold Side) . . . . .	163	5013 Silicone Oil Type 200.20 . . . . .	129	5627A-6-X Secondary PRT. . . . .	79
3103-Y Insert, custom 9011/9103. . . . .	157, 163	5013-1L Silicone oil, type 200.20, 1 liter. . . . .	153	5627A-9-X Secondary PRT. . . . .	79
3107-2000 Blank insert . . . . .	166	5014 Silicone Oil Type 200.50 . . . . .	129	5628-12-X Secondary Standard PRT . . . . .	52, 68
3107-2063 1/16 in Insert (1.6 mm) . . . . .	166	5017 Silicone Oil Type 710. . . . .	129	5628-15-X Secondary Standard PRT . . . . .	52, 68
3107-2125 1/8 in Insert (3.2 mm) . . . . .	166	5019 Halocarbon 0.8 Cold Bath Fluid . . . . .	129	5628-20-X High-temp PRT, 25.5Ω, 508 mm (20 in). . . . .	68
3107-2156 5/32 in Insert (4 mm) . . . . .	166	5020 Ethylene Glycol . . . . .	129	5635-S Thermocouple Cutout Probe. . . . .	133
3107-2188 3/16 in Insert (4.8 mm) . . . . .	166	5022 Dynalene HF/LO . . . . .	129	5640-X Standards Thermistor Probe. . . . .	83
3107-2250 1/4 in Insert (6.35 mm) . . . . .	166	5023 HFE Cold Bath Fluid . . . . .	129	5641-X Standards Thermistor Probe. . . . .	83
3107-2313 5/16 in Insert (7.9 mm) . . . . .	166	5121 Humidity Generator, 2500ST. . . . .	179	5642-X Standards Thermistor Probe. . . . .	52, 83
3107-2375 3/8 in Insert (9.5 mm) . . . . .	166	5313-001 Scanner, 20 channels . . . . .	20	5643-X Standards Thermistor Probe. . . . .	83
3107-2500 1/2 in Insert (12.7 mm) . . . . .	166	5313-002 Scanner, 10 channels . . . . .	20	5644-X Standards Thermistor Probe. . . . .	83
3107-2625 5/8 in Insert (15.9 mm) . . . . .	166	5313-003 IOTech 488 Interface Card . . . . .	20	5649-20CX Type R TC, 20 in x 1/4 in, with reference junction . . . . .	90
3107-2901 Insert, 1 User-Specified Hole . . . . .	166	5313-004 Windows Software . . . . .	20	5649-20CX Type R TC, 508 mm (20 in), with reference junction . . . . .	90
3107-2902 Insert, 2 User-Specified Holes . . . . .	166	5340-1 Resistor, AC/DC Standard, 1Ω . . . . .	37	5649-20-X Type R TC, 508 mm (20 in) . . . . .	90
3109-0 Insert, Blank (Hot Side). . . . .	163	5340-10 Resistor, AC/DC Standard, 10Ω . . . . .	37	5649-25CX Type R TC, 635 mm (25 in), with reference junction . . . . .	90
3109-1 Insert A, Miscellaneous (Hot Side) . . . . .	163	5340-100 Resistor, AC/DC Standard, 100Ω . . . . .	37	5649-25-X Type R TC, 635 mm (25 in) . . . . .	90
3109-2 Insert B, Comparison (Hot Side) . . . . .	163	5340-10K Resistor, AC/DC Standard, 10 KΩ . . . . .	37	5650-20CX Type S TC, 508 mm (20 in), with reference junction . . . . .	90
3109-3 Insert C, Eight 1/4 in Wells (Hot Side) . . . . .	163	5340-1K Resistor, AC/DC Standard, 1 KΩ . . . . .	37	5650-20-X Type S TC, 508 mm (20 in) . . . . .	90
3109-4 Insert D, Comparison - Metric (Hot Side) . . . . .	163	5340-200 Resistor, AC/DC Standard, 200Ω . . . . .	37	5650-25CX Type S TC, 635 mm (25 in), with reference junction . . . . .	90
3110-1 Comparison Insert, Blank . . . . .	32	5340-25 Resistor, AC/DC Standard, 25Ω . . . . .	37	5650-25-X Type S TC, 635 mm (25 in) . . . . .	90
3110-2 Comparison Insert A. . . . .	32	5340-400 Resistor, AC/DC Standard, 400Ω . . . . .	37	5665-X Miniature Immersion Probe . . . . .	85
3110-3 Comparison Insert B. . . . .	32	5581 MI Bridge . . . . .	20	5681-S SPRT 25.5Ω, 670 °C. . . . .	9
3110-4 Comparison Insert C. . . . .	32	5608-12-X Secondary Reference PRT, 12 in x 1/8 in, -200 to 500 °C. . . . .	72	5683-S SPRT 25.5Ω, 480 °C. . . . .	9
3125 Surface Calibrator. . . . .	176	5608-9-X Secondary Reference PRT, 9 in x 1/8 in, -200 to 500 °C . . . . .	72	5684-S SPRT 0.25Ω, 1070 °C. . . . .	9
3140-1 Insert, blank. . . . .	157	5609-500-X Secondary Reference PRT, 500 mm x 6 mm, -200 to 670 °C. . . . .	72	5685-S SPRT 2.5Ω, 1070 °C. . . . .	9
3140-2 Insert A. . . . .	157	5609-12-X Secondary Reference PRT, 12 in x 1/4 in, -200 to 670 °C. . . . .	72	5686-B Glass Capsule SPRT, -260 °C to 232 °C . . . . .	12
3140-3 Insert B. . . . .	157	5609-15-X Secondary Reference PRT, 15 in x 1/4 in, -200 to 670 °C. . . . .	72	5698-25 25Ω Working Standard SPRT. . . . .	10
3140-4 Insert C. . . . .	157	5609-20-X Secondary Reference PRT, 20 in x 1/4 in, -200 to 670 °C. . . . .	72	5699-S Extended Range Metal-Sheath SPRT . . . . .	11
3140-6 Insert D. . . . .	157	5609-300-X Secondary Reference PRT, 300 mm x 6 mm, -200 to 670 °C. . . . .	72	5699-S Extended Range PRT . . . . .	62
3141-1 Insert, blank. . . . .	157	5609-400-X Secondary Reference PRT, 400 mm x 6 mm, -200 to 670 °C. . . . .	72	5900 Mercury Cell, Stainless Steel . . . . .	24
3141-2 Insert A. . . . .	157	5609-9BEND-X Secondary Standard PRT Bend . . . . .	61	5901A-G TPW Cell, 12 mm ID with handle, glass shell . . . . .	15
3141-3 Insert B. . . . .	157	5609-9BND-X Secondary Reference PRT, 15 in x 1/4 in, 9 in bend, -200 °C to 670 °C . . . . .	72	5901A-Q TPW Cell, 12 mm ID with handle, quartz shell . . . . .	15
3141-4 Insert C. . . . .	157	5610-6-X Thermistor Probe . . . . .	52, 85	5901B Mini Pyrex® Triple Point of Water Cell 30 . . . . .	30
3141-6 Insert D. . . . .	157	5610-9-X Thermistor Probe . . . . .	52, 61, 85	5901C-G TPW Cell, 13.6 mm ID, glass shell . . . . .	15
3150-2 Insert A. . . . .	167	5611A-11X Silicone-Bead Probe . . . . .	85	5901C-Q TPW Cell, 14.4 mm ID, quartz shell . . . . .	15
3150-3 Insert B. . . . .	167	5611T-X Teflon Probe. . . . .	85	5901D-G TPW Cell, 12 mm ID, glass shell . . . . .	15
3150-4 Insert C. . . . .	167	5615-12-X Secondary Standard PRT . . . . .	52, 70	5901D-Q TPW Cell, 12 mm ID, quartz shell . . . . .	15
3150-6 Insert D. . . . .	167	5615-6-X Secondary Standard PRT . . . . .	52, 70	5901-ITST Isotopic Composition Analysis, TPW Cell. . . . .	15
3160-1 Comparison Insert, Blank. . . . .	34	5615-9-X Secondary Standard PRT . . . . .	52, 70	5901-SMPL Water Sample, TPW Cell . . . . .	15
3160-2 Comparison Insert . . . . .	34	5616-12-X Secondary Reference PRT, 6.35 mm x 298 mm (0.250 x 11.75 in), -200 to 420 °C . . . . .	74	5904 Indium Cell, Traditional Quartz Glass. . . . .	24
3160-3 Comparison Insert . . . . .	34	5616-6-X Secondary Standard PRT . . . . .	61	5905 Tin Cell, Traditional Quartz Glass. . . . .	24
3320 Spare Stir Bar, Micro-Bath . . . . .	153	5618B-12-X 305 mm (12 in) Small Diameter Probe . . . . .	77	5906 Zinc Cell, Traditional Quartz Glass . . . . .	24
3560 Extended Communications Module . . . . .	52	5618B-6-X 152 mm (6 in) Small Diameter Probe . . . . .	77	5907 Aluminum Cell, Traditional Quartz Glass 24 . . . . .	24
3901-11 TPW Bushing, 5901/5901A to 7.5 mm . . . . .	15	5618B-9-X 229 mm (9 in) Small Diameter Probe . . . . .	77	5908 Silver Cell, Traditional Quartz Glass . . . . .	24
3901-12 TPW Bushing, 5901/5901A to 5.56 mm (7/32 in) . . . . .	15	5622-05-X Fast Response PRT. . . . .	80	5909 Copper Cell, Traditional Quartz Glass. . . . .	24
3901-13 TPW Bushing, 5901/5901A to 6.35 mm (1/4 in). . . . .	15	5622-10-X Fast Response PRT. . . . .	80	5914A Mini Quartz Indium Cell. . . . .	30, 34
3901-21 TPW Bushing, 5901C to 7.5 mm . . . . .	15	5622-16-X Fast Response PRT. . . . .	80	5915A Mini Quartz Tin Cell. . . . .	30, 34
3901-22 TPW Bushing, 5901C to 5.56 mm (7/32 in). . . . .	15	5622-32-X Fast Response PRT. . . . .	80	5916A Mini Quartz Zinc Cell . . . . .	30, 34
3901-23 TPW Bushing, 5901C to 6.35 mm (1/4 in). . . . .	15	5623B-6-X Freezer Probe . . . . .	78	5917A Mini Quartz Aluminum Cell . . . . .	30, 34
4180 Precision Infrared Calibrator, -15 °C to 120 °C. . . . .	173	5624-20-X Probe, 1000 °C, 10 ohm PRT, 6.35 mm x 508 mm (0.25 x 20 in). . . . .	69	5918A Mini Quartz Silver Cell . . . . .	30
4180 Precision Infrared Calibrator, 35 °C to 500 °C. . . . .	173	5626-12-X Secondary Standard PRT . . . . .	52, 68	5919A Mini Quartz Copper Cell. . . . .	30
4180-APRT 2-in Aperture, 4180 or 4181 . . . . .	173	5626-15-S Secondary PRT. . . . .	62	5924 Indium Cell, Open Quartz Glass . . . . .	24
4180-CASE Carrying Case, 4180 or 4181 . . . . .	173	5626-15-X High-temp PRT, 100Ω, 381 mm (15 in). . . . .	68	5925 Tin Cell, Open Quartz Glass . . . . .	24
4180-DCAS Case, Transportation with wheels, 4180 or 4181. . . . .	173			5926 Zinc Cell, Open Quartz Glass . . . . .	24
5001 Bath Salt, 125 lb. . . . .	120, 129			5927A-L Aluminum Cell, Open Quartz Glass, Long . . . . .	24
5010 Silicone Oil Type 200.05 . . . . .	129			5927A-S Aluminum Cell, Open Quartz Glass, Short . . . . .	24
5010-1L Silicone oil, type 200.05, 1 liter. . . . .	153				
5011 Mineral Oil . . . . .	129				
5011-18.9L Fluid, Mineral Oil, 18.9 L (5 gal.) . . . . .	125				

# Index

- 5928 Silver Cell, Open Quartz Glass . . . . . 24  
5929 Copper Cell, Open Quartz Glass . . . . . 24  
5943 Gallium Cell, Metal Cased . . . . . 24  
5943 Mini Metal Cased Gallium Cell . . . . . 33  
5944 Mini Metal Cased Indium Cell . . . . . 30, 34  
5945 Mini Metal Cased Tin Cell . . . . . 30, 34  
5946 Mini Metal Cased Zinc Cell . . . . . 30, 34  
5947 Metal Cased Mini Aluminum Cell . . . . . 34  
5947 Mini Metal Cased Aluminum Cell . . . . . 30  
6020 Standard Bath, 20 °C to 300 °C . . . . . 119  
6022 Standard Bath, 20 °C to 300 °C, deep . . . . . 119  
6024 Standard Bath, 20 °C to 300 °C, high capacity . . . . . 119  
6050H Standard Bath, 60 °C to 550 °C . . . . . 120  
6054 Mid-Range Deep-Well Bath . . . . . 122  
6055 Hi-Temp Deep-Well Bath . . . . . 122  
6102 Micro-Bath, 35 °C to 200 °C . . . . . 153  
6330 Compact Bath, 35 °C to 300 °C . . . . . 111  
6331 Deep-Well Compact Bath, 40 °C to 300 °C . . . . . 109  
7007 Refrigerated Deep-Well Bath . . . . . 122  
7008 Standard Bath, -5 °C to 110 °C, high capacity . . . . . 117  
7008IR 7008, modified to accept an IR cone . . . . . 117  
7009 Resistor Bath, high capacity . . . . . 125  
7011 Standard Bath, -10 °C to 110 °C . . . . . 117  
7012 Standard Bath, -10 °C to 110 °C, deep . . . . . 117  
7012 TPW Maintenance Bat . . . . . 15  
7015 Resistor Bath . . . . . 125  
7037 Standard Bath, -40 °C to 110 °C, deep . . . . . 117  
7040 Standard Bath, -40 °C to 110 °C . . . . . 117  
7060 Standard Bath, -60 °C to 110 °C . . . . . 114  
7080 Standard Bath, -80 °C to 110 °C . . . . . 114  
7100 Standard Bath, -100 °C to 110 °C . . . . . 114  
7102 Micro-Bath, -5 °C to 125 °C . . . . . 153  
7103 Micro-Bath, -30 °C to 125 °C . . . . . 153  
7108 Resistor Bath, Peltier-cooled . . . . . 125  
7196-13 LN<sub>2</sub> Comparison Calibrator, 13 holes . . . . . 35  
7196-4 LN<sub>2</sub> Comparison Calibrator, 4 holes . . . . . 35  
7312 TPW Maintenance Bath . . . . . 15, 17  
7320 Compact Bath, -20 °C to 150 °C . . . . . 111  
7321 Deep-Well Compact Bath, -20 °C to 150 °C . . . . . 109  
7340 Compact Bath, -40 °C to 150 °C . . . . . 111  
7341 Deep-Well Compact Bath, -45 °C to 150 °C . . . . . 109  
7380 Compact Bath, -80 °C to 100 °C . . . . . 111  
7381 Deep-Well Compact Bath, -80 °C to 110 °C . . . . . 109  
742A-1 Resistor, DC Standard, 1Ω . . . . . 36  
742A-10 Resistor, DC Standard, 10Ω . . . . . 36  
742A-100 Resistor, DC Standard, 100Ω . . . . . 36, 41  
742A-100K Resistor, DC Standard, 100 KΩ . . . . . 36  
742A-10K Resistor, DC Standard, 10 KΩ . . . . . 36  
742A-10M Resistor, DC Standard, 10 MΩ . . . . . 36  
742A-1K Resistor, DC Standard, 1 KΩ . . . . . 36  
742A-1M Resistor, DC Standard, 1 MΩ . . . . . 36  
742A-25 Resistor, DC Standard, 25Ω . . . . . 36, 41  
742A-7002 Transit Case . . . . . 36  
7900B Controller, Rosemount-Designed Baths, bottom stirred . . . . . 132  
7900-T Controller, Rosemount-Designed Baths, top stirred . . . . . 132  
7911A2 Constant Temperature Ice Bath . . . . . 126  
8508A Reference Multimeter . . . . . 62  
8508A/01 Reference Multimeter with Front and Rear 4 mm binding posts and rear input ratio measurement . . . . . 62  
8508ALEAD Lead kit . . . . . 62  
9007 Portable Lab Dry-Well, -40 °C to 140 °C, 1/4 in (6.36 mm) insert . . . . . 166  
9009 Industrial Dual-Block Dry-Well . . . . . 161  
9011 High-Accuracy Dual-Well Calibrator . . . . . 163  
9100S-A HDRC Handheld Dry-Well A . . . . . 165  
9100S-B HDRC Handheld Dry-Well B . . . . . 165  
9100S-C HDRC Handheld Dry-Well C . . . . . 165  
9100S-D HDRC Handheld Dry-Well D . . . . . 165  
9101 Zero-Point Dry-Well . . . . . 170  
9102S HDRC Handheld Dry-Well . . . . . 165  
9103 Dry-Well . . . . . 157  
9103-6 Insert D . . . . . 157  
9112B Calibration Furnace (includes standard 406 mm 16 om block) . . . . . 169  
9114 Metrology Furnace . . . . . 29  
9115A Sodium Heat Pipe Furnace . . . . . 29  
9116A Three-Zone Freeze-Point Furnace . . . . . 29  
9117 Annealing Furnace . . . . . 13  
9132 Portable IR Calibrator, 500 °C . . . . . 175  
9133 Portable IR Calibrator, -30 °C . . . . . 175  
9140 Dry-Well . . . . . 157  
9141 Dry-Well . . . . . 157  
9142-CASE Carrying Case, 9142-4 Field Metrology Wells . . . . . 148  
9142-INSA Insert "A" 9142, Imperial Misc Holes . . . . . 148  
9142-INSB Insert "B" 9142, Imperial Comparison Holes . . . . . 148  
9142-INSC Insert "C" 9142, 0.25-inch Holes . . . . . 148  
9142-INSD Insert "D" 9142, Metric Comparison Holes . . . . . 148  
9142-INSE Insert "E" 9142, Metric Misc Holes w/0.25-inch Hole . . . . . 148  
9142-INSF Insert "F" 9142, Metric Comparison Misc Holes w/0.25-inch Hole . . . . . 148  
9142-INSZ Insert "Z" 9142, Blank . . . . . 148  
9142-X Field Metrology Well, -25 °C to 150 °C, w/9142-INSX . . . . . 148  
9142-X-P Field Metrology Well, -25 °C to 150 °C, w/9142-INSX, w/Process Electronics . . . . . 148  
9143-INSA Insert "A" 9143, Imperial Misc Holes . . . . . 148  
9143-INSB Insert "B" 9143, Imperial Comparison Holes . . . . . 148  
9143-INSC Insert "C" 9143, 0.25-inch Holes . . . . . 148  
9143-INSD Insert "D" 9143, Metric Comparison Holes . . . . . 148  
9143-INSE Insert "E" 9143, Metric Misc Holes w/0.25-inch Hole . . . . . 148  
9143-INSF Insert "F" 9143, Metric Comparison Misc Holes w/0.25-inch Hole . . . . . 148  
9143-INSZ Insert "Z" 9143, Blank . . . . . 148  
9143-X Field Metrology Well, 33 °C to 350 °C, w/9143-INSX . . . . . 148  
9143-X-P Field Metrology Well, 33 °C to 350 °C, w/9143-INSX, w/Process Electronics . . . . . 148  
9144-INSZ Insert "Z" 9144, Blank . . . . . 148  
9144-INSA Insert "A" 9144, Imperial Misc Holes . . . . . 148  
9144-INSB Insert "B" 9144, Imperial Comparison Holes . . . . . 148  
9144-INSC Insert "C" 9144, 0.25-inch Holes . . . . . 148  
9144-INSD Insert "D" 9144, Metric Comparison Holes . . . . . 148  
9144-INSE Insert "E" 9144, Metric Misc Holes w/0.25-inch Hole . . . . . 148  
9144-INSF Insert "F" 9144, Metric Comparison Misc Holes w/0.25-inch Hole . . . . . 148  
9144-X Field Metrology Well, 50 °C to 660 °C, w/9144-INSX . . . . . 148  
9144-X-P Field Metrology Well, 50 °C to 660 °C, w/9144-INSX, w/Process Electronics . . . . . 148  
9150 Thermocouple Furnace . . . . . 167  
9170-CASE Case, Carrying, 9170-3 Metrology Wells . . . . . 143  
9170-DCAS Case, Transportation with Wheels, 9170-3 Metrology Wells . . . . . 143  
9170-INSA Insert "A", 9170 . . . . . 143  
9170-INSB Insert "B", 9170 . . . . . 143  
9170-INSC Insert "C", 9170 . . . . . 143  
9170-INSD Insert "D", 9170 . . . . . 143  
9170-INSE Insert "E", 9170 . . . . . 143  
9170-INSF Insert "F", 9170 . . . . . 143  
9170-INSZ Insert "Z", 9170 . . . . . 143  
9170-X Metrology Well, -45 °C to 140 °C, w/INSX . . . . . 143  
9170-X-R Metrology Well, -45 °C to 140 °C, w/INSX, w/Built-In Reference . . . . . 143  
9171-INSA Insert "A", 9171 . . . . . 143  
9171-INSB Insert "B", 9171 . . . . . 143  
9171-INSC Insert "C", 9171 . . . . . 143  
9171-INSD Insert "D", 9171 . . . . . 143  
9171-INSE Insert "E", 9171 . . . . . 143  
9171-INSF Insert "F", 9171 . . . . . 143  
9171-INSZ Insert "Z", 9171 . . . . . 143  
9171-X Metrology Well, -30 °C to 155 °C, w/INSX . . . . . 143  
9171-X-R Metrology Well, -30 °C to 155 °C, w/INSX, w/Built-In Reference . . . . . 143  
9172-INSA Insert "A", 9172 . . . . . 143  
9172-INSB Insert "B", 9172 . . . . . 143  
9172-INSC Insert "C", 9172 . . . . . 143  
9172-INSD Insert "D", 9172 . . . . . 143  
9172-INSE Insert "E", 9172 . . . . . 143  
9172-INSF Insert "F", 9172 . . . . . 143  
9172-INSZ Insert "Z", 9172 . . . . . 143  
9172-X Metrology Well, 35 °C to 425 °C, w/INSX . . . . . 143  
9172-X-R Metrology Well, 35 °C to 425 °C, w/INSX, w/Built-In Reference . . . . . 143  
9173-INSA Insert "A", 9173 . . . . . 143  
9173-INSB Insert "B", 9173 . . . . . 143  
9173-INSC Insert "C", 9173 . . . . . 143  
9173-INSD Insert "D", 9173 . . . . . 143  
9173-INSE Insert "E", 9173 . . . . . 143  
9173-INSF Insert "F", 9173 . . . . . 143  
9173-INSZ Insert "Z", 9173 . . . . . 143  
9173-X Metrology Well, 50 °C to 700 °C, w/INSX . . . . . 143  
9173-X-R Metrology Well, 50 °C to 700 °C, w/INSX, w/Built-In Reference . . . . . 143  
9210 Mini TPW Maintenance Apparatus . . . . . 15, 30, 32  
9230 Gallium Cell Maintenance System . . . . . 33  
9260 Mini Fixed-Point Furnace . . . . . 30, 34  
9300 Rugged Carrying Case . . . . . 165  
9301 Carrying Case . . . . . 57  
9302 Case (holds 1560 and up to five modules) . . . . . 52  
9302 Rugged Carrying Case . . . . . 175  
9303 Rugged Carrying Case . . . . . 157  
9308 Rugged Carrying Case . . . . . 157, 165, 175  
9310 Carrying Case . . . . . 153  
9311 Carrying Case . . . . . 153  
9315 Rugged Carrying Case . . . . . 167  
9316 Rugged Carrying Case . . . . . 157  
9317 Carrying Case . . . . . 153  
9319 Large Instrument Case . . . . . 163  
9320A External Battery Pack . . . . . 177  
9320A External Battery Pack, 115 VAC . . . . . 57, 165  
9322 Rugged Carrying Case . . . . . 55  
9325 Rugged Carrying Case . . . . . 170  
9328 Protective Case for 1620A and two sensors . . . . . 65  
9930 Interface-*it* Software . . . . . 96

# Index

<b>9933</b> TableWare Software . . . . .	100	<b>G</b>	Gallium Cell Maintenance Apparatus . . . . .	33	Sensible temperature specifications . . . . .	76
<b>9934-M</b> LogWare, Single Channel, Multi User 57, 101 . . . . .			Glass Capsule SPRTs . . . . .	12	Small Diameter Industrial PRT . . . . .	77
<b>9934-S</b> LogWare, Single Channel, Single User . . . . .	57, 101		Guidelines for Hart product specifications . . . . .	194	Software Selection Guide . . . . .	96
<b>9935-M</b> LogWare II, Multi Channel, Multi User . . . . .	52, 55, 101	<b>H</b>			SPRT . . . . .	8, 10 - 12
<b>9935-S</b> LogWare II, Multi Channel, Single User . . . . .	52, 55, 61, 101		Handheld Dry-Wells . . . . .	164	Standard AC/DC Resistors . . . . .	37
<b>9936A</b> LogWare III Software (Single License) 65, 102 . . . . .			Handheld Thermometer Readouts . . . . .	58	stem conduction errors . . . . .	81
<b>9936A-L1</b> 1-Pack License, LogWare III Software . . . . .	102		Hart Scientific temperature seminars . . . . .	181	Super-Thermometer Readouts . . . . .	40
<b>9936A-L5</b> 5-Pack License, LogWare III Software . . . . .	102		High-Accuracy Dual-Well Calibrator . . . . .	162	Surface Calibrator . . . . .	176
<b>9936A-LST</b> Site License, LogWare III Software . . . . .	102	<b>I</b>	Hot Baths . . . . .	118		
<b>9936A-UPG</b> 9936A Software Upgrade from version 1.x . . . . .	102		How accurate is that probe? . . . . .	67	<b>T</b>	
<b>9938</b> MET/TEMP II Software . . . . .	99		How do I register? . . . . .	182	TableWare . . . . .	100
<b>9963A-L10</b> 10-Pack License, LogWare III Software . . . . .	102		How to Order . . . . .	195	Temperature conversion table . . . . .	92
<b>A</b>					The <i>Black Stack</i> Thermometer Readout . . . . .	48
A few dry-well dos and don'ts . . . . .	158		Industrial Calibrator Selection Guide . . . . .	134	The DewK Thermo-Hygrometer . . . . .	63
Annealing Furnace . . . . .	13		Industrial Dual-Block Calibrator . . . . .	160	Thermistor Standards Probes . . . . .	82
Avoid water problems in cold baths . . . . .	127		<b>INSU-5901</b> TPW Cell Insurance, one-year . . . . .	15	Thermistors: the under appreciated temperature standards . . . . .	86
<b>B</b>			Interface-It . . . . .	96	Thermocouple Calibration Furnace . . . . .	168
Bath Accessories . . . . .	121		International Temperature Scale of 1990 (ITS-90) quick reference . . . . .	45	Thermocouple EMF and sensitivity chart . . . . .	47
Bath Fluids . . . . .	128		ITS-90 Fixed-Point Cells . . . . .	23	Thermocouple Furnace . . . . .	167
Bath Selection Guide . . . . .	104	<b>L</b>			Thermocouples 101... or, maybe... 401! . . . . .	88
Benchtop Controllers . . . . .	133		<b>LIC-9938</b> MET/TRACK License . . . . .	99	Thermometer Probe Selection Guide . . . . .	66
Benchtop Temperature/Humidity Generator . . . . .	178		LN <sub>2</sub> Comparison Calibrators . . . . .	35	Thermometer Readout Selection Guide . . . . .	38
Built-In Reference Thermometry! . . . . .	140		LogWare I and II . . . . .	101	TPW and ratio . . . . .	18
Buying the right bath . . . . .	106				TPW Maintenance Bath . . . . .	17
<b>C</b>			<b>M</b>		Traceability . . . . .	26
Calibration Services . . . . .	186		MET/TEMP II . . . . .	97	Traceability and thermometric fixed-point cells . . . . .	26
Choosing the right temperature readout . . . . .	39		Metrology Well Calibrators . . . . .	139	Triple Point Of Water Cells . . . . .	14
Chub-E4 Thermometer Readout . . . . .	53		Micro-Baths . . . . .	152	Tweener Thermometer Readouts . . . . .	56
Cold Baths . . . . .	116		Mini Fixed-Point Cell Furnace . . . . .	34	Type R and S Thermocouple Standards . . . . .	90
Common pitfalls in infrared thermometer calibration . . . . .	172		Mini Fixed-Point Cells . . . . .	30		
Compact Baths . . . . .	110		Mini TPW Maintenance Apparatus . . . . .	32	<b>U</b>	
Constant Temperature Ice Bath . . . . .	126				Ultra High-Temp PRT . . . . .	69
Controller For Rosemount-Designed Baths . . . . .	132		<b>N</b>		Understanding the uncertainties . . . . .	149
<b>D</b>			NVLAP accreditation . . . . .	184	<b>V</b>	
DC Bridge . . . . .	20		NVLAP Accreditation at Hart . . . . .	184	VSMOW . . . . .	14
DC Resistance Standards . . . . .	36		<b>O</b>		<b>W</b>	
Deep-Well Baths . . . . .	122		Ordering . . . . .	195	What are stem conduction errors and how can they create errors in calibration? . . . . .	81
Deep-Well Compact Baths . . . . .	108		Other Neat Stuff Selection Guide . . . . .	177	Why a Hart bath? . . . . .	112
<b>E</b>			<b>P</b>		Why buy primary standards from Hart? . . . . .	6
Eliminating sensor errors in loop calibrations . . . . .	154		Portable IR Calibrators . . . . .	174	Why did my temperature sensor fail calibration? . . . . .	93
Establishing traceability . . . . .	103		Portable Lab Dry-Well . . . . .	166	Why use Fluke metal freeze-point cells? . . . . .	21
Evaluating calibration system accuracy . . . . .	44		Precision Freezer PRT . . . . .	78	Working Standard SPRT . . . . .	10
Extended Range Metal-Sheath SPRT . . . . .	11		Precision Industrial PRTs . . . . .	79	<b>Y</b>	
External Battery Pack . . . . .	177		Primary Standards Selection Guide . . . . .	4	<b>Y8508</b> Rack-Mount Kit . . . . .	62
<b>F</b>			PRT temperature vs. resistance table . . . . .	46	<b>Y8508S</b> Rack-Mount Slide Kit . . . . .	62
Fast Response PRTs . . . . .	80		<b>Q</b>		<b>Z</b>	
Field Dry-Wells . . . . .	156		Quartz-Sheath SPRT . . . . .	8	Zero-Point Dry-Well . . . . .	170
<b>FLK80P1</b> 80PK-1, Probe, Thermocouple, Beaded Type K . . . . .	61		<b>R</b>			
<b>FLK80P3</b> 80PK-3A, Probe, Thermocouple, Surface Measurement Type K . . . . .	61		Really Cold Baths . . . . .	114		
<b>FLUKETPAK</b> TPAK, Meter Hanging Kit . . . . .	61		Really Hot Bath . . . . .	120		
Freeze-Point Furnaces . . . . .	28		Reference Multimeter . . . . .	62		
			Reference table: letter-designated thermocouple tolerances . . . . .	91		
			Registration . . . . .	182		
			Resistor Baths . . . . .	124		
			rutabagas . . . . .	180		
			<b>S</b>			
			Secondary Reference Temperature Standards . . . . .	70		
			Secondary Reference Thermistor Probes . . . . .	84		
			Secondary Standard PRTs . . . . .	68		
			Selecting an industrial temperature calibrator . . . . .	136		



# Guidelines for Hart product specifications

Not all manufacturers list the same specifications for similar products. Worse, not all manufacturers mean the same thing when they do. To help explain our specs, we offer the following guidelines. (Since these are “guidelines” and not complete explanations, please contact us if you’d like any additional explanation.)

## Thermometer probes

**Calibration uncertainty** - This is the uncertainty with which a thermometer was calibrated and does not include all aspects of a thermometer’s performance. This specification can sometimes be improved by limiting the calibration of the thermometer to a narrower range or by calibrating it with fixed-point devices.

**Stability or repeatability** - Many thermometers include a stability spec separate from calibration uncertainty and long-term drift. This value includes all the uncertainties other than calibration uncertainty and long-term drift.

**Probe accuracy** - For some probes, calibration uncertainty and short-term stability have been combined. This is the uncertainty of the thermometer without considering long-term drift effects.

**Drift rate** - With use, particularly at high temperatures, resistance thermometers drift. Oxidation and handling are two of the biggest causes. Some drift effects can be reversed through annealing. Drift specs are usually limited by a given amount of time at high temperatures. With proper handling and less exposure to extreme temperatures, drift can be much less than the specification.

**Immersion** - The immersion requirement of a thermometer is difficult to state. The requirement changes with the medium in which the thermometer is immersed, the amount of thermal contact with the medium, and the difference between the medium’s temperature and ambient temperature. Our specifications are therefore general guidelines assuming use in a typical fluid bath or in a dry-well with excellent thermal contact in typical ambient conditions.

## Thermometer readouts

**Temperature range** - Because thermometer readouts are really ohm- or volt-meters, their “temperature” range is limited to their resistance or voltage range. The temperature ranges provided are guidelines. In most cases, the temperature range of the probe becomes the real limiting factor.

**Resistance (voltage) accuracy** - The “accuracy” of a readout is best stated by the accuracy with which it reads resistance or voltage. This is because all measurements are made in resistance or voltage and then translated into temperature using a user-selected conversion method. (The conversion algorithms in Hart readouts have been validated; no significant errors result from the mathematics in the conversion.) Readouts typically have different accuracies for different resistance or voltage ranges. The temperature and type of probe being used must be considered when computing the accuracy of the readout. Our spec is for one year, based on a rectangular probability distribution.

**Temperature accuracy** - These numbers are guidelines only and do not include the accuracy of the probe. Because readouts do not measure temperature directly, their true accuracy can only be stated in terms of resistance or voltage. To determine temperature accuracy, the type and temperature of the probe must be considered.

**Operating temperature range** - The accuracy of a resistance device depends on ambient temperatures. Accuracy specifications assume the unit is within its operating temperature range. A readout operating in the center of this range is more accurate than one operating on the edge, but both will meet the given specifications. Readouts will function outside the range but with less accuracy.

## Baths

**Stability** - All stability numbers are “2-sigma” figures. This means that two times the standard deviation of a bath’s temperature (over at least 30 minutes) will fall within the stated specification. Because bath stability varies with temperature and the fluid being used, these variables are also specified.

**Uniformity** - This is defined as the largest two-minute-average temperature difference found between two locations within the bath’s working area (which is defined as 1 inch from the bottom and sides of the bath and 3 inches below the fluid’s surface). Limiting work to an even smaller area can further reduce the temperature differences experienced during calibration. Uniformity is heavily dependent on the fluid being used. Our specs reference fluids that might commonly be used at the temperatures in question.

**Digital setting accuracy** - The control probes used in fluid baths are not calibrated and are accurate to 0.5 °C or 1.0 °C. (External references are preferred for determining a bath’s temperature.) Most baths, however, include set-point resolution to less than 0.001 °C.

## Dry-wells

**Accuracy** - The control sensors—and therefore the displays—of industrial calibrators are calibrated using a calibrated reference thermometer. Reliance on this accuracy depends on using the calibrator in a similar fashion to how it was calibrated—using 6.35 mm (1/4 in) (in most cases) probes inserted snugly to the bottom of the well.

**Stability** - Stability numbers are “2-sigma” figures. This means that two times the standard deviation of a dry-well’s temperature (over at least 30 minutes) will fall within the specification.

**Well-to-well uniformity** - This is the maximum temperature difference between two wells, assuming probes of similar size (less than 6.35 mm [1/4 in]) and construction are inserted to the full immersion depth of the dry-well.

## Certificates and reports

Calibrated thermometer probes come with a report of calibration including data at various temperatures, depending on the instrument. Whether or not the report of calibration comes from Hart (and was therefore an accredited calibration under Hart’s NVLAP scope) or from the thermometer’s manufacturer (and therefore may not have been an accredited cal) depends on the model of the probe and whether it is being purchased new or being sent to Hart for recalibration. Consult this catalog, and if you have remaining questions, contact Hart’s service group.

All Hart thermometer readouts, whether new instruments or recalibrated instruments, come with a Hart NVLAP report of calibration with data at a number of resistance or millivolt values, depending on the instrument. All Hart dry-wells and Micro-Baths, new or recalibrated, come with a Hart report of calibration that does not fall within Hart’s NVLAP scope and includes data at a number of temperatures, depending on the instrument. All Hart fluid baths come with a report of test that does not fall within Hart’s NVLAP scope and includes stability data.

# How to order

## Contacting Hart

Toll-Free (800) 438-4278  
Phone: (800) GET-HART  
(U.S. only)

Regular  
Phone: (801) 763-1600  
Email: info@hartscientific.com  
Fax: (801) 763-1010

Internet: www.hartscientific.com

Regular Fluke Corporation,  
Mail: Hart Scientific Division  
799 East Utah Valley Drive  
American Fork, UT 84003-9775

Outside the U.S., please contact your local representative. If you're not sure who that is, contact us directly (see list above) and we'll be happy to point you in the right direction.

## Application assistance

We know how to measure temperature and we know how to calibrate thermometers, so put our knowledge to work for you! Call us, email us, fax us... whatever. No matter how strange your application, our applications specialists are ready to discuss your needs and provide recommendations.

## Pricing, delivery, and quotes

Current price lists are available on request. Depending on the product, you should allow anywhere from one week to 90 days for delivery. Custom orders may take longer. Your local distributor (outside the U.S.) or our Applications Specialists in American Fork can provide quotes with pricing and delivery for specific requests.

## Specifications

We reserve the right to change any specification published in this catalog without notice. Since the catalog is published at infrequent intervals, these changes are reflected in current product user manuals. All products will conform to specifications effective at the time of order.

## Purchase orders

We require written purchase orders prior to shipment, but can schedule production for some items as soon as we have a PO number. Note: due to ISO/IEC Guide 17025 requirements, we do not begin any calibration that falls within the scope of our NVLAP accreditation without a written PO in hand, which we can review in its entirety. Please mail, email, or fax your PO to the above address or number.

## Shipping

We quote and ship F.O.B. American Fork, Utah, so shipping charges are prepaid by us and added to your invoice. We also use the carrier of our choice, which may be UPS, Fed Ex, an air express carrier, or anyone else we believe handles our product well. If you wish to specify a carrier or wish to have the shipping charges billed direct to you through your carrier, that's fine—just send us all the appropriate information before we ship.

Some fixed-point cells must be hand-carried and cannot be shipped. You may pick these up yourself or we will deliver them and bill you for the cost of delivery. These arrangements need to be made at the time of ordering.

Along with shipping charges, we prepay and add insurance unless you specifically request us not to—but then you accept all risk of shipping damage. (When Hart is paying for

shipping charges and not billing the customer—such as for in-warranty service returns—we self-insure against shipping damage.)

Items returned to Hart from outside the U.S. for service should not be subject to import duties when we return them to you—provided you returned them to us correctly. Consequently, if we are billed for duties, we will pass the charge through to you.

## Warranty

All products are warranted for parts and labor for one year, except where longer warranties are indicated by our warranty symbols:



Please be careful with your temperature instruments. Metal-sheathed thermometers can be as susceptible to mechanical shock as are quartz-sheathed thermometers. And even dry-wells, which include embedded control PRTs, are susceptible to mechanical shock. It doesn't have to look damaged to be damaged.

Here's what our warranty does not include. We don't include consequential damage or damage from abuse, misuse, or neglect. We don't include shipping charges (except the cost of returning a warranty to you). And we don't warrant calibrations once an instrument has left our control. Remember—particularly with thermometers!—we warrant parts and labor. We do not warrant calibrations.

## Fluke Precision Measurement

Fluke Precision Measurement provides the broadest range available of calibrators, standards, software, service, training and support solutions.

### Temperature calibration

- Temperature and humidity calibration
- Calibration software
- Services and training

### Electrical calibration

- DC/LF electrical calibration
- Power calibration
- Calibration software
- Time and frequency
- RF calibration
- Services and training

### Pressure and flow calibration

- Pressure and flow calibration
- Calibration software
- Services and training

For details about electrical, temperature, pressure and flow calibration products and services visit Fluke on the web at:

[www.fluke.com/fpmcat](http://www.fluke.com/fpmcat)



**Fluke.** *Keeping your world up and running.*®

**Fluke Corporation,**  
**Hart Scientific Division**  
 799 E. Utah Valley Drive  
 American Fork, UT 84003-9775 U.S.A.  
 Tel: (801) 763-1600  
 Fax: (801) 763-1010  
[www.hartscientific.com](http://www.hartscientific.com)

**Fluke Corporation,**  
**Hart Scientific Division**  
**Fluke Europe B.V.**  
 PO Box 1186, 5602 BD  
 Eindhoven, The Netherlands  
 Tel: +31 (0) 40 2676 403  
 Fax: +31 (0) 40 2676 404  
 E-mail: [hart.logistics@fluke.nl](mailto:hart.logistics@fluke.nl)

All other countries:  
 Tel: +1 (801) 763-1600  
 Fax: +1 (801) 763-1010

©2008 Fluke Corporation.  
 Specifications subject to change without notice.  
 Printed in U.S.A. 11/2008 2066445 C-EN-N Rev F

**Modification of this document is not permitted without written permission from Fluke Corporation.**