



# T5-600/T5-1000 *Electrical Tester*

## *Service Information*

### **Introduction**

This service information sheet provides the following information for the T5-600 and T5-1000 Electrical Testers (hereafter referred to as "the tester").

- Safety information
- Parts and service information
- Specifications
- Cleaning procedure
- Required equipment
- Performance tests
- Parts and accessories list
- Battery replacement procedure

For operating instructions, refer to the *T5-600/T5-1000 Electrical Tester Instruction Sheet*.

### **Safety Information**

#### **Warning**

**To avoid possible electric shock or personal injury, follow these guidelines:**

- **Do not use the tester if it is damaged or operating abnormally. Protection may be impaired.**
- **Before each use:**
- **Make sure the battery door is closed and latched.**
- **Inspect the tester and test leads. Look for cracks, missing plastic, exposed metal, or damaged insulation. Replace damaged test leads before using the tester.**
- **Verify the tester's operation by measuring a known voltage.**
- **Replace the batteries as soon as the low battery indicator (+) appears.**
- **Do not use the tester around explosive gas, vapor or dust.**
- **Do not apply more than the rated voltage, as marked on the tester, between terminals or between any terminal and earth ground.**
- **Refer servicing to qualified personnel.**
- **Use caution when working above 30 V ac rms, 42 V ac peak, or 60 V dc.**
- **When using the probes, keep your fingers behind the finger guards on the probes.**
- **Connect the common test lead before you connect the live test lead. Disconnect the live test lead first.**
- **The display will not display hazardous voltages in display hold. The voltage indicator LED (Ⓞ) continues to operate.**

## **Parts and Service**

The tester is warranted to be free from defects in material and workmanship for two years, while under normal use. Parts and repairs are warranted for 90 days. For the complete warranty statement, refer to the *T5-600/T5-1000 Electrical Tester Instruction Sheet*.

Test Equipment Depot  
99 Washington Street  
Melrose, MA 02176-6024

www.testequipmentdepot.com  
800-517-8431  
781-665-0780 FAX

## **Specifications**

Accuracy is specified for one year after calibration, at 18 °C to 28 °C (64 °F to 82 °F) with relative humidity to 90 %. AC conversions are ac-coupled, average responding, and calibrated to the rms value of a sine wave input. Accuracy specifications are given as follows:

$$\pm([\% \text{ of reading}] + [\text{number of least significant digits}])$$





Temperature coefficient of 0.1 x (specified accuracy)/ °C for <18 °C or >28 °C (<64.4 °F or >82.4 °F)

## **Serial Numbers 79560000 and Above**

### **General Specifications**

<b>Calibration</b>	One-year calibration cycle.
<b>Maximum Voltage Between any Terminal and Earth Ground</b>	T5-600: 600 V rms, Overvoltage Category III, Pollution Degree 2 T5-1000: 1000 V rms, Overvoltage Category III, 600 V RMS, Overvoltage Category IV, Pollution Degree 2
<b>Maximum Voltage Between Current Fork and Earth Ground</b>	T5-600 and T5-1000: 1000 V rms, Overvoltage Category III, also 600 V rms, Overvoltage Category IV, Pollution Degree 2, (This dual rating applies to the current fork only.)
<b>Temperature</b>	Operating: -10 °C to +50 °C (14 °F to 122 °F); Storage: -30 °C to +60 °C (-22 °F to +140 °F)
<b>Altitude</b>	Operating: 2000 m (6562 ft); Storage: 10,000 m (32808 ft)
<b>Relative Humidity</b>	0 % to 95 %, 5 °C to 30 °C (41 °F to 86 °F); 0 % to 75 %, 30 °C to 40 °C (86 °F to 104 °F); 0 % to 45 %, 40 °C to 50 °C (104 °F to 122 °F)
<b>Battery Type and Life</b>	AA (2); 360 hours continuous with alkaline; 125 hours continuous with zinc chloride
<b>Shock, Vibration</b>	1 m drop at -10 °C to + 50 °C (14 °F to 122 °F) per ANSI/ISA-S82.01-1994 and EN 61010-1 1995. Random vibration per MIL-PRF-28800F for a Class 2 instrument (5 Hz to 55 Hz, 3 g maximum)
<b>Surge Protection</b>	T5-600: 6 kV per IEC 61010, T5-1000: 8 kV per IEC 61010
<b>Enclosure Rating</b>	IP 52 per IEC 60529, no vacuum applied

### General Specifications (continued)

<b>RF Field Specification</b>	0.5 % full scale + (specified accuracy) at 3 V/m
<b>Safety</b>	Complies with ANSI/ISA-S82.01-94, UL Classified to IEC 61010, CSA/CAN C22.2 No.1010.1-92, and EN61010-1 1995.
<b>EMC</b>	EN 61326
<b>Certifications</b>	    In accordance with IEC 61010-1 54CJ

### Resolution and Accuracy

Function	T5-600 Range	T5-1000 Range	Resolution	Accuracy
$\tilde{V}$	600 V rms	1000 V rms	1 V	$\pm(1.5 \% + 2 \text{ digits})$
$\bar{V}$	600 V	1000 V	1 V	$\pm(1 \% + 1 \text{ digit})$
$\tilde{A}$	100.0 A	100.0 A	0.1 A	$\pm(3 \% + 3 \text{ digits})$
$\Omega$	1000 $\Omega$	1000 $\Omega$	1 $\Omega$	$\pm(1 \% + 2 \text{ digits})$

### Input Characteristics

Function	Input Protection		Input impedance (nomial
	T5-600	T5-1000	
$\tilde{V}$	600 V rms	1000 V rms	1 M $\Omega$ , <100 pF ac-coupled
$\bar{V}$	600 V rms	1000 V rms	1 M $\Omega$ , <100 pF
$\Omega$	600 V rms	1000 V rms	
$\Omega$	Open Circuit Test Voltage		Short Circuit Current
	1.65 V dc (nominal)		<600 $\mu$ A

**CAT III** protects against transients in a *fixed equipment installation* such as a distribution panel, and lighting systems in large buildings.





**CAT IV** protects against transients from a *primary supply* such as an electricity meter or an overhead or underground utility service.

### Serial Numbers 79559999 and Below

#### General Specifications

<b>Calibration</b>	One-year calibration cycle.
<b>Maximum Voltage Between any Terminal and Earth Ground</b>	T5-600: 600 V rms, Overvoltage Category III T5-1000: 1000 V rms, Overvoltage Category III
<b>Temperature</b>	Operating: -10 °C to +50 °C (14 °F to 122 °F); Storage: -30 °C to +60 °C (-22 °F to +140 °F)
<b>Altitude</b>	Operating: 2000 m (6562 ft); Storage: 10,000 m (32808 ft)
<b>Relative Humidity</b>	0 % to 95 %, 5 °C to 30 °C (41 °F to 86 °F); 0 % to 75 %, 30 °C to 40 °C (86 °F to 104 °F); 0 % to 45 %, 40 °C to 50 °C (104 °F to 122 °F)
<b>Battery Type and Life</b>	AA (2); 400 hours continuous with alkaline; 200 hours continuous with zinc chloride

### General Specifications (continued)

<b>Shock, Vibration</b>	1 m drop at 15 °C to 35 °C (59 °F to 95 °F) per ANSI/ISA-S82.01-1994 and EN 61010-1 1993. Sinusoidal vibration per MIL-PRF-28800F for a Class 2 instrument (5 Hz to 55 Hz, 3 g maximum)
<b>Surge Protection</b>	T5-600: 6 kV per IEC 1010-1, 1990-09: T5-1000: 8 kV per IEC 1010-1, 1990-09
<b>Enclosure Rating</b>	IP 52 per IEC 60529, no vacuum applied
<b>RF Field Specification</b>	0.5 % full scale + (specified accuracy) at 3 V/m
<b>Safety</b>	Complies with ANSI/ISA-S82.01-94 for use in overvoltage category III (CAT III) locations, UL3111, CSA/CAN C22.2 No.1010.1-92, and EN61010-1 1993.
<b>EMC</b>	EN 50081-1, EN 50082-1
<b>Certifications</b>	   

### Resolution and Accuracy

Function	T5-600 Range	T5-1000 Range	Resolution	Accuracy
$\tilde{V}$	600 V rms	1000 V rms	1 V	$\pm(1.5 \% + 2 \text{ digits})$
$\bar{V}$	600 V	1000 V	1 V	$\pm(1 \% + 1 \text{ digit})$
$\tilde{A}$	100.0 A	100.0 A	0.1 A	$\pm(3 \% + 3 \text{ digits})$
$\Omega$	1000 $\Omega$	1000 $\Omega$	1 $\Omega$	$\pm(1 \% + 2 \text{ digits})$

### Input Characteristics

Function	Input Protection		Input impedance (nomial)
	T5-600	T5-1000	
$\tilde{V}$	600 V rms	1000 V rms	1 M $\Omega$ , <100 pF ac-coupled
$\bar{V}$	600 V rms	1000 V rms	1 M $\Omega$ , <100 pF
$\Omega$	600 V rms	1000 V rms	
$\Omega$	Open Circuit Test Voltage		Short Circuit Current
	2.4 V dc (nominal)		<600 $\mu$ A

**CAT III** protects against transients in a *fixed equipment installation* such as a distribution panel, and lighting systems in large buildings.

**CAT IV** protects against transients from a *primary supply* such as an electricity meter or an overhead or underground utility service.

### Cleaning the Tester

#### **⚠ Warning**

**To avoid electric shock or damage to the tester, never allow water inside the case. To avoid damaging the tester's case, never use solvents on the tester.**

If the tester requires cleaning, wipe it down with a cloth that is lightly dampened with water or a mild detergent. Do not use aromatic hydrocarbons, chlorinated solvents, or methanol-based fluids when wiping down the tester.

## **Equipment Required for Performance Tests**

The following equipment is required for performance tests:

- Fluke 5500A Multi-Product Calibrator, or equivalent
- 0 V to 5 V adjustable dc power supply
- Approximately 8 m (26 ft) of #14 single-conductor magnet wire wound into a butterfly-shaped coil. Figure 1 shows how to make the coil.

## **Performance Tests**

Use the following procedures to verify the tester's performance. If the tester fails any of the tests, return it to Fluke for calibration or repair.

### **Testing the AC Current Function**

The tests in this section require the butterfly coil shown in Figure 1. Note that the 10 conductors in the middle of the coil cause the tester to read 10 times more current than the calibrator supplies.

1. Put one edge of the butterfly coil in a vice to hold the coil during testing.
2. Set the calibrator to the current and frequency given in Step 1 of Table 1.
3. Connect the butterfly coil to the calibrator.
4. Set the tester to the amperage function.
5. Place the tester's current fork around the middle of the coil so that the alignment marks are centered and perpendicular to the wire bundle, as shown in Figure 1.
6. Verify that the tester reads within the display limits shown for Step 1 in Table 1.
7. Apply the currents and verify the tester's readings for the remaining steps in Table 1.

**Table 1. AC Current Tests**

<b>Step</b>	<b>Calibrator output</b>	<b>T5-600/T5-1000 Display Limits</b>
1	10 A, 60 Hz	96.7 to 103.3
2	10 A, 45 Hz	96.7 to 103.3
3	0.5 A, 45 Hz	4.5 to 5.5

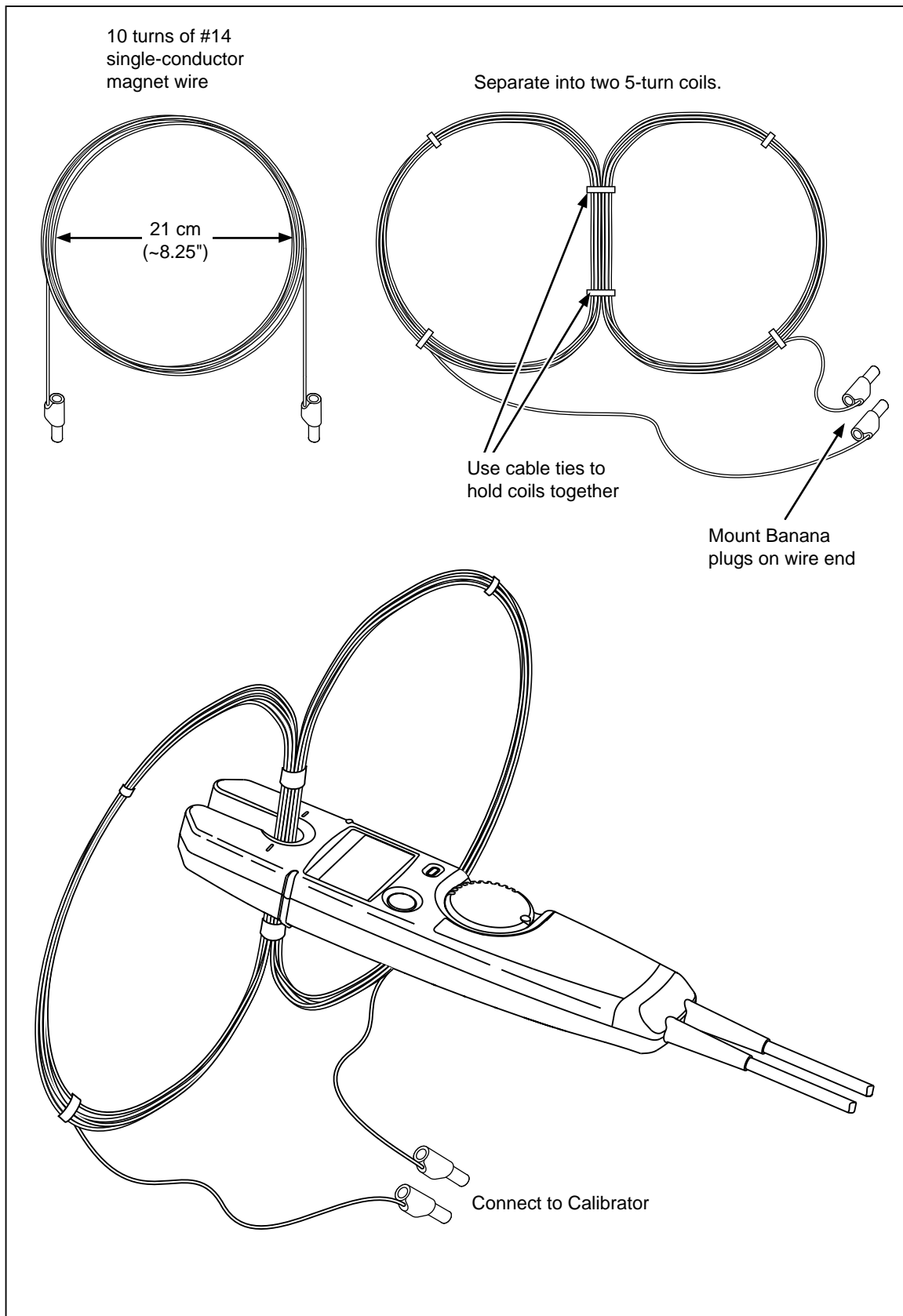

Figure 1. Making the Butterfly Coil

### Testing the Voltage Functions

The tests in this section check the following voltage functions:

- Automatic selection of ac or dc voltage mode
- Correct operation of the hazardous voltage indicator
- Correct operation of the HOLD function

Perform the tests as follows:

1. Set the calibrator to the T5-600 or T5-1000 test voltage given in Table 2.
2. Apply the voltage to the tester. Verify that the tester reads within the display limits shown.
3. Apply the voltages and verify the tester's readings for the steps in Tables 3 and 4.

**Table 2. AC Voltage Test**

T5-600		T5-1000	
Calibrator Output	T5-600 Display Limits (AC annunciator ON)	Calibrator Output	T5-1000 Display Limits (AC annunciator ON)
600 V, 60 Hz	589 to 611	1000 V, 60 Hz	983 to 1017

**Table 3. DC Voltage Tests**

Step	T5-600		T5-1000	
	Calibrator Output	T5-600 Display Limits (DC annunciator ON)	Calibrator Output	T5-1000 Display Limits (DC annunciator ON)
1	600 V dc	593 to 607	1000 V dc	989 to 1011
2	-60 V dc	-58 to -62	-100 V dc	-98 to -102
3	1.0 V dc	1 ±1*	1.0 V dc	1 ±1*
4	-1.0 V dc	-1 ±1*	-1.0 V dc	-1 ±1*

\* Verify that the ac annunciator is OFF.

**Table 4. Hazardous Voltage LED and HOLD Function Tests**

Step	Calibrator Output	T5-600/T5-1000 Display Indicators
1	12 V, 60 Hz	Reading: 12 ± 1 Hazardous voltage LED OFF
2	12 V, 60 Hz Tap tester's HOLD button	Reading: 12 ± 1 Hazardous voltage LED OFF HOLD indicator ON
3	+38 V dc	Reading: 12 ± 1 Hazardous voltage LED ON HOLD indicator ON

### **Resistance and Continuity Function Tests**

1. Set the calibrator to the resistance given in Step 1 of Table 5.
2. Apply the resistance to the tester. Verify that the tester reads within the display limits shown.
3. Apply the resistances and verify the tester's responses for the remaining steps in Table 5.

**Table 5. Resistance and Continuity Tests**

<b>Step</b>	<b>Calibrator Output</b>	<b>T5-600/T5-1000 Display Limits and Beeper Responses</b>
1	1 k $\Omega$	988 to 1012
2	26 $\Omega$	Beeper ON
3	300 $\Omega$	Beeper OFF
4	0 $\Omega$	-2 to 2, Beeper ON

### **Low Battery Indicator Test**

The following procedure verifies correct operation of the low battery indicator.

1. Remove the tester's batteries.
2. Set the dc power supply to 3.0 V. Apply this voltage to the tester's battery terminals.
3. Set the calibrator to 1 k $\Omega$ . Apply this resistance to the tester's probes.
4. Slowly decrease the dc voltage just until the tester's low battery indicator () turns on.
5. Verify that the tester reads 1000  $\pm$ 12 counts (988 to 1012).
6. Disconnect the calibrator and the dc power supply. Reinstall the tester's batteries.

### **Parts and Accessories**

Tables 6 shows the replacement parts and accessories available from Fluke for the T5-600 and T5-1000 Electrical Testers.

**Table 6. Replacement Parts and Accessories**

<b>Description</b>	<b>Fluke Part Number</b>
Test lead assembly  Replace only with Fluke double-insulated leads.	648029
Battery door	1626588
Battery door screw	1618578
AA battery, 1.5 V, carbon-zinc (2 required)	650181
AA battery, 1.5 V, alkaline (2 required)	376756
<i>T5-600/T5-1000 Electrical Tester Instruction Sheet</i> (English)	1629509

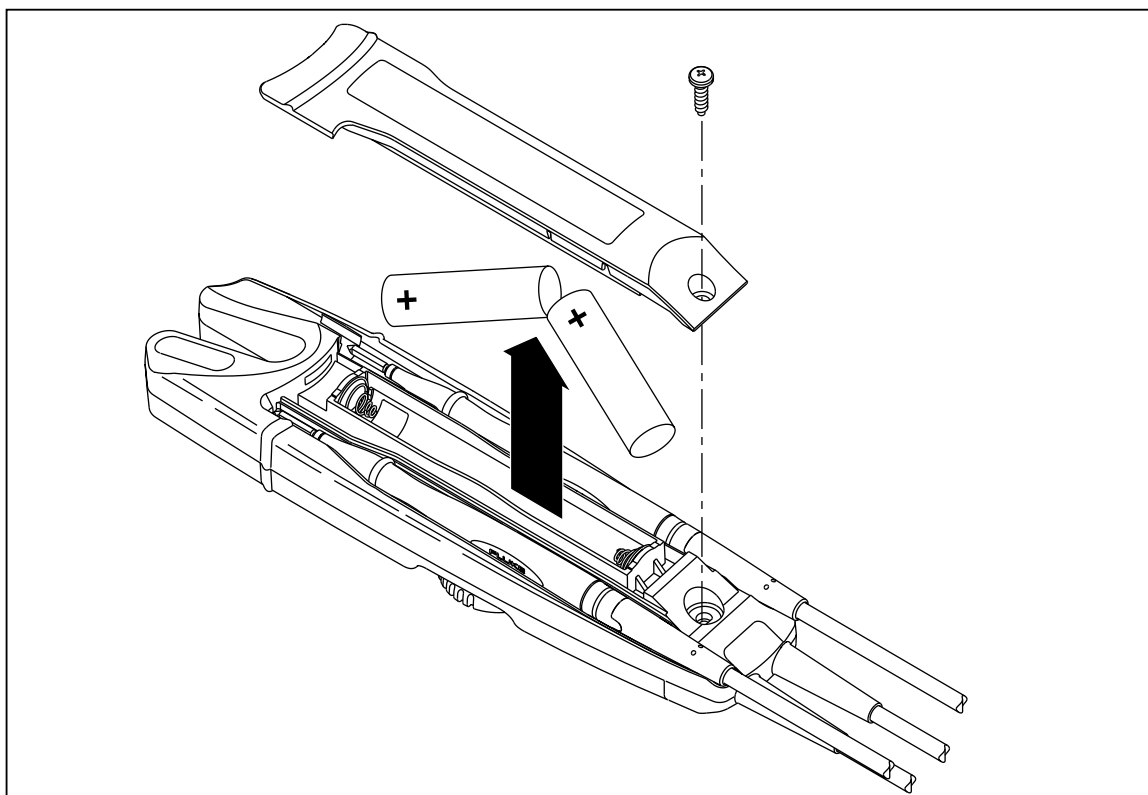

**Table 6. Replacement Parts and Accessories (continued)**

Description	Fluke Part Number
<i>T5-600/T5-1000 Electrical Tester Instruction Sheet (International)</i>	1621978
H5 Belt Holster	Accessory
TP1 Probe Set, Flat Blade	Accessory
TP4 Probe Set, 4 mm Round	Accessory

## **Battery Replacement**

Figure 2 shows how to replace the batteries. Observe the polarity markings inside the battery compartment.



**Figure 2. Replacing the Batteries**

qp1.eps

Test Equipment Depot  
 99 Washington Street  
 Melrose, MA 02176-6024

www.testequipmentdepot.com  
 800-517-8431  
 781-665-0780 FAX

[▶ Back to the Fluke T5 Series Product Page](#)

[▶ Visit us at www.TestEquipmentDepot.com](http://www.TestEquipmentDepot.com)