

Programmable AC Power Source

APS-7000 Series

PROGRAMMING MANUAL



ISO-9001 CERTIFIED MANUFACTURER

GW INSTEK

This manual contains proprietary information, which is protected by copyright. All rights are reserved. No part of this manual may be photocopied, reproduced or translated to another language without prior written consent of Good Will company.

The information in this manual was correct at the time of printing. However, Good Will continues to improve products and reserves the rights to change specification, equipment, and maintenance procedures at any time without notice.

Good Will Instrument Co., Ltd.
No. 7-1, Jhongsing Rd., Tucheng Dist., New Taipei City 236, Taiwan.

Table of Contents

SAFETY INSTRUCTIONS	4
GETTING STARTED.....	8
APS-7000 Series Overview.....	9
Appearance.....	12
REMOTE CONTROL.....	22
Interface Configuration	23
Command Syntax	42
Command List	46
Status Register Overview	126
Error List	141
APPENDIX.....	150
APS-7000 Default Settings	150
INDEX.....	152

S SAFETY INSTRUCTIONS

This chapter contains important safety instructions that you must follow during operation and storage. Read the following before any operation to insure your safety and to keep the instrument in the best possible condition.

Safety Symbols

These safety symbols may appear in this manual or on the instrument.



Warning: Identifies conditions or practices that could result in injury or loss of life.



Caution: Identifies conditions or practices that could result in damage to the APS-7000 or to other properties.



DANGER High Voltage



Attention Refer to the Manual



Protective Conductor Terminal



Earth (ground) Terminal



Do not dispose electronic equipment as unsorted municipal waste. Please use a separate collection facility or contact the supplier from which this instrument was purchased.

Safety Guidelines

General Guideline



CAUTION

- Do not place any heavy object on the APS-7000.
- Avoid severe impact or rough handling that leads to damaging the APS-7000.
- Do not discharge static electricity to the APS-7000.
- Use only mating connectors, not bare wires, for the terminals.
- Do not block the cooling fan opening.
- Do not disassemble the APS-7000 unless you are qualified.

(Measurement categories) EN 61010-1:2010 specifies the measurement categories and their requirements as follows. The APS-7000 doesn't fall under category II, III or IV.

- Measurement category IV is for measurement performed at the source of low-voltage installation.
- Measurement category III is for measurement performed in the building installation.
- Measurement category II is for measurement performed on the circuits directly connected to the low voltage installation.
- 0 is for measurements performed on circuits not directly connected to Mains.

Power Supply



WARNING

- AC Input voltage range:
115/230 Vac \pm 15% (APS-7050, APS-7100)
230 Vac \pm 15% (APS-7200, APS-7300)
 - Frequency: 50/60Hz
 - To avoid electrical shock connect the protective grounding conductor of the AC power cord to an earth ground.
-

- Cleaning the APS-7000
- Disconnect the power cord before cleaning.
 - Use a soft cloth dampened in a solution of mild detergent and water. Do not spray any liquid.
 - Do not use chemicals containing harsh material such as benzene, toluene, xylene, and acetone.

- Operation Environment
- Location: Indoor, no direct sunlight, dust free, almost non-conductive pollution (Note below)
 - Relative Humidity: 20%~ 80%
 - Altitude: < 2000m
 - Temperature: 0°C to 40°C
- (Pollution Degree) EN 61010-1:2010 specifies the pollution degrees and their requirements as follows. The APS-7000 falls under degree 2.
- Pollution refers to “addition of foreign matter, solid, liquid, or gaseous (ionized gases), that may produce a reduction of dielectric strength or surface resistivity”.
- Pollution degree 1: No pollution or only dry, non-conductive pollution occurs. The pollution has no influence.
 - Pollution degree 2: Normally only non-conductive pollution occurs. Occasionally, however, a temporary conductivity caused by condensation must be expected.
 - Pollution degree 3: Conductive pollution occurs, or dry, non-conductive pollution occurs which becomes conductive due to condensation which is expected. In such conditions, equipment is normally protected against exposure to direct sunlight, precipitation, and full wind pressure, but neither temperature nor humidity is controlled.

- Storage environment
- Location: Indoor
 - Temperature: -10°C to 70°C
 - Relative Humidity: ≤80%, no condensation

Disposal



Do not dispose this instrument as unsorted municipal waste. Please use a separate collection facility or contact the supplier from which this instrument was purchased. Please make sure discarded electrical waste is properly recycled to reduce environmental impact.

Power cord for the United Kingdom

When using the instrument in the United Kingdom, make sure the power cord meets the following safety instructions.

NOTE: This lead/appliance must only be wired by competent persons



WARNING: THIS APPLIANCE MUST BE EARTHED

IMPORTANT: The wires in this lead are coloured in accordance with the following code:

Green/ Yellow:	Earth
Blue:	Neutral
Brown:	Live (Phase)



As the colours of the wires in main leads may not correspond with the coloured marking identified in your plug/appliance, proceed as follows:

The wire which is coloured Green & Yellow must be connected to the Earth terminal marked with either the letter E, the earth symbol  or coloured Green/Green & Yellow.

The wire which is coloured Blue must be connected to the terminal which is marked with the letter N or coloured Blue or Black.

The wire which is coloured Brown must be connected to the terminal marked with the letter L or P or coloured Brown or Red.

If in doubt, consult the instructions provided with the equipment or contact the supplier.

This cable/appliance should be protected by a suitably rated and approved HBC mains fuse: refer to the rating information on the equipment and/or user instructions for details. As a guide, a cable of 0.75mm² should be protected by a 3A or 5A fuse. Larger conductors would normally require 13A types, depending on the connection method used.

Any exposed wiring from a cable, plug or connection that is engaged in a live socket is extremely hazardous. If a cable or plug is deemed hazardous, turn off the mains power and remove the cable, any fuses and fuse assemblies. All hazardous wiring must be immediately destroyed and replaced in accordance to the above standard.

GETTING STARTED

This chapter describes the power source in a nutshell, including its main features and front / rear panel introduction.



APS-7000 Series Overview	9
Series lineup	9
Main Features	9
Accessories	10
Appearance	12
Front Panel	12
Rear Panel	17

APS-7000 Series Overview

Series lineup

The APS-7000 series consists of 4 models, the APS-7050, APS-7100, APS-7200 and APS-7300, differing only in capacity. Note that throughout the user manual, the term “APS-7000” refers to any of the models, unless stated otherwise.

Model name	Max. Output Current	Power Rating	Output Voltage
APS-7050	4.2A/2.1A	500VA	0~310.0 Vrms
APS-7100	8.4A/4.2A	1000VA	0~310.0 Vrms
APS-7200	16.8A/8.4A	2000VA	0~310.0 Vrms
APS-7300	25.2A/16.8A	3000VA	0~310.0 Vrms

Main Features

- | | |
|-------------|--|
| Performance | <ul style="list-style-type: none"> • Low output ripple and noise • Excellent and feature-rich measurement capacity • Standard maximum output voltage is 310Vrms • Maximum output voltage and frequency of 600Vrms(APS-003 Option)/1000Hz(APS-004 Option) |
|-------------|--|

- Features
- OVP, OPP and OTP protection
 - Variable voltage, frequency and current limiter
 - Sequence and simulation function
 - Large 4.3 inch panel
 - Globally adjustable power inlet not restricted by the power supply environment
 - USB interface is equipped as standard with the ability to save and recall files.
 - Only 88mm (2U) case height (APS-7050 and APS-7100 models only).

- Interface
- Standard:
- Ethernet port
 - USB host
 - USB CDC (APS-7200 and APS-7300 models only)
- Optional:
- GPIB
 - RS-232 / USB CDC (APS-7050 and APS-7100 models only)
 - RS-232 (APS-7200 and APS-7300 models only)

Accessories

Standard Accessories	Part number	Description
	CD ROM	User manual, programming manual
	82GW1SAFE0M*1	Safety guide
	Region dependent	Type I Power cord (APS-7050)

Region dependent	Type II Power cord (APS-7100)
Region dependent	Type III Power cord (APS-7200, APS-7300)
62PS-7K0SC701 x1 5302-01613001 x1	Mains terminal cover set (APS-7050)
62PS-7K0SC401 x1 5302-01613001 x2	Mains terminal cover set (APS-7100)
GTL-123	Test leads: 1x red, 1x black

Optional Capacity	Part number	Description
	APS-003	Output Voltage Capacity: 0 ~ 600Vrms
	APS-004	Output Frequency Capacity: 45 ~ 1000Hz

Optional Accessories	Part number	Description
	GRA-423	APS-7050 and APS-7100 rack mount kit
	GRA-429	APS-7200 rack mount kit
	GRA-430	APS-7300 rack mount kit
	APS-001	GPIB interface card
	APS-002	RS-232 / USB CDC interface card (APS-7050 and APS-7100 only)
	APS-007	RS-232 interface card (APS-7200 and APS-7300 only)
	GPW-004	Power Cord 8mm ² /3C, 3m Max Length, 105°C, RNYBS8-6*3P, RNYB8-8*3P

Download	Name	Description
	gw_aps.inf	USB driver

Appearance

Front Panel

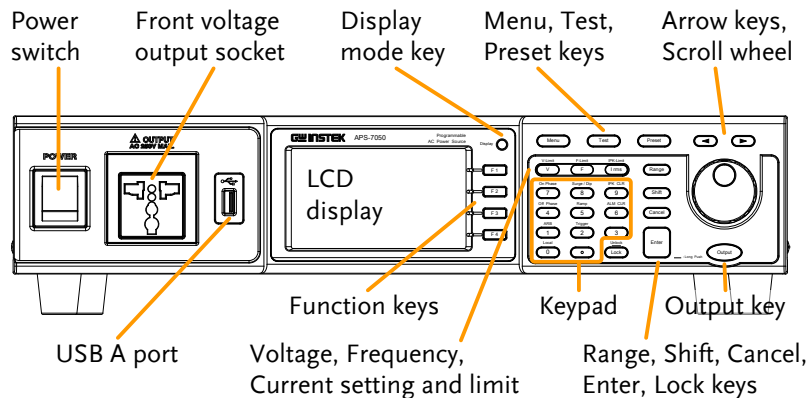

APS-7050, APS-7100





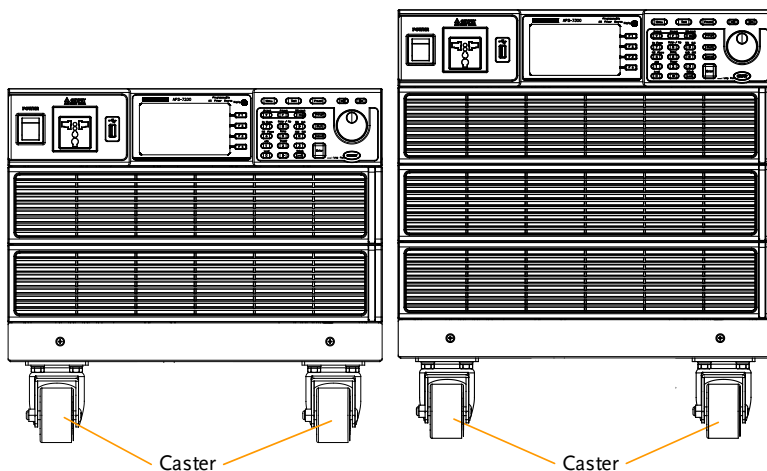

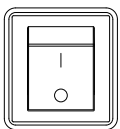
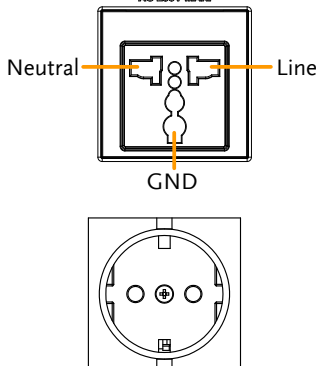
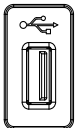



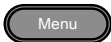
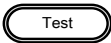



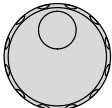

APS-7200

APS-7300



Item	Description	
Power Switch	<p data-bbox="403 231 481 255">POWER</p> 	Turns on the mains power.
Front Voltage Output Socket	<p data-bbox="515 406 593 438">⚠ OUTPUT AC 250V MAX.</p> 	Output voltage terminal using a regional universal plug. There is a Euro and a Universal regional plug.
<p data-bbox="386 853 436 909">⚠ CAUTION</p>		<p data-bbox="571 837 983 933">Maximum allowable output voltage and current are 250Vrms and 15Arms.</p>
<p data-bbox="571 949 983 1045">For voltages exceeding 250Vrms or current over 15Arms, please use the rear output terminal.</p>		
USB A Port		The USB port is used for data transfers and upgrading software.
LCD Screen		Displays the measured values or menu system.
Display Mode Select Key	<p data-bbox="386 1308 431 1332">Display</p> 	Selects between Standard mode and Simple mode.

Function Keys		Assigned to the functions displayed on the right-hand side of the screen.
Menu Key		Enters the Main menu or goes back to one of the display modes.
Test Key		Puts the instrument into the Sequence, Simulation and Program Control mode.
Preset Key		Puts the instrument into Preset mode.
Arrow Keys	 	The arrow keys are used to select the digit power of a value that is being edited.
V		Used for setting the output voltage.
V-Limit	(Shift + V)	Used for setting the output voltage limit value.
F		Used for setting the output frequency.
F-Limit	(Shift + F)	Used for setting the output frequency limit value.
I rms		Used for setting the maximum output current.
IPK-Limit	(Shift + I rms)	Used to set the peak output current limit value.
Range Key		Switches between the 155V, 310V and 600V ranges (the 600V range is an option).
Scroll Wheel		Used to navigate menu items or for incrementing/decrementing values one step at a time.

Lock Key		Locks the number pad to prevent accidentally changing panel settings.
Unlock Key	(Long press)	Disables the key lock.
Enter Key		Confirms selections / settings
Cancel Key		Clears entries that are made in the number entry dialog when a value is edited using the arrow keys or the scroll wheel. The Cancel key can also be used to cancel function setting menus or dialogs.
Shift Key		Turns on the shift state, which enables shortcut operations.
Output Key		Turns the output on or off.
Number Pad		Used to enter values.
Local Mode	(Shift + 0)	Switches operation back to local mode from remote mode.
ARB Mode	(Shift + 1)	Sets the ARB function.
Trigger Mode	(Shift + 2)	Sets the JI port trigger behavior on the rear panel.
Off Phase	(Shift + 4)	Sets the off phase for the output voltage.
RAMP	(Shift + 5)	Quick settings for Ramp control.
ALM CLR	(Shift + 6)	Clears alarms.
On Phase	(Shift + 7)	Sets the on phase for the output voltage.

Surge/Dip	(Shift + 8)	Quick settings for Surge/Dip control.
IPK CLR	(Shift + 9)	Clears peak current hold.

Rear Panel

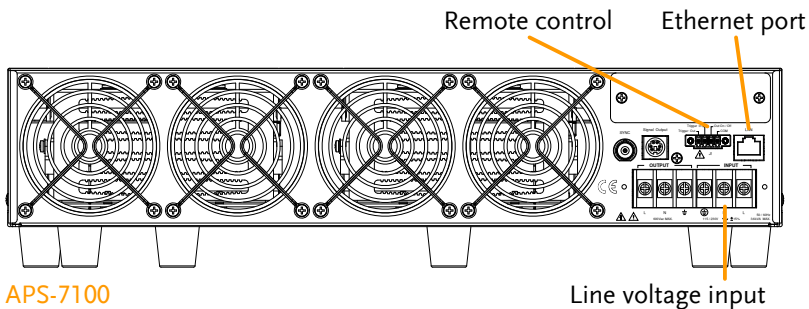
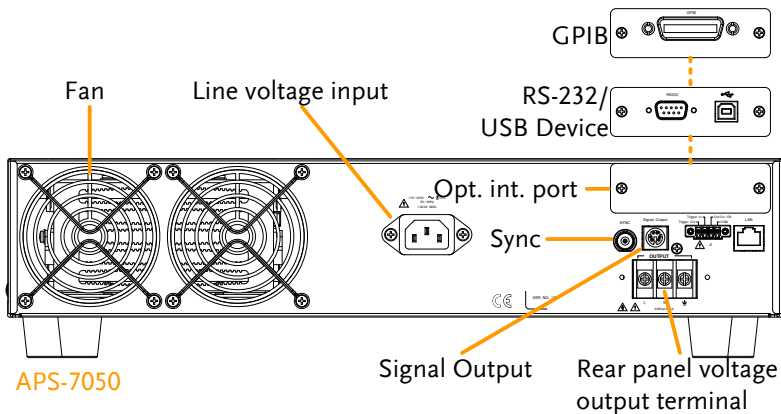

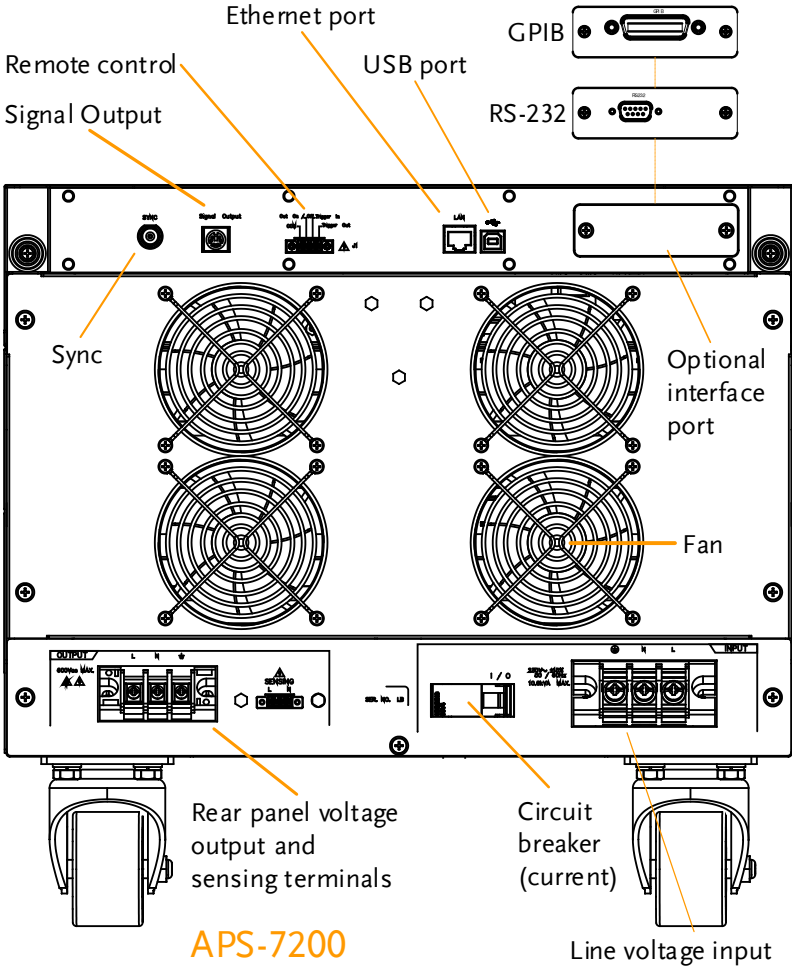

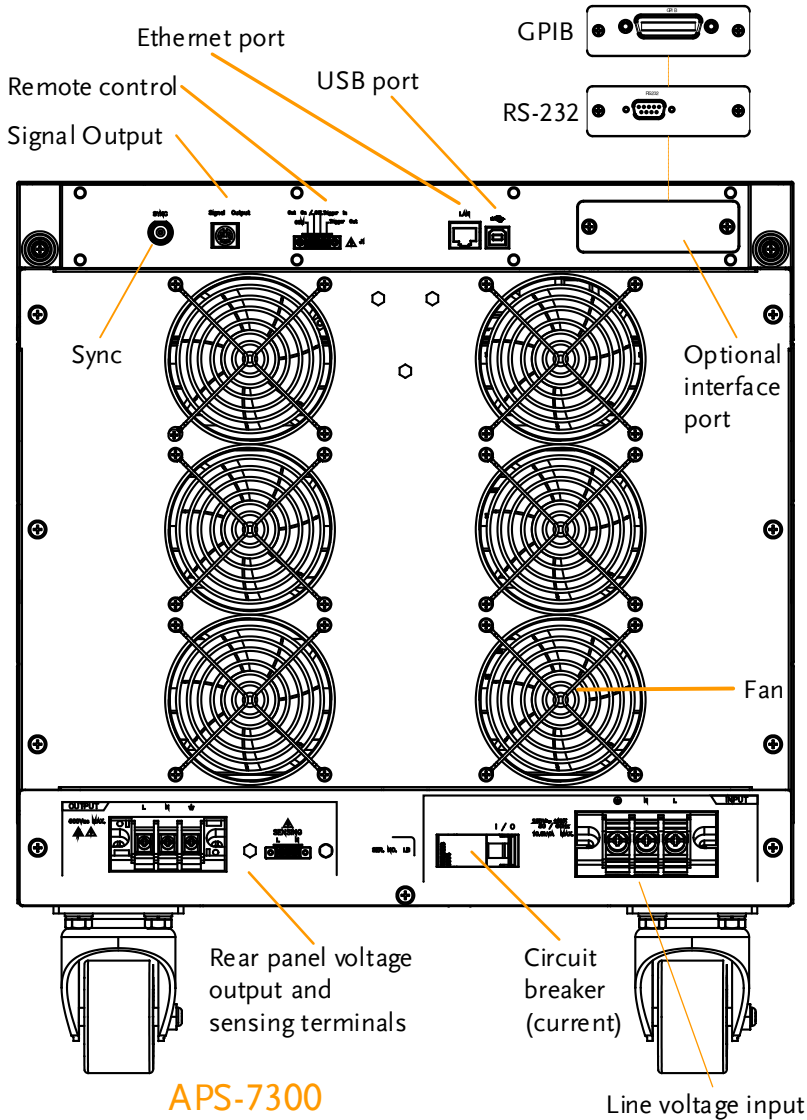

Line Voltage Input

APS-7050

Voltage Input: 115/230±15% VAC;
Line frequency: 50Hz/60 Hz
(Automatically switchable)

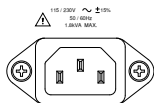

APS-7100

Voltage Input: 115/230±15% VAC ; Line frequency: 50Hz/60 Hz (Automatically switchable)

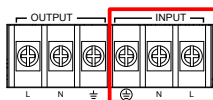

APS-7200 & 7300

Voltage Input: 230±15% VAC ; Line frequency: 50Hz/60 Hz

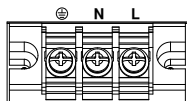

Rear Voltage Output Socket

Output voltage terminal.

APS-7050

APS-7100

APS-7200 & 7300

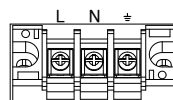
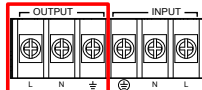
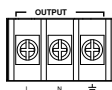

Sync Output Socket



BNC socket. This socket will output a signal of approximately 10V when the output is on.

Signal Output

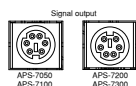

Connector for monitoring PASS, FAIL and PROCESSING output signals when using the Program mode.

Remote Control

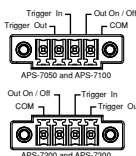

Connector for controlling the TRIGGER IN, TRIGGER OUT and OUT ON/OFF states.

Ethernet Port



The Ethernet port is used for remote control and digital monitoring from a PC.

Optional Interface Slot

Optional GPIB communication, RS-232/USB B communication and RS-232 communication.

Circuit breaker (APS-7200, APS-7300 only)

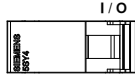

Main power circuit (current) breaker
Rating : 40A (APS-7200)
63A (APS-7300)

Note: Check the status of the power breaker before power-on the APS-7200 or APS-7300.

FAN

Temperature controlled fan.

Remote sense (APS-7200, APS-7300 only)

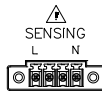

Compensation of the load wire drop.

REMOTE CONTROL

This chapter describes basic configuration of IEEE488.2 based remote control.

Interface Configuration	23
USB Remote Interface - Optional (APS-7050 and APS-7100 only)	23
RS-232 Remote Interface - Optional	24
RS-232/USB Remote Control Function Check	26
Using Realterm to Establish a Remote Connection.....	27
Configure GPIB Interface - Optional.....	30
GPIB Function Check	31
Configure Ethernet Connection.....	34
Web Server Remote Control Function Check	36
Socket Server Function Check.....	37
Command Syntax	42
Command List	46
Status Register Overview	125
Introduction to the Status Registers	128
The Status Registers.....	129
Questionable Status Register Group	130
Operation Status Register Group	133
Warning Status Register Group	135
Standard Event Status Register Group	137
Status Byte Register & Service Request Enable Register.....	139
Error List	141
Command Errors	141
Execution Errors	145
Device Specific Errors	147
Query Errors.....	148

Interface Configuration

USB Remote Interface – Optional (APS-7050 and APS-7100 only)



USB configuration	PC side connector	Type A, host
	APS-7000 side connector	Rear panel Type B, slave
	Speed	1.1/2.0 (full speed/auto speed)
	USB Class	CDC (communications device class)



Note

The RS-232/USB interface card (APS-002) must first be installed before the USB interface can be used for remote control. Please see the user manual for installation details.

Steps

1. Connect the Type A-Type B USB cable from the PC to the rear panel USB B port. 
2. Press the *Menu* key. The Menu setting will appear on the display. 
3. Use the scroll wheel to go to item 6, *Rear USB* and press *Enter*.
4. Go to the *Speed* setting and set the USB speed.

Speed	Full, Auto
-------	------------
5. If the connection is successful *Connection Status* will change from Offline to Online.

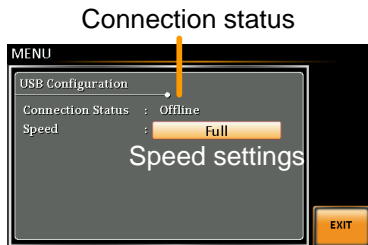

Exit

6. Press *Exit*[F4] to exit from the rear panel USB settings.



RS-232 Remote Interface - Optional

The APS-002 RS-232/USB or APS-007 RS-232 interface card must be installed to remotely control the APS-7000 via the serial port.

RS-232 configuration	Connector	BD-9, male
	Parameters	Baud rate, data bits, parity, stop bits.

Pin Assignment

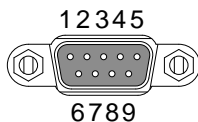

- 2: RxD (Receive data)
- 3: TxD (Transmit data)
- 5: GND
- 4, 6 ~ 9: No connection

Pin Connection

Use a Null Modem connection (RS-232C cable) as shown in the diagram below.

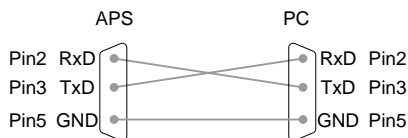





Note

The RS-232/USB (APS-002) or RS-232 (APS-007) must first be installed before the RS-232 interface can be used for remote control. Please see the user manual for installation details.

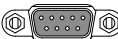
Steps

1. Connect the RS-232C cable from the PC to the rear panel RS-232 port. 
2. Press the *Menu* key. The Menu setting will appear on the display. 
3. Use the scroll wheel to go to item 7, *Serial Port* and press *Enter*.

4. Go to the *Function Active* setting and turn the serial port connection on.

Function Active	ON, OFF
-----------------	---------

5. Set the remaining serial port settings.

Baud rate	1200, 2400, 4800, 9600(default), 19200, 38400, 57600, 115200,
Data bits	7, 8(default)
Parity	None(default), odd, even
Stop bits	1(default),2

Serial port configuration

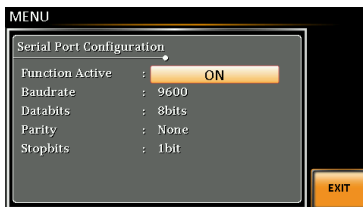

Exit

6. Press *Exit*[F4] to exit from the serial port settings.



RS-232/USB Remote Control Function Check

Functionality
check

Invoke a terminal application such as Realterm.

For both USB and RS-232, set the COM port, baud rate, stop bit, data bit and parity accordingly. The RS-232 settings are configured on the APS-7000. The UART settings for the USB connection can be seen in the Windows Device Manager.

To check the COM settings in Windows, see the Device Manager. For example, in WinXP go to the Control panel → System → Hardware tab.



Note

If you are not familiar with using a terminal application to send/receive remote commands from the serial port or via a USB connection, please page 27 for more information.

Run this query command via the terminal after the instrument has been configured for RS-232/USB remote control (page 24, 23).

*IDN?

This should return the Manufacturer, Model number, Serial number, and Software version in the following format.

```
GWINSTEK,APS-7050, GEXXXXXXX,  
XX.XX.XXXXXXX
```

```
Manufacturer: GWINSTEK  
Model number : APS-7050
```

Serial number : GEXXXXXXX

Software version : XX.XX.XXXXXXXX

Using Realterm to Establish a Remote Connection

Background

Realterm is a terminal program that can be used to communicate with a device attached to the serial port of a PC or via an emulated serial port via USB.

The following instructions apply to version 2.0.0.70. Even though Realterm is used as an example to establish a remote connection, any terminal program can be used that has similar functionality.



Note

Realterm can be downloaded on Sourceforge.net free of charge.

For more information please see
<http://realterm.sourceforge.net/>

Operation

1. Download Realterm and install according to the instructions on the Realterm website.
2. Connect the APS-7000 via USB (page 24) or via RS-232 (page 23).
3. If using RS-232, make note of the configured baud rate, stop bits and parity.
4. Go to the Windows device manager and find the COM port number for the connection. For example, go to the Start menu > Control Panel > Device Manager.

Double click the *Ports* icon to reveal the connected serial port devices and the COM port

for the each connected device.

If using USB, the baud rate, stop bit and parity settings can be viewed by right-clicking the connected device and selecting the *Properties* option.

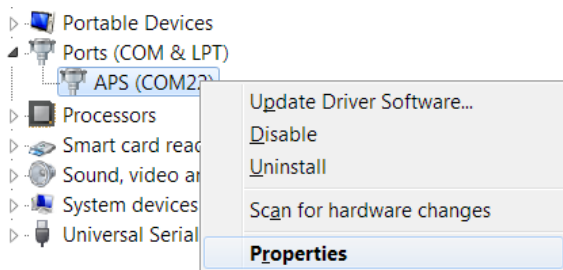

5. Start Realterm on the PC as an administrator.
Click:
Start menu>All Programs>RealTerm>realterm

Tip: to run as an administrator, you can right click the Realterm icon in the Windows Start menu and select the *Run as Administrator* option.

6. After Realterm has started, click on the *Port* tab.

Enter the *Baud**, *Parity*, *Data bits*, *Stop bits* and *Port* number configuration for the connection.

The *Hardware Flow Control*, *Software Flow Control* options can be left at the default settings.

Press *Open* to connect to the APS-7000.



Note

*The baud must be set to 115200 when using USB to control the APS with RealTerm.

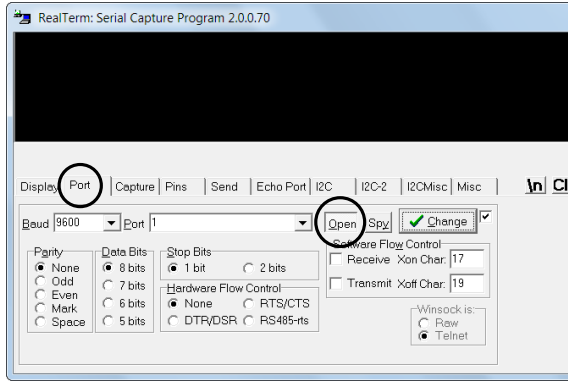

7. Click on the *Send* tab.

In the *EOL* configuration, check on the *+LF* check boxes.

Enter the query:

**idn?*

Click on *Send ASCII*.

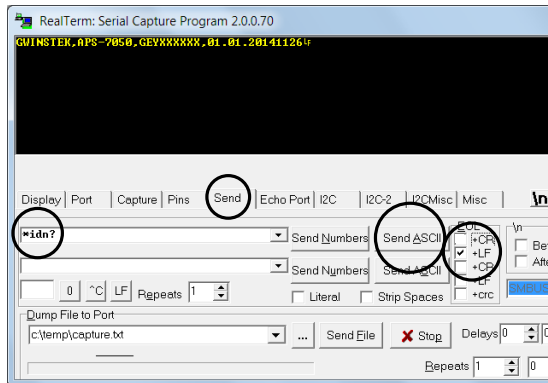

8. The terminal display will return the following:

```
GWINSTEK,APS-7050, GEXXXXXXX,
XX.XX.XXXXXXXX
```

(manufacturer, model, serial number, software version)

9. If Realterm fails to connect to the APS-7000, please check all the cables and settings and try again.

Configure GPIB Interface - Optional

To use GPIB, the optional APS-001 GPIB interface card must first be installed.



Note

The GPIB interface card (APS-001) must first be installed before the GPIB interface can be used for remote control. Please see the user manual for installation details.

GPIB Configuration

1. Connect a GPIB cable from the PC to the GPIB on the interface card.

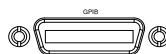

2. Press the *Menu* key. The Menu setting will appear on the display.

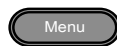

3. Use the scroll wheel to go to item 8, *GPIB* and press *Enter*.
4. If the GPIB card is installed successfully, the *Card Status* will show *Plugged in*.
5. Go to the *Function Active* setting and turn the GPIB port on.

Function Active ON, OFF

- Set the GPIB address.

GPIB Address 0 ~ 30

GPIB port configuration

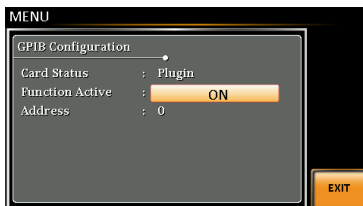

Exit

- Press *Exit*[F4] to exit from the serial port settings.



GPIB constraints

- Maximum 15 devices altogether, 20m cable length, 2m between each device
- Unique address assigned to each device
- At least 2/3 of the devices turned On
- No loop or parallel connection

GPIB Function Check

Functionality check

Please use the National Instruments Measurement & Automation Controller software to confirm GPIB/LAN functionality.

See the National Instrument website, <http://www.ni.com> for details.

Operation

- Start the NI Measurement and Automation Explorer (MAX) program. Using Windows, press:



Start>All Programs>NI MAX



2. From the Configuration panel access;
My System>Devices and Interfaces>GPIB0
3. Press the *Scan for Instruments* button.
4. In the *Connected Instruments* panel the APS-7000 should be detected as *Instrument 0* with the address the same as that configured on the APS-7000.
5. Double click the *Instrument 0* icon.

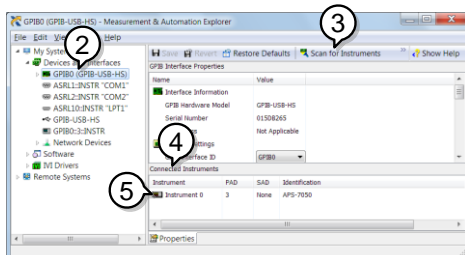

6. Click on *Visa Properties*.
7. Click on *Open Visa Test Panel*.

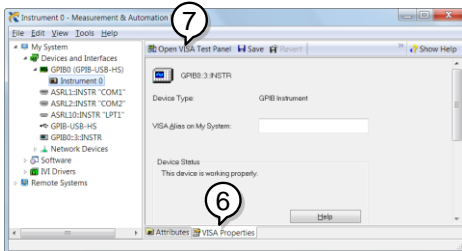

8. Click on the *Input/Output* icon.
9. Under the Basic I/O tab, ensure **IDN?* is written in the *Select or Enter Command* text box.
10. Click on the *Query* button to send the **IDN?* query to the instrument.
11. The instrument identification string will be returned to the buffer area:

*GWINSTEK,APS-7050, GEXXXXXXXXXX,
XX.XX.XXXXXXXXXX*

(manufacturer, model, serial number, software version)



12. The function check is complete.



Configure Ethernet Connection

The Ethernet interface can be configured for a number of different applications. Ethernet can be configured for basic remote control or monitoring using a web server or it can be configured as a socket server.

The APS-7000 supports both DHCP connections so the instrument can be automatically connected to an existing network or alternatively, network settings can be manually configured.

Ethernet Parameters	MAC Address (display only)	DHCP
	IP Address	Subnet Mask
	Gateway	DNS Address
	DNS Server	Socket port fixed at 2268

Ethernet Configuration

1. Connect a LAN cable from the PC to the Ethernet port on the rear panel. 
2. Press the *Menu* key. The Menu setting will appear on the display. 
3. Use the scroll wheel to go to item 5, *LAN* and press *Enter*.
4. If the LAN cable is installed correctly a connection is active, the *Connection Status* will show *Online*.
5. To automatically have the network assign an IP address, set DHCP to ON. Otherwise set DHCP to OFF to manually set the Ethernet settings.

DHCP	ON, OFF
------	---------

- If DHCP was set to OFF, configure the remaining LAN parameters.

IP Address

Subnet Mask

Gateway

DNS Server

LAN configuration

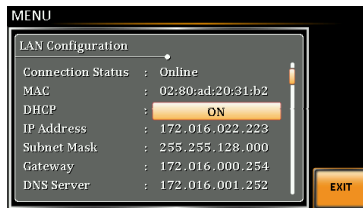

Exit

- Press *Exit*[F4] to exit from the LAN settings.



Web Server Remote Control Function Check

Functionality check

Enter the IP address of the power supply (for example: http:// XXX.XXX.XXX.XXX) in a web browser after the instrument has been configured for LAN(page 34).

The web interface allows you to:

- View the system and information and the network configuration.
- View the analog control pinout.
- View the dimensions of the unit.
- View the operating area

Example:

The screenshot shows the GW INSTEK web interface. At the top, there is the logo and navigation links: "Visit Our Site", "Support", and "Contact Us". Below the header, there are several menu items: "Welcome Page", "Network Configuration" (which is highlighted with a dashed border), "Analog Control", "Figure of Dimensions", and "Operating Area". The "Network Configuration" section contains a table of settings:

Network Configuration	
IP Address:	172.16.5.125
Subnet Mask:	255.255.128.0
Gateway:	172.16.0.254
DNS:	172.16.1.252
DHCP State:	<input type="radio"/> ON <input checked="" type="radio"/> OFF

Below the network configuration, there is a "Password:" field and a "Submit" button.

Socket Server Function Check

Background To test the socket server functionality, National Instruments Measurement and Automation Explorer can be used. This program is available on the NI website, www.ni.com, via a search for the VISA Run-time Engine page, or “downloads” at the following URL, <http://www.ni.com/visa/>

Requirements Operating System: Windows XP, 7, 8, 8.1

Functionality check 1. Start the NI Measurement and Automation Explorer (MAX) program. Using Windows, press:

Start>All Programs>NI MAX



2. From the Configuration panel access;

My System>Devices and Interfaces>Network Devices

3. Press *Add New Network Device>Visa TCP/IP Resource...*

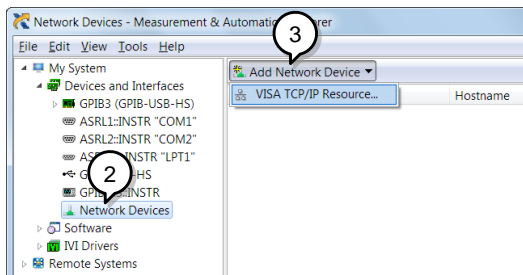

4. Select *Manual Entry of Raw Socket* from the popup window.

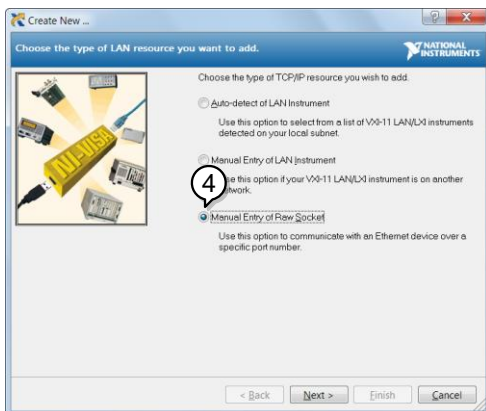

5. Enter the IP address and the port number of the APS-7000. The port number is fixed at 2268.
6. Double click the Validate button and press *Next*.

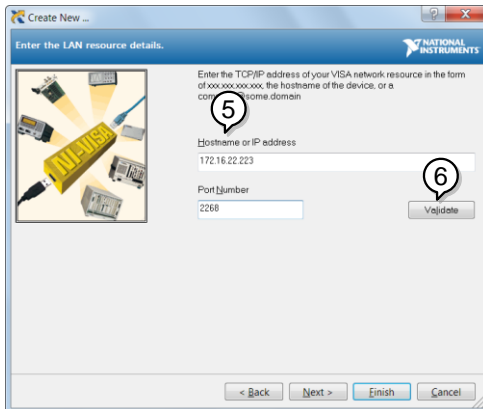

7. Next configure the Alias (name) of the APS-7000 connection. In this example the Alias is: APS
8. Click finish.

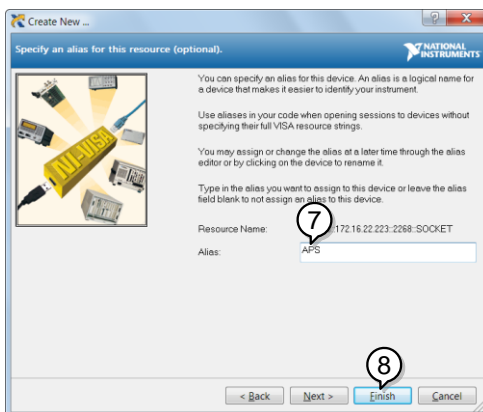

9. The IP address of the power supply will now appear under Network Devices in the configuration panel. Select this icon now.
10. Press *Open VISA Test Panel*.

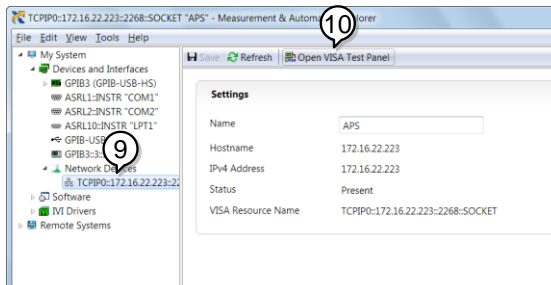

11. Click the *Configuration* Icon. Under the *IO Settings* tab check *Enable Termination Character*. The termination character should be set as *Line Feed - \n*.

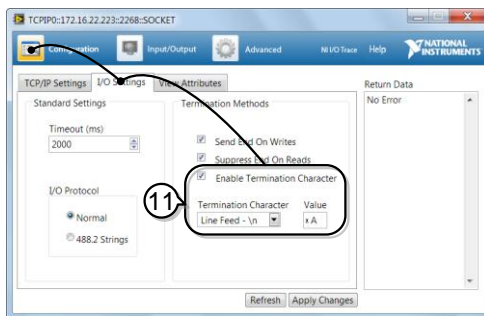

12. Click the *Input/Output* icon. Under the *Basic I/O* tab, make sure **IDN?\n* is entered in the *Select or Enter Command* drop box.
13. Click *Query*.

The APS-7000 will return the machine identification string into the buffer area:
**GWINSTEK,APS-7050, GEXXXXXXX,
 XX.XX.XXXXXXXX**

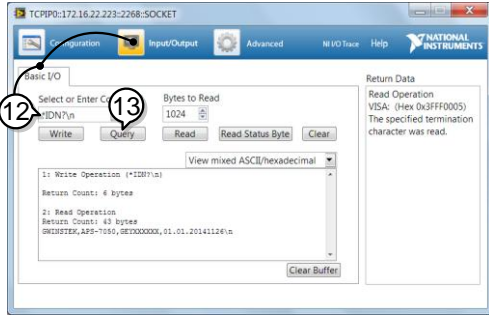

Command Syntax

Compatible Standard	IEEE488.2	Partial compatibility
	SCPI, 1999	Partial compatibility

Command Structure SCPI commands follow a tree-like structure, organized into nodes. Each level of the command tree is a node. Each keyword in a SCPI command represents each node in the command tree. Each keyword (node) of a SCPI command is separated by a colon (:).

For example, the diagram below shows an SCPI sub-structure and a command example.

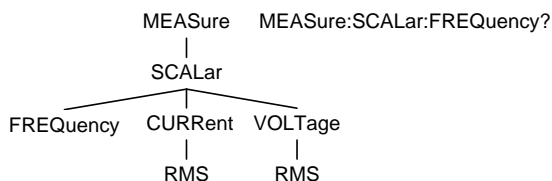

Command types There are a number of different instrument commands and queries. A command sends instructions or data to the unit and a query receives data or status information from the unit.

Command types

Simple A single command with/without a parameter

Example *IDN?

Query	A query is a simple or compound command followed by a question mark (?). A parameter (data) is returned.
-------	--

Example	meas:curr?
---------	------------

Compound	Two or more commands on the same command line. Compound commands are separated with either a semi-colon (;) or a semi-colon and a colon (;:).
----------	---

A semi-colon is used to join two related commands, with the caveat that the last command must begin at the last node of the first command.

Example	meas:volt?;curr?
---------	------------------

A semi-colon and colon are used to combine two commands from different nodes.

Example	meas:volt?;:sour:volt?
---------	------------------------

 Note
(Further explanation)

A semi-colon(;) is used to connect two commands. A colon(:) at the start of a command indicates that the command starts from the root node. The first command can ignore that first colon. Any commands after the first command (for compound commands) that do not begin with a colon, must begin at the last node of the first command.

Command Forms Commands and queries have two different forms, long and short. The command syntax is written with the short form of the command in capitals and the remainder (long form) in lower case.

The commands can be written in capitals or lower-case, just so long as the short or long forms are complete. An incomplete command will not be recognized.

Below are examples of correctly written commands.

Long form	:STATus:PRESet :STATUS:PRESET :status:preset
Short form	STAT:PRES stat:pres

Square Brackets Commands that contain square brackets indicate that the contents are optional. The function of the command is the same with or without the square bracketed items, as shown below.

For example the query “:OUTPut[:STATe]?” has two valid forms, “:OUTPut:STATe?” and “:OUTPut?”.

Command Format



1. Command header
2. Space
3. Parameter 1
4. Comma (no space before/after comma)
5. Parameter 2

Parameters	Type	Description	Example
	<Boolean>	Boolean logic	0, 1
	<NR1>	integers	0, 1, 2, 3
	<NR2>	decimal numbers	0.1, 3.14, 8.5
	<NR3>	floating point	4.5e-1, 8.25e+1
	<NRf>	any of NR1, 2, 3	1, 1.5, 4.5e-1
	<block data>	Definitive length arbitrary block data. A single decimal digit followed by data. The decimal digit specifies how many 8-bit data bytes follow.	

Message Terminator	LF	Line feed code	
--------------------	----	----------------	--

Command List

Abort Command	:ABORt	52
Common Commands	*CLS.....	53
	*ESE	53
	*ESR.....	54
	*IDN	54
	*OPC.....	54
	*RCL	55
	*RST.....	55
	*SAV	55
	*SRE.....	55
	*STB	56
	*TST	56
	*WAI.....	56
	*TRG.....	56
Data/Trace Commands	:DATA TRACe:SEQuence:CLEar	57
	:DATA TRACe:SEQuence:RECall	57
	:DATA TRACe:SEQuence:STORe	58
	:DATA TRACe:SIMulation:CLEar.....	58
	:DATA TRACe:SIMulation:RECall.....	58
	:DATA TRACe:SIMulation:STORe.....	59
Initiate Commands	:INITiate[:IMMediate]:NAME	60
	:INITiate[:IMMediate][:TRANsient]	60
Measure Commands	:MEASure[:SCALar]:CURRent:CFActor	61
	:MEASure[:SCALar]:CURRent:HIGH	61
	:MEASure[:SCALar]:CURRent:PEAK:CLEar	61
	:MEASure[:SCALar]:CURRent:PEAK:HOLD	62
	:MEASure[:SCALar]:CURRent[:RMS]	62
	:MEASure[:SCALar]:CURRent:RANGe	62

	:MEASure[:SCALar]:FREQuency	62
	:MEASure[:SCALar]:POWer[:AC]:APParent	63
	:MEASure[:SCALar]:POWer[:AC]:PFACTOR	63
	:MEASure[:SCALar]:POWer[:AC]:REACTiVe	63
	:MEASure[:SCALar]:POWer[:AC][:REAL]	63
	:MEASure[:SCALar]:VOLTAge[:RMS]	63
Memory	:MEMory:SAV	64
Commands	:MEMory:RCL	64
	:MEMory:TRIGgered	65
Output	:OUTPut:PON	66
Commands	:OUTPut:PROTection:CLear	66
	:OUTPut[:STATe]	66
	:OUTPut[:STATe]:TRIGgered	67
Status	:STATus:OPERation:CONDition	68
Commands	:STATus:OPERation:ENABle	68
	:STATus:OPERation[:EVENT]	69
	:STATus:OPERation:NTRansition	69
	:STATus:OPERation:PTRansition	69
	:STATus:QUEStionable[:EVENT]	70
	:STATus:QUEStionable:CONDition	70
	:STATus:QUEStionable:ENABle	70
	:STATus:QUEStionable:NTRansition	70
	:STATus:QUEStionable:PTRansition	71
	:STATus:PRESet	71
	:STATus:WARning:CONDition	72
	:STATus:WARning:ENABle	72
	:STATus:WARning[:EVENT]	72
	:STATus:WARning:NTRansition	73
	:STATus:WARning:PTRansition	73
System	:SYSTem:BEEPer:STATe	75
Commands	:SYSTem:COMMunicate:GPIB[:SELF]:ADDResS	75
	:SYSTem:COMMunicate:LAN:DHCP	75

:SYSTem:COMMunicate:LAN:DNS76
 :SYSTem:COMMunicate:LAN:GATEway76
 :SYSTem:COMMunicate:LAN:IPAdDress.....77
 :SYSTem:COMMunicate:LAN:MAC77
 :SYSTem:COMMunicate:LAN:SMASk.....77
 :SYSTem:COMMunicate:RLSState.....78
 :SYSTem:COMMunicate:SERial[:RECeive]
 :TRANsmit:BAUD.....78
 :SYSTem:COMMunicate:SERial[:RECeive]
 :TRANsmit:BITS79
 :SYSTem:COMMunicate:SERial[:RECeive]
 :TRANsmit:PARity.....79
 :SYSTem:COMMunicate:SERial[:RECeive]
 :TRANsmit:SBITs80
 :SYSTem:COMMunicate:TCPIp:CONTRol80
 :SYSTem:COMMunicate:USB:FRONt:STATe.....80
 :SYSTem:COMMunicate:USB:REAR:MODE81
 :SYSTem:COMMunicate:USB:REAR:STATe81
 :SYSTem:CONFigure:RAMP[:MODE]81
 :SYSTem:CONFigure:RAMP:VOLTage82
 :SYSTem:CONFigure:RAMP:TIME82
 :SYSTem:CONFigure[:MODE]83
 :SYSTem:CONFigure:PHASe83
 :SYSTem:CONFigure:SDIP[:MODE]83
 :SYSTem:CONFigure:SDIP:SITE84
 :SYSTem:CONFigure:SDIP:VOLTage84
 :SYSTem:CONFigure:SDIP:WIDTh85
 :SYSTem:CONFigure:TRIGger:INPut:SOURce.....85
 :SYSTem:CONFigure:TRIGger:INPut:WIDTh86
 :SYSTem:CONFigure:TRIGger:OUTPut:WIDTh ..86
 :SYSTem:CONFigure:TRIGger:OUTPut:SOURce.87
 :SYSTem:CONFigure:TRIGger:OUTPut:LEVel.....87
 :SYSTem:ERRor88
 :SYSTem:ERRor:ENABle88
 :SYSTem:KLOCK88
 :SYSTem:LANGUage:EMULation89
 :SYSTem:REBoot.....89
 :SYSTem:WRELease.....89
 :SYSTem:IPKHold:TIME89
 :SYSTem:HOLD:STATe90

Trigger	:TRIGger:OUTPut:SOURce	93
Commands	:TRIGger:OUTPut[:IMMediate].....	93
	:TRIGger:MEMory:SOURce	94
	:TRIGger:MEMory[:IMMediate]	94
	:TRIGger:SDIP:SOURce	94
	:TRIGger:SDIP[:IMMediate]	95
	:TRIGger:SEQuence:SELEcted:EXECute	95
	:TRIGger:SIMulation:SELEcted:EXECute	95
	:TRIGger[:TRANsient]:SOURce	96
	:TRIGger[:TRANsient][:IMMediate].....	96
Source	[:SOURce]:CURRent:LIMit:PEAK:HIGH	98
Commands	[:SOURce]:CURRent:LIMit:PEAK:TIME	99
	[:SOURce]:CURRent:LIMit:RMS[:AMPLitude].....	99
	[:SOURce]:CURRent:LIMit:RMS:MODE	100
	[:SOURce]:CURRent:LIMit:RMS:TIME	100
	[:SOURce]:FREQuency:LIMit:HIGH	101
	[:SOURce]:FREQuency:TRIGgered	101
	[:SOURce]:FREQuency[:IMMediate]	102
	[:SOURce]:FUNction:CSINe:CFActor	102
	[:SOURce]:FUNction:CSINe:CLIP	103
	[:SOURce]:FUNction:CSINe:SDIP	103
	[:SOURce]:FUNction:CSINe:STAircase	104
	[:SOURce]:FUNction:CSINe:TYPE	105
	[:SOURce]:FUNction[:SHAPE][:IMMediate]	106
	[:SOURce]:PHASe:STARt[:IMMediate]	106
	[:SOURce]:PHASe:STOP[:IMMediate]	107
	[:SOURce]:READ	107
	[:SOURce]:SEQuence:CPARAmeter	107
	[:SOURce]:SEQuence:CSTep	108
	[:SOURce]:SEQuence:SPARAmeter	109
	[:SOURce]:SEQuence:STEP	110
	[:SOURce]:SIMulation:ABNormal:CODE	110
	[:SOURce]:SIMulation:ABNormal:FREQuency... ..	110
	[:SOURce]:SIMulation:ABNormal:PHASe	
	:STARt:ENABle.....	111
	[:SOURce]:SIMulation:ABNormal:PHASe	
	:STARt[:IMMediate].....	111

[:SOURce]:SIMulation:ABNormal:PHASe	
:STOP:ENABLE	112
[:SOURce]:SIMulation:ABNormal:PHASe	
:STOP[:IMMediate]	112
[:SOURce]:SIMulation:ABNormal:TIME	113
[:SOURce]:SIMulation:ABNormal:VOLTage.....	113
[:SOURce]:SIMulation:CSTep	113
[:SOURce]:SIMulation:INITial:CODE.....	114
[:SOURce]:SIMulation:INITial:FREQuency	114
[:SOURce]:SIMulation:INITial:PHASe:START	
:ENABLE	115
[:SOURce]:SIMulation:INITial:PHASe	
:START[:IMMediate].....	115
[:SOURce]:SIMulation:INITial:PHASe:STOP	
:ENABLE	116
[:SOURce]:SIMulation:INITial:PHASe	
:STOP[:IMMediate]	116
[:SOURce]:SIMulation:INITial:VOLTage	117
[:SOURce]:SIMulation:NORMal<1 2>:CODE	117
[:SOURce]:SIMulation:NORMal<1 2>	
:FREQuency.....	117
[:SOURce]:SIMulation:NORMal<1 2>	
:PHASe:START:ENABLE	118
[:SOURce]:SIMulation:NORMal<1 2>	
:PHASe:START[:IMMediate]	118
[:SOURce]:SIMulation:NORMal<1 2>	
:PHASe:STOP:ENABLE	119
[:SOURce]:SIMulation:NORMal<1 2>	
:PHASe:STOP[:IMMediate].....	119
[:SOURce]:SIMulation:NORMal<1 2>:TIME.....	120
[:SOURce]:SIMulation:NORMal<1 2>	
:VOLTage.....	120
[:SOURce]:SIMulation:REPeat:COUNT	121
[:SOURce]:SIMulation:REPeat:ENABLE.....	121
[:SOURce]:SIMulation:TRANSition<1 2>	
:TIME.....	121
[:SOURce]:VOLTage:LIMit:RMS	122
[:SOURce]:VOLTage:RANGe	122
[:SOURce]:VOLTage[:LEVel]:TRIGgered	
:AMPLitude]	123

	[:SOURce]:VOLTage[:LEVel][:IMMEDIATE]	
	[:AMPLitude]	123
Remote Sense	:RSENse:[STATe]	125
Command (APS-7200, 7300 only)		
	:DISPlay[:WINDow]:DESIGN:MODE	126
Display	:DISPlay[:WINDow]:MEASure:SOURce<1 3> ...	126
Commands		

Abort Command

:ABORt.....52

:ABORt



Description	The ABORt command will cancel any triggered actions.
-------------	--

Syntax	:ABORt
--------	--------

IEEE 488.2 Common Commands

*CLS.....	53
*ESE.....	53
*ESR.....	54
*IDN.....	54
*OPC.....	54
*RCL.....	55
*RST.....	55
*SAV.....	55
*SRE.....	55
*STB.....	56
*TST.....	56
*WAI.....	56
*TRG.....	56

*CLS



Description The *CLS command clears all the event registers, including the status byte, event status and error queue.

Syntax *CLS

*ESE

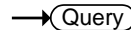
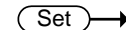

Description Sets or queries the Standard Event Status Enable register.

Syntax *ESE <NR1>

Query Syntax *ESE?

Parameter <NR1> 0~255

Return parameter <NR1> Returns the bit sum of the Standard Event Status Enable register.

***ESR** → Query

Description Queries the Standard Event Status (Event) register. The Event Status register is cleared after it is read.

Query Syntax *ESR?

Return parameter <NR1> Returns the bit sum of the Standard Event Status (Event) register and clears the register.

***IDN** → Query

Description Queries the manufacturer, model name, serial number, and firmware version of the APS.

Query Syntax *IDN?

Return parameter <string> Returns the instrument identification as a string in the following format:
 GWINSTEK,APS-7050,GEYXXXXXX,T1.01.20141009
 Manufacturer: GW-INSTEK
 Model number : APS-7050
 Serial number : GEYXXXXXX
 Firmware version : T01.01.2014109

Set →

***OPC** → Query

Description The *OPC command sets the OPC bit (bit0) of the Standard Event Status Register when all current commands have been processed.
 The *OPC? Query returns 1 when all the outstanding commands have completed.

Syntax *OPC

Query Syntax *OPC?

Return parameter 1 Returns 1 when all the outstanding commands have completed.

***RCL**

Set →

Description Recalls the contents stored in memory slot M0 ~ M9. These memory slots are mapped to the preset settings.

Syntax *RCL {<NR1>|MAX|MIN}

Parameter <NR1> 0 ~ 9 (as memory M0 ~ M9)
 MIN Recalls the M0 memory contents.
 MAX Recalls the M9 memory contents.

***RST**

Set →

Description Performs a device reset. Configures the unit to a known configuration (default settings). This known configuration is independent of the usage history.

Syntax *RST

***SAV**

Set →

Description Saves the settings into memory slot M0 ~ M9. These memory slots are mapped to the preset settings.

Syntax *SAV {<NR1>|MIN|MAX}

Return parameter <NR1> 0 ~ 9 (as memory M0 ~ M9)

***SRE**

Set →

→ Query

Description Sets or queries the Service Request Enable register. The Service Request Enable register determines which registers of the Status Byte register are able to generate service requests.

Syntax *SRE <NR1>

Query Syntax *SRE?

Parameter	<NR1>	0~255
Return parameter	<NR1>	Returns the bit sum of the Service Request Enable register.

***STB**

→ Query

Description	Queries the bit sum of the Status Byte register with MSS (Master summary Status) replacing the RQS bit (bit 6).	
-------------	---	--

Query Syntax *STB?

Return parameter	<NR1>	Returns the bit sum of the Status Byte register with the MSS bit (bit 6).
------------------	-------	---

***TST**

→ Query

Description	Executes a self test.	
-------------	-----------------------	--

Query Syntax *TST?

Return parameter	0	Returns "0" if there are no errors.
	<NR1>	Returns an error code <NR1> if there is an error.

***WAI**

Set →

Description	Prevents any other commands or queries from being executed until all outstanding commands have completed.	
-------------	---	--

Syntax *WAI

***TRG**

Set →

Description	The *TRG command is able to generate a "get" (Group Execute Trigger). If the unit cannot accept a trigger at the time of the command, an error message is generated (-211, "Trigger ignored").	
-------------	--	--

Syntax *TRG

Data/Trace Commands



Note

The DATA and the TRACe node for the following commands are functionally equivalent.

:DATA TRACe:SEQuence:CLEar.....	57
:DATA TRACe:SEQuence:RECall.....	57
:DATA TRACe:SEQuence:STORE.....	58
:DATA TRACe:SIMulation:CLEar.....	58
:DATA TRACe:SIMulation:RECall.....	58
:DATA TRACe:SIMulation:STORE.....	59

:DATA|TRACe:SEQuence:CLEar



Description Clears the sequence data for the selected save memory (Seq0 ~ Seq9).

Syntax :DATA|TRACe:SEQuence:CLEar
{<NR1>|MINimum|MAXimum}

Parameter	<NR1>	0~9
	MIN	0
	MAX	9

Example :DATA:SEQ:CLE 1
Clears the sequence data from Seq1.

:DATA|TRACe:SEQuence:RECall



Description Loads the sequence data. This command is the equivalent to recalling a sequence memory in the Sequence mode.

Syntax :DATA|TRACe:SEQuence:RECall
{<NR1>|MINimum|MAXimum}

Parameter	<NR1>	0~9 (Seq0 ~ Seq9).
	MIN	0
	MAX	9

Example :DATA:SEQ:REC 1
Loads the data from Seq1.

:DATA|TRACe:SEQuence:STORe (Set) →

Description Saves the sequence data. This command is the equivalent to saving a sequence memory in Sequence mode.

Syntax :DATA|TRACe:SEQuence:STORe
{<NR1>|MINimum|MAXimum}

Parameter <NR1> 0~9 (Seq0 ~ Seq9).
MIN 0
MAX 9

Example :DATA:SEQ:STOR 1
Saves the data from Seq1.

:DATA|TRACe:SIMulation:CLEar (Set) →

Description Clears the simulation data for the selected save memory (SIM0 ~ SIM9).

Syntax :DATA|TRACe:SIMulation:CLEar
{<NR1>|MINimum|MAXimum}

Parameter <NR1> 0~9
MIN 0
MAX 9

Example :DATA:SIM:CLE 1
Clears the simulation data from SIM1.

:DATA|TRACe:SIMulation:RECall (Set) →

Description Loads the simulation data. This command is the equivalent to recalling a simulation memory in the Simulation mode (SIM0~SIM9).

Syntax :DATA|TRACe:SIMulation:RECall
{<NR1>|MINimum|MAXimum}

Parameter	<NR1>	0~9 (SIM0 ~ SIM9).
	MIN	0
	MAX	9

Example :DATA:SIM:REC 1
 Loads the data from SIM1.

:DATA|TRACe:SIMulation:STORe (Set) →

Description Saves the simulation data. This command is the equivalent saving a simulation memory in Simulation mode (SIM0 ~ SIM9).

Syntax :DATA|TRACe:SIMulation:STORe
 {<NR1>|MINimum|MAXimum}

Parameter	<NR1>	0~9 (SIM0 ~ SIM9).
	MIN	0
	MAX	9

Example :DATA:SIM:STOR 1
 Saves the data from SIM1.

Initiate Commands

:INITiate[:IMMEDIATE]:NAME	60
:INITiate[:IMMEDIATE][:TRANSient]	60

:INITiate[:IMMEDIATE]:NAME



Description	The INITiate command starts the TRANSient, OUTPut, MEMory or SDIP (surge/dip) trigger.	
Syntax	:INITiate[:IMMEDIATE]:NAME {TRANSient OUTPut MEMory SDIP}	
Parameter	TRANSient	Starts the TRANSient trigger.
	OUTPut	Starts the OUTput trigger.
	MEMory	Starts the MEMory trigger.
	SDIP	Starts the (SDIP) Surge/Dip trigger.
Example	:INIT:NAME TRAN Starts the transient trigger.	

:INITiate[:IMMEDIATE][:TRANSient]



Description	This command controls the enabling of output triggers. When a trigger is enabled, a trigger causes the specified action to occur. If the trigger system is not enabled, all triggers are ignored.	
Syntax	:INITiate[:IMMEDIATE][:TRANSient]	
Example	:INIT	

Measure Commands

:MEASure[:SCALar]:CURRent:CFACtor	61
:MEASure[:SCALar]:CURRent:HIGH	61
:MEASure[:SCALar]:CURRent:PEAK:CLEar	61
:MEASure[:SCALar]:CURRent:PEAK:HOLD	62
:MEASure[:SCALar]:CURRent[:RMS]	62
:MEASure[:SCALar]:CURRent:RANGe	62
:MEASure[:SCALar]:FREQUency	62
:MEASure[:SCALar]:POWer[:AC]:APParent	63
:MEASure[:SCALar]:POWer[:AC]:PFACTOR	63
:MEASure[:SCALar]:POWer[:AC]:REACTIVE	63
:MEASure[:SCALar]:POWer[:AC][:REAL]	63
:MEASure[:SCALar]:VOLTagE[:RMS]	63

:MEASure[:SCALar]:CURRent:CFACtor → Query

Description	Returns the output current crest factor.
Query syntax	:MEASure[:SCALar]:CURRent:CFACtor?
Return parameter	<NR2> Returns the crest factor.

:MEASure[:SCALar]:CURRent:HIGH → Query

Description	Returns the output current maximum peak value (I _{pk}).
Note:	Current maximum peak value is defined as the highest peak value in the complete period.
Syntax	:MEASure[:SCALar]:CURRent:HIGH?
Return parameter	<NR2> Returns the current in amps.

:MEASure[:SCALar]:CURRent:PEAK:CLEar Set →

Description	Clears the current peak-hold value.
Syntax	:MEASure[:SCALar]:CURRent:PEAK:CLEar

:MEASure[:SCALar]:CURRent:PEAK:HOLD → **Query**

Description	Returns the current peak hold value in amps (Ipk).
Syntax	:MEASure[:SCALar]:CURRent:PEAK:HOLD?
Return	<NR2> Returns the peak hold value in amps.

:MEASure[:SCALar]:CURRent[:RMS] → **Query**

Description	Returns the output current (Irms).
Syntax	:MEASure[:SCALar]:CURRent[:RMS]?
Return	<NR2> Returns the Irms.

Set →

:MEASure[:SCALar]:CURRent:RANGe → **Query**

Description	Sets or queries the current range.
Syntax	:MEASure[:SCALar]:CURRent:RANGe?
Query Syntax	{AUTO R0A28 R1A40 R14A0 R70A0 R140A}
Parameter/	AUTO Auto range.
Return parameter	R0A28 0.28A range (APS-7050, APS-7100 only)
	R1A40 1.4A range (APS-7050, APS-7100 only)
	R14A0 14A range
	R70A0 70A range (APS-7050, APS-7100 only)
	R140A 140A range (APS-7200, APS-7300 only)

Example :MEAS:SCAL:CURR:RANG AUTO
 Sets the current range to Auto range.

:MEASure[:SCALar]:FREQuency → **Query**

Description	Returns the SYNC signal source frequency in Hz.
Syntax	:MEASure[:SCALar]:FREQuency?
Return	<NR2> Returns the SYNC frequency in Hz. (500Hz or 999.9Hz(with option))

:MEASure[:SCALar]:POWer[:AC]:APParent → [Query](#)

Description	Returns the apparent power (VA).
Syntax	:MEASure[:SCALar]:POWer[:AC]:APParent?
Return	<NR2> Returns the apparent power in VA.

:MEASure[:SCALar]:POWer[:AC]:PFACTOR → [Query](#)

Description	Returns the power factor.
Syntax	:MEASure[:SCALar]:POWer[:AC]:PFACTOR?
Return	<NR2> Returns the power factor.

:MEASure[:SCALar]:POWer[:AC]:REACTIVE → [Query](#)

Description	Returns the reactive power (VAR).
Syntax	:MEASure[:SCALar]:POWer[:AC]:REACTIVE?
Return	<NR2> Returns the reactive power in VAR.

:MEASure[:SCALar]:POWer[:AC][:REAL] → [Query](#)

Description	Returns the active power in Watts.
Syntax	:MEASure[:SCALar]:POWer[:AC][:REAL]?
Return	<NR2> Returns the power in W.

:MEASure[:SCALar]:VOLTage[:RMS] → [Query](#)

Description	Returns the voltage (Vrms).
Syntax	:MEASure[:SCALar]:VOLTage[:RMS]?
Return	<NR2> Returns the voltage in Vrms.

Memory Commands

:MEMory:SAV.....	64
:MEMory:RCL.....	64
:MEMory:TRIGgered	65

:MEMory:SAV



Description	Saves the settings into memory slot M0 ~ M9. These memory slots are mapped to the preset settings. Equivalent to the *SAV command.	
Syntax	:MEMory:SAV {<NR1> MINimum MAXimum}	
Parameter	<NR1>	0~9
	MINimum	0
	MAXimum	9
Example	:MEMory:SAV 1 Save the settings to M1.	

:MEMory:RCL

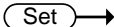
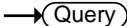

Description	Recalls the settings from memory slot M0~M9. These memory slots are mapped to the preset settings. Equivalent to the *RCL command.	
Syntax	:MEMory:RCL {<NR1> MINimum MAXimum}	
Parameter	<NR1>	0~9
	MINimum	0
	MAXimum	9
Example	:MEMory:RCL Recall the settings to M1.	

:MEMory:TRIGgered

Description Recalls the selected memory (M0 ~ M9) when receiving an input trigger. These memory slots are mapped to the preset settings.

Syntax :MEMory:TRIGgered {<NR1>|MINimum|MAXimum}

Query Syntax :MEMory:TRIGgered?

Parameter/ <NR1> 0 ~ 9

Return parameter MIN 0

 MAX 9

Example :MEMory:TRIGgered 1

 Recalls M1 when an input trigger is received.

Output Commands

:OUTPut:PON	66
:OUTPut:PROTection:CLEar	66
:OUTPut[:STATe]	66
:OUTPut[:STATe]:TRIGgered.....	67

:OUTPut:PON

Set →

→ Query

Description	Sets the output state at power-on.	
Syntax	:OUTPut:PON {<bool> OFF ON}	
Return Syntax	:OUTPut:PON?	
Parameter	OFF 0	Disabled
	ON 1	Enabled
Return parameter	<bool>	Returns the power-on state.

:OUTPut:PROTection:CLEar

Set →

Description	Clears the protection circuits (OCP, OTP).	
Syntax	:OUTPut:PROTection:CLEar	

:OUTPut[:STATe]

Set →

→ Query

Description	Sets or queries the output state of power source.	
Syntax	:OUTPut[:STATe] {<bool> OFF ON}	
Query Syntax	:OUTPut[:STATe]?	
Parameter	OFF 0	Turns the output off.
	ON 1	Turns the output on.
Return parameter	<bool>	Returns output status of the instrument.

Set →

→ Query

:OUTPut[:STATe]:TRIGgered

Description Turns the output on/off when a trigger has been generated.

Syntax :OUTPut[:STATe]:TRIGgered {<bool>|OFF|ON}

Query Syntax :OUTPut[:STATe]:TRIGgered?

Parameter/ Return parameter	OFF 0	Turns the output off when a trigger is generated.
	ON 1	Turns the output on when a trigger is generated.

Example The following example shows how to configure and trigger the output trigger:

```
:SYSTEM:CONFigure:TRIGger:INPut:SOURce NONE
:TRIGger:OUTPut:SOURce BUS (*TRG)
```

After you receive a trigger from the trigger source, you can then turn the output ON/OFF:

```
:OUTPut[:STATe]:TRIGgered <bool>|OFF|ON
:INITiate[:IMMediate]:NAME OUTPut
```

Lastly send a *TRG or trigger input.

Status Commands

For an overview of all the status registers, their associated register contents and the system diagram, please see the status overview on page 125

:STATus:OPERation:CONDition	68
:STATus:OPERation:ENABle.....	68
:STATus:OPERation[:EVENT]	69
:STATus:OPERation:NTRansition	69
:STATus:OPERation:PTRansition	69
:STATus:QUESTionable[:EVENT].....	70
:STATus:QUESTionable:CONDition	70
:STATus:QUESTionable:ENABle	70
:STATus:QUESTionable:NTRansition	70
:STATus:QUESTionable:PTRansition.....	71
:STATus:PRESet.....	71
:STATus:WARNIing:CONDition	72
:STATus:WARNIing:ENABle	72
:STATus:WARNIing[:EVENT].....	72
:STATus:WARNIing:NTRansition	73
:STATus:WARNIing:PTRansition	73

:STATus:OPERation:CONDition → Query

Description	Queries the Operation Status register. This query will not clear the register.
-------------	--

Syntax	:STATus:OPERation:CONDition?
--------	------------------------------

Return	<NR1> Returns the bit sum of the Operation Condition register. (0~32767)
--------	--

Set →

:STATus:OPERation:ENABle → Query

Description	Sets or queries the bit sum of the Operation Status Enable register.
-------------	--

Syntax :STATus:OPERation:ENABLE <NR1>

Query Syntax :STATus:OPERation:ENABLE?

Parameter <NR1> 0~32767

Return parameter <NR1> 0~32767

:STATus:OPERation[:EVENT] → Query

Description Queries the Operation Status Event register and clears the contents of the register.

Syntax :STATus:OPERation[:EVENT]?

Return <NR1> Returns the bit sum of the Operation Status Event register.

Set →

:STATus:OPERation:NTRansition → Query

Description Sets or queries the bit sum of the negative transition filter of the Operation Status register.

Syntax :STATus:OPERation:NTRansition <NR1>

Query Syntax :STATus:OPERation:NTRansition?

Parameter <NR1> 0~32767

Return parameter <NR1> 0~32767

Set →

:STATus:OPERation:PTRansition → Query

Description Sets or queries the bit sum of the positive transition filter of the Operation Status register.

Syntax :STATus:OPERation:PTRansition <NR1>

:STATus:OPERation:PTRansition?

Parameter <NR1> 0~32767

Return parameter <NR1> 0~32767

:STATus:QUESTionable[:EVENT] → Query

Description Queries the bit sum of the Questionable Status Event register. This query will also clear the contents of the register.

Query Syntax :STATus:QUESTionable[:EVENT]?

Return parameter <NR1> 0~32767

:STATus:QUESTionable:CONDition → Query

Description Queries the status (bit sum) of the Questionable Status register. This query will not clear the register.

Query Syntax :STATus:QUESTionable:CONDition?

Return parameter <NR1> 0~32767

Set →

:STATus:QUESTionable:ENABLE → Query

Description Sets or queries the bit sum of the Questionable Status Enable register.

Syntax :STATus:QUESTionable:ENABLE <NR1>

Query Syntax :STATus:QUESTionable:ENABLE?

Parameter <NR1> 0~32767

Return parameter <NR1> 0~32767

Set →

:STATus:QUESTionable:NTRansition → Query

Description Sets or queries the bit sum of the negative transition filter of the Questionable Status register.

Syntax :STATus:QUESTionable:NTRansition <NR1>

Query Syntax :STATus:QUESTionable:NTRansition?

Parameter <NR1> 0~32767

Return parameter <NR1> 0~32767

:STATus:QUEStionable:PTRansition (Set) →
→ (Query)

Description	Sets or queries the bit sum of the positive transition filter of the Questionable Status register.
Syntax	:STATus:QUEStionable:PTRansition <NR1>
Return Syntax	:STATus:QUEStionable:PTRansition?
Parameter	<NR1> 0~32767
Return parameter	<NR1> 0~32767

:STATus:PRESet (Set) →

Description This command resets the ENABLE register, the PTRansition filter and NTRansition filter on the Operation Status, Questionable Status and Warning Status Registers. The registers/filters will be reset to a default value.

Default Register/Filter Values	Setting
QUEStionable Status Enable	0x0000
QUEStionable Status Positive Transition	0x7FFF
QUEStionable Status Negative Transition	0x0000
Operation Status Enable	0x0000
Operation Status Positive Transition	0x7FFF
Operation Status Negative Transition	0x0000
WARning Status Enable	0x0000
WARning Status Positive Transition	0x7FFF
WARning Status Negative Transition	0x0000

Summary: The Questionable Status Enable registers, the Operation Status Enable registers and Warning Status registers are both reset to 0.

The Questionable Status, Operation Status and Warning Positive Transition filters are all set high (0x7FFF) and the Negative Transition filters are all set low (0x0000). I.e., only positive transitions will be recognized for the Questionable Status, Operation Status and Warning Status registers.

Syntax :STATus:PRESet

:STATus:WARning:CONDition → Query

Description Queries the Warning Status register. This query will not clear the register.

Syntax :STATus:WARning:CONDition?

Return <NR1> Returns the bit sum of the Warning Condition register. (0~32767)

:STATus:WARning:ENABLE Set →
→ Query

Description Sets or queries the bit sum of the Warning Status Enable register.

Syntax :STATus:WARning:ENABLE <NR1>

Query Syntax :STATus:WARning:ENABLE?

Parameter <NR1> 0~32767

Return parameter <NR1> 0~32767

:STATus:WARning[:EVENT] → Query

Description Queries the Warning Status Event register and clears the contents of the register.

Syntax :STATus:WARning[:EVENT]?

Return <NR1> Returns the bit sum of the Warning Status Event register.

:STATus:WARNing:NTRansition  

Description Sets or queries the bit sum of the negative transition filter of the Warning Status register.

Syntax :STATus:WARNing:NTRansition <NR1>

Query Syntax :STATus:WARNing:NTRansition?

Parameter <NR1> 0~32767

Return parameter <NR1> 0~32767

:STATus:WARNing:PTRansition  

Description Sets or queries the bit sum of the positive transition filter of the Warning Status register.

Syntax :STATus:WARNing:PTRansition <NR1>

:STATus:WARNing:PTRansition?

Parameter <NR1> 0~32767

Return parameter <NR1> 0~32767

System Function Command

:SYSTem:BEEPer:STATe	75
:SYSTem:COMMunicate:GPIB[:SELf]:ADDReSS	75
:SYSTem:COMMunicate:LAN:DHCP	75
:SYSTem:COMMunicate:LAN:DNS	76
:SYSTem:COMMunicate:LAN:GATEway	76
:SYSTem:COMMunicate:LAN:IPADdress	77
:SYSTem:COMMunicate:LAN:MAC	77
:SYSTem:COMMunicate:LAN:SMASk	77
:SYSTem:COMMunicate:RLSState	78
:SYSTem:COMMunicate:SERial[:RECeive]	
:TRANsmit:BAUD	78
:SYSTem:COMMunicate:SERial[:RECeive]	
:TRANsmit:BITS	79
:SYSTem:COMMunicate:SERial[:RECeive]	
:TRANsmit:PARity	79
:SYSTem:COMMunicate:SERial[:RECeive]	
:TRANsmit:SBITs	80
:SYSTem:COMMunicate:TCPip:CONTRol	80
:SYSTem:COMMunicate:USB:FRONt:STATe	80
:SYSTem:COMMunicate:USB:REAR:MODE	81
:SYSTem:COMMunicate:USB:REAR:STATe	81
:SYSTem:CONFigure:RAMP[:MODE]	81
:SYSTem:CONFigure:RAMP:VOLTagE	82
:SYSTem:CONFigure:RAMP:TIME	82
:SYSTem:CONFigure[:MODE]	83
:SYSTem:CONFigure:PHASe	83
:SYSTem:CONFigure:SDIP[:MODE]	83
:SYSTem:CONFigure:SDIP:SITe	84
:SYSTem:CONFigure:SDIP:VOLTagE	84
:SYSTem:CONFigure:SDIP:WIDTh	85
:SYSTem:CONFigure:TRIGger:INPut:SOURce	85
:SYSTem:CONFigure:TRIGger:INPut:WIDTh	86
:SYSTem:CONFigure:TRIGger:OUTPut:WIDTh	86
:SYSTem:CONFigure:TRIGger:OUTPut:SOURce	87
:SYSTem:CONFigure:TRIGger:OUTPut:LEVel	87
:SYSTem:ERRor	88

:SYSTem:ERRor:ENABle88
 :SYSTem:KLOCK88
 :SYSTem:LANGuage:EMULation89
 :SYSTem:REBoot89
 :SYSTem:WRELease89
 :SYSTem:IPKHold:TIME89
 :SYSTem:HOLD:STATe90

:SYSTem:BEEPer:STATe Set →
→ Query

Description	Sets or queries the buzzer state on/off.	
Syntax	:SYSTem:BEEPer:STATe {<bool> OFF ON}	
Query Syntax	:SYSTem:BEEPer:STATe?	
Parameter	OFF 0	Turns the buzzer off.
	ON 1	Turns the buzzer on.
Return parameter	<bool>	Returns the buzzer status.

**:SYSTem:COMMunicate:GPIB[:SELF]
:ADDRess** Set →
→ Query

Description	Sets or queries the GPIB address.	
Note:	The setting will only be valid after the power has been cycled.	
Syntax	:SYSTem:COMMunicate:GPIB[:SELF]:ADDRess <NR1>	
Query Syntax	:SYSTem:COMMunicate:GPIB[:SELF]:ADDRess?	
Parameter/Return	<NR1>	0~30
Example	SYST:COMM:GPIB:ADDR 15 Sets the GPIB address to 15.	

:SYSTem:COMMunicate:LAN:DHCP Set →
→ Query

Description	Turns DHCP on/off. Queries the DHCP status.	
-------------	---	--

Note: The setting will only be valid after the power has been cycled.

Syntax :SYSTem:COMMunicate:LAN:DHCP
{<bool>|OFF|ON}

Query Syntax :SYSTem:COMMunicate:LAN:DHCP?

Parameter OFF | 0 DHCP off
ON | 1 DHCP on

Return parameter <bool> Returns the DHCP status.

Set →

:SYSTem:COMMunicate:LAN:DNS

→ Query

Description Sets or queries the DNS address.

Note: The setting will only be valid after the power has been cycled.

Syntax :SYSTem:COMMunicate:LAN:DNS <string>

Query Syntax :SYSTem:COMMunicate:LAN:DNS?

Parameter/Return <string> DNS in string format ("mask")
Applicable ASCII characters: 20H to 7EH

Example SYST:COMM:LAN:DNS "172.16.1.252"
Sets the DNS to 172.16.1.252.

Set →

:SYSTem:COMMunicate:LAN:GATEway

→ Query

Description Sets or queries the Gateway address.

Note: The setting will only be valid after the power has been cycled.

Syntax :SYSTem:COMMunicate:LAN:GATEway <string>

Query Syntax :SYSTem:COMMunicate:LAN:GATEway?

Parameter/Return <string> Gateway address in string format ("address")
Applicable ASCII characters: 20H to 7EH

Example SYST:COMM:LAN:GATE "172.16.0.254"
Sets the LAN gateway to 172.16.0.254.

:SYSTem:COMMunicate:LAN:IPADdress (Set) →
→ (Query)

Description	Sets or queries LAN IP address.
Note:	The setting will only be valid after the power has been cycled.
Syntax	:SYSTem:COMMunicate:LAN:IPADdress <string>
Query Syntax	:SYSTem:COMMunicate:LAN:IPADdress?
Parameter/Return	<string> LAN IP address in string format ("address") Applicable ASCII characters: 20H to 7EH
Example	SYST:COMM:LAN:IPAD "172.16.5.111" Sets the IP address to 172.16.5.111.

:SYSTem:COMMunicate:LAN:MAC → (Query)

Description	Returns the unit MAC address as a string. The MAC address cannot be changed.
Query Syntax	:SYSTem:COMMunicate:LAN:MAC?
Return parameter	<string> Returns the MAC address in the following format "FF-FF-FF-FF-FF-FF"
Example	SYST:COMM:LAN:MAC? 02-80-AD-20-31-B1 Returns the MAC address.

:SYSTem:COMMunicate:LAN:SMASk (Set) →
→ (Query)

Description	Sets or queries the LAN subnet mask.
Note:	The setting will only be valid after the power has been cycled.
Syntax	:SYSTem:COMMunicate:LAN:SMASk <string>
Query Syntax	:SYSTem:COMMunicate:LAN:SMASk?
Parameter/Return	<string> Subnet mask in string format ("mask") Applicable ASCII characters: 20H to 7EH
Example	SYST:COMM:LAN:SMASk "255.255.0.0" Sets the LAN mask to 255.255.0.0.

Set →
 → Query

:SYSTem:COMMunicate:RLSTate

Description	Enables or disables local/remote state of the instrument.	
Syntax	:SYSTem:COMMunicate:RLSTate {LOCAL REMOte RWLock}	
Query Syntax	:SYSTem:COMMunicate:RLSTate?	
Parameter/Return parameter	LOCAL	All keys are valid. This instrument is controlled by the front panel controls.
	REMOte	All keys are invalid, except for the [local] key and the ability to turn the output off.
	RWLock	All keys are invalid. The instrument can only be controlled remotely.
Example	:SYST:COMM:RLST LOCAL Sets the operating mode to local.	



Set →
 → Query

**:SYSTem:COMMunicate:SERial[:RECEive]
:TRANsmit:BAUD**

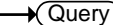
Description	Sets or queries the UART baud rate.	
Note:	The setting will only be valid after the power has been cycled.	
Syntax	:SYSTem:COMMunicate:SERial[:RECEive]:TRANsmit :BAUD <NR1>	
Query Syntax	:SYSTem:COMMunicate:SERial[:RECEive]:TRANsmit :BAUD?	
Parameter/Return	<NR1>	1200, 2400, 4800, 9600, 19200, 38400, 57600, 115200
Example	SYST:COMM:SER:TRAN:BAUD? >2400 Returns the baud rate settings.	

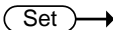

:SYSTem:COMMunicate:SERial[:RECeive]  →
:TRANsmit:BITS → 

Description	Sets or queries the UART number of data bits.	
Note:	The setting will only be valid after the power has been cycled.	
Syntax	:SYSTem:COMMunicate:SERial[:RECeive]:TRANsmit :BITS <NR1>	
Query Syntax	:SYSTem:COMMunicate:SERial[:RECeive]:TRANsmit :BITS?	
Parameter	0	7 bits
	1	8 bits
Return parameter	+0	7 bits
	+1	8 bits
Example	SYST:COMM:SER:TRAN:BITS? >+1 Indicates that 8 data bits are used for the UART connection.	

:SYSTem:COMMunicate:SERial[:RECeive]  →
:TRANsmit:PARity → 

Description	Sets or queries the parity of the UART connection.	
Note:	The setting will only be valid after the power has been cycled.	
Syntax	:SYSTem:COMMunicate:SERial[:RECeive]:TRANsmit :PARity {NONE ODD EVEN}	
Query Syntax	:SYSTem:COMMunicate:SERial[:RECeive]:TRANsmit :PARity?	
Parameter	NONE	No parity
	ODD	Odd parity
	EVEN	Even parity
Return parameter	+0	No parity
	+1	Odd parity
	+2	Even parity

Example SYST:COMM:SER:TRAN:PARity?>+0
Indicates that no parity is used for the UART connection.

:SYSTem:COMMunicate:SERial[:RECEive] 
:TRANsmmit:SBITs 

Description Sets or queries the number of stop bits used for the UART connection.

Note: The setting will only be valid after the power has been cycled.

Syntax :SYSTem:COMMunicate:SERial[:RECEive]:TRANsmmit:SBITs <NR1>

Query Syntax :SYSTem:COMMunicate:SERial[:RECEive]:TRANsmmit:SBITs?

Parameter	0	1 stop bit
	1	2 stop bits

Return parameter	+0	1 stop bit
	+1	2 stop bits

Example SYST:COMM:SER:TRAN:SBITs?>+1
Indicates that one stop bit is used for the UART connection.

:SYSTem:COMMunicate:TCPIp:CONTrol 

Description Queries the socket port number.

Query Syntax :SYSTem:COMMunicate:TCPIp:CONTrol?

Return parameter <NR1> 0000 ~ 9999

Example SYST:COMM:TCP:CONT?>2268
Returns the socket port number.

:SYSTem:COMMunicate:USB:FRONT:STATe 

Description Queries the front panel USB-A port state.

Query Syntax	:SYSTem:COMMunicate:USB:FRONT:STATe?	
Return parameter	+0	<NR1>Absent
	+1	<NR1>Mass Storage

Set →
 → Query

Description Sets or queries the speed of the rear panel USB B port. This setting is applied only after the unit is reset.

Syntax	:SYSTem:COMMunicate:USB:REAR:MODE {<NR1> AUTO FULL}	
Query Syntax	:SYSTem:COMMunicate:USB:REAR:MODE?	
Parameter	0 AUTO	AUTO
	1 FULL	FULL
Return parameter	<NR1>	
	+0	AUTO
	+1	FULL

:SYSTem:COMMunicate:USB:REAR:STATe → Query

Description	Queries the rear panel USB-B port state.	
Query Syntax	:SYSTem:COMMunicate:USB:REAR:STATe?	
Return parameter	+0	<NR1>Absent
	+1	<NR1>Connected to the PC

Set →
 → Query

Description Sets or queries the ramp mode for the power supply or disables the ramp mode.

Syntax	:SYSTem:CONFigure:RAMP[:MODE] {<NR1> DISable TIME VOLTage}	
Query Syntax	:SYSTem:CONFigure:RAMP[:MODE]?	
Parameter	0 DISable	Disables ramp mode.
	1 TIME	Time mode
	2 VOLTage	Voltage mode

Return parameter	<NR1>	
	+0	Ramp mode is disabled.
	+1	Time mode
	+2	Voltage mode

Set →

:SYSTem:CONFigure:RAMP:VOLTage → Query

Description	Sets or queries the ramp Vup and Vdn parameters.	
Syntax	:SYSTem:CONFigure:RAMP:VOLTage[:LEVel][:AMPLitude] {<NR2> MINimum MAXimum,<NR2> MINimum MAXimum}	
Query Syntax	:SYSTem:CONFigure:RAMP:VOLTage[:LEVel][:AMPLitude]? [MINimum MAXimum]	
Parameter	<NR2>	Vup (Vrms).
	MINimum	Minimum Vup.
	MAXimum	Maximum Vdn.
	<NR2>	Vdn (Vrms).
	MINimum	Minimum Vup.
	MAXimum	Maximum Vdn.
Return parameter	<NR2>,<NR2>	Returns the Vup,Vdn voltage levels.
Example	:SYST:CONF:RAMP:VOLT? >+0.2000,+0.3000 Returns the Vup,Vdn values.	

Set →

:SYSTem:CONFigure:RAMP:TIME → Query

Description	Sets or queries the ramp Tup and Tdn parameters.	
Syntax	:SYSTem:CONFigure:RAMP:TIME {<NR2> MINimum MAXimum,<NR2> MINimum MAXimum}	
Query Syntax	:SYSTem:CONFigure:RAMP:TIME? [MINimum MAXimum]	
Parameter	<NR2>	Tup in milliseconds
	MINimum	Minimum Tup
	MAXimum	Maximum Tup
	<NR2>	Tdn in milliseconds
	MINimum	Minimum Tdn
	MAXimum	Maximum Tdn

Return parameter <NR2>,<NR2> Returns the Tup,Tdn time.

Example :SYSTem:CONF:RAMP:TIME?
>+3.0000,+4.0000
Returns the Tup,Tdn values.

Set →

→ Query

:SYSTem:CONFigure[:MODE]

Description Sets or queries the test mode for the power supply.

Syntax :SYSTem:CONFigure[:MODE]
{<NR1>|CONTInuous|SEQuence|SIMulation|PROGram}

Query Syntax :SYSTem:CONFigure[:MODE]?

Parameter	0 CONTInuous	Continuous mode (normal operating mode)
	1 SEQuence	Sequence mode
	2 SIMulation	Simulation mode
	3 PROGram	Program mode

Return parameter	<NR1> CONT	Continuous mode (normal operating mode)
	SEQ	Sequence mode
	SIM	Simulation mode
	PROG	Program mode

:SYSTem:CONFigure:PHASe

→ Query

Description Queries the phase of the system.

Query Syntax :SYSTem:CONFigure:PHASe?

Return parameter +0 <NR1>Single phase

Set →

→ Query

:SYSTem:CONFigure:SDIP[:MODE]

Description Sets or queries the surge/dip mode for the power supply or disables the surge/dip mode.

Syntax :SYSTem:CONFigure:SDIP[:MODE]
{<NR1>|DISable|MANual|AUTO }

Query Syntax :SYSTem:CONFigure:SDIP[:MODE]?

Parameter	0 DISable	Disables surge/ dip mode.
	1 MANual	Sets the surge/ dip mode to manual.
	2 AUTO	Sets the surge/ dip mode to auto.
Return parameter	<NR1>	
	+0	Surge/ dip mode off.
	+1	Manual mode.
	+2	Auto mode.

Set →

:SYSTem:CONFIgure:SDIP:SITE

→ Query

Description	Sets or queries the surge/ dip site (equivalent to the T1 time setting using the panel controls).	
Syntax	:SYSTem:CONFIgure:SDIP:SITE {<NR2> MINimum MAXimum}	
Query Syntax	:SYSTem:CONFIgure:SDIP:SITE? [MINimum MAXimum]	
Parameter	<NR2>	Site number: 0 ~99ms(manual SDIP mode) 0 ~22ms(auto SDIP mode)
	MINimum	Minimum site 0
	MAXimum	Maximum site 99(manual)/22(auto)
Return parameter	<NR1>	Returns the site in msec (+NR1).

Set →

:SYSTem:CONFIgure:SDIP:VOLTage

→ Query



Description	Sets or queries the surge/ dip voltage level.	
Syntax	:SYSTem:CONFIgure:SDIP:VOLTage[:LEVel][:AMPLitude] {<NR2> MINimum MAXimum}	
Query Syntax	:SYSTem:CONFIgure:SDIP:VOLTage[:LEVel][:AMPLitude]? [MINimum MAXimum]	
Parameter	<NR2>	ACV level from 0V.
	MINimum	Minimum voltage (0V)
	MAXimum	Maximum voltage (set voltage range)
Return parameter	<NR1>	Returns the surge/ dip voltage (+NR1).

:SYSTem:CONFigure:SDIP:WIDTh (Set) →
→ (Query)

Description	Sets or queries the width of the surge/ dip site.	
Syntax	:SYSTem:CONFigure:SDIP:WIDTh {<NR2> MINimum MAXimum}	
Query Syntax	:SYSTem:CONFigure:SDIP:WIDTh? [MINimum MAXimum]	
Parameter	<NR2> MINimum MAXimum	Width in milliseconds Minimum width Maximum width
Return parameter	<NR2>	Returns the width in ms.

:SYSTem:CONFigure:TRIGger:INPut (Set) →
:SOURce → (Query)

Description	Configures the source for the trigger input. Equivalent to the Input Pin>Action settings when Shift + 2[Trigger] is pressed using the front panel controls.	
Syntax	:SYSTem:CONFigure:TRIGger:INPut:SOURce {<NR1> NONE OUTPut SETTing PRESet SDIP}	
Query Syntax	:SYSTem:CONFigure:TRIGger:INPut:SOURce?	
Parameter	0 NONE 1 OUTPut 2 SETTing 3 PRESet 4 SDIP	No source is assigned. Turning the output on will generate a trigger. Changing a setting will generate a trigger. Loading a preset will generate a trigger. Surge/ dip will generate a trigger.
Return parameter	+0 +1 +2 +3	No source is assigned. Turning the output on will generate a trigger. Changing a setting will generate a trigger. Loading a preset will generate a trigger.
Example	:SYST:CONF:TRIG:INP:SOUR? >0 No trigger source is assigned.	

:SYSTem:CONFigure:TRIGger:INPut 
:WIDTh 

Description	Sets or queries the type of trigger input. The trigger input can be set as a user-defined pulse width or as a trigger level.	
Syntax	:SYSTem:CONFigure:TRIGger:INPut:WIDTh {<NR2> MINimum MAXimum}	
Query Syntax	:SYSTem:CONFigure:TRIGger:INPut:WIDTh? [MINimum MAXimum]	
Parameter	<NR2>	0, 1ms ~ 60ms. 0 = trigger controlled by trigger level, not pulse width.
	MINimum	0
	MAXimum	60ms
Return parameter	<NR2>	Returns the input width.
Example	:SYST:CONF:TRIG:INP:WIDT 0.005 Sets the input width to 5ms.	

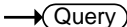
:SYSTem:CONFigure:TRIGger:OUTPut 
:WIDTh 

Description	Sets or queries the type of trigger output. The trigger output can be set as a user-defined pulse width or as a trigger output level.	
Syntax	:SYSTem:CONFigure:TRIGger:OUTPut:WIDTh {<NR2> MINimum MAXimum}	
Query Syntax	:SYSTem:CONFigure:TRIGger:OUTPut:WIDTh? [MINimum MAXimum]	
Parameter	<NR2>	0, 1ms ~ 60ms. 0 = trigger output is set to output level, not pulse width.
	MINimum	0 = trigger level
	MAXimum	60ms
Return parameter	<NR2>	Returns the output width.
Example	:SYST:CONF:TRIG:OUT:WIDT 0.005 Sets the input width to 5ms.	

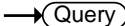
`:SYSTem:CONFigure:TRIGger:OUTPut` 
`:SOURce` 

Description	Configures the source for the trigger output. Equivalent to the Output Pin>Source settings when Shift + 2[Trigger] is pressed using the front panel controls.	
Syntax	:SYSTem:CONFigure:TRIGger:OUTPut:SOURce {<NR1> NONE OUTPut SETTing PRESet ALL}	
Query Syntax	:SYSTem:CONFigure:TRIGger:OUTPut:SOURce?	
Parameter	0 NONE	No source is assigned.
	1 OUTPut	Turning the output on will generate a trigger.
	2 SETTing	Changing a setting will generate a trigger.
	3 PRESet	Loading a preset will generate a trigger.
	4 ALL	The output source is any of the above actions.
Return parameter	+0	No source is assigned.
	+1	Turning the output on will generate a trigger.
	+2	Changing a setting will generate a trigger.
	+3	Loading a preset will generate a trigger.
	+4	The output source is any of the above actions.
Example	:SYST:CONF:TRIG:OUTP:SOUR? >0 No trigger source is assigned.	

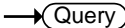
`:SYSTem:CONFigure:TRIGger:OUTPut` 
`:LEVel` 

Description	Sets or queries the trigger output level when the trigger output width is set to 0. See the :SYSTem:CONFigure:TRIGger:OUTPut:WIDTh command.	
-------------	---	--

Syntax	:SYSTem:CONFIgure:TRIGger:OUTPut:LEVel {<NR1> LOW HIGH}	
Query Syntax	:SYSTem:CONFIgure:TRIGger:OUTPut:LEVel?	
Parameter/	<NR1>	0 = Low, 1 = High
Return parameter	LOW	Low level
	HIGH	High level
Example	:SYSTem:CONFIgure:TRIGger:OUTPut:LEVel HIGH Sets the trigger level to high.	

:SYSTem:ERRor → Query

Description	Queries the error queue. The last error message is returned. A maximum of 32 errors are stored in the error queue.	
Query Syntax	:SYSTem:ERRor?	
Return parameter	<string>	Returns an error code followed by an error message as a single string.
Example	SYSTem:ERRor? -100, "Command error"	

:SYSTem:ERRor:ENABle Set →

Description	Clears the Error Queue and enables all error messages to be placed in the System Error Queue.	
Syntax	:SYSTem:ERRor:ENABle	

:SYSTem:KLOCK Set →
→ Query

Description	Enables or disables the front panel key lock.	
Syntax	:SYSTem:KLOCK {<bool> OFF ON}	
Query Syntax	:SYSTem:KLOCK?	
Parameter	OFF 0	Panel keys unlocked
	ON 1	Panel keys locked
Return parameter	<bool>	Returns the key lock status.

:SYSTem:LANGUage:EMULation (Set) →
→ (Query)

Description	Sets the SCPI remote control emulation mode.	
Syntax	:SYSTem:LANGUage:EMULation <string>	
Query Syntax	:SYSTem:LANGUage:EMULation?	
Parameter/ Return parameter	<string> "NONE" "EXTECH" "N/A"	The string parameter determines the which remote control mode. No emulation is used. The SCPI mode continues to use the GW Instek SCPI remote control mode. Sets the emulation mode to EXTECH SCPI remote control mode. Sets the emulation mode to ALL POWER mode (not an SCPI control mode).

Note: The string parameter must be enclosed in double brackets.

:SYSTem:REBoot (Set) →

Description	Reboots the APS system.
Syntax	:SYSTem:REBoot

:SYSTem:WRELease (Set) →

Description	Clears the protection circuits (OCP, OTP). This command is functionally the same as the :OUTPut:PROTection:CLear command (page 66).
Syntax	:SYSTem:WRELease

:SYSTem:IPKHold:TIME (Set) →
→ (Query)

Description	Sets or queries the Ipeak hold time for peak current measurement when output on.
-------------	--

Syntax	:SYSTem:IPKhold:TIME {<NR1>}
Query Syntax	:SYSTem:IPKhold:TIME?
Parameter	<NR1> 1~60,000
Example	:SYSTem:IPKHold:TIME 10 Sets the Ipeak hold time 10ms to measure when output on.

:SYSTem:HOLD:STATe





Description	Sets or queries the freeze hold state on/off.	
Syntax	:SYSTem:HOLD:STATe {<bool> OFF ON}	
Query Syntax	:SYSTem:HOLD:STATe?	
Parameter	OFF 0	Turns the freeze hold off.
	ON 1	Turns the freeze hold on.
Return parameter	<bool>	Returns the freeze hold status.

Trigger Commands

The triggering commands are divided into trigger input and trigger output commands. The trigger input commands are further divided into Bus, Immediate and External commands. To use the trigger subsystem a trigger source must be selected, the triggering system must then be initiated (immediate trigger only), and finally triggered, either manually or by a system trigger.

The trigger sources range from loading a memory setting, turning on the output or one of the transient trigger sources.

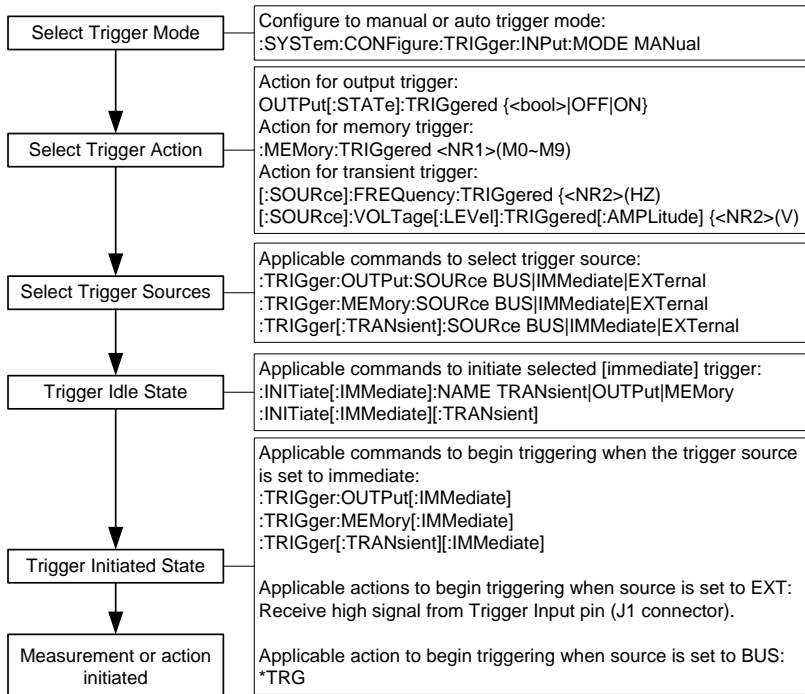
The flow chart below shows the basic steps for using the trigger system.



Trigger Examples

The follow 3 examples show the steps necessary to use the output, transient or memory trigger system:

Output Trigger Example:

```
:SYSTem:CONFIgure:TRIGger:INPut:MODE MANUal
:TRIGger:OUTPut:SOURce BUS
:OUTPut:STATe:TRIGgered <bool>|OFF|ON
:INITiate:IMMEDIATE:NAME OUTPut
*TRG
```

Transient Trigger Example:

```
:SYSTem:CONFIgure:TRIGger:INPut:MODE MANUal
:SOURce:FREQuency:TRIGgered 60
:SOURce:VOLTage:LEVel:TRIGgered:AMPLitude 100
:TRIGger:TRANsient:SOURce BUS
:INITiate:IMMEDIATE:NAME TRANsient
*TRG
```

Memory Trigger Example:

```
:SYSTem:CONFIgure:TRIGger:INPut:MODE MANUal
:MEMory:TRIGgered 1
:TRIGger:MEMory:SOURce BUS
:INITiate:IMMEDIATE:NAME MEMory
*TRG
```

:TRIGger:OUTPut:SOURce	93
:TRIGger:OUTPut[:IMMediate]	93
:TRIGger:MEMory:SOURce	94
:TRIGger:MEMory[:IMMediate]	94
:TRIGger:SDIP:SOURce	94
:TRIGger:SDIP[:IMMediate]	95
:TRIGger:SEQuence:SElected:EXECute	95
:TRIGger:SIMulation:SElected:EXECute	95
:TRIGger[:TRANsient]:SOURce	96
:TRIGger[:TRANsient][:IMMediate]	96

:TRIGger:OUTPut:SOURce



Description	Sets or queries the trigger source of the output trigger.	
Syntax	:TRIGger:OUTPut:SOURce {BUS IMMediate EXTErnal}	
Query Syntax	:TRIGger:OUTPut:SOURce?	
Parameter/ Return parameter	BUS	Output trigger is generated by the bus.
	IMMediate	Output trigger is immediately generated.
	EXTErnal	The output trigger is generated when an external signal triggers it.
Example	:TRIGger:OUTPut:SOURce? EXT Sets the output trigger source to EXT.	

:TRIGger:OUTPut[:IMMediate] 

Description	Generates an immediate trigger for the output trigger system.
Syntax	:TRIGger:OUTPut[:IMMediate]
Example	:TRIG:OUTP

:TRIGger:MEMory:SOURce

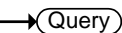
Description	Sets or queries the source of the memory trigger.	
Syntax	:TRIGger:MEMory:SOURce {BUS IMMEDIATE EXTERNAL}	
Query Syntax	:TRIGger:MEMory:SOURce?	
Parameter/ Return parameter	BUS	Memory trigger is generated by the bus.
	IMMEDIATE	Memory trigger is immediately generated.
	EXTERNAL	The memory trigger is generated when an external signal triggers it.
Example	:TRIGger:MEMory:SOURce? EXT Sets the memory trigger source to EXT.	

:TRIGger:MEMory[:IMMEDIATE] 

Description	Generates an immediate trigger for the memory trigger system.	
Syntax	:TRIGger:MEMory[:IMMEDIATE]	
Example	:TRIG:MEM	

:TRIGger:SDIP:SOURce



Description	Sets or queries the surge/dip source.	
Syntax	:TRIGger:SDIP:SOURce {BUS IMMEDIATE EXTERNAL}	
Query Syntax	:TRIGger:SDIP:SOURce?	
Parameter/ Return parameter	BUS	Sets the source to BUS.
	IMMEDIATE	Sets the source to IMMEDIATE.
	EXTERNAL	Sets the source to EXTERNAL.
Example	:TRIG:SDIP:SOUR? EXT Sets the surge/dip source to EXT.	

:TRIGger:SDIP[:IMMediate] (Set) →

Description	Generates an immediate trigger for the surge/dip trigger system.
Syntax	:TRIGger:SDIP[:IMMediate]
Example	:TRIG:SDIP

:TRIGger:SEQuence:SElected:EXECute (Set) →

Description	Sets the control parameters of the selected step for the sequence mode. This command can only be executed when the sequence mode is turned on.												
Syntax	:TRIGger:SEQuence:SElected:EXECute {<NR1> STOP START HOLD BRAN1 BRAN2}												
Parameter	<table border="0"> <tr> <td><NR1></td> <td>Step number <NR1>.</td> </tr> <tr> <td>STOP</td> <td>Stop the step</td> </tr> <tr> <td>START</td> <td>Start the step</td> </tr> <tr> <td>HOLD</td> <td>Hold the step (2) and wait for the user to continue.</td> </tr> <tr> <td>BRAN1</td> <td>Branch 1</td> </tr> <tr> <td>BRAN2</td> <td>Branch 2</td> </tr> </table>	<NR1>	Step number <NR1>.	STOP	Stop the step	START	Start the step	HOLD	Hold the step (2) and wait for the user to continue.	BRAN1	Branch 1	BRAN2	Branch 2
<NR1>	Step number <NR1>.												
STOP	Stop the step												
START	Start the step												
HOLD	Hold the step (2) and wait for the user to continue.												
BRAN1	Branch 1												
BRAN2	Branch 2												
Example	:TRIG:SEQ:SEL:EXEC STOP Stop the sequence.												

:TRIGger:SIMulation:SElected:EXECute (Set) →

Description	Sets the control parameters for the selected step for the simulation mode. This command can only be executed when the simulation mode is turned on.						
Syntax	:TRIGger:SIMulation:SElected:EXECute {<NR1> STOP START HOLD}						
Parameter	<table border="0"> <tr> <td><NR1></td> <td>Go to the step <NR1>.</td> </tr> <tr> <td>STOP</td> <td>Stop the step (0)</td> </tr> <tr> <td>START</td> <td>Start the step (1)</td> </tr> </table>	<NR1>	Go to the step <NR1>.	STOP	Stop the step (0)	START	Start the step (1)
<NR1>	Go to the step <NR1>.						
STOP	Stop the step (0)						
START	Start the step (1)						

HOLD Hold the step (2) and wait for the user to continue.

Example :TRIG:SIM:SEL:EXEC STOP
Stop the simulation.

:TRIGger[:TRANsient]:SOURce (Set) →
← (Query)

Description Sets or queries the source of the transient trigger.

Syntax :TRIGger[:TRANsient]:SOURce
{BUS|IMMEDIATE|EXTERNAL}

Query Syntax :TRIGger[:TRANsient]:SOURce?

Parameter/ Return parameter	BUS	Transient trigger is generated by the bus.
	IMMEDIATE	Transient trigger is immediately generated.
	EXTERNAL	The transient trigger is generated when an external signal triggers it.

Example :TRIG:SOUR?
EXT
Sets the transient trigger source to EXT.

:TRIGger[:TRANsient][:IMMEDIATE] (Set) →

Description Generates an immediate trigger for the transient trigger system.

Syntax :TRIGger[:TRANsient][:IMMEDIATE]

Example :TRIG

Source Commands

[.:SOURce]:CURRent:LIMit:PEAK:HIGH	98
[.:SOURce]:CURRent:LIMit:PEAK:TIME	99
[.:SOURce]:CURRent:LIMit:RMS[:AMPLitude]	99
[.:SOURce]:CURRent:LIMit:RMS:MODE	100
[.:SOURce]:CURRent:LIMit:RMS:TIME	100
[.:SOURce]:FREQuency:LIMit:HIGH	101
[.:SOURce]:FREQuency:TRIGgered	101
[.:SOURce]:FREQuency[:IMMEdiate]	102
[.:SOURce]:FUNction:CSINe:CFActor	102
[.:SOURce]:FUNction:CSINe:CLIP	103
[.:SOURce]:FUNction:CSINe:SDIP	103
[.:SOURce]:FUNction:CSINe:STAircase	104
[.:SOURce]:FUNction:CSINe:TYPE	105
[.:SOURce]:FUNction[:SHApe][:IMMEdiate]	106
[.:SOURce]:PHASe:STARt[:IMMEdiate]	106
[.:SOURce]:PHASe:STOP[:IMMEdiate]	107
[.:SOURce]:READ	107
[.:SOURce]:SEQuence:CPARAmeter	107
[.:SOURce]:SEQuence:CSTep	108
[.:SOURce]:SEQuence:SPARAmeter	109
[.:SOURce]:SEQuence:STEP	110
[.:SOURce]:SIMulation:ABNormal:CODE	110
[.:SOURce]:SIMulation:ABNormal:FREQuency... ..	110
[.:SOURce]:SIMulation:ABNormal:PHASe :STARt:ENABle	111
[.:SOURce]:SIMulation:ABNormal:PHASe :STARt[:IMMEdiate]	111
[.:SOURce]:SIMulation:ABNormal:PHASe :STOP:ENABle	112
[.:SOURce]:SIMulation:ABNormal:PHASe :STOP[:IMMEdiate]	112
[.:SOURce]:SIMulation:ABNormal:TIME	113
[.:SOURce]:SIMulation:ABNormal:VOLTage	113
[.:SOURce]:SIMulation:CSTep	113
[.:SOURce]:SIMulation:INITial:CODE	114
[.:SOURce]:SIMulation:INITial:FREQuency	114

[:SOURce]:SIMulation:INITial:PHASe
:STARt:ENABle..... 115

[:SOURce]:SIMulation:INITial:PHASe
:STARt[:IMMediate]..... 115

[:SOURce]:SIMulation:INITial:PHASe
:STOP:ENABle 116

[:SOURce]:SIMulation:INITial:PHASe
:STOP[:IMMediate] 116

[:SOURce]:SIMulation:INITial:VOLTage 117

[:SOURce]:SIMulation:NORMal<1 | 2>:CODE 117

[:SOURce]:SIMulation:NORMal<1 | 2>
:FREQuency 117

[:SOURce]:SIMulation:NORMal<1 | 2>
:PHASe:STARt:ENABle..... 118

[:SOURce]:SIMulation:NORMal<1 | 2>
:PHASe:STARt[:IMMediate] 118

[:SOURce]:SIMulation:NORMal<1 | 2>
:PHASe:STOP:ENABle 119

[:SOURce]:SIMulation:NORMal<1 | 2>
:PHASe:STOP[:IMMediate]..... 119

[:SOURce]:SIMulation:NORMal<1 | 2>:TIME 120

[:SOURce]:SIMulation:NORMal<1 | 2>
:VOLTage..... 120

[:SOURce]:SIMulation:REPeat:COUNt 121

[:SOURce]:SIMulation:REPeat:ENABle..... 121

[:SOURce]:SIMulation:TRANsition<1 | 2>
:TIME 121

[:SOURce]:VOLTage:LIMit:RMS 122

[:SOURce]:VOLTage:RANGe 122

[:SOURce]:VOLTage[:LEVel]:TRIGgered
[:AMPLitude] 123

[:SOURce]:VOLTage[:LEVel][:IMMediate]
[:AMPLitude] 123

[:SOURce]:CURRent:LIMit:PEAK:HIGH (Set) →
→ (Query)

Description Sets or queries the Ipk-Limit parameter for the continuous operation mode.

Syntax	[:SOURce]:CURRent:LIMit:PEAK:HIGH {<NR2> MINimum MAXimum}	
Query Syntax	[:SOURce]:CURRent:LIMit:PEAK:HIGH? [MINimum MAXimum]	
Parameter	<NR2>	Ipk-Limit in Arms.
	MINimum	Minimum settable peak current limit
	MAXimum	Maximum settable peak current limit
Return parameter	<NR2>	Returns the Ipk-Limit value
Example	CURR:LIM:PEAK:HIGH? 16.80 Returns the peak current limit as 16.8Arms.	

[:SOURce]:CURRent:LIMit:PEAK:TIME (Set) →
→ (Query)

Description	Sets or queries Ipk-Limit delay time by turn off.	
Syntax	[:SOURce]:CURRent:LIMit:PEAK:TIME {<NR2> MINimum MAXimum}	
Query Syntax	[:SOURce]:CURRent:LIMit:PEAK:TIME? {MINimum MAXimum}	
Parameter	<NR2>	0~10 Ipk-Limint delay time in Second
	MINimum	Minimum Ipk-Limint delay time
	MAXimum	Maximum Ipk-Limint delay time
Return parameter	<NR2>	Return the Ipk-Limint delay time value
Example	:CURR:LIM:PEAK:TIME? 0 Returns Ipk-Limint delay off time as 0Sec.	

[:SOURce]:CURRent:LIMit:RMS (Set) →
[:AMPLitude] → (Query)

Description	Sets or queries the Irms parameter for the continuous operation mode.	
Syntax	[:SOURce]:CURRent:LIMit:RMS[:AMPLitude] {<NR2> MINimum MAXimum}	

Query Syntax	[:SOURce]:CURRent:LIMit:RMS[:AMPLitude]? [MINimum MAXimum]	
Parameter	<NR2>	Irms in A.
	MINimum	Minimum settable current
	MAXimum	Maximum settable current
Return parameter	<NR2>	Returns the Irms.
Example	CURR:LIM:RMS? 4.20 Returns the Irms setting.	

Set →

[:SOURce]:CURRent:LIMit:RMS:MODE

→ Query

Description	Sets or queries IRMS OC-Fold enable.	
Syntax	[:SOURce]:CURRent:LIMit:RMS:MODE {<bool> OFF CONTinuous}	
Query Syntax	[:SOURce]:CURRent:LIMit:RMS:MODE?	
Parameter/	<bool>	OFF ON OC-Fold on(1)/off(0)
Return parameter	OFF	OC-Fold off
	CONTinuous	OC-Fold enable
Example	:CURR:LIM:RMS:MODE CONT Sets OC-Fold enable.	

Set →

[:SOURce]:CURRent:LIMit:RMS:TIME

→ Query

Description	Sets or queries IRMS delay time by turn off.	
Syntax	[:SOURce]:CURRent:LIMit:RMS:TIME {<NR2> MINimum MAXimum}	
Query Syntax	[:SOURce]:CURRent:LIMit:RMS:TIME? {MINimum MAXimum}	
Parameter	<NR2>	0~10 IRMS delay time in Second
	MINimum	Minimum IRMS delay time
	MAXimum	Maximum IRMS delay time
Return parameter	<NR2>	Return the IRMS delay time value

Example :CURR:LIM:RMS:TIME?
0
Returns IRMS delay off time as 0Sec.

[[:SOURce]:FREQUency:LIMit:HIGH

Set →

→ Query

Description Sets or queries the frequency upper limit range.

Syntax [[:SOURce]:FREQUency:LIMit:HIGH
{<NR2>|MINimum|MAXimum}

Query Syntax [[:SOURce]:FREQUency:LIMit:HIGH?
[INimum|MAXimum]

Parameter	<NR2>	Frequency in Hz.
	MINimum	Minimum settable frequency
	MAXimum	Maximum settable frequency

Return parameter	<NR2>	Returns the frequency limit
------------------	-------	-----------------------------

Example FREQ:LIM:HIGH?
>60.50
Returns the frequency limit.

Set →

→ Query

[[:SOURce]:FREQUency:TRIGgered

Description Sets or queries the frequency when triggered.

Syntax [[:SOURce]:FREQUency:TRIGgered
{<NR2>(HZ)|MINimum|MAXimum}

Query Syntax [[:SOURce]:FREQUency:TRIGgered?
[MINimum|MAXimum]

Parameter	<NR2>	Frequency in Hz.
	MINimum	Minimum settable frequency
	MAXimum	Maximum settable frequency

Return parameter	<NR2>	Returns the frequency
------------------	-------	-----------------------

Example :FREQ:TRIG?
>60.50
Returns the frequency setting.

[[:SOURce]:FREQuency[:IMMediate]



Description	Sets or queries the frequency for the immediate trigger.	
Syntax	[:SOURce]:FREQuency[:IMMediate] {<NR2>(HZ) MINimum MAXimum}	
Query Syntax	[:SOURce]:FREQuency[:IMMediate]? [MINimum MAXimum]	
Parameter/Return parameter	<NR2>	Frequency setting in Hz.
	MINimum	Minimum frequency
	MAXimum	Maximum frequency
Example	:FREQ 60.00 Sets the frequency of 60Hz.	

[[:SOURce]:FUNctIon:CSINe:CFActor]

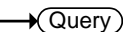

Description	Sets or queries the crest factor setting for the waveform.	
Note:	The :SOURce:FUNctIon:CSINe:TYPE command must first be used to set the save slot number (CLP1 2 3) and CFActor as the waveform type before this command is executed.	
Syntax	[:SOURce]:FUNctIon:CSINe:CFActor {CLP1 CLP2 CLP3,<NR2> MINimum MAXimum}	
Query Syntax	[:SOURce]:FUNctIon:CSINe:CFActor? {CLP1 CLP2 CLP3[,MINimum MAXimum]}	
Parameter/Return parameter	<NR2>	Crest factor
	CLP1	Save slot 1
	CLP2	Save slot 2
	CLP3	Save slot 3
	MIN	1.4
	MAX	10.0

Example :FUNC:CSIN:CFAC CLP1,2.0
Sets the crest factor to 2.0.

[[:SOURce]:]FUNCTION:CSINe:CLIP (Set) →
→ (Query)

Description Sets or queries the CLIP waveform settings.

Note: The :SOURce:FUNCTION:CSINe:TYPE command must first be used to set the save slot number (CLP1 | 2 | 3) and CLIP as the waveform type before this command is executed.

Syntax [:SOURce]:FUNCTION:CSINe:CLIP
{CLP1|CLP2|CLP3,<NR2>|MINimum|MAXimum,
<NR1>|RATio|KEEP}

Query Syntax [:SOURce]:FUNCTION:CSINe:CLIP?
{CLP1|CLP2|CLP3[,MINimum|MAXimum]}

Parameter/Return parameter	CLP1	Save slot 1
	CLP2	Save slot 2
	CLP3	Save slot 3
	<NR2>	Clip range. 0.5 ~ 0.99
	MIN	0.5
	MAX	0.99
	<NR1>	0 = Ratio, 1 = Keep
	RATio	Sets the VRMS of the clipped sine wave as the clip range ratio. I.e., if the clip range = 0.5 then the VRMS will be halved.
	KEEP	Keeps the VRMS value of the clipped sine wave the same as the setting value.

Example :FUNC:CSIN:CLIP CLP1,0.5,KEEP
Sets the clip range to 0.5.

[[:SOURce]:]FUNCTION:CSINe:SDIP (Set) →
→ (Query)

Description Sets or queries the surge | dip waveform type, site and voltage level.

Note: The `:SOURCE:FUNCTION:CSINE:TYPE` command must first be used to set the save slot number (CLP1 | 2 | 3) and SDIP as the waveform type before this command can be executed.

Syntax `[:SOURCE]:FUNCTION:CSINE:SDIP {CLP1|CLP2|CLP3,<NR1>|SQUare|SINE,<NR2>|MINimum|MAXimum,<NR2>|MINimum|MAXimum}`

Query Syntax `[:SOURCE]:FUNCTION:CSINE:SDIP? {CLP1|CLP2|CLP3[,MINimum|MAXimum]}`

Parameter/Return parameter	CLP1	Save slot 1
	CLP2	Save slot 2
	CLP3	Save slot 3
	<NR1>	0 Square, 1 Sine (Site waveform shape)
	SQUare SINE	
	<NR2>	0 ~100%. ACV.
	MINimum	0 (0%)
	MAXimum	100 (100%)
	<NR2>	0 ~100%. Site
	MINimum	0 (0%)
MAXimum	100 (100%)	

Example `:FUNC:CSIN:SDIP CLP1, SQU,50,50`
 Sets the surge/dip arbitrary waveform parameters as site=square, ACV=50%, site=50%.

`[:SOURCE]:FUNCTION:CSINE:STAIRcase` (Set) →
→ (Query)

Description Sets or queries the staircase waveform type and the number of "steps" in the waveform.

Note: The `:SOURCE:FUNCTION:CSINE:TYPE` command must first be used to set the save slot number (CLP1 | 2 | 3) and the waveform type (STAIRcase) before this command can be executed.

Syntax `[:SOURCE]:FUNCTION:CSINE:STAIRcase {CLP1|CLP2|CLP3,<NR2>|MINimum|MAXimum}`

Query Syntax `[:SOURCE]:FUNCTION:CSINE:STAIRcase? {CLP1|CLP2|CLP3[,MINimum|MAXimum]}`

Parameter/Return parameter	CLP1	Save slot 1
	CLP2	Save slot 2
	CLP3	Save slot 3
	<NR2>	1 ~100 steps
	MINimum	1 step
	MAXimum	100 steps

Example :FUNC:CSIN:STA CLP1,50
 Sets the staircase arbitrary waveform at memory CLP1 to have 50 steps.

[[:SOURce]:FUNcTion:CSINe:TYPE (Set) →
→ (Query)

Description Sets the selected save slot to a type of arbitrary waveform or queries its state.

Note: This command must be used before one of the [[:SOURce]:FUNcTion:CSINe:CFACTOR, [[:SOURce]:FUNcTion:CSINe:CLIP, [[:SOURce]:FUNcTion:CSINe:SDIP or [[:SOURce]:FUNcTion:CSINe:STAIRcase commands are used.

Syntax [[:SOURce]:FUNcTion:CSINe:TYPE {CLP1|CLP2|CLP3,CFACTOR|CLIP|SDIP|STAIRcase|TRIangle}

Query Syntax [[:SOURce]:FUNcTion:CSINe:TYPE? {CLP1|CLP2|CLP3}

Parameter/Return parameter	CLP1	Save slot 1
	CLP2	Save slot 2
	CLP3	Save slot 3
	CFACTOR	Set the type as a crest factor waveform.
	CLIP	Set the type as a clipped sine waveform.
	SDIP	Set the type as a surge/ dip waveform.
	STAIRcase	Set the type as a staircase waveform.
	TRIangle	Set the type as a triangle waveform.

Example :FUNC:CSIN:TYPE CLP1,CFACTOR
 Sets the arbitrary waveform type as a crest factor waveform.

Set →
 → Query

[[:SOURce]:FUNctioN[:SHAPE]][:IMMediate]

Description	Loads the selected arbitrary waveform into the power supply. The selected waveform will be output when the output is turned on.	
Note:	If the CLP1 2 3 arbitrary waveforms are to be used, they must first be setup before they can be output. Use the [:SOURce]:FUNctioN:CSINe:TYPE command to set the CLP1 2 3 save slots.	
Syntax	[:SOURce]:FUNctioN[:SHAPE]][:IMMediate] {SIN ARB1 ARB2 ARB3 ARB4 ARB5 ARB6 ARB7 ARB8 ARB9 ARB10 ARB11 ARB12 ARB13 ARB14 ARB15 ARB16 ARB17 ARB18 ARB19 ARB20 ARB21 ARB22 CLP1 CLP2 CLP3}	
Query Syntax	[:SOURce]:FUNctioN[:SHAPE]][:IMMediate]?	
Parameter/Return parameter	SIN	Sine waveform
	ARB1 ~ ARB22	Preset ARB waveforms, number 1 ~ 22. See the user manual for details.
	CLP1	Save slot 1
	CLP2	Save slot 2
	CLP3	Save slot 3

Example :FUNctioN CLP1

 Loads the ARB waveform stored in CLP1.

Set →
 → Query

[[:SOURce]:PHASe:STARt][:IMMediate]

Description	Sets or queries the start phase.	
Syntax	[:SOURce]:PHASe:STARt[:IMMediate] {<NR2> MINimum MAXimum}	
Query Syntax	[:SOURce]:PHASe:STARt[:IMMediate]? [MINimum MAXimum]	
Parameter/Return parameter	<NR2>	Start phase.
	MINimum	0°
	MAXimum	359 °

Example :PHAS:STAR 0
Sets the starting phase to 0.

[[:SOURce]:PHASe:STOP[:IMMediate] (Set) →
→ (Query)

Description Sets or queries the off phase of the waveform.

Note: Sets the off phase of the waveform after the output has been turned off.

Syntax [[:SOURce]:PHASe:STOP[:IMMediate]
{<NR2>|MINimum|MAXimum}

Query Syntax [[:SOURce]:PHASe:STOP[:IMMediate]?
[MINimum|MAXimum]

Parameter/Return parameter	<NR2> MINimum MAXimum	Stop phase. 0 ° 359 °
----------------------------	-----------------------------	-----------------------------

Example :PHAS:STOP 0
Sets the stop phase to 0.

[[:SOURce]:READ → (Query)

Description Returns the measurement readouts.

Query Syntax [[:SOURce]:READ?

Return parameter	<voltage>,<current>, <frequency>,<power>, <SVA>,<ipeak>	Returns each measurement readout as <NR3>.
------------------	---	--

Example :READ?
>+111.9700,+0.0000,+59.9990,+0.0000,+0.0000,
+0.0000

[[:SOURce]:SEQuence:CPARAmeter (Set) →

Description Sets the common parameters for the Sequence mode. Please see the user manual for a full description of each parameter.

Syntax [:SOURce]:SEQuence:CPARAmeter
 {<NR2>,<NR2>,<bool>|OFF|ON,<NR2>,<bool>|OFF|ON,<NR1>|CONTInue|END|HOLD,<NR1>,<bool>|OFF|ON,<NR1>,<bool>|OFF|ON,<NR1>,<bool>|OFF|ON,<NR1>,<bool>|OFF|ON}

Query Syntax [:SOURce]:SEQuence:CPARAmeter?

Parameter	<NR2>	Step Time
	<NR2>	On phase
	<bool> OFF ON	On phase on(1)/off(0)
	<NR2>	Off phase
	<bool> OFF ON	Off phase on/off
	<NR1> CONTInue END HOLD	Term settings: Continue(1)/End(2)/Hold(3)
	<NR1>	Jump step number (0 ~ 255)
	<bool> OFF ON	Jump on(1)/off(0)
	<NR1>	Jump Cnt (0~ 255)
	<bool> OFF ON	Code (External trigger output): ON=1/OFF=0
	<NR1>	Branch1 (0 ~ 255)
	<bool> OFF ON	Branch1 on(1)/off(0)
	<NR1>	Branch2 (0 ~ 255)
	<bool> OFF ON	Branch2 on(1)/off(0)
	<bool> OFF ON	Trig Out. HI=1/LO=0

Return parameter <NR2>,<NR2>,<bool>,<NR2>,<bool>,<NR1>,<NR1>,<bool>,<NR1>,<bool>,<NR1>,<bool>,<NR1>,<bool>,<bool>

Returns the common parameters in the following order:
 Step time, on phase, on phase on/off, off phase, off phase on/off, term settings, jump step number, jump on/off, jump count, code on/off, branch1, branch1 on/off, branch2, branch2 on/off, trig out on/off.

Example1 :SEQ:CPAR 1,0,10,1,HOLD,10,1,0,1,0,0,0,1

Example2 :SEQ:CPAR?
 >+0.1000,+0,+0,+0,+0,CONT,+1,+1,+1,+0,+0,+0,+0,+0,+0

[:SOURce]:SEQuence:CSTep → Query

Description Returns the currently running step number.

Query Syntax	[[:SOURce]:SEQuence:CSTep?
Return parameter	<NR1> Current step number

Example :SEQ:CSTep?
>1

Set →

→ Query

[[:SOURce]:SEQuence:SPARAmeter

Description Sets or queries the parameters for a specified step.

Syntax [[:SOURce]:SEQuence:SPARAmeter
{<NR2>,<NR1>|CONSt|KEEp|SWEep,<NR2>,<NR1>|C
ONSt|KEEp|SWEep,<NR2>,<NR1>|CONSt|KEEp|SWE
ep,SIN,<NR1>}

Query Syntax [[:SOURce]:SEQuence:SPARAmeter?

Parameter	<NR2>	ACV setting
	<NR1> CONSt KEEp SWEep	ACV mode: Constant(1) Keep(2) Sweep(3)
	<NR2>	DCV. Not applicable. This parameter will be ignored.
	<NR1> CONSt KEEp SWEep	DCV mode: Constant(1) Keep(2) Sweep(3)
	<NR2>	Frequency
	<NR1> CONSt KEEp SWEep	Frequency mode: Constant(1) Keep(2) Sweep(3)
	SIN	Fixed as sine.
	<NR1>	Phase angle. Fixed to 0.

Return parameter <NR2>,<NR1> | CONSt | KEEp | SWEep,<NR2>,<NR1> |
CONSt | KEEp | SWEep,<NR2>,<NR1> | CONSt | KEEp | S
WEep,SIN,<NR1>
Returns the step parameters in the following order:
ACV, ACV mode, DCV, DCV mode, frequency,
frequency mode, SIN, phase.

Example :SEQ:SPAR?
>+101.0000,KEEP,+0.0000,CONST,+50.0000,CONST,S
IN,0

Set →
 → Query

[[:SOURce]:SEQuence:STEP

Description	Sets or queries the current step number.	
Syntax	[:SOURce]:SEQuence:STEP {<NR1> MINimum MAXimum}	
Query Syntax	[:SOURce]:SEQuence:STEP? [MINimum MAXimum]	
Parameter/Return parameter	<NR1>	Step number
	MINimum	Minimum step number
	MAXimum	Maximum step number
Example	:SEQ:STEP 1 Sets the step number to 1.	

Set →
 → Query

[[:SOURce]:SIMulation:ABNormal:CODE

Description	Sets the external trigger output for the abnormal step parameter. This option is only applicable when in the Simulation mode.	
Syntax	[:SOURce]:SIMulation:ABNormal:CODE {<NR1> MINimum MAXimum}	
Query Syntax	[:SOURce]:SIMulation:ABNormal:CODE? [MINimum MAXimum]	
Parameter	<NR1>	External trigger output, HI=1, LO=0.
	MINimum	LO, 0
	MAXimum	HI, 1
Return parameter	+0	LO
	+1	HI
Example	SIM:ABN:CODE 1	

Set →
 → Query



[[:SOURce]:SIMulation:ABNormal:FREQuency

Description	Sets or queries the frequency of the abnormal step of the simulation mode.	
-------------	--	--

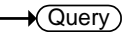
Syntax	[:SOURce]:SIMulation:ABNormal:FREQuency {<NR2> MINimum MAXimum}	
Query Syntax	[:SOURce]:SIMulation:ABNormal:FREQuency? [MINimum MAXimum]	
Parameter/Return parameter	<NR2> MINimum MAXimum	Frequency of abnormal step Minimum frequency Maximum frequency
Example	:SIM:ABN:FREQ 55 Sets the frequency to 55Hz.	

[:SOURce]:SIMulation:ABNormal:PHASe 
:START:ENABLE 

Description	Enables/Disables the ON Phs parameter of the abnormal step for the Simulation mode.	
Syntax	[:SOURce]:SIMulation:ABNormal:PHASe:START :ENABLE {<bool> OFF ON}	
Query Syntax	[:SOURce]:SIMulation:ABNormal:PHASe:START :ENABLE?	
Parameter/Return parameter	OFF 0 ON 1	Disabled Enabled
Example	:SIM:ABN:PHAS:STAR:ENAB 1 Enable the ON Phs.	

[:SOURce]:SIMulation:ABNormal:PHASe 
:START[:IMMEDIATE] 

Description	Sets or queries the ON Phs parameter of the abnormal step for the Simulation mode.	
Syntax	[:SOURce]:SIMulation:ABNormal:PHASe:START [:IMMEDIATE] {<NR2> MINimum MAXimum}	
Query Syntax	[:SOURce]:SIMulation:ABNormal:PHASe:START [:IMMEDIATE]? [MINimum MAXimum]	
Parameter/Return parameter	<NR2> MINimum	ON Phs (start phase) 0

parameter MAXimum 359

Example :SIM:ABN:PHAS:STAR 0
 Sets ON Phs to 0.

[[:SOURce]:SIMulation:ABNormal:PHASe (Set) →
 :STOP:ENABLE → (Query)]

Description Enables/Disables the OFF Phs parameter of the abnormal step for the Simulation mode.

Syntax [:SOURce]:SIMulation:ABNormal:PHASe:STOP
 :ENABLE {<bool>|OFF|ON}

Query Syntax [:SOURce]:SIMulation:ABNormal:PHASe:STOP
 :ENABLE?

Parameter/Return	OFF 0	Disabled
parameter	ON 1	Enabled

Example :SIM:ABN:PHAS:STOP:ENAB 1
 Enable the OFF Phs.

[[:SOURce]:SIMulation:ABNormal:PHASe (Set) →
 :STOP[:IMMediate] → (Query)]

Description Sets or queries the OFF Phs parameter of the abnormal step for the Simulation mode.

Note: Sets the off phase of the waveform after the output has been turned off.

Syntax [:SOURce]:SIMulation:ABNormal:PHASe:STOP
 [:IMMediate] {<NR2>|MINimum|MAXimum}

Query Syntax [:SOURce]:SIMulation:ABNormal:PHASe:STOP
 [:IMMediate]? [MINimum|MAXimum]

Parameter/Return	<NR2>	OFF Phs (Stop phase)
parameter	MINimum	0
	MAXimum	359

Example :SIM:ABN:PHAS:STOP 0
 Sets OFF Phs to 0.

[[:SOURce]:SIMulation:ABNormal:TIME
 →
 →

Description	Sets or queries the Time parameter of the abnormal step for the Simulation mode.	
Syntax	[:SOURce]:SIMulation:ABNormal:TIME {<NR2> MINimum MAXimum}	
Query Syntax	[:SOURce]:SIMulation:ABNormal:TIME? [MINimum MAXimum]	
Parameter/Return parameter	<NR2> MINimum MAXimum	Time of the abnormal step in seconds 0 99.99s
Example	:SIM:ABN:TIME 1 Sets the abnormal step time to 1 second.	

[[:SOURce]:SIMulation:ABNormal:VOLTage
 →
 →

Description	Sets or queries the Vset parameter of the abnormal step for the Simulation mode.	
Syntax	[:SOURce]:SIMulation:ABNormal:VOLTage {<NR2> MINimum MAXimum}	
Query Syntax	[:SOURce]:SIMulation:ABNormal:VOLTage? [MINimum MAXimum]	
Parameter/Return parameter	<NR2> MINimum MAXimum	Voltage of the abnormal step. Minimum settable voltage Maximum settable voltage
Example	:SIM:ABN:VOLT MAX Sets the abnormal step voltage to the maximum.	

[[:SOURce]:SIMulation:CSTep →

Description	Returns the currently running step.
Query Syntax	[:SOURce]:SIMulation:CSTep?

Return parameter	<NR1>	Current step +0 = Initial step +1 = Normal1 step +2 = Transition1 step +3 = Abnormal step +4 = Transition2 step +5 = Normal2 step
------------------	-------	---

Example :SIM:CStep?
>+1

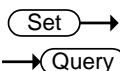

[[:SOURce]:SIMulation:INITial:CODE

Description Sets the external trigger output for the initial step parameter. This option is only applicable when in the Simulation mode.

Syntax [:SOURce]:SIMulation:INITial:CODE
{<NR1>|MINimum|MAXimum}

Query Syntax [:SOURce]:SIMulation:INITial:CODE?
[MINimum|MAXimum]

Parameter/Return parameter	<NR1> MINimum MAXimum	HI=1, LO=0. LO, 0 HI, 1
----------------------------	-----------------------------	-------------------------------

Example SIM:INIT:CODE 1

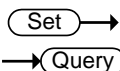

[[:SOURce]:SIMulation:INITial:FREQuency

Description Sets or queries the frequency of the initial step of the simulation mode.

Syntax [:SOURce]:SIMulation:INITial:FREQuency
{<NR2>|MINimum|MAXimum}

Query Syntax [:SOURce]:SIMulation:INITial:FREQuency?
[MINimum|MAXimum]

Parameter/Return parameter	<NR2> MINimum MAXimum	Frequency of initial step Minimum frequency Maximum frequency
----------------------------	-----------------------------	---

Example :SIM:INIT:FREQ 60
 Sets the frequency to 60Hz.

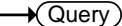
[[:SOURce]:SIMulation:INITial:PHASe:STARt 
 :ENABLE 

Description Enables/Disables the ON Phs parameter of the initial step for the Simulation mode.

Syntax [:SOURce]:SIMulation:INITial:PHASe:STARt:ENABLE
 {<bool>|OFF|ON}

Query Syntax [:SOURce]:SIMulation:INITial:PHASe:STARt:ENABLE?

Parameter/Return parameter	OFF 0	Disabled
	ON 1	Enabled

Example :SIM:INIT:PHAS:STAR:ENAB 1
 Enable the ON Phs.

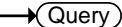
[[:SOURce]:SIMulation:INITial:PHASe:STARt 
 [:IMMEDIATE] 

Description Sets or queries the ON Phs parameter of the initial step for the Simulation mode.

Syntax [:SOURce]:SIMulation:INITial:PHASe:STARt
 [:IMMEDIATE] {<NR2>|MINimum|MAXimum}

Query Syntax [:SOURce]:SIMulation:INITial:PHASe:STARt
 [:IMMEDIATE]? [MINimum|MAXimum]

Parameter/Return parameter	<NR2>	ON Phs (start phase)
	MINimum	0
	MAXimum	359

Example :SIM:INIT:PHAS:STAR 0
 Sets ON Phs to 0.

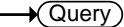
`[:SOURce]:SIMulation:INITial:PHASe:STOP` 
`:ENABle` 

Description	Enables/Disables the OFF Phs parameter of the initial step for the Simulation mode.	
Syntax	[:SOURce]:SIMulation:INITial:PHASe:STOP:ENABle {<bool> OFF ON}	
Query Syntax	[:SOURce]:SIMulation:INITial:PHASe:STOP:ENABle?	
Parameter/Return parameter	OFF 0	Disabled
	ON 1	Enabled
Example	:SIM:INIT:PHAS:STOP:ENAB 1 Enable the OFF Phs.	

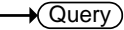
`[:SOURce]:SIMulation:INITial:PHASe:STOP` 
`[:IMMediate]` 

Description	Sets or queries the OFF Phs parameter of the abnormal step for the Simulation mode.	
Note:	Sets the off phase of the waveform after the output has been turned off.	
Syntax	[:SOURce]:SIMulation:INITial:PHASe:STOP [:IMMediate] {<NR2> MINimum MAXimum}	
Query Syntax	[:SOURce]:SIMulation:INITial:PHASe:STOP [:IMMediate]? [MINimum MAXimum]	
Parameter/Return parameter	<NR2>	OFF Phs (Stop phase)
	MINimum	0
	MAXimum	359
Example	:SIM:INIT:PHAS:STOP 0 Sets OFF Phs to 0.	

`[:SOURce]:SIMulation:INITial:VOLTage`



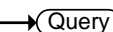

Description	Sets or queries the Vset parameter of the abnormal step for the Simulation mode.	
Syntax	[:SOURce]:SIMulation:INITial:VOLTage {<NR2> MINimum MAXimum}	
Query Syntax	[:SOURce]:SIMulation:INITial:VOLTage? [MINimum MAXimum]	
Parameter/Return parameter	<NR2> MINimum MAXimum	Voltage of the initial step. Minimum settable voltage Maximum settable voltage
Example	:SIM:INIT:VOLT MAX Sets the initial step voltage to the maximum.	

`[:SOURce]:SIMulation:NORMal<1|2>:CODE`

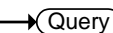

Description	Sets the external trigger output for the normal 1 or normal 2 step parameter. This option is only applicable when in the Simulation mode.	
Syntax	[:SOURce]:SIMulation:NORMal<1 2>:CODE {<NR1> MINimum MAXimum}	
Query Syntax	[:SOURce]:SIMulation:NORMal<1 2>:CODE? [MINimum MAXimum]	
Parameter/Return parameter	<NR1> MINimum MAXimum	HI=1, LO=0 LO, 0 HI, 1
Example	SIM:NORM1:CODE 1	

`[:SOURce]:SIMulation:NORMal<1|2>:FREQuency`



Description	Sets or queries the frequency of the normal1 or normal2 step of the simulation mode.	
-------------	--	--

Syntax	[:SOURce]:SIMulation:NORMal<1 2>:FREQuency {<NR2> MINimum MAXimum}	
Query Syntax	[:SOURce]:SIMulation:NORMal<1 2>:FREQuency? [MINimum MAXimum]	
Parameter/Return parameter	<1 2>	Normal 1 or Normal 2
	<NR2>	Frequency of abnormal step
	MINimum	Minimum frequency
	MAXimum	Maximum frequency
Example	:SIM:NORM1:FREQ 60 Sets the frequency to 60Hz.	

[:SOURce]:SIMulation:NORMal<1|2> Set →
 :PHASe:STARt:ENABle → Query

Description	Enables/Disables the ON Phs parameter of the normal1 or normal2 step for the Simulation mode.	
Syntax	[:SOURce]:SIMulation:NORMal<1 2>:PHASe:STARt:ENABle {<bool> OFF ON}	
Query Syntax	[:SOURce]:SIMulation:NORMal<1 2>:PHASe:STARt:ENABle?	
Parameter/Return parameter	<1 2>	Normal 1 or Normal 2
	OFF 0	Disabled
	ON 1	Enabled
Example	:SIM:NORM1:PHAS:STAR:ENAB 1 Enable the ON Phs.	

[:SOURce]:SIMulation:NORMal<1|2> Set →
 :PHASe:STARt[:IMMEDIATE] → Query

Description	Sets or queries the ON Phs parameter of the normal1 or normal2 step for the Simulation mode.	
Syntax	[:SOURce]:SIMulation:NORMal<1 2>:PHASe:STARt[:IMMEDIATE] {<NR2> MINimum MAXimum}	
Query Syntax	[:SOURce]:SIMulation:NORMal<1 2>:PHASe:STARt[:IMMEDIATE]? [MINimum MAXimum]	

Parameter/Return parameter	<1 2>	Normal 1 or Normal 2
	<NR2>	ON Phs (start phase)
	MINimum	0
	MAXimum	359

Example :SIM:NORM1:PHAS:STAR 0
Sets ON Phs to 0.

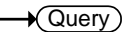
[[:SOURce]:SIMulation:NORMal<1|2>] 
:PHASe:STOP:ENABLE 

Description Enables/Disables the OFF Phs parameter of the normal1 or normal2 step for the Simulation mode.

Syntax [[:SOURce]:SIMulation:NORMal<1|2>]:PHASe:STOP:ENABLE {<bool>|OFF|ON}

Query Syntax [[:SOURce]:SIMulation:NORMal<1|2>]:PHASe:STOP:ENABLE?

Parameter/Return parameter	<1 2>	Normal 1 or Normal 2
	OFF 0	Disabled
	ON 1	Enabled

Example :SIM:NORM1:PHAS:STOP:ENAB 1
Enable the OFF Phs.

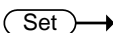
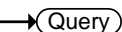
[[:SOURce]:SIMulation:NORMal<1|2>] 
:PHASe:STOP[:IMMEDIATE] 

Description Sets or queries the OFF Phs parameter of the normal1 or normal2 step for the Simulation mode.

Note: Sets the off phase of the waveform after the output has been turned off.

Syntax [[:SOURce]:SIMulation:NORMal<1|2>]:PHASe:STOP[:IMMEDIATE] {<NR2>|MINimum|MAXimum}

Query Syntax [[:SOURce]:SIMulation:NORMal<1|2>]:PHASe:STOP[:IMMEDIATE]? [MINimum|MAXimum]

Parameter/Return parameter	<1 2>	Normal 1 or Normal 2
	<NR2>	OFF Phs (Stop phase)

parameter	MINimum	0
	MAXimum	359

Example :SIM:NORM1:PHAS:STOP 0
Sets OFF Phs to 0.

Set →

[[:SOURce]:SIMulation:NORMal<1|2>:TIME → Query]

Description Sets or queries the Time parameter of the normal1 or normal2 step for the Simulation mode.

Syntax [[:SOURce]:SIMulation:NORMal<1|2>:TIME {<NR2>|MINimum|MAXimum}

Query Syntax [[:SOURce]:SIMulation:NORMal<1|2>:TIME? [MINimum|MAXimum]

Parameter/Return parameter	<1 2>	Normal 1 or Normal 2
	<NR2>	Time of the step in seconds
	MINimum	0
	MAXimum	99.99s

Example :SIM:NORM1:TIME 1
Sets the step time to 1 second.

Set →

[[:SOURce]:SIMulation:NORMal<1|2>:VOLTage

→ Query]

Description Sets or queries the Vset parameter of the normal1 or normal2 step for the Simulation mode.

Syntax [[:SOURce]:SIMulation:NORMal<1|2>:VOLTage {<NR2>|MINimum|MAXimum}

Query Syntax [[:SOURce]:SIMulation:NORMal<1|2>:VOLTage? [MINimum|MAXimum]

Parameter/Return parameter	<1 2>	Normal 1 or Normal 2
	<NR2>	Voltage of the abnormal step.
	MINimum	Minimum settable voltage
	MAXimum	Maximum settable voltage

Example :SIM:NORM1:VOLT MAX
Sets the normal1 step voltage to the maximum.

[[:SOURce]:SIMulation:REPeat:COUNT

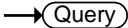

Description	Sets or queries the repeat count for the Simulation mode.	
Syntax	[:SOURce]:SIMulation:REPeat:COUNT {<NR1> MINimum MAXimum}	
Query Syntax	[:SOURce]:SIMulation:REPeat:COUNT?	
Parameter/Return parameter	<NR1> MINimum MAXimum	0 ~ 255 (0 = infinite loop)
Example	:SIM:REP:COUN 1 Sets the repeat count to 1.	

[[:SOURce]:SIMulation:REPeat:ENABLE



Description	Turns the repeat function on or off for the Simulation mode.	
Syntax	[:SOURce]:SIMulation:REPeat:ENABLE {<bool> OFF ON}	
Query Syntax	[:SOURce]:SIMulation:REPeat:ENABLE?	
Parameter/Return parameter	OFF 0 ON 1	Disabled Enabled
Example	:SIM:REP:ENAB 1 Enables the repeat function.	

[[:SOURce]:SIMulation:TRANSition<1|2>:TIME



Description	Sets or queries the Time parameter of the transition step for the Simulation mode.	
Syntax	[:SOURce]:SIMulation:TRANSition<1 2>:TIME {<NR2> MINimum MAXimum}	

Query Syntax [:SOURce]:SIMulation:TRANsition<1|2>:TIME?
[MINimum|MAXimum]

Parameter/Return parameter	<NR2> MINimum MAXimum	Time of the step in seconds 0 99.99s
----------------------------	-----------------------------	--

Example :SIM:TRAN1:TIME 1
Sets the step time to 1 second.

Set →

→ Query

[:SOURce]:VOLTage:LIMit:RMS

Description Sets or queries the voltage limit for the continuous operation mode.

Syntax [:SOURce]:VOLTage:LIMit:RMS
{<NR2>|MINimum|MAXimum}

Query Syntax [:SOURce]:VOLTage:LIMit:RMS?
[MINimum|MAXimum]

Parameter	<NR2> MINimum MAXimum	Vrms. Minimum voltage limit Maximum voltage limit
-----------	-----------------------------	---

Return parameter <NR2> Returns the voltage limit.

Example VOLT:LIM:RMS?
600.00
Returns the Vrms limit.

Set →

→ Query

[:SOURce]:VOLTage:RANGe

Description Sets or queries the voltage range for the continuous operation mode.

Syntax [:SOURce]:VOLTage:RANGe
{<NR1>|R155|R310|R600|AUTO}

Query Syntax [:SOURce]:VOLTage:RANGe? [MINimum|MAXimum]

Parameter	<NR1> R155 R310 R600	Voltage range (155, 310, 600). 155 V range 310 V range 600V range
-----------	-------------------------------	--

	AUTO	Auto range
	MINimum	155V range
	MAXimum	600V range
Return parameter	<NR1>	Returns the voltage range (155, 310, 600).
Example	VOLT:RANG R155 Sets the voltage range to 155V.	

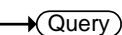
**[[:SOURce]:VOLTage[:LEVel]:TRIGgered
[:AMPLitude]**  →
→ 

Description	Sets or queries the RMS voltage for the continuous operation mode (normal operation mode).	
Syntax	[:SOURce]:VOLTage[:LEVel]:TRIGgered[:AMPLitude] {<NR2>(V) MINimum MAXimum}	
Query Syntax	[:SOURce]:VOLTage[:LEVel]:TRIGgered[:AMPLitude]? [MINimum MAXimum]	
Parameter/Return parameter	<NR2>	Vrms.
	MINimum	Minimum voltage
	MAXimum	Maximum voltage
Example	:VOLTage:TRIGgered 150.0 Sets the voltage to 150.0 ACV when triggered.	

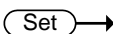
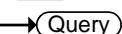
**[[:SOURce]:VOLTage[:LEVel][:IMMediate]
[:AMPLitude]**  →
→ 

Description	Sets or queries the RMS voltage for the continuous operation mode.	
Syntax	[:SOURce]:VOLTage[:LEVel][:IMMediate][:AMPLitude] {<NR2>(V) MINimum MAXimum}	
Query Syntax	[:SOURce]:VOLTage[:LEVel][:IMMediate][:AMPLitude]? [MINimum MAXimum]	
Parameter/Return parameter	<NR2>	Vrms.
	MINimum	Minimum voltage
	MAXimum	Maximum voltage

Example :VOLT
 150.0
 Sets the voltage to 150.0 ACV.

Remote Sense Command (APS-7200, 7300 only)

:RSENse:[STATe]125

:RSENse:[STATe]

Set →

→ Query

Description	Sets or queries the state of remote sense.	
Syntax	:RSENse[:STATE]{<bool> OFF ON}	
Query Syntax	:RSENse[:STATE]?	
Parameter	OFF 0	Turns the output off.
	ON 1	Turns the output on.
Return parameter	<bool>	Returns status of the instrument.

Display Command

:DISPlay[:WINDow]:DESIgn:MODE 126
 :DISPlay[:WINDow]:MEASure:SOURce<1|3> ..126

:DISPlay[:WINDow]:DESIgn:MODE Set →

Description	Sets two display mode.	
Syntax	:DISPlay[:WINDow]:DESIgn:MODE{NORMAl SIMPlE}	
Parameter	MORMAl	Configure setup and Measurement.
	SIMPlE	All measurement times.
Example	:DISP:DES:MODE NORM Sets standard normal display.	

:DISPlay[:WINDow]:MEASure:SOURce<1|3> Set →

Description	Sets standard normal display to measurement items.	
Syntax	:DISPlay[:WINDow]:MEASure:SOURce<1 3> {VOLTage RMS RPOWer SPOWer IPK IPKH FREQuency PFACTOR CFACTOR}	
Parameter	VOLTage	Measurement voltage. (Only source1, source2, source3)
	RMS	Measurement RMS. (Only source1, source2, source3)
	RPOWer	Measurement real power. (Only source1, source2, source3)
	SPOWer	Measurement apparent power. (Only source1)
	IPK	Measurement Ipeak. (Only source2)
	IPKH	Measurement Ipeak hold.(Only source2)
	FREQuency	Measurement frequency. (Only source3)
	PFACTOR	Measurement power factor. (Only source3)
	CFACTOR	Measurement current crest factor. (Only source3)

Example :DISP:MEAS:SOURC1 RMS
 Sets measurement source 1 RMS display.

Status Register Overview

To program the APS power supply effectively, the Status registers need to be understood. This chapter explains in detail how the Status registers are used and how to configure them.

Introduction to the Status Registers.....	128
The Status Registers	129
Questionable Status Register Group.....	130
Operation Status Register Group	133
Warning Status Register Group	135
Standard Event Status Register Group.....	137
Status Byte Register & Service Request Enable Register	139

Introduction to the Status Registers

Overview

The status registers are used to determine the status of the power supply. The status registers maintain the status of the protection conditions, operation conditions and instrument errors.

The APS Series have a number of register groups:

- Questionable Status Register Group
- Standard Event Status Register Group
- Operation Status Register Group
- Warning Status Register Group
- Status Byte Register
- Service Request Enable Register
- Service Request Generation
- Error Queue
- Output Buffer

The diagram below shows the structure of the Status registers.

The Status Registers

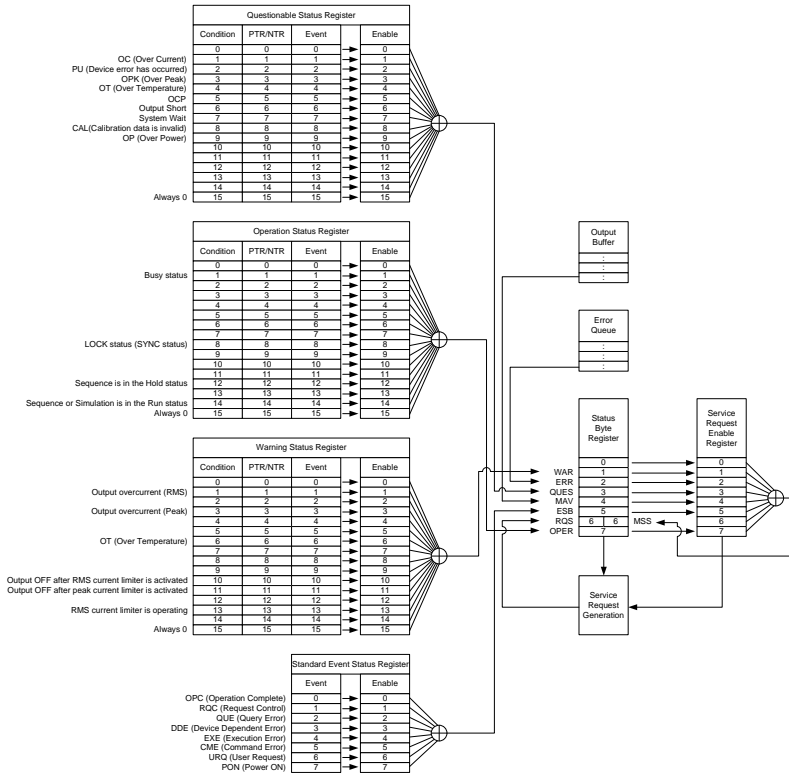

Questionable Status Register Group

Overview

The Questionable Status Register Group indicates if any protection modes or limits have been tripped.

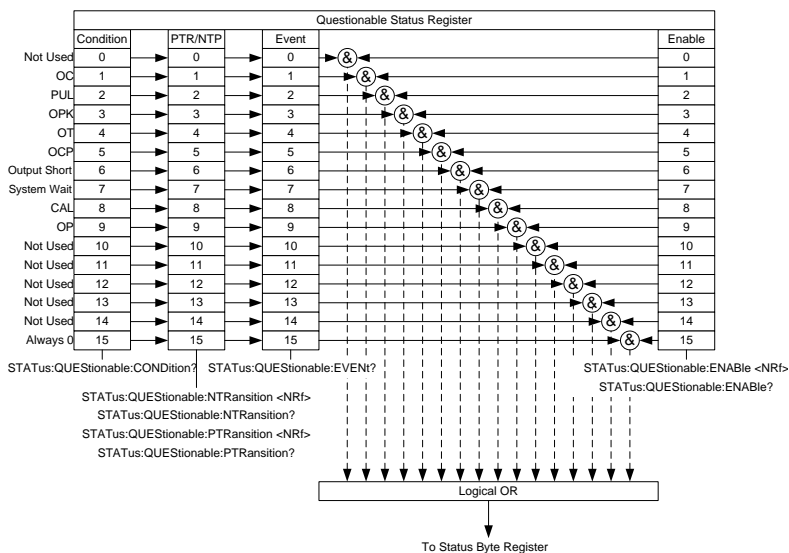

Bit Summary

Event	Bit #	Bit Weight
Not Used	0	1
OC (Over-Current) Over current protection has been tripped	1	2
PUL (Device error has occurred) AC power switch is off	2	4
OPK (Over Peak) Over Peak Protection has been tripped	3	8

OT (Over Temperature)	4	16
Over temperature protection has been tripped		
OCP	5	32
OCP protection has been tripped		
Output Short	6	64
Output Short protection has been tripped		
System Wait	7	128
If output short protection has been tripped, it requires to wait 10s for output on again after clearing protection		
CAL (Calibration data is invalid)	8	256
OP (Over-Power)	9	512
Over power protection has been tripped		
Always 0	15	32768

Condition Register The Questionable Status Condition Register indicates the status of the power supply. If a bit is set in the Condition register, it indicates that the event is true. Reading the condition register does not change the state of the condition register.

PTR/NTR Filters The PTR/NTR (Positive/Negative transition) register determines the type of transition conditions that will set the corresponding bit in the Event Registers. Use the Positive transition filter to view events that change from false to positive, and use the negative transition filter to view events that change from positive to negative.

Positive Transition 0→1

	Negative Transition	1→0
Event Register	The PTR/NTR Register will dictate the type of transition conditions will set the corresponding bits in the Event Register. If the Event Register is read, it will be cleared to 0.	
Enable Register	The Enable register determines which Events in the Event Register will be used to set the QUES bit in the Status Byte Register.	

Operation Status Register Group

Overview

The Operation Status Register Group indicates the operating status of the power supply.

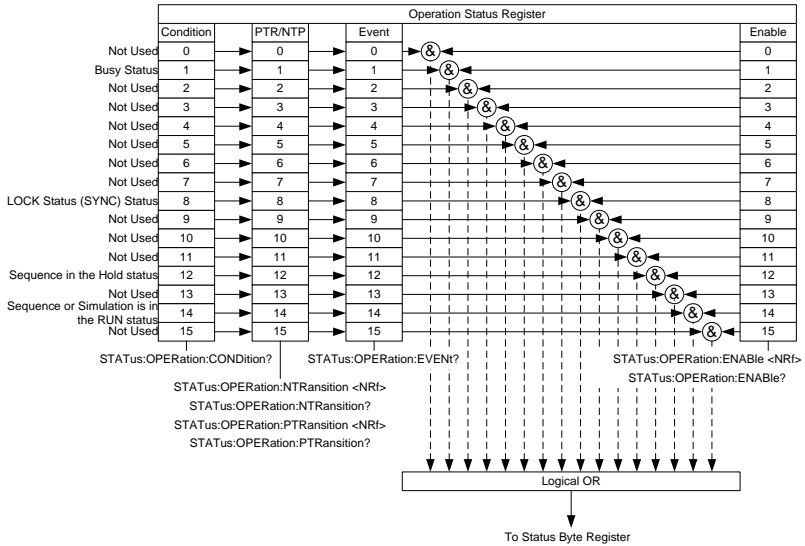

Bit Summary

Event	Bit #	Bit Weight
Busy Status	1	2
LOCK status (SYNC) status	8	256
Sequence is in the Hold status	12	4096
Sequence or Simulation is in the RUN status	14	16384

Condition Register The Operation Status Condition Register indicates the operating status of the power supply. If a bit is set in the Condition register, it indicates that the event is true. Reading the condition register does not change the state of the condition register.

PTR/NTR Filters The PTR/NTR (Positive/Negative transition) register determines the type of transition conditions that will set the corresponding bit in the Event Registers. Use the Positive transition filter to view events that change from false to positive, and use the negative transition filter to view events that change from positive to negative.

Positive Transition 0→1

Negative Transition 1→0

Event Register The PTR/NTR Register will dictate the type of transition conditions will set the corresponding bits in the Event Register. If the Event Register is read, it will be cleared to 0.

Enable Register The Enable register determines which registered Events in the Event Register will be used to set the OPER bit in the Status Byte Register.

Warning Status Register Group

Overview

The Warning Status Register Group is a secondary protection status register for the supply output.

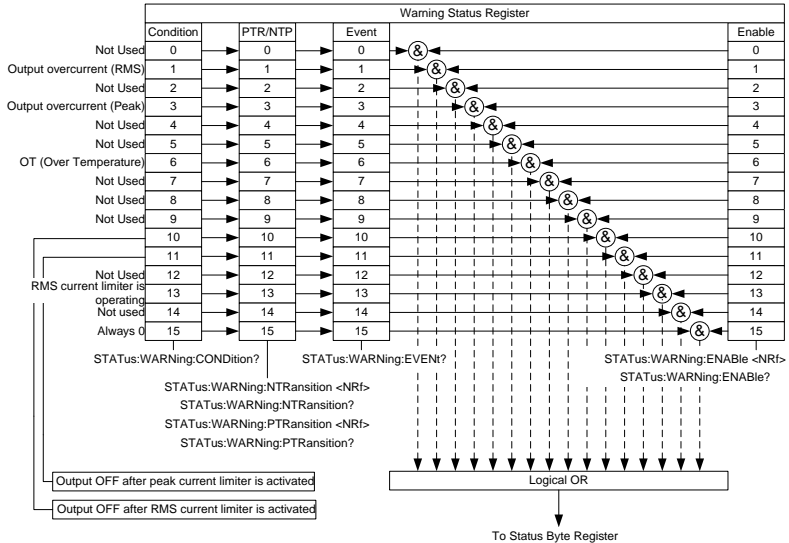

Bit Summary

Event	Bit #	Bit Weight
Output overcurrent (RMS)	1	2
Output RMS overcurrent has been tripped.		
Output over-current (Peak)	3	8
Output peak over-current has been tripped.		
OT (Over Temperature)	6	64
Output OFF after peak current limiter is activated	10	1024

Output OFF after RMS current limiter is activated	11	2048
RMS current limiter is operating	13	8192
Always 0	15	32768

Condition Register The Warning Status Condition Register indicates the warning status of the power supply. If a bit is set in the Condition register, it indicates that the event is true. Reading the condition register does not change the state of the condition register.

PTR/NTR Filters The PTR/NTR (Positive/Negative transition) register determines the type of transition conditions that will set the corresponding bit in the Event Registers. Use the Positive transition filter to view events that change from false to positive, and use the negative transition filter to view events that change from positive to negative.

Positive Transition	0→1
Negative Transition	1→0

Event Register The PTR/NTR Register will dictate the type of transition conditions will set the corresponding bits in the Event Register. If the Event Register is read, it will be cleared to 0.

Enable Register The Enable register determines which registered Events in the Event Register will be used to set the WAR bit in the Status Byte Register.

Standard Event Status Register Group

Overview

The Standard Event Status Register Group indicates if any errors have occurred. The bits of the Event register are set by the error event queue.

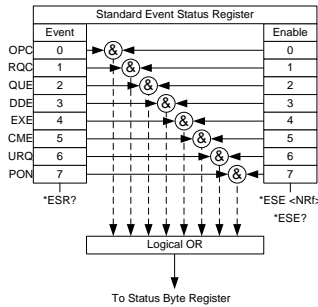

Bit Summary

Event	Bit #	Bit Weight
OPC (Operation complete)	0	1
The OPC bit is set when all selected pending operations are complete. This bit is set in response to the *OPC command.		
RQC (Request control)	1	2
QUE (Query Error)	2	4
The Query Error bit is set in response to an error reading the Output Queue. This can be caused by trying to read the Output Queue when there is no data present.		
DDE (Device Dependent Error)	3	8
Device specific error.		

EXE (Execution Error)	4	16
-----------------------	---	----

The EXE bit indicates an execution error due to one of the following: illegal command parameter, parameter out of range, invalid parameter, the command didn't execute due to an overriding operation condition.

CME (Command Error)	5	32
---------------------	---	----

The CME bit is set when a syntax error has occurred. The CME bit can also be set when a <GET> command is received within a program message.

URQ (User Request)	6	64
--------------------	---	----

PON (Power On)	7	128
----------------	---	-----

Indicates the power is turned on.

Event Register	Any bits set in the event register indicate that an error has occurred. Reading the Event register will reset the register to 0.
----------------	--

Enable Register	The Enable register determines which Events in the Event Register will be used to set the ESB bit in the Status Byte Register.
-----------------	--

Status Byte Register & Service Request Enable Register

Overview

The Status Byte register consolidates the status events of all the status registers. The Status Byte register can be read with the *STB? query and can be cleared with the *CLS command.

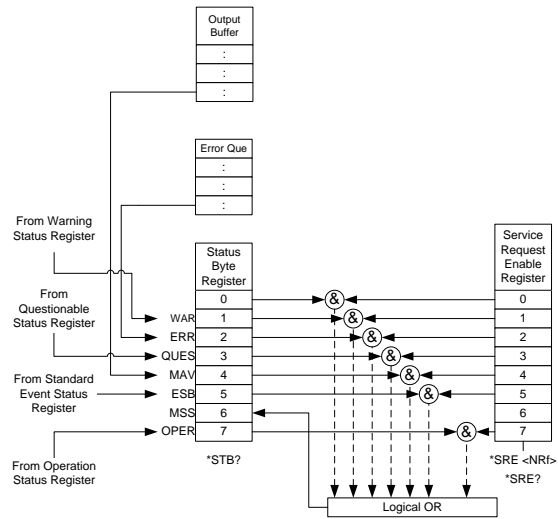

Bit Summary

Event	Bit #	Bit Weight
WAR (Warning Status Register) The summary bit for the Warning Status Register group.	1	2
ERR (Error Event/Queue) If data is present in the Error queue, the ERR bit will be set.	2	4
QUES (Questionable Status Register) The summary bit for the Questionable Status Register group.	3	8

MAV (Message Available) This is set when there is data in the Output Queue waiting to be read.	4	16
--	---	----

(ESB) Event Summary Bit. The ESB is the summary bit for the Standard Event Status Register group.	5	32
---	---	----

MSS Bit The MSS Bit is the summary of the Status Byte Register and Service Request register (bits 1-5, 7). This will be set to 1.	6	64
--	---	----

OPER (Operation Status Register) OPER bit is the summary bit for the Operation Status Register Group.	7	128
---	---	-----

Status Byte Register	Any bits set in the Status byte register acts as a summary register for all the three other status registers and indicates if there is a service request, an error in the Error Queue or data in the Output Queue. Reading the Status Byte register will reset the register to 0.
----------------------	---

Service Request Enable Register	The Service Request Enable Register controls which bits in the Status Byte Register are able to generate service requests.
---------------------------------	--

Error List

Command Errors	141
Execution Errors	145
Device Specific Errors	147
Query Errors	148

Command Errors

Overview

An <error/event number> in the range [-199 , -100] indicates that an IEEE 488.2 syntax error has been detected by the instrument's parser. The occurrence of any error in this class shall cause the command error bit (bit 5) in the event status register (IEEE 488.2, section 11.5.1) to be set. One of the following events has occurred:

- An IEEE 488.2 syntax error has been detected by the parser. That is, a controller-to-device message was received which is in violation of the IEEE 488.2 standard. Possible violations include a data element which violates the device listening formats or whose type is unacceptable to the device.
- An unrecognized header was received. Unrecognized headers include incorrect device-specific headers and incorrect or unimplemented IEEE 488.2 common commands.

Events that generate command errors shall not generate execution errors, device-specific errors, or query errors; see the other error definitions in this chapter.

Error Code	Description
-100 Command Error	This is the generic syntax error for devices that cannot detect more specific errors. This code indicates only that a Command Error as defined in IEEE 488.2,11.5.1.1.4 has occurred.
-102 Syntax error	An unrecognized command or data type was encountered; for example, a string was received when the device does not accept strings.
-103 Invalid separator	The parser was expecting a separator and encountered an illegal character; for example, the semicolon was omitted after a program message unit, MEAS:VOLT:DC?:MEASCURR:DC?
-104 Data type error	The parser recognized a data element different than one allowed; for example, numeric or string data was expected but block data was encountered.
-108 Parameter not allowed	More parameters were received than expected for the header; for example, the :SYSTem:KLOCK command only accepts one parameter, so receiving SYSTem:KLOCK 1,0 is not allowed.
-109 Missing parameter	Fewer parameters were received than required for the header; for example, the :SYSTem:KLOCK command requires one parameter, so receiving :SYSTem:KLOCK is not allowed.
-111 Header separator error	A character which is not a legal header separator was encountered while parsing the header; for example, no white space followed the header, thus *SRE2 is an error.

-112 Program mnemonic too long	The header contains more than twelve characters (see IEEE 488.2, 7.6.1.4.1).
-113 Undefined header	The header is syntactically correct, but it is undefined for this specific device; for example, *XYZ is not defined for any device.
-114 Header suffix out of range	The value of a numeric suffix attached to a program mnemonic, see Syntax and Style section 6.2.5.2, makes the header invalid.
-115 Unexpected number of parameters	The number of parameters received does not correspond to the number of parameters expected. This is typically due to an inconsistency with the number of instruments in the selected group.
-120 Numeric data error	This error, as well as errors -121 through -129, are generated when parsing a data element which appears to be numeric, including the nondecimal numeric types. This particular error message should be used if the device cannot detect a more specific error.
-121 Invalid character in number	An invalid character for the data type being parsed was encountered; for example, an alpha in a decimal numeric or a "9" in octal data.
-128 Numeric data not allowed	A legal numeric data element was received, but the device does not accept one in this position for the header.
-131 Invalid suffix	The suffix does not follow the syntax described in IEEE 488.2, 7.7.3.2, or the suffix is inappropriate for this device.

-141 Invalid character data	Either the character data element contains an invalid character or the particular element received is not valid for the header.
-148 Character data not allowed	A legal character data element was encountered where prohibited by the device.
-151 Invalid string data	A string data element was expected, but was invalid for some reason (see IEEE 488.2, 7.7.5.2); for example, an END message was received before the terminal quote character.
-158 String data not allowed	A string data element was encountered but was not allowed by the device at this point in parsing.
-160 Block data error	This error, as well as errors -161 through -169, are generated when parsing a block data element. This particular error message should be used if the device cannot detect a more specific error.
-161 Invalid block data	A block data element was expected, but was invalid for some reason (see IEEE 488.2, 7.7.6.2); for example, an END message was received before the length was satisfied.
-168 Block data not allowed	A legal block data element was encountered but was not allowed by the device at this point in parsing.
-178 Expression data not allowed	A legal expression data was encountered but was not allowed by the device at this point in parsing.

Execution Errors

Overview An <error/event number> in the range [-299 , -200] indicates that an error has been detected by the instrument's execution control block. The occurrence of any error in this class shall cause the execution error bit (bit 4) in the event status register (IEEE 488.2, section 11.5.1) to be set. One of the following events has occurred:

- A <PROGRAM DATA> element following a header was evaluated by the device as outside of its legal input range or is otherwise inconsistent with the device's capabilities.
- A valid program message could not be properly executed due to some device condition.

Execution errors shall be reported by the device after rounding and expression evaluation operations have taken place. Rounding a numeric data element, for example, shall not be reported as an execution error. Events that generate execution errors shall not generate Command Errors, device-specific errors, or Query Errors; see the other error definitions in this section.

Error Code	Description
-200 Execution error	This is the generic syntax error for devices that cannot detect more specific errors. This code indicates only that an Execution Error as defined in IEEE 488.2, 11.5.1.1.5 has occurred.

-201 Invalid while in local	Indicates that a command is not executable while the device is in local due to a hard local control (see IEEE 488.2, 5.6.1.5); for example, a device with a rotary switch receives a message which would change the switches state, but the device is in local so the message cannot be executed.
-203 Command protected	Indicates that a legal password-protected program command or query could not be executed because the command was disabled.
-211 Trigger ignored	Indicates that a GET, *TRG, or triggering signal was received and recognized by the device but was ignored because of device timing considerations; for example, the device was not ready to respond. Note: a DT0 device always ignores GET and treats *TRG as a Command Error.
-213 Init ignored	Indicates that a request for a measurement initiation was ignored as another measurement was already in progress.
-220 Parameter error	Indicates that a program data element related error occurred. This error message should be used when the device cannot detect the more specific errors described for errors -221 through -229.
-221 Settings conflict	Indicates that a legal program data element was parsed but could not be executed due to the current device state (see IEEE 488.2, 6.4.5.3 and 11.5.1.1.5.).

-222 Data out of range	Indicates that a legal program data element was parsed but could not be executed because the interpreted value was outside the legal range as defined by the device (see IEEE 488.2, 11.5.1.1.5.).
-224 Illegal parameter value	Used where exact value, from a list of possibles, was expected.

Device Specific Errors

Overview An <error/event number> in the range [-399 , -300] or [1 , 32767] indicates that the instrument has detected an error which is not a command error, a query error, or an execution error; some device operations did not properly complete, possibly due to an abnormal hardware or firmware condition. These codes are also used for self-test response errors. The occurrence of any error in this class should cause the device-specific error bit (bit 3) in the event status register (IEEE 488.2, section 11.5.1) to be set. The meaning of positive error codes is device-dependent and may be enumerated or bit mapped; the <error message>string for positive error codes is not defined by SCPI and available to the device designer.

Note that the string is not optional; if the designer does not wish to implement a string for a particular error, the null string should be sent (for example, 42,""). The occurrence of any error in this class should cause the device-specific error bit (bit 3) in the event status register (IEEE 488.2, section 11.5.1) to be set. Events that generate device-specific errors shall not generate command errors, execution errors,

or query errors; see the other error definitions in this section.

Error Code	Description
-310 System error	Indicates that some error, termed “system error” by the device, has occurred. This code is device-dependent.
-320 Storage fault	Indicates that the firmware detected a fault when using data storage. This error is not an indication of physical damage or failure of any mass storage element.

Query Errors

Overview An <error/event number> in the range [-499 , -400] indicates that the output queue control of the instrument has detected a problem with the message exchange protocol described in IEEE 488.2, chapter 6. The occurrence of any error in this class shall cause the query error bit (bit 2) in the event status register (IEEE 488.2, section 11.5.1) to be set. These errors correspond to message exchange protocol errors described in IEEE 488.2, section 6.5. One of the following is true:

- An attempt is being made to read data from the output queue when no output is either present or pending;
- Data in the output queue has been lost.

Events that generate query errors shall not generate command errors, execution errors, or device-specific errors; see the other error definitions in this section.

Error Code	Description
-400 Query error	This is the generic query error for devices that cannot detect more specific errors. This code indicates only that a Query Error as defined in IEEE 488.2, 11.5.1.1.7 and 6.3 has occurred.

APPENDIX

APS-7000 Default Settings

The following default settings are the factory configuration settings for the power supply.

For details on how to return to the factory default settings, please see the user manual.

Continuous Mode	APS-7050	APS-7100	APS-7200	APS-7300
Range			155V	
ACV			0.00V	
FREQ			60.00Hz	
IRMS	4.20A	8.40A	16.80A	25.20A
ON PHS			0°	
OFF PHS			0°	
V limit			155.0Vrms	
F Limit			500.0Hz	
Ipeak Limit	16.80A	33.60A	67.20A	100.8A

Simulation Mode	APS-7050	APS-7100	APS-7200	APS-7300
Step			Initial	
Repeat			1	
Time			0.10s	
ON Phs			ON, 0	
Vset			0.00	
OFF Phs			ON, 0	
Fset			50.00	
Trig Out			LO	
Range			HI	

Sequence Mode	APS-7050	APS-7100	APS-7200	APS-7300
Step			0	
Time			0.10s	
Jump To			ON, 1	
Jump Cnt			1	
Branch1			OFF	
Branch2			OFF	
Term			CONTI	
Trig Out			LO	
ON Phs			OFF	
OFF Phs			OFF	
Vset			0.00, CT	
Fset			50.00	

Program Mode	APS-7050	APS-7100	APS-7200	APS-7300
Not applicable				

Configuration Menu	APS-7050	APS-7100	APS-7200	APS-7300
Surge/Dip Control			OFF	
Ramp Control			OFF	
T ipeak, hold(msec)			1ms	
Power ON Output			OFF	
Buzzer			ON	
SCPI Emulation			GW	
Program Timer			SEC (seconds)	
Remote Sense	N/A	N/A	OFF	OFF
LAN, Rear USB, Serial Port, GPIB			N/A	
LCD Contrast			50%	
LCD Brightness			50%	
LCD Saturation			50%	

INDEX

Accessories	10	Command list.....	46
Caution symbol	4	Command syntax.....	42
Cleaning the instrument.....	6	Error list	140
Default settings.....	149	Ethernet.....	34
Disposal instructions.....	6	GPIB	30
EN61010		LAN.....	34
measurement category	5	RS232.....	24
pollution degree	6	Status registers	128
Environment		USB.....	23
safety instruction.....	6	Remote control function check	
Ethernet		GPIB	31
interface	34	Realterm.....	27
Front panel diagram	12	RS-232.....	26
Ground		USB.....	26
symbol	4	Service operation	
List of features	9	about disassembly	5
Model differences.....	9	Socket server function check	37
Power on/off		UK power cord.....	7
safety instruction.....	5	Warning symbol	4
Remote control.....	22	Web server function check	36