

Programmable DC Power Supply

PSU Series

PROGRAMMING MANUAL



ISO-9001 CERTIFIED MANUFACTURER

GW INSTEK

This manual contains proprietary information, which is protected by copyright. All rights are reserved. No part of this manual may be photocopied, reproduced or translated to another language without prior written consent of Good Will company.

The information in this manual was correct at the time of printing. However, Good Will continues to improve products and reserves the rights to change specification, equipment, and maintenance procedures at any time without notice.

Good Will Instrument Co., Ltd.
No. 7-1, Jhongsing Rd., Tucheng Dist., New Taipei City 236, Taiwan.

Table of Contents

SAFETY INSTRUCTIONS	4
GETTING STARTED.....	8
PSU Series Overview	9
Appearance	14
Configuration Settings	22
REMOTE CONTROL	32
Interface Configuration	34
Command Syntax	63
Command List	67
Status Register Overview	127
Error List	140
APPENDIX.....	149
PSU Default Settings	149
Error Messages & Messages	151
LED ASCII Table Character Set	153
INDEX.....	154

S SAFETY INSTRUCTIONS

This chapter contains important safety instructions that you must follow during operation and storage. Read the following before any operation to insure your safety and to keep the instrument in the best possible condition.

Safety Symbols

These safety symbols may appear in this manual or on the instrument.



Warning: Identifies conditions or practices that could result in injury or loss of life.



Caution: Identifies conditions or practices that could result in damage to the PSU or to other properties.



DANGER High Voltage



Attention Refer to the Manual



Protective Conductor Terminal



Earth (ground) Terminal



Do not dispose electronic equipment as unsorted municipal waste. Please use a separate collection facility or contact the supplier from which this instrument was purchased.

Safety Guidelines

General Guideline



CAUTION

- Do not place any heavy object on the PSU.
- Avoid severe impact or rough handling that leads to damaging the PSU.
- Do not discharge static electricity to the PSU.
- Use only mating connectors, not bare wires, for the terminals.
- Do not block the cooling fan opening.
- Do not disassemble the PSU unless you are qualified.

(Measurement categories) EN61010-1:2010 and EN61010-2-030 specifies the measurement categories and their requirements as follows. The PSU falls under category II.

- Measurement category IV is for measurement performed at the source of low-voltage installation.
- Measurement category III is for measurement performed in the building installation.
- Measurement category II is for measurement performed on the circuits directly connected to the low voltage installation.
- 0 is for measurements performed on circuits not directly connected to Mains.

Power Supply



WARNING

- AC Input voltage range: 85Vac~265Vac
 - Frequency: 47Hz to 63Hz
 - To avoid electrical shock connect the protective grounding conductor of the AC power cord to an earth ground.
-

- Cleaning the PSU
- Disconnect the power cord before cleaning.
 - Use a soft cloth dampened in a solution of mild detergent and water. Do not spray any liquid.
 - Do not use chemicals containing harsh material such as benzene, toluene, xylene, and acetone.

Operation Environment

- Location: Indoor, no direct sunlight, dust free, almost non-conductive pollution (Note below)
- Relative Humidity: 20%~ 85% (no condensation)
- Altitude: < 2000m
- Temperature: 0°C to 50°C

(Pollution Degree) EN61010-1:2010 and EN61010-2-030 specifies the pollution degrees and their requirements as follows. The PSU falls under degree 2.

Pollution refers to “addition of foreign matter, solid, liquid, or gaseous (ionized gases), that may produce a reduction of dielectric strength or surface resistivity”.

- Pollution degree 1: No pollution or only dry, non-conductive pollution occurs. The pollution has no influence.
- Pollution degree 2: Normally only non-conductive pollution occurs. Occasionally, however, a temporary conductivity caused by condensation must be expected.
- Pollution degree 3: Conductive pollution occurs, or dry, non-conductive pollution occurs which becomes conductive due to condensation which is expected. In such conditions, equipment is normally protected against exposure to direct sunlight, precipitation, and full wind pressure, but neither temperature nor humidity is controlled.

Storage environment

- Location: Indoor
- Temperature: -25°C to 70°C
- Relative Humidity: ≤90% (no condensation)

Disposal



Do not dispose this instrument as unsorted municipal waste. Please use a separate collection facility or contact the supplier from which this instrument was purchased. Please make sure discarded electrical waste is properly recycled to reduce environmental impact.

Power cord for the United Kingdom

When using the power supply in the United Kingdom, make sure the power cord meets the following safety instructions.

NOTE: This lead/appliance must only be wired by competent persons



WARNING: THIS APPLIANCE MUST BE EARTHED

IMPORTANT: The wires in this lead are coloured in accordance with the following code:

Green/ Yellow:	Earth
Blue:	Neutral
Brown:	Live (Phase)



As the colours of the wires in main leads may not correspond with the coloured marking identified in your plug/appliance, proceed as follows:

The wire which is coloured Green & Yellow must be connected to the Earth terminal marked with either the letter E, the earth symbol  or coloured Green/Green & Yellow.

The wire which is coloured Blue must be connected to the terminal which is marked with the letter N or coloured Blue or Black.

The wire which is coloured Brown must be connected to the terminal marked with the letter L or P or coloured Brown or Red.

If in doubt, consult the instructions provided with the equipment or contact the supplier.

This cable/appliance should be protected by a suitably rated and approved HBC mains fuse: refer to the rating information on the equipment and/or user instructions for details. As a guide, a cable of 0.75mm² should be protected by a 3A or 5A fuse. Larger conductors would normally require 13A types, depending on the connection method used.

Any exposed wiring from a cable, plug or connection that is engaged in a live socket is extremely hazardous. If a cable or plug is deemed hazardous, turn off the mains power and remove the cable, any fuses and fuse assemblies. All hazardous wiring must be immediately destroyed and replaced in accordance to the above standard.

G E T T I N G S T A R T E D

This chapter describes the power supply in a nutshell, including its main features and front / rear panel introduction. After going through the overview, please read the theory of operation to become familiar with the operating modes, protection modes and other safety considerations.



PSU Series Overview	9
Series lineup	9
Main Features	10
Accessories	11
Appearance	14
PSU Series Front Panel.....	14
PSU Series Display and Operation Panel	17
Rear Panel.....	19
Configuration Settings	22
Setting Normal Function Settings.....	22
Setting Power On Configuration Settings	24
Configuration Table.....	26

PSU Series Overview

Series lineup

The PSU series consists of 10 models, covering a number of different current, voltage and power capacities:

Model name	Voltage Rating ¹	Current Rating ²	Power
PSU 6-200	6V	200A	1200W
PSU 12.5-120	12.5V	120A	1500W
PSU 20-76	20V	76A	1520W
PSU 40-38	40V	38A	1520W
PSU 60-25	60V	25A	1500W
PSU 100-15	100V	15A	1500W
PSU 150-10	150V	10A	1500W
PSU 300-5	300V	5A	1500W
PSU 400-3.8	400V	3.8A	1520W
PSU 600-2.6	600V	2.6A	1560W

¹Minimum voltage guaranteed to 0.2% of rating voltage.

²Minimum current guaranteed to 0.4% of rating current.

Main Features

- Performance
- High power density: 1500W in 1U
 - Universal input voltage 85~265Vac, continuous operation.
 - Output voltage up to 600V, current up to 200A.
-

- Features
- Active power factor correction.
 - Parallel master/slave operation with active current sharing.
 - Remote sensing to compensate for voltage drop in load leads.
 - 19" rack mounted ATE applications.
 - A built-in Web server.
 - OVP, OCP and OHP protection.
 - Preset memory function.
 - Adjustable voltage and current slew rates.
 - Bleeder circuit ON/OFF setting.
 - CV, CC priority start function. (prevents overshoot with output ON)
 - Supports test scripts.
-

- Interface
- Built-in RS-232/485, LAN and USB interface.
 - Analog output programming and monitoring.
 - Optional interfaces: GPIB, Isolated Voltage (0-5V/0-10V) and Isolated Current (4-20mA) programming and monitoring interface. (Factory options)

Accessories

Before using the PSU power supply unit, check the package contents to make sure all the standard accessories are included.

Standard Accessories	Part number	Description	Qty.
		Output terminal cover	1
		Analog connector plug kit	1
		Output terminal M8 bolt set (6V~60V model)	1
		Input terminal cover	1
		Power Cord (230VAC/10A, 1.8M, provide for certain regions only)	1
	82GW1SAFE0M*1	Safety Guide	1
	62SB-8K0HD1*1	1U Handle, ROHS	2
	62SB-8K0HP1*1	1U BRACKET (LEFT), RoHS	1
	62SB-8K0HP2*1	1U BRACKET (RIGHT), RoHS	1
	CD ROM	User manual, Programming manual	1 set
	82SU-PSU00K*1	Packing list	
	82GW-00000C*1	* CTC GW/INSTEK JAPAN USE ,RoHS	1

Factory Installed Options	Part number	Description
	PSU-GPIB	GPIB interface
	PSU-ISO-V	Voltage programming isolated analog interface
	PSU-ISO-I	Current programming isolated analog interface

	PSU-001	Front Panel Filter Kit (Operation Temperature is guaranteed to 40°C)
Optional Accessories	Part number	Description
	PSU-01C	Cable for 2 units of PSU-Series in parallel mode connection
	PSU-01B	Bus Bar for 2 units of PSU-Series in parallel mode connection
	PSU-01A	Joins a vertical stack of 2 PSU units together. 2U-sized handles x2, joining plates x2.
	PSU-02C	Cable for 3 units of PSU-Series in parallel mode connection
	PSU-02B	Bus Bar for 3 units of PSU-Series in parallel mode connection
	PSU-02A	Joins a vertical stack of 3 PSU units together. 3U-sized handles x2, joining plates x2.
	PSU-03C	Cable for 4 units of PSU-Series in parallel mode connection
	PSU-03B	Bus Bar for 4 units of PSU-Series in parallel mode connection
	PSU-03A	Joins a vertical stack of 4 PSU units together. 4U-sized handles x2, joining plates x2.
	PSU-232	RS232 cable with DB9 connector kit. It Includes RS232 cable with DB9 connector, RS485 used master cable (gray plug), slave cable (black plug) and end plug terminal.
	PSU-485	RS485 cable with DB9 connector kit. It Includes RS485 cable with DB9 connector, RS485 used master cable (gray plug), slave cable (black plug) and end plug terminal.



GRM-001	Rack-mount slides (General Devices P/N: C-300-S-116-RH-LH)
GTL-246	USB Cable 2.0-A-B Type, Approx. 1.2M
GPW-001	Power Cord SJT 12AWG/3C, 3m MAX Length, 105 °C, RNB5-5*3P UL/CSA type
GPW-002	Power Cord H05W-F 1.5mm ² /3C, 3m MAX Length, 105 °C, RNB5-5*3P VDE type
GPW-003	Power Cord VCTF 3.5mm ² /3C, 3m MAX Length, 105 °C, RNB5-5*3P PSE type

Download	Name	Description
	psu_cdc.inf	PSU USB driver
Other	Name	Description
	Certificate of traceable calibration	

Appearance

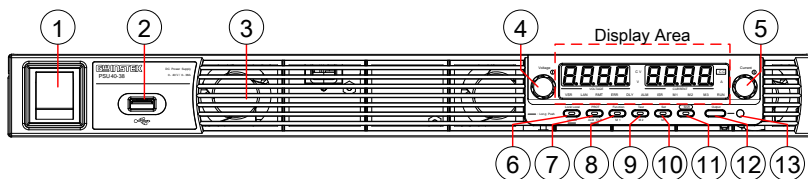

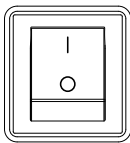
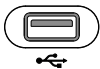
PSU Series Front Panel

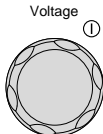

1. Power Switch  Used to turn the power on/off.
2. USB A Port  USB A port for data transfer, loading test scripts etc.
3. Air Inlet  Air inlet for cooling the inside of the PSU series.
4. Voltage Knob  Used to set the voltage value or select a parameter number in the Function settings.

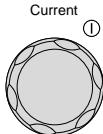
Display Area The display area shows setting values, output values and parameter settings. The function LEDs below show the current status and mode of the power supply. See page 17 for details.

5. Current Knob  Displays the current or the value of a Function parameter.

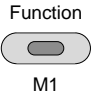
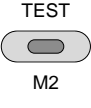
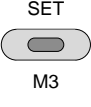
6. Lock/Local Button  Used to lock all front panel buttons other than the Output Button or it switches to local mode.
- Unlock Button (Long push) Used to unlock the front panel buttons.
7. PROT Button  Used to set and display OVP, OCP and UVL.
- ALM_CLR Button (Long push) Used to release protection functions that have been activated.
8. Function Button  Used to configure the various function.
- M1 Button (+Shift) Used to recall the M1 setup.
(+Shift and hold) Used to save the current setup to M1.
9. Test Button  Used to run customized scripts for testing.
- M2 Button (+Shift) Used to recall the M2 setup.
(+Shift and hold) Used to save the current setup to M2.
10. Set Button  Used to set and confirm the output voltage and output current.
- M3 Button (+Shift) Used to recall the M3 setup.
(+Shift and hold) Used to save the current setup to M3.

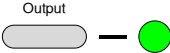
11. Shift Button  Used to enable the functions that are written in blue characters below the button.
12. Output Button  Used to turn output on and off.
13. Output ON LED Lights in green during output ON.

PSU Series Display and Operation Panel

Display Area

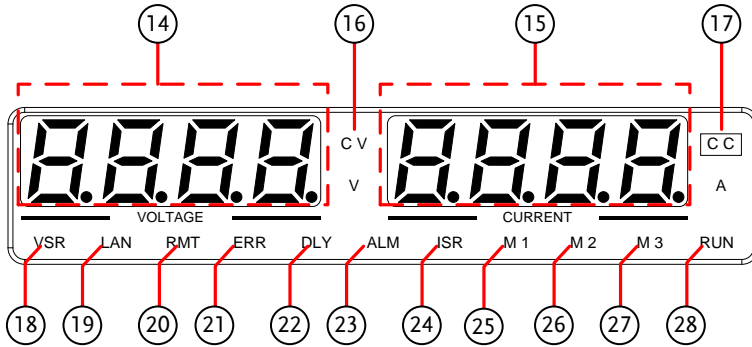

- | | |
|-------------------|-----------------------------------------------------------------------|
| 14. Voltage Meter | Displays the voltage or the parameter number of a Function parameter. |
| 15. Current Meter | Displays the current or the value of a Function parameter. |
| 16. CV LED | Lights in green during constant voltage mode. |
| 17. CC LED | Lights in green during constant current mode. |
| 18. VSR LED | The voltage slew rate enable. |
| 19. LAN LED | Lights up when the LAN interface is connected. |
| 20. RMT LED | Lights in green during remote control. |
| 21. ERR LED | Lights in red when an error has occurred. |
| 22. DLY LED | The output on/off delay enable. |
| 23. ALM LED | Lights in red when a protection function has been activated. |

- 24. ISR LED The current slew rate enable.
- 25. M1 LED Lights in green when the memory value are being recalled or saved.
- 26. M2 LED Lights in green when the memory value are being recalled or saved.
- 27. M3 LED Lights in green when the memory value are being recalled or saved.
- 28. RUN LED Auto sequence has been activated.



Note

Only the ERR and ALM LED's are red. All the others are green.

Rear Panel

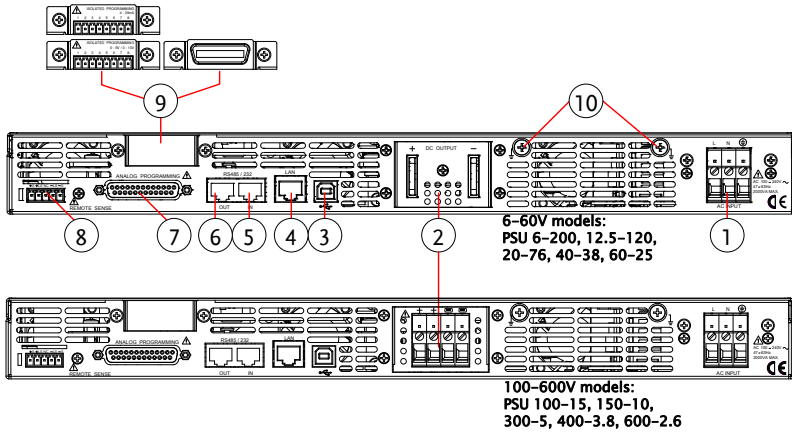

1. AC Input

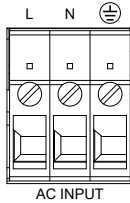

Wire clamp connector.

2. DC Output

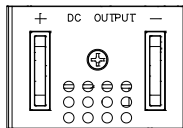

Output terminals for 6V to 60V models.

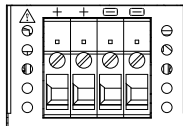

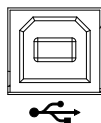

Output terminals for 100V to 600V models.

3. USB

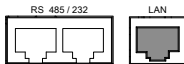

USB port for controlling the PSU remotely.

- 4. LAN  Ethernet port for controlling the PSU remotely.
- 5. Remote-IN  Two different types of cables can be used for RS232 or RS485-based remote control.

PSU-232: RS232 cable with DB9 connector kit.

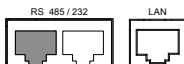
PSU-485: RS485 cable with DB9 connector kit.
- 6. Remote-OUT  RJ-45 connector that is used to daisy chain power supplies with the Remote-IN port to form a communication bus.

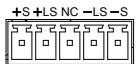
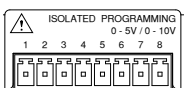
PSU-485S: Serial link cable with RJ-45 shielded connector.
- 7. Analog Control  External analog control connector.
- 8. Remote Sense  Compensation of load wire drop.
- 9. Option Slot  Blank sub-plate for standard units. Isolated Analog connector for units equipped with Isolated Current and Voltage Programming and Monitoring option. GPIB connector for units equipped with IEEE programming option.

10. Ground
Screw

Connector for grounding the output (two positions, shown in red).

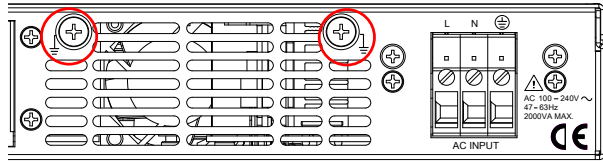

Configuration Settings

Setting Normal Function Settings

The normal function settings, F-01~F-61, F-70~F-78, F-88~F-89 and F100~F122 can be easily configured with the Function key.

- Ensure the load is not connected.
- Ensure the output is off.
- Function settings F-90~97 can only be viewed.



Note

Function setting F-89 (Show Version) can only be viewed, not edited.

Configuration settings F-90~ F-97 cannot be edited in the Normal Function Settings. Use the Power On Configuration Settings. See page 24 for details.

Steps

1. Press the Function key. The function key will light up.

Function



2. The display will show F-01 on the left and the configuration setting for F-01 on the right.

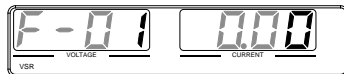

3. Rotate the voltage knob to change the F setting.

Range F-00~F-61, F-70~F-78,
F-88~F-97, F100~F122

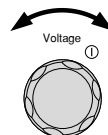

4. Use the current knob to set the parameter for the chosen F setting.

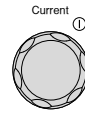

Press the Voltage knob to save the configuration setting. ConF will be displayed when it is configuring.

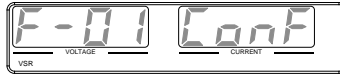
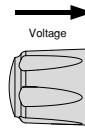

Exit

Press the Function key again to exit the configuration settings. The function key light will turn off.



Setting Power On Configuration Settings

Background The Power On configuration settings can only be changed during power up to prevent the configuration settings being inadvertently changed.

- Ensure the load is not connected.
- Ensure the power supply is off.

Steps 1. Hold the Function key whilst turning the power on.

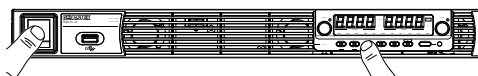

2. The display will show F-90 on the left and the configuration setting for F-90 on the right.

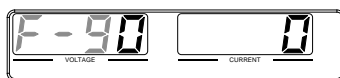

3. Rotate the voltage knob to change the F setting.

Range F-90 ~ F-97

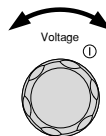

4. Use the current knob to set the parameter for the chosen F setting.



Press the Voltage knob to save the configuration setting. ConF will be displayed when it is configuring.

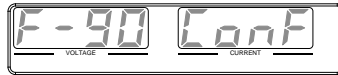
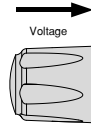

Exit

Cycle the power to save and exit the configuration settings.

Configuration Table

Please use the configuration settings listed below when applying the configuration settings.

Normal Function		
Settings	Setting	Setting Range
Output ON delay time	F-01	0.00s~99.99s
Output OFF delay time	F-02	0.00s~99.99s
V-I mode slew rate select	F-03	0 = CV high speed priority (CVHS) 1 = CC high speed priority (CCHS) 2 = CV slew rate priority (CVLS) 3 = CC slew rate priority (CVLS)
Rising voltage slew rate	F-04	0.001~0.06V/msec (PSU 6-200) 0.001~0.125V/msec (PSU 12.5-120) 0.001~0.2V/msec (PSU 20-76) 0.001~0.4V/msec (PSU 40-38) 0.001~0.6V/msec (PSU 60-25) 0.001~1.000V/msec (PSU 100-15) 0.001~1.500V/msec (PSU 150-10) 0.001~1.500V/msec (PSU 300-5) 0.001~2.000V/msec (PSU 400-3.8) 0.001~2.400V/msec (PSU 600-2.6)
Falling voltage slew rate	F-05	0.001~0.06V/msec (PSU 6-200) 0.001~0.125V/msec (PSU 12.5-120) 0.001~0.2V/msec (PSU 20-76) 0.001~0.4V/msec (PSU 40-38) 0.001~0.6V/msec (PSU 60-25) 0.001~1.000V/msec (PSU 100-15) 0.001~1.500V/msec (PSU 150-10) 0.001~1.500V/msec (PSU 300-5) 0.001~2.000V/msec (PSU 400-3.8) 0.001~2.400V/msec (PSU 600-2.6)

Rising current slew rate	F-06	0.001~2A/msec (PSU 6-200)
		0.001~1.2A/msec (PSU 12.5-120)
		0.001~0.76A/msec (PSU 20-76)
		0.001~0.38A/msec (PSU 40-38)
		0.001~0.25A/msec (PSU 60-25)
		0.001~0.150A/msec (PSU 100-15)
		0.001~0.100A/msec (PSU 150-10)
		0.001~0.025A/msec (PSU 300-5)
		0.001~0.008A/msec (PSU 400-3.8)
0.001~0.006A/msec (PSU 600-2.6)		
Falling current slew rate	F-07	0.001~2A/msec (PSU 6-200)
		0.001~1.2A/msec (PSU 12.5-120)
		0.001~0.76A/msec (PSU 20-76)
		0.001~0.38A/msec (PSU 40-38)
		0.001~0.25A/msec (PSU 60-25)
		0.001~0.150A/msec (PSU 100-15)
		0.001~0.100A/msec (PSU 150-10)
		0.001~0.025A/msec (PSU 300-5)
		0.001~0.008A/msec (PSU 400-3.8)
0.001~0.006A/msec (PSU 600-2.6)		
Internal resistance setting	F-08	0~0.03Ω (PSU 6-200)
		0~0.104Ω (PSU 12.5-120)
		0~0.263Ω (PSU 20-76)
		0~1.053Ω (PSU 40-38)
		0~2.4Ω (PSU 60-25)
		0~6.667Ω (PSU 100-15)
		0~15.00Ω (PSU 150-10)
		0~60.00Ω (PSU 300-5)
		0~105.3Ω (PSU 400-3.8)
0~230.8Ω (PSU 600-2.6)		
Bleeder circuit control	F-09	0 = OFF, 1 = ON, 2 = AUTO
Buzzer ON/OFF control	F-10	0 = OFF, 1 = ON
OCP Delay Time	F-12	0.1 ~ 2.0 sec
Current Setting Limit (I-Limit)	F-13	0 = OFF, 1 = ON
Voltage Setting Limit (V-Limit)	F-14	0 = OFF, 1 = ON

Display memory parameter when recalling (M1, M2, M3)	F-15	0 = OFF, 1 = ON
Auto Calibration Parallel Control	F-16	0 = Disable, 1 = Enable, 2 = Execute Parallel Calibration and set to Enable. Note: Must be a short between each unit before starting.
Measurement Average Setting	F-17	0 = Low, 1 = Middle, 2 = High
Alarm Recovery and Output Status	F-18	0 = Safe Mode, 1 = Force Mode
Lock Mode	F-19	0:Lock Panel, Allow Output OFF 1:Lock Panel, Allow Output ON/OFF
USB/GPIB settings		
Show front panel USB status	F-20	0 = None, 1 = Mass Storage
Show rear panel USB status	F-21	0 = None, 1 = Linking to PC
Setup rear USB Speed	F-22	0 = Disable USB, 1 = Full Speed, 2 = Auto Detect Speed
GPIB Address	F-23	0 ~ 30
GPIB Enable/Disable	F-24	0 = Disable GPIB, 1 = Enable GPIB
Show GPIB available status	F-25	0 = No GPIB, 1 = GPIB is available
SCPI Emulation	F-26	0 = GW Instek, 1 = TDK GEN, 2 = Agilent 5700, 3 = Kikusui PWX
LAN settings		
Show MAC Address-1	F-30	0x00~0xFF
Show MAC Address-2	F-31	0x00~0xFF
Show MAC Address-3	F-32	0x00~0xFF
Show MAC Address-4	F-33	0x00~0xFF
Show MAC Address-5	F-34	0x00~0xFF
Show MAC Address-6	F-35	0x00~0xFF
LAN Enable	F-36	0 = OFF, 1 = ON
DHCP	F-37	0 = OFF, 1 = ON
IP Address-1	F-39	0~255
IP Address-2	F-40	0~255
IP Address-3	F-41	0~255
IP Address-4	F-42	0~255
Subnet Mask-1	F-43	0~255

Subnet Mask-2	F-44	0~255
Subnet Mask-3	F-45	0~255
Subnet Mask-4	F-46	0~255
Gateway-1	F-47	0~255
Gateway-2	F-48	0~255
Gateway-3	F-49	0~255
Gateway-4	F-50	0~255
DNS address -1	F-51	0~255
DNS address -2	F-52	0~255
DNS address-3	F-53	0~255
DNS address-4	F-54	0~255
Socket Server Enable/Disable	F-57	0 = Disable, 1 = Enable
Show Socket Server Port	F-58	No setting
Web Server Enable/Disable	F-59	0 = Disable, 1 = Enable
Web Password Enable/Disable	F-60	0 = Disable, 1 = Enable
Web Enter Password	F-61	0000~9999
UART Settings		
UART Mode	F-70	0 = Disable UART, 1 = RS232, 2 = RS485
UART Baud Rate	F-71	0 = 1200, 1 = 2400, 2 = 4800, 3 = 9600, 4 = 19200, 5 = 38400, 6 = 57600, 7 = 115200
UART Data Bits	F-72	0 = 7 bits, 1 = 8 bits
UART Parity	F-73	0 = None, 1 = Odd, 2 = Even
UART Stop Bit	F-74	0 = 1 Bit, 1 = 2 Bits
UART TCP	F-75	0 = SCPI, 1 = TDK (emulation mode)
UART Address (For multi-unit remote control)	F-76	00 ~ 30
UART Multi-Drop control	F-77	0 = Disable, 1 = Master, 2 = Slave, 3 = Display information
UART Multi-Drop status	F-78	Displayed parameter: AA-S AA: 00~30 (Address), S: 0~1 (Off-line/On-line status).
System Settings		
Factory Set Value	F-88	0 = None 1 = Return to factory default settings

		0, 1 = Version 2, 3, 4, 5 = Build date (YYYYMMDD) 6, 7 = Keyboard CPLD 8, 9 = Analog Board CPLD A, B = Analog Board FPGA C, D, E, F = Kernel Build (YYYYMMDD) G, H = Test Command Version I, J, K, L = Test Command Build (YYYYMMDD) M, N = Reserved O, P = Option Module
Power On Configuration Settings*		
CV Control	F-90	0 = Control by Local 1 = Control by External Voltage 2 = Control by External Resistor - Rising <input checked="" type="checkbox"/> 3 = Control by External Resistor - Falling <input type="checkbox"/> 4 = Control by Isolated Board
CC Control	F-91	0 = Control by Local 1 = Control by External Voltage 2 = Control by External Resistor - Rising <input checked="" type="checkbox"/> 3 = Control by External Resistor - Falling <input type="checkbox"/> 4 = Control by Isolated Board
Output Status when Power ON	F-92	0 = Safe Mode (Always OFF), 1 = Force Mode (Always ON), 2 = Auto Mode (Status before last time power OFF)
Master/Slave Configuration	F-93	0 = Independent 1 = Master with 1 slave in parallel 2 = Master with 2 slaves in parallel 3 = Master with 3 slaves in parallel 4 = Slave (parallel)
External Output Logic	F-94	0 = High ON, 1 = Low ON
Monitor Voltage Select	F-96	0 = 5V, 1 = 10V
Control Range	F-97	0 = 5V [5kΩ], 1 = 10V [10kΩ]

External Output Control Function	F-98	0 = OFF, 1 = ON
Trigger Input and Output Configuration Settings		
Trigger Input Pulse Width	F100	0~60ms. 0 = trigger controlled by trigger level.
Trigger Input Action	F102	0 = None 1 = Output ON/OFF (refer to F103) 2 = Setting (refer to F104 & F105) 3 = Memory (refer to F106)
Output State When Receiving Trigger	F103	0 = OFF 1 = ON
Apply Voltage Setting on Trigger	F104	0 ~ rated voltage (only applicable when F102 =2)
Apply Current Setting on Trigger	F105	0 ~ rated current (only applicable when F102 =2)
Recall memory number	F106	1 ~ 3 (M1 ~ M3)
Trigger Output Pulse Width	F120	0 ~ 60ms. 0 = trigger output is set to the active level, not pulse width.
Trigger Output Level	F121	0 = LOW, 1 = HIGH (if F120 = 0)
Trigger Source	F122	0 = None 1 = Switching the output on or off 2 = Changing a setting 3 = Recalling a memory
Special Function Settings*		
Calibration	F-00	0000 ~ 9999

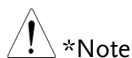

*Note

Power On configuration settings can only be set during power up. They can, however, be viewed under normal operation.

REMOTE CONTROL

This chapter describes basic configuration of IEEE488.2 based remote control.

Interface Configuration	34
USB Remote Interface	34
Configuration.....	34
Function Check	35
GPIB Remote Interface.....	36
Configuration.....	36
GPIB Function Check	37
UART Remote Interface	41
Configure UART	41
UART Function Check.....	44
Multiple Unit Connection.....	45
Legacy Multi-Drop mode.....	45
Multi-Drop mode.....	47
Multiple units Function Check.....	50
Configure Ethernet Connection.....	54
Web Server Configuration.....	54
Web Server Remote Control Function Check.....	55
Sockets Server Configuration	57
Socket Server Function Check	58
Command Syntax	63
Command List	67
Status Register Overview	127
Introduction to the Status Registers	127
The Status Registers.....	128
Questionable Status Register Group	129
Operation Status Register Group.....	133
Standard Event Status Register Group	136
Status Byte Register & Service Request Enable Register.....	138
Error List	140
Command Errors	140
Execution Errors.....	144

Device Specific Errors	146
Query Errors.....	147

Interface Configuration

USB Remote Interface

Configuration

USB Configuration	PC side connector	Type A, host
	PSU side connector	Rear panel Type B, slave
	Speed	1.1/2.0 (full speed/high speed)
	USB Class	CDC (communications device class)

Steps

1. Connect the USB cable to the rear panel USB B port.

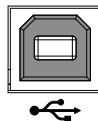

2. Change the Rear panel-USB (F-22) setting to 2 (Auto Detect Speed) or 1 (USB Full Speed).

Page 22



Note

If you are not using the rear panel USB device port, set F-22 to 0 (Disable USB).

Page 22

3. The RMT indicator will turn on when a remote connection has been established.

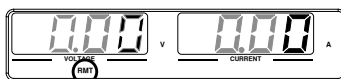

RMT indicator

Function Check

Functionality
check

Invoke a terminal application such as Realterm.

To check the COM port No., see the Device Manager in the PC. For WinXP; Control panel → System → Hardware tab.

Run this query command via the terminal application after the instrument has been configured for USB remote control (page 34).

*idn?

This should return the Manufacturer, Model number, Serial number, and Firmware version in the following format.

GW-INSTEK,PSU40-38,TW123456,T0.01.12345678

Manufacturer: GW-INSTEK

Model number : PSU40-38

Serial number : TW123456

Firmware version : T0.01.12345678

GPIB Remote Interface

Configuration

To use GPIB, the optional GPIB option (GW Instek part number: PSU-GPIB) must be installed. This is a factory installed option and cannot be installed by the end-user. Only one GPIB address can be used at a time.

- Configure GPIB
1. Ensure the PSU is off before proceeding.
 2. Connect a GPIB cable from a GPIB controller to the GPIB port on the PSU.
 3. Turn the PSU on.
 4. Press the Function key to enter the [Page 22](#) Normal configuration settings.
 5. Set the following GPIB settings.

F-24 = 1	Enable the GPIB port
F-23 = 0~30	Set the GPIB address (0~30)
 6. Check to see that the GPIB option is detected by the PSU. The F-25 setting indicates the GPIB port status.

F-25 = 1	Indicates that the GPIB port is available.
F-25 = 0	Indicates that the GPIB port is not detected.

7. The RMT indicator will turn on when a remote connection has been established.

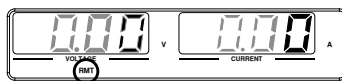

RMT indicator

-
- GPIB constraints
- Maximum 15 devices altogether, 20m cable length, 2m between each device
 - Unique address assigned to each device
 - At least 2/3 of the devices turned On
 - No loop or parallel connection

GPIB Function Check

Background To test the GPIB functionality, National Instruments Measurement and Automation Explorer can be used. This program is available on the NI website, www.ni.com, via a search for the VISA Run-time Engine page, or “downloads” at the following URL, <http://www.ni.com/visa/>

Requirements Operating System: Windows XP, 7, 8

Functionality check

1. Start the NI Measurement and Automation Explorer (MAX) program. Using Windows, press:

Start>All Programs>National Instruments>Measurement & Automation



2. From the Configuration panel access;
My System>Devices and Interfaces>GPIB
3. Press *Scan for Instruments*.

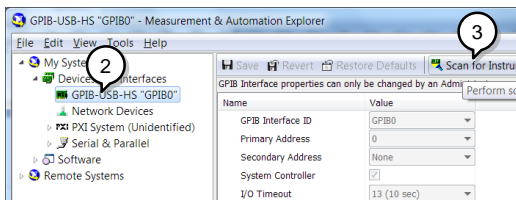

4. Select the device (GPIB address of PSU) that now appears in the *System>Devices and Interfaces > GPIB-USB-HS "GPIBX"* node.
5. Click on the *VISA Properties* tab on the bottom.
6. Click *Open Visa Test Panel*.

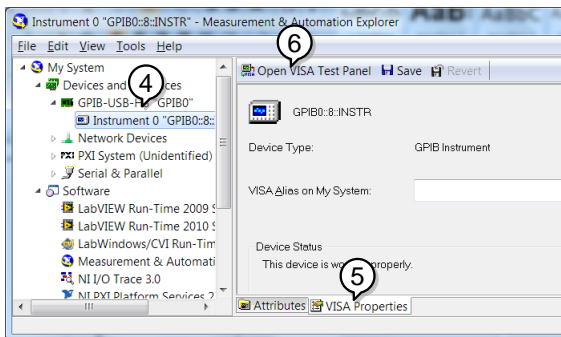

7. Click on *Configuration*.
8. Click on the *GPIB Settings* tab and confirm that the GPIB settings are correct.

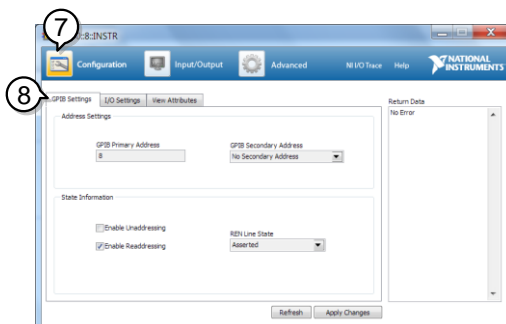

9. Click on the *I/O Settings* tab.
10. Make sure the *Enable Termination Character*

check box is checked, and the terminal character is \n (Value: xA).

11. Click *Apply Changes*.

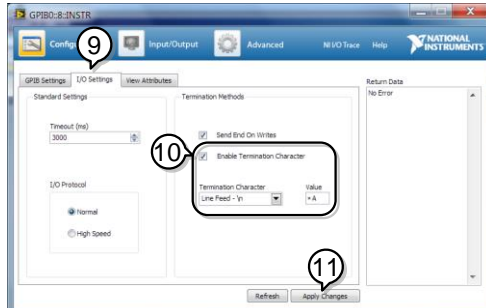

12. Click on *Input/Output*.

13. Click on the *Basic/IO* tab.

14. Enter *IDN? in the *Select or Enter Command* drop down box.

15. Click *Query*.

16. The *IDN? query will return the Manufacturer, model name, serial number and firmware version in the dialog box.

GW-INSTEK,PSU40-38,
TW123456,T0.02.20131205

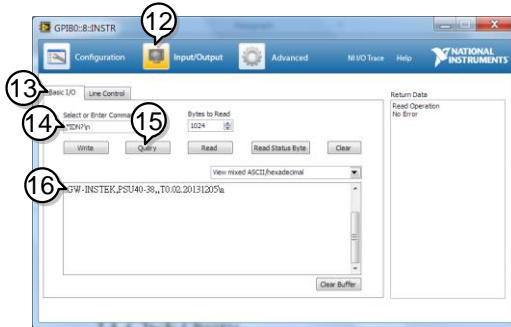

UART Remote Interface

Configure UART

Overview

The PSU uses the IN & OUT ports for UART communication coupled with RS232 (GW Part number PSU-232) or RS485 adapters (GW part number PSU-485).

The pin outs for the adapters are shown below.

PSU-232 RS232 cable with DB9 connector	DB-9 Connector		Remote IN Port		Remarks
	Pin No.	Name	Pin No.	Name	
	Housing	Shield	Housing	Shield	
	2	RX	7	TX	Twisted pair
	3	TX	8	RX	
5	SG	1	SG		

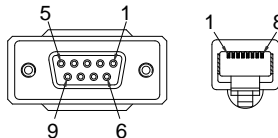

PSU-485 RS485 cable with DB9 connector

DB-9 Connector		Remote IN Port		Remarks
Pin No.	Name	Pin No.	Name	
Housing	Shield	Housing	Shield	
9	TXD -	6	RXD -	Twisted pair
8	TXD +	3	RXD +	
1	SG	1	SG	
5	RXD -	5	TXD -	Twisted pair
4	RXD +	4	TXD +	

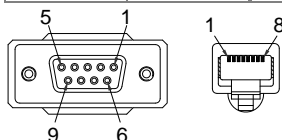

Steps

1. Connect the RS232 serial cable (include in the PSU-232 connection kit) or RS485 serial cable (include in the PSU-485 connection kit) to the Remote IN port on the real panel.

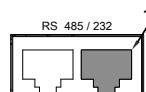

Connect the other end of the cable to the PC.

2. Press the Function key to enter the Page 22 Normal configuration settings.

Set the following UART settings:

F-70 = 1 or 2	Interface: 0= Disable UART, 1= RS232 or 2 = RS485
F-71 = 0 ~ 7	Set the baud rate: 0=1200, 1=2400, 2=4800, 3=9600, 4=19200, 5=38400, 6=57600, 7=115200
F-72 = 0 or 1	Data bits: 0=7 or 1=8

F-73 = 0 ~3	Parity: 0 = none, 1 = odd, 2 = even
F-74 = 0 or 1	Stop bits: 0 = 1, 1 = 2
F-75 = 0 or 1	TCP: 0 = SCPI, 1 = TDK (emulation mode)
F-76 = 00~30	UART address for multi-unit remote connection.
F-77 = 0~3	Multi-Drop control 0 = Disable, 1 = Master, 2 = Slave, 3 = Display Information
F-78 = 00~30	Multi-Drop status display Displayed parameter: AA-S AA: 00~30 (Address), S: 0~1 (Off-line/On-line status).

- The RMT indicator will turn on when a remote connection has been established.

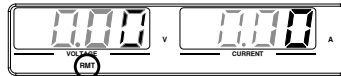

RMT indicator

 **Note**

If TDK (emulation mode) is selected for F-75, the TDK GENESYS legacy commands should be used for remote commands. See the TDK Genesys user manual for details.

UART Function Check

Functionality
check

Invoke a terminal application such as Realterm.

To check the COM port No, see the Device Manager in the PC. For WinXP; Control panel → System → Hardware tab.

Run this query command via the terminal application after the instrument has been configured for either RS232 or RS485 remote control (page 41).

*idn?

This should return the Manufacturer, Model number, Serial number, and Firmware version in the following format:

GW-INSTEK,PSU40-38,TW123456,T0.01.12345678

Manufacturer: GW-INSTEK

Model number : PSU40-38

Serial number : TW123456

Firmware version : T0.01.12345678

Multiple Unit Connection

The PSU power supplies can have up to 31 units daisy-chained together using the 8 pin connectors (IN OUT ports) on the rear panel. The first unit (master) in the chain is remotely connected to a PC using RS232 or RS485 (Legacy Multi-Drop mode), or USB, GPIB or LAN (Multi-Drop mode). Each subsequent unit (slave) is daisy-chained to the next using a RS485 local bus. The OUT port on the last terminal must be terminated by the end terminal connector.

There are two modes for controlling multiple units. The first mode only allows the user to enter TDK GENESYS legacy commands (Legacy Multi-Drop mode). All UART parameters have to be configured in this mode. The second mode allows the user to enter the SCPI commands developed for the instrument (Multi-Drop mode). In this mode, only the Multi-Drop parameters have to be specified. For both modes, each unit is assigned a unique address and can then be individually controlled from the host PC.

Legacy Multi-Drop mode

- | | |
|-----------|------------------------------------------------------------------------------------------------------------------------------------------------------------------------------------------------------------------------------------------------------------------------------------------------------------------------------------------------------------------------------------------------------------------------------------------------------------------------------------------------------------------------------------------------------------------------------------------------------------------------------------------------------------------------------------------------------------------------|
| Operation | <ol style="list-style-type: none">1. Check the F-89 (System version and build date) settings first on all units (see the user manual for more information). The two parameters O and P (Option Module) must be the same on all units before any multiple unit connection can be established.

Example: F-89 O:00, P:01.2. Connect the first unit's IN port to a PC via RS232 or RS485 serial cable.<ul style="list-style-type: none">• Use the serial cables supplied in the PSU-232 or PSU-485 connection kit.3. Connect the OUT port on the first unit to the IN port of the second unit using slave serial link cable (black plug) supplied in the PSU-232 or |
|-----------|------------------------------------------------------------------------------------------------------------------------------------------------------------------------------------------------------------------------------------------------------------------------------------------------------------------------------------------------------------------------------------------------------------------------------------------------------------------------------------------------------------------------------------------------------------------------------------------------------------------------------------------------------------------------------------------------------------------------|

PSU-485 connection kit.

4. Connect all the remaining units in the same fashion until all the units have been daisy-chained together.

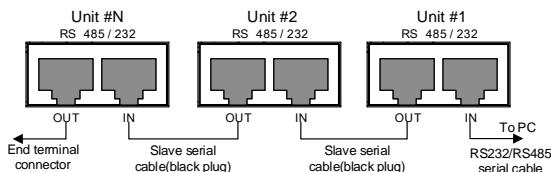

5. Terminate the OUT port of the last unit with the end terminal connector included in the PSU-232 or PSU-485 connection kit.
6. Press the Function key to enter the Page 22 Normal configuration settings for the master unit.

Set the following settings:

F-70 = 1 or 2	Configure the master unit as you normally would for RS232 or RS485 remote control, see page 41.
F-71 = 0~7	Set the baud rate (set all units the same). See page 41.
F-72 = 1	Set to 8 data bits.
F-73 = 0	Parity to none.
F-74 = 0	1 Stop bit.
F-75 = 1	Set the UART TCP to TDK (emulation mode).
F-76 = 00~30	Set the address of the master unit. It must be a unique address identifier.

7. Press the Function key to enter the Page 22 Normal configuration settings for the slave(s).

Set the following settings:

- F-70 = 2 Set the slave unit to RS485.
- F-71 = 0~7 Set the baud rate (make all units, including the master, the same baud). See page 41.
- F-72 = 1 Set to 8 data bits.
- F-73 = 0 Parity to none.
- F-74 = 0 1 Stop bit.
- F-75 = 1 Set the UART TCP to TDK (emulation mode).
- F-76 = 00~30 Set the address of each slave to a unique address identifier

8. Multiple units can now be operated at the same time. Only TDK GENESYS legacy commands can be used in this mode. See the programming manual or see the function check below for usage details.

Slave serial link cable with RJ-45 shielded connectors from PSU-232 or PSU-485 connection kit	RS-485 slave serial link pin assignment			
	8 Pin Connector (IN)		8 Pin Connector (OUT)	
	Pin No.	Name	Pin No.	Name
	Housing	Shield	Housing	Shield
1	SG	1	SG	
6	TXD -	6	TXD -	
3	TXD +	3	TXD +	
5	RXD -	5	RXD -	
4	RXD +	4	RXD +	

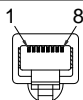

Multi-Drop mode

Operation

1. Check the F-89 (System version and build date) settings first on all units (see the user manual for more information). The two parameters O and P (Option Module) must be the same on all units before any multiple unit connection can be established.

Example: F-89 O:00, P:01.

2. All units must be powered down before starting the Multi-Drop mode configuration
3. Connect the first unit's LAN, USB or GPIB port to a PC.
4. Connect the OUT port on the first unit to the IN port of the second unit using the master serial link cable (gray plug) supplied in the PSU-232 or PSU-485 connection kit.
5. Connect all the remaining units between the OUT port and the IN port with the slave serial link cable (black plug) supplied in the PSU-232 or PSU-485 connection kit until all the desired units have been daisy-chained together.

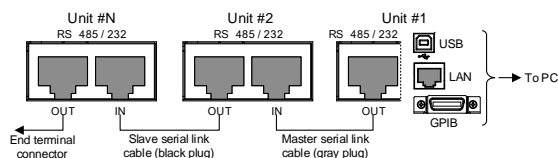

6. Terminate the OUT port of the last unit with the end terminal connector included in the PSU-232 or PSU-485 connection kit.

7. Power up all slave units.
8. Set the addresses of all slave units using the F-76 parameter.
F-76 = 00~30 Set the address of the unit. It must be a unique address identifier.
9. Set the Multi-Drop setting parameter (F-77) to Slave for all slave units.
F-77 = 2 Set the Multi-Drop setting to slave.
10. Power up the master unit.
11. Set the address of the master unit using the F-76 parameter.
F-76 = 00~30 Set the address of the unit. It must be a unique address identifier.
12. You can check the slaves' addresses by using the F-77 parameter on the master unit.
F-77 = 3 Display on each slave units the configured address. This can show if identical addresses have been assigned individually to each slave units.
13. Set the Multi-Drop setting parameter (F-77) to Master.
F-77 = 1 Set the Multi-Drop setting to master.
14. You can display the status of each slave unit by using the F-78 parameter.

F-78 = 0~30

Displayed parameter: AA-S
 AA: 00~30 (Address),
 S: 0~1 (Off-line/On-line status).

15. Multiple units can now be operated using SCPI commands. See the programming manual or see the function check below for usage details.

Slave serial link cable with RJ-45 shielded connectors from PSU-232 or PSU-485 connection kit	RS-485 slave serial link pin assignment			
	8 Pin Connector (IN)		8 Pin Connector (OUT)	
	Pin No.	Name	Pin No.	Name
	Housing	Shield	Housing	Shield
	1	SG	1	SG
	6	TXD -	6	TXD -
	3	TXD +	3	TXD +
Master serial link cable with RJ-45 shielded connectors from PSU-232 or PSU-485 connection kit	RS-485 master serial link pin assignment			
	8 Pin Connector (IN)		8 Pin Connector (OUT)	
	Pin No.	Name	Pin No.	Name
	Housing	Shield	Housing	Shield
	1	SG	1	SG
	6	TXD -	5	RXD -
	3	TXD +	4	RXD +
5	RXD -	6	TXD -	
4	RXD +	3	TXD +	

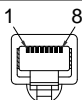

Multiple units Function Check

Functionality
check

Invoke a terminal application such as Realterm.

To check the COM port No, see the Device Manager in the PC. For WinXP; Control panel → System → Hardware tab.

Below shows examples using the Legacy Multi-Drop mode and the Multi-Drop mode.

Legacy Multi-Drop mode

When using the TDK GENESYS legacy commands, each unit can be individually controlled using the unique address identifiers. For this function check, we will assume that the master unit is assigned to address 8, while a slave is assigned address 11.

Run this query command via the terminal application after the instruments have been configured for multi-unit control with Legacy Multi-Drop mode mode. See page 45.

ADR 8
IDN?

The identity string for the Master unit will be returned:

GW-INSTEK,PSU40-38,,T0.01.12345678

Type the following:

ADR 11
IDN?

The identity string for the slave with address 11 will be returned:

GW-INSTEK,PSU40-38,,T0.01.12345678

Note: TDK commands do not use LF (line feed) codes to terminate commands. See the TDK GENESYS user manual for further information.

Multi-Drop mode

When using the Multi-Drop mode, the entire SCPI command list developed for the PSU can be used. Each unit can be individually controlled after a slave unit has been selected. For this function check, we will assume that the master unit is assigned to address 0, while a slave is assigned address 5.

Run this query command via the terminal application after the instruments have been configured for multi-unit control with Multi-Drop mode. See page 45.

INST:SEL 0

*IDN?

GW-INSTEK,PSU100-15,,T0.01.12345678

Selects the unit with address 0 and returns its identity string.

INST:SEL 5

*IDN?

GW-INSTEK,PSU150-10,,T0.01.12345678

Selects the unit with address 5 and returns its identity string.

INST:SEL 6

Selects the unit with address 6 (not configured in our example). An error is displayed on the master front panel.

INST:SEL 0

SYST:ERR?

Settings conflict

Query the system errors. "Settings conflict" is returned.

INST:STAT?
33,0

Returns the active units and master unit in the bus.

33=0b100001

The units at address 0 and address 5 are on-line.

0

Master device's address is 0.



Note

For further details, please see the programming manual, available on the GW Instek web site @ www.gwinstek.com.

Configure Ethernet Connection

The Ethernet interface can be configured for a number of different applications. Ethernet can be configured for basic remote control or monitoring using a web server or it can be configured as a socket server.

The PSU series supports both DHCP connections so the instrument can be automatically connected to an existing network or alternatively, network settings can be manually configured.

Ethernet configuration Parameters	For details on how to configure the Ethernet settings, please see the configuration chapter on page 22.
	MAC Address (display only) LAN Enable/Disable
	DHCP Enable/Disable IP Address
	Subnet Mask Gateway
	DNS Address Sockets Server Enable/Disable
	Web Server Enable/Disable Web Password Enable/Disable
	Web Enter Password

Web Server Configuration

Configuration This configuration example will configure the PSU as a web server and use DHCP to automatically assign an IP address to the PSU.

1. Connect an Ethernet cable from the network to the rear panel Ethernet port.

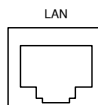

2. Press the Function key to enter the Page 22 Normal configuration settings.

Set the following LAN settings:

F-36 = 1	Turn LAN on
F-37 = 1	Enable DHCP
F-59 = 1	Turn the web server on
F-60 = 0 or 1	Set to 0 to disable web password, set to 1 to enable web password
F-61 = 0000 ~9999	Set the web password

3. The LAN indicator will turn on when a network cable is plugged in.

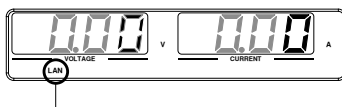

LAN indicator



Note

It may be necessary to cycle the power or refresh the web browser to connect to a network.

Web Server Remote Control Function Check

Functionality check

Enter the IP address of the power supply in a web browser after the instrument has been configured as a web server (page 54).

The web server allows you to monitor the function settings of the PSU.

You can check the IP address by checking F-39 to F-42.

F-39 = AAA	IP Address part 1 of 4
F-40 = BBB	IP Address part 2 of 4

F-41 = CCC IP Address part 3 of 4
 F-42 = DDD IP Address part 4 of 4

http:// AAA.BBB.CCC.DDD

The web browser interface appears.



<p>Welcome Page</p> <p>Network Configuration</p> <p>Analog Control</p> <p>Figure of Dimensions</p> <p>Operating Area</p>	<p>PSU Series</p> <p>Web Control Pages</p> <p>Thanks For Your Using.</p> <p>Use the left menu to select the features you need.</p> <p>More How-to Please refer to user manual.</p> 	<p>System Information</p> <table border="1"> <tr><td>Manufacturer :</td><td>GW-INSTEK</td></tr> <tr><td>Serial Number :</td><td></td></tr> <tr><td>Description :</td><td>GW-INSTEK.PSU12.5-120</td></tr> <tr><td>Firmware Version :</td><td>T1.13.20170310</td></tr> <tr><td>Hostname :</td><td>P-</td></tr> <tr><td>IP Address :</td><td>172.16.23.146</td></tr> <tr><td>Subnet Mask :</td><td>255.255.128.0</td></tr> <tr><td>Gateway :</td><td>172.16.0.254</td></tr> <tr><td>DNS :</td><td>172.16.1.252</td></tr> <tr><td>MAC Address :</td><td>02:80:ad:20:31:b2</td></tr> <tr><td>DHCP State :</td><td>ON</td></tr> <tr><td>VISA TCP/IP Connect String :</td><td>TCP0-172.16.23.146-2268::SOCKET</td></tr> </table>	Manufacturer :	GW-INSTEK	Serial Number :		Description :	GW-INSTEK.PSU12.5-120	Firmware Version :	T1.13.20170310	Hostname :	P-	IP Address :	172.16.23.146	Subnet Mask :	255.255.128.0	Gateway :	172.16.0.254	DNS :	172.16.1.252	MAC Address :	02:80:ad:20:31:b2	DHCP State :	ON	VISA TCP/IP Connect String :	TCP0-172.16.23.146-2268::SOCKET
Manufacturer :	GW-INSTEK																									
Serial Number :																										
Description :	GW-INSTEK.PSU12.5-120																									
Firmware Version :	T1.13.20170310																									
Hostname :	P-																									
IP Address :	172.16.23.146																									
Subnet Mask :	255.255.128.0																									
Gateway :	172.16.0.254																									
DNS :	172.16.1.252																									
MAC Address :	02:80:ad:20:31:b2																									
DHCP State :	ON																									
VISA TCP/IP Connect String :	TCP0-172.16.23.146-2268::SOCKET																									

Copyright 2011 © Good Will Instrument Co., Ltd All Rights Reserved.

The web browser interface allows you to access the following:

- Network configuration settings
- Analog control pinouts & usage
- PSU dimensions
- Operating area diagram

Sockets Server Configuration

Configuration This configuration example will configure the PSU socket server.

The following configuration settings will manually assign the PSU an IP address and enable the socket server. The socket server port number is fixed at 2268.

1. Connect an Ethernet cable from the network to the rear panel Ethernet port.

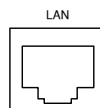

2. Press the Function key to enter the Page 22 Normal configuration settings.

Set the following LAN settings:

F-36 = 1	Enable LAN
F-37 = 0	Disable DHCP
F-39 = 172	IP Address part 1 of 4
F-40 = 16	IP Address part 2 of 4
F-41 = 5	IP Address part 3 of 4
F-42 = 133	IP Address part 4 of 4
F-43 = 255	Subnet Mask part 1 of 4
F-44 = 255	Subnet Mask part 2 of 4
F-45 = 128	Subnet Mask part 3 of 4
F-46 = 0	Subnet Mask part 4 of 4
F-47 = 172	Gateway part 1 of 4
F-48 = 16	Gateway part 2 of 4
F-49 = 21	Gateway part 3 of 4
F-50 = 101	Gateway part 4 of 4
F-57 = 1	Enable Sockets

Socket Server Function Check

Background To test the socket server functionality, National Instruments Measurement and Automation Explorer can be used. This program is available on the NI website, www.ni.com, via a search for the VISA Run-time Engine page, or “downloads” at the following URL, <http://www.ni.com/visa/>

Requirements Operating System: Windows XP, 7, 8

Functionality check

1. Start the NI Measurement and Automation Explorer (MAX) program. Using Windows, press:

Start>All Programs>National Instruments>Measurement & Automation



2. From the Configuration panel access;

My System>Devices and Interfaces>Network Devices

3. Press *Add New Network Device>Visa TCP/IP Resource...*



4. Select *Manual Entry of Raw Socket* from the popup window.

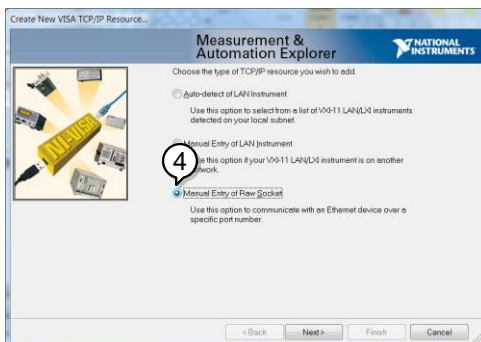

5. Enter the IP address and the port number of the PSU. The port number is fixed at 2268.
6. Click the Validate button.
7. A popup will appear if a connection is successfully established.
8. Click Next.

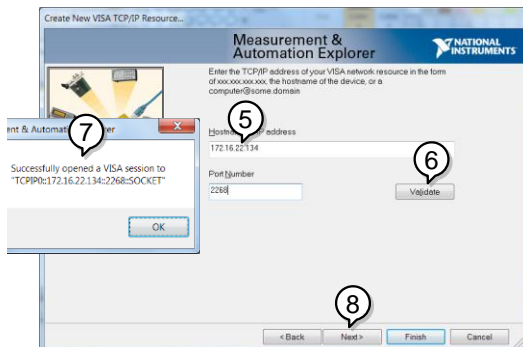

9. Next configure the Alias (name) of the PSU connection. In this example the Alias is: PSU_DC1

10. Click finish.

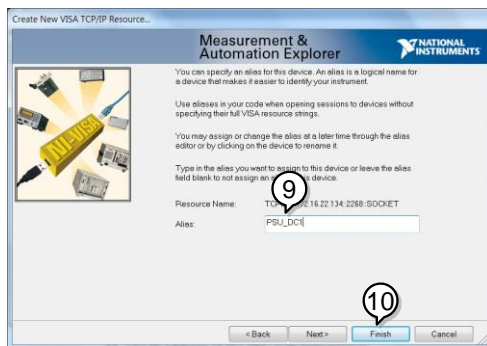

11. The IP address of the PSU will now appear under Network Devices in the configuration panel. Select this icon now.

12. Click *Open VISA Test Panel*.

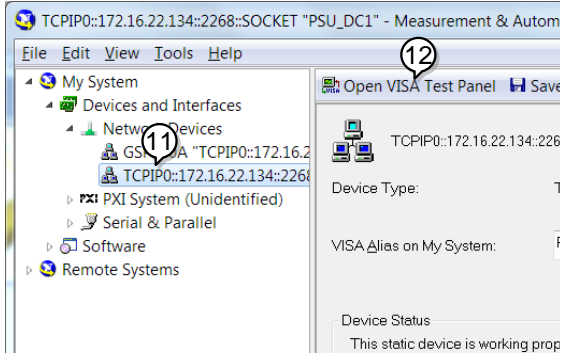

13. Click the *Configuration* icon,

14. Click on *I/O Settings*.

15. Make sure the *Enable Termination Character* check box is checked, and the terminal character is \n (Value: xA).

16. Click *Apply Changes*.

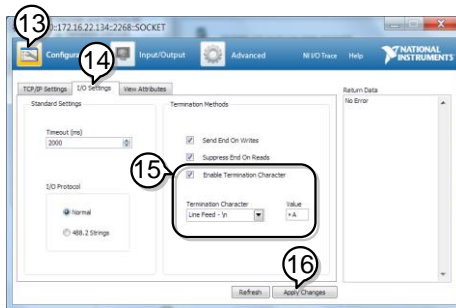

17. Click the *Input/Output* icon.

18. Enter *IDN? in the *Select or Enter Command* dialog box if it is not already.

19. Click the *Query* button.

20. The *IDN? query will return the Manufacturer, model name, serial number and firmware version in the dialog box.

GW-INSTEK,PSU40-38,TW123456,T0.02.20131205

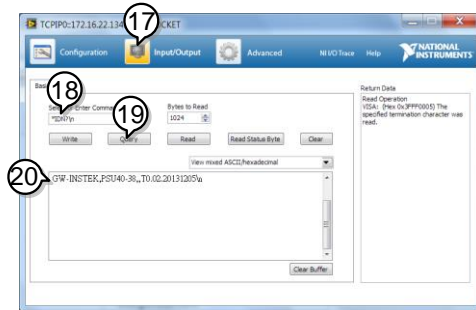

Command Syntax

Compatible Standard	IEEE488.2	Partial compatibility
	SCPI, 1999	Partial compatibility

Command Structure

SCPI commands follow a tree-like structure, organized into nodes. Each level of the command tree is a node. Each keyword in a SCPI command represents each node in the command tree. Each keyword (node) of a SCPI command is separated by a colon (:).

For example, the diagram below shows an SCPI sub-structure and a command example.

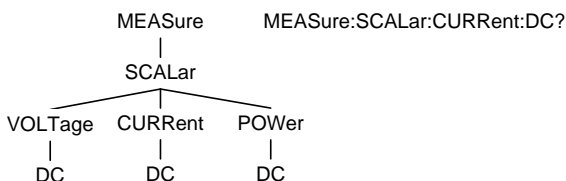

Command types

There are a number of different instrument commands and queries. A command sends instructions or data to the unit and a query receives data or status information from the unit.

Command types

Simple A single command with/without a parameter

Example *IDN?

Query	A query is a simple or compound command followed by a question mark (?). A parameter (data) is returned.
Example	meas:curr:dc?
Compound	<p>Two or more commands on the same command line. Compound commands are separated with either a semi-colon (;) or a semi-colon and a colon (;:).</p> <p>A semi-colon is used to join two related commands, with the caveat that the last command must begin at the last node of the first command.</p> <p>A semi-colon and colon are used to combine two commands from different nodes.</p>
Example	meas:volt:dc?;;meas:curr:dc?

Command Forms Commands and queries have two different forms, long and short. The command syntax is written with the short form of the command in capitals and the remainder (long form) in lower case.

The commands can be written in capitals or lower-case, just so long as the short or long forms are complete. An incomplete command will not be recognized.

Below are examples of correctly written commands.

Long form	STATus:OPERation:NTRansition? STATUS:OPERATION:NTRANSITION? status:operation:ntransition?
Short form	STAT:OPER:NTR? stat:oper:ntr?

Square Brackets Commands that contain square brackets indicate that the contents are optional. The function of the command is the same with or without the square bracketed items, as shown below.

Both "DISPlay:MENU[:NAME]?" and "DISPlay:MENU?" are both valid forms.

Command Format

APPLY 1.5,5.2

1. Command header
2. Space
3. Parameter 1
4. Comma (no space before/after comma)
5. Parameter 2

Parameters	Type	Description	Example
	<Boolean>	Boolean logic	0, 1

<NR1>	integers	0, 1, 2, 3
<NR2>	decimal numbers	0.1, 3.14, 8.5
<NR3>	floating point	4.5e-1, 8.25e+1
<NRf>	any of NR1, 2, 3	1, 1.5, 4.5e-1
<block data>	Definitive length arbitrary block data. A single decimal digit followed by data. The decimal digit specifies how many 8-bit data bytes follow.	

Message Terminator

LF

Line feed code

Command List

:ABORt	:ABORt	71
:APPLY	:APPLy	71
Commands		
Display	:DISPlay:MENU[:NAME]	72
Commands	:DISPlay[:WINDow]:TEXT:CLEAr	72
	:DISPlay[:WINDow]:TEXT[:DATA]	73
	:DISPlay:BLINK	73
Initiate	:INITiate:CONTInuous[:TRANSient]	74
Commands	:INITiate[:IMMEdiate]:NAME	74
	:INITiate[:IMMEdiate][:TRANSient]	75
Instrument	:INSTrument:SCAN	76
Commands	:INSTrument:SELEct	76
	:INSTrument:STATe	76
	:INSTrument:DISPlay	77
Measure	:MEASure[:SCALar]:ALL[:DC]	78
Commands	:MEASure[:SCALar]:CURREnt[:DC]	78
	:MEASure[:SCALar]:VOLTage[:DC]	78
	:MEASure[:SCALar]:POWEr[:DC]	79
Memory	:MEMory:TRIGgered	80
Output	:OUTPut:DELAy:ON	81
Commands	:OUTPut:DELAy:OFF	81
	:OUTPut:MODE	82
	:OUTPut[:STATe][:IMMEdiate]	82
	:OUTPut[:STATe]:TRIGgered	82
	:OUTPut:PROTEction:CLEAr	83
	:OUTPut:PROTEction:TRIPPed	83

Sense	:SENSe:AVERAge:COUNT	84
Commands		
Status	:STATus:OPERation[:EVENT]	85
Commands	:STATus:OPERation:CONDition	85
	:STATus:OPERation:ENABle	86
	:STATus:OPERation:PTRansition	86
	:STATus:OPERation:NTRansition	86
	:STATus:QUEStionable[:EVENT]	86
	:STATus:QUEStionable:CONDition	87
	:STATus:QUEStionable:ENABle	87
	:STATus:QUEStionable:PTRansition	87
	:STATus:QUEStionable:NTRansition	87
	:STATus:QUEStionable:INSTrument:	
	ISUMmary<n>[:EVENT]	88
	:STATus:QUEStionable:INSTrument:	
	ISUMmary<n>:CONDition	88
	:STATus:QUEStionable:INSTrument:	
	ISUMmary<n>:ENABle	88
	:STATus:PRESet	89
Source	[:SOURce]:CURRent:EXTernal:RANGe	91
Commands	[:SOURce]:CURRent[:LEVel][:IMMEDIATE]	
	[:AMPLitude]	92
	[:SOURce]:CURRent[:LEVel]:TRIGgered[:AMPLitude]	92
	[:SOURce]:CURRent:LIMit:AUTO	93
	[:SOURce]:CURRent:PROTection:DELay	93
	[:SOURce]:CURRent:PROTection[:LEVel]	93
	[:SOURce]:CURRent:PROTection:STATe	94
	[:SOURce]:CURRent:PROTection:TRIPped	94
	[:SOURce]:CURRent:SLEWrate:RISing	95
	[:SOURce]:CURRent:SLEWrate:FALLing	95
	[:SOURce]:MODE?	96
	[:SOURce]:RESistance[:LEVel][:IMMEDIATE]	
	[:AMPLitude]	96
	[:SOURce]:VOLTage:EXTernal:RANGe	97
	[:SOURce]:VOLTage[:LEVel][:IMMEDIATE]	
	[:AMPLitude]	97
	[:SOURce]:VOLTage[:LEVel]:TRIGgered[:AMPLitude]	97
	[:SOURce]:VOLTage:LIMit:AUTO	98
	[:SOURce]:VOLTage:LIMit:LOW	98

	[:SOURce]:VOLTage:PROTection[:LEVel]	99
	[:SOURce]:VOLTage:PROTection:TRIPped	99
	[:SOURce]:VOLTage:SLEWrate:RISing	100
	[:SOURce]:VOLTage:SLEWrate:FALLing	100
System	:SYSTem:BEEPPer[:IMMediate]	102
Commands	:SYSTem:CONFigure:BEEPPer[:STATe]	103
	:SYSTem:CONFigure:BLEeder[:STATe]	103
	:SYSTem:CONFigure:CURREnt:CONTRol	104
	:SYSTem:CONFigure:VOLTage:CONTRol	104
	:SYSTem:CONFigure:OUTPut:PON[:STATe]	105
	:SYSTem:CONFigure:PROTection:RECOvery	106
	:SYSTem:CONFigure:MSLave	106
	:SYSTem:CONFigure:OUTPut:EXTernal:MODE	107
	:SYSTem:CONFigure:OUTPut:EXTernal[:STATe]	108
	:SYSTem:CONFigure:MONitor:RANGe	108
	:SYSTem:CONFigure:TRIGger:INPut:SOURce	108
	:SYSTem:CONFigure:TRIGger:INPut:WIDTh	109
	:SYSTem:CONFigure:TRIGger:OUTPut:SOURce	109
	:SYSTem:CONFigure:TRIGger:OUTPut:WIDTh	110
	:SYSTem:CONFigure:TRIGger:OUTPut:LEVel	110
	:SYSTem:COMMunicate:ENABle	111
	:SYSTem:COMMunicate:GPIB[:SELF]:ADDReSS	111
	:SYSTem:COMMunicate:LAN:IPADdress	112
	:SYSTem:COMMunicate:LAN:GATEway	112
	:SYSTem:COMMunicate:LAN:SMASK	113
	:SYSTem:COMMunicate:LAN:MAC	113
	:SYSTem:COMMunicate:LAN:DHCP	113
	:SYSTem:COMMunicate:LAN:DNS	114
	:SYSTem:COMMunicate:RLState	114
	:SYSTem:COMMunicate:TCPip:CONTRol	114
	:SYSTem:COMMunicate:SERial:LANGUage[:SELeCt]	115
	:SYSTem:COMMunicate:SERial[:RECeive]	
	:TRANsmit:BAUD	115
	:SYSTem:COMMunicate:SERial[:RECeive]	
	:TRANsmit:BITS	116
	:SYSTem:COMMunicate:SERial[:RECeive]	
	:TRANsmit:PARity	116
	:SYSTem:COMMunicate:SERial[:RECeive]	
	:TRANsmit:SBITS	117
	:SYSTem:COMMunicate:SERial:MULTidrop	
	:CONTRol	117
	:SYSTem:COMMunicate:USB:FRONt:STATe	117

	:SYSTem:COMMunicate:USB:REAR:MODE.....	118
	:SYSTem:COMMunicate:USB:REAR:STATe.....	118
	:SYSTem:ERRor.....	118
	:SYSTem:KLOCK	119
	:SYSTem:KEYLock:MODE.....	119
	:SYSTem:ERRor:ENABle	119
	:SYSTem:LANGuage:EMULation	119
	:SYSTem:LANGuage:[:SELect].....	120
	:SYSTem:PRESet	120
	:SYSTem:VERSion	120
	:SYSTem:REBoot	120
Trigger	:TRIGger:OUTPut:SOURce.....	121
Commands	:TRIGger:OUTPut[:IMMediate]	121
	:TRIGger[:TRANsient]:SOURce	121
	:TRIGger[:TRANsient][:IMMediate]	122
Common	*CLS	123
Commands	*ESE.....	123
	*ESR	123
	*IDN	124
	*OPC.....	124
	*RCL.....	124
	*RST	125
	*SAV.....	125
	*SRE	125
	*STB	126
	*TRG	126
	*TST	126
	*WAI	126

Abort Commands

:ABORt71

:ABORt



Description The :ABORt command will cancel any triggered actions.

Syntax :ABORt

Apply Commands

:APPLy71

:APPLy

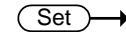

Description The apply command sets the voltage and current at the same time.

Syntax :APPLy
{<NRf>(V)|MINimum|MAXimum[,<NRf>(A)|MINimum|MAXimum]}

Query Syntax :APPLy?

Parameter/	<NRf>(V)	Voltage setting.
Return parameter	MINimum	Minimum voltage level
	MAXimum	Maximum voltage level
	<NRf>(A)	Current setting.
	MINimum	Minimum voltage level
	MAXimum	Maximum voltage level

Example APPL MIN, MIN
Sets the current and voltage to the minimum settings.

Display Commands

:DISPlay:MENU[:NAME]	72
:DISPlay[:WINDow]:TEXT:CLEar	72
:DISPlay[:WINDow]:TEXT[:DATA]	73
:DISPlay:BLINK	73

:DISPlay:MENU[:NAME] (Set) →
→ (Query)

Description	The DISPlay MENU command selects a screen menu or queries the current screen menu.	
Syntax	:DISPlay:MENU[:NAME] <NR1>	
Query Sytax	:DISPlay:MENU[:NAME]?	
Parameter/ Return parameter	<NR1>	Description
	0	Measure voltage & current
	1~2	Not Used
	3	Set Menu
	4	OVP / OCP Menu
	5~99	Not Used.
	100~199	F-00~99 Menu.
	200~229	F100~F129 Menu.
Example	DISP:MENU:NAME 0 Sets the display to the Voltage/Current display screen.	

:DISPlay[:WINDow]:TEXT:CLEar (Set) →

Description	Clears the text on the main screen from the :DISPlay[:WINDow]:TEXT[:DATA] command.	
Syntax	:DISPlay[:WINDow]:TEXT:CLEar	

:DISPlay[:WINDow]:TEXT[:DATA]  

Description Sets or queries the data text that will be written to the display. Writing to the display will overwrite data that is currently on the screen. Overwriting a display area with a shorter string may or may not overwrite the screen. The string must be enclosed in quotes: "STRING". Only ASCII characters 20H to 7EH can be used in the <string>.

Syntax :DISPlay[:WINDow]:TEXT[:DATA] <string>

Query Syntax :DISPlay[:WINDow]:TEXT[:DATA]?

Parameter/Return parameter <string> ASCII character 20H to 7EH can be used to in the string parameter. The string must be enclosed in quotes: "STRING"

Example DISP:WIND:TEXT:DATA "STRING"
Writes STRING to the display.

Query Example DISP:WIND:TEXT:DATA?
"STRING"
Returns the text data string on the screen.

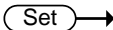
:DISPlay:BLINK  

Description Turns blink on or off for the display. Blink is set to OFF by default.

Syntax :DISPlay:BLINK {<bool>|OFF|ON}

Query Syntax :DISPlay:BLINK?

Parameter OFF | 0 Turns blink OFF
ON | 1 Turns blink ON

Return parameter <bool> Returns the blink status.

Example DISP:BLIN 1
Turns blink ON.

Initiate Commands

:INITiate:CONTInuous[:TRANsient]	74
:INITiate[:IMMEDIATE]:NAME	74
:INITiate[:IMMEDIATE][:TRANsient]	75

:INITiate:CONTInuous[:TRANsient]

Set →

→ Query

Description	This command continuously initiates software triggers for the transient or output triggers.
Syntax	:INITiate:CONTInuous[:TRANsient] {<bool> OFF ON}
Query Syntax	:INITiate:CONTInuous[:TRANsient]?
Parameter	OFF 0 OFF ON 1 ON
Return parameter	0 OFF 1 ON
Example	INIT:TRAN 1 Turns on the continuous trigger.

:INITiate[:IMMEDIATE]:NAME

Set →

Description	The INITiate command starts the TRANsient or OUTPut trigger.
Syntax	:INITiate[:IMMEDIATE]:NAME {TRANsient OUTPut}
Parameter	TRANsient Starts the TRANsient trigger. OUTPut Starts the OUTPut trigger.
Example	INITiate:NAME TRANient Starts the TRANsient trigger.

:INITiate[:IMMEDIATE][:TRANSient]

Set →

Description This command controls the enabling of output triggers. When a trigger is enabled, a trigger causes the specified action to occur. If the trigger system is not enabled, all triggers are ignored.

Syntax :INITiate[:IMMEDIATE][:TRANSient]

Example INIT

Instrument Commands

:INSTrument:SCAN	76
:INSTrument:SELEct.....	76
:INSTrument:STATe.....	76
:INSTrument:DISPlay.....	77

:INSTrument:SCAN

Set →

Description Links the units which could be scanned from system when using Multi-Drop mode.

Syntax :INSTrument:SCAN

Set →

:INSTrument:SELEct

→ Query

Description Specifies the address of the unit to which communication will be established when using the Multi-Drop mode.

Syntax :INSTrument :SELEct {<NR1>}

Query Syntax :INSTrument :SELEct?

Parameter <NR1> The address of the unit to be selected (0~30).

Return parameter <NR1> The currently selected address.

Example :INST:SEL?
>30

The currently selected address is 30.

:INSTrument:STATe

→ Query

Description Displays the status (on-line/off-line) of each slave unit and the address of master unit, when using the Multi-Drop mode.

Query Syntax :INSTrument:STATe?

Return parameter	<code><NR1>,<NR1></code>	<p>0~1073741823, 0~30 (1073741823=2^30-1)</p> <p>First value:</p> <p>Each bit of the binary value corresponds to a unit from 0 to 30 (LSB to MSB). The bit will be set to 1 when the corresponding unit is on-line.</p> <p>Second value:</p> <p>This value represents the master address.</p>
------------------	--------------------------------------	---------------------------------------------------------------------------------------------------------------------------------------------------------------------------------------------------------------------------------------------------------------------------------------------------

Example

```
:INST:STAT?
33,0
33=0b100001
The units at address 0 and address 5 are on-line.
0
Master device's address is 0.
```

:INSTrument:DISPlay



Description	Displays information (configured address) for all slave units when using the Multi-Drop mode.
-------------	-----------------------------------------------------------------------------------------------

Syntax	:INSTrument:DISPlay
--------	---------------------

Example	:INST:DISP
---------	------------

Measure Commands

:MEASure[:SCALar]:ALL[:DC]	78
:MEASure[:SCALar]:CURRent[:DC]	78
:MEASure[:SCALar]:VOLTage[:DC]	78
:MEASure[:SCALar]:POWer[:DC]	79

:MEASure[:SCALar]:ALL[:DC] → Query

Description	Takes a measurement and returns the average output current and voltage	
Syntax	:MEASure[:SCALar]:ALL[:DC]?	
Return parameter	" +0.0000,+0.0000"	<voltage>,<current> Returns the voltage (V) and current (A), respectively.

:MEASure[:SCALar]:CURRent[:DC] → Query

Description	Takes a measurement and returns the average output current	
Syntax	:MEASure[:SCALar]:CURRent[:DC]?	
Return parameter	" +0.0000"	Returns the current in amps.

:MEASure[:SCALar]:VOLTage[:DC] → Query

Description	Takes a measurement and returns the average output voltage.	
Syntax	:MEASure[:SCALar]:VOLTage[:DC]?	
Return	" +0.0000"	Returns the voltage in volts.

:MEASure[:SCALar]:POWer[:DC]

→ Query

Description	Takes a measurement and returns the average output power.
Syntax	:MEASure[:SCALar]:POWer[:DC]?
Return	" +0.0000" Returns the power measured in watts.

Memory Commands

:MEMory:TRIGgered.....80

:MEMory:TRIGgered





Description	Sets or queries which memory is loaded when a trigger input is received and the trigger input is configured to load a memory setting.	
Related Commands	:SYSTem:CONFigure:TRIGger:INPut:SOURce :SYSTem:CONFigure:TRIGger:OUTPut:SOURce	
Syntax	:MEMory:TRIGgered {<NR1> MINimum MAXimum}	
Return Syntax	:MEMory:TRIGgered? [MINimum MAXimum]	
Parameter	<NR1> MINimum MAXimum	0(M1)~2(M3)
Return Parameter	<NR1>	Returns the memory setting

Output Commands

:OUTPut:DELAy:ON.....	81
:OUTPut:DELAy:OFF.....	81
:OUTPut:MODE.....	82
:OUTPut[:STATe][:IMMediate].....	82
:OUTPut[:STATe]:TRIGgered.....	82
:OUTPut:PROTEction:CLEar.....	83
:OUTPut:PROTEction:TRIPped.....	83

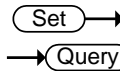
:OUTPut:DELAy:ON



Description	Sets the Delay Time in seconds for turning the output on. The delay is set to 0.00 by default.	
Syntax	:OUTPut:DELAy:ON {<NR2> MINimum MAXimum}	
Query Syntax	:OUTPut:DELAy:ON?	
Parameter	<NR2>	0.00~99.99 seconds, where 0=no delay.
Return parameter	"0.00"	Returns the delay on time in seconds until the output is turned on.

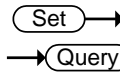

:OUTPut:DELAy:OFF

Description	Sets the Delay Time in seconds for turning the output off. The delay is set to 0.00 by default.	
Syntax	:OUTPut:DELAy:OFF {<NR2> MINimum MAXimum}	
Return Syntax	:OUTPut:DELAy:OFF?	
Parameter	<NR2>	0.00~99.99 seconds, where 0=no delay.
Return parameter	"0.00"	Returns the delay off time in seconds until the output is turned off.

Set →
→ Query

:OUTPut:MODE

Description	Sets the PSU output mode. This is the equivalent to the F-03 (V-I Mode Slew Rate Select) settings.
Syntax	:OUTPut:MODE {<NR1> CVHS CCHS CVLS CCLS}
Return Syntax	:OUTPut:MODE?
Parameter	CVHS 0 CV high speed priority CCHS 1 CC high speed priority CVLS 2 CV slew rate priority CCLS 3 CC slew rate priority
Return parameter	<NR1> Returns the output mode.

Set →
→ Query

:OUTPut[:STATe][:IMMediate]

Description	Turns the output on or off.
Syntax	:OUTPut[:STATe][:IMMediate] { <bool> OFF ON }
Query Syntax	:OUTPut[:STATe][:IMMediate]?
Parameter	OFF 0 Turns the output off. ON 1 Turns the output on.
Return parameter	<bool> Returns output status of the instrument.

Set →
→ Query

:OUTPut[:STATe]:TRIGgered

Description	Turns the output on or off when a software trigger is generated.
Syntax	:OUTPut[:STATe]:TRIGgered { <bool> OFF ON }
Query Syntax	:OUTPut[:STATe]:TRIGgered?
Parameter	OFF 0 Turns the output off when a software trigger is generated (*TRG). ON 1 Turns the output on when a software trigger is generated (*TRG).
Return parameter	<bool> Returns output trigger status of the instrument.

:OUTPut:PROTection:CLEar**Set** →

Description Clears over-voltage, over-current and over-temperature (OVP, OCP, OTP) protection circuits. It also clears the shutdown and sense protection circuit. The AC failure protection cannot be cleared.

Syntax :OUTPut:PROTection:CLEar

:OUTPut:PROTection:TRIPped→ **Query**

Description Queries the unit to see if a protection circuit has been tripped.

Syntax :OUTPut:PROTection:TRIPped?

Return <boolean> 0 = No protection error
1 = A protection error had occurred

Sense Commands

:SENSe:AVERAge:COUNT84

:SENSe:AVERAge:COUNT
Set →
 → Query

Description	Sets or queries the level of smoothing for the average setting.	
Syntax	:SENSe:AVERAge:COUNT	
Return Syntax	{<NR1> LOW MIDDLE HIGH}	
	:SENSe:AVERAge:COUNT?	
Parameter	LOW 0	Low setting
	MIDDLE 1	Middle setting
	HIGH 2	High setting
Return Parameter	<NR1>	Returns the average setting.

Status Commands

For an overview of all the status registers, their associated register contents and the system diagram, please see the status overview on page 126

:STATus:OPERation[:EVENT]	85
:STATus:OPERation:CONDition	85
:STATus:OPERation:ENABle	86
:STATus:OPERation:PTRansition	86
:STATus:OPERation:NTRansition	86
:STATus:QUESTionable[:EVENT]	86
:STATus:QUESTionable:CONDition	87
:STATus:QUESTionable:ENABle	87
:STATus:QUESTionable:PTRansition	87
:STATus:QUESTionable:NTRansition	87
:STATus:QUESTionable:INSTrument	
:ISUMmary<n>[:EVENT]	88
:STATus:QUESTionable:INSTrument	
:ISUMmary<n>:CONDition	88
:STATus:QUESTionable:INSTrument	
:ISUMmary<n>:ENABle	88
:STATus:PRESet	89

:STATus:OPERation[:EVENT] → Query

Description	Queries the Operation Status Event register and clears the contents of the register.
Syntax	:STATus:OPERation[:EVENT]?
Return	<NR1> Returns the bit sum of the Operation Status Event register.

:STATus:OPERation:CONDition → Query

Description	Queries the Operation Status register. This query will not clear the register.
Syntax	:STATus:OPERation:CONDition?

Return <NR1> Returns the bit sum of the Operation Condition register.

Set →

:STATus:OPERation:ENABLE

→ Query

Description Sets or queries the bit sum of the Operation Status Enable register.

Syntax :STATus:OPERation:ENABLE <NR1>

Query Syntax :STATus:OPERation:ENABLE?

Parameter <NR1> 0~32767

Return parameter <NR1> 0~32767

Set →

:STATus:OPERation:PTRansition

→ Query

Description Sets or queries the bit sum of the positive transition filter of the Operation Status register.

Syntax :STATus:OPERation:PTRansition <NR1>

:STATus:OPERation:PTRansition?

Parameter <NR1> 0~32767

Return parameter <NR1> 0~32767

Set →

:STATus:OPERation:NTRansition

→ Query

Description Sets or queries the bit sum of the negative transition filter of the Operation Status register.

Syntax :STATus:OPERation:NTRansition <NR1>

Query Syntax :STATus:OPERation:NTRansition?

Parameter <NR1> 0~32767

Return parameter <NR1> 0~32767

:STATus:QUESTionable[:EVENT]

→ Query

Description Queries the bit sum of the Questionable Status Event register. This query will also clear the contents of the register.

Query Syntax :STATus:QUESTionable[:EVENT]?

Return parameter <NR1> 0~32767

:STATus:QUESTionable:CONDition → Query

Description Queries the status (bit sum) of the Questionable Status register. This query will not clear the register.

Query Syntax :STATus:QUESTionable:CONDition?

Return parameter <NR1> 0~32767

:STATus:QUESTionable:ENABLE → Query

Description Sets or queries the bit sum of the Questionable Status Enable register.

Syntax :STATus:QUESTionable:ENABLE <NR1>

Query Syntax :STATus:QUESTionable:ENABLE?

Parameter <NR1> 0~32767

Return parameter <NR1> 0~32767

Set →

:STATus:QUESTionable:PTRansition → Query

Description Sets or queries the bit sum of the positive transition filter of the Questionable Status register.

Syntax :STATus:QUESTionable:PTRansition <NR1>

Return Syntax :STATus:QUESTionable:PTRansition?

Parameter <NR1> 0~32767

Return parameter <NR1> 0~32767

Set →

:STATus:QUESTionable:NTRansition → Query

Description Sets or queries the negative transition filter of the Questionable Status register.

Set →

Syntax	:STATus:QUESTionable:NTRansition <NR1>	
Query Syntax	:STATus:QUESTionable:NTRansition?	
Parameter	<NR1>	0~32767
Return parameter	<NR1>	0~32767

:STATus:QUESTionable:INSTrument:ISUMmary<n>[:EVENT] → Query

Description	Queries the bit sum of the Questionable Instrument Summary Status Event register. This query will also clear the contents of the register (Multi-Drop mode).	
Query Syntax	:STATus:QUESTionable:INSTrument:ISUMmary<n>[:EVENT]?	
Parameter	<n>	1,2 or 3
Return parameter	<NR1>	0~32767

:STATus:QUESTionable:INSTrument:ISUMmary<n>:CONDition → Query

Description	Queries the status (bit sum) of the Questionable Instrument Summary Status Condition register. This query will not clear the register (Multi-Drop mode).	
Query Syntax	:STATus:QUESTionable:INSTrument:ISUMmary<n>:CONDition?	
Parameter	<n>	1, 2 or 3
Return parameter	<NR1>	0~32767

:STATus:QUESTionable:INSTrument:ISUMmary<n>:ENABle Set →
→ Query

Description	Sets or queries the bit sum of the Questionable Instrument Summary Status Enable register. (Multi-Drop mode).	
-------------	---------------------------------------------------------------------------------------------------------------	--

Syntax	:STATus:QUEStionable:INSTrument:ISUMmary <n>:ENABle <NR1>
Query Syntax	:STATus:QUEStionable:INSTrument:ISUMmary <n>:ENABle?
Parameter	<n> 1,2 or 3 <NR1> 0~32767
Return parameter	<NR1> 0~32767

:STATus:PRESet



Description This command resets the ENABle register, the PTRansition filter and NTRansition filter on the Operation Status and Questionable Status Registers. The registers/filters will be reset to a default value.

Default Register/Filter Values	Setting
QUEStionable Status Enable	0x0000
QUEStionable Status Positive Transition	0x7FFF
QUEStionable Status Negative Transition	0x0000
QUEStionable Instrument Summary1 Status Enable	0x7FFF
QUEStionable Instrument Summary2 Status Enable	0x7FFF
QUEStionable Instrument Summary3 Status Enable	0x7FFF
Operation Status Enable	0x0000
Operation Status Positive Transition	0x7FFF
Operation Status Negative Transition	0x0000

Summary: The Questionable Status Enable registers and the Operation Status Enable registers are both reset to 0.

The Questionable Status and Operation Status Positive Transition filters are all set high (0x7FFF) and the Negative Transition filters are all set low (0x0000). I.e., only positive transitions will be recognized for the Questionable Status and Operation Status registers.

Syntax :STATus:PRESet

Source Commands

[:SOURce]:CURRent:EXTernal:RANGe	91
[:SOURce]:CURRent[:LEVel][:IMMediate]	
[:AMPLitude]	92
[:SOURce]:CURRent[:LEVel]:TRIGgered[:AMPLitude]	92
[:SOURce]:CURRent:LIMit:AUTO	93
[:SOURce]:CURRent:PROTection:DELay	93
[:SOURce]:CURRent:PROTection[:LEVel]	93
[:SOURce]:CURRent:PROTection:STATe	94
[:SOURce]:CURRent:PROTection:TRIPped	94
[:SOURce]:CURRent:SLEWrate:RISing	95
[:SOURce]:CURRent:SLEWrate:FALLing	95
[:SOURce]:MODE?	96
[:SOURce]:RESistance[:LEVel][:IMMediate]	
[:AMPLitude]	96
[:SOURce]:VOLTage:EXTernal:RANGe	97
[:SOURce]:VOLTage[:LEVel][:IMMediate]	
[:AMPLitude]	97
[:SOURce]:VOLTage[:LEVel]:TRIGgered[:AMPLitude]	97
[:SOURce]:VOLTage:LIMit:AUTO	98
[:SOURce]:VOLTage:LIMit:LOW	98
[:SOURce]:VOLTage:PROTection[:LEVel]	99
[:SOURce]:VOLTage:PROTection:TRIPped	99
[:SOURce]:VOLTage:SLEWrate:RISing	100
[:SOURce]:VOLTage:SLEWrate:FALLing	100

[:SOURce]:CURRent:EXTernal:RANGe



Description	Sets or queries the CC or CV control range that is used during external control. Note: the setting will only be valid after the power has been cycled.	
Syntax	[:SOURce]:CURRent:EXTernal:RANGe {LOW HIGH}	
Query Syntax	[:SOURce]:CURRent:EXTernal:RANGe?	
Parameter/Return parameter	LOW	A range of 0 V to 5 V is used.
	HIGH	A range of 0 V to 10 V is used.

Example SOUR:CURR:LEV:TRIG:AMPL?
 38.000
 Returns the maximum possible current level in amps.

Set →
 → Query

Description Enables or disables the limit on the current setting.

Syntax [:SOURce]:CURRent:LIMit:AUTO {<bool>|OFF|ON}

Query Syntax [:SOURce]:CURRent:LIMit:AUTO?

Parameter OFF | 0 Disable the setting current limit
 ON | 1 Enable the setting current limit

Return parameter <bool> Returns the setting in <bool> format.

Example SOUR:CURR:LIM:AUTO 0
 Disables the current limit.

Set →
 → Query

Description Sets the Delay Time for OCP in seconds for turning the output off. The delay is set to 0.1 by default.

Syntax [:SOURce]:CURRent:PROTection:DELAy
 {<NR2>|MINimum|MAXimum}

Query Syntax [:SOURce]:CURRent:PROTection:DELAy?

Parameter <NR2> 0.1~2.0 seconds, where 0=no delay
 MAX The maximum allowed delay time
 MIN The minimum allowed delay time

Return parameter <NR2> Returns the delay time in seconds

Example SOUR:CURR:PROT:DEL MAX
 Sets the current protection delay to the maximum.

Set →
 → Query

Description Sets or queries the OCP (over-current protection) level in amps.

Syntax	[:SOURce]:CURRent:PROTection[:LEVel] {<NR2>(A) MINimum MAXimum}	
Query Syntax	[:SOURce]:CURRent:PROTection[:LEVel]?	
Parameter	<NR2>	Current protection level. Minimum: Depend on the unit type: if Irated * 0.1 > 5A, then minimum = 5A, else minimum = Irated * 0.1 Maximum: Irated * 1.1
	MIN	Minimum current level.
	MAX	Maximum current level.
Return parameter	<NR2>	Returns the current protection level.
Example	SOUR:CURR:PROT:LEV? +5.000 Returns the minimum possible current level in amps.	

[:SOURce]:CURRent:PROTection:STATe (Set) →
→ (Query)

Description	Turns OCP (over-current protection) on or off.	
Syntax	[:SOURce]:CURRent:PROTection:STATe {<bool> OFF ON}	
Query Syntax	[:SOURce]:CURRent:PROTection:STATe?	
Parameter	OFF 0	Turns the OCP off.
	ON 1	Turns the OCP on.
Return parameter	<bool>	Returns the over current protection state in <bool> format.
Example	SOUR:CURR:PROT:STAT OFF Turns OCP off.	

[:SOURce]:CURRent:PROTection:TRIPped → (Query)

Description	Returns the state of the current protection circuits.	
Query Syntax	[:SOURce]:CURRent:PROTection:TRIPped?	
Return parameter	<bool>	Returns protection status.

Example SOUR:CURR:PROT:TRIP?
 >0
 The protection circuit has not been tripped.

Set →
 → Query

Description Sets or queries the rising current slew rate. This is only applicable for CC slew rate priority mode.

Syntax [:SOURce]:CURRent:SLEWrate:RISing
 {<NR2>(A)|MINimum|MAXimum}

Query Syntax [:SOURce]:CURRent:SLEWrate:RISing?

Parameter	<NR2>	Per step is between 0.001A/msec and rated current divided by 100 msec.
	MIN	Minimum rising current slew rate is 0.001A/msec.
	MAX	Maximum rising current slew rate is rated current divided by 100msec.

Return parameter **<NR2>** Returns the step current in amps.

Example SOUR:CURR:SLEW:RIS?
 0.950
 Sets the rising current slew rate to 0.950 A/ms.

Set →
 → Query

Description Sets or queries the falling current slew rate. This is only applicable for CC slew rate priority mode.

Syntax [:SOURce]:CURRent:SLEWrate:FALLing
 {<NR2>(A)|MINimum|MAXimum}

Query Syntax [:SOURce]:CURRent:SLEWrate:FALLing?

Parameter	<NR2>	Per step is between 0.001A/msec and rated current divided by 100 msec.
	MIN	Minimum falling current slew rate is 0.001A/msec.
	MAX	Maximum falling current slew rate is rated current divided by 100msec.

Return Parameter **<NR2>** Returns the step current

Example SOUR:CURR:SLEW:FALL MAX
 Sets the falling current slew rate to the maximum.

[:SOURce]:MODE? → Query

Description Returns the status of the output mode (CC, CV, Off) of the power supply.
 The interface will return "CV" if the supply is in Constant Voltage Mode, "CC" if the supply is in Constant Current Mode or "OFF" if the supply output is off.

Query Syntax [:SOURce]:MODE?

Return parameter <string> Returns the output state as a string, "CC", "CV", "OFF"

Example :SOUR:MODE?
 >CC
 The power supply is currently in CC mode.

[:SOURce]:RESistance[:LEVel][:IMMEDIATE] Set →
[:AMPLitude] → Query

Description Sets or queries the internal resistance in ohms.

Syntax [:SOURce]:RESistance[:LEVel][:IMMEDIATE][:AMPLitude] {<NR2>(OHM)|MINimum|MAXimum}

Query Syntax [:SOURce]:RESistance[:LEVel][:IMMEDIATE][:AMPLitude]?

Parameter <NR2> Resistance in ohms:
 0 ohm ~ Rrated = Vrated/Irated
 MIN Minimum internal resistance in ohms
 MAX Maximum internal resistance in ohms

Return parameter <NR2> Returns the internal resistance in ohms.

Example SOUR:RES:LEV:IMM:AMPL 0.1
 Sets the internal resistance to 100mΩ.

`[[:SOURce]:VOLTage:EXTernal:RANGe`



Description Sets or queries the CC or CV control range that is used during external control. Note: the setting will only be valid after the power has been cycled.

Syntax `[[:SOURce]:VOLTage:EXTernal:RANGe {LOW|HIGH}`

Query Syntax `[[:SOURce]:VOLTage:EXTernal:RANGe?`

Parameter/Return parameter

LOW	A range of 0 V to 5 V is used.
HIGH	A range of 0 V to 10 V is used.

Example `VOLT:EXT:RANG?`
`LOW`
Returns LOW range.

`[[:SOURce]:VOLTage[:LEVel][:IMMediate]`

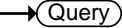

`[[:AMPLitude]`

Description Sets or queries the voltage level in volts.

Syntax `[[:SOURce]:VOLTage[:LEVel][:IMMediate][:AMPLitude]`
`{<NR2>(V)|MINimum|MAXimum}`

Query Syntax `[[:SOURce]:VOLTage[:LEVel][:IMMediate][:AMPLitude]?`

Parameter

<NRf>	0~105% of the rated output voltage in volts.
MIN	Minimum voltage level
MAX	Maximum voltage level

Return parameter <NR2> Returns the voltage level in volts

Example `SOUR:VOLT:LEV:IMM:AMPL 10`
Sets the voltage level to 10 volts.

`[[:SOURce]:VOLTage[:LEVel]:TRIGgered`

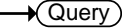

`[[:AMPLitude]`

Description Sets or queries the voltage level in volts when a software trigger has been generated.

Syntax	[:SOURce]:VOLTage[:LEVel]:TRIGgered[:AMPLitude] {<NR2>(V) MINimum MAXimum}	
Query Syntax	[:SOURce]:VOLTage[:LEVel]:TRIGgered[:AMPLitude]?	
Parameter	<NR2>	0%~105% of the rated voltage output in volts.
	MIN	Minimum current level.
	MAX	Maximum current level.
Return parameter	<NR2>	Returns the voltage level.
Example	SOUR:VOLT:LEV:TRIG:AMPL 10 Sets the voltage level to 10 volts when a software trigger is generated.	

Set →
 → Query

[:SOURce]:VOLTage:LIMit:AUTO

Description Sets whether to limit the voltage setting so that it does not exceed the OVP setting or become lower than the UVL setting.

If you enable the limit when the OVP setting is lower than the voltage setting, the OVP setting will be set to 105 % of the voltage setting.

If you enable the limit when the UVL setting is higher than the voltage setting, the UVL setting will be set equal to the voltage setting.

Syntax	[:SOURce]:VOLTage:LIMit:AUTO {<bool> OFF ON}	
Query Syntax	[:SOURce]:VOLTage:LIMit:AUTO?	
Parameter	OFF 0	Disable the limit setting
	ON 1	Enable the limit setting
Return parameter	<bool>	Returns the setting in <bool> format.
Example	SOUR:VOLT:LIM:AUTO 0 Disables the limit setting.	

Set →
 → Query

[:SOURce]:VOLTage:LIMit:LOW

Description	Sets or queries the under voltage (UVL) trip point.	
Syntax	[:SOURce]:VOLTage:LIMit:LOW <NR2>(V) MINimum MAXimum	

Query Syntax	[:SOURce]:VOLTage:LIMit:LOW?	
Parameter/Return	<NR2>	0 ~ the present setting voltage
	MIN	Minimum allowed voltage level
	MAX	Maximum allowed voltage level

Example SOUR:VOLT:LIM:LOW MAX
 Sets the UV> level to its maximum.

Set →
 → Query

[:SOURce]:VOLTage:PROTection[:LEVel]		
Description	Sets or queries the overvoltage protection level.	
Syntax	[:SOURce]:VOLTage:PROTection[:LEVel] {<NR2>(V) MINimum MAXimum}	
Query Syntax	[:SOURce]:VOLTage:PROTection[:LEVel]?	
Parameter/Return	<NR2>	Minimum: Depends on the unit type: if $V_{rated} * 0.1 > 5V$, then Minimum = 5V, else Minimum = $V_{rated} * 0.1$
		Maximum: $V_{rated} * 1.1$
	MIN	Minimum OVP level
	MAX	Maximum OVP level

Example SOUR:VOLT:PROT:LEV MAX
 Sets the OVP level to its maximum.

Query

[:SOURce]:VOLTage:PROTection:TRIPped		
Description	Sets or queries the overvoltage protection level.	
Query Syntax	[:SOURce]:VOLTage:PROTection:TRIPped?	
Return parameter	<bool>	
	0	Protection not tripped
	1	Protection tripped

Example SOUR:VOLT:PROT:TRIP?
 >0
 Indicates that the OVP protection has not been tripped.

`[:SOURce]:VOLTage:SLEWrate:RISing`



Description	Sets or queries the rising voltage slew rate. This is only applicable for CV slew rate priority mode.	
Syntax	[:SOURce]:VOLTage:SLEWrate:RISing	
Query Syntax	{<NR2>(V) MINimum MAXimum}	
Parameter	<NR2>	Per step is between 0.001V/msec and rated voltage divided by 100msec.
	MIN	Minimum rising voltage slew rate is 0.001V/msec.
	MAX	Maximum rising voltage slew rate is rated voltage divided by 100msec.
Return parameter	<NR2>	Returns the slew rate in V/msec.
Example	SOUR:VOLT:SLEW:RIS MAX Sets the rising voltage slew rate to its maximum.	

`[:SOURce]:VOLTage:SLEWrate:FALLing`





Description	Sets or queries the falling voltage slew rate. This is only applicable for CV slew rate priority mode.	
Syntax	[:SOURce]:VOLTage:SLEWrate:FALLing	
Query Syntax	{<NR2>(V) MINimum MAXimum}	
Parameter	<NR2>	Per step is between 0.001V/msec and rated voltage divided by 100msec.
	MIN	Minimum falling voltage slew rate is 0.001V/msec.
	MAX	Maximum falling voltage slew rate is rated voltage divided by 100msec.
Return parameter	<NR2>	Returns the voltage slew rate in V/msec
Example	SOUR:VOLT:SLEW:FALL MIN Sets the falling voltage slew rate to its minimum.	

System Function Command

:SYSTem:BEEPer[:IMMediate]	102
:SYSTem:CONFigure:BEEPer[:STATe]	103
:SYSTem:CONFigure:BLEeder[:STATe]	103
:SYSTem:CONFigure:CURRent:CONTRol	104
:SYSTem:CONFigure:VOLTagE:CONTRol	104
:SYSTem:CONFigure:OUTPut:PON[:STATe]	105
:SYSTem:CONFigure:PROTection:RECOvery	106
:SYSTem:CONFigure:MSLave	106
:SYSTem:CONFigure:OUTPut:EXTernal:MODE	107
:SYSTem:CONFigure:OUTPut:EXTernal[:STATe]	108
:SYSTem:CONFigure:MONitor:RANGe	108
:SYSTem:CONFigure:TRIGger:INPut:SOURce	108
:SYSTem:CONFigure:TRIGger:INPut:WIDTh	109
:SYSTem:CONFigure:TRIGger:OUTPut:SOURce	109
:SYSTem:CONFigure:TRIGger:OUTPut:WIDTh	110
:SYSTem:CONFigure:TRIGger:OUTPut:LEVel	110
:SYSTem:COMMunicate:ENABle	111
:SYSTem:COMMunicate:GPIB[:SELF]:ADDReSS	111
:SYSTem:COMMunicate:LAN:IPADdress	112
:SYSTem:COMMunicate:LAN:GATEway	112
:SYSTem:COMMunicate:LAN:SMASK	113
:SYSTem:COMMunicate:LAN:MAC	113
:SYSTem:COMMunicate:LAN:DHCP	113
:SYSTem:COMMunicate:LAN:DNS	114
:SYSTem:COMMunicate:RLState	114
:SYSTem:COMMunicate:TCPip:CONTRol	114
:SYSTem:COMMunicate:SERial:LANGuage [:SELEct]	115
:SYSTem:COMMunicate:SERial[:RECEive] :TRANsmit:BAUD	115
:SYSTem:COMMunicate:SERial[:RECEive] :TRANsmit:BITS	116
:SYSTem:COMMunicate:SERial[:RECEive] :TRANsmit:PARity	116
:SYSTem:COMMunicate:SERial[:RECEive] :TRANsmit:SBITs	117
:SYSTem:COMMunicate:SERial:MULTidrop :CONTRol	117
:SYSTem:COMMunicate:USB:FRONt:STATe	117
:SYSTem:COMMunicate:USB:REAR:MODE	118

:SYSTem:COMMunicate:USB:REAR:STATe.....118
 :SYSTem:ERRor.....118
 :SYSTem:KLOCK119
 :SYSTem:KEYLock:MODE.....119
 :SYSTem:ERRor:ENABle.....119
 :SYSTem:LANGuage:EMULation119
 :SYSTem:LANGuage:[:SElect].....120
 :SYSTem:PRESet120
 :SYSTem:VERSion120
 :SYSTem:REBoot120

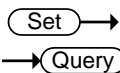
:SYSTem:BEEPer[:IMMediate]



Description	This command causes an audible tone to be generated by the instrument. The duration time is specified in seconds.	
Syntax	:SYSTem:BEEPer[:IMMediate] {<NR1> MINimum MAXimum}	
Query Syntax	:SYSTem:BEEPer[:IMMediate]? [MINimum MAXimum]	
Parameter	<NR1>	0 ~ 3600 seconds.
	MINimum	Sets the beeper time to the minimum (0 seconds)
	MAXimum	Sets the beeper time to the maximum (3600 seconds)
Return parameter	<NR1>	Returns the remaining beeper duration time in seconds or returns the maximum or minimum beeper time in seconds (for the [MINimum MAXimum] query parameters).

Example 1

```
:SYST:BEEP 10
**after a 2 second wait**
:SYST:BEEP?
>8
```

The first command turns the beeper on for 10 seconds. After 2 seconds the SYST:BEEP? query returns the remaining beeper time (8 seconds).

:SYSTem:CONFIgure:CURRent:CONTRol



Description	Sets or queries the CC control mode (local control (panel), external voltage control, external resistance control). This setting is applied only after the unit is reset.	
Syntax	:SYSTem:CONFIgure:CURRent:CONTRol { <NR1> NONE VOLTage RRISing RFALLing VISolation }	
Query Syntax	:SYSTem:CONFIgure:CURRent:CONTRol?	
Parameter	<NR1>	Description
	0 NONE	Local (Panel) control
	1 VOLTage	External voltage control
	2 RRISing	External resistance control; 10kΩ or 5kΩ = I _o max*, 0kΩ = I _o min.
	3 RFALLing	External resistance control; 10kΩ or 5kΩ = I _o min*, 0kΩ = I _o max.
	4 VISolation	External voltage control (isolated)
	*The resistance value depends on the [:SOURce]:CURRent:EXTernal:RANGe command. If the range is high, then the resistance is 10kΩ, else it is 5kΩ. See page 91 for details.	
Return Parameter	<NR1>	Returns the current control configuration.

:SYSTem:CONFIgure:VOLTage:CONTRol



Description	Sets or queries the CV control mode (local control (panel), external voltage control, external resistance control). This setting is applied only after the unit is reset.	
Syntax	:SYSTem:CONFIgure:VOLTage:CONTRol { <NR1> NONE VOLTage RRISing RFALLing VISolation }	
Query Syntax	:SYSTem:CONFIgure:VOLTage:CONTRol?	
Parameter	<NR1>	Description
	0 NONE	Local (Panel) control

1 VOLTage	External voltage control
2 RRISing	External resistance control; 10kΩ or 5kΩ = I _o max*, 0kΩ = I _o min.
3 RFALLing	External resistance control; 10kΩ or 5kΩ = I _o min*, 0kΩ = I _o max.
4 VISolation	External voltage control (isolated)

*The resistance value depends on the [:SOURce]:VOLTage:EXTernal:RANGe command. If the range is high, then the resistance is 10kΩ, else it is 5kΩ. See page 91 for details.

Return Parameter	<NR1>	Returns the current control configuration.
------------------	-------	--------------------------------------------

Set →

:SYSTem:CONFigure:OUTPut:PON[:STATe] → Query

Description Sets the output state at power-on. This is the equivalent to the F-92 (Output Status when Power ON) power on configuration settings. These settings only apply after the unit has been reset.

Syntax :SYSTem:CONFigure:OUTPut:PON[:STATe]

Return Syntax {<NR1>|{SAFE|OFF}}|{FORCe|ON}|AUTO}

:SYSTem:CONFigure:OUTPut:PON[:STATe]?

Parameter	SAFE OFF 0	The PSU turns on in the same state the unit was in prior to the previous shut down. The output is set to off (default).
	FORCe ON 1	The PSU turns on in the same state the unit was in prior to the previous shut down. The output is set to on.
	AUTO 2	The PSU turns on in the same state the unit was in prior to the previous shut down, but with the same output on/off setting.

Return parameter	0	The power on output setting is "SAFE" or "OFF".
	1	The power on output setting is "FORCe" or "ON".
	2	The power on output setting is "AUTO".

Set →

:SYSTem:CONFigure:PROTection:RECover → Query

Description	Sets or queries how the OHP, FAN, AC-FAIL, and SD alarms are cleared.	
Syntax	:SYSTem:CONFigure:PROTection:RECover {SAFE AUTO}	
Return Syntax	:SYSTem:CONFigure:PROTection:RECover?	
Parameter	SAFE	The output is not turned on automatically when the cause of the alarm is fixed.
	AUTO	The output is turned on automatically when the cause of the alarm is fixed.

Set →

:SYSTem:CONFigure:MSLave → Query

Description	Sets or queries the unit operation mode. This setting is only applied after the unit has been reset.	
Syntax	:SYSTem:CONFigure:MSLave { <NR1> }	
Query Syntax	:SYSTem:CONFigure:MSLave?	
Parameter/Return	<NR1>	Description
	0	Master/Local
	1	Master/with 1 unit in Parallel (total:2 units)
	2	Master/with 2 units in Parallel (total: 3 units)
	3	Master/with 3 units in Parallel (total: 4 units)
	4	Slave

:SYSTem:CONFigure:OUTPut:EXTernal
:MODE

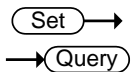

Description	<p>Sets the logic used to turn the output on or off when using an external contact. This is the equivalent to the F-94 (External Output Logic) power on configuration settings.</p> <p>This setting is only applied after the unit has been reset.</p>
Syntax	:SYSTem:CONFigure:OUTPut:EXTernal:MODE
Return Syntax	{<NR1> LOW HIGH}
	:SYSTem:CONFigure:OUTPut:EXTernal:MODE?
Parameter	HIGH 0 Active high LOW 1 Active low
Return Parameter	<NR1> Returns the logic setting.

:SYSTem:CONFigure:OUTPut:EXTernal (Set) →
[:STATe] → (Query)

Description	Sets whether the output will be turned on or off externally. By default this setting is turned off. This setting is only applied after the unit has been reset.	
Syntax	:SYSTem:CONFigure:OUTPut:EXTernal[:STATe]	
Return Syntax	{<bool> OFF ON}	
	:SYSTem:CONFigure:OUTPut:EXTernal[:STATe]?	
Parameter	ON 1	External control is performed.
	OFF 0	External control is not performed.
Return parameter	<bool>	Returns output status of the instrument.

:SYSTem:CONFigure:MONitor:RANGe (Set) →
→ (Query)

Description	This command is used to select the monitor voltage range. This setting is only applied after the unit has been reset.	
Syntax	:SYSTem:CONFigure:MONitor:RANGe	
	{<NR1> LOW HIGH}	
Return Syntax	:SYSTem:CONFigure:MONitor:RANGe?	
Parameter	HIGH 0	10V
	LOW 1	5V
Return Parameter	<NR1>	Returns the logic setting.

:SYSTem:CONFigure:TRIGger:INPut (Set) →
:SOURce → (Query)

Description	Sets or queries what action will be performed on receiving a trigger.	
Syntax	:SYSTem:CONFigure:TRIGger:INPut:SOURce	
	{<NR1> NONE OUTPut SETTing MEMory}	
Return Syntax	:SYSTem:CONFigure:TRIGger:INPut:SOURce?	

Parameter	NONE 0	No input trigger.
	OUTPut 1	Toggles the output on receiving a trigger.
	SETTing 2	Sets the voltage/current on receiving a trigger.
	MEMory 3	Loads a memory setting on receiving a trigger.
Return Parameter	<NR1>	Returns the input source.

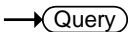
:SYSTem:CONFigure:TRIGger:INPut 
:WIDTh 

Description	Sets or queries the input trigger pulse width. A setting of 0 indicates that the input trigger is controlled by the trigger input level, rather than a trigger pulse.	
Syntax	:SYSTem:CONFigure:TRIGger:INPut:WIDTh {<NR2> MINimum MAXimum}	
Return Syntax	:SYSTem:CONFigure:TRIGger:INPut:WIDTh? [MINimum MAXimum]	
Parameter	<NR2>	0 ~ 60ms.
	MINimum	Minimum width = 0.
	MAXimum	60ms
Return Parameter	<NR2>	Returns the trigger input width.

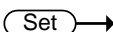
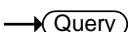
:SYSTem:CONFigure:TRIGger:OUTPut 
:SOURce 

Description	Sets or queries the output trigger source.	
Syntax	:SYSTem:CONFigure:TRIGger:OUTPut:SOURce {<NR1> NONE OUTPut SETTing MEMory}	
Return Syntax	:SYSTem:CONFigure:TRIGger:OUTPut:SOURce?	
Parameter	NONE 0	No output trigger.
	OUTPut 1	Output trigger is generated by a change in the output.
	SETTing 2	Output trigger is generated when a setting is changed.
	MEMory 3	Output trigger is generated when a memory setting is loaded.

Return Parameter <NR1> Returns the output source.

:SYSTem:CONFigure:TRIGger:OUTPut
:WIDTh (Set) →
→ (Query)

Description Sets or queries the output trigger pulse width. A setting of 0 indicates that the output trigger will go high or low, depending on the output level setting.

Related Commands :SYSTem:CONFigure:TRIGger:OUTPut:LEVel

Syntax :SYSTem:CONFigure:TRIGger:OUTPut:WIDTh {<NR2>|MINimum|MAXimum}

Return Syntax :SYSTem:CONFigure:TRIGger:OUTPut:WIDTh? [MINimum|MAXimum]

Parameter	<NR2>	0 ~ 60ms.
	MINimum	Minimum width = 0
	MAXimum	60ms

Return Parameter <NR2> Returns the trigger output width.

:SYSTem:CONFigure:TRIGger:OUTPut
:LEVel (Set) →
→ (Query)

Description Sets the polarity of the output trigger level when the output trigger pulse width is set to 0.

Syntax :SYSTem:CONFigure:TRIGger:OUTPut:LEVel {<NR1>|LOW|HIGH}

Return Syntax :SYSTem:CONFigure:TRIGger:OUTPut:LEVel?

Parameter	0 LOW	Sets the output trigger to active low.
	1 HIGH	Sets the output trigger to active high.

Return Parameter <NR1> Returns the trigger output width.

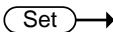
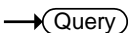
:SYSTem:COMMunicate:ENABle

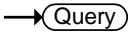

Description	Enables/Disables GPIB, USB or other remote interfaces such as Sockets and the Web Server. This setting is only applied after the unit has been reset.	
Syntax	:SYSTem:COMMunicate:ENABle {<bool> OFF ON,GPIB USB LAN SOCKETs WEB SERial}	
Query Syntax	:SYSTem:COMMunicate:ENABle? {GPIB USB LAN SOCKETs WEB SERial}	
Parameter 1	OFF 0 ON 1	Disables the selected interface. Enables the selected interface.
Parameter 2	GPIB USB LAN SOCKETs WEB SERial	Select GPIB Select USB Select LAN Select Sockets Select the web server Selected Serial (UART)
Return Parameter	<bool>	Returns the status of the selected mode.
Example	SYST:COMM:ENAB 1,USB Turns the USB interface on.	
Query Example	SYST:COMM:ENAB? USB 1 Queries the USB state, returns 1 (USB is on).	

**:SYSTem:COMMunicate:GPIB[:SELF]
:ADDRess**



Description	Sets or queries the GPIB address. Note: the setting will only be valid after the power has been cycled.	
Syntax	:SYSTem:COMMunicate:GPIB[:SELF]:ADDRess <NR1>	
Query Syntax	:SYSTem:COMMunicate:GPIB[:SELF]:ADDRess?	

Parameter/Return <NR1> 0~30

Example SYST:COMM:GPIB:SELF:ADDR 15
Sets the GPIB address to 15.

:SYSTem:COMMunicate:LAN:IPADdress  →
→ 

Description Sets or queries LAN IP address. Note: the setting will only be valid after the power has been cycled.

Syntax :SYSTem:COMMunicate:LAN:IPADdress <string>

Query Syntax :SYSTem:COMMunicate:LAN:IPADdress?

Parameter/Return <string> LAN IP address in string format ("address")
Applicable ASCII characters: 20H to 7EH

Example SYST:COMM:LAN:IPAD "172.16.5.111"
Sets the IP address to 172.16.5.111.

:SYSTem:COMMunicate:LAN:GATEway  →
→ 

Description Sets or queries the Gateway address. Note: the setting will only be valid after the power has been cycled.

Syntax :SYSTem:COMMunicate:LAN:GATEway <string>

Query Syntax :SYSTem:COMMunicate:LAN:GATEway?

Parameter/Return <string> Gateway address in string format ("address")
Applicable ASCII characters: 20H to 7EH

Example SYST:COMM:LAN:GATE "172.16.0.254"
Sets the LAN gateway to 172.16.0.254.

:SYSTem:COMMunicate:LAN:SMASk



Description	Sets or queries the LAN subnet mask. Note: the setting will only be valid after the power has been cycled.
Syntax	:SYSTem:COMMunicate:LAN:SMASk <string>
Query Syntax	:SYSTem:COMMunicate:LAN:SMASk?
Parameter/Return	<string> Subnet mask in string format ("mask") Applicable ASCII characters: 20H to 7EH
Example	SYST:COMM:LAN:SMASK "255.255.0.0" Sets the LAN mask to 255.255.0.0.

:SYSTem:COMMunicate:LAN:MAC

Description	Returns the unit MAC address as a string. The MAC address cannot be changed.
Query Syntax	:SYSTem:COMMunicate:LAN:MAC?
Return parameter	<string> Returns the MAC address in the following format "FF-FF-FF-FF-FF-FF"
Example	SYST:COMM:LAN:MAC? 02-80-AD-20-31-B1 Returns the MAC address.

:SYSTem:COMMunicate:LAN:DHCP



Description	Turns DHCP on/off. Queries the DHCP status. Note: the setting will only be valid after the power has been cycled.
Syntax	:SYSTem:COMMunicate:LAN:DHCP {<bool> OFF ON}
Query Syntax	:SYSTem:COMMunicate:LAN:DHCP?
Parameter	OFF 0 DHCP off ON 1 DHCP on
Return parameter	<bool> Returns the DHCP status.

Set →
 → Query

:SYSTem:COMMunicate:LAN:DNS

Description	Sets or queries the DNS address. Note: the setting will only be valid after the power has been cycled.
Syntax	:SYSTem:COMMunicate:LAN:DNS <string>
Query Syntax	:SYSTem:COMMunicate:LAN:DNS?
Parameter/Return	<string> DNS in string format (“mask”) Applicable ASCII characters: 20H to 7EH
Example	SYST:COMM:LAN:DNS “172.16.1.252” Sets the DNS to 172.16.1.252.

Set →
 → Query

:SYSTem:COMMunicate:RLState

Description	Enables or disables local/remote state of the instrument.						
Syntax	:SYSTem:COMMunicate:RLState {LOCAL REMOte RWLock}						
Query Syntax	:SYSTem:COMMunicate:RLState?						
Parameter/Return parameter	<table style="width: 100%; border-collapse: collapse;"> <tr> <td style="width: 15%;">LOCAL</td> <td>All keys are valid. This instrument is controlled by the front panel controls.</td> </tr> <tr> <td>REMOte</td> <td>All keys are invalid, except for the [local] key and the ability to turn the output off.</td> </tr> <tr> <td>RWLock</td> <td>All keys are invalid. The instrument can only be controlled remotely.</td> </tr> </table>	LOCAL	All keys are valid. This instrument is controlled by the front panel controls.	REMOte	All keys are invalid, except for the [local] key and the ability to turn the output off.	RWLock	All keys are invalid. The instrument can only be controlled remotely.
LOCAL	All keys are valid. This instrument is controlled by the front panel controls.						
REMOte	All keys are invalid, except for the [local] key and the ability to turn the output off.						
RWLock	All keys are invalid. The instrument can only be controlled remotely.						
Example	:SYST:COMM:RLST LOCAL Sets the operating mode to local.						

→ Query

:SYSTem:COMMunicate:TCPIp:CONTRol

Description	Queries the socket port number.
Query Syntax	:SYSTem:COMMunicate:TCPIp:CONTRol?
Return parameter	<NR1> 0000 ~ 9999
Example	SYST:COMM:TCP:CONTRol? >2268 Returns the socket port number.

**:SYSTem:COMMunicate:SERial:LANGUage[Set]
:SElect] Query**

Description	Sets or queries the communication protocol for the serial port.	
Syntax	:SYSTem:COMMunicate:SERial:LANGUage[:SElect] {"SCPI" "LEGACY"}	
Query Syntax	:SYSTem:COMMunicate:SERial:LANGUage[:SElect]?	
Parameter/Return parameter	"SCPI"	Sets the communication protocol to SCPI.
	"LEGACY"	Sets the communication protocol to legacy mode. (Emulate TDK Genesys)
Example	SYST:COMM:SER:LANG? >SCPI Indicates that the communication protocol is set to SCPI.	

**:SYSTem:COMMunicate:SERial[:RECeive] Set
:TRANsmit:BAUD Query**

Description	Sets or queries the UART baud rate. Note: the setting will only be valid after the power has been cycled.	
Syntax	:SYSTem:COMMunicate:SERial[:RECeive]:TRANsmit :BAUD <NR1>	
Query Syntax	:SYSTem:COMMunicate:SERial[:RECeive]:TRANsmit :BAUD?	
Parameter/Return	<NR1>	2400, 4800, 9600, 19200, 38400, 57600, 115200
Example	SYST:COMM:SER:TRAN:BAUD? >2400 Returns the baud rate settings.	

:SYSTem:COMMunicate:SERial[:RECEive] (Set) →
:TRANsmit:BITS → (Query)

Description	Sets or queries the UART number of data bits. Note: the setting will only be valid after the power has been cycled.	
Syntax	:SYSTem:COMMunicate:SERial[:RECEive]:TRANsmit	
Query Syntax	:BITS <NR1> :SYSTem:COMMunicate:SERial[:RECEive]:TRANsmit :BITS?	
Parameter/Return parameter	<NR1>	
	0	7 bits
	1	8 bits
Example	SYST:COMM:SER:TRAN:BITS? >1 Indicates that 8 data bits are used for the UART connection.	

:SYSTem:COMMunicate:SERial[:RECEive]:T (Set) →
RANsmit:PARity → (Query)

Description	Sets or queries the parity of the UART connection. Note: the setting will only be valid after the power has been cycled.	
Syntax	:SYSTem:COMMunicate:SERial[:RECEive]:TRANsmit	
Query Syntax	:PARity <NR1> :SYSTem:COMMunicate:SERial[:RECEive]:TRANsmit :PARity?	
Parameter/Return parameter	0	None
	1	Odd
	2	Even
Example	SYST:COMM:SER:TRAN:PARity? >1 Indicates that odd parity is used for the UART connection.	

Set →

:SYSTem:COMMunicate:USB:REAR:MODE → Query

Description	Sets or queries the speed of the rear panel USB B port. This setting is applied only after the unit is reset.	
Syntax	:SYSTem:COMMunicate:USB:REAR:MODE {<NR1> DISable AUTO FULL}	
Query Syntax	:SYSTem:COMMunicate:USB:REAR:MODE?	
Parameter	0 DISable	Disable
	1 AUTO	Auto detect speed
	2 FULL	Full speed
Return parameter	<NR1>	
	0	Disable
	1	Auto detect speed
	2	Full speed

:SYSTem:COMMunicate:USB:REAR:STATe → Query

Description	Queries the rear panel USB-B port state.	
Query Syntax	:SYSTem:COMMunicate:USB:REAR:STATe?	
Return parameter	0	<NR1>Absent
	1	<NR1>Connected to the PC

:SYSTem:ERRor → Query

Description	Queries the error queue. The last error message is returned. A maximum of 32 errors are stored in the error queue.	
Query Syntax	:SYSTem:ERRor?	
Return parameter	<string>	Returns an error code followed by an error message as a single string.
Example	SYSTem:ERRor? -100, "Command error"	

Set →
 → Query

:SYSTem:KLOCK

Description	Enables or disables the front panel key lock.	
Syntax	:SYSTem:KLOCK {<bool> OFF ON }	
Query Syntax	:SYSTem:KLOCK?	
Parameter	OFF 0	Panel keys unlocked
	ON 1	Panel keys locked
Return parameter	<bool>	Returns the key lock status.

Set →
 → Query

:SYSTem:KEYLock:MODE

Description	Sets or queries the keylock mode. This setting is the equivalent to the F-19 function setting.	
Syntax	:SYSTem:KEYLock {<bool> OFF ON}	
Query Syntax	:SYSTem:KEYLock?	
Parameter/Return parameter	0 OFF	Panel lock: allow output off.
	1 ON	Panel lock: allow output on/off.

Set →

:SYSTem:ERRor:ENABLE

Description	Clears the Error Queue and enables all error messages to be placed in the System Error Queue.	
Syntax	:SYSTem:ERRor:ENABLE	

Set →
 → Query

:SYSTem:LANGUage:EMULation

Description	Sets or queries the command language.	
Syntax	:SYSTem:LANGUage:EMULation {“NONE” ”N5700” ”GENSYS” ”PWX”}	
Query Syntax	:SYSTem:LANGUage:EMULation?	
Parameter/Return parameter	“NONE”	Emulation is not used. This is the default setting

“N5700”	N5700/N8700 emulation is used.
“GENSYS”	GENESYS emulation is used.
“PWX”	PAG emulation is used.

(Set) →

:SYSTem:LANGUage[:SElect]

→ (Query)

Description	Sets or queries the command language.	
Syntax	:SYSTem:LANGUage[:SElect] {“SCPI” “LEGACY”}	
Query Syntax	:SYSTem:LANGUage[:SElect]?	
Parameter/ Return parameter	“SCPI”	Use the SCPI command language. This the default language
	“LEGACY”	Use the GEN command language.

:SYSTem:PRESet

(Set) →

Description	Loads the default settings.
Syntax	:SYSTem:PRESet

:SYSTem:VERSion

→ (Query)

Description	Returns the version of the PSU SCPI version.	
Query Syntax	:SYSTem:VERSion?	
Return	<string>	Returns the SCPI version as a string.
Query Example	SYST:VERS? >1999.9	

:SYSTem:REBoot

(Set) →

Description	Reboots the PSU system.
Syntax	:SYSTem:REBoot

Trigger Commands

:TRIGger:OUTPut:SOURce.....	121
:TRIGger:OUTPut[:IMMediate]	121
:TRIGger[:TRANsient]:SOURce	121
:TRIGger[:TRANsient][:IMMediate].....	122

:TRIGger:OUTPut:SOURce (Set) →
→ (Query)

Description	Sets or queries the trigger source of the output trigger.	
Syntax	:TRIGger:OUTPut:SOURce {BUS IMMediate EXTernal}	
Query Syntax	:TRIGger:OUTPut:SOURce?	
Parameter/ Return parameter	BUS IMMediate EXTernal	Output trigger is generated by the bus. Output trigger is immediately generated. The output trigger is generated when an external signal triggers it.
Example	:TRIGger:OUTPut:SOURce? EXT Sets the output trigger source to EXT.	

:TRIGger:OUTPut[:IMMediate] (Set) →

Description	Generates an immediate trigger for the output trigger system.
Syntax	:TRIGger:OUTPut[:IMMediate]
Example	:TRIG:OUTP
Example	:TRIG:MEM

:TRIGger[:TRANsient]:SOURce (Set) →
→ (Query)

Description	Sets or queries the source of the transient trigger.
-------------	------------------------------------------------------

Syntax	:TRIGger[:TRANsient]:SOURce {BUS IMMEDIATE EXTernal}	
Query Syntax	:TRIGger[:TRANsient]:SOURce?	
Parameter/ Return parameter	BUS	Transient trigger is generated by the bus.
	IMMEDIATE	Transient trigger is immediately generated.
	EXTernal	The transient trigger is generated when an external signal triggers it.
Example	:TRIG:SOUR? EXT Sets the transient trigger source to EXT.	

:TRIGger[:TRANsient][:IMMEDIATE]



Description	Generates an immediate trigger for the transient trigger system.	
Syntax	:TRIGger[:TRANsient][:IMMEDIATE]	
Example	:TRIG	

IEEE 488.2 Common Commands

*CLS	123
*ESE	123
*ESR	123
*IDN	124
*OPC	124
*RCL	124
*RST	125
*SAV	125
*SRE	125
*STB	126
*TRG	126
*TST	126
*WAI	126

*CLS

Set →

Description The *CLS command clears all the event registers, including the status byte, event status and error queue.

Syntax *CLS

Set →

*ESE

→ Query

Description Sets or queries the Standard Event Status Enable register.

Syntax *ESE <NR1>

Query Syntax *ESE?

Parameter <NR1> 0~255

Return parameter <NR1> Returns the bit sum of the Standard Event Status Enable register.

*ESR

→ Query

Description Queries the Standard Event Status (Event) register. The Event Status register is cleared after it is read.

Query Syntax *ESR?

Return parameter <NR1> Returns the bit sum of the Standard Event Status (Event) register and clears the register.

***IDN** → **Query**

Description Queries the manufacturer, model name, serial number, and firmware version of the PSU.

Query Syntax *IDN?

Return parameter <string> Returns the instrument identification as a string in the following format:
 GW-INSTEK,PSU-2076,TW123456,01.00.20110101
 Manufacturer: GW-INSTEK
 Model number : PSU-3036
 Serial number : TW123456
 Firmware version : 01.00.20110101

→ **Set** →

***OPC** → **Query**

Description The *OPC command sets the OPC bit (bit0) of the Standard Event Status Register when all current commands have been processed.
 The *OPC? Query returns 1 when all the outstanding commands have completed.

Syntax *OPC

Query Syntax *OPC?

Return parameter 1 Returns 1 when all the outstanding commands have completed.

***RCL** → **Set** →

Description Recalls the contents stored in memory slot M1, M2 or M3.

Syntax *RCL {<NR1>|MAX|MIN}

Parameter	<NR1>	0, 1, 2 (as memory M1 , M2, M3)
	MIN	Recalls the M1 memory contents.
	MAX	Recalls the M3 memory contents.

***RST** (Set) →

Description Performs a device reset. Configures the unit to a known configuration (default settings). This known configuration is independent of the usage history.

Syntax *RST

***SAV** (Set) →

Description Saves the settings into memory slot M1, M2 or M3.

Syntax *SAV {<NR1>|MIN|MAX}

Return parameter	<NR1>	0, 1, 2 (as memory M1 , M2, M3)
	MIN	Saves the M1 memory contents.
	MAX	Saves the M3 memory contents.

***SRE** (Set) →
→ (Query)

Description Sets or queries the Service Request Enable register. The Service Request Enable register determines which registers of the Status Byte register are able to generate service requests.

Syntax *SRE <NR1>

Query Syntax *SRE?

Parameter	<NR1>	0~255
Return parameter	<NR1>	Returns the bit sum of the Service Request Enable register.

***STB** → Query

Description Queries the bit sum of the Status Byte register with MSS (Master summary Status) replacing the RQS bit (bit 6).

Query Syntax *STB?

Return parameter <NR1> Returns the bit sum of the Status Byte register with the MSS bit (bit 6).

***TRG** Set →

Description The *TRG command is able to generate a “get” (Group Execute Trigger). If the PSU cannot accept a trigger at the time of the command, an error message is generated (-211, “Trigger ignored”).

Syntax *TRG

***TST** → Query

Description Executes a self test.

Query Syntax *TST?

Return parameter 0 Returns “0” if there are no errors.
 <NR1> Returns an error code <NR1> if there is an error.

***WAI** Set →

Description Prevents any other commands or queries from being executed until all outstanding commands have completed.

Syntax *WAI

Status Register Overview

To program the PSU power supply effectively, the Status registers need to be understood. This chapter explains in detail how the Status registers are used and how to configure them.

Introduction to the Status Registers	127
The Status Registers.....	128
Questionable Status Register Group	129
Operation Status Register Group.....	133
Standard Event Status Register Group	136
Status Byte Register & Service Request Enable Register	138

Introduction to the Status Registers

Overview

The status registers are used to determine the status of the power supply. The status registers maintain the status of the protection conditions, operation conditions and instrument errors.

The PSU Series have a number of register groups:

- Questionable Status Register Group
- Standard Event Status Register Group
- Operation Status Register Group
- Status Byte Register
- Service Request Enable Register
- Service Request Generation
- Error Queue
- Output Buffer

The next page shows the structure of the Status registers.

The Status Registers

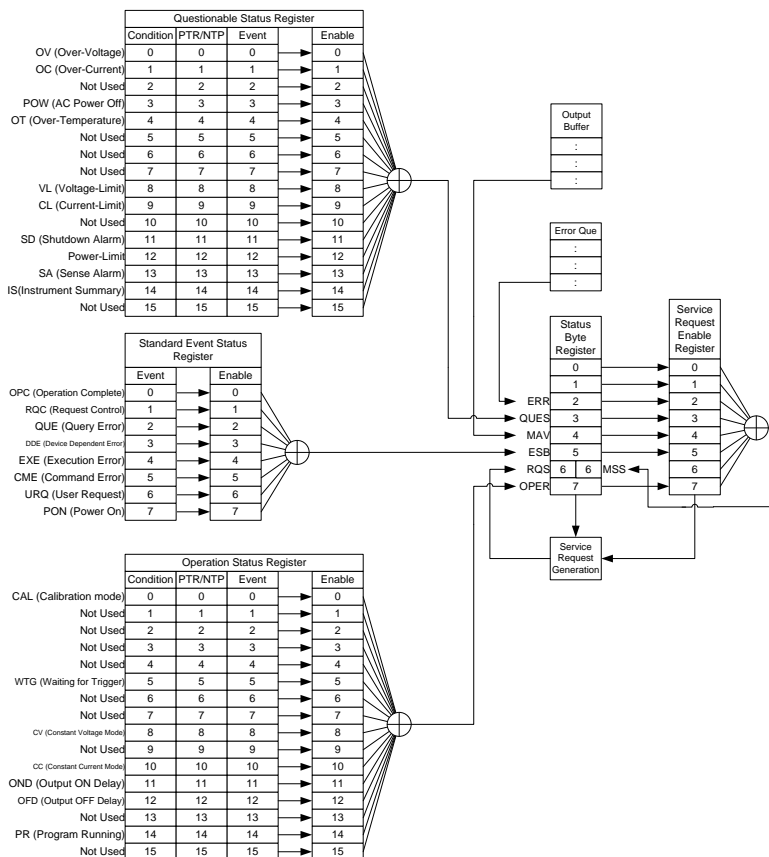

Questionable Status Register Group

Overview

The Questionable Status Register Group indicates if any protection modes or limits have been tripped.

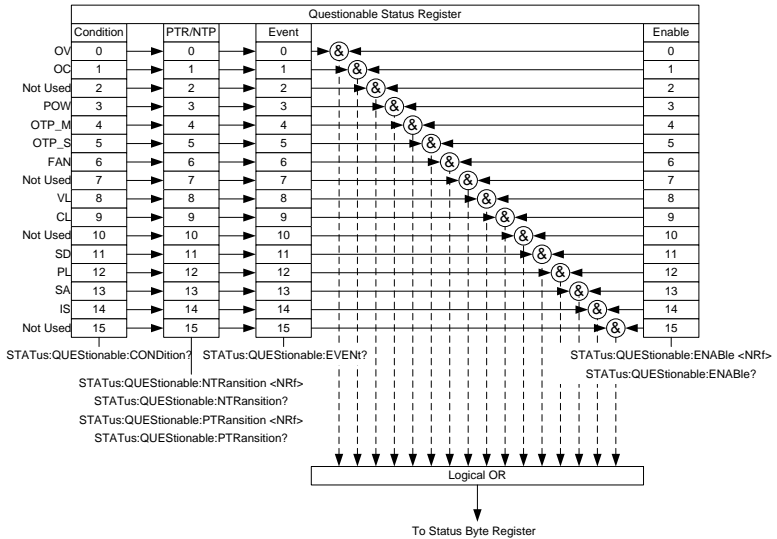

Bit Summary

Event	Bit #	Bit Weight
OV (Over-Voltage)	0	1
Over voltage protection has been tripped		
OC (Over-Current)	1	2
Over current protection has been tripped		
POW (AC Power Off)	3	8
AC power switch is off		

OTP_M (Over Temperature Protection Master Board)	4	16
Over temperature protection has been tripped on the master		
OTP_S (Over Temperature Protection Slave Board)	5	32
Over temperature protection has been tripped on the slave		
FAN failure	6	64
VL (Voltage Limit)	8	256
Voltage limit has been reached		
CL (Current Limit)	9	512
Current limit has been reached		
SD (Shutdown Alarm)	11	2048
PL (Power-Limit)	12	4096
SA (Sense Alarm)	13	8192
IS (Instrument Summary)	14	16384

Condition Register The Questionable Status Condition Register indicates the status of the power supply. If a bit is set in the Condition register, it indicates that the event is true. Reading the condition register does not change the state of the condition register.

PTR/NTR Filters The PTR/NTR (Positive/Negative transition) register determines the type of transition conditions that will set the corresponding bit in the Event Registers. Use the Positive transition filter to view events that change from false to positive, and use the negative transition filter to view events that change from positive to negative.

Positive Transition 0→1

	Negative Transition	1→0
Event Register	The PTR/NTR Register will dictate the type of transition conditions will set the corresponding bits in the Event Register. If the Event Register is read, it will be cleared to 0.	
Enable Register	The Enable register determines which Events in the Event Register will be used to set the QUES bit in the Status Byte Register.	

Instrument Summary Registers

The Instrument Summary Registers indicate if the protection mode or limit of any of the instruments connected in Multi-Drop mode has been tripped.

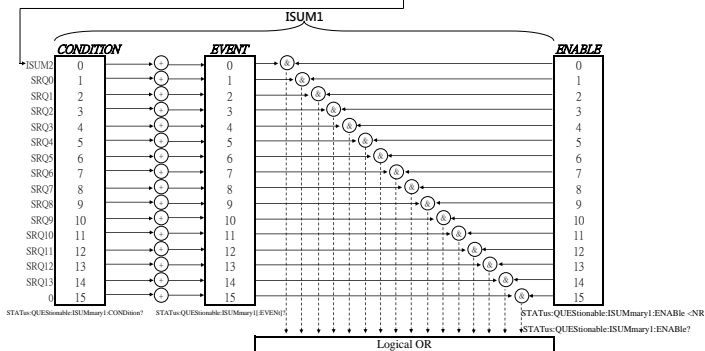
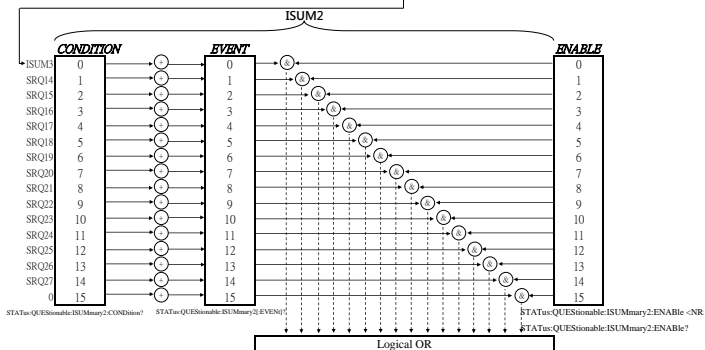
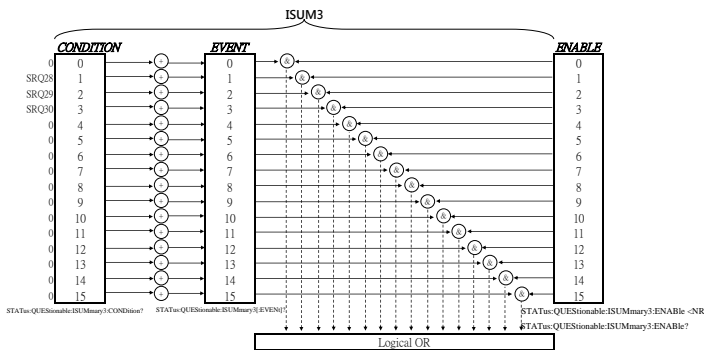

To Instrument Summary in Questionable Condition register (bit 14)

Operation Status Register Group

Overview

The Operation Status Register Group indicates the operating status of the power supply.

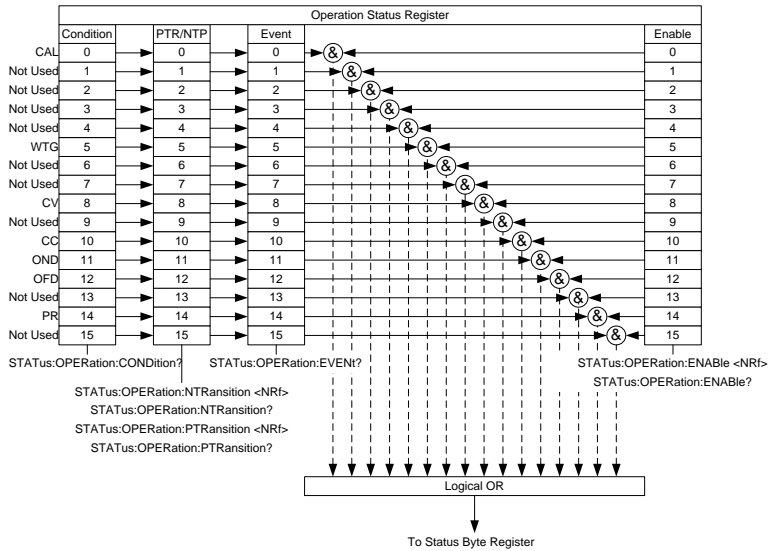

Bit Summary

Event	Bit #	Bit Weight
CAL (Calibration mode)	0	1
Indicates if the PSU is in calibration mode.		
WTG (Waiting for trigger)	5	32
Indicates if the PSU is waiting for a trigger.		

	CV (Constant voltage mode)	8	256
	Indicates if the PSU is in CV mode.		
	CC (Constant current mode)	10	1024
	Indicates if the PSU is in CC mode.		
	OND (Output ON Delay)	11	2048
	Indicates if Output ON delay time is active		
	OFD (Output OFF Delay)	12	4096
	Indicates if Output OFF delay time is active		
	PR (Program Running)	14	16384
	Indicates if a Test is running		
Condition Register	The Operation Status Condition Register indicates the operating status of the power supply. If a bit is set in the Condition register, it indicates that the event is true. Reading the condition register does not change the state of the condition register.		
PTR/NTR Filters	The PTR/NTR (Positive/Negative transition) register determines the type of transition conditions that will set the corresponding bit in the Event Registers. Use the Positive transition filter to view events that change from false to positive, and use the negative transition filter to view events that change from positive to negative.		
	Positive Transition	0→1	
	Negative Transition	1→0	

Event Register The PTR/NTR Register will dictate the type of transition conditions will set the corresponding bits in the Event Register. If the Event Register is read, it will be cleared to 0.

Enable Register The Enable register determines which registered Events in the Event Register will be used to set the OPER bit in the Status Byte Register.

Standard Event Status Register Group

Overview

The Standard Event Status Register Group indicates if any errors have occurred. The bits of the Event register are set by the error event queue.

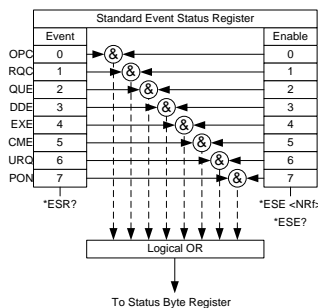

Bit Summary

Event	Bit #	Bit Weight
OPC (Operation complete)	0	1
The OCP bit is set when all selected pending operations are complete. This bit is set in response to the *OPC command.		
RQC (Request control)	1	2
QUE (Query Error)	2	4
The Query Error bit is set in response to an error reading the Output Queue. This can be caused by trying to read the Output Queue when there is no data present.		
DDE (Device Dependent Error)	3	8
Device specific error.		

	EXE (Execution Error)	4	16
	The EXE bit indicates an execution error due to one of the following: illegal command parameter, parameter out of range, invalid parameter, the command didn't execute due to an overriding operation condition.		
	CME (Command Error)	5	32
	The CME bit is set when a syntax error has occurred. The CME bit can also be set when a <GET> command is received within a program message.		
	URQ (User Request)	6	64
	PON (Power On)	7	128
	Indicates the power is turned on.		
Event Register	Any bits set in the event register indicate that an error has occurred. Reading the Event register will reset the register to 0.		
Enable Register	The Enable register determines which Events in the Event Register will be used to set the ESB bit in the Status Byte Register.		

Status Byte Register & Service Request Enable Register

Overview

The Status Byte register consolidates the status events of all the status registers. The Status Byte register can be read with the *STB? query and can be cleared with the *CLS command.

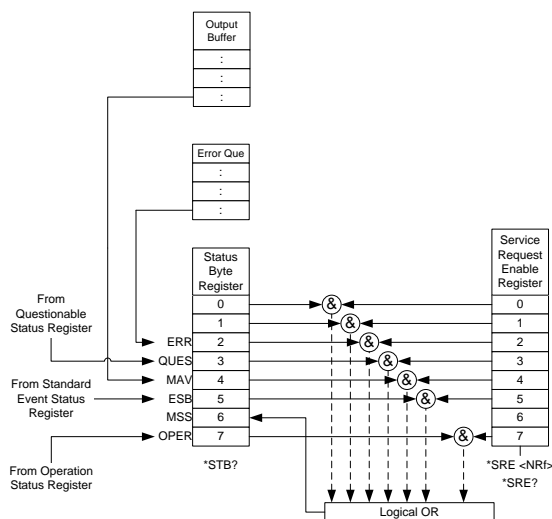

Bit Summary

Event	Bit #	Bit Weight
ERR (Error Event/Queue) If data is present in the Error queue, the ERR bit will be set.	2	4
QUES (Questionable Status Register) The summary bit for the Questionable Status Register group.	3	8
MAV (Message Available) This is set when there is data in the Output Queue waiting to be read.	4	16

	(ESB) Event Summary Bit. The ESB is the summary bit for the Standard Event Status Register group.	5	32
	MSS Bit The MSS Bit is the summary of the Status Byte Register and Service Request register (bits 1-5, 7). This will be set to 1.	6	64
	OPER (Operation Status Register) Group. OPER bit is the summary bit for the Operation Status Register Group.	7	128
Status Byte Register	Any bits set in the Status byte register acts as a summary register for all the three other status registers and indicates if there is a service request, an error in the Error Queue or data in the Output Queue. Reading the Status Byte register will reset the register to 0.		
Service Request Enable Register	The Service Request Enable Register controls which bits in the Status Byte Register are able to generate service requests.		

Error List

Command Errors	140
Execution Errors	144
Device Specific Errors.....	146
Query Errors	147

Command Errors

Overview

An <error/event number> in the range [-199 , -100] indicates that an IEEE 488.2 syntax error has been detected by the instrument's parser. The occurrence of any error in this class shall cause the command error bit (bit 5) in the event status register (IEEE 488.2, section 11.5.1) to be set. One of the following events has occurred:

- An IEEE 488.2 syntax error has been detected by the parser. That is, a controller-to-device message was received which is in violation of the IEEE 488.2 standard. Possible violations include a data element which violates the device listening formats or whose type is unacceptable to the device.
- An unrecognized header was received. Unrecognized headers include incorrect device-specific headers and incorrect or unimplemented IEEE 488.2 common commands.

Events that generate command errors shall not generate execution errors, device-specific errors, or query errors; see the other error definitions in this chapter.

Error Code	Description
-100 Command Error	This is the generic syntax error for devices that cannot detect more specific errors. This code indicates only that a Command Error as defined in IEEE 488.2,11.5.1.1.4 has occurred.
-102 Syntax error	An unrecognized command or data type was encountered; for example, a string was received when the device does not accept strings.
-103 Invalid separator	The parser was expecting a separator and encountered an illegal character; for example, the semicolon was omitted after a program message unit, MEAS:VOLT:DC?:MEASCURR:DC?
-104 Data type error	The parser recognized a data element different than one allowed; for example, numeric or string data was expected but block data was encountered.
-108 Parameter not allowed	More parameters were received than expected for the header; for example, the KLOCK command only accepts one parameter, so receiving SYSTem:KLOCK 1,0 is not allowed.
-109 Missing parameter	Fewer parameters were received than required for the header; for example, the KLOCK command requires one parameter, so receiving KLOCK is not allowed.
-111 Header separator error	A character which is not a legal header separator was encountered while parsing the header; for example, no white space followed the header, thus *SRE2 is an error.

-112 Program mnemonic too long	The header contains more than twelve characters (see IEEE 488.2, 7.6.1.4.1).
-113 Undefined header	The header is syntactically correct, but it is undefined for this specific device; for example, *XYZ is not defined for any device.
-114 Header suffix out of range	The value of a numeric suffix attached to a program mnemonic, see Syntax and Style section 6.2.5.2, makes the header invalid.
-115 Unexpected number of parameters	The number of parameters received does not correspond to the number of parameters expected. This is typically due to an inconsistency with the number of instruments in the selected group.
-120 Numeric data error	This error, as well as errors -121 through -129, are generated when parsing a data element which appears to be numeric, including the nondecimal numeric types. This particular error message should be used if the device cannot detect a more specific error.
-121 Invalid character in number	An invalid character for the data type being parsed was encountered; for example, an alpha in a decimal numeric or a "9" in octal data.
-128 Numeric data not allowed	A legal numeric data element was received, but the device does not accept one in this position for the header.
-131 Invalid suffix	The suffix does not follow the syntax described in IEEE 488.2, 7.7.3.2, or the suffix is inappropriate for this device.

-141 Invalid character data	Either the character data element contains an invalid character or the particular element received is not valid for the header.
-148 Character data not allowed	A legal character data element was encountered where prohibited by the device.
-151 Invalid string data	A string data element was expected, but was invalid for some reason (see IEEE 488.2, 7.7.5.2); for example, an END message was received before the terminal quote character.
-158 String data not allowed	A string data element was encountered but was not allowed by the device at this point in parsing.
-160 Block data error	This error, as well as errors -161 through -169, are generated when parsing a block data element. This particular error message should be used if the device cannot detect a more specific error.
-161 Invalid block data	A block data element was expected, but was invalid for some reason (see IEEE 488.2, 7.7.6.2); for example, an END message was received before the length was satisfied.
-168 Block data not allowed	A legal block data element was encountered but was not allowed by the device at this point in parsing.
-178 Expression data not allowed	A legal expression data was encountered but was not allowed by the device at this point in parsing.

Execution Errors

Overview An <error/event number> in the range [-299 , -200] indicates that an error has been detected by the instrument's execution control block. The occurrence of any error in this class shall cause the execution error bit (bit 4) in the event status register (IEEE 488.2, section 11.5.1) to be set. One of the following events has occurred:

- A <PROGRAM DATA> element following a header was evaluated by the device as outside of its legal input range or is otherwise inconsistent with the device's capabilities.
- A valid program message could not be properly executed due to some device condition.

Execution errors shall be reported by the device after rounding and expression evaluation operations have taken place. Rounding a numeric data element, for example, shall not be reported as an execution error. Events that generate execution errors shall not generate Command Errors, device-specific errors, or Query Errors; see the other error definitions in this section.

Error Code	Description
-200 Execution error	This is the generic syntax error for devices that cannot detect more specific errors. This code indicates only that an Execution Error as defined in IEEE 488.2, 11.5.1.1.5 has occurred.

-201 Invalid while in local	Indicates that a command is not executable while the device is in local due to a hard local control (see IEEE 488.2, 5.6.1.5); for example, a device with a rotary switch receives a message which would change the switches state, but the device is in local so the message cannot be executed.
-203 Command protected	Indicates that a legal password-protected program command or query could not be executed because the command was disabled.
-211 Trigger ignored	Indicates that a GET, *TRG, or triggering signal was received and recognized by the device but was ignored because of device timing considerations; for example, the device was not ready to respond. Note: a DT0 device always ignores GET and treats *TRG as a Command Error.
-213 Init ignored	Indicates that a request for a measurement initiation was ignored as another measurement was already in progress.
-220 Parameter error	Indicates that a program data element related error occurred. This error message should be used when the device cannot detect the more specific errors described for errors -221 through -229.
-221 Settings conflict	Indicates that a legal program data element was parsed but could not be executed due to the current device state (see IEEE 488.2, 6.4.5.3 and 11.5.1.1.5.).

-222 Data out of range	Indicates that a legal program data element was parsed but could not be executed because the interpreted value was outside the legal range as defined by the device (see IEEE 488.2, 11.5.1.1.5.).
-224 Illegal parameter value	Used where exact value, from a list of possibles, was expected.

Device Specific Errors

Overview An <error/event number> in the range [-399 , -300] or [1 , 32767] indicates that the instrument has detected an error which is not a command error, a query error, or an execution error; some device operations did not properly complete, possibly due to an abnormal hardware or firmware condition. These codes are also used for self-test response errors. The occurrence of any error in this class should cause the device-specific error bit (bit 3) in the event status register (IEEE 488.2, section 11.5.1) to be set. The meaning of positive error codes is device-dependent and may be enumerated or bit mapped; the <error message>string for positive error codes is not defined by SCPI and available to the device designer.

Note that the string is not optional; if the designer does not wish to implement a string for a particular error, the null string should be sent (for example, 42,""). The occurrence of any error in this class should cause the device-specific error bit (bit 3) in the event status register (IEEE 488.2, section 11.5.1) to be set. Events that generate device-specific errors shall not generate command errors, execution errors,

or query errors; see the other error definitions in this section.

Error Code	Description
-310 System error	Indicates that some error, termed “system error” by the device, has occurred. This code is device-dependent.
-320 Storage fault	Indicates that the firmware detected a fault when using data storage. This error is not an indication of physical damage or failure of any mass storage element.

Query Errors

Overview

An <error/event number> in the range [-499 , -400] indicates that the output queue control of the instrument has detected a problem with the message exchange protocol described in IEEE 488.2, chapter 6. The occurrence of any error in this class shall cause the query error bit (bit 2) in the event status register (IEEE 488.2, section 11.5.1) to be set. These errors correspond to message exchange protocol errors described in IEEE 488.2, section 6.5. One of the following is true:

- An attempt is being made to read data from the output queue when no output is either present or pending;
- Data in the output queue has been lost.

Events that generate query errors shall not generate command errors, execution errors, or device-specific errors; see the other error definitions in this section.

Error Code	Description
-400 Query error	This is the generic query error for devices that cannot detect more specific errors. This code indicates only that a Query Error as defined in IEEE 488.2, 11.5.1.1.7 and 6.3 has occurred.

A PPENDIX

PSU Default Settings

The following default settings are the factory configuration settings for the power supply (Function settings/Test settings).

Initial Settings	Default Setting	
Output	Off	
LOCK	0 (Disabled)	
Voltage	0V	
Current	0A	
OVP	1.1 X Vrate	
OCP	1.1 X Irate	
Normal Function Settings	Setting	Default Setting
Output ON delay time	F-01	0.00s
Output OFF delay time	F-02	0.00s
V-I mode slew rate select	F-03	0 = CV high speed priority
Internal resistance setting	F-08	0.000Ω
Bleeder circuit control	F-09	1 = ON
Buzzer ON/OFF control	F-10	1 = ON
OCP Delay Time	F-12	0.1 (seconds)
Current Setting Limit	F-13	0 = OFF
Voltage Setting Limit	F-14	0 = OFF
Display Memory parameter when recalling	F-15	0 = OFF
Auto parallel Control	F-16	0 = OFF
Measurement Average Setting	F-17	0 = Low
Alarm Recovery and Output Status	F-18	0 = Safe Mode
Lock Mode	F-19	0:Lock Panel, Allow Output OFF

USB / GPIB setting		
Setting	Setting	Default Setting
Setup Rear USB Speed	F-22	2 = Auto detect
GPIB address	F-23	8
GPIB Enable/Disable	F-24	1 = Enable
SCPI Emulation	F-26	0 = GW Instek
LAN setting		
Setting	Setting	Default Setting
LAN	F-36	1 = Enable
DHCP	F-37	1 = Enable
Socket Server Enable/Disable	F-57	1 = Enable
Web Server Enable/Disable	F-59	1 = Enable
Web Password Enable/Disable	F-60	1 = Enable
UART setting		
Setting	Setting	Default Setting
UART Mode	F-70	1 = Enable
UART Baudrate	F-71	7 = 115200
UART Data Bits	F-72	1 = 8 bits
UART Parity	F-73	0 = None
UART Stop Bit	F-74	0 = 1 bit
UART Transmission Control Protocol	F-75	0 = SCPI
UART Address	F-76	30
UART Multi-Drop control	F-77	0 = Disable
Power On Configuration setting		
Setting	Setting	Default Setting
CV Control	F-90	0 = Panel control (local)
CC Control	F-91	0 = Panel control (local)
Output Status when Power ON	F-92	0 = Safe Mode
Master/Slave	F-93	0 = Independent
External Out Logic	F-94	0 = High ON
Monitor Voltage Select	F-96	0 = 5V
Control Range	F-97	0 = 5V[5kΩ]
External Output Control Function	F-98	0 = OFF

Trigger Input and Output Configuration Settings	Setting	Default Setting
Trigger Input Pulse Width	F100	0 = trigger controlled by trigger level.
Trigger Input Action	F102	0 = None
Output State When Receiving Trigger	F103	0 = OFF
Apply Voltage Setting on Trigger	F104	0 = 0V
Apply Current Setting on Trigger	F105	0 = 0A
Recall memory number	F106	1 = M1
Trigger Output Pulse Width	F120	0ms
Trigger Output Level	F121	0 = LOW
Trigger Source	F122	0 = None

Error Messages & Messages

The following error messages or messages may appear on the PSU screen during operation.

Error Messages	Description
OHP	Master & slave board over temperature protection in PSU
OHP1	Master board over temperature protection in PSU
OHP2	Slave board over temperature protection in PSU
ALM SENS	Sense Alarm
HW OVP	Hardware over voltage protection
AC	AC fail
OVP	Over voltage protection
OCP	Over current protection
FAN FAIL	Fan failure
SHUT DOWN	Force shutdown
Err 001	USB mass storage is not present
Err 002	No (such) file in USB mass storage
Err 003	Empty memory location
Err 004	File access error
Err 007	Slave occurs Off-line (Multi-drop mode)

Normal Messages	Description
MSG 001	External control of output. Output off (F-94=0, High=on)
MSG 002	External control of output. Output off (F-94=1, Low=on)

Communication Interface Messages	Description
USB ON	Rear USB port connected to PC
USB OFF	Rear USB port disconnected from PC
MS ON	Mass storage plugged into front USB port
MS OFF	Mass storage removed from front USB port

LED ASCII Table Character Set

Use the following table to read the LCD display messages.

0	1	2	3	4	5	6	7	8	9	A	B	C	D
0	1	2	3	4	5	6	7	8	9	A	b	C	d
E	F	G	H	I	J	K	L	M	N	O	P	Q	R
E	F	G	H	I	J	K	L	ñ	n	o	P	q	r
S	T	U	V	W	X	Y	Z	()	+	-	,	
s	t	u	v	w	x	y	z	()	+	-	,	.

INDEX

Accessories	11	Optional accessories	11
Caution symbol	4	Package contents.....	11
Cleaning the instrument.....	6	Power on/off	
Configuration		safety instruction	5
normal function settings		Rear panel diagram	19
operation	22	Remote control.....	32
power on configuration operation	24	Command list.....	67
table.....	26	Command syntax.....	63
Default settings.....	149	Error list	140
Display diagram	17	Ethernet configuration	54
Display format	153	Ethernet function check	55
Disposal instructions.....	6	GPIB configuration.....	36
EN61010		GPIB function check	37
measurement category	5	interface configuration	34
pollution degree	6	local bus configuration.....	45, 48
Environment		multi-unit configuration	45, 48
safety instruction.....	6	multi-unit function check	51
Error messages.....	152	sockets configuration	57
Ethernet		sockets function check.....	58
interface.....	54	Status registers	127
sockets	57	UART configuration.....	41
web server.....	54	UART function check.....	44
Front panel diagram	14	USB configuration.....	34
Ground		USB function check.....	35
symbol	4	Service operation	
LED conversion	153	about disassembly	5
List of features	10	Socket server function check	58
Messages.....	152	UK power cord.....	7
Model differences.....	9	Warning symbol	4
		Web server function check	55