

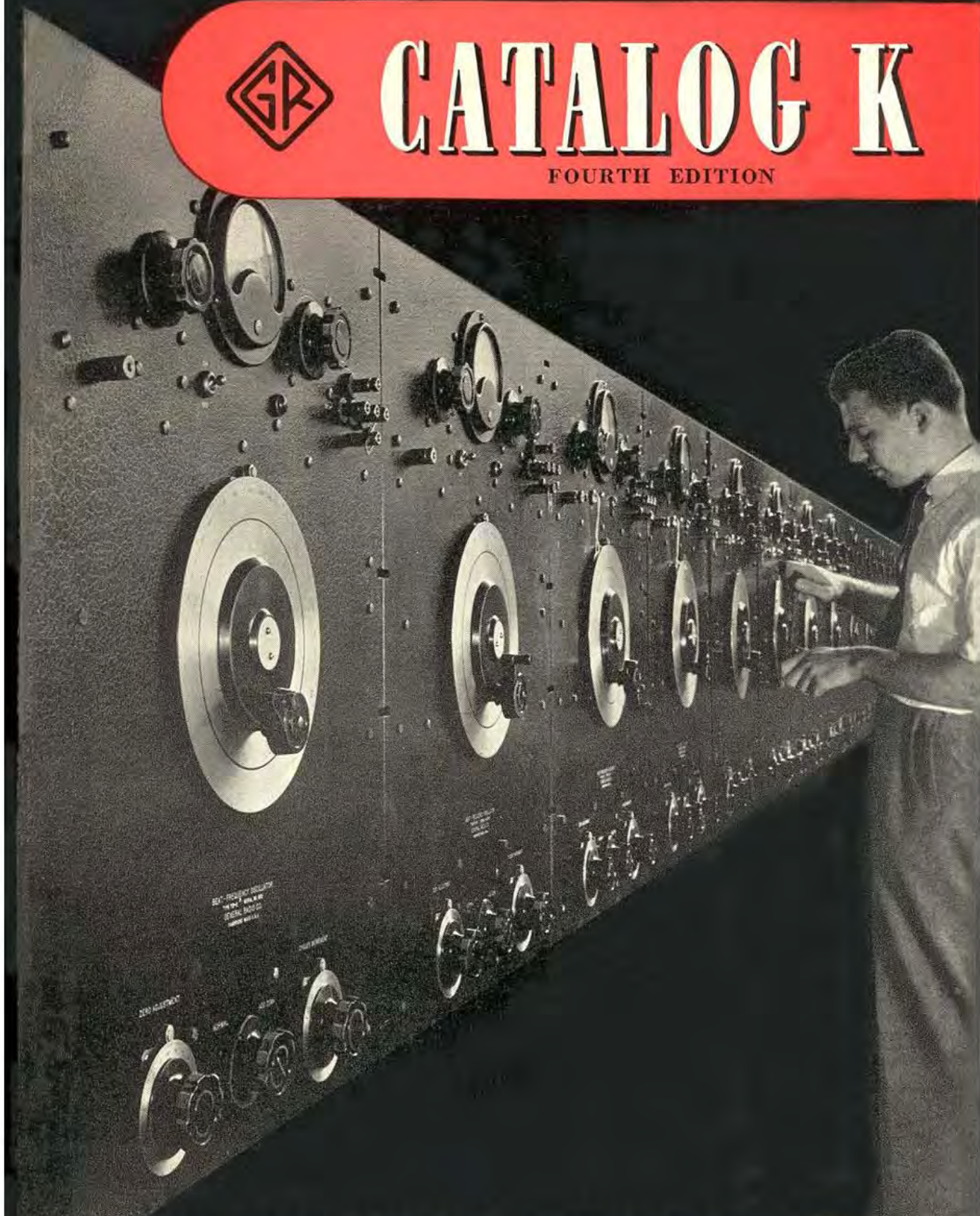

CATALOG K

FOURTH EDITION



GENERAL RADIO COMPANY · CAMBRIDGE, MASS., U.S.A.

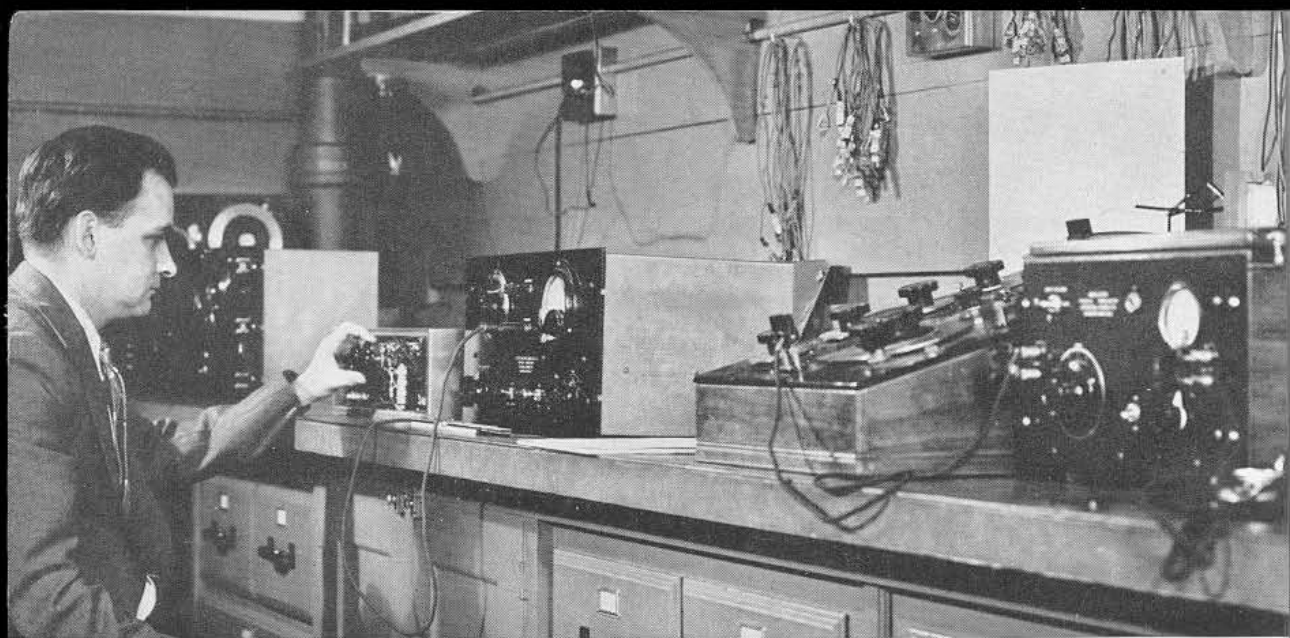

Above—Tests on an experimental model of Type 732-B Distortion and Noise Meter.

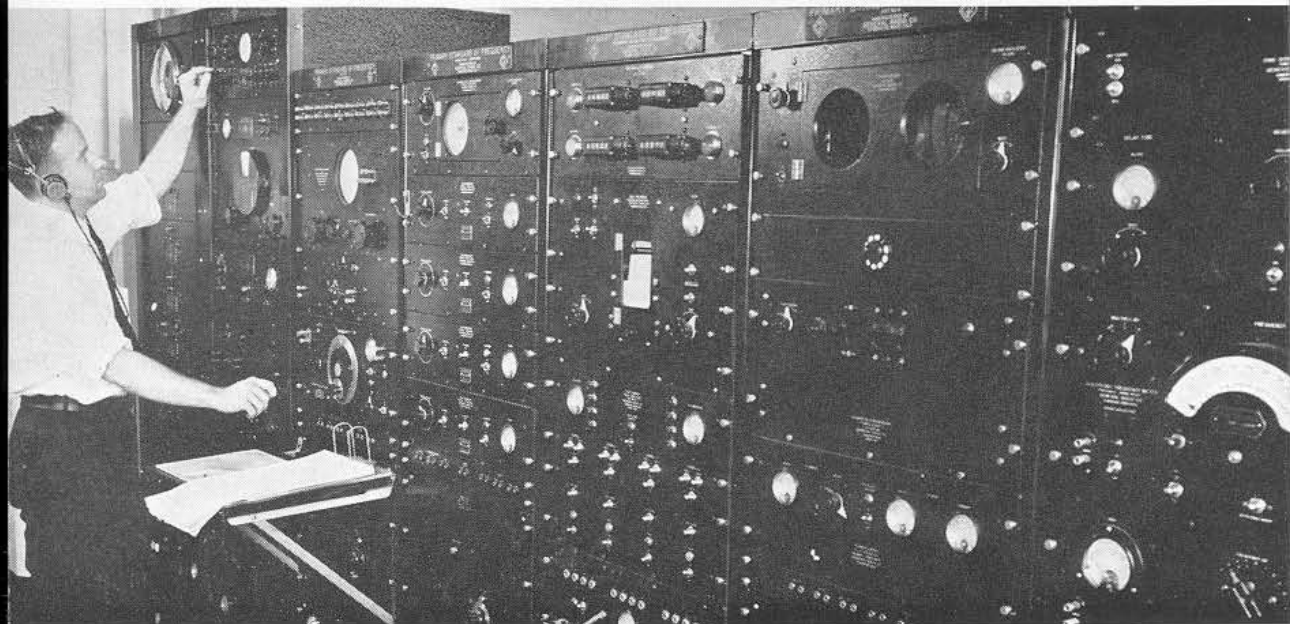

Above—Measuring frequencies with the General Radio Primary Standard of Frequency.
Below—Engineering tests on a high-voltage, 60-cycle Schering Bridge.

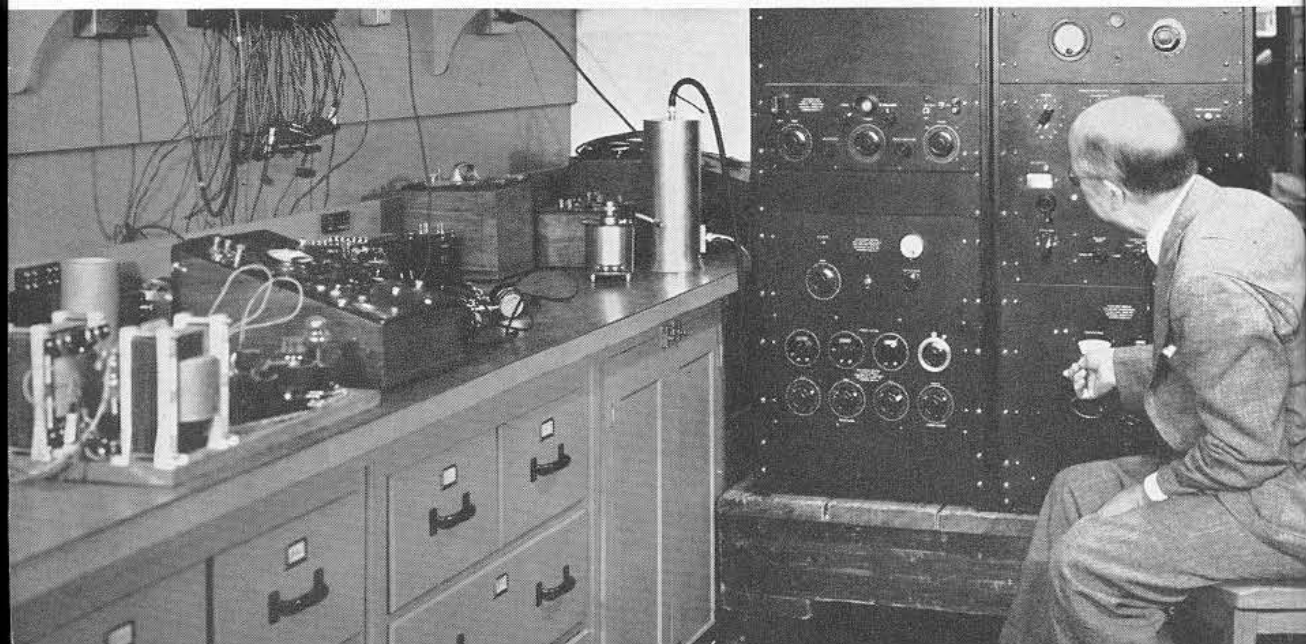

QUICK INDEX

HOW TO ORDER	v
INDUSTRIAL INSTRUMENTS	3
RESISTORS	25
CAPACITORS	41
INDUCTORS	53
BRIDGES AND ACCESSORIES	59
STANDARD-SIGNAL GENERATORS AND OSCILLATORS .	87
WAVEFORM-MEASURING INSTRUMENTS	103
METERS	111
FREQUENCY-MEASURING INSTRUMENTS	123
PARTS AND ACCESSORIES	151
INDEX BY TYPE NUMBER	165
INDEX BY TITLE	165

WE SELL DIRECT . . .

To develop the type of product manufactured by the General Radio Company requires a large staff of engineers, each a specialist in one or more phases of the work involved. One of the functions of this staff is to assist the customer in the selection of instruments in order that the correct equipment may be purchased with a minimum expenditure.

There has always been an intimate contact between our engineers and our customers. The technical nature and the manifold uses of our product make the maintenance of this contact essential. For this reason, the General Radio Company maintains no sales agencies in the United States, but distributes its products directly to the consumer on a net, no discount, basis.

In order that customers outside the United States may receive equivalent technical service, exclusive distributors have been appointed in many foreign countries, each capable of giving technical information regarding General Radio products. In all matters regarding General Radio apparatus the customer should communicate with the distributor from whom this catalog was received. Prices listed in the catalog are for domestic use only. Costs in foreign countries, where import duty and freight must be added, can be obtained from the distributors in those countries.

GENERAL RADIO COMPANY



CATALOG K

FOURTH EDITION

1

9

4

5



**GENERAL RADIO COMPANY
CAMBRIDGE, MASS., U.S.A.**

SUGGESTIONS FOR ORDERING

ORDER BY TYPE NUMBER

Always order by catalog type number, and whenever possible mention ranges or other significant specifications as protection against misunderstanding.

Be sure to include orders for any accessories desired or for calibrations which must be made before shipment.

TELEGRAPH AND CABLE ORDERS

We have direct telegraph printer connections with Western Union for the prompt handling of messages.

Use Bentley's code and the code words accompanying each catalog description. Our cable address is GENRADCO BOSTON.

SHIPPING INSTRUCTIONS

Unless specific instructions accompany the order we shall use our best judgment as to the method of shipment.

All prices are F.O.B. Cambridge, Massachusetts. There is no domestic packing charge and no charge for shipping cases.

Cases are not returnable.

TERMS

Net 30 days. Unless credit has already been established, shipments are made C.O.D.

When full payment accompanies an order for new equipment, we pay transportation charges to any point in the continental United States, except Alaska.

REMITTANCES

Should be made payable at par in Boston or New York funds.

SALES AGENCIES

Because of the Company's direct sales policy no general sales agencies are appointed. Complete stocks are carried only at the factory warehouse. A partial stock is maintained at Los Angeles.

PRICE CHANGES

All prices are subject to change without notice. Billed prices will be in accordance with applicable Federal Regulations at time of shipment. Formal price quotations remain open for 30 days.

PRIORITIES AND DELIVERIES

Our aim under ordinary conditions is to have all items listed in the catalog available for immediate shipment from stock. Under wartime conditions it is impossible to maintain a complete stock, and deliveries may be deferred for reasons beyond the Company's control. Deliveries are made in accordance with the priorities and allocation systems and, in general, are dependent upon the requirements of the war program. These requirements are determined by governmental agencies under emergency regulations and are not subject to modification by the Company.

RESERVATION ORDERS

We will accept reservation orders for delivery after war restrictions are removed. No deposit is required, and the order may be cancelled by either the customer or the General Radio Company up to 60 days before the scheduled shipping date. Estimated shipping date, complete specifications, and price will be furnished well in advance of the 60-day limit. Since many items will be replaced by newer types after the war, your order may refer to either present type numbers or to a general class of equipment. Within the limits of governmental restrictions that may be imposed, these reservation orders will receive first attention as soon as the priority restrictions are removed; the latest design of equipment will be used to fill them; and shipment will be made in the sequence in which orders are received.

SPECIFICATION CHANGES

We reserve the right to discontinue instruments without notice, and to change specifications at any time without incurring any obligation to incorporate new features in instruments previously sold.

SUGGESTIONS FOR ORDERING

TAXES

Prices are subject to such additions for Federal, state or local taxes as we are now or may be required to collect, and to revision as to any sales, excise, or similar taxes which may hereafter be imposed.

NO TRADE OR EDUCATIONAL DISCOUNTS

Our prices are made on a direct-to-consumer basis which permits of no special discounts.

QUANTITY DISCOUNTS

When 10 or more identical items are ordered at the same time for a single shipment, the following quantity discounts are allowed:

10-19	5 per cent
20-99	10 per cent
100 or more	Special discounts quoted on request.

The above discounts also apply to quantities of packages where the unit of sale is a package of small parts.

BRANCH ENGINEERING OFFICES

Engineering offices are maintained in the following cities:

New York 6: 90 West Street
Telephone WOrth 2-5837

Chicago 5: 920 South Michigan Avenue
Telephone WABash 3820

Los Angeles 38: 1000 North Seward Street
Telephone HOLlywood 6321

Customers in or near these cities can quickly and conveniently obtain information about our products from these offices. Each office is in charge of a graduate engineer who has had several years' experience in the engineering department at the home office.

Although our domestic sales are made on a direct-to-the-consumer basis, we have arranged with numerous foreign distributors for the sale and servicing of our products outside of the United States.

WARRANTY

We warrant each new instrument manufactured and/or sold by us to be free from defects in material and workmanship; our obligation under this warranty being limited to repairing or replacing any instrument or part thereof, except tubes and batteries, which shall, within one year after delivery to the original purchaser, prove upon our examination to be thus defective. Material shall not be considered as defective or not in compliance with your order even though not in accordance with our catalog specifications or other specifications if it substantially fulfills performance specifications.

REPAIR PARTS

When ordering repair parts, be sure to describe carefully the parts required and to give the type number and serial number from the panel of the instrument.

SHIPMENTS TO GENERAL RADIO

When returning instruments for repair, recalibration, or for any other reason, please ask our Service Department for shipping instructions. Please state type number and serial number of instrument and date of purchase.

OTHER GENERAL RADIO PUBLICATIONS

In addition to this catalog we publish a monthly magazine, the *General Radio Experimenter*, for free distribution among interested persons. It contains technical and semi-technical engineering articles which are contributed, for the most part, by our engineering staff. To be placed on the mailing list, simply address a request to us containing your name, mailing address, and business affiliation.

PATENTS

Many of our products are manufactured and sold under United States Letters Patent owned by the General Radio Company or under license grants from other companies. To simplify the listing of these patents they are given here in a single list and referred to at each instrument only by appropriate reference number.

1. Vacuum-tube amplifier devices, electric wave filters, and vacuum-tube oscillators are licensed by Western Electric Company, Inc., under all United States Letters Patent owned or controlled by American Telephone and Telegraph Company, or Western Electric Company, Inc., and any or all other United States patents with respect to which Western Electric Company, Inc., has the right to grant a license, solely for utilization in research, investigation, measurement, testing, instruction, and development work in pure and applied science, including engineering and industrial fields.

- | | |
|------------------------|-----------------------|
| 2. Patent 1,871,886. | 7. Patent 1,944,315. |
| 3. Patent 2,294,941. | 8. Patent 1,967,185. |
| 4. Patent applied for. | 9. Patent 2,173,427. |
| 5. Patent 1,901,343. | 10. Patent 2,367,681. |
| 6. Patent 1,901,344. | 11. Patent 2,009,013. |

12. Licensed under all patents and patent applications of Dr. G. W. Pierce pertaining to piezo-electric crystals and their associated circuits.

13. Patent 2,069,934. 14. Patent 1,943,302.

15. Licensed under designs, patents and patent applications of Edgerton, Germeshausen and Grier, including Patents Nos.

2,185,189	2,302,690
2,201,166	2,331,317
2,201,167	

16. Patent 2,376,394.

17. Patents 1,713,146 and 1,744,675.

18. Patent 1,983,447.

19. Patent 1,967,184.

20. Patent 2,012,497.

21. Patent 2,012,291.

22. Patent 1,999,869.

23. Patent 1,790,153 and other patents, covering electrical discharge devices and circuits with which said devices may be used, owned by the General Electric Company or under which it may grant licenses.

24. Patent 2,173,426. 28. Patent 2,354,718.

25. Patent 2,298,177. 29. Patent 2,025,775.

26. Patent 2,362,503. 30. Patent 2,374,248.

27. Patent 2,029,358.



INDUSTRIAL INSTRUMENTS



STROBOSCOPES

•
SOUND AND
VIBRATION METERS

•
D-C AMPLIFIER

•
VARIACS

THE STROBOSCOPE is a device that permits rotating or reciprocating objects to be viewed intermittently and thus produces the optical effect of slowing down or stopping motion. If, for example, an electric fan revolving at 1800 rpm is viewed under a light which flashes 1800 times per minute, the fan will apparently be standing still. A slight decrease in the flashing rate will make the fan appear to revolve slowly in the direction of its actual rotation, and an increase will produce a similar motion in the reverse direction. Because the eye retains images for an appreciable fraction of a second (so-called persistence of vision), no flicker is seen except at very low speeds.

Stroboscopes with mechanically operated shutters for interrupting vision have been in use for many years but are subject to the limitations of slow speed and insufficient illumination. General Radio stroboscopes use the flashing lamp principle as developed by Edgerton, Germeshausen, and Grier of the Massachusetts Institute of Technology. Short, brilliant, light flashes are produced by a lamp filled with rare gases, and the speed of the flash is controlled by an electronic switch or a motor-driven contactor. Flashing speeds up to 14,000 per minute, for visual investigation, are obtained by this method with the STROBOTAC, and up to 90,000 per minute for high-speed photography with the Power Stroboscope.

When mechanisms operating at high speeds are viewed by stroboscopic light, in slow motion, all irregularities of the motion present in the original motion are made visible, thus making it possible to observe high-speed mechanisms under actual operating conditions. When the speed of flash coincides with the speed of rotation, motion is apparently stopped. The stroboscope thus becomes an excellent means of measuring speed, and for this purpose the dial which controls the flashing rate of the STROBOTAC is calibrated directly in rpm. Speed measurement by the stroboscopic method absorbs no power from the mechanism under measurement, since no mechanical contact is required.

For the photography of objects moving at high speeds, stroboscopic light provides a means of taking both still and motion pictures. High-speed single-flash and multiple-flash photographs of small areas can be made with the STROBOLUX. For photographing large areas, and for taking ultra-high-speed motion pictures, the TYPE 621 Power Stroboscope should be used.

TYPE 631-B STROBOTAC*

USES: The Strobotac is used for measuring the speed of rotating, reciprocating, or vibrating mechanisms and for observing their operation in slow motion. In the design and testing of machines and high-speed mechanisms, the

Strobotac is invaluable. The operation of motors, fans, pulleys, gears, cams, and other machine elements can be examined in slow motion. Speed measurements for overload and underload tests can be made. It is ideally suited for rapidly adjusting the speeds of a number of machines intended to operate at the same speed, as, for instance, textile spindles. In production testing, it provides a means of rapidly aligning mechanisms that operate under close tolerances. It is approved for use in checking the calibration of aircraft tachometers.

DESCRIPTION: The Strobotac is a small, portable stroboscope calibrated to read speed directly in revolutions per minute. The light source is a Strobotron neon lamp mounted in a parabolic reflector. The frequency of a self-contained electronic pulse generator determines the flashing speed, which can be adjusted, by means of a direct-reading dial, to any value between 600 rpm and 14,400 rpm. If desired, the flashing speed can be controlled by an external contactor, by the a-c line frequency, or by a vacuum-tube oscillator.

The Strobotron is designed to give an extremely short flash, and hence sharp images are obtained even at speeds up to several times the scale values.

Speeds outside the scale range of the instrument can be measured by using multiples of the flashing speed. The upper limit is not



sharply defined, but, in general, speeds up to about 100,000 rpm can be measured. Speeds below 600 rpm can also be measured, but the use of the Strobotac for this range is not recommended, because of flicker caused by the inability of the eye to retain successive images for a sufficiently long period of time to give the illusion of continuous motion.

FEATURES: For speed measurement, the Strobotac has one outstanding advantage over other types of tachometers: no contact with the mechanism under measurement is required, and hence no power is absorbed.

The Strobotac is portable, compact, and light in weight. Because of this, it can be used in

places inaccessible to larger instruments. The speed scale is on a drum-type dial, easily read when the instrument is held in the position of normal use, and a slow-motion drive facilitates precise settings of the dial. High accuracy and a wide speed range are further advantages for general speed measurement. The direct-reading accuracy as a tachometer is within $\pm 1\%$ when the calibration is standardized in terms of a frequency controlled power line.

When a larger area is to be illuminated, or sufficient light for photography is required, the Strobotac can be used to control the flashing speed of the TYPE 648-A Strobolux described on page 4.

*Reg. U. S. Pat. Office.

SPECIFICATIONS

Range: The fundamental range of flashing speed is from 600 to 14,400 per minute. The speed is read directly from a dial calibrated in rpm. By using multiples of the flashing speed, the range of measurement can be extended up to about 100,000 rpm, and, by multiple images, speeds somewhat below 600 rpm can be measured.

Accuracy: $\pm 1\%$ of the dial reading above 900 rpm when the Strobotac is standardized in terms of a frequency-controlled power line. Controls for this standardization adjustment are provided. When an external flashing means is used, the accuracy is that of the flashing source.

Duration of Flash: Between 5 and 10 microseconds.

Power Supply: 105 to 125 volts, 60 cycles. Prices for operation from lines of other voltages and frequencies will be quoted on request. **Power Input:** 25 watts.

Vacuum Tubes: One TYPE 631-P1 Strobotron, one 6X5-G type, and one 6N7-G type are required. A complete set of tubes is furnished with the instrument.

Accessories Supplied: Spare fuses and pilot lamps, seven-foot line connector cord, and plug to fit contactor jack.

Mounting: Metal cabinet with carrying handle. To facilitate mounting the instrument on a tripod, a tapped hole ($\frac{1}{4} \times 20$) is provided in the base of the cabinet.

Dimensions: $7\frac{1}{2} \times 8\frac{3}{4} \times 9\frac{7}{8}$ inches, over-all.

Net Weight: $8\frac{3}{4}$ pounds.

Type		Code Word	Price
631-B	Strobotac.....	BRAVO	\$95.00
631-P1	Replacement Strobotron.....	SENA	4.50

PATENT NOTICE. See Note 15, page vi.

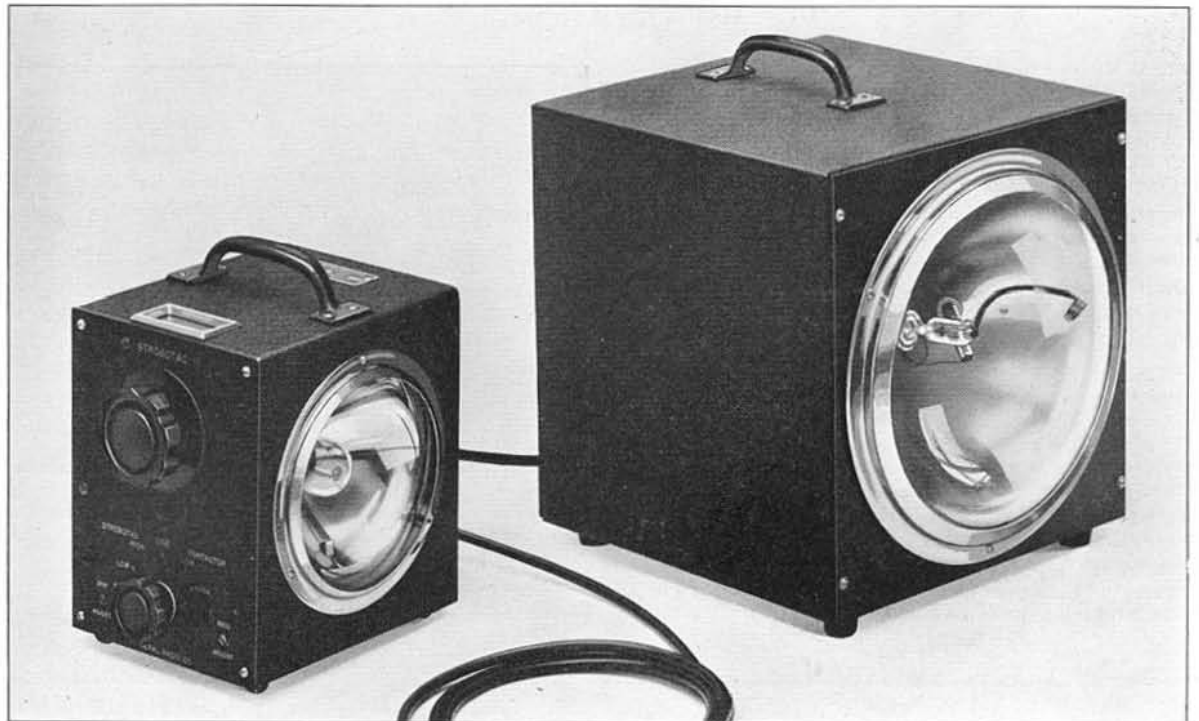

TYPE 631-B Strobotac with TYPE 648-A Strobolux.

TYPE 648-A STROBOLUX



TYPE 648-A Strobolux.

USES: The TYPE 648-A Strobolux extends the usefulness of the Strobotac to applications requiring considerably more light than the Strobotron lamp is capable of supplying. Specifically, it should be used where larger areas are to be illuminated or where greater light intensity is required.

It has been used in experimental work for

making high-speed single-flash photographic records of limited areas. It has also found some application as a light source in conjunction with a continuous-film recorder (see page 105).

DESCRIPTION: TYPE 648-A Strobolux consists of a power supply and lamp, capable of producing brilliant light flashes at speeds up to 6000 per minute. The flashing source is a TYPE 631-B Strobotac and consequently can be controlled by (1) the self-contained pulse generator in the Strobotac, (2) the a-c line, (3) an external contactor (TYPE 549), or (4) an external oscillator such as TYPE 913-B.

The lamp, filled with a rare gas, furnishes about one hundred times as much light as that of the Strobotac.

The entire assembly is housed in a metal cabinet with the lamp and its 9-inch reflector on one side. The lamp housing is removable from the case and is furnished with a 10-foot extension cable.

FEATURES: The combination of the TYPE 631-B Strobotac and TYPE 648-A Strobolux has all the advantages of the Strobotac itself plus the feature of high illumination. No appreciable duplication of facilities is involved, so that the purchase of the TYPE 648-A Strobolux is an economical solution to problems requiring greater illumination than is provided by the Strobotac.

SPECIFICATIONS

Range: Up to 100 flashes per second (6000 per minute). Single flashes for photography can also be obtained.

Duration of Flash: Between 15 and 50 microseconds, depending upon flashing speed and upon the setting of the SPEEDS range switch. The shorter flash is obtained at the higher speeds.

Accuracy: The accuracy is that of the source controlling the flashing speed. (See specifications for TYPE 631-B Strobotac, page 3.)

Power Supply: 105 to 125 volts, 50 to 60 cycles.

Power Input: 125 watts, maximum.

Vacuum Tube: One 5Z3 Rectifier and one TYPE 648-P1 Lamp, both of which are furnished with the instrument.

Mounting: The complete assembly is housed in a sheet metal case. The lamp and its 9-inch reflector are mounted on one side, the power supply on the other. The removable lamp assembly is provided with a $\frac{1}{4}$ x 20 tapped hole for tripod mounting.

Accessories Required: A Strobotac is necessary to operate the Strobolux.

Accessories Supplied: A power cable, a cable for connection to the Strobotac, an extension cable for the lamp, spare pilot lamps and fuses.

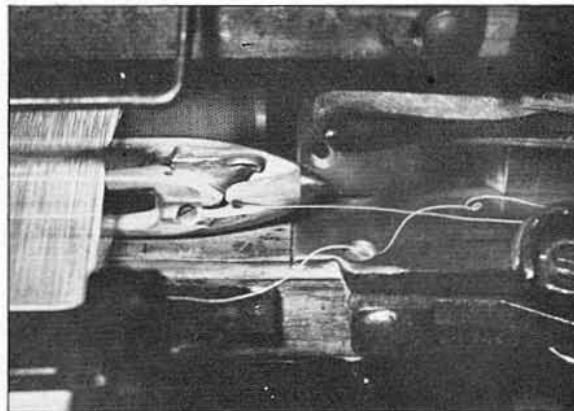

This unretouched single-flash photograph, taken with the Strobolux, shows a loom shuttle in motion.

Dimensions: 13 $\frac{3}{8}$ x 11 $\frac{5}{8}$ x 13 $\frac{1}{2}$ inches, over-all.

Net Weight: 31 $\frac{3}{4}$ pounds.

Type		Code Word	Price
648-A	Strobolux.....	SCALY	\$150.00
648-P1	Replacement Lamp.....	SURLY	15.00

PATENT NOTICE. See Note 15, page vi.

**TYPE 549-C SYNCHRONOUS-MOTOR CONTACTOR
TYPE 549-P2 HAND CONTACTOR**

USES: These contactors are intended for use with TYPE 631 Strobotac and TYPE 648 Strobolux as sources of accurately timed impulses for flashing. A plug-in cable is provided for connections between the contactor head and the Strobotac.

DESCRIPTION: The synchronous-motor contactor, TYPE 549-C, when driven from a 115-volt, 60-cycle line, is capable of flashing a TYPE 631-B Strobotac at any rate between 150 and 3600 flashes per minute. The contactor is driven by an 1800-rpm self-starting synchronous motor. Flashing rate adjustment is made by turning the fluted knob, which changes the ratio of the friction-drive mechanism. A calibrated scale gives the flashing rate in flashes per minute. Phase can be adjusted independently at the contactor head. Two ranges are provided, one covering speeds from 150 to 1300 rpm, the other from 700 to 3600 rpm. These are fundamental ranges; speeds which are multiples of them can, of course, be measured. Two discs and two scales are provided, and the change from one range to the other can be accomplished in a few minutes.

The contactor head can be removed and used independently as a hand contactor. A rubber driving tip is provided for this purpose.

The uncalibrated head, fitted with rubber tip so that it can be driven from a rotating shaft,

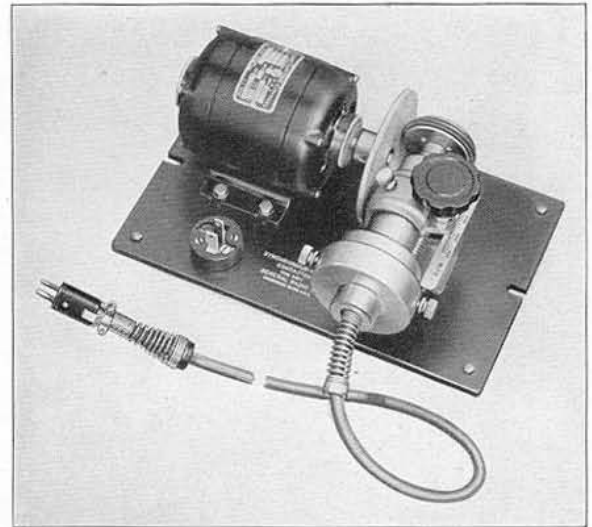

TYPE 549-C Synchronous-Motor-Driven Contactor.

is available separately as the TYPE 549-P2 Hand Contactor.

FEATURES: Accurately timed flashing rates as low as 150 per minute can be obtained. The phase of the flash, i.e., its time in the flashing cycle, can be adjusted. This makes it possible to arrest the motion of a mechanism at any point in its cycle of operation. In many stroboscopic investigations this feature is valuable.

SPECIFICATIONS

TYPE 549-C

Range of Flashing Speeds: 150 to 3600 flashes per minute, in two ranges.

Controls: One knob for adjusting speed and the movable contactor head for adjusting phase. Each is provided with

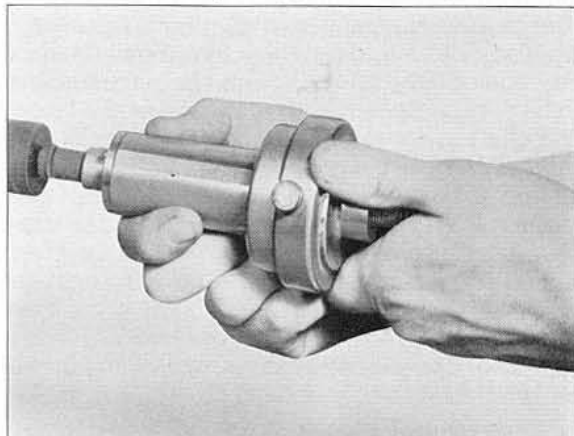

TYPE 549-P2 Hand Contactor.

a locking arrangement for holding it firmly in the desired position.

Accuracy: The accuracy is determined by the frequency stability of the power line and the amount of wear of the rubber rim on the driven wheels. When the wheels and scales are set correctly, the error will increase as either scale end is approached, and may be considered to be not greater than ± 50 rpm on the low, and ± 100 rpm on the high scales.

Power Supply: 105 to 125 volts, 60 cycles.

Power Input: 35 watts.

Mounting: Motor and contactor are mounted on an aluminum base. Changing from the high to the low speed range, and vice versa, necessitates changing the size and position of the driven disc. Two sets of mounting holes, two discs, and two scales are provided for this purpose.

Dimensions: (Length) $9\frac{3}{4}$ x (width) $6\frac{3}{4}$ x (height) $4\frac{3}{8}$ inches, over-all.

Net Weight: $10\frac{1}{2}$ pounds.

TYPE 549-P2

Dimensions: (Length) 7 x (diameter) $3\frac{1}{4}$ inches, over-all.

Cord: Connecting cord is furnished.

Net Weight: $2\frac{5}{8}$ pounds.

Type	Code Word	Price
549-C	MACAW	\$70.00
549-P2	MADAM	30.00
549-373	HYDRA	3.50
549-371	HYMEN	2.50

PATENT NOTICE. See Note 15, page vi.

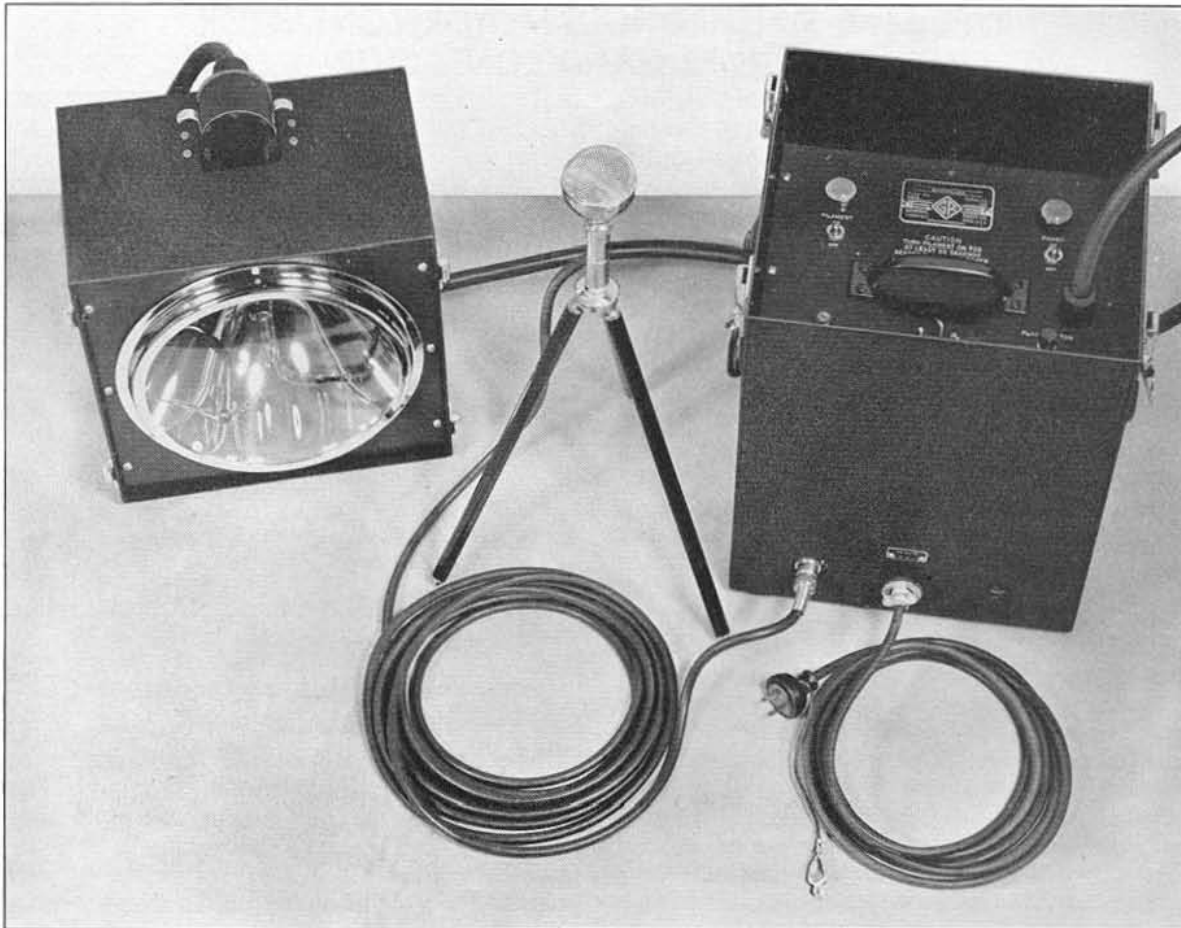

TYPE 1530-A MICROFLASH

USES: The Microflash is a light source for single-flash photography. It provides a high-intensity light flash whose duration is approximately 2 millionths of a second. Consequently, it is capable of arresting extremely rapid motion. Conventional camera equipment is quite satisfactory for use with the Microflash.

Photographs of bodies moving at extremely high speeds are possible with the Microflash, and it finds many applications in engineering and the physical sciences, particularly in such fields as ballistics, hydraulics, kinematics, and industrial chemistry.

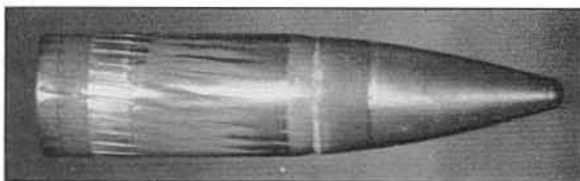

The Microflash was used as a light source in taking this photograph of a projectile in flight.

DESCRIPTION: The elements of the Microflash are a power supply, a gas-filled lamp, and a trigger circuit. The high-voltage transformer and rectifier, operating from the a-c power line, charge a condenser across the lamp terminals. An electrical impulse, which may be derived in any one of several ways from the phenomenon to be photographed, ionizes the gas in the lamp, and the energy stored in the condenser is dissipated in a discharge through the lamp, producing a short brilliant flash. A minimum of 10 seconds is required between flashes for the condenser to become fully charged.

The trigger circuit includes an amplifier, so that the flash can be tripped with a conventional crystal microphone, if desired. The flash can also be triggered by a make or break contact.

FEATURES: The outstanding feature of the Microflash is its high intensity and very short flash. During the flash, an object moving at 1000 feet per second would be displaced only one or two hundredths of an inch. Consequently, sharp records can be obtained of bullets and other projectiles in flight.

SPECIFICATIONS

Duration of Flash: Approximately 2 microseconds.

Temperature and Humidity Effects: Temperature and humidity variations (32 to 100° F, 0 to 95% R.H.) have no appreciable effect upon the operation of the instrument.

Power Supply: 105 to 125, 210 to 250 volts, 50 to 60 cycles.

Power Input: 70 watts.

Tubes:

- 1 — 5T4 (RCA)
- 1 — 2V3G(RCA)
- 1 — FG-17 (GE)
- 1 — 6AC7 (1852) RCA
- One 1530-P1 (General Radio)

Accessories Supplied: Microphone with cable; tripod; all tubes; spare pilot lamps and fuses; 2 spare flash lamps TYPE 1530-P1; plug for connection to contactor-trip jack.

Mounting: The power supply and trigger circuits are assembled in one metal case, the lamp in another. The two cases lock together for transportation, completely protecting the lamp and controls.

Dimensions: 24 1/8 x 13 1/4 x 11 3/4 inches, overall.

Net Weight: 72 pounds.

(Right) View of the Microflash assembled for transportation.

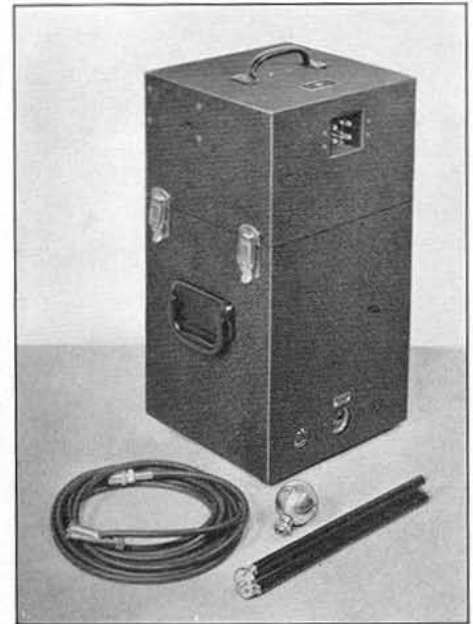

Type		Code Word	Price
1530-A	Microflash	TAFFY	\$525.00*
1530-P1	Replacement Flash Lamp	TONIC	15.00*

*Plus current Federal tax on photographic equipment.
 PATENT NOTICE. See Note 15, page vi.

TYPE 621 POWER STROBOSCOPE

The TYPE 621 Power Stroboscope supplies even greater light intensity per flash than does the TYPE 648-A Strobolux and is capable of being flashed at much higher speeds. It is particularly designed as a light source for the TYPE 651-A Recorder. With this combination, motion pictures can be taken at speeds up to 1500 exposures per second, permitting the study of high-speed transient or non-repetitive motion, turbulence and cavitation in fluid flow, and other industrial and research problems.

When the Power Stroboscope is used in ultra-high-speed photography, the flashing rate is commonly controlled by a commutator on the camera. In this way the individual exposures are accurately framed for projection at normal speeds.

When stroboscopic lighting of high intensity at a high flashing rate is desired, considerable power is required, since the power that must be supplied to the light is directly proportional to the desired intensity, as well as to the frequency of flashing. Thus, although the TYPE 648-A Strobolux furnishes a light intensity adequate for illuminating small areas or for single-flash photography, the maximum useful flashing rate is limited by the power supply to about 100 per second. For applications involving very high

flashing rates or for taking high-speed motion pictures, a stroboscope of considerable power capacity is required.

The power stroboscope is built to order only.
 Prices on request.

PATENT NOTICE. See Note 15, page vi.

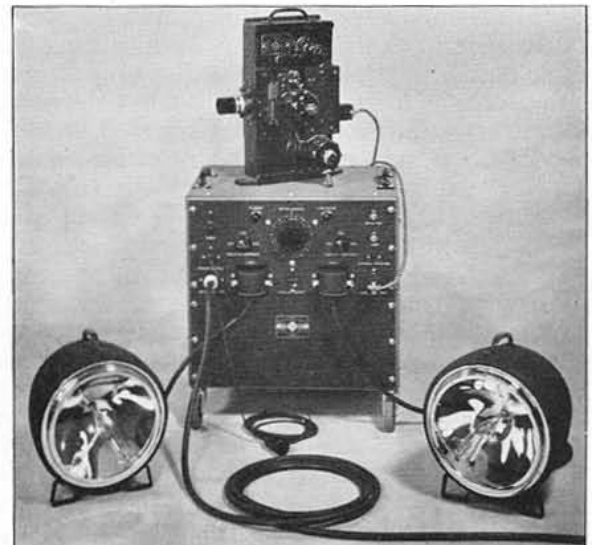

TYPE 759-B
SOUND-LEVEL
METER

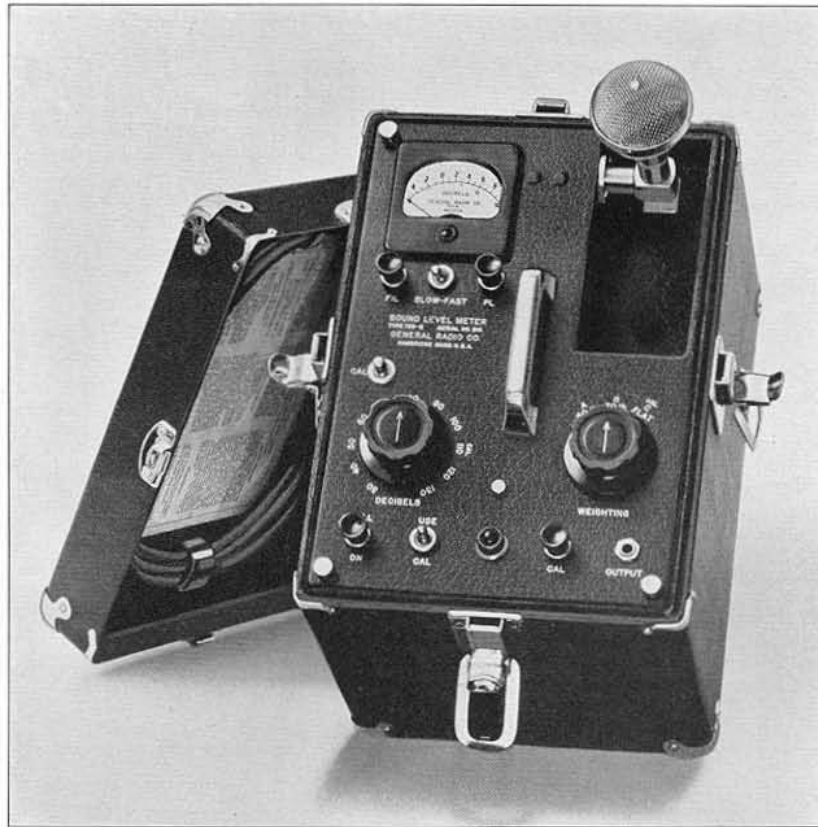

USES: The TYPE 759-B Sound-Level Meter is suitable for all types of commercial and industrial noise measurement. Manufacturers of machinery and appliances use it for measuring product noise both in the research laboratory and in production. Sound transmission and absorption and the acoustical properties of materials can also be measured with it. It meets equally well the requirements for noise measurement in surveys of the psychological and physiological effects of noise.

For the industrial plant, it provides a means of measuring product noise, setting up noise standards, accepting or rejecting products on the basis of noise tests, and, finally, analyzing and correcting trouble in the rejected units.

In this last use, as in many others, a frequency analysis of the noise is usually valuable. For this purpose, the TYPE 760-A Sound Analyzer (see page 11) has been designed.

The usefulness of the sound-level meter may be extended to include vibration measurements by substituting a vibration pickup (see page 10) for the microphone. The low-frequency response of the sound-level meter is sufficiently good to permit vibration measurements at frequencies down to 20 cycles. Such measurements include the fundamental and harmonic frequency vibrations of machines rotating at 1200 rpm or higher, as well as many structural resonances.

For vibration measurements below 20 cycles,

however, the TYPE 761-A Vibration Meter is recommended (see page 13).

DESCRIPTION: TYPE 759-B Sound-Level Meter is an accurate, portable, low priced meter for reading, in terms of a standard reference level, the sound level at its microphone.

The sound-level meter consists of a non-directional microphone, an amplifier, a calibrated attenuator, and an indicating meter. It is battery operated and completely self-contained.

An a-c power supply unit is also available (see page 10).

This sound-level meter complies with all the tentative standards for sound-level meters specified by the American Standards Association, the American Institute of Electrical Engineers, and the Acoustical Society of America.

All three frequency response characteristics recommended by the A.S.A. are included. In addition to the standard meter characteristic, a heavily damped movement, for reading rapidly fluctuating sounds, is provided.

FEATURES: The outstanding features of this instrument are its portability and ease of operation. Weighing a little over 20 pounds, and being completely self-contained (including the batteries or a-c power supply), the instrument is completely portable. It is so simple in operation that it can be used by non-technical personnel.

SPECIFICATIONS

Sound-Level Range: Calibrated in decibels from +24 db to 140 db above the standard reference level of 10^{-16} watts (a pressure of 0.0002 dynes) per square centimeter in a free, progressive wave at 1000 cycles.

Frequency Characteristics: The frequency characteristic of the sound-level meter is adjustable to follow three different curves. The first and second of these are, respectively, the 40 and 70 db equal-loudness contours in accordance with the tentative standard proposed by the American Standards Association. The third frequency response characteristic gives a substantially equal response to all frequencies within the range of the instrument. This characteristic is used when measuring extremely high sound levels or when using the instrument with TYPE 760-A Sound Analyzer.

Microphone: The microphone mounts on a folding bracket on top of the instrument and folds down into a recess in the panel when not in use. It can be removed from its mounting bracket for use with an extension cable and tripod (see price list).

The microphone is of the crystal, diaphragm, type with an essentially non-directional response characteristic. It is rugged and stable, and its sensitivity is substantially unaffected by ordinary changes in temperature and humidity.

The response of the microphone is essentially flat below 4000 cycles, and the absolute level (of the sound-level meter) is corrected in accordance with the ASA tentative standards to cancel out any minor microphone irregularities when sounds of average frequency distribution are being measured.

The absolute level of all microphones is checked at several frequencies against a standard microphone, whose calibration is periodically checked by the U. S. Bureau of Standards. In addition the impedance of the microphone is held to close tolerances.

Vibration Pickup: The TYPE 759-P35 Vibration Pickup with the TYPE 759-P36 Control Box can be used in place of the microphone (see next page).

Meter plus Attenuator: The sound level is read as the sum of the meter reading and the reading of a stepped attenuator. A single knob controls two attenuators furnishing a total of 100 db attenuation in steps of 10 db. The indicating meter is approximately linear in decibels, and its scale is open and easily read. It covers a 16 db range, thus providing a satisfactory overlap between the steps of the attenuator. A SLOW-FAST switch makes available two meter speeds. With the control switch in the FAST position the ballistic characteristics of the meter closely match those of the human ear and agree with tentative standards of the American Standards Association. In the SLOW position the meter is shunted by a large condenser. The resulting heavily damped movement is convenient for observing the average level of rapidly fluctuating sounds.

Calibration: A means is provided for standardizing the sensitivity of the instrument. Any a-c power line of ap-

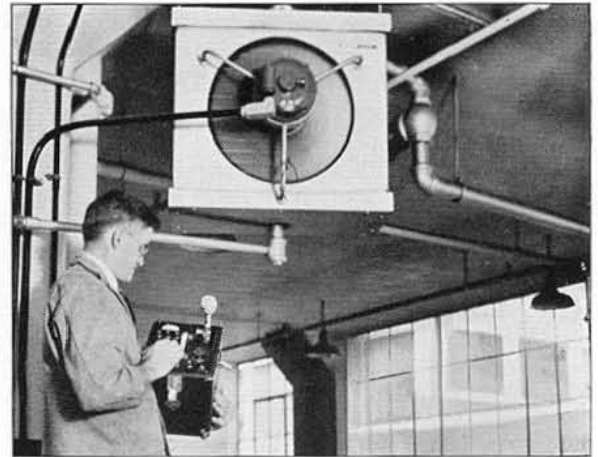

Measuring the noise from a ventilating fan with the sound-level meter.

proximately 115 volts can be used as a source of standardizing voltage. A seven-foot line-connector cord is furnished for this purpose and is stored in the cover of the carrying case.

Accuracy: The frequency response curves of the TYPE 759-B Sound-Level Meter fall within the tolerances specified by the ASA tentative standards. When the amplifier sensitivity is standardized the absolute accuracy of sound-level measurements is within ± 1 decibel for average machinery noises in accordance with the ASA standards.

Temperature and Humidity Effects: Readings are independent (within 1 db) of temperature and humidity over the ranges of room conditions normally encountered.

Extension Cable and Tripod: An extension cable and tripod (TYPE 759-P21) can be supplied for using the microphone at a distance from the sound-level meter. A correction curve is supplied, giving the cable correction as a function of temperature. This temperature correction is of importance only above 85° Fahrenheit.

Batteries: A single block battery (Burgess type 6TA60) is used and one is supplied with the instrument. The TYPE 759-P50 Power Supply is available if a-c operation is desired (see next page).

Tubes: Three type 1N5-GT and one type 1D8-GT are required. A complete set is supplied with the instrument.

Case: The sound-level meter is mounted in a shielded carrying case of durable airplane-luggage construction.

Dimensions: The over-all dimensions are approximately: (height) $11\frac{1}{2}$ x (length) $13\frac{1}{2}$ x (width) $9\frac{1}{2}$ inches.

Net Weight: $22\frac{1}{4}$ pounds, with battery; $17\frac{1}{4}$ pounds, without battery.

Type		Code Word	Price
759-B	Sound-Level Meter.....	NOMAD	\$195.00
759-P21	Replacement Battery for above.....	NOMADNUBAT	3.50
	Extension Cable (25 ft.) and Tripod.....	KIMBO	11.50

PATENT NOTICE. See Notes 1, 2, page vi.

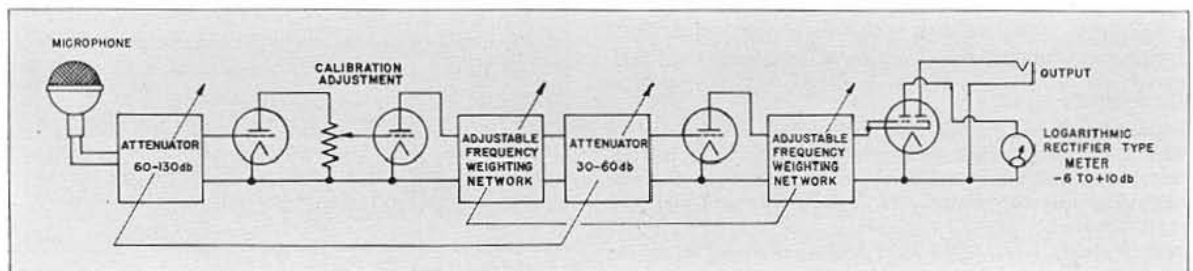

Functional block diagram of the TYPE 759-B Sound-Level Meter.

TYPE 759-P50 POWER SUPPLY

USES: The TYPE 759-P50 Power Supply has been designed for use with the TYPE 759 Sound-Level Meter where an a-c power line is available.

DESCRIPTION: This power supply is a light,

compact unit that fits into the battery compartment of the TYPE 759-B or TYPE 759-A Sound-Level Meter. A selenium rectifier provides the filament supply. A conventional rectifier and filter provide the plate supply.

SPECIFICATIONS

Output: 1.5 volts filament supply and 90-volt plate supply for TYPE 759-B Sound-Level Meter. Alternatively, a 3-volt filament supply is available for use with the older TYPE 759-A Sound-Level Meter.

Hum and Noise Level: Sufficiently low to assure satisfactory operation of the TYPE 759-B Sound-Level Meter, when the supply-line frequency is 60 cycles.

On the older TYPE 759-A Sound-Level Meter, operation at line frequencies below 60 cycles is generally possible, but is not recommended. At 60 cycles, satisfactory operation is obtained on all ranges except at the 30-db attenuator setting.

Input Voltage: 105 to 125 volts, 40 to 60 cycles.

Input Power: Less than 8 watts at 115 volts, 60 cycles.

Tube: One type 6H6 is supplied.

Terminals: An output socket fits the plug on the battery cable of the TYPE 759-B Sound-Level Meter.

Dimensions: (Length) 10 x (width) 2 1/4 x (depth) 5 inches.

Net Weight: 7 3/8 pounds.

Type	Code Word	Price
759-P50 A-C Power Supply . . .	NUTTY	\$55.00

VIBRATION PICKUP AND CONTROL BOX

The TYPE 759-P35 Pickup and TYPE 759-P36 Control Box have been designed for use with the TYPE 759-B Sound-Level Meter. To make vibration measurements with the sound-level meter it is merely necessary to replace the microphone by the control box and pickup (see TYPE 759-B, page 8).

The TYPE 759-P35 Vibration Pickup is an inertia-operated crystal device which generates a voltage proportional to the acceleration of the vibrating body. By means of integrating networks in the control box, voltages proportional to velocity and displacement can also be delivered to the sound-level meter. The desired response is selected by means of a three-point switch on the control box.

SPECIFICATIONS

Calibration: The db readings of the sound-level meter can be converted into absolute values of displacement, velocity, or acceleration by means of calibration figures supplied with each pickup and control box.

Range: The range of measurement of the pickup and control box when used with the TYPE 759-B Sound-Level Meter is approximately as follows:

Average Double Amplitude—100 micro-inches (minimum).

Average Velocity—1000 micro-inches per second (minimum). The upper limit of velocity and displacement measurements is dependent on the frequency and is determined by the maximum acceleration permissible before non-linearity occurs (10 g).

Average Acceleration—1000 micro-g to 10 g
g = 32.2 ft./sec./sec.

Frequency Characteristic: The over-all response is approximately flat up to 1000 cycles. A typical response curve is shown at the right.

Mounting: Both control box and pickup are housed in metal containers, finished in black lacquer. The control box plugs into the sound-level meter, and the pickup in turn plugs into the control box. A flexible cable 7 feet long is supplied.

Net Weight: TYPE 759-P35 Vibration Pickup, 8 ounces (pickup only); pickup plus cable and tips, 1 pound; TYPE 759-P36 Control Box, 1 pound, 6 ounces.

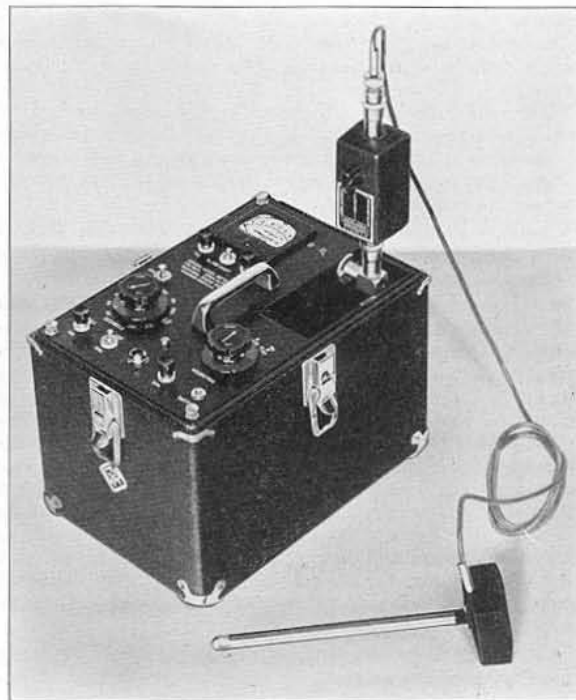

The vibration pickup and control box plug into the sound-level meter in place of the microphone, as shown here.

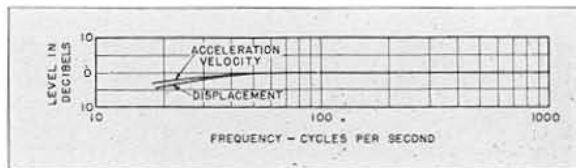

Over-all frequency response characteristic of the vibration pickup, control box, and sound-level meter.

Type	Code Word	Price
759-P35 Vibration Pickup	NOSEY	\$32.50
759-P36 Control Box	NANNY	30.00

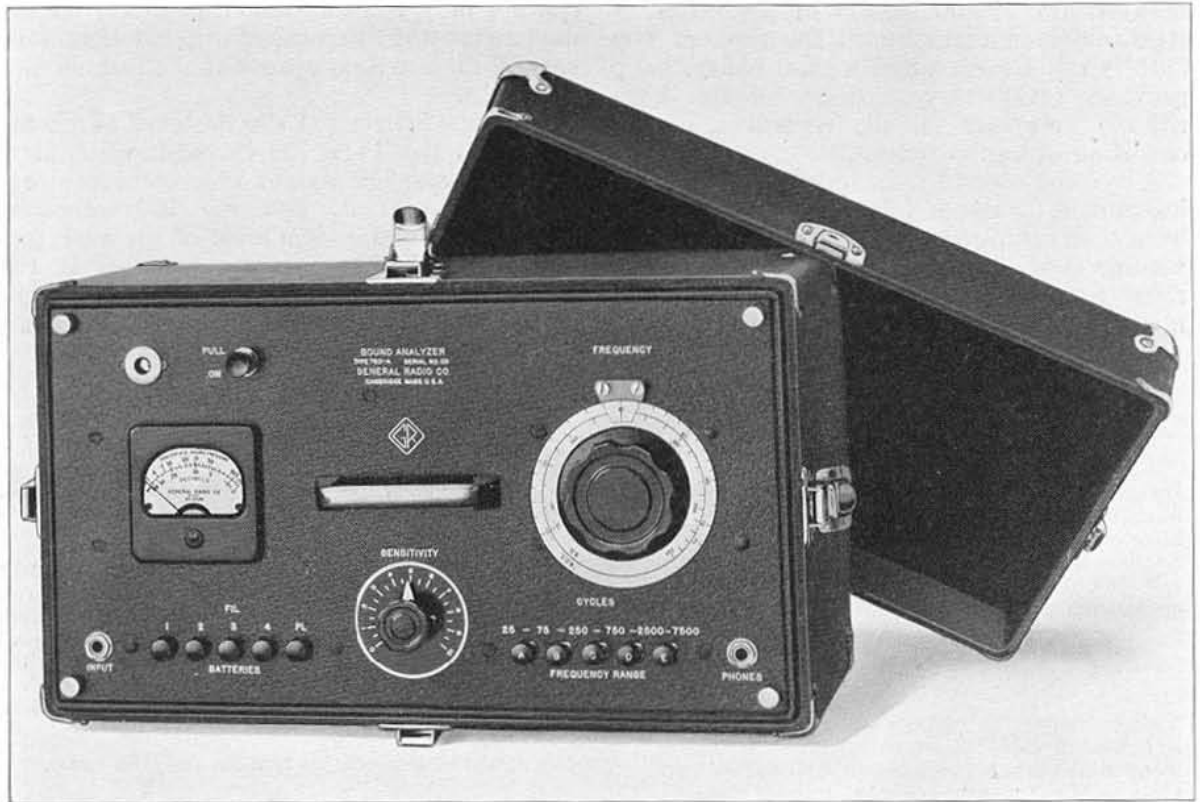

TYPE 760-A SOUND ANALYZER

USES: The TYPE 760-A Sound Analyzer has been designed particularly for analyzing machinery noises or noise levels caused mainly by electrical or mechanical equipment. The fact that the selectivity curve widens proportionally as the frequency is increased makes it suitable for measuring noises caused by machines that do not run at absolutely constant speed. The instrument is particularly well adapted for analyzing the sound made by automobile and airplane motors and industrial or household equipment.

Although designed for use with the TYPE 759 Sound-Level Meter, the analyzer is not necessarily restricted to this application. It may be used in conjunction with any microphone and amplifier combination that provides sufficient output voltage.

As a general laboratory instrument the TYPE 760-A Sound Analyzer can be used as a harmonic analyzer to measure components down to 1% of the fundamental. It is very useful as a bridge-balancing indicator, since it can be tuned to the bridge frequency, thus eliminating errors caused by harmonics. The logarithmic indicating meter is of particular advantage in this application.

Another important use is the analysis of vibrations in conjunction with the TYPE 761-A

Vibration Meter or with the TYPE 759-B Sound-Level Meter and vibration pickup.

DESCRIPTION: The TYPE 760-A Sound Analyzer consists of a selective amplifier, operating on the degeneration principle and having a constant percentage band width, combined with a vacuum-tube voltmeter having approximately logarithmic characteristics over a wide range.

The principles on which the analyzer operates are shown in the functional diagram on the next page.

The instrument was designed particularly for use with the TYPE 759 Sound-Level Meter, and this combination provides an accurate and convenient means for measuring not only the actual level of sound, but also the relative amplitudes of the component frequencies.

FEATURES: In the development of this analyzer, simplicity and convenience of operation were considered of primary importance. The frequency calibration is read directly on a large dial, which can be rotated continuously to cover the entire frequency range of the instrument with a minimum of effort. A push-button switch operates the multipliers, so that it is a simple matter to scan quickly the entire frequency range of the analyzer or to change the tuning

between two remote points in the range. A stabilized circuit eliminates the need of any battery adjustments, and a neon ballast lamp provides satisfactory accuracy of the logarithmic voltmeter circuit, regardless of the condition of the batteries.

A volume control is included to adjust the instrument for use at various input levels, but, in actual operation, no meter multipliers or volume controls are used since the complete range may be read on the single logarithmic meter scale.

The selective circuits used in this analyzer

contain only resistors and capacitors; no inductors are used. Because of this, external magnetic fields have no appreciable effect on the operation.

Since the instrument was designed as a companion to the TYPE 759 Sound-Level Meter, small size and low weight were considered extremely important, and the instrument is smaller and lighter than most of the analyzers which have been used for noise work in the past. The complete instrument is mounted in an airplane-luggage type of case matching that of the sound-level meter in appearance.

SPECIFICATIONS

Frequency Range: Calibrated directly in cycles per second from 25 to 7500. This total range is covered in five complete turns of the tuning knob, the ranges on the various dial rotations being 25 to 75, 75 to 250, 250 to 750, 750 to 2500, and 2500 to 7500 cycles. A push-button switch allows immediate change of the main control to any of these ranges.

Frequency Calibration: The accuracy of frequency calibration is $\pm 1\frac{1}{2}\%$ of the frequency to which the dial is set or $\pm 1\frac{1}{2}$ cycles per second, whichever is the larger.

Voltage Range: The analyzer will give usable indications on input voltages ranging from 1 millivolt to 10 volts. The meter scale is calibrated for reading directly component tones down to 1% of the sound pressure (or voltage) of the fundamental or loudest component. Accordingly, to make full use of this feature, the input voltage at the loudest component or fundamental should be 0.1 volt or higher.

Input Impedance: The input impedance is between 20,000 and 30,000 ohms, depending upon the setting of the sensitivity control. A 3- μ f blocking condenser is in series with the input.

Frequency Response: The response is flat within ± 2 db over the entire range. At points where two ranges overlap, the sensitivity is the same on either range, within ± 1 db.

Band Width: The average selectivity is such that the relative attenuation is 3 db at 1% off the peak to which the analyzer is tuned.

Temperature and Humidity Effects: Under very severe conditions of temperature and humidity only slight, and generally negligible, shifts in calibration, sensitivity, and band width will occur.

Circuit: The circuit consists of a three-stage amplifier made selective by the use of degeneration, and an approximately logarithmic vacuum-tube voltmeter circuit, which allows a range slightly in excess of 40 decibels, or 100 to 1, to be read on the meter scale.

Meter: The indicating meter is calibrated down to 1% of the fundamental or loudest component of the sound. A decibel scale is also included, extending to 40 decibels below the fundamental or loudest component.

Telephones: A jack is provided on the panel for plugging in a pair of head telephones, in order to listen to the actual component of the sound to which the instrument is tuned. This is also useful when using the analyzer as a bridge-balance indicator.

Tubes: Three 1H4-G and one 1F7-GV tubes are required. A neon regulator tube (type T-4 $\frac{1}{2}$) is also used. A complete set of tubes is supplied with the instrument.

Batteries: The batteries required are four Burgess No. F2BP 3-volt batteries, or the equivalent, and three Burgess No. Z30N 45-volt batteries, or the equivalent. A compartment is provided in the case of the analyzer for holding all batteries, and connections are automatically made to the batteries when the cover of this compartment is closed. A set of batteries is included in the price of the instrument.

Accessories Supplied: A shielded cable-and-plug assembly for connecting the analyzer to the sound-level meter.

Case: The analyzer is built into a shielded carrying case of airplane-luggage construction. In addition to the handle on the carrying case, a handle is provided on the panel of the instrument for convenience in moving the instrument about while it is in operation.

Dimensions: (Length) 18 x (width) 10 x (height) 11 $\frac{1}{2}$ inches, over-all.

Net Weight: 34 pounds, with batteries; 27 $\frac{1}{4}$ pounds, without batteries.

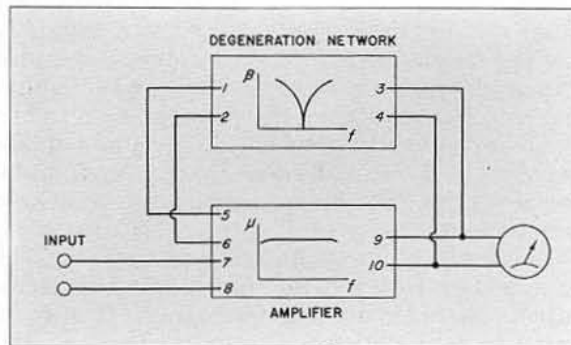

A functional diagram of the general type of circuit used in TYPE 760-A Sound Analyzer. The system consists of an amplifier with a propagation constant μ and a feedback network with a propagation constant β having the frequency characteristics shown above. The degeneration network is highly selective, and at its null point the normal gain of the amplifier is obtained. At lower and higher frequencies, degeneration occurs, and the gain of the amplifier is greatly reduced.

Type	Code Word	Price
760-A Sound Analyzer.....	ATTAR	\$260.00
Set of Replacement Batteries for Above.....	ATTARADBAT	7.10

PATENT NOTICE. See Notes 1, 24, page vi.

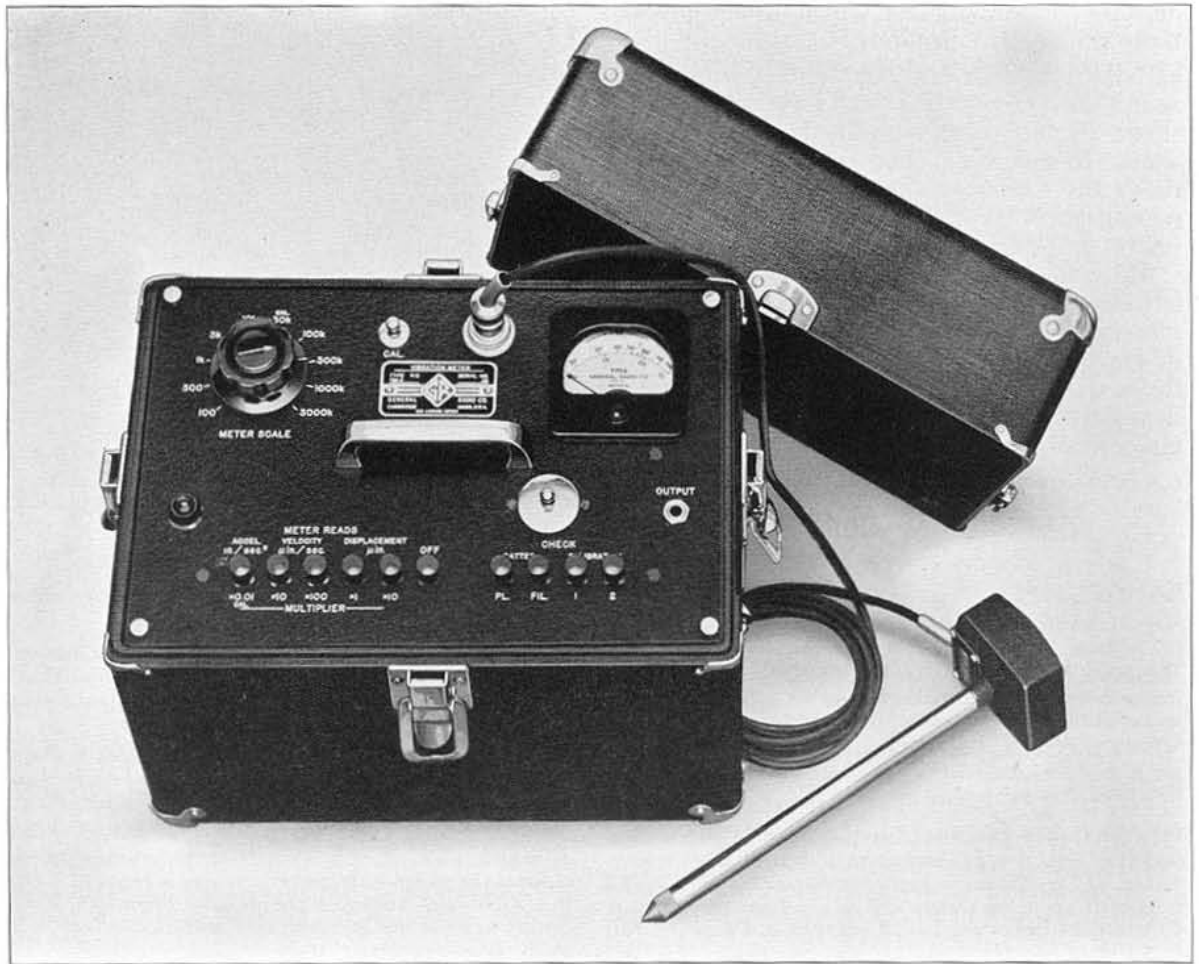

TYPE 761-A VIBRATION METER

USES: With the TYPE 761-A Vibration Meter measurements of the vibratory characteristics of machines and structures can be made quickly and easily. The excellent low-frequency response of this instrument makes possible the measurements of vibrations at frequencies as low as two cycles per second. This permits the study of the operation of belt drives and of the effectiveness of mountings designed to reduce vibrations in adjacent structures.

For the manufacturer of machinery and equipment, the TYPE 761-A Vibration Meter is extremely useful in research, design, and production testing. Maintenance engineers will find the instrument useful for checking the operating condition of bearings, gear trains, and other mechanisms. With this instrument excessive vibrations due to improper adjustment or design and to structural resonances may be located and measured.

DESCRIPTION: The TYPE 761-A Vibration Meter consists essentially of a vibration pickup, an adjustable attenuator, an amplifier, and a direct-reading indicating meter. The pickup is of the inertia-operated crystal type which delivers a voltage proportional to the acceleration of the vibratory motion. An integrating network converts this output, when desired, to a voltage proportional to velocity or displacement. The type of response is selected by push-button switches. Thus the acceleration, velocity, and displacement of a vibrating body may be measured independently.

Calibrations are made in terms of r-m-s values. The basic units in which the instrument is calibrated, inches and seconds, are the simplest and least confusing of those commonly used. Acceleration is read directly in terms of inches per second per second, velocity in micro-inches per second, and displacement in micro-

inches. Calibrations are made on a motor-driven precision vibrator, which produces essentially sinusoidal vibrations.

FEATURES: Like the sound-level meter and sound analyzer this new vibration meter is small, portable, self-contained, and extremely simple in operation. The instrument reads directly the absolute value of the quantity under measurement so that no reference to calibration figures is necessary.

The inclusion of three response characteristics—namely, acceleration, velocity, and displacement—and the extension of the range down to 2 cycles per second with substantially flat response characteristics provide a degree of flexibility hitherto unapproached in commercially available vibration-measuring apparatus.

(Right) Over-all frequency characteristics of the vibration meter, including the vibration pickup.

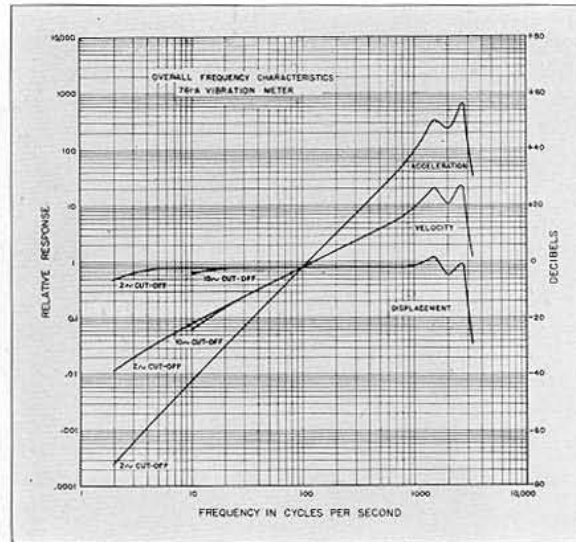

SPECIFICATIONS

RANGES:

Vibration Displacement: Calibrated directly in r-m-s micro-inches from 16 micro-inches to 30 inches.

Vibration Velocity: Calibrated directly in r-m-s micro-inches per second from 160 micro-inches per second to 300 inches per second.

Vibration Acceleration: Calibrated directly in r-m-s inches per second per second from .160 inch per second per second to 3900 inches per second per second.

PICKUP UNIT: The vibration pickup is of the inertia-operated crystal type, housed in a cast aluminum container. The maximum vibration acceleration which can be impressed upon the pickup before non-linearity occurs is 10 g or 3900 inches per second per second. Point and ball tips and an 8-inch extension rod are supplied.

RESPONSE CHARACTERISTICS:

Acceleration Characteristic: The over-all response of the vibration pickup and vibration meter for acceleration measurements follows a theoretical curve of acceleration vs. frequency within $\pm 10\%$ from 4 to 500 cycles per second. Below 4 cycles per second the sensitivity drops gradually, so that at 2 cycles per second it is down approximately 25%.

Velocity Characteristic: The over-all response of the vibration pickup and vibration meter for velocity measurements between 1600 micro-inches per second and 300 inches per second follows a theoretical curve of velocity vs. frequency within $\pm 10\%$ from 5 to 500 cycles per second. Below 5 cycles per second the sensitivity drops gradually, so that at 2 cycles per second it is down approximately 40%. For velocity measurements below 1600 micro-inches per second the response is within $\pm 15\%$ from 20 to 500 cycles per second, and drops off approximately 25% at 10 cycles per second.

Displacement Characteristic: The over-all response of the vibration pickup and vibration meter for displacement measurements between 160 micro-inches and 30 inches is flat within $\pm 10\%$ from 10 to 500 cycles per second. Below 5 cycles per second the sensitivity drops off, so that at 2 cycles per second it is down approximately 50%. For measurements below 160 micro-inches the response is flat

within $\pm 10\%$ to 20 cycles per second and drops off approximately 25% at 10 cycles per second.

Higher Frequencies: Above 500 cycles the error increases and may possibly reach $\pm 30\%$ at 1000 cycles. This is caused by the differences in response of individual pickups near resonance.

Meter: The indicating meter has a scale which reads directly in the quantity being measured—r-m-s micro-inches for displacement, r-m-s micro-inches per second for velocity, and r-m-s inches per second per second for acceleration.

Attenuators: A 10-step attenuator is provided which changes the meter scale calibration over a range of 30,000 to 1. Additional multipliers are provided which indicate the correct units of measurement and multiplying factors for each response characteristic.

Calibration: A calibrating circuit is provided in the instrument which, by connection to any a-c power line, makes it possible to check the over-all calibration of the vibration meter, excluding the vibration pickup. A seven-foot line connector cord is provided for this purpose.

Telephones: A jack is provided on the panel for plugging in a pair of head telephones in order to listen to the vibrations being measured, for connecting the TYPE 760-A Sound Analyzer, or for connecting a cathode-ray oscilloscope. Practically any load impedance can be impressed across this output telephone jack without affecting the reading of the meter.

Tubes: Three 1N5-GT tubes and one 1D8-GT tube are required. A complete set of tubes is supplied.

Batteries: A single battery unit, Burgess type 6TA60, which supplies the necessary plate and filament voltages, is included.

Case: The unit is built into a shielded carrying case of airplane-luggage construction, covered with durable black waterproof material, and equipped with chromium-plated corners, clasps, etc.

Dimensions: The over-all dimensions are approximately: (height) 12 1/2 inches x (length) 13 1/2 inches x (width) 9 1/2 inches.

Net Weight: Approximately 21 pounds with battery.

Type	Code Word	Price
761-A	VIRUS	\$260.00
Vibration Meter	VIRUSADBAT	3.50
Replacement Battery for Above		

PATENT NOTICE. See Note 1, page vi.

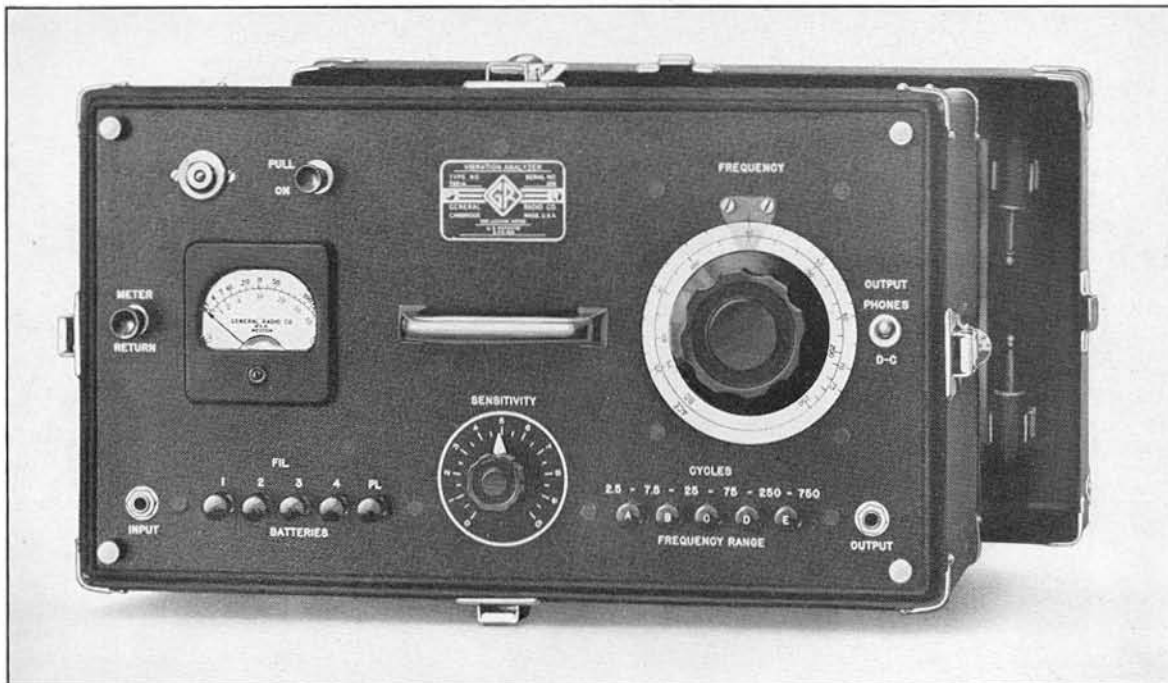

TYPE 762-B VIBRATION ANALYZER*

USES: The TYPE 762-B Vibration Analyzer makes possible the analysis of vibration phenomena having fundamental frequencies as low as 2.5 cycles per second. It is intended primarily for use with the TYPE 761-A Vibration Meter but can also be used with other pickup and amplifier combinations that provide sufficient voltage to give useful deflections. It can also be used for general harmonic analysis of low audio- and sub-audible-frequency voltages in the laboratory.

The frequency range covered (2.5 cycles to 750 cycles) includes practically all frequencies normally encountered in vibration studies, from the fundamental vibrations of ships and other

large structures to the unbalance vibrations of high-speed centrifuges.

DESCRIPTION: This analyzer is similar in all essential characteristics of performance, construction, operation, and appearance to the TYPE 760-A Sound Analyzer (page 11) except that the frequency has been lowered by a factor of 10 and provision has been made for operation with broad selectivity if desired. The latter arrangement is particularly useful in identifying components in the two lowest frequency ranges (2.5 to 25 cycles per second) and in making analyses involving components that vary slightly about a mean frequency.

SPECIFICATIONS

Frequency Range: 2.5 to 750 cycles, covered in five ranges as follows: 2.5 to 7.5, 7.5 to 25, 25 to 75, 75 to 250, 250 to 750.
Band Width: For the sharp selectivity position, the relative attenuation is approximately 30% (3 db) at a frequency differing by 1% from that to which the analyzer is tuned. For the broad selectivity position, the attenuation is 30% for a frequency difference of 5%. At one octave from the peak, the relative attenuations are 98% (35 db) and 90% (20 db), respectively.
Frequency Calibration: The accuracy of frequency calibration of the sharp selectivity network is $\pm 1\frac{1}{2}\%$ or $\pm 1\frac{1}{2}$ cycles, whichever is the larger, over the three highest

ranges (25 to 750 cycles); on the two lower ranges (2.5 to 25 cycles), the accuracy is $\pm 5\%$ or ± 0.2 cycle, whichever is the larger. The frequency as determined with the broad selectivity network deviates on the average by less than $\pm 2\%$ from that determined with the sharp selectivity network.

Frequency Response: The response of the sharp selectivity network is flat within ± 2 db over the entire range. At points where two ranges overlap, the sensitivity is the same on either range within ± 1 db. The sensitivity of the broad selectivity network is the same as that of the sharp selectivity network to within ± 2 db.

For other specifications see TYPE 760-A, page 11.

Type	Code Word	Price
762-B	Vibration Analyzer.....	AWARD \$275.00

PATENT NOTICE: See Notes 1, 24, page vi.
 *Photograph shows earlier model, TYPE 762-A.

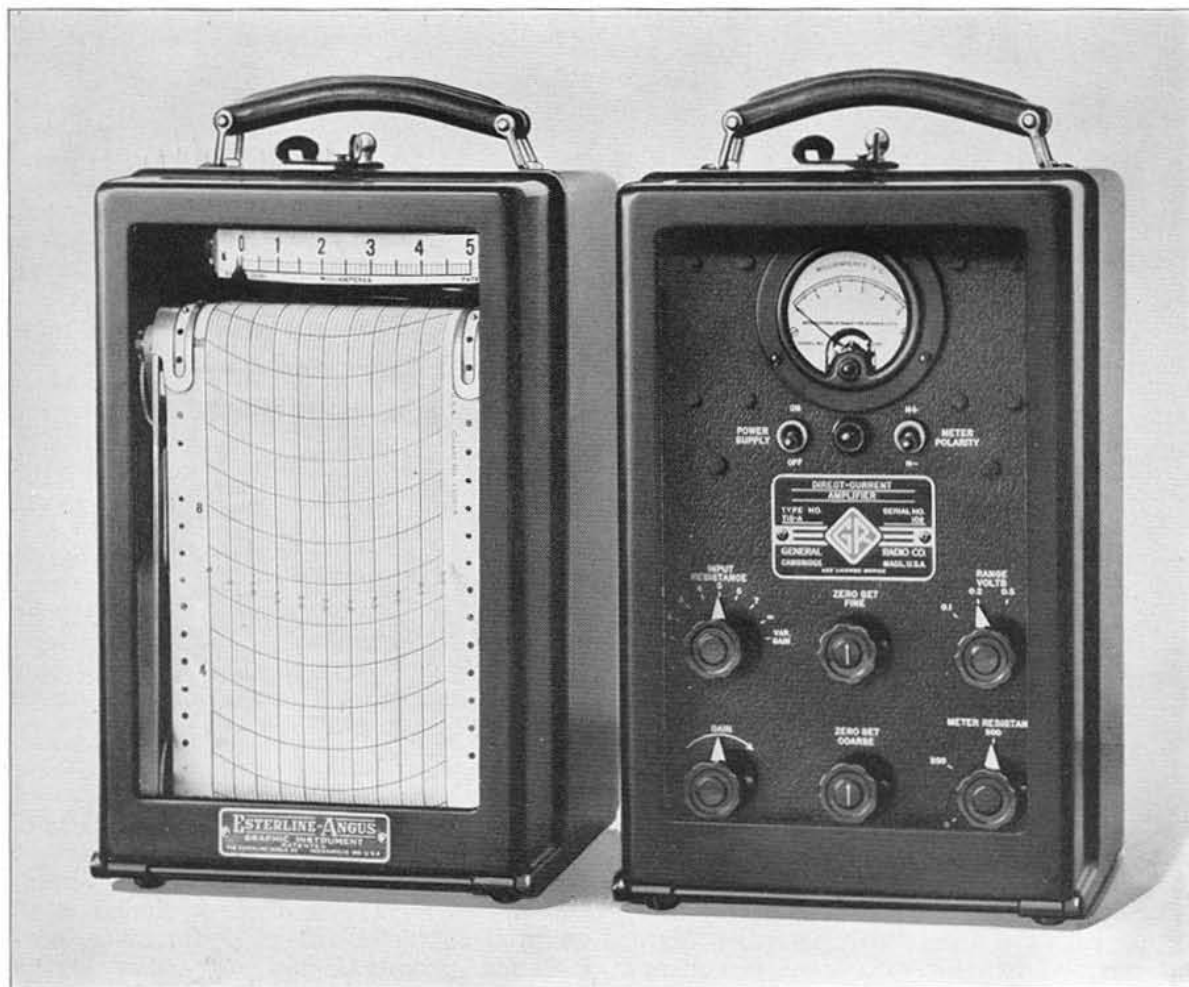

The TYPE 715-AE Direct-Current Amplifier with a 5-Ma Recorder.

TYPE 715-A DIRECT-CURRENT AMPLIFIER

USES: The TYPE 715-A Direct-Current Amplifier is designed primarily for use with the Esterline-Angus 5-milliamper recorder. This combination of amplifier and recorder is capable of accurately recording small d-c voltages and currents. In addition to its obvious use as a recording d-c milliammeter or millivoltmeter, it has a number of applications in process control and in measurements in physical and chemical laboratories.

Since the introduction of this amplifier, it has found application to a wide variety of industrial and research problems. It has been used for the recording of frequency and for recording the modulation level of broadcast transmitters. Other applications include the recording of the insulation resistance of electrical machinery during dehydration, the measurement of the emf of electro-chemical cells, and the recording

of sound and vibration intensities. The instrument may equally well be used to operate from photoelectric cells, resistance strain gauges, resistance thermometers, and similar devices.

DESCRIPTION: The amplifier is a highly stable a-c operated instrument, and gives full-scale output over a range of input voltages from 0.1 volt to 1.0 volt. Means are provided for selecting input resistances between 100 ohms and 10 megohms.

The circuit employs one type 6F6-G and two type 6J7-G tubes for the amplifiers in a degenerative circuit arrangement giving high stability of calibration. A bridge-type balancing network using a voltage regulator tube provides for balancing out the steady plate current in the meter, so that the meter indicates current change. Both fine and coarse zero adjustments

are provided for setting the meter for normal zero. The circuit is unaffected by changes in plate voltage caused by normal variations in a-c supply voltage.

In the design of a direct-current amplifier the most critical point is the temperature of the cathode of the first amplifier. Very effective means have been provided for overcoming any variations in temperature of this cathode. A regulating transformer and a filament ballast lamp are employed. This system maintains the heater voltage constant for line voltage changes from 100 to 130 volts.

FEATURES: Particular care has been taken in the design and construction of this new instrument to combine, with high gain and simplicity of operation, stability of calibration with freedom from effects of ambient temperature and line voltage variations—features which for so long prevented the development of the d-c amplifier as a commercial instrument.

Operation from the a-c power line, convenient size and mounting, and a wide range of input voltage and resistance combinations make this amplifier a convenient and reliable adjunct to the graphic recorder.

SPECIFICATIONS

Range: The instrument is provided with four calibrated ranges, selected by means of a switch, giving 5 milliamperes linear output in the recorder circuit of 1000 ohms, for input voltages of 0.1, 0.2, 0.5, and 1.0 volt applied at the input terminals with either polarity. The gain is best expressed as a transconductance; the maximum value is 50,000 micromhos.

Accuracy: As a calibrated voltmeter, the accuracy of calibration is approximately 1% of full scale, this accuracy being maintained over considerable periods of time.

Input Circuit: Means are provided for selecting any one of a number of input resistances, so that the instrument not only has an adjustable input resistance, but can serve as a calibrated millivoltmeter or microammeter. The input resistances range in powers of 10 from 100 ohms to 10 megohms. Short-circuit and open-circuit positions are also supplied on the selector switch.

For those applications where relative values only are of interest and where the voltage available exceeds 1 volt, one of the switch positions connects the input to a variable gain control, so that the voltage applied to the first grid can be adjusted to any desired value. The input resistance for this position is 150,000 ohms approximately.

Grid Current: The grid current in the input circuit is less than .002 microampere.

Output: The output circuit is designed to operate a 5-milliamper meter mounted on the panel and an external meter or device such as the Esterline-Angus 5-milliamper recorder, and is provided with a manually adjusted compensating resistance. The compensating resistance is adjusted to allow for the resistance of the external device, so that the instrument always works into a normal resistance of 1000 ohms. Although the instrument functions perfectly when operating into resistances from 0 to 2000 ohms, its calibration is affected slightly if the total impedance deviates materially from the 1000-ohm value.

Temperature and Humidity Effects: Over the range of room conditions normally encountered (65° Fahrenheit to 95° Fahrenheit; 0 to 95% relative humidity), the operation and stability are independent of ambient conditions.

Power Supply: The instrument is intended for operation directly from 105 to 125 or 210 to 250 volts, 60 cycles. Other voltages or other frequencies can be supplied on special order only.

Power Input: The power drawn from the 60-cycle mains is approximately 35 watts. No batteries of any kind are employed.

Vacuum Tubes: The tubes furnished with the instrument are: two type 6J7-G, one 6F6-G, one 6X5-G, one VR-105-30, one 4A1.

Mounting: The amplifier is mounted in a cast metal case identical with that used on the Esterline-Angus recorder, or in walnut cabinet, as desired.

Accessories Supplied: Seven-foot line connector cord, spare pilot lamps and fuses, and two TYPE 274-M Plugs.

Dimensions: TYPE 715-AM, (height) 15 1/4 x (width) 9 x (length) 8 1/2 inches, over-all; TYPE 715-AE, (height) 15 x (width) 8 1/2 x (length) 8 3/4 inches, over-all.

Net Weight: With Esterline-Angus case, 25 3/4 pounds; with walnut cabinet, 22 1/4 pounds.

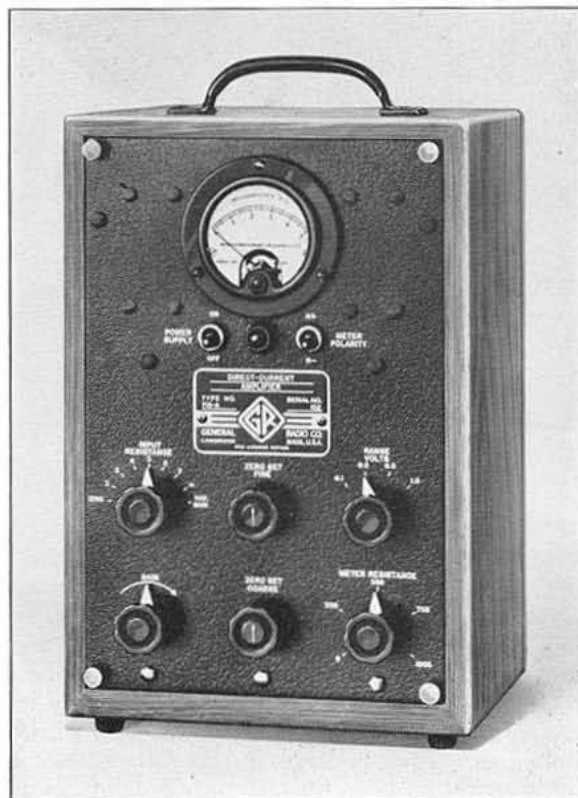

The TYPE 715-AM Direct-Current Amplifier.

Type	Code Word	Price
715-AE		
715-AM		
In Cast Metal Case.....		DISCONTINUED
In Walnut Cabinet.....	ALOFT	\$225.00

PATENT NOTICE. See Note 1, page vi.

VARIAC*

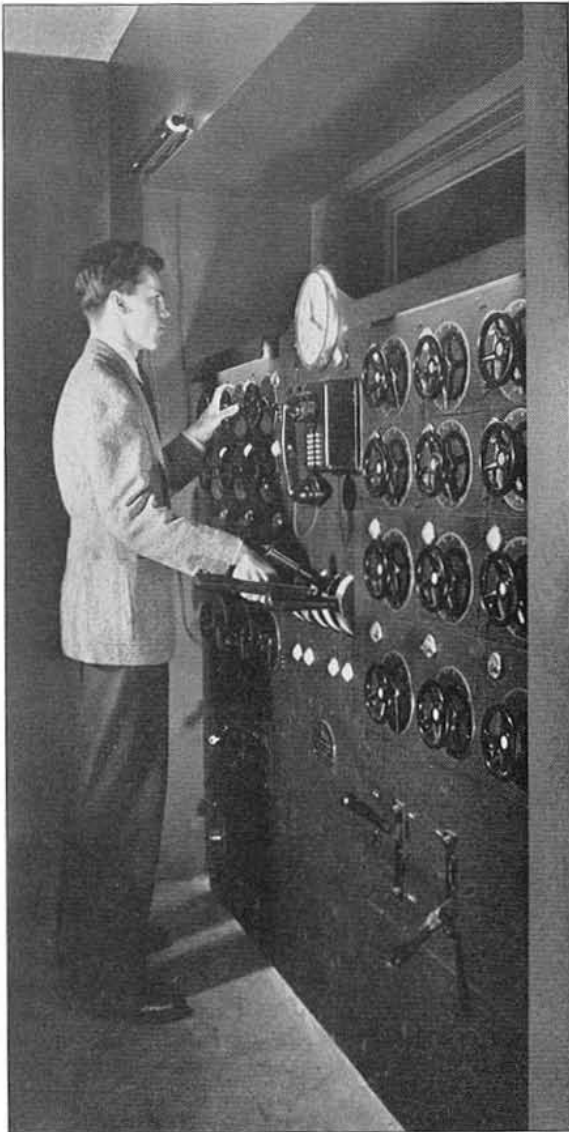

VARIACS in a theater lighting control panel at Allegheny College.

USES: The VARIAC is a voltage control that finds applications in shop and laboratory wherever a-c voltage must be adjusted smoothly and continuously. Thousands are in use for motor speed control; for heat control on electric ovens and furnaces; for illumination control in auditoriums, photographic studios, and dark-rooms; as voltage controls in laboratory testing and research; and as output voltage controls in transformer-rectifier systems.

Although designed primarily for use at ordinary power frequencies, VARIACS are equally useful as voltage controls in power circuits operating at higher frequencies.

*Reg. U. S. Pat. Office.

In the testing and calibration of voltmeters, ammeters, wattmeters, and power-factor meters, the VARIAC is a convenient source of adjustable voltage, and, by using combinations of VARIACS, the phase of the test voltage can be varied, as well as the amplitude.

Two and three-gang assemblies of VARIACS are available for use on three-phase systems. With the largest units, volt-ampere loads up to 17.5 kva can be controlled in this way. Although VARIACS are built for 115 and 230-volt service, they can be used on circuits of higher or lower voltage in conjunction with fixed-ratio auxiliary transformers and auto-transformers.

DESCRIPTION: The VARIAC is a continuously variable autotransformer supplying an output voltage from zero to *above* line voltage. It consists of a single-layer winding on a toroidal iron core. As the dial is rotated a carbon-brush contact traverses the winding, "tapping off" a portion of the total voltage across the winding. The brush is always in contact with the winding, and the voltage between turns is always less than 1 volt, even in the largest models, while in the smallest model it is only about 0.2 volt. The actual increments of voltage obtained as the dial is turned are always less than the voltage between turns, the action of the carbon brush being such that the change in voltage is practically continuous. The resistance of the brush is so chosen that no excessive heating can occur in the short-circuited turn.

FEATURES: Compared to resistive methods of voltage control, the VARIAC has the advantages of high efficiency, smooth control, good voltage regulation, and comparatively small size. Because the output voltage is essentially independent of load, a linear variation of voltage is obtained. VARIACS also furnish output voltages above line voltage, making it possible to compensate for under-voltage lines.

Functional diagram of the VARIAC.

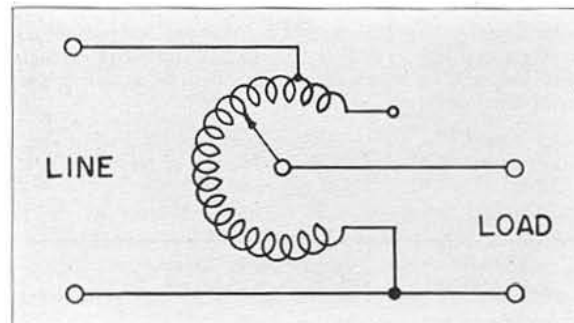

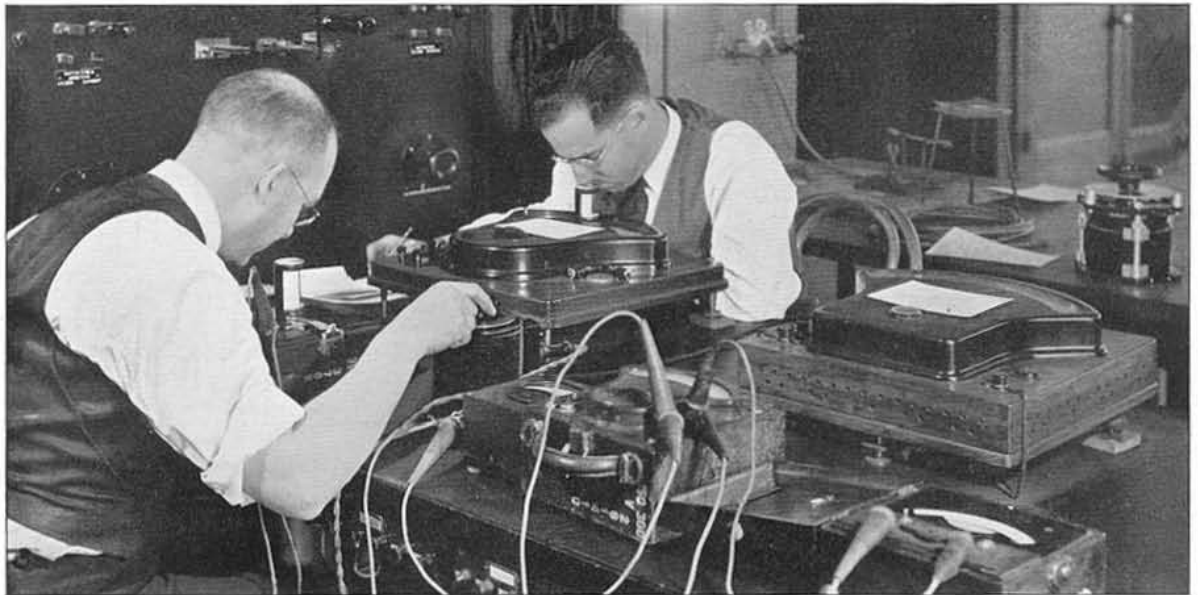

Standardizing meters with the aid of VARIACS in the laboratory of a public utility company.

GENERAL SPECIFICATIONS

Models ranging in capacity from 170 va to 7 kva are listed on the next page. Specifications are for 50 to 60-cycle service.

Rated Current can be drawn from the VARIAC at any dial position. It is limited by heat loss in the winding.

Maximum Current can be drawn at low voltages or at voltages near the input voltage. It is limited by losses in the carbon brush. Currents up to 150% of this value can be drawn for brief periods without damage to the VARIAC.

Input Voltage is the voltage that should be applied to the input terminals to make the dial calibration correct. All 230-volt VARIACS have center-taps for use on 115-volt lines. When so used, the rated current is reduced by a factor of 2, and the regulation is not quite as good as with a 230-volt input.

Output Voltage is the range of voltage available at the output terminals, with rated voltage applied to the input terminals.

Load Rating is the maximum output current multiplied by input voltage. A VARIAC can handle, at any lower setting, a constant impedance load which draws at input voltage a current no greater than the "maximum current."

Temperature Rise: The ratings of VARIACS are based on a temperature rise of 50° Centigrade, or less, at 60 cycles.

No Load Loss is measured at 60 cycles with rated input voltage. The values quoted in the table are the guaranteed maxima.

Driving Torque is the torque required to turn the VARIAC shaft.

Terminals: TYPE 200-B and TYPE 100 models are equipped with threaded terminal studs and soldering lugs. TYPE 200-CU and TYPE 200-CUH have soldering lugs only. TYPE 50 units have special self-locking terminals and provision for attaching BX cable.

Panel Thickness is the maximum thickness of panel on which the VARIAC can be mounted, with the shaft supplied.

Dial: A reversible dial, direct reading in output voltage, is provided on all models. One side of the dial is used when the VARIAC is connected to give a maximum output voltage equal to the line voltage; the other side is used when the over-voltage connection of the VARIAC is used. The total angle of rotation of the dial is about 320°.

Mounting: All models except the TYPES 200-B, 200-CU, and 200-CUH are provided with a perforated metal housing. VARIACS are shipped ready for table mounting but can easily be converted for back-of-panel mounting.

Dimensions: Over-all height for table mounting and depth behind panel for panel mounting are given in the table on page 20. Complete dimensional sketches can be furnished on request.

FREQUENCY AND VOLTAGE RATINGS

The voltage and power ratings of all VARIACS are based on a 50°C. maximum temperature rise for 60-cycle operation. At 50 cycles the temperature rise may exceed the above value slightly, but the VARIACS can safely be operated at full voltage and current ratings.* For operation at 25 cycles the VARIAC should be operated at half rated voltage or excessive

heating will result. Thus the TYPE 200-CH, 100-R, and 50-B VARIACS can be used on 115-volt, 25-cycle supply lines.

At frequencies above 60 cycles all VARIACS can be used at full rated current and voltage. No-load losses will be reduced compared to the 60-cycle values, but regulation will be poorer because of the increased leakage reactance.

*The over-voltage feature of the TYPE 200-B should not be used at 50 cycles.

TYPE 200-CM and TYPE 200-CMH VARIACS.

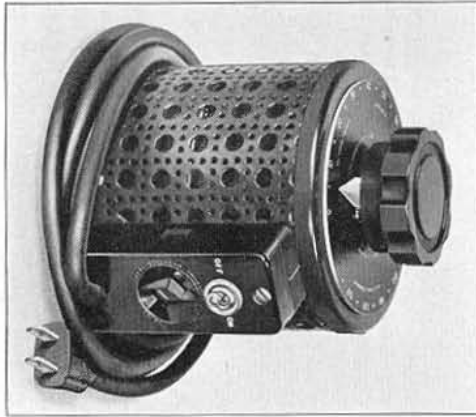

TYPE 200-CU and TYPE 200-CUH VARIACS.

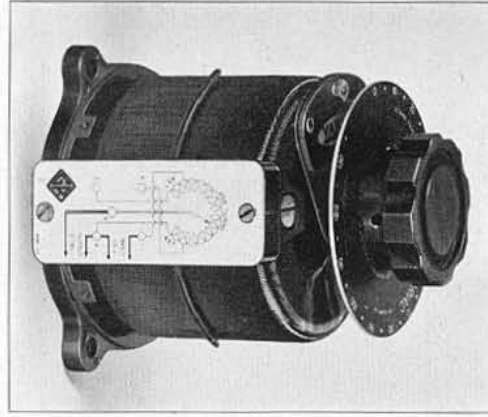

TYPE 200-B VARIAC.



VARIACS

Type	200-B	200-CUH	200-CMH	200-CU	200-CM	100-Q	100-R	50-A	50-B
Load Rating (va).....	170	580*	580*	860	860	2000	2000*	5000	7000*
Input Voltage.....	115	230 or 115	230 or 115	115	115	115	230 or 115	115	230 or 115
Output Voltage (Zero to —).....	135 115	270 230	270 230	135 115	135 115	135 115	270 230	135 115	270 230
Rated Current (Amps.).....	1	2*	2*	5	5	18	9*	40	20*
Maximum Current (Amps.).....	1.5	2.5	2.5	7.5	7.5	18	9	45	31
No-Load Loss (Watts) 60~	3	10	10	10	10	20	25	60	75
Depth Behind Panel (Inches).....	3	4 3/8	...	4 3/8	...	7	7	7 1/8	7 1/8
Over-all Height for Table Mounting	4	5 3/4	5 3/4	5 3/4	5 3/4	9	9	10 1/8	10 1/8
Maximum Panel Thickness (Inches)	1/4	1/2	...	1/2	...	3/8	3/8	1 1/2	1 1/2
Net Weight (Lbs.).....	2 7/8	8 1/4	8 7/8	8 1/4	9 1/4	30 1/4	29 3/4	85	81
Driving Torque (Inch-Ounces).....	20-40	← 30-50 →				← 50-70 →		← 250-500 →	
Code Word.....	BALSA	BAGUE	BAIRN	BAKER	BALMY	BEAMY	BEARD	TOKEN	TOPAZ
Price.....	\$10.00	\$18.50	\$21.50	\$14.50	\$17.50	\$40.00	\$40.00	\$100.00	\$100.00

*For 115 volts applied across half the winding, the rating is reduced to one-half the value shown.

PATENT NOTICE. See Note 11, page vi.

The photographs on these pages are approximately in proportion to the actual sizes of the VARIACS with the exception of that of the Type 50, which is shown relatively somewhat smaller. Dimension sketches of all VARIACS are available on request.



TYPE 50 VARIAC.

TYPE 100 VARIAC.



MULTIPLE OPERATION OF VARIACS

Two and three-gang VARIAC assemblies are available for controlling several circuits from a single dial, or for controlling 3-phase circuits in the same manner that one VARIAC controls a single-phase circuit.

In polyphase circuits a large variety of input and output voltage combinations is possible. The Y and open-delta connections listed on the next page are most frequently used, although the closed-delta find occasional application. It should be noted that the assemblies are shipped with standard terminal plates on each VARIAC. Hence the use of any of the assemblies listed on the next page is not limited to the circuit connections suggested.

Parallel operation of TYPES 100 and 200 is not recommended, as it is generally more economical to use the next larger size VARIAC if more capacity is desired for a given application. For parallel operation of the TYPE 50 VARIACS the TYPE 50-P1 Current-Equalizing Choke is available.

Several combinations for three-phase operation are listed in the table on the next page. These are representative of the many possible useful combinations and the ratings given are conservative.

VARIAC

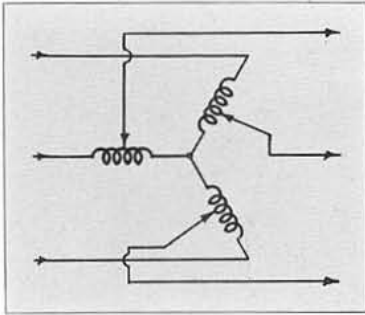

(Left) A Wye-connected three-phase arrangement of VARIACs.

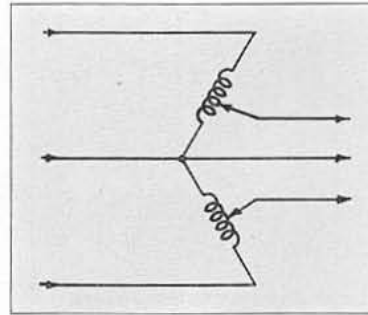

(Right) A three-phase arrangement of VARIACs in the open-delta circuit.

Three-Phase Line Voltage	Kva		Line Current in Amperes Rated	Three-Phase Line Voltage	Type of Assembly	Circuit
	At Input Voltage	At Maximum Voltage				
230	1.0	0.94	2.0	0-270	200-CUHG2	Open-Delta
230	3.0	3.0	5.0	0-230	200-CUG3	Wye
230	3.6	4.2	9.0	0-270	100-RG2	Open-Delta
230	7.2	7.0	15	0-270	100-QG3	Wye
230	18	17.5	37.5	0-270	50-AG3	Wye
230	12.5	9.4	20	0-270	50-BG2	Open-Delta
460	2	2	2.0	0-460	200-CUHG3	Wye
460	7.2	7.2	9	0-460	100-RG3	Wye
460	25	25	20	0-460	50-BG3	Wye

VARIAC ASSEMBLIES

Type	Description	Net Weight in Pounds	Code Word	Price
200-CUG2	2-Gang 200-CU...	17 3/4	BAKERGANDU	\$36.50
200-CUG3	3-Gang 200-CU...	26 3/4	BAKERGANTY	56.00
200-CUHG2	2-Gang 200-CUH...	17 3/4	BAGUEGANDU	44.50
200-CUHG3	3-Gang 200-CUH...	25 3/4	BAGUEGANTY	68.00
100-QG2	2-Gang 100-Q...	60	BEAMYGANDU	85.00
100-QG3	3-Gang 100-Q...	90	BEAMYGANTY	130.00
100-RG2	2-Gang 100-R...	59	BEARDGANDU	85.00
100-RG3	3-Gang 100-R...	88 1/2	BEARDGANTY	130.00
50-AG2	2-Gang 50-A...	180	TOKENGANDU	225.00
50-AG3	3-Gang 50-A...	265	TOKENGANTY	335.00
50-BG2	2-Gang 50-B...	175	TOPAZGANDU	225.00
50-BG3	3-Gang 50-B...	256	TOPAZGANTY	335.00
50-P1	Choke.....	1 1/4	PARALLCHOK	7.50

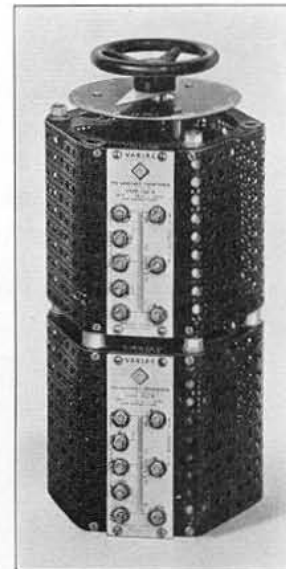

(Right) View of TYPE 100-RG2 Variac Assembly.

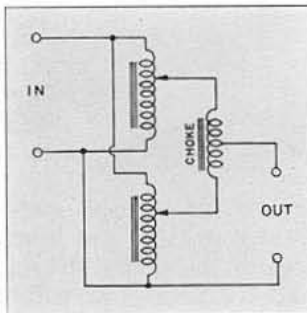

PARALLEL OPERATION

The TYPE 50-P1 Choke is available for parallel operation of two TYPE 50 VARIACs. Connections for this choke are shown in the sketch. The choke serves to equalize the currents from the two VARIACs and also to limit the flow of circulating currents. The use of a choke with smaller sizes of VARIACs is not recommended, because better results can be obtained by using a single larger unit.

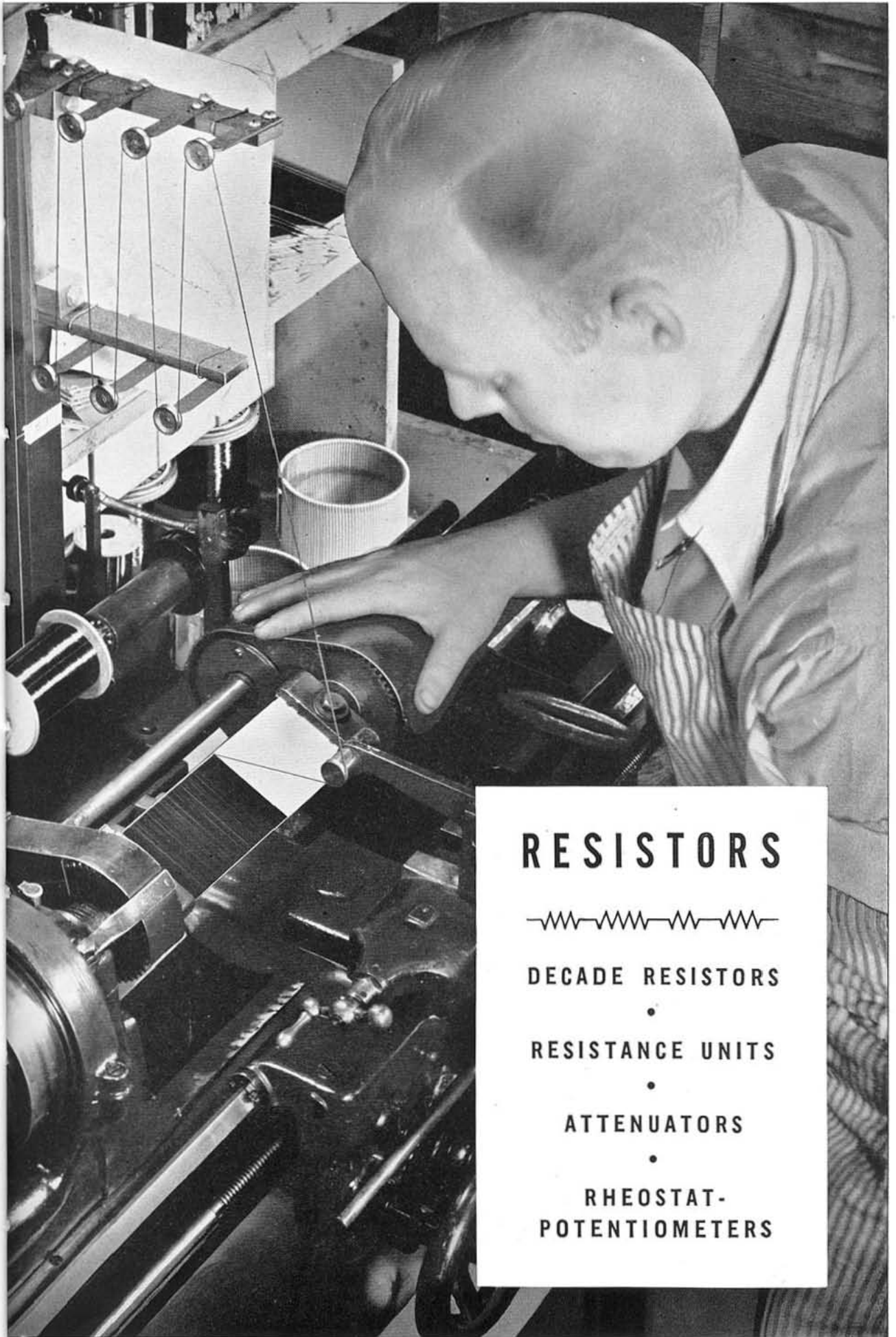

RESISTORS



DECADE RESISTORS

•

RESISTANCE UNITS

•

ATTENUATORS

•

RHEOSTAT-
POTENTIOMETERS

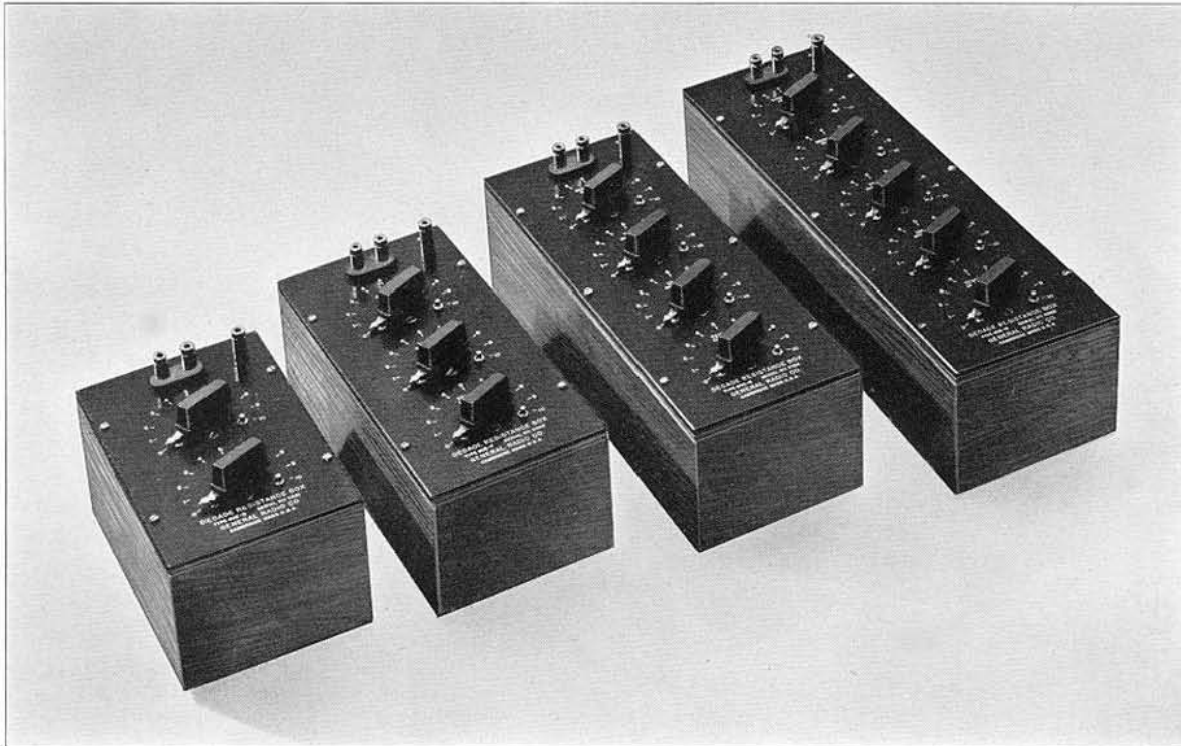

TYPE 602 DECADE-RESISTANCE BOX

USES: Accurate resistance boxes are extremely valuable wherever electrical measurements are made. Such boxes are constantly used in circuits where a wide range of resistance values is required or where variable dummy generator and load resistances are needed. The accuracy of TYPE 602 Decade-Resistance Boxes also permits them to be used as laboratory standards and as ratio arms for direct- and alternating-current bridges.

Although designed primarily for direct-current and audio-frequency work, they are useful well into the radio-frequency range for many applications.

DESCRIPTION: The TYPE 602 Decade-Resistance Box is an assembly of two or more TYPE 510 Decade-Resistance Units in a single cabinet. Mechanical and electrical protection of the units is provided by the shielded walnut cabinet and aluminum panel, which completely enclose both the resistance units and switch contacts. The resistance elements have no electrical connection to the shield, which is brought out to a separate terminal connected to the panel.

Two-, three-, four-, and five-dial decade assemblies are available. Each decade has eleven contact studs and ten resistance units, so that the dials overlap. A positive detent

mechanism assists in setting squarely on the contacts and so permits adjustments to be made without looking at the dials.

FEATURES: By careful mechanical design the zero resistance of the TYPE 602 Decade-Resistance Boxes has been kept below 0.003 ohm per decade. In applications where a minimum zero resistance is desired, this feature is very valuable. On the other hand, there are many types of measurement, such as substitution measurements, in which the difference between two settings of a resistance box is the significant value. This difference is given correctly only when the individual resistors have been adjusted independently of switch and wiring resistance. Accordingly, the resistance units in the TYPE 602 Decade-Resistance Boxes are adjusted to have their specified values at their own terminals, rather than at the terminals of the box.

All resistors except the 10,000-ohm cards are wound with manganin wire; consequently no difficulty due to thermal emf is encountered in direct-current measurements, except when using the high-resistance decades of the TYPES 602-M and 602-L. With these decades, some attention should be given to temperature differences, if maximum accuracy is desired.

At radio frequencies, the residual inductances

and capacitances cause the effective series resistance at the terminals to depart from the low-frequency value.* In addition, the reactance component, which is negligible at audio frequencies, may become significant. The 100-, 10-, and 1-ohm-per-step decades of the TYPE 602 Decade-Resistance Boxes are the most

*See "Radio Frequency Characteristics of Decade Resistors," General Radio *Experimenter*, Vol. XV, No. 6.

SPECIFICATIONS

Frequency Characteristics:* A TYPE 602 Decade-Resistance Box can be represented quite closely by the equivalent circuit below, which represents one decade of a box, with the remaining decades set to zero. R_0 and L_0 are the zero resistance and inductance of the box, due to the wiring and switches. These values are proportional to the number of decades in the box. ΔL is the inductance associated with each increment of resistance, ΔR . The effective capacitance C depends, in general, upon the dial setting, the variation being approximately linear with setting (the higher value is for the lowest setting). The values of the constants are tabulated below:

- L_0 = 0.10 μ h per dial
- R_0 (d-c) = .002 to .003 ohm per dial
- R_0 (1 Mc) = 0.04 ohm per dial; proportional to the square root of frequency at all frequencies above 100 kc.

Type of Decade	.1-Ohm Step	1-Ohm Step	10-Ohm Step	100-Ohm Step	1000-Ohm Step	10,000-Ohm Step
ΔR in ohms	0.1	1.0	10	100	1000	10,000
ΔL (μ h)	.014	.05	0.11	0.29	3.3	9.5
C^\dagger (μ mf)	—	27	26-23	21-13	—	—

Zero Resistance: The direct-current zero resistance of the various boxes depends on the number of dials, as follows:

No. of Dials	Zero Resistance
2	0.004-0.006 ohm
3	0.006-0.009 ohm
4	0.008-0.012 ohm
5	0.010-0.015 ohm

Temperature Coefficient: Less than $\pm 0.002\%$ per degree Centigrade at room temperatures, except for the 0.1 Ω decade, where the box wiring will affect the over-all temperature coefficient.

*See "Radio Frequency Characteristics of Decade Resistors," General Radio *Experimenter*, Vol. XV, No. 6.

† The value of the capacitance shunting a single decade in a box depends upon the location of the decade in the box, as well as on the resistance of the decade. The values given here are for a TYPE 602-G and may be taken as representative.

If several decades of a box are in circuit at the same time, the incremental inductances of the several decades may be added directly, and the capacitance may be taken to be approximately that of the highest decade in use.

satisfactory for use at high frequencies. In no case, however, is the frequency error serious below 50 kc. The magnitudes of the residual impedances are given in the specifications below.

The maximum allowable current for each decade, based on a 40° Centigrade temperature rise, is engraved just above each decade switch knob.

Type of Winding: See specifications for TYPE 510 Decade-Resistance Units, page 26.

Accuracy of Adjustment: All cards are adjusted within 0.1% of the stated value between card terminals, except the 1-ohm cards which are adjusted within 0.25% and the 0.1-ohm units which are adjusted within 1%.

Maximum Current: See specifications for TYPE 510 Decade-Resistance Units, page 26. Values for 40° Centigrade rise are engraved on panels directly above switch knobs.

Switches: Quadruple-leaf, phosphor-bronze switches bear on contact studs $\frac{3}{8}$ inch in diameter. Switch brushes are bent so as not to be tangent to the arc of travel, thus avoiding cutting. A cam-type detent is provided. There are eleven contact points (0 to 10 inclusive).

Terminals: Jack-top binding posts set on General Radio standard $\frac{3}{4}$ -inch spacing for resistance connections. There is an extra post at the corner of the panel for connections to the shield.

Mounting: A copper-lined walnut cabinet, with aluminum panel, completely encloses switches and resistance units. The panel finish is black crackle lacquer.

Dimensions: Panel length depends on the number of dials (see price list), being 7 $\frac{3}{4}$ for 2-dial, 10 $\frac{3}{8}$ for 3-dial, 13 for 4-dial, and 15 $\frac{3}{8}$ inches for 5-dial boxes. Panel width, 5 inches. Over-all height, 5 inches.

Net Weight: 3 $\frac{1}{4}$ for 2-dial, 4 $\frac{1}{4}$ for 3-dial, 5 for 4-dial, and 6 $\frac{1}{4}$ pounds for 5-dial boxes.

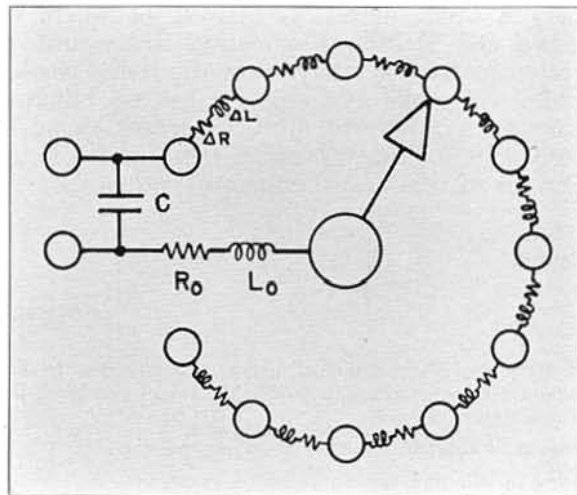

Type	Resistance	No. of Dials	Type 510 Decades Used	Code Word	Price
602-D	11 ohms, total, in steps of 0.1 ohm	2	A, B	DECOY	\$25.00
602-E	110 ohms, total, in steps of 1 ohm	2	B, C	DISCONTINUED	
602-F	111 ohms, total, in steps of 0.1 ohm	3	A, B, C	DELTA	35.00
602-G	1110 ohms, total, in steps of 1 ohm	3	B, C, D	DIGIT	35.00
602-K	1111 ohms, total, in steps of 0.1 ohm	4	A, B, C, D	DEFER	45.00
602-J	11,110 ohms, total, in steps of 1 ohm	4	B, C, D, E	DEBIT	50.00
602-N	11,111 ohms, total, in steps of 0.1 ohm	5	A, B, C, D, E	DEMON	62.00
602-M	111,110 ohms, total, in steps of 1 ohm	5	B, C, D, E, F	DEMIT	70.00
602-L	111,100 ohms, total, in steps of 10 ohms	4	C, D, E, F	DECAY	58.00

TYPE 510 DECADE-RESISTANCE UNIT

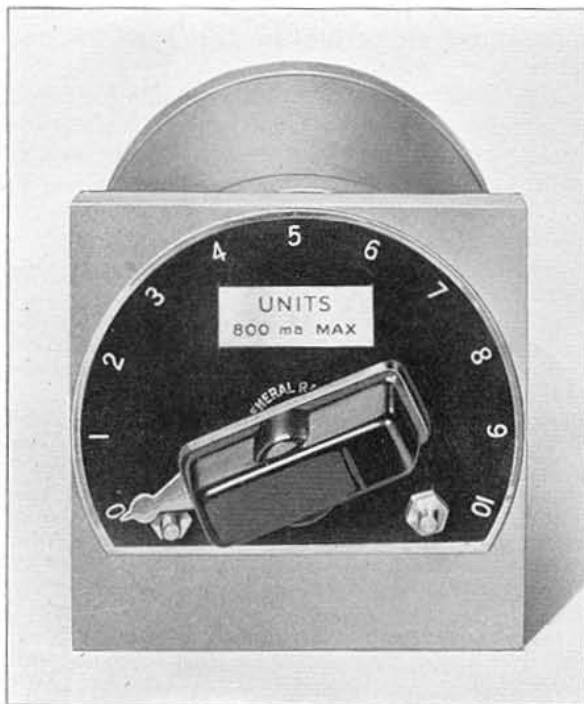

USES: Because of their precision, compactness, and sturdy construction the TYPE 510 Decade-Resistance Units are ideal for assembly into special test equipment, bridges, and other experimental or permanent equipment. They are particularly useful in applications where only a single decade is desired, or where a TYPE 602 Decade Box cannot be mounted conveniently. In many cases the use of these units will make available for general laboratory work relatively more expensive decade-resistance boxes, otherwise tied up for long periods of time in experimental equipment.

DESCRIPTION: The 1-, 10-, and 100-ohm steps are Ayrton-Perry wound of manganin wire on molded bakelite forms, especially shaped and heat treated to minimize aging effects. The 0.1-ohm steps are bifilar wound of manganin ribbon, while the 1000 and 10,000-ohm steps are unifilar wound on mica cards, the former of manganin wire and the latter of advance wire. The 100,000-ohm steps are wound in pies of advance wire.

Each decade is enclosed in an aluminum shield, and a knob and etched-metal dial plate are supplied. The mechanical assembly is also available complete with shield, blank dial plate, switch stops, and knob, but without resistors, as the TYPE 510-P3 Switch.

FEATURES: Each resistor is aged at a temperature of 135° Centigrade before being assembled into the units. The construction is such that frequency errors are negligible below 50 kilocycles. Complete information is given in the specifications under "Frequency Characteristics."

All resistors have a temperature coefficient of resistance of less than $\pm 0.002\%$ per degree Centigrade at room temperatures. Manganin wire is used in all decades except the TYPES 510-F and 510-G. Since the thermal emf's generated at a manganin-copper junction are very small, no difficulties arise in low-voltage direct-current measurements when these boxes are used. The 10,000-ohm and 100,000-ohm cards are not wound with manganin, and care should be taken in low-voltage direct-current work to see that temperature differences are kept at a minimum.

SPECIFICATIONS

Accuracy of Adjustment: Resistors are adjusted to be accurate at card terminals within the tolerances given in Table I on next page.

Maximum Current: See Table I on next page.

Type of Winding: See Table I on next page.

Frequency Characteristics: In Table II is listed the maximum percentage change in effective series resistance of each decade as a function of frequency. For the TYPES 510-A and 510-B the error is due almost entirely to skin effect and is independent of switch setting. For the TYPE 510-C the error changes slowly with dial setting and is a maximum at maximum resistance setting. For the TYPE 510-D (100-ohm step decade) a broad maximum occurs at the 600-ohm setting, while for all the higher resistance units, the position of maximum frequency error is at the maximum resistance setting. For these latter decades (TYPES 510-E and -F) the error is due almost entirely to

shunt capacitance and is approximately proportional to the square of the resistance setting.

The reactance at any frequency and setting may be determined quite accurately from the equivalent circuit shown on page 25 for the TYPE 602 Decade-Resistance Box. The values of the constants, as determined by high-frequency bridge measurements, are listed in Table III.

The high-resistance decades (TYPES 510-F and 510-G) are very commonly used as parallel resistance elements in measurement circuits, and so the error due to the shunt capacitance of the decades can frequently be eliminated. The remaining parallel resistance changes by only a fraction of the amount indicated in Table II as the series resistance change. This fact is particularly important with reference to the TYPE 510-G which has 100,000-ohm steps. At maximum setting this unit has a -1% change in series resistance at 1 kilocycle, but its parallel resistance is changed by only -1% at 10 kilocycles.

TABLE I

Type	Resistance per Step	Accuracy	Type of Winding	Maximum Current		Maximum Power per Resistor
				20° C. Rise	40° C. Rise	40° C. Rise
510-A	0.1 Ω	±1.0 %	Bifilar	1 a	1.6 a	0.25 watt
510-B	1 Ω	±0.25 %	Ayrton-Perry	550 ma	800 ma	0.6 watt
510-C	10 Ω	±0.1 %	Ayrton-Perry	170 ma	250 ma	0.6 watt
510-D	100 Ω	±0.1 %	Ayrton-Perry	55 ma	80 ma	0.6 watt
510-E	1000 Ω	±0.1 %	Unifilar on Mica	16 ma	23 ma	0.5 watt
510-F	10,000 Ω	±0.1 %	Unifilar on Mica	5 ma	7 ma	0.5 watt
510-G	100,000 Ω	±0.1 %	Pies	1.5 ma	2.5 ma	0.6 watt

TABLE II

Maximum Percentage Change in Series Resistance as a Function of Frequency

Decade	Frequency in kc						
	50 kc	100 kc	200 kc	500 kc	1000 kc	2000 kc	5000 kc
0.1-ohm steps	—	—	—	—	0.1 %	0.8 %	5 %
1.0-ohm steps	—	—	—	0.1 %	0.5 %	1.5 %	9 %
10-ohm steps	—	—	—	—	0.1 %	0.2 %	1.5 %
100-ohm steps	—	—	—	—	0.1 %	0.2 %	0.9 %
1000-ohm steps	—	-0.1 %	-0.3 %	-1.5 %	-6.5 %	—	—
10,000-ohm steps	-2 %	-8 %	—	—	—	—	—

TABLE III

Value of Constants for the Equivalent Circuit of a TYPE 510 Decade-Resistance Unit (See diagram on page 25)

Type of Decade	ΔR Ohms	ΔL μh	L _o μh	C* μf
510-A	0.1	0.014	0.023	7.7-4.5
510-B	1.0	0.056	0.023	7.7-4.5
510-C	10.0	0.11	0.023	7.7-4.5
510-D	100	0.29	0.023	7.7-4.5
510-E	1000	3.3	0.023	7.7-4.5
510-F	10,000	9.5	0.023	7.7-4.5
510-G	100,000	—	0.023	7.7-4.5

*The larger capacitance occurs at the lowest setting of the decade. The values given are for units without the shield cans in place. With the shield cans in place, the shunt capacitance is from 10 to 20 μf greater than indicated here, depending on whether the shield is tied to the switch or to the zero end of the decade.

Switches: Quadruple-leaf, phosphor-bronze switches bear on contact studs 3/8 inch in diameter. Switch brushes are bent so as not to be tangent to the arc of travel, thus avoiding cutting. A cam-type detent is provided. There are eleven contact points (0 to 10 inclusive). The switch resistance is between 0.002 and 0.003 ohm, and the effective capacitance of the switch is of the order of 5 μf, with a dissipation factor of 6% at 1 kilocycle. A molded bakelite switch form is used. The form for TYPE 510-G is molded from low-loss bakelite.

Temperature Coefficient: The temperature coefficient of resistance is less than ±0.002 % per degree Centigrade at room temperatures.

Terminals: Soldering lugs are provided.

Mounting: Each decade is complete with dial plate and knob and can be mounted on any panel between 1/4 inch and 3/8 inch in thickness.

Dimensions: See sketch; shaft diameter is 3/8 inch.

Net Weight: TYPE 510 Units, 11 ounces; TYPE 510-P3 9 1/2 ounces.

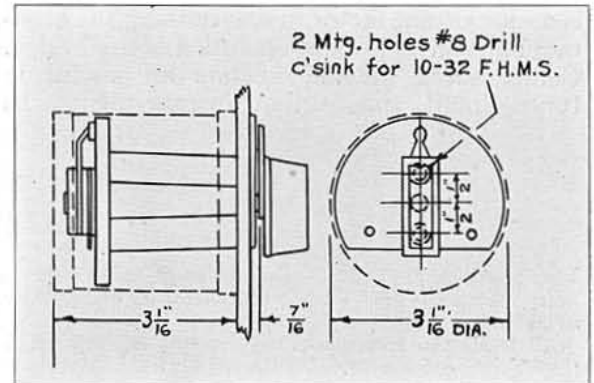

Type	Resistance		Code Word	Price
	Total	Per Step		
510-A	1 ohm	0.1 ohm	ELATE	\$8.50
510-B	10 ohms	1 ohm	ELDER	8.50
510-C	100 ohms	10 ohms	ELEGY	8.50
510-D	1000 ohms	100 ohms	ELBOW	8.50
510-E	10,000 ohms	1000 ohms	ELECT	12.00
510-F	100,000 ohms	10,000 ohms	ELVAN	14.00
510-G	1,000,000 ohms	100,000 ohms	ENTER	30.00
510-P3 Switch			ENVOY	5.00

NOTE: The shield shown in the photograph on the preceding page is no longer furnished.

TYPE 670 COMPENSATED DECADE RESISTOR

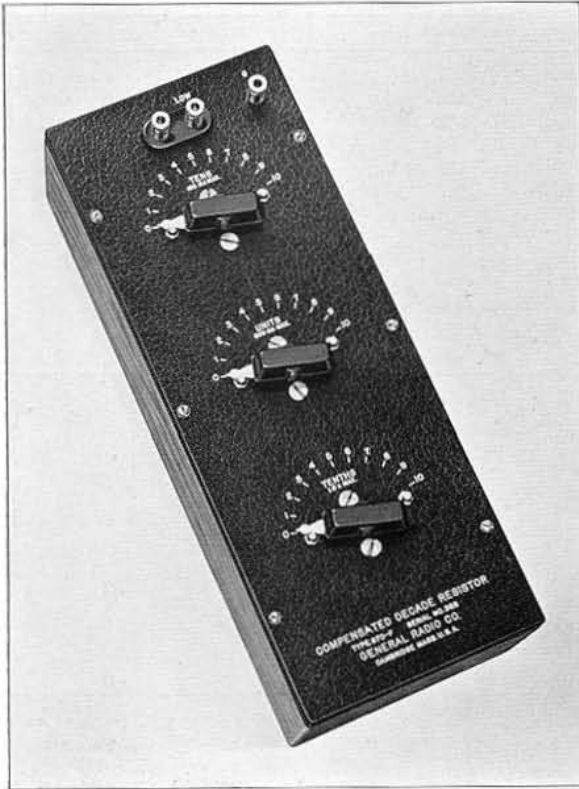

USES: The TYPE 670 Compensated Decade Resistor is intended for use in a-c impedance measurements where non-reactive increments of resistance are desired. This type of decade resistor made possible the development of the first precision radio-frequency bridge. It is also used in the TYPE 667-A Inductance Bridge and is an important factor in determining the accuracy and convenience of operation of this bridge. Compensated decade resistors are useful in tuned-circuit substitution measurements, as

variable resistance elements in antenna measuring circuits, and, in general, for bridge measurements wherever the variation in inductance of the conventional type of decade resistor cannot be tolerated.

DESCRIPTION: The TYPE 670-F Compensated Decade Resistor is an assembly of TYPE 668 Compensated Decade-Resistance Units.

The decade-resistance units use a double card system, as shown on page 30, and the switch is so arranged that a copper coil is substituted when a resistance coil is switched out of circuit. The inductance of the copper coil is equal to the inductance of the resistance coil but its resistance is very small. Consequently, as the position of the switch is changed, the inductance of the decade is kept constant and only the resistance is varied.

The decade units are mounted on a black crackle-finished aluminum panel and encased in a walnut cabinet, lined with sheet copper. The copper lining, together with the aluminum panel, forms a complete shield for the resistors. A separate terminal is provided so that independent connection to this shield may be made.

FEATURES: The greatest advantage of the TYPE 670 Compensated Decade Resistor is that its inductance is constant within 0.1 microhenry regardless of the resistance setting of the box. Furthermore, the total inductance of the box is but one microhenry, and so little difficulty is encountered in balancing out this amount in preliminary adjustments.

High accuracy and low temperature coefficient of resistance are maintained in the TYPE 670 Boxes. The current ratings for all decades, based on a 40° Centigrade temperature rise, are engraved on the panel.

SPECIFICATIONS

Type of Winding: The 10-ohm and 1-ohm steps are Ayrton-Perry resistance cards, while the 0.1-ohm steps are bililar ribbon units.

All decades are compensated by copper coils as shown in the diagram on page 30.

Accuracy of Adjustment: Resistance increments are correct within $\pm 0.1\%$ for the 10-ohm steps, $\pm 0.25\%$ for the 1-ohm steps, and $\pm 1\%$ for the 0.1-ohm steps.

Zero Resistance: The zero resistance is of the order of 0.04 ohm.

Inductance: The zero inductance is 1.05 microhenry. This value remains constant regardless of resistance setting within 0.1 microhenry.

Switches: Double-leaf, phosphor-bronze switches bear on contact studs $\frac{1}{4}$ inch in diameter. Switch brushes are bent so as not to be tangent to the arc of travel, thus avoiding

cutting. A cam-type detent is provided. There are eleven contact points (0 to 10 inclusive).

Terminals: Standard $\frac{3}{4}$ -inch spacing is used on the terminals. A ground post connected to shield and panel is also provided.

Maximum Current: See specifications for TYPE 668 Compensated Decade-Resistance Unit on page 30. Values for 40° Centigrade rise are engraved on the panels directly above the switch knob.

Frequency Characteristics: The frequency characteristics of the TYPE 670 Compensated Decade Resistor are similar to those of the TYPE 668 Unit which is used in the boxes. However, the box wiring and cabinet shield affect these characteristics somewhat.

Temperature Coefficient: Less than $\pm 0.002\%$ per degree Centigrade at room temperatures, except at the lower settings where the temperature coefficient of the copper

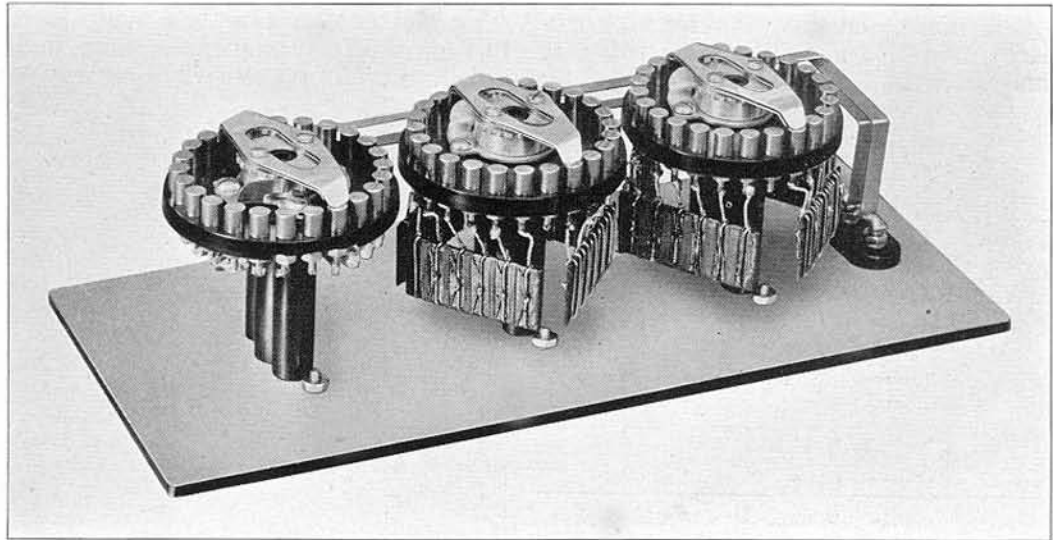

Interior of TYPE 670-F Compensated Decade Resistor.

compensating windings may affect the over-all temperature coefficient.

Mounting: The dials are mounted on aluminum panels in copper-lined walnut cabinets.

Dimensions: Panel, (length) 13 x (width) 5 inches. Cabinet, (height) 5 inches, over-all.

Net Weight: 5½ pounds.

Type	Resistance	Type Units Used	Code Word	Price
670-F	0 to 111 ohms, total, in steps of 0.1 ohm	668-A, -B, -C	ABYSS	\$45.00

TYPE 668 COMPENSATED DECADE-RESISTANCE UNIT

USES: The TYPE 668 Compensated Decade-Resistance Unit is the basic unit for the TYPE 670 Compensated Decade Resistor. In addition, it has found wide application as a component part for building into experimental or permanent measuring equipment for use at radio frequencies. It has been built into antenna measuring equipment as well as into general r-f impedance-measuring circuits. It is useful for any measurements where constancy of inductance is desired.

DESCRIPTION: The TYPE 668 Compensated Decade-Resistance Unit is equipped with a double set of switch contacts, by means of which a copper winding is exchanged, step by step, for the resistance cards, thus keeping the total inductance constant regardless of resistance setting. This arrangement is shown in the diagram on the next page.

The units are mounted with an etched-metal dial plate, knob, and stops, but with no shield.

FEATURES: The TYPE 668 Compensated Decade-Resistance Units are accurately adjusted resistances with a low temperature coefficient of resistance.

Since it is impossible to build a resistance with no inductance, the next best condition is a unit with a low but constant inductance. Accordingly, the TYPE 668 Units have been built to have but a few tenths of a micro-

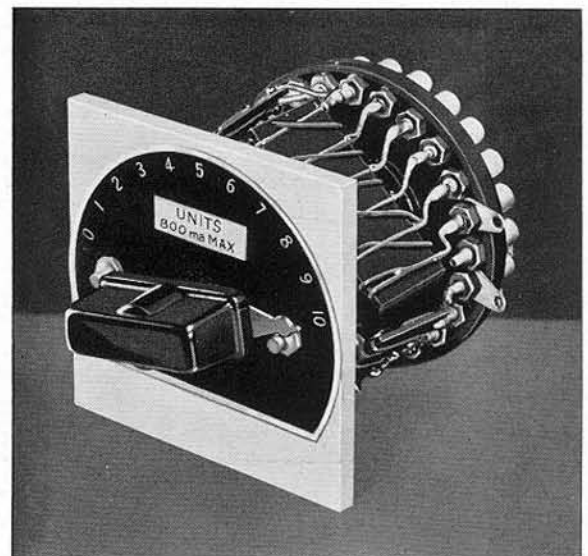

henry inductance, and this value remains constant to within 0.05 microhenry regardless of resistance setting.

Careful construction has made it possible to keep the frequency errors small, and so all units are useful up to several megacycles.

SPECIFICATIONS

Accuracy of Adjustment: Resistance increments are correct within $\pm 1\%$ for the 0.1-ohm steps, $\pm 0.25\%$ for the 1-ohm steps, and $\pm 0.1\%$ for the 10-ohm steps.

Zero Resistance: The zero resistance of the different units is given in Table I.

TABLE I

Type	Zero Resistance	Inductance
668-A	0.001-0.010 ohm	0.15 microhenry
668-B	0.015-0.025 ohm	0.30 microhenry
668-C	0.010-0.020 ohm	0.50 microhenry

Inductance: The inductance of the different units is given in the table above. The inductance remains constant regardless of resistance setting within 0.05 microhenry.

Temperature Coefficient: The temperature coefficient of resistance is less than $\pm 0.002\%$ per degree Centigrade at room temperatures, except for the lower settings of TYPES 668-A and 668-B, where the temperature coefficient of the compensating windings may affect the over-all temperature coefficient.

Frequency Characteristics: The frequency characteristics of TYPE 668 Compensated Decade-Resistance Units are similar to those of TYPE 510 Decade-Resistance Units, page 26. Because 10-ohm cards are the largest used, the effects of shunt capacitance are entirely negligible, and the change in resistance with frequency results almost entirely from skin effect.

Although skin effect produces a positive effect on the total resistance, the skin effect in the compensating winding is greater than that in the resistance cards. Accordingly there is a net negative change in resistance increments. That is, the increment in resistance between one switch point and the next higher one will be less at high frequencies than at low. This "negative skin effect," at one megacycle, is about -0.8% for the units decade and about -0.6% for the tens decade.

Maximum Current: The following table gives the allowable current for the different units. The values of current for a 40° Centigrade temperature rise, based on one-quarter watt dissipation per resistor, are engraved on the dial plate.

TABLE II

Type	Current for 20° C. Rise	Current for 40° C. Rise
668-A	1.0 a	1.6 a
668-B	300 ma	500 ma
668-C	100 ma	160 ma

Type	Resistance		Code Word	Price
	Total	Per Step		
668-A	1 ohm	0.1 ohm	GABLE	\$10.00
668-B	10 ohms	1 ohm	GAILY	12.50
668-C	100 ohms	10 ohms	GALOP	12.50

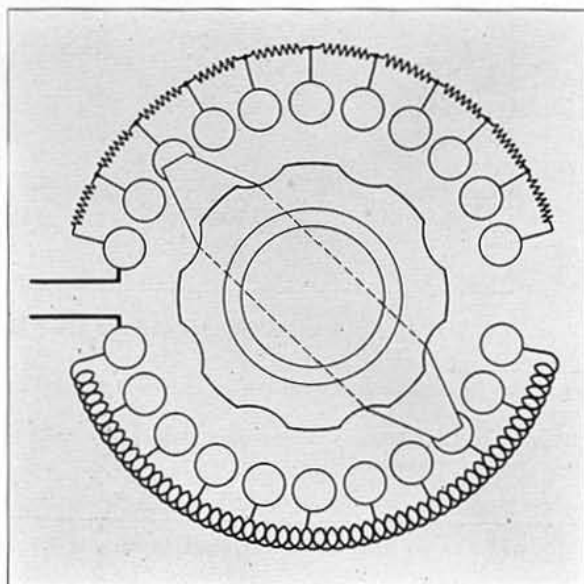

The construction of the compensated decade resistance is shown above. Opposite ends of the switch blade make contact with resistance or inductance windings, respectively. As a resistance step is added to the circuit, a compensating inductance step is removed, and vice versa.

Type of Winding: The 10-ohm and 1-ohm cards are Ayrton-Perry wound, while the 0.1-ohm steps are bifilar ribbon. Compensated windings are used on all decades to maintain constant inductance. (See diagram above.)

Switch: A double-leaf, phosphor-bronze switch bears on contact studs $\frac{1}{4}$ inch in diameter. Switch brushes are bent so as not to be tangent to the arc of travel, thus avoiding cutting. A cam-type detent is provided and there are eleven contact points (0 to 10 inclusive).

Terminals: Soldering lugs are provided.

Mounting: Interchangeable (except for switch stops) with TYPE 510 (see page 26). A combination dial plate and drilling template is furnished.

Dimensions: Diameter, $3\frac{1}{8}$ inches; depth behind panel, 3 inches, over-all; shaft diameter, $\frac{3}{8}$ inch.

Net Weight: 7 ounces.

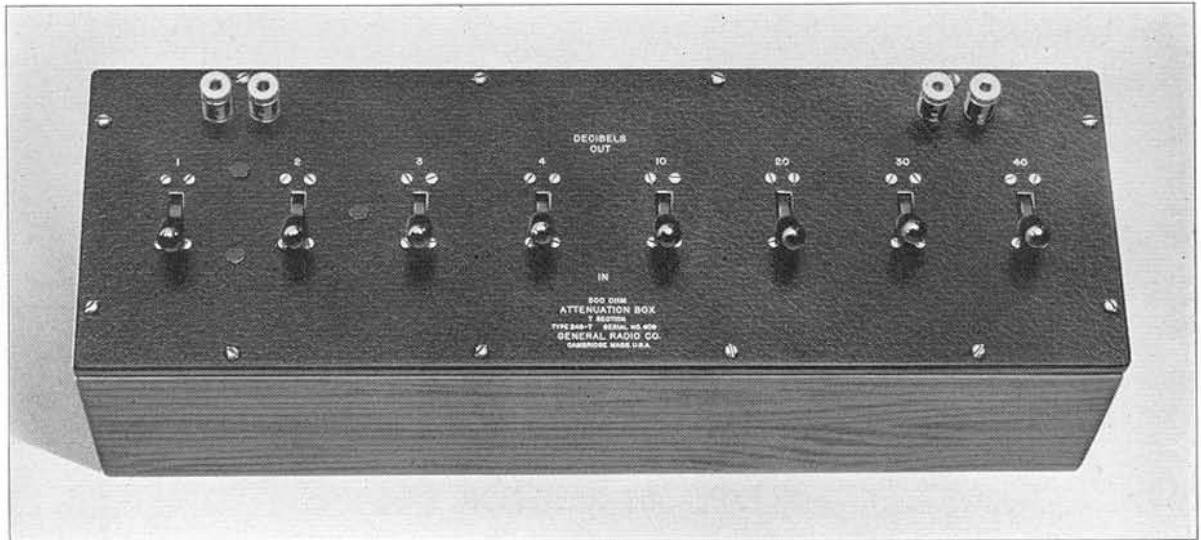

TYPE 249 ATTENUATION BOX

USES: The TYPE 249 Attenuation Box is useful in power-level measurements, transmission-efficiency tests, and in gain or loss measurements on transformers, filters, amplifiers, and similar equipment. It is also used as a power-level control in circuits not equipped with other volume controls.

DESCRIPTION: The TYPE 249 Attenuation Box is a constant impedance attenuator which contains a group of resistance elements so arranged that definite and known amounts of power loss

can be introduced by operating the key switches, when the box is used between specified values of input and output impedances. The total attenuation is given by adding the decibel values engraved by each of the keys.

FEATURES: The outstanding features of this box are its wide range and high accuracy. It can be used on frequencies as high as fifty kilocycles without introducing any appreciable error. Both the T-type section and the balanced-H section are available.

SPECIFICATIONS

Attenuation Range: 110 decibels in steps of 1.0 decibel. Boxes with other attenuation ranges can be made on special order.

Terminal Impedance: 600 ohms. Boxes for other impedances can be made on special order.

Accuracy: Each individual resistor is adjusted within 0.5% of its correct value. At frequencies below 50 kc the maximum error in attenuation is 0.2 db.

Type of Section: Both the T-section and balanced-H-section models are available. Both types present a constant impedance in both directions, but the balanced-H should be used where both sides of the circuit must be balanced to ground.

Type of Winding: Ayrton-Perry windings are used for the low-resistance elements, while unifilar windings on thin mica cards are used for the high-resistance units.

Maximum Voltage: The maximum permissible voltage varies somewhat with the attenuation, but the power-handling capacity of the boxes will not be exceeded, for any setting, if the voltage applied to the input of the TYPE 249-T is kept below 25 volts and that applied to the TYPE 249-H below 35 volts.

Switches: Eight low-capacity key switches control the eight attenuation sections.

Mounting: The units are mounted in shielded walnut cabinets with aluminum panels. The panel and shield are connected to the terminal marked G.

Terminals: Jack-top binding posts with 3/4-inch spacing.

Dimensions: Panel, (length) 16 x (width) 5 1/4 inches. Cabinet, (depth) 5 1/4 inches, over-all.

Net Weight: 7 1/8 pounds.

Type	Range	Impedance	Type of Section	Code Word	Price
249-H	110 db in steps of 1.0 db	600 ohms	Balanced-H	NETWORKROD	\$120.00
249-T	110 db in steps of 1.0 db	600 ohms	T	NETWORKTOP	100.00

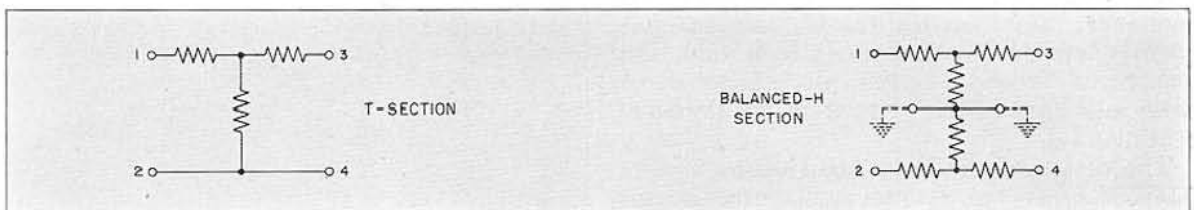

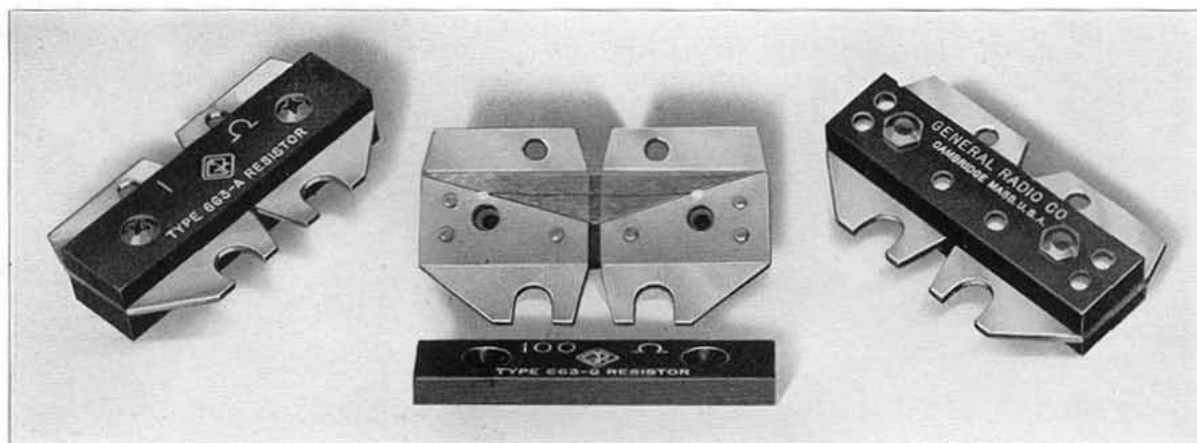

TYPE 663 RESISTOR

USES: The TYPE 663 Resistor is designed to have an accurately known impedance at high frequencies. It is particularly useful as a standard resistor for the resistance-variation method of impedance measurement at radio frequencies and as a circuit element in bridges and similar equipment. It is also useful as a terminating resistor for matching radio-frequency transmission lines and, generally, as a low-resistance standard in high-frequency applications where small residual reactance, accurately known resistance, and moderate power-handling capacity are required.

DESCRIPTION: A straight piece of resistance wire is soldered to two flat metal plates, which are mounted close together on a strip of insulating material. A thin piece of mica insulates the wire from the plates, except at the soldered ends. This assembly is rigidly clamped together with a top piece of insulating material. The flat metal plates extend on either side to form slotted terminals.

FEATURES: A resistor for high-frequency use should have an impedance which varies as little as possible with frequency and which is as nearly resistive in nature as possible. These requirements demand that skin effect be kept at a minimum and that residual inductance and capacitance be made very small.

The straight-wire resistor approaches this ideal more closely than any other type through the use of short pieces of fine wire. In the conventional form, however, two disadvantages occur. First, the fine wire has relatively high series inductance compared to its shunt capacitance, and low-resistance units consequently tend to have relatively high inductive reactances. Second, the fine wire cannot dissipate any appreciable power without overheating.

The design of the TYPE 663 Resistor* over-

*See D. B. Sinclair, "The TYPE 663 Resistor," *General Radio Experimenter*, Vol. XIII, No. 8, page 6, January, 1939.

comes these disadvantages. The straight wire is clamped down upon the flat metal fins and, as a result, the inductance is decreased over the free space value by virtue of the shielding effect of the current flow in the plates. By this same construction the power dissipation is greatly increased because the heat is carried away from the wire by the terminal fins.

The equivalent circuit for the TYPE 663 Resistor, when mounted approximately one inch above a metal panel, is given below. Values of the residual inductance, L , for the different units are tabulated in the specifications.

Residual inductance and capacitance cause two effects. First, they cause the resistance component to vary with frequency and, second, they create a residual reactive component. If the resistance, R , is large compared to $\sqrt{\frac{L}{C}}$, where L is the effective series resistance and C the effective shunt capacitance, the resistive component decreases with frequency; if the resistance is small compared to $\sqrt{\frac{L}{C}}$, the resistance increases with frequency up to a peak beyond which it decreases. For values of R large compared with $\sqrt{\frac{L}{C}}$, the reactance is

Equivalent circuit of TYPE 663 Resistor, mounted $\frac{3}{8}$ inch above a metal panel.

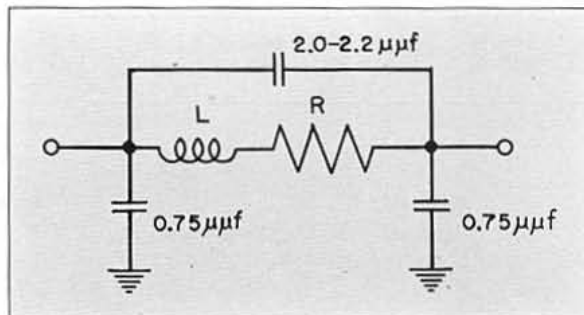

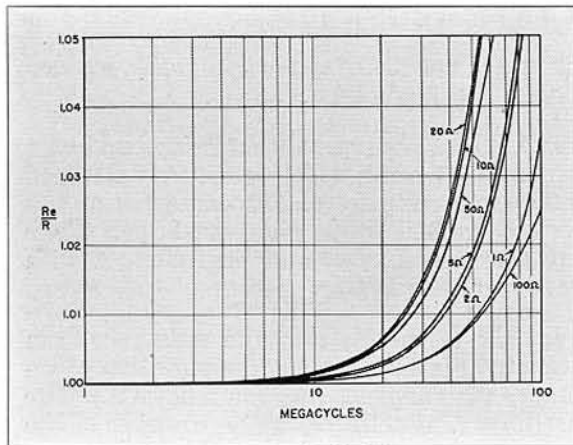

Ratio of effective resistance to d-c resistance as a function of frequency, for the TYPE 663 Resistor mounted on binding posts, as described in the text.

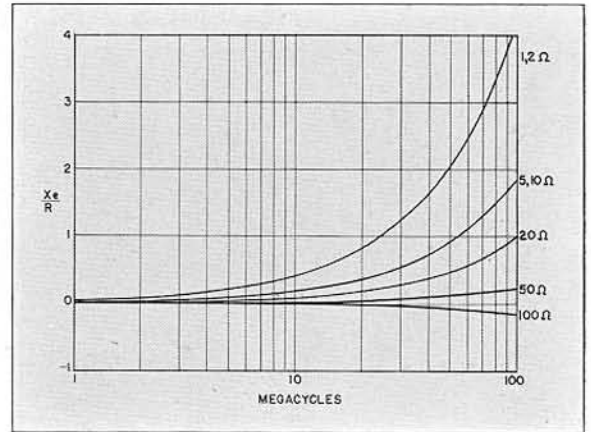

Ratio of equivalent series reactance to d-c resistance as a function of frequency, for the TYPE 663 Resistor mounted on binding posts, as described in the text.

capacitive; for values of R less than $\sqrt{\frac{L}{C}}$, the reactance is inductive up to the resistance peak. It is desirable to maintain $\sqrt{\frac{L}{C}}$ of the same order of magnitude as the resistance in order to minimize both resistance change and reactive component. The construction of the TYPE 663 Resistor, which gives low inductance at the expense of increased capacitance, fulfills this condition.

The accompanying curves illustrate the behavior of TYPE 663 Resistors as a function of frequency when mounted on a pair of TYPE 138-VD Binding Posts with one end grounded to a 1/4-inch metal panel upon which the binding posts are assembled with TYPE 274-Y

Mounting Plates. With this setup, the effective shunt capacitance consists of the sum of (1) the direct capacitance of the resistor, (2) the capacitance to ground of one mounting lug, (3) the direct capacitance between binding posts, and (4) the capacitance of one binding post to ground.* The total capacitance in this case is approximately 6.5 $\mu\mu\text{f}$ and the conditions are therefore more severe than would exist if a low-capacitance mounting were used.

It will be seen that the reactance is large compared to the resistance for low values of resistance and high frequencies. In most applications, this is not important because the reactance can be tuned out.

*See R. F. Field, "Direct Capacitance and Its Measurement," *General Radio Experimenter*, Vol. VIII, No. 6, page 5, Nov. 1933.

SPECIFICATIONS

Resistance Values: Standard units are available in the following resistances: 1, 2, 5, 10, 20, 50, and 100 ohms.

Accuracy: All units are adjusted within $\pm 1\%$.

Residual Parameters: The following table gives approximate values for L for the different units:

Resistance	L	Current for 40° C. Rise
1 ohm	0.0065 μh	1.4 a
2 ohms	0.013 μh	1.0 a
5 ohms	0.015 μh	0.5 a
10 ohms	0.029 μh	0.35 a
20 ohms	0.032 μh	0.2 a
50 ohms	0.034 μh	0.1 a
100 ohms	0.039 μh	0.06 a

Skin Effect: For all units the skin effect is less than 1% for frequencies below 50 megacycles.

Temperature Coefficient: At normal room temperature the temperature coefficient is less than $\pm 0.002\%$ per degree Centigrade.

Maximum Power and Current: The allowable power dissipation for a 40° Centigrade temperature rise varies with resistance, being 2 watts for the 1-ohm unit and 0.4 watt for the 100-ohm unit. The rated current for this temperature rise for the different units is given in the table.

Terminals: The flat metal plates to which the resistance wire is attached are used as terminals, and are both slotted and drilled for convenience in mounting.

Dimensions: (Length) 2 1/4 x (width) 1 1/4 inches. Over-all height, 5/8 inch.

Net Weight: 2 ounces.

Type	Resistance	Code Word	Price
663-A	1 ohm	PANIC	\$5.00
663-B	2 ohms	PARTY	5.00
663-C	5 ohms	PATY	5.00
663-D	10 ohms	PEDAL	5.00
663-E	20 ohms	PENAL	5.00
663-F	50 ohms	PENNY	5.00
663-G	100 ohms	PETTY	5.00

RHEOSTATS AND VOLTAGE DIVIDERS

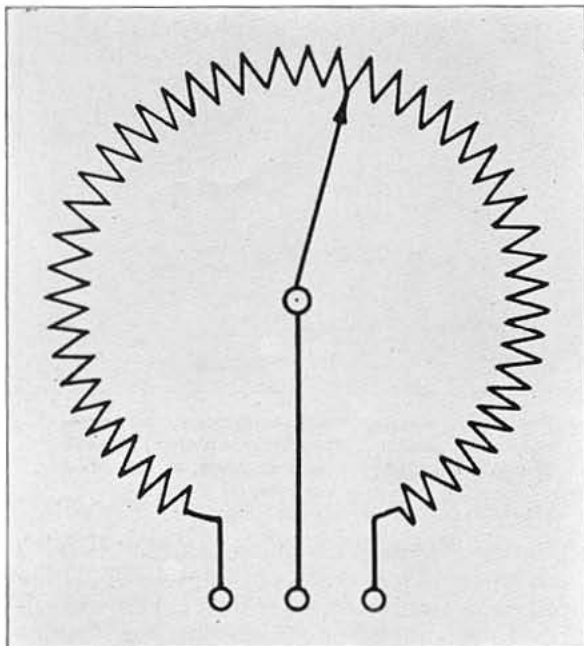

USES: Variable resistors and voltage dividers are useful in assembling experimental equipment where tube voltages and circuit elements are to be varied until the final design is obtained. In standard equipment, such as oscillators, bridges, test equipment, and industrial instruments, many manufacturers find General Radio rheostats extremely useful as filament- and plate-supply controls, output controls, bridge arms, and as parts of almost any instrument where variable resistances are needed. Ganged units can be used where simultaneous control is desired. Units with special resistance values or tolerances can be made to order. In addition to the ordinary linear models, tapered units of both the straight and logarithmic type can be made to satisfy particular requirements.

GENERAL DESCRIPTION: The resistance wire is wound on a strip of insulating material such as bakelite, which is then bent around and fastened to the molded bakelite supporting form. All units are so constructed that the shaft may extend through either or both ends of the rheostat. Terminals and mounting holes are provided on all models. Terminals are provided at both ends of the winding. The contact arm is in continuous contact with the winding. There is no "off" position.

FEATURES: General Radio rheostats and voltage dividers are manufactured in eight basic models under several different types of construction. The essential features of each type of design are outlined below. The shafts turn in accurately machined brass bushing inserts which are molded into the bakelite form (except TYPE

533 and TYPE 333, where integrally molded bakelite bearing holes are used).

Type 371-A. The resistance wire is wound on a linen bakelite strip, which is securely clamped to the supporting form. The contact arm is a specially formed single phosphor-bronze blade that provides smooth and firm contact with the edge of the winding.

Type 371-T. In this unit the resistance form is tapered linearly, so that the variation of resistance with angle of rotation follows a square law (increasing with clockwise rotation of the knob in a panel-mounted unit). In all other respects it is similar to the TYPE 371-A.

Type 214. This is similar to the TYPE 371-A in every respect except that the winding form is narrower.

Type 471. This is a high grade unit suitable for use in high-impedance circuits where low noise level is desired.

The high resistance windings are protected from mechanical damage or disturbance by an external protecting strip of linen bakelite.

An inside contact arm, bearing four separate wiping fingers, insures low noise level and extremely smooth operation.

Type 314. The design features of this unit are those of the TYPE 471; in physical dimensions it is similar to the TYPE 214.

Type 301. This type is a small, compact unit similar in construction to the TYPE 214.

Type 533. This is a heavy-duty unit capable of dissipating 250 watts under continuous load. The resistance element is wound on an asbestos-covered aluminum strip that serves to distribute the heat to be dissipated to all portions of the element for better radiation characteristics. An internal wiping contact is used. The TYPE 533 is designed to operate at extremely high temperatures, and care should be taken in its location with respect to associated apparatus.

Type 333. This unit has the same general constructional features as the TYPE 533, but uses a single-blade contact arm.

Type 433. This is a large unit, which is stocked only in the 500,000-ohm size. The large diameter (5 inches) allows a large number of turns on the winding form, making possible extremely high resistance together with very smooth control. The contact arm is a specially formed phosphor-bronze blade. A protecting strip of linen bakelite is provided to protect the high resistance windings from mechanical damage.

GENERAL SPECIFICATIONS

Accuracy: All types are wound to an accuracy of $\pm 10\%$ of the nominal values listed.

Maximum Current: The maximum current is the current which will produce the rated power dissipation when flowing through the entire winding. This current should not be exceeded in any portion of the winding.

Terminals: Screw terminals with 3-fingered tinned soldering lugs are provided on all models except TYPES 533 and 333 which are furnished with jack-top binding posts.

Accessories: All models are provided with the necessary screws and nuts for mounting, as well as a template for laying out the mounting holes.

Dimensions: Over-all size and mounting dimensions are shown on the sketches below.

Power Rating: In the table below are given the approximate power ratings of the various models. These ratings (except for the TYPES 533 and 333) are for a temperature rise of

from 50 to 60 degrees Centigrade for open shelf or panel mountings. When mounted in enclosed spaces slightly higher temperature rises or somewhat reduced ratings are to be expected. TYPE 333 and TYPE 533 are rated for a rise of approximately 250° Centigrade.

Type	Power Rating
301	4 watts
301 (with protecting strip)	3 watts
214	10 watts
314	8 watts
371	15 watts
371 (with protecting strip)	12 watts
471	12 watts
433	25 watts
333	60 to 100 watts
533	250 watts

MECHANICAL SPECIFICATIONS

Type	Type of Shaft	Type of Knob*	Useful Angle of Rotation	Net Weight in Ounces
371	1/4-in. Steel	637-G	303°	8
214	1/4-in. Steel	637-G	303°	6
471	3/8-in. Bakelite	637-H	294°	8
314	3/8-in. Bakelite	637-H	294°	6
301	1/4-in. Steel	637-A	254°	3
533	3/8-in. Steel	637-Q	305°	30
333	3/8-in. Steel	637-H	289°	10
433	3/8-in. Bakelite	637-Q	322°	18

*See page 157 for a description of these knobs.

TYPES 214, 314, 371, 471, 333

Type	A (Inches)	B (Inches)
214-A	3 3/16	1 1/4
314-A	3 3/16	1 3/8
371-A	3 3/16	2 1/2
471-A	3 3/16	2 3/8
333-A	4	2 3/8

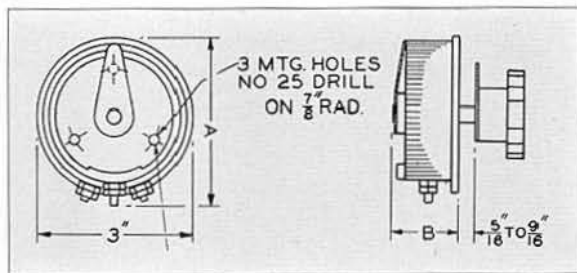

TYPE 533

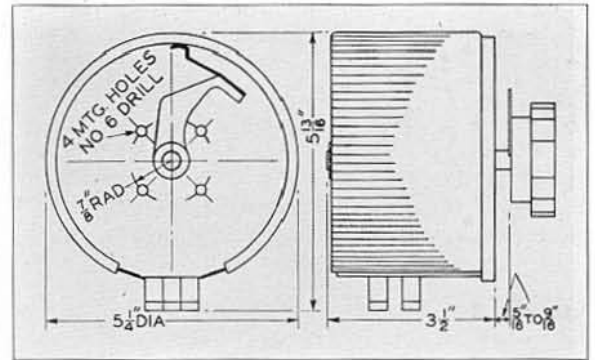

TYPE 433

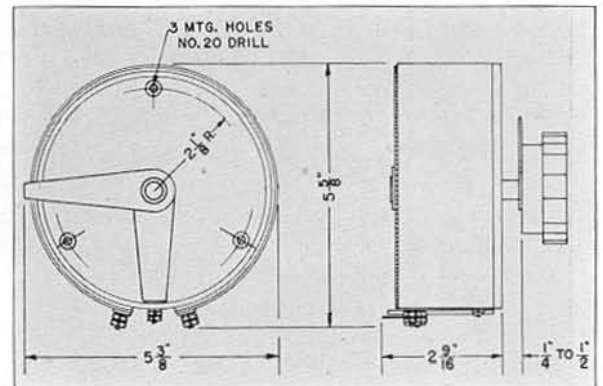

TYPE 301

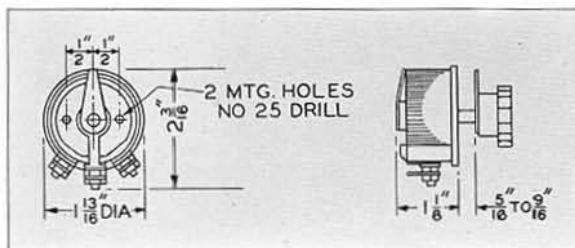

RESISTORS

GENERAL

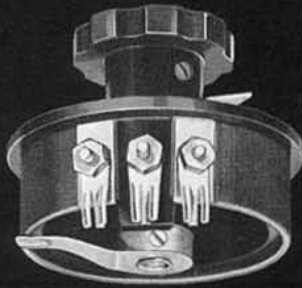

TYPE 214-A

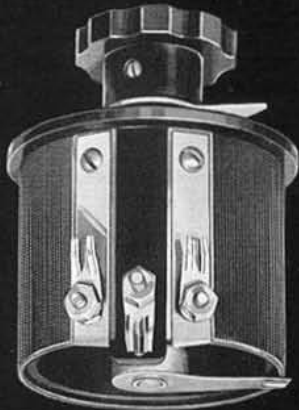

TYPE 371-A

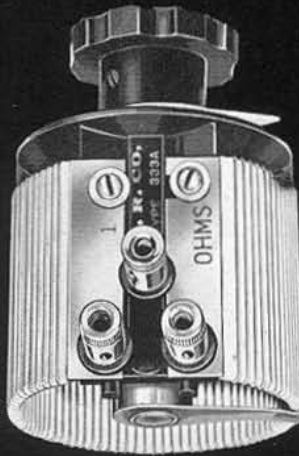

TYPE 333-A



TYPE 533-A

Type	Maximum Resistance	Maximum Current	Code Word	Price
214-A	10	1.0 a	RURAL	\$2.00
214-A	20	0.7 a	RAZOR	2.00
214-A	50	450 ma	RAPID	2.00
214-A	100	320 ma	RIVET	2.00
214-A	200	220 ma	EMPTY	2.00
214-A	500	140 ma	ROSIN	2.00
214-A	1000	100 ma	ENACT	2.00
214-A	2000	70 ma	SYRUP	2.00
214-A	5000	45 ma	ROWEL	2.00
214-A	10,000	32 ma	RUMOR	2.00

Type	Maximum Resistance	Maximum Current	Code Word	Price
371-A	1000	120 ma	REDAN	\$4.00
371-A	2000	90 ma	REFIT	4.00
371-A	5000	55 ma	ROTOR	4.00
371-A	10,000	38 ma	ROWDY	4.00
371-A	20,000	28 ma	RULER	4.00
*371-A	50,000	16 ma	SATYR	4.00
*371-A	100,000	11 ma	SEPOY	4.00

371-T	10,000	28 ma	SULLY	4.00
-------	--------	-------	-------	------

Type	Maximum Resistance	Maximum Current	Code Word	Price
333-A	1	DISCONTINUED		
333-A	3			
333-A	10			
333-A	30			
333-A	100			
333-A	300			
333-A	1000			

Type	Maximum Resistance	Maximum Current	Code Word	Price
533-A	1	DISCONTINUED		
533-A	3			
533-A	10			
533-A	30			
533-A	100			
533-A	300			
533-A	1000			

Type	Maximum Resistance	Maximum Current	Code Word	Price
*314-A	1000	90 ma	DIVAN	\$4.00
*314-A	2000	65 ma	ENEMY	4.00
*314-A	5000	40 ma	ENJOY	4.00
*314-A	10,000	28 ma	DIVER	4.00
*314-A	20,000	20 ma	ENROL	4.00
*314-A	50,000	13 ma	DONAX	4.00
*314-A	100,000	9 ma	DONGA	4.00

Type	Maximum Resistance	Maximum Current	Code Word	Price
*471-A	10,000	35 ma	ERECT	\$6.00
*471-A	20,000	25 ma	HUMAN	6.00
*471-A	50,000	15 ma	ERODE	6.00
*471-A	100,000	10 ma	ERUPT	6.00
*471-A	200,000	8 ma	ESKER	6.00

Type	Maximum Resistance	Maximum Current	Code Word	Price
301-A	5	0.9 a	PALSY	\$1.00
301-A	10	0.65 a	REMIT	1.00
301-A	20	450 ma	RENEW	1.00
301-A	50	280 ma	RIFLE	1.00
301-A	100	200 ma	RIGID	1.00
301-A	200	140 ma	REBUS	1.00
301-A	500	90 ma	RIVAL	1.00
301-A	1000	65 ma	RAVEL	1.00
301-A	2000	45 ma	READY	1.00
301-A	5000	28 ma	ROMAN	1.00
*301-A	10,000	17 ma	CURRY	1.50
*301-A	20,000	12 ma	CRUMB	1.50

Type	Maximum Resistance	Maximum Current	Code Word	Price
*433-A	500,000		DISCONTINUED	

*Supplied with linen-bakelite protecting strip.

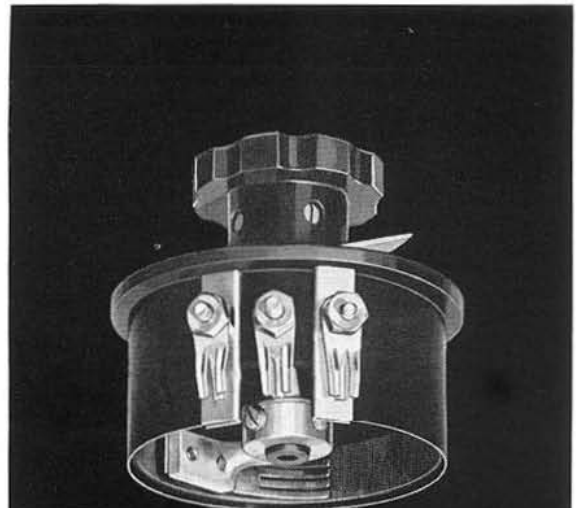

TYPE 314-A

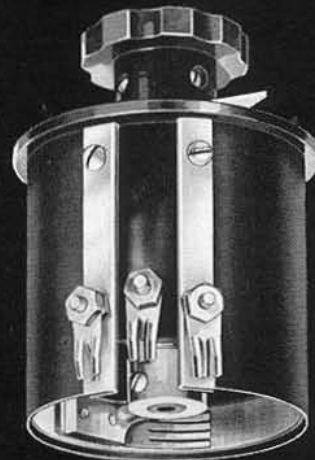

TYPE 471-A

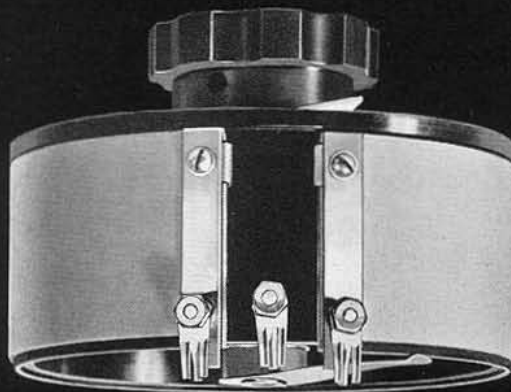

TYPE 433-A



TYPE 301-A

RESISTORS

TYPE 500 RESISTOR

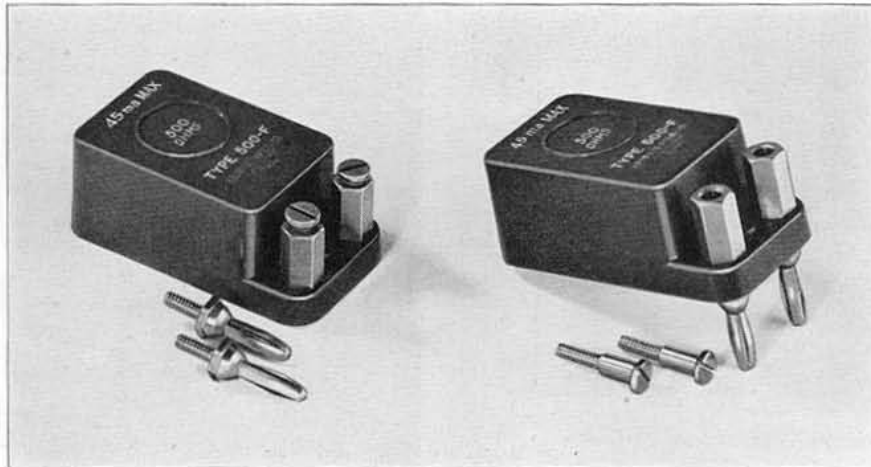

USES: The TYPE 500 Resistors are particularly recommended as resistance standards for use in impedance bridges. They are also valuable as secondary standards for laboratory use. The plug-type terminals make them convenient as terminating impedances for attenuation boxes, lines, and similar circuits and as circuit elements in either experimental or permanent equipment.

DESCRIPTION: This resistor is an accurately-adjusted resistance card, sealed in a bakelite

case. Both screw-type and plug-type terminals are provided.

FEATURES: In the TYPE 500 Resistors both convenience and accuracy are combined. The terminal arrangement allows either permanent or temporary connections to be made in the simplest possible manner. Low temperature coefficient and excellent high-frequency characteristics make these resistors suitable for a wide variety of applications.

SPECIFICATIONS

Resistance: Nine standard values, as tabulated below, are stocked. Other values can be built to special order.

Accuracy of Adjustment: Each resistor is adjusted within $\pm 0.1\%$ of its stated value at the terminals of the unit, except the 1-ohm unit which is adjusted within $\pm 0.25\%$.

Frequency Characteristics: The table given on page 27 for the TYPE 510 Decade-Resistance Unit represents the behavior of the TYPE 500 Resistors quite accurately, particularly for the lower resistance units (up to 600 ohms). For the 1000- and 10,000-ohm units the errors are less than those tabulated for the TYPE 510, because of the relatively small shunt capacitance of an isolated resistor.

Maximum Power and Current: All units will dissipate one watt for a temperature rise of 40° Centigrade. The value of current for this rise is given in the table below and is engraved on each unit.

Temperature Coefficient: At normal room temperature, the temperature coefficient is less than $\pm 0.002\%$ per degree Centigrade.

Type of Winding: For resistances of less than 200 ohms Ayrton-Perry windings are used; for 200 ohms and higher values of resistance the winding is unifilar on mica cards.

Terminals: Both terminal screws and plugs are supplied, and both can be used. Each terminal stud is recessed as a jack to accommodate a plug. Standard $\frac{3}{4}$ -inch spacing is used.

Mounting: Each resistor is sealed in a case of black molded bakelite with an impregnating wax. Two mounting holes are provided.

Dimensions: (Length) $2\frac{3}{4}$ x (width) $1\frac{5}{16}$ inches. Over-all height, exclusive of plugs, 1 inch.

Net Weight: 2 ounces.

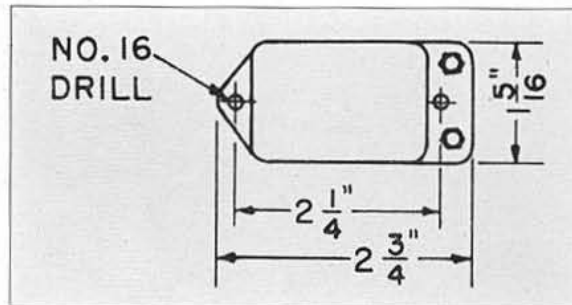

Type	Resistance	Maximum Current	Code Word	Price
500-A	1 ohm	1.0 a	RESISTBIRD	\$2.00
500-B	10 ohms	310 ma	RESISTDESK	2.00
500-C	50 ohms	140 ma	RESISTFORD	2.00
500-D	100 ohms	100 ma	RESISTFROG	2.00
500-E	200 ohms	70 ma	RESISTGIRL	2.00
500-F	500 ohms	45 ma	RESISTGOAT	2.00
500-G	600 ohms	40 ma	RESISTGOOD	2.00
500-H	1000 ohms	30 ma	RESISTHYMN	2.00
500-J	10,000 ohms	10 ma	RESISTMILK	2.00

RESIDUAL IMPEDANCES IN AIR CONDENSERS

As a continuously adjustable standard of impedance the variable air condenser approaches very closely the ideal circuit element. At audio and low-radio frequencies the residual components are usually negligible, and it is permissible to consider the condenser as having a pure, constant capacitance. However, for use in precise measurements of impedance, especially at high radio frequencies, it is necessary to take account of the small residual parameters.

In a variable air condenser these residual impedances are caused by: (1) losses in the solid dielectric material, (2) losses in the metallic structure, and (3) inductance in the leads and stack supports. An equivalent circuit representing a variable air condenser including these residual parameters is shown below.

The parameters, R , L , and G , are all essentially constant as a function of dial setting for TYPE 722 Precision Condensers. The dielectric conductance, G , may be considered as the sum of two components, one the d-c leakage conductance of the dielectric supports and the other a conductance corresponding to polarization losses in the supports. The first of these is constant as a function of frequency; the second increases approximately as the first power of the frequency. Except at very low frequencies (order of 5 cycles or less), the leakage conductance is negligible.

The metallic resistance, R , is essentially constant as a function of frequency for low frequencies and increases approximately as the square root of the frequency at frequencies sufficiently high so that skin effect is essentially complete (above 1 Mc).

The inductance, L , remains very closely constant as a function of frequency.

The metallic resistance, R , and the dielectric conductance, G , combine to cause a dissipative

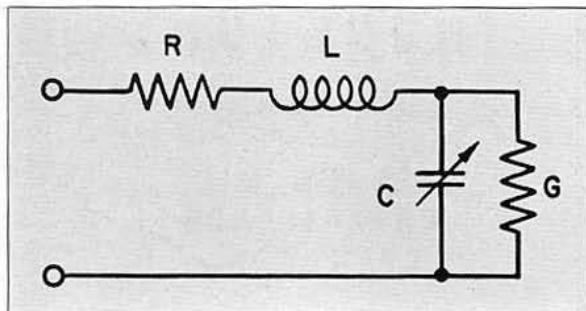

In this circuit the resistance, R , corresponds to losses in the metallic portions of the condenser; the conductance, G , corresponds to losses in the solid dielectric portions of the condenser; and the inductance, L , corresponds to magnetic flux set up by conduction currents in the metal portions of the condenser. The capacitance, C , represents the static capacitance of the condenser.

component approximately equivalent to a resistance

$$R_e = R + \frac{G}{(\omega C)^2}$$

in series with a perfect capacitance, or to a conductance

$$G_e = G + R(\omega C)^2$$

in parallel with a perfect capacitance.

The corresponding over-all dissipation factor is approximately

$$D = D_G + D_R = \frac{G}{\omega C} + R\omega C.$$

The residual inductance, L , causes the effective terminal capacitance, C_e , to depart from the static capacitance, C , according to the law

$$C_e = \frac{C}{1 - \omega^2 LC}.$$

At low frequencies the effect of the residual parameters, R and L , is negligible, and the condenser acts like a pure capacitance, C , in parallel with a conductance

$$G_e = G$$

or in series with a resistance

$$R_e = \frac{G}{(\omega C)^2}.$$

Under this condition

$$\frac{G}{\omega} = R_e \omega C^2 = DC = \text{constant}$$

where D is the dissipation factor due to dielectric loss. The numerical value of this constant is a convenient figure of merit to define the magnitude of the losses at low frequencies.

At high frequencies the other residual parameters become important. The losses in the metal parts of the condenser increase with frequency until they are first comparable to, and finally in excess of, the losses in the solid dielectric. At high frequencies it is, therefore, necessary to consider both components of loss.

A precision condenser is used normally under such conditions that the dissipation factor components, D_G and D_R , and the inductive error are small. The expressions for the effective terminal impedance and admittance of the condenser under these conditions are

$$Z_e = R_e - j \frac{1}{\omega C_e}$$

$$Y_e = G_e + j\omega C_e$$

TYPE 722 PRECISION CONDENSER

USES: The TYPE 722 Precision Condenser is a variable air condenser intended for use as a standard of capacitance.

It is widely used in a-c bridges both as a built-in standard and as an external standard for substitution measurements. It is also used as a tuning condenser in oscillators, frequency meters, and other instruments where accuracy and stability are important.

DESCRIPTION: The whole condenser assembly is mounted in a cast frame, which is used to give the unit rigidity. This frame, the stator rods and spacers, and the rotor shaft are made of alloys of aluminum which combine the mechanical strength of brass with the weight and temperature coefficient of aluminum. The condenser plates are of aluminum, so that all parts have the same temperature coefficient of linear expansion.

A worm drive is used in this condenser to obtain the desired precision of setting. In order to avoid the slight eccentricity which is almost inevitable when a worm gear is mounted on a shaft, the worm in the TYPE 722 Precision Condenser is cut directly on the shaft. The dial end of this worm shaft runs in ball bearings, while the other end is supported by an adjustable spring mounting. Ball bearings are used at both ends of the rotor shaft. Electrical connection to the rotor is made, not through the bearing, but by means of a phosphor-bronze brush running on a brass drum. This method assures a positive electrical contact.

A preliminary assembly of the frame, shaft, and gears is driven by a motor to grind in the gears before final assembly.

Interior view of the TYPE 722-D Precision Condenser.

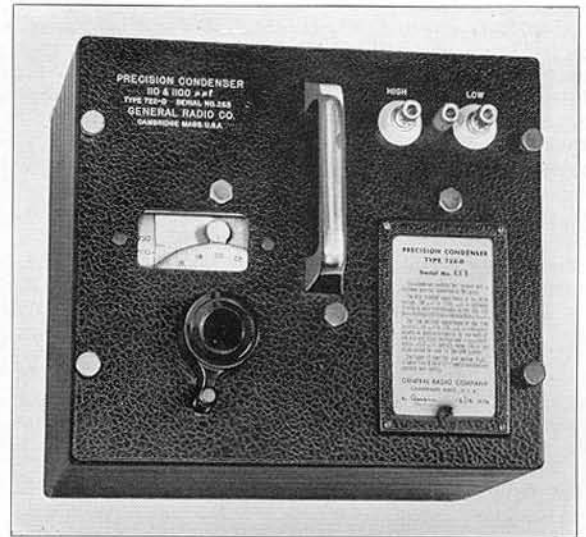
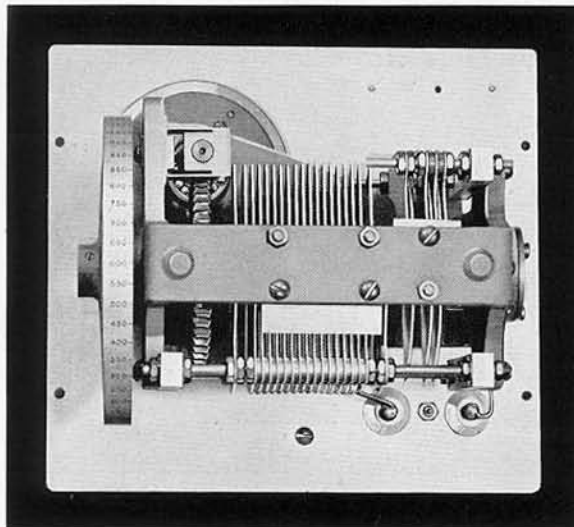

Panel view of the TYPE 722-D Precision Condenser.

FEATURES: Both the materials and the mechanical arrangement used in the TYPE 722 Precision Condenser have been carefully selected to give the instrument a high degree of stability under constant laboratory use. The entire mounting is extremely rigid, and the bearings and drive mechanism have been arranged so as to reduce the backlash to less than one-half a worm division, and to give an extremely small worm correction.

The temperature coefficient of capacitance has been kept low by using metal parts which all have the same temperature coefficient of linear expansion. In order to keep the dielectric losses low, a low-power-factor ceramic material is used for the solid dielectric, and the capacitance associated with it is kept very small. When it is desired to reduce the dielectric losses still further, quartz insulation may be used instead of the standard ceramic.

All models can be set to one part in 25,000 of full scale, a precision of setting which is more than adequate for most measurement uses. Standard calibrations are accurate to, and give an internal consistency of, $\pm 0.1\%$ of full scale. A more precise calibration with a worm correction can be supplied, giving corrections which permit an internal consistency of $0.1 \mu\mu\text{f}$. The absolute accuracy of capacitance differences, however, is limited to 0.1% by the accuracy of calibration, and the usable accuracy at the terminals may still be limited to approximately $1 \mu\mu\text{f}$ by the lack of a standard technique for connecting the condenser into a measuring circuit. (See *General Radio Experimenter*, Vol. XII, No. 8, January, 1938, for a complete discussion of connection errors.)

SPECIFICATIONS

Capacitance Range: Three stock models are available: TYPE 722-D, direct reading in capacitance over two ranges, 25 to 110 $\mu\mu\text{f}$, and 100 to 1100 $\mu\mu\text{f}$; TYPE 722-F, calibrated every worm half turn, 500 $\mu\mu\text{f}$ maximum; TYPE 722-M, intended for bridge-substitution measurements and direct reading in capacitance removed from the condenser over a range of 1000 $\mu\mu\text{f}$.

Rotor Plate Shape: Semicircular for all models, to give a linear capacitance characteristic.

Standard Calibration Accuracy: TYPE 722-D: The capacitance of the HIGH section, 100 to 1100 $\mu\mu\text{f}$, is indicated directly in micromicrofarads by the dial and drum readings within $\pm 1 \mu\mu\text{f}$. The capacitance of the LOW section, 25 to 110 $\mu\mu\text{f}$, is indicated directly in micromicrofarads by one-tenth of the dial and drum readings within $\pm 0.2 \mu\mu\text{f}$.

TYPE 722-F: The capacitance at every worm half turn is given in a mounted chart to 0.1 $\mu\mu\text{f}$, accurate within $\pm 0.5 \mu\mu\text{f}$. The capacitance differences between succeeding worm half turns is also given to 0.1 $\mu\mu\text{f}$, and is accurate to $\pm 1 \mu\mu\text{f}$.

TYPE 722-M: The capacitance at a reading of zero for the dial and drum is indicated on a small card mounted on the panel. This capacitance, about 1150 $\mu\mu\text{f}$ in magnitude, is given to 0.1 $\mu\mu\text{f}$ and is accurate within $\pm 1 \mu\mu\text{f}$. The condenser is adjusted to indicate directly in micromicrofarads the capacitance removed from the circuit to an accuracy of $\pm 1 \mu\mu\text{f}$.

These accuracies are indicated on the certificate or chart which accompanies each condenser.

Worm-Correction Calibration: Worm corrections can be supplied for all three models according to the price list. Mounted charts are supplied, which give the corrections to at least one more figure than the guaranteed accuracies, which are stated below.

TYPE 722-D: When this correction is used, the capacitance of either section can be determined within $\pm 0.1 \mu\mu\text{f}$ or $\pm 0.1\%$, whichever is the greater, and capacitance differences can be measured to an accuracy of $\pm 0.2 \mu\mu\text{f}$ or $\pm 0.1\%$, whichever is the greater, with the HIGH section; and $\pm 0.04 \mu\mu\text{f}$ or $\pm 0.1\%$, whichever is the greater, with the LOW section.

TYPE 722-F: The capacitance can be determined within $\pm 0.1 \mu\mu\text{f}$ or $\pm 0.1\%$, whichever is the greater. Capacitance differences can be measured within $\pm 0.1 \mu\mu\text{f}$ or $\pm 0.1\%$, whichever is the greater.

TYPE 722-M: Capacitance differences, in capacitance removed, can be measured within $\pm 0.2 \mu\mu\text{f}$ or $\pm 0.1\%$, whichever is the greater.

Maximum Voltage: All models, 1000 volts, peak.

Dielectric Supports: Two bars of steatite support the stator assembly, and conical bushings insulate the terminals from the panel. Quartz insulation can be supplied on special order. (See price list.)

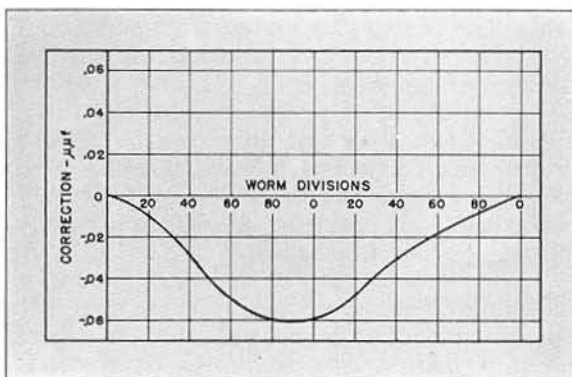

Plot of a typical worm correction for a TYPE 722-F Precision Condenser.

Dielectric Losses: The figure of merit, $R\omega C^2$, when measured at 1000 cycles is approximately 0.04×10^{-12} for steatite insulation and 0.003×10^{-12} for quartz.

Residual Parameters: The series inductance and the series metallic resistance are given in the following table:

Type	L	R
722-D		
high section	0.065 μh	0.02 Ω
low section	0.11 μh	0.03 Ω
722-F	0.055 μh	0.02 Ω
722-M	0.060 μh	0.02 Ω

Temperature Coefficient: The temperature coefficient of capacitance is approximately $+0.002\%$ per degree Centigrade, for small temperature changes.

Drive: A worm-and-gear drive is used. To reduce irregularities and backlash the worm is cut integral with the shaft. The backlash is less than one-half worm division (there are 250 divisions per worm turn for the TYPE 722-D and the TYPE 722-M; 200 divisions for the TYPE 722-F). If the desired setting is always approached in the direction of increasing scale reading, no calibration error from this cause will result.

Terminals: Jack-top binding posts are provided. Standard $\frac{3}{4}$ -inch spacing is used. The rotor terminal is connected to the panel and shield.

Mounting: The condenser is mounted on an aluminum panel finished in black crackle lacquer and enclosed in a shielded walnut cabinet. A wooden storage case with lock and carrying handle is included.

Dimensions: Panel, 8 x 9 $\frac{1}{8}$ inches; depth, 8 $\frac{1}{8}$ inches.

Weight: 10 $\frac{1}{2}$ pounds; 19 $\frac{3}{4}$ pounds with carrying case.

Type	Capacitance Range	Code Word	Price
722-F	45 to 500 $\mu\mu\text{f}$	CUBIT	\$85.00
722-D	25 to 110 $\mu\mu\text{f}$ and 100 to 1100 $\mu\mu\text{f}$, direct reading	CRUEL	110.00
722-M	0 to 1000 $\mu\mu\text{f}$, direct reading in capacitance removed from circuit...	COMIC	100.00
Worm-Correction Calibration for Types 722-F and 722-M		WORMY	35.00
Worm-Correction Calibration for Type 722-D		WORMY	50.00

When ordering, use compound code word, CUBITWORMY, etc.

QUARTZ INSULATION

Any TYPE 722 Precision Condenser can be obtained with quartz insulation.

	Code Word	Additional Price
Quartz Insulators.....	QUATZ	\$55.00

When ordering, use compound code word, CUBITQUATZ, etc.

TYPE 722-N PRECISION CONDENSER

FOR USE AT RADIO FREQUENCIES

USES: This condenser is a capacitance standard which has been designed particularly for use at radio frequencies in series- or parallel-resonance methods of impedance measurement. It is also useful as a variable capacitor in radio-frequency bridges.

DESCRIPTION: The frame, bearing, and drive mechanism of this condenser are identical with those used on the other TYPE 722 Precision Condensers. The rotor and stator leads, however, are not brought out in the conventional manner. In the TYPE 722-N Precision Condenser connection is made at the center of both plate stacks, spring-temper silver alloy brushes bearing on a silver-plated brass disc being used for the rotor connection.

FEATURES: The important features of this condenser are its low metallic resistance and low inductance. Both of these quantities are about one-third the magnitude of those in the TYPE 722-D Precision Condenser. The accuracy of calibration is as good and the dielectric losses

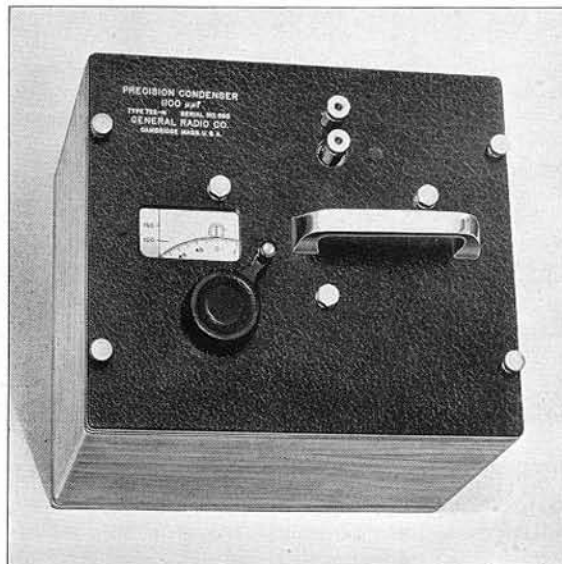

Panel view of the TYPE 722-N Precision Condenser.

nearly as low as in the other TYPE 722 Condensers.

SPECIFICATIONS

Capacitance Range: 100 to 1100 $\mu\mu\text{f}$, direct reading.

Rotor Plate Shape: Semicircular to give a linear capacitance characteristic.

Standard Calibration Accuracy: The capacitance, measured at 1000 cycles, is indicated directly in micromicrofarads by the dial and drum readings to $\pm 1 \mu\mu\text{f}$.

Worm-Correction Calibration: A worm correction can be supplied on special order. (See price list.) A mounted chart

is supplied giving the corrections to at least one more figure than the guaranteed accuracy stated below.

When this correction is used, the capacitance can be determined within $\pm 0.1 \mu\mu\text{f}$ or $\pm 0.1\%$, whichever is the greater, and capacitance differences can be measured to an accuracy of $\pm 0.2 \mu\mu\text{f}$ or $\pm 0.1\%$, whichever is the greater.

Dielectric Supports: Two bars of steatite support the stator assembly, and a third bar insulates the high terminal from the panel.

Dielectric Losses: The figure of merit, $R\omega C^2$, when measured at 1000 cycles, is approximately 0.05×10^{-12} . (See discussion on "Residual Impedances in Air Condensers" on page 40.)
Other Residual Parameters: The series metallic resistance is about 0.008 ohm at 1 megacycle and increases directly as the square root of the frequency. The dielectric and metallic losses are approximately equal at a setting of 1000 $\mu\mu\text{f}$ and a frequency of 1 Mc.

The series inductance is approximately 0.024 μh . The increase in capacitance caused by this inductance reaches 10% at a setting of 1000 $\mu\mu\text{f}$ and a frequency of 10 Mc.

At smaller capacitance settings the effects of residual parameters are less. The equal division of losses occurs at 20 Mc for a setting of 100 $\mu\mu\text{f}$ and the 10% capacitance rise occurs at 30 Mc for the same setting.

Maximum Voltage: 1000 volts, peak.

Temperature Coefficient: Approximately $+0.002\%$ per degree Centigrade, for small temperature changes.

Mounting: The condenser is mounted on an aluminum panel finished in black crackle lacquer and enclosed in a shielded walnut cabinet. A wooden storage case with lock and carrying handle is included.

Dimensions: Panel, 8 x 9 $\frac{1}{2}$ inches; depth, 8 $\frac{1}{8}$ inches.

Net Weight: 11 $\frac{1}{4}$ pounds; 20 $\frac{1}{2}$ pounds with carrying case.

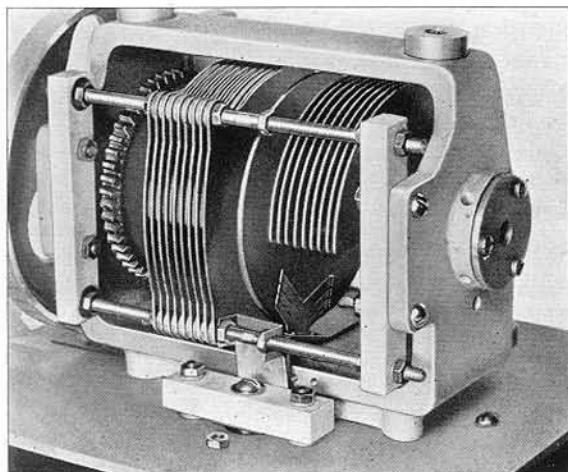

Interior photograph of a TYPE 722-N Precision Condenser with half the stator removed, showing the leads and the method of connection to the rotor.

Type	Code Word	Price
722-N	BOXER	\$150.00
Worm-Correction Calibration	WORMY	35.00

When ordering, use compound code word, BOXERWORMY.

TYPE 568 VARIABLE AIR CONDENSER

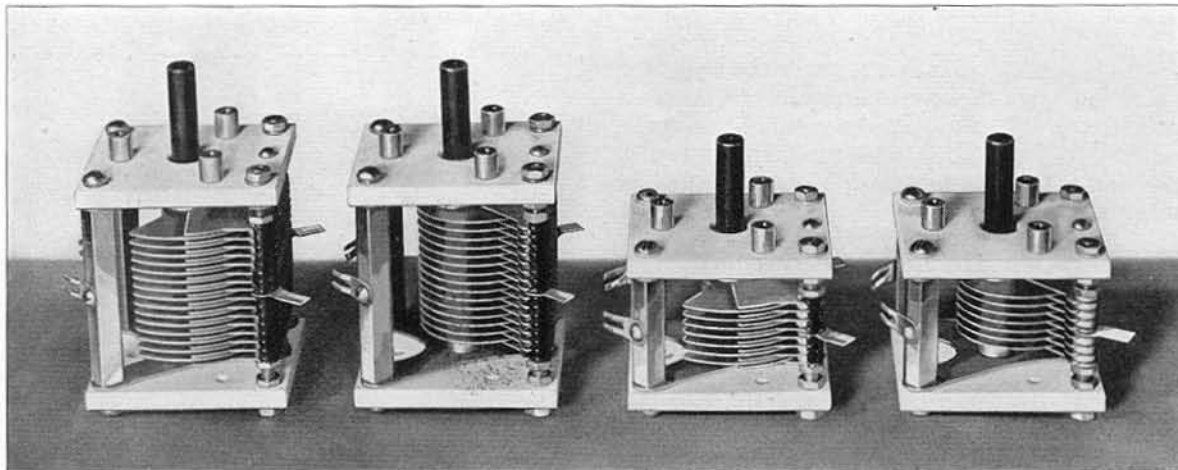

USES: The TYPE 568 Variable Air Condenser has been designed for use as a tuning element in high-frequency receivers, transmitters, wave-meters, and experimental circuits.

DESCRIPTION: The rotor and stator stacks are each made up of several brass plates soldered into a single unit. The terminals are brought out at the center of the stacks to reduce inductance and resistance and to improve the

high-frequency characteristics. Contact to the rotor is made through a conical bearing kept under heavy spring pressure.

FEATURES: This condenser is specifically designed for high-frequency work. The losses are low and the terminal arrangement is convenient where short leads are necessary. The shaft arrangement allows several units to be ganged for tandem operation.

SPECIFICATIONS

Capacitance Range: Four stock models are available as listed below.

Dielectric Losses: The figure of merit, $R\omega C^2$, is approximately 0.03×10^{-12} .

Plate Shape: Straight-line capacitance for TYPES 568-D and 568-E; approximately straight-line frequency for TYPES

568-K and 568-L, with a frequency ratio of approximately 3:1.

Supports: End plates are of isolantite treated to prevent moisture absorption.

Maximum Voltage: 500 volts, peak.

Knobs: None supplied.

Rotation Angle: 180° for TYPES 568-D and 568-E, 270° for TYPES 568-K and 568-L.

Mounting: See accompanying sketch. Drilling template and 3 flat-head screws are furnished.

Terminals: Soldering lugs are provided. These are brought out from the centers of the plate stacks and of the main posts connected to the rotor.

Shaft: $\frac{3}{8}$ -inch bakelite rod. The shaft is removable, and when several units are ganged, a single long shaft can be used.

Dimensions: See accompanying sketch. Depth (dimension A) is $2\frac{1}{16}$ inches for TYPES 568-D and 568-K, and $3\frac{1}{16}$ inches for TYPES 568-E and 568-L.

Net Weight: $\frac{3}{4}$ pound for TYPES 568-D and 568-K; 1 pound for TYPE 568-L; $1\frac{1}{4}$ pounds for TYPE 568-E.

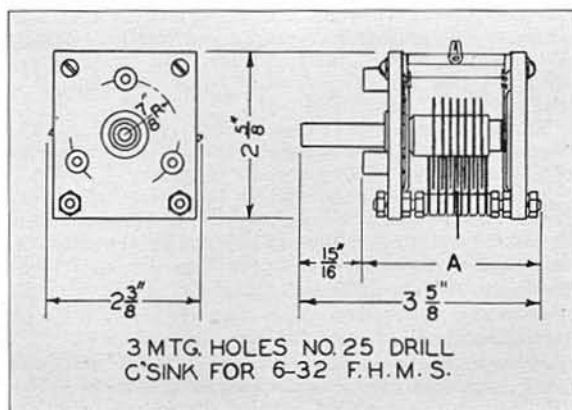

Nominal Capacitance

Type	Maximum	Minimum	Code Word	Price
568-D	175 $\mu\mu\text{f}$	13 $\mu\mu\text{f}$	CLOVE	\$4.50
568-E	360 $\mu\mu\text{f}$	18 $\mu\mu\text{f}$	CLOWN	7.00
568-K	50 $\mu\mu\text{f}$	11 $\mu\mu\text{f}$	CLOUD	4.50
568-L	100 $\mu\mu\text{f}$	14 $\mu\mu\text{f}$	CAGED	7.00

TYPE 539 VARIABLE AIR CONDENSER



TYPE 539-A Condenser.

USES: The TYPE 539 Variable Air Condenser is a general-purpose unit which can be used in experimental circuits or built into standard

instruments. Many manufacturers, including the General Radio Company, have used these condensers as the variable capacitances in bridges, beat-frequency oscillators, standard-signal generators, and other measuring equipment. Different plate shapes are available for different applications, and one model is available with an insulated rotor so that both rotor and stator may be above ground potential.

DESCRIPTION: Three brass rods, extensions of which serve as mounting pillars, rigidly support the two end plates. On each end plate is mounted a ceramic block, which carries the two rods to which the stator is attached. This method of mounting insures low losses and facilitates the use of special plate shapes.

In the mounted models, which are supplied only with semicircular plates, a 100-division dial, using a friction-drive vernier, is provided. Capacitance calibrations can be furnished to order on these units.

FEATURES: This condenser is a rugged and stable unit which is also low in price. The mechanical design is such that it may very easily be built into other instruments, and the fact that special plate shapes are available makes it very adaptable for use in oscillators, signal generators, and similar apparatus.

SPECIFICATIONS

Capacitance Range: Five unmounted and three mounted models having the nominal capacitances listed on the next page are stocked.

Calibration: No calibration is normally supplied with any of the units, but the mounted models carry an engraved nameplate which gives the actual maximum and minimum capacitance, accurate within 0.5% of full scale.

On special order a mounted calibration curve, accurate within 0.5% of full scale, or a calibration table for 11 points, accurate within 0.5% of full scale, can be supplied for the mounted models. (See the price list on the next page.)

Dielectric Losses: The figure of merit, $R\omega C^2$, is approximately 0.04×10^{-12} .

Insulated Rotor Model (Type 539-TA): Direct capacitance between rotor and stator is given in the price list. The power factor of this capacitance is less than 0.00002. The capacitance between rotor and frame is $24 \mu\mu\text{f}$; that between stator and frame is $12 \mu\mu\text{f}$.

Plate Shape: Semicircular rotor plates giving linear capacitance variation with setting are used on TYPES 539-J, 539-K, and 539-L and on all mounted models.

Rotor plates for TYPES 539-T and 539-TA are cut to give a linear frequency variation with setting over 255° of a possible 270° angle of rotation when a capacitance of $25 \mu\mu\text{f}$ is connected in parallel with the condenser. The ratio of maximum to minimum frequency thus obtained is approximately 3:1.

Maximum Voltage: TYPE 539-J is rated at 1100 volts peak; TYPE 539-K at 800 volts, peak; and TYPES 539-L, 539-T, and 539-TA at 550 volts, peak.

Knobs and Dials: Mounted models are furnished with friction drive dials having 100 divisions in 180° , but none is supplied with the unmounted models. Note that all models have $\frac{3}{8}$ -inch shafts and that TYPES 539-T and 539-TA require a scale spread over 270° , instead of the 180° required by the other types.

Terminals: On unmounted models, soldering lugs are mounted on the lower ceramic support. The rotor connection for TYPE 539-TA is brought out through an insulantite bushing in the rear end plate. Mounted models have jack-top binding posts mounted on the panel.

Mounting: TYPES 539-A, 539-B, and 539-C are mounted on an aluminum panel and enclosed in a shielded walnut cabinet. All other models are unmounted.

Dimensions: Unmounted models, see accompanying outline drawing; depth behind panel (A) 6 inches, over-all.

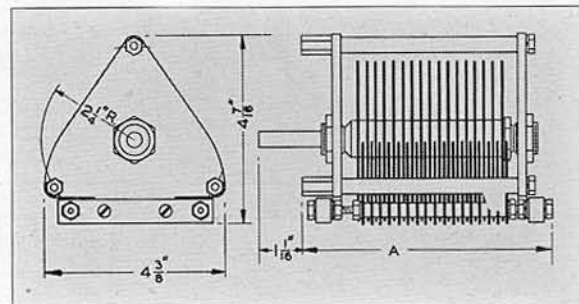

Mounted models, panel, 6½ x 6½ inches; height, 8¾ inches, over-all. **Net Weight:** Approximately 2¾ pounds for unmounted models; 7 pounds for mounted models.

UNMOUNTED MODELS

Type	Nominal Capacitance		Plate Shape	Code Word	Price
	Maximum	Minimum			
539-J	500 $\mu\mu\text{f}$	40 $\mu\mu\text{f}$	Straight-line Capacitance	DISCONTINUED	
539-K	1000 $\mu\mu\text{f}$	40 $\mu\mu\text{f}$	Straight-line Capacitance	ATONE	\$11.00
539-L	2000 $\mu\mu\text{f}$	40 $\mu\mu\text{f}$	Straight-line Capacitance	DISCONTINUED	
539-T	500 $\mu\mu\text{f}$	30 $\mu\mu\text{f}$	Straight-line Frequency	DISCONTINUED	
539-TA	500 $\mu\mu\text{f}$	18 $\mu\mu\text{f}$	Straight-line Frequency, Insulated Rotor	DISCONTINUED	

MOUNTED MODELS

Type	Nominal Capacitance		Code Word	Price
	Maximum	Minimum		
*539-A	500 $\mu\mu\text{f}$	50 $\mu\mu\text{f}$	DISCONTINUED	
*539-B	1000 $\mu\mu\text{f}$	55 $\mu\mu\text{f}$	ASSET	\$23.00
*539-C	2000 $\mu\mu\text{f}$	60 $\mu\mu\text{f}$	DISCONTINUED	
Mounted Calibration Curve			CURVE	4.00
11-point Calibration Table			CHART	3.50

*Calibrations supplied only when ordered. Use compound code words, ASSAYCHART, ASSETCHART, or ASTERCHART. PATENT NOTICE. See Note 17, page vi.

TYPE 368 VARIABLE AIR CONDENSER

USES: The TYPE 368 Variable Air Condenser is useful as an auxiliary balancing or trimmer condenser in bridges, oscillators, and similar equipment. It is also used as a tuning or trimmer condenser in high-frequency receivers.

DESCRIPTION: Soldered brass plates are used in this condenser. The stator is mounted on a single isolantite end plate. An angle bracket is provided so that the condenser can be mounted either on a baseboard or on a panel.

FEATURES: The TYPE 368 Variable Air Condenser is compact and easy to mount. It has extremely low losses and low minimum capacitance.

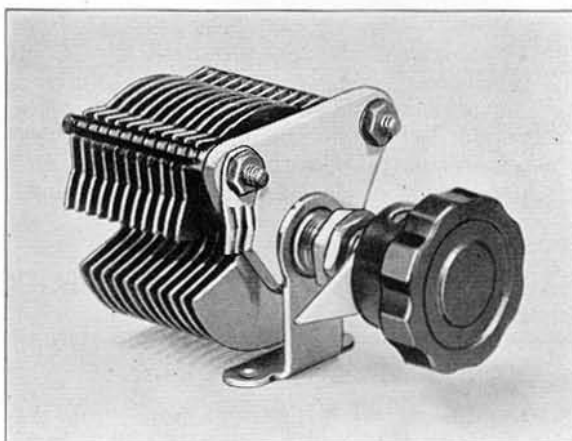

SPECIFICATIONS

Capacitance Range: Three stock models are available as listed below.

Plate Shape: All models have straight-line-capacitance plates.

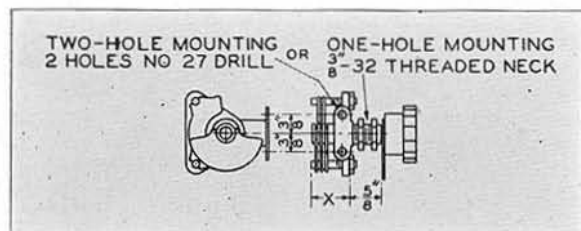

Dielectric Losses: The figure of merit, $R\omega C^2$, is approximately 0.004×10^{-12} .

Support: A single, isolantite end plate supports the entire assembly.

Maximum Voltage: 500 volts, peak.

Knob: TYPE 637-A Knob is supplied with all units.

Terminals: A soldering lug is provided as a stator terminal. Contact to the rotor is made through the angle bracket or shaft bushing.

Mounting: A bushing is provided for single-hole panel mounting, and a bracket is provided for baseboard mounting. (See accompanying sketch.)

Dimensions: See accompanying sketch. Depth (dimension X) is given in the table below.

Net Weight: TYPE 368-A, 2¾ ounces; TYPE 368-B, 3½ ounces; TYPE 368-C, 4½ ounces.

Type	Capacitance		Depth (X)	Code Word	Price
	Maximum	Minimum			
368-A	15 $\mu\mu\text{f}$	2 $\mu\mu\text{f}$	1¼ in.	BULLY	\$.90
368-B	50 $\mu\mu\text{f}$	3 $\mu\mu\text{f}$	1½ in.	BURIN	1.00
368-C	100 $\mu\mu\text{f}$	4 $\mu\mu\text{f}$	1½ in.	AZURE	1.50

TYPE 509 STANDARD CONDENSER

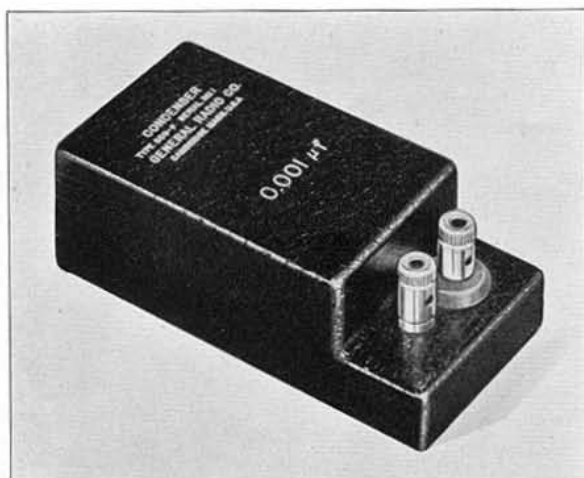

USES: These condensers are fixed standards of capacitance for laboratory use. When they are used in conjunction with a TYPE 722-D or a TYPE 722-M Precision Condenser in a parallel substitution method of measurement, precise measurements of capacitance up to several microfarads can be made. For condenser

manufacturers who maintain a capacitance standardization laboratory, a set of TYPE 509 Condensers, used with a TYPE 716-B Capacitance Bridge, is recommended.

DESCRIPTION: Each TYPE 509 Standard Condenser consists of two TYPE 505 Condenser Units which have been put through an additional aging process. The final accuracy and stability are thus increased markedly. The units are mounted in cast aluminum cases and are furnished with jack-top binding posts.

FEATURES: In addition to being very accurately adjusted and stable, the TYPE 509 Standard Condenser is a compact plug-in unit which can be used with extreme convenience. The terminals are so arranged that several units may be stacked one upon the other without using leads. There is no cumulative connection error* when the condensers are so stacked, so that these units can be used in parallel in much the same way that precision gauges are added in mechanical measurements.

*See R. F. Field, "Connection Errors in Capacitance Measurement," *General Radio Experimenter*, January, 1938.

SPECIFICATIONS

Capacitance: Ten stock units are available as listed below.

Accuracy of Adjustment: Each condenser is carefully adjusted within 0.25% of the nominal capacitance value engraved on the case.

Accuracy of Calibration: After each condenser has been aged, adjusted, and mounted, its capacitance is measured as carefully as possible, and the value of capacitance, accurate within 0.1%, is entered on a certificate of calibration which is packed with each unit.

Stability: Over reasonable periods of time (e.g., one year) each condenser will maintain its calibrated value within 0.1%.

Temperature Coefficient: Less than +0.01% per degree Centigrade between 10° and 50° Centigrade.

Power Factor: The power factor of all units, when measured at 1000 cycles and 25° Centigrade, is less than 0.05%.

Frequency Characteristics: The frequency characteristics of these units are similar to those of the TYPE 505 Condenser. (See page 48.)

Leakage Resistance: The leakage resistance, when measured at 500 volts, is greater than 100,000 megohms except for

the TYPES 509-U, 509-X, and 509-Y. In these units the resistance is greater than 50,000, 20,000, and 10,000 megohms, respectively.

Maximum Voltage and Frequency: The maximum peak voltage is 500 volts, at frequencies below the limiting frequencies tabulated below. At higher frequencies the allowable voltage decreases and is inversely proportional to the square root of the frequency. These limits correspond to a temperature rise of 40° Centigrade.

Mounting: Cast aluminum cases are used.

Terminals: Two jack-top binding posts spaced $\frac{3}{4}$ of an inch apart are mounted on the case. One terminal is grounded, and the other one is insulated by means of a low-loss bakelite bushing.

Dimensions: Small case, (length) $4\frac{7}{8}$ inches x (width) $2\frac{1}{2}$ inches x (height) $1\frac{3}{8}$ inches, over-all. Large case, (length) 6 inches x (width) $3\frac{3}{8}$ inches x (height) $2\frac{3}{8}$ inches, over-all.

Net Weight: TYPES 509-F, -G, $1\frac{1}{4}$ pounds; TYPES 509-K, -L, -M, $1\frac{3}{8}$ pounds; TYPES 509-R, -T, $2\frac{5}{8}$ pounds; TYPE 509-U, $2\frac{3}{4}$ pounds; TYPE 509-X, $3\frac{1}{4}$ pounds; TYPE 509-Y, $3\frac{5}{8}$ pounds.

Type	Capacitance	Peak Volts	Frequency	Case	Code Word	Price
509-F	0.001 μ f	500	2500 kc	Small	GOODCONBOY	\$12.50
509-G	0.002 μ f	500	1250 kc	Small	GOODCONBUG	12.50
509-K	0.005 μ f	500	500 kc	Small	GOODCONCAT	12.50
509-L	0.01 μ f	500	250 kc	Small	GOODCONDOG	12.50
509-M	0.02 μ f	500	125 kc	Small	GOODCONEYE	15.00
509-R	0.05 μ f	500	80 kc	Large	GOODCONPIG	18.00
509-T	0.1 μ f	500	40 kc	Large	GOODCONROD	22.00
509-U	0.2 μ f	500	20 kc	Large	GOODCONINS	25.00
509-X	0.5 μ f	500	8 kc	Large	GOODCONSUM	32.00
509-Y	1.0 μ f	500	4 kc	Large	GOODCONTOP	48.00

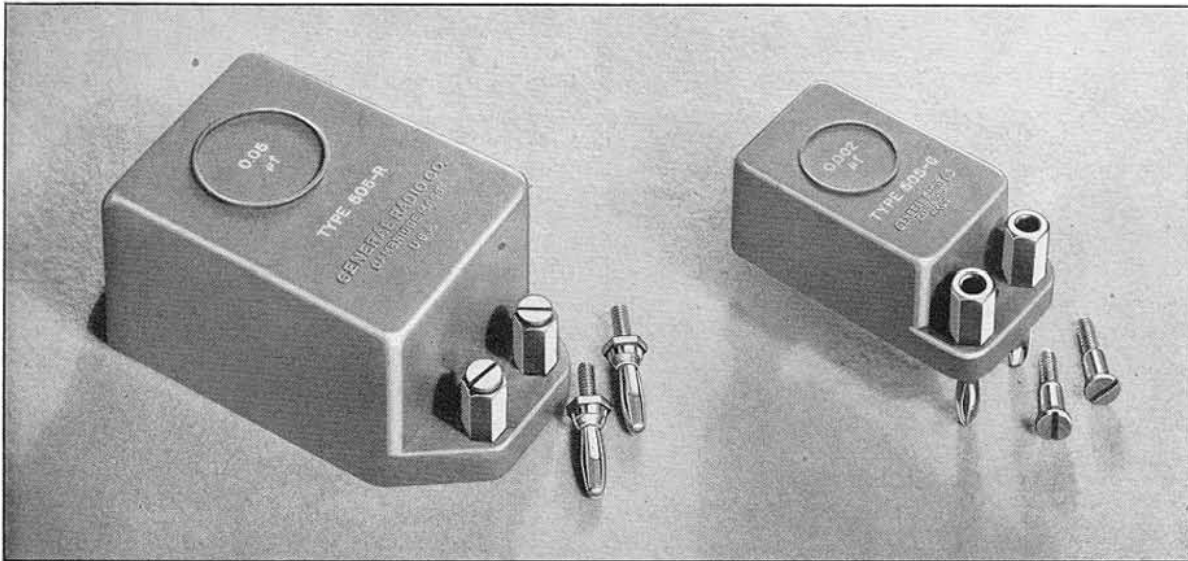

TYPE 505 CONDENSER

USES: The TYPE 505 Condensers are convenient and accurate plug-in units which can be used as secondary laboratory standards and circuit elements in all types of equipment. An assortment of various sizes is indispensable to any communications laboratory.

DESCRIPTION: The condenser unit, consisting of a mica and foil pile, is held by a heavy metal clamp. This unit is placed in the low-loss bakelite case and surrounded by silica gel and ground cork. The clamp is not connected to either condenser terminal but is left floating. The whole unit is covered with paper and sealed with wax.

FEATURES: In addition to being small, convenient and accurate, the TYPE 505 Condenser has excellent stability and very low losses. India

mica has been chosen because of its electrical characteristics, and the mounting method used makes the capacitance practically independent of temperature and the power factor independent of humidity. Every piece of mica is inspected for mechanical defects and other imperfections, which might cause large dielectric losses.

Each unit is carefully aged to increase stability and is heated to eliminate moisture before sealing. Silica gel in the case absorbs any moisture which may collect on the condenser after it is in use for some time.

Low-loss (yellow) bakelite cases are used to insure low power factor and low leakage conductance. The plug-type terminals permit the condensers to be stacked in parallel and so built up to any required value of capacitance.

SPECIFICATIONS

Capacitance: The sizes listed in the price list are available from stock.

Accuracy of Adjustment: All units are adjusted within 1% or 10 micromicrofarads, whichever is the larger.

Temperature Coefficient: The temperature coefficient of capacitance is less than +0.01% per degree Centigrade between 10° and 50° Centigrade.

Frequency Characteristics: The effective terminal capacitance is essentially constant over a wide frequency range. At very low frequencies a very slight rise in capacitance occurs because of dielectric absorption. At high frequencies a rise is caused by a residual inductance of about 0.055 μ h which is effectively in series with the condenser. The effect of this inductance on the capacitance of several TYPE 505 Condensers is shown in the accompanying plot.

Power Factor: The power factor of all units, except the three smallest sizes, measured at 1000 cycles and at 25° Centigrade, is less than 0.05%. Because of the increasing effect of the losses in the bakelite case on the power factor as the capacitance decreases, the power factor, at 1000 cycles and 25° Centigrade, of the TYPES 505-A, 505-B, and

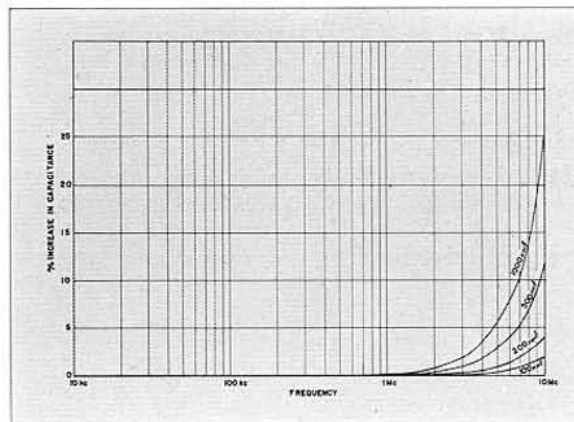

This shows the increase in capacitance at high frequencies which is caused by the series inductance of the condenser terminals and leads.

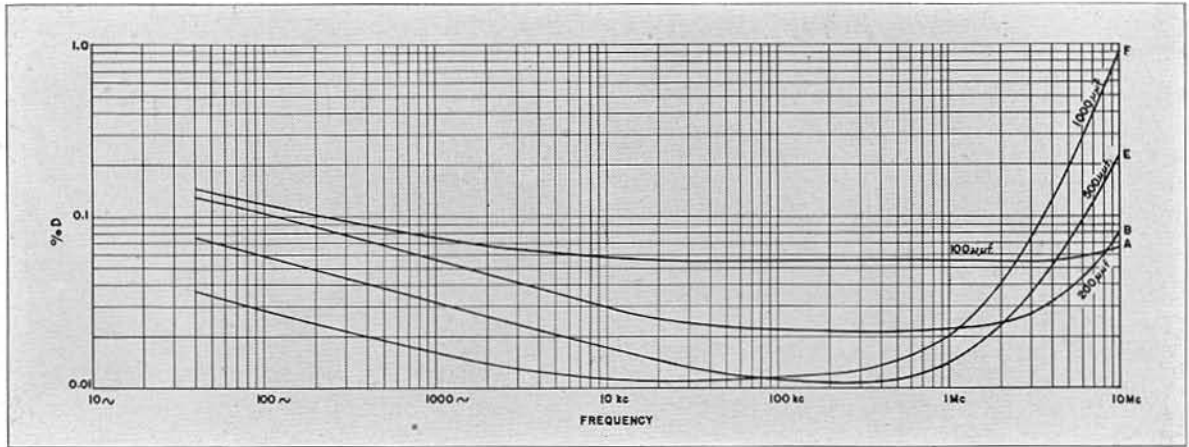

Dissipation factor of TYPE 505 Condensers as a function of frequency.

505-E is less than 0.1%, 0.08%, and 0.06%, respectively. A change of about +5% of its value occurs in the power factor for a temperature rise of 1° Centigrade.

The changes in power factor with frequency are shown, for some sample condensers, in the accompanying plot. At very low frequencies, the rise in power factor is caused by losses due to dielectric absorption. At the high frequencies the rise is caused by the effect of the series resistance in the leads and terminals. This resistance, practically independent of capacitance, varies as the square root of the frequency because of skin effect and is about 0.03 ohm at 1 megacycle and about 0.1 ohm at 10 megacycles. The effect of this resistance on the power factor is increased as the capacitance increases.

Leakage Resistance: The leakage resistance, when measured at 500 volts, is greater than 100,000 megohms.

Maximum Voltage and Frequency: The maximum peak voltage which the condensers will safely withstand is 500

volts for all but the two smallest units, which will withstand 700 volts peak. As the frequency of a constant applied voltage increases, the power dissipated in the unit also increases. If an a-c voltage, whose maximum value equals the allowable peak voltage previously specified, is applied to the condensers, the following table shows the maximum allowable frequency. This table is based on the ability of the units to dissipate 1 watt. For higher frequencies the allowable voltage decreases and is inversely proportional to the square root of the frequency.

Type	Frequency
505-A	2000 kc
505-B	1000 kc
505-E	980 kc
505-F	800 kc
505-G	400 kc
505-K	160 kc
505-L	80 kc
505-M	40 kc
505-R	40 kc
505-T	20 kc
505-U	10 kc
505-X	4 kc

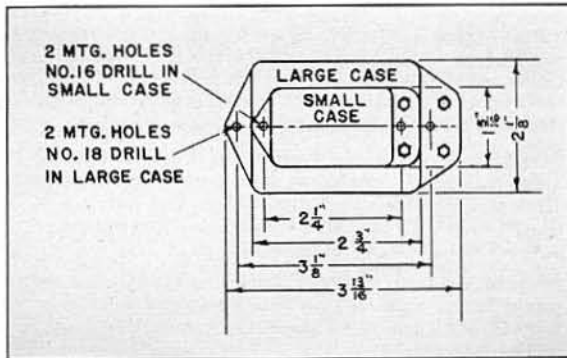

Terminals: Screw terminals spaced 3/4 inch apart. Two TYPE 274-P Plugs are supplied with each condenser so that it may be converted to a plug-terminal model.

Mounting: Low-loss (yellow) bakelite cases.

Dimensions: See sketch. Over-all height, 1 3/8 inches for large case, 1 inch for small case, exclusive of plugs.

Net Weight: 4 ounces.

Type	Capacitance	Code Word	Price
505-A	100 µmf	CONDENALLY	\$3.50
505-B	200 µmf	CONDENBELL	3.50
505-E	500 µmf	CONDENCOAT	3.50
505-F	0.001 µf	CONDENDRAM	3.50
505-G	0.002 µf	CONDENEYRE	3.50
505-K	0.005 µf	CONDENFACT	4.00
505-L	0.01 µf	CONDENGIRL	4.50
505-M	0.02 µf	CONDENHEAD	5.50
*505-R	0.05 µf	CONDENCALM	6.50
*505-T	0.1 µf	CONDENCROW	7.50
*505-U	0.2 µf	CONDENWIPE	12.00
*505-X	0.5 µf	CONDENWILT	20.00

*Mounted in large case.

TYPE 219 DECADE CONDENSER

USES: The TYPE 219 Decade Condensers find uses in every laboratory as tuned circuit elements, bridge impedances, filter elements, or as components of any circuit where a wide-range variable condenser is necessary.

DESCRIPTION: The TYPE 219 Decade Condensers are assemblies of three TYPE 380 Decade-Condenser Units mounted in a shielded cabinet. Each decade has eleven positions, 0 to 10 inclusive, so that the decades overlap. A positive detent mechanism allows the switch to be set accurately.

FEATURES: The TYPE 219 Decade Condensers are direct-reading units covering a wide range of capacitance values. Although not designed as standards, their accuracy is sufficient for most laboratory work. The zero capacitance has been kept at a minimum and its value is marked on each box for ready reference. By employing mica condensers on all decades except the 0.1-microfarad decade of the TYPE 219-M, the power factor has also been held low.

TYPE 219-K uses mica dielectric throughout and has many uses where the comparatively higher losses of paper condensers cannot be tolerated.

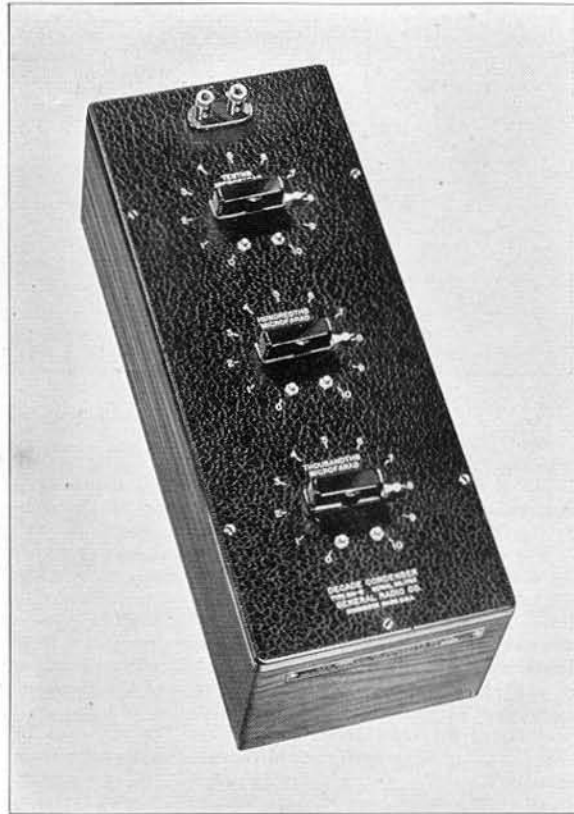

SPECIFICATIONS

Accuracy: All units are accurate at the decade terminals within 1%, except the 0.1-microfarad decade of the TYPE 219-M which is within 2%. To obtain these accuracies at the box terminals, account must be taken of the effective zero capacitance of the box, which is made up of the true zero capacitance and the mutual capacitance between units. The values for the different boxes follow:

Type	Effective Zero Capacitance
219-K	35 μf
219-M	30 μf

These values are engraved on the Instruction Plate on every box.

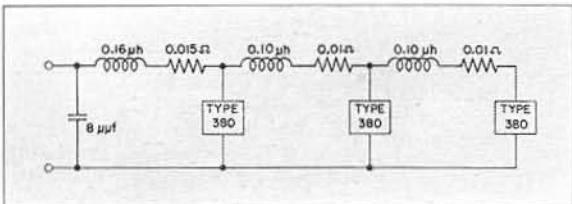

Residual impedances in the TYPE 219 Decade Condenser.

Power Factor: The power factor for the individual decades is given in the specifications for the TYPE 380 Decade-Condenser Units. For the three lowest steps of the thousandths-microfarad decades, the tabulated values will be exceeded because of losses in the zero capacitance.

Maximum Voltage and Frequency: These values for the different decades are given in the specifications for the TYPE 380 Decade-Condenser Units. The limiting values for the different TYPE 219 Decade Condensers are engraved on the Instruction Plate for each box.

Frequency Characteristics: The variation in capacitance and power factor with frequency is similar to that shown on page 51 for TYPE 380 Decade-Condenser Units, modified by the characteristics of the wiring, constants for which are shown in the accompanying sketch.

Terminals: Standard jack-top binding posts with a 3/4-inch spacing are used. The shield is connected to the "G" terminal.

Mounting: The decades are assembled on an aluminum panel and mounted in a shielded walnut cabinet.

Dimensions: TYPES 219-K and 219-M, (length) 13 3/4 x (width) 5 1/2 x (height) 5 3/4 inches.

Net Weight: TYPE 219-K, 10 3/4 pounds; TYPE 219-M, 8 5/8 pounds.

Type	Capacitance	No. of Dials	Type 380 Decades Used	Code Word	Price
219-K	1.110 μf in 0.001 μf steps	3	F, M, N	CROSS	\$90.00
219-M	1.110 μf in 0.001 μf steps	3	L, M, N	BRIER	45.00

TYPE 380 DECADE-CONDENSER UNIT

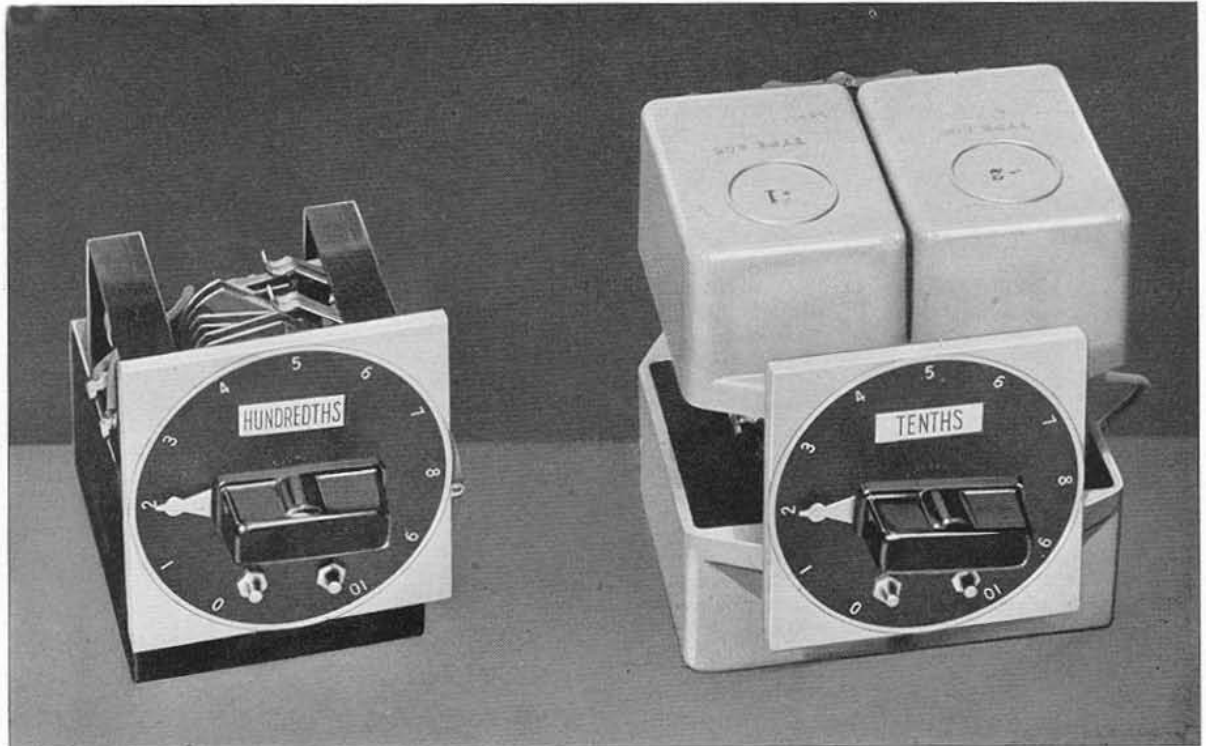

TYPE 380-M.

TYPE 380-F.

USES: The TYPE 380 Decade-Condenser Units are extremely useful as elements in tuned circuits, wave filters, and other experimental or permanent equipment where a rather large variable capacitance is desired. They are also useful in oscillators, analyzers, amplifiers, and similar apparatus, especially during the preliminary design period when exact values for different capacitances are to be determined by experiment.

DESCRIPTION: Each decade is an assembly of four individual mica or paper condensers. A selector switch is arranged to make parallel combinations of the units so that any one of ten values may be obtained.

The switch is of rigid construction and carries a detent mechanism for positive location of the switch positions. A bakelite shaft is used and contact is made by means of cams bearing on phosphor-bronze springs. A brass shaft bushing is molded in. This switch together with dial plate and knob is available separately as the TYPE 380-P3. (See price list.)

All standard units are furnished complete with knob, photo-etched dial plate, and stops.

FEATURES: The TYPE 380 Decade-Condenser Units are carefully aged and assembled so as to be stable and rugged. The smaller decades consist of molded mica condensers while the mica 0.1-microfarad decade employs TYPE 505 Condensers. The paper condensers that are

used are thoroughly impregnated with molten ceresin during winding. A non-inductive type of winding is used, with the foil projecting at each end of the roll, thus avoiding the large increases in power factor and effective capacitance which occur at high frequencies when only the ends are connected.

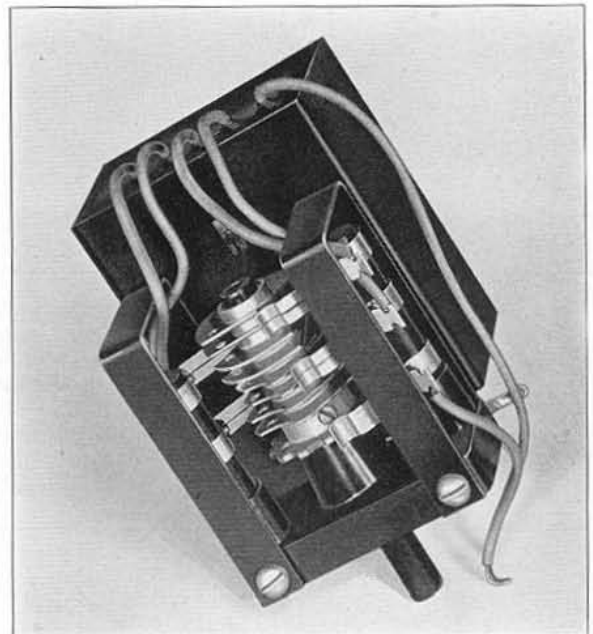

Rear View of TYPE 380-M.

SPECIFICATIONS

Accuracy: All units are within 1% when measured at 1000 cycles except the TYPE 380-L, which is accurate within 2%. The units are checked with the switch mechanism high, electrically, and the common lead and case grounded.

Dielectric: The TYPE 380-F is made up of TYPE 505 Condensers which have mica as the dielectric. The TYPE 380-L uses ceresin-impregnated linen-paper condenser units while the TYPE 380-M and TYPE 380-N use mica condensers molded in bakelite cases.

Power Factor: The power factor of the different units, when measured at 1000 cycles and 25° Centigrade, will be less than the values in the following table, with the exception of the three lowest settings of the TYPES 380-M and 380-N. Here, because of the losses in the switch and mounting, the tabulated power factor may be exceeded by a slight amount.

Type	Power Factor
380-F	0.05 %
380-L	1.0 %
380-M	0.1 %
380-N	0.25 %

Frequency Characteristics: The variation of capacitance and power factor with frequency is shown in the accompanying plots. The rise in capacitance at low frequencies is caused by interfacial polarization in the dielectric, that at high frequencies by series inductance. The dissipation factor rises at low frequencies because of the loss in the dielectric; and at high frequencies because of series metallic resistance.

Maximum Voltage and Frequency: The maximum peak voltage which the units will safely withstand is 300 volts with the exception of the TYPE 380-F which will withstand 500 volts. As the frequency of the applied voltage increases, the current increases and more power must be dissipated by the unit. In order that this power does not become excessive, the frequencies listed here must not be exceeded when peak voltages equal to the maxima just specified are

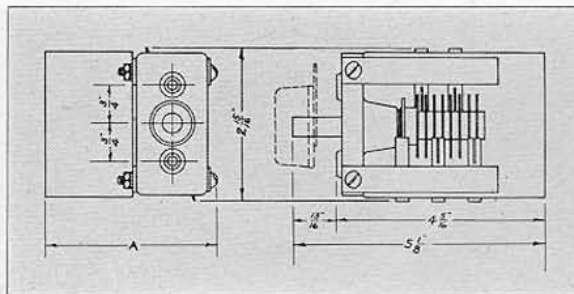

Over-all dimensions of TYPES 380-L, -M, and -N Decade-Condenser Units; dimension A is 3 5/16 inches. While TYPE 380-F uses the same switch mechanism, condensers are mounted on both sides of the switch and the panel space required is 4 3/4 x 4 1/4 inches.

applied. For higher frequencies the maximum safe voltage decreases and is inversely proportional to the square root of the frequency.

Type	Frequency
380-F	5 kc
380-L	1 kc
380-M	100 kc
380-N	1000 kc

Terminals: Flexible, rubber-insulated leads are provided.

Mounting: Machine screws for attaching the decade to a panel are supplied.

Dimensions: TYPE 380-F, panel space, 4 3/4 x 4 1/4 inches; behind panel, 4 inches. TYPES 380-L, 380-M, and 380-N, see accompanying sketch.

Net Weight: TYPE 380-F, 3 pounds, 12 ounces; TYPES 380-L and 380-M, 1 1/2 pounds; TYPE 380-N, 1 pound, 6 ounces.

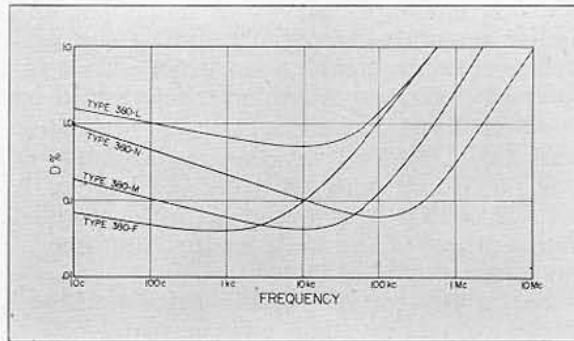
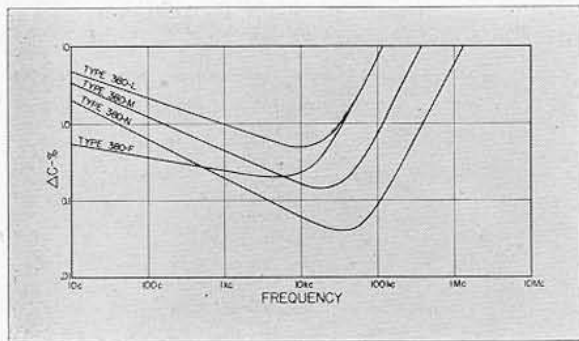

(Left) Change in capacitance as a function of frequency. The capacitance curves are referred to the value the condenser would have if there were no interfacial polarization and no series inductance. Since the condensers are adjusted to their rated accuracy at 1000 cycles, the 1000-cycle value on the plots should be used as a basis of reference in estimating the frequency error.

(Right) Dissipation factor as a function of frequency.

Type	Capacitance	Code Word	Price
380-F	1.0 μf in 0.1 μf steps	ACUTE	\$58.00
380-L	1.0 μf in 0.1 μf steps	ADAGE	10.00
380-M	0.1 μf in 0.01 μf steps	ADDER	12.00
380-N	0.01 μf in 0.001 μf steps	ADDLE	10.00
380-P3	Switch Only	SWITCHFORD	5.00

TYPE 106 STANDARD INDUCTANCE



USES: The TYPE 106 Standard Inductance is an accurate standard of self-inductance for use in bridge and other measurements at audio frequencies.

DESCRIPTION: An astatic form of mounting is used wherein two D-shaped coils are mounted parallel to each other. The coils are form wound, bound with tape, and impregnated with wax before being mounted. A minimum of metal is used in the mounting, thus minimizing variations in inductance with frequency.

FEATURES: Low and nearly constant resistance at audio frequencies is insured by the use, wherever practicable, of stranded wire in which the separate strands are insulated from one another.

The inductance has been made independent of surroundings by using an astatic form of mounting in which the fields of the two coil sections neutralize each other in regions external to the case. Thus, interaction between external fields and the field of the inductor is reduced to a minimum.

SPECIFICATIONS

Type	Nominal D-C Resistance	Maximum Current	Maximum Q	Frequency for Maximum Q	Natural Frequency
106-L	0.18 Ω	3.5 a	210	300 kc	6000 kc
106-G	1.80 Ω	1.0 a	190	150 kc	2000 kc
106-J	12.2 Ω	0.5 a	170	60 kc	500 kc
106-K	85.3 Ω	250 ma	80	20 kc	150 kc
106-M	545 Ω	150 ma	40	7 kc	35 kc

Accuracy: All units are adjusted within $\pm 0.1\%$ at 1000 cycles.

Resistance: The resistance at 1000 cycles is the same as the d-c resistance. This resistance, together with the temperature, is entered on a certificate mounted on the bottom of the cabinet when the inductor is measured in the Standardizing Laboratory. The nominal values are given in the table above.

Temperature Coefficient: The temperature coefficient is less than $\pm 0.004\%$ per degree Centigrade.

Maximum Current: See table.

Losses: The maximum value of the storage factor $Q = \frac{X}{R}$, and the frequency for which it occurs for each size are given in the table.

Frequency Error: Disregarding skin effect the fractional change in inductance with frequency is f^2/f_0^2 where f is operating frequency and f_0 the natural frequency. At one-tenth the natural frequency, therefore, the error is 1%.

Terminals: Binding posts are provided.

Mounting: All units are assembled in walnut cabinets with bakelite panels.

Dimensions: Panel, $5\frac{7}{8} \times 5\frac{7}{8}$ inches. Cabinet, (height) $3\frac{1}{2}$ inches, over-all, except TYPE 106-M which is $5\frac{5}{8}$ inches, over-all.

Net Weight: Approximately $2\frac{5}{8}$ pounds, except TYPE 106-M which is 5 pounds.

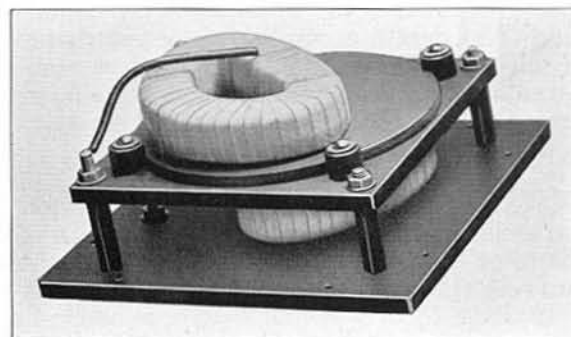

Type	Inductance	Code Word	Price
106-L	0.1 mh	INNER	\$25.00
106-G	1 mh	INERT	25.00
106-J	10 mh	IRATE	25.00
106-K	100 mh	ISLET	25.00
106-M	1 henry	ISSUE	30.00



TYPE 107 VARIABLE INDUCTOR

USES: The TYPE 107 Variable Inductors find their greatest uses in the laboratory as standards of moderate accuracy for measurements of self- and mutual inductance, and as components of bridges, oscillators, and similar equipment where a variable inductor is needed as a circuit element.

DESCRIPTION: Two coils, a rotor and a stator, are mounted concentrically. As the position of the rotor is changed the coupling between the two coils changes, and the inductance is varied.

In most models stranded wire is used, in which the separate strands are insulated from one another. The coils are impregnated and baked in a high-melting-point material before being securely mounted to the bakelite panel.

FEATURES: The TYPE 107 Variable Inductor is direct reading in inductance for both series

and parallel connections of the coils. The inductances of the rotor and stator have been carefully equalized, and the coils are so mounted that the inductance for the parallel connection is exactly one-fourth the value shown by the dial for the series connection. This equalization of the two coils also eliminates losses from circulating currents when the parallel connection is used.

Separate terminals are brought out for both rotor and stator so that they may be quickly connected in either series or parallel as a self-inductor, or used separately as a mutual inductor. The formula for the mutual inductance is given on the nameplate together with the value of d-c resistance and maximum current.

Other features of these inductors are their permanence of construction, low losses, and high current-carrying capacity.

SPECIFICATIONS

Self-Inductance Range: Five sizes are available in stock covering a total range of approximately 1.7 microhenrys to 500 millihenrys by the use of both the series and parallel connections. Maximum and minimum values for both connections are shown in the price list.

Mutual Inductance: Either positive or negative values of mutual inductance can be obtained. The exact formula for the mutual inductance is engraved on each individual instrument. The approximate ranges are given in Table I.

Calibration: The inductance for the series connection, measured at 1000 cycles and accurate within 1% of full-scale reading, is engraved on the dial. The inductance for the parallel connection is within 0.1% of one-fourth of the series inductance.

Frequency Error: Disregarding errors due to skin effect, the fractional change in inductance with frequency will be f^2/f_0^2 where f is the operating frequency and f_0 the natural frequency. Accordingly, at one-tenth the natural frequency, the frequency error is but 1%. At higher frequencies skin effect errors, which are different for the different units, may become appreciable. Table I gives the natural frequencies for the different standard units, for full setting with series connection.

Losses: The maximum value of the storage factor $Q = \frac{X}{R}$ for full-scale setting with the series connection is given in Table I for each inductor together with the frequency at which this value of Q is obtained.

Maximum Power and Current: The total amount of power which each inductor is capable of dissipating is 15 watts. This amount causes a temperature rise of 40° Centigrade. The maximum allowable current, for the series connection, is given below in Table I and is engraved on each nameplate.

Direct-Current Resistance: The approximate values of d-c resistance for the different units are given in Table I and are also engraved on the nameplates of the instruments.

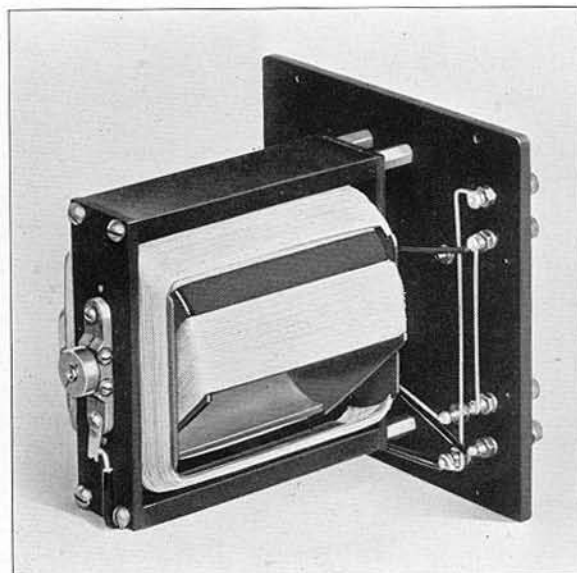

Terminals: Standard 3/4-inch spacing, jack-top binding posts are provided which allow separate connections to rotor and stator. Connecting links are supplied so that either a series or parallel connection of the rotor and stator can be made available at a third pair of binding posts.

Mounting: All units are mounted on bakelite panels and enclosed in walnut cabinets.

Dimensions: 6 1/2 x 6 1/2 x 8 3/4 inches, over-all.

Net Weight: 5 pounds, all ranges.

TABLE I

Type	Mutual Inductance	D-C Resistance	Maximum Current	Maximum Q*	Frequency for Maximum Q*	Natural Frequency*
107-J	0-10.8 μh	0.05 Ω	16 a	140	270 kc	3700 kc
107-K	0-110 μh	0.38 Ω	6 a	140	130 kc	1100 kc
107-L	0-1.1 mh	4.6 Ω	1.7 a	140	60 kc	360 kc
107-M	0-11 mh	32 Ω	0.65 a	100	25 kc	130 kc
107-N	0-110 mh	410 Ω	0.18 a	60	15 kc	35 kc

*For full-scale setting, series connection.

Self-Inductance

Type	Series	Parallel	Code Word	Price
107-J	7- 50 μh	1.7-12.5 μh	HAREM	\$35.00
107-K	60-500 μh	15-125 μh	HARPY	35.00
107-L	0.6- 5 mh	0.15-1.25 mh	HARRY	35.00
107-M	6- 50 mh	1.5-12.5 mh	HOTEL	40.00
107-N	60-500 mh	15-125 mh	HOVER	40.00

PATENT NOTICE. See Note 17, page vi.



OTHER INDUCTORS

TYPE 119 R-F Chokes are described on page 163. Because of their low capacitances, high inductance, and high Q , these chokes are useful as inductance elements in filters and tuned circuits.

BLANK PAGE

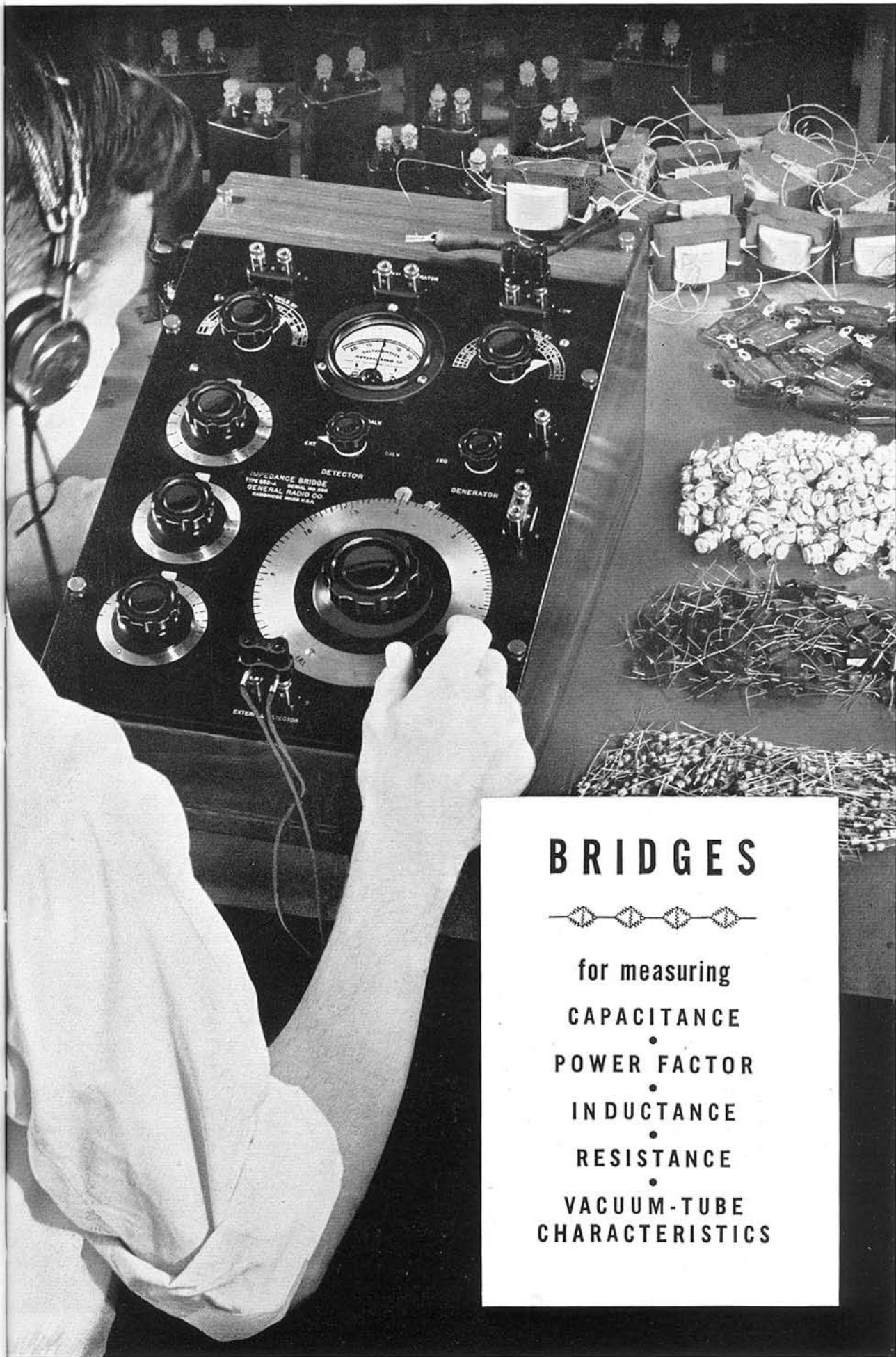

BRIDGES



for measuring
CAPACITANCE
•
POWER FACTOR
•
INDUCTANCE
•
RESISTANCE
•
VACUUM-TUBE
CHARACTERISTICS

IMPEDANCE BRIDGES

For the measurement of all types of impedances, resistive or reactive, inductive or capacitive, the Wheatstone bridge circuit in its many modifications has proved best fitted on grounds of both accuracy and convenience.

The balance of the bridge is attained by a null method, that is, by reducing to zero the voltage between two opposite corners of the bridge. The precision of balance is not limited by the scale length of a deflecting instrument, but only by the voltage which can be applied to the bridge and by the sensitivity of the null detector. It is, therefore, possible to utilize completely the accuracy of the standards.

Because of the variety of possible bridge circuits, a bridge can usually be devised the controls of which can be made direct reading in any particular impedance or circuit characteristic. The direct-reading feature adds greatly to convenience in measurement, since it obviates laborious calculations which are always a bar to rapid work.

The fundamental bridge network is shown in Figure 1. The condition of balance is that the voltage across the detector be zero. This will occur when

$$\frac{A}{B} = \frac{N}{P} \quad \text{or} \quad AP = BN \quad (1)$$

The four arms of the bridge are not necessarily simple impedances, but are frequently series and parallel combinations of resistance, inductance, and capacitance. Hence the bridge arms represented by the symbols used in Equation (1) are, in general, complex impedances, and there are two balance conditions, one for the resistive component and the other for the reactive component. The principal balance component of bridges designed specifically to

measure inductance or capacitance should preferably be independent of frequency.

Usually, at least one of these balance conditions varies with frequency, but no frequency limitation on the use of the bridge is inherent in the variation. Alternating current bridges can be used at frequencies extending to tens of megacycles. The upper frequency limit for any particular design is set by the increasing effect of residual impedances in the various impedance standards and in the wiring.

BRIDGE CIRCUITS: Impedance bridges can be divided into two classes, the one in which like reactances are compared, and the other in which unlike reactances are compared. Both classes are illustrated in Figure 1. In bridges of the first class, referred to as inductance or capacitance bridges, arms *A* and *B* are resistance arms, while arms *N* and *P* are either both inductive or both capacitive, one arm containing the known standard, the other the unknown reactance. Of the bridges described in this section, TYPES 740, 716, and 667 are of this kind, the first two being capacitance bridges and the last an inductance bridge. The TYPE 650 also falls in this class for the measurement of capacitance.

Bridges in the second class carry the names of their discoverers, Maxwell, Hay, Owen, and others. The inductance and capacitance arms are opposite one another. These circuits derive their greatest importance from the fact that they permit the measurement of inductance in terms of capacitance standards, which are generally superior to, and more convenient than, inductance standards. The TYPE 650 Impedance Bridge utilizes both the Maxwell and Hay circuits for the measurement of inductance.

FIGURE 1. Left, the general Wheatstone bridge circuit; center, circuit for a capacitance bridge in which like reactances, *N* and *P*, are compared; and, right, a circuit in which unlike reactances, *A* and *P*, are compared.

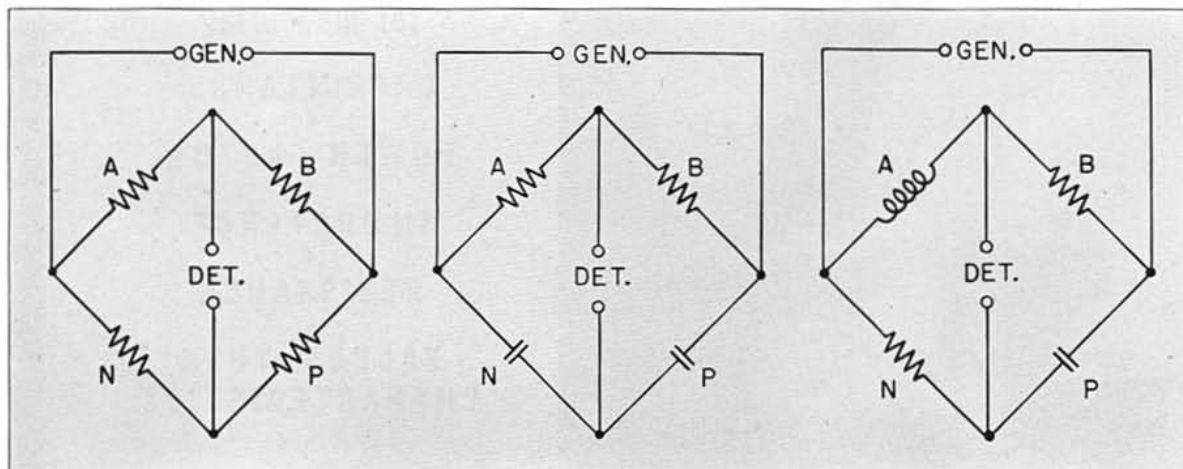

The TYPE 544-B Megohm Bridge is a d-c Wheatstone bridge for high resistance measurements in which the detector is a vacuum-tube voltmeter, which has an extremely high input resistance.

T-Networks: In addition to the bridge circuits described above there are a number of other networks which can be adjusted to give zero transmission for a particular configuration of circuit elements. Several of these, particularly the Twin-T or Parallel-T illustrated in Figure 2, have proved to be of great value for impedance measurements at high radio frequencies. This circuit is used in the TYPE 821 for impedance measurements from 0.5 to 40 megacycles.

Resistive Balance: All impedances have resistive components, and the bridges used for impedance measurement must be capable of measuring this resistance in some manner. Three methods are in general use: (1) Series resistance, in which the balancing resistor is placed in series with the standard reactance; (2) parallel resistance, in which the balancing resistor is placed in parallel with the standard reactance; and (3) the Schering bridge in which a balancing condenser is placed in parallel with the ratio arm opposite the unknown condenser. The series resistance method is used in the TYPES 650, 740, and 667, while the TYPE 716 uses the Schering circuit for balancing the resistive component of impedance in terms of the dissipation factor. The TYPE 916 resembles a Schering bridge but uses a series-substitution method, with a fixed condenser in the *N*-arm for reactance measurement, which makes possible the calibration of the condenser across the *A*-arm in terms of the series resistance of the unknown, independent of frequency. The TYPES 716 and 650 are so constructed that the parallel resistance method can also be used.

In the Twin-T type of null-balance circuit that is used in the TYPE 821, the conductive

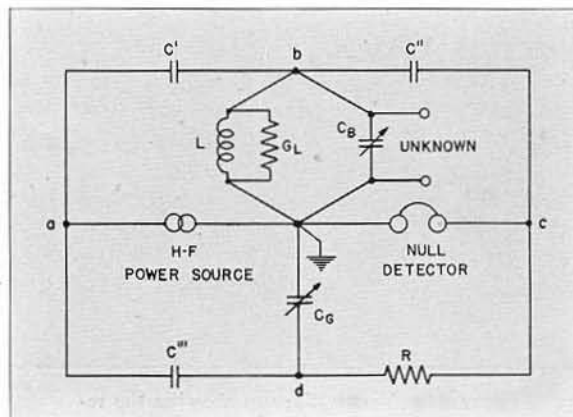

FIGURE 2. Parallel-T circuit for measuring impedance at radio frequencies.

component of the unknown is measured in terms of a fixed resistor and a variable capacitance, thus avoiding the errors inherent in variable resistors at high frequencies.

Dissipation Factor and Storage Factor: An important characteristic of an inductor or a capacitor is the ratio of reactance to resistance, or the reciprocal of this ratio. For an inductor, the ratio of reactance to resistance, which is proportional to the ratio of energy storage to energy dissipation and is commonly called the "storage factor" or *Q*, is most often used. For a capacitor the ratio of resistance to reactance, which is proportional to the ratio of energy dissipation to energy storage and is called "dissipation factor" or *D*, is most often used. These ratios may be written as

$$Q = \frac{X}{R} = \frac{\omega L}{R} \text{ and } D = \frac{R}{X} = R\omega C,$$

respectively, where *R*, *L*, and *C* are the equivalent series values for the resistance, inductance, and capacitance of the impedance in question. For values commonly encountered, the dissipation factor ($D = \tan \theta$, where θ is the loss

FIGURE 3. Left, series resistance bridge; center, parallel resistance bridge; and, right, Schering bridge.

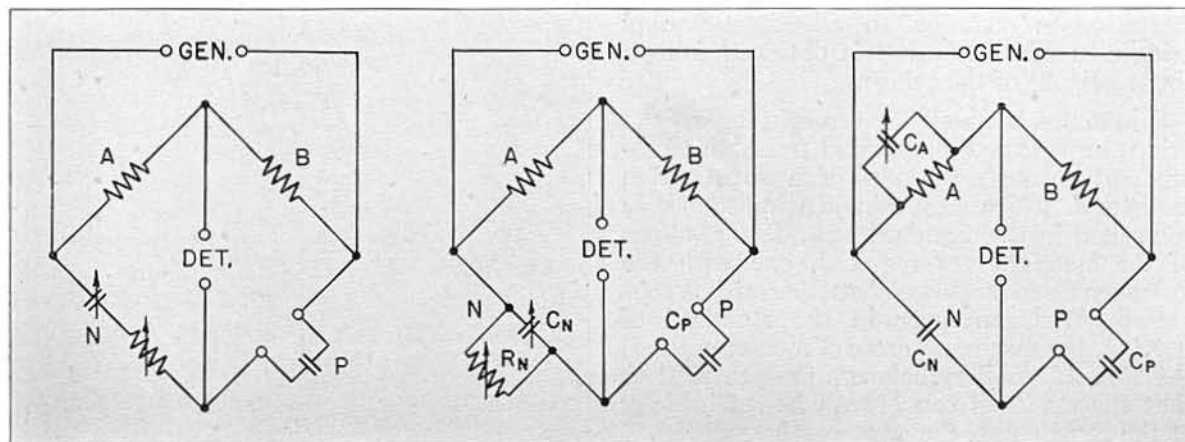

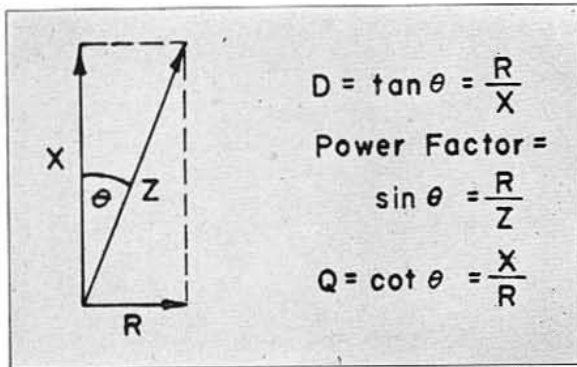

FIGURE 4. Vector diagram showing the relations among R , X , Q , and D .

angle) is practically equal to power factor ($\sin \theta = \frac{D}{\sqrt{1+D^2}}$), for values of D less than 0.1.

Where the Schering or series resistance method of resistive balance is used, the bridge can be calibrated in dissipation factor or in storage factor, for a given frequency. The TYPES 740 and 716 have dials calibrated in dissipation factor at 60 cycles and 1000 cycles, respectively. The TYPE 650 reads directly the dissipation factor of capacitors and the storage factor of inductors, at 1000 cycles.

The TYPE 916 reads directly the series resistance of the unknown, independent of frequency, while the TYPE 821 is calibrated in parallel conductance for 1, 3, 10, and 30 megacycles.

ERRORS: A bridge circuit provides a means of comparing two impedances, an unknown and a standard. It does not provide an absolute measurement. The possible error in the measurement is always greater than the error in the standard itself by the errors in the other bridge arms entering into the comparison. If, for instance, the error in the standard and in each of the two ratio arms is $\pm 0.1\%$, there can then occur in the most unfavorable case an error of $\pm 0.3\%$ in the measurement. This accuracy limitation is common to all direct-reading bridges in which a result is obtained from a single balance of the bridge.

Substitution Method: The errors in three of the bridge arms can be eliminated from the measurement through the use of a substitution method in which the unknown impedance is connected in the standard arm. Two readings of the standard are required, one with the unknown disconnected and another with it connected. With an error in the standard of $\pm 0.1\%$, the maximum error of measurement is $\pm 0.2\%$. If auxiliary balances are provided so that the standard can always be set initially at the same point, the error can be reduced.

Residual Impedances: The bridge equations derived from Equation (1) presuppose an accurate knowledge of the behavior of the impedances in each arm. No impedance element, however carefully constructed, is free from residual impedances. Resistors have series inductance and shunt capacitance. Inductors have relatively large series resistance and shunt capacitance. Even air condensers, while more nearly perfect than other impedance standards, have resistive and inductive residual impedances. All of these extra impedances must be included in the values used for calculation in order to avoid error. The over-all residuals are greatly increased by the various connections forming the bridge circuit.

Shunt capacitance across the various arms is an important source of error even at audio frequencies. When capacitance occurs across a resistive arm, its effect on the resistive component of balance varies directly as the magnitude of the capacitance and directly as the operating frequency. Errors arising from this source account for the large differences between the listed errors in dissipation factor given for TYPE 650 and TYPE 740 Bridges. TYPE 650 not only operates at a higher frequency but has unavoidable switching capaci-

FIGURE 5. The substitution method (shown for a capacitance measurement with a Schering bridge) reduces the error to essentially the accuracy with which the capacitance difference between two settings of the standard condenser is known.

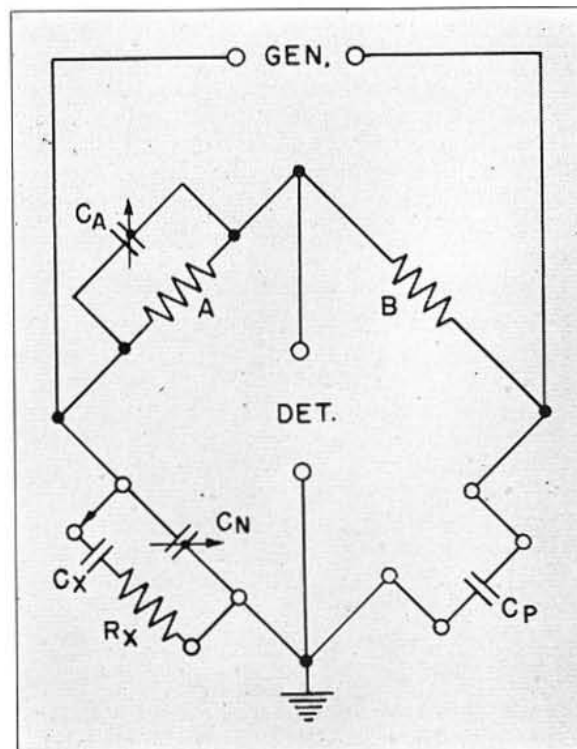

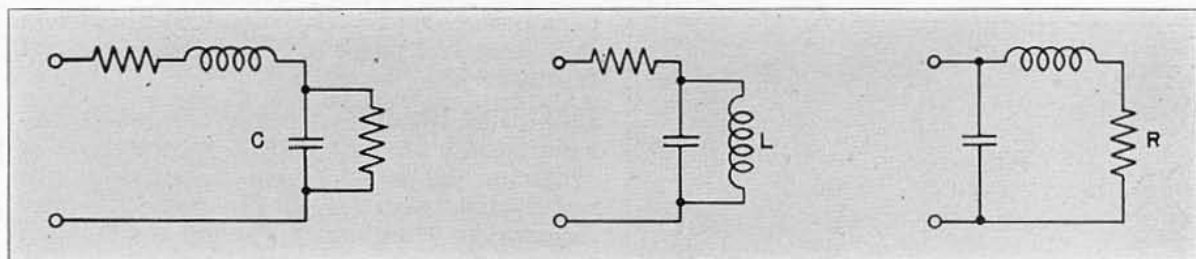

FIGURE 6. Schematic representation of capacitance, inductance, and resistance standards, showing the most important residual impedances. The ohmic resistance and inductance of the stacks and leads of the capacitor (left) are represented by series resistance and inductance, while the dielectric losses are represented by a shunt conductance. For an inductance (center), the copper losses and the distributed capacitance of the coil are the important residuals. A resistor (right), to a first approximation, is represented by an inductance in series, and a capacitance in shunt.

tances because it is designed for such a great variety of measurements.

Shunt capacitance across a reactive arm is also serious. In the TYPE 667-A Inductance Bridge it increases the inductance error from $\pm 0.2\%$ to $\pm 0.4\%$ on the highest multiplier. In the TYPE 716-B Capacitance Bridge complete shielding of the ratio arms reduces it to less than $1 \mu\text{mf}$ (see Figure 9). In the TYPE 916-A Radio-Frequency Bridge the equivalent shunt capacitance across the resistance arm has been reduced to less than $0.4 \mu\text{mf}$. This residual capacitance does not affect the resistive balances, and affects the reactance balance only slightly at 60 Mc; all other stray capacitances are either incorporated into the bridge arms or, by means of shielding, placed across the generator or detector terminals where they become harmless.

At high radio frequencies the limiting residual impedance has been found to be the residual inductance of variable air condensers. Thus, in the TYPE 916-A Radio-Frequency Bridge, the residual inductance of the resistance balancing condenser is the limiting factor on the upper frequency range of the bridge, in so far as the bridge elements themselves are concerned. In the TYPE 821, on the other hand, the residual inductance of the susceptance balancing condenser is the factor which determines the upper frequency limit at which accurate measurements may be made.

Residual series inductance in bridge arms is ordinarily negligible at audio frequencies, except in measurements of very small inductors. The TYPE 667-A Inductance Bridge uses TYPE 668 Compensated Decade Resistors in order to avoid change in residual inductance as the resistance is varied. At radio frequencies the effect of inductance is much more serious, and variable resistors are not suitable for use above a few megacycles.

SHIELDING AND GROUNDING: The readings of any bridge should be sensibly independent of its surroundings and the position of the

operator. To satisfy these conditions, bridges are completely surrounded by a grounded shield, and care is taken to use either grounded or insulated shafts on all controls. It is also common practice to ground the junction of the unknown and standard arms to this shield. Residual capacitances of the bridge arms to the shield are placed across the two arms thus grounded. Although a relatively large error may be introduced by these capacitances, it can often be eliminated by an initial zero reading or by making the residual capacitance part of the capacitance standard. A bridge with one unknown terminal grounded in this manner will measure the "total impedance" of the unknown, which includes its terminal impedance to ground. The TYPES 716, 740-BG, 916, and 667 are of this type, placing one terminal of the unknown at ground potential. If, on the other

FIGURE 7. In the TYPE 916-A Radio-Frequency Bridge a series-substitution method of measurement is used. In this type of measurement stray capacitance to ground in the unknown arm can be particularly troublesome. Triple shielding is used in this arm to control the stray capacitances, as illustrated in Figure 8.

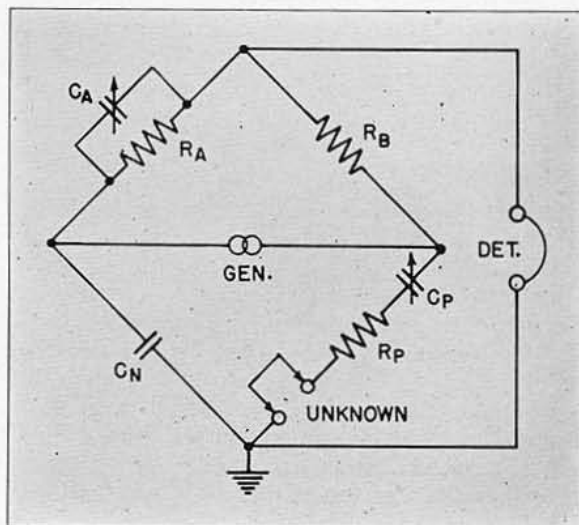

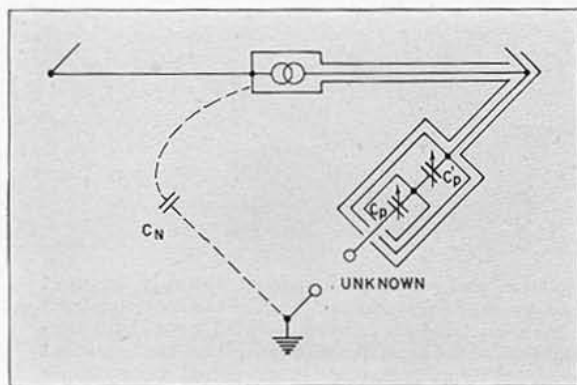
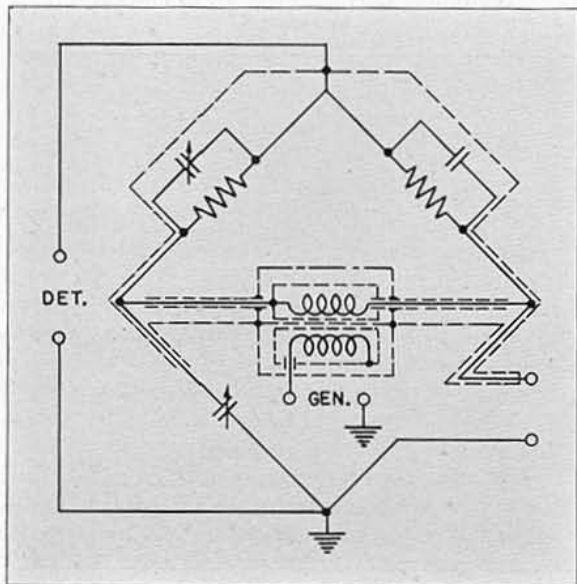

FIGURE 8. Showing the shielding of the unknown arm in the TYPE 916-A Radio-Frequency Bridge. In this assembly the innermost shield localizes the variable stray capacitance of the rotor of C_p and prevents it from falling across C_d , where it would cause interlocking of the settings of the two condensers. The middle shield throws the stray capacitances of the two condensers to the right-hand corner of the bridge, while the outermost shield places the capacitance of the right-hand corner across the generator, where it is harmless.

This puts the capacitance from the outer shield to ground across the N arm of the bridge. Actually, the physical arrangement of the bridge is such that this capacitance constitutes the bridge arm, with only a trimmer condenser connected across it to correct for small variations between instruments.

hand, neither of the unknown terminals is grounded, the bridge will measure the direct impedance across these terminals, provided that the terminal impedances to ground are large compared to the bridge arms. TYPES 650 and 740-B have neither unknown terminal grounded and hence measure direct impedance. Under certain conditions, however, the TYPE 650 can be adapted for measuring grounded impedances, and the TYPE 740-BG for measuring direct impedance. The TYPE 544-B Meg-



ohm Bridge can be connected either way and can, therefore, measure either total or direct resistance.

SHIELDED TRANSFORMER: The bridge balance should be independent of the type of generator and detector used. This condition is met by the use of a TYPE 578 Shielded Transformer. One transformer winding is connected between two opposite corners of the bridge, neither of which is grounded. It is immaterial which side of the transformer is connected to generator or detector, except as the sensitivity of the bridge is affected by the transformer ratio. For bridge balances, the small, constant, and known terminal capacitances of the transformer are then substituted for the large, variable, and unknown capacitances of the generator or detector.

DETECTORS: To obtain the maximum precision of balance with any bridge or null-balance circuit it is necessary to obtain a virtually complete null balance. With modern vacuum-tube circuits, however, sufficient sensitivity can be obtained to utilize all the potential precision of any null-balance network.

In some bridge circuits the balance is dependent upon frequency, and the value of the unknown impedance usually varies with frequency. Consequently, the presence of harmonics in the input to the bridge or their production in a non-linear impedance within the bridge may obscure the fundamental balance. A null balance may also be masked by the residual noise level of the oscillator and amplifier used. For these reasons it is usually advisable to employ a selective detector, tuned to the frequency at which it is desired to balance the bridge.

Audio and Sub-Audio Frequencies: At audio frequencies, the conventional detector is a

FIGURE 9. Illustrating the shielding arrangement of the TYPE 716-B Capacitance Bridge. The ratio arms with their compensating condensers, the dissipation factor condenser, and the input transformer are all mounted on insulated subpanels and completely shielded. The shield is connected to the junction of the ratio arms, thereby placing its capacitance to ground across the detector terminals.

The shield around each transformer winding is connected to the winding, eliminating the terminal capacitances. A third shield, between the winding shields, is connected to the junction of the ratio arms. The capacitance between the third shield and the secondary winding shield is thus placed across the left-hand ratio arm, and its effect can be eliminated in the initial balance. Similarly, the capacitance between the primary shield and the interwinding shield goes across the detector terminals and does not affect the balance.

No capacitances are placed across the standard and unknown arms other than that of the leads and of the panel binding posts. The small amount placed across the standard condenser is taken into account in the calibration, while that across the unknown terminals is less than one micromicrofarad.

vacuum-tube amplifier and a pair of head telephones. Where a visual indication of balance is desired, as is necessary at frequencies below about 300 cycles, a rectifier-type voltmeter or a vacuum-tube voltmeter can be substituted for the head telephones. TYPE 830 Wave Filters can be used to obtain selectivity.

The TYPE 736-A Wave Analyzer and the TYPE 760-A Sound Analyzer, in conjunction with an amplifier, are also very satisfactory selective bridge detectors. The wave analyzer is particularly useful when extreme selectivity at the higher audio frequencies is required, while the sound analyzer provides exceptionally good selectivity at low audio frequencies. For measurements over a wide range of frequencies, these instruments have the advantage of being continuously variable in frequency.

Radio Frequencies: At radio frequencies, the TYPE 619 Heterodyne Detector can be used, as can any well-designed commercial radio receiver. Head telephones, a loudspeaker, or a meter can be used as the actual balance indicator. Since tuned radio-frequency devices are inherently selective, the problem of radio-frequency harmonics is not significant. If a radio receiver is used, it should preferably have an r-f sensitivity control and provision for disconnecting the a-v-c circuit, in order to facilitate the approach to balance.

SENSITIVITY: The precision to which a bridge can be balanced depends primarily upon the voltage applied to the bridge and the sensitivity of the detector. It also depends upon the ratio of impedances of the two arms across which the generator is placed and the ratio of the impedance of the detector to the bridge impedance.

If the generator is connected across two similar bridge arms, the ratio of output voltage to input voltage is

$$\frac{E_o}{E_i} = \frac{\frac{A}{B}}{\left(1 + \frac{A}{B}\right)^2} d \quad (2)$$

where A and B are the arms across which the generator is connected, and d is the fractional precision desired in balancing the reactive component, or the minimum value of dissipation factor to be detected.

If the two bridge arms across which the generator is connected are not alike, but one is resistive and one reactive, the equation becomes

$$\frac{E_o}{E_i} = \frac{\frac{A}{B}}{1 + \left(\frac{A}{B}\right)^2} d \quad (3)$$

Both expressions are developed on the assumption that the impedance of the detector is high compared to that of the bridge arms. This condition is met by the use of a vacuum-tube amplifier.

From the above equations and the known input voltage, the output voltage corresponding to a given value of d can be calculated. The ratio of this voltage to the minimum voltage which will actuate the detector is the amplification required.

As an example, consider the TYPE 716 Capacitance Bridge. For equal ratio arms 100 volts can be applied to the bridge from a 0.5 watt generator. To make a capacitance balance to $\pm 0.1\%$ demands the detection of 25 mv. To make a dissipation factor balance to ± 0.00001 requires a sensitivity of $250 \mu\text{v}$. The first voltage is easily within the range of head telephones without an amplifier, while the second is not. A typical bridge amplifier has a gain of 77 db or 7000 when working with head telephones or a rectifier voltmeter such as the TYPE 483-F Output Meter. With the telephones the gain is more than sufficient. With the rectifier meter (minimum deflection = 0.2 volt), the gain is also sufficient, since even for the dissipation factor balance a gain of only 800 is needed. Now suppose these same measurements to be made on a $1 \mu\text{f}$ condenser for which the ratio arms must be 1000 to 1. Using the full gain of the amplifier, the rectifier meter can only balance for dissipation factor to ± 0.0003 , so that telephones must be used to obtain the required sensitivity.

POWER SOURCE: The main considerations in the selection of a power source for a-c bridge measurements are frequency stability, power output, and harmonic content.

The TYPES 740-B and 740-BG are designed for 60-cycle measurements and operate directly from the a-c power line. The TYPE 650-A has a self-contained 1000-cycle microphone hummer, and no external oscillator is required unless it is desired to make measurements at frequencies other than 1000 cycles. All the other bridges described in this section require some type of external oscillator.

For single-frequency measurements at 1000 cycles, the TYPE 572-B Microphone Hummer, the TYPE 813-A Audio Oscillator, and the TYPE 723 Vacuum-Tube Fork are satisfactory provided the power requirements are low. All these operate from batteries, although the TYPE 723 can also be obtained in a-c operated models. A 400-cycle model of the TYPE 723 is also available.

When a highly precise balance is desired, more power is required than can be furnished by small battery-operated oscillators of the type mentioned above. For measurements at

1000 cycles or at a number of fixed frequencies, the TYPE 608-A Oscillator is recommended. This oscillator is a-c operated and delivers at least $\frac{1}{2}$ watt with extremely good waveform. When a continuously variable frequency is needed the TYPE 913-B Beat-Frequency Oscillator is recommended. The TYPE 913-B covers the audio-frequency range to 20,000 cycles with an output of approximately one watt. It is a-c operated.

For measurements at radio frequencies with the TYPE 916-A Radio-Frequency Bridge, or the TYPE 821-A Twin-T Impedance-Measuring Circuit, a radio-frequency oscillator is required. The TYPE 805-B and Type 805-C Standard-Signal Generators are suitable.

MODULATION: For radio-frequency measurements, it is preferable that the power source be unmodulated. Distortion in the modulating system and asymmetrical side-band cutting in the receiver can produce appreciable errors in the balance point. In addition, maximum sensitivity is obtained with an unmodulated signal and an oscillating detector.

CONNECTIONS: To achieve maximum freedom from electrostatic pickup and body effects, it is desirable to use shielded leads between generator and bridge and between bridge and detector. At audio and low radio frequencies the reactance of the leads and terminals is unimportant, and it is merely necessary to prevent the introduction of extraneous voltages into the detector or the unknown impedance. At frequencies above a few megacycles, not only does the problem of shielding assume greater importance, but also the reactance of the interconnecting leads becomes a potential source of

error. This is illustrated by the block diagram of Figure 10.

A small amount of series inductance in the ground side of the generator cable is designated as L_G , similar inductances in the receiver cable and the common ground lead as L_R and L_M . The voltage drop in L_G produces a flow of current around the loop consisting of the cable sheath, the ground lead, L_M , and the ground capacitance of the oscillator. Similarly, current flows in the right-hand loop that includes L_R .

The voltage applied to the receiver has, therefore, two components, one from the Twin-T, the other from the drop across L_R . When a null point is reached, therefore, the Twin-T is out of balance by an amount necessary to cancel the effect of the extraneous voltage from L_R , that is, to make the vector sum of the Twin-T output voltage and the extraneous voltage equal to zero.

The error in measurement caused by this series inductance is one of the most serious encountered in null measurements at radio frequencies, and, in order to avoid it, coaxial terminals should be used on both generator and receiver.

The TYPES 916-A and 821-A are equipped with coaxial terminals, and coaxial leads are supplied to plug into the signal generator.

CLASSIFICATION: The table on the opposite page briefly summarizes the operating ranges, accuracy, and other pertinent data regarding the bridges listed in this section. From this table the most suitable instrument for any given measurement can be determined at a glance, while detailed specifications for each bridge are given on the following pages.

FIGURE 10. Showing how series inductance in the generator and detector leads can cause errors in measurement at radio frequencies.

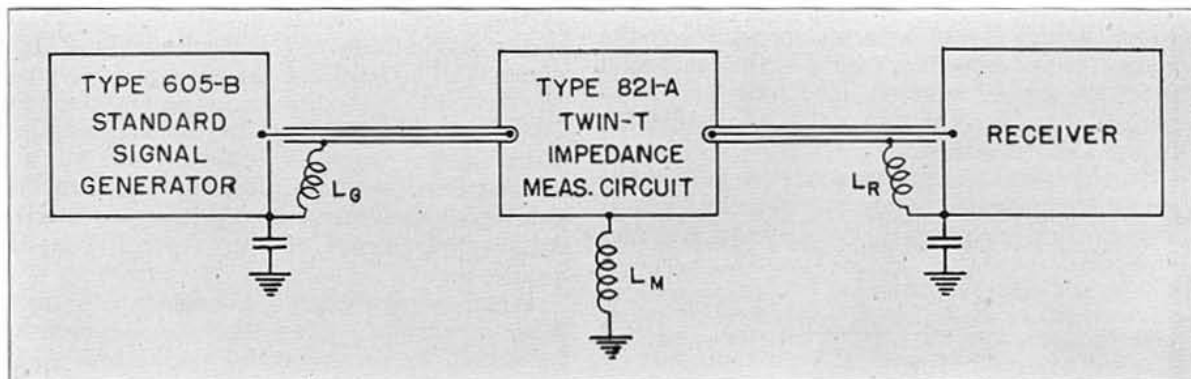

Type No.	Measures	Range of Measurement	Accuracy*	Frequency	Circuit	Method	Power Source	Detector
650-A	R	.001 Ω to 1 M Ω	$\pm 1\%$	dc	Wheatstone	Direct	Self-Contained Batteries	Self-Contained Galvanometer
	L	1 μ h to 1 h	$\pm 2\%$	1 kc	Maxwell and Hay	Direct	Internal Oscillator	Head Telephones
	C	1 μ mf to 100 μ f	$\pm 1\%$	1 kc	Series R	Direct		
	D	.002 to 1	$\pm 20\%$	1 kc		Direct		
	Q	.02 to 1000	$\pm 20\%$	1 kc		Direct		
716-B	C	100 μ mf to 1 μ f	$\pm 0.2\%$	1 kc	Schering	Direct	External Oscillator	Amp. and Head Tel.
	D	.002% to 56%	$\pm 2\%$	1 kc		Direct		
	C	0.1 μ mf to 1000 μ mf	$\pm 0.2\%$	1 kc		Parallel Substitution		
	D	Depends on C_X	$\pm 2\%$	1 kc		Parallel Substitution		
916-A	X	-5000 Ω to +5000 Ω † at 1 Mc	$\pm 2\%$	400 kc to 60 Mc	Modified Schering	Series Substitution	External Oscillator	Radio Receiver
	R	0 to 1000 Ω	$\pm 1\%$	400 kc to 60 Mc		Series Substitution		
821-A	C	0 to 1000 μ mf	$\pm 0.2\%$	460 kc to 40 Mc	Parallel-T	Parallel Substitution	External Oscillator	Radio Receiver
	B	-6000 to +6000 μ mho‡ at 1 Mc		460 kc to 40 Mc		Parallel Substitution		
	G	0 to 100 μ mho‡ at 1 Mc	$\pm 2\%$	460 kc to 40 Mc		Parallel Substitution		
667-A	L	0.1 μ h to 1 h	$\pm 0.2\%$	1 kc	Series R	Direct	External Oscillator	Amp. and Head Tel.
740-B	C	5 μ mf to 1100 μ f	$\pm 1\%$	60 cycles	Series R	Direct	A-C Line	Self-Contained Electron-Ray Tube
	D	0 to 50%	$\pm 1.5\%$ of full scale	60 cycles		Direct		
740-BG	C	5 μ mf to 110 μ f	$\pm 1\%$	60 cycles	Series R	Direct	A-C Line	Self-Contained Electron-Ray Tube
	D	0 to 50%	$\pm 1.5\%$ of full scale	60 cycles		Direct		
544-B	R	100 k Ω to 10,000 M Ω	$\pm 5\%$	dc	Wheatstone	Direct	A-C Line	Self-Contained Galvanometer
561-D	μ	.001 to 10,000		1 kc		Direct	External Oscillator	Amp. and Head Tel.
	r_p	50 Ω to 20 x 10 ⁶ Ω				Direct		
	S_m	.02 to 20,000 μ mho				Direct		

*Approximate. For detailed accuracy statement, see specifications for each bridge.

†Range varies inversely as the frequency.

‡Range varies directly as the frequency.

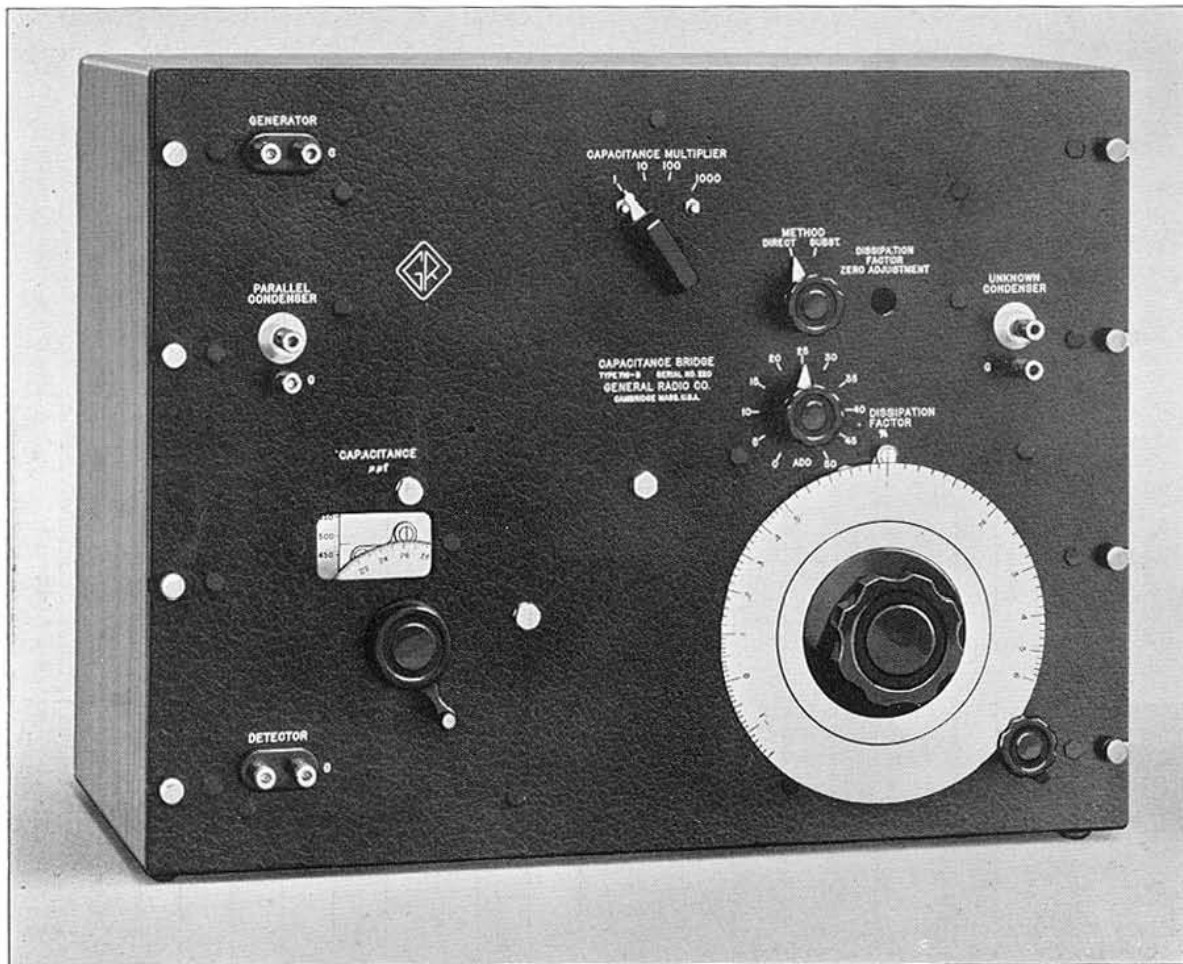

TYPE 716-B CAPACITANCE BRIDGE

USES: This direct-reading capacitance bridge can be used for a wide variety of capacitance and dissipation-factor measurements. Within its scope are the determination of dielectric constant, loss factor, power factor, phase angle, and other dielectric properties of insulating materials, as well as their change with such factors as temperature and humidity.

In the General Radio laboratories the TYPE 716-B Capacitance Bridge is used for all capacitance standardization measurements. In production, it is used for the testing and adjustment of TYPE 505 Condensers and TYPE 380 Decade-Condenser Units.

By adding an external decade resistance box, the bridge can be converted to a series- or parallel-resistance bridge. The latter is especially useful in measuring the resistance of electrolytes.

DESCRIPTION: The TYPE 716-B Capacitance Bridge is a modified Schering bridge, direct reading in capacitance and in dissipation factor at 1000 cycles.

A wide capacitance range is obtained by providing four sets of ratio arms giving multiplying factors from 1 to 1000 in decade steps. The standard condenser is a TYPE 722 Precision Condenser calibrated to read directly in total capacitance. The zero capacitance across the unknown terminals is not greater than $1 \mu\text{f}$. All capacitances to ground of the input transformer and ratio arms are removed from the capacitance arms by placing them in a shielded compartment insulated from the grounded panel and connected to the junction of the ratio arms.

This bridge differs from the older TYPE 716-A in that the dissipation-factor range has been extended to 56%, and a METHOD switch has been added.

Dissipation factor is read directly in per cent from the setting of a TYPE 539 Condenser and a decade step condenser connected across the fixed ratio arm. The 12-inch scale of the air condenser is approximately logarithmic, so that, while having a maximum reading of 6%, its

smallest division near zero is 0.01%, thus allowing the estimation of 0.002%. The accuracy of the dissipation factor reading over the wide capacitance range is made possible by adding capacitance across the lower-valued ratio arms, so that the product *RC* of all the ratio arms is the same.

The setting of the METHOD switch determines the ratio arm across which the dissipation-factor condenser is connected, so that

the dissipation-factor dial is direct reading for either direct or substitution measurements.

FEATURES: Three highly desirable properties are combined in this bridge: wide range, high accuracy, and direct-reading dials. Operation is simple, and both terminals and controls are arranged for convenience and flexibility of operation. Because of these features, it can be used for practically any type of capacitance measurement.

SPECIFICATIONS

Ranges: Direct Reading—capacitance, 100 μf to 1 μf; dissipation factor, 0.002% to 56% (0.00002 to 0.56 expressed as a ratio).

Substitution Method—capacitance, 0.1 μf to 1000 μf with internal standard; to 1 μf with external standards; dissipation factor, $56\% \times \frac{C'}{C_x}$ where *C'* is the capacitance of the standard condenser and *C_x* that of the unknown.

Accuracy: Direct Reading—capacitance, ±0.2% or ±2 μf × multiplier reading (0.2% of full scale for each range) when the dissipation factor of the unknown is less than 1%; dissipation factor ±0.0005 or ±2% of dial reading, for values of *D* below 10%.

Substitution Method—capacitance ±0.2% or ±2 μf; dissipation factor, ±0.00005 or ±2% for change in dissipation factor observed, when the change is less than 6%.

When the dissipation factor of the unknown exceeds the limits given above, additional errors occur in both capacitance and dissipation-factor readings. Corrections are supplied, by means of which the accuracy given above can be maintained over the entire range of the bridge.

Ratio Arms: The arm across which the dissipation factor condenser is normally connected has a resistance of 20,000 ohms. The other arm has four values, 20,000 ohms, 2000 ohms, 200 ohms, 20 ohms, providing the four multiplying factors 1, 10, 100, 1000. Suitable condensers are placed across these arms, so that the product *RC* is constant.

A switch is provided for shifting the dissipation-factor condensers to the other ratio arm when the substitution method of measurement is used, so that the dissipation-factor dial will read up-scale.

Standards: Capacitance, TYPE 722 Precision Condenser direct reading from 100 μf to 1100 μf; dissipation factor, TYPE 539-T Condenser with semi-logarithmic scale and decade-step condenser calibrated directly in dissipation factor at 1 kc.

Shielding: Ratio arms, dissipation-factor condensers, and shielded transformer are enclosed in an insulated shield. The unknown terminals are shielded so that the zero capacitance across them is not greater than 1 μf. A metal dust cover and the aluminum panel form a complete external shield.

Frequency Range: All calibration adjustments are made at 1 kc and the accuracy statements above hold for an operating frequency of 1 kc. The bridge can be used, however, at any frequency between 60 cycles and 10 kc. Dissipation-factor readings must be corrected by multiplying the dial reading by the frequency in kilocycles.

Voltage: Voltage applied at the GENERATOR terminals is stepped up by a 1-to-4 ratio shielded transformer. A maximum of 50 volts can be applied to the transformer. If

desired, power can be applied to the bridge between the junctions of the pairs of resistance and capacitance arms. With equal ratio arms, a maximum of 700 volts can be applied.

Mounting: The bridge is supplied for mounting on a 19-inch relay rack or for cabinet mounting.

Accessories Required: Oscillator, amplifier, and telephones or rectifier meter. TYPE 608-A Oscillator (see page 94) and Western Electric TYPE 1002-C Telephones are recommended. If a visual detector is required, TYPE 483-F Output Meter (see page 117). (See also the discussion of bridge detectors on page 62.)

For substitution measurements, a balancing condenser is needed. This may be either an air-dielectric model, TYPE 539-C, or a fixed mica condenser of the TYPE 505 series.

Accessories Supplied: One TYPE 274-NC Shielded Conductor and one TYPE 274-NE Shielded Plug and Cable.

Dimensions: (Length) 19 x (height) 14 x (depth) 9 inches, over-all.

Net Weight: 41 1/2 pounds, relay-rack model; 53 3/4 pounds, cabinet model.

A schematic circuit diagram of the TYPE 716-B Capacitance Bridge.

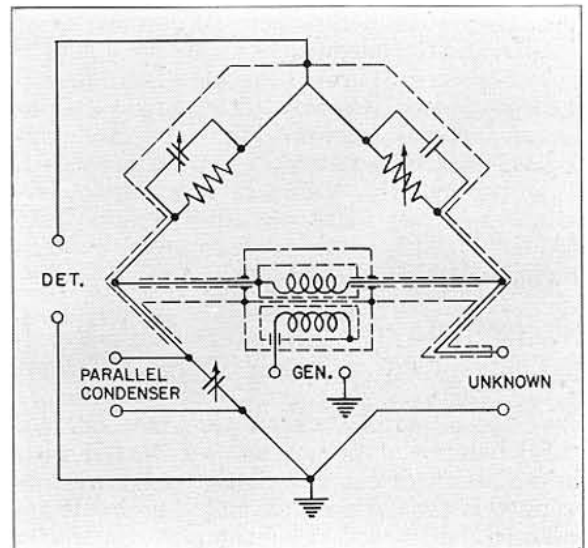

Type	Code Word	Price
716-BR	BONUS	\$335.00
716-BM	BOSOM	360.00

PATENT NOTICE. See Note 17, page vi.



TYPE 821-A TWIN-T IMPEDANCE MEASURING CIRCUIT

USES: This instrument is used for impedance measurements at radio frequencies between 0.46 Mc and 40 Mc. It is calibrated in capacitance and conductance and can be used to measure directly the capacitance and power factor of condensers, the inductance and Q of coils, the resonant impedance of parallel tuned circuits, and the magnitudes and phase angles of high resistances. Through the use of an external fixed condenser, low resistances, grounded antennas, coaxial transmission lines, and impedance-matching networks can be measured. It is particularly useful for measuring impedances having small phase differences from zero or 90° , such as dielectric samples, low-loss condensers, high- Q coils, and r-f resistors.

DESCRIPTION: The instrument uses a Parallel-T null circuit, as shown in simplified form in the schematic diagram. Measurements are made by a parallel-substitution method. An initial balance of the circuit is obtained with the unknown disconnected; the unknown impedance is then connected and the circuit re-balanced for a null. The components of the unknown impedance are determined from the changes in setting of condensers C_B and C_G . The measurement is made in terms of the admittance components of the unknown, susceptance and conductance.

The value of conductance is given by:

$$G_x = \omega^2 C' C'' R \frac{\Delta C_G}{C'''} = k \omega^2 \Delta C_G,$$

and the dial of C_G is calibrated to be direct reading at 1, 3, 10, and 30 Mc. For other frequencies, dial reading is multiplied by the ratio of the squares of the working and direct-reading frequencies. For the initial balance, the conductance dial is set at zero.

The setting of the condenser C_B determines the susceptive balance. The condenser dial is calibrated in micromicrofarads and is direct reading in capacitance. Condenser capacitance

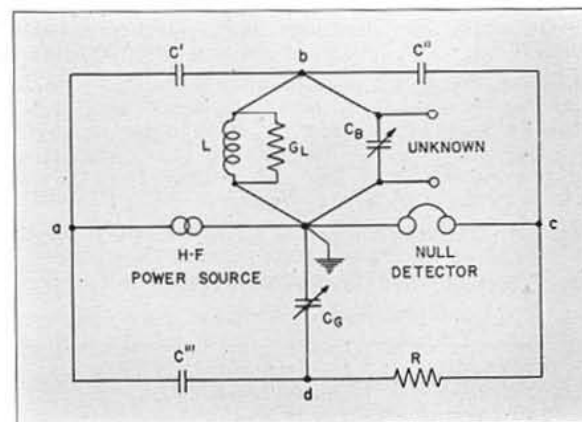

can therefore be measured directly. For other types of unknown, it is generally more convenient to use the susceptance,

$$B_x = \omega \Delta C_B$$

Impedance components, reactance and resistance, can, of course, be calculated from the admittance components.

The Twin-T is mounted in a shielded, airplane-luggage type case and is completely portable. TYPE 774 Coaxial Plugs and Jacks are used for the generator and detector terminals. The unknown connects directly to terminals on the panel.

FEATURES: The null method used in measurements with the Twin-T yields highly precise settings. The circuit arrangement also contributes to accuracy of measurement at high frequencies by eliminating the effects of some of the residual capacitances that limit high-frequency performance in bridge circuits. In particular, no transformer is needed because the generator, the detector, the unknown, and the two standard condensers are brought to a common ground point. Lead impedances are minimized by a mechanical arrangement in which leads are short and direct. The circuit elements themselves are designed to have low residual impedances. Susceptance is measured

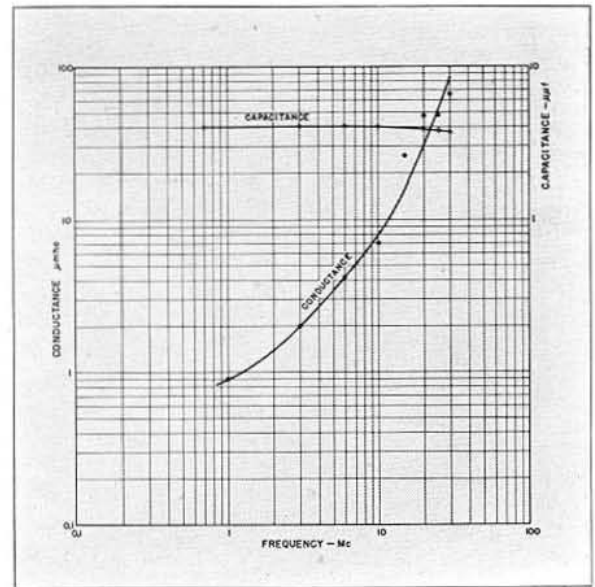

Capacitance and conductance of a TYPE 119-A R-F Choke as measured on the Twin-T.

in terms of an especially designed variable air condenser, and conductance in terms of a variable air condenser and a fixed resistor of the 663-type, thus avoiding errors inherent in variable resistors at high frequencies.

SPECIFICATIONS

Frequency Range: 460 kc to 40 Mc.

Capacitance Range: The dial of the standard condenser is calibrated from 100 to 1100 μmf, and the range of capacitance measurement by the parallel-substitution method is therefore 0 to 1000 μmf.

Susceptance Range: - 6000 μmho to +6000 μmho at 1 Mc. The range varies directly as the frequency, and at other frequencies the dial reading must be multiplied by the frequency in megacycles.

Conductance Range:

0- 100 μmho at 1 Mc }
 0- 300 μmho at 3 Mc } Direct Reading
 0-1000 μmho at 10 Mc }
 0-3000 μmho at 30 Mc }

Between these direct-reading ranges the range of the conductance dial varies as the square of the frequency.

Accuracy: ±2 μmf ±0.1% for capacitance. For conductance, ±0.1% of full scale ±2% of actual dial reading. At the higher frequencies, corrections for residual parameters must be applied, and the correction data are included in the instruction book.

Accessories Supplied: Coaxial cables for connections to generator and detector.

Accessories Required: A suitable radio-frequency generator and detector are required. The TYPE 805-C Standard-Signal Generator is a satisfactory generator. A well shielded radio receiver covering the desired frequency range is recommended for the detector. The coaxial cable supplied for connection to the receiver is fitted with spade terminals at one end for connecting to the receiver input terminals. For best results, however, it is recommended that the receiver be fitted with a TYPE 774-G Panel Plug and the cable with a TYPE 774-M Cable Jack. These coaxial terminals are described on page 159.

Mounting: The instrument is mounted in a shielded, airplane-luggage type of case with carrying handle.

Dimensions: 17 3/4 x 12 x 9 1/2 inches, over-all.

Net Weight: 26 pounds.

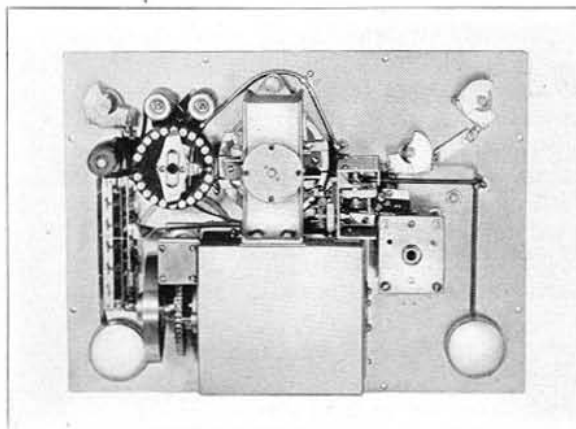

Interior view of the Twin-T, showing constructional details.

Type	Code Word	Price
821-A Twin-T.....	LAGER	\$340.00

PATENT NOTICE. See Notes 2, 17, page vi.

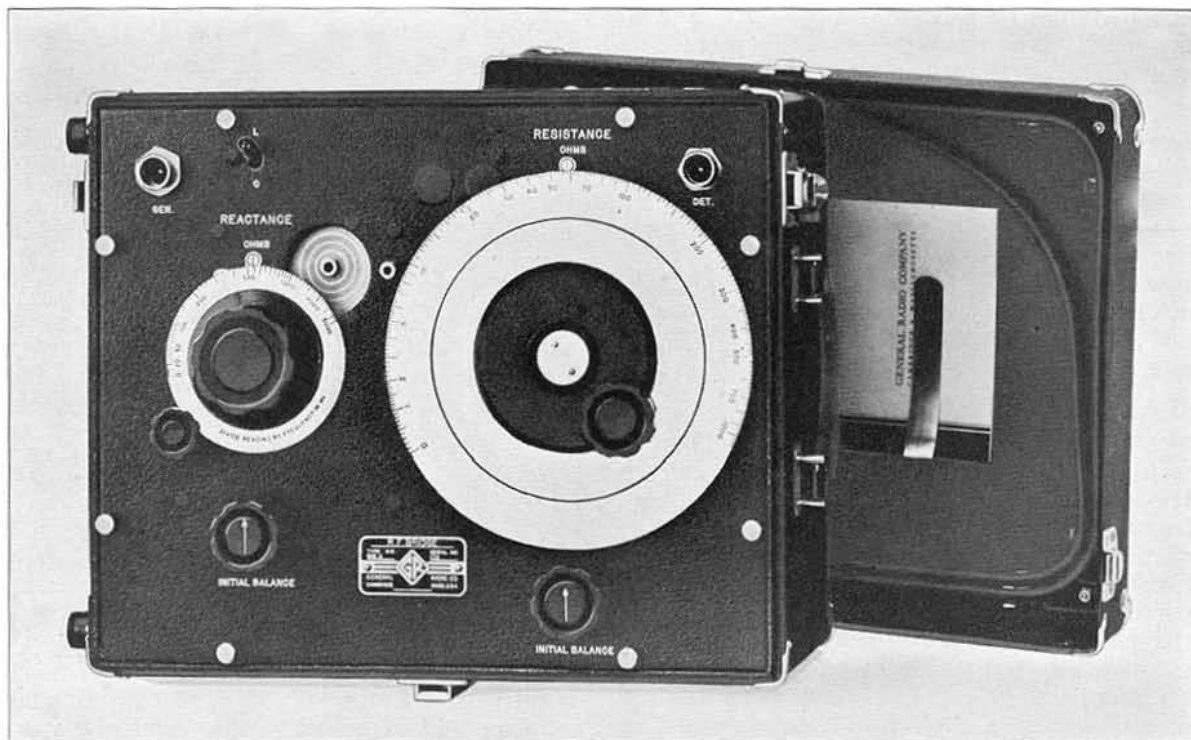

TYPE 916-A RADIO-FREQUENCY BRIDGE

USES: The TYPE 916-A Radio-Frequency Bridge is designed for impedance measurements at frequencies between 400 kc and 60 Mc. It can be used to measure directly the reactance and resistance of antennas, transmission lines, and circuit elements. Through the use of an external parallel condenser, parallel tuned circuits, high resistances, and other high impedances can be measured.

Schematic circuit diagram of the TYPE 916-A Radio-Frequency Bridge.

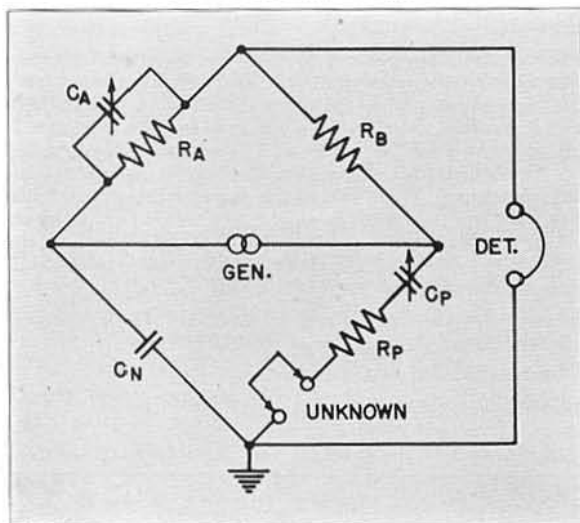

This instrument is intended for measuring low impedances and complements the TYPE 821-A Twin-T, which is best suited for measuring high impedances.

DESCRIPTION: A new type of bridge circuit is used, which is shown schematically in the diagram below. Measurements are made by a series-substitution method. The components of the unknown impedance are determined from the change in settings of condensers C_A and C_P . The unknown reactance at 1 Mc is read directly in ohms from the dial of C_P , and the unknown resistance in ohms from the dial of C_A .

In making measurements the bridge is first balanced by means of condensers C_P and C_A with a short-circuit across the unknown terminals. The short is then removed, the unknown impedance connected, and the bridge re-balanced. The resistance is then given by

$$R_x = R_B \frac{(C_{A2} - C_{A1})}{C_N}$$

and the reactance by

$$X_x = \frac{1}{\omega} \left(\frac{1}{C_{P2}} - \frac{1}{C_{P1}} \right)$$

where the subscripts 1 and 2 denote the dial readings for the initial and final balances, respectively.

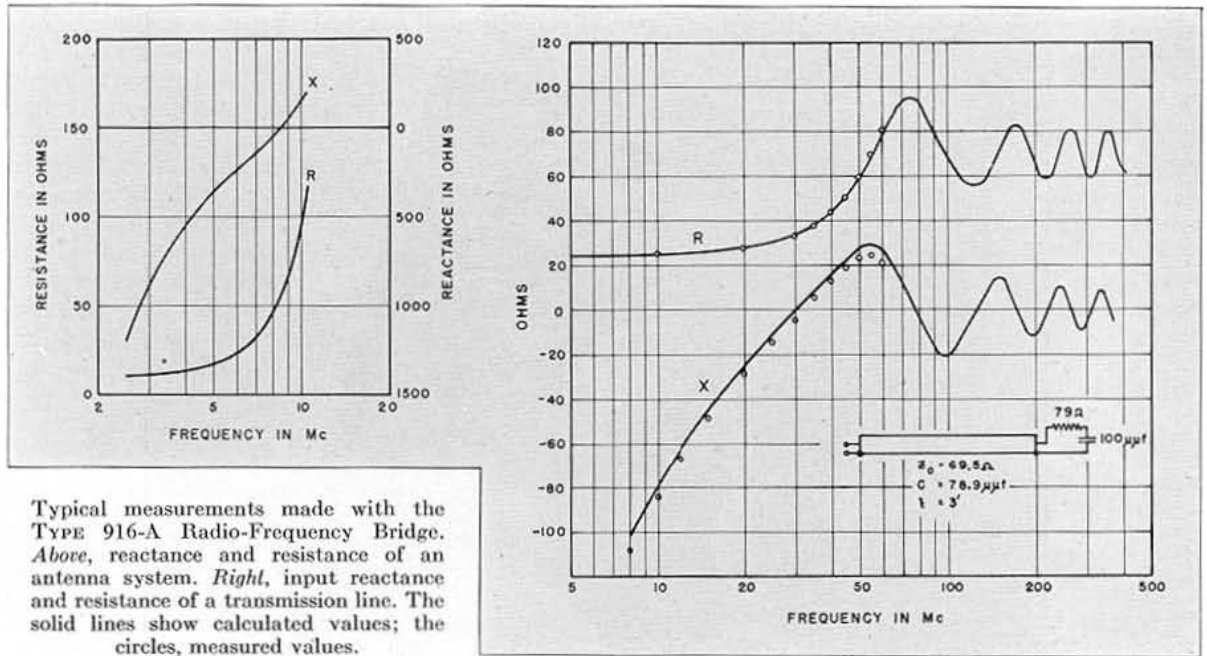

Typical measurements made with the TYPE 916-A Radio-Frequency Bridge. Above, reactance and resistance of an antenna system. Right, input reactance and resistance of a transmission line. The solid lines show calculated values; the circles, measured values.

FEATURES: This new bridge circuit with the use of a substitution method of measurement makes it possible to read resistance in ohms, independent of frequency, directly from the scale of an air condenser. This and the fact that the dial of C_p is calibrated in ohms reactance at 1 megacycle make the bridge particularly easy to use for antenna measurements.

The resistive component is measured in terms of a fixed resistor (R_B), a fixed condenser (C_N), and a variable condenser (C_A). This important feature makes possible the high-frequency performance of the bridge, because residual parameters can be made much smaller in a fixed resistor and a variable capacitor than in a variable resistor.

SPECIFICATIONS

Frequency Range: 400 kc to 60 Mc.
Reactance Range: 5000 Ω at 1 Mc. This range varies inversely as the frequency, and at other frequencies the dial reading must be divided by the frequency in megacycles.
Resistance Range: 0 to 1000 Ω .
Accuracy: For reactance, $\pm 2\% \pm 1 \Omega$. For resistance, $\pm 1\% \pm 0.1 \Omega$, subject to correction for residual parameters. At high frequencies the correction depends upon the frequency and upon the magnitude of the unknown resistance component. At low frequencies the correction depends upon the frequency and upon the magnitude of the unknown reactance component. Plots of both these corrections are given in the instruction book that is supplied with the bridge.
Accessories Supplied: Two input transformers, one covering the range from 400 kc to 3 Mc, the other from 3 Mc to 60 Mc; two leads of different lengths (for connecting the unknown impedance); two coaxial cables for connecting generator and detector.

Accessories Required: A radio-frequency generator and detector are required. The TYPE 805-B Standard-Signal Generator is a satisfactory generator. A well-shielded radio receiver covering the desired frequency range is recommended as the detector. The coaxial cable supplied for connection to the receiver is fitted with spade terminals at one end for connection to the receiver input terminals. For best results, however, it is recommended that the receiver be fitted with a TYPE 774-G Panel Plug and the cable with a TYPE 774-M Cable Jack. These coaxial terminals are described on page 159.
Mounting: Airplane-luggage type case with carrying handles. Both input transformers are mounted inside the case. Coaxial cables, leads, and instruction book are stored in the cover of the instrument when not in use.
Dimensions: 17 x 13 1/2 x 11 1/8 inches, over-all.
Net Weight: 35 pounds.

Type	Code Word	Price
916-A Radio-Frequency Bridge.....	CIVIC	\$350.00

PATENT NOTICE. See Notes 16, 17, page vi.



TYPE 650-A IMPEDANCE BRIDGE

USES: Whether in the laboratory or on the test bench, the uses of the TYPE 650-A Impedance Bridge are almost numberless. Rapid measurements of resistance, capacitance, and inductance are constantly required in any electrical laboratory. With the TYPE 650 these measurements can be made conveniently and with sufficient accuracy for all but very precise work.

This bridge will measure the inductance and storage factor, Q , of coils, the capacitance and dissipation factor, D , of condensers, the d-c resistance of all types of resistors. In the laboratory it is extremely useful for measuring the circuit constants in experimental equipment, testing preliminary samples, and identifying unlabeled parts. In the shop and on the test bench it has many applications in routine

testing and fault location. Hundreds of these bridges are in use all over the world, in government and industrial laboratories, educational institutions, electric generating stations, and radio broadcasting stations.

DESCRIPTION: TYPE 650-A Impedance Bridge is a conventional 4-arm impedance bridge. It is entirely self-contained, including standards, batteries, and tone source, and is direct reading over wide ranges of d-c resistance, a-c resistance at 1000 cycles, capacitance and dissipation factor $D = \frac{R}{X}$ at 1000 cycles, and inductance and storage factor $Q = \frac{X}{R}$ at 1000 cycles.

Results are read directly from dials having

approximately logarithmic scales. The position of the decimal point and the electrical unit in terms of which the measurement is made are indicated by the positions of two selector switches.

Resistance is measured in terms of a standard resistance arm; inductance and capacitance are measured in terms of mica condenser standards, similar in construction to the TYPE 505 Condensers. Power is supplied from dry cells, which operate a 1000-cycle hummer for a-c measurements. The bridge may also be used with an external generator of any audio frequency.

The detector for d-c measurements is a built-in galvanometer. For 1000-cycle measurements, head telephones are used.

FEATURES: The particular value of this bridge lies in its complete availability and the speed with which the results can be obtained. Self-contained, including standards and power source, it is always set up ready for use. The only accessory needed is a pair of head telephones. Direct-reading dials make its operation simple and rapid. The panel photograph shows the simplicity of the controls.

SPECIFICATIONS

Range: The ranges of the instrument are given in the following table. The numerical values are the readings of the calibrated dials multiplied by the settings of the decade selector switches.

	Minimum	Maximum
Resistance	1 milliohm	1 megohm
Capacitance	1 micromicrofarad	100 microfarads
Inductance	1 microhenry	100 henrys
Dissipation Factor $\left(\frac{R}{X}\right)$.002	1
Storage Factor $\left(\frac{X}{R} \text{ or } Q\right)$.02	1000

Accuracy: The large direct-reading dial covers two decades, the main decade being spread out over 12 inches (three-quarters of the dial). It may be set to 0.2%.

Accuracy of readings for capacitance and d-c resistance is 1% for the intermediate multiplier decades; for inductance, 2%. The accuracy falls off in the lower ranges because of the extremely small values to be measured. The error increases to 5% for very large values of capacitance and d-c resistance, and to 10% for large values of inductance.

Accuracy of reading for dissipation factor or for storage factor in terms of its reciprocal is either 20% or 0.005, whichever is the larger.

The frequency of the microphone hummer is 1000 cycles within ±5%.

External Generator: Provision has been made for using an external generator, although its capacitance to ground may introduce some error. Subject to this limitation, the frequency may be varied over a wide range from a few cycles to 10 kc. The effect of generator ground capacitance can be reduced by using a TYPE 578 Transformer between generator and bridge. (See page 79.) The reading of the main dial is independent of frequency, while the reading of the storage factor dial must be multiplied by, and that of the dissipation factor dial divided by, the generator frequency in kilocycles to give the correct values. Provision is made for adding external resistance if it is necessary to increase the ranges of these dials.

Power Supply: Four No. 6 dry cells for the d-c measurements and for driving the microphone hummer are required. Space for them is provided in the cabinet, and they are supplied with the instrument. A higher d-c voltage may be connected to the bridge for high-resistance measurements.

Accessories Required: Head telephones; Western Electric No. 1002-C are recommended. To increase the sensitivity, an amplifier is recommended.

Mounting: Black crackle-finish aluminum panel mounted in a shielded walnut cabinet.

Dimensions: (Width) 12 x (depth) 20 x (height) 8½ inches, over-all.

Net Weight: 31¼ pounds including batteries.

Type	Code Word	Price
650-A Impedance Bridge	BEAST	\$175.00*

*Without telephones, but including batteries.
 PATENT NOTICE. See Note 17, page vi.

Schematic diagrams of the circuits used in TYPE 650-A Impedance Bridge.

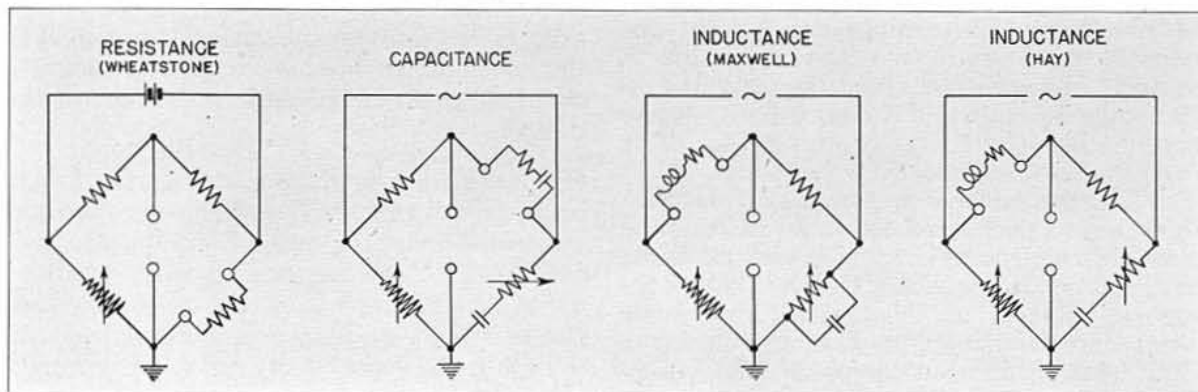

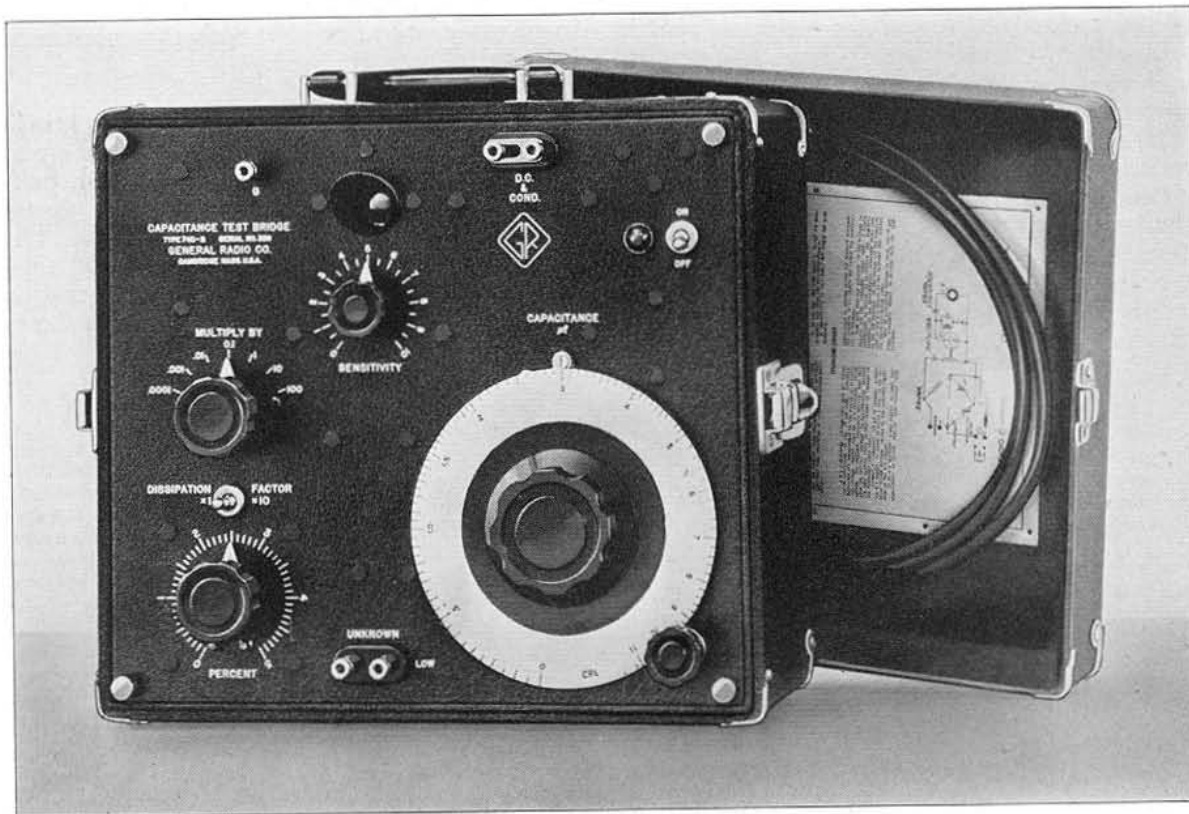

TYPE 740-B CAPACITANCE TEST BRIDGE

USES: The TYPE 740-B Capacitance Test Bridge is a 60-cycle capacitance and power-factor bridge for use in both laboratory and production testing of paper, mica, and electrolytic condensers. The condenser manufacturer can use it for production tests, the condenser user for acceptance tests. It is particularly useful in testing electrolytic condensers because the test conditions approximate the normal operating conditions for the condensers.

DESCRIPTION: The circuit used in this instrument is that of a series-resistance capacitance bridge. It is similar to the capacitance portion of the TYPE 650-A Impedance Bridge, but adapted for 60-cycle use. One ratio arm is variable in decade steps, and the other is continuously variable and calibrated directly in capacitance. The bridge measures the direct capacitance of ungrounded condensers.

Dissipation factor is measured by means of a dual-range variable resistor in series with the standard condenser. The dial is direct reading in dissipation factor ($R\omega C$). Because the switching capacitances of TYPE 650-A Impedance Bridge are eliminated in this instrument, a considerably higher accuracy of dissipation-factor measurement is obtained.

Provision is made for introducing a d-c polarizing voltage in series with the condenser under test.

A visual null indicator is used, consisting of tuned amplifier and an electron-ray tube (the so-called magic eye). A sensitivity control is provided. With this type of null indicator, it is possible to use the bridge as a limit bridge in production testing.

Power is obtained from the 60-cycle line through a shielded isolating transformer.

The complete bridge assembly is mounted in an airplane-luggage type of carrying case. Operating instructions are conveniently mounted in the cover of the instrument, and a complete circuit diagram is attached to the base of the cabinet.

FEATURES: For production testing, this bridge has many advantages. Power-line operation and the visual indicator make it completely self-contained. It can be used in noisy locations where headphones would be useless. Its small size and light weight are important features, since it can be moved easily and set up wherever necessary.

The range of measurement is wide, the operation is simple, and the construction is rugged and practically foolproof.

Care has been taken in the design of the power-supply transformer to insure a minimum of capacitance between generator terminals and ground. As a result of this and other design features, an accuracy of 1% for capacitance, and 1.5% of full scale for power factor, has been obtained over most of the range.

For testing electrolytic condensers, normal operating conditions can be reproduced by using a polarizing voltage. The a-c voltage impressed by the bridge itself is small and simulates the ripple usually encountered in power-supply filters.

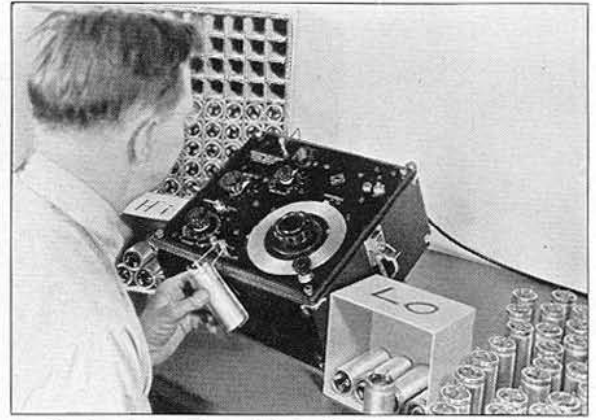

Production testing of electrolytic condensers with the capacitance test bridge.

SPECIFICATIONS

Capacitance Range: 5 μf to 1100 μf in seven ranges. Capacitance values are read directly from a logarithmic dial and multiplier switch.

Capacitance Accuracy: Within $\pm 1\%$ over the main decade (1 to 11) of the CAPACITANCE dial for all multiplier settings except .0001. Within $\pm 1.5\%$ or $\pm 3 \mu\text{f}$, whichever is the larger, on the .0001 multiplier on the main decade of the CAPACITANCE dial. Below 100 μf the error gradually increases to $\pm 5 \mu\text{f}$ as zero is approached.

Dissipation Factor Range: 0 to 50% in two ranges. Dissipation factor values are read directly from an engraved scale and multiplier switch.

Dissipation Factor Accuracy: Within 1.5% of full-scale reading for all capacitance multipliers except .0001.

On the .0001 capacitance multiplier a correction of 0.3% should be subtracted from the dial reading. When this correction is made the calibration is within ± 2 divisions on the x1 multiplier and within ± 1 division on the x10 multiplier (see photograph).

Temperature and Humidity Effects: For measurements above 100 μf the accuracy of measurement is completely independent of temperature and humidity conditions over the range 65° Fahrenheit to 95° Fahrenheit, 0 to 95% relative humidity. For very small capacitances the reading of the

dissipation factor dial will be affected by severe humidity conditions.

Voltage Applied to Unknown: The voltage impressed across the unknown terminals varies continuously with the bridge setting. For very small capacitances in the lowest range, this voltage is approximately 35 volts, and it decreases with increasing capacitance, so that at 100 μf it is approximately one volt.

Polarizing Voltage: Terminals for connecting a polarizing voltage are provided on the panel.

Power Supply: 105 to 125 volts, 60 cycles. The power input is 15 watts.

Controls: Capacitance dial and multiplier, dissipation factor control and multiplier, sensitivity control.

Accessories Supplied: A six-foot line connector cord, spare fuses and pilot lamps.

Vacuum Tubes: One each of types 6X5, 6J7, 6E5; all are supplied with the bridge.

Mounting: Portable carrying case, of airplane-luggage construction.

Net Weight: 19 pounds.

Dimensions: (Length) 14½ x (width) 15 x (height) 9¼ inches, over-all, including cover and handles.

Type	Code Word	Price
740-B Capacitance Test Bridge	BABEL	\$140.00

PATENT NOTICE. See Notes 1, 17, page vi.

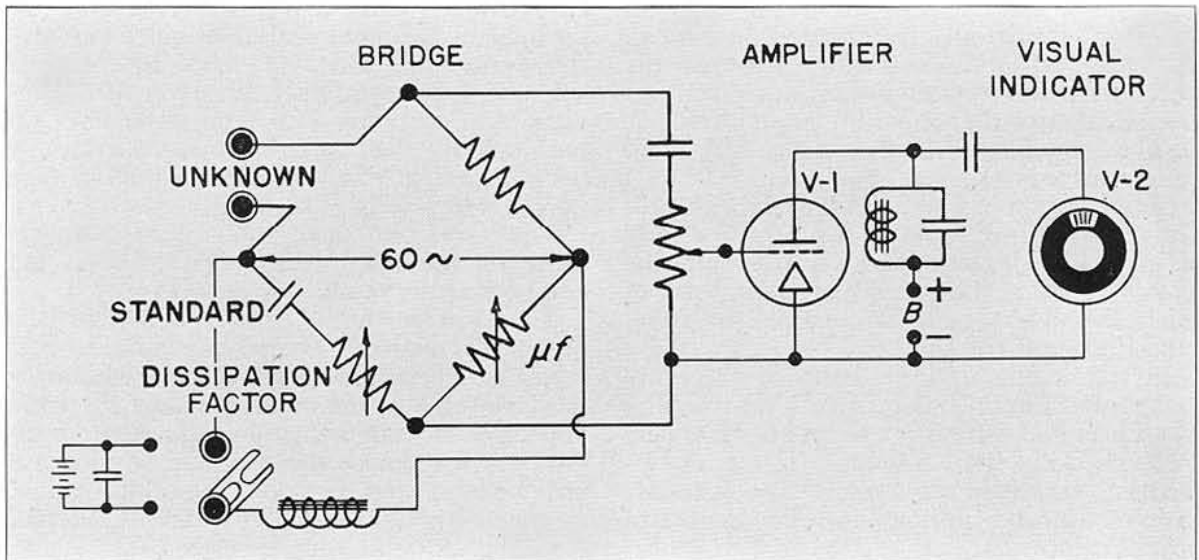



TYPE 740-BG CAPACITANCE TEST BRIDGE

USES: The TYPE 740-BG Capacitance Test Bridge is designed for measurements where it is desired to ground one side of the test specimen. It meets the requirements of the electric power industry for shop tests on insulation, particularly the measurement of the power factor of bushings, insulators, transformer insulation, and cables. It is also useful for measurements in the field, where the adjacent bus potentials are not greater than a few thousand volts. A booklet describing these uses of the bridge will be sent on request.

Manufacturers of electrical equipment will also find this bridge useful for production tests of insulation. Typical of such tests are the measurement of bushings and insulators, of shielded cables, and of winding-to-ground capacitances of transformers.

In the communications industry there are many capacitance measurements that require one side of the unknown to be grounded, among them checking the capacitance of circuit elements to chassis in radio receivers, and the location of breaks in the inner conductors of coaxial cables.

DESCRIPTION: The bridge is similar in general design to the TYPE 740-B, but the circuit is so arranged that one of the unknown terminals is grounded.

FEATURES: In the measurement of small capacitances, the grounded terminal eliminates the disturbing effects of moderate 60-cycle fields, such as are usually encountered in laboratories. For power-factor measurements on bushings, the fact that the bridge operates at low voltage gives it a considerable advantage in cost and size over high-voltage equipment. Comparative tests have proved that the operating voltage has practically no effect on the accuracy of the results.

This instrument is quite usable in the presence of moderate electrostatic fields such as might be encountered in laboratories with overhead voltages of the order of a few thousand volts. For measurements of bushings and insulators in the neighborhood of high-tension bus structures or lines, however, the bridge cannot be used satisfactorily unless sufficient external shielding of the bushings is provided.

SPECIFICATIONS

Capacitance Range: 5 μf to 110 μf in six ranges. Capacitance values are read directly from a logarithmic dial and multiplier switch.

Capacitance Accuracy: Within $\pm 1\%$ over the main decade (1 to 11) of the capacitance dial for all multipliers except the 0.0001. If the zero capacitance of the bridge (approximately 12 μf) is taken into consideration, an accuracy of $\pm 1\%$ or $\pm 2\%$ μf can be obtained on this 0.0001 multiplier range. Below 100 μf the error gradually increases to $\pm 4\%$ μf as zero is approached.

Because the sensitivity is low at high values of unknown capacitance, the bridge is not recommended for accurate measurements above 10 μf .

Dissipation Factor Range: 0 to 50% in two ranges. Dissipation factor values are read directly from an engraved scale and multiplier switch.

Dissipation Factor Accuracy: Within 1.5% of full-scale reading for all capacitance multipliers except 0.0001. On the 0.0001 capacitance multiplier measurements to within 1.5% of full-scale reading can be maintained, provided the initial dissipation factor reading is taken into consideration. The approximate DC product of the initial balance is 60, where C is expressed in micromicrofarads and D in per cent. These statements hold only over the main decade of the capacitance dial (1 to 11).

Temperature and Humidity Effects: Over the normal range of room conditions (65° Fahrenheit to 95° Fahrenheit, 0 to 90% relative humidity) the accuracy of capacitance indication is completely independent of temperature and humidity. Under severe humidity conditions, however, a small error in dissipation factor reading may occur. The error due to this cause, however, will be less than the nominal limits defined above.

Voltage Applied to Unknown: The voltage impressed across the bridge is approximately 80 volts, and the portion of that voltage that is impressed across the unknown condenser can be obtained from the ratio of the unknown capacitance to the standard capacitance. The standard condenser has a capacitance of 0.01 microfarad, so that, for small capacitances of the order of 1000 micromicrofarads or below, essentially 80 volts are impressed across the unknown terminals, whereas for larger capacitances the voltage across the unknown rapidly decreases with increasing capacitance.

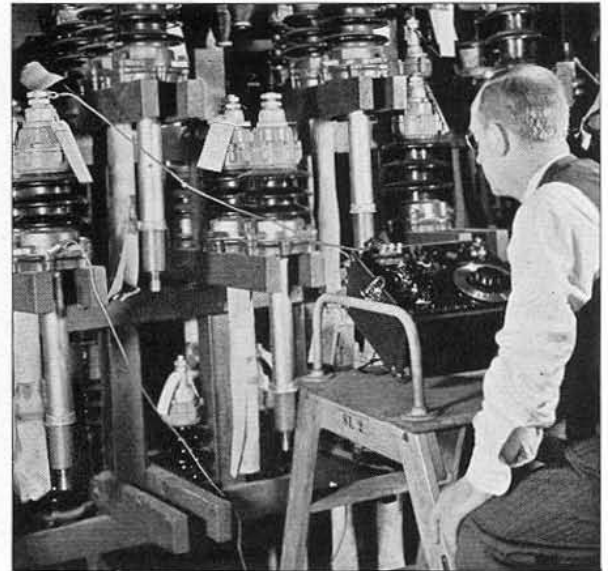

Measuring bushings on a storage rack with the TYPE 740-BG Capacitance Test Bridge.

Power Supply: 105 to 125 volts, 60 cycles.

Power Input: 15 watts.

Controls: Capacitance dial and multiplier, dissipation factor dial and multiplier, sensitivity control, and power-supply reversing switch.

Accessories Supplied: A six-foot line connector cord, spare fuses and pilot lamps.

Vacuum Tubes: One each types 6X5, 6J7, 6E5 are all supplied with the bridge.

Mounting: Portable carrying case of airplane-luggage construction. Carrying case is lined with copper to insure freedom from electrostatic pickup in the instrument.

Net Weight: 20 pounds.

Dimensions: (Length) 14½ x (width) 15 x (height) 9¼ inches, over-all, including cover and handles.

Type	Code Word	Price
740-BG Capacitance Test Bridge	BASAL	\$160.00

PATENT NOTICE. See Notes 1, 17, page vi.

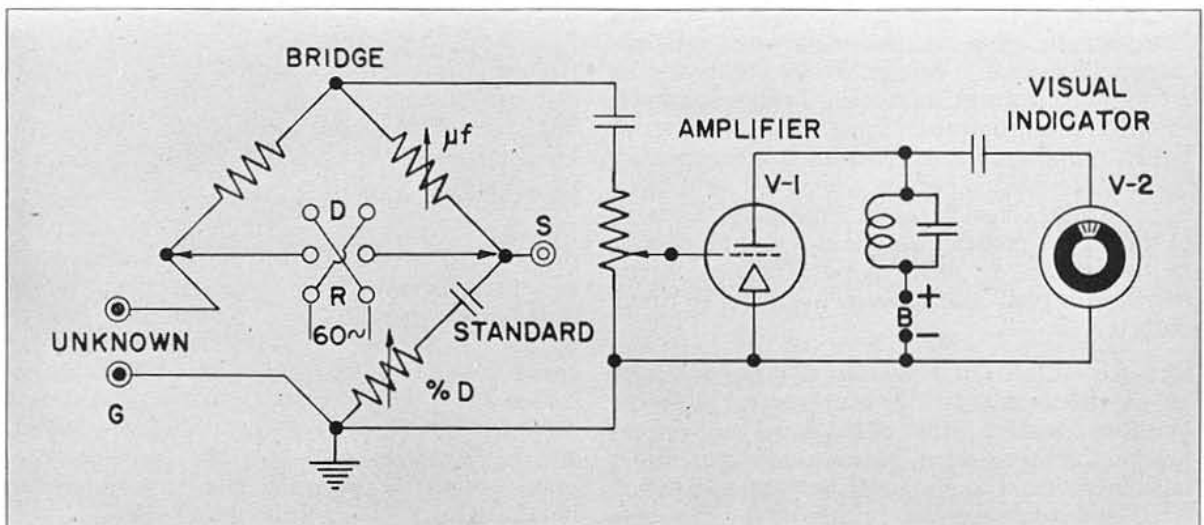

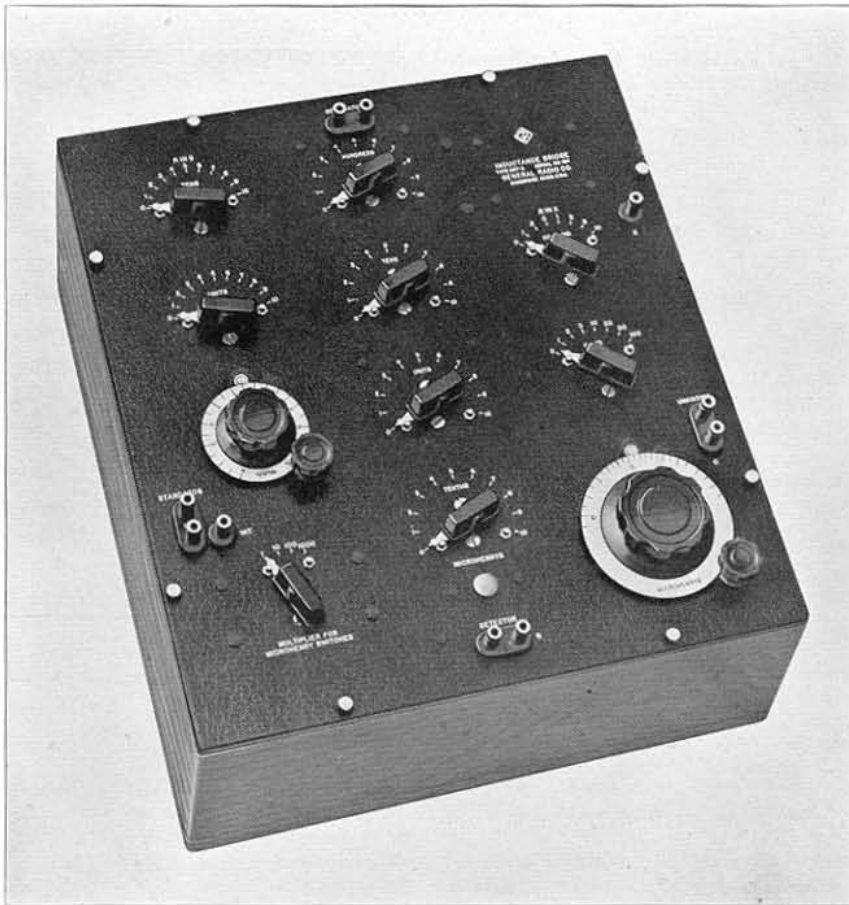

TYPE 667-A INDUCTANCE BRIDGE

USES: This bridge is designed for accurately measuring the inductance of small coils having a low value of storage factor, Q , at audio frequencies, such as are used in radio receivers. It is used by many coil and receiver manufacturers for all audio-frequency measurements on the tuning coils for radio receivers. It is capable of measuring higher values of inductance (up to 1 henry) and hence can be used as a general-purpose inductance bridge. When connected as a Campbell mutual inductance bridge, it can be used to measure mutual inductance in terms of the internal standard. Terminals are provided so that the bridge can be connected as a resonance bridge for such measurements as the ratio of a-c to d-c resistance. The d-c resistance can be determined by using a battery and galvanometer in place of the usual a-c generator and detector.

DESCRIPTION: The schematic diagram of TYPE 667-A Inductance Bridge is shown on page 79. It differs little from that of the usual inductance bridge. Certain design features, however, have been introduced to eliminate residual sources of error and to make the bridge direct reading.

The variable resistors in both the standard and the unknown arms are inductance compensated, identical in construction with TYPE 668 Compensated Decade-Resistance Units and TYPE 669 Compensated Slide Wire.

The variable inductor, L_p , in series with the unknown makes it possible to obtain a final inductance balance independent of the resistive balance of the bridge. The standard inductor is wound on a ceramic toroidal form in order to minimize magnetic coupling with the variable inductor. The switch, K , is used when the bridge is connected as a resonance bridge.

FEATURES: High accuracy (within $0.1 \mu h$) for the measurement of small inductances is one of the outstanding features of this bridge. Coils of a few microhenrys inductance cannot be measured accurately on the ordinary bridge, owing to the errors introduced by the (1) sliding-zero balance (reactive and resistive balances not independent), (2) variation of inductance with setting of any decade resistors used in the bridge, and (3) capacitance across the resistive component of any of the arms. These are eliminated in the TYPE 667-A Inductance Bridge.

SPECIFICATIONS

Range: Inductance, 0.1 microhenry to 1 henry. The range can be extended to 1111 henrys by using TYPE 106 Standard Inductors as external standards. When the internal standard is used, the bridge will balance for storage factors between 0.06 and infinity at 1 kc.

Accuracy: Inductance, $\pm 0.2\%$ or $\pm 0.1 \mu\text{h}$, whichever is the greater, for three smaller multiplier settings and at 1 kc; $\pm 0.4\%$ for the largest multiplier at 1 kc. The larger error is caused by the capacitance across the unknown terminals and is reduced at lower frequencies.

Frequency Range: All calibration adjustments are made at a frequency of 1 kc. The bridge can be used at any frequency between 60 cycles and 10 kilocycles, but errors resulting from stray capacitance increase with frequency. The capacitance across the UNKNOWN terminals is approximately $90 \mu\text{f}$. When high values of inductance are measured with external standards, the frequency must be lowered to avoid resonance effects.

Standards: The standard inductor is a 1-millihenry toroid wound on a ceramic form. Resistance balance of the bridge is made by means of an inductance-compensated resistor.

Mounting: The bridge is supplied for cabinet mounting.

Accessories Required: Oscillator, amplifier, and head telephones. TYPE 608-A Oscillator (see page 94), is recommended. Any convenient audio-frequency amplifier is satisfactory.

Accessories Supplied: Two TYPE 274-NC Shielded Conductors.

Dimensions: (Length) $17\frac{1}{2}$ x (width) 16 x (height) $9\frac{1}{2}$ inches, over-all.

Net Weight: 33 pounds.

Type	Code Word	Price
667-A	AERIE	\$325.00

PATENT NOTICE. See Note 17, page vi.

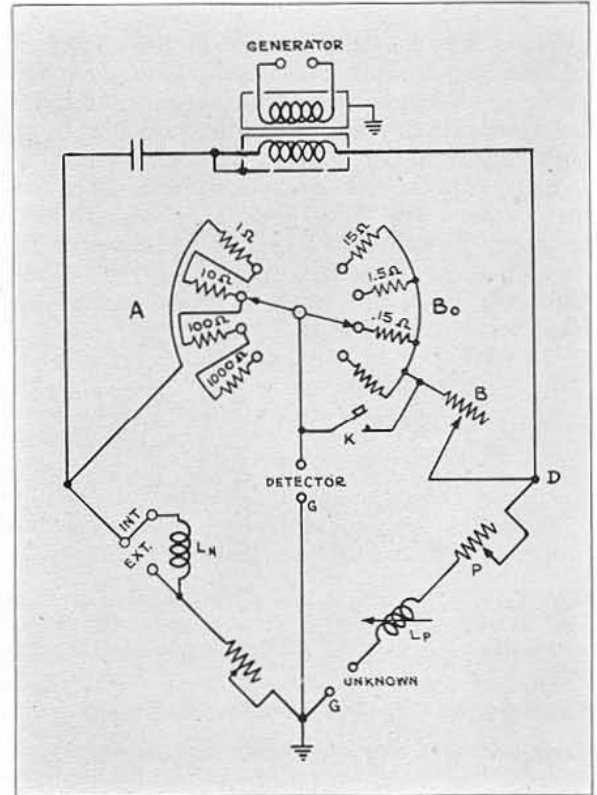

TYPE 578 SHIELDED TRANSFORMER



USES: A shielded transformer is necessary in a direct-reading a-c bridge to isolate the bridge from changes of electrostatic potential in the external circuit and to reduce the effect of the capacitance of this external circuit to ground. Obviously, the transformer can be used to isolate the bridge from either generator or detector.

TYPE 578 Transformer has been designed for this application. It is also useful in other types of circuits to isolate measuring circuits from the generator and to produce a balanced output from a grounded generator.

DESCRIPTION: This transformer is provided with two shields, one around each winding. A third shield effectively grounds the core laminations. The accompanying diagram shows the arrangement of shields and the capacitances between elements.

FEATURES: The direct capacitance between windings is less than $0.3 \mu\text{f}$. The capacitance placed across the bridge arms by the inter-shield capacitance is only $30 \mu\text{f}$ in place of the large generator-to-ground capacitance which

exists when no transformer is used, and is balanced to ground. This small value of capacitance is obtained by maintaining an air space between primary and secondary shields, using eight hard rubber spacers 0.1-inch thick.

Each transformer covers a wide range of frequency and load impedance, and can be used in either direction, i.e., can be used to step up or step down from generator to bridge. Used thus, the frequency range is 200 to 1 and the impedance range 100 to 1.

SPECIFICATIONS

Turns Ratio: All models have a turns ratio of 4 to 1 and may be used equally well in either direction. The actual number of turns for each winding is given in the table below.

Frequency and Impedance Range: See table below.

Capacitance: The direct capacitance between primary and secondary windings is less than $0.3 \mu\text{f}$; that between the primary and secondary shields is less than $30 \mu\text{f}$. Average values for the capacitances in the diagram are:

C_1, C_2, C_5, C_6	each $200 \mu\text{f}$
C_3	$0.3 \mu\text{f}$
C_7, C_8	each $70 \mu\text{f}$
C_4	$30 \mu\text{f}$

Winding Inductance: The approximate inductance of any winding is equal to the square of the number of turns multiplied by 3.5×10^{-6} henrys.

Winding Resistance: The d-c resistance of any winding (in ohms) is approximately 30 times the inductance in henrys.

Applied Voltage: The high-impedance winding of TYPES 578-A or -B may be connected directly across a 115-volt, 50 to 60-cycle line if the impedance connected to the other winding equals or exceeds the lowest value given under "primary impedance" in the table below. The TYPE 578-B may be used at 25 cycles under the same conditions.

For TYPES 578-A or -B, the low-impedance winding may be connected directly to a 115-volt, 50 to 60-cycle line, provided that the resistance across the high-impedance winding exceeds 10,000 ohms. The TYPE 578-B may be used at 25 cycles under the same conditions.

Insulation: The insulation from winding to winding and from windings to case will withstand 1000 volts.

Mounting and Dimensions: These transformers are mounted in Model B cases (see page 108 for dimensions).

Net Weight: $2\frac{1}{2}$ pounds.

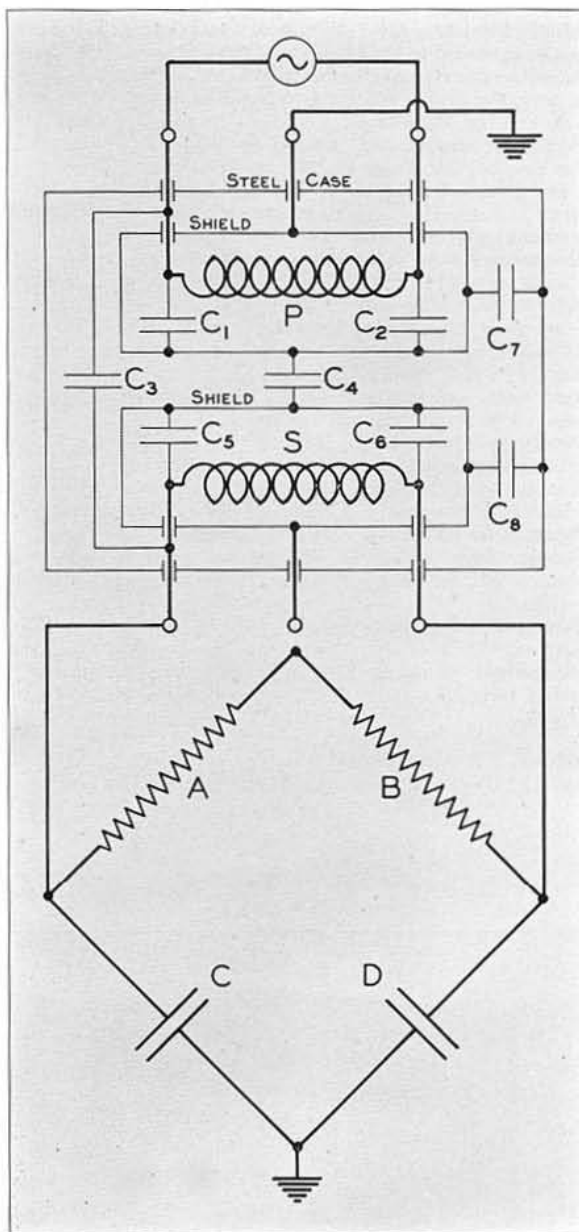

(Above) This diagram shows a grounded bridge supplied through a double-shielded transformer. When the case is grounded, the capacitance placed across each capacitance arm is $40 \mu\text{f}$. This value is known and is considerably smaller than the unknown generator-to-ground capacitance which usually exists when a transformer is not used.

Type	Turns	Frequency Range*	Impedance Range*		Code Word	Price
			Primary	Secondary		
578-A	600 to 2400	50 cycles to 10 kc	50 Ω to 5 k Ω	1 k Ω to 100 k Ω	TABLE	\$15.00
578-B	1000 to 4000	20 cycles to 5 kc	60 Ω to 6 k Ω	1.2 k Ω to 120 k Ω	TENOR	15.00
578-C	60 to 240	2 kc to 500 kc	20 Ω to 2 k Ω	0.4 k Ω to 40 k Ω	TEPID	15.00

*These ranges are for transmission within 6 db. At extremes of both impedance and frequency ranges, the transmission may be down by 12 db.

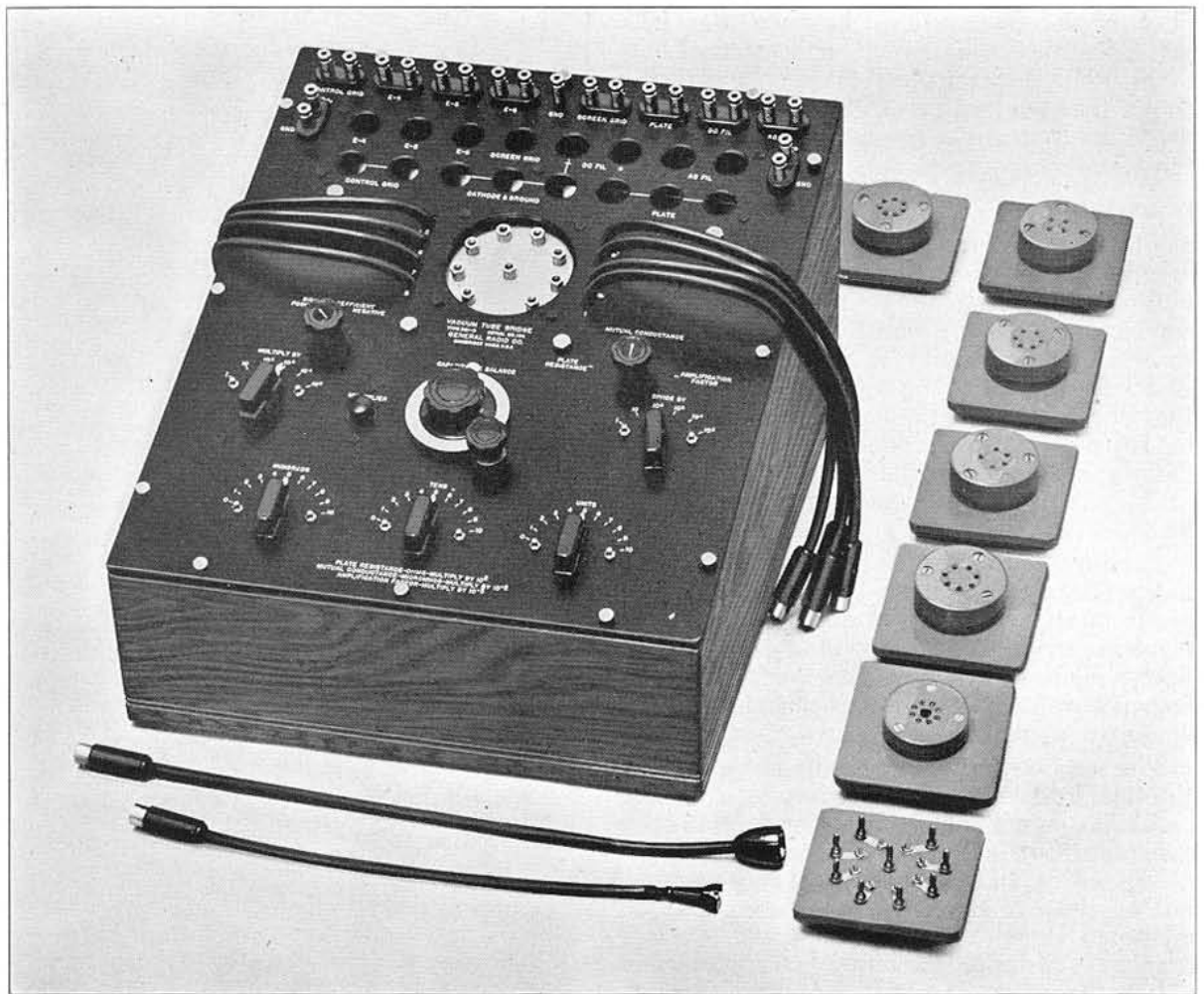

TYPE 561-D VACUUM-TUBE BRIDGE

USES: This instrument makes possible accurate measurements of the three fundamental vacuum-tube parameters: amplification factor, mutual conductance or transconductance, and plate resistance; over wide ranges of values. The accuracy is sufficient so that the bridge has found acceptance among tube manufacturers as a standard of reference for tube measurements, particularly where extreme values of the parameters are encountered and where ordinary measuring circuits become untrustworthy.

In the field of development and research the instrument, in addition to providing accurate measurements of the usual tube parameters, affords a means of studying the behavior of tubes used in unconventional and special circuits, when any one of the electrodes may be used as the operating electrode and where the parameters may have negative values.

The tube circuits have large enough current-carrying capacity and sufficient insulation so that low-power transmitting tubes may be tested in addition to receiving tubes.

DESCRIPTION: The bridge makes use of improved alternating-current null methods of measurement, in which phase shift and capacitance errors have been given special consideration in order that the operating range of the bridge may be as wide as possible. Each of the three coefficients is obtained in terms of the ratio of two alternating test voltages. A third voltage is employed in the capacitance balancing circuit, but its value does not enter into the results. A complete analysis of the bridge circuits will be found in the paper "Dynamic Measurement of Electron-Tube Coefficients" by W. N. Tuttle, *Proc. I.R.E.*, June, 1933.

An extremely flexible arrangement of the tube control circuits makes it possible to measure the tube parameters referred to any pair of electrodes. Connections from the tube under test to the measuring circuit are made by means of concentric cables and jacks, connected to an eight-terminal jack plate, mounted on the panel. Sixteen concentric plugs are mounted on the panel, permitting a wide va-

riety of interconnections between the jack plate, the measuring circuit, and external batteries. Eight adapter plug plates, each carrying one of the standard type tube sockets, are provided, so that any commercial receiving tube can be measured.

FEATURES: The procedure in making measurements is simple and straightforward, and is exactly the same for the three coefficients: amplification factor, plate resistance, and transconductance. A three-position switch is turned to whichever quantity is desired, multiplier switches are set at the appropriate value for the tube being tested, and balance is obtained by adjusting a three-decade attenuator and a variable condenser. At balance the decades read directly, to three significant figures, the quantity being measured.

The three main tube parameters are measured independently, i.e., none of the balances depends in any way on any other so that independent cross checks can be obtained from the known relationship among the three coefficients. Negative values of the tube coefficients may be measured as readily as positive values.

The method of balancing out the effects of the tube inter-electrode capacitances is a more satisfactory one than has heretofore been available. Not only is the accuracy of the measurement thereby considerably improved, but all three of the usual parameters may be measured independently over a much wider range. For instance, the mutual conductance of a tube having a high value of grid to plate capacitance can be measured without any error from this capacitance.

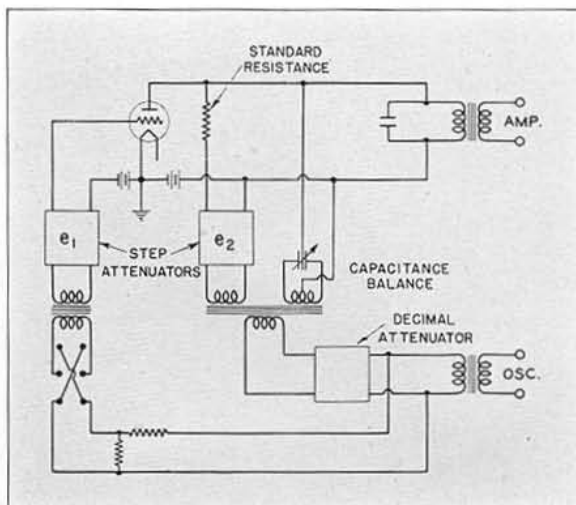

Simplified diagram of the circuit employed for the measurement of transconductance with the TYPE 561-D Vacuum-Tube Bridge. The a-c plate current resulting from the application of e_1 to the grid is balanced by an equal and opposite current applied to the plate from the source e_2 , through the standard resistance. The setting of the decimal attenuator at the bottom of the panel gives the significant figures in the result, and the settings of the step attenuators (e_1 and e_2) indicate multiplying factors (MULTIPLY BY and DIVIDE BY on the panel switches).

Any quadrature component through the output transformer resulting from the tube interelectrode capacitances can be balanced out by the voltage of the extra split secondary, acting through the double-stator condenser. This balance does not affect the balance conditions for the in-phase components and consequently has no effect on the measurement.

The points of introduction of the test voltages e_1 and e_2 are changed by a switch when the other constants are measured. Another switch reverses the polarity of e_1 when negative values of the coefficients are to be measured.

SPECIFICATIONS

Range: Amplification factor (μ); 0.001 to 10,000.

Dynamic internal plate resistance (r_p); 50 ohms to 20 megohms.

Mutual conductance (s_m); 0.02 to 20,000 micromhos.

Under proper conditions, the above ranges can be exceeded. The various parameters can also be measured with respect to various elements, such as screen grids, etc. Negative, as well as positive, values can be measured.

Accuracy: Within $\pm 2\%$ for resistances (R_p switch position) from 1000 to 1,000,000 ohms. At lower and higher values the accuracy decreases slightly.

The expression $\mu = r_p s_m$ will check to $\pm 2\%$ when the quantities are all measured by the bridge, and when r_p is between 1000 and 1,000,000 ohms.

Tube Mounting: Socket adapters are provided, as follows: 4-prong, 5-prong, 6-prong, small 7-prong, medium 7-prong, octal and loctal. Thus all standard commercial receiving tubes can be measured. In addition, a "universal" adapter, with eight soldering lugs, is provided so that unmounted tubes, or tubes with non-standard bases, can be measured conveniently. The panel jack plate and the adapters are made of low-loss yellow bakelite, reducing to a minimum the shunting effect of dielectric losses on the dynamic resistance being measured.

Accessories Supplied: Two TYPE 274-NC Shielded Conductors for connecting bridge to oscillator and detector, two grid-lead connectors, special connector.

Current and Voltage Ratings: The tube circuits have large enough current-carrying capacity and sufficient insulation so that low-power transmitting tubes may be tested in addition to receiving tubes. Maximum allowable plate current is 150 ma and maximum plate voltage is 1500 volts.

Electrode Voltage Supply: Batteries or suitable power supplies are necessary for providing the various voltages required by the tube under test.

Bridge Source: A source of 1000 cycles is required. The TYPE 813-A Audio Oscillator or the TYPE 723-A Vacuum-Tube Fork is suitable for this purpose.

Null Indicator: An amplifier in conjunction with a sensitive pair of head telephones is recommended.

Mounting: The instrument is mounted on a black crackle-lacquered aluminum panel and is furnished in a polished walnut cabinet. A wooden storage case is provided for the plug plates and leads.

Dimensions: (Length) $18\frac{3}{8}$ x (width) $15\frac{3}{4}$ x (height) 11 inches.

Net Weight: 51 pounds.

Type	Code Word	Price
561-D Vacuum-Tube Bridge	BEIGE	\$375.00

PATENT NOTICE. See Note 17, page vi.

TYPE 544-B MEGOHM BRIDGE



USES: The megohm bridge is very useful for measuring cartridge-type resistors in the megohm ranges, such as those used as grid leaks and coupling resistors in vacuum-tube circuits. It is also capable of measuring the insulation resistance of electrical machinery such as generators, motors, and transformers, of electrical equipment such as rheostats and household appliances, of single conductors, cables, and condensers; of sufficiently long sections of high-voltage cables; of paper condensers; and of slabs of insulating materials. Volume resistivity can be determined and its change with temperature and humidity. Guard connections are provided for the measurement of three-terminal resistors such as multi-wire cables, three-terminal condensers, networks, and guarded specimens of insulating materials.

This bridge has been widely used for measuring the dielectric absorption effects in the insulation of electrical machinery, transformers, and cables. Charging-current curves can be

easily obtained, over time intervals from one second to many hours.

DESCRIPTION: The TYPE 544-B Megohm Bridge is a combination of Wheatstone bridge and vacuum-tube voltmeter.

The bridge is composed of the four arms, A , B , N , P , as shown for the OPERATE position in the diagram at the top of the next page, with the power applied across the arms, A and B , and the vacuum-tube voltmeter connected across the conjugate pairs, $A-N$ and $B-P$. For checking the galvanometer zero, the tube is isolated from the bridge voltage as shown in the CHECK position, with the high resistors, N and P , connected to the grid exactly as in the OPERATE position. The effects of any voltages, alternating or direct, in the unknown resistor, P , and of any grid current of the tube will not appear in the bridge balance because they are balanced out in the zero adjustment. There is also a CHARGE position, in which the unknown resistor, P , is placed across the arm, B . This is valuable in measuring the resistance of large condensers because full voltage is applied directly to the condenser which can then charge at a maximum rate. The zero of the galvanometer can also be checked at any time without being affected by the residual charge in the condenser.

FEATURES: The use of a vacuum tube detector, which absorbs a negligible amount of power, makes possible the direct measurement of re-

The MEGOHMS dial of TYPE 544-B Megohm Bridge. The scale is approximately logarithmic over the main decade from 1 to 10.

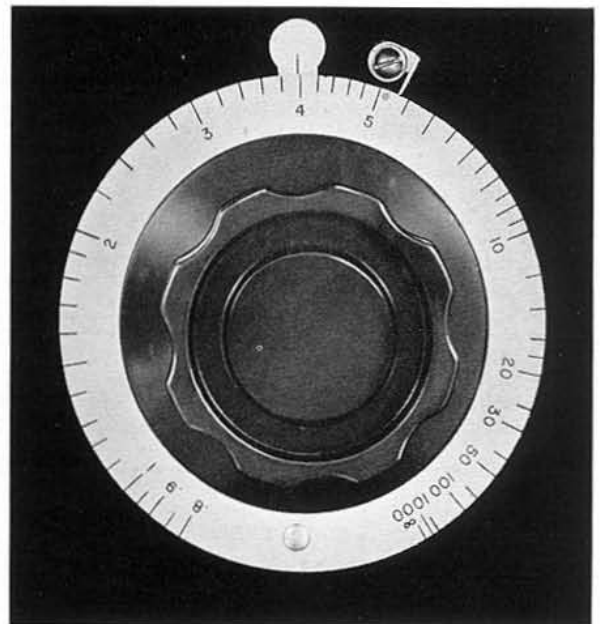

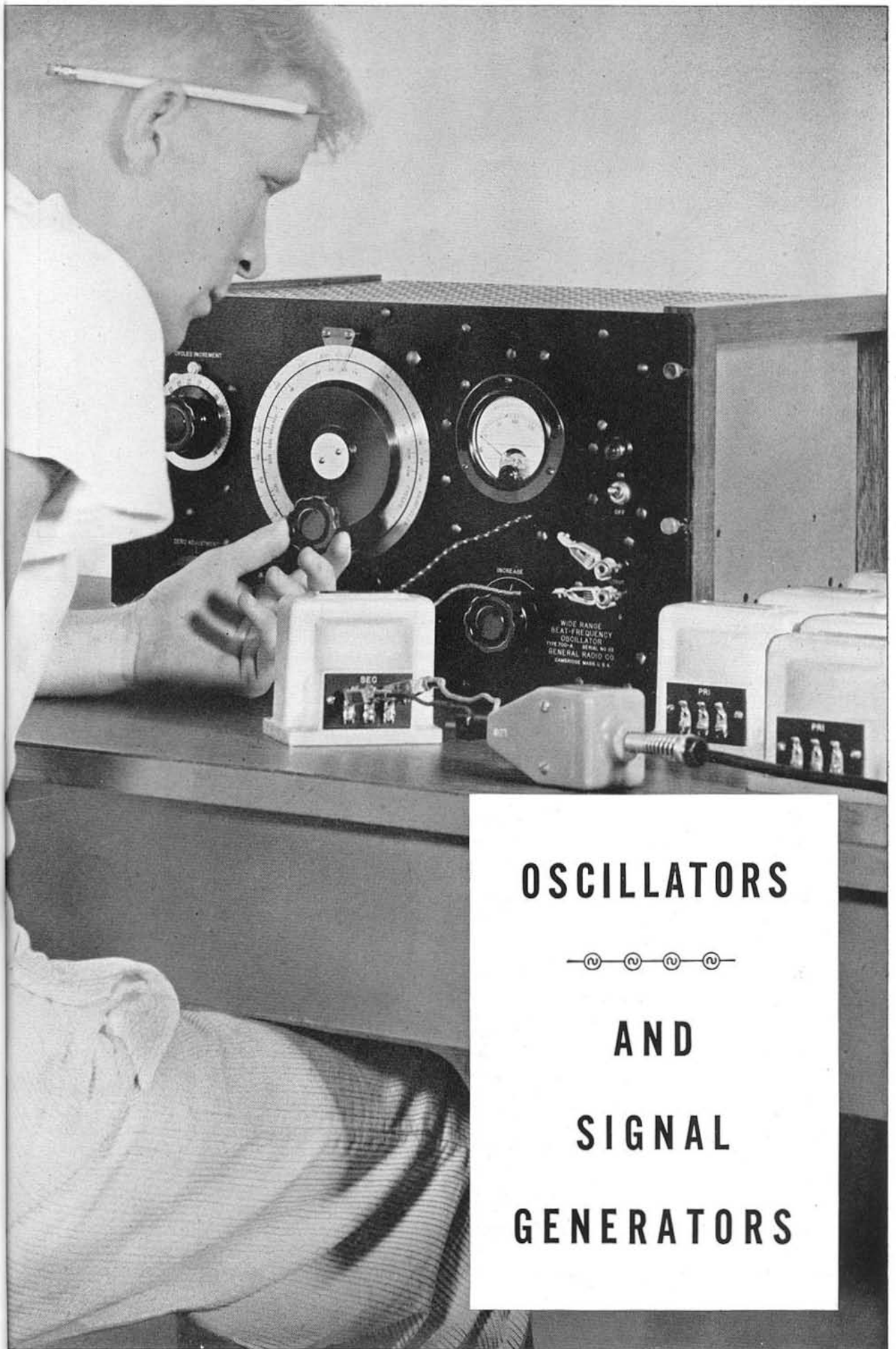

OSCILLATORS



AND

SIGNAL

GENERATORS

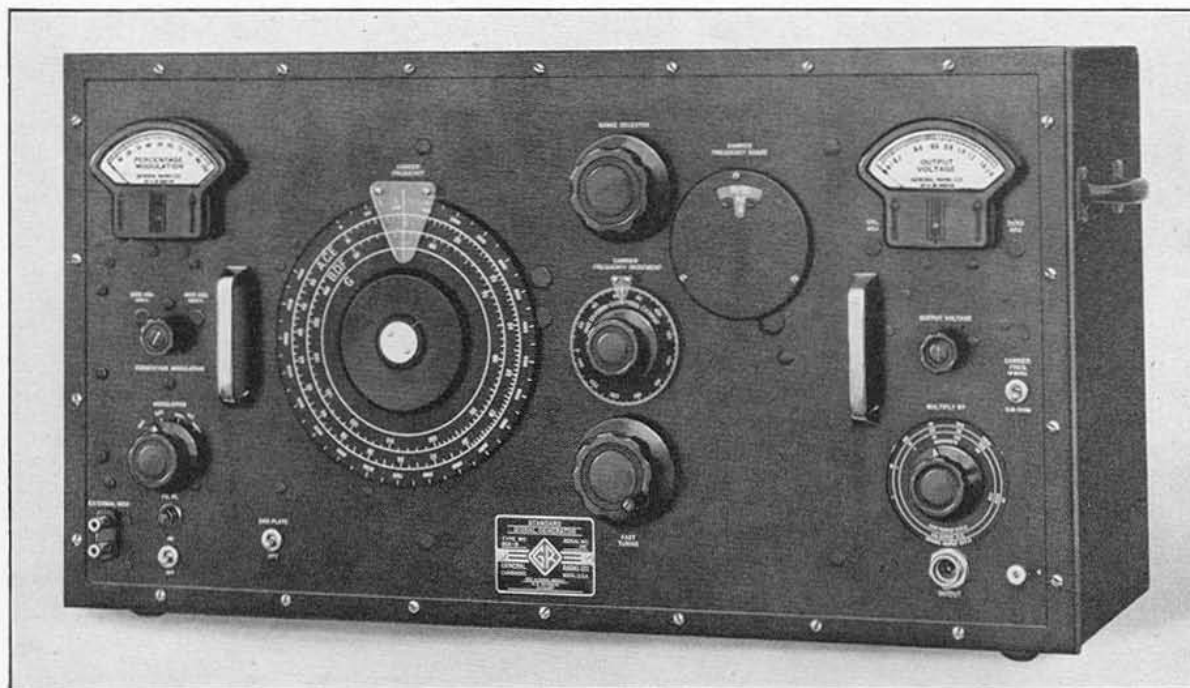

(Illustration shows earlier model, TYPE 805-B)

TYPE 805-C STANDARD-SIGNAL GENERATOR

USES: The TYPE 805-C Standard-Signal Generator is designed primarily as a precision laboratory instrument for rapid and accurate testing of radio receivers. Because of its accuracy, wide frequency range, and high voltage output, it is an almost indispensable instrument for laboratories engaged in research and design on radio receivers and allied apparatus, while its speed and simplicity of operation make it well adapted to production testing.

DESCRIPTION: Functionally this instrument consists of (1) a carrier-frequency oscillator, (2) a tuned radio-frequency amplifier, (3) a resistive output attenuator and a voltmeter to read the output level, (4) a modulating oscillator (400 cycles and 1000 cycles) with a voltmeter for reading percentage modulation, and (5) a well-regulated power supply.

The oscillator and amplifier assemblies are virtually identical in construction, and the coil switching assemblies, as well as the tuning condensers, are ganged and driven from common panel controls. Seven coils covering the frequency range from 16 kc to 50 Mc are carried on a selector disc in each assembly. An eighth coil position is also provided, so that an extra set of coils may be installed if desired. The discs are driven from a panel knob through a gear mechanism, which also brings into panel view a frequency range identification dial. As each coil is rotated into position, it is connected into circuit through silver-overlaid contact blades, which firmly engage silver alloy brushes, mounted on the tuning condenser. The contacts

are mounted on polystyrene strips, insuring both low capacitance and low dielectric losses.

The main tuning condensers are exceptionally rugged, utilizing the cast frame type of construction, with ball-bearing supports for the rotor. The plates are shaped to give a logarithmic variation of frequency with angular rotation. The two condensers are driven through a set of gears, which also drive the direct-reading frequency dial. A gear-reduction vernier drive is provided, which permits an accuracy of setting of better than 0.01% for frequency increments. Backlash in the gear trains is kept to a minimum by automatic take-up springs.

The modulation level is indicated directly in per cent on a linear meter scale. Both 400-cycle and 1000-cycle internal modulation are available, continuously adjustable from 0-100%. An external oscillator can also be used to modulate the generator.

The output system consists of a vacuum-tube voltmeter, a resistive attenuator network, a 3-foot, 75-ohm output cable, and a terminating unit. This unit terminates the cable in its characteristic impedance. It provides, in addition to the normal output at 37.5 ohms, outputs reduced by 10 and 100, with corresponding output impedances of 7.1 and 0.75 ohms. A standard dummy antenna output is also provided.

Electronic stabilizer circuits are used in the plate power-supply circuits, while a ballast tube is used in the filament supply of the vacuum-tube voltmeters to insure stability of operation. The stabilization eliminates the effect of ordi-

nary line-voltage fluctuations over the range from 105 to 125 volts (or 210 to 250 volts).

FEATURES: This signal generator provides signals of accurately known intensity at the end of a properly terminated low impedance cable. The voltage is thus known at the point of application, and the necessity for computing or estimating lead effects is eliminated.

SPECIFICATIONS

Carrier Frequency Range: 16 kilocycles to 50 megacycles, covered in seven direct-reading ranges, as follows: 16 to 50 kc, 50 to 160 kc, 160 to 500 kc, 0.5 to 1.6 Mc, 1.6 to 5.0 Mc, 5.0 to 16 Mc, 16 to 50 Mc. A spare range position is provided so that a special set of coils can be installed if desired.

Frequency Calibration: Each range is direct reading to an accuracy of $\pm 1\%$ of the indicated frequency.

Frequency Drift: Not greater than 0.05% on any frequency range for a period of 5 hours' continuous operation.

Incremental Frequency Dial: A slow-motion vernier drive dial is provided, by means of which frequency increments as small as 0.01% may be obtained.

Output Voltage Range: Continuously adjustable from 0.1 microvolt to 2 volts. The output voltage (at the termination of the 75-ohm output cable) is indicated by a panel meter and seven-point multiplier:

Output System: The output impedance at the panel jack is 75 ohms, resistive. A 75-ohm output cable is provided, together with a termination unit that furnishes constant output impedances of 37.5, 7.1, and 0.75 ohms. The calibration of the panel voltmeter-multiplier combination is in terms of the actual voltage across the 37.5-ohm output. When the 7.1 and 0.75-ohm positions are used, the indicated output voltage must be divided by 10 and 100, respectively. A standard dummy antenna output is also available at the termination unit.

Output Voltage Accuracy: For multiplier settings below 1 volt the maximum error in output voltage is the sum of the attenuator and voltmeter errors listed below.

Maximum Voltmeter Error: At full scale, $\pm 3\%$ at frequencies below 25 Mc, rising to between $+3\%$ and -6% at 50 Mc; at 1/10 full scale, $\pm 8\%$ at frequencies below 25 Mc, rising to between $+13\%$ and -19% at 50 Mc.

Maximum Attenuator Error:

- Below 3 Mc, $\pm 3\%$ of meter reading ± 0.1 microvolt
- 3 to 10 Mc, $\pm 5\%$ of meter reading ± 0.2 microvolt
- 10 to 30 Mc, $\pm 10\%$ of meter reading ± 0.4 microvolt
- 30 to 50 Mc, $\pm 15\%$ of meter reading ± 0.8 microvolt

There is no attenuator error for the 1-volt multiplier setting.

Modulation: Continuously variable from 0 to 100%. The percentage of modulation is indicated by a panel meter to an accuracy of $\pm 10\%$ of the meter reading up to 80%, for

By unusually careful filtering and shielding, radio-frequency leakage and stray fields have been reduced to a minimum; measurements may be made at output levels as low as 0.5 microvolt. The tuned amplifier stage reduces reaction of the output circuit on carrier frequency, and side-band cutting is kept very low by heavy damping of the tuned plate circuit.

carrier frequencies below 16 Mc; 15% for higher carrier frequencies.

Internal modulation is available at 400 cycles and 1000 cycles, accurate in frequency within $\pm 5\%$.

The generator can be modulated by an external oscillator. Approximately 10 volts across 500,000 ohms are required for 80% modulation. The over-all modulation characteristic is as follows:

Carrier Frequency	Audio Range	Level
0.5—50 Mc	50—15,000	± 1 db
0.1—0.5 Mc	50—10,000	± 1.5 db
16—100 kc	50—10% Carrier Frequency	± 1.5 db

Frequency Modulation: Negligible for all intended uses.

Distortion and Noise Level: The envelope distortion at a modulation level of 80% is less than 4% at 1 Mc carrier frequency. Carrier noise level is at least 40 db below 80% modulation.

Leakage: The magnetic induction leakage is less than 5 microvolts per meter at a distance of 2 feet from the generator. The 3-foot output cable permits the receiver under test to be kept beyond this limit. Radiation fields are negligible.

Power Supply: The instrument operates from any 40 to 60 cycle, 115-volt (or 230-volt) line. An electronic voltage regulator compensates for line voltage fluctuations from 105 to 125 volts (or from 210 to 250 volts). A maximum input power of 140 watts is required.

Tubes: Supplied with instrument:

- 2—type 1614
- 1—type 6C8-G
- 1—type 6L6-G
- 1—type 5T4
- 2—type 2A3
- 1—type 6SF5
- 1—type VR-150-30
- 1—type 955
- 1—type 6H6
- 1—Amperite 3-4

Accessories Supplied: Seven-foot line connector cord, spare pilot lamps and fuses, shielded output cable and termination unit.

Mounting: The panel is finished in black crackle and the cabinet is black wrinkle finish.

Dimensions: (Height) 16 x (width) 33 x (depth) 12 inches, over-all.

Net Weight: 120 pounds, approximately.

Type	Code Word	Price
805-B Standard-Signal Generator	LEPER	\$850.00

PATENT NOTICE. See Note 1, page vi.

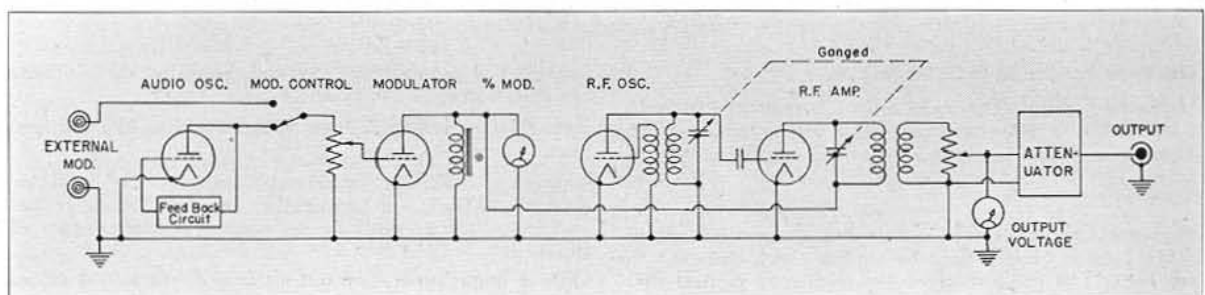

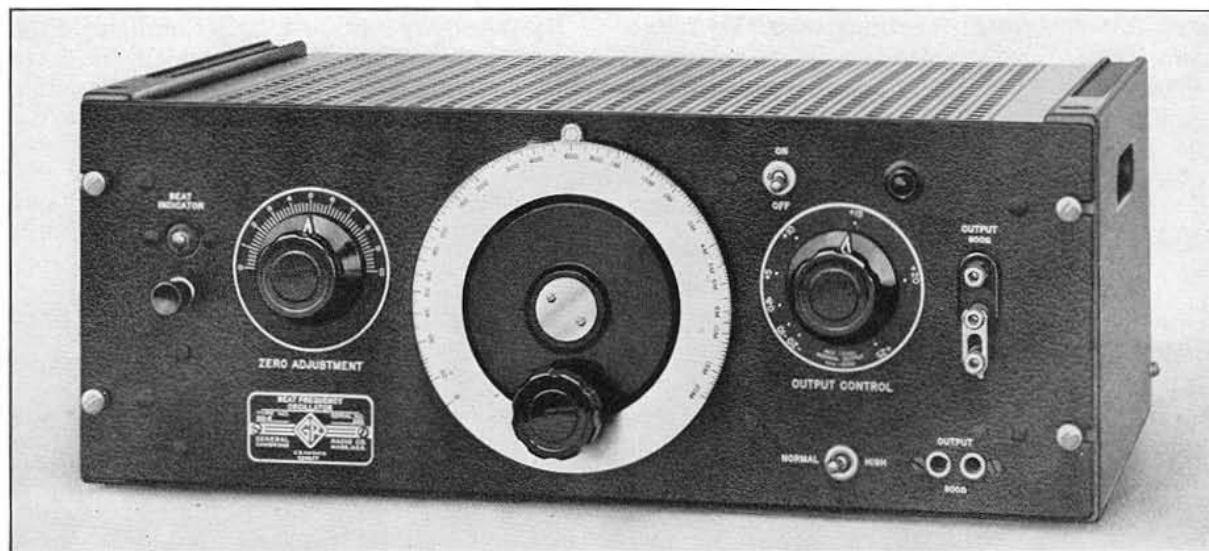

TYPE 913-B BEAT-FREQUENCY OSCILLATOR

USES: This is a general-purpose beat-frequency oscillator that is particularly useful as a power source for tests on audio-frequency lines and associated networks. It is also useful as a voltage source for bridge measurements and for modulating signal generators and test oscillators. The oscillator can be used on either balanced or unbalanced systems.

DESCRIPTION: The TYPE 913-B utilizes the conventional beat-frequency oscillator design, but has a number of unusual design features that contribute to improved performance and ease of operation. Two radio-frequency oscillators, one fixed and one variable, feed a pentagrid converter. The resulting difference frequency, after passing through a low-pass filter, is amplified in a balanced, degenerative amplifier. The output level is controlled by a constant-impedance attenuator that is calibrated in decibels with respect to an output of one milliwatt into a 600-ohm line.

For permanent or relay-rack installation, duplicate output terminals are provided at the rear of the instrument, through standard multi-point connectors (Jones plug).

A neon lamp beat indicator is provided to assist in standardizing the frequency calibration of the oscillator by setting to zero beat. The frequency dial carries a logarithmic scale, and is driven by a vernier gear-reduction drive.

FEATURES: Because the output voltage is practically constant over the entire frequency band and the output control is calibrated in db, it is possible to use this oscillator to take frequency characteristics directly without a dummy generator resistance and oscillator voltmeter. The use of temperature compensated elements in the oscillator circuits, as well as stabilization of the power supply, contributes to a high degree of stability, in output voltage as well as frequency.

Careful design of the power-supply filter has reduced the power-frequency hum to a very low level, while excellent waveform is achieved by improved oscillator circuit design in conjunction with degeneration in the audio amplifier.

Small size and light weight facilitate moving the oscillator about the laboratory or radio station and contribute to its general utility.

SPECIFICATIONS

Frequency Range: 20 to 20,000 cycles.

Frequency Control: The main control is engraved from 20 to 20,000 cycles per second and has a true logarithmic frequency scale. The total scale length is approximately 12 inches. The effective angle of rotation is 240°, or 80° per decade of frequency.

Frequency Calibration: The calibration can be standardized within 1 cycle at any time by setting the instrument to zero beat. The calibration of the frequency control dial

can be relied upon within $\pm 2\%$ ± 1 cycle after the oscillator has been correctly set to zero beat.

Zero Beat Indicator: A neon lamp is used to indicate zero beat.

Frequency Stability: Improved design of the oscillator circuits and the use of temperature-compensated capacitors and inductances result in an unusually high degree of stability.

Output Impedance: The output impedance is 600 ohms,

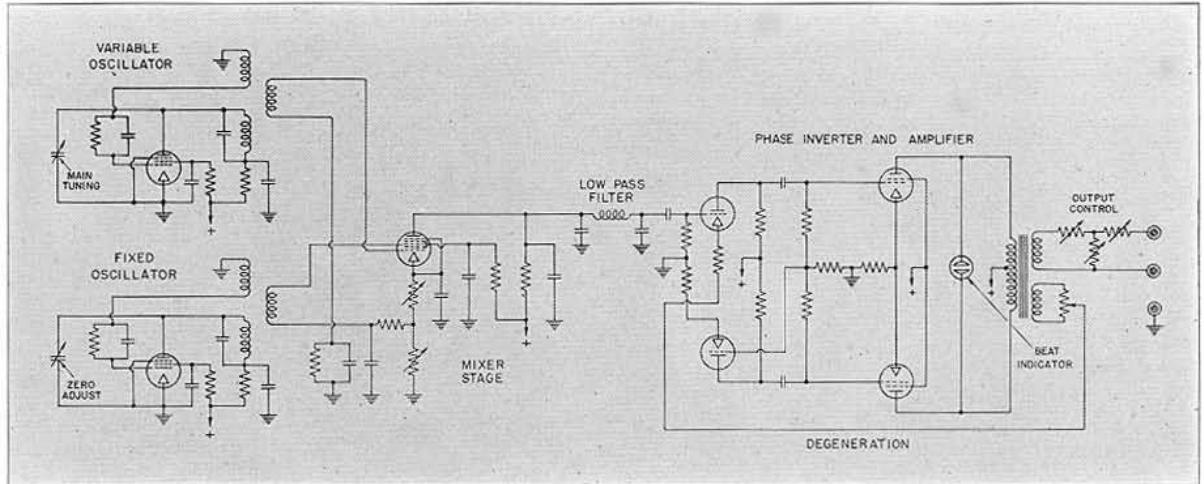

either grounded or balanced-to-ground, and is essentially constant regardless of the output control setting. With load impedances of 2000 ohms or less, the output is balanced for all settings of the output control. With higher load impedances, unbalance may occur at low settings of the output control.

Output Voltage: Approximately 25 volts open circuit. For a matched resistive load the output voltage varies by less than ± 0.25 db between 20 and 15,000 cycles. The open-circuit output voltage is approximately 40 volts with the output switch in the HIGH position.

Output Control: The output control is calibrated in db referred to 1 milliwatt into 600 ohms. The total range is from +25 to -20 db.

Output Power and Waveform: Normal output 0.3 watt maximum when operated into a matched load, with total harmonic content approximately 0.3% between 150 and 7000 cycles. Below 150 cycles the harmonic content increases, reaching approximately 2% at 50 cycles. A panel switch allows an increase in the output power to a maximum of 1 watt. For this HIGH position of the OUTPUT switch the distortion is approximately 1% between 150 and 7000 cycles and increases to 5% at 50 cycles. With the OUTPUT control turned fully on, the harmonic content is approximately doubled when the oscillator is operated into a very low impedance. If, however, the OUTPUT control is turned 3 db or more below the maximum setting, the load impedance has very little effect upon the waveform.

A-C Hum: For NORMAL output the a-c hum is less than 0.05% of the output voltage at a line frequency of 60 cycles, and is less than 0.1% at 50 cycles. Since the volume control is in the output circuit, the hum percentage does not increase for low output voltages. The hum may be slightly greater on the HIGH output range.

Temperature and Humidity Effects: Large changes in ambient temperature and humidity necessitate a readjustment of the zero-beat setting. High temperatures and humidity cause a slight increase in distortion and a slight decrease in output.

Terminals: Jack-top binding posts with standard $\frac{3}{4}$ -inch spacing and standard Western Electric double output jack are provided on the panel. A Jones socket and plug provide duplicate output terminals on the back of the instrument for relay-rack installation.

Mounting: The panel is designed for mounting on a 19-inch relay rack, but removable wooden ends are supplied so that it may be used equally well on a table.

Power Supply: 105 to 125 volts, 40 to 60 cycles ac. A simple change in the connections to the power transformer allows the instrument to be used on 210 to 250 volts. The total consumption is about 100 watts.

Tubes:

- 2 — type 6SK7
- 1 — type 6SA7
- 2 — type 6SF5
- 2 — type 6V6-GT
- 2 — type 6X5-G
- 2 — type VR-150-30
- 1 — 139-949 Neon Lamp

All are supplied with the instrument.

Accessories Supplied: A seven-foot connecting cord, a multipoint connector, and spare fuses and pilot lamp are supplied.

Dimensions: $19\frac{3}{8} \times 14\frac{1}{4} \times 7\frac{1}{2}$ inches, over-all.

Net Weight: 35 pounds.

Type	Code Word	Price
913-B Beat-Frequency Oscillator	CAROL	\$260.00

PATENT NOTICE. See Notes 1, 25, page vi.

OTHER BEAT-FREQUENCY OSCILLATORS

Other types of beat-frequency oscillators are described on pages 90 and 136. TYPE 700-A (page 90), with an upper frequency limit of 5 Mc, is designed for wide-band measurements. TYPE 617-C (page 136) has a linear scale from 0 to 5000 cycles, and is used as an interpolation device in frequency measurements.

TYPE 700-A WIDE-RANGE BEAT-FREQUENCY OSCILLATOR

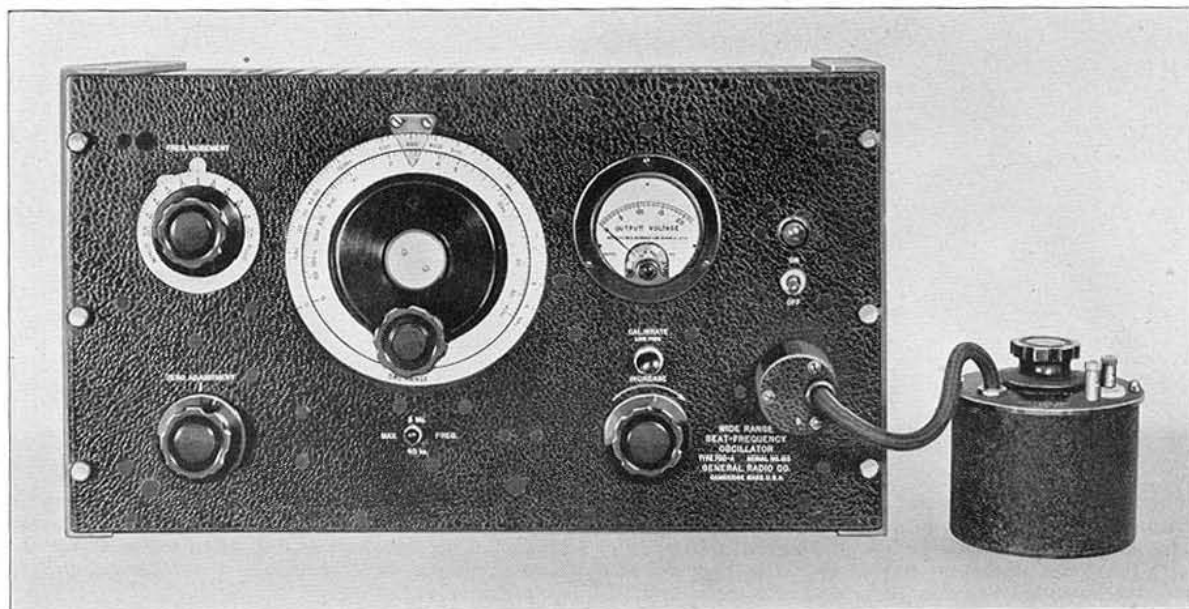

Panel view of TYPE 700-A Wide-Range Beat-Frequency Oscillator with TYPE 700-P1 Voltage Divider.

USES: This oscillator is useful for taking selectivity curves on tuned circuits over a wide range of frequencies, for measuring the transmission characteristics of filters, and for testing wide-band systems such as television amplifiers and coaxial cables. The instrument is also an excellent general laboratory oscillator for use as a source for bridge measurements and as a modulator for standard-signal generators.

DESCRIPTION: Two high-frequency oscillators, one fixed and the other variable, feed a detector from which the difference frequency is obtained. The detector is followed by a low-pass filter and a two-stage wide-band amplifier.

Both oscillator circuits are mounted in a heavy cast-aluminum box to assure uniform heat distribution and practically perfect shielding. Two ranges are provided for by changing the frequencies of both the oscillators by a factor of one hundred. A single switch on the panel changes from one range to the other.

Degeneration is employed in the amplifier to minimize hum and distortion, and to equalize

the frequency response. Low-pass filters are provided to maintain a high ratio of desired output voltage to beating voltage. A pentagrid mixer tube and a buffer amplifier are used to isolate the two oscillators electrically.

FEATURES: The outstanding feature of this oscillator is the wide range of frequencies which is covered with a single control, direct reading in frequency. The frequency variation with dial setting is approximately logarithmic. Small variations in frequency can be made at any point by the use of an incremental frequency control which is also direct reading. A low-frequency range has been incorporated in the TYPE 700-A Wide-Range Beat-Frequency Oscillator for convenience in working in the audio-frequency range. A delayed automatic volume control circuit maintains a high degree of constancy in the output voltage. Since the delay voltage used is essentially constant, it tends to maintain the output level constant in the face of line voltage variations.

SPECIFICATIONS

Frequency Range: Two ranges are provided: 50 cycles to 40 kilocycles, and 10 kilocycles to 5 megacycles.

Frequency Control: The main dial is direct reading in frequency and carries two approximately logarithmic frequency scales covering the ranges specified above. A frequency range switch is provided for rapidly changing from one range to the other. There is also an incremental frequency control which is calibrated between -100 and $+100$ cycles on the low range and -10 and $+10$ kilocycles on the high range. Any frequency change made with this control adds algebraically to the frequency of the main control.

Frequency Calibration: The calibration may be standardized at any time by setting the instrument to zero beat with the zero adjustment control. This adjustment can be made within 5 cycles on the low range or 500 cycles on the high range.

After the oscillator has been correctly set to zero beat, the calibration of the main frequency-control dial can be relied upon within $\pm 2\%$ ± 5 cycles on the low range and $\pm 2\%$ ± 800 cycles on the high range. The calibration of the incremental frequency dial is within ± 5 cycles or ± 500 cycles on the low and high ranges, respectively.

Frequency Stability: Through careful design adequate

thermal distribution and ventilation are provided for minimizing frequency drifts. The oscillator can be accurately reset to zero beat at any time, thereby eliminating errors caused by any small remaining frequency drift.

Output Impedance: The output is taken from a 1500-ohm Ayrton-Perry-wound potentiometer. One output terminal is grounded.

Output Voltage: The maximum open-circuit output voltage of the oscillator is between 10 and 15 volts. Because of the automatic volume control circuit, this voltage remains constant within ± 1.5 decibels over each entire frequency range.

Waveform: The total harmonic content of the open-circuit voltage is less than 3% for frequencies above 300 cycles on the low range and above 30 kilocycles on the high range.

A-C Hum: When the oscillator is operated at any supply frequency from 40 to 60 cycles, the power-supply ripple is less than 1% of the output voltage on either range.

Voltmeter: A vacuum-tube voltmeter circuit is used in the oscillator for measuring the output voltage. The indicating meter on the panel is calibrated directly in volts at the output terminals.

Controls: In addition to the main frequency-control dial and the incremental frequency dial, there is a frequency range switch, and a zero beat adjustment. The output voltage is varied by a potentiometer control provided near the output terminals.

Terminals: The output terminals are jack-top binding posts with standard $\frac{3}{4}$ -inch spacing. The lower terminal is grounded to the panel and shields.

Mounting: The instrument is normally supplied for table mounting, but can be easily adapted for relay-rack mounting by removing two walnut brackets at the ends of the panel.

Power Supply: A-C power supply, 105 to 125 volts, 40 to 60 cycles, is used. A simple change in the connections to the power transformer allows the instrument to be used on 210 to 250 volts.

The total power consumption is approximately 85 watts.

Tubes: The following tubes are used:

- 2—type 6J5-G
- 1—type 6J7
- 1—type 6L7
- 2—type 25L6
- 1—type 6H6
- 1—type 5T4
- 1—neon lamp T-4 $\frac{1}{2}$

All tubes are supplied.

Accessories Supplied: A seven-foot power cord, spare fuses and pilot lights.

Dimensions: Panel, (width) 19 x (height) 10 $\frac{1}{2}$ inches, over-all; depth behind panel, 11 inches.

Screw holes in the panel are the standard spacing for mounting the instrument in a standard 19-inch relay rack.

Net Weight: 56 pounds.

Type	Code Word	Price
700-A Wide-Range Beat-Frequency Oscillator	ORGAN	\$555.00

PATENT NOTICE. See Note 1, page vi.

TYPE 700-P1 VOLTAGE DIVIDER

The TYPE 700-P1 Voltage Divider extends the readable range of the output voltmeter-potentiometer combination of the TYPE 700 Oscillator down to 100 microvolts.

The frequency characteristic is flat within 10%, on all settings, at frequencies up to 5 Mc, permitting measurements on high-gain, wide-band systems.

SPECIFICATIONS

Accuracy: The accuracy of attenuation is $\pm 3\%$.

Impedance: The input impedance is 2000 ohms; the output impedance is 200 ohms.

Dimensions: (Height) 4 $\frac{1}{2}$ x (diameter) 4 $\frac{1}{2}$ inches.

Net Weight: 1 $\frac{1}{2}$ pounds.

Type	Code Word	Price
700-P1 Voltage Divider	OTHER	\$35.00

Functional schematic diagram of the TYPE 700-A Wide-Range Beat-Frequency Oscillator.

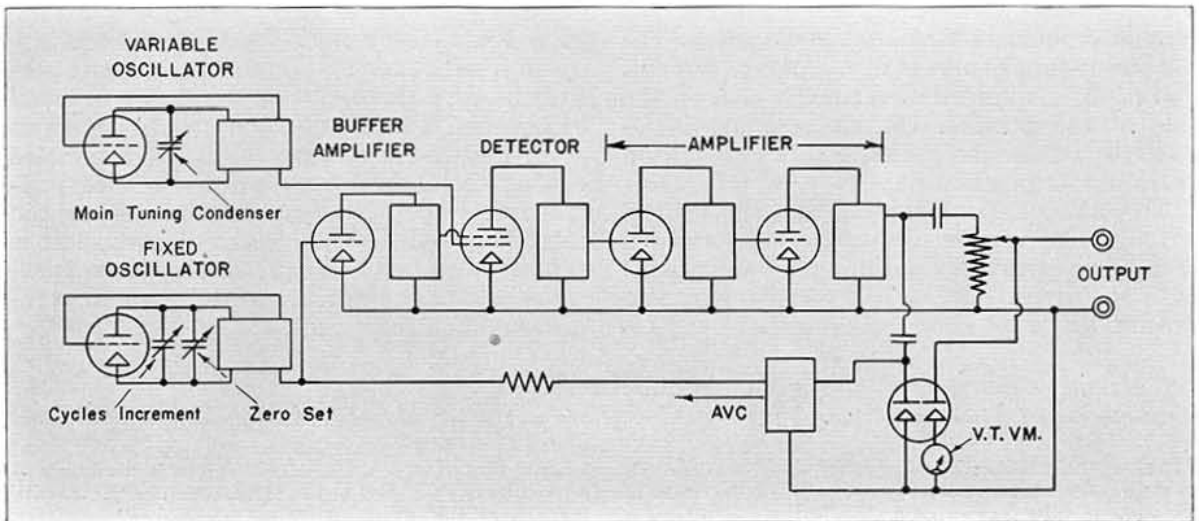

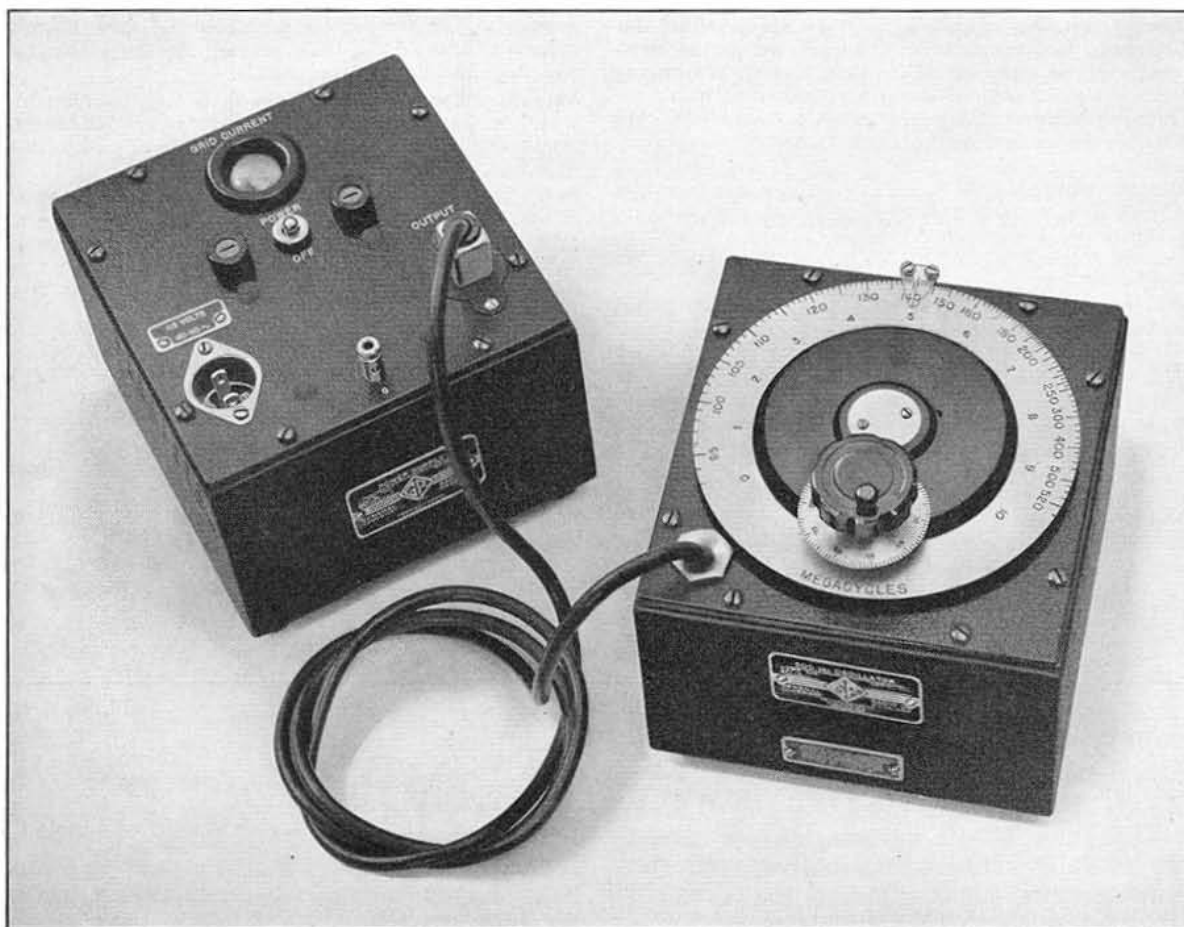

TYPE 857-A U-H-F OSCILLATOR 100 Mc to 500 Mc

USES: The TYPE 857-A U-H-F Oscillator is a power source for measurements and testing in the frequency range between 100 Mc and 500 Mc.

DESCRIPTION: The oscillator consists of a butterfly-type tuned circuit and a W. E. 316-A Vacuum Tube, enclosed in a metal housing that provides a moderate amount of shielding. The a-c power-supply unit is in a separate cabinet.

Output is obtained at a coaxial jack on the side of the cabinet. Output coupling is inductive and can be varied continuously from maximum to practically zero.

The main dial is calibrated directly in megacycles. The vernier dial carries 100 uniform divisions and covers the tuning range in about 10 revolutions. An auxiliary scale indicates revolutions of the slow-motion dial.

Filament and plate power are supplied by the TYPE 857-P1 Power Supply. A 3-conductor shielded cord of 6-foot length, permanently connected to the oscillator, plugs into the power supply unit.

FEATURES: The TYPE 857-A U-H-F Oscillator delivers a moderate amount of power over a wide frequency range. Single-dial frequency control, with slow-motion drive, makes it possible to vary the oscillator frequency in small increments. The use of the butterfly circuit as a frequency-determining element eliminates output fluctuations from erratic electrical contact, since no electrical connections to the rotor are needed. The insulated rotor shaft is supported in ball bearings, and backlash is extremely low. The entire assembly is small, compact and light in weight.

SPECIFICATIONS

Frequency Range: 100 Mc to 500 Mc.

Frequency Calibration: The frequency dial reads directly in megacycles with an accuracy of $\pm 1\%$. Replacement of the vacuum tube may cause a shift in the calibration. A

trimmer capacitor is provided to compensate for variations in tube capacitance.

Output Power: The oscillator will deliver a maximum of approximately 0.5 watt at the highest frequency. At lower frequencies, the output increases.

Output Coupling: By rotating the output jack, the orientation of the small output coupling loop can be varied from zero to maximum coupling. By moving the jack in or out, the spacing between the oscillator tuned circuit and the loop can be adjusted in three steps. The output terminal is a coaxial plug.

Output Impedance: The output system, with its adjustable coupling, is adapted for use with coaxial lines. Maximum power can be delivered to load impedances in the range normally encountered in coaxial systems.

Power Supply: Filament and plate power is furnished by the TYPE 857-P1 Power Supply, which is mounted in a separate cabinet with connecting cord and plug. The plate voltage supplied by this unit is fixed at the maximum value for safe operation of the tube. It operates from a 105- to 125-volt (or 210- to 250-volt) a-c line, 40 to 50 cycles. When other types of power supply are used, the power requirements are:

Filament 3.65 ma at 25 volts
 Plate 50 ma at 350 volts

Oscillation Indicator: An electron-ray tube is provided in the TYPE 857-P1 Power Supply to indicate grid current and thus furnish an indication of oscillation.

Mounting: Both oscillator and the power supply unit are mounted in metal cabinets.

Dimensions: Oscillator, 6 7/8 x 7 5/8 x 7 1/4 inches, overall; power supply, 5 1/2 x 6 5/8 x 6 7/8 inches, overall.

Net Weight: Oscillator, 6 1/4 pounds; power supply, 9 1/2 pounds.

(Right) View of the tuned circuit of the TYPE 857-A Oscillator, showing also the output coupling loop and output jack in approximately their normal position.

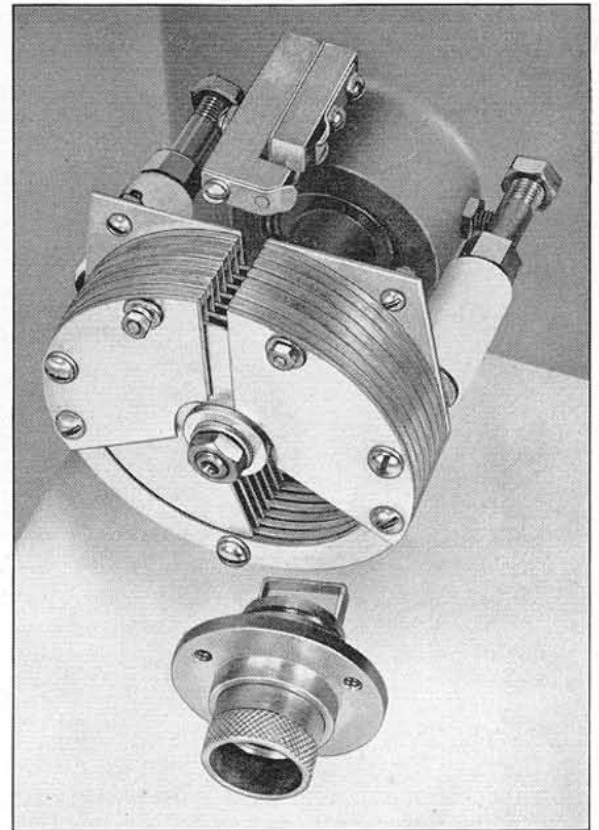

Type	Code Word	Price
857-A	U-H-F Oscillator (with Power Supply)	OFTEN \$250.00

PATENT NOTICE: See Notes 1, 10, page vi.

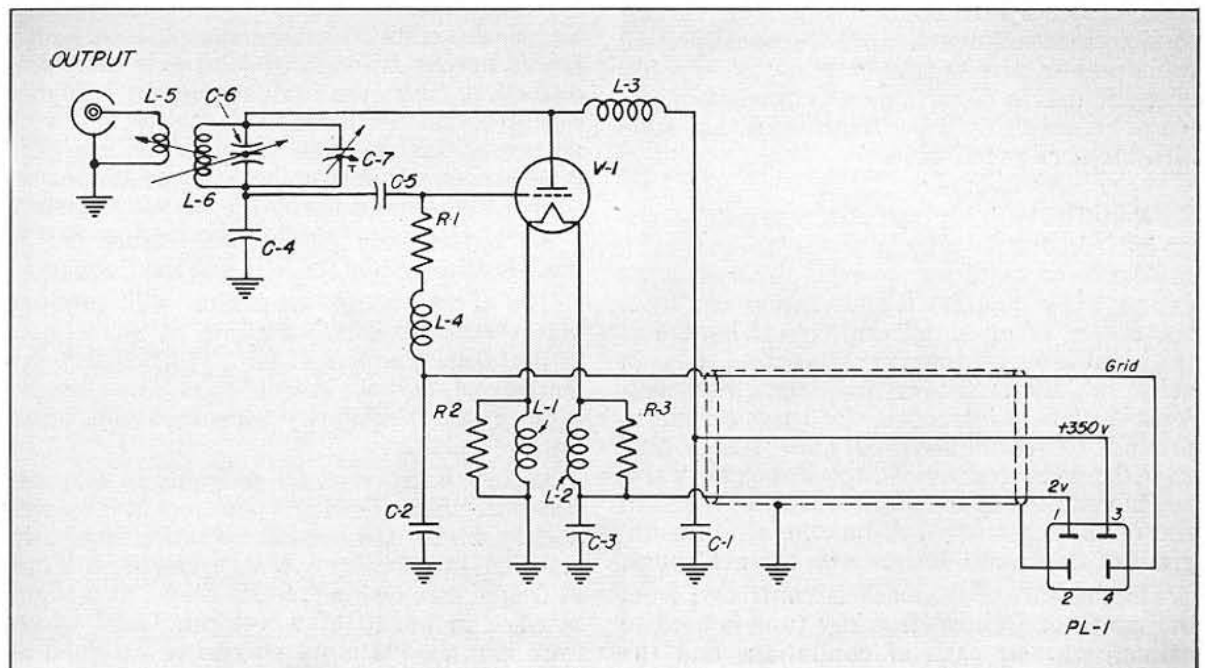

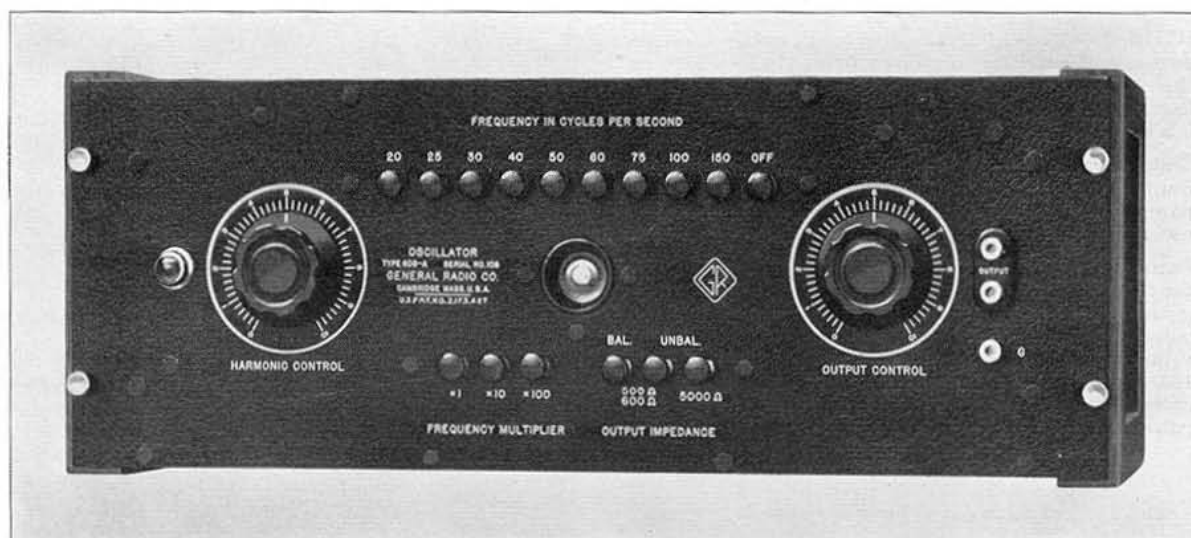

TYPE 608-A OSCILLATOR

USES: The TYPE 608-A Oscillator was designed particularly for use as a tone source for distortion measurements and as a power source for bridge measurements at audio frequencies. Because of the large number of frequencies at which this oscillator will operate, it is also satisfactory for measuring frequency characteristics and for use as a general laboratory oscillator.

The output frequencies include those recommended by the FCC for distortion measurements on broadcast transmitters. This oscillator is recommended for use as a tone source in distortion measurements. The unusually pure waveform of the output voltage at low frequencies makes distortion measurements possible at considerably lower frequencies than have hitherto been practicable.

DESCRIPTION: This oscillator operates on the inverse feedback principle. By means of a resistance capacitance network all frequencies except the oscillation frequency are fed from the output of an amplifying circuit back into the input in such a manner as to cancel the gain at all but the oscillation frequency. Sufficient regeneration is introduced into the circuit to produce self-oscillation and, since this is controlled by the resistance-capacitance network, no inductances or transformers are required in the oscillating circuit. A functional block diagram of the circuit is shown on the next page.

The amount of feedback is controlled from the panel, and an electron-ray tube is used to indicate the strength of oscillations and the harmonic content.

The desired frequency is selected by push-button switches. Another push-button switch determines the output impedance. An output control is provided for regulating the output voltage.

FEATURES: Both electrically and mechanically the design of this oscillator is new and represents a considerable advance over previous practice.

In the electrical circuit, the principle of inverse feedback is applied to the production of electrical oscillation with the result that a high power output is obtained with extremely low distortion. Since the feedback circuit is highly selective, the frequency of the oscillator is unusually stable. The absence of iron-core inductances minimizes the amount of power-supply hum picked up by the circuit elements.

An outstanding mechanical feature is the push-button system for selecting the frequency.

The TYPE 608-A Oscillator will produce voltages of excellent waveform at any one of 27 frequencies, ranging from 20 to 15,000 cycles per second, and the frequency can be changed rapidly and simply by means of the push-button switches.

Jacks are provided for plugging in external resistors, thus allowing operation at any frequency within the normal operating range. In addition, satisfactory operation can be obtained at frequencies outside of this range, at a slight sacrifice in purity of waveform. Good waveform and adequate output can be attained at frequencies as low as one cycle per second.

For any additional frequency three resistors are required, and for any set of three resistors, three frequencies, in decade steps, can be obtained.

A harmonic control and electron-ray tube are provided so that the unit can be adjusted for minimum distortion under all conditions of operation.

SPECIFICATIONS

Frequency Range: 20 to 15,000 cycles.

Frequency Control: The frequency is controlled by two push-button switches. The first provides frequencies of 20, 25, 30, 40, 50, 60, 75, 100, and 150 cycles, while the second multiplies these frequencies by 1, 10, and 100. The frequencies included cover practically the entire audible range in increments small enough so that the oscillator may be used for measuring frequency characteristics. Furthermore, these frequencies include all important standard bridge and broadcast test frequencies.

Other frequencies within the operating range of the instrument may be obtained by plugging in external resistances.

Frequency Calibration: Each instrument is adjusted within $\pm 2\%$ or 1 cycle, whichever is the greater, of the frequency engraved on the panel. The best accuracy is secured when the harmonic control is adjusted for low distortion.

Frequency Stability: When this oscillator is operated at normal room temperatures, the frequency will not drift by more than 1% over a period of several hours. The harmonic control provides a means whereby the operating conditions of the oscillator may be brought back to the correct values regardless of ordinary changes in load or line voltage.

Output Impedance: Three output circuits are provided. Selection among them is obtained by means of a push-button switch on the panel. The output impedances are as follows:

1. 500-ohm balanced to ground.
2. 500-ohm unbalanced.
3. 5000-ohm unbalanced.

The volume control is a potentiometer in the 5000-ohm circuit. The actual output impedance of the 5000-ohm output circuit will vary between 1000 and 6000 ohms, depending upon the setting of the volume control. Suitable resistance pads keep the impedance of the 500-ohm output circuit between 400 and 600 ohms regardless of the volume control setting.

Balanced Output: The 500-ohm balanced output circuit is balanced at all frequencies when operating into a balanced load of any impedance.

Output Power: The 5000-ohm output circuit provides an output power of approximately 0.5 watt into a matched load when the instrument is operated on a 115-volt line. The maximum power obtainable from the 500-ohm output circuit is approximately 100 milliwatts.

Waveform: The harmonic control provides a means of obtaining unusually pure waveform. With the harmonic control so set that the output voltage is about 90% of maximum the distortion will be approximately 0.2%. By a further reduction of the output voltage the distortion will be reduced to less than 0.1%, on the 5000-ohm output circuit. Because of distortion in the output transformer the harmonic content in the 500-ohm output circuit may exceed the above values slightly at frequencies below 50 cycles.

With the harmonic control turned full on, and the oscillator delivering its maximum power output, the distortion will be of the order of 5%.

Hum Level: When the oscillator is properly grounded and operated from a 25 to 60-cycle line, the hum level is less than 0.05% or 0.1 millivolt, whichever is the greater.

Temperature and Humidity Effects: Over the normal range of room conditions (65° Fahrenheit to 95° Fahrenheit; 0 to 95% relative humidity) the operation of the oscillator is substantially independent of temperature and humidity conditions.

Controls: In addition to the push-button switches for adjusting the frequency and the output impedance, harmonic output controls are provided on the panel. An electron-ray tube provides a means for adjusting the harmonic control correctly under all conditions of operation. Except where minimum harmonic distortion is an absolute necessity, the harmonic control need not be readjusted.

Terminals: Jack-top binding posts with standard $\frac{3}{4}$ -inch spacing are provided for the output connection. A ground terminal is also provided.

Mounting: The instrument is designed for either table or relay-rack mounting. The wooden ends supplied with the oscillator are removed when it is used on a relay rack. A perforated metal shield is provided.

Power Supply: 105 to 125 volts, 25 to 60 cycles ac. A simple change in the connections to the power transformer allows the instrument to be used on 210 to 250 volts. The total power consumption is approximately 50 watts.

Tubes: The following tubes are used: 1 6F5-G, 1 6Y6-G, 1 6X5-G, 1 6E5. A complete set of tubes is supplied with each instrument.

Accessories Supplied: A seven-foot connecting cord, spare fuses and pilot lamps, and a multipoint connector.

Dimensions: (Length) 19½ x (depth) 11½ x (height) 7¾ inches, over-all. Panel, 19 x 7 inches.

Net Weight: 36¼ pounds.

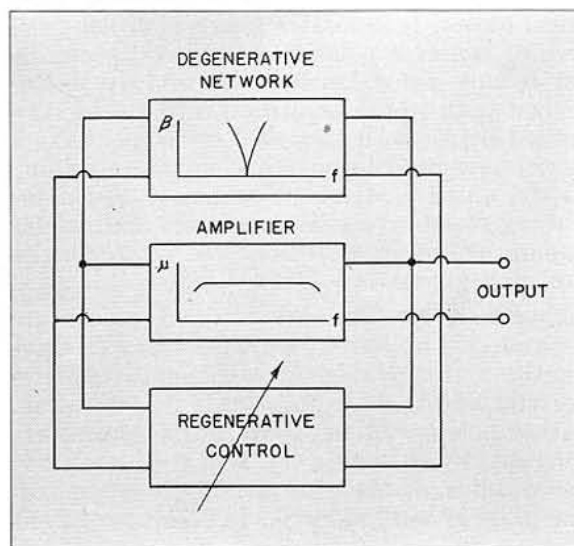

Functional schematic diagram of TYPE 608-A Oscillator. The amplifier, which has a propagation constant μ , is made degenerative, except at the frequency of oscillation, by means of the network with propagation constant β , thus providing a sharply selective circuit. Sufficient regeneration is provided to cause self-oscillation.

Type	Code Word	Price
608-A	ORBIT	\$260.00
PATENT NOTICE. See Notes 1, 9, page vi.		

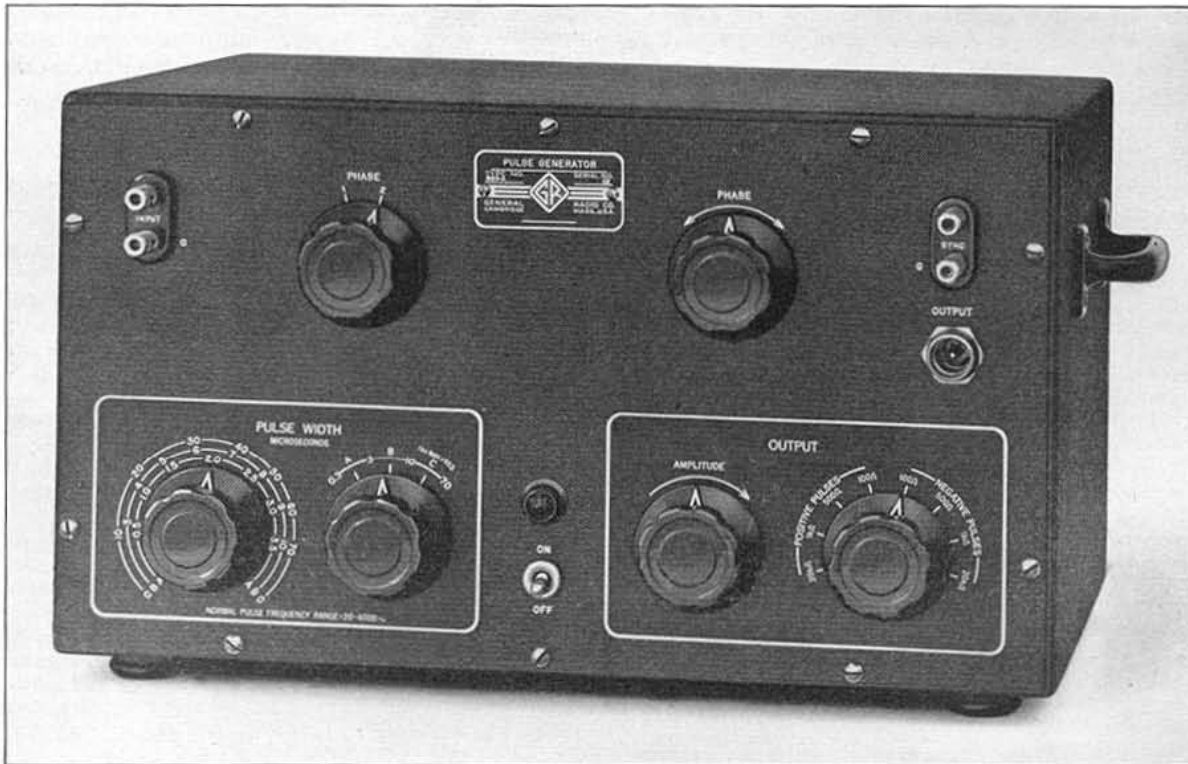

TYPE 869-A PULSE GENERATOR

USES: The pulse generator is intended for use in tests on circuits designed to pass short electrical pulses. It generates pulses of either positive or negative polarity, whose width can be set to any value between 0.3 and 70 microseconds and whose repetition rate can be controlled between 20 and 4000 cycles per second from an external a-c source. Complete shielding of the entire instrument makes it useful for pulsing standard-signal generators and similar apparatus, where extremely low voltage levels are encountered.

DESCRIPTION: The microsecond pulses are generated in an output amplifier stage by driving the control grid between the limits of plate-current cutoff and plate-current saturation. Either positive or negative output pulses are provided by switching the load resistance into the cathode, or plate circuit. The amplitude of the pulse is continuously adjustable by means of a screen voltage control. A negative bias voltage applied to the grid of this tube maintains the tube in a cutoff condition between pulses. During the pulse period a high positive bias is applied to the grid.

The positive pulse, used to control the output amplifier, is derived from a circuit employing two gas-triodes. The output amplifier grid is coupled to the center point of these series connected gas-triodes which are, in turn, placed across a condenser. A positive d-c potential is

developed across the condenser terminals by charging it from the power supply through a suitable series resistance.

When the first gas-triode becomes conducting, the positive condenser voltage appears across both the output amplifier grid and the other gas-triode. Conduction in the second gas triode removes the positive voltage from the amplifier grid. Simultaneously, the two gas-triodes now present a low-impedance path across the condenser and discharge it. When the condenser terminal voltage falls below a critical value, both gas-triodes deionize and resume their normal non-conducting state. The condenser then recharges through the series resistor and the circuit is ready for a second pulse operation.

The time delay between the conduction periods of the two gas-triodes determines the pulse width. A simple R-C circuit is employed for this purpose. Variable circuit elements provide a continuous range of adjustment.

In order that a microsecond pulse be clearly visible on the screen of a cathode-ray tube, the timing of the pulse and the sweep circuit must be maintained to within a fraction of a microsecond. This condition must exist even at the lowest pulse repetition rates. Hence, a synchronizing circuit with a high degree of control is provided. The input control voltage is first rectified, and then passed through a series of differen-

tiating amplifiers. This results in a peaked waveform with a sharp leading edge, and is used to control the action of the gas-triode circuit.

An output voltage is provided for controlling a high speed sweep circuit. A limited phase ad-

justment is provided between this point and the internal synchronizing amplifier. This permits adjustment of the timing of the pulse with respect to the high-speed sweep circuit of an external oscilloscope.

SPECIFICATIONS

Repetition Rate: 20 to 4000 cycles. Pulses longer than 10 microseconds are limited to a maximum frequency of 1000 cycles.

Input Voltage: Between 5 and 10 volts are required for normal control. For improved stability at the lowest frequencies, this may be increased to a maximum of 30 volts.

Input Voltage Waveform: This is not critical, and may vary from a sine wave to a triangular wave. Care must be taken, however, to keep this signal reasonably free from power supply hum voltage.

Synchronizing Output: A clipped sine wave appears across the synchronizing output terminals of approximately -160 and +50 peak volts. This may be used to control the high-speed sweep circuit of an oscillograph that has been provided with suitable triggering amplifiers.

Pulse Amplitude Control: A panel control permits the pulse amplitude to be adjusted from zero to maximum, with a negligible effect upon the pulse waveform.

Pulse Waveform: The pulse is essentially flat-topped, and has an effective rise time of 0.1 microsecond for pulse widths less than 10 microseconds. For longer pulses, the rise time is less than 10% of the pulse width.

Output Selector: A panel switch permits any one of four impedances to be inserted in the output amplifier, and also provides either positive or negative pulses.

Pulse Width: The output pulse is continuously adjustable over three ranges. These are 0.3-3.0, 3-10, and 10-70 microseconds, respectively. The calibration of these controls is approximately correct over the entire frequency range.

Output Amplitude: See table below.

Phasing Controls: Panel controls are provided to permit adjustable phasing of the output pulse, with respect to the voltage obtained at the synchronizing output terminals, over a limited range.

Power Supply: Either 115 or 230 volts, 50-60 cycles may be used. A variation of $\pm 10\%$ in the supply voltage will cause a minor variation in the output pulse amplitude, and will generally tend to change the pulse width. For optimum performance, operation at the 115- or 230-volt value is recommended. Power input is 60 watts.

Accessories Required: To drive the generator an a-c source is needed. The General Radio TYPE 913-B Beat-Frequency Oscillator is recommended.

Accessories Supplied: A seven-foot line connector cord, two TYPE 274-M Plugs, one TYPE 774-R2 Patch Cord, spare fuses, and pilot lamps are supplied.

Tubes Supplied with Instrument:

- 2 — type 6H6
- 1 — type 6AC7
- 1 — type 6X5
- 1 — type VR-150-30
- 1 — type 6SN7GT
- 2 — type 884
- 1 — type 6SC7
- 1 — type 6ZY5G
- 1 — type VR-105-30
- 1 — type 6L6

Mounting: Metal cabinet.

Dimensions: (Length) 19 x (height) 9 $\frac{3}{4}$ x (depth) 12 $\frac{1}{2}$ inches, overall.

Net Weight: 38 $\frac{1}{4}$ pounds.

PEAK OUTPUT VOLTS—OPEN CIRCUIT

Pulse Polarity Output Setting	Positive				Negative				Operating Frequency*
	20 K Ω	1000 Ω	500 Ω	100 Ω	100 Ω	500 Ω	1000 Ω	20 K Ω	
Range A	90	80	70	20	18	80	150	300	500 \sim
Range B	100	90	80	20	18	90	170	300	500 \sim
Range C	100	80	80	20	18	90	180	300	500 \sim

*For other operating frequencies, the voltages will be approximately within 20% of the values given above. In general, the open circuit output voltage will tend to decrease as the pulse width and operating frequency increase.

Type	Code Word	Price
869-A	Pulse Generator	\$260.00

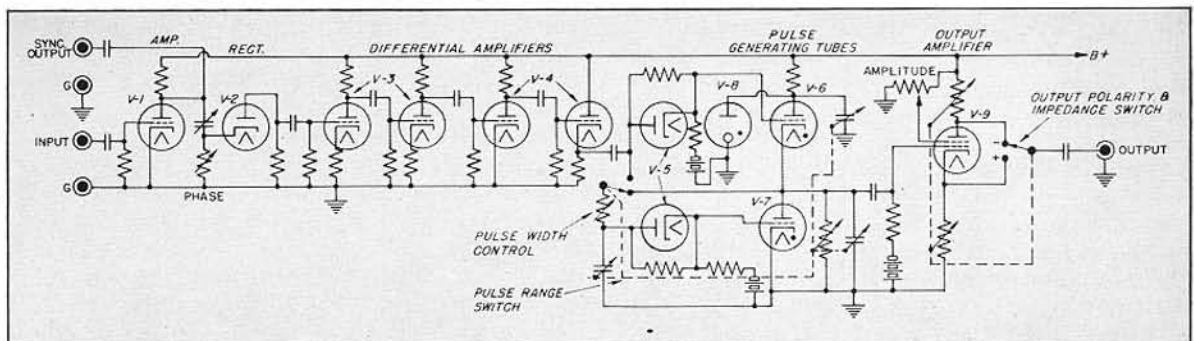

TYPE 723 VACUUM-TUBE FORK

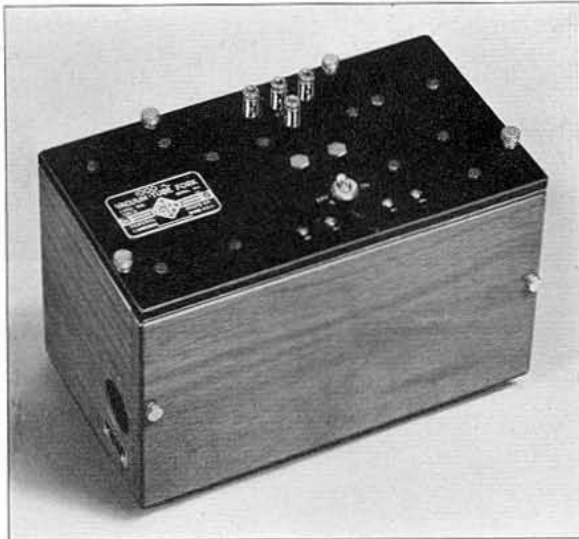

USES: The TYPE 723 Vacuum-Tube Fork is a compact, stable, fixed-frequency oscillator. It is particularly useful as a modulating source for standard-signal generators and beacon trans-

mitters, as a power source for transmission measurements on lines and cables, and as a test-tone generator for communication systems. Its waveform is sufficiently pure to permit its use as a test-signal source for many types of distortion measurements. It is an excellent source of timing pulses for oscillograms.

DESCRIPTION: This instrument is an electro-mechanical oscillator whose frequency is determined by a vacuum-tube driven tuning fork. The driving and pickup coils are so arranged as to load the tines of the fork equally and to affect only slightly its free vibration.

Space is provided in the cabinet for mounting batteries or an a-c power-supply unit. (See price list on page 99.)

A filter and an output transformer are included to suppress harmonics and to provide three output impedances.

FEATURES: The outstanding features of this new oscillator are accuracy and stability of frequency, low harmonic content, constant output, light weight, and the low cost.

SPECIFICATIONS

Frequency: Two frequencies are available, 1000 cycles and 400 cycles.

Frequency Stability: The temperature coefficient of frequency is approximately -0.008% per degree Fahrenheit. The frequency is entirely independent of load impedance. When the a-c power supply is used an initial downward drift of frequency occurs as the temperature of the fork is affected by heat generated in the power-supply unit. The total frequency drift is of the order of $.15\%$ to $.2\%$. Most of this drift, however, occurs in the first 30 minutes of operation.

Accuracy: The frequency is adjusted to within $\pm 0.01\%$ of its specified value, at 77° Fahrenheit.

Output: The output to a matched load is approximately 50 milliwatts.

Internal Output Impedance: Output impedances of 50, 500, and 5000 ohms are provided.

Waveform and Hum Level: The total harmonic content is less than 0.5% . The hum is negligible.

Terminals: Binding posts for the output circuit are mounted on the panel. Battery terminals are brought out to sunken screw heads on the panel to permit measurement of the battery voltages.

Power Supply: The instrument is available for either battery operation or for operation from 105 to 125-volt, 50 to 60-cycle line. For battery operation one Burgess type 4FA ($1\frac{1}{2}$ -volt) and two Burgess type Z30-N (45-volt) are required. The batteries and a-c power supply are interchangeable. The power supply, TYPE 723-P1, is available separately. (See price list.) The ON-OFF switch is arranged to control the a-c line or the battery current.

Schematic wiring diagram of TYPE 723 Vacuum-Tube Fork.

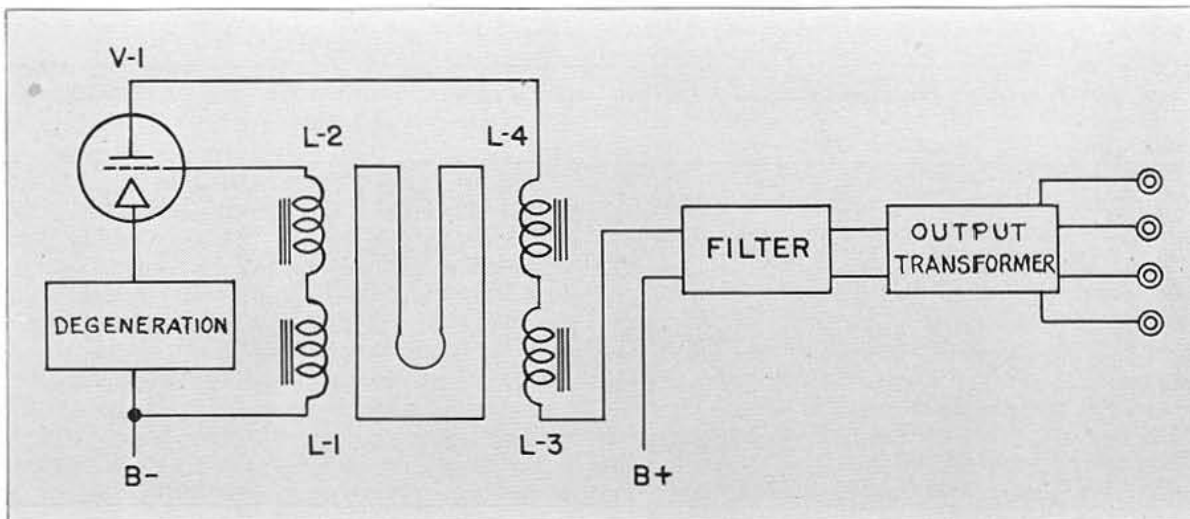

Vacuum Tubes:

For battery supply: 1 type 1A5-G
 For a-c supply: 1 type 1A5-G
 1 type VR-105-30

The necessary tubes are supplied.

Accessories Supplied: A seven-foot line connector cord is supplied with the a-c operated model.

Mounting: The oscillator assembly is mounted on a bakelite panel and is enclosed in a walnut cabinet.

Dimensions: (Length) 10 3/8 x (width) 6 1/4 x (height) 7 3/4 inches, over-all.

Net Weight: 11 1/4 pounds, including batteries; 9 pounds, with a-c supply; a-c power supply alone, 1 1/4 pounds.

Type	Frequency	Power Supply*	Code Word	Price
723-A	1000 cycles	Batteries	SNAKE	\$70.00
723-C	1000 cycles	105 to 125 volts, 50 to 60 cycles	SOLID	90.00
723-B	400 cycles	Batteries	STORY	70.00
723-D	400 cycles	105 to 125 volts, 50 to 60 cycles	SULKY	90.00
723-P1	A-C Operated Power Supply Only.....		SNAKEYPACK	22.00
723-P2	Set of Replacement Batteries.....		SNAKEYBATT	3.85

*Included in price.

TYPE 813-A AUDIO OSCILLATOR

USES: The TYPE 813-A Audio Oscillator is intended for the same general applications as the TYPE 723 Vacuum-Tube Fork, but where the requirements of waveform, stability, and output are not so severe.

DESCRIPTION: This instrument is a battery-operated electro-mechanical oscillator in which the frequency is determined by a tuning fork. Two microphone buttons, one for the driving circuit and one for the output circuit, are mounted at the side of the fork in such a manner as to load the tines equally and to affect only slightly the free vibration of the fork.

The fork itself is mounted rigidly at the heel beneath a metal base panel which carries the driving electromagnet. This base panel is suspended from the bakelite panel with four resilient mountings.

A filter and output transformer are placed inside the cabinet underneath the fork. A battery compartment is also provided although external batteries may be used, if desired.

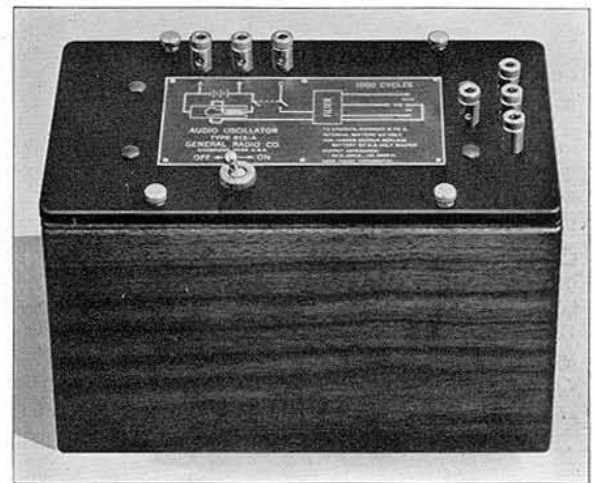

FEATURES: Good waveform and frequency stability are among the features of this convenient tuning-form oscillator. The mechanical construction is rugged and the fork is protected from dirt and external injury.

Schematic wiring diagram of TYPE 813-A Audio Oscillator.

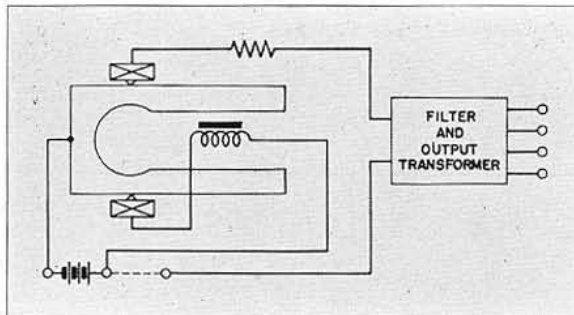

SPECIFICATIONS

Frequency: 1000 cycles.

Frequency Stability: The temperature coefficient of frequency is -0.008% per degree Fahrenheit. The voltage coefficient is less than 0.01% per volt. The frequency is entirely independent of load impedance.

Accuracy: The frequency is adjusted within 0.5% of its specified value. The actual frequency is measured and recorded on the base of the cabinet to an accuracy of 0.1%.

Output: The output to a matched load impedance is 20 to 30 milliwatts with 6-volt drive and 10 to 15 milliwatts with

OSCILLATORS

4½-volt drive. When the oscillator is operated continuously for several hours, the output may drop below these values.

Internal Output Impedance: Output impedances of 50, 500, and 5000 ohms are provided.

Waveform: The total harmonic content is approximately 0.75% with 4½-volt drive and approximately 1% with 6-volt drive.

Power Supply: For intermittent operation with a moderate power output, an internal 4½-volt battery can be used.

For greater output or continuous operation, an external battery of 4½ to 6 volts should be used. Batteries are not supplied.

Terminals: Binding posts for the power supply and for the output circuit are provided on the panel.

Mounting: The fork is suspended from a metal plate on a bakelite panel and is enclosed in a walnut cabinet.

Dimensions: (Length) 9 x (width) 5 x (height) 6 inches, over-all.

Net Weight: 8¼ pounds.

Type	Frequency	Code Word	Price
813-A	1000 cycles	ANGEL	\$34.00

TYPE 572-B MICROPHONE HUMMER

USES: The hummer is intended for use as a low-power a-c source for bridge and other measurements where extreme purity of waveform and frequency stability are not essential. This type of oscillator is used in the TYPE 650-A Impedance Bridge as the 1000-cycle internal generator.

DESCRIPTION: A tuned reed determines the frequency of this electro-mechanical oscillator. A microphone button is mounted near the reed to pick up energy for continuing the oscillations.

FEATURES: The TYPE 572-B Microphone Hummer is extremely compact, convenient, simple to use, and inexpensive.

SPECIFICATIONS

Frequency: 1000 cycles ±10%.

Output Power: Approximately 15 milliwatts with 4½-volt drive.

Internal Output Impedance: Two impedances are available, 10 or 300 ohms.

Waveform: In this type of oscillator, distortion varies considerably with mechanical adjustment, driving voltage,

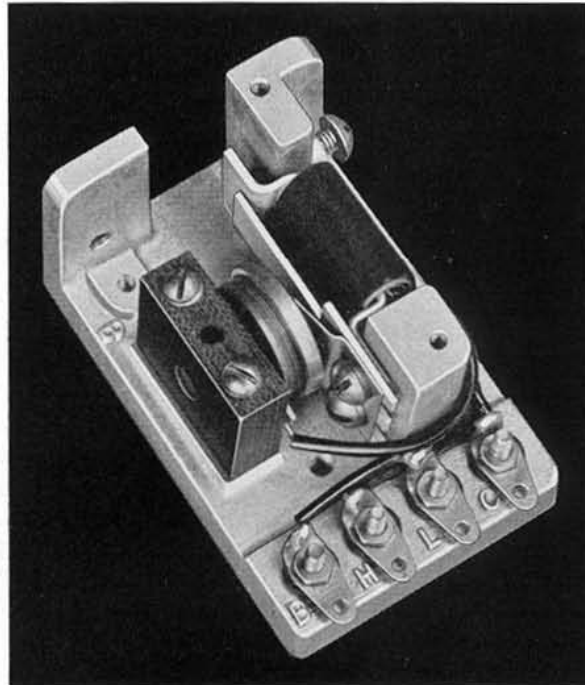

Schematic wiring diagram of the microphone hummer.

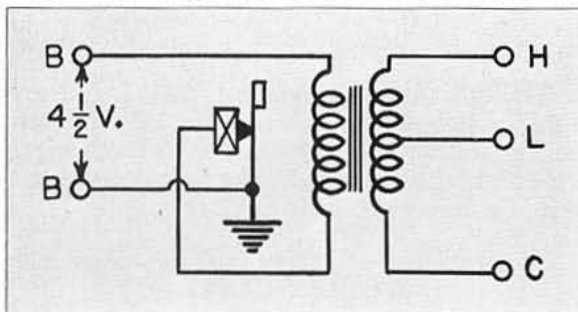

and other operating parameters. Consequently, no definite specifications can be given.

Power Supply: The hummer is designed to operate from a 4½-volt battery. A 6-volt drive can be used if more power is desired.

Terminals: Soldering lugs are provided.

Mounting: A cast-aluminum mounting base is used. (See sketch.)

Dimensions: (Length) 3¼ x (width) 2⅜ x (height) 1⅝ inches, over-all.

Net Weight: 9 ounces.

Type	Code Word	Price
572-B Microphone Hummer	APHIS	\$10.00

LOW FREQUENCY TUNING-FORK OSCILLATORS

suitable for use as frequency standards are described on pages 146 to 148.

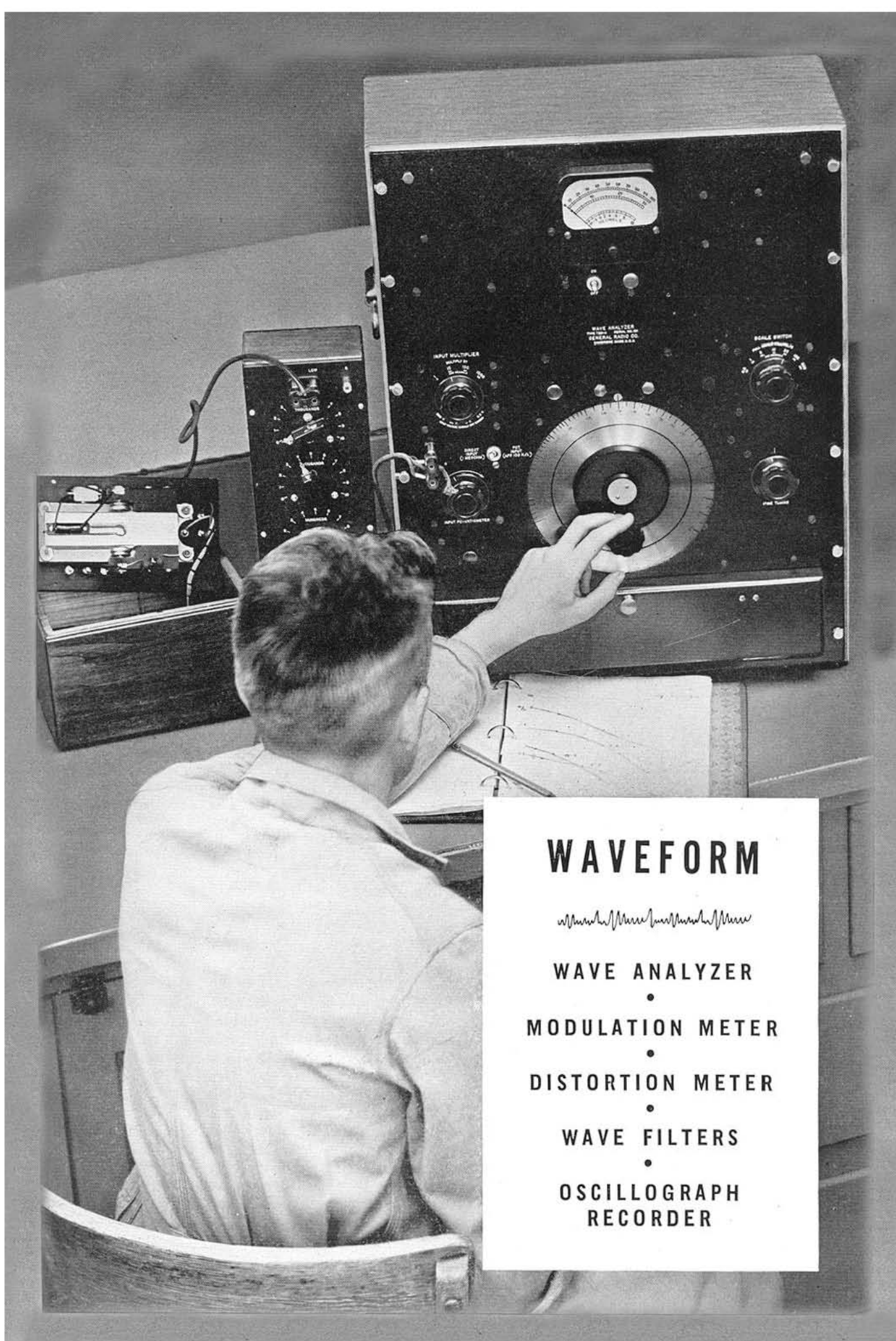

WAVEFORM



WAVE ANALYZER

•

MODULATION METER

•

DISTORTION METER

•

WAVE FILTERS

•

OSCILLOGRAPH
RECORDER

TYPE
736-A
WAVE
ANALYZER



USES: The wave analyzer is used to measure the amplitude and frequency of the components of a complex electrical waveform. These include not only the components of harmonic distortion, but also non-multiple voltages such as noise and hum.

Specific uses of the TYPE 736-A Wave Analyzer include the measurement of harmonic distortion in audio-frequency equipment, broadcast receivers and transmitters, telephone systems, public address equipment, oscillators, amplifiers, and vacuum-tube circuits in general; harmonic studies on electric power systems and electrical machinery; hum measurement in a-c operated communication equipment; noise analysis; and induction studies on telephone lines. As a sharply-tuned voltmeter, it is invaluable in the measurement of the transmission characteristics of electric wave filters.

DESCRIPTION: The TYPE 736-A Wave Analyzer is a heterodyne type of vacuum-tube voltmeter. The intermediate-frequency amplifier includes

a highly selective filter using three quartz crystals. The use of a heterodyne method makes it possible to vary the response frequency while using a fixed-frequency filter.

The output of the local oscillator and the whole of the complex waveform to be examined are fed to a balanced modulator where their combination produces both the sum and difference frequencies, or side bands, in the output. The original of the complex waveform is not passed by the modulator intermediate-frequency output transformer, and the local oscillator carrier frequency is suppressed in the output because of the two-tube balanced modulator employed.

The 50-kilocycle component of the upper side band, proportional to the voltage of that frequency present in the original wave to which the main dial is set, is selected and amplified by the intermediate stages. The adjustable gain control of the amplifier gives the many values listed below for full-scale deflections of the output meter. The standards

for the voltage and frequency calibrations are self-contained within the instrument.

The entire assembly is a-c operated from a 115 or 230-volt, 40 to 60-cycle line.

FEATURES: A number of design and operating features make the TYPE 736-A Wave Analyzer one of the outstanding instruments in the field of audio-frequency measurements.

(1) The instrument is completely a-c operated.

(2) The crystal filter is designed to give a flat top characteristic as shown by the curve at the right. This feature makes for ease of tuning and stability of tuning adjustment.

(3) The input impedance is constant at 1 megohm, but a built-in 100,000-ohm potentiometer is provided as an alternate input system.

(4) The instrument can easily be calibrated at any time, using the built-in calibrating system operating from the a-c line.

(5) There is no pickup from external mag-

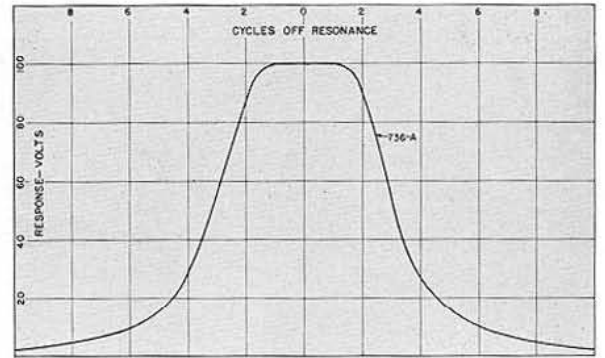

Transmission characteristic of crystal filter in TYPE 736-A Wave Analyzer.

netic fields since the balanced modulator is fed by a phase inverter tube, rather than by a transformer.

(6) All critical parts, including the crystals, are hermetically sealed to minimize the effects of humidity.

SPECIFICATIONS

Frequency Range: 20 to 16,000 cycles.

Selectivity: Approximately 4 cycles "flat top" band width. The response is down 15 db at 5 cycles, 30 db at 10 cycles, 60 db at 30 cycles from the peak. The selectivity is constant over the frequency range.

Voltage Range: 300 microvolts to 300 volts full scale. The lowest division on the meter corresponds to 10 μ v. The over-all range is divided into four major ranges: 300 μ v to 300 mv, 3 mv to 3v, 30 mv to 30 v, .3 v to 300 v. Each of these ranges is divided into seven scale ranges; for example, the .3 v to 300 v range has the following full-scale ranges: 0.3 v, 1 v, 3 v, 10 v, 30 v, 100 v, 300 v.

A direct-reading decibel scale is also provided.

Voltage Accuracy: Within $\pm 5\%$ on all ranges. Spurious voltages from higher order modulation products introduced by the detector are suppressed by at least 70 db. Hum is suppressed by at least 75 db.

Input Impedance: One megohm when used for direct voltage measurements. When used with the input potentiometer it is approximately 100,000 ohms.

Accuracy of Frequency Calibration: $\pm 2\%$.

Vacuum Tubes Required:

- 3—type 6C6
- 2—type 6K6-G
- 3—type 6J7
- 1—type 6B8
- 1—type 6C5
- 1—type 6X5-G
- 1—type 6F5-G
- 3—type T-4 $\frac{1}{2}$ neon lamps

These are supplied with the instrument.

Power Supply: A-C line, 105 to 125 volts, 40 to 60 cycles. A change in the power transformer connection permits the use of 210 to 250 volts, 40 to 60 cycles. A voltage-stabilizing circuit is included.

Accessories Supplied: Spare fuses, two spare pilot lights, spare neon lamp, one TYPE 274-NE Shielded Plug and Cable, and a seven-foot line connector cord.

Mounting: Shielded oak cabinet.

Dimensions: (Width) 19 $\frac{1}{2}$ x (height) 25 $\frac{1}{8}$ x (depth) 10 $\frac{7}{8}$ inches, over-all.

Net Weight: 86 $\frac{1}{4}$ pounds.

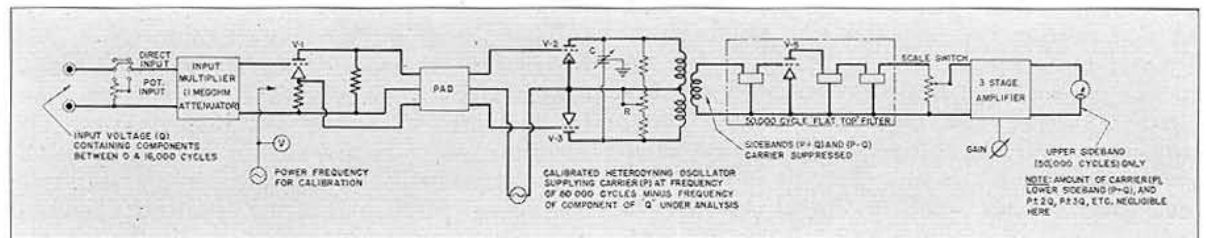

Type	Code Word	Price
736-A Wave Analyzer.....	ASKEW	\$640.00

PATENT NOTICE. See Notes 1, 19, 27, page vi.

The TYPE 760-A Sound Analyzer, an analyzer having a constant percentage band width, and designed primarily for sound and noise analysis, is described on page 11.

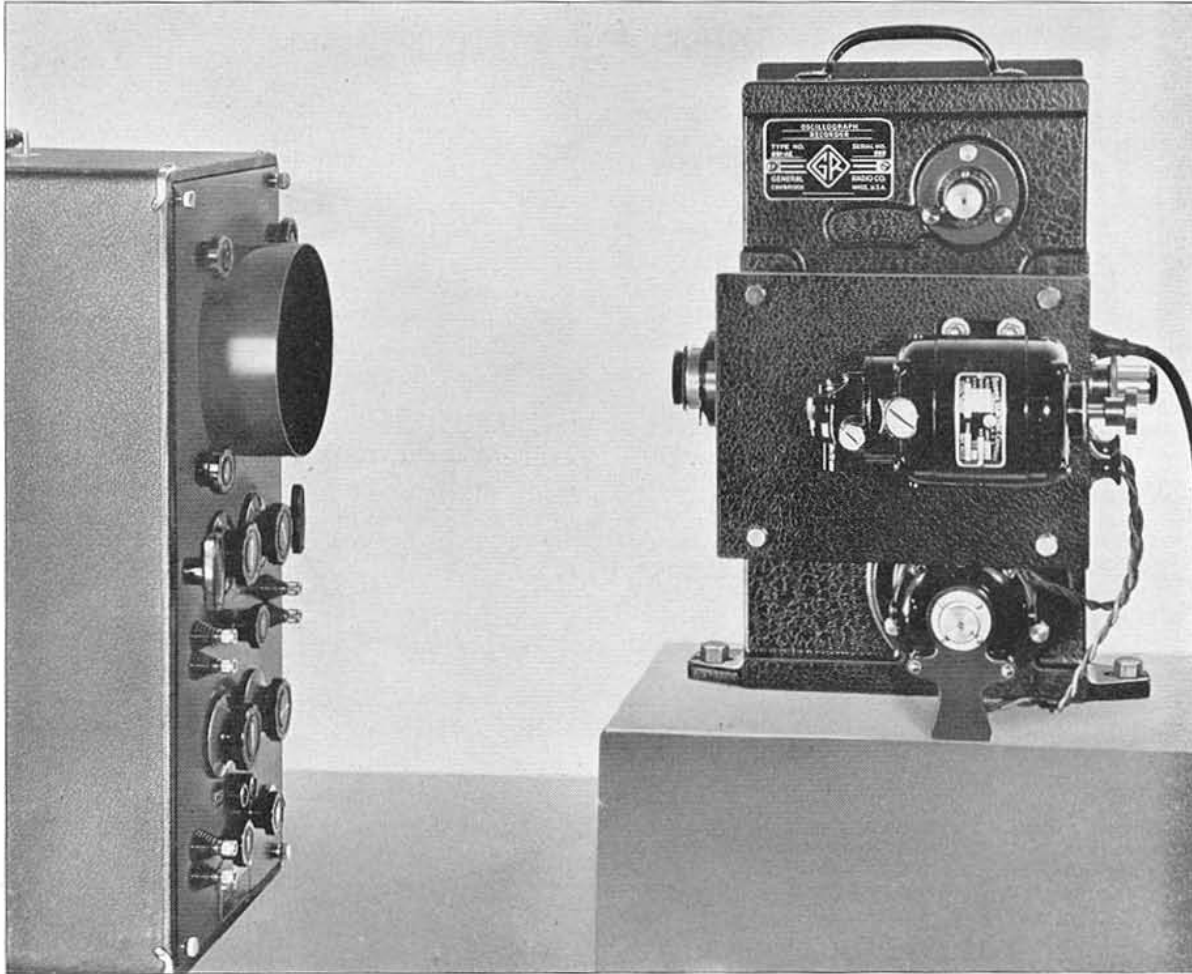

TYPE 651-AE OSCILLOGRAPH RECORDER

USES: This device is suitable for recording the trace of a cathode-ray oscillograph to obtain an accurate record of transient phenomena. Typical applications are the study of the response of electrical networks to suddenly applied voltages, the recording of switching transients, and the study of the instantaneous variations of voltages and currents in electrical machinery under arbitrary load variations. From records of the Lissajous figures produced by two transient voltages of the same frequency the instantaneous phase displacement between the two voltages may be deduced.* In this manner the variation in power factor of electrical circuits under transient conditions may be studied.

DESCRIPTION: In the TYPE 651-AE Oscillograph Recorder the film is driven continuously past the aperture, so that the trace of the

cathode-ray spot is recorded as a continuous line.

The accompanying photograph shows the internal construction of the recorder. The large central driving sprocket and the bottom take-up reel are driven by separate motors. The torque characteristics of the motors are such that the proper film tension is maintained as the film passes from the loading reel to the take-up reel. Focusing is accomplished by viewing the image through the focusing eyepiece when the two apertures in the driving sprocket are aligned as shown. The image forms on a small piece of translucent film which can be inserted in the gate.

The speed of the film drive can be adjusted over wide limits by varying the voltage applied to the driving and take-up motors. The film can be driven at speeds up to 35 feet per second.

*See Bulletin of Research of the Underwriters' Laboratories, Inc., No. 11, September, 1939.

SPECIFICATIONS

Film: Any 35-mm film or paper with standard perforations can be run. Daylight loading and unloading with negligible waste. Capacity of reels, 100 feet.

Lens System: Lens must be purchased separately. A lens of aperture f/1.5 is available in an adjustable mounting that permits focusing for distances between 8 and 20 inches. The image for focusing is observed directly on the equivalent of a ground glass in the plane of the film.

These lenses are sufficiently "fast" to permit the recording of traces from a cathode-ray oscillograph on super-sensitive panchromatic film at a speed of 35 feet per second, when the ratio of total length along the trace to length of film is less than 5 to 1.

Oscillograph Screen: A low-persistence actinic blue screen should be used for best results.

Reels: Specially-made loading and take-up reels are supplied.

Drive System: Both the film-drive sprocket and the take-up reel are driven by universal (a-c or d-c) motors. The film speed is varied by applying voltages between 50 and 230 volts to these motors.

Film-Speed Range: When the motors are operated at the voltages mentioned above, film speeds between 5 and 35 feet per second are obtainable. At the highest recommended operating voltage, higher speeds will sometimes be obtained.

Speed Control: When 115-volt or 230-volt, 50 to 60-cycle service is available, a TYPE 200-CMH or TYPE 200-CUH Variac may be used to vary the voltage applied to the motors. For d-c service, resistive methods of voltage control must be used.

Starting Characteristics: Full operating speed is reached in approximately 10 feet of film travel, at maximum speed. At lower speeds, less film is consumed in reaching operating speeds.

Dimensions: (Length) 11 7/8 x (width) 6 1/2 x (height) 16 1/2 inches, over-all.

Net Weight: 32 pounds.

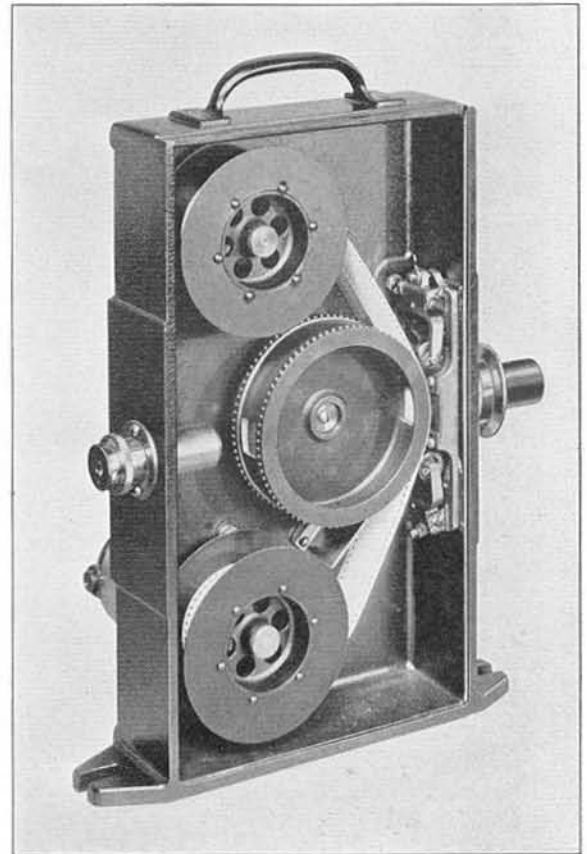

Interior view of the oscillograph recorder, showing the film reels and sprocket.

Class	Description	Code Word	Price
*651-AE	Oscillograph Recorder	DINER	\$410.00
651-P5	Lens	150.00

*Without lens. PATENT NOTICE. See Note 15, page v.

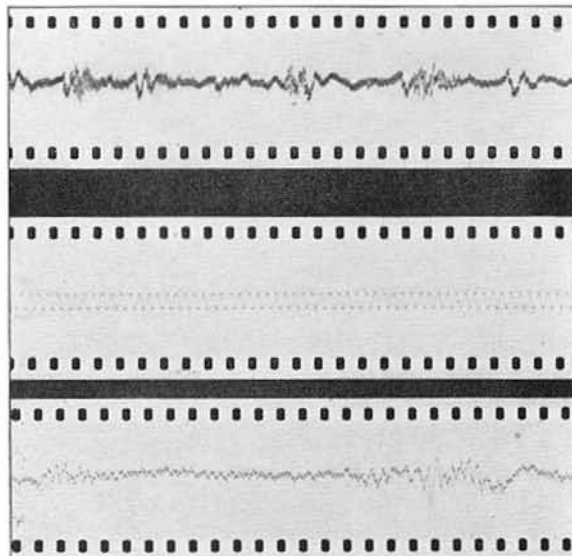

STROBOSCOPIC RECORDERS

For recording high-speed phenomena by means of stroboscopic light, an adaptation of the oscillograph recorder can be supplied on order. This differs from the conventional motion-picture camera in that no shutter is employed. A commutator is provided on the sprocket to trip a stroboscope (such as the TYPE 621 Power Stroboscope described on page 7) at single-frame intervals, so that the photographic record is properly framed for projection. Although the film is continuously in motion, the stroboscopic flash is so short in duration that no blur of the image is noticeable. Speeds up to 1500 frames per second can be obtained.

Oscillograms taken with the TYPE 651-AE Oscillograph Recorder.

TYPE 830 WAVE FILTERS



DESCRIPTION: TYPE 830 Wave Filters are compact, two-section filters having exceptionally good characteristics. They are available in low-pass, high-pass, and band-pass models. The sections co-operate to give both a sharp cut-off and high discrimination against frequencies outside the pass band.

The band-pass model, TYPE 830-R, is sharply tuned to pass 1000 cycles and discriminate against other frequencies, the design being such that a maximum of attenuation is provided for the second harmonic at 2000 cycles. The input and output coils of this unit are tapped so that the filter can be used with high or low terminating impedances, or to replace the combination of a filter and transformer to work between different impedances.

FEATURES: It will be seen from the accompanying curves that the attenuation at the cut-off frequency is less than 3 decibels for the high-pass and low-pass models, and that for the band-pass model the attenuation at the desired frequency is only 5 or 6 decibels. The curves also show that a discrimination of at least 40 decibels is maintained for all frequencies greater than 1.5 times the cut-off frequency for the high-pass types.

An excellent band-pass filter covering one octave may be obtained by using the 500-cycle high-pass and the 1000-cycle low-pass in tandem. The curve of attenuation vs. frequency for this combination is shown below.

The combinations of input and output im-

USES: Electric wave filters are widely used for the elimination of harmonics from distorted waveforms, for the isolation of specific components of complex waveforms, and, in general, to remove voltages of undesired frequencies from measuring and communications circuits.

Characteristics of 1000-cycle low-pass and 1000-cycle high-pass filters.

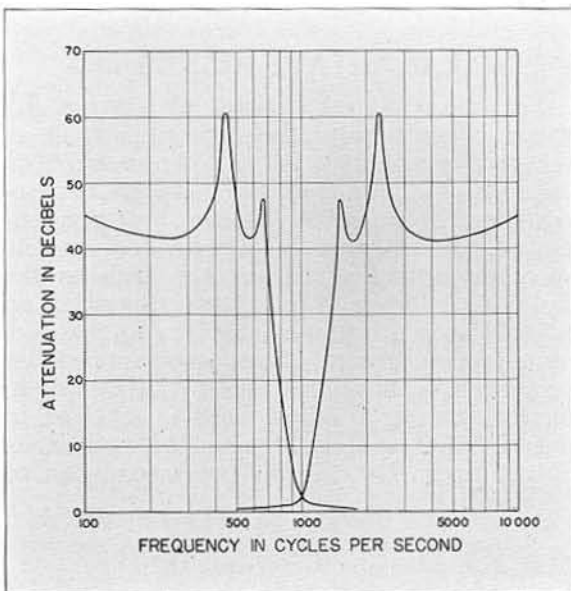

The 500-cycle high-pass and 1000-cycle low-pass models can be used in tandem to give a one-octave band-pass characteristic.

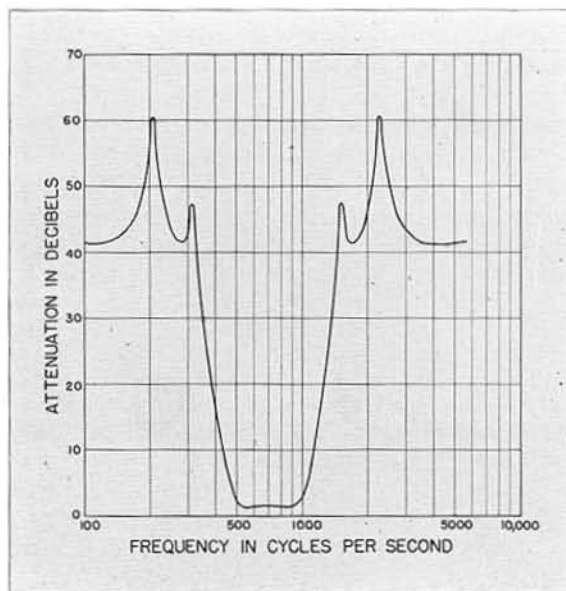

pedances available with the TYPE 830-R are such that this filter may be worked from either a 500-ohm line or a vacuum tube (plate resistance approximately 5000 ohms) into a circuit of almost any impedance with satisfactory results.

The attenuation characteristics are the same for either connection on the two-impedance side, but differ somewhat for different connections on the four-impedance side. From the plot at the right, it will be seen that greatest attenuation to harmonics is obtained on the 5000-ohm output tap. An attenuation peak at the second harmonic occurs when the 500- and 5000-ohm taps on the four-impedance side are used. This peak is not present with the other two taps.

Since either side may be used as input or output, two different connections are possible when working between 500 and 5000 ohms. From the curves shown, it is evident that somewhat better characteristics will be obtained if the 500-ohm connection is made at the two-impedance side.

The discrimination against harmonics or other unwanted frequencies is 5 decibels less than the height of the curves since the attenu-

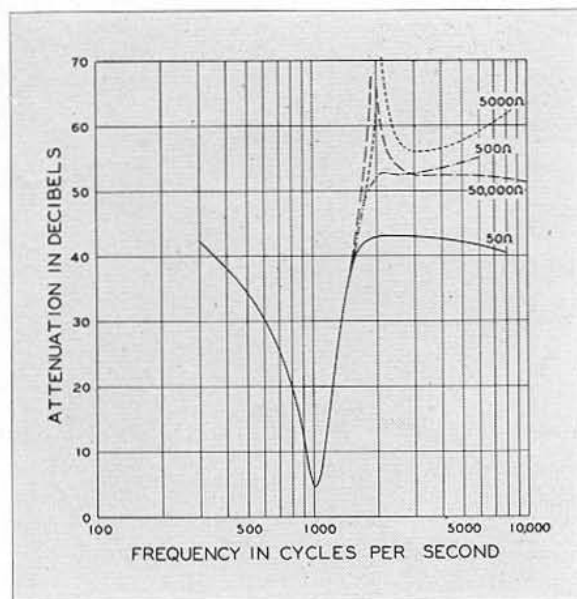

Attenuation characteristics of TYPE 830-R Band-Pass Filter for the various terminating impedances.

ation at the desired frequency is approximately 5 decibels.

SPECIFICATIONS

Attenuation Characteristic: See accompanying curves.

Voltage Limit: Voltages up to approximately 3 volts at any frequency may be applied to the 500-ohm filter (10 volts for 5000-ohm filter) input terminals without significantly altering the response curves. At higher voltage levels, slight shift in the location of the attenuation peaks may be expected.

Mounting: All models except TYPE 830-B are mounted in

Model C cases, dimensions for which are given below. TYPE 830-B is mounted in a Model D case.

Terminals: TYPES 830-A to 830-H inclusive are provided with both soldering lugs and jack-top binding posts. TYPE 830-R has soldering lugs only.

Dimensions: See dimensions for Model C and Model D cases on next page.

Net Weight: TYPE 830-B, 7½ pounds; all others, 3½ pounds.

Type	Cut-Off Frequency	Impedance		Code Word	Price
*830-A	500 cycles	500 Ω	Low-Pass	FILTERGOAT	\$18.50
*830-B	500 cycles	500 Ω	High-Pass	FILTERGIRL	21.50
*830-C	500 cycles	5000 Ω	Low-Pass	FILTERSHOE	18.50
*830-D	500 cycles	5000 Ω	High-Pass	FILTERSEAT	18.50
*830-E	1000 cycles	500 Ω	Low-Pass	FILTERTOAD	18.50
*830-F	1000 cycles	500 Ω	High-Pass	FILTERMUSH	18.50
*830-G	1000 cycles	5000 Ω	Low-Pass	FILTERSIGN	18.50
*830-H	1000 cycles	5000 Ω	High-Pass	FILTERPIPE	18.50
830-R	1000 cycles { 5000, 500 Ω } { 50,000, 5000, 50 Ω }		Band-Pass	FILTERROTE	19.50

*PATENT NOTICE. See Note 1, page vi.

OTHER FILTERS

A 400-cycle band-pass filter, TYPE 530, for use in distortion measurements, is described on the next page.

WAVEFORM

TYPE 530-A BAND-PASS FILTER



View of TYPE 530-A Filter.

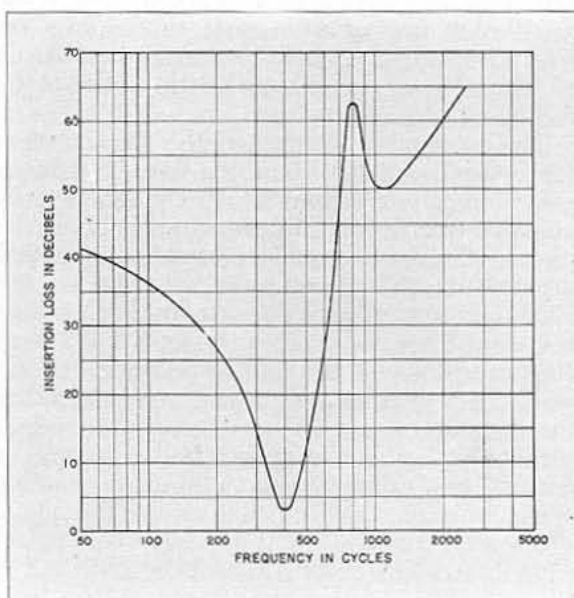

Transmission characteristic of TYPE 530 Band-Pass Filter.

This filter is designed for use with a 400-cycle oscillator to provide a very pure signal for distortion measurements, and for other applications where only an extremely small harmonic content can be tolerated. It may be used

with fundamental frequencies from 375 to 425 cycles, providing an attenuation of at least 50 decibels to all harmonics. In addition considerable attenuation to power-line frequencies is provided.

SPECIFICATIONS

Attenuation Characteristic: (See accompanying curve.) A peak of maximum attenuation is set for rejection of the 800-cycle second harmonic.

Voltage Limit: Voltages up to approximately 3 volts at any frequency may be applied to the filter input terminals without significantly altering the response curve. At higher voltage levels slight shift in the location of the attenuation peaks may be expected.

Mounting: Filters are mounted in standard drawn steel, wax-filled Model D cases.

Dimensions: Case, (width) $5\frac{3}{4}$ x (height) $5\frac{1}{2}$ x (depth) $5\frac{1}{2}$ inches, over-all. (See also dimensioned drawing below.)

Net Weight: 8 pounds.

Type	Impedance	Pass Band	Code Word	Price
530-A	600 ohms	375 to 425 cycles	FOCAL	\$30.00

PATENT NOTICE. See Note 1, page v.

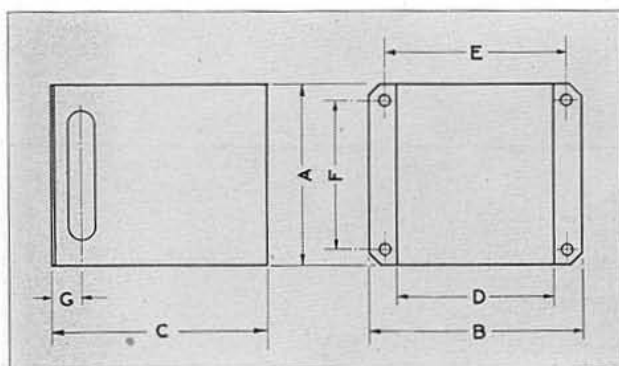

DIMENSIONS OF FILTER CASES

	MODEL B	MODEL C	MODEL D
A.....	$2\frac{13}{16}$ inches	$3\frac{3}{16}$ inches	$5\frac{3}{4}$ inches
B.....	$3\frac{1}{8}$ inches	4 inches	$5\frac{1}{4}$ inches
C.....	$4\frac{1}{8}$ inches	$4\frac{1}{8}$ inches	$5\frac{3}{16}$ inches
D.....	$2\frac{3}{16}$ inches	$3\frac{1}{16}$ inches	$4\frac{1}{4}$ inches
E.....	$2\frac{3}{4}$ inches	$3\frac{1}{2}$ inches	$4\frac{3}{4}$ inches
F.....	$1\frac{7}{8}$ inches	$2\frac{7}{8}$ inches	$4\frac{1}{2}$ inches
G.....	$\frac{5}{8}$ inch	$\frac{5}{8}$ inch	$\frac{5}{8}$ inch

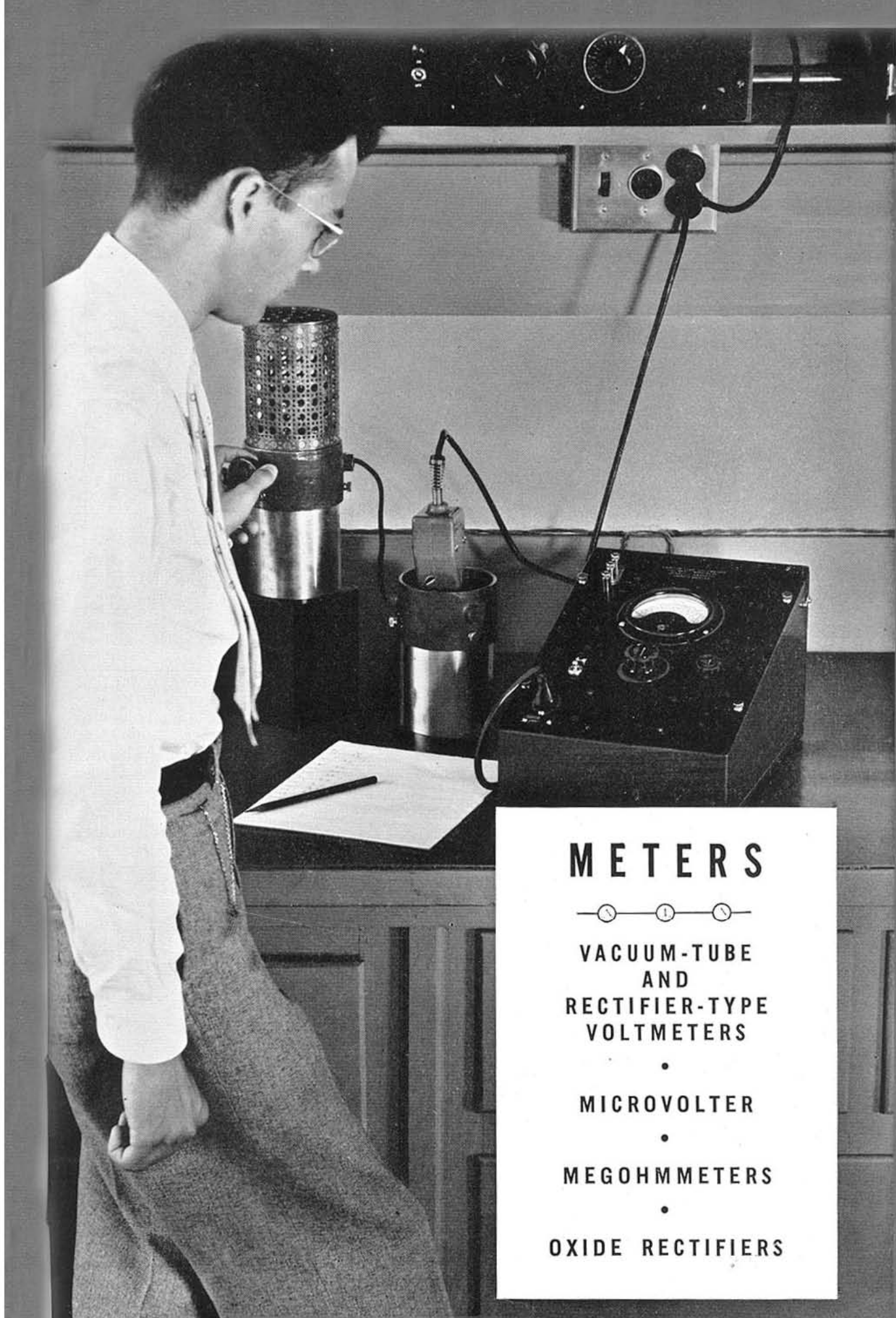

METERS

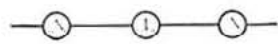

VACUUM-TUBE
AND
RECTIFIER-TYPE
VOLTMETERS

•
MICROVOLTER

•
MEGOHMMETERS

•
OXIDE RECTIFIERS

TYPE 726-A
 VACUUM-TUBE
 VOLTMETER
 (A-C OPERATED)



USES: A high-impedance wide-range voltmeter, such as the TYPE 726-A Vacuum-Tube Voltmeter, which can be used at both audio and radio frequencies, is an extremely valuable instrument to the communications engineer. In addition to its use as a voltmeter, it is an excellent ammeter at radio frequencies when used with capacitive shunts. Used in this way, it has found wide application in the measurement of antenna current, for the determination of antenna power input.

Although calibrated to give readings of the r-m-s values of approximately sinusoidal voltages, the voltmeter may be used, except on the lowest voltage ranges, to determine the peak value of complex voltage waves.

DESCRIPTION: An improved type of diode-condenser rectifier circuit, using an acorn tube, is built into a small probe which is made of low-loss bakelite. A cable, which also supplies heater voltage to the tube in the probe, carries the rectified voltage to a d-c amplifier and indicating meter in the cabinet of the instrument.

The d-c amplifier is of the degenerative type using but one tube. The rectified voltage is applied directly to the amplifier control grid, rather than through a voltage-dividing network, and the change from one voltage range to another is accomplished by varying the degeneration factor.

FEATURES: The arrangement described above makes it possible to use constants in the diode circuit which will maintain high input impedance over all the ranges of the instrument. Thus very little power is taken from the source under measurement.

The degeneration in the d-c amplifier stabilizes the gain and results in the calibration being permanent and substantially independent of tube characteristics. Except on the lowest range, the scale is essentially linear. There is sufficient overlapping of the various ranges, in consequence, so that all readings may be made well up on the scale.

Schematic circuit diagram of TYPE 726-A Vacuum-Tube Voltmeter.

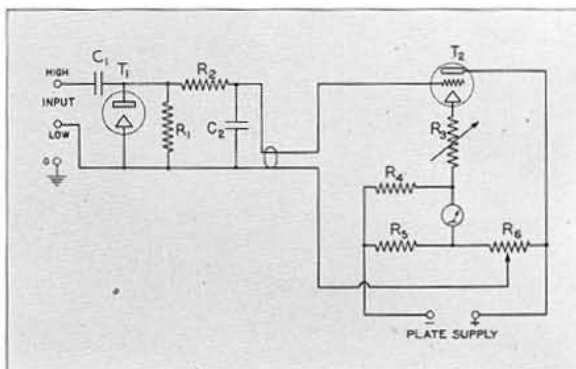

A regulated power supply is employed, so that line variations do not result either in fluctuating readings or zero shifts. One zero adjustment serves for all ranges. There is a slight initial zero drift when the instrument is first turned on, but this becomes negligible after a brief warming-up period. Severe overloads for any scale setting will not damage the instrument.

Since the entire a-c measuring circuit is mounted in the small probe, the leads to the source of voltage can be kept short, and good accuracy is obtained even at high radio frequencies. The plug terminals of the probe can be removed when necessary to shorten the leads still more. For measurements at low frequencies, where the effect of the leads is not important, the probe and cable can be placed inside the instrument and connections made to terminals on the panel.

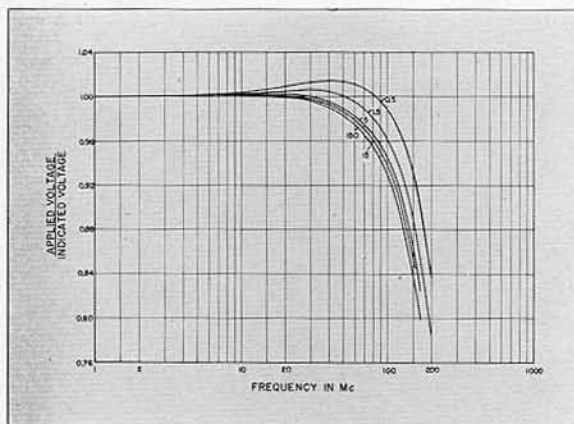

Ratio of applied voltage to indicated voltage as a function of frequency for various values of indicated voltage.

SPECIFICATIONS

Range: 0.1 to 150 volts ac. in five ranges (1.5, 5, 15, 50, 150 volts, full scale). The range can be extended to 1500 volts by means of the TYPE 726-P1 Multiplier described on the next page.

Accuracy: $\pm 2\%$ of full scale on all five ranges, on sinusoidal voltages.

Waveform Error: The instrument is essentially a peak voltmeter calibrated to read r-m-s values of a sine wave, or 0.707 of the peak value of a complex wave. On distorted waveforms the percentage deviation of the reading from the r-m-s value may be as large as the percentage of harmonics present.

Frequency Error: At high frequencies resonance in the input circuit and transit-time effects in the diode rectifier

introduce errors in the meter reading. The resonance effect causes the meter to read high and is independent of the applied voltage. The transit-time error, on the other hand, is a function of the applied voltage and tends to cause the meter to read low. The accompanying curve gives the frequency correction for several different voltage levels. It will be noted that at low voltages the transit-time and resonance effects tend to cancel, while at the higher voltages the error is almost entirely due to resonance.

At the low audio-frequency end, this voltmeter may be used at frequencies as low as 20 cycles with an error of less than 1%.

Input Impedance: The input circuit is equivalent to a resistance of 6 megohms in parallel with 6.6 μmf . At the higher frequencies the effective parallel resistance is reduced by losses in the shunt capacitance. The accompanying plot gives the variation of R_P and X_P with frequency.

Temperature and Humidity Effects: Over the normal range of room conditions (65° Fahrenheit to 95° Fahrenheit; 0 to 95% relative humidity) the accuracy is substantially unaffected by temperature and humidity conditions.

Power Supply: 100 to 130 volts ac, 60, 50, or 42 cycles and 200 to 260 volts, 50 cycles. (See price list.) The instrument incorporates a voltage regulator to compensate for supply variations over this voltage range. The power input is less than 30 watts.

Tubes: One type 955, one type 6Q7-G, and one type 1-v are used; all are supplied.

Accessories Supplied: A seven-foot line connector cord, spare pilot lamps and fuses.

Mounting: Black crackle-finish aluminum panel mounted in a shielded walnut cabinet.

Dimensions: (Width) 9½ x (depth) 14 x (height) 8½ inches, over-all.

Net Weight: 17½ pounds.

Plots of the resistive and reactive components of the input impedance, and of the dissipation factor of the input circuit, of TYPE 726-A Vacuum-Tube Voltmeter.

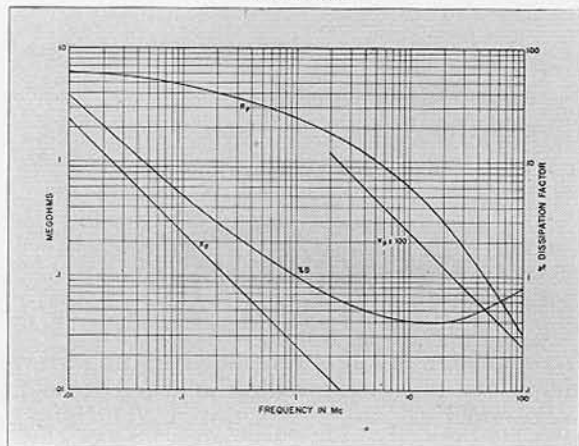

Power Supply

Type	Frequency	Voltage	Code Word	Price
726-A	60 cycles	100 to 130 v	ALLOT	\$165.00
726-A	50 cycles	100 to 130 v	ABAFI	165.00
726-A	50 cycles	200 to 260 v	ALTER	165.00
726-A	42 cycles	100 to 130 v	AMASS	165.00

TYPE 726-P1 MULTIPLIER

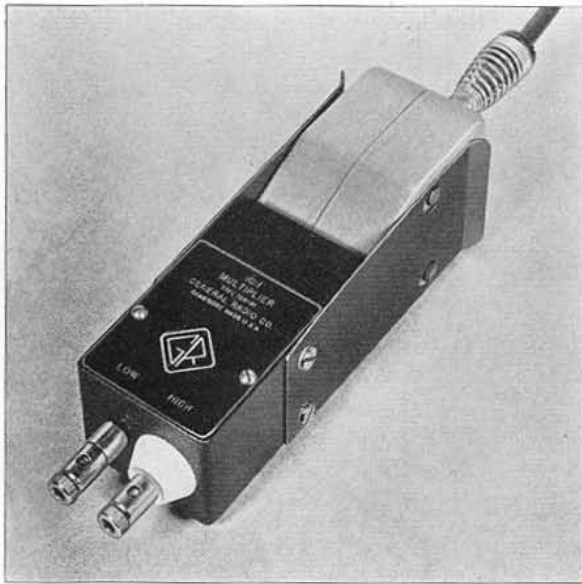

This multiplier extends the range of the TYPE 726-A Vacuum-Tube Voltmeter to 1500 volts.

It consists of a capacitive voltage divider which provides a ten-to-one reduction between the voltage applied to the multiplier and the voltage appearing across the voltmeter terminals. The multiplier fits snugly to the voltmeter probe, adding about three inches to the effective length of the probe. The flanges which secure the multiplier to the probe also act as an electrostatic shield for the probe.

SPECIFICATIONS

Multiplier Ratio: 10 to 1, within $\pm 1\%$.

Input Impedance: From 1 Mc to 100 Mc, the input impedance is effectively that of a 4.5 μf condenser of less than 0.5% power factor.

Frequency Error: The frequency error is shown in the plot. No appreciable error occurs between 1 Mc and 100 Mc. The multiplier is not recommended for frequencies below 1 Mc.

Net Weight: 12 ounces.

Type	Code Word	Price
726-P1	AL0UD	\$15.00

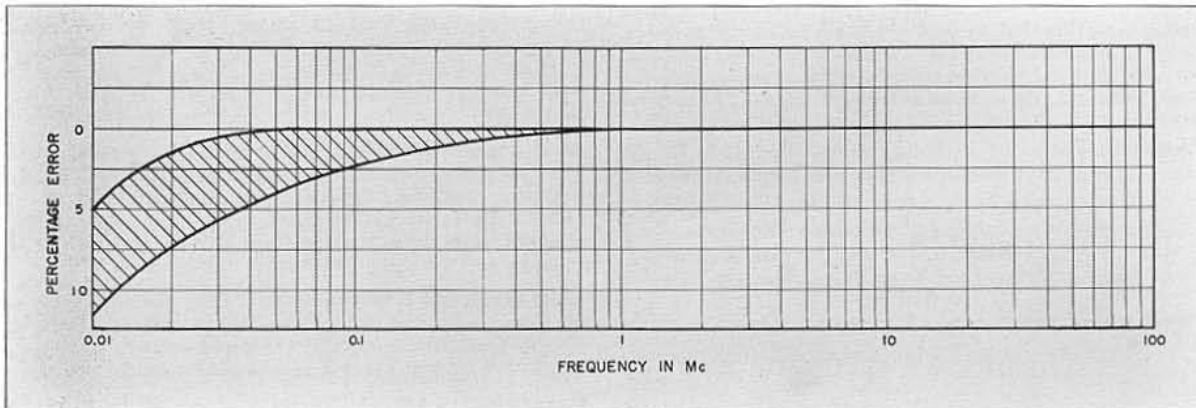

Plot of frequency error for TYPE 726-P1 Multiplier.

TYPE 727-A VACUUM-TUBE VOLTMETER
(BATTERY OPERATED)

USES: This is a general-purpose vacuum-tube voltmeter for use at frequencies up to about 100 megacycles. Because it is battery operated and portable, it has many applications in the field, where an a-c power line is not always available.

DESCRIPTION: A diode rectifier circuit is employed as in the TYPE 726-A Voltmeter but with a more sensitive two-stage d-c amplifier, permitting the measurement of a-c voltages

down to 50 millivolts over the entire frequency range. The high-voltage limit is also extended, to 300 volts.

FEATURES: The high input impedance, wide voltage range, and wide frequency range of this instrument combined with its convenience and portability make the TYPE 727-A Vacuum-Tube Voltmeter an extremely useful meter for the communications laboratory, as well as for field work.

SPECIFICATIONS

Range: 0.05 volt to 300 volts ac, in seven ranges (0.3, 1, 3, 10, 30, 100, 300 volts, full scale).

Accuracy: The meter reads peak values of the applied voltage, and is calibrated in r-m-s values of a sine wave. With sinusoidal voltages applied, the accuracy is as follows:

- ±3% of full scale on the 0.3-volt range
- ±2% of full scale on the 1, 3, and 10-volt ranges
- ±5% of full scale on the 30, 100, and 300-volt ranges

Waveform Error: The instrument is calibrated to read the r-m-s value of a sinusoidal voltage. On the higher voltage ranges, however, it is essentially a peak reading device, calibrated to read 0.707 of the peak value of the applied voltage, and on distorted waveforms the percentage deviation of the reading from the r-m-s value may be as large as the percentage of harmonics present. On the lowest ranges the instrument approximates a true square-law device.

Frequency Error: Less than 1% between 20 cycles and 30 Mc. At higher frequencies, the error is about +5% at 65 Mc and about +10% at 100 Mc.

Input Impedance: The input capacitance is approximately 16 μf . The parallel input resistance (at low frequencies) is about 5 megohms on the lower ranges and about 3 megohms on the 30, 100, and 300-volt ranges. The accompanying curves give the variation of R_P and X_P with frequency.

Temperature and Humidity Effects: Over the normal range of room conditions (65° Fahrenheit to 95° Fahrenheit;

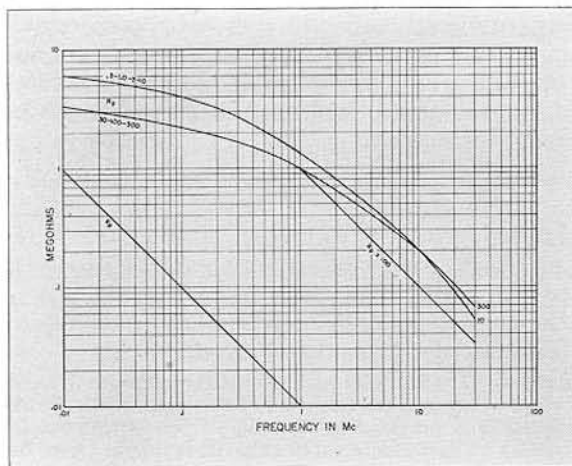

Plot of resistive and reactive components of input impedance of TYPE 727-A Vacuum-Tube Voltmeter.



0 to 95% relative humidity) the accuracy of indication is substantially independent of temperature and humidity conditions. Somewhat reduced accuracy may be expected, however, if the instrument is subjected to extremes of temperature.

Zero Adjustment: A zero adjustment is provided on the panel. The setting is the same for all ranges.

Vacuum Tubes: Two 1S5 tubes and one 957 tube are used and are supplied with the instrument.

Batteries: Two Burgess W20P1, one Burgess W5BP, and three Burgess 2F batteries are required, and are supplied with the instrument. Battery life is approximately 250 hours of intermittent operation.

Mounting: The instrument is supplied in a walnut case with cover and is mounted on an engraved black crackle-finish aluminum panel.

Dimensions: 11 x 6 $\frac{5}{8}$ x 5 $\frac{3}{8}$ inches, over-all (cover closed).

Net Weight: 10 $\frac{3}{8}$ pounds, including batteries.

Type	Code Word	Price
727-A Vacuum-Tube Voltmeter.....	PIGMY	\$115.00

PATENT NOTICE. See Note 28, page vi.

Schematic circuit diagram of TYPE 727-A Vacuum-Tube Voltmeter.

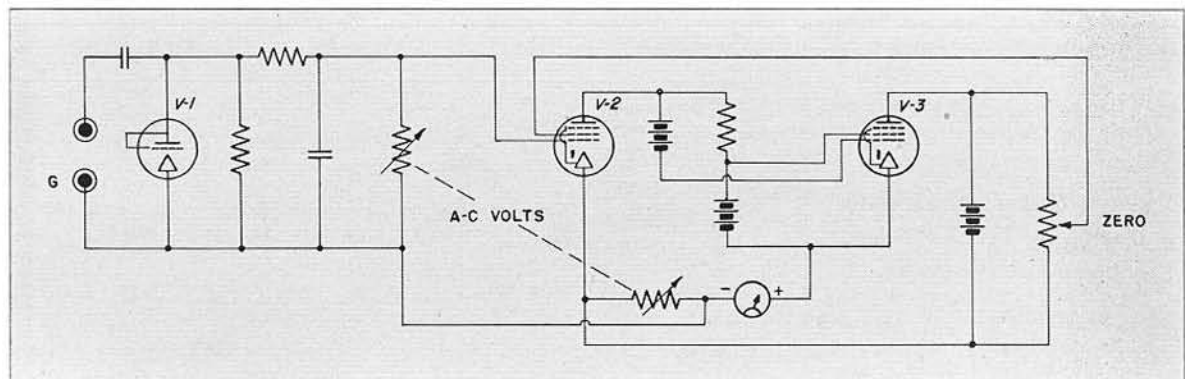

TYPE 728-A D-C VACUUM-TUBE VOLTMETER
(BATTERY OPERATED)



USES: This voltmeter is intended for measuring d-c voltages in low-power circuits where no appreciable power can be taken by the meter. It is particularly useful for measuring electrode voltages on vacuum tubes and cathode-ray oscillographs.

DESCRIPTION: The circuit is that of a degenerative d-c amplifier. The voltage to be measured is applied directly to the grid on the lower ranges, and through a high resistance voltage divider for the high ranges. The instrument is portable, and power supply is obtained from self-contained batteries.

FEATURES: The input resistance is extremely high, greater than 1000 megohms on all ranges. Wide range and complete portability are also important features. A reversing switch is provided on the panel so that either the positive or the negative terminal of the source under measurement can be grounded to the panel. Superimposed a-c voltages of considerable magnitude have no effect on the meter indication, thus making possible the measurement of fixed electrode voltages in the presence of signal voltages.

SPECIFICATIONS

Range: 0.05 to 3000 volts in seven ranges (3, 10, 30, 100, 300, 1000, 3000 volts, full scale).

Accuracy: Within $\pm 3\%$ of full scale for the lower voltage ranges (3, 10, 30 volts, full scale). Within $\pm 5\%$ of full scale for the higher voltage ranges (100, 300, 1000, 3000 volts, full scale). Battery aging may cause an additional error of $\pm 2\%$ of full scale on the 3-volt range.

Input Resistance: 1000 megohms on the higher voltage ranges (100, 300, 1000, 3000 volts, full scale). Greater than 5000 megohms on the low voltage ranges.

Terminals: Two sets of input terminals are provided on the panel. One set is used for measurements at the low voltage end of the range (0 to 30 volts) and the other set is used for the higher voltage measurements (30 to 3000 volts).

Polarity: A reversing switch on the panel permits measurements with either the positive or the negative terminal

of the source grounded to the panel of the instrument.

Effect of A-C: A superimposed a-c voltage of as high as 200 volts has a negligible effect on the meter indication.

Tube: The tube, a type 1E5-GP, is supplied.

Batteries: The batteries required are three Burgess W30BP or equivalent and one Burgess F2BP or equivalent. A compartment is provided in the case of the instrument for holding all batteries. A set of batteries is supplied with the instrument.

Mounting: The instrument is supplied in a walnut case with cover and is mounted on an engraved black crackle-finish aluminum panel.

Dimensions: With cover closed, (length) 11 x (width) $6\frac{3}{8}$ x (height) $5\frac{7}{8}$ inches, over-all

Net Weight: $9\frac{3}{4}$ pounds, including batteries.

Type	Code Word	Price
728-A	D-C Vacuum-Tube Voltmeter PILOT	\$110.00

(Right) Elementary schematic diagram for TYPE 728-A D-C Vacuum-Tube Voltmeter.

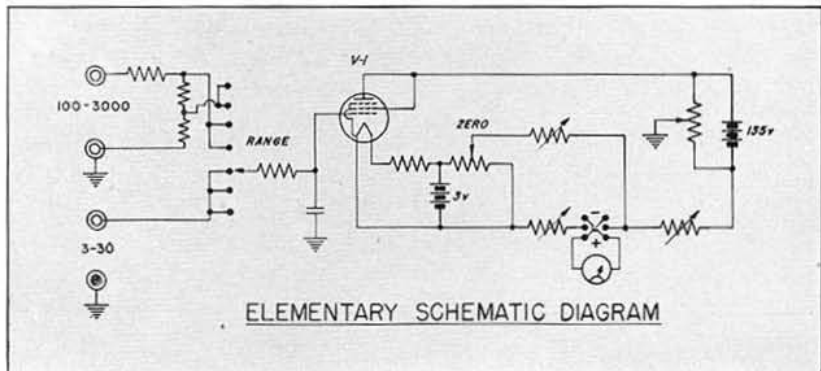

**TYPE 729-A MEGOHMMETER
(BATTERY OPERATED)**

USES: This megohmmeter is a new battery-operated design particularly intended for applications where portability is required. It is well adapted for field use in the measurement of the leakage resistance of cables and insulation. The wide range of resistance covered by this instrument makes it suitable for use as a moisture content indicator for such materials as lumber, paper, and leather, where a definite relationship exists between moisture content and electrical conductivity.

DESCRIPTION: The circuit employed is that of a conventional ohmmeter. The necessary sensitivity for measuring high resistance is obtained by using a vacuum-tube voltmeter as the indicating element.

The highest resistance standard (1000 megohms) is sealed in glass and especially treated to prevent surface leakage. This construction insures that the readings of the instrument are essentially independent of humidity. This feature is particularly valuable in field use, where adverse humidity conditions are frequently encountered.

FEATURES: A wide range of resistance is covered with excellent accuracy. The meter is calibrated at mid-scale for each range, and the circuit is stabilized to insure accuracy of calibration, independent of tube characteristics. The features of portability and self-contained



power supply are important for many applications.

SPECIFICATIONS

Range: 2000 ohms to 50,000 megohms in five overlapping ranges.

Scale: The standard direct-reading ohmmeter calibration is used; center scale values are .1, 1, 10, 100, and 1000 megohms. Length of scale, 3 1/4 inches; central decade, 1 1/2 inches.

Accuracy: Within ±5% of the indicated value between 30,000 ohms and 3 megohms, and within 8% between 3 megohms and 3000 megohms when the central decade of the scale is used. Outside the central decade the error increases because of the compressed scale. For voltage measurements the accuracy is ±2% of full scale.

Temperature and Humidity Effects: Over the normal range of room conditions (65° Fahrenheit to 95° Fahrenheit; 0 to 95% relative humidity) the accuracy of indication is substantially independent of temperature and humidity conditions. Somewhat reduced accuracy may be expected, however, if the instrument is subjected to temperatures beyond the above range.

Voltage on Unknown: The voltage applied on the unknown does not exceed 22 1/2 volts and varies with the meter indication.

Tube: The tube, a type 1E5-GP, is supplied.

Batteries: The batteries required are two Burgess W30BP or equivalent and one Burgess 2F2H or equivalent. A compartment is provided in the case of the instrument for holding all batteries. A set of batteries is supplied with the instrument. Battery life is approximately 250 hours of intermittent operation.

Mounting: The instrument is supplied in a walnut case with cover and is mounted on an engraved black crackle-finish aluminum panel.

Dimensions: With cover closed: (Length) 11 x (width) 6 1/2 x (height) 5 7/8 inches, over-all.

Net Weight: 8 3/8 pounds, including batteries.

Type	Code Word	Price
729-A Megohmmeter.....	PIOUS	\$85.00

TYPE 1861-A MEGOHMMETER AND VOLTMETER (A-C OPERATED)



USES: The TYPE 1861-A Megohmmeter is a direct-reading ohmmeter for measuring relatively high resistances, such as carbon resistors, and the leakage resistance of cables and samples of insulating material. It can also be used to locate defective insulation in electrical equipment.

The leakage resistance of condensers can also

be measured, but in measuring large condensers with low leakage, the time constant results in equilibrium being reached slowly. For example, a condenser of 1 μ f capacitance, having a leakage resistance of 1000 megohms, could be shown in a few seconds to have a resistance greater than 500 megohms, but perhaps a minute would be required to obtain the resistance within 10%. If a higher test voltage or a lower time constant is required, the TYPE 544-B Megohm Bridge is recommended. (See page 83.)

This instrument can also be used as a vacuum-tube voltmeter for measuring d-c voltage up to 100 volts.

DESCRIPTION: This instrument is very similar to the ordinary ohmmeter, except that, in order to obtain high ranges, a vacuum-tube voltmeter is used instead of the conventional indicator. A zero adjustment is provided for setting all five ranges in a single operation.

FEATURES: The TYPE 1861-A Megohmmeter indicates resistance directly on the large meter scale. Its operation is just as simple as that of an ordinary ohmmeter, and a wide range of resistances can be measured on the five overlapping ranges. The instrument is completely a-c operated and has a voltage-regulated power supply. The d-c voltage scale greatly increases the usefulness of this instrument over that of previous models.

SPECIFICATIONS

Range: 2,000 ohms to 50,000 megohms in five overlapping ranges; zero to 100 volts, dc.

Scale: The standard direct-reading ohmmeter calibration is used; center scale values are 0.1, 1, 10, 100, and 1000 megohms. Length of scale, 3 $\frac{1}{4}$ inches; center decade, 1 $\frac{3}{4}$ inches. The scale is illuminated by a lamp in the indicating meter. The voltage scale is linear.

Accuracy: Within $\pm 5\%$ of the indicated value between 30,000 ohms and 3 megohms, and within 8% between 3 megohms and 3000 megohms when the central decade of the scale is used. Outside the central decade the error increases because of the compressed scale. For voltage measurements the accuracy is $\pm 2\%$ of full scale.

Input Impedance: For voltage measurements the input impedance in megohms is indicated by the selector switch.

Temperature and Humidity Effects: Over the normal range of room conditions (65° Fahrenheit to 95° Fahrenheit; 0 to

95% relative humidity) the accuracy of the instrument is substantially independent of temperature and humidity.

Voltage on Unknown: The applied voltage on the unknown does not exceed 106 volts and varies with the indication.

Tubes: The necessary tubes, one type 1-v, one type 85, and one VR-105 are supplied.

Power Supply: 105 to 125 (or 210 to 250) volts, 40 to 60 cycles ac. The power required is 10 watts.

Accessories Supplied: A seven-foot connecting cord.

Mounting: The instrument is supplied in a walnut case and is mounted on an engraved black crackle-finish aluminum panel.

Dimensions: (Width) 10 x (height) 8 x (depth) 5 $\frac{1}{2}$ inches, over-all.

Net Weight: 8 $\frac{1}{4}$ pounds.

Type	Code Word	Price
1861-A	MEG OHM METER	\$95.00

TYPE 483-F OUTPUT METER

USES: The TYPE 483-F Output Meter finds its greatest uses in the routine laboratory measurements of voltages at audio frequencies and for comparison measurements of various types, where the meter is used to match two voltages.

When used in conjunction with a TYPE 814-A Amplifier, this meter is an excellent bridge null detector for commercial and audio frequencies.

DESCRIPTION: A copper-oxide-rectifier voltmeter is used as the indicating meter. An L-type multiplying network is used to extend the range and to furnish a constant input impedance.

SPECIFICATIONS

Voltage Range: Below 0.5 volt to 200 volts in seven ranges (2, 4, 10, 20, 40, 100, 200 volts, full scale).

Accuracy: The fundamental accuracy is $\pm 5\%$ of full scale, which is equivalent to 0.1 volt multiplied by the multiplier setting. This accuracy applies only when the instrument is operated on sinusoidal voltages and on the flat portions of the characteristic curves shown below.

Waveform Error: The copper-oxide rectifier type meter is calibrated in r-m-s values for a sinusoidal applied voltage. When non-sinusoidal voltages are applied an error in indication may occur, since the meter is not a true r-m-s indicating device. The error will depend on the magnitude and phase of the harmonics present, but with waveforms normally encountered in communications work will not be serious.

Input Impedance: The impedance on the 100 multiplier is 20,000 ohms $\pm 2\%$. For lower multiplier settings, however, the impedance varies slightly with voltage. The greatest change in impedance occurs on the 1 multiplier where the impedance increases by approximately 15% as the voltage is dropped from full scale, 2 volts, to quarter scale, 0.5 volt.

Scale Length: 2 1/2 inches.

Terminals: Jack-top binding posts are provided. Standard 3/4-inch spacing is used.

Plot showing the effect of temperature on the meter indication. Note that in the normal room temperature range the temperature coefficient is practically zero. Data plotted here are the average from a number of instruments.

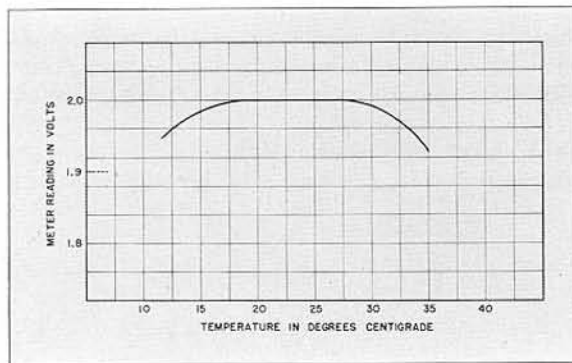

Mounting: Mounted on an aluminum panel which is mounted in a walnut cabinet.

Dimensions: (Length) 9 3/8 x (width) 4 1/4 x (height) 5 1/4 inches, over-all.

Net Weight: 3 1/2 pounds.

Average frequency characteristic of the meter.

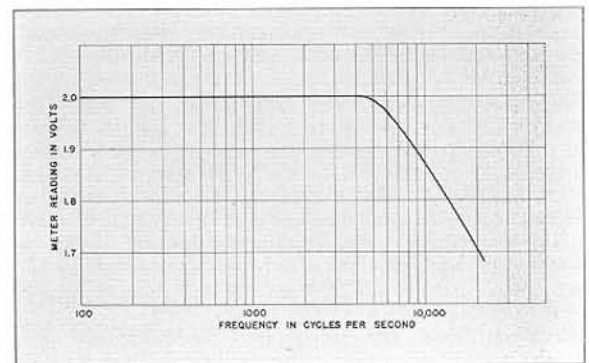

Type	Code Word	Price
483-F Output Meter.....	AVOID	\$54.00

PATENT NOTICE. See Note 5, page vi.

TYPE 583-A
OUTPUT-POWER
METER

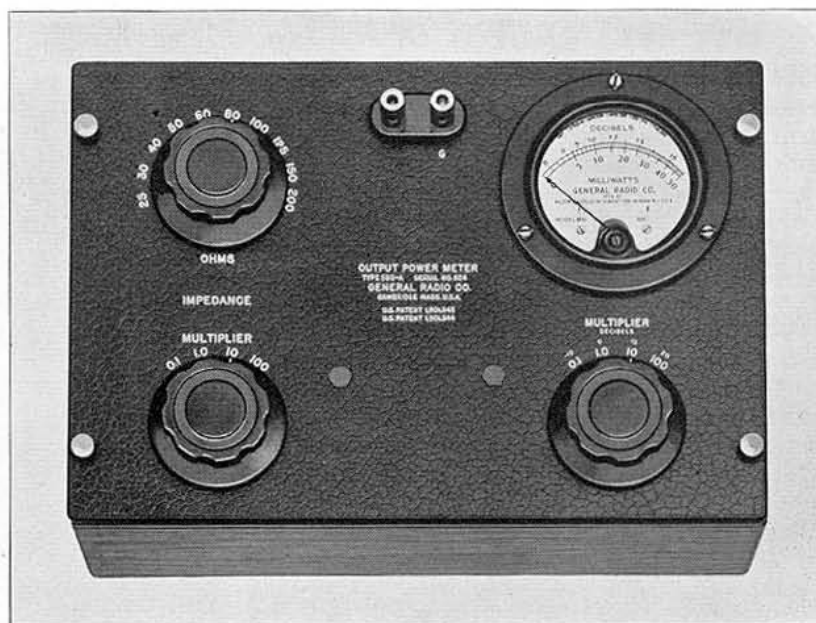

USES: The output-power meter reads directly the amount of audio-frequency power that a source is capable of delivering into any desired load. Thus the effect of load impedance on power delivered can be easily measured, and the characteristic impedance of telephone lines, phonograph pickups, oscillators, and similar equipment can be found by observing the impedance which gives the maximum reading on the instrument.

In testing radio receivers the TYPE 583-A Output-Power Meter is very useful as an output indicator for standard selectivity, sensitivity, band-width, and fidelity tests, and an auxiliary decibel scale is furnished on the meter for this purpose.

DESCRIPTION: This instrument may be considered to be an adjustable load impedance across which is connected a voltmeter that is calibrated directly in watts lost in the load. Actually the input is connected through a multi-tap transformer and a resistance network to an output meter.

FEATURES: The TYPE 583-A Output-Power Meter covers a wide range of both power and impedance values. The power range is 50,000:1, and the impedance range is 8000:1. All readings can be made directly and quickly. The indicating element is a rectifier-type voltmeter and will stand considerable overload for short periods.

SPECIFICATIONS

Power Range: 0.1 to 5000 milliwatts in four ranges (5, 50, 500, 5000 milliwatts, full scale). The copper-oxide meter is calibrated from 1 to 50 milliwatts with an auxiliary scale reading from 0 to 17 decibels above a reference level of 1 milliwatt.

Impedance Range: 2.5 to 20,000 ohms. Forty discrete impedances, distributed approximately logarithmically, are obtained by means of a ten-step OHMS dial and a four-step MULTIPLIER.

Accuracy: The accuracy of both power and impedance measurements varies with frequency. The maximum error in full-scale power reading does not exceed 0.5 decibel between 150 and 2500 cycles, nor does it exceed 1.5 decibels at 20 and 10,000 cycles. The average error is 0.3 decibel at 30 and 5000 cycles, and 0.6 decibel at 20 and 10,000 cycles.

The maximum error in impedance does not exceed 7% between 150 and 3000 cycles, nor does it exceed 50% at 20 and 10,000 cycles. The average error is 8% at 30 and 5000 cycles and 20% at 20 and 10,000 cycles.

Waveform Error: The indicating instrument used is a copper-oxide rectifier-type meter, calibrated in r-m-s values

for a sinusoidal applied voltage. When non-sinusoidal voltages are applied an error in indication may occur, since the meter is not a true r-m-s indicating device. The error will depend on the magnitude and phase of the harmonics present, but with waveforms normally encountered in communications work will not be serious.

Mounting: The instrument is mounted on an aluminum panel in a walnut cabinet.

Dimensions: (Length) 10 x (width) 7 x (height) 6 inches, over-all.

Net Weight: 3 1/4 pounds.

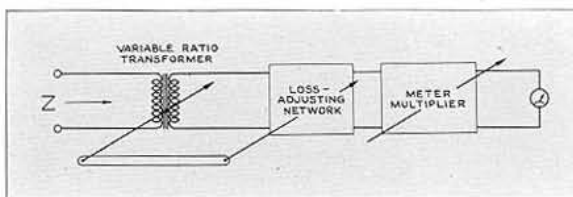

Type	Code Word	Price
583-A Output-Power Meter.....	ABUSE	\$95.00

PATENT NOTICE. See Notes 5, 6, page vi.

TYPE 783-A OUTPUT-POWER METER

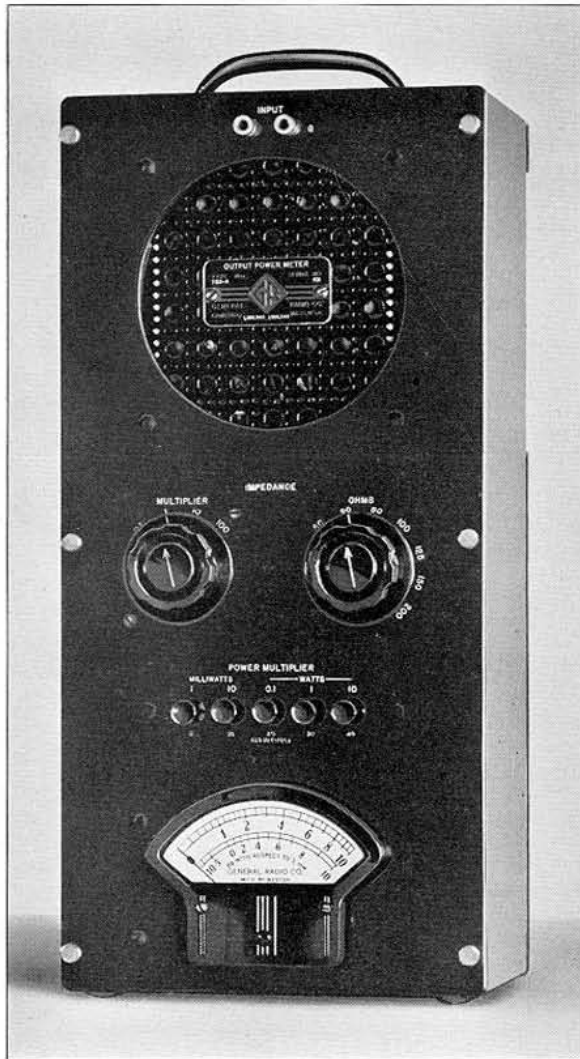

USES: The TYPE 783-A Output-Power Meter is a direct-reading instrument for measuring the power output of audio-frequency circuits.

Some of its specific uses include the testing of amplifiers, transformers, and other networks. It is particularly useful for simulating loud-speaker or other load impedances in testing the output characteristics of high-power audio systems, since it will measure power outputs as high as 100 watts. It is sufficiently sensitive, on the other hand, to be useful in measuring very low-level circuits.

DESCRIPTION: Functionally the TYPE 783-A Output-Power Meter is equivalent to an adjustable load impedance across which is con-

nected a voltmeter that is calibrated directly in watts dissipated in the load.

This instrument is very similar to the TYPE 583-A Output-Power Meter described on the previous page but has a much higher power range (100 watts, maximum) as well as better frequency and impedance characteristics.

FEATURES: This instrument gives accurate power indications over a wide range of power, impedance, and frequency. The auxiliary decibel scale is convenient for many types of measurement.

SPECIFICATIONS

Power Range: 0.2 milliwatt to 100 watts in five ranges (10 and 100 milliwatts, 1, 10, and 100 watts, full scale). An auxiliary decibel scale reads from -10 to +50 db referred to a level of 1 milliwatt.

Impedance Range: 2.5 to 20,000 ohms. Forty discrete impedances, distributed approximately logarithmically, are obtained by means of a ten-step OHMS dial and a four-step MULTIPLIER.

Impedance Accuracy: The input impedance is within $\pm 2\%$ of the indicated value, except at the higher audio frequencies, where the error for the higher impedance settings may exceed this value. At 15,000 cycles the input impedance error is about 5% for impedances from 10,000 to 20,000 ohms.

Power Accuracy: The indicated power is accurate to ± 0.25 db at full-scale reading. At the lowest impedance multiplier setting (2.5 to 20 ohms) there may be an additional error of 0.2 db due to switch contact resistance when the power multiplier is set at 10 (10 to 100 watt range).

The over-all frequency characteristic of the power indication is flat within ± 0.5 db from 20 cycles to 10,000 cycles; within ± 0.75 db to 15,000 cycles.

Waveform Error: The indicating instrument used is a copper-oxide rectifier meter, calibrated in r-m-s values for a sinusoidal applied voltage. When non-sinusoidal voltages are applied an error in indication may occur, since the meter is not a true r-m-s indicating device. The error will depend on the magnitude and phase of the harmonics present, but, with waveforms normally encountered in measurement circuits at communications frequencies, will not be serious.

Temperature and Humidity Effects: Humidity conditions have a negligible effect on the accuracy of the instrument.

The instrument is calibrated at 77° Fahrenheit and, if the ambient temperature departs widely from this value, additional errors of indication may be expected. At high temperatures (95° Fahrenheit) this additional error may approach the nominal calibration error, particularly at the higher frequencies.

The heat dissipated by the instrument itself has no effect on the accuracy.

Mounting: The instrument is mounted on a bakelite panel in a walnut cabinet.

Dimensions: 8 x 18 x 7 inches, over-all.

Net Weight: 17 pounds.

Type	Code Word	Price
783-A Output-Power Meter	ABBEY	\$185.00

PATENT NOTICE. See Notes 5, 6, page vi.

METERS

TYPE 546-B AUDIO-FREQUENCY MICROVOLTER

USES: The TYPE 546-B Audio-Frequency Microvolter is a useful source of small, known, audio-frequency voltages. In measuring the response of amplifiers, transformers, and other audio equipment, such a source of known input voltage is extremely valuable. The microvolter can also be used to measure other small voltages by substitution methods.

DESCRIPTION: This instrument consists, essentially, of a constant impedance attenuator and a voltmeter by means of which the input to the attenuator is standardized. A switch controls the output voltage in decade steps while an individually calibrated dial provides continuous control over each decade.

FEATURES: This instrument has an excellent frequency characteristic, extending from very low frequencies up to 20,000 cycles. The low-frequency limit is determined by the characteristics of the meter. Excellent accuracy is obtainable for absolute voltage levels, and for voltage ratios, as are used in gain or loss

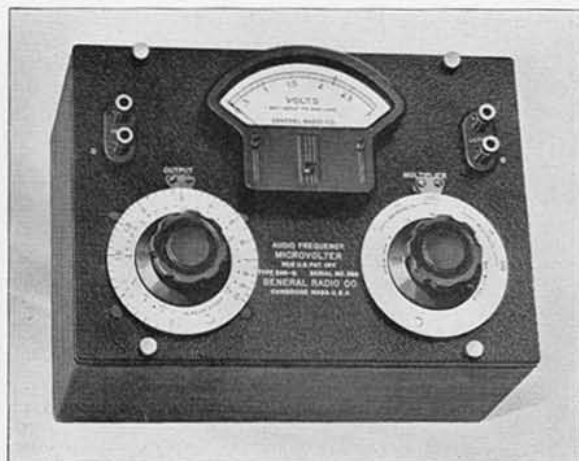

measurements, still better accuracy can be obtained.

In addition to the voltage calibration of the meter and multiplier, a decibel scale is provided. This facilitates the work of obtaining response characteristics, since no calculations are necessary to obtain the relative response in decibels.

SPECIFICATIONS

Output Voltage Range: From 0.1 microvolt to 1.0 volt, open circuit, when the input voltage is set to the standardized reference value.

Accuracy: For open-circuit output voltages the calibration is accurate within $\pm 3\% \pm 0.1$ microvolt for output settings above 1 microvolt and for all frequencies between 20 and 20,000 cycles. This accuracy applies only where waveform and temperature errors are negligible (see below). Below 1 microvolt the error increases owing to crowding of the scale.

For ratios or increments of voltage, at a given frequency, the accuracy of any reading is within $\pm 2\% \pm 0.1$ microvolt, at frequencies up to 100,000 cycles. At the higher frequencies this accuracy applies only at levels above 100 microvolts.

Output Impedance: The output impedance is approximately 200 ohms and is constant with setting within $\pm 5\%$. This impedance is sufficiently low so that no correction on the output voltage is necessary for load impedances of the order of 50,000 ohms and greater.

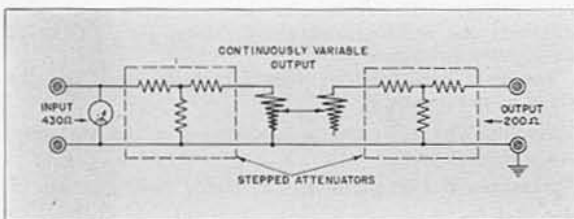

Input Impedance: Approximately 430 ohms, substantially independent of output setting on all but the highest multiplier position.

Waveform Error: The accuracy of the microvolter as a calibrated attenuator or voltage divider is independent of waveform. The absolute accuracy of the output voltage calibration depends on the characteristics of the input voltmeter, which has a small waveform error that depends in turn on both the phase and the magnitude of harmonics present in the input. This error in the voltmeter can, in general, be neglected when the microvolter is used with ordinary laboratory oscillators.

Temperature Error: The accuracy of the calibration is independent of temperature when the microvolter is used as an attenuator or voltage divider. The absolute accuracy is affected slightly by temperature because of change in the voltmeter characteristics. The necessary correction for temperatures from 65° to 95° Fahrenheit is furnished with the instrument. The effects of humidity are negligible.

Power Source: The driving oscillator must be capable of furnishing about 2.2 volts across 430 ohms, or about 11 milliwatts.

Terminals: Jack-top binding posts are mounted on standard $\frac{3}{4}$ -inch spacing.

Mounting: The instrument is mounted on an aluminum panel in a shielded walnut cabinet.

Dimensions: (Length) 10 x (width) 7 x (height) $6\frac{3}{8}$ inches, over-all.

Net Weight: $6\frac{1}{2}$ pounds.

Type	Code Word	Price
546-B	Audio-Frequency Microvolter*	CROWN
		\$80.00

*Reg. U. S. Pat. Off.

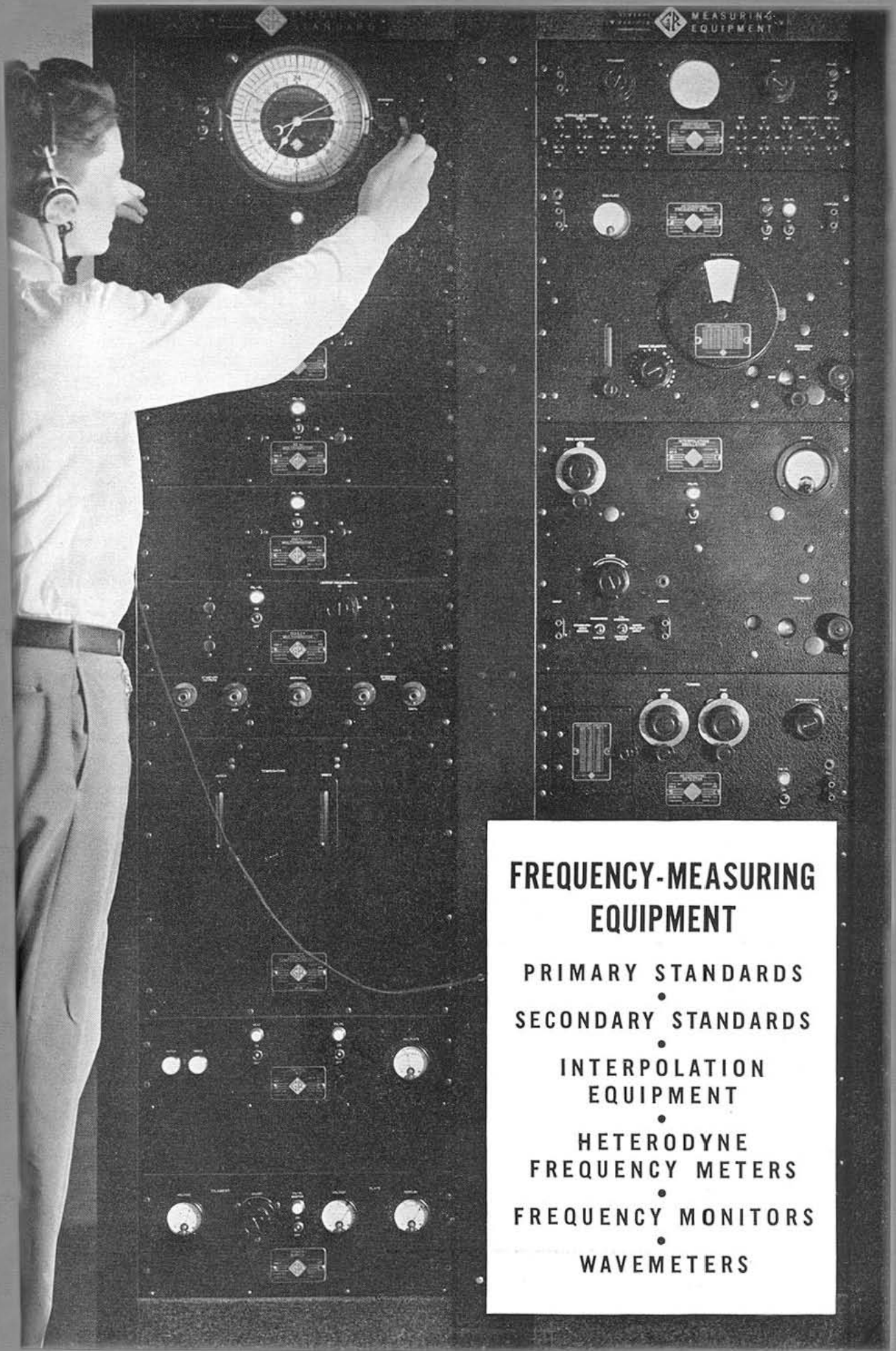

FREQUENCY-MEASURING EQUIPMENT

PRIMARY STANDARDS

•
SECONDARY STANDARDS

•
INTERPOLATION
EQUIPMENT

•
HETERODYNE
FREQUENCY METERS

•
FREQUENCY MONITORS

•
WAVEMETERS

FREQUENCY AND TIME

THE PRIMARY STANDARD

The determination of frequency directly in terms of time is a fundamental measurement, since frequency is the *time* rate of recurrence of a cyclical phenomenon. A primary standard of frequency is, therefore, defined as one whose frequency is determined directly in terms of time. A secondary standard of frequency is one whose frequency is determined by comparison with a primary standard or by comparison with other secondary standards some one of which originally was compared with a primary standard.

In order to establish a primary standard of frequency, it is first necessary to establish a reliable standard of time. A cyclical system, having a substantially constant rate, then becomes a primary frequency standard when referred to the time standard.

In practice, the responsibility of establishing and maintaining accurate time determinations by astronomical observations is not assumed by the individuals desiring a primary standard of frequency. The time determinations are carried out by observatories especially equipped for the purpose, and the results are made available to a large number of users by standard time transmissions by radio and wire. In the United States, the U. S. Naval Observatory transmits high-precision time signals by radio through the facilities of the U. S. Naval Radio Service. The Arlington transmission on 122 kc is now available several times a day and can be received over a large part of the continental United States. Less frequent transmissions on high frequencies can be received nearly all over the world.

The user of a primary frequency standard can then conveniently determine the frequency of the standard in terms of the standard time interval sent to him by radio. In the General Radio equipment means are provided for quickly and conveniently making this comparison.

In principle, the constant-frequency oscillator, checked in terms of time, is a primary frequency standard, but is a single-frequency device. For convenience in use, it is desirable to have means of obtaining from such a source many other frequencies above and below the oscillator frequency.

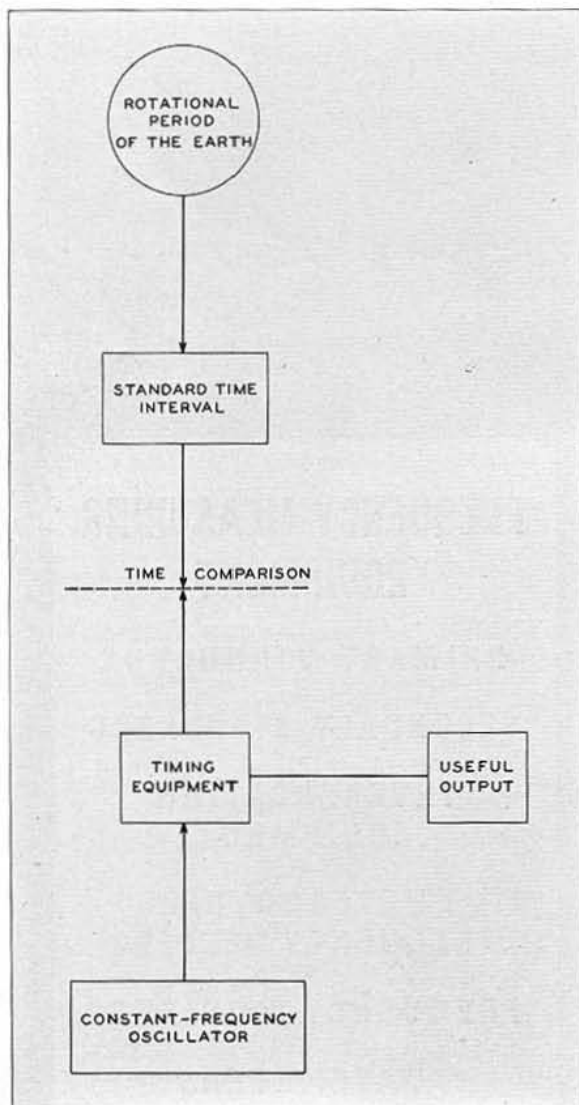

FREQUENCY MULTIPLICATION AND DIVISION

For practical reasons it is desirable to divide a standard frequency, if this frequency be a low radio frequency, to obtain an output frequency such that an easily constructed synchronous motor can be operated to count the number of cycles executed by the standard oscillator in a standard time interval. In measurements of frequencies and particularly of high radio frequencies, it is desirable to multiply the standard frequency by some factor to obtain an output frequency near the frequency being measured. Both of these operations are performed by a relaxation oscillator called a multivibrator.

FIGURE 1. Functional diagram of a primary standard of frequency. The frequency of a primary standard is measured by direct comparison with the rotational period of the earth. Hence any primary standard will consist of a constant-frequency oscillator (such as a pendulum, or a piezo-electric crystal) and some means for counting the number of its oscillations in a given standard time interval.

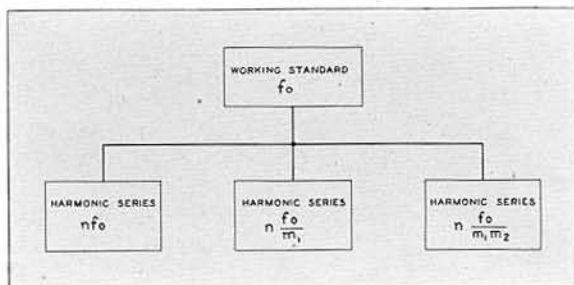

FIGURE 2. Showing functionally the operation of a frequency division system.

An oscillator of this type is characterized by its susceptibility to control by an introduced voltage whose frequency lies near its fundamental or a low-order harmonic frequency. In this condition of control, the relaxation oscillator locks into step with the control voltage, and the frequency bears an integral relationship to the frequency of the controlling voltage.

If the frequency of the standard oscillator is f , a multivibrator, controlled by it and acting as a frequency divider, would have a fundamental frequency of f/m_1 , where m_1 is a whole number (generally less than 10). This frequency divider can, in turn, control a second divider operating at a frequency $1/m_2$ below its fundamental frequency. The two dividers then give a division of $1/m_1 m_2$ for the standard oscillator.

From each of the three fundamental frequencies f , f/m_1 , and $f/m_1 m_2$ a series of multiple frequencies can be derived by the generation of harmonics. The multivibrators have extremely distorted waveforms, and their outputs contain hundreds of harmonics useful for measurement purposes.

By these two processes, a great number of standard frequencies, each of which is known with the same accuracy as the frequency of the standard oscillator, can be produced from a single-frequency source. By suitable choice of the factors by which the standard frequency is divided, the derived frequencies may be made to cover a large part of the communication-frequency spectrum, from low audio frequencies to high- and even ultra-high radio frequencies. The range of output frequencies obtainable from the General Radio Primary Frequency Standard is shown in Figure 3. Complete specifications for this standard are given on page 126.

FIGURE 3. Functional diagram of CLASS C-21-HLD Primary Standard of Frequency. The output frequencies are shown in the spectra at the right of the diagram.

THE SECONDARY STANDARD

In many cases an elaborate and costly primary frequency standard may not be justified for the work at hand. Satisfactory secondary standards can be assembled to meet the particular requirements of measurements at some loss in accuracy, but at a considerable saving in cost. Since accurate standard frequencies are now available by radio, it is possible to check the standard frequently, and, if necessary, readjust the frequency into agreement with standard-frequency radio transmissions. A secondary standard of moderately good performance will maintain its frequency sufficiently well over the periods between standard-frequency transmissions so that entirely satisfactory average accuracy may be maintained.

In general, a secondary frequency standard consists of a standard-frequency oscillator and one or more multivibrators, depending upon the output harmonic frequencies desired and the purposes for which they are required. A generally useful combination is shown functionally in Figure 4 and is described under the CLASS C-10-H Secondary Standard, page 130. Other combinations can be assembled to meet particular requirements.

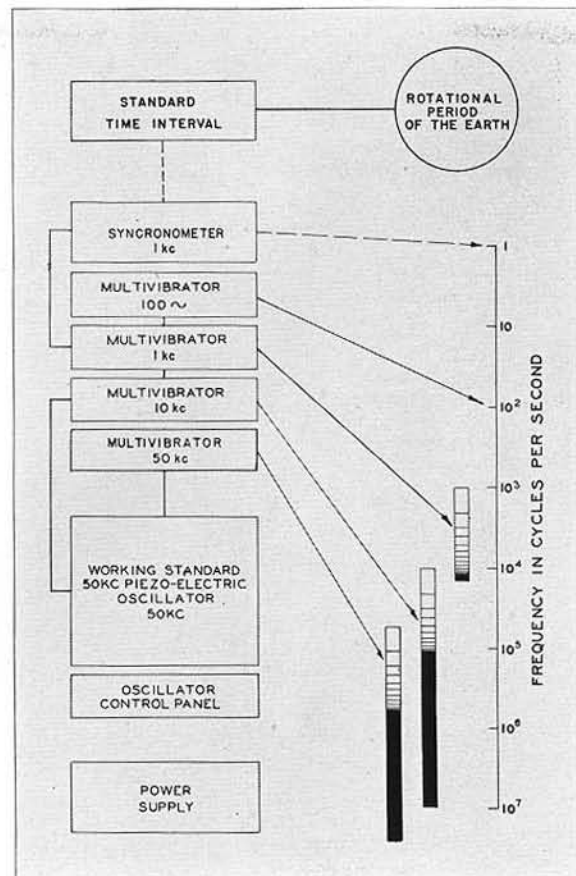

FREQUENCY MEASUREMENT

The next step, after establishing a series of standard frequencies embracing a portion of the frequency spectrum in which measurements of frequency are to be made, is to evaluate any unknown frequency in terms of one of the standard frequencies. Any unknown frequency will lie between two of the standard-frequency harmonics, as shown in Figure 5. The simplest process is to determine the difference in frequency between the unknown frequency and the nearest of the standard frequencies. This difference is added to the standard frequency if the unknown lies above the standard, or subtracted if the unknown lies below the standard frequency.

INTERPOLATION METHODS

For evaluating the frequency difference (A or B, Figure 5), either of two methods is ordinarily used, the direct-beating method and the linear interpolation method. The direct-beating method, outlined in Figure 6, consists of beating the standard and unknown frequencies in a detector, and measuring the beat frequency by comparison with a calibrated audio oscillator.

FIGURE 4. Functional diagram of CLASS C-10-H Secondary Frequency Standard.

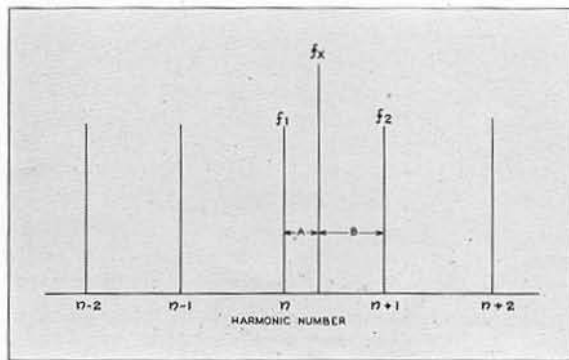
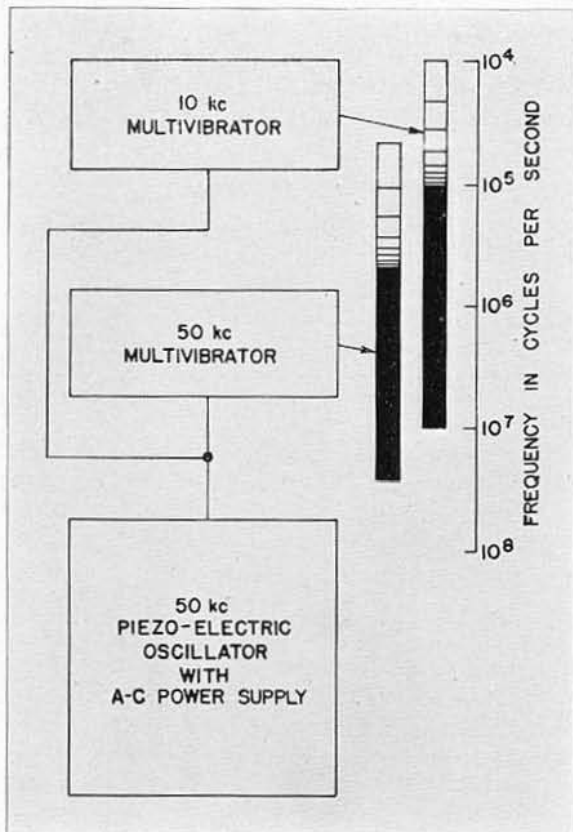

FIGURE 5. This diagram shows the relation between an unknown frequency and a standard harmonic series.

The linear-interpolation method uses a radio-frequency oscillator whose output frequency varies linearly with scale setting. This linear scale is used to interpolate directly between the two standard frequencies to locate the unknown. Figure 7 shows how this is accomplished.

When the oscillator is successively adjusted to zero beat with the unknown frequency f_x and with each of the standard frequencies f_1 and f_2 , between which f_x lies, three dial settings S_x , S_1 , and S_2 are obtained. Since the frequency intervals are proportional to corresponding scale intervals,

$$\frac{f_x - f_1}{f_2 - f_1} = \frac{S_x - S_1}{S_2 - S_1}$$

and

$$f_x = f_1 + \frac{S_x - S_1}{S_2 - S_1} (f_2 - f_1).$$

Similarly,

$$f_x = f_2 - \frac{S_2 - S_x}{S_2 - S_1} (f_2 - f_1).$$

Assemblies of frequency-measuring equipment for measuring unknown frequencies in terms of standard-frequency harmonics are described on pages 128 and 131.

When portability and simplicity are important requirements for a frequency measuring system, the secondary standard and interpolation device can be combined in a single cabinet. The heterodyne frequency meter, with built-in crystal calibrator, described on page 142, is an example of this type of instrument. For rapid operation and freedom from ambiguity in the identification of harmonics, a direct-reading dial is provided. Numerous checking points are obtained on each range of the heterodyne frequency meter so that any drift caused by aging or by temperature is easily corrected. Interpolation between known checking points is accomplished by use of the direct-reading dial.

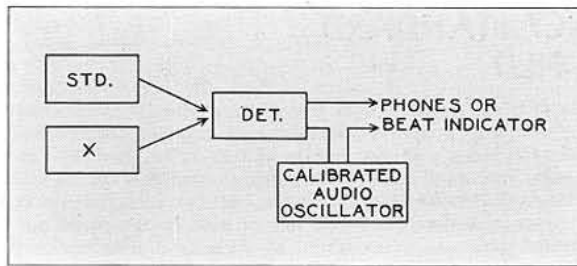

FIGURE 6. Functional diagram showing the operation of the direct-beating method of frequency measurement.

FREQUENCY MONITORING

As contrasted with the problem of frequency measurements over wide ranges of frequencies, certain operating requirements demand the continuous measurement of a single, or a very few frequencies. The continuous monitoring of the frequency of a radio transmitter is one instance. Frequency monitors are now required by law for many classes of service in the United States and foreign countries.

For continuous monitoring, the process of measurement must be reduced either to automatic or very simple operation. In the TYPE 25-A Broadcast Frequency Monitor*, the carrier frequency is compared with that of a piezo-electric oscillator which is offset from the assigned carrier frequency by 1000 cycles. The carrier and secondary standard frequencies are fed to a detector, where the beat-frequency difference is obtained and is then amplified. The amplified output is then passed to a frequency-indicating device, usually referred to as a frequency-deviation meter. If the transmitter frequency varies with reference to the frequency of the secondary standard, the beat-frequency also varies, and the departure from the normal value is a measure of the carrier-frequency deviation in both magnitude and sign. The carrier-frequency deviation may thus be continuously indicated on a meter; the operating personnel can easily check the frequency at any time and make any necessary

FIGURE 7. Plot of frequency vs. scale setting for a linear-scale oscillator.

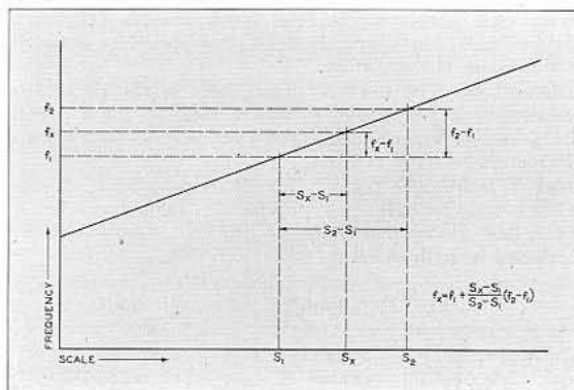

*Discontinued for the duration of the war.

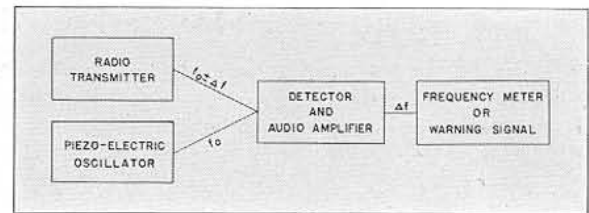

FIGURE 8. General functional diagram of a frequency monitoring system. The difference in frequency Δf between transmitter and piezo-electric oscillator is obtained in the detector, is amplified, and operates the frequency meter. To overcome ambiguity as to the sense of the deviation, Δf is made to have a definite value, say 1000 cycles, when the transmitter is at correct frequency, by adjusting the piezo-electric oscillator for a frequency 1000 cycles above or below the assigned transmitter frequency.

adjustments to correct any deviations which occur. If desired, such deviations may be recorded, so that a permanent record of the station performance is obtained.

In some cases, a simpler type of monitor is more desirable, for example, one in which the station deviation is indicated only if it exceeds a prescribed limit. In one such type* the operating range of the monitor may be adjusted to meet the requirements imposed on the particular channel to which a station may be assigned. Once adjusted, the monitor operates either of two signal lights, one for positive and one for negative deviations, but only if the carrier frequency deviation exceeds the limit for which the monitor has been set. Since the sign of the deviation is indicated, the operating personnel may at once make the proper readjustment of the transmitter to bring it within the tolerance permitted.

WAVEMETERS

For making preliminary adjustments on transmitters, and for general experimental work, the simple resonant-circuit wavemeter is still a valuable tool. Sufficient accuracy is possible so that preliminary adjustments may be made closely enough to be representative of final conditions. Several models of wavemeters are described on pages 148 to 150, covering different frequency ranges, with various accuracies and with different types of resonance indicators adapted to the types of service for which the instruments are intended.

In the following pages assemblies of standard-frequency and frequency-measuring equipment, which have been found to meet conveniently most general requirements, are described. Modifications in choice and grouping of units are possible to meet efficiently many and varied special requirements. Suggestions on equipment will gladly be made by our Engineering Department.

PRIMARY FREQUENCY STANDARD Class C-21-HLD

The CLASS C-21-HLD Standard-Frequency Assembly is a complete and highly precise primary standard of frequency. Units have been installed and are now operating in all parts of the world in industrial organizations, research laboratories, observatories, and frequency monitoring stations. Many of them are used as national standards of frequency by communications administrations in American, European, and Asiatic countries.

The assembly is provided with a means of measuring

its output frequencies in terms of standard time without reference to any other standard of frequency. Harmonic series based on fundamentals of 0.1, 1, 10, and 50 kilocycles are available at its output terminals to furnish standard frequencies over the entire communication-frequency spectrum. From it can also be obtained one-second pulses. The accuracy of all output frequencies is the same and is better than ± 5 parts in ten million over periods of several months.

SPECIFICATIONS

Frequency Range: Standard frequencies ranging from one pulse per second to frequencies of several megacycles can be obtained from this equipment.

The output frequencies are as follows. The upper frequency limit depends upon the method used to detect and utilize the harmonics. The values here quoted are easily reached when using the TYPE 619-E Heterodyne Detector.

From 50-kc multivibrator, 50 kc and its harmonics up to 25 megacycles (upper limit of TYPE 619-E).

From 10-kc multivibrator, 10 kc and its harmonics up to 10 megacycles.

From 1-kc multivibrator, 1 kc and its harmonics in the audio-frequency range.

From 100-cycle multivibrator, 100 cycles and its harmonics in the lower audio range.

From the synchronometer unit, one-second contactor. The time of occurrence of the contact may be phased to occur at any instant over a range of one second.

If a suitable high-frequency receiver is used to detect them, 50-kc harmonics up to 50 megacycles can be utilized directly. For work at higher frequencies, harmonics of an auxiliary oscillator whose fundamental is monitored against the standard at a lower frequency can be used.

Output Voltage: The harmonic outputs of the 50 and 10 kc are at low impedance (65 ohms). The r-m-s voltages, measured at the terminal strip of the frequency standard, across a 65-ohm load, are: at 50 kc, 0.3 volt; and 10 kc, 0.3 volt. The audio-frequency outputs are at high-impedance (10,000 to 20,000 ohms). The r-m-s voltages measured at the terminal strip of the standard, across a 10,000-ohm load, are: 1 kc, 25 volts; 100 cycles, 15 volts. These voltages are representative only; they are not guaranteed values.

Frequency Adjustment: The frequency of the quartz bar in its oscillator circuit is adjusted to within 1 part in ten million of its specified frequency in terms of standard time. Slight changes in frequency may occur during shipment. A control is provided for adjusting the frequency over a range of approximately plus or minus 6 parts in one million. Complete instructions for making adjustments over a wider range are given.

Frequency Stability: When the assembly is operated in accordance with instructions, the frequency will remain within 5 parts in ten million over long periods of time. Since time comparisons can be made several times daily, the frequency is known with a high degree of precision at all times.

The temperature coefficient of frequency of the quartz bar is of the order of 1 part per million per degree Centigrade. The temperature regulation is within 0.01° Centigrade so that the effect of ambient temperature fluctuations should not cause any change in frequency greater than 0.1 part in ten million. The voltage coefficient of frequency of the oscillator is approximately 2 parts per hundred million

for line voltage changes of 10%. The average frequency variation from this cause will be substantially less.

Output Terminals: The various output frequencies are made available at shielded plug connections on a terminal panel at the front of the rack. This panel is permanently wired into the cable assembly. Since all necessary wiring, for all interconnections between units of the assembly, is provided in the form of cables, no connections need be made by the user other than power-supply connections, and a connection to the point where the standard frequencies are to be used.

Vacuum Tubes: The following tubes are required and are supplied with the assembly:

25—type 6J5-G	1—6SN7-GT
1—6H6-GT	1—type 6K6-G
1—6A7-C	1—type VR-105-30
1—type 83	

Power Supply: 105 to 125 volts, 50 to 60 cycles. Two types of power-supply equipment are available: (1) a complete a-c power supply; or (2) a unit for continuously charging storage batteries.

For the completely a-c operated assembly no batteries of any kind are required.

For the floating-battery-operated assembly the following lead-type storage batteries are required:

Two 6-volt, 300 ampere-hour
Four 48-volt, 24 ampere-hour

In addition, a reserve power supply for the heaters is recommended. This should be capable of supplying 100 watts at 115 volts. Batteries must be purchased separately. None are supplied.

Power Input: The power demand from the supply line is approximately 210 watts; with heaters off, the power required is approximately 130 watts. The average heating power at normal room temperatures is approximately 20 watts.

Accessories Supplied: Complete set of tubes, spare sets of fuses, fusible links, pilot lights. All connecting cables, including power-supply leads, and complete operating instructions.

Mounting: All units are mounted on standard 19-inch relay-rack panels finished in black crackle lacquer. A cabinet rack, black wrinkle finish, is supplied for mounting the units of the assembly.

Dimensions: The over-all dimensions of the assembly in cabinet rack are (height) 76 $\frac{1}{4}$ x (width) 22 x (depth) 24 $\frac{1}{2}$ inches. The available panel space is 40 rack units or 70 inches.

Net Weight: 530 pounds for floating-battery assembly (TYPE 695-C Charging Equipment); 500 pounds for a-c operation (TYPE 696-C Power Supply). Cabinet rack is included in both cases.

Class	Description	Code Word	Price
C-21-HLD	For Complete A-C Operation	LAYER	\$2595.00
C-21-HLD	For Floating-Battery Operation	LYRIC	2720.00

PATENT NOTICE. See Notes 1, 8, 11, 12, 19, 27, 29, page vi.

TYPE 693-B SYNCHRONOMETER

This panel includes a 1000-cycle synchronous motor for effectively counting the number of cycles executed by the standard piezo-electric oscillator in a standard time interval. A large, illuminated, 24-hour dial with a long sweep hand makes for easy visibility. A microdial contactor, operating once each 50,000 cycles of the standard oscillator, is provided for comparison with time signals. The microdial mechanism may be phased by means of a panel control. Comparison of the synchronometer reading with standard time may be made on the microdial scale to one part in ten million over a 24-hour interval. The 1000-cycle synchronous motor is started by a 60-cycle motor controlled by a push-button on the panel.

TYPE 692-B MULTIVIBRATOR

The 10-kc and 1-kc multivibrators divide the standard frequency of 50 kc down to 1 kc for operation of the synchronometer and supply standard-frequency harmonics for measuring purposes. The 50-kc and 100-cycle multivibrators provide additional output frequencies for use in measurements of high radio frequencies and audio frequencies, respectively. (See also page 133.)

TYPE 698-A DUPLEX MULTIVIBRATOR

The TYPE 698-A Duplex Multivibrator supplies frequencies of 9 and 11 kc and is for the purpose of avoiding measurements near zero beat, particularly on channels whose frequencies lie at multiples of 10 kc.

TERMINAL BOARD

Shielded low-impedance cable is used for all radio-frequency circuits. On the connecting panel, shielded output plugs are provided for outputs at 50, 10, and 1 kc, 100 cycles, and for the microdial.

TYPE 690-D PIEZO-ELECTRIC OSCILLATOR**TYPE 691-C TEMPERATURE CONTROL****TYPE 676-B QUARTZ BAR**

This group constitutes the standard-frequency oscillator of the system. Double temperature control of the quartz bar holds the temperature to better than 0.01° Centigrade over a range in ambient temperature from -6° to +50° Centigrade. A dial at the rear permits adjustment of the oscillator over a range of plus or minus 6 parts per million, approximately.

TYPE 694-C CONTROL UNIT

This unit contains the necessary meters, relays, controls, and signal lights for operation of both the piezo-electric oscillator and the temperature-control system.

TYPE 696-C POWER SUPPLY

For complete alternating-current operation, the TYPE 696-C Power Supply is used. In this case no batteries of any kind are required. If floating-battery operation is desired, to avoid interruptions due to supply line failures, this unit is replaced by the TYPE 695-C Charging Equipment.

TYPE 480-P CABINET RACK

A cabinet rack is furnished to house all the equipment of the standard-frequency assembly. Openings, with removable finished covers, are provided in the sides for cabling between the frequency standard and measuring equipment. (See page 128.)

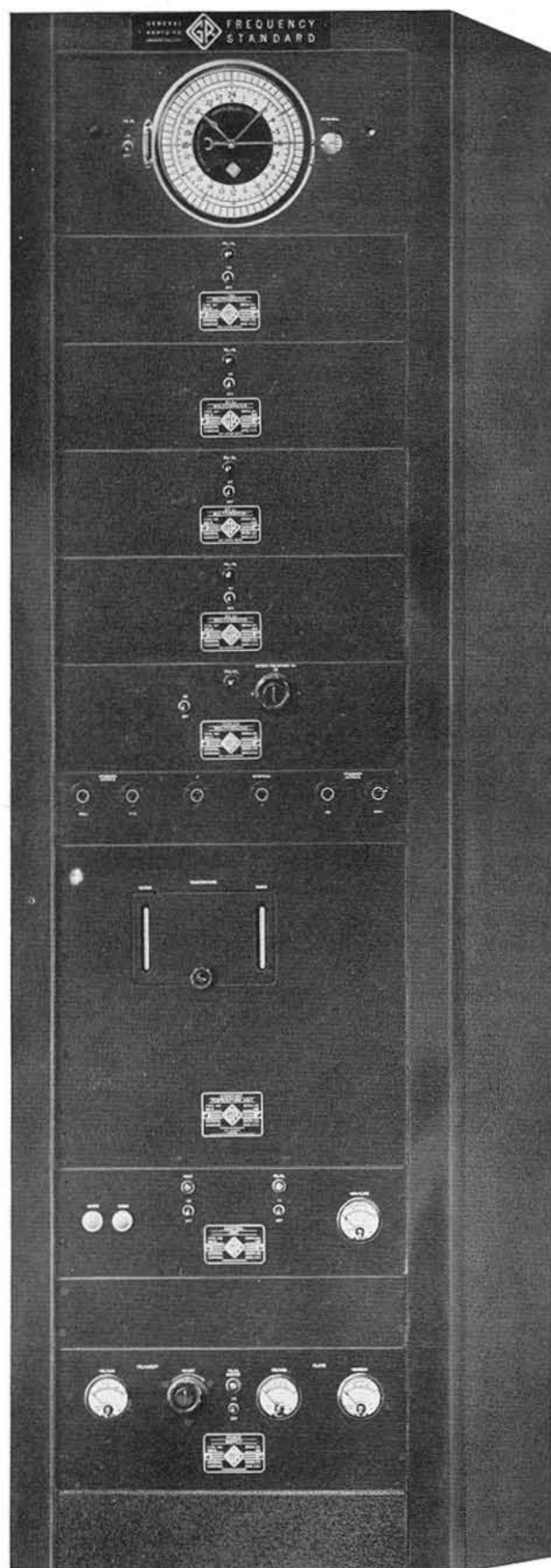

FREQUENCY-MEASURING EQUIPMENT

FOR USE WITH CLASS C-21-HLD PRIMARY FREQUENCY STANDARD

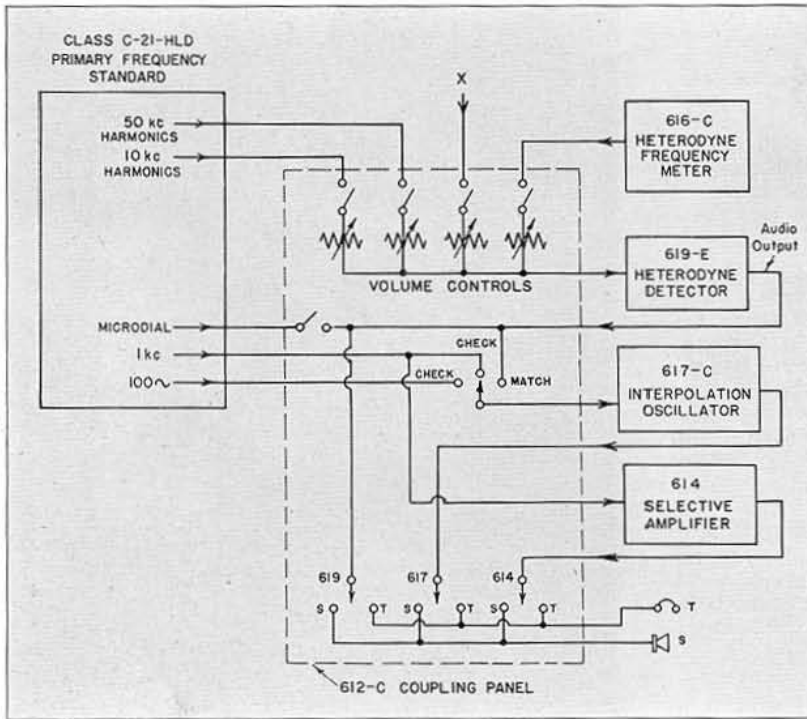

This diagram shows in functional form the operation of the frequency-measuring assembly. The TYPE 612-C Coupling Panel is the central unit from which all operations are controlled.

Both the unknown frequency, X, and a series of standard-frequency harmonics are applied through radio-frequency attenuators to the heterodyne detector. The unknown can then be measured by the direct-beating method, using the interpolation oscillator, or by the linear-interpolation method, using the heterodyne frequency meter.

Switching is provided for the standard and unknown radio-frequency circuits; for connecting the output of the detector to the interpolation oscillator and to headphones or loudspeaker; for standardizing the interpolation oscillator in terms of 1000-cycle and 100-cycle harmonics; and for controlling the operation of the selective amplifier and comparison oscilloscope. In order to keep the diagram as simple as possible, connections to the oscilloscope are not shown.

This assembly of frequency-measuring equipment, in conjunction with the primary frequency standard, makes possible the direct precision measurement of any frequency up to 25 megacycles. At frequencies above 25 megacycles, measurements can be made with almost equal ease by using harmonics of an auxiliary oscillator. Other uses include the calibration of

audio- and radio-frequency equipment in terms of the primary standard. Many frequency-monitoring stations use this equipment.

The assembly is illustrated on the opposite page. Brief descriptions of the units are given, and each instrument is more completely described on another page. Each instrument can be purchased separately, if desired.

SPECIFICATIONS

Terminals and Connections: All instruments are equipped with multipoint protected plug connectors on the rear of each unit. A complete interconnecting cable, using low-impedance shielded cable for all radio-frequency circuits, and shielded cable for all audio-frequency circuits, is furnished for making connections with the CLASS C-21-HLD Standard-Frequency Assembly.

Power Supply: 105 to 125 or 210 to 250 volts, 50 to 60 cycles. Other voltages or other frequencies on special order only.

Power Input: 100 watts with heaters of TYPE 616-D Heterodyne Frequency Meter off. Heater demand is 182 watts; average heater power is 60 watts, approximately. Average power input is 160 watts.

Accessories Supplied: Complete set of tubes, spare sets of fuses, fusible links, pilot lights. All connecting cables, including power-supply leads, and complete operating instructions.

Mounting: The complete assembly mounts in a standard 19-inch TYPE 480-M Cabinet Rack. The TYPE 480-M Rack includes power service outlets for each instrument.

Dimensions: (Height) 76 1/8 x (width) 22 x (depth) 24 1/2 inches, over-all. The total rack space is 40 rack units, or 70 inches.

Net Weight: 530 pounds, including cabinet rack.

Description	Code Word	Price
Frequency-Measuring Equipment.....	BASIC	\$2325.00

PATENT NOTICE. See Notes 1, 14, 17, page vi.

TYPE 699-A COMPARISON OSCILLOSCOPE

This unit contains a cathode-ray oscilloscope, with its power supply, 100-cycle and 1-kilocycle smoothing filters, networks for obtaining circular sweeps at these frequencies, and switching for the interconnection of units of the frequency standard and measuring equipment to the oscilloscope. Over twenty different operations in comparing the frequency of one source with that of another may be quickly carried out, without the use of any temporary connections. (See also page 138.)

TYPE 616-D HETERODYNE FREQUENCY METER

This frequency meter covers a fundamental frequency range of 100 to 5000 kc. Harmonic frequencies, or the fundamental frequency, may be utilized in measurements, through a low impedance output circuit. For quick measurements, the interpolation dial, used in conjunction with the direct-reading finder dial, will give results with sufficient accuracy for many purposes. For more accurate measurements, use is made of the interpolation oscillator. (See also page 134.)

TYPE 617-C INTERPOLATION OSCILLATOR

A direct-reading linear-scale audio-frequency oscillator covering frequencies between 0 and 5000 cycles. It is used to measure the audio-frequency difference between the unknown frequency and a standard 10-kilocycle harmonic. A mixer circuit is included to obtain maximum beat amplitude between the oscillator frequency and the frequency under measurement. (See also page 136.)

TYPE 619-E HETERODYNE DETECTOR

The heterodyne detector is used to obtain beats between standard and unknown radio frequencies. The instrument includes a tuned, regenerative detector and an audio-frequency amplifier. Low-impedance radio-frequency input circuits are provided. Plug-in coils for a range of 25 kc to 25 Mc are furnished. (See also page 140.)

TYPE 612-C COUPLING PANEL

This unit is the centralized control point at which all switching and level control, necessary for using the various combinations of the measuring equipment, may be easily and quickly carried out. (See also page 139.)

TYPE 619-P1 COIL DRAWER

Space for all coils normally supplied with the TYPE 619-E Heterodyne Detector is provided.

TYPE 614-C SELECTIVE AMPLIFIER

A regenerative selective amplifier which is employed to select any multiple of 1 kc between 1 and 10. These selected output frequencies are very useful in cases where a frequency is to be adjusted to a multiple of 1 kc, or when the cathode-ray oscilloscope is to be used in calibrating oscillators in the upper audio-frequency and low radio-frequency ranges. (See also page 141.)

LOUDSPEAKER

The permanent magnet speaker and its baffle are permanently mounted in the relay rack. A grilled opening is provided in the panel.

TYPE 480-M CABINET RACK

Power outlets are provided for all instruments in the rack.

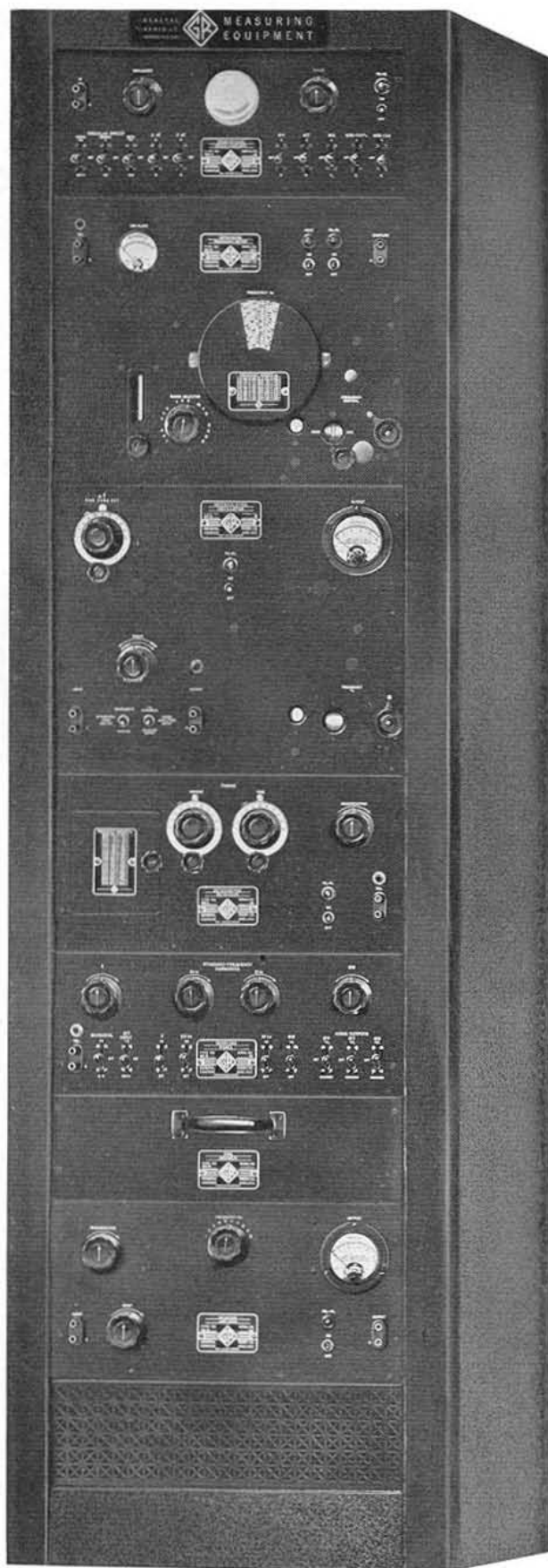

CLASS C-10-H SECONDARY FREQUENCY STANDARD

Where the extreme precision of the primary standard is not required, the less expensive secondary standard is usually quite satisfactory. It can be used as a source of standard frequencies for the laboratory or as the basic unit of a frequency-measuring assembly as shown on the next page.

The CLASS C-10-H Secondary Frequency Standard consists of the following instruments:

- TYPE 675-P Piezo-Electric Oscillator
- TYPE 676-B Quartz Bar (50 kc)
- TYPE 692-B Multivibrator (50 kc)
- TYPE 692-B Multivibrator (10 kc)

TYPE 480-B Relay Rack and Blank Panels
Terminal strip and connecting cables

This stock assembly is illustrated below. Other combinations can be assembled to meet the user's needs. For instance, a 1-kc multivibrator can be used in place of the 50-kc unit, or an additional multivibrator can be added. A primary standard can be made up by using a 1-kc multivibrator and adding a TYPE 693-B Synchronometer, although its stability would not be as good as that of the CLASS C-21-HLD Assembly. Prices on these special assemblies will be quoted on request.

SPECIFICATIONS

Output Frequency Range: When the TYPE 619-E Heterodyne Detector is used for detecting and utilizing the standard-frequency harmonics, the output frequency ranges of the multivibrator are:

- 10 kc and its harmonics up to 10 Mc
- 50 kc and its harmonics up to 25 Mc

If a suitable high-frequency receiver is used to detect them, 50-kc harmonics up to 50 megacycles can be utilized directly. For work at higher frequencies, harmonics of an auxiliary oscillator, whose fundamental is monitored against the standard at a lower frequency, can be used.

Output Amplitude: 0.3 volt, rms, across a 65-Ω load.

Accuracy: Before shipment, the frequency of the piezo-

electric oscillator is adjusted within ±1 part in 1,000,000 of its specified frequency. Slight changes in frequency may occur during shipment. The frequency is, therefore, guaranteed to ±20 parts per million. Means for adjusting the frequency are provided, and the frequency can be brought into agreement with standard-frequency transmissions such as those of the U. S. Bureau of Standards. Periodic checks against these transmissions make it possible to maintain the frequency to an accuracy of 1 part in 1,000,000 over long periods of time.

Quartz Bar: The TYPE 676-B Quartz Bar is supplied to operate at 50 kc.

(Continued on next page)

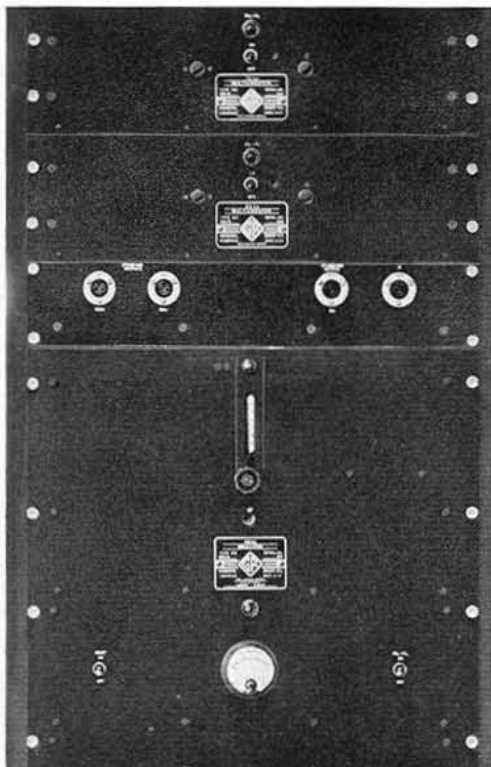

COMPONENT UNITS

TYPE 692-B MULTIVIBRATORS

Two multivibrators are supplied with the secondary frequency standard, one operating at 10 kc, the other at 50 kc. (See also page 133.)

TERMINAL STRIP AND CABLE

Complete shielded interconnecting cables are supplied and the multivibrator outputs are brought out to shielded plugs on the terminal strip.

TYPE 675-P PIEZO-ELECTRIC OSCILLATOR
TYPE 676-B QUARTZ BAR

This piezo-electric oscillator, like the TYPE 690 Unit used in the primary standard, is especially designed for use as a low-frequency standard. The TYPE 676-B Quartz Bar is identical with that used in the primary standard. Since the accuracy requirements for the secondary standard are less severe, only one stage of temperature control is provided. The power supply furnishes power for operating the multivibrators and is capable of supplying a maximum of three such units.

TYPE 480-B RELAY RACK

The units of the secondary standard are mounted on an open bench-type relay rack which is supplied with the equipment.

Temperature Control: A single-stage temperature-control unit is provided, at 60° Centigrade. Control of the temperature of the inner space is maintained within 0.1° Centigrade for ambient temperature changes of ± 20° Centigrade from a normal of 25° Centigrade. The frequency changes by 0.2 part per million for a change of 0.1° Centigrade.

Power Supply: 105 to 125 or 210 to 250 volts, 50 to 60 cycles. Other voltages or other frequencies on special order only. The power supply of the TYPE 675-P Piezo-Electric Oscillator will furnish power to a maximum of three TYPE 692-B Multivibrators.

Power Input: Demand, 175 watts; average, 115 watts.

Terminals and Connections: All interconnecting cables are supplied, and the output is available at shielded plug connections on the terminal panel.

Vacuum Tubes: The following tubes are required and are furnished:

- 1—type 6AC7
- 1—type 6SN7-GT
- 1—type 6H6-GT
- 1—type 5V4-G
- 12—type 6J5-G
- 1—6w 115v Mazda

Accessories Supplied: Complete set of tubes, spare sets of fuses, fusible links, pilot lights. All connecting cables, including power-supply leads, and complete operating instructions.

Mounting: TYPE 480-B Relay Rack is supplied.

Dimensions: (Height) 44 x (width) 20 x (depth) 15 inches, over-all.

Net Weight: 125 pounds.

Class	Description	Code Word	Price
C-10-H	Secondary Frequency Standard	EPOCH	\$795.00

PATENT NOTICE. See Notes 1, 8, 12, 19, 27, 29, page vi.

CLASS C-10-H SECONDARY FREQUENCY STANDARD WITH FREQUENCY-MEASURING EQUIPMENT

The secondary frequency standard combined with suitable interpolation equipment is available as a stock assembly. While not as flexible or as accurate as the primary standard and measuring equipment described on pages 126 to 129, it is adequate for most purposes and is widely used by communication companies, universities, military services, and laboratories.

DESCRIPTION: In addition to the CLASS C-10-H Secondary Frequency Standard the assembly includes a TYPE 616-D Heterodyne

Frequency Meter, a TYPE 619-E Heterodyne Detector, and a TYPE 612-K Coupling Panel. The equipment is mounted on an open relay rack as shown on page 132. Other units, such as the TYPE 617-C Interpolation Oscillator, can be added, if desired, and provision for switching this instrument is made in the coupling panel. Frequencies up to 25 megacycles can be measured directly by the linear interpolation method. Through the use of heterodyne methods higher frequencies are easily measured.

Functional diagram of the frequency-measuring assembly. All switching and amplitude adjustment is accomplished by means of the TYPE 612-K Coupling Panel.

The unknown and standard frequencies are applied through attenuators to the heterodyne detector. The unknown is then measured by linear interpolation, using the heterodyne frequency meter.

The interpolation oscillator (shown by broken lines) is not included with this assembly. It can be ordered separately or added later, if desired. Provision for using it is made in the TYPE 612-K Coupling Panel as shown.

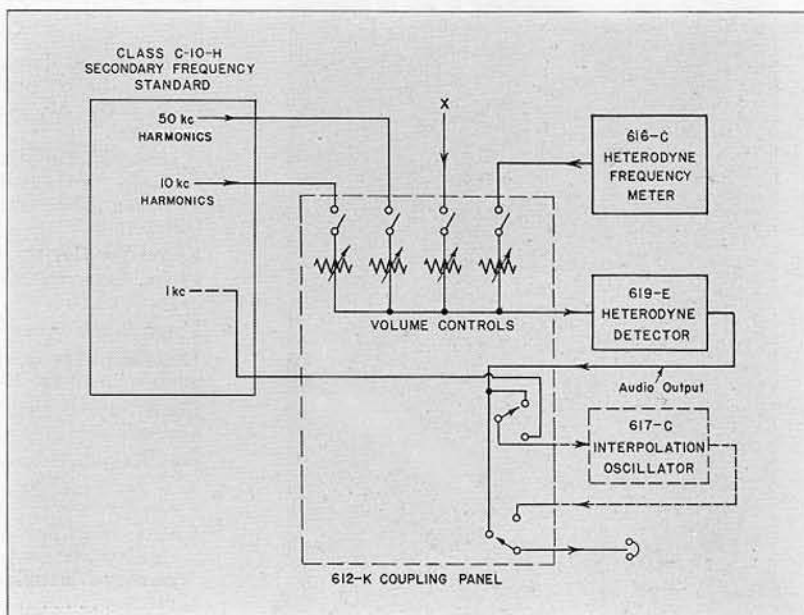

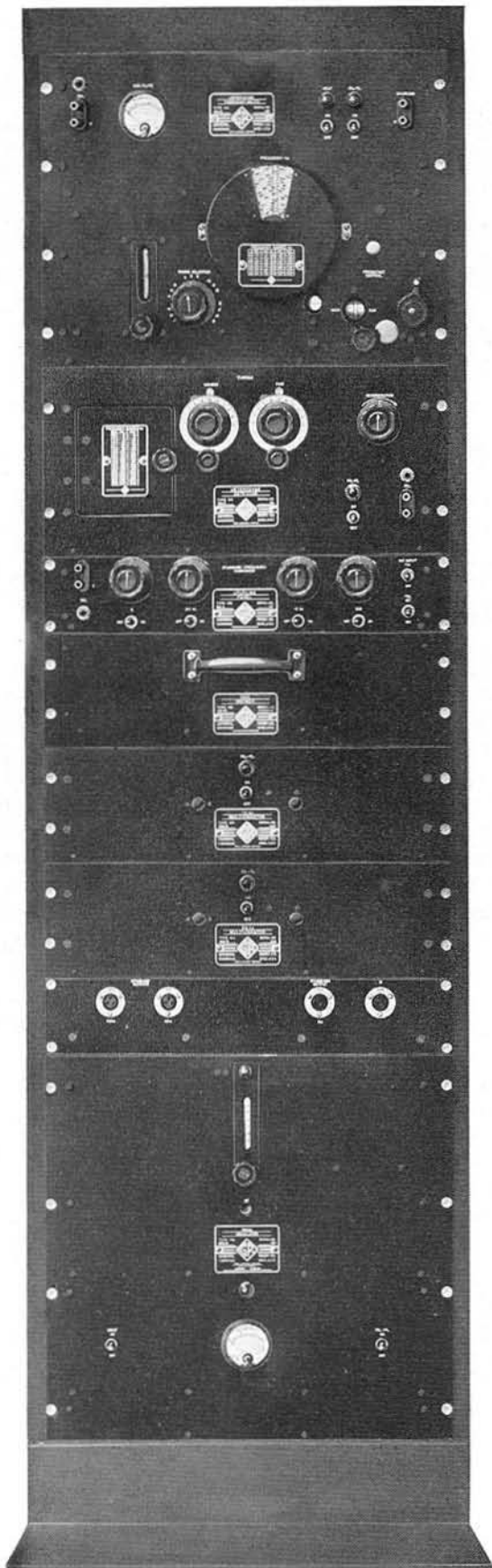

TYPE 616-D HETERODYNE FREQUENCY METER

The heterodyne frequency meter is used to measure unknown frequencies in terms of standard-frequency harmonics by the linear-interpolation method. (See page 124.) This instrument is completely described on page 134.

TYPE 619-E HETERODYNE DETECTOR

Beats and zero-beat settings between the heterodyne frequency meter and a standard or unknown frequency are obtained in the heterodyne detector. (See page 140 for a complete description.)

TYPE 612-K COUPLING PANEL

This is a simplified form of the TYPE 612-C Coupling Panel used with the assembly described on page 129. All amplitude control and switching necessary in making frequency measurements are accomplished here. (See page 139 for description.)

TYPE 619-P1 COIL DRAWER

This drawer for storing the heterodyne detector coils is supplied as an accessory with the heterodyne detector.

TYPE 692-B MULTIVIBRATORS

Two multivibrators are supplied with the secondary frequency standard, one operating at 10 kc, the other at 50 kc. (See also page 133.)

TERMINAL STRIP AND CABLE

Complete shielded interconnecting cables are supplied and the multivibrator outputs are brought out to shielded plugs on the terminal strip.

TYPE 675-P PIEZO-ELECTRIC OSCILLATOR

TYPE 676-B QUARTZ BAR

This piezo-electric oscillator, like the TYPE 690 Unit used in the primary standard, is especially designed for use as a low-frequency standard. The TYPE 676-B Quartz Bar is identical with that used in the primary standard. Since the accuracy requirements for the secondary standard are less severe, only one stage of temperature control is provided. The power supply furnishes power for operating the multivibrators and is capable of supplying a maximum of three such units.

TYPE 480-A RELAY RACK

The CLASS C-10-H Secondary Frequency Standard, when sold as a single unit, is mounted on an open bench-type relay rack. The secondary standard and measuring equipment shown here uses an open floor-type rack.

SPECIFICATIONS

Terminals and Connections: All instruments are equipped with multipoint protected plug connectors on the rear of each unit. All necessary interconnecting cables are furnished.

Accessories Supplied: Complete set of tubes, spare sets of fuses, fusible links, pilot lights. All connecting cables, including power-supply leads, and complete operating instructions.

Power Supply: 105 to 125 or 210 to 250 volts, 50 to 60 cycles. Other voltages or other frequencies on special order only.

Power Input: Demand, 375 watts; average, 200 watts.

Mounting: The complete assembly mounts in a standard 19-inch TYPE 480-A Relay Rack, which is supplied.

Dimensions: (Height) 69 1/8 x (width) 20 x (depth) 18 inches, over-all.

Net Weight: 340 pounds.

Description	Code Word	Price
Class C-10-H Secondary Frequency Standard with Frequency-Measuring Equipment.....	BAYAN	\$1920.00

PATENT NOTICE. See Notes 1, 8, 12, 14, 17, 19, 27, 29. page vi.

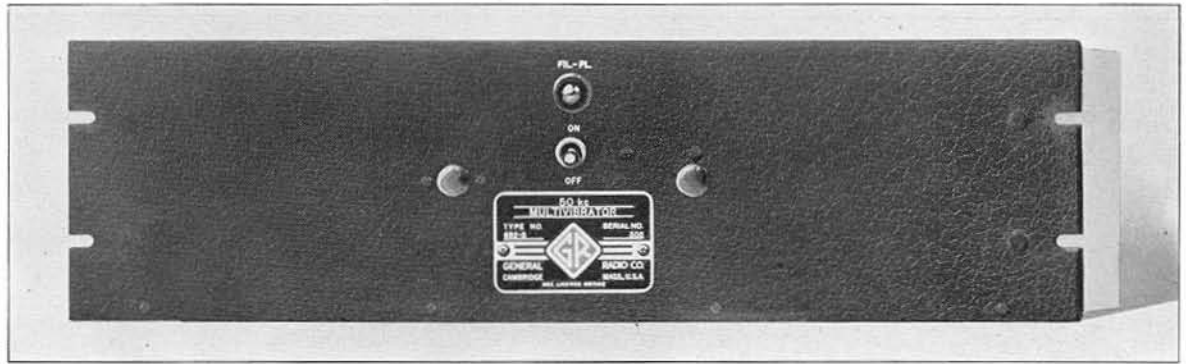

TYPE 692-B MULTIVIBRATOR

USES: These multivibrators are designed for use as frequency dividers and multipliers in General Radio standard-frequency assemblies. They are also available for general laboratory or experimental use.

DESCRIPTION: Each multivibrator includes an input amplifier, a two-tube multivibrator, and two output amplifiers. Protected screwdriver adjustments provide for regulation of the control voltage input and for adjustment of the

fundamental frequency over a limited range.

The frequency adjustment permits the uncontrolled frequency to be set exactly to the desired controlled value, leading to greatest reliability of control over long periods of time.

One output amplifier is provided for the control of succeeding multivibrators, where a number of stages of frequency division are desired. The other output amplifier is intended for use on the harmonic frequencies of the multivibrator.

TYPE 698-A DUPLEX MULTIVIBRATOR

The TYPE 698-A Duplex Multivibrator is a special-purpose unit intended for use in standard-frequency assemblies to avoid measurements very near zero beat on multiples of 10 kc (as in the broadcast band). The multivibrator operates at either 9 or 11 kc controlled by selected harmonics of the 10 kc standard

output, either frequency being selected by a switch. If a frequency lies very close to a multiple of 10 kc, giving a very low beat frequency, the beat will generally be very close to 1 kc, or to a multiple of 1 kc, when referred to a harmonic of 9 or 11 kc from the duplex multivibrator.

SPECIFICATIONS FOR TYPE 692-B AND TYPE 698-A

Frequency: Standard models are available for operation at the frequencies listed below. Multivibrators for operation at other frequencies can be supplied on special order.

Output Impedance: Approximately 65 ohms for fundamental frequencies of 5 kc and higher; approximately 10,000 ohms for fundamental frequencies below 5 kc.

Vacuum Tubes: Five type 6J5-G tubes are supplied with TYPE 692-B; four 6J5-G tubes with TYPE 698-A.

Power Supply: 6.3 volts ac or dc, for cathode heaters; 180 volts for plates. Power supply is not incorporated in instruments. Spare fuses and pilot lamps are supplied.

Terminals: All external connections are made through multipoint enclosed connectors.

Mounting: Standard 19-inch relay rack.

Dimensions: Panel, (length) 19 x (height) 5 1/4 inches; behind panel, (length) 17 3/8 x (height) 5 x (depth) 10 3/4 inches.

Weight: TYPE 692-B Multivibrators, 16 1/2 pounds; TYPE 698-A Duplex Multivibrator, 17 3/4 pounds.

Schematic circuit diagram of a TYPE 692-B Multivibrator. The circuit of TYPE 698-A Duplex Multivibrator is the same in principle, but switching is provided for operating on either of two frequencies.

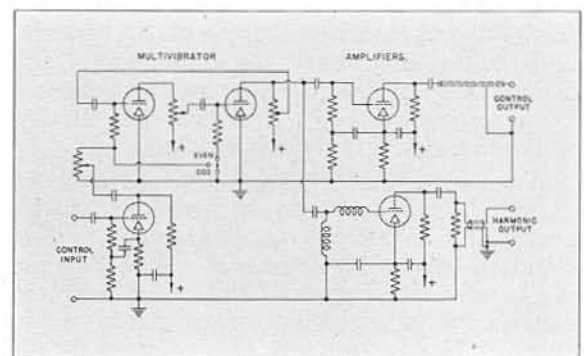

Type	Frequency	Code Word	Price
692-B	100 cycles	STANFREAPE	\$140.00
692-B	1 kc	STANFREANT	140.00
692-B	10 kc	STANFREBOY	140.00
692-B	50 kc	STANFRECAT	140.00
698-A	9 or 11 kc	STANFREFIB	220.00

PATENT NOTICE. See Note 1, page v.

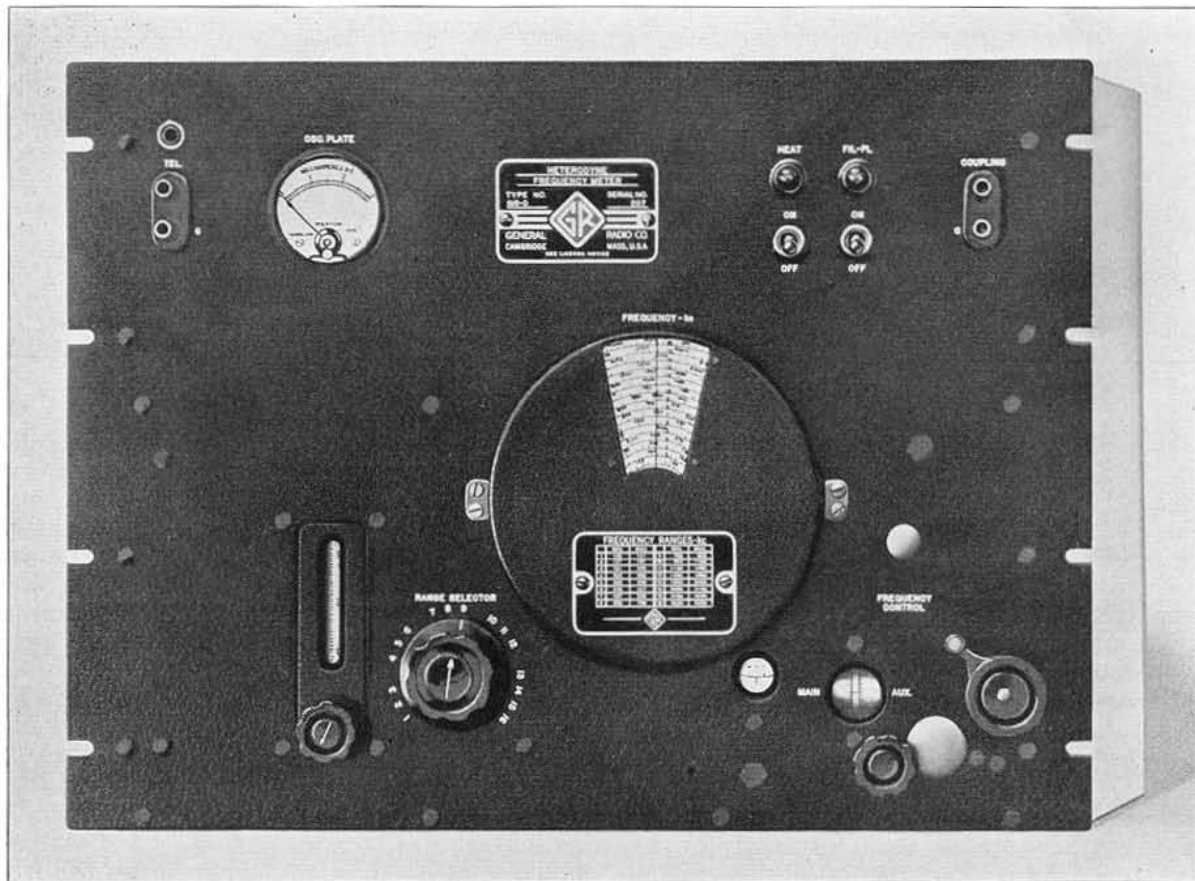

TYPE 616-D HETERODYNE FREQUENCY METER

USES: The TYPE 616-D Heterodyne Frequency Meter may be used either as a calibrated frequency meter or as an interpolation device for use with an harmonic frequency standard.

A detector and audio-frequency amplifier are included so that, when the instrument is used as a calibrated frequency meter, beats can be obtained between its oscillator frequency and the frequency under measurement. Frequencies both below and above the fundamental frequency range of 100 to 5000 kc may be measured by harmonic methods, provided only that a reasonable signal voltage is available.

When used in conjunction with a frequency standard, the heterodyne frequency meter provides a means of rapid identification of standard-frequency harmonics and harmonics of the frequency meter itself which may be used in the measurement of an unknown frequency. The instrument also is used in the measurement of high frequencies, as a "stepping stone," to pass from the frequency range where direct beating of the unknown against the frequency standard may be accomplished into the higher frequency ranges where such direct beating is not feasible.

In either the fundamental or harmonic

ranges, the heterodyne frequency meter provides a means of linear interpolation between standard frequencies for the measurement of an unknown frequency.

DESCRIPTION: The instrument contains a very stable temperature-controlled radio-frequency oscillator with tube-controlled plate voltage supply. A detector and audio-frequency amplifier are provided for listening for heterodyne beats between the frequency being measured and that of the oscillator.

The oscillator tuned circuit includes a heavy cast-frame, straight-line-frequency variable condenser with precision worm drive. Spring-pressed ball bearings are used, which maintain the condenser adjustment, with practically no backlash, over long periods of time.

The direct-reading finder dial is nearly 6 inches in diameter and carries a separate scale for each of the sixteen ranges of the instrument. The dial is driven through spring pressed gearing directly from the main condenser shaft. Nearly 360-degree rotation of the dial is utilized. Since the variation in frequency is very closely linear with dial rotation, each scale is essentially uniformly divided and can be easily read.

FEATURES: Temperature control, a ruggedly constructed precision condenser, low-loss inductances, and stabilized plate voltage make this instrument an accurate and stable frequency meter.

The direct-reading finder dial is very useful for obtaining a quick approximation to the frequency measured, for presetting the instrument to a desired frequency, or for identifying harmonics of the heterodyne frequency meter which may be used in making the measurement.

When the heterodyne frequency meter is used with a harmonic frequency standard, the finder dial makes possible the rapid identification of standard-frequency harmonics without reference to calibration charts. Direct inter-

polation (see page 124) is, of course, always possible using the readings of the main scale. As a convenience, an auxiliary dial is provided which makes possible interpolation without the need of taking differences of dial readings, as must be done when the main scale is used. By means of a panel control the auxiliary dial may be set to zero at a known standard frequency; when the heterodyne frequency meter is set to the unknown frequency one reading is obtained; when set to the next higher standard frequency a second reading is obtained. The ratio of these two readings gives the fractional part of the standard-frequency interval that the unknown frequency is above the lower standard frequency.

SPECIFICATIONS

Frequency Range: The fundamental frequency range is from 100 to 5000 kc, covered in 16 bands. The harmonic output may be utilized in suitable receivers up to 30 megacycles or more.

Calibration: The direct-reading finder dial provides a calibration at approximately 700 points throughout the range, at frequency intervals varying from 1 kc at the low frequencies to 10 kc at the high frequencies. Adjustment is provided to correct the principal part of any error resulting from long-time drift of the calibration.

Calibration Chart: A list of settings of the *main condenser scale* for 10 or more frequencies in each range will be supplied if desired. This list is supplied *on order only* and a charge for it is made. (See price list.)

Accuracy: When used with a frequency standard, accuracy sufficient for positive identification of standard-frequency harmonics is all that is required. This is provided by the direct-reading finder dial. The calibration chart data can be relied upon to 0.1%.

Frequency Stability: Tube stabilization of plate voltage to the oscillator tube prevents frequency changes due to supply voltage changes from exceeding 0.5 part per million for plus or minus 10% change in supply line voltage.

Output: Two coupling systems are provided. One, high-impedance capacity coupling to the detector for listening for beats in the heterodyne frequency meter itself, is provided with terminals on the front panel. The second is a

low-impedance shielded output, 65 ohms approximately, connected to terminals at the rear for permanent cable connection in frequency-measuring assemblies. Harmonics of the oscillator frequency may easily be used up to 30 megacycles or more.

Power Supply: 105 to 125 or 210 to 250 volts, at 50 to 60 cycles. Other voltages and frequencies on special order only

Power Input: Approximately 20 watts, heaters off; 200 watts, heaters on. Heaters operate approximately 20% of the time at normal room temperatures. Total average power input 60 watts.

Meters: Oscillator plate current.

Tubes: Supplied with instrument:

- 1—type 6J7-G
- 2—type 6J5-G
- 1—type 6X5-G
- 1—type VR-105-30
- 1—type 4A1

Accessories Supplied: Spare pilot lamps, fuses, fusible links, a seven-foot line connector cord.

Controls: Tube supply ON-OFF switch; heater supply ON-OFF switch; range selector; frequency control.

Mounting: Standard 19-inch relay-rack mounting. Can be supplied in walnut or oak cabinet on special order.

Dimensions: Panel, (length) 19 x (height) 14 inches; behind panel, (length) 17 1/4 x (height) 13 5/8 x (depth) 11 3/4 inches.

Net Weight: 69 pounds.

Type	Code Word	Price
616-D Heterodyne Frequency Meter	MANOR CHART	\$575.00
*Calibration Chart		20.00

*Calibrations supplied only when ordered. Use compound code word, MANORCHART.
 PATENT NOTICE. See Notes 1, 14, page vi.

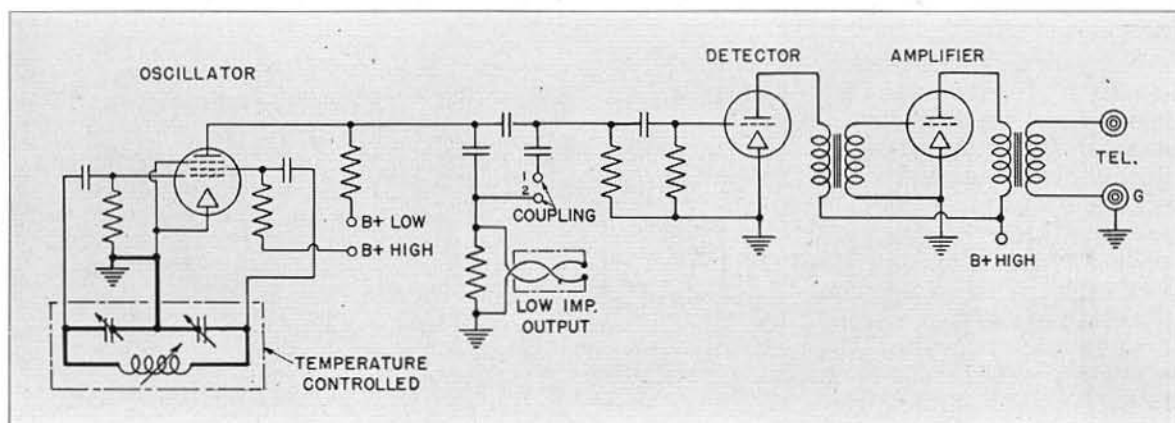

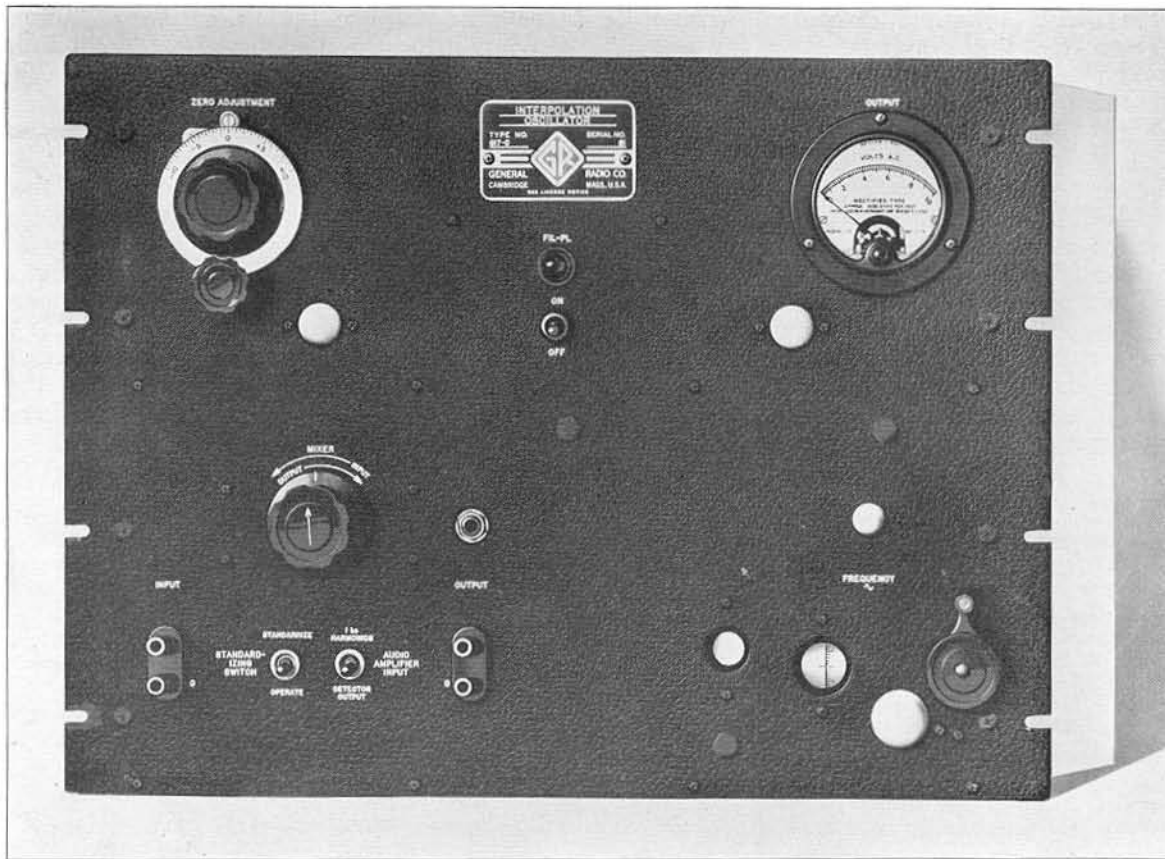

TYPE 617-C INTERPOLATION OSCILLATOR

USES: The principal use of the TYPE 617-C Interpolation Oscillator is, in connection with a frequency standard, to measure the difference between the unknown frequency and a standard harmonic. The direct-reading linear scale of 5000 divisions for 5000 cycles makes possible the rapid evaluation of this difference with a high accuracy.

DESCRIPTION: The oscillator is of the beat-frequency type, with the radio-frequency oscillators operating in the region of 43 to 48 kc. A

vacuum-tube regulator is employed in the plate supply of the oscillators and detector, by means of which changes in output frequency and amplitude due to changes in supply line voltage are made negligibly small.

The variable-frequency oscillator is controlled by a precision condenser. The inductors are wound on ceramic forms and have low losses and a low temperature coefficient of inductance. Each inductor is enclosed in a balsa-wood box which reduces the effect of changes in ambient temperature.

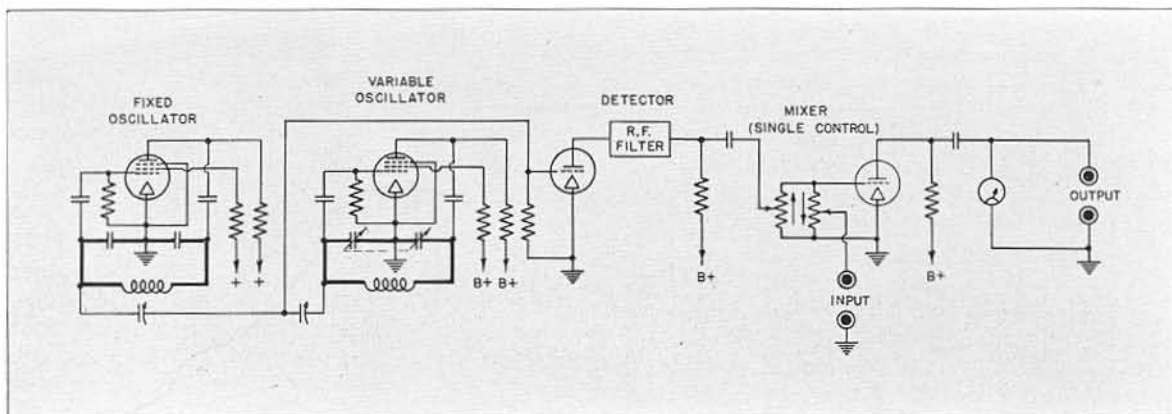

The instrument contains an output meter on which the beats between an unknown and the oscillator frequency may be observed. Telephone connections are also provided so that the beat may be observed visually, or aurally, or both.

The direct-reading incremental dial makes it possible to evaluate very small frequency differences, of a fraction of a cycle to a few cycles. This is particularly useful in measuring broadcasting stations, whose frequencies lie close to the 10-kc harmonics supplied by the CLASS C-21-HLD Primary Frequency Standard.

Means are also provided so that the output meter may be used as a beat meter in matching a given audio frequency to multiples of 1 kc (obtained from a frequency standard). For example, in adjusting piezo-electric crystals to

integral multiples of 1 kc, the beat meter indicates the frequency difference between the crystal oscillator being adjusted and the frequency standard.

A mixer control is included for adjusting the relative amplitudes of two beating frequencies in order to secure the maximum beat amplitude.

FEATURES: Stability of the output frequency was one of the design requirements of this oscillator. The use of low-temperature-coefficient materials in the tuned circuits, heat insulation to reduce differential temperature effects, a cast-frame variable air condenser, and a voltage-stabilized power supply have made possible a high degree of stability.

The linear scale, the beat indicator, and the various switching and mixing controls make this oscillator a valuable and convenient unit in a frequency-measuring system.

SPECIFICATIONS

Frequency Range: 0 to 5000 cycles per second.

Accuracy: The instrument is aligned to agree with the linear direct-reading scale within ± 2 cycles. A correction chart is furnished giving the deviations at 100-cycle intervals throughout the range.

The condenser is provided with a precision worm drive so that very precise frequency settings can be made. Small residual errors are easily and quickly removed in the region of any frequency in the range by fine adjustment of the zero by reference to a frequency standard having a 1-kc or 100-cycle multivibrator, or both. For evaluating very small frequency differences, a direct-reading frequency-increment dial is provided.

Output: The output voltage is approximately 7 volts across a 20,000-ohm load.

Power Supply: 105 to 125 or 210 to 250 volts, 50 to 60 cycles. A change of transformer connections provides for using 115 or 230-volt service. Other voltages or frequencies on special order only.

Power Input: 20 watts, approximately.

Controls: ON-OFF switch; STANDARDIZE switch; AMPLIFIER-INPUT switch; MIXER control, which operates also as oscillator output control; incremental frequency control and zero set; oscillator frequency control.

Meters: Output voltmeter; used also as a beat-indicator meter.

Terminals: Terminals, both on panel and at rear, are provided for both mixer input and oscillator output. Rear terminals are provided for introducing 1-kc standard frequency and its harmonics when the beat-indicator is to be used for adjusting a frequency to exact multiples of 1 kc.

Tubes: Furnished with instrument:
 2—type 6J7-G R. F. Oscillators
 2—type 6J5-G Detector; Amplifier
 1—type 6X5-G Rectifier
 1—type VR-105-30 Voltage Regulator

Accessories Supplied:
 Pilot Light
 Dial Light } with spares
 Fuses
 Line Attachment Cord
 1—Multipoint Connector

Mounting: Standard 19-inch relay-rack mounting. Can be supplied in walnut or oak cabinet on special order.

Dimensions: Panel, (length) 19 x (height) 14 inches; behind panel, (length) 17 1/4 x (height) 13 5/8 x (depth) 11 3/4 inches.

Net Weight: 58 pounds.

Type	Code Word	Price
617-C Interpolation Oscillator	MAPLE	\$500.00

PATENT NOTICE. See Notes 1, 17, page vi.

REPLACEMENT THERMOSTATS AND THERMOMETERS

Replacement thermostats and thermometers can be supplied for all temperature-controlled instruments listed in this catalog. Type numbers and prices are given in the following table.

Instrument Type No.	Thermometer			Thermostat		
	Type No.	Temperature Range	Price	Type No.	Operating* Temperature	Price
475-C	TH-509	57°-63° C.	\$4.00	TH-503	60° C.	\$22.00
675-P	TH-509	57°-63° C.	4.00	TH-503	60° C.	22.00
691-C (Inner)	TH-489	56°-64° C.	4.00	TH-503	60° C.	22.00
691-C (Outer)	TH-481	40°-60° C.	4.00	TH-503	55° C.	22.00
616-D	TH-181	40°-60° C.	4.00	TH-503	50° C.	22.00

*Always specify operating temperature when ordering.

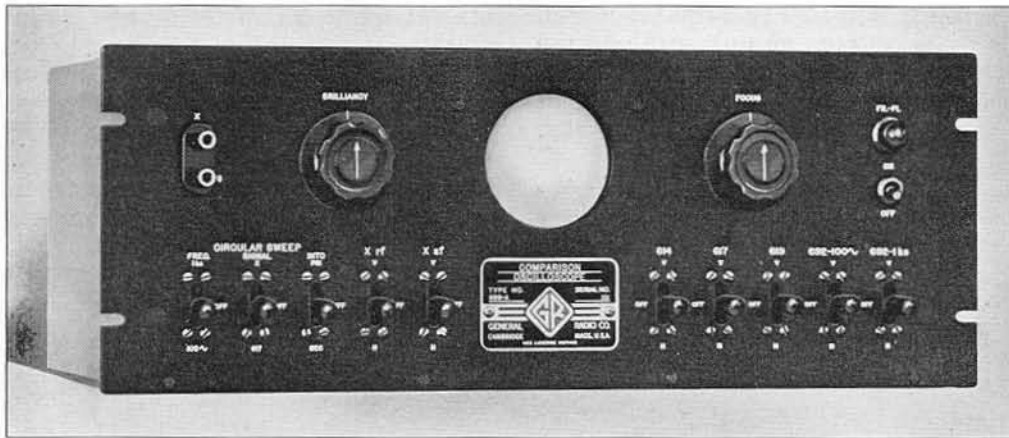

TYPE 699-A COMPARISON OSCILLOSCOPE

USES: This instrument is intended for use with a CLASS C-21-HLD Primary Frequency Standard and interpolation equipment as an aid in making interpolations with high accuracy, in calibrating the interpolation equipment in terms of the standard, and in calibrating or measuring the frequencies of audio-frequency or low radio-frequency oscillators external to the frequency-measuring assembly.

DESCRIPTION: The TYPE 699-A Comparison Oscilloscope contains a 3-inch cathode-ray tube, with its power supply. Filters are supplied for smoothing the 100-cycle and 1-kilocycle outputs of the CLASS C-21-H Primary Frequency Standard, so that sharply defined patterns may be obtained. Circular sweep circuits are provided for both 100- and 1000-cycle operation.

Ten key-type switches are provided for selection of the type of pattern to be observed and the sources whose frequencies are to be compared. Over twenty different comparisons are easily and quickly carried out by simple settings of these switches. While a full list of all

the possible operations cannot be given here, it may be said that comparisons for calibration or measurements can be made between any pair of the following sources: external source, selective amplifier, interpolation oscillator, heterodyne detector, 100-cycle standard frequency, and 1000-cycle standard frequency.

FEATURES: Shielded cabling; all external connections to the various sources are made through shielded cable, supplied as part of the frequency-measuring equipment, page 128.

Built-in power supply; brilliancy and focusing adjustments for cathode-ray tube.

Key-type switches for setting up all required circuit arrangements. No temporary connections are needed except those to an external source for measurement.

The circular sweep circuits for standard frequencies of 100 and 1000 cycles result in very simple and easily interpreted patterns, particularly when the frequency being measured or checked is a rather high multiple of the standard frequency. The usual Lissajous figures may also be obtained.

SPECIFICATIONS

Frequency Range: Useful patterns may be obtained over the range from very low audio frequencies to radio frequencies of the order of 50 kc, or more, dependent upon the voltage available from the source being calibrated or measured.

Controls: ON-OFF switch; BRILLIANCY and FOCUS adjustments for cathode-ray tube; ten key-type circuit selecting switches.

Terminals: All interconnections to other units of the frequency standard and measuring equipment are made through protected multipoint connectors at rear of instrument. Connections to an external source are made through panel terminals on the front of the instrument.

Power Supply: 105 to 125 or 210 to 250 volts, 50 to 60

cycles. Other voltages or other frequencies on special order only.

Power Input: 13 watts, approximately.

Tubes Supplied:

- 1—type 906 three-inch Cathode-Ray Tube
- 1—type 2X2/879 Rectifier

Accessories Supplied: All vacuum tubes, spare pilot lamps and fuses, seven-foot line connector cord, and two multipoint connectors.

Mounting: Standard 19-inch relay rack.

Dimensions: Panel, (length) 19 x (height) 7 inches; behind panel, (depth) 16 3/4 inches.

Net Weight: 41 1/2 pounds.

Type	Code Word	Price
699-A	ODIUM	\$215.00

PATENT NOTICE. See Note 1, page vi.

*Available only with complete frequency measuring assembly described on page 128.

TYPE 612-C COUPLING PANEL

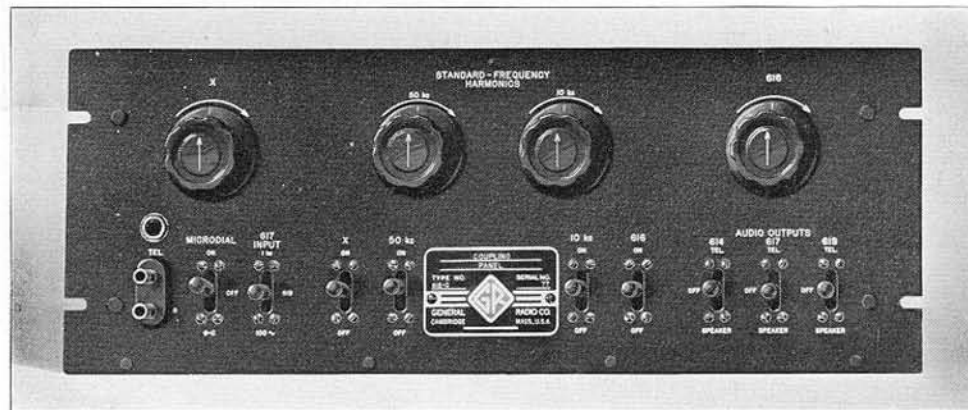

USES: This coupling panel is designed specifically for use as a centralized control panel in a frequency-measuring equipment employing a primary frequency standard, as described on pages 127 and 128. The panel carries the necessary switches and volume controls for transferring frequencies from one unit to another in the assembly, and for mixing frequencies to obtain the beat-frequency difference in the output of the heterodyne detector.

DESCRIPTION: The instrument includes four low-impedance shielded L-type attenuators, or volume controls, for the four radio-frequency circuits involved in measuring frequencies: (1) the unknown, or "X", frequency; (2) 50-kc harmonics from the frequency standard; (3) 10-kc harmonics from the frequency standard, and (4) the output of the heterodyne frequency meter. These controls, in general, are operated to regulate the amplitudes of the voltages, from two of the above sources, fed to the heterodyne detector.

The windings are Ayrton-Perry. When used

with the shielded interconnecting cables designed for the measuring equipment, very satisfactory freedom from cross-talk is obtained.

Anti-capacity key-type ON-OFF switches are provided with each volume control, so that the corresponding signals may be removed from the detector without the necessity of turning the volume control back to zero.

SPECIFICATIONS

Terminals: All connections to the various instruments comprising the measuring equipment used with a primary frequency standard (see page 126) are made through multipoint protected connectors mounted at the rear of the instrument. Telephone terminals and jack are brought out on the panel.

Mounting: Standard 19-inch relay-rack mounting. The instrument is fitted with dust cover.

Dimensions: Panel, (length) 19 x (height) 7 inches; behind panel, (length) 17 1/4 x (height) 6 3/4 x (depth) 12 3/4 inches.

Net Weight: 24 3/4 pounds.

Type	Code Word	Price
612-C* Coupling Panel	occur	\$190.00

*Available only with complete assembly described on page 128.

TYPE 612-K COUPLING PANEL

USES: This coupling panel is a smaller and somewhat simplified unit for use with a secondary frequency standard. All necessary switches and volume controls for complete and flexible operation of the units of the assembly are provided.

DESCRIPTION: The instrument includes four low-impedance, shielded attenuators, or volume controls, for the four radio-frequency circuits: (1) the unknown, or "X", frequency; (2) 50-kc harmonic series from the secondary standard; (3) 10-kc harmonic series from the standard, and (4) the output of the heterodyne frequency meter. Provision is made on the coupling panel for the addition of a TYPE 617-C Interpolation Oscillator, with switching provided both for checking of the oscillator against a standard

1-kc source and for matching the beat-frequency difference appearing in the heterodyne detector output.

SPECIFICATIONS

Terminals: All connections to the various instruments comprising the secondary standard and measuring equipment (see page 132) are made through multipoint protected connectors mounted at the rear of the instrument. Telephone terminals and jack are provided on the panel.

Mounting: Standard 19-inch relay-rack mounting. The instrument is supplied with a dust cover.

Dimensions: Panel, (length) 19 x (height) 3 1/2 inches; behind panel, (length) 17 1/4 x (height) 3 1/4 x (depth) 7 3/4 inches.

Net Weight: 8 3/4 pounds.

Type	Code Word	Price
612-K† Coupling Panel	offer	\$125.00

†Available only with complete assembly described on page 132.

TYPE 619-E HETERODYNE DETECTOR

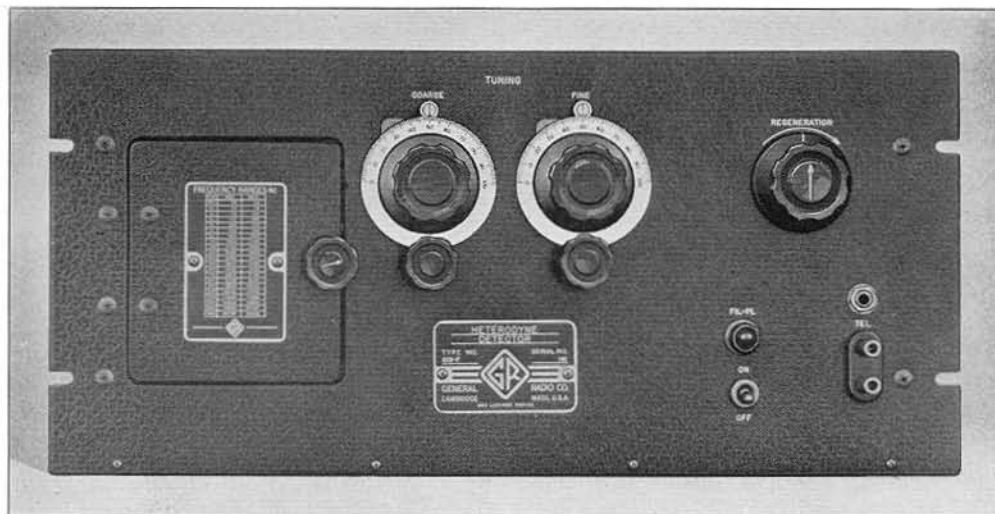

USES: This heterodyne detector is designed primarily for use with a frequency standard and frequency-measuring equipment for obtaining the beat-frequency difference between standard and unknown frequencies. It can also be used as a detector in conjunction with a radio-frequency bridge.

DESCRIPTION: The instrument contains a regenerative detector and two stages of audio-frequency amplification. A regeneration control is provided so that the detector may be operated either oscillating or non-oscillating, as the conditions of use require.

Plug-in coils are used, and a complete set is

supplied with the instrument. A relay-rack-size drawer (TYPE 619-P1) for holding the coils is also supplied.

FEATURES: Some of the features of this instrument are high sensitivity, wide frequency range, and low-impedance radio-frequency input.

The tuned circuit for the regenerative detector is provided with an auxiliary fine-tuning condenser. The detector plate voltage is stabilized, which contributes to the frequency stability. Regeneration is controlled by adjusting the screen voltage, a noise filter giving smooth and quiet control.

SPECIFICATIONS

Frequency Range: A frequency range of 25 kc to 25 Mc is covered by the 21 coils supplied with the instrument. Two tuning condensers, on the same shaft, are used. The condenser in use is automatically selected by the coil plugged into the circuit, for the low- and high-frequency ranges.

R-F Input Impedance: 65 ohms, approximately.

Calibration: A frequency calibration is supplied. While this calibration is accurately determined, it is not guaranteed, as the instrument is not intended for use as a calibrated-frequency measuring device. The calibration is useful in making approximate settings, identifying standard-frequency harmonics, etc.

Power Supply: 105 to 125 or 210 to 250 volts, 50 to 60 cycles. Transformer connections changed for 115- or 230-volt supply. Other frequencies or voltages on special order only. The power input is 25 watts, approximately.

Tubes: Supplied with instrument:

- 1—type 6J7-G Detector
- 2—type 6J5-G Amplifiers
- 1—type 6X5-G Rectifier
- 1—type VR-105-30 Voltage Regulator

Accessories Supplied:

- Pilot Light } with spares
- Fuses } with spares
- 1—Line Attachment Cord
- 1—Multipoint Connector
- 21—Plug-in Coils
- 1—TYPE 619-P1 Coil Drawer
- 3—Calibration Charts

Controls: ON-OFF switch; coarse and fine tuning; regeneration.

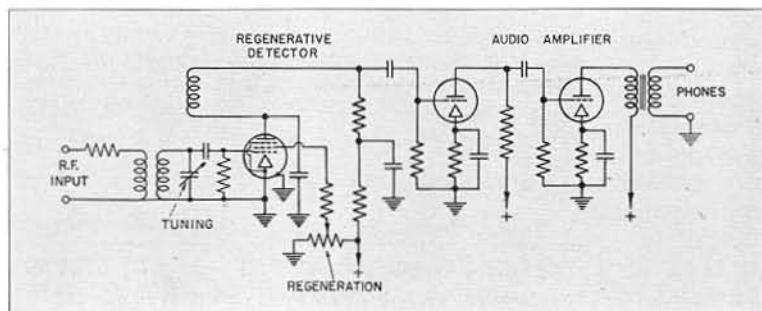

Schematic circuit diagram of the TYPE 619-E Heterodyne Detector. Power supply is not shown. The radio-frequency input is connected by low-impedance cable to the terminals at the left. The tuning condenser is in two sections—one being used for low frequencies and the other for high. The correct condenser is automatically selected when the coil is plugged in.

Terminals: Shielded, low-impedance radio-frequency input connections are provided in rear. Telephone connections are provided at rear and on panel.

Mounting: Standard 19-inch relay rack. Can be supplied in walnut or oak cabinet on special order.

Dimensions: Panel, (length) 19 x (height) 8 3/4 inches; behind panel, (length) 17 1/4 x (height) 8 1/2 x (depth) 11 3/4 inches. TYPE 619-P1: Panel, (length) 19 x (height) 5 1/4 inches; behind panel, (length) 17 1/4 x (height) 5 x (depth) 13 1/2 inches.

Net Weight: TYPES 619-E and 619-P1, 65 1/2 pounds.

Type	Description	Code Word	Price
619-E	Heterodyne Detector	MATIN	\$360.00

PATENT NOTICE. See Notes 1, 17, page vi.

TYPE 614-C SELECTIVE AMPLIFIER

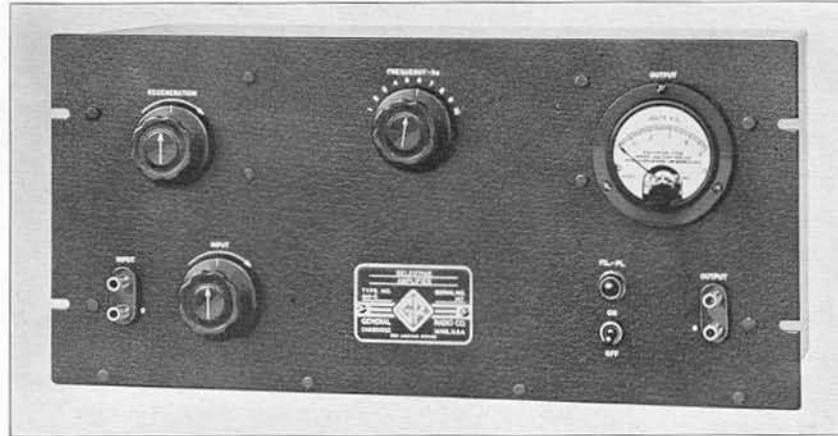

USES: This amplifier is used for selecting individual harmonics from the 1 kc output of a frequency standard. Multiples of 1 kc between 1 and 10 may be chosen, with good suppression of the fundamental and adjacent harmonics. The selected output frequency is useful for many audio-frequency measurements, particularly in making frequency comparisons by

means of a cathode-ray tube.

DESCRIPTION: The instrument contains a harmonic-generating amplifier stage, a regenerative selective stage, and an output stage. The selective stage may be tuned to any one of the first 10 multiples of 1 kc by means of a single switch.

SPECIFICATIONS

Frequency Range: 1 to 10 kc in steps of 1 kc.

Calibration: Amplifier is adjusted for maximum response at each of the 10 frequencies at the factory. Trimming adjustments are provided, which may be used in realigning the tuned circuits, if necessary.

Tubes: Supplied with instrument:
 3—type 6J5-G Amplifiers
 1—type 6X5-G Rectifier

Accessories Supplied: One seven-foot line connector cord, spare fuses and pilot lamps, and a multipoint connector

are supplied.

Power Supply: 105 to 125 or 210 to 250 volts, 50 to 60 cycles.

Power Input: 25 watts, approximately.

Mounting: Standard 19-inch relay rack.

Dimensions: Panel, (length) 19 x (height) 8 3/4 inches; behind panel, (length) 17 1/4 x (height) 8 1/2 x (depth) 11 3/4 inches.

Net Weight: 40 pounds.

Type	Description	Code Word	Price
614-C*	Selective Amplifier	DICKY	\$275.00

PATENT NOTICE. See Note 1, page vi.

Schematic circuit diagram of the TYPE 614-C Selective Amplifier. Power supply is not shown. A voltage from a 1-kc source is applied to the terminals at the left. Harmonics are generated in the first amplifier, selected in the second, regenerative, amplifier, and the selected harmonic is amplified by the output amplifier.

*Available only with complete assembly described on page 128.

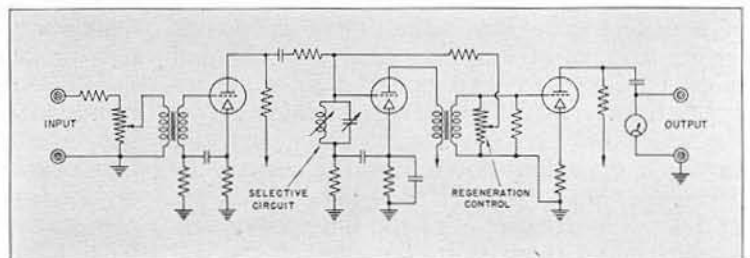

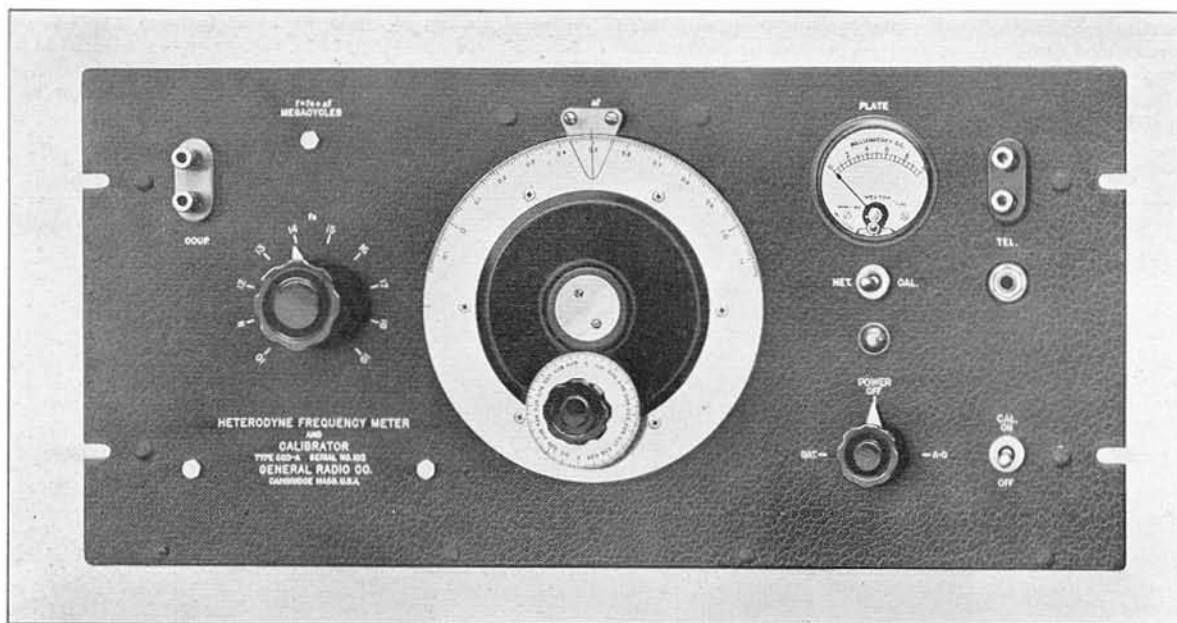

TYPE 620-A HETERODYNE FREQUENCY METER AND CALIBRATOR

USES: Although designed primarily for measuring high and ultra-high frequencies, this instrument can also be used to measure frequencies down to a few hundred kilocycles, provided the signal being measured is sufficiently strong. As a general-purpose instrument in the communication laboratory, it is invaluable. For communication companies it provides an excellent means of rapidly measuring the frequencies of a large number of transmitters (either local or remote) in addition to its use in calibrating and servicing receiving equipment. Receiver manufacturers will find it useful in checking the ranges of receivers and oscillators. It is suitable for monitoring the frequencies of radio transmitters where the allowable frequency tolerance is 0.02% or greater.

DESCRIPTION: The schematic diagram shows the essential elements of the instrument: (1) a heterodyne frequency meter, (2) a crystal calibrator, and (3) a detector and audio amplifier.

The heterodyne frequency meter is direct reading, which is an important operating convenience, particularly when using harmonics. The fundamental frequency range is 10 to 20 Mc. This range is divided into 10 steps of 1 Mc each, and the desired step is selected by means of a coil switch. The main tuning condenser covers a range of 1 Mc for each coil, the dial being engraved to read hundredths of megacycles directly. An auxiliary dial, which drives the main dial through a reduction gear train, carries a scale that subdivides the main scale divisions, the smallest division being 0.001 Mc or 1 kc. The frequency of the heterodyne frequency meter is given by the sum of the coil

switch and condenser dial readings, subject to any scale correction as determined by the crystal calibrating points.

For checking the calibration of the heterodyne frequency meter, a piezo-electric calibrator, employing a one-megacycle low-temperature-coefficient quartz plate, is provided. Several points on each coil range of the heterodyne frequency meter may be checked.

The procedure in making measurements is simple. When the unknown frequency is within the fundamental range of the heterodyne, the heterodyne frequency is set to zero beat with the unknown, and the frequency is read directly from the dial. When the unknown is above or below the heterodyne fundamental range, the dial reading must be multiplied or divided by the harmonic number.

The fundamental frequency range being 10 to 20 Mc, measurements of high and ultra-high frequencies are easily made. Because of the direct-reading feature and the widespread frequency scale, no confusion as to harmonics is encountered in measuring ultra-high frequencies.

FEATURES: The TYPE 620-A Heterodyne Frequency Meter and Calibrator is designed for the greatest flexibility and for simplicity of operation. It covers a wide range of frequencies and is capable of a high accuracy of measurement.

The direct-reading frequency scale makes rapid measurements possible. The oscillator has been designed and constructed to give a high degree of frequency stability. The variable air condenser has ball bearings to insure smooth operation without backlash. The inductors are wound on isolantite forms to keep the losses

and the temperature coefficient of inductance as low as possible.

The same model can be used on either batteries or the built-in a-c power supply; this is a considerable convenience when the same instrument is to be used both in the laboratory and in the field.

SPECIFICATIONS

Frequency Range: The fundamental frequency range is from 10 to 20 megacycles, in 10 ranges of 1 Mc each. By harmonic methods frequencies between 300 kc and 300 Mc are easily measured.

Frequencies up to about 300 Mc can be measured by setting a harmonic of the heterodyne frequency meter to zero beat with the unknown. In general, the beat is obtained in the detector, but for the very highest frequencies it is advisable to use an auxiliary receiver. For frequencies below 10 Mc and down to about 300 kc, harmonics of adequate strength for measurement can be generated in the detector tube provided a sufficiently strong signal is applied to the instrument. For weak signals, a local oscillator as a harmonic-generating means is necessary.

Calibration: The condenser dials are graduated to read decimal fractions of megacycles directly, the smallest division corresponding to 0.001 Mc (1000 cycles).

Calibrator: A 1-Mc piezo-electric oscillator, employing a low-temperature coefficient quartz plate, is provided for checking the calibration of the frequency meter. Harmonics of 1 Mc fall at the upper and lower limits of the dial, giving a bracketing check on each coil range of the heterodyne frequency meter. Harmonics of the heterodyne also produce beats with harmonics of the calibrator, giving checking points at multiples of $\frac{1}{2}$, $\frac{1}{3}$, $\frac{1}{4}$, and $\frac{1}{5}$ Mc, etc., over the dial range. Since these points occur at the same dial readings for each range, checking is made very simple and convenient.

Accuracy: The over-all accuracy of measurement is 0.01% or better when the frequency meter is checked in terms of the crystal calibrator and the resulting correction applied to the dial reading.

Vacuum Tubes: The following tubes are used and are supplied with the instrument:

- 1—954-type
- 3—955-type
- 1—84-type

Power Supply: Either 105 to 125 or 210 to 250 volts, 50 to 60 cycles, or 6 and 180 volts dc. A switch on the panel selects the type of power supply desired. The a-c operated power supply is built in. Batteries are not supplied with either the relay-rack or portable model.

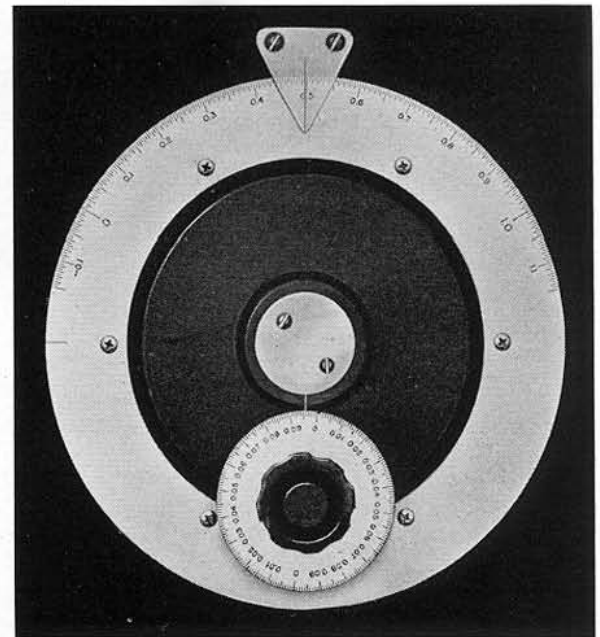

Closeup view of the tuning dial, showing details of the scale.

Power Input: 15 watts; from 115-volt, 60-cycle supply.

Mounting: The instrument is supplied either for relay-rack mounting (TYPE 620-AR) or in a portable aluminum cabinet (TYPE 620-AM).

Accessories Supplied: One-megacycle quartz plate, seven-foot line connector cord, spare pilot lamps and fuses. With the relay-rack model (TYPE 620-AR) two multipoint connectors are furnished, while a battery plug and cable and a multipoint connector are furnished with the portable model (TYPE 620-AM).

Accessories Required: Head telephones, which can be connected either at the panel or at the rear of the instrument.

Dimensions: TYPE 620-AR, panel, (length) 19 x (height) 8 $\frac{3}{4}$ inches; behind panel, (length) 17 $\frac{1}{4}$ x (height) 8 $\frac{3}{8}$ x (depth) 11 $\frac{3}{4}$ inches; TYPE 620-AM, 20 $\frac{1}{2}$ x 14 $\frac{1}{2}$ x 10 inches, over-all.

Net Weight: TYPE 620-AR, 32 $\frac{3}{4}$ pounds; TYPE 620-AM, 47 $\frac{3}{4}$ pounds.

Type	Description	Code Word	Price
620-AR	Relay-Rack Model	DAISY	\$490.00
620-AM	Portable Model	DISCONTINUED	

PATENT NOTICE. See Notes 1, 12, page vi.

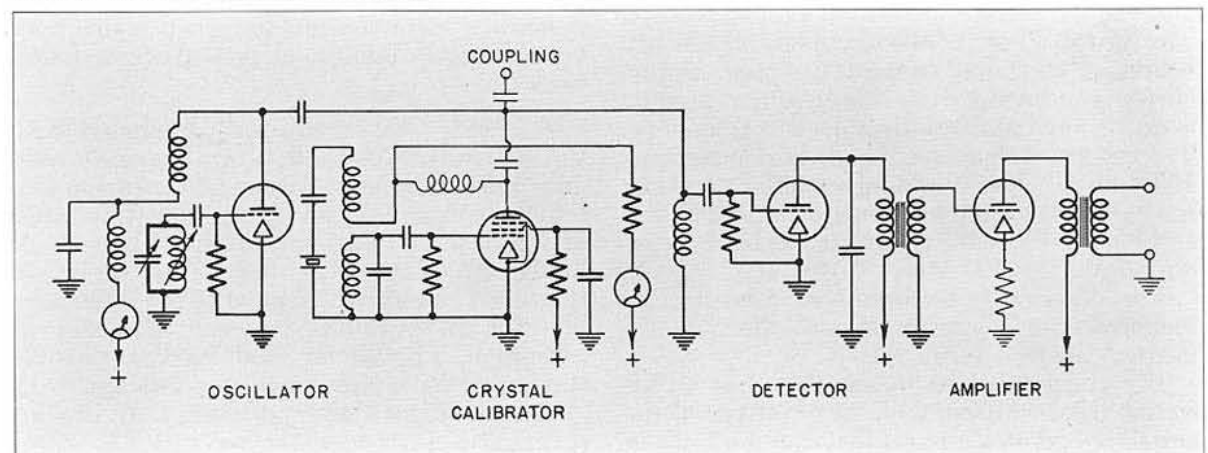

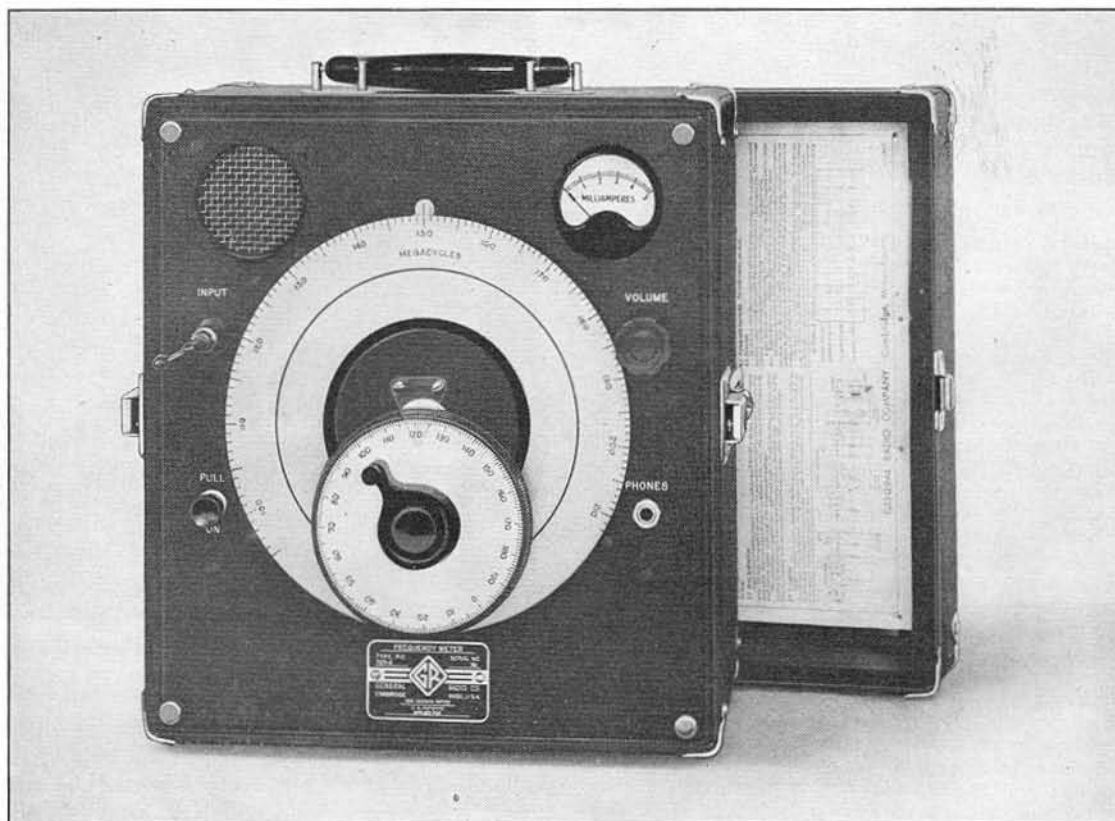

TYPE 720-A HETERODYNE FREQUENCY METER

USES: The TYPE 720-A Heterodyne Frequency Meter is used for the measurement of frequency in the v-h-f and u-h-f bands. It extends the field of the familiar heterodyne method of measurement to a frequency of 3000 Mc.

DESCRIPTION: The principal elements of the instrument are a calibrated oscillator, a crystal detector and an audio amplifier. The frequency-determining element of the oscillator is a butterfly circuit in which the capacitance and the inductance are varied simultaneously. The movable part of the circuit rotates in ball bearings. No sliding contacts are used, and no current is carried by the bearings. This permits a smooth and stable adjustment of frequency. The oscillator frequency is adjustable between 100 and 200 Mc. Harmonics of the oscillator are used to measure frequencies above 200 Mc, and harmonics of the unknown are used at frequencies below 100 Mc.

The detector is an iron-pyrites crystal, so mounted that it is easily accessible for replacement. A spare is furnished.

The three-stage audio amplifier has an effective band width of 50 kc. The output of the amplifier operates a panel meter and a built-in

loud speaker. A jack is provided as well for head telephones.

The entire assembly is battery-operated, completely self-contained, and mounted in a portable, fabric-covered cabinet. Complete operating instructions are mounted in the cover of the cabinet.

The sensitivity of the instrument is high, and no direct connection to the source under measurement is required. The pickup obtained by the adjustable antenna mounted on the panel is usually adequate, but provision is made for connecting an additional pickup wire, if necessary.

FEATURES: The sensitivity obtainable with the heterodyne method of measurement permits this instrument to be used on comparatively weak signals, and permits a wide range of frequencies to be measured with a single fundamental frequency band. The design of the tuned circuit avoids most of the difficulties inherent in variable-frequency elements at ultra-high frequencies and makes possible stable and repeatable frequency settings.

The small size and portability of the instrument is a considerable convenience.

SPECIFICATIONS

Frequency Range: The fundamental frequency range is from 100 to 200 megacycles. This range is covered in a single band with approximately logarithmic frequency distribution. By harmonic methods frequencies between 10 megacycles and 3000 megacycles can be measured. Since harmonics of the internal oscillator are considerably stronger than harmonics of the unknown as generated in the detector, the sensitivity of the instrument for frequencies below the range of the oscillator fundamental is considerably less than that at frequencies equal to or above the oscillator fundamental.

The unknown frequencies are measured by setting the frequency meter to a point where a beat note is produced with the unknown frequency.

Beat Indication: A strong beat note will be heard in the small dynamic speaker in the front panel. For weaker signals a pair of headphones should be used. In addition to the audible beat, a visual indication is obtained by the deflection of the panel meter. Since the band width of the detector circuit is 50 kilocycles, the panel meter will deflect even when the frequency measured is unstable and does not produce a steady audible beat note.

Calibration: The main dial is calibrated in frequency, each division corresponding to one megacycle.

The vernier dial is geared to the tuning unit to make one-half turn of the dial correspond to 1% change in frequency over the major part of the tuning range. The vernier dial carries 200 uniform divisions.

Accuracy: The overall accuracy of measurement is 0.1%.

Temperature and Humidity Effects: Over the range of room conditions normally encountered temperature and humidity do not affect the accuracy of the instrument.

Vacuum Tubes: The following tubes are used and are supplied with the instrument:

- 1—type 1N5-GT (RCA or equivalent)
- 1—type 1D8-GT (RCA or equivalent)
- 1—type 958

Battery: A single-block Burgess TYPE 6TA60 Battery is used and is supplied with the instrument. The power required is approximately 90 volts, 6 ma, and 1.4 volts, 250 ma.

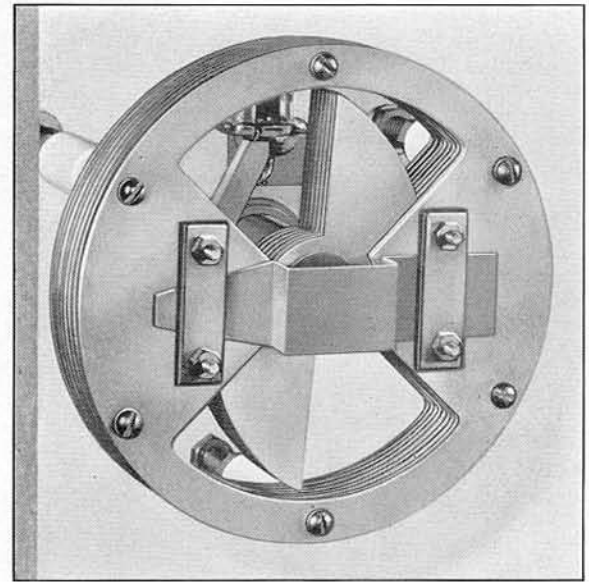

View of the butterfly-type tuned circuit used in the TYPE 720-A Heterodyne Frequency Meter.

Case: The TYPE 720-A Heterodyne Frequency Meter is mounted in a shielded carrying case of durable airplane luggage construction. Complete operating instructions are attached to the cover, and a complete wiring diagram, with circuit constants, is attached to the inside of the cabinet.

Spare Parts: One TYPE Z2DEC-1 Detector is supplied as spare in addition to the one in the instrument.

Accessories Required: Headphones which can be plugged in on the front panel, and which can be stored in the cover of the instrument.

Dimensions: Overall, 12½ x 13½ x 10½ (depth) inches. Panel, 10¾ x 11¾ inches.

Net Weight: 27¾ pounds, with battery.

Type		Code Word	Price
720-A	Heterodyne Frequency Meter	FANCY	250.00

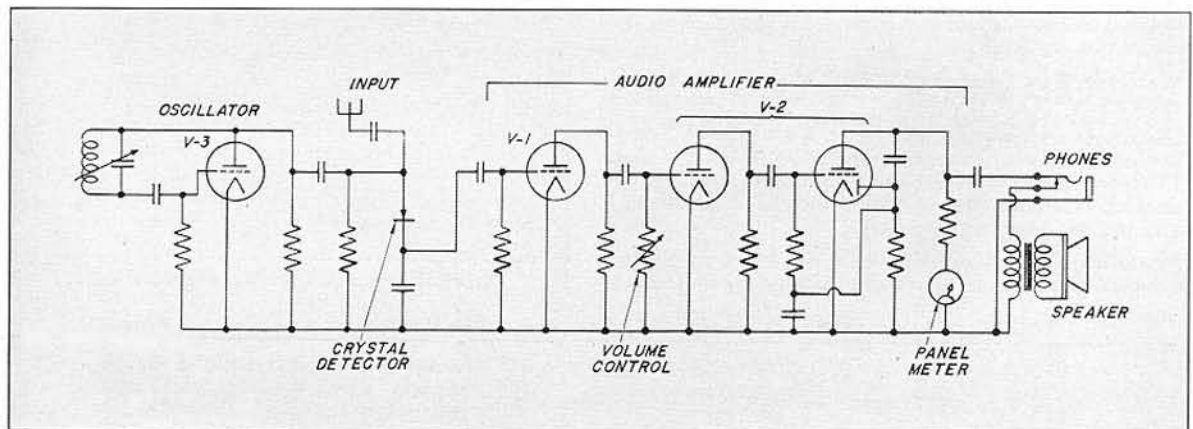

TYPE 815 PRECISION FORK

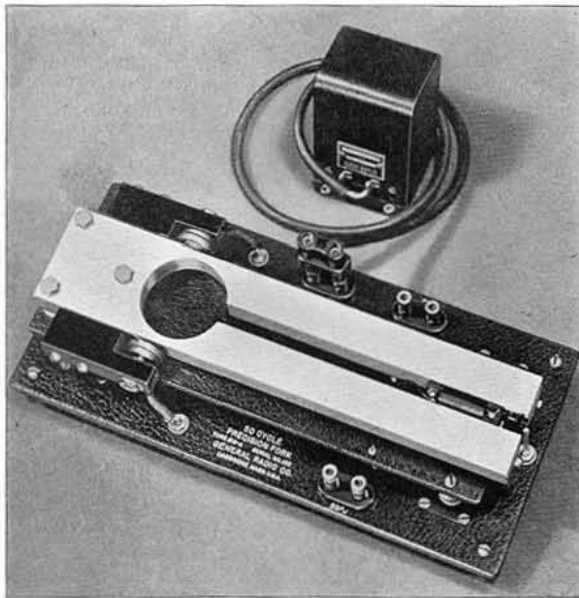

USES: TYPE 815 Precision Fork is designed for such uses as timing in geophysical exploration, rating clocks and watches, synchronizing facsimile transmission, and low-frequency standardization. It is also an excellent source for accurately timing stroboscopic flashes.

DESCRIPTION: The fork is made of low-temperature-coefficient stainless steel. It is mounted at the heel on a metal panel which is attached to the main base by means of rubber shock absorbers to reduce energy dissipation through the mounting.

One microphone button is mounted on each tine near the heel of the fork, where the amplitude of vibration is low. This minimizes the damping action which the presence of the microphones exerts on the fork. At the end of each tine, adjusting screws are provided. By means of these, the loading on the tines is equalized. This factor, too, is important in reducing the decrement.

Separate microphone buttons are used for the driving and output circuits. No output filter or transformer is included, since different uses may require different circuit arrangements.

The frequency stability is considerably improved by the use of the condenser, *C*, shown in the diagram below. This condenser is supplied with the fork.

FEATURES: TYPE 815 Precision Fork combines high accuracy and stability with simplicity of construction and operation. Because of its small size and low-power requirements the fork is easily portable.

SPECIFICATIONS

Frequency: Three stock models, operating at 50, 60, and 100 cycles, respectively, are available.

Calibration: The fork will be exactly on frequency at some temperature between 70 and 80 degrees Fahrenheit. The measured value, with a driving voltage of 4 volts, at a stated temperature between 70 and 80 degrees Fahrenheit is given on the calibration certificate to $\pm .001\%$.

Temperature Coefficient: The temperature coefficient of frequency is about .001% per degree Fahrenheit and is negative. The actual measured value is given on the calibration certificate.

Voltage Coefficient: The voltage coefficient of frequency is about .005% per volt and is given for each fork on the calibration certificate.

Waveform: Harmonics are about 30% of the output voltage at all loads.

Output: It is recommended that a TYPE 815-P1 Transformer be used between the output circuit and the load. The internal output impedance is about 50 ohms, and the maximum output about 25 milliwatts when a 6-volt battery is used in the output circuit.

Power Supply: A 4-volt battery is recommended as the driving source and a 4 to 6-volt battery in the output

circuit. The battery can be common to both circuits. Driving current is less than 50 milliamperes.

Accessories Supplied: A "phasing" condenser with plug-in leads.

Mounting: The fork assembly is mounted on a metal base.

Dimensions: 13 x 6 x 3 inches, over-all.

Weight: 10 $\frac{1}{8}$ pounds.

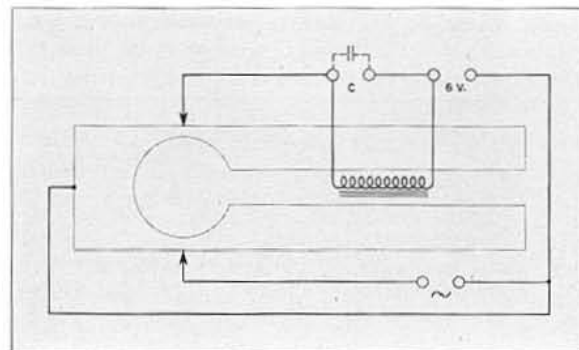

Circuit diagram of TYPE 815 Precision Fork.

Type	Frequency	Code Word	Price
815-A	50 cycles	FAUNA	\$165.00
815-B	60 cycles	FATAL	175.00
815-C	100 cycles	FELON	175.00
815-P1	Transformer	TARDY	6.00

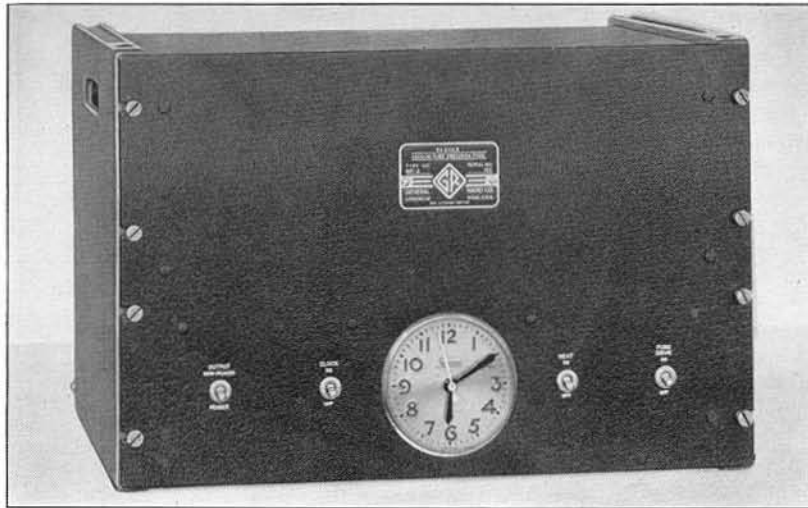

TYPE 816

VACUUM-TUBE

PRECISION FORK

USES: The TYPE 816 Vacuum-Tube Precision Fork is a primary standard of frequency. It can be used for the same purposes as TYPE 815 Precision Fork (page 146), but its higher precision and stability make it adaptable to considerably more accurate measurements and, in addition, to timekeeping and chronographic measurements.

DESCRIPTION: The complete instrument consists of a tuning fork similar to that used in TYPE 815 Precision Fork, a temperature control system, a vacuum-tube amplifier, and a synchronous motor clock. The fork is made of low-temperature-coefficient stainless steel. It is mounted at the heel on a metal panel, which is attached to the base of the temperature-control box by means of four vertical helical springs to reduce energy dissipation through the mounting. The fork is driven electromagnetically, and the drive and pickup coils are symmetrically placed with respect to the tines in order to keep the decrement low and give a Q of the order of 20,000.

A two-stage amplifier couples the pickup and

the driving coils. An a-v-c circuit is included, and a fourth vacuum tube supplies output power at the fork frequency. The general circuit is shown in the accompanying schematic diagram.

The temperature-controlled chamber in which the fork is mounted is a metal box enclosed in a balsa-wood case. Heaters are provided for 115-volt, d-c or a-c operation.

The synchronous clock is designed to register correct time when the fork is exactly on its rated frequency. Comparison of the readings of this clock with standard time signals as transmitted by radio provides a means of checking the frequency of the fork over 24-hour periods of continuous operation.

FEATURES: High accuracy and a high degree of frequency stability are important characteristics of this fork. Because provision is made for using either of two types of power supply, the fork can be operated under a wide variety of conditions, in the field as well as in the laboratory.

SPECIFICATIONS

Frequency: 50 cycles per second or 60 cycles per second.

Calibration: The frequency is adjusted within 0.0005% of its rated value and is measured to 0.0001% in our standardizing laboratory.

Screws are provided in the ends of the tines of the fork for adjusting the frequency. These are accessible from the outside of the temperature-control box. Minute changes are accomplished by adjusting the a-v-c circuit while in operation.

Stability: When the temperature-control system is operated, the frequency is within one part in 100,000 (0.001%) of its

mean value, thus timing to better than one second per day. Without temperature control, the frequency will follow (with a considerable lag) variations in ambient temperature. At ordinary room temperatures, the temperature

(Right) Plot of a 10-day frequency record of TYPE 816 Vacuum-Tube Precision Fork. The full line shows the observed frequency, the dotted line the frequency after the barometer correction was applied.

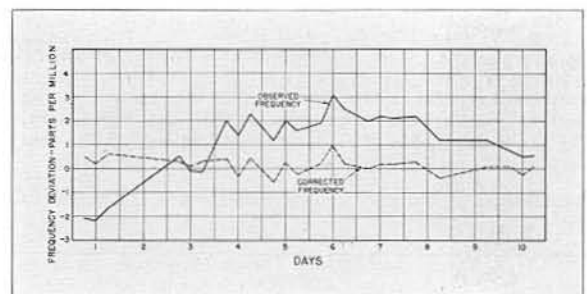

coefficient of frequency is negative and is -22 parts in 10^6 (0.0022%) per degree Centigrade. Frequency changes with supply voltage and atmospheric pressure are usually negligible in comparison to the rated accuracy of the fork.

Power Supply: The amplifier circuit and the heaters for temperature control are arranged to operate on either of two types of power supply, selection being made by plug and jack terminals:

- (1) a-c line, 100 to 130 volts, 50 to 60 cycles.
- (2) d-c line, 100 to 130 volts.

Power Input: For temperature control, 30 watts; for fork and amplifier, 45 watts.

Output: Peaked or sinusoidal, as selected by a switch. When the synchronous clock is operated, maximum output is 1 watt. When clock is not used, maximum output is 2 watts. Output circuit is not grounded and is free from any d-c polarization. Various output impedances between 200 and 30,000 ohms are provided.

Maximum peaked open-circuit output voltage is 350 volts.

Tubes: Supplied with instrument:

- 2—type 6J7-G
- 1—type 25L6GT
- 1—type 139-949-A
- 1—type 6Q7-G
- 1—type 25Z6

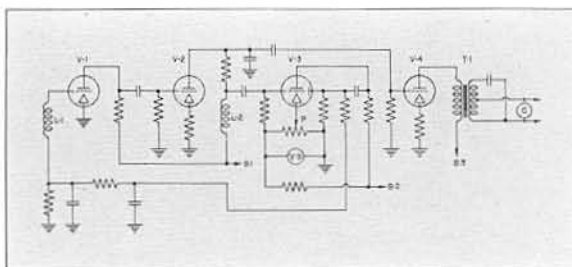

Schematic circuit diagram of the fork amplifier and output circuits. L_1 and L_2 are the pickup and driving coils.

Accessories Supplied: Spare fuses, 2 multipoint connectors, one line connector cord.

Mounting: The entire assembly is mounted on a standard 19-inch relay-rack panel, which can be adapted for table mounting by the use of the wooden end frames supplied. The instrument is readily portable in an operating condition if kept in approximately its operating position.

Dimensions: Panel, 19 x 12 1/4 inches; depth, 12 1/4 inches.

Net Weight: 49 1/2 pounds.

Type		Frequency	Code Word	Price
816-A	Vacuum-Tube Precision Fork	50 cps	FERRY	\$385.00
816-B	Vacuum-Tube Precision Fork	60 cps	FABLE	385.00

PATENT NOTICE. See Note 1, page vi.

TYPE 566-A WAVEMETER

USES: TYPE 566-A Wavemeter is a wide-range, general-purpose, absorption-type instrument intended for rapid frequency checks in the laboratory or the field. Of moderate accuracy, it replaces the TYPE 358 and the TYPE 574, formerly listed in our catalog.

DESCRIPTION: The wavemeter consists of an air condenser similar in construction to the TYPE 568, a set of five plug-in inductors, and an incandescent lamp, which is used to indicate resonance. The condenser is mounted in a walnut cabinet. A friction-type slow-motion drive is provided on the condenser, and the dial carries three scales, which are calibrated directly in frequency.

FEATURES: Compactness and low price are important features of this wavemeter. The plug-in terminals are so arranged that the inductor can be moved in one plane to vary the coupling to the source under measurement. A rack is provided on the side of the cabinet for storing the coils when the wavemeter is not in use.



SPECIFICATIONS

Frequency Range: 0.5 to 150 Mc (600 to 2 meters) using the five plug-in inductors furnished with the instrument. The condenser dial is direct reading in frequency. The precision with which the dial can be read is 2% or better.

Accuracy: The accuracy of dial indication is $\pm 2\%$, 0.5 to

16 Mc; and $\pm 3\%$, 16 to 150 Mc.

Accessories Supplied: Two spare indicator lamps.

Dimensions: 4 3/4 x 5 7/8 x 5 3/4 inches, over-all.

Net Weight: 3 pounds.

Type		Code Word	Price
566-A	Wavemeter.....	WAGON	\$45.00

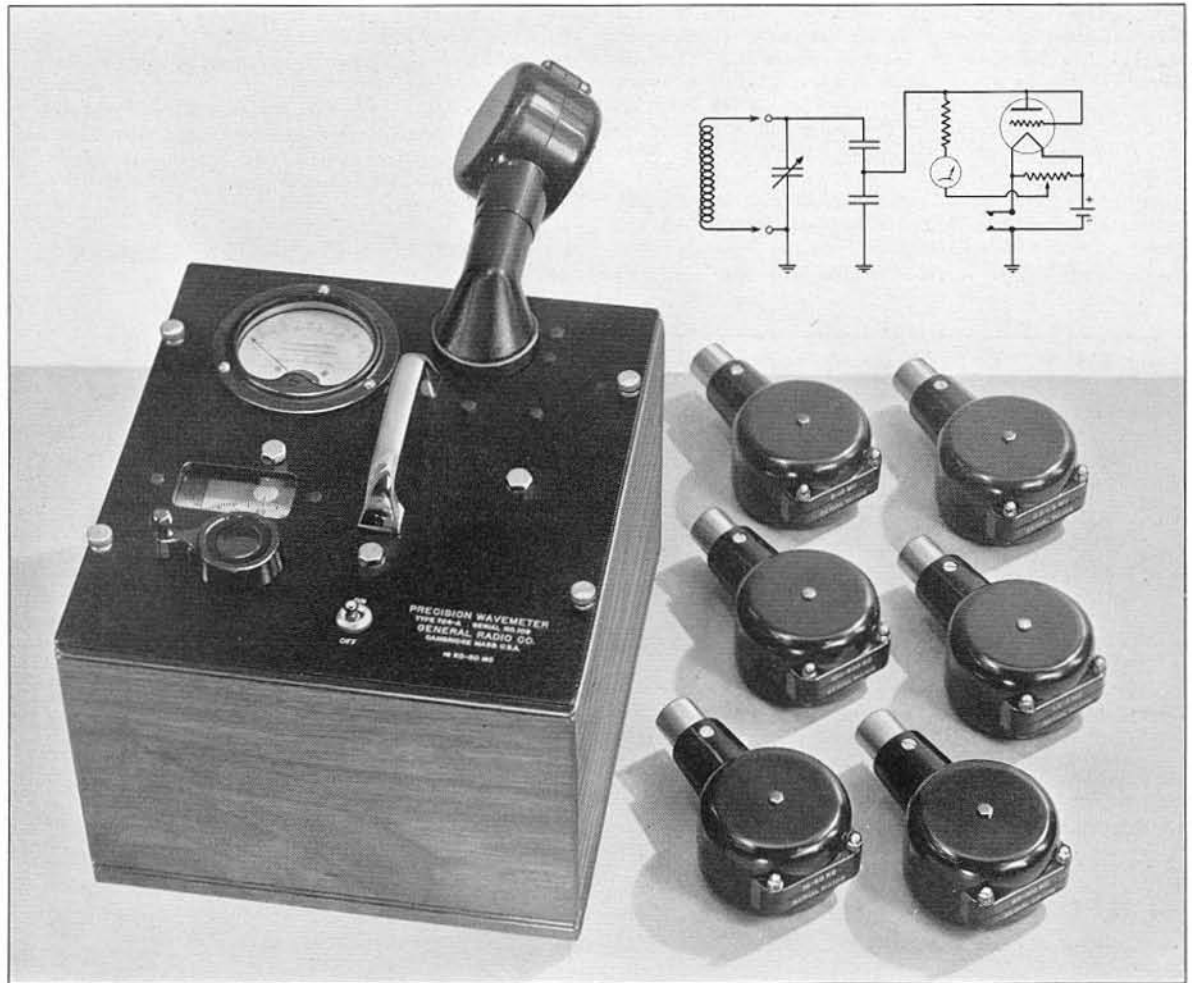

TYPE 724-A PRECISION WAVEMETER

USES: The precision wavemeter fills a definite need in the field of frequency measurement. Its accuracy is sufficient for many measurements which require a fairly close knowledge of the frequency but where more precise heterodyne methods are neither necessary nor convenient. Among these applications is the preliminary lining up of radio transmitters and checking the frequency span of oscillators.

DESCRIPTION: The TYPE 724-A Precision Wavemeter is a tuned-circuit instrument, consisting of a condenser, a resonance indicator, and a set of inductors.

The condenser is similar in constructional details to TYPE 722. (See page 41.)

The coils are designed to have low losses and a high degree of stability.

FEATURES: The straight-line-frequency condenser obviates the use of cumbersome calibration curves. The calibration data are in tabular form, and specific frequencies are found by interpolating between the points in the table. The plug-in coil mounting allows the coil to be rotated to obtain different degrees of coupling. This is a considerable aid to convenience in operation, making it unnecessary to hold the wavemeter in awkward positions to couple it to oscillator tuned circuits.

The resonance indicator is a rectifier-type vacuum-tube voltmeter, which is not damaged by severe overloads.

SPECIFICATIONS

Frequency Range: 16 kilocycles to 50 megacycles.

Accuracy: $\pm 0.25\%$ between 50 kc and 50 Mc; $\pm 1.0\%$ between 16 kc and 50 kc.

Calibration: The calibration is supplied in the form of a table of calibrated points. Linear interpolation between these points is used to obtain settings for other frequencies.

FREQUENCY

Condensers: Precision worm-drive type similar to TYPE 722. The condenser setting is indicated on the dial and drum and is controlled from the front of the panel. There are 7500 divisions for the entire 270-degree angular rotation of the condenser rotor. The precision of setting is better than one part in 25,000. The plates are shaped to give an approximately linear variation in frequency with scale setting.

Inductors: Coils are wound on isolantite forms and enclosed in molded bakelite cases. Seven coils are used to cover a frequency range between 16 kilocycles and 50 megacycles.

Resonance Indicator: A vacuum-tube voltmeter is used to

indicate resonance. This is coupled to the tuned circuit through a capacitive voltage divider.

Vacuum Tube: One type 1G4-G tube is required and is furnished with the instrument.

Power Supply: One type 4FA 1½-volt battery is supplied.

Mounting: A wooden storage case, fitted with lock and carrying handle, is furnished. This has compartments for holding the condenser, inductors, and calibration charts.

Dimensions: Carrying case, 17 $\frac{7}{8}$ x 13 x 12 $\frac{1}{2}$ inches, over-all.

Net Weight: With carrying case, 35 $\frac{1}{4}$ pounds; without carrying case, 20 pounds.

Type		Code Word	Price
724-A	Precision Wavemeter.....	WOMAN	\$190.00

TYPE 758-A WAVEMETER

USES: In the ultra-high-frequency range, 55 to 400 Mc, this wavemeter provides a convenient and accurate means of measuring the frequencies of oscillators.

DESCRIPTION: TYPE 758-A Wavemeter is a tuned-circuit, absorption-type of instrument, in which the capacitance and inductance are varied simultaneously. This permits a wide range of frequency to be covered with a single coil. The coil is connected permanently into the circuit. The resonance indicator is an incandescent lamp.

FEATURES: An outstanding feature of this wavemeter is the wide range of frequency which is covered without the bother of changing coils.

Although both coil and condenser are completely enclosed, the case is of transparent material so that the circuit elements can be seen at all times. This is a considerable aid in coupling the wavemeter to an oscillating circuit. The dial is direct reading in frequency. The lamp will glow on an oscillator of about 2 watts output. For low-power oscillators, the



reaction of the wavemeter on the plate or grid current can be used to indicate resonance.

SPECIFICATIONS

Range: 55 Mc to 400 Mc, direct reading.

Accuracy: ±2%.

Temperature and Humidity: The accuracy of this wavemeter is completely independent of temperature and humidity effects over the ranges normally encountered.

Resonance Indicator: Incandescent lamp.

Dimensions: 5 x 5 x 4 $\frac{3}{4}$ inches, over-all.

Net Weight: 1 pound, 12 ounces.

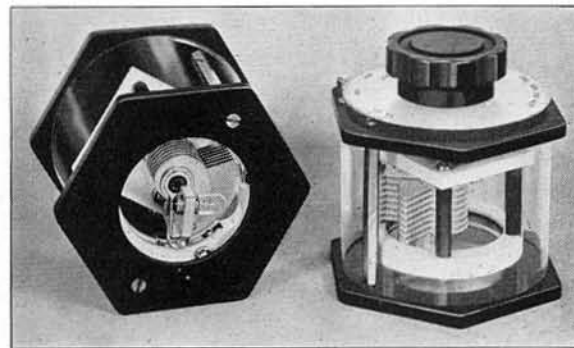

Type		Code Word	Price
758-A	Wavemeter.....	WITTY	\$28.00

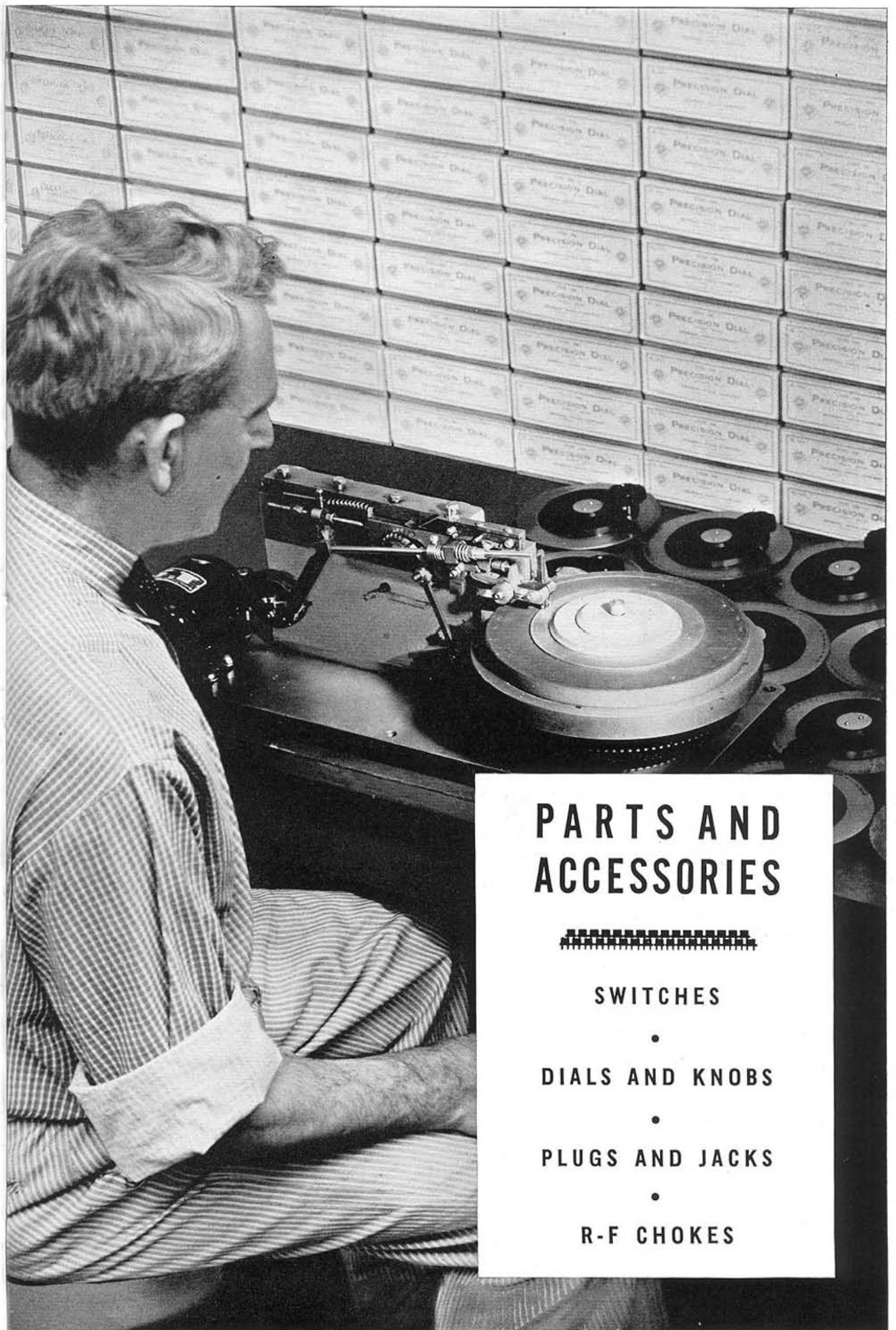

PARTS AND ACCESSORIES



SWITCHES

•

DIALS AND KNOBS

•

PLUGS AND JACKS

•

R-F CHOKES

TYPES 704 AND 706 PRECISION DIALS

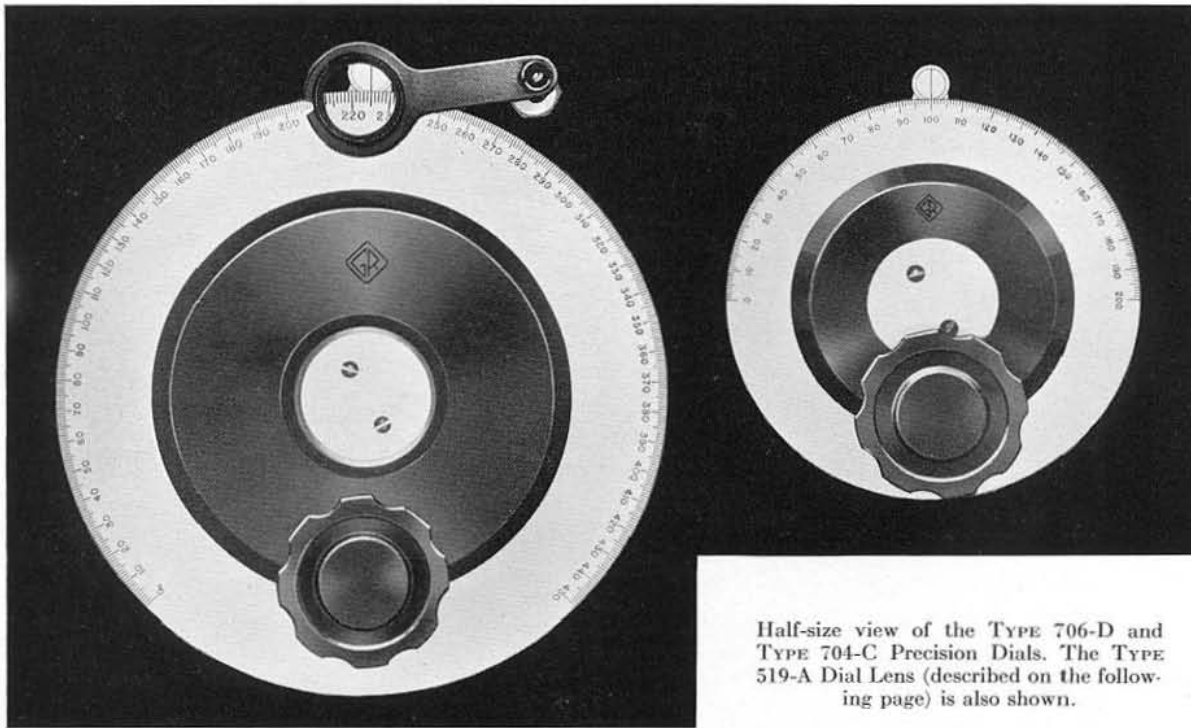

Half-size view of the TYPE 706-D and TYPE 704-C Precision Dials. The TYPE 519-A Dial Lens (described on the following page) is also shown.

These are high-grade precision dials, with scales individually engraved on an automatic self-indexing engraving machine in fine, radial, and accurately located lines. The dial scale and the slow-motion drive knob rotate in the same direction.

The accuracy of the engraving and the precision of setting obtainable justify the use of a TYPE 519-A Dial Lens (see next page).

Backlash has been eliminated in the construction of these long-scale dials by setting the scale permanently and securely on the main shaft which thus has its angular position accurately indicated. The tension of the friction drive is adjustable to suit the load and the preference of the operator, and the position of the friction drive shaft may be adjusted by means of an eccentric bushing to compensate for any errors in the centering of the main shaft in the center hole.

These dials are secured to their shafts through

the use of two setscrews separated by 120° and are supplied bored to receive a $\frac{3}{8}$ -inch shaft. For use with a $\frac{1}{4}$ -inch shaft, a split collar bushing is provided which securely grips the shaft throughout one inch of its length, averting all possibility of slipping.

Settings of these dials can consistently be duplicated to one-fifth of a division, allowing an accuracy of resetting, for the TYPE 706-D Precision Dial, of better than 0.05%. Parallax is eliminated through the use of an indicator which always remains flush with the surface of the dial, and which at the same time absorbs any slight eccentricities of the main shaft through the flexibility of its mounting arm.

The dial indicator and knob (TYPE 637-P) are supplied, as are complete instructions for mounting. Only one hole in the panel, in addition to that for the main shaft, is required for mounting; this hole can be accurately located with the drilling template furnished.

● 4-INCH DIAMETER PRECISION DIALS

Type	Dial		Friction-Drive Ratio	Net Weight	Code Word	Price
	Arc	Divisions				
704-C	180°	200	1:6	9 oz.	DABBY	\$6.00
704-D	270°	300	1:6	9 oz.	DAIRY	6.00

● 6-INCH DIAMETER PRECISION DIALS

Type	Dial		Friction-Drive Ratio	Net Weight	Code Word	Price
	Arc	Divisions				
706-C	180°	300	1:8	15 oz.	DASHY	\$6.50
706-D	270°	450	1:8	15 oz.	DATUM	6.50

TYPE 520-A DIAL LOCK

Any General Radio dial may be firmly clamped in any position by means of the TYPE 520-A Dial Lock which holds the edge of the dial in a vise-like grip, without exerting appreciable force on the shaft on which the dial is mounted. The lock does not alter the dial setting and may be unclamped by loosening the knurled knob when it is desired to change dial to a new setting.

Dimensions: (Length) 2 x (width) 1 x (height) 1 1/2 inches, over-all. Height above panel, 1 inch.

Mounting: Two No. 28 holes, 3/8 inch apart, are required for mounting.

Net Weight: 1 1/2 ounces.

Type	Code Word	Price
520-A	ABATE	\$0.75

View of TYPE 520-A Dial Lock installed on a precision dial.

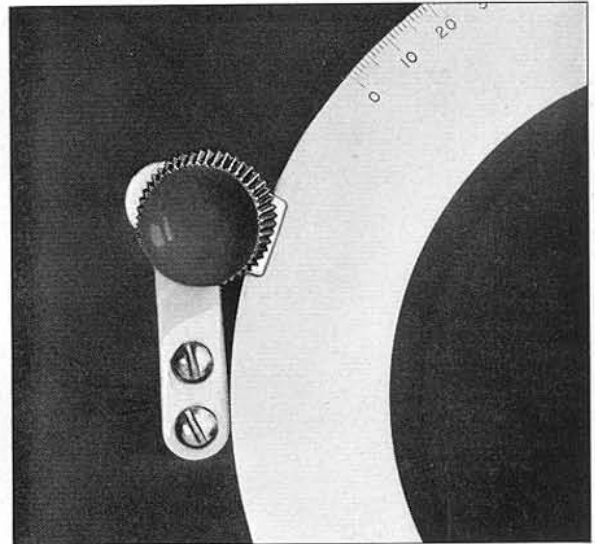

TYPE 519-A DIAL LENS

(Illustrated on preceding page)

This consists of a small lens with an adjustable holder to mount on a panel, over the dial indicator. It makes possible increased precision of reading of the TYPES 704 and 706 Precision Dials, for which it is particularly designed. When not in use the arm can be swung out of the way and the lens pushed against the panel to minimize space requirements. When in use the lens is held in proper position by a detent device.

Dimensions: (Height above panel) 2 x (width) 1 1/8 x (length or radius) 2 3/8 inches.
Focal length, 1 1/4 inches.

Mounting: One 3/8-inch hole required for mounting.

Net Weight: 2 ounces.

Type	Code Word	Price
519-A	ABASH	\$1.75

DIAL PLATES

These dial plates have photo-etched scales with raised nickel-silver graduations on a flat black background. Each can be attached to the panel with the same screws which hold the rheostat-potentiometer or condenser with which the dial plate is used.

TYPE 522-A

A 2 1/2-inch diameter plate for use with a TYPE 637-A Knob and a TYPE 301-A Rheostat-Potentiometer. Marked with 20 divisions around 254°.

Type	Net Weight	Code Word	Price
522-A	1/2 oz.	DOGMA	\$0.35

TYPE 318

This is a 3-inch diameter plate with provision for standard 3-hole mounting. The TYPE 318-B, marked with 50 divisions around 298°, is suitable for use with rheostat-potentiometers such as TYPES 214, 371, 314, 471, and 333. The TYPE 318-C is marked with 50 divisions around 180° for use with condensers having 180° rotation, such as TYPES 368 and 568. A 1 3/8-inch knob, either pointer or skirt, may be used.

Type	Net Weight	Code Word	Price
318-B	3/4 oz.	DEVIL	\$0.35
318-C	3/4 oz.	DILEG	.35

TYPE 318-B

TYPE 318-C

TYPE 522-A

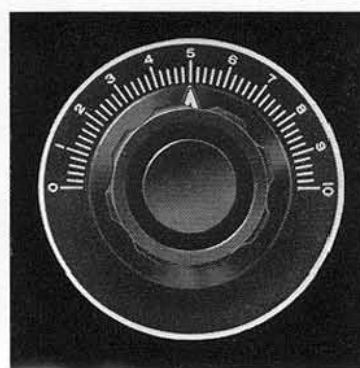
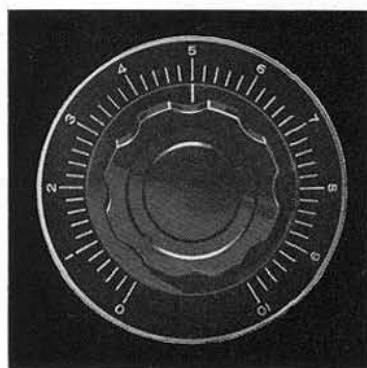



TYPE 701-K

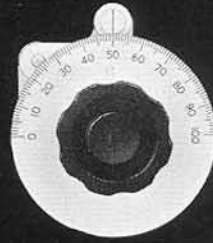

TYPE 701-A

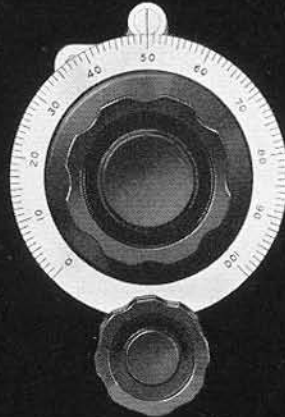

TYPE 702-B

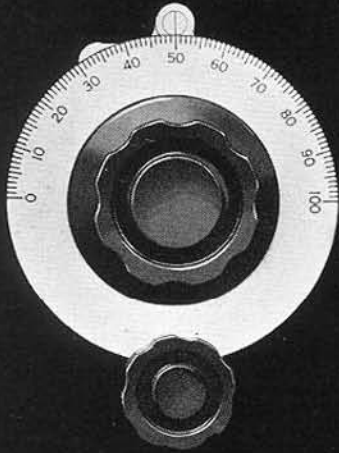

TYPE 705-A

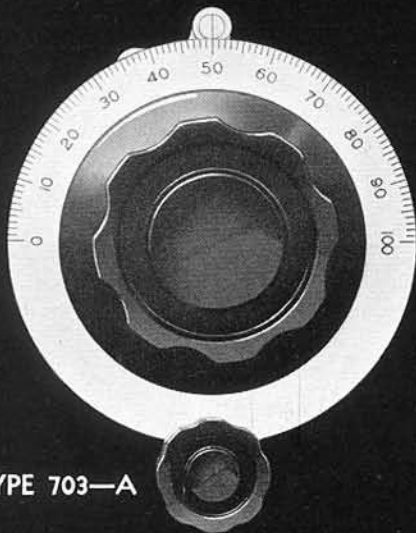

TYPE 703-A

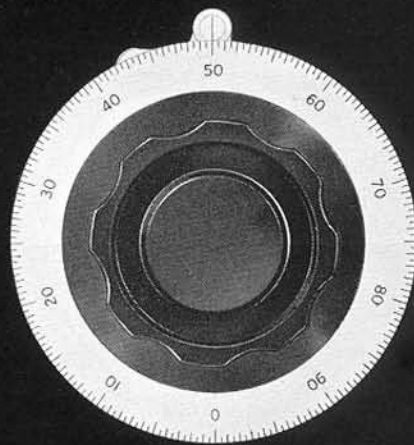

TYPE 717-K

ONE HALF ACTUAL SIZE

FRICION-DRIVE AND DIRECT-DRIVE DIALS

These dials have nickel-silver scales with photo-etched characters and scale divisions. The knobs are TYPE 637 of the appropriate size. They are available in two shaft sizes and in four diameters. All are available with or without friction drive, except the 2-inch size (TYPE 701), which is sold only as a direct-drive dial. The metal dial plate is insulated from the shaft in all models except the smallest (TYPE 701) on which the dial plate is swedged to the metal insert which holds the shaft.

The direct-drive dials TYPES 710, 712, and 717 are the same as TYPES 702, 705, and 703, respectively, except that they do not have the friction-drive mechanism. This mechanism con-

sists of a thin disc gripped and driven by two small discs attached to the driving shaft.

The photographs are approximately half size. The indicator shown is supplied with the dial, as is a mounting template, and the vernier drive knob (for the friction-drive dials).

Naturally the photo-etched scale divisions of these dials are not as accurately determined as those of the TYPES 706 and 704 Precision Dials. They are, nevertheless, completely satisfactory for applications where extreme precision is not required.

The position of the friction drive in the photographs is chosen to illustrate clearly the scales and the construction. The normal position is 45° to the right of that shown.

FRICION-DRIVE DIALS

● 4-INCH DIAMETER — TYPE 703 FRICION-DRIVE DIALS*

Type	Shaft Diameter	Dial		Friction-Drive Ratio	Net Weight	Code Word	Price
		Arc	Divisions				
703-A	1/4 in.	180°	100	1:5	8 oz.	DIANT	\$2.00
703-B	1/4 in.	270°	200†	1:5	8 oz.	DIBUT	2.00
703-K	1/4 in.	360°	200†	1:5	8 oz.	DIHOP	2.50
703-L	3/8 in.	360°	200†	1:5	8 oz.	DIHIP	2.50
703-F	3/8 in.	180°	100	1:5	8 oz.	DIFUN	2.00
703-G	3/8 in.	270°	200†	1:5	8 oz.	DIGUM	2.00

● 3 1/4-INCH DIAMETER — TYPE 705 FRICION-DRIVE DIALS*

705-A	1/4 in.	180°	100	1:4	5 oz.	DIARK	\$1.75
705-F	3/8 in.	180°	100	1:4	5 oz.	DIFAL	1.75

● 2 3/4-INCH DIAMETER — TYPE 702 FRICION-DRIVE DIALS*

702-A	1/4 in.	180°	100	1:3.3	4 oz.	DIACK	\$1.75
702-B	1/4 in.	270°	100	1:3.3	4 oz.	DIBOG	1.75
702-F	3/8 in.	180°	100	1:3.3	4 oz.	DIFAG	1.75
702-G	3/8 in.	270°	100	1:3.3	4 oz.	DIGOD	1.75

DIRECT-DRIVE DIALS

● 4-INCH DIAMETER — TYPE 717 DIRECT-DRIVE DIALS

717-A	1/4 in.	180°	100	5 oz.	DIARM	\$1.50
717-B	1/4 in.	270°	200†	5 oz.	DIBAR	1.50
717-K	1/4 in.	360°	200†	5 oz.	DIHUG	2.00
717-L	3/8 in.	360°	200†	5 oz.	DIKEG	2.00
717-F	3/8 in.	180°	100	5 oz.	DIFIT	1.50
717-G	3/8 in.	270°	200†	5 oz.	DIGAR	1.50

● 3 1/4-INCH DIAMETER — TYPE 712 DIRECT-DRIVE DIALS

712-A	1/4 in.	180°	100	3 oz.	DIAPE	\$1.25
712-F	3/8 in.	180°	100	3 oz.	DIFAR	1.25

● 2 3/4-INCH DIAMETER — TYPE 710 DIRECT-DRIVE DIALS

710-A	1/4 in.	180°	100	2 1/2 oz.	DIALY	\$1.25
710-B	1/4 in.	270°	100	2 1/2 oz.	DIBIN	1.25
710-F	3/8 in.	180°	100	2 1/2 oz.	BEFIT	1.25
710-G	3/8 in.	270°	100	2 1/2 oz.	DIGUT	1.25

● 2-INCH DIAMETER — TYPE 701 DIRECT-DRIVE DIALS

701-A	1/4 in.	180°	100	2 oz.	DILAP	\$1.25
701-K	1/4 in.	360°	100	2 oz.	DILUX	1.25

*PATENT NOTICE. See Note 17, page vi.

†Numbered 0 to 100, with half-division points indicated.

TYPE 339 SWITCH

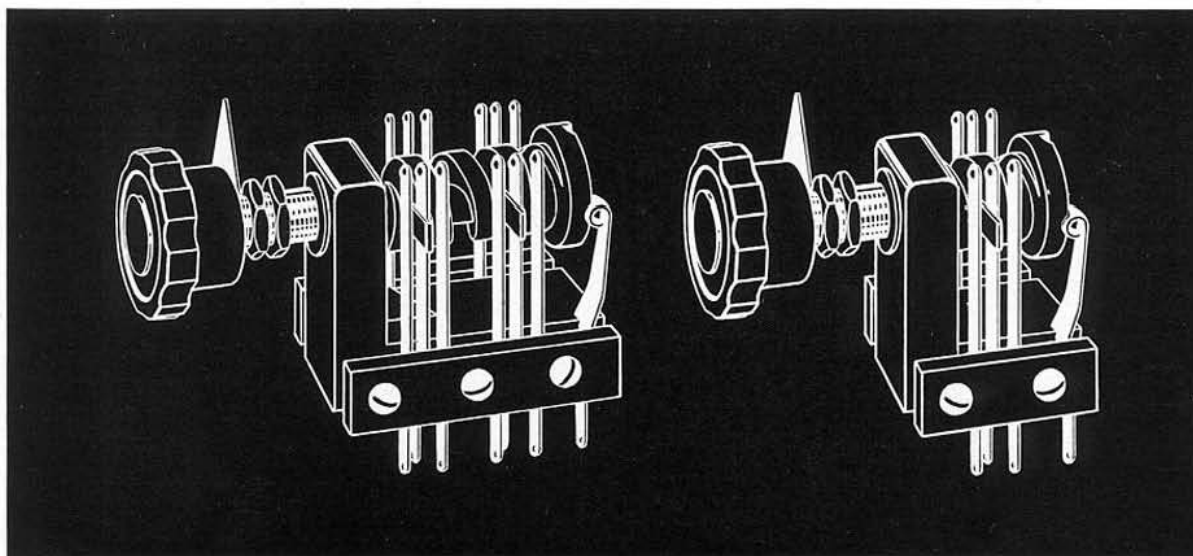

Although this is primarily a double-throw switch, both the movable and the fixed blades can be bent to achieve a wide variety of switching arrangements. For instance, they can be bent to make contact in the center (normally OFF) position, or individual blades can be bent by different amounts so that contacts are made and broken in a definite sequence. Similarly, the duration of contact can be adjusted.

The TYPE 339 Switch is a low-capacitance, high-quality, rotary-action switch that is useful in low-power circuits.

A worm and shaft actuate the nickel-silver blades, and a detent spring locates the switch positions in a positive manner. Actual contact between blades is made on silver-plated contact buttons. The frame and worm shaft are of black bakelite.

SPECIFICATIONS

Insulation: Molded bakelite.

Voltage and Current Rating: The insulation will withstand 250 volts. The maximum current is 2 amperes in a non-inductive circuit. The switch is designed for use in low-power, vacuum-tube circuits.

Dimensions: Panel space required, $1\frac{5}{8} \times 2\frac{3}{8}$ inches; depth behind panel, TYPE 339-A, $2\frac{1}{2}$ inches; TYPE 339-B, $1\frac{7}{8}$ inches.

Terminals: Tinned soldering terminals are an integral part of the switch blades.

Mounting: Single-hole type, $\frac{3}{8}$ -inch diameter. Will fit panels up to $\frac{3}{8}$ inch thick.

Net Weight: TYPE 339-A, $4\frac{1}{4}$ ounces. TYPE 339-B, $3\frac{1}{4}$ ounces.

Type		Code Word	Price
339-A	4-Pole, Double-Throw	PUPPY	\$2.50
339-B	2-Pole, Double-Throw	PUTTY	2.00

DECADE SWITCHES

Decade switches of the type used in General Radio decade-resistance and decade condenser boxes are also available for sale. The TYPE 510-P3, an 11-position rotary switch used in decade-resistance units, is listed on page 27. The TYPE 380-P3 Switch, listed on page 52, is an 11-position rotary switch, designed to give a complete decade of capacitance values by means of parallel combinations of 4 individual condensers.

TYPE 637 FLUTED KNOBS

These molded bakelite knobs are used on nearly all General Radio apparatus. They were chosen from among dozens of preliminary designs as the ones best suited to the requirements of measuring instruments. The smooth fluted knurling affords a positive, cramp-free grip for the most delicate adjustments.

The white pointers are made of non-conducting material, and they can be easily pried off when knobs alone are required. Each knob is provided with two setscrews to insure permanence of setting.

Below are shown the various sizes of TYPE 637 Knob in the order in which they are listed in the price table.

1 1/8-INCH DIAMETER — WITH POINTER

Type	Shaft Diameter	Code Word	Unit Price	Package of 10
637-A	1/4 in.	NURLNOBANT	\$0.30	\$2.10
637-B	3/8 in.	NURLNOBBOY	.35	2.35

Net Weight: 3/4 ounce

1 5/8-INCH DIAMETER — WITH POINTER

Type	Shaft Diameter	Code Word	Unit Price	Package of 10
637-G	1/4 in.	NURLNOBGUN	\$0.35	\$2.35
637-H	3/8 in.	NURLNOBHAT	.35	2.35

Net Weight: 1 1/4 ounces

1 5/8-INCH DIAMETER — WITH 2-INCH SKIRT

Type	Shaft Diameter	Code Word	Unit Price	Package of 10
637-J	1/4 in.	NURLNOBJIM	\$0.40	\$2.75
637-K	3/8 in.	NURLNOBKOP	.45	3.25

Net Weight: 1 1/2 ounces

2 3/8-INCH DIAMETER — WITH POINTER

Type	Shaft Diameter	Code Word	Unit Price	Package of 10
637-P	1/4 in.	NURLNOBPIG	\$0.50	\$3.75
637-Q	3/8 in.	NURLNOBQUO	.50	3.75

Net Weight: 3 ounces

2 3/8-INCH DIAMETER — WITH 3-INCH SKIRT

Type	Shaft Diameter	Code Word	Unit Price	Package of 10
637-R	1/4 in.	NURLNOBRAM	\$0.50	\$3.75
637-S	3/8 in.	NURLNOBSUM	.50	3.75

Net Weight: 3 1/2 ounces

TYPE 637 Knobs are shown approximately one-half actual size in the photographs at the right.

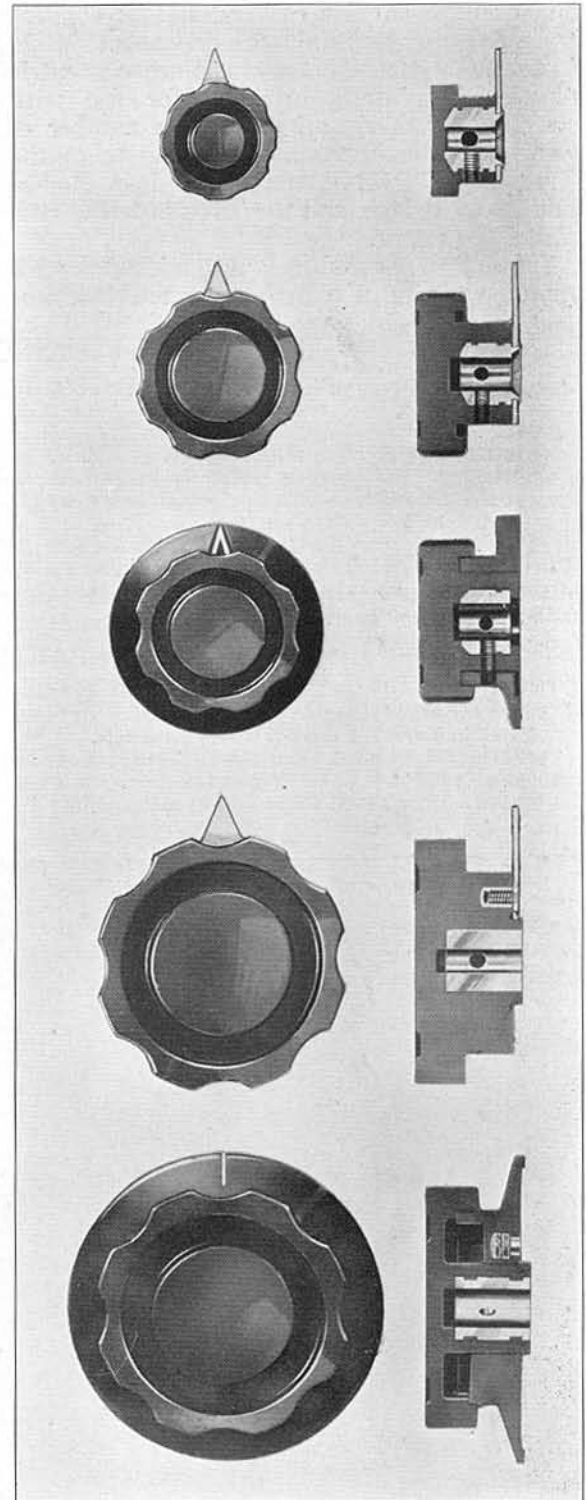

THE QUANTITY DISCOUNTS MENTIONED ON PAGE v ALSO APPLY TO QUANTITIES OF PACKAGES.

TYPE 774 COAXIAL TERMINALS

At high and ultra-high frequencies, the interconnection of the various elements in a measuring system is best accomplished by means of coaxial lines. To obtain maximum benefit from coaxial lines, however, proper terminal equipment is necessary, and for convenience plug-and-jack units are desirable.

TYPE 774 Coaxial Terminals are concentric plug-and-jack units intended for use with coaxial lines. They are used in a number of General Radio instruments, among them the TYPE 821-A Twin-T, the TYPE 916-A Radio-Frequency Bridge, and the TYPE 804-B U-H-F Signal Generator.

In order to reduce impedance mismatch with any line having a different characteristic im-

pedance, TYPE 774 Coaxial Terminals have been made with short internal conductors and with low capacitance. In order to provide as continuous an external shield as possible, lugs have been provided for four connections to the outer shell from the cable sheath at points uniformly distributed around the circumference.

The solid dielectric is polystyrene, which has both a low dielectric constant and a low power factor.

A plug unit and a jack unit are available for mounting on panels, and a similar pair of units for terminating coaxial cables. The plug connector and the jack connector make it possible to join two cables having identical terminations, that is, two plugs or two jacks.

SPECIFICATIONS

Capacitance: For many applications the capacitance of these units is the factor to be considered in determining their suitability. The capacitance for each TYPE 774 Unit is given in the description on the next page. In addition to the total capacitance there is given, for many units, a figure called "insertion capacitance," which is the capacitance added to a circuit when that particular unit is plugged in. This is lower than the total capacitance because of the overlapping when a plug unit is plugged into a jack.

Materials: Metallic parts are of nickel-plated brass; insulation is polystyrene.

Cable: The cable consists of a standard beryllium-copper conductor, separated from a braided tinned-copper shield by Anhydrex A insulation, with an over-all covering of abrasion-resistant rubber. The nominal characteristic impedance is 72 ohms $\pm 10\%$; the nominal capacitance is 26 μmf per foot; and the power factor is 2% or less at 1000 cycles.

Dimensions: All drawings are approximately $\frac{1}{2}$ scale.

Net Weight: See descriptions on next page.

PATCH CORDS

The TYPE 774-R Patch Cords consist of a 3-foot section of concentric-shielded cable (see specifications above) terminated in TYPE 774 Coaxial Cable Terminals.

The TYPE 774-R1 has a TYPE 774-M Cable Jack at one end and a TYPE 774-E Cable Plug at the other. The TYPE 774-R2 has a TYPE 774-M Cable Jack at each end.

Type	Description	Net Weight	Code Word	Price
774-R1	Patch Cord	5 oz.	ACCESSORIM	\$4.00
774-R2	Patch Cord	5 oz.	ACCESSORAT	4.00

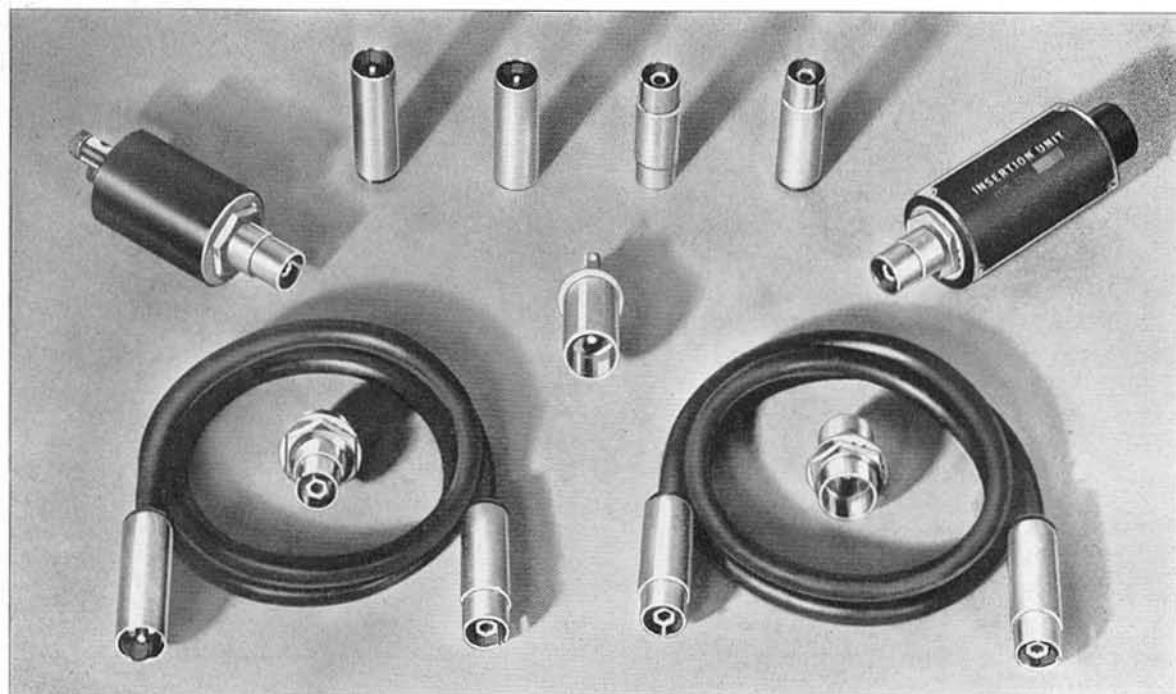

TYPE 774-E CABLE PLUG

This is a plug connector unit for use with concentric shielded cables ($\frac{3}{16}$ inch or less in diameter). The connection of the inner conductor is made by means of a TYPE 274 Plug, while the outer sleeve fits snugly around the split sleeves of the jack terminals or connectors. Four soldering lugs are provided for connecting to the shield of a concentric cable, as is a lug for the inner conductor.

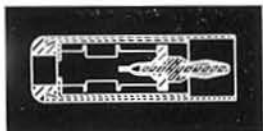

Total Capacitance: 2.5 μ f.
 Insertion Capacitance: 1.4 μ f.
 Net Weight: 1 $\frac{1}{2}$ oz.
 Code Word: ACCESSOEYE
 Price: \$1.50

TYPE 774-M CABLE JACK

This is the jack unit for connecting a concentric cable to a TYPE 774-G Panel Plug. Similar in construction to the cable plug, a recessed stud takes the TYPE 274 Plug, while a split sleeve fits into the outer sleeve of the plug terminals.

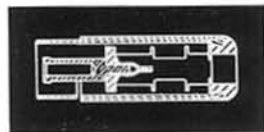

Total Capacitance: 2.8 μ f.
 Insertion Capacitance: 1.7 μ f.
 Net Weight: 1 $\frac{1}{2}$ oz.
 Code Word: ACCESSOMUD
 Price: \$1.50

TYPE 774-P PANEL JACK

A metal stud, supported by a polystyrene strip, is mounted concentrically with the outer shell, and is recessed to receive the TYPE 774 Plug of the plug connector units. The outer conductor is a split sleeve which grounds to the panel on which the jack is mounted. In conjunction with the sleeve of a cable plug or connector unit it very effectively shields the high lead connection.

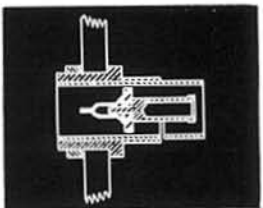

Total Capacitance: 2.8 μ f.
 Insertion Capacitance: 1.7 μ f.
 Net Weight: 1 $\frac{3}{4}$ oz.
 Code Word: ACCESSOPOD
 Price: \$1.00

TYPE 774-G PANEL PLUG

This unit consists of a TYPE 274 Plug mounted axially in the center of a brass shell. The plug is supported on a polystyrene insulating strip which serves to isolate it from the outer conductor. The assembly requires a $\frac{3}{4}$ -inch mounting hole and may be mounted on any panel thickness up to $\frac{1}{2}$ inch. The entire plug assembly is finished with a nickel plate. A tinned soldering terminal is provided for the central plug, while the outer conductor grounds to the metal panel.

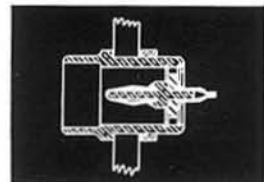

Total Capacitance: 2.4 μ f.
 Insertion Capacitance: 1.3 μ f.
 Net Weight: 1 $\frac{3}{4}$ oz.
 Code Word: ACCESSOGOD
 Price: \$1.00

CONCENTRIC CONNECTORS

To obtain maximum flexibility with the cable and panel terminals described above, it is desirable to have adapters available to connect between two terminals of the same kind. The TYPE 774-F Plug Connector and TYPE 774-N Jack Connector are two-way units designed for this purpose.

The plug connector has a plug terminal at either end and may thus be used to connect a jack-terminated cable to a panel jack, or to connect two cable jacks together. In a similar manner the jack connector makes possible connection of two plug-type terminals.

TYPE 774-N JACK CONNECTOR

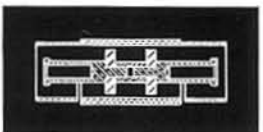

Total Capacitance: 4.2 μ f.
 Insertion Capacitance: 2.0 μ f.
 Net Weight: 1 oz.
 Code Word: ACCESSONUT
 Price: \$1.00

TYPE 774-F PLUG CONNECTOR

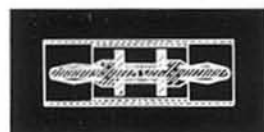

Total Capacitance: 3.6 μ f.
 Insertion Capacitance: 1.3 μ f.
 Net Weight: 1 oz.
 Code Word: ACCESSOFIG
 Price: \$1.00

TYPE 774-X INSERTION UNIT

This unit is designed for housing dummy antennas, impedance-matching networks, attenuators, and similar circuits. It consists essentially of a hollow cylindrical aluminum casting with a plug connector at one end and a jack connector at the other. One side is partially cut away to permit the connection of circuit elements between the two terminals. A nickel-silver nameplate covers this opening, completing the shielding of the high potential terminals.

Total Capacitance: 6.0 μ f.
 Insertion Capacitance: 4.9 μ f.

Type	Net Weight	Code Word	Price
774-X	4 $\frac{1}{2}$ oz.	ACCESSOXEB	\$4.50

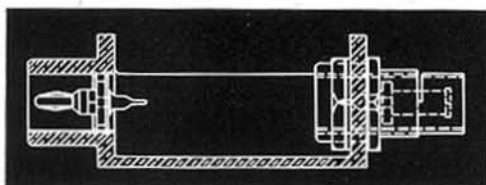

TYPE 774-YB TERMINAL UNIT

This unit provides a shielded housing for terminating resistors, at the same time making the output of a coaxial system available at a pair of $\frac{3}{4}$ -inch spaced binding posts. As shown in the accompanying sketch, it consists of a coaxial jack, a pair of TYPE 138-V Binding Posts, and a metal housing.

Total Capacitance: 5.1 μ f.
 Insertion Capacitance: 4.0 μ f.

Type	Net Weight	Code Word	Price
774-YB	4 oz.	ACCESSOYAM	\$3.50

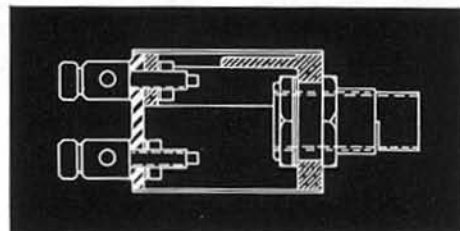

ALL
 DRAWINGS
 ARE $\frac{1}{2}$ SIZE

TYPE 274 PLUGS AND JACKS

The TYPE 274 parts have become almost indispensable in laboratories everywhere as a simple and flexible means of interconnecting equipment in temporary or semi-permanent setups. In addition to being used on all General Radio instruments, they are used by many other manufacturers of laboratory equipment.

JACKS

The basic jack unit is the TYPE 274-J which is made of nickel-plated brass. All TYPE 274-J Jacks are furnished with tinned terminals and nuts. TYPES 274-U and 274-D Plugs and all double plugs are recessed in the top, thus making jacks for other plugs.

SINGLE PLUGS

The TYPE 274-P, the basic unit, consists of a threaded nickel-plated brass stud which is fitted with a beryllium-copper spring. A nut and terminal are furnished. TYPE 274-X is similar to TYPE 274-P, except the stud is not threaded but has a tubular rivet top. TYPE 274-U has a larger threaded stud which is recessed to take a TYPE 274 Plug. TYPE 274-D is similar to TYPE 274-U but has an insulating bakelite sleeve and a thumbscrew.

All plugs will carry a maximum current of 15 amperes on a resistive load.

DOUBLE PLUG

The TYPE 274-M Double Plug consists of two plugs set $\frac{3}{4}$ inch between centers in a molded polystyrene form. The top is recessed, forming a double jack, so that these units can be stacked in parallel. The plugs are drilled to take cord tips, or wire leads, small setscrews being provided for fastening.

The use of polystyrene as the molding material insures high leakage resistance and low dielectric losses. The capacitance between pins is about 1.1 $\mu\mu\text{f}$ at a power factor of less than 0.1%. The direct-current leakage resistance is greater than 10^8 megohms.

SHORT-CIRCUIT PLUG

The TYPE 274-SB Short-Circuit Plug consists of two TYPE 274-U Plugs and a nickel-plated brass bar.

TYPE 274 Plugs and Jacks are shipped unassembled.

THE QUANTITY DISCOUNTS MENTIONED ON PAGE v ALSO APPLY TO QUANTITIES OF PACKAGES.

Type 274-P Plug

A = $\frac{1}{4}$ inch max. C = 6-32
 B = $\frac{1}{8}$ inch max. D = $\frac{3}{8}$ inch
 Code Word: STANPARCAT
 Unit Price \$0.12
 Package of 1090
 Package of 100 6.25
 1000-1999 59.40/M
 2000-19,999 56.25/M

Type 274-J Jack

A = $\frac{3}{8}$ inch hex. B = $\frac{3}{8}$ inch max.
 C = $\frac{1}{4}$ -28
 Code Word: STANPARTOP
 Unit Price \$0.10
 Package of 1055
 Package of 100 3.50
 1000-1999 33.25/M
 2000-19,999 31.50/M

Type 274-X Plug

A = 0.135 inch diam. C = $\frac{3}{16}$ inch
 B = $\frac{3}{16}$ inch D = $\frac{1}{2}$ inch
 Code Word: STANPARTIN
 Unit Price \$0.10
 Package of 1060
 Package of 100 4.25
 1000-1999 40.40/M
 2000-19,999 38.25/M

Type 274-U Plug

A = $\frac{3}{8}$ inch hex. nut C = $\frac{1}{4}$ -28
 B = $\frac{3}{8}$ inch max. D = $\frac{1}{4}$ inch
 Code Word: STANPARGOT
 Unit Price \$0.15
 Package of 10 1.00
 Package of 100 8.00

Type 274-D Insulated Plug

A = $\frac{1}{2}$ inch B = $\frac{7}{8}$ inch
 Code Word: STANPAREYE
 Unit Price \$0.25
 Package of 10 2.25

Type 274-M Double Plug

A = $1\frac{3}{8}$ inches B = $1\frac{13}{16}$ inches
 Code Word: STANPAR
 Unit Price \$0.50
 Package of 10 3.50

Type 274-SB Short-Circuit Plug

A = $1\frac{1}{2}$ inches B = $1\frac{5}{16}$ inches
 Code Word: STANPARZIP
 Unit Price \$0.65

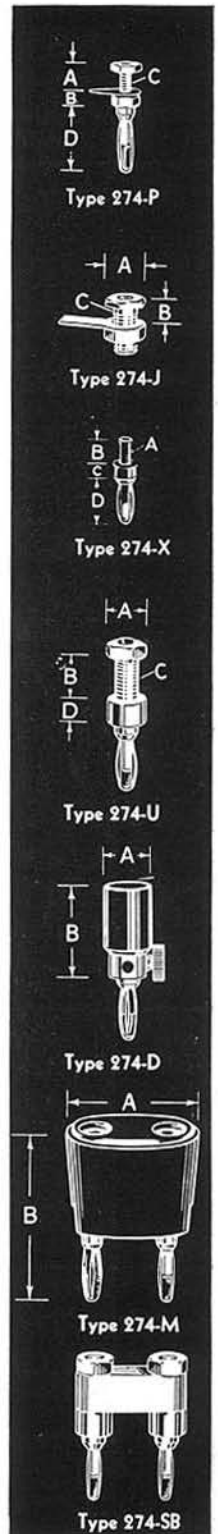

PANEL TERMINAL INSULATORS

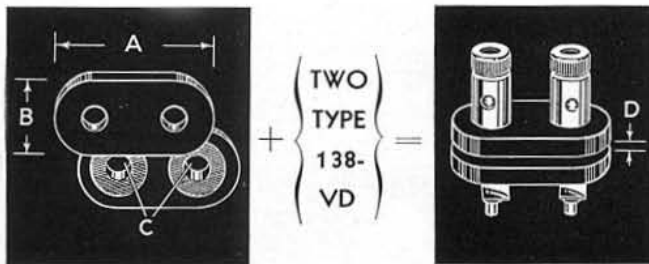

The terminal insulators are designed for mounting a pair of TYPE 138-VD Binding Posts on a metal panel so that both terminals are insulated from the panel. They are available both in black bakelite and in low-loss yellow bakelite.

A = 1 1/2 inches
 B = 3/4 inch
 C = 3/16 inch diam.
 D = 1/8 inch to 3/16 inch

Type	Bakelite Material	Net Weight	Code Word	Price	
				Pair	Package of 10 Pairs
274-Y	Black	1/2 oz. per pair	STANPARBEL	\$0.20	\$1.35
274-Z	Yellow (low-loss)	1/2 oz. per pair	STANPARHOD	.30	2.10

TYPE 274-ND SHIELDED PLUG

This assembly consists of a pair of TYPE 274 Plugs mounted at standard 3/4-inch spacing on a yellow bakelite support. A black finish drawn-aluminum shield fits over the plugs and is connected to the ground terminal. The assembly is designed to plug into and over a pair of TYPE 138-VD Binding Posts, mounted on a metal panel by means of the TYPE 274-Y or -Z Insulators. The aluminum cap fits snugly against

the metal panel, completely shielding the connection.

Type	Net Weight	Code Word	Price
274-ND	2 oz.	STAPLUGDOG	\$1.50

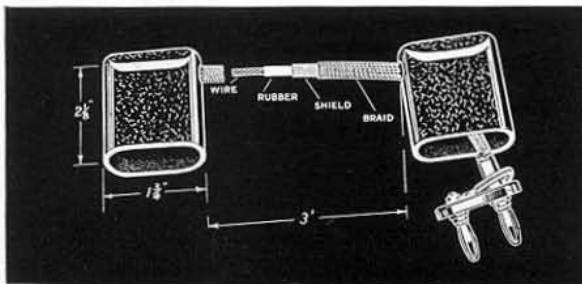

TYPE 274-NE SHIELDED CONNECTOR

The TYPE 274-NE Shielded Connector consists of a pair of TYPE 274-ND Shielded Plugs with a 3-foot length of shielded concentric cable. The cable has a characteristic impedance of about 40 ohms and the total capacitance of the assembly is of the order of 160 μμf.

This connector is useful in high-frequency work and in measurements where the utmost precautions in regard to shielding must be observed.

Type	Net Weight	Code Word	Price
274-NE	5 3/4 oz.	STAPLUGEYE	\$4.00

TYPE 274-NC SHIELDED CONNECTOR

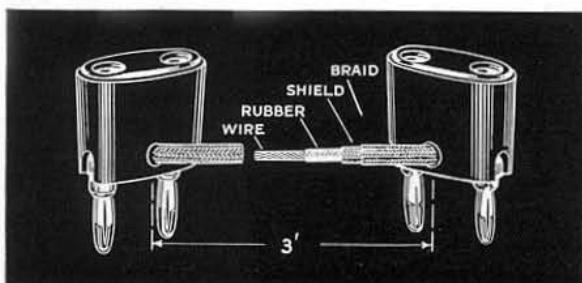

This assembly is similar to the TYPE 274-NE except that the plugs are the standard TYPE 274-M Double Plug. It is useful in applications where the shielding requirements are not sufficiently severe to justify the use of the TYPE 274-NE but where unshielded leads cannot safely be used.

Type	Net Weight	Code Word	Price
274-NC	2 3/4 oz.	STANPARZOO	\$1.50

TYPE 674 JUMBO PLUGS AND JACKS

USES: These are rugged, heavy-duty parts designed for use in circuits carrying relatively large currents. They make safe and convenient connectors for currents of 35 amperes or less.

The TYPES 674-P and 674-J are very useful as the plug and jack elements for plug-in units, such as oscillator coils.

DESCRIPTION: Except for size, these parts are very similar in design to the TYPE 274

Plugs and Jacks. Nickel-plated brass is used in the construction except for the plug springs, which are made of specially tempered beryllium copper.

The TYPE 674-C has a solder-filled shank for sweating in 1/4-inch tubing, while the TYPE 674-D has an insulated shank and a soldering lug. The TYPES 674-P and 674-J are supplied with nuts and tinned soldering terminals.

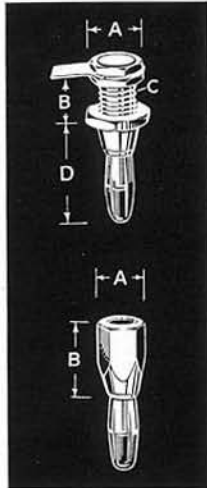

Type 674-P Jumbo Plug
 A = 3/4 inch C = 3/8-32
 B = 5/16 inch D = 1 3/16 inches
 Code Word: STANPARAPE
 Unit Price \$0.30
 Package of 10 1.75

Type 674-C Jumbo Plug
 A = 1/2 inch B = 3/4 inch
 Code Word: STANPARCOX
 Unit Price \$0.25
 Package of 10 1.50

Type 674-D Insulated Jumbo Plug
 A = 3/4 inch B = 1 1/16 inches
 Code Word: STANPARARK
 Unit Price \$0.50
 Package of 10 4.00

Type 674-J Jumbo Jack
 A = 3/4 inch B = 9/16 inch max.
 C = 1/2-20
 Code Word: STANPARAYE
 Unit Price \$0.30
 Package of 10 1.65



THE QUANTITY DISCOUNTS MENTIONED ON PAGE v ALSO APPLY TO QUANTITIES OF PACKAGES.

TYPE 119 RADIO-FREQUENCY CHOKE

USES: TYPE 119 Choke is useful not only as a radio-frequency choke in vacuum-tube circuits, but also as an inductance element in filters and tuned circuits.

DESCRIPTION: The winding is the so-called helical type, composed of a large number of thin, spiral-wound pies. TYPE 119-B uses a dust-type core. The coil is mounted in a molded bakelite housing which is effectively sealed against moisture penetration.

FEATURES: There is only one significant point of resonance, all minor resonances being practically eliminated by the method of winding and assembling. The shunt capacitance is low, so that the choke can be used at frequencies as high as 40 megacycles. The use of an iron-dust core in TYPE 119-B makes possible a high-inductance unit with very little increase in capacitance and resistance. The capacitance and conductance of this choke as a function of frequency are shown on page 69.

SPECIFICATIONS

Accuracy of Inductance: ±20%.
Maximum Current: 60 ma.
Dimensions: (Height) 2 inches; for base dimensions, see sketch.
Net Weight: TYPE 119-A, 2 1/2 oz.; TYPE 119-B, 3 oz.

Type	Inductance	Capacitance	D-C Resistance
119-A	0.25 h	4 μmf	450 Ω
119-B	0.5 h	5 μmf	450 Ω

At the left is a view of the TYPE 119 Choke and at the right a sketch of the base dimensions.

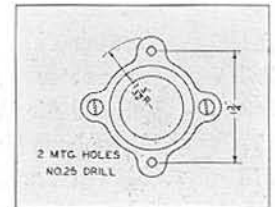
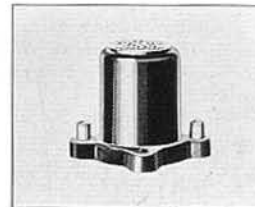

Type	Code Word	Price
119-A	Radio-Frequency Choke.....	\$1.50
119-B	Radio-Frequency Choke.....	2.00

INDEX BY TYPE NUMBER

<i>Type</i>	<i>Name</i>	<i>Page</i>	<i>Type</i>	<i>Name</i>	<i>Page</i>
50	Variac	20, 21	614-C	Selective Amplifier	141
50	Ganged Variacs	21, 22	616-D	Heterodyne Frequency Meter	134
50-P1	Choke	22	617-C	Interpolation Oscillator	136
100	Variac	20, 21	619-E	Heterodyne Detector.	140
100	Ganged Variacs	21, 22	620-A	Heterodyne Frequency Meter and Calibrator	142
106	Standard Inductance.	53	621	Power Stroboscope	7
107	Variable Inductor.	54	631-B	Strobotac	2
119	Radio-Frequency Choke.	163	637	Fluted Knobs	157
138	Binding Posts	160	648-A	Strobolux	4
138	Switch Contacts and Stops	160	650-A	Impedance Bridge	72
200	Variacs.	20	651-AE	Oscillograph Recorder	104
200	Ganged Variacs	21, 22	663	Resistor	32
214-A	Voltage Divider—Rheostat	36	667-A	Inductance Bridge	78
219	Decade Condenser	50	668	Compensated Decade-Resistance Unit	29
249	Attenuation Box	31	670	Compensated Decade Resistor	28
274	Panel Terminal Insulators	162	674	Plugs and Jacks	163
274	Plugs and Jacks	161	675-P	Piezo-Electric Oscillator	130
274	Shielded Plugs and Cables	162	690-D	Piezo-Electric Oscillator	127
301-A	Voltage Divider—Rheostat	37	691-C	Temperature-Control Box	127
314-A	Voltage Divider—Rheostat	37	692-B	Multivibrators	133
318	Dial Plates	153	693-B	Synchrometer	127
339	Switch	156	694-C	Control Panel	127
368	Variable Air Condenser	46	695-B	Battery Charging Panel	127
371	Voltage Divider—Rheostat	36	696-C	A-C Power Supply	127
380	Decade-Condenser Unit	51	698-A	Duplex Multivibrator	133
471-A	Voltage Divider—Rheostat	37	699-A	Comparison Oscilloscope.	138
483-F	Output Meter.	117	700-A	Wide-Range Beat-Frequency Oscil- lator	90
500	Resistor	38	700-P1	Voltage Divider	91
505	Condenser	48	701	Direct-Drive Dial.	155
509	Standard Condenser	47	702	Friction-Drive Dial	155
510	Decade-Resistance Unit	26	703	Friction-Drive Dial	155
519-A	Dial Lens	153	704	Precision Dial.	152
520-A	Dial Lock	153	705	Friction-Drive Dial	155
522-A	Dial Plate	153	706	Precision Dial.	152
530	Band-Pass Filter	108	710	Direct-Drive Dial.	155
539	Variable Air Condenser	45	712	Direct-Drive Dial.	155
544-B	Megohm Bridge	83	715-A	Direct-Current Amplifier	16
546-B	Microvolter	120	716-B	Capacitance Bridge	66
549	Contactoer	5	717	Direct-Drive Dials	155
561-D	Vacuum-Tube Bridge	81	720-A	Heterodyne Frequency Meter	144
566-A	Wavemeter	148	722	Precision Condenser	41-43
568	Variable Air Condenser	44	723	Vacuum-Tube Fork	98
572-B	Microphone Hummer	100	723-P1	Power Supply.	98
578	Shielded Transformer.	79	724-A	Precision Wavemeter.	149
583-A	Output-Power Meter.	118	726-A	Vacuum-Tube Voltmeter	110
602	Decade-Resistance Box	24			
608-A	Oscillator	94			
612	Coupling Panel	139			

INDEX BY TYPE NUMBER (continued)

<i>Type</i>	<i>Name</i>	<i>Page</i>	<i>Type</i>	<i>Name</i>	<i>Page</i>
726-P1	Multiplier	112	774	Coaxial Connectors (Terminals)	158
727-A	Vacuum-Tube Voltmeter	112	783-A	Output-Power Meter.	119
728-A	D-C Vacuum-Tube Voltmeter	114	805-B	Standard-Signal Generator	86
729-A	Megohmmeter.	115	813-A	Oscillator	99
736-A	Wave Analyzer	102	815	Precision Fork	146
740-B	Capacitance Test Bridge.	74	816-A	Vacuum-Tube Fork	147
740-BG	Capacitance Test Bridge.	76	821-A	Twin-T Impedance-Measuring Circuit	68
758-A	Wavemeter	150	830	Wave Filters	106
759-B	Sound-Level Meter	8	857-A	U-H-F Oscillator	92
759-P35	Vibration Pickup	10	869-A	Pulse Generator	96
759-P36	Control Box	10	913-B	Beat-Frequency Oscillator	88
759-P50	Power Supply	10	916-A	Radio-Frequency Bridge.	70
760-A	Sound Analyzer	11	1530-A	Microflash	6
761-A	Vibration Meter	13	1861-A	Megohmmeter	116
762-B	Vibration Analyzer	15			

INDEX BY TITLE

<i>Page</i>	<i>Page</i>
Adjustable attenuator	31
Adjustable transformer (Variac)	18-22
Air condensers	41-46
Alternating-current meter	110, 112, 117, 118, 119
Amplifier	16, 141
direct-current	16
selective	141
Analyzer, sound	11
noise	11
vibration	15
wave	102
Attenuation box	31
Attenuator, adjustable	31
Audio-frequency oscillator	88, 90, 94, 98-100
Band-pass filter	106, 108
Beat-frequency oscillator	88, 90, 136
wide-range	90
Binding posts and assemblies	160
Bridges	57-83
Bridge transformer	79
Bridge, capacitance	66, 68, 70, 72, 74, 76
capacitance test	74, 76
high-resistance	83
Bridge, impedance	72
inductance.	72, 78
megohm	83
power-factor	66, 72, 74, 76
radio-frequency	68, 70
resistance	70, 72, 83
Schering	66
vacuum-tube	81
Cable jack	158
plug	158
shielded	158, 162
Calibrator, piezo-electric	142
Capacitance bridge.	66, 68, 70, 72, 74, 76
Capacitance test bridge	74, 76
Capacitors	39-52
Choke, radio-frequency	163
Coaxial connectors.	158
Comparison oscilloscope	138
Compensated decade-resistance unit	29
decade resistor	28
Condenser, air dielectric	41-46
decade	50, 51
fixed	47, 48
mica dielectric.	47, 48, 50, 51
paper dielectric	50, 51
precision	41-43
standard	41-43, 47
Contact, stroboscope	5
hand	5
Contacts, switch	160
Copper-oxide rectifier voltmeter	117
Cord, patch.	158, 162
Coupling panel.	139
Decade condenser	50
-condenser unit	51
-resistance box	24
-resistance unit	26
-resistance unit, compensated	29
Detector, heterodyne	140
Dial, direct-drive	155
friction-drive	152, 155
lens.	153
lock.	153
plates	153
precision	152
Direct-current amplifier	16
Direct-current vacuum-tube voltmeter	114

INDEX BY TITLE (continued)

	<i>Page</i>		<i>Page</i>
Filter, band-pass	106, 108	Oscillators	86-100
high-pass	106	Oscillator, audio	88, 90, 94, 98-100, 136
low-pass	106	beat-frequency	88, 90, 136
wave	106, 108	electro-mechanical	98, 99, 100
Flash, high speed	6	interpolation	136
Fork, precision	146, 147	inverse feedback	94
vacuum-tube driven	98, 147	piezo-electric	127, 130
Frequency-measuring equipment	121-150	radio-frequency	86, 90, 92
Frequency meter, heterodyne	134, 142, 144	resistance-capacitance-tuned	94
Frequency standard	126, 130, 144, 147	tuning-fork-driven	98, 99, 146, 147
Friction-drive dial	152, 155	ultra-high frequency	92
 		Oscillograph recorder	104
Generator, standard-signal	86	Oscilloscope, comparison	138
Generator, pulse	96	Output meter	117
 		power meter	118, 119
Hand contactor	5	 	
Harmonic analyzer	11, 13, 102	Panel jack, coaxial	158
Heterodyne detector	140	plug, coaxial	158
frequency meter	134, 142, 144	terminal insulators	162
High-speed recorder	104	Parts and accessories	151-163
Hummer, microphone	100	Patch cord	158, 162
 		Pickup, vibration	10
Impedance bridge	72	Piezo-electric oscillator	127, 130
Impedance-measuring network, Twin-T	68	Plate, dial	153
Inductance bridge	72, 78	Plug connector, coaxial	158
standard	53	Plugs and jacks	158, 161, 163
Inductors	53, 54, 163	Power meter, output	118, 119
Inductor, variable	54	stroboscope	7
Industrial instruments	2-22	Precision condenser	41-43
Insertion unit, coaxial	158	dial	152
Insulated plugs	161	fork	146, 147
Insulators, panel terminal	162	wavemeter	147
Interpolation equipment	128, 131	Primary frequency standard	126
oscillator	136	Pulse generator	96
Inverse feedback oscillator	94	 	
 		Radio-frequency bridge	68, 70
Jack connector, coaxial	158	choke	161
Jacks and plugs	158, 161, 163	oscillator	86, 90, 92
Jumbo jacks	163	Resistance box, decade	24, 28
plugs	163	bridge	72, 76, 82
 		unit, compensated decade	29
Knobs, fluted	157	unit, decade	26
 		Resistance-capacitance-tuned oscillator	94
Lens, dial	153	Resistors	23-38
Lock, dial	153	Resistor, compensated decade	28, 29
Losses in air condensers	40	decade	24, 26
 		fixed	32, 38
Megohm bridge	83	high-frequency	32
meter	115, 116	Rheostat—voltage divider	34-37
Meters	110-120	 	
Meter, alternating-current	110-120	Schering bridge	66
battery-operated	112-115	Secondary frequency standard	130
heterodyne frequency	134, 142, 144	Selective amplifier	141
megohm	115, 116	Shielded conductors	158, 162
noise	8	plug and cable	158, 162
output	117	transformer	79
output-power	118, 119	Signal generator, standard	86
sound-level	8	Sound analyzer	11
vibration	13	Sound-level meter	8
Microflash	6	Standard condenser	41-43, 47
Microphone hummer	100	inductance	53
Microvolter, audio-frequency	120	mutual inductance	54
Multivibrators	133	primary frequency	126
Mutual inductance standard	54	secondary frequency	130
 		-signal generator	86
Network, attenuation	31	Strobolux	4
Noise meter	8	Stroboscope	2-6
 		recorder	105
		Strobotac	2
		Strobotron	3

INDEX BY TITLE (continued)

	<i>Page</i>		<i>Page</i>
Switch contacts and stops	160	Vacuum-tube bridge	81
Switches	156	driven fork	98, 147
Synchronous-motor contactor	5	voltmeter	110, 112, 114
Synchrometer	127	voltmeter, d-c	114
		Variable air condenser	41-46
Temperature-control box	127	inductor	54
Terminal insulators, panel	162	Variac	18-22
Terminal unit, coaxial	158	Variometer	54
Test bridge, capacitance	74, 76	Vibration analyzer	15
Thermometers	137	Vibration meter	13
Thermostats	137	pickup	10
Transformer, adjustable (Variac)	18-22	Voltage divider	34-37
bridge	79	Voltmeter, oxide-rectifier	117
shielded	79	vacuum-tube	110, 112, 114
Tuning fork, precision	146, 147		
vacuum-tube driven	98, 147	Waveform-measuring instruments	11, 102
Tuning-fork oscillators	98, 99, 146, 147	Wave analyzer	11, 102
Twin-T impedance-measuring network	68	filter	106, 108
		Wavemeters (see also Frequency meter, hetero- dyne)	148-150
U-H-F Heterodyne frequency meter	144	precision	149
U-H-F Oscillator	92	Wide-range beat-frequency oscillator	90
U-H-F wavemeter	150		

QUICK INDEX

iv HOW TO ORDER
2 INDUSTRIAL INSTRUMENTS
24 RESISTORS
40 CAPACITORS
52 INDUCTORS
58 BRIDGES AND ACCESSORIES
86 STANDARD-SIGNAL GENERATORS AND OSCILLATORS
102 WAVEFORM-MEASURING INSTRUMENTS
110 METERS
122 FREQUENCY-MEASURING INSTRUMENTS
150 PARTS AND ACCESSORIES
164 INDEX BY TYPE NUMBER
164 INDEX BY TITLE



Above—Development work on an experimental standard-signal generator.



Above—Calibrating Type 724-A Precision Wavemeters in the standardization laboratory.
Below—Analyzing fan noise with the Type 760-A Sound Analyzer.

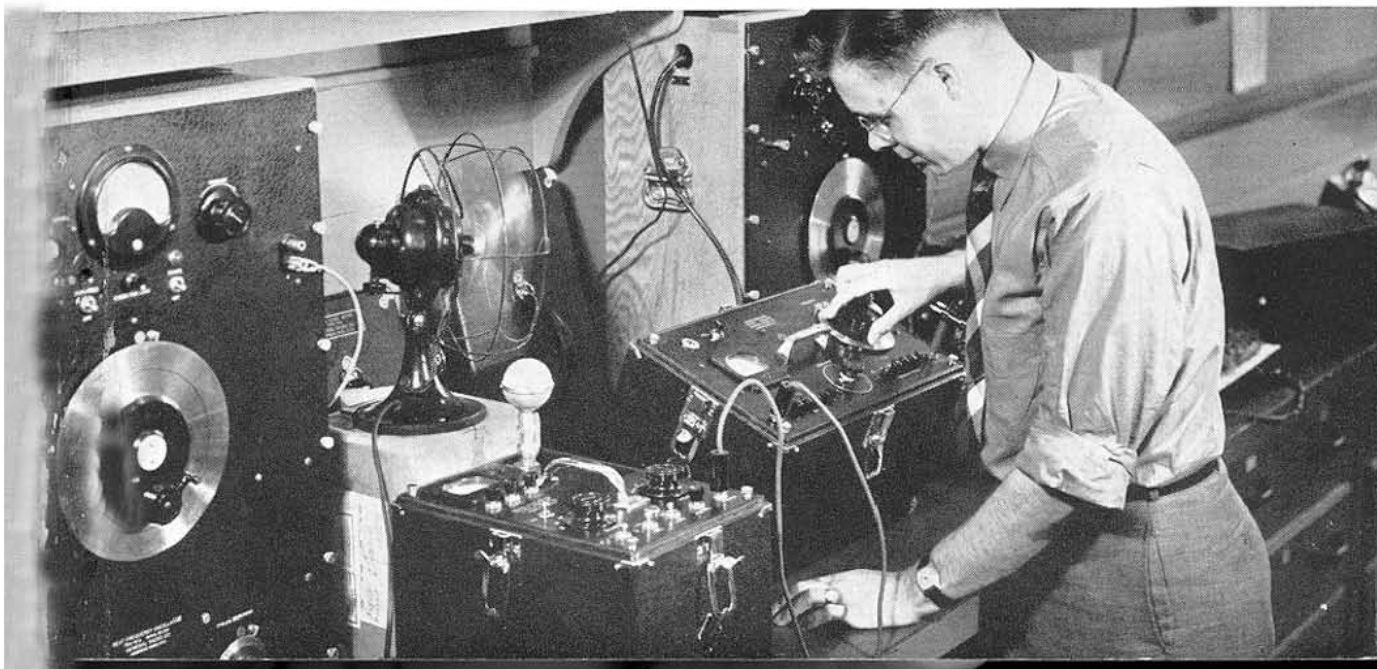



CATALOG K
FOURTH EDITION

1945

BEAT-FREQUENCY OSCILLATOR
SERIAL NO. 813
TYPE T10-B
GENERAL RADIO CO.
CAMBRIDGE MASS. U.S.A.

CYCLES INCREMENT

ADD 20K₂