

VOLUME I

TECHNICAL MANUAL

FOR

MODEL 6675A

AUTOMATIC DIRECT-CURRENT-COMPARATOR

RESISTANCE BRIDGE

NOTICE

The contents and information contained in this manual are proprietary to Guildline Instruments. They are to be used only as a guide to the operation and maintenance of the equipment with which this manual was issued and may not be duplicated or transmitted by any means, either in whole or in part, without the written permission of Guildline Instruments.

VOL I TM6675A-C-00
January 30, 2001

TABLE OF CONTENTS

1. INTRODUCTION	1-1
1.1. MODEL 6675A AUTOMATIC DIRECT-CURRENT-COMPARATOR RESISTANCE BRIDGE GENERAL DESCRIPTION	1-1
1.2. PANEL FRONT TERMINALS/CONTROLS	1-1
1.2.1. Reference Resistor Input Terminals	1-1
1.2.2. Resistor Under Test Input Terminals	1-1
1.2.3. Numeric Keypad	1-1
1.2.4. Special Keys	1-2
1.2.4.1. Cursor Movement Keys	1-2
1.2.4.2. Function Keys	1-2
1.2.5. Display	1-2
1.2.6. High Voltage Out Terminals	1-2
1.2.7. Program Out Terminals	1-2
1.2.8. Extender In Terminals	1-3
1.2.9. Ground Terminals	1-3
1.2.10. Guard Terminals	1-3
1.3. REAR PANEL CONNECTORS/CONTROLS	1-4
1.3.1. Chart Recorder Output	1-4
1.3.2. IEEE-488 Interface	1-4
1.3.3. RS232 Interface	1-4
1.3.4. Sync Output	1-4
1.3.5. Line Input Voltage Selector	1-4
1.3.6. Line Input Connector	1-4
1.3.7. Power Switch	1-5
2. PERFORMANCE SPECIFICATIONS	2-1
2.1. GENERAL SPECIFICATIONS	2-1
2.2. GENERAL SPECIFICATIONS (continued)	2-2
2.3. RESISTANCE MEASUREMENT SPECIFICATIONS	2-3
2.4. TEMPERATURE MEASUREMENT SPECIFICATION	2-4
3. OPERATING INSTRUCTIONS	3-1
3.1. PRELIMINARIES	3-1
3.1.1. Rackmount Bracket	3-1
3.2. WARNING	3-2
3.3. OPERATING PROCEDURE	3-4
3.4. GENERAL KEY/DISPLAY OPERATIONS	3-7
3.4.1. Base Menu	3-7
3.4.1.1. Base Menu Display	3-7

3.5.	BASIC MENU OPERATIONS	3-8
3.5.1.	Menu Option - <MEASURE>	3-8
3.5.2.	Menu Option - <any other menu but measure>.....	3-9
3.5.3.	Base Edit/Select Menu - one column of data.....	3-10
3.5.4.	Base Edit/Select Menu - two columns of data.....	3-10
3.5.5.	Operation of Select/Edit Data Menus	3-10
3.5.5.1.	Function - <Screen ?>	3-10
3.5.5.2.	Function - <Select>	3-11
3.5.5.3.	Function - <Ok>	3-11
3.6.	TITLE SCREEN	3-12
3.7.	MAIN MENU.....	3-13
3.7.1.1.	<Measure> MENU Fn-1 (MAIN) Page 1 of 3	3-14
3.7.1.2.	<Measure> MENU Fn-1 (MAIN) Page 2 of 3	3-16
3.7.1.3.	<Measure> MENU Fn-1 (MAIN) Page 3 of 3	3-17
3.7.2.	<Setup> MENU Fn-2 (MAIN)	3-18
3.7.2.1.	<Load> MENU Fn-1 (Setup_MAIN).....	3-18
3.7.2.2.	<Edit> Resistors MENU Fn-2	3-20
3.7.2.3.	<Save> MENU Fn-3 (Resistors_Setup_MAIN)	3-32
3.7.3.	<Voltmeter> MENU Fn-1 (MAIN)	3-34
3.7.4.	<Sofcal> MENU Fn-4 (MAIN)	3-36
3.7.4.1.	<GPIB> MENU Fn-1 (Sofcal_MAIN).....	3-37
3.7.4.2.	<RS232> MENU Fn-2 (Sofcal_MAIN).....	3-38
3.7.4.3.	<Voltmeter> MENU Fn-3 (Sofcal_MAIN).....	3-40
3.7.4.4.	<Diagnostic> MENU Fn-1 (Sofcal_MAIN)	3-42
3.7.4.5.	<Selftest> MENU Fn-2 (Sofcal_MAIN).....	3-45
3.7.4.6.	<Chart> MENU Fn-3 (Sofcal_MAIN)	3-46
3.7.4.7.	<Filter> MENU Fn-1 (Sofcal_MAIN)	3-47
3.7.4.8.	<Datum> MENU Fn-2 (Sofcal_MAIN).....	3-47
3.7.4.9.	<PASSWORD> MENU Fn-3 (Sofcal_MAIN).....	3-48
3.8.	MEASUREMENT OPERATION GUIDE	3-49
3.8.1.	Introduction	3-49
3.8.2.	Resistance Measurement Normal Ohms - $1\text{ m}\Omega \leq R_s \leq 10\text{ k}\Omega$	3-49
3.8.2.1.	General Procedures.....	3-52
3.8.3.	Resistance Measurement - High Ohms - $100\text{ k}\Omega \leq R_s \leq 100\text{ M}\Omega$; $R_x \leq 1\text{ G}\Omega$	3-56
3.8.3.1.	High Ohms Measurements - General Procedures.....	3-56
3.8.4.	Resistance Measurement - Low Ohms.	3-61
3.8.4.1.	General Procedures Using Guildline High Current Range Extenders.	3-62
3.8.5.	Thermometry Measurements.	3-65
3.8.6.	Summary of Recommended Test Setups	3-67
3.9.	6675A DATA ACQUISITION SOFTWARE	3-69
4.	THEORY OF OPERATION.....	4-1
4.1.	THEORY I INTRODUCTION	4-1
4.1.1.	The automatic direct-current-comparator resistance bridge.....	4-2
4.1.1.1.	The manual bridge - background.	4-2
4.1.2.	The automatic bridge.....	4-3
4.1.3.	Automatic direct-current-comparator bridge balance.....	4-5
4.2.	THEORY II RESISTANCE MEASUREMENT - 9975 BACKGROUND.....	4-8
4.2.1.	Theory II 6675A.....	4-9
4.2.2.	6675A Servo Circuit.....	4-13

4.2.3.	6675A Primary Current I_x	4-13
4.2.3.1.	Low- Ω Measurement Mode	4-13
4.2.3.2.	Normal- Ω Measurement Mode	4-14
4.2.3.3.	High- Ω Measurement Mode	4-14
4.2.4.	6675A Signal Acquisition	4-17
4.2.5.	6675A Measurement Cycle - 4-Terminal "Normal- Ω "	4-19
4.2.6.	Graphical Representation of Turns Switching and nV readings	4-21
4.3.	NANOVOLT DETECTOR CPU OPTIONS	4-23
4.3.1.	Dip Switches	4-23
4.3.1.1.	Option Switch 1 - 50/60 Hz Select	4-23
4.3.1.2.	Option Switches 2 to 8 - ADC Beta	4-23
4.3.2.	Nanovolt Detector Principles of Operation.	4-24
4.3.2.1.	Introduction.	4-24
4.3.2.2.	Nanovolt Detector Power Supply (19103.01.02)	4-24
4.3.2.3.	Nanovolt Detector CPU PCB (19855.01.02)	4-24
4.3.2.4.	Analog Interface	4-25
4.3.2.5.	Central Processing Unit	4-25
4.3.2.6.	Memory	4-26
4.3.2.7.	Serial Fibre-Optic Communication Interface	4-26
4.3.2.8.	Gpib Interface	4-26
4.3.3.	Analog To Digital (A/D) Converter (19502.01.02)	4-26
4.3.3.1.	Voltage To Current (V/I) Converter.	4-28
4.3.3.2.	High Speed Low Noise Current Buffer.	4-28
4.3.3.3.	Precision References.	4-28
4.3.3.4.	Precision Current Sink	4-28
4.3.3.5.	Current Mode Switch.	4-28
4.3.3.6.	Start/Stop Integrator Switch.	4-28
4.3.3.7.	The Integrator.	4-29
4.3.3.8.	Charge Balance Sampler.	4-29
4.3.3.9.	Master Clock	4-29
4.3.3.10.	Conversion Timer	4-29
4.3.3.11.	Interconversion Pause.	4-29
4.3.3.12.	A/D Trigger.	4-30
4.3.3.13.	12 BIT A/D Converter	4-30
4.3.4.	Nanovolt Detector Input Amplifier PCB (19503.01.02)	4-30
4.3.4.1.	High Input Impedance Low Noise Amplifier	4-30
4.3.4.2.	Input And Range Selection.	4-31
4.3.4.3.	Charge Pump.	4-31
4.3.4.4.	Attenuator	4-31
4.3.4.5.	Power Supplies.	4-31
4.3.4.6.	Overload Protection	4-31
4.3.5.	Nanovolt Detector Software	4-32
5.	REMOTE CONTROL	5-1
5.1.	INTERFACES	5-1
5.2.	IEEE-488 (GPIB) INTERFACE	5-1
5.2.1.	Controller.	5-2
5.2.2.	IEEE-488 Responses.	5-2
5.2.3.	Interconnecting Cable And IEEE-488 Connector.	5-2
5.2.4.	Typical System.	5-2
5.2.5.	Address And Talk/Listen Selection.	5-3
5.2.6.	IEEE-488 Electrical Interface.	5-3
5.2.7.	IEEE-488 Input Buffering	5-3

5.2.8.	IEEE-488 Output Buffering.....	5-5
5.2.9.	IEEE-488 Deadlock.....	5-5
5.3.	RS232C INTERFACE.....	5-6
5.3.1.	RS232C - Pin Designations.....	5-7
5.3.2.	RS232C Responses.....	5-7
5.4.	COMMAND LANGUAGE.....	5-8
5.4.1.	General Syntax For Commands.....	5-8
5.4.2.	General Syntax For Numbers.....	5-8
5.5.	REMOTE AND LOCAL OPERATION.....	5-8
6.	CALIBRATION.....	6-1
6.1.	TEST EQUIPMENT.....	6-1
6.2.	RATIO 1:1 Using Model 9330 / 1 Ω to Model 9330 / 1 Ω.....	6-1
6.3.	RATIO 1:1 Using Model 9330 / 10 kΩ to Model 9350 / (10 kΩ Configuration).....	6-1
6.4.	RATIO 10:1.....	6-2
1.1.1.	Model 9330 /10 k Ω to Model 9350 /(100 k Ω Configuration).....	6-2
6.4.2.	Model 9350 /(1K Ω Configuration) to Model 9330 /10 k Ω	6-2
6.5.	RATIO 1:1.....	6-1
6.5.1.	Model 9330 /100 M Ω to Model 9330 /100 M Ω	6-1
7.	MAINTENANCE.....	7-1
7.1.	INTRODUCTION.....	7-1
7.1.1.	Error Messages.....	7-1
7.1.2.	6675A Warnings.....	7-2
7.1.3.	Nanovolt Detector Calibration.....	7-3
7.1.3.1.	Introduction.....	7-3
7.1.3.2.	Nanovoltmeter Calibration.....	7-3
7.1.3.3.	ADC Beta.....	7-4
7.1.4.	Disassembly Procedure.....	7-5
7.1.4.1.	Cover Removal Procedure.....	7-5
7.1.4.2.	Primary Current Drive Module (19327) Removal Procedure.....	7-5
7.1.4.3.	Servo-loop Module (19328) Removal Procedure.....	7-6
7.1.4.4.	PDCC Comparator Module (19121) Removal Procedure.....	7-7
7.1.5.	Reassembly Procedure.....	7-8
7.2.	TROUBLESHOOTING.....	7-8
7.2.1.	Introduction.....	7-8
7.2.2.	Power Up.....	7-8
7.2.3.	Power Supply Check.....	7-9
7.2.3.1.	Primary Current Drive Power Supply PCB Test Procedure.....	7-9
7.2.3.2.	Servo Loop Power Supply PCB Test Procedure.....	7-10
7.2.3.3.	Nanovolt Dual Power Supply PCB Assy 19334 Test Procedure.....	7-11
7.2.3.4.	6675A CPU and Display Power Supply PCB Test Procedure.....	7-12
7.2.4.	Alignment Procedure.....	7-12
7.2.4.1.	Alignment Test Equipment Required.....	7-12
7.2.4.2.	Initial Checks.....	7-13

7.2.4.3. Primary Current Drive Adjustments (Board 19108)	7-13
8. PARTS LISTS - MODEL 6675A	8-1
9. DRAWINGS - MODEL 6675A.....	9-1

LIST OF FIGURES

FIGURE 1-1 : FRONT PANEL CONTROLS	1-3
FIGURE 1-2 : REAR PANEL CONTROLS	1-5
FIGURE 3-1 : LINE VOLTAGE SELECTOR.....	3-3
FIGURE 3-2: MENU TREE - SETUP/MEASURE	3-5
FIGURE 3-3: MENU TREE - SOFCAL/VOLTMETER.....	3-6
FIGURE 3-4 : FRONT PANEL CONNECTIONS - NORMAL OHMS.....	3-50
FIGURE 3-5 : RECOMMENDED GUARDING FOR NORMAL OHMS	3-51
FIGURE 3-6 : FRONT PANEL CONNECTIONS HIGH OHMS - EXTERNAL HV SUPPLY	3-57
FIGURE 3-7 : FRONT PANEL CONNECTIONS HIGH OHMS - INTERNAL HV SUPPLY	3-58
FIGURE 3-8 : RECOMMENDED GUARDING FOR HIGH RESISTANCE MODE.....	3-59
FIGURE 3-9 : FRONT PANEL CONNECTIONS LOW OHMS, 6623 RANGE EXTENDER	3-64
FIGURE 4-1 : DIRECT-CURRENT-COMPARATOR BRIDGE.....	4-3
FIGURE 4-2 : AUTOMATIC DCC BRIDGE BALANCE	4-5
FIGURE 4-3 : BLOCK DIAGRAM 9975, 4-WIRE MEASUREMENT	4-11
FIGURE 4-4 : BLOCK DIAGRAM 6675A	4-12
FIGURE 4-5 : 6675A SERVO "IS".....	4-15
FIGURE 4-6 : 6675A PRIMARY CURRENT "IX".....	4-16
FIGURE 4-7 : 6675A MEASUREMENT CYCLE	4-20
FIGURE 4-8 : 6675A TURN SWITCHING AND NV READING GRAPHICAL REPRESENTATION	4-22
FIGURE 4-9 : NANOVOLT DETECTOR CPU OPTION SWITCH LOCATION	4-23
FIGURE 4-10 : CHARGE BALANCE A/D CONVERTER	4-27

LIST OF TABLES

TABLE 2-1 : GENERAL SPECIFICATIONS	2-1
TABLE 2-2 : GENERAL SPECIFICATIONS (CONTINUED)	2-2
TABLE 2-3 : RESISTANCE MEASUREMENT SPECIFICATIONS	2-3
TABLE 2-4 : TEMPERATURE MEASUREMENT SPECIFICATIONS	2-4
TABLE 3-1 : 4-TERMINAL MODE TEST SETUP	3-67
TABLE 3-2 : 2-TERMINAL MODE TEST SETUP	3-68
TABLE 3-3 : LOW OHM MODE TEST SETUP	3-68
TABLE 4-1 : NANO VOLT DETECTOR CPU OPTION SWITCHES	4-23
TABLE 5-1 : IEEE488 CONNECTOR PIN DESIGNATIONS	5-4
TABLE 5-2 : IEEE488 DEVICE CAPABILITIES	5-5
TABLE 5-1 : RS232 CONNECTOR PIN DESIGNATIONS	5-7
TABLE 7-1 : 6675A ERROR MESSAGES.....	7-1
TABLE 7-1 : 6675A WARNINGS	7-2
TABLE 7-1 : TEST POINT VOLTAGES ASSEMBLY 19108	7-9
TABLE 7-1 : TEST POINT VOLTAGES ASSEMBLY 19107	7-10
TABLE 7-1 : TEST POINT VOLTAGES ASSEMBLY 19334	7-11
TABLE 7-1 : TEST POINT VOLTAGES POWER SUPPLY ASSEMBLY 19473	7-12
TABLE 7-1 : REFERENCE VOLTAGES.....	7-30

1. INTRODUCTION

1.1. MODEL 6675A AUTOMATIC DIRECT-CURRENT-COMPARATOR RESISTANCE BRIDGE GENERAL DESCRIPTION

This document describes the preliminaries to setup and use the Guildline Model 6675A Automatic Direct-Current-Comparator Resistance Ratio Bridge.

1.2. PANEL FRONT TERMINALS/CONTROLS

The 6675A front panel controls are shown in Figure 1-1.

1.2.1. Reference Resistor Input Terminals

The reference resistor input terminals consist of 4 low thermal copper binding posts. The binding posts have the 'Rs' label inside the group of four posts. The posts are labeled from left to right, 'C1', 'P1', 'P2', and 'C2'. A 2 meter, 4 conductor cable set with guard wire, is provided in the 6675A Spare Parts Kit, Guildline part number 19543.01.02, for connection to these terminals.

1.2.2. Resistor Under Test Input Terminals.

The resistor under test input terminals consist of 4 low thermal copper binding posts. The binding posts have the 'Rx' label inside the group of four posts. The posts are labeled from left to right, 'C1', 'P1', 'P2' and 'C2'. A 2 meter, 4 conductor cable set with guard wire, is provided in the 6675A Spare Parts Kit, Guildline part number 19543.01.02, for connection to these terminals.

1.2.3. Numeric Keypad.

The numeric keypad consists of 15 keys. The key list contains the following; <0>, <1>, <2>, <3>, <4>, <5>, <6>, <7>, <8>, <9>, <->, <.>, <CLEAR>, <E>, <LOAD>.

1.2.4. Special Keys.

1.2.4.1. Cursor Movement Keys.

The cursor movement keys consist of 4 keys, <LEFT ARROW>,<UP ARROW>,<DOWN ARROW> and <RIGHT ARROW>

1.2.4.2. Function Keys.

The function keys consist of four unlabelled keys located below the display. The function of these four keys are variable and can take on any of the "soft" functions described in section 3.4 of this manual. In addition to the "soft" function keys are two keys fixed function keys <PREVIOUS> and <CANCEL>. Pressing the <PREVIOUS> key returns control to the previous menu level, above the currently selected menu. Pressing the <CANCEL> key will undo any keypad entry changes that have been made.

1.2.5. Display.

The green vacuum fluorescent graphic display is a combined 256 x 64 pixel graphic display and an 8 line by 42 column character display.

1.2.6. High Voltage Out Terminals.

The High Voltage Output Terminal is a blue four way binding post located on the sloped part of the front panel, on the far left side. The output from this terminal can be used to provide the test current when measuring two terminal high value resistances. A 1 meter single conductor, high voltage cable is provided in the 6675A Spare Parts Kit, Guildline part number 19543.01.02. for connection to this terminal.

1.2.7. Program Out Terminals.

The Program Out Terminals consist of 2 four way binding posts, one black and one red. These terminals can be used when a reversing switch external to the 6675A is to be used to control the test voltage for a two terminal high value resistance measurement. The signal low terminal is referenced to the Rx input. An optional 1.5 meter, double banana plug, cable set is offered as Guildline part number 996-00122, for connection between these terminals and the reversing switch.

1.2.8. Extender In Terminals.

The Extender In Terminals consist of 2 four way binding posts, one black and one red, the middle two terminals in the group of 6. These terminals can be used when low values of resistance are to be measured using an external current range extender. An optional 1.5 meter, double banana plug, cable set is offered as Guildline part number 996-00122, for connection between these terminals and the range extender.

1.2.9. Ground Terminals.

The Ground Terminal consists of 1 green four way binding post. The bottom terminal in the group of 6. This terminal provides a suitable termination point when a single safety ground is required in the measurement cabling. A signal low terminal referenced to the R_s input resistor is provided along side the safety ground terminal. See figure 3-5 for the recommended connections for these terminals. The low thermal cable set provided with the 6675A Spare Parts Kit (Guildline part number 19543.01.02) includes wires for connection to the ground terminals.

1.2.10. Guard Terminals.

The Guard Terminals consist of 2 white four way binding posts. Two guard points are provided, one guard is referenced to the signal high side of the four terminal R_x resistor and the other to the signal high side of the four terminal R_s resistor. See figure 3-5 for the recommended connections for these terminals. The low thermal cable set provided with the 6675A Spare Parts Kit (Guildline part number 19543.01.02) includes wires for connection to the guard terminals.

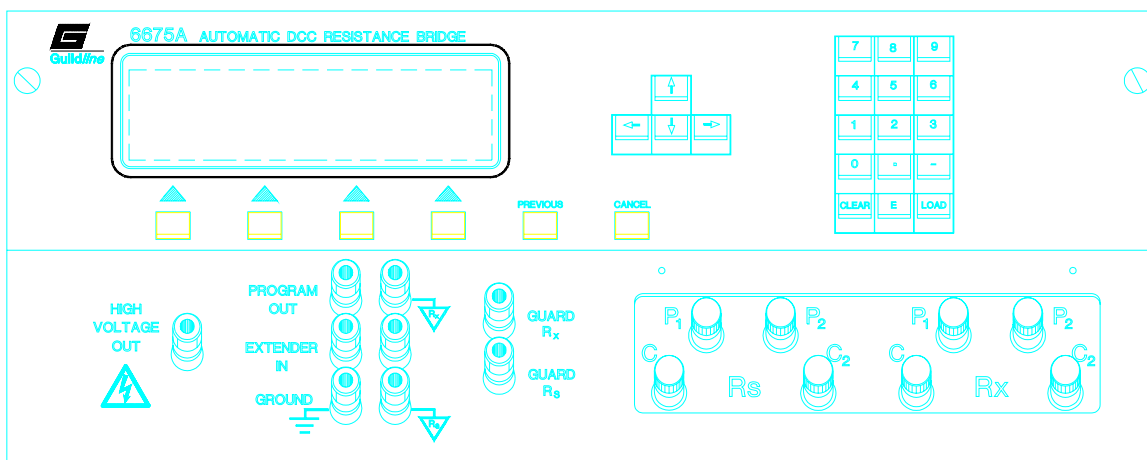

Figure 1-1 : Front Panel Controls

1.3. REAR PANEL CONNECTORS/CONTROLS

The 6675A rear panel controls are shown in Figure 1-2.

1.3.1. Chart Recorder Output.

The Chart Recorder Output connectors consist of 2 four way binding posts, one black terminal and one red terminal with a full scale output of ± 5 volts. An optional 1.5 meter, double banana plug, cable set is offered as Guildline part number 996-00122, for connection between these terminals and the chart recorder.

1.3.2. IEEE-488 Interface.

The IEEE-488 interface consists of a standard shielded IEEE 488 interface connector. When an external connection to this communication interface is necessary, it is recommended that a double shielded cable assembly be used. The Guildline Part Number 996-23006 is a recommended 2 meter cable set, suitable for attachment to this interface.

1.3.3. RS232 Interface.

The RS232 Interface consists of standard shielded RS232 DB25S type connector. When an external connection to this communication interface is necessary, it is recommended that a double shielded cable assembly be used. The Guildline Part Number 996-00070 is a 2 meter, 25-pin male-female connector cable set, suitable for attachment to this interface.

1.3.4. Sync Output.

The Sync Output Connectors consist of 2 four way binding posts one black terminal and one red terminal with an output switching between 0 to +5 Vdc when a test current reversal occurs. An optional 1.5 meter, double banana plug, cable set is offered as Guildline part number 996-00122, for connection between these terminals and the external device monitoring current reversals.

1.3.5. Line Input Voltage Selector.

The line input voltage selector consists of a four position selector and one 2 A time delay fuse for 120 V operation or one 1 A time delay fuse for 240 V. The selector allows switching between 100 V, 120 V, 220 V, and 240 V.

1.3.6. Line Input Connector.

The Line Input Connector is a standard male 3 prong AC connector which allows a standard AC power cord to be connected.

1.3.7. Power Switch.

The power ON/OFF switch for the 6675A is an integral part of the line input power assembly.

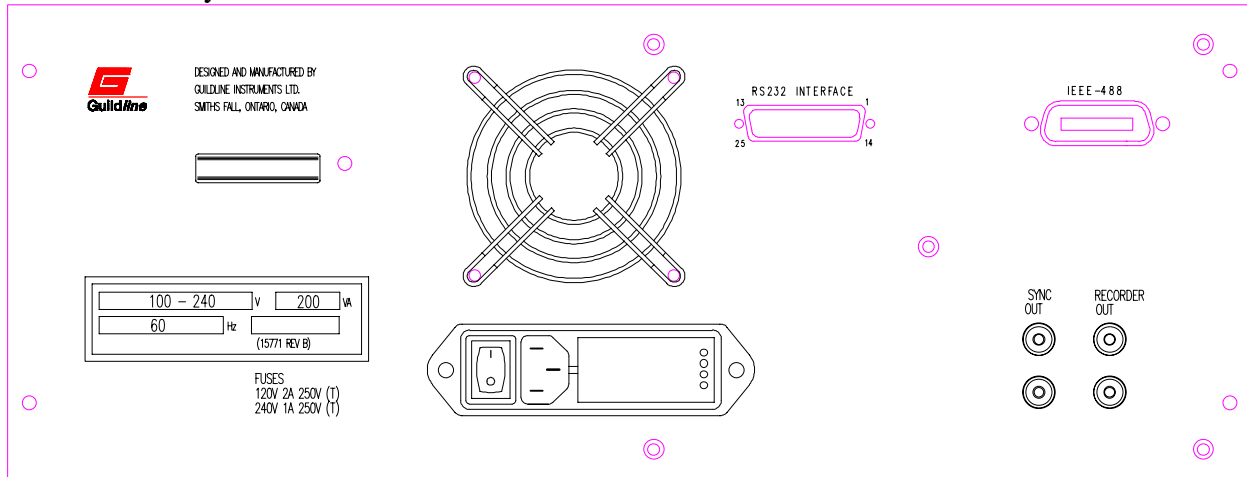

Figure 1-2 : Rear Panel Controls

2. PERFORMANCE SPECIFICATIONS

2.1. GENERAL SPECIFICATIONS

6675A AUTOMATIC DCC RESISTANCE BRIDGE General Specifications		
Operating Temperature to Full Specification	+23 ± 5	°C
	+73 ± 9	°F
Operating Temperature Maximum Range <50% RH	(+10 to +18) (+28 to +40)	°C
	(+50 to +64) (+82 to +104)	°F
Storage Temperature Maximum Range	-20 to +60	°C
	-4 to +140	°F
Operating Humidity	15 to 70	% RH
Storage Humidity	15 to 80	% RH
Power Requirements	180	VA
Voltage Requirements	100, 120, 220, 240 ±10%	VAC
Line Frequency	50 ±5% , 60 ±5%	Hz
Dimensions	413(D) , 483(W) , 178(H)	mm
	16(D) , 19(W) , 7(H)	in
Weight	25	kg
	55	lbs

Table 2-1 : General Specifications

2.2. GENERAL SPECIFICATIONS (continued)

6675A AUTOMATIC DCC RESISTANCE BRIDGE General Specifications			
Measurement Resistance Range		1 m to 1 G	Ω
Resistance Ratio (Rx/Rs) Range		0.078 to 13.4	
Linearity		±0.01	ppm of full scale
Temperature Coefficient (+10 to +18)°C (+28 to +40)°C		±0.01	ppm/°C
Warm-up time to full rated accuracy		60	minutes
Display update rate (digital filter off)		2 X Current Reversal rate	seconds
Automatic Current Reversal Rate (programmable)		4 to 32000 in steps of 2	seconds
Analog output	Range	±5.0	VDC
	Accuracy	±5	mV
	Digital Resolution	12	binary bit
	Maximum Ratio Resolution (programmable)	0.001	ppm
Digital Communication		IEEE488, RS232	
Test Currents	Range (to 30Vdc compliance)	0.5μ to 150m	A
	Steps	0.5 μ	A
	Accuracy	±100 ±10 μ	ppm + A
	Stability (10 minutes)	±1	ppm

Table 2-2 : General Specifications (continued)

2.3. RESISTANCE MEASUREMENT SPECIFICATIONS

Rx RANGE	RESOLUTION ±ppm FS	UNCERTAINTY @23±5°C 1 year				NOISE LIMITS	
		Ratio <1		Ratio ≥1		Voltage 1nV ppm (max)	Current 0.1uA ppm (max)
		ppm of Ratio + ppm/Ratio	with 6623*	ppm of Ratio	with 6623*		
1mΩ - 10mΩ	0.001	50+20	1.2+0.5	50	1.2	< 1.0	< 0.01
10mΩ - 100mΩ	0.001	50+20	1.2+0.5	5	1.2	< 1.0	< 0.01
0.1Ω - 1Ω	0.001	0.5+0.2		0.5		< 0.1	< 0.001
1Ω - 10Ω	0.001	0.1+0.06		0.1		< 0.01	0.001
10Ω - 100Ω	0.001	0.1+0.04		0.1		< 0.003	0.01
100Ω - 1kΩ	0.001	0.1+0.04		0.1		na	0.01
1kΩ - 10kΩ	0.001	0.15+0.04		0.15		na	0.1
10kΩ - 100kΩ	0.001	0.35+0.04		0.35		na	0.1
100kΩ - 1MΩ	0.001	0.5+0.1		0.5		na	0.1
1MΩ - 10MΩ	0.001	0.75+0.3		0.75		na	0.1
10MΩ - 100MΩ	0.001	2.5+1.0		2.5		na	1.0
100MΩ - 1GΩ	0.001	8.0+3.0		8.0		na	10

* Guildline Model 6623 High Current Range Extender

Table 2-3 : Resistance Measurement Specifications

**2.4. TEMPERATURE MEASUREMENT SPECIFICATION**

The uncertainty of temperature measurement is primarily determined by the uncertainty of the temperature probe. The 6675A contributions to resolution and uncertainty are listed below.

Nominal PRT Resistance (Ω)	Recommended Excitation Current (mA)	Resolution ($^{\circ}\text{C}$)	Uncertainty (equivalent $^{\circ}\text{C}$)
0.25	10	0.0001	0.0002
2.5	3	0.0001	0.00005
25.5	1	0.0001	0.00005
100	0.5	0.0001	0.0001

Table 2-4 : Temperature Measurement Specifications

3. OPERATING INSTRUCTIONS

3.1. PRELIMINARIES

The 6675A has been shipped with the line input voltage selector set to 120 V. The line input selector must be set to the correct line voltage before power is applied to the instrument. The settings available are 100 V, 120 V, 220 V, and 240 V. Figure 3-1 details the line input voltage selector setting. Remove the warning label positioned across the power line input socket after setting the correct operating voltage.

Ensure that the correct fuse has been installed : 2 A 250 V (T) should be used for a nominal line input of 120 V and 1 A, 250 V (T) should be used for a nominal line input of 240 V. Only fuses with the rated current and specified type should be used for replacement.

Verify that the local line input power frequency is as indicated on the rear panel label. If the line input frequency is not as marked, see section 4.3.1 to set the correct line input frequency option.

The supplied molded line cord should be plugged into the 3-pin power receptacle on the rear panel of the instrument. Ensure that the other end of the line cord is plugged into a wall socket or extension cord that has a protective or safety ground. Where 3-contact power supply outputs are not available, a suitable protective ground connection must be made before switching the instrument power on. Any interruption of the protective ground may possibly render the instrument unsafe.

Where the molded plug on the line cord supplied with the instrument does not match the local power outlet socket, the plug can be removed and replaced with one that does fit the local service. The plug should be re-wired as follows :

Brown wire	-	Line input
Blue wire	-	Neutral input
Green/Yellow	-	Ground (safety)

3.1.1. Rackmount Bracket.

An optional set of rackmount brackets can be supplied with the 6675A. When the 6675A is to be used in a standard 19 inch rack, it is recommended that the supplied rackmount brackets be used in conjunction with a shelf or other support plate inside the 19 inch rack. To use the rackmount brackets, first remove the standard carrying handles at the front panel by removing the two screws securing each handle. Place the rackmount brackets in

position and secure using the original handle screws. Offer the 6675A to the panel opening and install on the appropriate support shelf. Care must be exercised when using a rack mount configuration to ensure that sufficient cooling air circulation is available to the 6675A when in the rack. The 6675A will fit a standard 5U opening in the 19 inch rack, it will protrude beyond the front of the rack and will extend slightly into the front panel space of the rack opening below.

3.2. **WARNING**



Dangerous voltages to 990 V dc can appear at the HIGH VOLTAGE OUTPUT front panel terminal during two-terminal, high resistance measurements. Also, when line power is first applied to the 6675A at power up, a momentary, high voltage pulse can appear at the HIGH VOLTAGE OUTPUT terminal.

Care should be exercised when working near the HIGH VOLTAGE OUTPUT terminal.

DO NOT TOUCH the HIGH VOLTAGE OUTPUT terminal until you are sure that it is safe to do so.

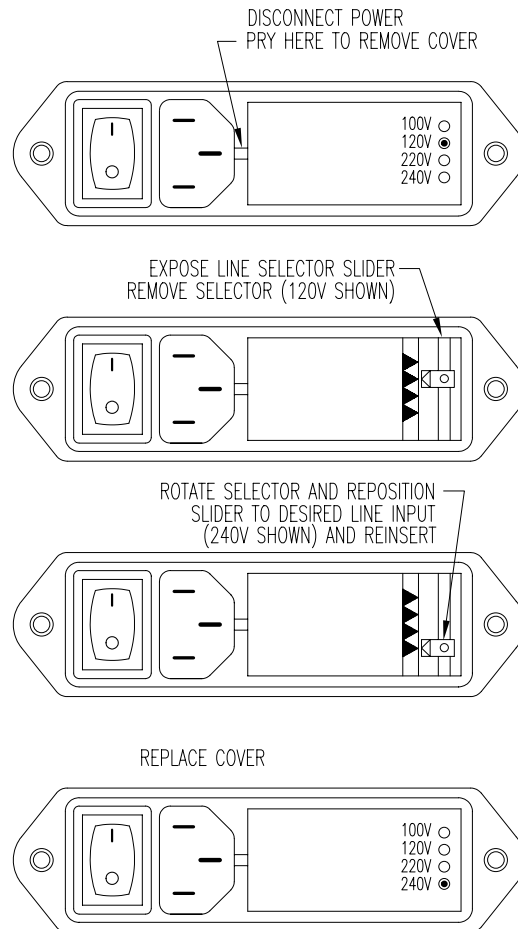

Figure 3-1 : Line Voltage Selector

3.3. OPERATING PROCEDURE

The front panel of the 6675A consists of a keypad and display area with binding posts for termination of the resistors to be measured. The keypad consists of :

one set of numeric keys <0,1,2,3,4,5,6,7,8,9> for numeric data entry;

one change sign key <->;

one enter exponent key <E>;

one <CLEAR> data value key;

one <LOAD> data value key.

A set of four cursor movement keys are also provided, in the form of the <up arrow>, <down arrow>, <left arrow> and <right arrow>.

Four software programmable keys are positioned beneath the display area. These keys take on the function as displayed in the display area immediately above the key.

Two additional keys are provided to move backward (to last menu level) through the menuing software <PREVIOUS> and to <CANCEL> the last data entry.

The display is used to provide data information and user function feedback to the operator. The display is divided into three main areas:

1. status line area; for display of system status information;
2. function key area; for description of function key operation;
3. data area; for display of result data and configuration data.

The following information describes typical displays and corresponding menu descriptions for associated function keys. Figures 3.2 and 3.3 illustrate the 6675A menu tree.

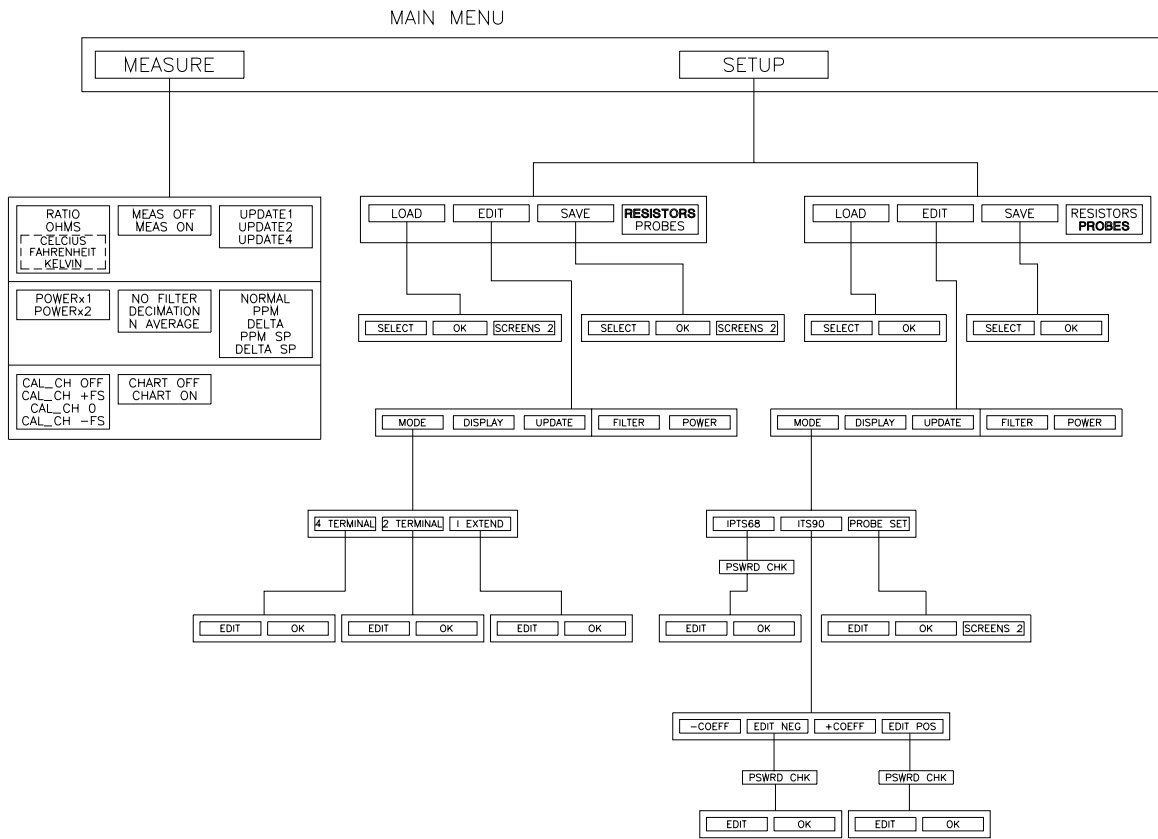

Figure 3-2: Menu Tree - SETUP/MEASURE

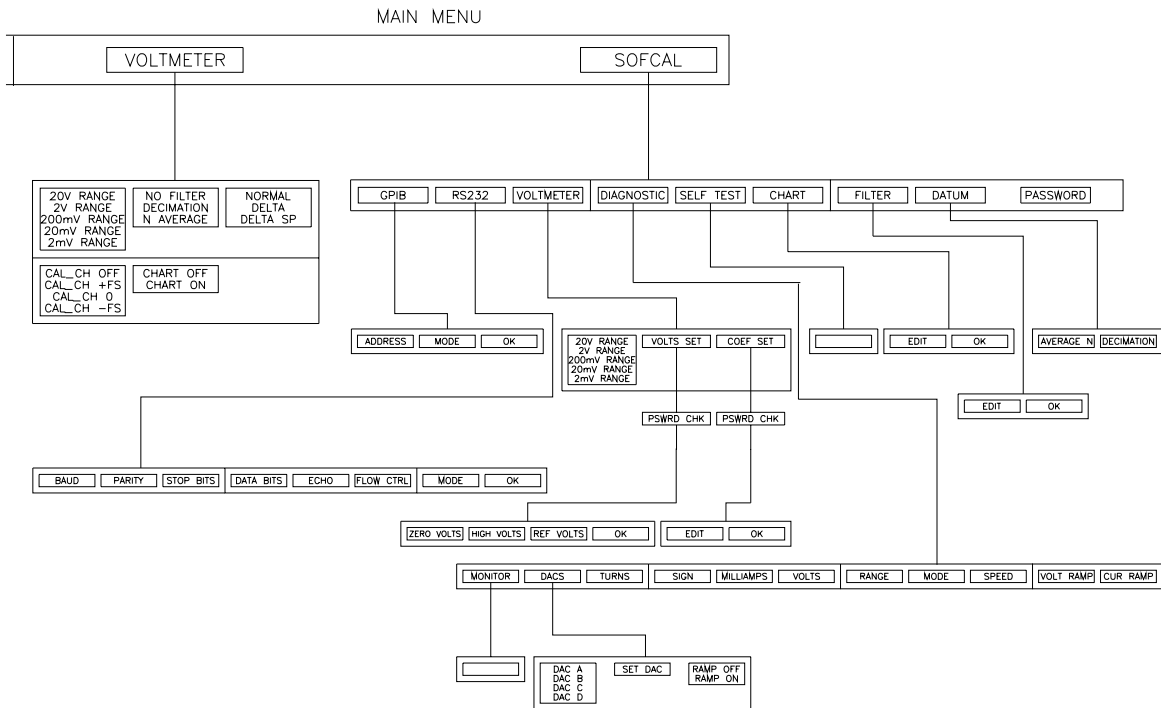
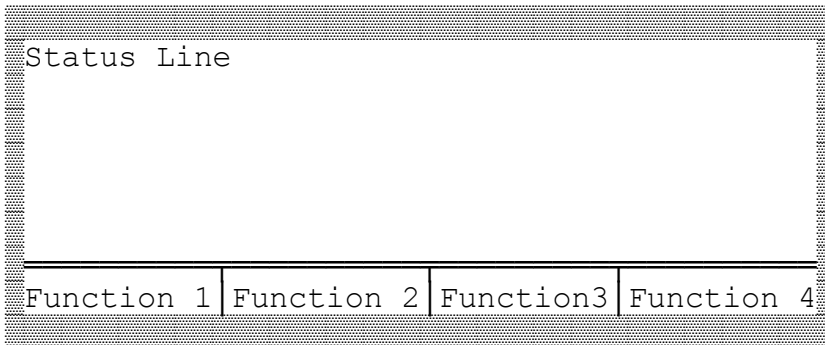

Figure 3-3: Menu Tree - SOFCAL/VOLTMETER

3.4. GENERAL KEY/DISPLAY OPERATIONS

3.4.1. Base Menu.

Typically consists of four function key (or less) description areas, and a status line.



3.4.1.1. Base Menu Display.

When there are more than four functions for a given menu level a <MORE> function key will appear. Pressing this menu option will display the remaining set of operations available at the current menu level.

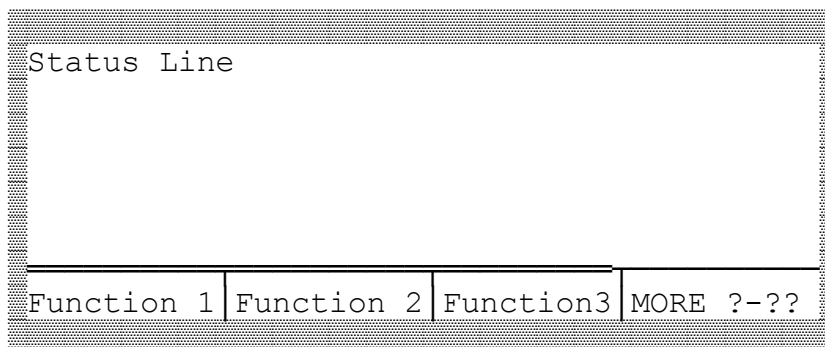

Where, in the function key - <MORE ? - ??>

- ?? represents the total number of available menu pages
- ? represents the current menu page

3.5. BASIC MENU OPERATIONS

3.5.1. Menu Option - <MEASURE>

In the menu option <MEASURE>, several function keys are defined where each key can cause one of several actions. If the function key <Fn> has multiple states, pressing the key beneath the displayed function will cause it to toggle between the valid states. The displayed name of the key will be updated to reflect the newly assigned state.

Example: Current key option

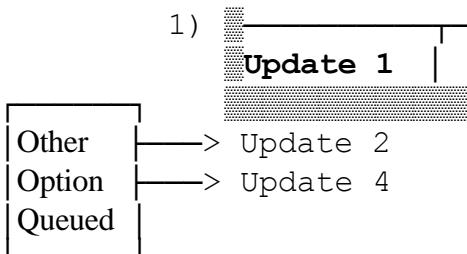

Option after key press

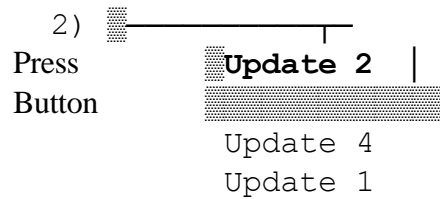

If the displayed option leads to another menu level then the functions available at the next (lower) level menu will be displayed on the screen.

To return to the previous menu (go up one menu level), press the <PREVIOUS> key that is located to the right of the screen.

Continually pressing the <PREVIOUS> key will return control to the Main Menu.

3.5.2. Menu Option - <any other menu but measure>

In all other menu options if a function key has a defined set of alternate values, pressing that function key will cause one of the alternate values to be selected and displayed in the associated active area of the display screen.

Example: Current Screen

Mode:	RS W:		
Display: Ratio	RS SN:		
Update: Update 1	RX W:		
Filter:	RRate:		
Power:	Ratio:		
Mode	Display	Update	MORE 1-2

Example continued: Screen after pressing function key <Display>

Mode:	RS W:		
Display: Ohms	RS SN:		
Update: Update 1	RX W:		
Filter:	RRate:		
Power:	Ratio:		
Mode	Display	Update	MORE 1-2

The alternate value "Ohms", associated with the function key <Display>, is toggled into the active screen area to replace the previous value "Ratio".

NOTE:

When a function key box is drawn with two lines in the display window pressing that function key will select a set of lower level menu options. In the previous example, the function key <Mode> will move to a second lower level in the menu system.

3.5.3. Base Edit/Select Menu - one column of data

An optional header line can appear at the top of a screen display to prompt or inform the user with "details" of the present menu level. If a header line is displayed the number of selections are restricted to 6 or less. If there is no header line then the number of selections can be 7 or less.

Header Line			
Select/Data 0			
Select/Data 1			
Select/Data 2			
Select/Data 3			
Select/Data 4			
Select	Ok		

3.5.4. Base Edit/Select Menu - two columns of data

If there is a header line then the number of selections is displayed is limited to a maximum of 10. Without the header line up to 12 selections can be displayed. (Header line is optional.)

Header Line			
Select/Data 0		Select/Data 5	
Select/Data 1		Select/Data 6	
Select/Data 2		Select/Data 7	
Select/Data 3		Select/Data 8	
Select/Data 4		Select/Data 9	
Select	Ok		

3.5.5. Operation of Select/Edit Data Menus

3.5.5.1.Function - <Screen ?>

If more than one screen of display information is available for selection as current at a menu level, then a <Screen ?> software function key will appear above the fourth function key <Fn-4>. The numeric "?" represents the total number of screens available for view. Pressing the <Screen ?> function key will cause the display to move to the next sequential screen. Pressing the key on the last screen will cause the display to move back to the first screen.

3.5.5.2. Function - <Select>

Pressing the <Select> key will cause one of the currently selected items or the first item in a list to be highlighted. The cursor arrow keys can then be used to move the highlight from selection to selection on the screen.

If the screen type is a selection screen, for example the <Resistor select menu function>, the highlighted item will be selected active, only when the soft function key <Ok> is pressed.

While in an <Edit screen function>, the highlighted item can be modified by using direct entry from the numeric key pad. If the cursor movement <left/right arrow> keys, or <CLEAR> key have not been pressed then any numeric entry will clear the current line and display the pressed key at the cursor position. Pressing any one of the cursor movement keys will cause the current character under the cursor to be replaced with the next numeric key pressed.

The <CLEAR> key, when editing data will clear the current data.

3.5.5.3. Function - <Ok>

Pressing the soft function <Ok> key will either load the item selected or accept all the changes that have been made in the current menu (including the screens not currently displayed if there are multiple screens).

At any time before pressing the <Ok> key, the <CANCEL> key can be pressed to undo all changes that have been made.

3.6. TITLE SCREEN

At power ON the 6675A will start its internal self-test programming and display its opening banner:

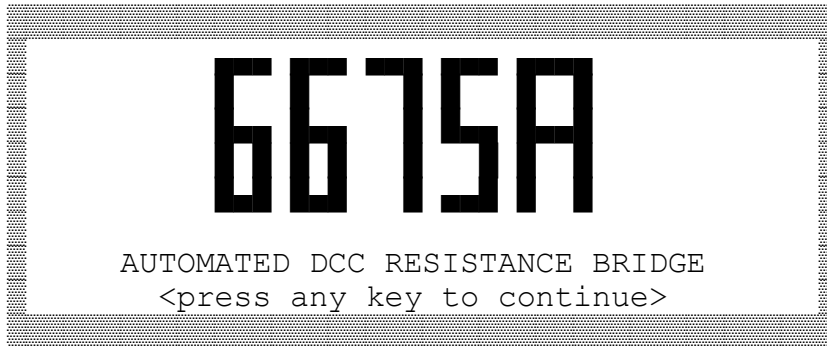

Pressing any key before the self-test routines have finished will remove the opening banner and display a null instrument configuration where all parameters are initialized to zero. If no key is pressed the opening banner will be automatically removed at the termination of the self-test routines.

The REMOTE DISPLAY screen will appear only when the 6675A has been addressed by a remote communication device on the GPIB or RS232 port.

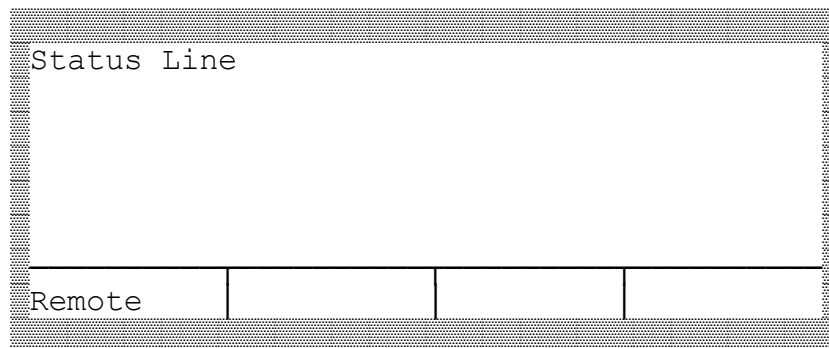

The only active soft function key that will work when in Remote mode is the function key <Fn-1>, <Remote>. The exception is when local lockout has been enabled; in this case none of the keys on the front panel will be enabled.

3.7. MAIN MENU

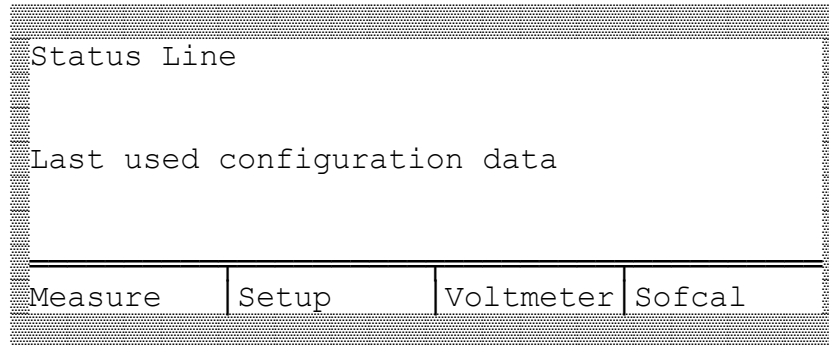

The main menu, on power up will display a null measurement configuration where all parameters have been initialized to zero.

On power up the 6675A will default to a standby condition with the measurement cycle of operations OFF i.e. <Measure off>.

During instrument operation, the operator can return to the main menu from any previously selected lower menu level. When at the Main Menu level, pressing the <CANCEL> key will automatically stop the measurement cycle and cause a return to the <Measure off> mode.

There are four other menu sequences that will also turn <Measure off> automatically:

1. When entering another measurement mode using the <Setup> <Edit> <Mode> menu.
For example, when currently measuring a pair of 4 wire resistors and then selecting 2 wire mode, the measurement cycle will be terminated and the 6675A will enter the <Measure off> mode.
2. When entering the <Voltmeter> menu from the main menu.
3. When changing the measurement type in the <Setup> menu from <Probe> to <Resistor> or vice versa.
4. When entering the <Sofcal> <Voltmeter> menu or the <Sofcal> <Diagnostic> menu.

3.7.1.1.<Measure> MENU Fn-1 (MAIN) Page 1 of 3.

STATUS LINE			
Current reading or Measurement configuration			
Ratio	Meas Off	Update 1	MORE 1-3
Ohms	Meas On	Update 2	
Celsius		Update 4	
Fahrenheit			
kelvin			
Ratio			
Ohms			

The <STATUS LINE> will only appear if the 6675A is currently measuring a set of resistors. The information displayed in the <STATUS LINE> depends on the options selected.

1. if <PPM>, <PPM SP>, <DELTA>, or <DELTA SP> is the current selection then the <STATUS LINE> will contain the Datum of preceding numbers.
2. if <N AVERAGE> is selected the the standard deviation will be displayed, on the <STATUS LINE>, for the raw unfiltered values.
3. if the current measurement mode is <I EXTEND> then the extender ratio will also be displayed on the <STATUS LINE>.

Available functions (menu page 1 of 3).

Function key <Fn-1> toggles through the set of available measurement units for the displayed result; when the <Resistor> measurement mode is active, the displayed result can have units of <Ratio> and <Ohms>. When the <Probe > measurement mode is active, the displayed result can have additional units of temperature, <Celsius>, <Fahrenheit> and <kelvin>. The active engineering units will be displayed in the <Fn-1> function key descriptor position.

Function key <Fn-2> enables or disables the measurement cycle by turning <Measure ON> or <Measure OFF>. The state of the measurement cycle is displayed in the <Fn-2> function key window.

NOTE:

A graphic block (■) will be displayed on the right most vertical column of the menu to show which measurement cycle the 6675A is in. This block will appear on all menus and is one way to tell if the 6675A is making a measurement.

Function key <Fn-3> selects the screen measurement update rate as a function of the test current reversal rate. <Update 1> sets a screen update rate at twice the test current reversal rate; <Update 2> sets a screen update rate at the test current reversal rate; <Update 4> sets a screen update rate at half the test current reversal rate.

Function key <Fn-4> selects the next menu page of available functions.

3.7.1.2. <Measure> MENU Fn-1 (MAIN) Page 2 of 3.

STATUS LINE			
CURRENT READING OR Measurement configuration			
Power x1	No Filter	Normal	MORE 2-3
Power x2	Decimation	PPM	
	N Average	Delta	
		PPM SP	
		Delta SP	

Available functions (menu page 2 of 3).

Function key <Fn-1> selects twice the rated power.

Function key <Fn-2> turns on the filter function to operate on the measurement data. Select from <No Filter>, <Decimation> and <N Average> where the sample size N must be entered from the keypad.

Function key <Fn-3> selects the mode of displaying the measurement data as <Normal>; parts per million <PPM>; change <Delta>; change ppm from a setpoint <PPM SP>; and change from a setpoint <Delta SP>. When this function is enabled, the datum value will be displayed on the STATUS LINE of the display.

Function key <Fn-4> displays next menu page of available functions.

3.7.1.3.<Measure> MENU Fn-1 (MAIN) Page 3 of 3.

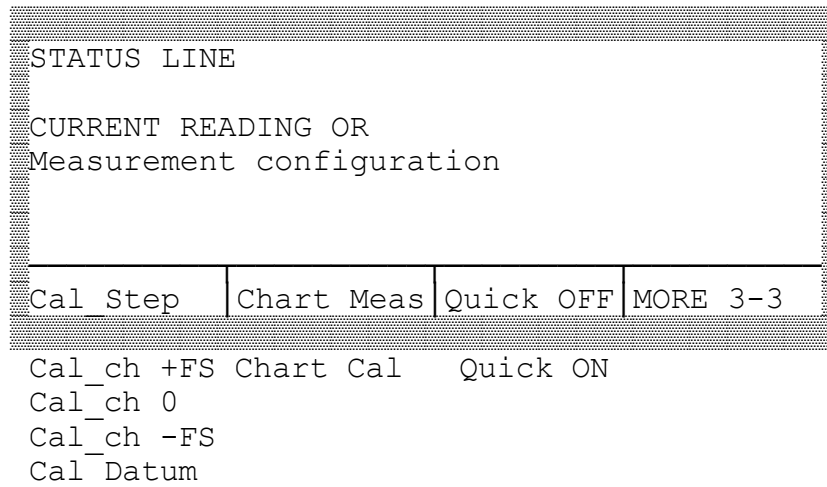

Available functions (menu page 3 of 3), last menu page.

Function key <Fn-1> sets the calibration point for the chart recorder output. Select from <Cal_Step> to force a preset step change in the chart recorder output; <Cal_+FS> set positive full scale; <Cal_ch 0> set zero; <Cal_ch -FS> set negative full scale and <Cal_Datum> to set the chart recorder output to zero at the present displayed measurement value. Scrolling through the options using this function key can be done at any time. However, the chart recorder will not respond to the windowed value until the <Chart_Cal> function is made active in the window for function key Fn-2. The option <Cal_Step> allows a user to quickly check the sensitivity of the chart recorder plot. This check is only active when <Chart_Cal> is active and causes a preset level to be sent to the chart recorder output. The level of the step is determined from the SOFCAL CHART menu selection (see <Chart> menu Fn-3 (Sofcal_MAIN)). The engineering unit of measure for the step uses the global setting from the set <ppm>, <ratio>, <Celsius>, <Fahrenheit>, <kelvin>, <Volts>, and <Ohms>.

Function key <Fn-2> toggles the chart recorder output mode between <Chart Meas> and <Chart Cal>. When <Chart Meas> is active the chart recorder output is scaled to follow the measured data value. When <Chart Cal> is active, the options available through function key Fn-1 are active and the windowed value is sent to the chart recorder output.

Function key <Fn-3> toggles the quick measure mode on <Quick ON> and off <Quick OFF>. The quick measure function disables the internal software filters that

are invoked for the four cycle precision measurements and are used in the calculation of resistance ratio. Disabling the software filter function decreases the time required to calculate and report the measured ratio. However, the data are now noisier, and so two least significant digits are removed from the display when quick measure is turned on.

Function key <Fn-4> returns to menu page 1 of 3.

3.7.2. <Setup> MENU Fn-2 (MAIN)

This menu function allows selection and edit of the measurement configuration.

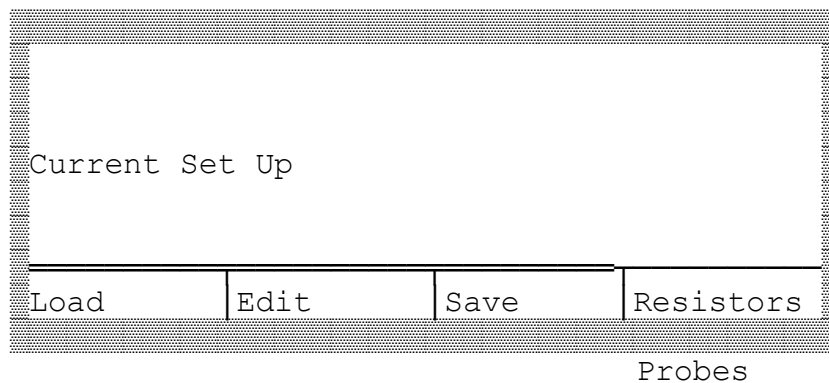

3.7.2.1. <Load> MENU Fn-1 (Setup_MAIN)

This menu function displays the list of configurations available. Up to 15 unique configurations can be saved for review, 10 are shown on the first screen and 5 on the second screen.

Each entry in the list is identified by the serial number entered for the Standard Resistor in the test setup.

Where a temperature probe (one of up to five) is specified the serial number for that probe is displayed at the list entry.

3.7.2.1.1. <Load> MENU Fn-1 (Resistors_Setup_MAIN)

Screen 1 of 2 available screens.

Resistors File : ??			
00	SN of Resistor	05	_____
01		06	_____
02		07	_____
03		08	_____
04		09	_____
Select	Ok		Screen 2

To load and make active, one of the displayed measurement configuration files, press the <Select> function key; use the movement arrow keys to highlight the required file and press the <Ok> function key. The header line displays the number 00-14, of the selected/active file.

3.7.2.1.2. <Load> MENU Fn-1 (Resistors_Setup_MAIN)

Second screen of the two available screens.

Resistors File : ??			
10	_____		
11			
12			
13			
14			
Select	Ok		Screen 2

3.7.2.1.3.<Load> MENU Fn-1 (Probes_Setup_MAIN)

Allows selection of temperature probe files.

```

Probes File : ??
00 SN of Probe _____
01
02
03
04
-----
Select   Ok
  
```

The header line displays the number ?? (00-04), of the selected/active probe file.

3.7.2.2.<Edit> Resistors MENU Fn-2

3.7.2.2.1. <Edit> Resistors MENU Fn-2 (Resistors_Setup_MAIN)

Edit resistors menu page 1 of 2.

```

Mode:                RS Ω:
Display: <Fn-2>      RS SN:
Update: <Fn-3>      RX Ω:
Filter:              RRate:
Power:               Ratio:
-----
Mode                 Display      Update      MORE 1-2
                   Ohms         Update 1
                   Ratio        Update 2
                                   Update 4
  
```

Function key <Fn-1> ,<Mode>, allows selection of the mode of operation of the 6675A from the <Mode> sub-menu.

Function Key <Fn-2> ,<Display>, allows selection of the units displayed on the screen either Ohms or Ratio (no units).

Function Key <Fn-3> ,<Update>, allows selection of the number of times that the display should be updated for each measurement cycle; 1, 2, or 4 times per measurement cycle.

<Edit> Resistors MENU Fn-2 (Resistors_Setup_MAIN)

Edit resistors menu page 2 of 2.

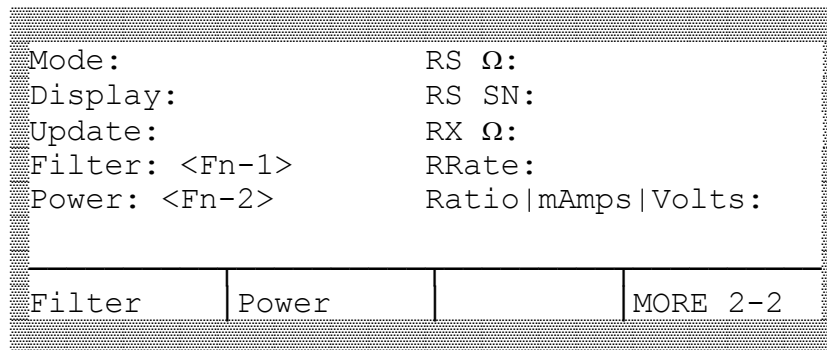

No Filter Power x1
 Decimation Power x2
 N Average

Function Key <Fn-1> ,<Filter>, allows selection of the filter that will be used on the displayed readings, where:

- No Filter = display most recent reading
- Decimation = display (100-N) percent of the previous reading. Where N is the percentage value set in the <Sofcal><Filter> menu for Decimation.
- N Average = display the average of the last N readings. Where N is the is the number of readings to be averaged and is that value set in the <Sofcal><Filter> menu.

Function Key <Fn-2> ,<Power>, allows selection of a multiple of the power to be dissipated in the test resistor as X1 (unity) or as X2 (two times power level).

3.7.2.2.1.1. <Mode> MENU Fn-1 (Edit_Resistors_Setup_MAIN)

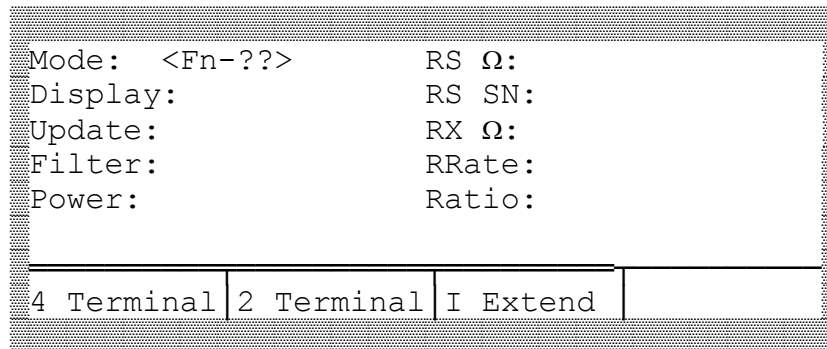

Function key <Fn-1>, <4 Terminal>, will select the 4-terminal measurement mode of operation.

Function key <Fn-2>, <2 Terminal>, will select the 2-terminal measurement mode of operation.

Function key <Fn-3>, <I Extend>, will select operation using a high current range extender for low value resistance measurements.

**3.7.2.2.1.1.1. <4 Terminal> MENU Fn-1
(Mode_Edit_Resistors_Setup_MAIN)**

Enter configuration for 4-terminal resistance mode measurements.

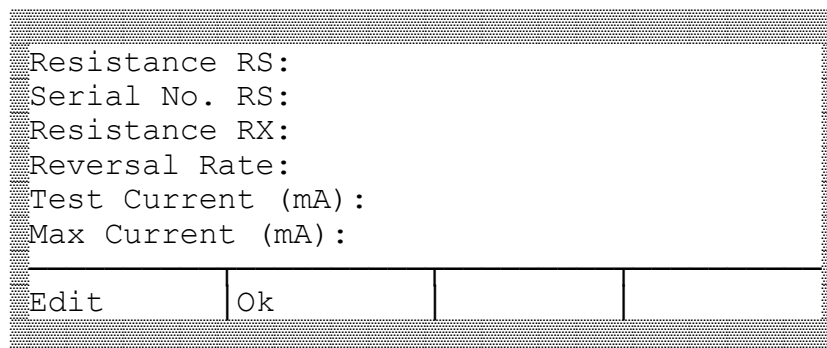

Press <Edit> and use arrow keys to move the highlight to the data line to be changed. Modify data and press <Ok>. Check resistance limits for Rs and Rx. Check also power limits set by test current.

Where the Test Current ($I(\text{test}) \rightarrow I_x$) sets the current in the UNKNOWN RESISTOR (R_x).

If the condition :

$$(I(\text{test}) \times (R_x/R_s)) \geq \text{Max Current}$$

is satisfied, then the test is terminated.

Max current is the maximum current that can be carried by the REFERENCE RESISTOR (Rs).

The reported ratio is (Rx/Rs).

**3.7.2.2.1.1.2.<2 Terminal> MENU Fn-2
(Mode_Edit_Resistors_Setup_MAIN)**

Enter configuration for 2-terminal high resistance mode measurements.

Resistance RS:			
Serial No. RS:			
Resistance RX:			
Reversal Rate:			
Test Voltage (V):			
Max Voltage (V):			
Edit	Ok		

Press <Edit> and use arrow keys to move the highlight to the data line to be changed. Modify data and press <Ok>.

Where:

Test Voltage (V) is the common terminal voltage providing current for Rs and Rx

and

Max Voltage (V) is the maximum voltage rating for Rs or Rx. Enter the lower of the two maximum voltage ratings.

**3.7.2.2.1.1.3.<I Extend> MENU Fn-3
(Mode_Edit_Resistors_Setup_MAIN)**

Enter range extender configuration data.

Resistance RS: 0000000000			
Serial No. RS: 1111111111			
Resistance RX: 2222222222			
Reversal Rate: 3333333333			
Extender Ratio: 4444444444			
Edit	Ok		

Press <Edit> and use arrow keys to move the highlight to the data line to be changed. Modify data and press <Ok>. Check resistance limits on this screen.

3.7.2.2.2.<Edit> Probes MENU Fn-2 (Probes_Setup_MAIN)

Display temperature probe configuration menu page 1 of 2.

Mode: RS Ω:			
Display: <Fn-2> RS SN:			
Update: <Fn-3> R0:			
Filter: Pr SN:			
Power: RRate:			
mAmps:			
Mode	Display	Update	MORE 1-2

Fahrenheit Update 1
kelvin Update 2
Ratio Update 4
Ohms
Celsius

Function Key <Fn-1> ,<Mode>, allows entry to the <Mode> menu level where the temperature mode of operation of the 6675A can be set from one of :

- IPTS-68 - Set the IPTS-68 coefficients for the temperature probe under test.
- ITS-90 - Set the ITS-90 coefficients for the temperature probe under test.
- Probe Set - Set the temperature probe parameters for ice-point or triple-point resistance, serial number, test current etc..

Function Key <Fn-2> ,<Display>, allows selection of the engineering units that will be used during the measurement and displayed on the screen.

Function Key <Fn-3> ,<Update>, allows selection of the number of times that the display should be updated for each measurement cycle; from 1, 2, or 4 times for each measurement cycle.

3.7.2.2.2.1.<Mode> MENU Fn-1 (Edit_Probes_Setup_MAIN)

Setup the parameters for the probe.

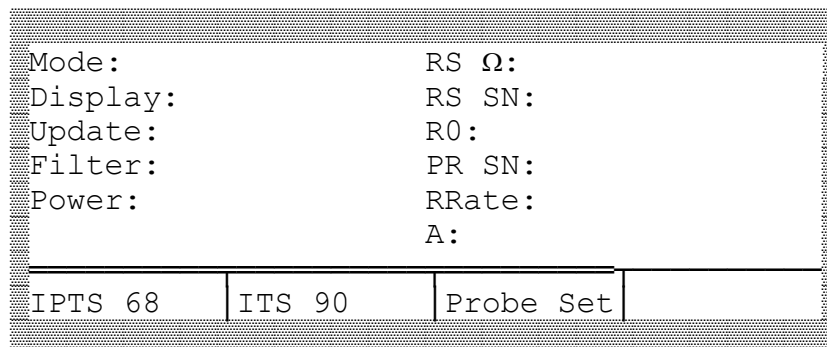

Function Key <Fn-1> ,<IPTS 68>, allows entry to the IPTS-68 measurement menu and enables the IPTS-68 coefficients for the probe to be viewed and or edited.

Function Key <Fn-2> ,<ITS 90>, allows entry to the ITS-90 measurement menu and enables the ITS-90 coefficients for the probe to be viewed and or edited.

Function Key <Fn-3> ,<Probe Set>, allows entry to the Probe set menu and enables the test values for the probe to be viewed and or edited.

**3.7.2.2.1.2. <ITS 90> MENU Fn-2
(Mode_Edit_Probes_Setup_MAIN)**

-Coeff: <Range 1>		+Coeff: <Range 6>	
a1:		a6:	
b1:		b6:	
c1:		c6:	
c2:		d:	
-Coeff	Edit Neg	+Coeff	Edit Pos

Function Key <Fn-1> ,<-Coeff>, selects from the ITS90 set of temperature ranges:

- <Range 1> := <13.8 K to 273.16 K> : screen display ‘-259C to 0C’
- <Range 2> := <24.5 K to 273.16 K> : screen display ‘-279C to 0C’
- <Range 3> := <54.4 K to 273.16 K> : screen display ‘-219C to 0C’
- <Range 4> := <83.8 K to 273.16 K> : screen display ‘-189C to 0C’
- <Range 5> := <234.3 K to 302.91 K> : screen display ‘-39C to 30C’

When <Range 5> is selected for <-Coeff> the menu options <+Coeff> and <Edit Pos> are removed from the display screen along with the display of “+Coeff” values.

Function key <Fn-3>, <-Coeff>, selects from the ITS90 set of temperature ranges:

- <Range 6> := <273.15 K to 1234.93 K> : screen display ‘0C to 962C’
- <Range 7> := <273.15 K to 933.47 K> : screen display ‘0C to 660C’
- <Range 8> := <273.15 K to 692.68 K> : screen display ‘0C to 420C’
- <Range 9> := <273.15 K to 505.08 K> : screen display ‘0C to 232C’
- <Range 10> := <273.15 K to 429.75 K> : screen display ‘0C to 157C’
- <Range 11> := <273.15 K to 302.91 K> : screen display ‘0C to 30C’

Function Key <Fn-2> ,<Edit Neg>, allows selection of the edit menu to enter and view the ITS90 probe (negative degree Celsius) temperature coefficients.

Function Key <Fn-4> ,<Edit Pos>, allows selection of the edit menu to enter and view the ITS90 probe (positive degree Celsius) temperature coefficients.

When either the <Edit Neg> or <Edit Pos> key is pressed the **PASSWORD CHECK** display menu is activated.

Before the selected set of coefficients can be changed the correct password must be entered.

If an incorrect password is entered, the error message "Invalid Password" will be displayed and the edit session will be terminated.

3.7.2.2.2.1.2.1. <Edit Neg> MENU Fn-2

3.7.2.2.2.1.2.1.1. <Edit Neg> MENU Fn-2 (ITS90_Mode_Edit_Probes_Setup_MAIN)

Neg Coeff Range : <-259C to 0C>			
a1:			
b1:			
c1:			
c2:			
c3:			
Edit	Ok		Screen 2

Press <Edit> and use arrow keys to move the highlight to the data line to be changed. Modify data and press <Ok>.

**3.7.2.2.2.1.2.1.2.<Edit Neg> MENU Fn-2
(ITS90_Mode_Edit_Probes_Setup_MAIN)**

Neg Coeff Range : <-259C to 0C>			
c4:			
c5:			
Edit	Ok		Screen 2

Press <Edit> and use arrow keys to move the highlight to the data line to be changed.
Modify data and press <Ok>.

**3.7.2.2.2.1.2.2.<Edit Pos> MENU Fn-4
(ITS90_Mode_Edit_Probes_Setup_MAIN)**

Pos Coeff Range: <0C to 962C>			
a6:			
b6:			
c6:			
d:			
Edit	Ok		

Press <Edit> and use arrow keys to move the highlight to the data line to be changed.
Modify data and press <Ok>.

**3.7.2.2.2.1.3.<Probe Set> MENU Fn-3
(Mode_Edit_Probes_Setup_MAIN)**

Probe set menu screen 1 of 2.

Resistance RS:			
Serial No. RS:			
R0 Probe (or R(tpw)):			
Ser. No. Probe:			
RRate:			
Test Current (mA):			
Edit	Ok		Screen 2

Press <Edit> and use arrow keys to move the highlight to the data line to be changed. Modify data and press <Ok>.

A resistance value >0 for the ice point resistance (R0) or triple point of water resistance (Rtpw), MUST be entered for the probe before a measurement can take place.

**<Probe Set> MENU Fn-3 (Mode_Edit_Probes_Setup_MAIN)
Probe set menu screen 2 of 2.**

Max Current (mA):			
Edit	Ok		Screen 2

Press <Edit> and use arrow keys to move the highlight to the data line to be changed. Modify data and press <Ok>.

3.7.2.2.1.4.Password Check Menu.

PASSWORD CHECK			
PASSWORD:			
Edit	Ok		

Press <Edit> and enter the numeric password from the keypad. If the password entered is incorrect the edit function that initiated the password check will terminate without any action being taken. Enter the password and press <Ok>.

3.7.2.2.3.<Edit> Probes MENU Fn-2 (Probes_Setup_MAIN)

Display and edit temperature probe configuration data, menu page 2 of 2. See section 3.7.2.2.2. for menu page 1 of 2.

Mode:	RS Ω:		
Display:	RS SN:		
Update:	R0:		
Filter: <Fn-1>	PR SN:		
Power: <Fn-2>	RRate:		
	mAmps:		
Filter	Power		MORE 2-2

Decimation Power x2
 N Average Power x1
 Filter Off

Function Key <Fn-1> ,<Filter>, allows selection of the filter that will be used on the displayed readings, where:

- No Filter = display most recent reading
- Decimation = display (100-N) percent of the previous reading. Where N is the percentage value set in the <Sofcal><Filter> menu for Decimation.
- N Average = display the average of the last N readings. Where N is the number of readings to be averaged and is that value set in the <Sofcal><Filter> menu.

Function Key <Fn-2> ,<Power>, allows selection of a multiple of the power to be dissipated in the test resistor as X1 (unity) or as X2 (two times power level).

3.7.2.3.<Save> MENU Fn-3 (Resistors_Setup_MAIN)

This menu allows saving to memory of the resistor parameter information. Up to 15 resistor files can be saved. Screen 1 of 2.

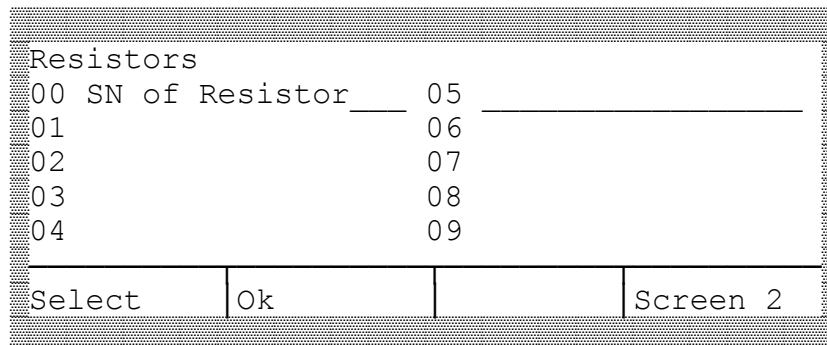

<Save> MENU Fn-3 (Resistors_Setup_MAIN)

Screen 2 of 2.

Resistors			
10	_____		
11			
12			
13			
14			
Select	Ok		Screen 2

3.7.2.3.1.<Save> MENU Fn-3 (Probes_Setup_MAIN)

This menu allows saving to memory of the temperature probe parameter information. Up to 5 temperature probe files can be saved.

Probes			
00	SN of Probe _____		
01			
02			
03			
04			
Select	Ok		

3.7.3. <Voltmeter> MENU Fn-1 (MAIN)

The function keys behave the same as in the <Measure> menu and toggle through the available options in the function key window.

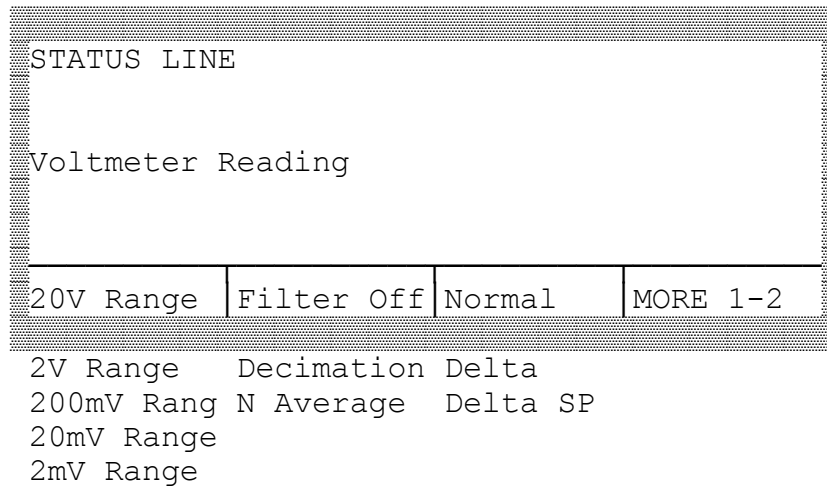

Function Key <Fn-1> ,<20V Range>, allows selection of the voltage range that the voltmeter function will use during the test measurement.

Function Key <Fn-2> ,<Filter>, allows selection of the filter that will be used on the displayed readings, where:

- No Filter = display most recent reading
- Decimation = display (100-N) percent of the previous reading. Where N is the percentage value set in the <Sofcal><Filter> menu for Decimation.
- N Average = display the average of the last N readings. Where N is the number of readings to be averaged and is that value set in the <Sofcal><Filter> menu.

Function Key <Fn-3> ,<Normal>, allows selection of displaying the most recent reading with no offset (<Normal>); or displaying the offset of the most recent reading from the time that this softkey was last pressed (<Delta>); or displaying the offset of the most recent reading from the value that was set in the <Sofcal><Datum> menu (<Delta SP>).

Voltmeter function menu selection screen 2 of 2

STATUS LINE			
Voltmeter Reading			
Cal_Ch Off	Chart Off		MORE 2-2
Cal_Ch +FS Chart On			
Cal_Ch 0			
Cal_Ch -FS			

Function Key <Fn-1> ,<Cal_Ch off>, allows selection of the value of the chart recorder output. Where:

- <Cal_Ch Off> leaves the value of the chart recorder output unchanged
- <Cal_Ch +FS> sets the chart recorder output to maximum positive voltage
- <Cal_Ch 0> sets the chart recorder output to zero output voltage
- <Cal_Ch -FS> sets the chart recorder output to maximum negative voltage.

Function Key <Fn-2> ,<Chart Off>, allows selection between turning the chart recorder output on or off. The values will be scaled depending on the values set in the <Sofcal><Chart> menu. The datum will either be the value displayed when the chart recorder output was turned on, or the value set in the previous <Voltmeter> menu screen by the function key <Fn-3> (<Delta> or <Delta SP>).

3.7.4. <Sofcal> MENU Fn-4 (MAIN)

The menu options available through this function allow configuration setup and general modes of operation of the 6675A. Three pages of menu options are available for this Sofcal selection.

Sofcal menu page 1 of 3.

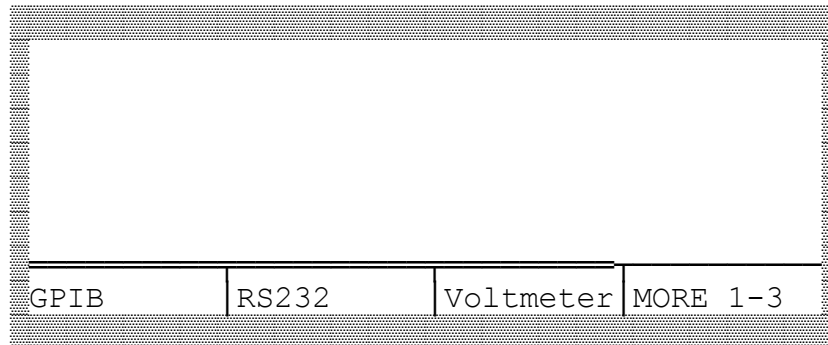

Function Key <Fn-1> ,<GPIB>, allows selection of the device GPIB parameters including address and mode.

Function Key <Fn-2> ,<RS232>, allows selection of the RS232 serial communication parameters including baud rate, number of start/stop/parity bits etc.

Function Key <Fn-3> ,<Voltmeter>, allows selection of the function to set the calibration coefficients for the 6675A when used as a voltmeter with nanovolt resolution.

Sofcal menu selection menu page 2 of 3.

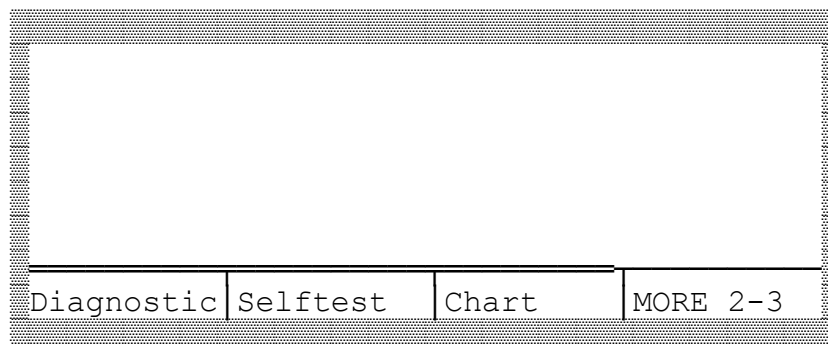

Function Key <Fn-1> ,<Diagnostic>, allows selection of functions that control the hardware. This function is useful when diagnosing problems with the 6675A.

Function Key <Fn-2> ,<Selftest>, displays the result of the power on self test and the revision level of the installed software.

Function Key <Fn-3> ,<Chart>, allows setting of the chart recorder/analog output range value.

Sofcal menu selection menu page 3 of 3.

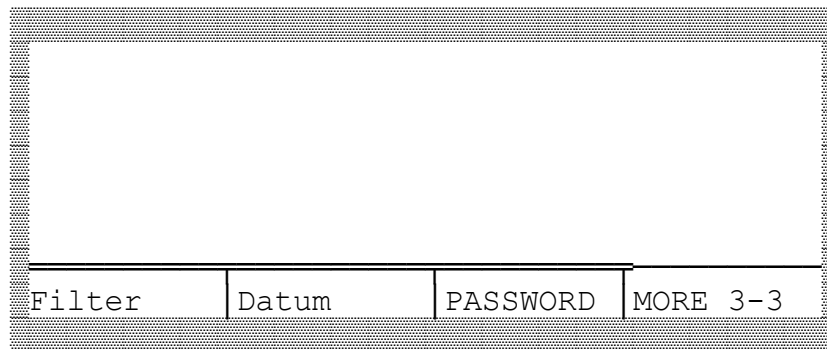

Function Key <Fn-1> ,<Filter>, allows setting of the filter constants for the AVERAGE and DECIMATION filters.

Function Key <Fn-2> ,<Datum>, allows setting of reference/datum values for measurement display changes.

Function Key <Fn-3> ,<PASSWORD>, allows setting of the unit password feature.

3.7.4.1.<GPIB> MENU Fn-1 (Sofcal_MAIN)

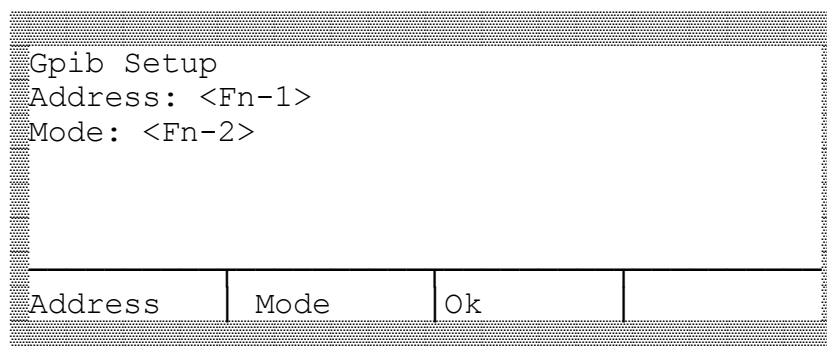

<Address> function key Fn-1 sets the GPIB address.

<Mode> function key Fn-2 selects from the options <Talk/Listen>, <Talk Only>, <Disabled>.

No GPIB settings will be saved or acted upon until <FN-3> the <Ok>. key has been pressed.

NOTE:

If RS232 is in the Talk/Listen mode then the <Mode> key will never display the Talk/Listen mode option since only one remote controller can be active with the 6675A at a time.

3.7.4.2. <RS232> MENU Fn-2 (Sofcal_MAIN)

RS232 Sofcal menu selection page 1 of 3.

```

RS232 Setup
Baud: <Fn-1>           Flow Control:
Parity: <Fn-2>         Mode:
Stop Bits: <Fn-3>
Data Bits:
Echo:

```

Baud	Parity	Stop	MORE 1-3
------	--------	------	----------

Function key, <Fn-1>, <Baud> selects data rate from: <9600>, <4800>, <2400>, <1200>.

Function key, <Fn-2>, <Parity> selects parity from: <Even>, <None>, <Odd>.

Function key, <Fn-3>, <Stop> selects number of stop bits from: <1>, <2>.

RS232 Sofcal menu selection page 2 of 3.

```

RS232 Setup
Baud:                               Flow Cont (rol):<Fn-3>
Parity:                             Mode:
Stop Bits:
Data Bits: <Fn-1>
Echo: <Fn-2>
-----
Data Bits | Echo       | Flow Cont | MORE 2-3
  
```

Function key <Fn-1>, <Data Bits> selects data size in bits from: <8>, <7>.
 Function key <Fn-2>, <Echo> turns echo <On> or <Off>.
 Function key <Fn-3>, <Flow Cont> turns data flow control <On> or <Off>.

RS232 Sofcal menu selection page 3 of 3.

```

RS232 Setup
Baud:                               Flow Control:
Parity:                             Mode: <Fn-1>
Stop Bits:
Data Bits:
Echo:
-----
Mode | Ok       |          | MORE 3-3
  
```

Function Key <Fn-1>, <Mode> selects mode of communication from:
 <Talk/Listen>, <Talk Only>, <Disable>.
 Function Key <Fn-2>, <Ok> accepts all the information that has changed, saves the changes to memory, and resets RS232 interface. If <Ok> is not pressed then all changes are ignored and the previous settings are reloaded.

NOTE:

If GPIB is in the Talk/Listen mode then the <Mode> key will never display the Talk/Listen mode option since only one remote controller can be active with the 6675A at a time.

3.7.4.3.<Voltmeter> MENU Fn-3 (Sofcal_MAIN)

```

Zero Volts:
High Volts:
Ref Volts:
ADC Beta:

20V Range | Volts Set | Coeff Set |
2V Range
200mV Range
20mV Range
2mV Range
  
```

Function Key <Fn-1>, <Range> selects the measurement voltage range for the built-in voltmeter from: <20V>, <2V>, <200mV>, <20mV>, <2mV>.

When either the <Volts Set> or the <Coeff Set> key is pressed the PASSWORD CHECK display menu is activated.

Before the selected set of coefficients can be changed the correct password must be entered. If an incorrect password is entered, the error message "Invalid Password" will be displayed and the edit session will be terminated.

3.7.4.3.1.<Volts Set> MENU Fn-3 (Voltmeter_Sofcal_MAIN)

```

Zero Volts: <Fn-1>
High Volts: <Fn-2>
Ref Volts: <Fn-3>

Zero Volts | High Volts | Ref Volts | Ok
  
```

Function Key <Fn-1>, <Zero Volts> takes a 5 second average of the reading on the nanovolt meter in counts and displays it on the screen. Make sure that the P₂ terminals are shorted together.

Function Key <Fn-2>, <High Volts> takes a 5 second average of the reading on the nanovolt meter in counts and displays it on the screen. Make sure that the applied voltage is set between the P₂ terminals and that a voltage level is entered for <Ref Volts>.

Function Key <Fn-3>, <Ref Volts> allows the actual value of the <High Volts> to be entered.

Function Key <Fn-4>, <Ok> accepts all the information that has changed and saves the changes to memory.

3.7.4.3.2.<Coeff Set> MENU Fn-4 (Voltmeter_Sofcal_MAIN)

This menu allows viewing and edit of the nanovoltmeter coefficients.

Zero Volts:			
High Volts:			
Ref Volts:			
Edit	Ok		

Function key <Edit> allows editing of the coefficients displayed. Use the arrow keys to move the highlight to the data line to be changed, modify the data and press function key <Ok> to accept the value.

3.7.4.4.<Diagnostic> MENU Fn-1 (Sofcal_MAIN)

Diagnostic menu selection page 1 of 4.

Set Internal Values			
Reading:		Range:	
Turns: <Fn-3>		Mode:	
Sign:		Speed:	
milliAmps:		Cur Ramp:	
Volts:		Volt Ramp:	
Monitor	Dacs	Turns	MORE 1-4

Function Key <Fn-1>, <Monitor> selects the monitor menu level and displays the value of the internal channels reported from the servo card assembly.

Function Key <Fn-2>, <Dacs> selects the values for a four channel 12-bit digital to analog convertor on the servo card assembly.

Function key <Fn-3>, <Turns> allows the number of turns to be entered for the RX side, from 0 → 8747 turns.

3.7.4.4.1.<Monitor> MENU Fn-1 (Diagnostic_Sofcal_MAIN)

This diagnostic menu allows monitoring of the signals on the servo board.

Monitor readings on the Servo Board			
Servo:		Prim. Cur:	
Speed Up:		Calibrate:	
Offset:			
+40 Volts:			
-40 Volts:			

3.7.4.4.2.<Dacs> MENU Fn-2 (Diagnostic_Sofcal_MAIN)

Dac Settings			
DAC A (10V) :			
DAC B (10V) :			
DAC C (10V) :			
DAC D (10V) :			
DAC A	Set DAC	Ramp Off	
DAC B		Ramp On	
DAC C			
DAC D			

Function key <Fn-1>, <DAC A> selects which DAC will be modified.

Function key <Fn-2>, <Set DAC> edits the value of the currently selected DAC in <Fn-1>.

Function key <Fn-3>, <Ramp Off> enables or disables the automatic ramping feature for the selected DAC.

3.7.4.4.3. <Diagnostic> MENU Fn-1 (Sofcal_MAIN)

Diagnostic menu selection page 2 of 4.

Set Internal Values			
Reading:		Range:	
Turns:		Mode:	
Sign:	<Fn-1>	Speed:	
milliAmps:	<Fn-2>	Cur Ramp:	
Volts:	<Fn-3>	Volt Ramp:	
Sign	milliamps	Volts	MORE 2-4

Function key <Fn-1>, <Sign> enables sets the direction of current flow and the polarity of the voltage outputs.

Function key <Fn-2>, <milliamps> sets the magnitude of the current output. For the current to flow to the front panel <Mode> must be set to <4 Wire>. The current range is from 0 to 150 mA.

Function key <Fn-3>, <Volts> sets the magnitude of the voltage output. For the voltage to be set onto the front panel <Mode> must be set to <2 Wire>. The voltage range is from 15.7 V to 990 V in steps of 15 V.

CAUTION

When changing the voltage level using this function the voltage must first be set to zero for 4 seconds before setting the voltage to the other value

Diagnostic menu selection page 3 of 4.

Set Internal Values			
Reading:		Range:	<Fn-1>
Turns:		Mode:	<Fn-2>
Sign:		Speed:	<Fn-3>
milliAmps:		Cur Ramp:	
Volts:		Volt Ramp:	
Range	Mode	Speed	MORE 3-4

Function key <Fn-1>, <Range> selects the measurement voltage range for the built-in voltmeter from: <20V>, <2V>, <200mV>, <20mV>, <2mV>.

Function key <Fn-2>, <Mode> sets the measurement mode from the choice of <2-terminal>, <4-terminal> and <I extend> (range extender).

Function key <Fn-3>, <Speed> sets the servo-loop speed from the choice of <Slowest>, <Slow>, <Moderate> and <Fast>. The servo loop is used for balancing the flux in the core.

Diagnostic menu selection page 4 of 4.

Set Internal Values			
Reading:		Range:	
Turns:		Mode:	
Sign:		Speed:	
milliAmps:		Cur ramp: <Fn-1>	
Volts:		Volt ramp: <Fn-2>	
Cur ramp	Volt ramp		MORE 4-4

Function key <Fn-1>, enables or disables the automatic ramping feature for the Current. For current to flow to the front panel, the <Mode> must be set to 4-terminal.

Function key <Fn-2>, enables or disables the automatic ramping feature for the Voltage. For the Voltage to be set onto the front panel, the <Mode> must be set to 2-terminal.

3.7.4.5. <Selftest> MENU Fn-2 (Sofcal_MAIN)

This Sofcal menu selection displays the results of the internal self test performed by the 6675A.

ERROR STATUS:			
ROM Checksum:			
EEROM Checksum:			
40 Volt Rails:			
DAC A & B:			
Calibration Channel:			

NOTE:

A restricted access password system has been implemented for several coefficients stored in non-volatile memory. If the password is changed it can be reset to the factory default password by entering this menu and pressing in order: Function key <Fn-1> followed by Function key <Fn-4>.

ERROR STATUS displays the error bits in hexadecimal notation.

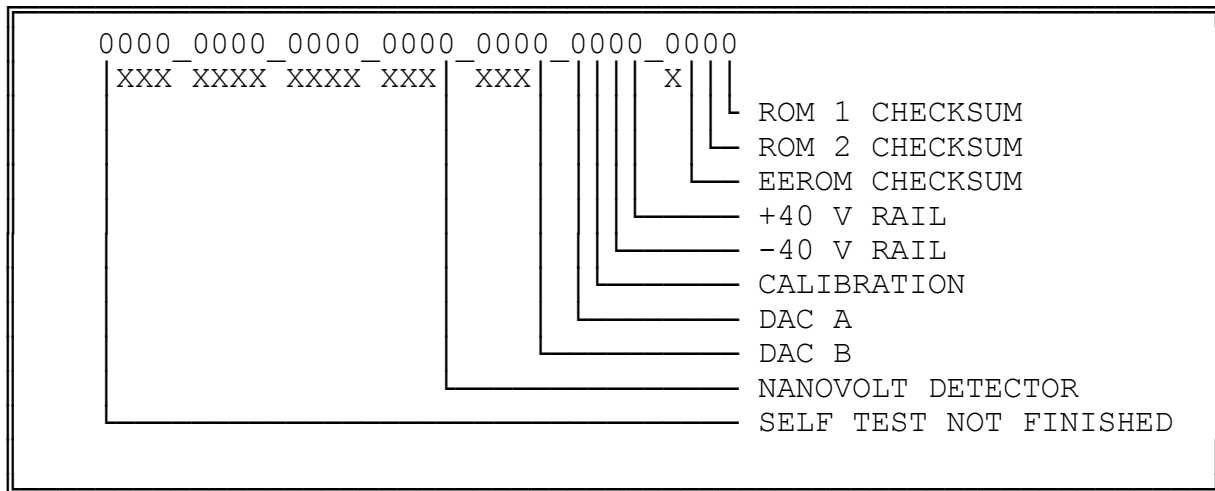

NOTE: 0 = Success, 1 = Failure

ROM CHECKSUM is the sum of the crcs of both proms. **EEROM CHECKSUM** is the CHECKSUM for the battery backed RAM.

3.7.4.6. <Chart> MENU Fn-3 (Sofcal_MAIN)

This menu selection allows display and edit of the chart recorder settings.

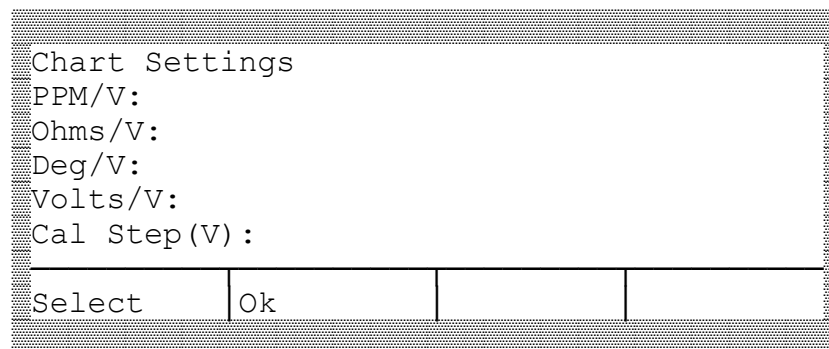

The chart recorder output consists of a 12 bit digital to analog converter having 4096 steps for a 10 volt dynamic range. The settings entered at this menu level determine the measurement resolution of the chart recorder output. The parameter <Cal Step (V)> sets the step calibration value that is issued to the chart recorder output when the command <Cal Step> is made active during the measurement cycle (with <Chart Cal> active). The value entered for <Cal Step (V)> will apply for the active engineering units of measurement from the data set <ppm>, <ratio>, <Celsius>, <Fahrenheit>, <kelvin>, <Ohms> and <Volts>.

3.7.4.7.<Filter> MENU Fn-1 (Sofcal_MAIN)

Filters			
Average N: _____			
Decimation: _____			
Average N	Decimation		

Function key Fn-1 <Average N> allows the number of data samples to be set for the simple averaging filter <1, 2, 4, 8, 16, 32, 64, 128>.

Function key Fn-2 <Decimation> allows the setting of the decimation filter factor <1% through 50%>.

3.7.4.8.<Datum> MENU Fn-2 (Sofcal_MAIN)

Celsius:			
Fahrenheit:			
Kelvin:			
Ratio:			
Ohms:			
Edit	Ok		

The values displayed in this menu are used as datum values when the 6675A is measuring ratio, resistance, temperature, or voltage.

The datum function is applied only to two menu functions from the <MAIN> menu, they are the <Measure> menu and the <Voltmeter> menu.

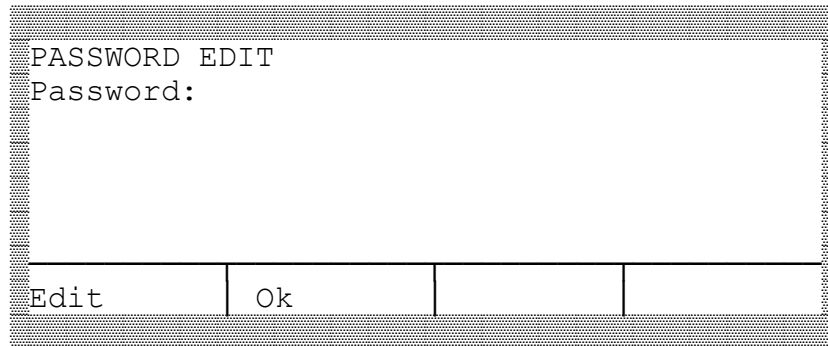
3.7.4.9.<PASSWORD> MENU Fn-3 (Sofcal_MAIN)

```

PASSWORD EDIT
Password:

```

Edit	Ok		
------	----	--	--

When the <Edit> key is pressed the active password will be displayed. The password can be changed using the keypad numeric keys. A string of up to nine (9) characters can be entered for the password. Function key <Ok> will accept the new password as entered.

NOTE:

The factory default password is :

6675A

If the password has been changed and subsequently misplaced see section 3.7.4.5 <SOFCAL_Selftest>, to allow recovery of the factory default password setting.

3.8. MEASUREMENT OPERATION GUIDE**3.8.1. Introduction**

This section contains information regarding the measurement of low value resistors and low value resistance thermometers in the ranges of R_s equal to 1 m Ω to R_s equal to 10 k Ω as four terminal measuring devices. It also contains information on the measurement of high resistance values in the range of R_s equal to 100 k Ω to R_s equal to 1 G Ω .

A section on low resistance measurements ($R_s = 1 \Omega$) is included, where use is made of the Guildline model 9923 and model 6623 range extenders.

Thermometry applications use of the 6675A is discussed in section 3.8.5.

3.8.2. Resistance Measurement Normal Ohms - $1 \text{ m}\Omega \leq R_s \leq 10 \text{ k}\Omega$

The Model 6675A bridge in its normal ohms mode enables measurement of resistance of values up to 10 k Ω : 100 k Ω ($R_x:R_s$). Several types of resistance thermometers, each involving a different resistance range, reference resistor and thermometer current can also be measured in this mode. Figure 3-4 shows a typical front panel connection for this measurement mode. A suggested guarding termination is shown in Figure 3-5

NOTE:

In this as in all measurements, optimum results will be obtained if the environment is controlled. The recommendations in the Instrument Society of America (ISA) publication ISA RE52.1, especially in regards to relative humidity should be observed.

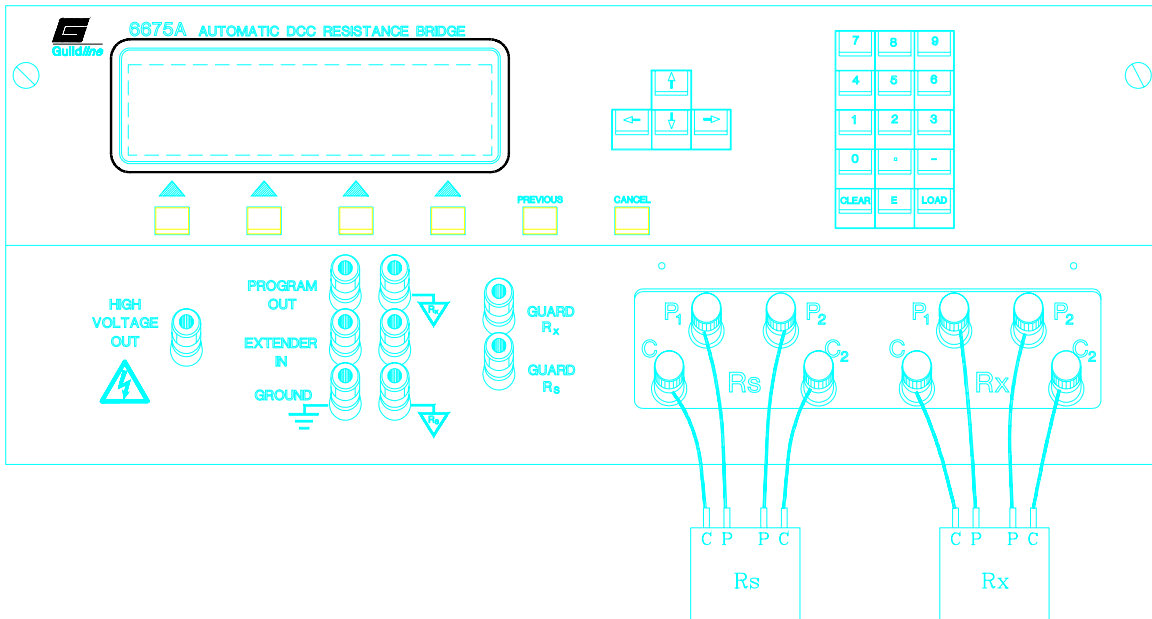

Figure 3-4 : Front Panel Connections - Normal Ohms

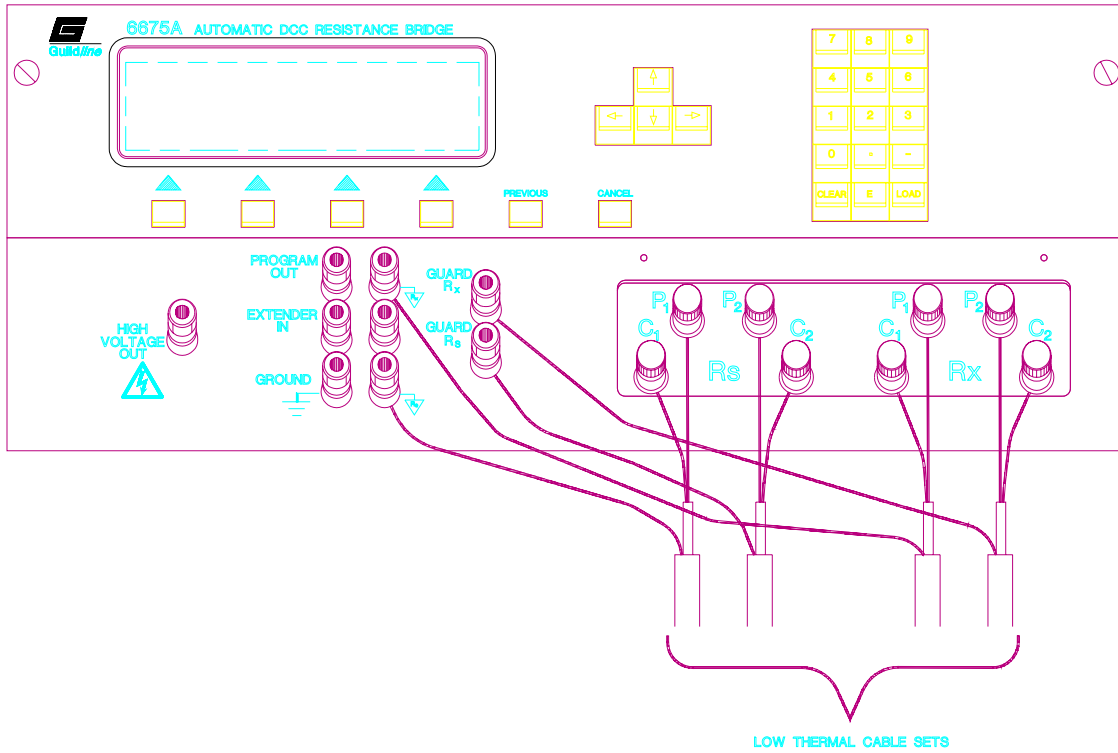

Figure 3-5 : Recommended Guarding for Normal Ohms

3.8.2.1. General Procedures

- Step 1)** Connect the thermometer leads or the resistor to be measured on the four terminals labeled RX on the front panel, where C₁P₁ identifies one current potential pair and C₂P₂ the other pair.
- Step 2)** Select a reference resistor and connect it to the four terminals labeled Rs, also on the front panel. Normally a value is chosen that will make the expected ratio lie between 1:1 and 13.4:1 (Rx:Rs). This ensures the best available precision.
- Step 3)** From the **<Main Menu>** on the 6675A, select the **<Setup Menu>** and make sure the softkey on the extreme right indicates **<Resistors>** (and not **<Probes>**).

and either:

Select a stored measurement configuration:

<Main> → **<Setup>** → **<load>** → **<select>** ;

Use arrow keys to select a stored setup ;

<Ok> key to select setup ;

Then use **<PREVIOUS>** key to get back to the **<Main Menu>** so that the **<Measure Menu>** can be selected

or:

Create a new measurement configuration:

<Main> → **<Setup>** → **<Edit>** → **<mode>** →

<4-terminal> → **<Edit>**

Resistor Setup:

Rs - The value in ohms of the Rs resistor.

A positive number has to be entered for a valid measurement configuration. The value given for Rs determines what nanovoltmeter range the measurement is done on as follows:

Nanovoltmeter Range = 20 V	$R_s \geq 300 \text{ k}\Omega$
Nanovoltmeter Range = 2 V	$R_s \geq 3 \text{ k}\Omega$
Nanovoltmeter Range = 200 mV	$R_s \geq 30 \Omega$
Nanovoltmeter Range = 20 mV	$R_s \geq 0.3 \Omega$
Nanovoltmeter Range = 2 mV	$R_s \leq 0.3 \Omega$

Rs serial # - The character string entered here is the label the file is saved under if you do decide to save this measurement configuration.

Rx - no entry is needed here. A value is entered if you want to skip the rough null checks in the startup of the measurement.

Reversal Rate (seconds)- A whole number ≥ 4 and $\leq 32,000$ (9hrs) must be entered for a valid measurement cycle.

For the best possible measurements with the lowest noise it is highly recommended that:

- for $R_s > 10 \text{ k}\Omega$ that a reversal rate of at least 90 seconds be chosen
- for $R_s \leq 10 \text{ k}\Omega$ a reversal rate of at least 60 seconds be chosen.

Test Current (mA) - a number greater than 0 must be entered here for a valid measurement configuration. Resistance measurements are generally done at a 10 mW power level on the Rs resistor.

Note that "Test Current" is the current sent to the Rx resistor.

Test current may be determined using the following relationship:

$$I_s = Testcurrent \times \left(\frac{R_x}{R_s}\right)$$

Max Current (mA) - a number greater than 0 needs to be entered here for a valid measurement configuration. This current is the maximum current allowed in the Rs resistor and the check :

$$(\text{Max current}) > (\text{Test Current} \times (\text{Ratio}))$$

is made continually and if the check fails then the measurement is terminated and the currents are shut off.

Once editing is complete and the <Ok> softkey is pressed, continuously press and release the <PREVIOUS> key until return is made to the <Main Menu>.

Step 4)

On returning to the <Main Menu> and the measurement configuration setup is complete, press the <Measure> softkey to begin a measurement. The choices in the Measure Menu are:

a) <Ratio/ohms> - displays the measurement result as the ratio

$$\frac{R_x}{R_s}$$

or as

$$\left(\frac{R_x}{R_s}\right) \times R_s \text{ ohms}$$

where Rs is the value entered in the measurement configuration.

b) <Measure off/on> -toggles the measurement on or off.

- c) <Update 1/2/4> - the display is updated every
2 × Reversal rate for update 1.
1 × Reversal rate for update 2.
½ × Reversal rate for update 4.
- d) <Power ×1/×2> - ×1 : the I_x current (voltage for 2 wire) is as set
×2 : the I_x current (voltage for 2 wire) is set to $(I_x \times \sqrt{2})$
- e) <No filter /Decimation/N average>
This sets the type of filter on the displayed measurement. Decimation is an IIR type and N average is a FIR type filter. See <Sofcal_Filter> to set the filter types. Note that when the N average filter is chosen the standard deviation for the last N measurements is displayed.
- f) <Normal/ppm/delta/ppm sp/delta sp> - The measurement is displayed as :
1. direct ratio or ohms.
2. ppm from "reading" where "reading" is the displayed value when the ppm key is pressed.
3. delta from "reading" where "reading" is the displayed value when the <delta> key is pressed.
4. ppm sp (ppm from set point) when set point is an internally set value. See <Sofcal_Datum> to change the set point.
5. delta sp (delta from set point) where set point is an internally set value. See <Sofcal_Datum> to change the set point.
- g) <Cal-ch off/+FS/0/-FS> - this key is used to calibrate the chart recorder used
+FS = +5 V output
-FS = -5 V output
0 = 0 V output
Cal-Ch is set to off when you want to use the chart recorder.
- h) <Chart off/on> - This function key toggles the chart recorder on or off. To set the scale of the chart recorder (in ppm/volt) see <Sofcal> chart.
- i) <Quick OFF> - This function key toggles the quick measure feature on and off to speed up the measurement cycle (quick measurement on).

3.8.3. Resistance Measurement - High Ohms - $100\text{ k}\Omega \leq R_s \leq 100\text{ M}\Omega$; $R_x \leq 1\text{ G}\Omega$

Refer to Figure 3-6 for External High Voltage (HV) power supply connections and to Figure 3-7 for Internal HV power supply connections. Figure 3-8 details a suggested guarding interconnection for the high resistance measurement mode.

The Model 6675A bridge in its High Ohms mode enables measurement of resistance values up to $1\text{ G}\Omega:100\text{ M}\Omega$ ($R_x:R_s$). This is a 2-terminal measurement. In this measurement mode there is a $\pm 90\text{ mA}$ current source with a 30 volt compliance available on the Program Out terminals in order to drive a Model 9607 High Voltage Reversing Switch directly. Also in this measurement mode the test voltage set in the measurement setup is available at the High Voltage and terminal (referenced to ground R_x) once the measurement has been started.

3.8.3.1. High Ohms Measurements - General Procedures

- Step 1)** Connect one end of the resistor to be measured to the $R_x\text{-C}_2$, P_2 terminals (use one of the shorting bars provided to short the $R_x\text{-P}_2$ to $R_x\text{-C}_2$ terminals)
- Step 2)** Connect one end of the reference resistor to the $R_s\text{-C}_2$, P_2 terminals (use one of the shorting bars provided to short the $R_s\text{-P}_2$ to $R_s\text{-C}_2$ terminals).
- Step 3)** Connect the free end of the R_s and R_x resistor to the internal or external HV supply (make sure the external HV supply is disabled first!).

NOTE:

To minimize errors in this 2-terminal measurement introduced by the wire interconnects, the wiring from the HV supply to the R_s and R_x resistors and the wiring from the R_s and R_x resistors to the front panel should be as short as possible.

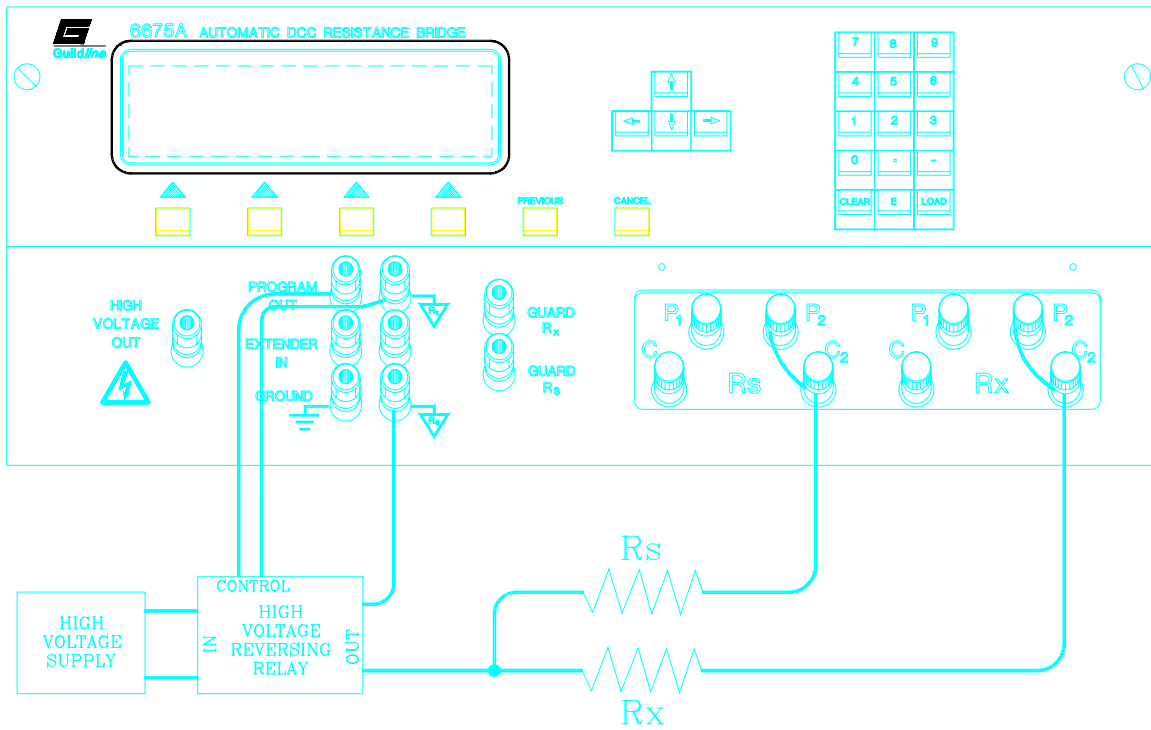
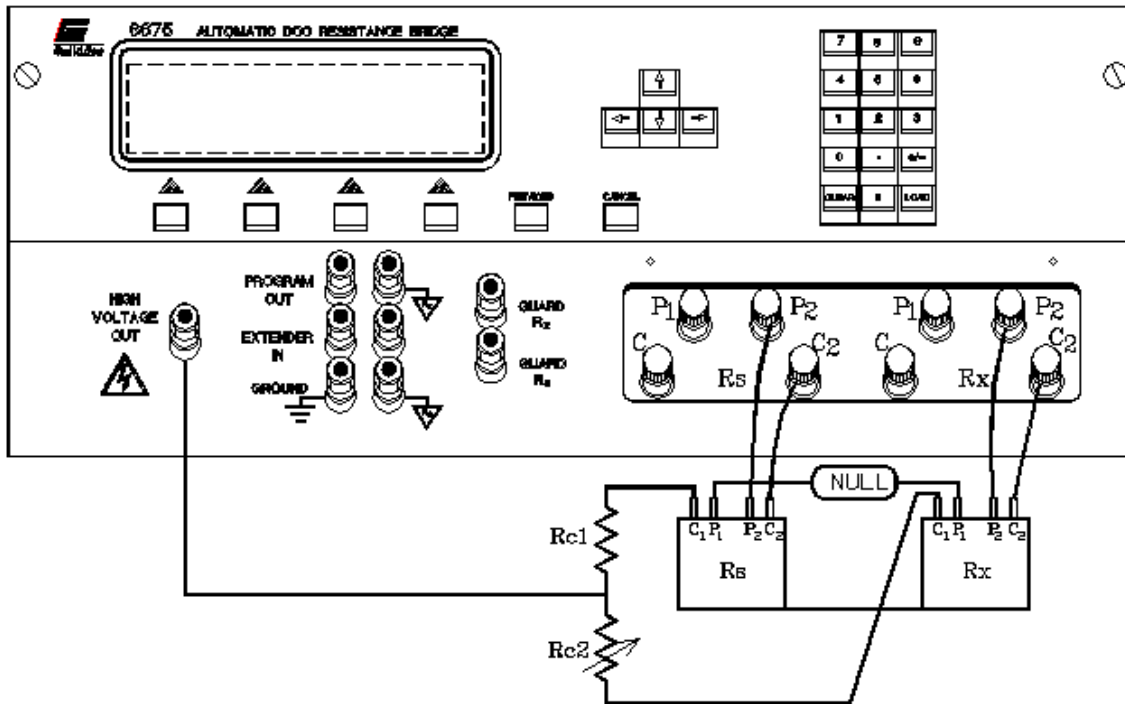

Figure 3-6 : Front Panel Connections High Ohms - External HV Supply



Notes:

1. For 4 terminal measurement; adjust Rc2 lead compensation for null across P1's and then short P1's together.
2. For 2 terminal measurement; C and P terminals are combined as 1 terminal, and lead compensation is optional.

Figure 3-7 : Front Panel Connections High Ohms - Internal HV Supply

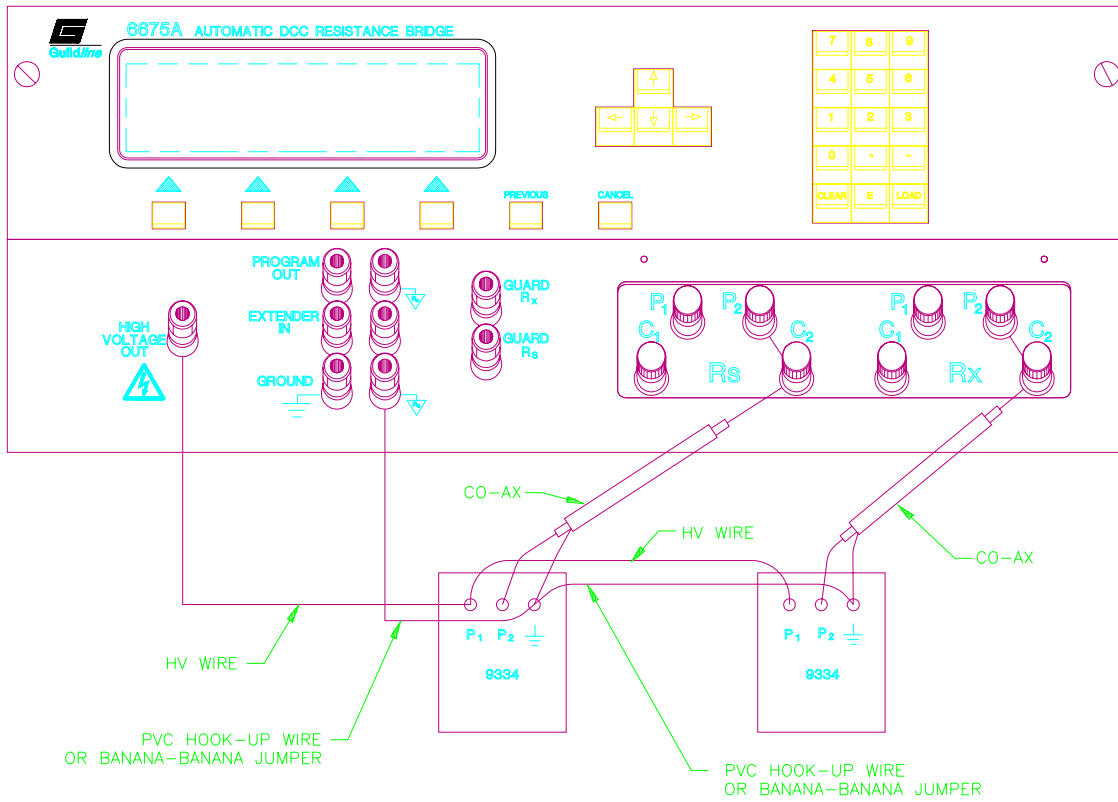

Figure 3-8 : Recommended Guarding for High Resistance Mode

- Step 4)** From the Main Menu on the 6675A, select the **<Setup Menu>** (making sure the softkey on the extreme right displays **<resistors>** and not **<probes>**)

and either

- a) Select a stored measurement configuration by entering the **menu <Main_Setup_load_select>** and using the arrow keys to select a stored setup (then using the **<Ok>** key to select it). Use the **<PREVIOUS>** key to get back to the Main Menu so that the **<Measure Menu>** can be selected

or

- b) Create a new measurement configuration by entering the menu **<Main_Setup_Edit_Mode_2-terminal_Edit>**

Resistor Setup:

Rs:

the value in Ohms of the Rs resistor. A positive number has to be entered for a valid measurement configuration.

Rs serial #:

the character string entered here is the label the file is saved under if you do decide to save the measurement configuration.

Rx:

a value should be entered here as the autoranger has trouble for $R_x > 100 \text{ M}\Omega$ and for $R_s < 1 \text{ M}\Omega$.

Reversal Rate (seconds):

a whole number ≥ 4 and $\leq 32,000$ has to be entered for a valid measurement cycle. For the best possible measurements with the lowest noise it is highly recommended that a minimum reversal rate of 90 seconds be chosen.

Test Voltage:

a number greater than or equal to 15.7 must be entered here for a valid measurement configuration. Resistance measurements are generally done at a 10 mW power level on the Rs resistor. **Note that Test Voltage is the voltage applied to the Rx resistor.**

Max Voltage:

a number greater than or equal 15.7 and greater than Test Voltage must be entered here for a valid measurement configuration. It is the maximum voltage that the Rs and Rx resistors can safely handle.

Once editing is complete press the <Ok> softkey to accept the changes made, then press and release the <PREVIOUS> key several times until the display returns to the Main Menu.

Step 5) Now that you are back to the Main Menu proceed to the <Measure> menu to start the measurement, as in the Normal-Ω mode.

3.8.4. Resistance Measurement - Low Ohms.

Typically $R_s = 1 \Omega$, $R_x \leq 100 \text{ m}\Omega$. This setup requires an external high current power supply and Guildline model 6623 Range Extender. A typical "Low Ohms" measurement configuration, using the model 6623 Range Extender is shown in Figure 3-9.

Ratio measurements made with the Guildline Range Extender should be made such that the condition :

$$R_s = (R_x) \times (\text{EXTENDER RATIO})$$

is maintained.

3.8.4.1. General Procedures Using Guildline High Current Range Extenders.

Step 1) Connect the 1 Ω Rs resistor to the 4 Rs copper terminals. Connect Rx, to the high current supply, and to the model 6623 Range Extender as shown in Figure 3-9.

Step 2) From the Main Menu on the 6675A select the **<Setup Menu>** (making sure the Softkey on the extreme right displays **<resistors>** and not **<probes>**)

and either

a) Select a stored measurement configuration by entering the **<Main_Setup_load_select>** menu and using the arrow keys to select a stored setup (using the **<Ok>** key to select it). Use the **<PREVIOUS>** key to get back to the Main Menu so that the **<Measure Menu>** can be selected

or

b) Create a new measurement configuration by entering the **<Main_Setup_Edit_Mode_Iextend_Edit>** menu.

Resistor Setup:

R_s - the value in ohms of the R_s resistor. It is usually 1 Ohm but does not have to be. A positive number has to be entered for a valid measurement configuration.

R_s Serial # - the character string entered here is the label the file is saved under if you do decide to save this measurement configuration.

R_x - a value does not need to be entered here. If a value is entered than the rough null checks are omitted in the measurement cycle.

Reversal Rate - a whole number ≥ 4 and $\leq 32,000$ has to be entered for a valid measurement cycle. For the best possible measurements with the lowest noise it is highly recommended that a reversal rate of 60 seconds be chosen.

Extender Ratio - if no value is entered for Rx then no value needs to be entered here. If a value for Rx is entered, then the extender ratio needs to be entered. For the Model 6623 range extender this number is 10, 100 or 1000.

Once editing is completed press the <Ok> softkey to accept the changes, then press and release the <PREVIOUS> key several times until the display returns to the Main Menu.

Step 3) Now that you are back to the Main Menu proceed to the <Measure> menu to start the measurement, as in the Normal- Ω mode.

NOTE:

In this measurement mode there is a ± 5 mA current source signal with 30 V compliance available at the PROGRAM OUT terminals, which is sufficient to drive a Guildline model 9606 High Current Reversing Switch or the "Program Input" terminals of the model 6623. It is also possible to use the "pseudo" open collector output of the SYNC terminals on the rear panel to drive the Model 9606 switch. This would be done if more isolation is desired between the reversing switch control line and the measurement current.

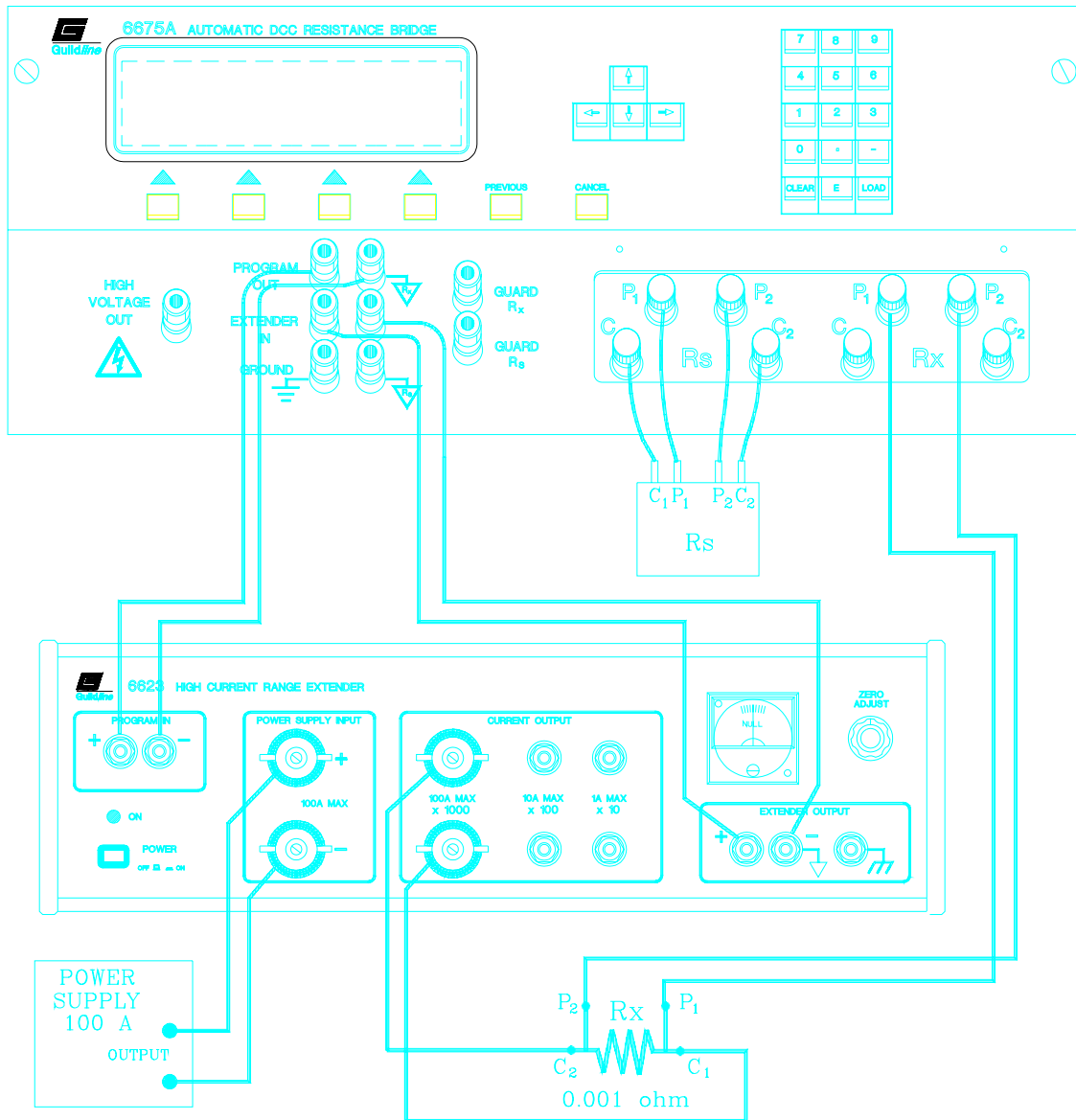

Figure 3-9 : Front Panel Connections Low Ohms, 6623 Range Extender

3.8.5. Thermometry Measurements.

This is very close to the 4-terminal "Normal Ohm" measurement routine. The difference, is that on large temperature changes the rough null routines are re-enabled so that the "null Turn" on the toroid can track the temperature change.

As this mode is essentially a 4-terminal Normal Ohm measurement, probes, having R0 or triple point resistance values in the working range (0.25Ω to $>100.0\Omega$) where $0.001\Omega < R_s \leq 10k\Omega$, can be connected directly to the 6675A.

Step 1) Connect the standard resistor (Guildline Model 9334 $100\ \Omega$ and $25\ \Omega$ resistors work quite well here) to the R_s terminals and connect the temperature probe to the R_x terminals.

Step 2) From the Main Menu on the 6675A select **<Setup>** (making sure that the right most softkey displays **<probes>** and not **<resistors>**).

Step 3) Then either:

a) Select a stored measurement configuration by going to the **<Main_Setup_load_select>** menu and by using the arrow keys and **<Ok>** key choose the proper configuration

or

b) Create a new measurement configuration by going to the **<Main_Setup_Edit_Mode>** menu.

IPTS 68 - coefficient set for your probe. There are 4 coefficients and they are changed by the **<edit>**, arrow and number keys. The **<Ok>** key accepts changed data.

ITS 90 - coefficient set for your probe. There are 5 negative $^{\circ}\text{C}$ ranges and 6 positive $^{\circ}\text{C}$ ranges. Use the **<edit>**, arrow and number keys to change the coefficient.

The **<Ok>** key accepts changed data.

The **<-coeff>** and **<+coeff>** keys allow you to browse through all 11 ranges.

NOTE:

When a temperature measurement is in progress the last coefficient set selected is used to calculate temperature.

Probe Setup:

Rs - the value of the standard resistor used in this temperature measurement. A positive non-zero number has to be entered for a valid configuration. Since the power (and hence current) levels are so low (100 μ W is typical) for thermometry measurements the 20 mV range on the nanovolt detector is always used. (in a resistance measurement with $R_s=100 \Omega$, the 200 mV range on the nanovolt detector is used.)

Rs Serial # - The character string entered is the label of the configuration file if you decide to save it.

R0 Probe - The triple point (or if applicable ice point) resistance of the probe.

Probe Serial # - the serial number for your probe.

Reversal Rate - a whole number ≥ 4 and $\leq 32,000$. For best results with lowest noise a reversal rate ≥ 30 seconds is highly recommended.

Test Current - a positive non zero number needs to be entered here. This is the current sent to the thermometer probe.

Max Current - a positive non zero number needs to be entered here. This is the maximum safe current that can be handled by the R_s resistor.

At all times the inequality:

**Max Current > Test Current × ratio
is tested and if it fails, the measurement is stopped.**

When editing is complete, press the <OK> key to accept all changed data and press the <PREVIOUS> key until the display returns to the Main Menu.

Step 4) Now that you are in the Main Menu you can go into the <Measure> menu and start up the measurement as in a 4-terminal "Normal Ohms" mode application with the exception that now instead of displaying the measurement in ratio or ohms, you can now display the measurement as ratio, ohms, °C, °F or K. (if you have entered values for the IPTS68 or ITS90 coefficient sets).

3.8.6. Summary of Recommended Test Setups

a) Normal Ohm mode, 4-terminal measurements (10 milliwatt on Rs)

Rs (Ω)	Rx (Ω)	I _{test} (mA)	I _{max} (mA)	Comment
0.1	0.1	141	150	2 mW tests due to output current limit of 150 mA on Rx and 250 mA on Rs
0.1	1	14.1	150	
1	1	100	150	
1	10	10	150	
10	10	31.6	100	
10	100	3.16	100	
100	100	10	31.6	
100	1 k	1	31.6	
1 k	1 k	3.16	10	
1 k	10 k	0.316	10	
10 k	10 k	1	3.16	
10 k	100 k	0.1	3.16	Reversal rate 90 seconds minimum
100 k	100 k	0.316	0.35	Not a recommended configuration. Use 2-terminal mode.
100 k	1 M	0.032	0.35	Not a recommended configuration Use 2-terminal mode

Table 3-1 : 4-Terminal Mode Test Setup

- b) High Ohm mode, 2-terminal measurements (10 milliwatt on Rs), 90 second reversal rate.

Rs (Ω)	Rx (Ω)	Vtest (V)	Vmax (V)	Comment
100 k	100 k	31.6	100	
100 k	1 M	31.6	100	
1 M	1 M	100	316	
1 M	10 M	100	316	
10 M	10 M	316	1000	
10 M	100 M	316	1000	
100 M	100 M	990	1000	Output limit of voltage source
100 M	1 G	990	1000	

Table 3-2 : 2-Terminal Mode Test Setup

- c) Low Ohm mode, Current Range Extender measurements.

These measurements have been standardized at 1 Watt dissipation in the current shunt.

Rs (Ω)	Rx (Ω)	Itest (A)	Extender Ratio	Comment
10	0.1	3.16	100:1	
1	0.1	0.316	10:1	Test at 10 mW
1	0.01	10.0	100:1	
1	0.001	31.6	1000:1	
1	0.0001	100	1000:1	

Table 3-3 : Low Ohm Mode Test Setup

3.9. 6675A DATA ACQUISITION SOFTWARE

A computer program that can assist with the remote control and operation of the model 6675A is included with Volume II of the 6675A Technical Manual.

The Guildline 6675A Data Acquisition software, ResCal™, requires the following hardware and software for proper execution.

Hardware

- An 80386 or 80486 based IBM or compatible computer.
- At least 4 megabytes of memory.
- A hard drive with at least 4 megabytes of free space for the Guildline 6675A Data Acquisition files.
- A monitor and graphics card compatible with Windows.
- A mouse supported by Windows.
- Any printer supported by Windows.
- National Instruments GPIB Controller.

Software

- MS-DOS or PC-DOS version 3.3 or later.
- Microsoft® Windows™ version 3.1 or later.
- National Instruments driver software.

The 6675A distribution software package supports the National Instruments GPIB-PC interface card only. Other IBM-PC interface cards will be supported with further releases of the software. It is important that the National Instruments GPIB-PC interface card be properly configured prior to running the program and attempting to communicate with the 6675A hardware.

4. THEORY OF OPERATION

4.1. THEORY I INTRODUCTION

The Guildline Model 6675A is a microprocessor-based, direct-current-comparator bridge designed for the automatic measurement and display of the ratio of two resistances to accuracies approaching 0.1 ppm. The ratio of the two resistances is determined from a direct measurement of the voltage of the bridge imbalance while an ampere-turn balance is maintained. A microprocessor-based, 16 bit technology, is used to control the direct-current-comparator, set the bridge measurement currents and measurement configuration, initiate the voltage measurement cycle and maintain the ampere-turn balance. This fully automated measurement process achieves optimum resistance ratio resolution and accuracy at the sub-ppm level.

The bridge is designed for flexibility and ease of use and is based on the manually operated direct-current-comparator bridge manufactured by Guildline Instruments (Model 9975) and also on the original work of the National Research Council of Canada¹. Remote access to the embedded microprocessor-controller, through a simple control language command set and GPIB communication interface allows the 6675A operator to fully exploit the capabilities of the direct-current-comparator to suit each user requirement while still maintaining optimum resistance ratio measurement accuracy at the sub-ppm level.

The design approach taken for the 6675A results in an effective bridge measurement accuracy of 27 bits (to a maximum of 32 bits depending on configuration), allowing the resistance ratio of resistances in the range 0.001 Ω to 1 G Ω to be automatically measured.

¹ MacMartin, M.P. and Kusters, N.L., "A direct -current-comparator for four terminal resistance measurements", IEEE Trans. Instrumentation and Measurement, vol IM-15, pp.212-220, December 1966.

4.1.1. The automatic direct-current-comparator resistance bridge.**4.1.1.1. The manual bridge - background.**

The direct-current-comparator bridge is a resistance bridge particularly suited for the comparison of "low value" resistors and the scaling of low resistances under conditions in which each resistor functions at its own power level. In this bridge network, the ratio of the resistances is determined from a knowledge of the ratio of the currents flowing in the bridge resistors.

The direct-current-comparator, shown schematically in Figure 4-1, provides a means for connecting together two isolated current sources with two resistors and the two ratio windings of the current comparator. The current comparator is a current ratio indicator based on the detection of zero flux in the magnetic core of the device. For direct current applications a double core magnetic modulator is used which consists of a double toroidal core magnetic modulator and a magnetic shield. The two ratio windings link the modulator and the magnetic shield which carries the currents to be compared. When the modulator output is zero the current ratio is equal to the turns ratio to a high degree of accuracy.

At ampere-turn balance,

$$(N_x) \times (I_x) = (N_s) \times (I_s)$$

For the manually operated direct reading bridge (model 9975), a second bridge balance condition is necessary to make the resistance ratio result direct reading. This second balance is achieved by manually adjusting the number of turns N_x until the output from the bridge null detector is zero.

At the null voltage condition

and $V_d=0$
 $(I_x) \times (R_x) = (I_s) \times (R_s)$

When a flux and voltage balance is achieved it is clear that:

$$R_x = (R_s) \times (N_x / N_s)$$

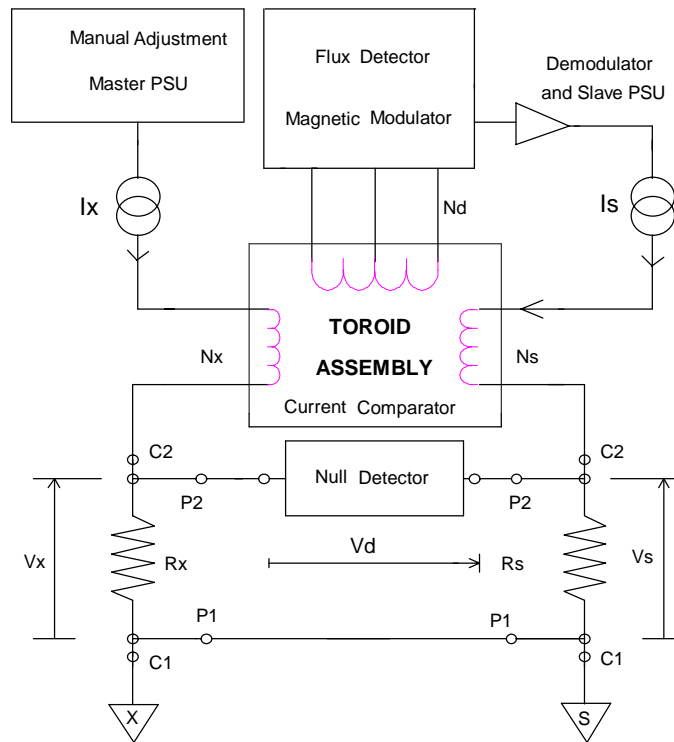

Figure 4-1 : Direct-Current-Comparator Bridge

Also, by semi-automating the balance of the zero ampere-turn flux condition, using an electronic closed loop feedback network operating on the flux detector output to drive a slave power supply for I_s , the operator need only make manual adjustments for one effective bridge balance (null voltage condition), by adjusting the windings in the turns N_x .

4.1.2. The automatic bridge.

A simplified diagram of the automatic direct-current-comparator is shown in Figure 4-2. As with the bridge of Figure 4-1, it can be seen that two sets of four terminal connection hardware are provided, one set for the reference resistor and one set for the unknown resistance. A current (I_x), set under control of the microprocessor, is passed through the variable turns of winding (N_x) of the comparator and through the unknown resistance (R_x). The isolated slave current (I_s) is generated under microprocessor control, as a linear function of the number of turns (N_x) and is forced through the fixed slave windings (N_s) and the reference resistor (R_s). The currents (I_s) and (I_x) flowing in the windings (N_s) and (N_x) respectively generate a net magnetic flux imbalance in the flux detector windings (N_d). This flux imbalance is proportional to the net ampere-turn error between the two windings [$(I_s) \times (N_s)$] and [$(I_x) \times (N_x)$]. By sensing this imbalance with the sensitive flux detector winding and an electronic peak detector, a voltage signal is generated proportional to the sign and magnitude of the ampere-turn error. This voltage is used in a simple closed loop control configuration to adjust the slave current (I_s) to bring the (ampere-turn) error signal to zero.

At balance, the ratio of the two currents (I_x and I_s) flowing in the two windings is the same as the ratio of the turns set for each winding (N_x and N_s).

Complete electrical isolation between circuit currents is maintained throughout the 6675A by making full use of fibre optic technology. A fibre optic serial data communication link is used to transfer data between each functional component and the embedded microcontroller.

A link joining the two potential leads of the unknown resistance (R_x) and the reference resistance (R_s) and the nanovoltmeter detector, provides the only connection between the two halves of the bridge. Power supply isolation techniques as recommended by Kibble² are used throughout to further isolate the bridge halves. The nanovolt detector is a high input impedance ($>1\text{ G}\Omega$) amplifier arrangement capable of resolving voltages at the nanovolt level with a typical linearity accuracy of 14 bits (to a maximum of 18 bits). In the automatic direct-current-comparator bridge arrangement this amplifier is used to measure the voltage difference between the two bridge circuits (bridge imbalance).

Knowledge of the reference resistance value (R_s), the effective bridge voltage imbalance and confirmation that ampere-turn balance is maintained, with the turns (N_x , N_s) and current (I_x , I_s) settings, allows the unknown resistance value (R_x) to be calculated.

² Kibble, B.P. and Robinson, I.A., "An Isolated Mains Driven Power Supply", NPL Memorandum DES 54, September 1985.

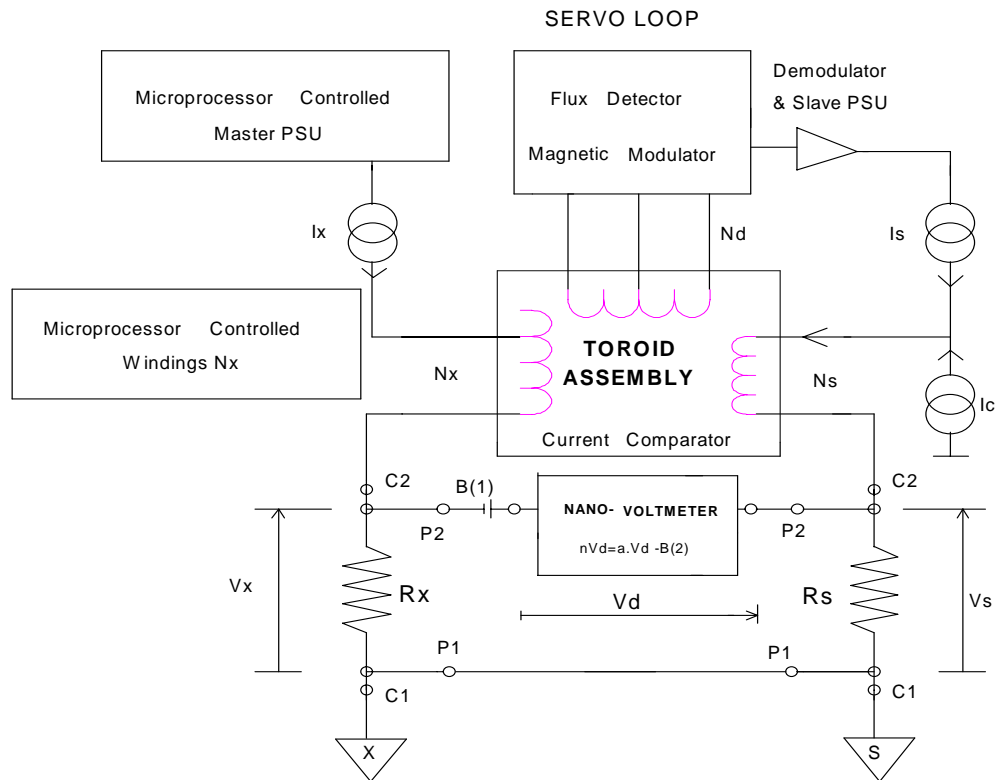

Figure 4-2 : Automatic DCC Bridge Balance

4.1.3. Automatic direct-current-comparator bridge balance.

With reference to Figure 4-2 , at the ampere-turn balance point, if:

- N_x = number of turns in variable comparator winding
- N_s = number of turns in slave fixed comparator winding
- I_s = current in the slave winding and R_s
- I_x = current in the variable comparator winding and R_x
- V_d = bridge voltage imbalance
-
- I_c = core offset current

and:

- V_{os} = the combined offset due to thermal voltage

$$\begin{aligned}
 & \beta(1) \text{ and nanovoltmeter offset } \beta(2) \\
 \bullet \quad I_c + (I_x) \times (N_x) & = (I_s) \times (N) \\
 \bullet \quad I_s & = (I_x) \times (N_x / N) + I_c / N \\
 \bullet \quad nV & = (I_s) \times (R_s) - (I_x) \times (R_x) + V_{os}
 \end{aligned}$$

Then we can state the generalized formula:

$$nV = R_s \left[I_x \cdot \frac{N_x}{N} + \frac{I_c}{N} \right] - I_x \cdot R_x + V_{os} \quad (4)$$

If at the approximate null of the bridge $N_x = T_n$ and we switch $\pm(t)$ turns to winding N_x , then assuming ampere-turn balance is maintained, the bridge voltage imbalance (nV) for current (+) becomes $nV(+t)(+)$ and $nV(-t)(+)$. Where:

$$nV(-t)(+) = R_s \cdot \left[\frac{T_n - t}{N} \right] - I_x \cdot R_x + V_{os}(-t) \quad (5)$$

and:

$$nV(+t)(+) = R_s \cdot \left[\frac{T_n + t}{N} \right] - I_x \cdot R_x + V_{os}(+t) \quad (6)$$

Subtracting (5) from (6):

$$nV(+t)(+) - nV(-t)(+) = R_s \cdot \left[\frac{2 \cdot t}{N} \cdot I_x \right] \quad (7)$$

If we now reverse the direction of the test current to $I_{xx} (-)$, where I_{xx} is not necessarily equal to $I_x (+)$ then:

$$nV(-t)(-) = R_s \cdot \left[\frac{-T_n + t}{N} \right] + I_{xx} \cdot R_x + V_{os}(-t) \quad (8)$$

and:

$$nV(+t)(-) = R_s \cdot \left[\frac{-T_n - t}{N} \right] + I_{xx} \cdot R_x + V_{os}(+t) \quad (9)$$

Subtracting (9) from (8):

$$nV(-t)(-) - nV(+t)(-) = R_s \cdot \left[\frac{2 \cdot t}{N} \cdot I_{xx} \right] \quad (10)$$

Adding expressions (7) and (10):

$$\left[\frac{2 \cdot t}{N} \right] \cdot [I_x + I_{xx}] \cdot R_s = [nV_{expr}] \quad (11)$$

where:

$$nV_{expr} = [nV(+t)(+) - nV(-t)(+)] + [nV(-t)(-) - nV(+t)(-)] \quad (12)$$

Then:

$$I_x + I_{xx} = \left[\frac{N}{2 \cdot R_s \cdot t} \right] \cdot [nV_{expr}] \quad (13)$$

To remove the offset caused by any core offset currents we can subtract expression (5) from (8) to get:

$$nV(-t)(-) - nV(-t)(+) = \left[\frac{t - Tn}{N} \cdot (I_x + I_{xx}) \cdot R_s \right] + (I_x + I_{xx}) \cdot R_x \quad (14)$$

Then:

$$\left[\frac{R_x}{R_s} \right] \cdot [nV_{expr}] + \left[\frac{t - Tn}{N} \right] \cdot [nV_{expr}] = \left[\frac{2 \cdot t}{N} \right] \cdot [nV(-t)(-) - nV(-t)(+)] \quad (15)$$

and the resistance ratio can be resolved:

$$\left[\frac{R_x}{R_s} \right] = \left[\frac{Tn-t}{N} \right] + \left[\frac{2.t}{N} \right] \cdot [NVexpr] \quad (16)$$

Where:

$$NVexpr = \left[\frac{I}{I + \left[\frac{nV(+t)(+) - nV(+t)(-)}{nV(-t)(-) - nV(-t)(+)} \right]} \right] \quad (17)$$

Expression (16) allows us to include the offsets due to:

- Vos = the combined offsets due to thermals and nanovoltmeter offsets
- Ios = the offset in the primary current

and:

- Ic = the core offset current.

The complete operation of the 6675A, including coarse control of the slave current (Is) to track both the turns setting (Nx), and the current setting (Ix), is achieved through the microprocessor / fibre optic control function. A graphical display unit and keypad arrangement controlled by the microprocessor are used for display of the calculated ratio result and operator interaction respectively.

Bridge currents to ± 150 mA with up to 30 volt compliance can be generated by the 6675A when measuring four terminal resistances. When measuring very low resistance values to 0.001Ω , a high current range extender option is available for use with the 6675A. A stable, microprocessor controlled, adjustable power supply capable of sourcing up to 990 V DC is provided by the 6675A to allow higher resistance values ($100 \text{ k}\Omega$ to $1 \text{ G}\Omega$) to be measured in a two terminal configuration.

4.2. THEORY II RESISTANCE MEASUREMENT - 9975 BACKGROUND.

To understand how the 6675A makes a resistance measurement it is best to go back and look at the Model 9975 (manually operated version of the bridge). See Figure 4-3 for a block diagram of the 9975.

The measurement principle is based on a DC transformer and flux detector. Electronic circuitry maintains the flux balance and the operator adjusts the voltage balance by changing the turn dials while watching the Galvanometer balance dial. The photocell galvanometer has a coil resistance of 20 Ω . This isn't a problem until we get to the higher R_s , R_x values when the 60/50 Hz "line frequency" (induced pickup) current is a significant portion of the DC signal current and the galvanometer becomes an AC short.

The core of the 9975 is a 27-bit current digital to analog converter (dac) where the upper 13 ½ bits consists of 0 to 11,111 real turns and the lower 13 ½ bits consists of a (4×10 turn) current splitting network based on a 53 Ω manganin wire-wound resistor and hence stability and accuracy of the lower 13 ½ bits depends on the stability and accuracy of a resistor network.

To assist in the nulling of the flux in the core the upper 13 ½ bits of the flux on the "B" side (N_x turns, I_x current) is fed over to the "A" side by means of a multiplying digital to analog converter (mdac) so that the servo circuitry on the "A" side only has to null out the lower 10-13 bits of the total flux. There is a resistor network on the real turns dials whose value is changed by 1 Ω /turn and that is the dac portion of the mdac.

(Note that there is more than 1 link electrically between the "A" and "B" sides.)

4.2.1. Theory II 6675A

See Figure 4-4 for a block diagram of the 6675A. The measurement principle is again, based on a DC transformer and flux detector and also includes a linear voltage detector and an interpolation algorithm described in Figure 4-9.

In the 6675A, electronic circuitry maintains the flux balance in the toroid and the 6675A controller measures the voltage imbalance while changing turns and current directions. The " I_x -side", " I_s -side" and nanovoltmeter are all isolated from each other and the 6675A controller by fibre optic communications for maximum isolation.

The core of the 6675A is a 13 bit current dac based on 0 to 8747 real turns which is done in a base 3 switching arrangement to minimize the number of relays used.

The voltage imbalance between the "X" and "S" sides is measured by an autoranging, 5 range, uncalibrated nanovoltmeter. It has a resolution of 22 bits and more than 14 bits linearity. On the mV ranges of the nanovolt detector where we are (generally) measuring ≤ 3 k Ω on its input, the nanovolt detector bias current is ≤ 50 pA and on its "volts ranges", for $R_s > 3$ k Ω , its input bias current < 0.1 pA. When these bias currents are compared to the currents



used to measure resistance ratios at a power level of 10 mW, we see that $I_{\text{bias}} \leq 10^{-8} \times I_{\text{test}}$ so that the DC loading of the nanovolt detector is negligible.

(Note that in the 6675A we have no fractional or subfractional turns to deal with and the attendant calibration problems associated with fractional turns, however the nanovoltmeter has to be linear to 14 bits on all 5 ranges).

4.2.2. 6675A Servo Circuit

See Figure 4-5 for a block diagram of the 6675A Servo circuit.

The key feature of the 9975 servo that has been kept is the "Tracking" or rough ampere-turn "rough A-T" balance feature, except that in this case there is no mechanical or electrical link to the "X-side". We know what turns and current have been set on the "X-side" and this is fed to the "S-side" via the fibre optic link to set the rough A-T balance.

The controller has been changed from a Voltage (Proportional), P-controller (9975) to a Current, I-controller (6675A). This was done to increase the noise immunity of the servo and to increase the open loop gain.

The "smart" feature of the 6675A servo is the 8 channel 12-bit A/D converter, the Tracking dac and the variable speed of the I-controller. During all phases of the measurement cycle (see Figure 4-7) the servo value is looked at and its value is added to the tracking dac the next time through that phase.

The result is that after a couple of measurement cycles the servo output stays within a few mV of ground S even though it has a dynamic range of ± 14 V. Also during all transitions the response of the servo is slowed down by a factor of 10 for 60 mS. The net effect of the Tracking dac and slowed down servo is that a very deep null is kept on the flux detector at all times, even during transitions.

4.2.3. 6675A Primary Current I_x

See Figure 4-6 for a block diagram of the Primary current module.

The main features of the "I" side are a stable 19-bit (including sign) current dac and a 7-bit (including sign) optically isolated high voltage dac.

This section includes all mode configuration relays .

4.2.3.1. Low- Ω Measurement Mode

This mode allows a 4 terminal resistance measurement to be made down to 0.1 m Ω . Full accuracy can be maintained when a model 6623 Range Extender and an external high current supply are used. The program out terminals provide a ± 5 mA current source with 30 volt compliance to drive the 6623 reversing switch. (The sync output on the 6675A rear panel will also drive the Guildline model 9606 reversing switch). The Extender input is used for current sensing.

4.2.3.2. Normal- Ω Measurement Mode

This mode allows a 4-terminal resistance measurement to be made from $1\text{ m}\Omega \leq R_s \leq 10\text{ k}\Omega$. No external devices (except the two resistors) are required with the 6675A to make this measurement.

4.2.3.3. High- Ω Measurement Mode

This mode allows a 2-terminal resistance measurement to be made from $100\text{ k}\Omega \leq R_s \leq 100\text{ M}\Omega$, $R_x \leq 1\text{ G}\Omega$ and can be done with the internal high voltage supply of the 6675A.

Here **Program Out** is a $\pm 90\text{ mA}$ current supply with 30 volt compliance. This signal is suitable for driving a Guildline model 9607 High Voltage Reversing Switch when an external high voltage power supply is used.

- **Relay/Turns Switching.**

A note on the relay board and turns switching. The relay board is controlled via the fibre optic interface through the primary turns module (from which it gets its power). All turns switching is done by guarded ultra-high impedance relays. All turn switch interconnect wiring is done on guarded ceramic standoffs. This minimizes any current leakage paths that could cause an error in the measurement.

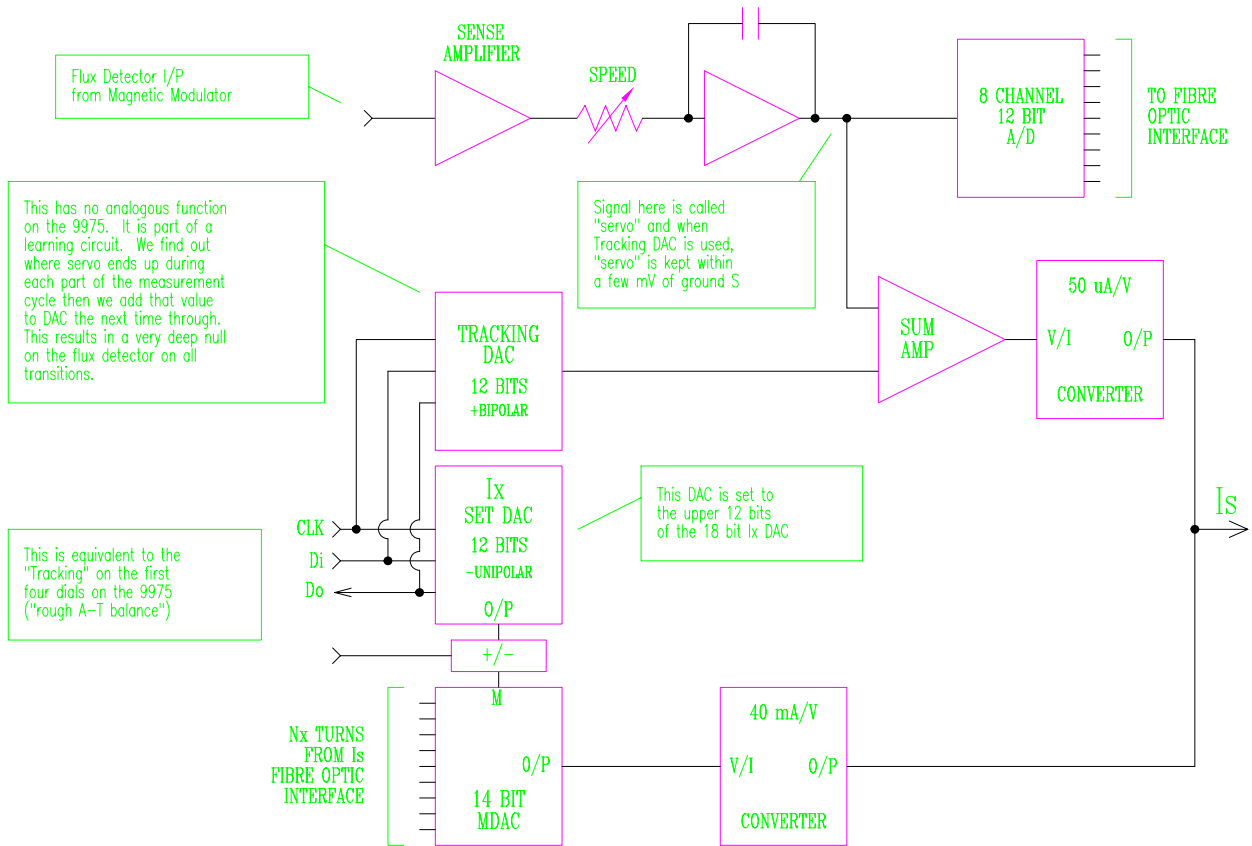

Figure 4-5 : 6675A Servo "Is"

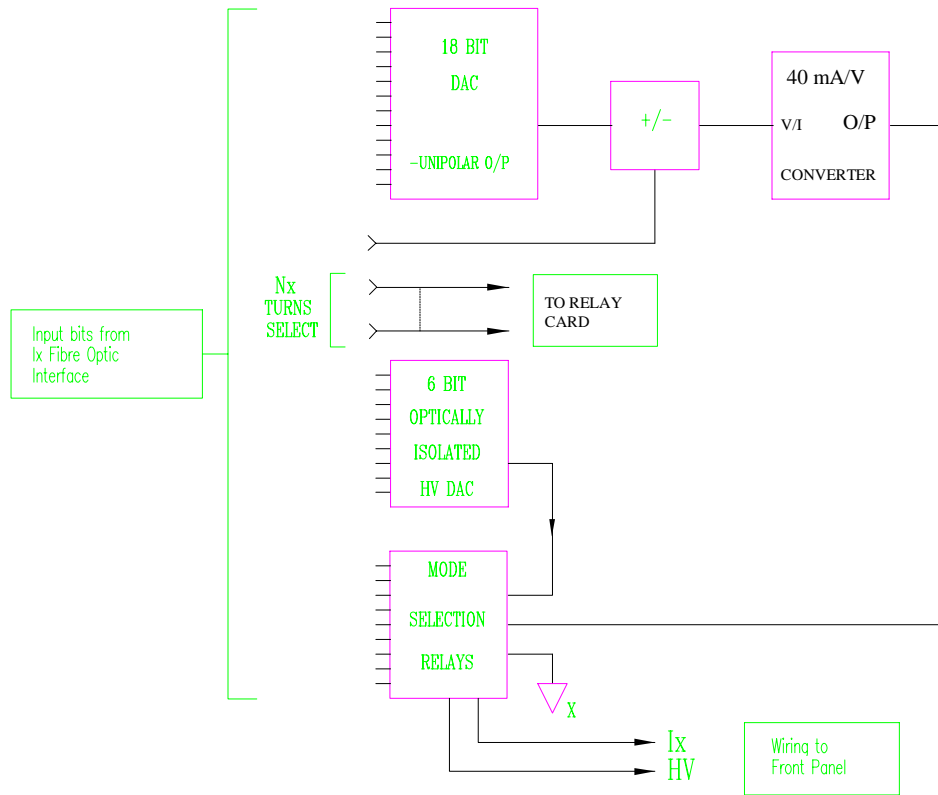

Figure 4-6 : 6675A Primary Current "Ix"

4.2.4. 6675A Signal Acquisition

This section details the three stage signal acquisition process consisting of a Rough Null Phase, a Fine Null Phase and a Measurement Phase, and also the derivation of the formula used to determine the null turn (T_n).

In the following discussion:

nanovolt detector reading = $nV(T,I)$
 current $I_x = I$
 and turns $N_x = T$

• **Rough Null Phase**

- a) $I_x = +0.1 \times (I_{TEST})$; Turns = 0 ; Time = $(1/4) \times (\text{Reversal Rate})$; $nV(0,+I)$
- b) $I_x = +0.1 \times (I_{TEST})$; Turns = 648 ; Time = $(1/4) \times (\text{Reversal Rate})$; $nV(648,+I)$
- c) $I_x = -0.1 \times (I_{TEST})$; Turns = 0 ; Time = $(1/4) \times (\text{Reversal Rate})$; $nV(0,-I)$
- d) $I_x = -0.1 \times (I_{TEST})$; Turns = 648 ; Time = $(1/4) \times (\text{Reversal Rate})$; $nV(648,-I)$

Therefore :

$$T_n^{Rough} = \text{Int}[648 \times (R_x/R_s)]$$

and

$$T_n^{Rough} = \text{Int} \left[648 \left[\frac{1}{1 + \left[\frac{nV(648,+I) - nV(648,-I)}{nV(0,-I) - nV(0,+I)} \right]} \right] \right]$$

During this measurement phase :

- the tracking dac is set to 0
- the ratio (R_x/R_s) is shown as a three digit number
- if the preset value for R_x is setup, then this Rough Null step is skipped.

• **Fine Null Phase**

This is a **regular measurement phase** with :

- a) $I_x = \pm(I_{TEST})$
- b) Tracking dac set to 0
- c) $T_n = T_n^{Rough}$
- d) $t = 1$
- e) the ratio (R_x/R_s) is shown as a six digit number

For the Fine Null measurement phase :

$$T_n^{Fine} = \text{Int}[648 \times (R_x/R_s)]$$

and

$$T_n^{Fine} = \text{Int} \left[648 \left[\frac{T_n^{Rough} - t}{648} + \frac{2t}{648} \left[\frac{1}{1 + \left[\frac{nV(t,+I) - nV(t,-I)}{nV(-t,-I) - nV(-t,+I)} \right]} \right] \right] \right]$$

• **Regular Measurement Phase**

- a) $I_x = \pm(I_{TEST})$
- b) Tracking dac is started
- c) $T_n = T_n^{Fine}$
- d) $t = 1$
- e) the ratio (Rx/Rs) is shown as a nine digit number

For measurements where the resistance ratio is $\geq 10:1$ the servo signal can be slewing 20 V at a 1 second time constant. Hence, the flux detector output will be unbalanced for a relatively long time on all transitions, so that the first measurement reported is not very trustworthy. However, second and subsequent measurement cycles will be valid since they invoke the tracking dac and the flux detector will barely see any transitions.

Note that the formula given for T_n^{Rough} is a special case of the formula for T_n^{Fine} if we let $T_n^{Rough} = t = 324$.

Note also that $nV(\pm T, I)$ refers to the nanovolt detector reading with current $I_x = I$; turns $N_x = \text{"Null turn"} \pm T$ turns, and $\text{Int}(x)$ is the integer part of the real number x , for example $\text{Int}(4.7) = 4$.

The values I_{TEST} and **Reversal Rate** are the values entered in the <Setup Menu> for the measurement configuration.

The displayed ratio is always R_x/R_s .

4.2.5. 6675A Measurement Cycle - 4-Terminal "Normal- Ω "

See Figure 4-7 for a graphical representation of the 6675A measurement cycle.

The first thing to notice is that it is an 8 phase measurement cycle, where on every turns switch we've added in 2 intermediate states. These 2 intermediate states guarantee that the current through the N_x windings of the toroid is zero (and hence the flux in the toroid) **before** the turns are switched. This means that any relay chatter on a turns switch has no effect on the "0" flux in the toroid and the current is switched back on after the relays have settled down. The net result is that the flux detector sees two small glitches on a turns switch instead of one rather large transient.

The 6675A uses the algorithm described in section 4.2 and the reasons for doing so was that the algorithm described in section 4.1 and the next section (the original 6675A measurement algorithm) was based on the original 9975 measurement principle which didn't correctly account for the Primary Current offsets. The difference between the 2 algorithms are : for $R_s \leq 1 \text{ k}\Omega$, difference $\leq 0.01 \text{ ppm}$: for $R_s = 10 \text{ k}\Omega$ difference $\leq 0.3 \text{ ppm}$: and for $R_s = 100 \text{ k}\Omega$ difference $\leq 4 \text{ ppm}$

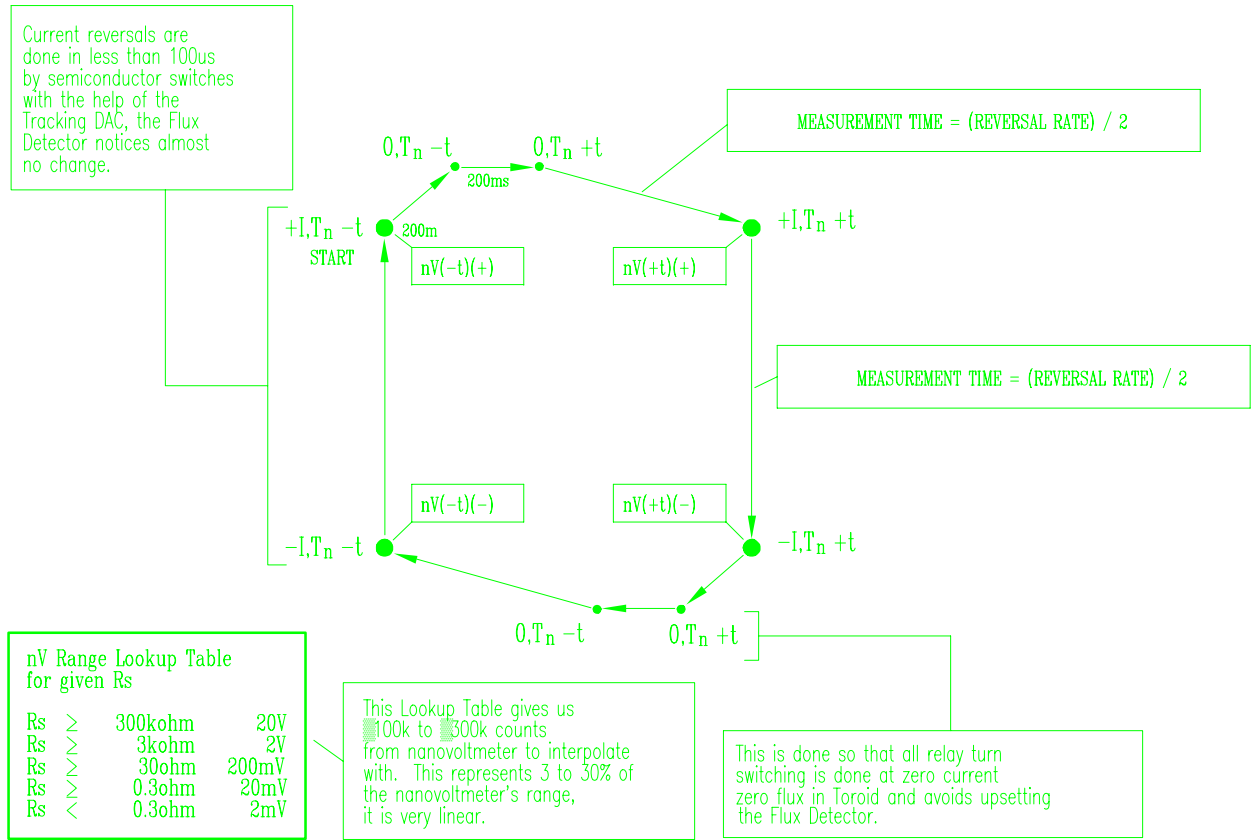

Figure 4-7 : 6675A Measurement Cycle

The alternative approach was to use the original algorithm and go to the expense of actually nulling the Primary Current and core offsets. However, we have a linear detector, and so we are actually measuring their effects and can account for them in the present algorithm.

The final thing to notice is that in the expression for resistance ratio, the nanovolt detector readings only appear in the form:

$$\frac{nV(+t)(+) - nV(+t)(-)}{nV(-t)(-) - nV(-t)(+)}$$

and so if a perfect nanovolt detector was replaced by one with a gain and offset error i.e. $nV \rightarrow A(nV) + B = nV$

Then the offsets subtract and the gain errors divide leaving the same fraction!

Hence all we need is an uncalibrated linear detector that can be allowed to drift slowly with time.

4.2.6. Graphical Representation of Turns Switching and nV readings

See Figure 4-8

Note that this describes the original (pseudo model 9975) measurement algorithm and gives insight into turns and nanovolt detector readings.

The graph may look confusing but the main point is that the nanovolt detector readings take "quanta" jumps for every turn switched in or out. If you plotted these nV readings for a given turn you would find that they were all on a line and that the signal acquisition algorithm described in section 4.2.4 guaranteed that T_n gave the smallest absolute value of the nanovolt detector reading and by switching turns ± 2 turns about T_n we could interpolate the line to find out where it crossed the Turns axis (i.e. where the nanovolt detector would read 0). By doing this for both current directions we could calculate a resistance ratio for R_x/R_s that correctly accounts for thermals and works quite well for $R_s \leq 1 \text{ k}\Omega$. The problem appears at $R_s \geq 10 \text{ k}\Omega$ and is accounted for in the present measurement algorithm.

$$nV(Nx, Ix) = R_s [I_x (N_x / N) + I_c / N] + V_{os} \dots\dots\dots 1$$

also,

$$nV(Nx+1, Ix) = R_s [(I_x / N) (N_x + 1) + I_c / N] - I_x R_x + V_{os} \dots\dots 2$$

Subtracting [1] - [2] implies that $nV(Nx, Ix) = (R_s I_x) / N = \text{a constant}$
 $= \Delta V_{nano} > 0, \text{ if } I_x > 0$
 $= \Delta V_{nano} < 0, \text{ if } I_x < 0$

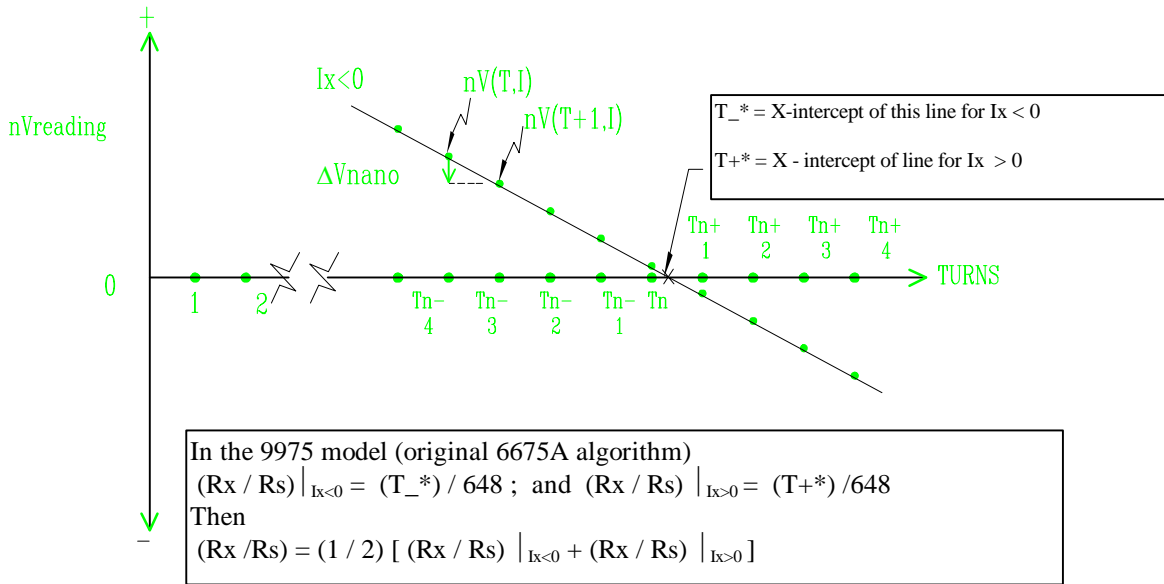

Figure 4-8 : 6675A Turn Switching and nV Reading Graphical Representation

4.3. NANOVOLT DETECTOR CPU OPTIONS

4.3.1. Dip Switches.

The nanovolt detector has an 8 position piano style switch located as shown in Figure 4-9 on the nanovolt detector CPU PCB. Each of the 8 switches enable or disable an option.

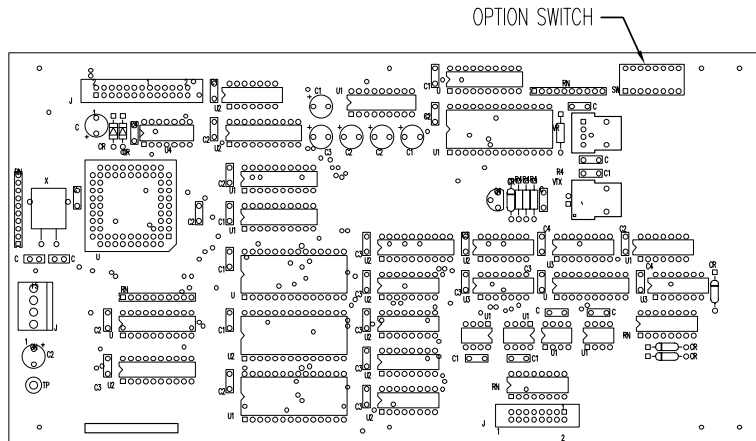

Figure 4-9 : Nanovolt Detector CPU Option Switch Location

4.3.1.1. Option Switch 1 - 50/60 Hz Select.

This option switch must be set to correspond with the nominal line input frequency. The nanovolt detector processor will read the position of the switch to determine if the instrument will be operated from a 50 Hz power source or a 60 Hz power source. This switch must be set correctly for the nanovolt detector to operate correctly.

4.3.1.2. Option Switches 2 to 8 - ADC Beta.

The ADC Beta value is factory set and should be left as is. The value is 220 + the value set on the dip switch in binary, shifted to the right by one (0 → 127). If switch one is set to 50 Hz the value is $(220 + (0 \rightarrow 127)) \times 1.2$.

Switch	Position	Description
1	Closed	When connected to 50 Hz line power
	Open	When connected to 60 Hz line power
2 - 8	$2^n = \text{Closed}$	ADC Beta Value = 220 plus binary value of switches 2-8 (0→127) (if 50Hz multiply value by 1.2)
	0 = Open	

Table 4-1 : Nanovolt Detector CPU Option Switches

4.3.2. Nanovolt Detector Principles of Operation.

4.3.2.1. Introduction.

The nanovolt detector consists of the following functional blocks:

- a) Power Supply (Guildline drawing number 19103.01.02) - generates +5 volts, ± 15 volts, and ± 30 volts.
- b) Nanovolt Detector CPU PCB (Guildline drawing number 19855.01.02) - consisting of a microprocessor with its input/output latches, random access memory, read only memory, GPIB interface, serial communication interface (fiber-optic).
- c) Analog to Digital (A/D) Converter PCB (Guildline drawing number 19502.01.02) - with high speed integrator.
- d) Amplifier/Attenuator PCB (Guildline drawing number 19503.01.02) - with high gain.
- e) Software - the nanovolt detector operating software in read only memory.

The functional blocks are described below.

4.3.2.2. Nanovolt Detector Power Supply (19103.01.02)

A single transformer with two secondary windings drives three standard series-pass regulated supplies. The supplies have a rectifier, filter, three terminal monolithic regulator and output filter.

The ± 15 V is used to power the A/D Converter PCB and the Amplifier/Attenuator PCB. The ± 30 V supply is used to power the attenuator circuitry on the Amplifier/Attenuator PCB. The +5 V is used to power the nanovolt CPU PCB.

4.3.2.3. Nanovolt Detector CPU PCB (19855.01.02)

The nanovolt detector CPU PCB contains a microprocessor, memory and input/output devices. The input/output devices interface to the Amplifier/Attenuator PCB and to the A/D Converter PCB. The I/O devices also interface to the GPIB (IEEE-488). These sections of the CPU PCB are represented on schematic 19855.01.04.

4.3.2.4. Analog Interface

Address decoder U27 and PAL U28 provide the address decoding and read/write controls for the I/O latches. U23, U24, and U25 form a 24-bit Input Latch, which receives the serial data from the 12-bit ADC on the A/D Converter PCB. The serial data and clock from the ADC are coupled through the optocoupler U11. U26 is the Output Latch for Input and Range Selection Control data that is sent to the Amplifier/Attenuator PCB.

Counter U30 and PAL U8 provide the clocking signals to transmit the data through the optocoupler U13, to the Input Amplifier PCB. U12 transmits the Charge Balance Counter Clock and the Status signal. The Status signal is fed to U29 to generate a processor interrupt.

4.3.2.5. Central Processing Unit

The nanovolt detector CPU is an Intel 80188 processor and the design is similar to most 80188 CPU designs. The following sections describe the major functional blocks, however a detailed timing analysis is far beyond the scope of this manual. If a problem is suspected in this section then checking the subsystems in the order which they are presented is recommended.

Clock Generation: Crystal X1 provides 14.74 MHz signal to the processor U5, which generates the system clock (CLK) pin 56. Flip-flop U10 is used to generate CLK/2 and CLK/4.

Control Signal Generation: The 80188 CPU (U5) contains the required logic to generate, read, and write strobes for the memory and input/output devices. During normal system operation the RD signal (Pin 62) should show the most activity, since the processor should be continually fetching instructions from the program ROM. The WR signal (Pin 63) should toggle at a rate less than the RD signal and show a reasonable amount of activity as the processor writes to RAM.

Address And Data Buffers: Addresses from the CPU cluster are latched by the 2 octal latches U1, and U19. This latching operation demultiplexes the address/data bus of the CPU cluster into separate address and data busses for the peripherals components. Integrated circuit U16 is an octal bi-directional buffer which transfers data from the peripheral circuitry to the CPU cluster and vice versa.

Memory And I/O Address Decoding: The CPU (U5) performs all memory and address decoding internally. The memory chip selects are UCS (for the ROM), LCS (for the RAM), and the MCS0-3 for other memory devices. The I/O chip selects are PCS0-6 for the various I/O devices.

Interrupt Controller The system Interrupt Controller is within the CPU IC (U5) and interrupt priorities are set by software.

4.3.2.6.Memory

The Memory section of the CPU PCB consists of 3 general purpose 28 pin sockets which will allow up to 192 kbytes of ROM with 32 kbytes of RAM, or 96 kbytes of RAM with 64 kbytes of ROM, or a number of intermediate compromises. In addition the memory includes an 8 section piano switch which can be used to select various factory options.

Option Switches: Switch Bank SW1 contains 8 switches which can be gated onto the bus by U7 when the processor reads the appropriate input/output port.

Memory Sockets: U20 contains a Smart Watch (which has a real time clock and battery backup for the RAM). Integrated circuit U9 is configured to be ROM since the processor performs its boot from location 0xFFFF0, and U17 is configured as RAM.

4.3.2.7.Serial Fibre-Optic Communication Interface.

The serial fibre-optic communication interface section contains an interface to the main 6675A controller cpu assembly.

4.3.2.8.Gpib Interface.

The GPIB interface is built up from a 68488 controller IC (U6) and two buffers (U3 and U4). U2 inverts the polarity of the interrupt output for the system interrupt controller.

4.3.3. Analog To Digital (A/D) Converter (19502.01.02)

The type of Analog to Digital (A/D) Converter that is used in the nanovolt detector is a charge-balance (integrating) converter. The converter is completely self-running and performs 50 or 60 22-bit conversions per second. The conversion speed is set by the 50/60 Hz option switch on the nanovolt detector cpu assembly, to get excellent normal mode rejection at the line frequency. Note that ADC Beta must be increased by 1.2 (60/50) for 50 Hz operation, to agree with the increased integration time. The nanovolt detector selects the appropriate ADC Beta on power up or reset by reading the option switch to determine if 50 Hz or 60 Hz operation has been selected.

One conversion of the A/D converter consists of two blocks of data. One block of data comes from the charge-balance clock that is counted during a conversion and the other

block of data comes from the digitized output of the integrator, after the integrator has been halted at the end of the conversion cycle. The pause between conversions is 3.5 mS, which allows ample time for the processor to compute the result before the next cycle begins.

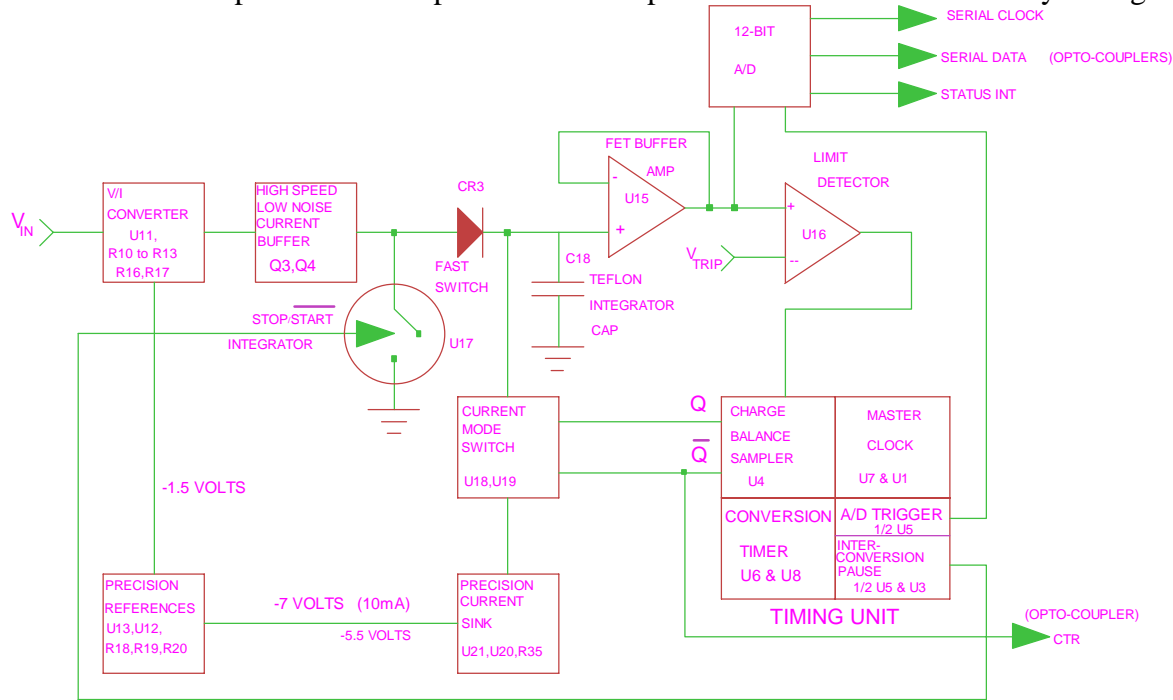

Figure 4-10 : Charge Balance A/D Converter

The integrator in the converter is never reset (only halted), and the 22-bit conversion consists of the 14-bit charge-balance counter, and the apparent 8-bit step the integrator has taken between conversions.

In the approach taken, an input signal in the ± 1 V range, always has two possible outputs, that is:

- 1) (count) + (+step)
- 2) (count + 1) + (-step)

However, they both yield the same result because:

$$|(+step)| + |(-step)| = \text{maximum possible swing of integrator (which is fixed)} \\ = \text{ADC Beta}$$

It would be useful to refer to the schematic drawing 19502.01.04 and Figure 4-10 for the following circuit descriptions.

4.3.3.1. Voltage To Current (V/I) Converter.

The input signal is converted into a current by an op amp U11, resistors R10-R13, R16, and R17. The op amp is configured as a bilateral current source with an offset current added in (via a -1.5 V reference source) so that bipolar input signals can be accommodated.

4.3.3.2. High Speed Low Noise Current Buffer.

This consists of Q3 and Q4 configured as a darlington cascade amplifier. This amplifier is needed to isolate the DC part of the circuit (the V/I converter) from the high speed part of the circuit (the integrator).

4.3.3.3. Precision References.

U13 is used to generate a stable -7 V, 10 mA power supply, and as well it is divided down and buffered by U12 to provide a -1.5 V power supply. A -5.5 V tap is also provided by U13 which is used as a sense voltage in the precision current sink.

4.3.3.4. Precision Current Sink.

This is generated by op amp U21, dual gate MOSFET U20, and R35, an ultrastable resistor. The dual gate MOSFET is the ideal current sink as it provides very high isolation between the fast switching that is occurring at its drain and the DC current that is generated at its source.

4.3.3.5. Current Mode Switch.

U18 and U19 are a matched transistor pair. A matched pair was used so that self-heating effects on current gain would not be a problem. Both sides of the current switch are run at the same power levels, so that no matter what side is conducting, the heating effect on the transistor package is the same.

The matched pair U18 and U19 experience close to a one hour warmup drift as it comes up to temperature, but this is an effect that "divides itself out" in the calculation of the input signal level.

4.3.3.6. Start/Stop Integrator Switch.

This consists of U17, a DMOS switch, CR3, a fast silicon diode, and Q5, a fast pnp switch. Q5 is used to translate HCMOS logic levels into +5 V, -6 V gate drive signals for the DMOS switch. A DMOS switch was chosen because of its ultrafast gating, low drain node capacitance and low charge injection from the gate.

4.3.3.7. The Integrator.

This consists of an ultrastable Teflon capacitor C18, and a FET buffer amplifier U15.

4.3.3.8. Charge Balance Sampler.

This consists of U16, a limit comparator, and U4, a very fast flip-flop. On the rising edge of the master clock the output of the limit detector is sampled. If the integrator has gone over the preset limit, then on the next falling edge of the master clock, a charge packet is taken out of the integrator capacitor to bring it back below the preset limit.

4.3.3.9. Master Clock.

This consists of U7, a crystal oscillator chip, U1, a 4-bit up/down counter. The 4.9152 MHz crystal and $\div 5$ or $\div 6$ counter was chosen so that exactly 2^{14} master clock cycles would occur during one power line cycle.

4.3.3.10. Conversion Timer.

This consists of U6, a 14-bit ripple counter and U8, a dual flip-flop configured as a 2-bit ripple counter. This circuit is configured so that $2^{12} - 2^{16}$ master clock cycles would occur during one conversion, (depending on the frequency of the oscillator chosen, and the number of power line cycles to integrate over). The timer counts the falling edges of the master clock.

4.3.3.11. Interconversion Pause.

This consists of 1/2 of U5, a one shot, and U3, a dual flip-flop configured as a sampler with "metastability" rejection. The one shot is fired by the falling edge of the conversion timer output, and is sampled on the rising edges of the master clock by U3. This gives a high degree of flexibility and simplicity to the timing circuitry.

4.3.3.12.A/D Trigger.

This consists of 1/2 of U5, a one shot, which generates a 1 μ s trigger pulse to start the 12-bit A/D converter. This trigger pulse occurs about 30 μ s after the integrator has been halted, so that the output of U15, the integrator buffer, has settled to better than 0.01% of its final value.

4.3.3.13.12 BIT A/D Converter.

This consists of U10, a 12-bit A/D converter. Its internal 6.3 V reference is used to set the limit point of the integrator. Its serial clock and serial data lines are used to send data to the processor via optocouplers located on the processor board.

As well, the status signal line is used to generate an interrupt to the processor (again via an optocoupler) once the 12-bit conversion is done.

4.3.4. Nanovolt Detector Input Amplifier PCB (19503.01.02)

The analog amplifier PCB consists of the following functional blocks:

- a) High Input Impedance Low Noise Amplifier.
- b) Input and Range Selection.
- c) Charge Pump.
- d) Power Supplies.
- e) Overload Protection.

It will be helpful to refer to Amplifier/Attenuator Schematic 19503.01.04 for the following circuit descriptions.

4.3.4.1.High Input Impedance Low Noise Amplifier.

Q300 is a matched FET pair that is used in a differential mode to provide the high impedance front end for the amplifier. R301 and R302 act as the loads for Q300. R300 is used to trim the offset. Q302 together with R303, R304, DS300, and C301 provide the current sink for Q300.

U300 provides most of the gain for the amplifier. The output of U300 is fed directly to the A/D PCB, as well as to the resistor network R306-R311 which provides feedback to the differential pair Q300.

4.3.4.2. Input And Range Selection.

Control data from the CPU (SD) for Input and Range Selection is clocked into the shift register U200 by a clock signal (SCLK) provided by the CPU PCB. SCLK is also monitored by the monostable U201, which provides U200 a signal used to latch the data after all the data has arrived.

The data in the register of U200 is fed to 2 line to 4 line decoder U202 and U 203. This is used to drive the comparators U205, U206 and U207 to select the input and range to be measured. It should be noted that the input FET drive signals have both pull up resistors and pull down resistors so that the drive for Q103-Q108 and Q115 is -7 V.

Range selection FET signals do not have pull down resistors and so FETs Q100-102 and Q303-305 are driven to -15 V.

4.3.4.3. Charge Pump.

The switching on the input FET Q104 injects or removes small quantities of charge from the input. U208 provides a signal which is coupled to the input by C201, to either remove or add a small amount of charge to compensate switching charge addition or removal respectively.

4.3.4.4. Attenuator.

U106 is a FET input op-amp which buffers the input signal. The signal is then divided by R118-R120 to provide signals for the 2 V and 20 V ranges.

4.3.4.5. Power Supplies.

U301 and U302, along with their resistor and capacitor networks, regulate the system ± 15 V to ± 13 V for use on the Analog Amplifier PCB. U105 with its network provides a floating ± 9 V supply, which is used to power the input differential pair Q300. The circuitry including Q111-Q114 provides bootstrapped ± 8 V supply for the input attenuator buffer U106.

4.3.4.6. Overload Protection.

Input Overload Protection is provided by Q109, Q110, VR100, VR101, R105, R106, and R117. When the voltage between the input terminals exceeds 25 volts, Q109 or Q110 is forward biased and starts to conduct. The power is dissipated through R117.

**4.3.5. Nanovolt Detector Software.**

The control program within the nanovolt detector controls the operation of the nanovolt analog interfaces and communication interfaces from the nanovolt cpu microprocessor. The major hardware interfaces to the nanovolt detector microprocessor are the fibre-optic interface (and ultimately the 6675A user) to the 6675A cpu, and the analog to digital (also analog input amplifier) converter.

The nanovolt detector control program is approximately 42 thousand bytes long. It is written in the "C" programming language and stored as binary numbers in the 27C512 read only memory.

5. REMOTE CONTROL

The 6675A automatic direct-current-comparator operates directly from the front panel or under remote control of an instrument controller, computer or terminal. Remote control can be interactive, with the user controlling each step from a terminal, or under the control of a computer running the 6675A in an automated system. It is also possible to connect a printer to the remote interface of the 6675A and have the 6675A output some or all of the measurements taken to the printer for a permanent record.

This chapter describes the interfaces and the commands to which the 6675A will respond. The setting of the IEEE-488 address and operating mode is described in Section 4.1. A detailed description of the remote control command set is included in Volume II of this Technical Manual.

5.1. INTERFACES

The model 6675A has two interfacing standards available:

- An IEEE-488 interface conforming to IEEE-488.2.
- A serial interface conforming to RS232C.

The IEEE-488 connector is mounted to the rear panel. **The IEEE-488 address defaults to a factory setting of 04.** This setting can be viewed and set to a valid address using the front panel controls. Setting up the IEEE-488 address from the front panel is explained in section 3.7.4.1.

The RS232C connector is on the rear but it has to be configured from the front panel as explained in Section 4.2.

5.2. IEEE-488 (GPIB) INTERFACE

The 6675A is fully programmable for use on the IEEE standard 488.1 interface bus (also known as the General Purpose Interface Bus GPIB). The interface is also designed in compliance with the supplemental standard IEEE-488.2. Devices connected to the bus in a system are designated as talkers, listeners, talker/listeners, or controllers. The 6675A can be operated on the IEEE-488 bus as a talker or under the control of an instrument controller as a talker/listener.

This manual assumes that the user is familiar with the basics of the IEEE-488 interface bus.

5.2.1. Controller.

There can be only one designated controller in charge on the IEEE-488 bus. This device exercises overall bus control and is capable of both receiving and sending data. The rest of the devices can be designated as listener, talker or talker/listener.

The controller can address other devices and command them to listen, address one device to talk and wait till the data is sent. Data routes are set by the controller but it need not take part in the data interchange.

All controller query and command sequences should be terminated with the line-feed character (0x0A) and or optionally, the controller should assert the EOI data byte control signal to terminate the query command sequence.

5.2.2. IEEE-488 Responses.

The reply to any IEEE-488 query command will be a sequence of ASCII characters followed by a line-feed character (0x0A). The line-feed character may also be expressed as 0A₁₆ or 10₁₀ or 12₈ or control-J. Throughout this manual we will use the "C" programming language notation for expressing numbers in base 16, specifically 0x0A indicates that 0A is to be interpreted in base 16 (hex).

5.2.3. Interconnecting Cable And IEEE-488 Connector.

The interconnecting cable of IEEE-488 1978 consists of 24 conductors, 16 conductors are for carrying signals and 8 for grounding. The individual cable assembly could be up to 4 metres long. The cable should be double shielded and should have both a shielded plug and a receptacle connector type at each end of the cable. Guildline Part Number 996-23006 is a suitable IEEE-488 cable assembly of length 2 metres. Each connector assembly is fitted with a pair of captive locking screws.

5.2.4. Typical System.

Data Input/Output Lines - The 8 data I/O lines form the data bus over which data between the various devices is transmitted under the supervision of the controller. The message bytes are carried on Data I/O signal lines in a bit parallel byte serial form, asynchronously and generally in a bidirectional manner.

Handshake or Data Byte Control - The three interface signals are used to effect the transfer of each byte of data on the DIO signal lines from a talker or controller or one or more listeners.

1. DAV (DATA VALID) is used to indicate the condition of (availability and validity) information on the DIO signal lines.
2. NDAC (NOT DATA ACCEPTED)
3. NRFD (NOT READY FOR DATA) is used to indicate the condition of readiness of devices to accept data.
4. SRQ (SERVICE REQUEST) is used by a device to indicate the need for attention and to request an interruption of the current sequence of events.
5. REN (REMOTE ENABLE) is used (by a controller) in conjunction with other messages to select between two alternate sources of device programming data.
6. EOI (END OR IDENTIFY) is used (by a talker) to indicate the end of a multiple byte transfer sequence or in conjunction with ATN (by a controller) to execute a polling sequence.
7. ATN (ATTENTION)
8. IFC (INTERFACE CLEAR)

5.2.5. Address And Talk/Listen Selection.

The IEEE-488 Address and Talk/Listen status can be set using the front panel controls as directed by the operator menuing system.

If there is no controller and the 6675A is hooked up to a printer for hard copy then Talk Only mode should be selected as the preferred mode of operation.

5.2.6. IEEE-488 Electrical Interface.

The 6675A meets the subsets of the IEEE-488 interface specification IEEE-488.1 shown in Table 5-2. The pin connections on the IEEE-488 interface connector are shown in Table 5-1.

5.2.7. IEEE-488 Input Buffering.

The IEEE-488 input buffer is 256 bytes long. The input full bit is set when the buffer is above 75% full 64 bytes remaining.

PIN	NAME	DESCRIPTION
1	DIO1	Data Input Output Line 1
2	DIO2	Data Input Output Line 2
3	DIO3	Data Input Output Line 3
4	DIO4	Data Input Output Line 4
5	EIO	End or Identify
6	DAV	Data Valid
7	NRF \bar{D}	Not Ready for Data
8	NDAC	Not Data Accepted
9	IFC	Interface Clear
10	SRQ	Service Request
11	ATN	Attention
12	SHIELD	Screening on Cable (connected to safety ground)
13	DIO5	Data Input Output Line 5
14	DI06	Data Input Output Line 6
15	DIO7	Data Input Output Line 7
16	DIO8	Data Input Output Line 8
17	REN	Remote Enable
18	GND6	Ground wire of twisted pair with DAV
19	GND7	Ground wire of twisted pair with NRF \bar{D}
20	GND8	Ground wire of twisted pair with NDAC
21	GND9	Ground wire of twisted pair with IFC
22	GND10	Ground wire of twisted pair with SRQ
23	GND11	Ground wire of twisted pair with ATN
24	GND	Logic Ground

Table 5-1 : IEEE488 Connector Pin Designations

Source Handshake	SH1
Acceptor Handshake	AH1
Talker	T5
Listener	L3
Service Request	SR1
Remote Local	RL1
Parallel Poll	PP0
Device Clear	DC1
Device Trigger	DT0
Controller	C0
Electrical Interface	E2

Table 5-2 : IEEE488 Device Capabilities

5.2.8. IEEE-488 Output Buffering.

Output from query commands are placed into a 256 byte output buffer. If for some reason the controller does not read the responses from its query commands the output buffer will overflow, in this case the first data into the buffer will still be valid and the later data will be lost. When output data is lost the query error bit in the status register will be set. When the output buffer is not empty then the message available (MAV) bit will be set in the status register.

5.2.9. IEEE-488 Deadlock.

If the controller demands a byte of data from the 6675A and the buffer is empty, the 6675A will set the Query Error flag in the Event Status Register.

5.3. RS232C INTERFACE

The 6675A has an RS232C interface which can be connected to a controller or to a simple printer. The controller (which can be almost any computer with an RS232C interface) can control the 6675A through a variety of commands which allow setting the instruments operating parameters, and analyzing the measurements made by the 6675A. The simple printer interface can be used to log any or all of the measurements taken by the 6675A during normal operation.

A double shielded RS232 cable assembly is recommended for attachment to this communication port. Guildline part number 996-00070 is a 2 meter double shielded, male-female, RS232 cable assembly, suitable for this purpose.

When using the RS232C port to remotely control the 6675A, either interactively with a terminal or under computer control, operation is the same as using an IEEE-488 controller connected to the IEEE-488 port for control, with the following exceptions:

- The end of line input terminator is Carriage Return (0x0D).
- There is no SRQ capability when using serial remote control. The status registers still behave as described in this chapter, but the 6675A serial interface does not have a way to perform the SRQ function.
- There is no direct way to perform IEEE-488 hardware interface functions such as DCL (Device CLear) or SDC (Selected Device Clear).

5.3.1. RS232C - Pin Designations.

The 6675A Automatic direct-current-comparator is a data communication equipment (DCE) so TxD is an input (the data which the modem is to transmit).

Pin		Function	Direction
1	CHG	CHassis Ground	IN/OUT
2	TxD	Transmit Data	IN
3	RxD	Receive Data	OUT
4	RTS	Request To Send	IN
5	CTS	Clear To Send	OUT
6	DSR	Data Set Ready	OUT
7	GND	Signal Ground	IN/OUT
8	DCD	Data Carrier Detect	OUT
20	DTR	Data Terminal Ready	IN
All other pins not used or connected.			

Table 5-3 : RS232 Connector Pin Designations

5.3.2. RS232C Responses.

The reply to any RS232C query command will be a sequence of ASCII characters followed by a Carriage-Return character (0x0D) and then a Line-Feed character (0x0A). The Line-Feed character may also be expressed as 0A₁₆ or 10₁₀ or 12₈ or control-J. Throughout this document we will use the "C" programming language notation for expressing numbers in base 16, specifically 0x0A indicates that 0A is to be interpreted in base 16 (hex).

5.4. COMMAND LANGUAGE

The commands for IEEE-488 and RS232C mainly correspond to the labels assigned to the front panel menus. Throughout this document when examples are given they apply to commands through the RS232C interface or through the IEEE-488 interface. The examples will not show the termination characters since these differ for each of the interfaces (See sections 5.2.2 and 5.3.2).

5.4.1. General Syntax For Commands.

The 6675A uses a sophisticated command parser which can usually determine which command was desired, even if the command is entered incorrectly.

No command used in the 6675A has an embedded space in its name, spaces (0x20) are used only to separate command names from their parameters.

The comma "," must delimit all multiple arguments used in a command sequence.

5.4.2. General Syntax For Numbers.

Numeric parameters may have up to 30 characters, and although the 6675A will accept numeric parameters in the range $\pm 2.2E-308$ through $\pm 1.8E308$, the useful range of numbers is between $\pm 1.0E-8$ and $1.0E5$.

5.5. REMOTE AND LOCAL OPERATION

The 6675A can be operated using the front panel keys or it can be operated remotely using a remote controller. In addition the 6675A can be placed in a local lockout condition at any time by a command from the controller. When combined, the local, remote, and lockout conditions yield four possible operating states:

Local:

The 6675A responds to local and remote commands. This is also called "Front Panel Operation". Only remote commands that do not affect the state of the 6675A are allowed to execute.

Local With Lockout:

Local with lockout is identical to Local except that the 6675A will go into remote with lockout instead of the remote state when the 6675A receives a remote command.



Remote:

When the Remote Enable (REN) line is asserted and the controller addresses the 6675A as a listener, the 6675A enters the remote state.

Front panel operation is restricted to the use of the Remote softkey/pushbutton. Pressing the Remote softkey or sending the GTL (Go To Local) interface message returns the 6675A to the local state.

Remote With Lockout:

The remote with lockout state can be entered from remote or local with lockout, but not directly from local. Remote with lockout is similar to the remote state but restricted: The Remote softkey will not return to the local state. To return the 6675A to the local with lockout state the controller must send a GTL interface command. To return the 6675A to the local state the controller must unassert the REN control line.

6. CALIBRATION

The following is the minimum testing required to verify the performance of the 6675A Resistance Bridge. All tests are to run for a minimum of 1 hour. If the unit under test fails any test outlined in this section refer to the 6675A Technical Manual to assist in the repair and alignment of the unit. The procedure for testing low resistance ratios using the Model 6623 Range Extender is covered in the 6623 Technical Manual.

6.1. TEST EQUIPMENT

Test equipment required includes:

- One Guildline model 5010 Fluid Bath or Guildline model 9730 series Oil Bath
- Two Guildline model 9330 / 1 Ω Standard Resistors
- One Guildline model 9350/10 k Ω Resistance Transfer Standard
- One Guildline model 9330 /10 k Ω Standard Resistor

- Two Guildline model 9330 / 100M Ω Standard Resistors

6.2. RATIO 1:1 Using Model 9330 / 1 Ω to Model 9330 / 1 Ω

- Step 1. Set up the 6675A in Normal Ohms measurement mode with the two 1 Ω Standard Resistors in a temperature controlled oil bath attached to Rs and Rx
- Step 2. Set test current = 100 mA
- Step 3. Set reversal rate = 60 seconds
- Step 4. Start measurement and record ratio = R_a
- Step 5. Interchange resistors and repeat test
- Step 6. Record ratio = R_b

Unit under test passes when:

$$(R_a \times R_b - 1) \times 10^6 < 0.2$$

6.3. RATIO 1:1 Using Model 9330 / 10 k Ω to Model 9350 / (10 k Ω Configuration)

- Step 1. Set up the 6675A in Normal Ohms measurement mode with the two resistors in a temperature controlled oil bath. Attach the 10 k Ω Standard Resistor to Rs and the Resistance Transfer Standard configured as 10 k Ω to Rx
- Step 2. Set test current = 1.0 mA
- Step 3. Set reversal rate = 60 seconds
- Step 4. Start measurement and record ratio = R_a

- Step 5. Interchange resistors and repeat test
- Step 6. Record ratio = R_b

Unit under test passes when:

$$(R_a \times R_b - 1) \times 10^6 < 0.7$$

6.4. RATIO 10:1

6.4.1. Model 9330 /10 kΩ to Model 9350 /(100 kΩ Configuration)

- Step 1. Set up the 6675A in Normal Ohms measurement mode with the two resistors in a temperature controlled oil bath. Attach the 10 kΩ Standard Resistor to R_s and the Resistance Transfer Standard configured as 100 kΩ to R_x
- Step 2. Set test current = 0.10 mA
- Step 4. Set reversal rate = 120 seconds
- Step 5. Start measurement and record ratio = R_a

6.4.2. Model 9350 /(1K Ω Configuration) to Model 9330 /10 kΩ

- Step 1. Set up the 6675A in Normal Ohms measurement mode with the two resistors in a temperature controlled oil bath. Attach the Resistance Transfer Standard configured as 1k Ω to R_s and the 10 kΩ Standard Resistor to R_x
- Step 2. Set test current = 0.316 mA
- Step 4. Set reversal rate = 60 seconds
- Step 5. Start measurement and record ratio = R_b

Unit under test passes when:

$$\left| \frac{100/R_b - R_a}{10} \right| \times 10^6 \leq 0.5$$

6.5. RATIO 1:1**6.5.1. Model 9330 /100 MΩ to Model 9330 /100 MΩ**

- Step 1. Set up the 6675A in High Ohms measurement mode. Do not immerse the two resistors in oil. Attach the 100 MΩ Standard Resistor to Rs and the Resistance Transfer Standard configured as 100 MΩ to Rx
- Step 2. Set test voltage = 990 Volts
- Step 3. Set reversal rate = 120 seconds
- Step 4. Start measurement and record ratio = R_a
- Step 5. Interchange resistors and repeat test
- Step 6. Record ratio = R_b

Unit under test passes when:

$$(R_a \times R_b - 1) \times 10^6 < 16$$

7. MAINTENANCE

7.1. INTRODUCTION

This section covers troubleshooting and repair and alignment of the 6675A.

7.1.1. Error Messages.

Error Number	Error	Corrective Measures
0	nV Detector Communication Failure	- None , fatal hardware error (try power switch)
1	Invalid Test Setup	-Resistors not wired to front panel properly, improper test setup
2	Servo Railed	-No current path on Rx or Rs terminals
3	Nano Zero, nVoltmeter not responding	-Cycle power switch, else fatal hardware error
4	Null out of Range	-Autoranger having problems, so enter in approx. ratio
5	Max Test Exceeded	-Exceeded max current or voltage on Rs resistor
6	EEROM Failure, Resetting all values to default	-Loss of resistor and probe setup files
7	No Serial Number Specified, File not saved	-Rs Serial number left blank in setup, put one in
8	Nano Railed, Out of Nanovoltmeter range	-Resistors not wired to front panel properly, invalid Test setup
9	Failed Self Test	- None , fatal error (try power switch)

Table 7-1 : 6675A Error Messages

7.1.2. 6675A Warnings.

Corrective measures : Enter prompted or missing variable.

WARNING	6675A OPERATING MODE
Reversal Rate too low or not set!! Minimum reversal rate is 4 seconds!!	<Main_Setup_Edit>
Rs value has not been set!!	<Main_Setup_Edit>
R0 or Rtpw value has not been set!!	<Main_Setup_Probes_Edit_Mode_Probe>
Extender Ratio not set	<Main_Setup_Resistor_Edit_Mode_lxtend>
Test Value not set	
Max Test Value has not been set	
Test Value EXCEEDS Max Test Value	
Test Value Exceeds Maximum Current Output!! Test Value set to _ _ _ _ _	
Max Current Output (250 mA)!!!	
Test Value is below minimum current output (1mA)!!!	
Maximum Current Value exceeds Maximum Current output (250mA)!!!	
Test Value Exceeds Maximum Voltage output!!! Test Value set to _ _ _ _ _ Maximum Voltage Output (990V)!!!	
Test Value is below minimum Voltage output (15.8V)!!!	
Setting DAC C or DAC D may magnetize the core!!!!	
Set Internal Values. This menu allows full control of 6675A. Great care should be taken when using these functions.	
Self test not completed Operation cancelled.	

Table 7-2 : 6675A Warnings

7.1.3. Nanovolt Detector Calibration.

7.1.3.1. Introduction.

There is a 5 range, 6 ½ digit, nanovolt detector connected between the Rx - P₂ (Low) and Rs - P₂ (High) terminals, and we allow the user to calibrate the gain and offset of each range for use as long-scale digital voltmeter, DVM, as an auxiliary/debug function. The gain and offset coefficients are used only when this DVM auxiliary function is selected. The 6675A does not require or have calibration coefficients for resistance ratio measurements. The accuracy of the resistance ratio measurement reported by the 6675A depends on the turns setting of the current comparator and on the linearity of the nanovoltmeter (not the absolute nanovolt detector reading). The gain and offset coefficients for each range will change slowly with time (≈ 50 ppm/year) but this will not be noticed in a resistor ratio measurement.

7.1.3.2. Nanovoltmeter Calibration.

You should always calibrate the voltmeter option with the **<Main_SoftCal_Voltmeter_Volts Set>** routines whereas the **<Main_SoftCal_Voltmeter_Coeff Set>** routines were for manually adjusting the coefficients and this is not a recommended practice.

The numbers displayed in the menu **<Main_SoftCal_Voltmeter_Volts Set>** and menu **<Main_SoftCal_Voltmeter_Coeff Set>**

for zero volts and high volts are raw A/D converter counts with no offset or gain corrections added in. The span of the counts is approximately ±950,000 and a reading of ±200 counts for zero volts is sufficient.

The voltage displayed in voltmeter mode is given by the formula:

$$DisplayedVoltage = \frac{(Inputcount - Zerocount)}{(Referencecount - Zerocount)} \times ReferenceVoltage$$

The suggested Reference voltage is 75% of range for all ranges and you should see about 500,000 counts for it.

The procedure to calibrate a voltage range on the 6675A is as follows:

- 1) Go into the menu **<Main_SoftCal_Voltmeter_(select range)_Volts Set>** and connect a precision voltage source to the Rs-P₂ (High) and Rx-P₂ (Low) terminals.
- 2) Set the voltage source to 0 volts (and enable its output) and select the **<zero volts>** key. Do this a few times until the displayed count is stable in the units digit.
- 3) Set the voltage source to 75% of range and enter this value with the **<Ref volts>** key. Enable the voltage source output and measure this signal by pressing the **<HighVolts>** key. Do this a few times until the displayed count is stable in the unit's digit.
- 4) Finally press the **<Ok>** key to internally store these values in the internal EEROM.
- 5) Exit this routine by selecting the **<PREVIOUS>** key a few times to return to the main menu.
- 6) Go into the menu **<Main_Voltmeter_(select calibrated range)>** and check the voltmeter range you have just calibrated.

7.1.3.3.ADC Beta.

For the 50Hz operation ADC Beta = 300 (nominally) and for the 60Hz operation ADC Beta = 250 (nominally). The 6675A communications card/controller does not use this number when it calculates voltages or resistor values. It is a number that is reported to it from the nanovoltmeter processor so that it can be put up on display. The nanovoltmeter controller gets the value for ADC Beta from dip switches that are factory set on the nanovoltmeter processor card (and should not be changed).

7.1.4. Disassembly Procedure.

This section describes the general procedure to be followed to gain access to modules located in the 6675A main assembly.

7.1.4.1. Cover Removal Procedure.

1. Remove the rear handles (remove the 10-32 x 3/4" polished oval head (oh) screws (3 for each) that secure the handles).
2. Remove the rear bracket (remove the 6-32 x 3/8" polished oh screws (3) that secure the bracket).
3. Remove the outer top cover (slide back 1/4" and remove).
4. Remove both outer side covers (slide back 1/4" and remove).
5. Remove the inner top cover as follows :
 - i) remove the 6-32 x 1/2" flat head (fh) screws (4) at each corner of the cover.
 - ii) remove the 6-32 x 1/4" binder head (bh) screws (6) along each side of the cover.
 - iii) loosen the 10-32 x 3/4" polished oh screws (3 for each) that secure the handles).
 - iv) lift up and remove the cover.

7.1.4.2. Primary Current Drive Module (19327) Removal Procedure.

1. Carefully free the Primary Current Drive module from the unit's frame (remove the 6-32 x 3/8" fh screws (6), located under the unit, that secure the module to the base plate).
2. Free the front panel from the unit's frame as follows :
 - i) remove the 6-32 x 3/8" fh screws (4), located under the unit, that secure the panel to the base plate.
 - ii) remove the 10-32 x 1/2" polished oh screws (2) that secure the panel to the side panels).
3. Disconnect fibre-optic wires #7, #4 and #5 from the Primary Current Drive module.

4. Carefully disconnect BLU wire #15 or #16 that runs between the Primary Current Drive and PDCC Comparator modules.
5. Carefully disconnect YEL wire #3 that runs between the Primary Current Drive module and the Rx C1 terminal on the front panel.
6. Carefully disconnect BLU wire #5 that runs between the Primary Current Drive module and positive PROGRAM OUT terminal on the front panel.
7. Carefully disconnect WHT wire #9 that runs between the Primary Current Drive module and the Rs C1 terminal on the front panel.
8. Carefully disconnect YEL wire #7 and RED wire #11 that run between the Primary Current Drive and Servo-loop modules.
9. Unsolder the coax cable from the HIGH VOLTAGE OUT terminal on the front panel.
10. Disconnect the wires that run between the Transformer and Primary Current Drive modules at TB2-11, TB2-12 and TB3-2 through TB3-12 on the Transformer Module.
11. Remove the Primary Current Drive module (carefully lift up and remove).

7.1.4.3. Servo-loop Module (19328) Removal Procedure.

1. Carefully free the Servo-loop module from the unit's frame (remove the 6-32 x 3/8" fh screws (6), located under the unit, that secure the module to the base plate).
2. Free the front panel from the unit's frame as follows :
 - i) remove the 6-32 x 3/8" fh screws (4), located under the unit, that secure the panel to the base plate.
 - ii) remove the 10-32 x 1/2" polished oh screws (2) that secure the panel to the side panels).
3. Disconnect fibre-optic wires #4, #6 and #3 from the Servo-loop module.
4. Disconnect the coax cable from W1 on the Magnetic Modulator PCB (19110).
5. Disconnect P1 from J1 on the Magnetic Modulator PCB (19110).
6. Disconnect P3 from the Relay PCB (19109).

7. Carefully disconnect RED wire #1 or #2 and GRN wires #17 and #18 that run between the Servo-loop and PDCC Comparator modules.
8. Carefully disconnect WHT wire #4 that runs between the Servo-loop module and the Rs C1 terminal on the front panel.
9. Carefully disconnect YEL wire #7 and RED wire #11 that run between the Servo-loop and Primary Current Drive modules.
10. Disconnect the wires that run between the Transformer and Servo-loop modules at TB4-2 through TB4-12 on the Transformer Module.
11. Remove the Servo-loop module (carefully lift up and remove).

7.1.4.4. PDCC Comparator Module (19121) Removal Procedure

1. Carefully free the PDCC Comparator module from the unit's frame (remove the 6-32 x 3/8" fh screws (6), located under the unit, that secure the module to the base plate).
2. Free the front panel from the unit's frame as follows :
 - i) remove the 6-32 x 3/8" fh screws (4), located under the unit, that secure the panel to the base plate.
 - ii) remove the 10-32 x 1/2" polished oh screws (2) that secure the panel to the side panels).
3. Remove the left side panel (when viewed from the front of the instrument) as follows :
 - i) remove the 6-32 x 3/8" fh screws (5), that secure the panel to the base plate.
 - ii) remove the special 6-32 x 3/8" fh screw that secures the panel to the Nanovolt CPU/Power Supply Bracket.
 - iii) remove the 10-32 x 1/2 screws that secure the rear panel to the right side panel.
4. Disconnect the coax cable from W1 on the Magnetic Modulator PCB (19110).
5. Disconnect P1 from J1 on the Magnetic Modulator PCB (19110).
6. Disconnect P3 from the Relay PCB (19109).

7. Disconnect the BLU guard wire that runs between the PDCC Comparator module and GUARD Rx terminal on the front panel from the PDCC Comparator module.
8. Carefully disconnect RED wires #1 and #2, BLU wires #15 and #16 and GRN wires #17 and #18 that run between the PDCC Comparator module and the rest of the system.
9. Remove the PDCC Comparator module (carefully lift up and remove).

7.1.5. Reassembly Procedure

Follow the reverse actions as outlined in section 7.1.4 for each module removed from the main assembly.

7.2. TROUBLESHOOTING

7.2.1. Introduction

The following information is provided to help localize faults to within sub-assemblies or discrete components. To do any troubleshooting at this level the unit requires disassembly so as to access one or more of the sub-assemblies.

Disassembly and reassembly are covered in section 7.1.4 and 7.1.5 respectively.

Before disassembling the unit, verify the performance of the unit, see Calibration section 6, to help isolate the problem.

7.2.2. Power Up

If the unit shows no reaction to being plugged into the power line socket and turned on, then:

- Check the fuse.
- Ensure that the line cord is inserted properly and that the power switch is depressed. If the unit comes up with isolated segments lighting up weakly, then check the line voltage selector switch on the rear of the instrument.

7.2.3. Power Supply Check

7.2.3.1. Primary Current Drive Power Supply PCB Test Procedure

1. Using a DMM, measure the DC voltages at the Primary Current Drive Power Supply PCB test points. The voltages should be as shown in Table 7-3.
2. Using an oscilloscope, measure the noise voltage levels at the Primary Current Drive Power Supply PCB test points. The noise levels should be as listed in Table 7-3.

Test points on PCB Assy 19108 (near J100)	Voltage (V \pm 5%)	Noise Limits (mV p-p)
TP -40V with respect to TP110	-40.0	<100
TP +40V with respect to TP110	+40.0	<100
TP -15V with respect to TP110	-15.0	<100
TP +15V with respect to TP110	+15.0	<100
TP +12VR with respect to TP110	+12.0	<100
TP +5V with respect to TP110	+5.0	<500
J300-1 with respect to TP303	+15.0 \pm 10%	<200

Table 7-3 : Test Point Voltages Assembly 19108

7.2.3.2.Servo Loop Power Supply PCB Test Procedure

1. Using a DMM, measure the DC voltages at the Servo Loop PCB test points. The voltages should be as shown in Table 7-4.
2. Using an oscilloscope, measure the noise voltage levels at the Servo Loop Power Supply PCB test points. The noise levels should be as listed in Table 7-4.

Test points on PCB Assy 19107 (near J100)	Voltage (V \pm 5%)	Noise Limits (mV p-p)
TP313 with respect to TP301	-40	<100
TP310 with respect to TP301	+40	<100
TP303 with respect to TP301	-15	<100
TP300 with respect to TP301	+15	<100
TP311 with respect to TP301	+12	<100
TP314 with respect to TP301	+5	<500
J101-1 with respect to J101-2	+30 \pm 15%	<800

Table 7-4 : Test Point Voltages Assembly 19107

7.2.3.3. Nanovolt Dual Power Supply PCB Assy 19334 Test Procedure

1. Using a DMM, measure the DC voltages at the Nanovolt Dual Power Supply PCB test points. The voltages should be as shown in Table 7-5.

NOTE : Ensure that a jumper is installed at E2.

2. Using an oscilloscope, measure the noise voltage levels at the Nanovolt Dual Power Supply PCB test points. The noise levels should be as listed in Table 7-5.

Test points on PCB Assy 19334	Voltage (V)	Noise Limits (mV p-p)
J3-2 with respect to GND1	+5.0 ±0.25	<500
J3-8 with respect to GND3	+5.0 ±0.25	<500
J6-3 with respect to GND3	+15.0 ±1.0	<100
J6-5 with respect to GND3	-15.0 ±1.0	<100
J6-6 with respect to GND3	-30.0 ±1.0	<100
J6-8 with respect to GND3	+30.0 ±1.0	<100

Table 7-5 : Test Point Voltages Assembly 19334

7.2.3.4.6675A CPU and Display Power Supply PCB Test Procedure

1. Using a DMM, measure the DC voltages at the 6675A CPU and Display Power Supply PCB test points. The voltages should be as shown in Table 7-6.
2. Using an oscilloscope, measure the noise voltage levels at the 6675A CPU and Display Power Supply PCB test points. The noise levels should be as listed in Table 7-6.

Test points on PCB Assy 19473	Voltage (V)	Noise Limits (mV p-p)
J3-1 with respect to J2-3	+5.0 ±5%	≤500
J3-3 with respect to J2-3	+10.0 ±10%	≤200
3-4 with respect to J2-3	-10.0 ±10%	≤200
J2-1 with respect to J2-3	+5.0 ±5%	≤500

Table 7-6 : Test Point Voltages Power Supply Assembly 19473

7.2.4. Alignment Procedure

7.2.4.1. Alignment Test Equipment Required

- DMM (FLUKE 8840A or equiv.)
- Oscilloscope (PHILIPS PM 3055 or equiv.)
- Scopemeter (FLUKE 95 or equiv.)
- Long-scale DMM (DATRON 1271 or equiv.)
- Precision DC Voltage Standard (VALHALLA 2701C or equiv.)
- Standard Resistor Set (GUILDLINE 9330 or equiv.)
- Potentiometric Chart Recorder (ABB SE 120 or equiv.)
- 2 resistors @ 10 Ω 0.01% ¼W (General Radio or equivalent)
- 2 resistors @ 1 kΩ 0.1% ¼W (Vishay S102K or equivalent)
- 2 resistors @ 100 kΩ 0.1% ½W (Ultronix UL42 or equivalent)

7.2.4.2. Initial Checks

1. Set the Power Entry Module for 120 V operation (or set to local line power conditions as described in Section 3.1).
2. Install correct fuse in the Power Entry Module 2 A, 250 V time delay fuse (MDL2).
3. Turn the 6675A Power Switch to the ON (1) position.
4. Ensure that there is NO loud hum from any of the transformers and that the ventilation fan at the rear of the unit is exhausting air OUT of the 6675A.
5. Verify that the front panel display illuminates and no error message is displayed after initialisation is complete (after approximately 15 seconds)
6. Turn the 6675A power OFF.

7.2.4.3. Primary Current Drive Adjustments (Board 19108)**7.2.4.3.1. Primary Current Calibration**

1. Link Rs C₁ to Rs P₁. Link Rs P₂ to Rs C₂.
2. Connect a 10 Ω , 0.01% GR resistor across Rs P₁ and Rs P₂.
3. Link Rx C₁ to Rx P₁. Link Rx P₂ to Rx C₂.
4. Connect a 10 Ω , 0.01% resistor across Rx P₁ and Rx P₂.
5. Using a DMM, monitor the DC voltage at Rx P₂ with respect to Rx P₁ (use the 2 V range on the DMM).
6. Turn the 6675A Power ON.
7. After initialization, the "Measure/Setup/Voltmeter/Sofcal " menu should appear on the 6675A display.

8. Select the "Sofcal" function by pressing the corresponding menu key.

NOTE:

The software responds slowly to a key press. Quick key presses may not be acknowledged.

9. The "Gpib/RS232/Voltmeter/More 1-3" menu should appear on the display.
10. Press the menu key under "More 1-3" until the "Diagnostic/Self Test/Chart/More 2-3" menu appears on the display.
11. Select the "Diagnostic" function by pressing the corresponding menu key.
12. A WARNING screen will appear. Press any key to continue. The "Monitor/Dacs/Turns/More 1-4" menu should appear on the display.
13. Press the menu key under "More 1-4" until the "Range/Mode/Speed/More 3-4" menu appears on the display.
14. If necessary, press the menu key under "Mode" until "Normal Ohm" is indicated as the "Mode:" parameter.

NOTE:

There will be a delay when switching to and from "High Ohm" if "Volts" is set to a voltage other than 0.

15. If necessary, press the menu key under "Speed" until "Moderate" is indicated as the "Speed:" parameter.
16. Note the voltage at Rx P₂ with respect to Rx P₁.
17. Reverse the current polarity and again note the voltage at Rx P₂ with respect to Rx P₁.

NOTE:

To reverse the current polarity, press the menu key under "More x-x" until the "Sign/milliAmps/Volts/More 2-4" menu appears. Press the menu key under "Sign".

18. If necessary, adjust potentiometer R101 on the Primary Current Drive PCB until the voltage for POSITIVE polarity is greater than the voltage for NEGATIVE polarity.
19. If necessary, further adjust R101 on the Primary Current Drive PCB until the voltage closest to 0 V is of opposite polarity to the voltage furthest from 0 V and within 20 μ V of 0 V.

NOTE:

If the voltage for POSITIVE polarity is closest to 0 V, further adjust potentiometer R101 until the voltage for POSITIVE polarity is between 0 μ V and +20 μ V. If the voltage for NEGATIVE polarity is closest to 0 V, further adjust potentiometer R101 until the voltage for NEGATIVE polarity is between 0 μ V and -20 μ V.

20. Set the current polarity to POSITIVE.
21. Set the current to 100 mA.

NOTE:

To set the current, press the menu key under "More x-x" until the "Sign/milliAmps/Volts/More 2-4" menu appears. Press the menu key under "milliAmps", key in the current and press the menu key under "milliAmps" again.

22. Note the voltage at Rx P₂ with respect to Rx P₁.
23. Reverse the current polarity and again note the voltage at Rx P₂ with respect to Rx P₁.
24. If necessary, adjust potentiometer R102 on the Primary Current Drive PCB until the voltages for the POSITIVE and NEGATIVE polarities are symmetrical about ± 1 V.

e.g. A voltage of +1.00004 V (40 μ V above +1 V) for POSITIVE polarity and a voltage of -0.99996 V (40 μ V below -1 V) for NEGATIVE polarity is a proper adjustment.

NOTE:

BOTH voltages should be within 100 μ V of ± 1 V.

25. Set the current to 0 mA.
26. Repeat Steps 16 to 25.

7.2.4.3.2. Output Impedance Calibration

1. Remove the 10 Ω resistors and the links from the Rs and Rx front panel terminals.
2. Short Rs C₁ to Rs C₂.
3. Connect a 1 k Ω , 0.1% resistor across Rx C₁ and Rx C₂.
4. Using a 10 M Ω input impedance DMM, monitor the voltage at Rx C₂ with respect to Rx C₁ (use the 2 V range on the DMM).
5. Note the voltage at Rx C₂ with respect to Rx C₁.
6. Set the current to 0.3 mA.
7. Note the voltage swing at Rx C₂ with respect to Rx C₁.
8. Set the current to 0 mA.
9. Remove the 1 k Ω resistor and connect a 100 k Ω , 0.1% ULT resistor across Rx C₁ and Rx C₂.
10. Using a 10 M Ω input impedance DMM, monitor the voltage at Rx C₂ with respect to Rx C₁ (use the 200 V range on the DMM).
11. Note the voltage at Rx C₂ with respect to Rx C₁.
12. Set the current to 0.3 mA.
13. Note the voltage swing at Rx C₂ with respect to Rx C₁.
14. If necessary, adjust potentiometer R213 on the Primary Current Drive PCB to obtain a voltage swing of within 0.1 % of 99x the voltage swing noted in Step 7.

15. Set the current to 0 mA.
16. Remove the 100 k Ω resistor and reconnect the 1 k Ω 0.1% resistor across Rx C₁ and Rx C₂.
17. Repeat Steps 4 to 15.
18. Record the voltages and the voltage swings.
19. Remove the 100 k Ω resistor from across Rx C₁ and Rx C₂ and remove the short from across Rs C₁ and Rs C₂.
20. Repeat the Primary Current Calibration.
21. Record the voltages.

7.2.4.3.3.High Voltage Check

1. Turn the 6675A Power ON.
2. Enter the Sofcal Diagnostic menu.
3. Using a DMM, monitor the DC voltage at the HIGH VOLTAGE OUT terminal with respect to. the Rx Ground terminal.
4. Set the mode to "High Ohm" and the speed to "Fast".
5. Set the voltage to 990 V.

NOTE:

- **There will be a delay when switching to and from “High Ohm “ if “Volts” is set to a voltage other than 0.**
 - **To set the voltage, press the menu key under "More x-x" until the "Sign/milliAmps/Volts/More 2-4" menu appears. Press the menu key under "Volts", key in the voltage and press the menu key under "Volts" again.**
6. Ensure that the voltage indicated on the DMM is between 988 V and 992 V. Adjust R321 to set this voltage. If the output is too low, shunt R321.

7. Record the voltage.
8. Set the voltage to 0 V.
9. Using a DMM, monitor the ac voltage (noise level) at the Rx Ground terminal.
10. Set the voltage to 990 V. Ensure that the noise level is ≤ 40 mV rms.
11. Record the noise level.
12. Set the voltage to 0 V and disconnect the DMM.
13. Ensure that the Primary Current Drive module covers have been re-installed (if removed).

7.2.4.3.4.Servo-loop/Comparator Toroid Gain Adjustment

1. Remove the $10\ \Omega$ 0.01% resistors and the links connected to the Rs and Rx test set front panel terminals, and install one of the $10\ \Omega$ 0.01% resistors across the Rx C₁ and C₂ terminals.
2. Set the number of turns to 1 and the current to 0 mA.

NOTE:

To set the number of turns, press the menu key under "More x-x" until the "Monitor/Dacs/Turns/More 1-4" screen appears. Press the menu key under "Turns", key in the number of turns and press the menu key under "Turns" again.

3. Using the Scopemeter, observe the waveform on the Servo-loop PCB at TP200 with respect to TP302.
4. Check the sense amp gain as follows :
 - a) Set the current to 1 mA while remaining in Sofcal diagnostic mode.
 - b) The DC level of TP200 should be between +0.43 and +0.53 Volts.
 - c) Exit Sofcal Diagnostic mode

5.
 - a) Link Rs C₁ to Rs P₁. Link Rs P₂ to Rs C₂.
 - b) Connect a 10 Ω , 0.01% GR resistor across Rs P₁ and Rs P₂.
 - c) Link Rx C₁ to Rx P₁. Link Rx P₂ to Rx C₂.
 - d) Connect a 10 Ω , 0.01% resistor across Rx P₁ and Rx P₂.
 - e) Re-enter Sofcal Diagnostic mode, set the number of turns to 0. While observing the waveform on the Scopemeter, set the number of turns to 8747.
 - f) Check that rail-to-rail ringing dampens quickly when the turn switching is done.
 - g) Set the turns to 648 and 6480.
 - h) Check that waveform at TP200 is less than 2.5 V_{p-p} (including 50/60 Hz envelope).
 - i) Exit Sofcal Diagnostic mode.

6. If the DC level is out of tolerance or the rail to rail ringing does not dampen quickly or the TP200 waveform amplitude is greater than 2.5 V p-p, the Servo-loop circuits may require adjustment. Due to the complexity of the adjustments, it is recommended that these adjustments be done at the factory. Contact Guildline Instruments for further information.

7.2.4.3.5.Servo-loop Adjustments (Board 19107)

a) A/D Converter Calibration

1. Leave the 10 Ω , 0.01% GR resistors and the links connected to the Rs and Rx test set front panel terminals.
2. Connect a precision voltage standard (set on its 20 V range) to TP305 and TP302 on the Servo-loop PCB (connect the positive terminal of the standard to TP305). Leave the standard's output disabled.
3. Turn the 6675A Power ON and enter the Sofcal Diagnostic menu.
4. Select the "Monitor" function by pressing the corresponding menu key.
5. Set the voltage standard for +9.9927 V and enable the standard's output.

6. If necessary, adjust potentiometer R311 on the Servo-loop PCB until the "Calibration" reading is between +2046 and +2047. Adjust R311 until both numbers appear 50% of the time.
7. Disable the voltage standard's output, set the standard for -9.9976 V and re-enable the standard's output.
8. If necessary, adjust potentiometer R312 on the Servo-loop PCB until the "Calibration" reading is between -2047 and -2048. Adjust R312 until both numbers appear 50% of the time.
9. Disable the voltage standard's output.
10. The "Calibration" reading should be 0 ± 1 count.
11. Disconnect the voltage standard from the Servo-loop PCB.

b) Tracking Calibration

1. Leave the 10 Ω , 0.01% GR resistors and the links connected to the Rs and Rx test set front panel terminals.
2. Press the <PREVIOUS> key until the "Monitor/Dacs/Turns/More 1-4" menu is displayed.
3. Using a long-range DMM, monitor the DC voltage at TP202 with respect to TP302.
4. Set the current to 9.9976 mA and the number of turns to 8747.
5. Note the voltage at TP202 with respect to TP302.
6. Reverse the current polarity and again note the voltage at TP202 with respect to TP302.
7. If necessary, adjust potentiometer R313 on the Servo-loop PCB until the voltage for POSITIVE polarity is the same as the voltage for NEGATIVE polarity. The magnitude of the voltage should be ≤ 1.5 V.
8. Set the current polarity to POSITIVE.

9. Set the number of turns to 6480 and ensure that the amplitude of the voltage is ≤ 1.5 V for both current polarities.
10. Set the number of turns to 3240 and ensure that the amplitude of the voltage is ≤ 1.5 V for both current polarities.
11. Set the number of turns to 648 and ensure that the amplitude of the voltage is ≤ 1.5 V for both current polarities.
12. Set the number of turns to 8747 and vary the current from 0.033 mA to 0.037 mA in 0.001 mA steps, reversing the current polarity for each setting. In each case, the amplitude of the voltage should be ≤ 13 V. The highest voltage should occur at 0.036 mA.
13. Set the current to 0 mA and the number of turns to 0.

c) Output Impedance Calibration

1. Remove the 10 Ω resistors and the links from the Rs and Rx front panel terminals.
2. Turn the 6675A Power OFF.
3. Disconnect RED wires #1 and #2 and BLUE wires #15 and #16.
4. Connect the BLUE wire from TP104 on the Primary Current Drive PCB to the BLU wire from the Rx C₂ terminal on the 6675A front panel (i.e. bypass the Comparator Toroid's Nx winding.)

NOTE:

A male-to-male interface wire will be required.

5. Connect the RED wire from TP102 on the Servo-loop PCB to the RED wire from the Rs C₂ terminal on the 6675A front panel (i.e. bypass the Comparator Toroid's Ns winding.)

NOTE:

A female-to-female interface wire will be required.

6. Short Rx C₁ to Rx C₂.
7. Connect a 1 k Ω , 0.1% resistor across Rs C₁ and Rs C₂.

8. Turn the 6675A Power ON.
9. Enter into the Sofcal Diagnostic menu.
10. Set the Speed to "Slowest" (reset) and the number of turns to 648.
11. Using a 10 M Ω input impedance DMM, monitor the voltage at Rs C₂ with respect to Rs C₁ (use the 2 V range on the DMM).
12. Note the voltage at Rs C₂ with respect to Rs C₁.
13. Set the current to 0.3 mA.
14. Note the voltage swing at Rs C₂ with respect to Rs C₁.
15. Set the current to 0 mA.
16. Remove the 1 k Ω resistor and connect a 100 k Ω , 0.1% ULT resistor across Rs C₁ and Rs C₂.
17. Using a 10 M Ω input impedance DMM, monitor the voltage at Rs C₂ with respect to Rs C₁ (use the 200 V range on the DMM).
18. Note the voltage at Rs C₂ with respect to Rs C₁.
19. Set the current to 0.3 mA.
20. Note the voltage swing at Rs C₂ with respect to Rs C₁.
21. If necessary, adjust potentiometer R116 on the Servo-loop PCB to obtain a voltage swing of within 0.1 % of 99x the voltage swing noted in Step 15.
22. Set the current to 0 mA and the number of turns to 0.
23. Remove the 100 k Ω resistor and reconnect the 1 k Ω 0.1% resistor across Rs C₁ and Rs C₂.
24. Repeat Steps 11 to 22.
25. Record the voltages and the voltage swings.

26. Remove the 100 k Ω resistor from across Rx C₁ and Rx C₂ and remove the short from across Rs C₁ and Rs C₂.
27. Repeat the Tracking Calibration.
28. Record the voltages.
29. Turn the 6675A Power OFF.
30. Remove the interface wires installed in Steps 4 and 5.
31. Reconnect RED wires #1 and #2 and BLUE wires #15 and #16.
32. Recheck the tracking calibration.
33. Put the lids on the Servo-loop Module.

7.2.4.3.6.Flux Detector Balancing (Board 19110)

1. Connect two 100 M Ω 9330 standard resistors to the 6675A as shown in Figure 3-9.
2. Set the mode to "High Ohm" and the speed to "Fast".
3. Set the number of turns to 648 and the voltage to 990 V.
4. Press the menu key under "More x-x" until the "Monitor/Dacs/Turns/More 1-4" menu is displayed.
5. Select the "Monitor" function by pressing the corresponding menu key.
6. Adjust potentiometer R42 on the Magnetic Modulator PCB until the "Servo:" readings are as close to 0 as possible.
7. Allow time for the reading to stabilize and readjust potentiometer R42 on the Magnetic Modulator PCB if necessary.
8. Temporarily place the top cover on the 6675A and allow time for the unit to warm up with the cover on.

9. Observe the "Servo:" readings and if necessary, remove the top cover and readjust potentiometer R42 on the Magnetic Modulator PCB.
10. Set the voltage to 0 V and the number of turns to 0.
11. Record the number of the Current Comparator module installed in the 6675A.
12. Properly install the top cover on the 6675A.

7.2.4.3.7. A/D Converter (Board 19502)

1. Visually inspect the A/D Converter PCB to be tested for errors.
2. Connect the OUTPUT terminals of a Precision DC Calibrator to the Rs P₂ and Rx P₂ terminals on the 6675A front panel using SCW cable (connect the positive Precision DC Calibrator OUTPUT terminal to the Rs P₂ terminal).
3. Set the Precision DC Calibrator for 0 V. Ensure that the Precision DC Calibrator is NOT in STANDBY mode.
4. Turn the 6675A Power ON.

NOTE:

When turning the 6675A Power ON, wait ≈15 seconds for initialization.

5. After initialization, the "Measure/Setup/Voltmeter/Sofcal" menu should be displayed.
6. Allow at least 10 minutes for the A/D Converter PCB being tested to warm up.
7. Select the "SOFCAL" function by pressing the corresponding menu key.

NOTE:

The software responds slowly to a key press. Quick key presses may not be acknowledged.

8. The "GPIB/RS232/Voltmeter/More 1-3" menu should appear on the 6675A display.
9. Select the "Voltmeter" function by pressing the corresponding menu key.
10. The "20V Range/Volts Set/Coef Set/" screen should appear on the display.
11. Select the "Volts Set" function by pressing the corresponding menu key.
12. The "Zero Volts/High Volts/Ref Volts/Ok" screen should appear on the display.
13. Select the "Zero Volts" function by pressing the corresponding menu key.
14. Wait ≈ 5 seconds (as per the displayed message) and observe the returned "Zero Volts:" reading (nominally $1.000000e+01$).
15. Repeat Steps 13 and 14, ensuring that the "Zero Volts:" reading is stable over the next 10 readings (± 1 count).
16. Select the "Ref Volts" function by pressing the corresponding menu key. Key in 15 and press the menu key under "Ref Volts".
17. Set the Precision DC Calibrator for +15 V (+75% of full scale).
18. Select the "High Volts" function by pressing the corresponding menu key.
19. Wait ≈ 5 seconds (as per the displayed message) and observe the returned "High Volts:" reading (nominally $5.000000e+05$).
20. Repeat Steps 18 and 19 ensuring that the "High Volts:" reading is stable over the next 10 readings (± 1 count).
21. Select <Ok> by pressing the corresponding menu key.
22. Press the <PREVIOUS> key until the "Measure/Setup/Voltmeter/Sofcal" menu is displayed.

23. Select the "Voltmeter" function by pressing the corresponding menu key.
24. Ensure that the voltage displayed on the 6675A display is between +14.9997 V and +15.0003 V ($\pm 15 \text{ V} \pm 20 \text{ ppm}$).
25. Set the Precision DC Calibrator for -15 V (-75% of full scale).
26. Ensure that the voltage displayed is between -14.9997 V and -15.0003 V ($-15 \text{ V} \pm 20 \text{ ppm}$).
27. Set the Precision DC Calibrator for +10 V (+50% of full scale).
28. Ensure that the voltage displayed is between +9.9998 V and +10.0002 V ($+10 \text{ V} \pm 20 \text{ ppm}$).
29. Set the Precision DC Calibrator for -10 V (-50% of full scale).
30. Ensure that the voltage displayed is between -9.9998 V and -10.0002 V ($-10 \text{ V} \pm 20 \text{ ppm}$).
31. Set the Precision DC Calibrator for 0 V.
32. The voltage displayed should be very close to 0 V.
33. Turn the 6675A Power OFF.

7.2.4.3.8. Amplifier Attenuator (Board 19503)

1. Disassemble 6675A so that the Right side panel (with nanovoltmeter front end) is laying flat on the bench.
2. Remove nanovoltmeter lid so that trimpots and test points are exposed.
3. Connect the OUTPUT terminals of a Precision DC Calibrator to Rs-P₂ and Rx-P₂ terminals on the 6675A front panels using a SCW cable (connect the positive Precision DC Calibrator OUTPUT terminal to Rs-P₂).
4. Set the Precision DC Calibrator for 0 V. Ensure that the Precision DC Calibrator is NOT in STANDBY mode.

5. Turn the 6675A Power ON.

NOTE:

When turning the 6675A Power ON, wait \approx 15 seconds for initialization.

6. After initialization, the "Measure/Setup/Voltmeter/Sofcal" menu should be displayed.
7. Select the "Voltmeter" function by pressing the corresponding menu key.

NOTE:

The software responds slowly to a key press. Quick key presses may not be acknowledged.

8. The "20V Range/No Filter/Normal/More 1-2" menu should be displayed. The measured voltage should also be displayed.
9. If necessary, adjust potentiometer R127 on the Amp/Attenuator PCB until the displayed reading is as close to 0 V as possible.
10. Press the menu key under "20V Range" to select the 2 V range and, if necessary, re-adjust potentiometer R127 until the displayed reading is as close to 0 V as possible.
11. Using an oscilloscope, monitor the waveform at TP SIGNAL with respect to TP GND.
12. Select the 200 mV range and adjust potentiometer R300 until the waveform at TP SIGNAL with respect to TP GND is as close to 0 V as possible.
13. Select the 20 mV range and re-adjust potentiometer R300 until the waveform at TP SIGNAL with respect to TP GND is as close to 0 V as possible.
14. Select the 2 mV range and re-adjust potentiometer R300 until the waveform at TP SIGNAL with respect to TP GND is as close to 0 V as possible.

15. Put the lid on the 6675A Nanovoltmeter module and allow approximately 15 minutes for the module to warm up.
16. Press the **<PREVIOUS>** key until the "Measure/Setup/Voltmeter/Sofcal" menu is displayed.
17. Select the "Sofcal" function by pressing the corresponding menu key.
18. The "GPIB/RS232/Voltmeter/ More 1-3" menu should appear on the 6675A display.
19. Select the "Voltmeter" function by pressing the corresponding menu key.
20. The "20V Range/Volts Set/Coef Set/ " menu should appear on the display.
21. Press the menu key under "20V Range" until the desired range appears.
22. Select the "Volts Set" function by pressing the corresponding menu key.
23. The "Zero Volts/High Volts/Ref Volts/Ok" menu should appear on the display.
24. Select the "Zero Volts" function by pressing the corresponding menu key.
25. Wait ≈ 5 seconds (as per the displayed message) and observe the returned "Zero Volts reading.
26. Repeat Steps 24 and 25 ensuring that the "Zero Volts:" reading is stable over the next 10 readings (± 1 count).
27. Select the "Ref Volts" function by pressing the corresponding menu key. Key in the desired voltage (as per Table 7-7) and press the menu key under "Ref Volts".
28. Set the Precision DC Calibrator for +75% of full scale of the range selected.

29. Select the "High Volts" function by pressing the corresponding menu key.
30. Wait ≈ 5 seconds (as per the displayed message) and observe the returned "High Volts" reading.
31. Ensure the "High Volts" reading is stable over the next 10 readings (± 1 count) (± 10 counts for 2 mV range).
32. Select <Ok> by pressing the corresponding menu key.
33. Press the <PREVIOUS> key until the "Measure/Setup/Voltmeter/Sofcal" menu is displayed.
34. Select the "Voltmeter" function by pressing the corresponding menu key.
35. Press the menu key under "20V Range" until the desired range appears.
36. Ensure that the voltage displayed on the 6675A display is within the voltage range indicated in Table 7-7.
37. Set the Precision DC Calibrator for -75% of full scale of the range selected.
38. Ensure that the magnitude of the voltage displayed is within the voltage range indicated in Table 7-7.
39. Set the Precision DC calibrator for +50% of full scale of the range selected.
40. Ensure that the voltage displayed is within the voltage range indicated in Table 7-7.
41. Set the Precision DC Calibrator for -50% of full scale of the range selected.
42. Ensure that the magnitude of the voltage displayed is within the voltage range indicated in Table 7-7.
43. Set the Precision DC calibrator for 0 V.
44. The voltage displayed should be very close to 0 V.

45. Repeat Steps 16 to 44 for the remaining ranges indicated in Table 7-7.
46. Turn the 6675A Power OFF.
47. Reassemble 6675A.

Range	Reference Volts	Range of Voltage for 75% FS	Range of Voltage for 50% FS
20 V	15 V	14.9997 V to 15.0003 V	9.9998 V to 10.0002 V
2 V	1.5 V	1.49997 V to 1.50003 V	0.99998 V to 1.00002 V
200 mV	0.15 V	149.997 mV to 150.003 mV	99.998 mV to 100.002 mV
20 mV	0.015 V	14.9993 mV to 15.0007 mV	9.9995 mV to 10.0005 mV
2 mV	0.0015 V	1.49993 mV to 1.50007 mV	0.99995 mV to 1.00005 mV

Table 7-7 : Reference Voltages

8. PARTS LISTS - MODEL 6675A

PL19482.02.02	General Assembly
PL19128.01.02	Comparator Toroid Assembly
PL19855.01.02	Nanovolt Amplifier CPU PCB Assembly
PL19334.01.02	Nanovolt Dual Power Supply PCB Assembly
PL19464.02.02	6675A CPU PCB Assembly
PL19473.01.02	6675A CPU & Display Power Supply PCB Assembly
PL19331.01.02	Transformer Module Assembly
PL19485.02.01	Front Panel Mechanical Assembly
PL19472.01.02	Keypad Switch PCB Assembly
PL19111.01.02	Primary Current Drive Power Supply PCB Assembly
PL19110.01.02	Magnetic Modulator PCB Assembly
PL19109.01.02	Relay PCB Assembly
PL19107.01.02	Servo Loop PCB Assembly
PL19105.01.02	Fibre-Optic Interface PCB Assembly
PL19112.01.02	Servo Loop Power Supply PCB Assembly
PL20065.01.02	Primary Current Drive PCB Assembly
PL19503.01.02	Nanovolt Amplifier Attenuator PCB Assembly
PL19502.01.02	Nanovolt A/D Converter PCB Assembly

9. DRAWINGS - MODEL 6675A

19482.02.02	General Assembly
19855.01.04	Nanovolt Amplifier CPU PCB Schematic
19855.01.02	Nanovolt Amplifier CPU PCB Assembly
19334.01.04	Nanovolt Dual Power Supply PCB Schematic
19334.01.02	Nanovolt Dual Power Supply PCB Assembly
19464.02.04	6675A CPU PCB Schematic
19464.02.02	6675A CPU PCB Assembly
19473.01.04	6675A CPU & Display Power Supply PCB Schematic
19473.01.02	6675A CPU & Display Power Supply PCB Assembly
19331.01.02	Transformer Module Assembly
19485.02.01	Front Panel Mechanical Assembly
19472.01.04	Keypad Switch PCB Schematic
19472.01.02	Keypad Switch PCB Assembly
19111.01.04	Primary Current Drive Power Supply PCB Schematic
19111.01.02	Primary Current Drive Power Supply PCB Assembly
19110.01.04	Magnetic Modulator PCB Schematic
19110.01.02	Magnetic Modulator PCB Assembly
19109.01.04	Relay PCB Schematic
19109.01.02	Relay PCB Assembly
19107.01.04	Servo Loop PCB Schematic
19107.01.02	Servo Loop PCB Assembly
19105.01.04	Fibre-Optic Interface PCB Schematic
19105.01.02	Fibre-Optic Interface PCB Assembly
19112.01.04	Servo Loop Power Supply PCB Schematic
19112.01.02	Servo Loop Power Supply PCB Assembly
20065.01.04	Primary Current Drive PCB Schematic
20065.01.02	Primary Current Drive PCB Assembly
19503.01.04	Nanovolt Amplifier Attenuator PCB Schematic
19503.01.02	Nanovolt Amplifier Attenuator PCB Assembly
19502.01.04	Nanovolt A/D Converter PCB Schematic
19502.01.02	Nanovolt A/D Converter PCB Assembly
19121.01.02	PDCC Comparator General Assembly
19327.01.02	Primary Current General Assembly
19328.01.02	Servo Loop General Assembly