

## Errata

**Title & Document Type:** 141T Display Section Operating and Service Manual

**Manual Part Number:** N/A

**Revision Date:** June 1977

---

### HP References in this Manual

This manual may contain references to HP or Hewlett-Packard. Please note that Hewlett-Packard's former test and measurement, semiconductor products and chemical analysis businesses are now part of Agilent Technologies. We have made no changes to this manual copy. The HP XXXX referred to in this document is now the Agilent XXXX. For example, model number HP8648A is now model number Agilent 8648A.

### About this Manual

We've added this manual to the Agilent website in an effort to help you support your product. This manual provides the best information we could find. It may be incomplete or contain dated information, and the scan quality may not be ideal. If we find a better copy in the future, we will add it to the Agilent website.

### Support for Your Product

Agilent no longer sells or supports this product. You will find any other available product information on the Agilent Test & Measurement website:

[www.tm.agilent.com](http://www.tm.agilent.com)

Search for the model number of this product, and the resulting product page will guide you to any available information. Our service centers may be able to perform calibration if no repair parts are needed, but no other support from Agilent is available

# DISPLAY SECTION 141T

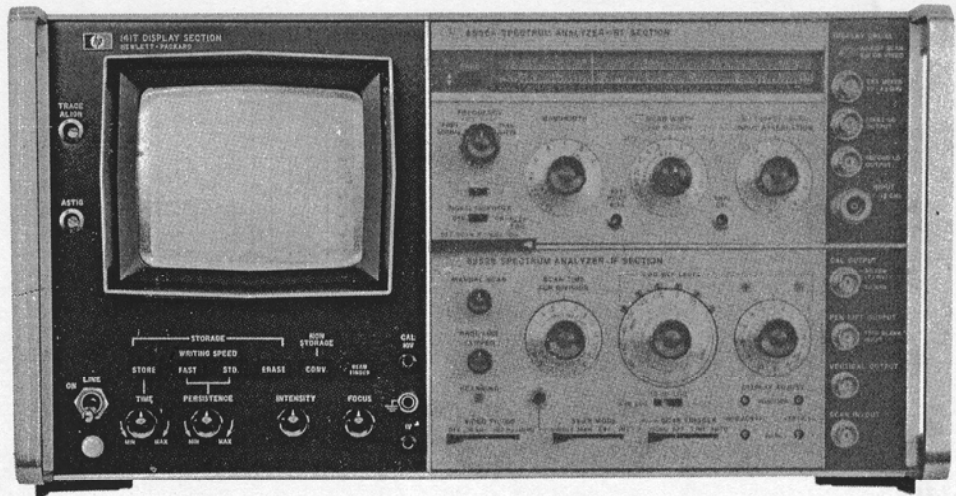

HEWLETT  PACKARD

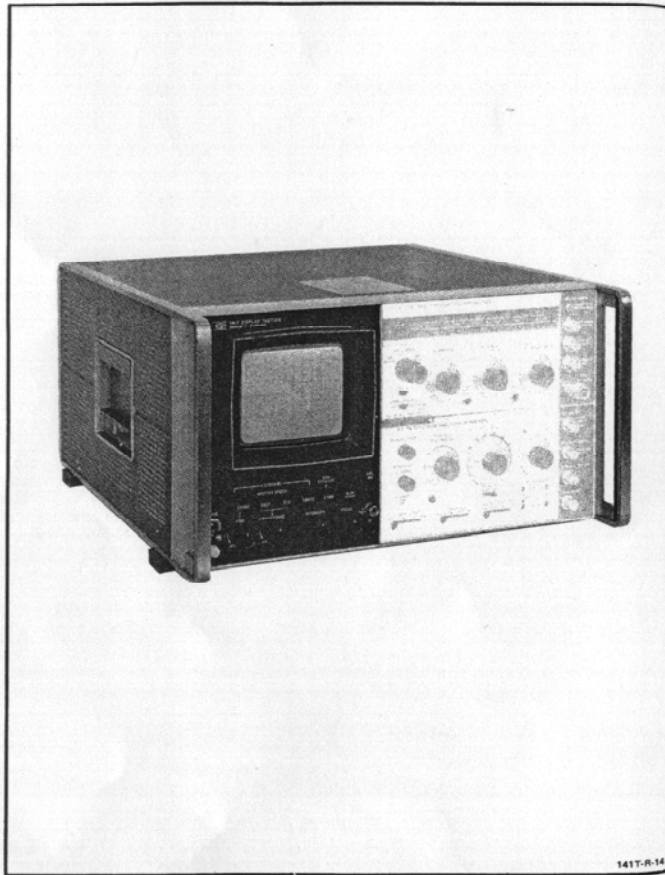

Figure 1-1. Model 141T Display Section

## SECTION I

## GENERAL INFORMATION

**1-1. INTRODUCTION.**

1-2. This manual provides operating and service information for the Hewlett-Packard Model 141T Display Section (figure 1-1). The manual is divided into eight sections, each covering a specific topic or aspect of the instrument. All schematics are located at the rear of the manual and can be unfolded and used for reference while reading any part of the manual.

1-3. This section contains a description of the Model 141T. The instrument specifications are listed in table 1-1. Table 1-2 lists and describes the abbreviations used in this manual except Section VI. The parts list is a computer printout and uses computer-supplied abbreviations. Table 1-3 contains a list of current plug-ins available for use with the Model 141T.

**1-4. DESCRIPTION.**

1-5. The Model 141T is designed for use as a display section for the HP Model 141T/8550-series plug-in spectrum analyzer and as an oscilloscope when used with HP Model 1400-series plug-ins. The instrument has variable persistence (duration of trace afterglow) and storage of CRT displays. Persistence is variable from 0.2 second to more than 60 seconds. A display can be stored (at reduced intensity) for more than 2 hours or displayed at normal intensity for up to 1 minute. Stored displays can be erased in 350 milliseconds.

1-6. Variable persistence is especially useful for viewing slow-sweep signals. The persistence of the signals from electrocardiograms or other bio-chemical phenomena can be adjusted to provide a complete trace, yet to fade fast enough to prevent interference with the next trace. Display persistence of swept frequency and time domain reflectometry measurement readouts can be adjusted to eliminate flicker and still provide high resolution.

1-7. The storage feature of the instrument can be used to store single-shot waveforms and to later view and photograph the phenomena. Comparison of waveforms can be accomplished by storing several displays separately and then viewing them simultaneously.

1-8. The instrument accepts all HP Model 1400-series plug-in units. Amplifiers with bandwidths to

20 MHz and sensitivities to 100 microvolts per division are available as well as time domain reflectometry and swept frequency indicator units.

**1-9. CATHODE RAY TUBE.**

1-10. The Model 141T uses a post-accelerator CRT with a non-glare rectangular faceplate. An internal graticule is located on the same plane as the display to eliminate parallax errors. The tube has a 9-kV accelerating potential, and 8 vertical by 10 horizontal divisions. A type P31 phosphor is used in the standard CRT.



The warranty may be void for instruments having a mutilated serial number tag.

**1-11. WARRANTY.**

1-12. The instrument (except the CRT) is certified and warranted as stated on the inside front cover of this manual. The CRT is covered by a separate warranty. The CRT warranty and a warranty claim form are located at the rear of this manual. Should the CRT fail within the time specified on the CRT warranty page, complete the warranty claim form and return it with the defective CRT. The procedure for returning a defective CRT is described on the CRT warranty page.

**1-13. ASSOCIATED EQUIPMENT.**

1-14. Plug-ins available for use with the instrument are listed in table 1-3 and in the Hewlett-Packard Instrumentation Catalog. The instrument is normally operated with an IP section plug-in in the lower compartment and an RP section plug-in in the upper compartment. The instrument can also be used as an oscilloscope with a vertical plug-in in the lower compartment and a time-base plug-in in the upper compartment. Both plug-in compartments are the same size, and the plug-in instruments may be interchanged for any special application. The divider shield that separates the two compartments can be removed and one double sized plug-in installed. Blank plug-in kits, both single and double sized, are available for fabrication of special circuits. See table 4-1 for power supply current limitations.

Table 1-1. Specifications

<p><b>PLUG-INS</b></p> <p>accepts Model 8550-series IF and RF Section spectrum analyzer plug-ins without the use of a center divider shield.</p> <p>Also, accepts all HP Model 1400-series plug-ins. All plug-ins operate directly into the horizontal and vertical deflection plates. Center shield may be removed to provide double-sized compartment for use with a single, dual axis Model 1400-series unit.</p> <p><b>CATHODE-RAY TUBE</b></p> <p>Type: Post-accelerator storage tube; 9000V accelerating potential; aluminumized P31 phosphor; etched safety glass face plate.</p> <p>Graticule: 8 x 10 divisions (approx. 7.1 x 8.9 cm) parallax-free internal graticule. Subdivisions of 0.2 div per major division on major horizontal and vertical axes.</p> <p>Intensity Modulation: AC coupled, +20 volt pulse will blank trace of normal intensity; input terminals on rear panel.</p> <p><b>PERSISTENCE</b></p> <p>Conventional: Natural persistence of P31 phosphor (about 40 usec).</p> <p>Variable: STANDARD Writing Speed Mode: Continuously variable from less than 0.2 second to more than one minute.</p> <p><b>ERASE</b></p> <p>Manual or optional remote (see Section VII options); Erasure takes approximately 350 msec; scope ready to record immediately after erasure.</p> <p><b>WRITING SPEED PHOTOGRAPHIC</b></p> <p>Conventional operation (using a HP Model 197A camera with f/1.9 lens and Polaroid® 3000 speed-film): 100 div/usec.</p> <p><b>WRITING SPEED</b></p> <p>Storage: Standard Mode: greater than 20 div/ms. Fast Mode: greater than 1 div/usec.</p>	<p><b>STORAGE TIME</b></p> <p>Standard Writing Speed: more than two hours at reduced brightness (typically four hours). Traces may be viewed at maximum brightness for more than one minute.</p> <p>Fast Writing Speed: traces may be stored at reduced brightness for more than 15 minutes (typically 30 minutes) or stored at maximum brightness for more than 15 seconds.</p> <p>Brightness: 100 foot-lamberts in standard mode.</p> <p><b>CALIBRATOR</b></p> <p>Type: Line-frequency rectangular signal, approximately 0.5 usec rise time.</p> <p>Voltage: Two outputs: 1 volt and 10 volts peak-to-peak ±1% from 15°C to 35°C, ±3% from 0°C to 55°C.</p> <p><b>BEAM FINDER</b></p> <p>Pressing BEAM FINDER pushbutton brings trace on screen regardless of setting of horizontal, or vertical position controls.</p> <p><b>GENERAL</b></p> <p>Power Requirements: 100, 120, 220 or 240 volts (+5 to -10%), 48 to 66 Hz (Option H16 48 to 440 Hz), normally less than 285 watts (varies with plug-in units).</p> <p>Dimensions:</p> <p>Weight: Net, 40 lbs (18 kg) (without plug-ins). Shipping, 51 lbs. (23 kg).</p>
---	---

**1-15. INSTRUMENT AND MANUAL IDENTIFICATION.**

1-16. This manual applies directly to Model 141T instruments with a serial prefix number as listed on the manual title page. The serial prefix number is the first group of digits in the instrument serial number (figure 1-2). The instrument serial number is on a tag located on the rear panel.

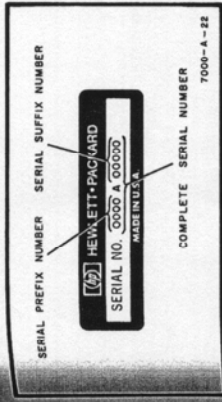

Figure 1-2. Instrument Serial Number

1-17. Check the serial prefix number of the instrument. If the serial prefix number is different from that listed on the title page of this manual, refer to Section VII for instructions to adapt this manual for proper instrument coverage.

1-18. Errors in the manual are listed under errata on an enclosed MANUAL CHANGES sheet (if any).

**1-19. INQUIRIES.**

1-20. Refer any questions regarding the manual, the change sheet, or the instrument to the nearest HP Sales/Service Office. Always identify the instrument by model number, complete name, and complete serial number in all correspondence. Refer to the inside rear cover of this manual for a world-wide listing of HP Sales/Service Offices.

Table 1-2. Reference Designators and Abbreviations

<p><b>A</b> = assembly</p> <p><b>AT</b> = attenuator</p> <p><b>B</b> = motor, fan</p> <p><b>BT</b> = battery</p> <p><b>CP</b> = capacitor</p> <p><b>CR</b> = relay</p> <p><b>DL</b> = diode</p> <p><b>DS</b> = delay line</p> <p><b>E</b> = elec. electrical part</p> <p><b>FL</b> = fuse</p> <p><b>H</b> = hardware</p> <p><b>J</b> = jack</p> <p><b>K</b> = keyboard</p> <p><b>L</b> = inductor</p> <p><b>LS</b> = speaker</p> <p><b>M</b> = meter</p> <p><b>MP</b> = mechanical part</p>	<p><b>F</b> = field-effect transistor(s)</p> <p><b>G</b> = giga (10<sup>9</sup>)</p> <p><b>H</b> = henry(ies)</p> <p><b>hr</b> = hour(s)</p> <p><b>Hz</b> = hertz</p> <p><b>int</b> = intermediate freq.</p> <p><b>k</b> = kilo (10<sup>3</sup>)</p> <p><b>lb</b> = pounds</p> <p><b>ipf</b> = low-pass filter(s)</p> <p><b>m</b> = milli (10<sup>-3</sup>)</p> <p><b>Ms</b> = mega (10<sup>6</sup>)</p> <p><b>ms</b> = millisecond</p>	<p><b>n</b> = nano (10<sup>-9</sup>)</p> <p><b>nc</b> = normally closed</p> <p><b>npn</b> = negative-positive-negative</p> <p><b>ns</b> = nanosecond</p> <p><b>pc</b> = pins (10<sup>12</sup>)</p> <p><b>pc</b> = printed (etched) circuit(s)</p> <p><b>pk</b> = peak</p> <p><b>pnp</b> = positive-negative-part of program</p> <p><b>p/p</b> = peak-to-peak voltage(s)</p> <p><b>prv</b> = program voltage</p> <p><b>ps</b> = picosecond</p> <p><b>pvv</b> = peak working voltage</p> <p><b>rf</b> = radio frequency</p>	<p><b>P</b> = plug (unrepairable)</p> <p><b>Q</b> = quartz, tube, neon bulb, photo tube, etc.</p> <p><b>VR</b> = voltage regulator</p> <p><b>W</b> = wire</p> <p><b>X</b> = cable</p> <p><b>Y</b> = test point</p> <p><b>Z</b> = network</p>	<p><b>RI</b> = radio frequency interference</p> <p><b>rms</b> = root-mean-square</p> <p><b>rww</b> = reverse working voltage</p> <p><b>SCR</b> = silicon controlled rectifier</p> <p><b>sec</b> = second(s)</p> <p><b>std</b> = standard</p> <p><b>trmr</b> = trimmer</p> <p><b>u</b> = micro (10<sup>-6</sup>)</p> <p><b>usec</b> = microsecond</p> <p><b>v</b> = volts</p> <p><b>var</b> = variable</p> <p><b>w/o</b> = without</p> <p><b>w/v</b> = working voltage</p>
---	---	---	--	---

Table 1-3. Plug-ins for Model 141T Display Section

FUNCTION	HP MODEL NUMBER	CAPABILITIES												
		Wide Band	Sampling	Differential	Dual Trace	Four Trace	X-Y	Delayed Sweep	No Drift	High CMR	Algebraic Addition	TDR*	Wide Band TDR	Swept Frequency
VERTICAL PLUG-INS	1402A	x	x	x	x	x								
	1430C		x									x		
TIME BASE PLUG-INS	1421A	x		x	x	x	x	x	x	x	x			
SPECTRUM ANALYZER PLUG-INS	8552A 8552B 8553B 8554B 8555A 8556A	Fixed or variable scan spectrum analysis. Spectrum analyzer IF section, 50 Hz bandwidth. Spectrum analyzer IF section, 10 Hz bandwidth. Spectrum analyzer RF section, 1 kHz to 110 MHz. Spectrum analyzer RF section, 100 kHz to 1250 MHz. Spectrum analyzer RF section, 10 MHz to 40 GHz. Spectrum analyzer LF section, 20 Hz to 300 kHz.												

\*Time Domain Reflectometry.

## SECTION II INSTALLATION

### 2-1. INTRODUCTION.

2-2. This section contains instructions for performing an initial inspection of the Model 141T. Installation procedures and precautions are presented in step-by-step order. The procedures for making a claim for warranty repairs and for repacking the instrument for shipment are also described in this section.

### 2-3. INITIAL INSPECTION.

2-4. The instrument was inspected mechanically and electrically before shipment. Upon receipt, inspect it for damage that may have occurred in transit. Check for broken knobs, bent or broken connectors, and dents or scratches. If damage is found, refer to the claims paragraph in this section. Retain the packing material for possible future use.

### 2-6. PREPARATION FOR USE.

2-7. The instrument requires a power source of 100-, 120-, 220-, or 240-volt +5 - 10%, single phase, 48 to 440 Hz, that can deliver approximately 400 volt-amperes. A removable jumper board in power module A7, provides selection of the line voltage to be used (figure 2-1).

2-5. Check the electrical performance of the instrument immediately after receipt. Refer to Section V for the performance check procedure. The performance check will determine whether or not the instrument is operating within the specifications listed in table 1-1. Initial performance and accuracy of the instrument are certified as stated on the inside front cover of this manual. If the instrument does not operate as specified, refer to the claims paragraph in this section.

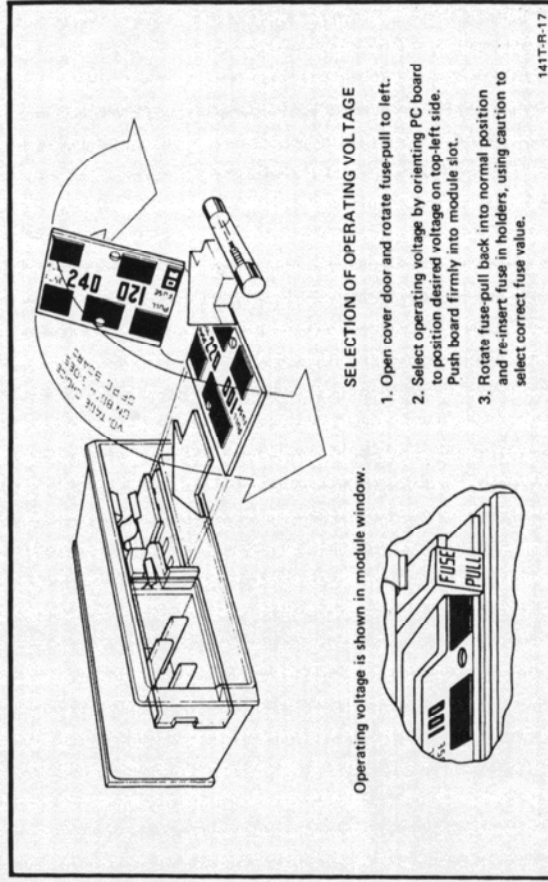

Figure 2-1. Voltage Selection

**CAUTION**

Before placing the Model 141T in operation, ensure that the operating voltage indicated in the power module window (figure 2-1) agrees with the line voltage being used.

To avoid damaging CRT perform Intensity adjustment (figure 3-2).

2-8. When operating the Model 141T from a 100V or 125V source, replace line fuse with a 4A slow-blow fuse. When operating from a 220V or 240V source, replace line fuse with a 2A slow-blow fuse.

**2-9. THREE-CONDUCTOR AC POWER CABLE.**

2-10. For the protection of operating personnel Hewlett-Packard Company recommends that the instrument panel and cabinet be grounded. This instrument is equipped with a three-conductor, ac power cable that, when connected to an appropriate receptacle, grounds the instrument through the offset pin. The power jack and mating plug of the power cord meet International Electro-technical Commission (IEC) safety standards.

**2-11. INSTRUMENT MOUNTING.**

2-12. The instrument is shipped from the factory as a bench instrument with the tilt stand, feet, and

plastic trim in place. Four supports are mounted on the rear panel of the instrument for operation in a vertical position. Top, left side, and bottom panel covers can be removed, giving access to components and adjustments. Allow sufficient space around the cabinet for air circulation.

2-13. A kit for converting the modular cabinet to a rack mount is included. Instructions for making the conversion are given below (figure 2-2).

- a. Detach tilt stand by pressing away from front feet A.
- b. Remove plastic feet by pressing metal button and sliding each foot free.
- c. Using thin-bladed tool, remove aluminum trim strips. These strips have adhesive backing, and are located on sides behind front handles.
- d. Attach rack mounting flange, using screws provided in kit, in each space where trim strip was removed. Position large notch of flange at instrument bottom.

e. Rack-mounting kit contains filler strips that should be used as spacers between Model 141T and other equipment mounted in same rack.

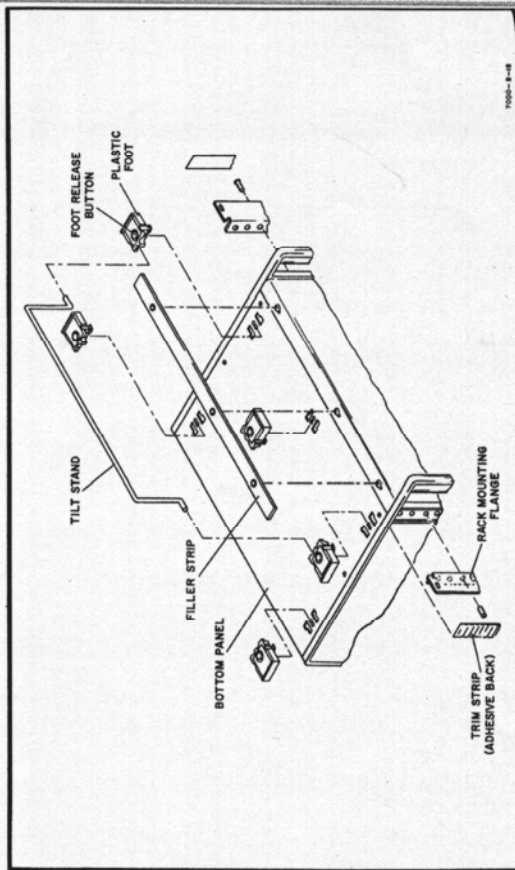

Figure 2-2. Rack Mounting Procedure

**2-14. INSTRUMENT COOLING.**

2-15. Forced-air cooling is used to maintain the required operating temperatures within the instrument. The air intake and filter are located on the rear of the instrument. Warm air is exhausted through the side-panel perforations. Allow at least 3 inches of clearance around the top, rear, and both sides of the instrument for cooling.

2-16. The cooling fan does not require lubrication, but the filter should be cleaned often enough to ensure sufficient air flow. A thermal switch is mounted on the fan to protect against over-heating.

**2-17. CLAIMS.**

2-18. The warranty statement applicable to this instrument is printed inside the front cover of this manual. Refer to the rear of this manual for the CRT warranty statement. If physical damage is found

or if operation is not as specified when the instrument is received, notify the carrier and nearest HP Sales/Service Office immediately (refer to the list in back of this manual for addresses). The HP Sales/Service Office will arrange for repair or replacement without waiting for settlement of the claim with the carrier.

**2-19. REPACKING FOR SHIPMENT.**

2-20. If the instrument is to be shipped to a Hewlett-Packard Sales/Service Office for service or repair, attach a tag showing owner (with address), complete instrument serial number, and a description of the service required.

2-21. Use the original shipping carton and packing material. If the original packing material is not available, the Hewlett-Packard Sales/Service Office will provide information and recommendations on materials to be used.

### SECTION III OPERATION

#### 3-1. INTRODUCTION.

3-2. This section contains front panel control information and considerations for operating the instrument. Controls for operation of power supplies and cathode-ray tube are located on the instrument front panel. All other controls are located on the plug-in units. The instrument includes high and low-voltage power supplies, a calibrator circuit, a CRT, and a pulse circuit for variable persistence and storage operation.

#### 3-3. CONTROLS AND CONNECTORS.

3-4. Figure 3-1 identifies the front panel controls and gives a brief functional description of each. The following paragraphs provide detailed descriptions of controls with multiple or complex functions.

#### 3-5. TRACE ALIGN.

3-6. The TRACE ALIGN adjustment compensates for external magnetic fields that affect alignment of the horizontal trace with the graticule. The alignment should be checked when the instrument is moved to a new location and adjustment made when necessary.

#### 3-7. BEAM FINDER.

3-8. A high dc input signal may drive the trace off the CRT screen. When the BEAM FINDER pushbutton is pressed, the trace will be returned to the screen regardless of the setting of horizontal or vertical POSITION controls. If pressing the BEAM FINDER pushbutton does not return a beam to the viewing area press and hold the BEAM FINDER and gradually adjust the INTENSITY control until a visible trace is obtained and release BEAM FINDER. When used with 8550-series frequency domain plug-ins, the BEAM FINDER has no function.

#### 3-9. FOCUS AND ASTIGMATISM.

3-10. These controls provide uniform focus of the trace over the entire CRT screen. Adjustment is made in the STD WRITING SPEED with a low intensity spot on the CRT screen. FOCUS and ASTIG are adjusted for a round, sharply focused spot.

#### 3-11. Z-AXIS INPUT.

3-12. The Z-AXIS INPUT jack and selector switch are on the rear panel of the instrument (figure 6-3).

To externally modulate the trace intensity, set the switch to EXT, and connect the modulation signal to the terminals. The amplitude of the pulse required to blank the trace depends on the front panel INTENSITY control setting, and is approximately 20 volts positive for normal intensity settings. When not using external modulation, set the switch to INT.

#### 3-13. PLUG-IN UNITS.

3-14. Available plug-ins for the Model 141T are listed in table 1-2. This instrument is normally operated with an RF section plug-in in the upper compartment and an IF section plug-in in the lower compartment. The Operating and Service Manuals for the plug-in units contain detailed information for installing plug-ins.

3-15. Arrangement of plug-ins can be selected to suit special applications. For example, a vertical amplifier and time base plug-in can be reversed so that sweep is vertical and signal deflection is horizontal. A vertical plug-in can be used in each compartment to take X-Y measurements.

3-16. Double-sized plug-ins, such as the Model 1415A and Model 1416A, can be inserted into the instrument after removal of the divider shield between lower and upper compartments. Blank plug-ins, both single and double size, are available for customer fabrication of specialized vertical amplifier and time base plug-ins. Refer to table 4-1 for power supply current limitations.

#### NOTE

For proper operation, the divider shield must be in place when using standard size plug-ins (does not apply to spectrum analyzer plug-ins).

3-17. The Model 141T also accepts Model 1400-series plug-ins for standard oscilloscope use. When standard 1400-series oscilloscope plug-ins are used, plug-in shield (HP Part No. 00140-0601) must also be used. Order the shield from the nearest HP Sales/Service Office.

**CAUTION**

Do not operate instrument above 45°C, when using real time plug-ins.

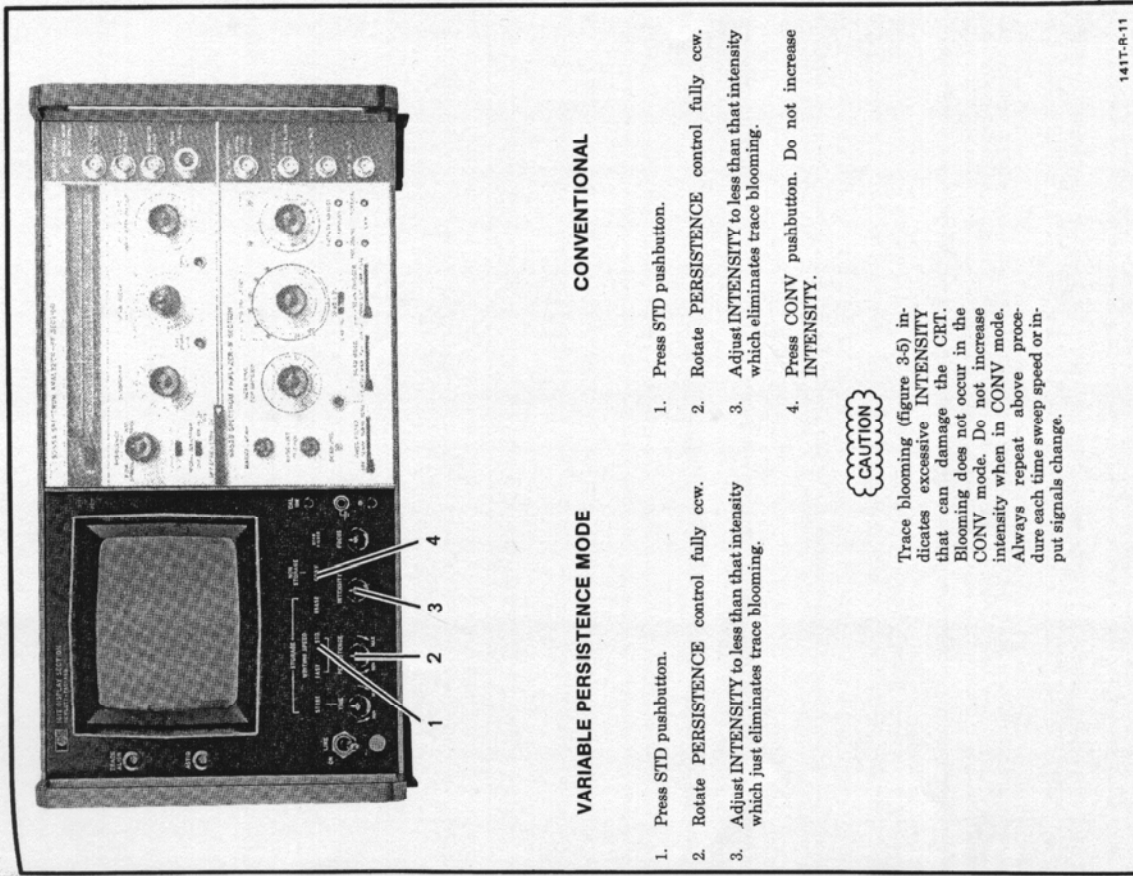

VARIABLE PERSISTENCE MODE

1. Press STD pushbutton.
2. Rotate PERSISTENCE control fully ccw.
3. Adjust INTENSITY to less than that intensity which just eliminates trace blooming.

CONVENTIONAL

1. Press STD pushbutton.
2. Rotate PERSISTENCE control fully ccw.
3. Adjust INTENSITY to less than that intensity which eliminates trace blooming.
4. Press CONV pushbutton. Do not increase INTENSITY.

**CAUTION**

Trace blooming (figure 3-5) indicates excessive INTENSITY that can damage the CRT. Blooming does not occur in the CONV mode. Do not increase intensity when in CONV mode. Always repeat above procedure each time sweep speed or input signals change.

Figure 3-2. Intensity Adjustment

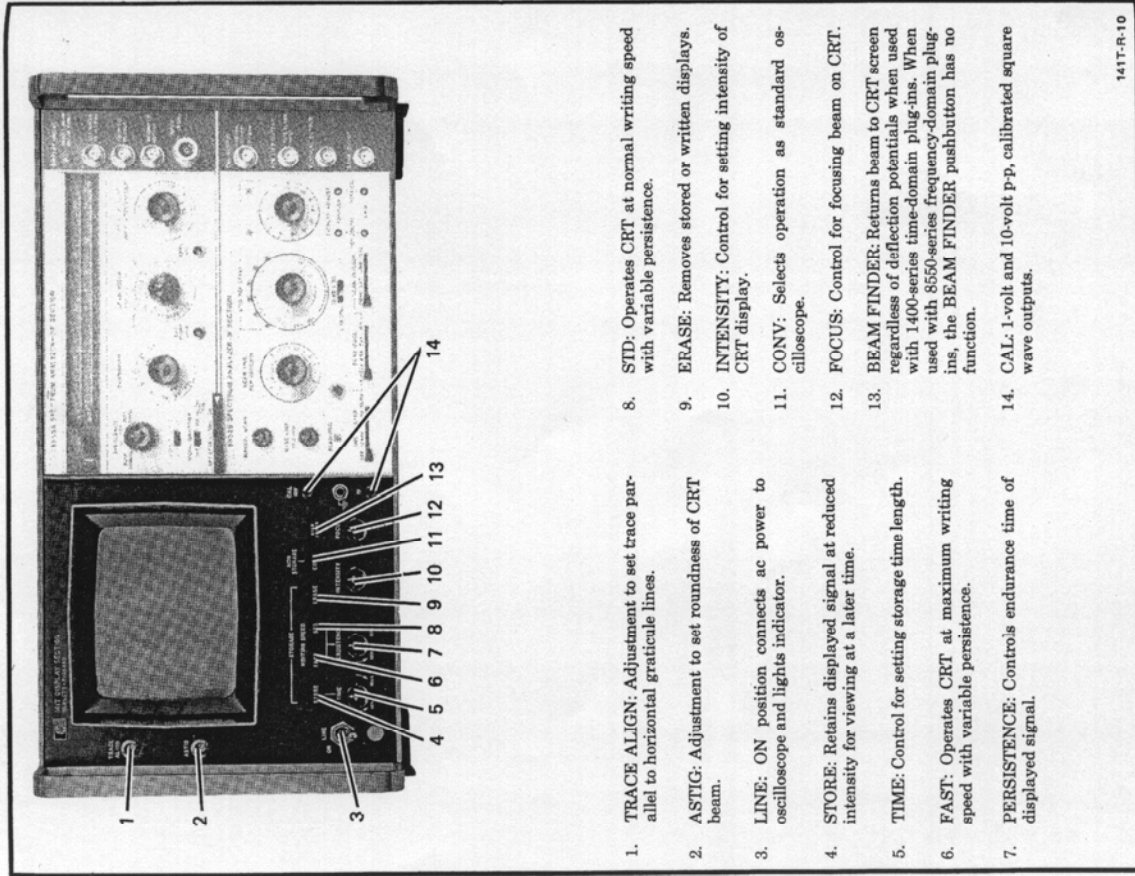

1. TRACE ALIGN: Adjustment to set trace parallel to horizontal graticule lines.
2. ASTIG: Adjustment to set roundness of CRT beam.
3. LINE: ON position connects ac power to oscilloscope and lights indicator.
4. STORE: Retains displayed signal at reduced intensity for viewing at a later time.
5. TIME: Control for setting storage time length.
6. FAST: Operates CRT at maximum writing speed with variable persistence.
7. PERSISTENCE: Controls endurance time of displayed signal.
8. STD: Operates CRT at normal writing speed with variable persistence.
9. ERASE: Removes stored or written displays.
10. INTENSITY: Control for setting intensity of CRT display.
11. CONV: Selects operation as standard oscilloscope.
12. FOCUS: Control for focusing beam on CRT.
13. BEAM FINDER: Returns beam to CRT screen regardless of deflection potentials when used with 1400-series time-domain plug-ins. When used with 8550-series frequency-domain plug-ins, the BEAM FINDER pushbutton has no function.
14. CAL: 1-volt and 10-volt p-p, calibrated square wave outputs.

Figure 3-1. Model 141T Controls and Connectors



3-31. These operating procedures will familiarize the operator with instrument controls and aid in obtaining desired CRT display.

visible after ERASE pushbutton has been released. It may be necessary to press and release ERASE pushbutton more than once to complete erasure of high intensity displays.

**3-22. CONTROL FUNCTIONS.**



Excessive intensity may damage the CRT storage mesh. The INTENSITY setting for any sweep speed should be less than that intensity which just eliminates any trace blooming with minimum PERSISTENCE setting.

**3-19. OPERATING CONSIDERATIONS.**

**3-20. DEFINITIONS.**

3-21. The definition of some words and phrases used in this manual may vary slightly from common usage. The definitions of these words and phrases are as follows:

- a. Write. To transform an input signal into a visible display on the CRT screen.
- b. Persistence. The length of time a single sweep-written display remains visible on the CRT screen (intensity and sweep time constant).
- c. Store. To retain, at reduced intensity, a display which has been written on the CRT.
- d. Erase. To remove all displays and blooms that have been stored or written with persistence on the CRT.
- e. Intensity. The brightness of a display as it is written on the CRT screen (persistence and sweep time constant).
- f. Bloom. A visible, non-symmetrical expansion of a display written on the CRT screen, figure 3-5.
- g. Fade positive. Appears as random green areas on a dark background in MAX PERSISTENCE mode, figure 3-7.
- h. Background illumination. A green cloud of illumination visible on the CRT screen, figure 3-3.
- i. Sweep time. The time (in seconds, milliseconds, or microseconds) required for the beam to move horizontally one unit of distance (division) across the CRT screen, when writing a display.
- j. Fade negative. A condition in which a portion of the trace or screen begins to dim.
- k. Burn. A burn is permanent damage to the CRT phosphor or mesh resulting from excessive intensity being maintained for too long a period. Phosphor burns appear as a discolored area on the CRT screen. Mesh burns appear as spots or traces that are darker than the background illumination in the MAX PERSISTENCE, FAST WRITING SPEED modes.

- a. To improve persistence uniformity in STD mode adjust A5R45, STD collimator adjust. This will reduce size of useable display area.
- b. For variable persistence operation, use minimum INTENSITY and maximum PERSISTENCE compatible with desired display (figure 3-4).
- c. Use WRITING SPEED in FAST mode only for fast sweep time, single-shot displays, or to improve uniformity of trace intensity. FAST WRITING SPEED mode causes more rapid positive fading on CRT and reduced persistence or storage time.
- d. To store a display, press STD pushbutton and adjust INTENSITY and PERSISTENCE for desired display and press STORE.

**3-30. OPERATING PROCEDURES.**

**NOTE**

After applying power, allow instrument 15 minutes warm up before attempting to make measurements.

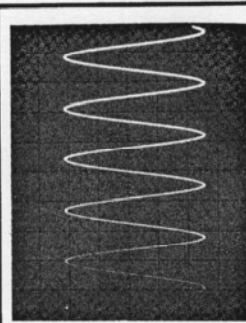

Figure 3-4. Variable persistence with a slow, repetitive sweep

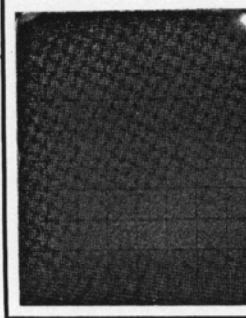

Figure 3-3. Background illumination immediately after erasing with WRITING SPEED in FAST and PERSISTENCE to MAX

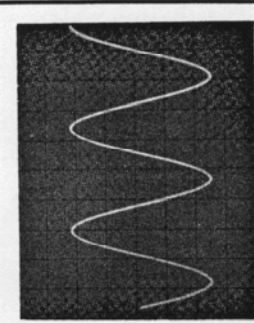

Figure 3-5. Single-shot display with INTENSITY and PERSISTENCE set to high and increased amplitude

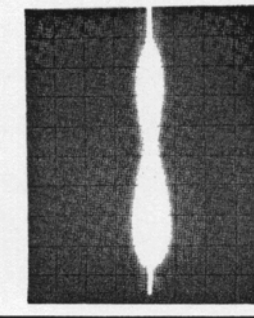

Figure 3-6. Single-shot trace bloom caused by INTENSITY and/or PERSISTENCE set too high

3-18. Slight differences in CRT sensitivities, may require readjusting the sensitivity calibration of plug-ins installed in the instrument for the first time, or when moved from one display section mainframe to another. Refer to the Operating and Service Manual of the plug-in for the required adjustment procedure.

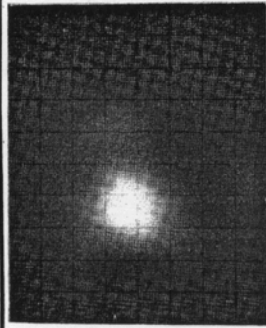

Figure 3-7. Fade positive after 2 to 4 minutes in STD mode.

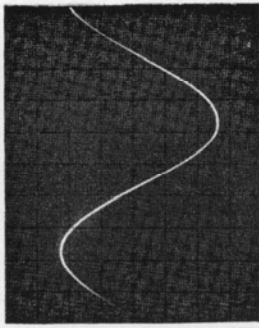

Figure 3-8. Same display as figure 3-7 after three minutes in STD mode

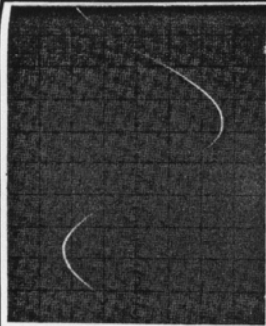

Figure 3-8. Single-shot 20 usec/div display

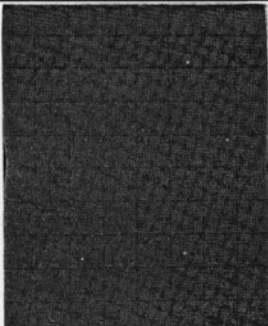

Figure 3-10. Small bright spots caused by minute imperfections in storage mesh

141T-R-13

e. To view a stored display, adjust TIME control until stored display has desired brightness.

f. To store more than one display, press STD pushbutton, set PERSISTENCE fully cw and INTENSITY as required; allow first display to be written on CRT. Set INTENSITY fully ccw, and connect second signal to be stored. Reset vertical POSITION if second display is not to be superimposed on first. Slowly rotate INTENSITY clockwise until second display appears. Press STORE pushbutton and both displays will be stored.

g. A display stored when instrument power is turned off will remain stored for several days. To observe a stored display, press STORE, set the verti-

cal position control ccw before turning on the instrument. Then adjust the TIME control until the stored display is visible.

h. To erase stored displays, press STD or FAST and rotate the PERSISTENCE control fully ccw, or press ERASE for approximately one second, then release. (First method is not effective when WRITING SPEED is set to FAST).

**3-32. SINGLE-SHOT OPERATION.**

3-33. To write with persistence or store a single-shot phenomena, trial setting of INTENSITY is the best approach. The amplitude of the phenomena and the sweep-time required to display it will affect the

persistence. For example, with maximum PERSISTENCE and some settings of INTENSITY, a single-shot straight-line trace may bloom as shown in figure 3-5, while a single-shot signal with amplitude variations of several divisions may not cause blooming (figure 3-6). To determine the best INTENSITY setting, connect a signal which approximates the sweep time and amplitude of the single-shot signal to be written. Set PERSISTENCE fully cw and trigger a single sweep of the test signal. Set the INTENSITY as far cw as possible without causing blooming. Repeat the single sweep signal, erasing the display and setting the INTENSITY after each trace until the desired display is obtained. This setup should give maximum persistence to the single-shot display. After the single-shot signal has been written, the display may be retained by pressing STORE and setting the TIME control to MAX.

3-34. Single-shot signals which require a beam speed faster than 50 microseconds per division can be

written with more brightness by setting the WRITING SPEED to FAST. The screen will be unevenly illuminated after erasing when WRITING SPEED is in FAST, however, the INTENSITY can be set high enough to make the display visible through the illumination. A display, written with WRITING SPEED set to FAST, will be obscured by positive fading more rapidly than a display written with WRITING SPEED set to STD.

3-35. Single-shot signals which require a beam speed between 20 and 200 microseconds per division may have low brightness at some location on the screen. Fire a single-shot test signal with INTENSITY and PERSISTENCE fully cw and WRITING SPEED in STD, and if the center brightness is low, wait for one to three minutes for the low-brightness area to become brighter. Likewise, if the entire display brightness appears below a usable level, or the display is not visible at all, wait for one to five minutes for the display to appear (figures 3-8 and 3-9).

### SECTION IV PRINCIPLES OF OPERATION

#### 4-1. INTRODUCTION.

This section contains functional descriptions related to an overall block diagram of the instrument, and circuit descriptions keyed to simplified block diagrams of circuit groups. The schematics are located in Section VIII.

#### 4-3. OVERALL FUNCTIONAL DESCRIPTION.

The Model 141T Display Section has five main circuits (figure 4-1): low-voltage power supply, high-voltage power supply, calibrator circuit, pulse circuit, and horizontal driver circuit. The horizontal and vertical amplifier circuits are in the plug-in units.

#### 4-5. LOW-VOLTAGE POWER SUPPLY.

The low-voltage power supply operates on 100, 120, 220- or 240-volts, single phase, 48-440 Hz. Output voltages are -12.6, -100, +100, and +248-volts. All outputs are fused and electronically regulated.

Voltages are distributed to the high-voltage power supply, calibrator, pulse circuits, and horizontal and vertical plug-ins. The low voltage transformer supplies 6.3 Vac to the main filament of the CRT and to the calibrator circuit.

#### 4-7. CALIBRATOR.

The 6.3 Vac is applied to the calibrator circuit where it is shaped into a square wave (of line frequency) and applied to two front-panel connectors, 1V and 10V pk-pk. The 1-volt output is also applied to the vertical and horizontal plug-ins for sensitivity calibration. Accuracy of the calibrating signals is ±1%.

#### 4-9. HIGH-VOLTAGE POWER SUPPLY.

A transistorized oscillator and a step-up transformer are used to generate negative and positive high voltages for the CRT. The negative 2350-volt supply is electronically regulated.

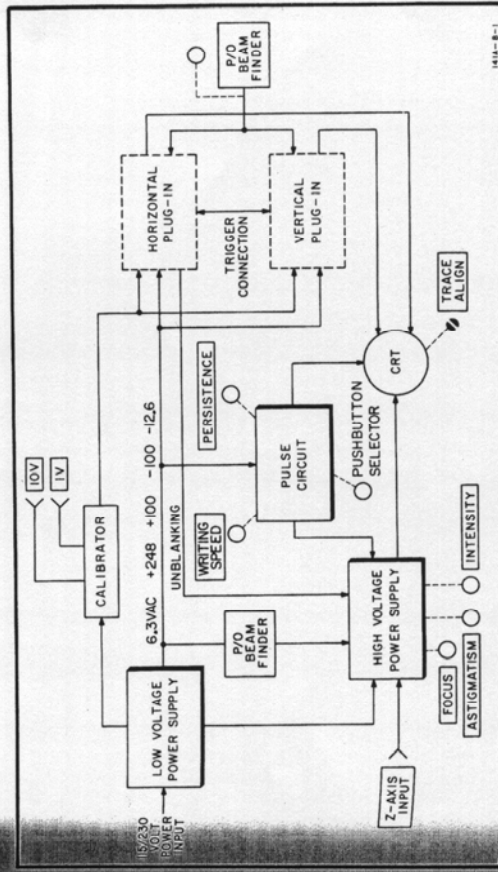

Figure 4-1. Model 141T Block Diagram

#### 4-11. PULSE CIRCUIT.

4-12. This circuit generates pulses of variable level and rate. These pulses and other dc voltages from the circuit are applied to the storage and persistence elements in the CRT. The low-voltage power supply provides all operating power for the pulse circuit.

#### 4-13. HORIZONTAL DRIVER CIRCUIT.

4-14. The horizontal driver is an impedance converter circuit. The output from the horizontal amplifier circuit in the plug-in unit is applied to the input of the horizontal driver circuit, which in turn drives the horizontal plates of the CRT.

#### 4-15. CIRCUIT DESCRIPTION.

##### 4-16. LOW-VOLTAGE POWER SUPPLY.

4-17. The low-voltage power supply consists of +100-volt supply, -100-volt supply, +248-volt supply and -12.6-volt supply. The +100-volt supply is independent and provides a reference voltage for the -100-volt supply. The +248-volt and -12.6-volt supplies are dependent on the -100-volt supply for reference voltages.

4-18. Figure 4-2 is a simplified block diagram of the regulator used in the low-voltage supply. The series regulator acts as a variable resistance in the regulated output. A sensor (or differential amplifier) compares the output voltage with a reference voltage. The driver (emitter follower or amplifier) controls the bias on the series regulator, which effectively controls the series resistance. Any change in output voltage is fed back to the series regulator. The change in series resistance and the resulting voltage drop is opposite to the output voltage change, maintaining the output voltage at a constant level.

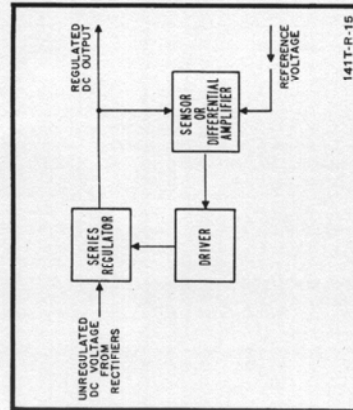

Figure 4-2. Regulated Power Supply Block Diagram

4-19. Figure 8-10 is a schematic diagram of the low voltage power supply. The primary winding is wired through a rear panel power module for conversion to 100-, 120-, 220-, or 240-Vac operation. Line voltage is applied to the primary of T1 through an on-off switch, a fuse and a thermal switch. Plot lamp DS1, lights when power is applied to T1. Two shunt resistors are connected to the -248-volt supply to reduce series regulator power dissipation when high-current plug-ins are used. Each shunt is wired to a rear panel connector. The internal wiring of the plug-in determines whether the shunt is in the circuit or not.

4-20. +100-Volt Supply. The ac voltage from the secondary of T1 is rectified by A1CR5-A1CR8 and partially filtered by C3 and A2R17. The resulting dc voltage is applied through the series regulator Q2, to the output. Differential amplifier A2Q4/A2Q5, compares the voltage across A2V1 with a sample of the output voltage. Any change in output voltage is applied to the base of driver A2Q3, which controls the bias on regulator Q2. Series regulator Q2, compensates for the change in output voltage by changing resistance and restores the output level to normal. The +100-volt output is adjusted by A2R11B and fuse A2F2 provides overload protection.

4-21. -100-Volt Supply. Reference voltage for the -100-volt supply is taken from the output of the +100-volt supply. The reference voltage across A2R31 is compared with a sample of -100-volt output across A2R35. The error voltage sensed by differential amplifier A2Q7/A2Q8 is applied through driver A2Q6, and series regulator Q3. The series regulator brings the -100-volt supply back into proper balance with respect to the +100-volt supply. Ac voltage from T1 is rectified by A1CR9-A1CR12, partially filtered by C4/C5/A2R27, and the resulting dc voltage is applied by the series regulator Q3, to the -100-volt output. Regulation is obtained as in the +100-volt supply. A2R11C adjusts the -100-volt output, and fuse A2F3 provides overload protection.

4-22. +248-Volt Supply. Sensor amplifier A2Q2, in the +248-volt supply senses any variation in the output voltage with respect to -100 volts. The error voltage is amplified by driver A2Q1, which applies corrective bias to series regulator Q1. A2R11A adjusts the +248-volt output and fuse A2F1 provides overload protection. A2CR4 provides temperature compensation for A2Q2, and is normally forward-biased.

4-23. -12.6-Volt Supply. Sensor amplifier A2Q11 senses any variation of output voltage with respect to -100 volts and applies the error voltage to driver amplifier A2Q9. The driver increases signal current to the level required to control series regulator Q4. The -12.6-volt output is adjusted by A2R47A. Current limiter A2Q10 is a protective circuit for the series regulator and is normally biased off. If an overload occurs across the -12.6-volt output, the base of

A2Q10 goes positive by the voltage drop across R11, minus the forward voltage drop across A2CR16, turning A2Q10 on. The collector of A2Q10 is applied through A2Q9 to the base of series regulator Q4, reducing the current flowing through Q4. The current flows through an external overload which limits the current required to keep A2Q10 on. Additional overload protection is provided by fuse, A12F4.

#### 4-24. CALIBRATOR.

4-25. The calibrator circuit (figure 8-10) consists of three parts: a tunnel diode (square wave generator), a transistor switch, and a calibration network.

4-26. Input to tunnel diode A2CR19, is applied through A2R50. The tunnel diode generates a square wave at line frequency. Transistor switch A2Q12, is off during the time of the positive half-cycle of the square wave (when the voltage at the base is close to zero), and the collector voltage is at a level set by breakdown diode A2VR6 and resistor A2R47B. When the negative-going portion of the square wave is applied to the base of A2Q12, the transistor increases conduction, effectively shorting the collector to ground. The output of the calibrator becomes zero. At the end of the negative input half-cycle (bias of A2Q12 returns to zero) the transistor is turned off, and the output returns to its previous value.

4-27. Tunnel diode bias current is supplied through A2R51. The bias current sets an operating level for the diode which affects the symmetry of the square wave output. Cal adj A2R47B, is used to set the dc

voltage at the collector of A2Q12 to -10 volts when the transistor is off. Breakdown diode A2VR6 reduces the output impedance, and provides the temperature compensation for the circuit. Voltage divider A2R54/A2R55, reduces the 10-volt output to 1 volt. Both 10- and 1-volt outputs are available at the front panel of the instrument, and the 1-volt output is available to both plug-ins.

#### 4-28. HIGH-VOLTAGE SUPPLY.

4-29. Figure 4-3 is a block diagram of the high-voltage power supply. The output of a regulated transistor oscillator is stepped-up in voltage and applied to a series of high voltage rectifiers. The positive output of the voltage tripler is connected to the post-accelerator of the CRT. The negative output voltages are used in the gun assembly of the CRT and its associated controls. The Z-axis input can be used to apply intensity modulating signals to the CRT.

4-30. Figure 8-13 is a schematic diagram of the high-voltage supply and the CRT. Oscillator A2Q12 operates at a frequency of approximately 30 kHz. Any change in the output voltage is applied to A2Q15, which converts the voltage change to a current change. This current change is applied, by emitter follower A2Q14, to the base of the oscillator transistor. The amplitude of oscillations is changed in such a direction as to oppose the original output voltage change. High-voltage adjust A2R63 sets the amplitude of oscillation to produce the correct output voltage.

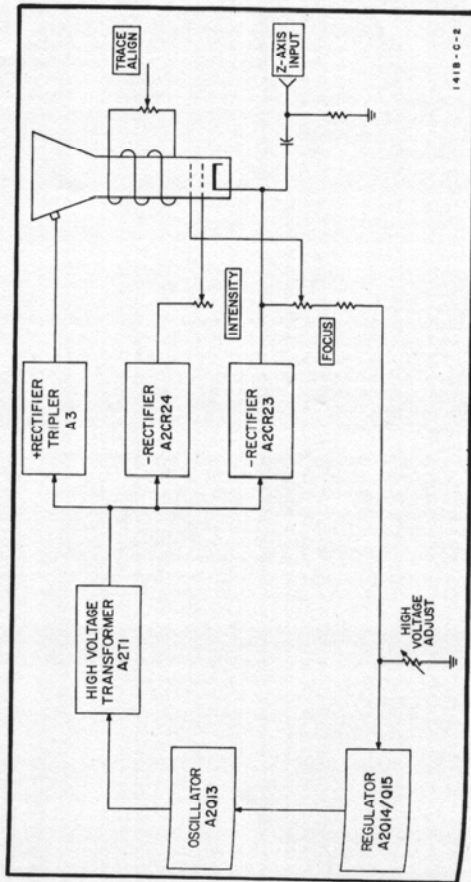

Figure 4-3. High-Voltage Power Supply Block Diagram

4-31. Two separate negative supplies are used, one for the control grid of the CRT, and one to provide the CRT cathode and focusing voltages. Both supplies use half-wave rectifiers (A2CR23 and A2CR24). The unblanking gate from the horizontal plug-in (pin 1, J2) is applied to the return side of the grid supply, and changes the negative grid voltage by about +50 volts to unblank the trace. A positive pulse of about 20 volts will blank the trace when applied to Z-axis input. When Z-axis input is not used, S4 is set to INT to receive chopped blanking from a dual-trace plug-in.

4-32. The voltage tripler circuit provides the 6.6 kV post-accelerating voltage applied to the CRT.

4-33. The ASTIG adjustment, R8, adjusts the roundness of the spot, and the geometry adjustment, A2-R72, is used to optimize pattern shape.

#### 4-34. STORAGE CRT.

4-35. Refer to figure 8-13 for the schematic diagram of the storage CRT, VI. The CRT contains the conventional electron (writing) gun, deflection plates, post-accelerator, and phosphor screen. In addition, there are two floodguns, a collimator, a collector mesh, and a storage mesh. These added elements make possible the variable persistence and storage functions of the instrument.

4-36. *Flood Guns.* Two flood guns are located on the electron gun, outside of the horizontal deflection plates. Horizontal drivers, A6Q1 and A6Q2, prevent flood gun electrons from flowing through the deflection plates to the output stage of the plug-in. The guns operate continuously when the power switch is ON. An electron cloud, that is emitted by the flood guns, is accelerated toward the CRT screen by collimator and collector mesh voltages. These electrons make stored or persisting display visible. They are also used to erase stored and persisting displays.

4-37. *Collimator.* The collimator is an internal coating along the tapered portion of the CRT. A positive voltage applied to the collimator focuses the flood-gun electrons. The flood-gun electrons are formed into a column perpendicular to, and approximately equal to the width of the CRT screen.

4-38. *Collector Mesh.* The collector mesh is between the flood guns and the storage mesh (closer to the storage mesh). It is always positive with respect to the storage mesh except in the ERASE mode of operation; both are then at the same potential. In addition to accelerating flood gun electrons, the collector mesh also repels positive ions generated by the flood guns.

4-39. *Storage Mesh.* The storage mesh is just behind the CRT screen and is coated with non-conducting material. It is statically held at a slightly positive potential (approximately +3 volts). When the

electron beam from the writing gun strikes the mesh coating, secondary electrons are emitted. This secondary emission creates a pattern of positive potential identical to the movement of the beam. Flood gun electrons are accelerated by this positive potential pattern and strike the phosphor screen, creating a visible display.

4-40. The storage mesh is pulsed with pulses of approximately 10 microseconds duration. These pulses charge the positive pattern on the storage mesh by discharging the mesh coating. Time required for this erasing operation is determined by the pulse repetition rate. The positive pattern on the mesh may also be neutralized manually by connecting the collector and storage meshes (erase). The high positive potential (approximately +156 volts) allows more uniform discharging of the surface. When the storage mesh is disconnected from the collector mesh and returned to +3 volts, the coated surface is at a uniformly equal potential of -9 volts. In both cases, the screen has no illumination. The pattern may be lost by the storage mesh fading positive and allowing the entire screen to be illuminated. This occurs when positive ions from the flood gun raise the surface potential of the storage mesh in random areas sufficiently to allow flood gun electrons to strike the screen.

#### 4-41. PULSE CIRCUIT.

4-42. Figure 4-4 is a simplified block diagram of the pulse circuit. The pulse circuit supplies pulses of variable repetition rate to control the operation of the CRT. The pulse timer generates a pulse which triggers the monostable multivibrator. The two outputs of the monostable multivibrator are applied to the flood gun driver and output pulser. The flood gun driver applies pulses to the accelerator of the CRT to control storage time of the display.

4-43. The output pulser applies a positive voltage to the storage mesh of the CRT. The erase timer provides a signal to the monostable multivibrator and output pulser to generate an erase pulse and also triggers the blanking circuit. The blanking circuit energizes a relay in the high voltage supply which applies a blanking voltage to the CRT. The CRT collimator voltage is supplied by a linear amplifier and is controlled by the selection of the writing speed at the front panel.

#### 4-44. STD AND FAST MODES.

4-45. *Pulse Timer.* Figure 8-16 is a schematic diagram of the pulse circuit. Setting the front panel PERSISTENCE control, R10, determines the amount of current available from the pulse timer current source, A5Q1. A5C1 charges to a potential which turns A5Q2 on. A5C1 discharges through A5Q2, A5-Q2 turns off, and A5C1 again begins to build a ramp voltage. The repetition rate of this action is controlled by the setting of the front panel PERSISTENCE con-

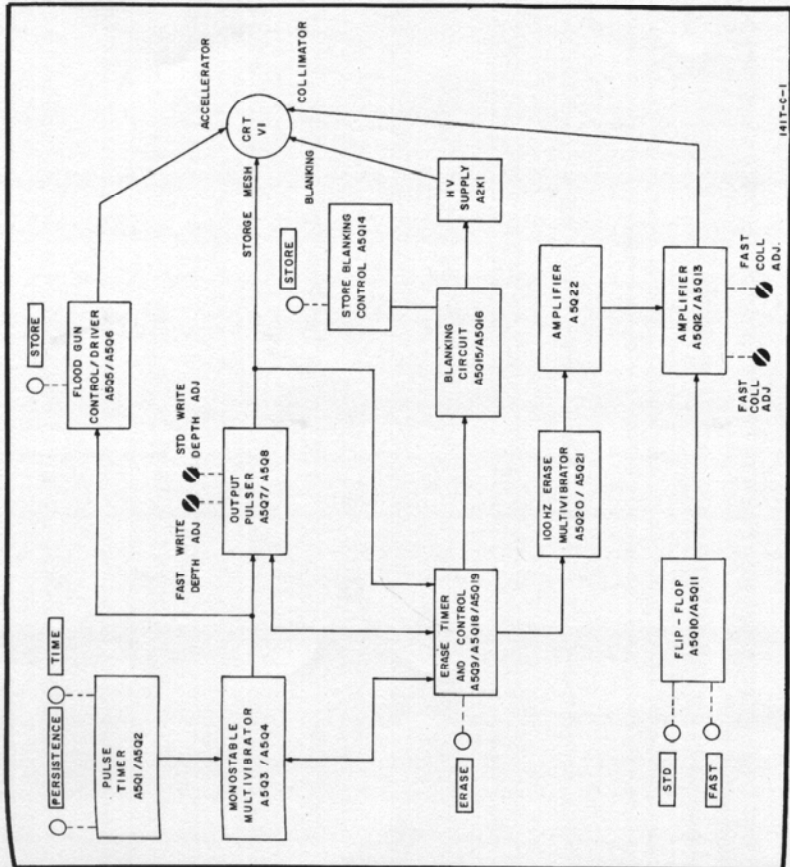

Figure 4-4. Pulse Circuit Block Diagram

4-46. *Monostable Multivibrator.* The multivibrator, A5Q3/A5Q4, operating in a monostable state, receives pulses from the pulse timer, and applies a negative-going pulse (approximately 10 usec wide) to A5CR3.

4-47. *Output Pulser.* The negative-going pulse from the monostable multivibrator allows A5CR7 to become forward biased with a current controlled by the setting of the fast write depth adjustment A5R14A, or the standard write depth adjustment A5R10A, depending on whether FAST or STD mode is being used. This current pulse is amplified and converted to a voltage pulse by A5Q7/A5Q8 and applied to the storage mesh backing electrode.

4-48. *Erase Timer.* The erase timer circuits are in a quiescent state during operation in either STD or FAST write modes. When erase timer A5Q9 is turned off, A5CR8 in the erase pulse shaping circuit is back biased. This effectively disconnects the erase timer circuit from the output pulser.

4-49. When operating in the STD mode, at the instant the ERASE pushbutton is pressed, figure 4-5 point A, the following actions take place simultaneously:

a. The collector mesh potential of +156 volts is applied to the junction of A5R27 and A5R28. This voltage causes A5CR14 to become reverse-biased, which protects A5Q7 and A5Q8.

b. The +156 volts applied to A5R27 turns A5Q9 on which charges A5C8 to 0 volts. This action turns on A5Q15/A5Q16 through A5R63 which blanks the CRT write gun by means of a relay closure on the high voltage power supply board.

c. Zero volts on A5R17 reduces the output of amplifier A5Q7/A5Q8 by approximately -12 volts. A5Q18 turns on, turning A5Q19 off. A5Q3 is turned on by current through A5R7 which allows amplifier A5Q7/A5Q8 to reach its full output amplitude, less the reduction in amplitude due to the current through A5R17. The result is approximately -4 volts. The erase multivibrator A5Q20/A5Q21 begins to free run at approximately 100 Hz. This signal is amplified through A5Q22 to drive A5Q12 and A5Q13 for an alternating collimation voltage to better erase the CRT.

d. The circuits remain in this state as long as the ERASE pushbutton is pressed.

4-50. When the ERASE pushbutton is released, the following circuit actions occur simultaneously:

- A5Q9 is turned off.
- The voltage on A5C8 begins to discharge from approximately 0 volt toward -12.6 volts.

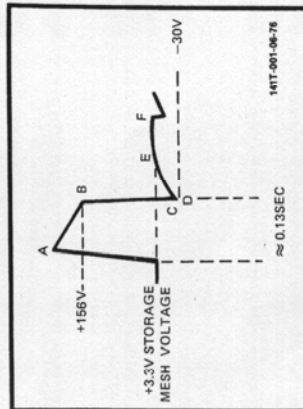

Figure 4-5. Erase Functional Waveform

c. The voltage change across A5R17/A5V1R1 causes the output of amplifier A5Q7/A5Q8 to increase from about -4 volts. The increase is in the form of a ramp to the output voltage determined by the standard write depth adjustment A5R10. When A5V1R1 is no longer conducting, the ramp stops.

d. A5Q3 is held in saturation by A5R7. This establishes the output voltage of amplifier A5Q7/A5Q8.

e. When A5C8 voltage decreases to -12.6 volts, A5Q3 turns off (figure 4-5 point F), and the output pulse returns to the quiescent voltage of approximately 3.3 volts. A5Q20 and A5Q21 stop running and the collimator voltage returns to the nominal value.

4-51. Operation of the ERASE pushbutton when in the FAST mode is as described in paragraphs 4-49 and 4-50 except that the storage mesh potential drops less after releasing the ERASE pushbutton and remains constant until A5C8 voltage decreases to -12.6 volts. This action results from the forward-biasing of A5CR29 which prevents current flow through A5CR8 and allows the output of A5Q7 and A5Q8 to go to its maximum level as determined by the fast write depth adjustment.

4-52. At this point, all pulse circuits have returned to the condition they were in prior to pressing the ERASE pushbutton, and pulses from the pulse timer may again be applied to the storage mesh backing electrode.

#### 4-53. PULSE CIRCUIT: STORE MODE.

4-54. *Flood Gun Control.* Pressing the STORE pushbutton removes +156 volts from A5R19 and A5R50. This turns off A5Q5 and pulses from the monoastable multivibrator are now coupled through A5C5 to the base of A5Q6. During the 10 usec that A5Q4 output goes positive, A5C5 is charged. When A5Q4 output goes negative, A5CR9 is back biased and A5Q6 turns off. The collector of A5Q6 goes positive until A5C5 is charged and turns A5Q6 back on. This pulse has a duration of approximately 60 usec. This pulse is applied to the flood gun accelerator, which turns the flood gun on for the pulse duration.

4-55. The repetition rate of these positive pulses at the collector of A5Q6 is now determined by the setting of the STORE TIME control, R9, which replaces the PERSISTENCE control when the STORE pushbutton is pressed.

4-56. The write gun is blanked by A5Q16 through the action of A5Q14 and A5Q15.

#### 4-57. PULSE CIRCUIT: CONVENTIONAL MODE.

4-58. When the CONV pushbutton is pressed, a +100-volt potential is removed from A5R25. A5CR15 is forward biased by -100 volts through A5R26, A5CR14, and R25. This voltage divider sets the storage mesh backing electrode to approximately 29 volts. A5CR13 is reverse-biased, preventing output pulser signals from passing through. This action produces conventional oscilloscope operation by disabling the variable persistence mode.

4-59. When the oscilloscope is turned off, a display stored on the CRT is protected from unintentional erasure by A5Q17 and the associated circuit.

#### 4-60. TRACE ALIGN.

4-61. The trace align coil L1, is located around the CRT near the screen. Adjustment of TRACE ALIGN R7A/B, changes the magnitude and direction of current through the coil and rotates the trace into alignment with the CRT graticule.

#### 4-62. PLUG-IN KIT FABRICATION.

4-63. The HP Model 10477A and Model 10487A Accessory Plug-ins are blank plug-in units for the instrument. These two units permit the user to design his own special-purpose circuits. Current available from

Table 4-1. Current Capability

Supply Voltage and J1/J2 pin number	Current Available at each Jack (J1 and J2)
+248 Vdc	9 0-50 ma
+248 Vdc	9 50-100 ma (pin 2 must be wired to pin 3 in the plug-in.)
+100 Vdc	2 0-137.5 ma
-100 Vdc	6 10-200 ma
-12.6 Vdc	21 0-0.9 amps
6.3 Vac	13-14 0-3.25 amps

each of the instrument power supplies is shown in table 4-1. Do not exceed the current capabilities in table 4-1.

**SECTION V**  
**PERFORMANCE CHECK AND ADJUSTMENTS**

**5-1. INTRODUCTION.**

5-2. This section contains step-by-step procedures for checking the instrument specifications as given in table 1-1 of this manual. A table (performance check record) is provided at the end of the performance check for recording the measurements obtained in the first running of the procedure. This record may be used to compare measurements taken at later dates with the original. The procedures for making all internal adjustments are covered in paragraphs 5-21 through 5-33. A photograph showing the locations of all internal adjustment controls is presented in figure 5-1.

**5-3. TEST EQUIPMENT.**

5-4. Test equipment required for procedures in this section is listed in table 5-1. Test equipment equivalent to that recommended may be substituted, provided it meets the required characteristics listed in the table. For best results, use recently calibrated test equipment. Use a non-metallic screwdriver when making adjustments.

**5-5. PERFORMANCE CHECK.**

5-6. The following subparagraphs describe procedures to determine whether or not the instrument is operating within the specifications of table 1-1. This check can be used as part of an incoming inspection, as a periodic operational test, or to check calibration after repairs or adjustments have been made. Any one of the following checks can be made separately if desired.

5-7. The first time the performance check is made, enter the results on the performance check record at the end of the procedure. Remove the record from the manual and file it for future reference. Be sure to include the instrument serial number on the record for identification.

**5-8. PRELIMINARY SETUP.**

- a. Install time base and vertical plug-ins.
- b. Adjust time base for a free-running 1 msec/div sweep.

Table 5-1. Recommended Test Equipment

Instrument		Characteristics Required	Required For
Type	Model		
Voltmeter Calibrator	HP 745A	Accuracy: 0.1% Output Voltages: 1V, 10V	Calibrator Performance Check Calibrator Adjustment
Digital Voltmeter	HP 3465A	Accuracy: 0.1% Voltage Range: $\pm 300V$ Input Impedance: 10.2M $\Omega$	Low Voltage Power Supply Adjustment High Voltage Power Supply Adjustment
Voltage Divider Probe	HP K05 3440A	Accuracy: 1% Division Ratio: 1000:1 Maximum Voltage: 4 KV	High Voltage Power Supply Adjustment
Oscillator	HP 204C	Waveform: Sine Wave Frequency: 80 Hz to 400 kHz	Geometry Adjustment Pulse Circuit Adjustment

Performance Check

- c. Set vertical plug-in input switch to off or ground.
- d. Set Model 141T controls as follows:

INTENSITY ..... MIN  
 PERSISTENCE ..... MIN  
 WRITING SPEED ..... STD

- e. Turn instrument on and allow a 15 minute warm-up period.

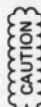

The INTENSITY control should never be set high enough to cause blooming. Excessive intensity can permanently damage the CRT storage mesh.

5-9. BEAM FINDER.

NOTE

The BEAM FINDER returns beam to CRT screen regardless of deflection potentials when used with the 1400-series time-domain plug-ins.

When used with the 8550-series frequency-domain plug-ins, the BEAM FINDER has no function.

- a. Perform preliminary setup (paragraph 5-8).
- b. Rotate vertical and horizontal position controls fully cw.
- c. Press and hold BEAM FINDER pushbutton while slowly rotating INTENSITY cw until a trace becomes visible.
- d. BEAM FINDER should return trace to CRT regardless of position of vertical or horizontal controls.
- e. Adjust vertical and horizontal position controls until trace is centered on CRT display.
- f. Release BEAM FINDER.

5-10. Paragraphs 5-11 through 5-14 contain preliminary operational checks of performance characteristics not listed in table 1-1. Because these characteristics are not specified, stated results are approximate.

5-11. FOCUS AND ASTIG.

5-12. FOCUS and ASTIG controls should give a sharply defined trace when set to approximately mid-range positions. Adjust for sharpest trace possible and leave in that position.

Model 141T

5-13. TRACE ALIGN.

- a. Perform preliminary setup (paragraph 5-8).
- b. Adjust TRACE ALIGN until trace is parallel to center graticule line. This condition should occur near center of adjustment range.

5-14. CALIBRATOR.

- a. Perform preliminary setup (paragraph 5-8).
- b. Connect voltmeter calibrator to vertical input.
- c. Set voltmeter calibrator for output of 1V pp.
- d. Set vertical amplifier sensitivity to .1 V/div.
- e. Adjust vertical vernier to display exactly 8 divisions of vertical deflection.
- f. Disconnect voltmeter calibrator.
- g. Connect Model 141T CAL 1V output to vertical input.
- h. Observe deflection of  $8 \pm 0.1$  division.
- i. Repeat steps a through g, using 10 volts from the voltmeter calibrator, 1 V/div vertical sensitivity, and CAL 10V.

5-15. VARIABLE PERSISTENCE.

- a. Perform preliminary setup (paragraph 5-8).
- b. Adjust INTENSITY for normal viewing level.
- c. Set time base to 2 sec/div and observe that trace line disappears and that spot develops a short tail.
- d. Slowly adjust PERSISTENCE cw and note that tail lengthens.
- e. Rotate PERSISTENCE fully cw and turn INTENSITY fully ccw.
- f. Observe that trace remains visible for one minute.

5-16. WRITING SPEED, FAST.

- a. Perform preliminary setup (paragraph 5-8).
- b. Set PERSISTENCE to MAX.
- c. Set time base for 1  $\mu$ sec/div sweep.
- d. Set time base for single sweep.

Model 141T

- e. Press FAST pushbutton and press ERASE. Observe that background appears foggy.
- f. Repeatedly erase and trigger a single sweep, increasing INTENSITY slightly each time, until trace writes and remains visible for 15 seconds.

5-17. STORE TIME, FAST.

- a. Perform preliminary setup (paragraph 5-8).
- b. Rotate STORE TIME to MAX.
- c. Press ERASE.
- d. Trigger a single sweep and immediately press STORE.
- e. After 15 minutes rotate STORE TIME to MIN. Trace should still be visible.

5-18. WRITING SPEED, STANDARD.

- a. Perform preliminary setup (paragraph 5-8).
- b. Press STD.
- c. Set time base for 50  $\mu$ sec/div sweep.
- d. Repeatedly erase and trigger a single sweep, increasing INTENSITY slightly each time, until trace writes and remains visible for one minute.

5-19. STORE TIME, STANDARD.

- a. Perform preliminary setup (paragraph 5-8).
- b. Rotate STORE TIME to MAX.
- c. Press ERASE.
- d. Trigger a single sweep and immediately press STORE.
- e. After 2 hours, rotate STORE TIME to MIN. Observe that trace is still visible.

5-20. This completes the Performance Check. If the instrument does not meet specifications, the adjustment procedure which follows should be done. If this does not result in satisfactory performance, refer to Section VIII for maintenance and troubleshooting information.

5-21. ADJUSTMENTS.

5-22. The following paragraphs describe procedures to calibrate the instrument so that it will perform as specified in table 1-1. The entire adjustment procedure can be done in sequence, or any separate adjustment can be calibrated by following the steps out-

Adjustments

lined in the appropriate paragraph. The locations of adjustment controls are shown in figure 5-1, a photograph included at the end of the section on a foldout page.

5-23. Use a nonmetallic screwdriver and recently calibrated test equipment with characteristics as specified in table 5-1. After adjustments are complete, check instrument performance by doing the performance check procedure at the beginning of this section. If difficulty is encountered in making any adjustment, refer to Section VIII for troubleshooting procedures.

5-24. PRELIMINARY SETUP.

- a. Install plug-ins in both compartments. Proper power supply regulation may not occur without load connected.
- b. Remove top, bottom, left side and high voltage deck covers. All internal adjustments are identified in figure 5-1.

WARNING

Voltages present in the power supplies are dangerous.

- c. Rotate INTENSITY, PERSISTENCE, and STORE TIME fully ccw.

- d. Turn instrument on and allow 15 minutes warm-up period.

5-25. LOW VOLTAGE POWER SUPPLY ADJUSTMENT.

- a. Perform preliminary setup (paragraph 5-24).
- b. Adjust low voltage regulators as indicated in table 5-2.

NOTE

Because +100-volt supply is a reference for the other mainframe supplies it must be set first. Voltage may be measured on any terminal with wire color shown in table 5-2.

- c. Recheck all supplies before proceeding. The +100V supply must be set as near to +100V as possible.

5-26. HIGH VOLTAGE POWER SUPPLY ADJUSTMENT.

- a. Perform preliminary setup (paragraph 5-24).
- b. Monitor +100 Vdc supply with digital voltmeter using voltage divider probe. Note exact reading.



Table 5-2. Low Voltage Power Supply Adjustment

SUPPLY	ADJUST	LIMIT	MEASURE POINT WIRE COLOR
+100V	A2R11B	±1V	WHITE/RED
-100V	A2R11C	+1V	VIOLET
+245V	A2R11A	±2.5V	RED
-12.6V	A2R47A	±0.13V	WHITE/VIOLET

- c. Multiply value obtained in step b by 23.50.
- d. While monitoring high voltage, —2350V MON-ITOR POINT (4), set HV adj A2R65, to obtain a voltage reading equal to result obtained in step c (—2350 ±25V).

e. This procedure will set high voltage within 1%, provided +100V supply is set to indicate exactly +100V on digital voltmeter.

### 5-27. INTENSITY LIMIT ADJUST.

#### NOTE

Method A must be used for Model 141T's with 1400-Series vertical and time-base plug-ins. Method B must be used for Model 141T's with spectrum analyzer plug-ins.

#### Method A.

- Turn power off.
- Remove 1400-Series plug-ins.
- Short pins 1 and 2 of upper compartment connector, J2, together.

#### WARNING

Voltages present in the high voltage supply are dangerous.

- Turn power ON.
- Set intensity limit A2R65 fully ccw.
- Set INTENSITY to 11 o'clock position.
- Press STD pushbutton.
- Slowly adjust A2R65 cw until a spot is just visible.
- Turn INTENSITY fully ccw.

- Turn power off.
- Remove short from upper compartment connector J2.

- Replace plug-ins.

#### Method B.

- Turn power off.
- Install spectrum analyzer plug-ins.
- Set plug-ins for 0.5 ms SCAN mode and AUTO trigger.
- Turn power ON.

- Turn intensity limit A2R65 full ccw, extinguishing trace.
- Set INTENSITY to 11 o'clock position.
- Press STD pushbutton.
- Set PERSISTENCE to MIN.

- Turn A2R65 slowly cw until crest of trace is bright with rest of trace barely visible as shown in figure 5-1A.

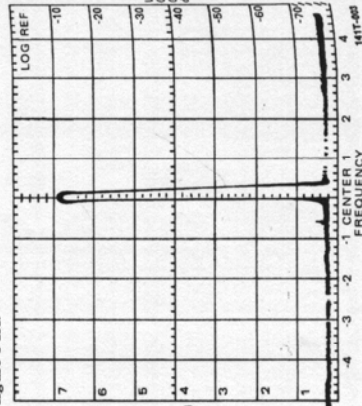

Figure 5-1A. Spectrum Analyzer Intensity Limit Adjust

### 5-28. GEOMETRY.

- Perform preliminary setup (paragraph 5-24).
- Set controls as follows:
 

trigger level.....	auto
trigger source.....	int (+)
sweep time.....	0.5 msec/div
WRITING SPEED.....	STD
PERSISTENCE.....	MIN

- Slowly adjust INTENSITY for normal viewing level.

- Press ERASE.

- Press CONV.

- Adjust TRACE ALIGN and vertical position controls so that trace is parallel to center graticule line.

- Connect 400-kHz oscillator output to vertical amplifier input.

- Adjust vertical deflection factor to obtain slightly under 8 divisions of vertical deflection.

#### CAUTION

If it is necessary to increase intensity, do so only in STD mode. There is no indication of excessive beam intensity while in the CONV mode and CRT mesh can be burnt.

- Adjust geometry A2R72 for best compromise between distortion of vertical and horizontal edges of display. Vertical and horizontal controls may be adjusted to permit viewing of edges.

- Set INTENSITY fully ccw.

- Disconnect oscillator.

### 5-29. CALIBRATOR ADJUSTMENT.

- Perform preliminary setup (paragraph 5-24).

- Press STD.

- Connect 10V p-p output of voltmeter calibrator to vertical amplifier input.

- Set vertical amplifier deflection sensitivity to 1 V/div.

- Slowly increase INTENSITY to normal viewing level.

- Adjust vertical amplifier vernier to display exactly 8 divisions of vertical deflection.

- Disconnect voltmeter calibrator.

- Connect Model 141T 10V CAL output to vertical amplifier input.

- Set cal adj A2R47B to obtain exactly 8 divisions of vertical deflection.

### 5-30. PULSE CIRCUIT ADJUSTMENTS.

#### 5-31. FAST MODE ADJUSTMENTS.

- Perform preliminary setup (paragraph 5-24).

- Press FAST pushbutton.

- Turn INTENSITY and PERSISTENCE fully ccw.

- Set time base for single sweep so that sweep will not occur during this portion of procedure.

- Set fast write depth adj A5R14A fully ccw.

- Set fast coll adj A5R14B so that entire flood gun illumination pattern is visible.

- Adjust flood gun grid adj A5R14C to obtain most uniform CRT illumination. The normal flood gun grid adjustment is at or near 0 volt (A5R14C fully cw).

- Adjust fast coll adj A5R14B so that flood gun illumination just fills graticule.

- Set PERSISTENCE to MAX.

- Press ERASE.

- Adjust fast write depth adj A5R14A slowly cw in small increments, erasing after each step, until a good compromise between no light and saturated brightness is obtained on CRT after ERASE button is pressed.

- Adjust fast coll adj A5R14B in small increments. Erase and readjust fast write depth adj A5R14A (step k) between increments until uniform fogging is obtained.

- Set controls as follows:
 

sweep time.....	0.2 msec/div
INTENSITY.....	normal (recurrent)
PERSISTENCE.....	fully cw
MIN	MIN

- Connect 4 kHz oscillator sine-wave output to vertical amplifier input.

- o. Adjust vertical gain to obtain 8 divisions of vertical deflection.
- p. Adjust INTENSITY for normal viewing level.
- q. Increase vertical gain by a factor of 10. Do not adjust INTENSITY.
- r. Set time base for single sweep operation.
- s. Set PERSISTENCE to MAX.

t. Increase INTENSITY gradually while erasing CRT until beam writes evenly, but not to point where beam is always on.

u. Press ERASE pushbutton until no trace remains.

v. Erase, and immediately arm and trigger a single sweep. The resulting waveform should be visible inside a 6 x 8 division rectangle for 15 seconds. If not, rotate fast write depth adj A5R14A clockwise until it is. If CRT still will not hold trace for 15 seconds, return to step g and reduce the illuminated area to no less than a centered 7.6 x 9.5 division rectangle.

#### NOTE

The 7.6 x 9.5 division rectangle is the minimum rectangle size allowable for this adjustment.

w. Rotate fast write depth adj A5R14A ccw in small increments. Leave A5R14A at point farthest ccw that permits trace to remain visible for 15 seconds.

#### 5-32. STD. MODE ADJUSTMENTS.

- a. Perform preliminary setup (paragraph 5-24).
- b. Set INTENSITY fully ccw.
- c. Set PERSISTENCE to MIN.
- d. Set std write depth adj A5R10A fully ccw.
- e. Press STD pushbutton.
- f. Set time base to single sweep to prevent beam from sweeping.

- g. Press ERASE for one second and release.
- h. Turn std coll adj A5R10 fully ccw and then slowly cw until CRT face is uniformly illuminated to within 1 mm of aluminumized CRT ring around perimeter of CRT. Collimator dimples may protrude up to 3 mm out from aluminumized CRT ring but in no case may come into CRT gratiule or nomenclature.
- i. Set time base for sweep of 10 msec/div.
- j. Set time base for recurrent sweep.
- k. Connect 80-Hz oscillator sine-wave output to vertical amplifier input.
- l. Adjust vertical gain to obtain 8 divisions of vertical deflection.
- m. Adjust INTENSITY for normal viewing level.
- n. Increase vertical gain by factor of 10. Do not adjust INTENSITY.
- o. Set time base for single sweep operation.
- p. Set PERSISTENCE to MAX.

q. Increase INTENSITY gradually while erasing CRT until beam writes evenly, but not to the point where beam is always on.

r. Press ERASE. If CRT does not erase completely, rotate std write depth adj A5R10A, cw in 10° increments, pressing ERASE pushbutton each time. Repeat until CRT erases completely.

s. If CRT will not erase completely, adjust flood gun grid adj A5R14C slightly. Then recheck the FAST MODE and STD MODE adjustments. Repeat adjustments of A5R14C, FAST MODE, and STD MODE until CRT will erase properly.

t. Press ERASE. Immediately arm and trigger a single sweep. The waveform should be visible inside a 7 x 9 division rectangle for 60 seconds without positive fade (screen turning bright green). If trace is not continuous, adjust std write depth adj A5R10A cw in small increments until continuous trace is obtained.

5-33. This completes adjustment procedures. If satisfactory operation cannot be obtained, refer to Section VIII for troubleshooting information.

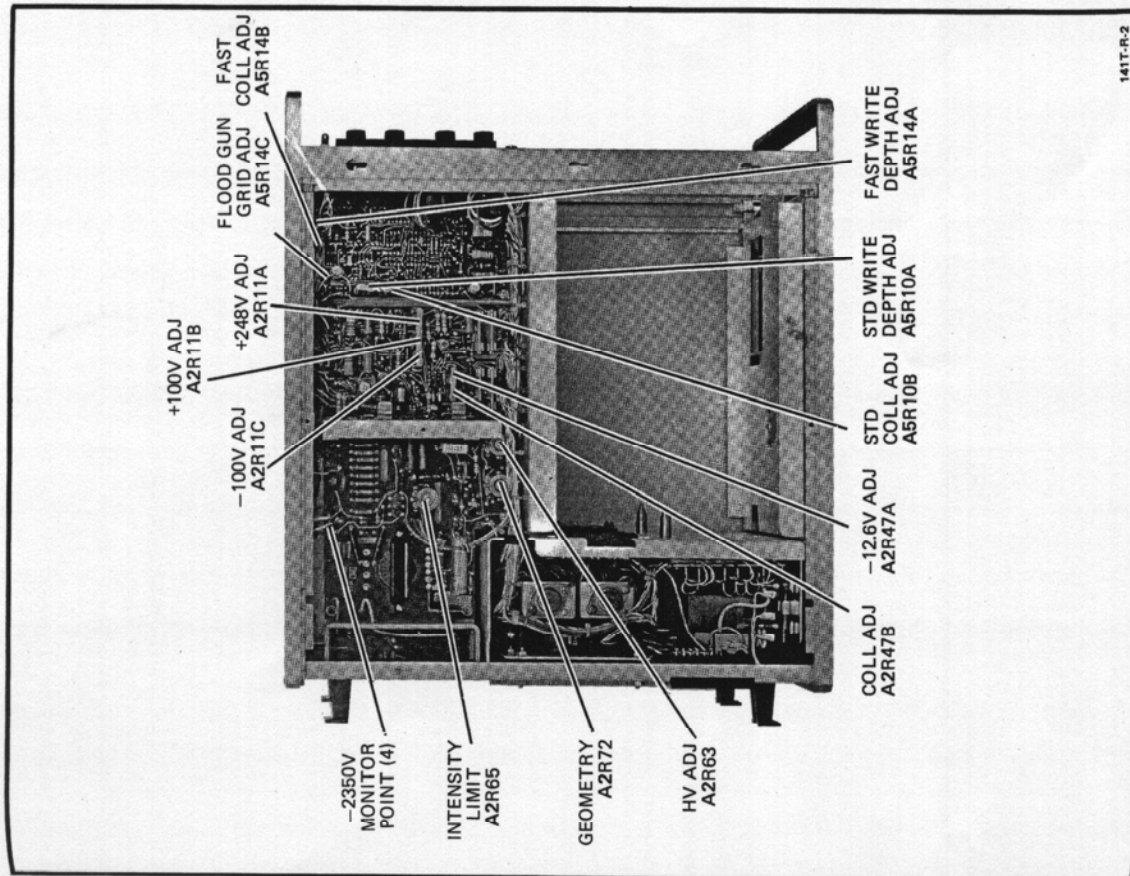

Figure 5-1. Adjustment Location

Table 6-2. Replaceable Parts (Cont'd)

Table with 5 columns: Reference Designation, HP Part Number, Qty, Description, Mfr Code, Mfr Part Number. Contains parts like PANEL EXTRUDED, DECK VERTICAL, BRACKET MAIN, BRACKET DIODE, etc.

Table 6-2. Replaceable Parts

Table with 5 columns: Reference Designation, HP Part Number, Qty, Description, Mfr Code, Mfr Part Number. Contains parts like DIODE SUPPLY ASSY, PULSE CIRCUIT BOARD ASSY, HORIZONTAL DRIVER ASSY, etc.

See introduction to this section for ordering information

See introduction to this section for ordering information

Table 6-2. Replaceable Parts (Cont'd)

Table with 5 columns: Reference Designation, HP Part Number, Qty, Description, Mfr Part Number. Lists various electronic components like capacitors, resistors, and fuses.

See Introduction to this section for ordering information

Table 6-2. Replaceable Parts (Cont'd)

Table with 5 columns: Reference Designation, HP Part Number, Qty, Description, Mfr Part Number. Continues the list of components from the previous table, including transformer top, heat sink, and various capacitors.

See Introduction to this section for ordering information



Table 6.2. Replaceable Parts (Cont'd)

Reference Designation	HP Part Number	Qty	Description	Mfr Code	Mfr Part Number
A5937	0044-1001	7	R-FXDP COMP 1REGDHH 1E 1/W	01121	CB 1051
A5938	0044-4721		R-FXDP COMP 4700 OHM 10E 1/W	01211	CB 4721
A5941	0757-0480		R-FXDP FLK 432K OHM 1E 1/BW	28480	0757-0480
A5944	0757-0440		R-FXDP FLK 432K OHM 1E 1/BW	28460	0757-0440
A5946	0757-0791	1	R-FXDP FLK 432K OHM 1.0E 1/W	28480	0757-0791
A5947	0757-0476	1	R-FXDP MET FLK 201K OHM 1E 1/W	28480	0757-0476
A5948	0757-0083	1	R-FXDP MET DX 68K OHM 5E 1W	28480	0757-0083
A5949	0044-4721		R-FXDP COMP 4700 OHM 10E 1/W	01121	CB 4721
A5950	0044-4721		R-FXDP COMP 4700 OHM 10E 1/W	01121	CB 4721
A5951	0044-1001	5	R-FXDP COMP 1REGDHH 1E 1/W	01121	CB 1051
A5952	0044-1001		R-FXDP COMP 100K OHM 10E 1/W	01121	CB 1051
A5954	0044-1001	1	R-FXDP COMP 10 REGDH 10E 1/W	01121	CB 1051
A5956	0044-1001	1	R-FXDP COMP 100K OHM 10E 1/W	01121	CB 1051
A5957	0044-2231	1	R-FXDP COMP 820 OHM 10E 1/W	01121	CB 2231
A5958	0044-1001		R-FXDP COMP 1REGDHH 1E 1/W	01121	CB 1051
A5960	0044-1811	1	R-FXDP COMP 180 OHM 10E 1/W	01121	CB 1811
A5961	0048-2647	1	R-FXDP MET DX 15K OHM 5E 2W	28480	0498-2647
A5962	0044-1001		R-FXDP COMP 100K OHM 10E 1/W	01121	CB 1051
A5963	0044-1001		R-FXDP COMP 100K OHM 10E 1/W	01121	CB 1051
A5965	0044-1001		R-FXDP COMP 22K OHM 10E 1/W	01121	CB 2231
A5966	0044-2231		R-FXDP COMP 22K OHM 10E 1/W	01121	CB 2231
A5967	0044-4721		R-FXDP COMP 4700 OHM 10E 1/W	01121	CB 4721
A5968	0044-6931	2	R-FXDP COMP 68K OHM 10E 1/W	01121	CB 6931
A5969	0044-4721		R-FXDP COMP 4700 OHM 10E 1/W	01121	CB 4721
A5970	0044-4721	2	R-FXDP COMP 4700 OHM 10E 1/W	01121	CB 4721
A5971	0044-6931		R-FXDP COMP 68K OHM 10E 1/W	01121	CB 6931
A5972	0044-4721		R-FXDP COMP 4700 OHM 10E 1/W	01121	CB 4721
A5973	0044-3321		R-FXDP COMP 3300 OHM 10E 1/W	01121	CB 3321
A5974	0044-2231		R-FXDP COMP 22K OHM 10E 1/W	01121	CB 2231
A5975	0044-1055	1	R-FXDP COMP 105K OHM 10E 1/W	01121	CB 1055
A5976	0043-1555		R-FXDP COMP 1.5 REGDH 15K 1/W	01121	CB 1555
A5977	0044-1001		R-FXDP COMP 100K OHM 10E 1/W	01121	CB 1051
A5978	0044-1001		R-FXDP COMP 100K OHM 10E 1/W	01121	CB 1051
A5981	0663-5635	1	R-FXDP 56K OHM 5W 1/W	01211	CB 5635
A5982	3102-7059	1	DIODE BRIDG 1N4001 100V 1W	28480	S1027059
A5983	1802-0987	1	DIODE BRIDG 1N4001 100V 1W	28480	1802-0987
A6	00141-64502	1	HORIZONTAL DRIVER ASSY	28480	00141-64502
A6C1	0150-0092		C-FXDP CER 0.05 UF 20E 400VCK	56289	33C17A
A6C2	0150-0092		C-FXDP CER 0.05 UF 20E 400VCK	56289	33C17A
A6L1	8110-0029	2	COIL MAG SHIELDING BEAD	02114	8110-0029
A6L2	1183-0038	2	TESTER PMP	28480	1183-0038
A6R1	0757-0401		R-FXDP MET FLM 100 OHM 1% 1/W	28480	0757-0401
A6R2	0757-0401		R-FXDP MET FLM 100 OHM 1% 1/W	28480	0757-0401
A6R3	0757-0850		R-FXDP MET FLM 39.2K OHM 1.0% 1/2W	28480	0757-0850
A6R4	0757-0850		R-FXDP MET FLM 39.2K OHM 1.0% 1/2W	28480	0757-0850
A6R5	0757-0401		R-FXDP MET FLM 100 OHM 1% 1/W	28480	0757-0401
A7	0090-0443	1	ASSY POWER MIDDLE	28480	0090-0443
A7E1	5020-8122	1	LINE VOLTAGE SELECTION CARD	28480	5020-8122
A7F1	2110-0014	1	FUSE CARTRIDGE LAMP 250V SLOW BLOW	76915	3130004
A7F1	2110-0003	1	FUSE CARTRIDGE LAMP 250V SLOW BLOW (220V OR 240V OPERATION ONLY)	71400	MDX-24

See Introduction to this section for ordering information

Table 6-3. List of Manufacturers' Codes

MFR NO.	MANUFACTURER NAME	ADDRESS	ZIP CODE
00000	U.S.A. COMMON	ANY SUPPLIER OF U.S.A.	
01121	ALLEN BRADLEY CO.	MILWAUKEE, WIS.	53204
03508	G.E. CO, SEMICONDUCTOR COMPONENTS DIV.	SYRACUSE, N.Y.	13201
04213	ROTUNDA SEMICONDUCTOR PROD. INC.	PHOENIX, ARIZ.	85008
07263	FAIRCHILD CAMERA & INST. CO. - SEMICONDUCTOR DIV.	PHOENIX, ARIZ.	19801
08718	NO M/F DESCRIPTION FOR THIS MFR NUMBER	MOUNTAIN VIEW, CALIF.	94040
24545	GREEN MANUFACTURER CO.	NEWARK, N.J.	07106
27091	CUTLER-HAMMER INC. - POWER DIST. & CONTROL DIV.	MILWAUKEE, WIS.	53216
28480	HEWLETT-PACKARD CO., CORPORATE HQ	YOUR NEAREST HP OFFICE	
58474	RUSSMANN REG. DIV. MC GRAM-EDISON CO.	BRISTOL, CONN.	06010
71400	GLOBAL UNION INC. CENTRAL LAB DIV.	ST. LOUIS, MO.	63017
71900	GLOBAL UNION INC. CENTRAL LAB DIV.	US. AMBULELE, CALIF.	90031
71707	CORD COIL CO. INC.	PROVIDENCE, R.I.	02905
71795	CHICAGO MINIATURE LAMP WORKS	CHICAGO, ILL.	60640
72825	ERY HIGH T.M. INC.	PHILADELPHIA, PA.	19144
72922	ERIE TECHNOLOGICAL PROD. INC.	ERIE, PA.	16512
75515	LETTER-FUSE INC.	DES PALMINEZ, ILL.	60439
76530	CINCH MONRODICK MILLS DIV. TRW INC.	CITY OF INDUSTRY, CALIF.	91746
80131	ELECTRONIC INDUSTRIES ASSOCIATION	WASHINGTON, D.C.	20039
82142	AT&T SPEER ELECT. COMP.	DU BOIS, PA.	15801
83380	SMTCHICKEN INC.	CHICAGO, ILL.	60630
91418	RADIO MATERIALS CO.	CHICAGO, ILL.	60604
91598	AURUM OPTICS COMP.	ATLANTIC, MASS.	02708
92500	INDUSTRIAL RETAINING RING CO.	BLOOMFIELD, N.J.	07009
92548	GORDON COMP.	BLOOMFIELD, N.J.	07009
97464	INDUSTRIAL RETAINING RING CO.	IRVINGTON, N.J.	07111

See Introduction to this section for ordering information

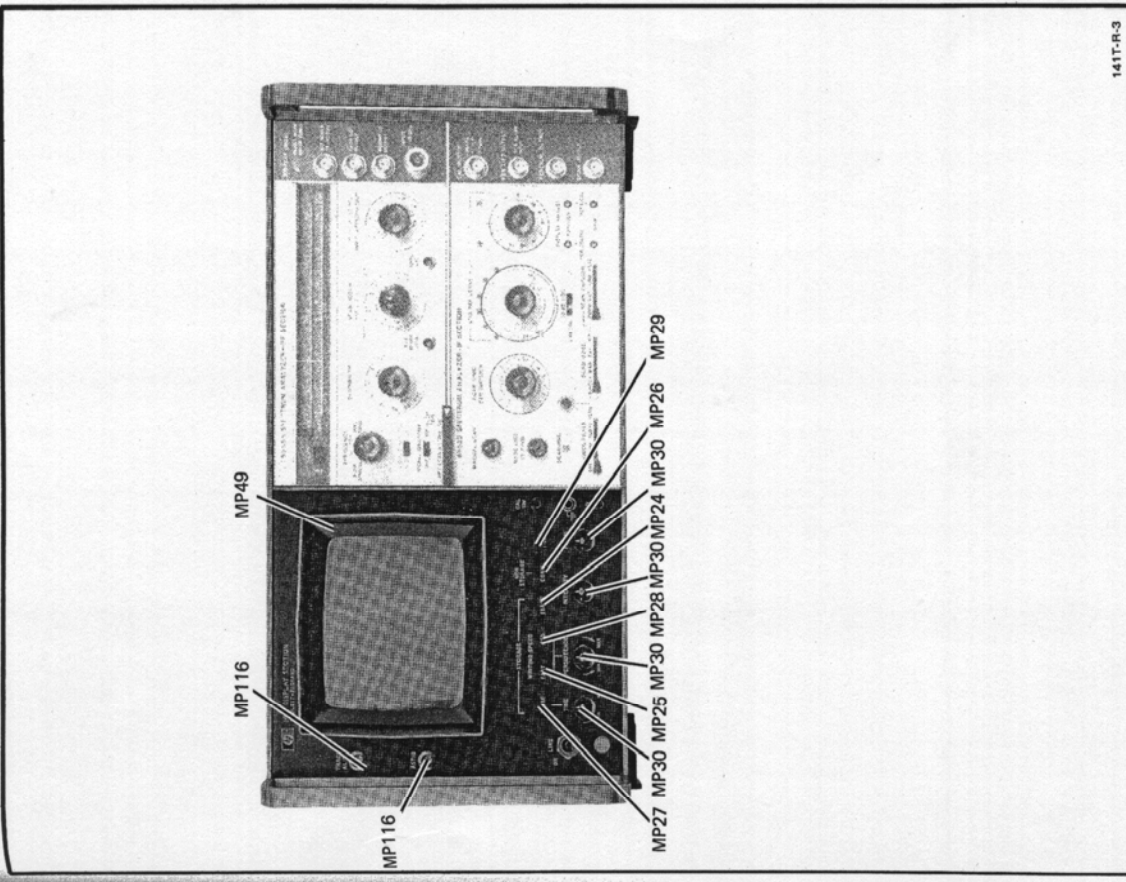

141T-R-3

Figure 6-2. Mechanical Parts, Front View

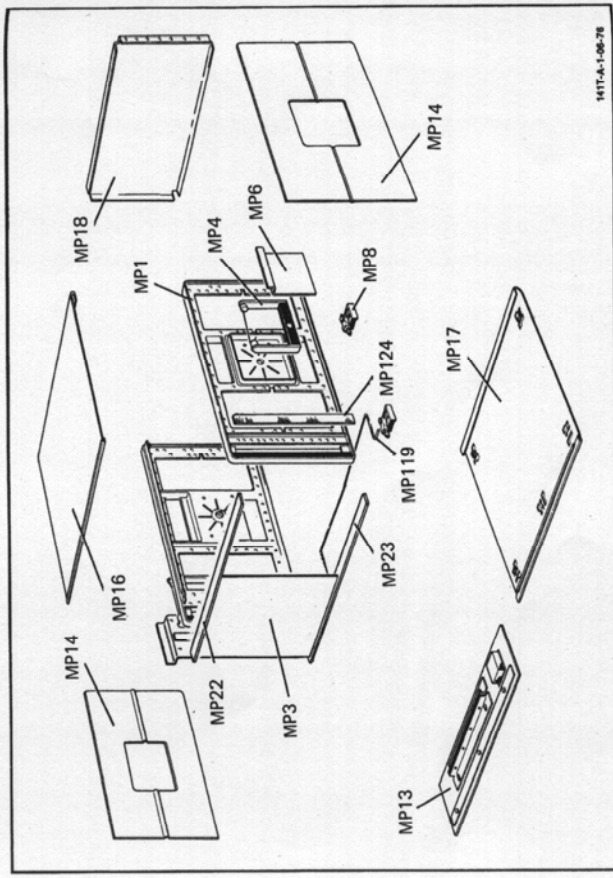

141T-A-1-06-76

Figure 6-1. Cabinet Parts, Exploded View

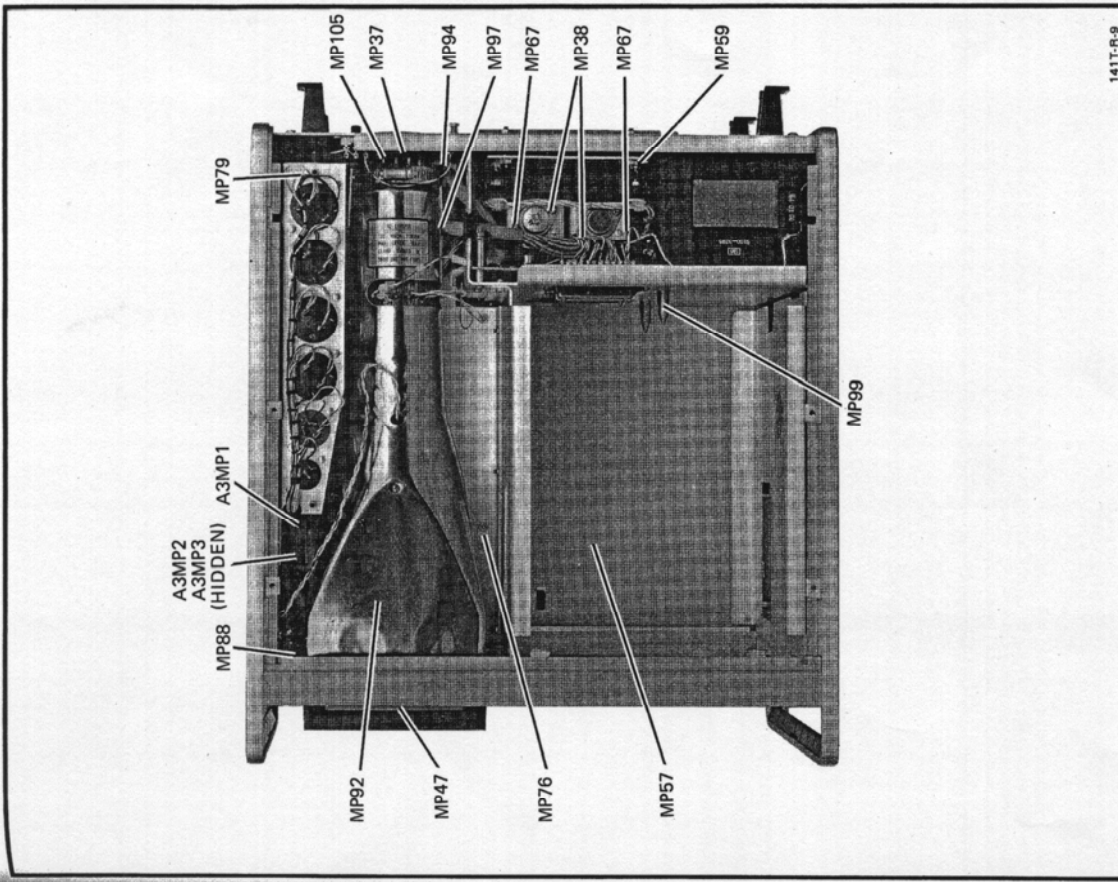

141T-R-9

Figure 6-4. Mechanical Parts, Top View

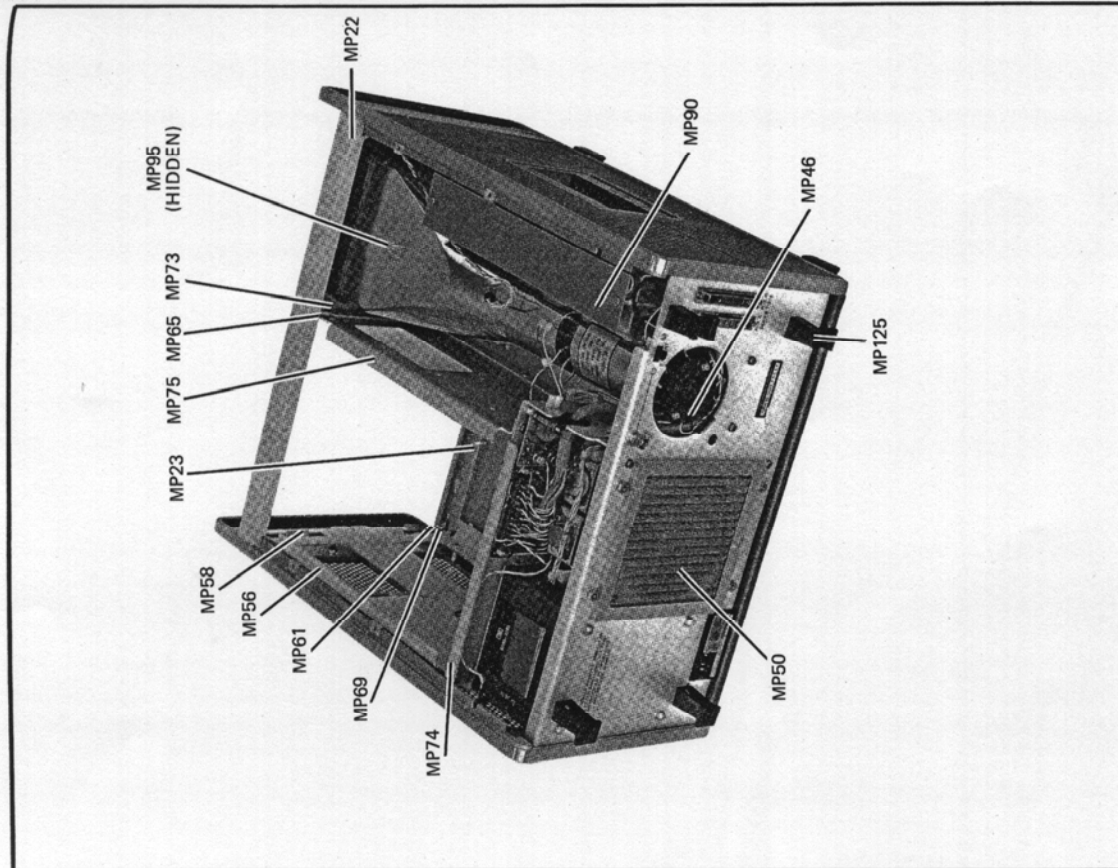

141T-R-4

Figure 6-3. Mechanical Parts, Rear View



SECTION VII  
MANUAL CHANGES AND OPTIONS

7-1. INTRODUCTION.

This section contains information required to update or update this manual for a specific instrument. Description of special options and standard options are also in this section.

7-3. MANUAL CHANGES.

This manual applies directly to the instrument having the same serial prefix shown on the manual title page. If the serial prefix of the instrument is the same as the one on the title page, find your serial prefix in table 7-1 and make the changes indicated in the manual that are listed for that serial prefix. When making changes listed in table 7-1, make the change with the highest number first. Example: if backdating changes 1, 2, and 3 are required for your serial prefix, do change 3 first, then change 2, and finally change 1. If the serial prefix of the instrument is not listed either in the title page or in table 7-1, refer to an enclosed MANUAL CHANGES sheet for updating information. Also, if a MANUAL CHANGES sheet is supplied, make all indicated ERRATA corrections.

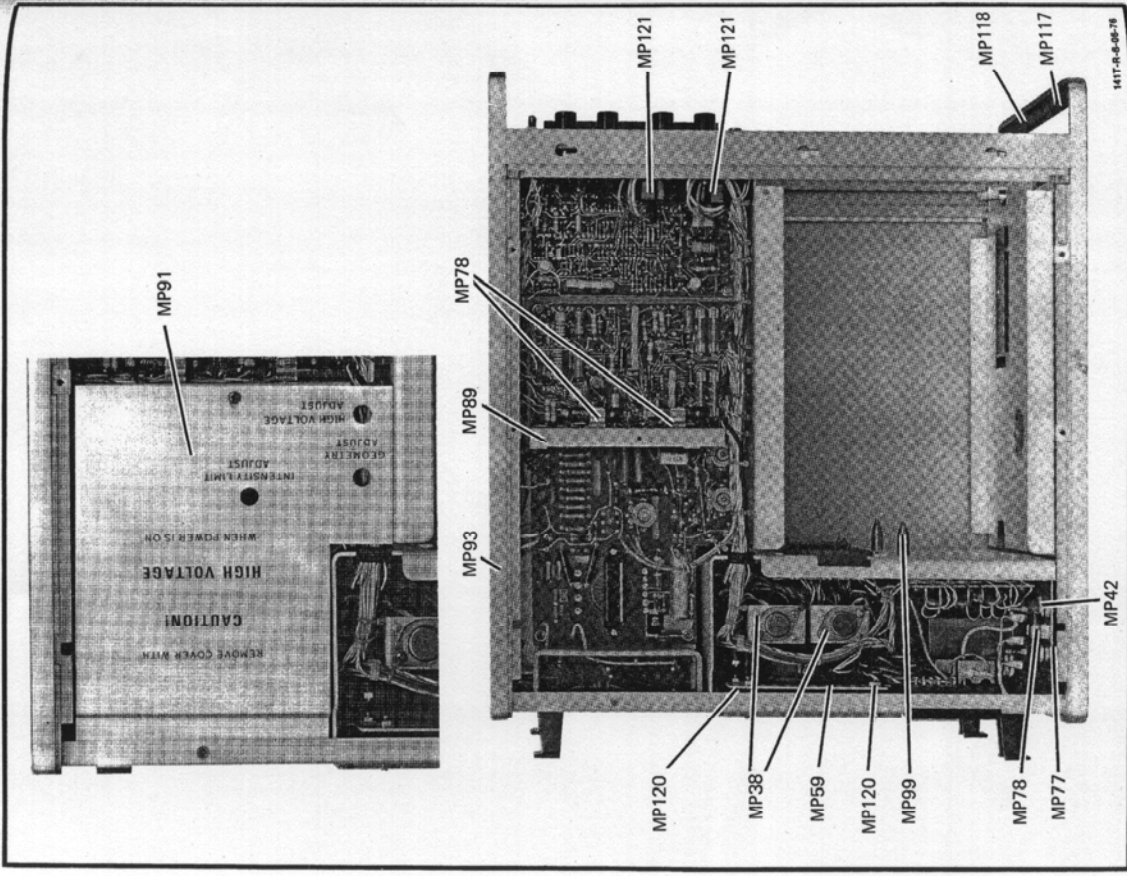

Figure 6-5. Mechanical Parts, Bottom View

Figures 6-8, 8-10, Add: R42 (between R3 and R46 on A2 assembly photo). Add: R42 (0.36 ohms) between the anode of A2CR16 and the base of A2Q10.

CHANGE 2

Table 6-2

- MP18: Change to HP Part Number 00141-60202.
- FL1: Change to HP Part Number 9100-2818; Qty 1; FILTER:LINE 115/230 VAC; Mfr. Code 65289; Mfr. Part Number JN10-1991A1.
- J8: Change to HP Part Number 1251-0148, Qty 1; J:NSR P/O FL1; Mfr. Code 87930; Mfr. Part Number 1065-1.
- S4: Change to HP Part Number 3101-0011; Qty 1; SWITCH: SLIDE DPDT; Mfr. Code 82389; Mfr. Part Number 11A-1013.
- W1: Change to HP Part Number 8120-0078; Qty 1; CABLE ASSY: CORD SET (7.5'); Mfr. Code 70903; Mfr. Part Number KH-4147.

CHANGE 3

Table 6-2

- Delete: J10, J10E1, J11, J11E1.
- Delete: W11, W11MP1, W11MP2.
- Section VIII.
- Delete: Auxiliary B portion of figure 8-7.

CHANGE 4

Table 6-2

- MP3: Change to HP Part Number 00141-00212; Qty 1; PANEL:FRONT; Mfr. Code 28480; Mfr. Part Number 00141-00212.
- MP6: Change to HP Part Number 5060-0765; Qty 2; RETAINER: HANDLE ASSY; Mfr. Code 28480; Mfr. Part Number 5060-0765.
- MP13: Change to HP Part Number 5060-0777; Qty 2; KIT: RACK MOUNT; Mfr. Code 28480; Mfr. Part Number 5060-0777.
- MP14: Change to HP Part Number 5000-0747; Qty 2; COVER: SIDE; Mfr. Code 28480; Mfr. Part Number 5000-0747.
- MP16: Change to HP Part Number 5060-0740; Qty 1; COVER ASSY: TOP; Mfr. Code 28480; Mfr. Part Number 5060-0740.
- MP17: Change to HP Part Number 5060-0752; Qty 1; COVER ASSY: BOTTOM; Mfr. Code 28480; Mfr. Part Number 5060-0752.
- MP22: Change to HP Part Number 00141-24701; Qty 1; SUPPORT: TOP PANEL; Mfr. Code 28480; Mfr. Part Number 00141-24701.

Table 7-1. Manual Changes

Serial Prefix	Make Changes
950- , 973-	12 through 1
1047A	12 through 2
1112A	12 through 3
1113A	12 through 4
1141A	12 through 5
1145A	12 through 6
1147A	12 through 7
1218A	12 through 8
1223A, 1232A	12 through 9
1250A, 1315A, 1320A,	12 through 10
1337A	12 and 11
1502A	12

CHANGE 1

- Paragraph 4-18.
- Sentence 5: Change R11 to A2R42.
- Table 6-2.
- A2: Change to HP Part Number 00141-66514, Qty 1; POWER SUPPLY BOARD ASSY; Mfr. Code 28480; Mfr. Part No. 00141-66514.
- Add: A2R42; HP Part Number 0811-1746; Qty 1; R: FXD WW 0.36 OHM 5% 2W; Mfr. Code 28480; Mfr. Part Number 0811-1746.

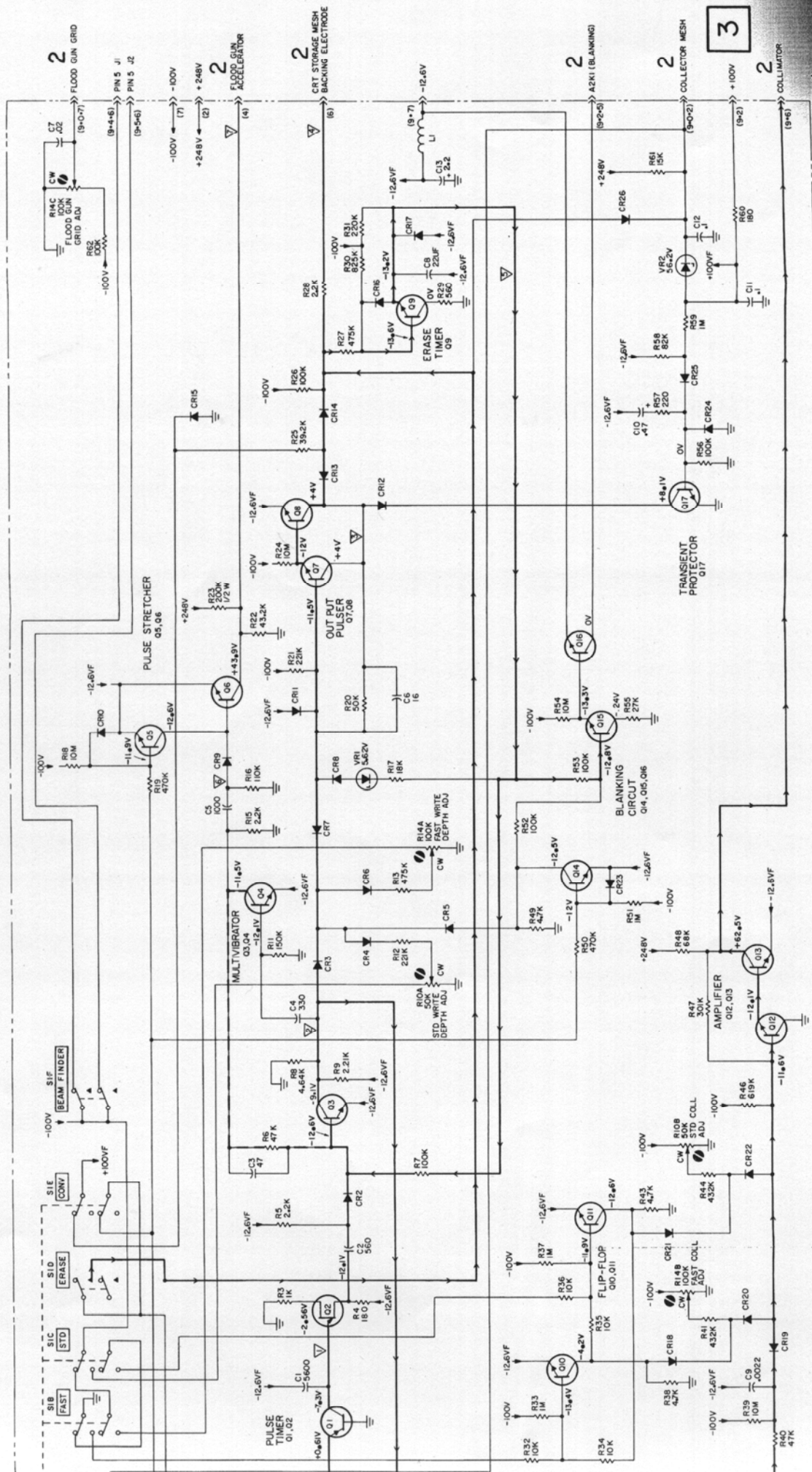

Model 141T

Model 141T

Removable Parts

- 1 Remote erase
- 2 ERASE board
- 3 Remote erase board
- 4 Remote erase board
- 5 Remote erase board
- 6 Remote erase board

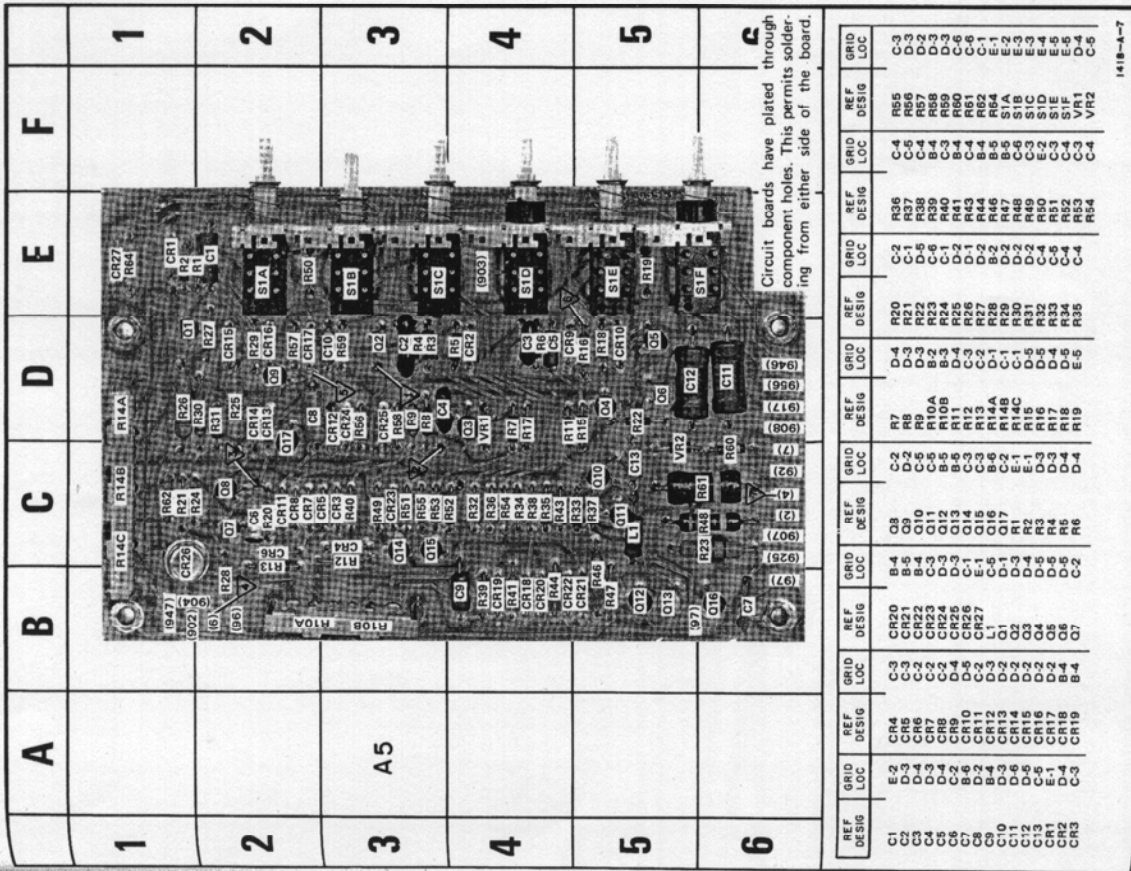
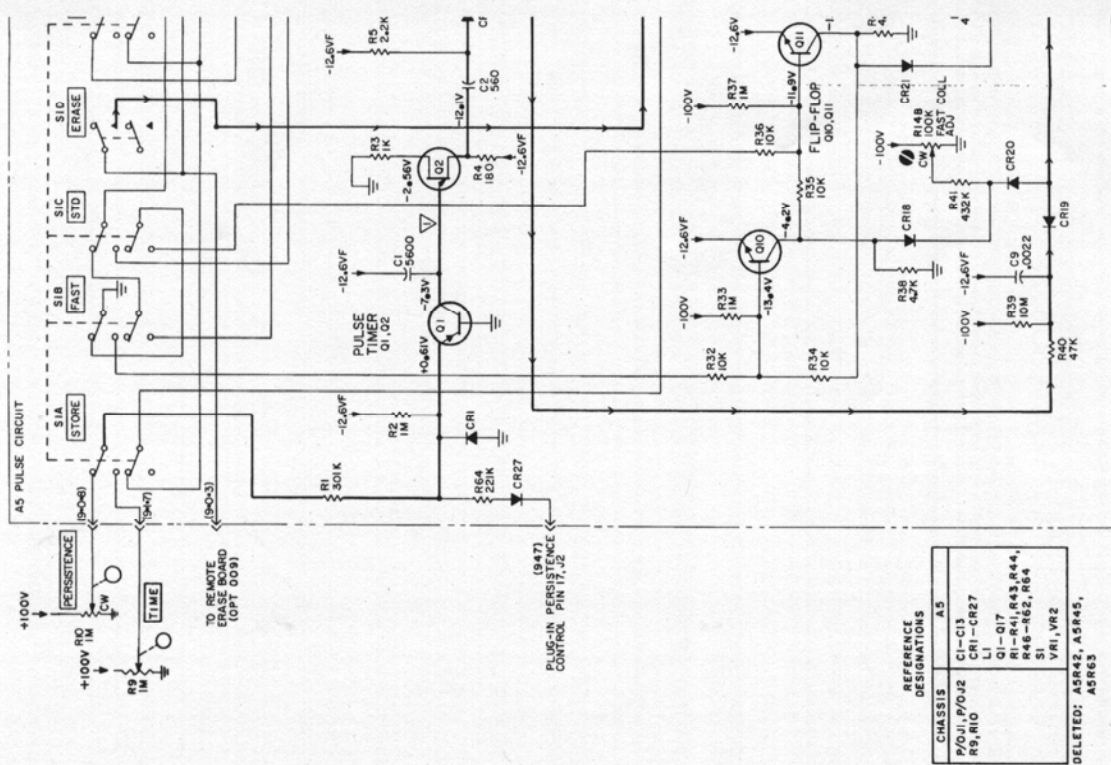

Figure 7-1. Component Identification Pulse Circuit A5



REFERENCE DESIGNATIONS

CHASSIS	A5
P/OJ1/P/OJ2	C1-C13
R9, R10	CR1-CR27
	L1
	LI-O17
	R1-R41, R43, R44, R46-R62, R64, S1
	VR1, VR2

DELETED: A5R42, A5R45, A5R63

**SECTION VIII**  
**SCHEMATICS AND TROUBLESHOOTING**

**8-1. INTRODUCTION.**

8-2 This section contains schematics, repair/replacement and troubleshooting information, component-location and component-identification illustrations, and waveforms for Model 141T. Tables 8-1 and 8-2 provide guides to locating possible high voltage supply problems. Table 8-3 defines symbols and conventions used on the schematics. Disassembly procedures for removing the CRT and cooling fan for repair and replacement are also contained in this section.

**8-3. SCHEMATICS.**

8-4 Schematics are printed on foldout pages for easy reference to the text and figures in other sections. The schematics are drawn to show the electronic function of the circuits. Any one schematic may include all or part of several different physical assemblies.

8-5 The schematics are numbered in sequence with a bold number in a box at the lower right-hand corner of each page. These numbers are used to cross reference signal connections between schematics. At each circuit breaking point, a notation is made of the signal name and a number (in bold type). This number indicates the associated schematic which shows the source or destination of the signal. To find the source or destination of any point on a given schematic, turn to the schematic referred to by number and find the name of the signal in question.

8-6 A table on each schematic lists all components shown on the schematic by reference designation. Component reference designators which have been deleted from the schematic are listed below the table.

8-7 All components within the shaded areas of a schematic are physically located on circuit boards. Components not physically located on a circuit board are shown in the unshaded areas of the schematic.

**8-8. REFERENCE DESIGNATIONS.**

8-9 The unit system of reference designations used in this manual is in accordance with the provisions of USA Standard Y32.16-1968, Reference Designations for Electrical and Electronics Parts and Equip-

ments, dated March 1, 1968. Minor variations from the standard, due to design and manufacturing practices, may be noted.

8-10 Each electrical component is assigned a class letter and number. This letter-number combination is the basic reference designation. Components which are not part of an assembly have only the basic reference designation. Components which are part of an assembly have, in addition to the basic designation, a prefix designation indicating the assembly of which the component is a part (resistor R23 on assembly A1 is called AIR23).

8-11 Assemblies are numbered consecutively. If an assembly reference designation is assigned and later deleted, that number is not reused.

**8-12. COMPONENT LOCATIONS.**

8-13 Locations of components on assemblies and subassemblies are illustrated in photos adjacent to the schematics. Since the schematics are drawn to show function, portions of a particular assembly may appear on several different schematics. The component-location photo is printed next to the schematic that shows most of the circuitry on the assembly. Components located on the chassis are identified in figures 8-2 through 8-5. The locations of all adjustments are shown in Section V. Cabinet parts and other mechanical parts are shown in drawings located in Section VI.

**8-14. PREVENTIVE MAINTENANCE.**

8-15. DELETED.

8-16. DELETED.

**8-17. FILTER MAINTENANCE.**

8-18. This instrument uses a wire-mesh air filter over the cooling blower. If the filter becomes clogged with dirt, the blower will not provide adequate cooling for the instrument. Check the filter periodically and clean it when necessary. To clean, remove the filter and use a warm soap and water solution. Rinse the filter in clear water and allow it to dry before re-installing.

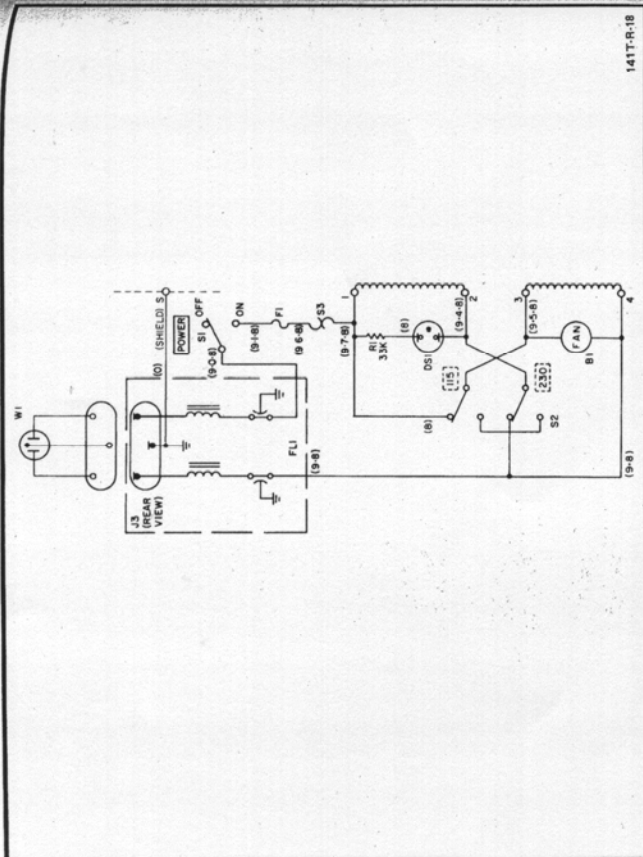

Figure 7-3. Line Voltage Schematic

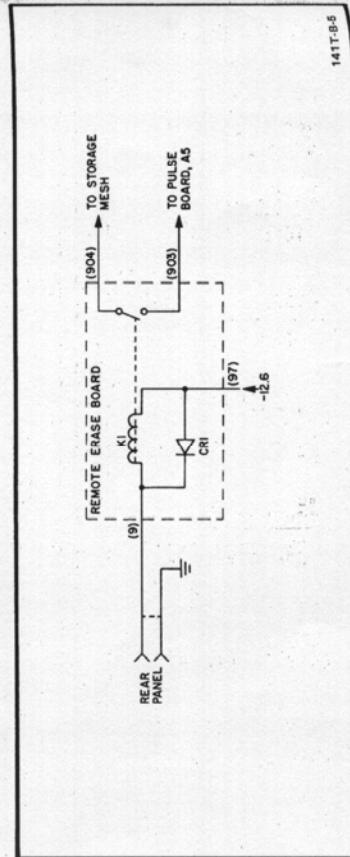

Figure 7-4. Option 009 Schematic Diagram

**8-19. ELECTRICAL MAINTENANCE.**

8-20. Do the electrical adjustments in Section V once every 6 months and after repair or component replacement.

**8-21. REPAIR AND REPLACEMENT.**

8-22. The following paragraphs provide information for repair, removal and replacement of assemblies, subassemblies, and components in the Model 141T. Special servicing instructions for the circuit boards are covered under paragraphs 8-33 through 8-35. Section VI provides a detailed parts list for use in ordering replacement parts.

**8-23. INSTRUMENT REPAIR.**

8-24. Chassis-mounted components are identified in figures 8-2 through 8-5. Components on circuit boards are identified in figures near the applicable schematic (also see table 8-3).

8-25. Figure 6-1 is an exploded view drawing of the instrument frame. All parts are keyed to table 6-2 by reference designators. Other mechanical parts are identified in figures 6-2 through 6-5.

**8-26. CRT REMOVAL AND REPLACEMENT.**

8-27. Remove the CRT as follows:



To prevent personal injury, wear a face mask or goggles when handling the CRT. Wear protective gloves and handle the CRT carefully.

- a. Remove top and left side cover of instrument.
- b. Remove bezel and discharge post-accelerator lead and CRT connection to chassis ground.
- c. Remove flexible three conductor CRT lead (W12, figure 8-2) from connector block.
- d. Disconnect clip-on leads from CRT neck.
- e. Loosen clamp at CRT socket.
- f. Carefully remove socket from CRT base.

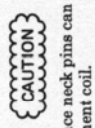

Use care since neck pins can damage the trace alignment coil.

- g. Place one hand on CRT face, and use other hand to slide CRT forward and out of instrument.

8-28. To install a CRT, reverse the above procedure. Insure that connector block and neck leads are connected before turning power on. After the CRT is installed, do performance checks and geometry adjustment procedure in Section V.

**8-29. FAN REMOVAL AND REPLACEMENT.**

8-30. Use the following procedure for removing, and reverse the procedure for replacing the cooling fan.

- a. Remove top and bottom covers of instrument.
- b. Disconnect, white-gray and white-green-gray wires from fan terminals.
- c. Remove all transistor heat sinks from fan assembly and push out of way.
- d. Remove four fan mounting nuts on rear panel of instrument.
- e. Lift out fan assembly.

**8-31. SEMICONDUCTOR REPLACEMENT.**

8-32. Figure 8-1 is included to help identify the leads in the common shapes and sizes of semiconductor devices. When removing a semiconductor, use long-nosed pliers as a heat sink between the device and the soldering iron. When replacing a semiconductor, ensure sufficient lead length to dissipate the soldering heat by using the same length of exposed lead as was used for the original part.

**8-33. SERVICING CIRCUIT BOARDS.**

8-34. This instrument uses circuit boards with plated-through component holes. This allows components to be removed or replaced by unsoldering or soldering from either side of the board. When removing large components, such as potentiometers, rotate the soldering iron tip from lead to lead while applying pressure to the part to lift it from the board. HP Service Note M-20E contains additional information on the repair of circuit boards. Important considerations are as follows:

- a. Do not apply excessive heat.
- b. Apply heat to component leads and remove component with straight pull away from board.
- c. Do not force replacement leads into holes.

8-35. If the metal conductor lifts from the board, it can be cemented back with a quick-drying acetate base cement having good insulating properties. If the metal conductor is broken, solder a wire to the conductor to bridge the break.

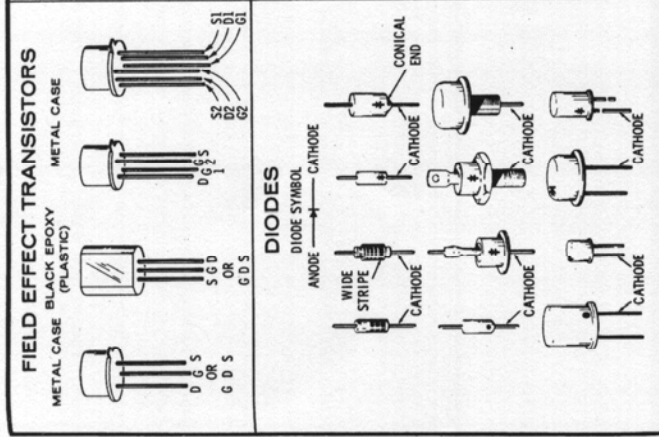

Figure 8-1. Semiconductor Terminal Identification

**8-36. OVERALL TROUBLESHOOTING.**

8-37. The most important prerequisite for successful troubleshooting is understanding how the instrument is designed to operate and correct use of front panel controls. Improper control settings or circuit connections can cause apparent malfunctions. Read Section III (operating procedures) for an explanation of controls and connectors and general operating considerations. Read Section IV (principles of operation) for explanations of circuit theory.

**8-39. FRONT PANEL CONTROLS.**

8-40. Equipment troubles are frequently caused simply by improper front panel settings. Refer to the operating procedures in Section III for a complete explanation of each control's function along with typical operating instructions if in doubt. Possibly the intensity control on the oscilloscope front panel is not turned up, or the level control on the time base plug-in is misadjusted. Use the controls as a guide to help isolate a trouble to a specific area.

**8-41. VISUAL CHECKS.**

8-42. After localizing the trouble to a specific area of the instrument, make a visual check of that area. Check for burned or broken components, loose wires or circuit board connections, faulty switch contacts, or any similar condition suggesting a source of trouble. If everything appears normal, proceed to the next step.

8-38. Troubleshooting is much easier if more than one symptom of a trouble is evident. Observe the instrument and note all indications of faulty operation. If symptoms indicate more than one trouble, treat each problem individually and locate one trouble at a time. Don't waste time making random checks. Instead, follow the logical procedure presented here, and refer to other areas of information in this manual as necessary.

**8-43. WAVEFORMS AND VOLTAGES.**

8-44. Allow the instrument to warm-up for about fifteen minutes before making any measurements. Note the conditions for measuring waveforms and the dc voltages. These conditions are stated in the detailed troubleshooting procedures or listed adjacent to each schematic and must be followed to obtain proper readings. Waveform measurement points ( $\nabla$ ) with a number enclosed are placed on the schematics along main signal paths. The numbers inside the measurement point symbols ( $\nabla$ ) are keyed to corresponding waveforms adjacent to each schematic. Waveforms can be used to measure gain or pin-point a defective stage. Use a probe with a needle tip to avoid creating a short circuit. Dc voltages are shown on the schematics near active components such as transistors. As an aid to locating measurement points, note a small dot etched on the circuit boards near the emitter of transistors, source of field effect transistors, cathode of diodes, and positive lead of electrolytic capacitors.

**8-45. FINAL CHECKS.**

8-46. Review the theory of operation in Section IV to learn how the circuit should operate. With the aid of this information, it will be easier to discover why a defective circuit is inoperative. Finally make resistance checks to uncover the faulty component. If it appears necessary to calibrate the instrument, refer to Section V for the proper procedures.

**8-47. DETAILED TROUBLESHOOTING.****WARNING**

Voltages present in the power supplies are dangerous.

**8-48. LOW-VOLTAGE SUPPLY.**

8-49. The series regulator transistors are located on the fan assembly. Each is easily replaced by removing the two screws and pulling the transistor from its socket. All other low voltage power supply transistors are located on the power supply board.

8-50. Dc voltages shown on the low voltage schematic diagram were measured to ground, with Model 1402A and 1421A plug-ins installed. Voltages may vary slightly when other plug-ins are used. Correct voltages for points not marked are generally obvious by being connected (directly or indirectly) to a supply output. Transistor base voltage in most cases should not measurably differ from emitter voltage when measured with respect to ground. Voltage drops across breakdown diodes are indicated on the schematic.

8-51. Excessive ripple in line frequency is usually caused by a faulty input filter or regulator circuit. Compare the ripple voltages at the rectifier outputs with values given on the schematic. For ripple above the specified value, check C1, C3, C4 or C6. Line frequency ripple above specified value at these points indicates an open rectifier or low-gain amplifier transistors. Maximum ripple on supply outputs (at 115 Vac with maximum load on supply) is: 10 mV at +248V; 7 mV at +100V and -100V; and 2 mV at -12.6V.

8-52. If the -12.6, -100 or +248 volt supply should be accidentally shorted to ground, the fuse for that particular supply will blow. This cuts off current in the supply and protects the transistors.

8-53. The -12.6 volt supply is fused and employs a current limiter, A2Q10, for protection against brief shortings of the output to ground. The supply should function normally upon removal of the short, provided the fuse has not blown.

8-54. Trouble in the +100 volt supply can be reflected in the operation of all other low voltage power supply outputs. If the +100 volt supply is incorrect, proper circuit repair may eliminate the trouble. If the +100 volt supply is correct, follow these steps in their given order:

a. Check -100 volt supply. The +248 volt and -12.6 volt supplies are referenced to this supply. A fault in -100 volt supply can cause malfunction of either of other two supplies. If -100 volt supply is incorrect, proper circuit repair may eliminate trouble in +248 volt or -12.6 volt supply. If -100 volt supply is correct, proceed to next step.

b. The +248 volt supply is referenced to -100 volt supply. If trouble here has not been eliminated by checking -100 volt supply, trouble lies in this circuit and can be located by making proper circuit and component checks as described in paragraph 8-50.

c. A trouble that appeared to be in the -12.6 volt supply may have been eliminated by above procedures. If not, it will be necessary at this point to make thorough voltage and component checks of the supply.

**8-55. HIGH-VOLTAGE SUPPLY.**

8-56. If one high-voltage supply output is zero but other outputs are normal, one of the rectifiers is likely at fault. Normal dc voltages are given on the high voltage schematic.

8-57. If there is no high-voltage output, observe the waveforms at the collector of A2Q14 (blue wire). If an approximately 30 kHz, 20-volt peak-to-peak sine wave appears for short intervals, the trouble is

Table 8-1. Troubleshooting High-Voltage Supply, No Voltage

Procedure	Indication	Conclusion
1. Check A2Q13, A2L1, and the associated transformer primary for open circuits or shorts. Replace any defective components.		
2. Check voltage at emitter of A2Q14.	Voltage is not more negative than -2 volts.	Check A2Q14 and A2Q15.
3. Check voltage at emitter of A2Q13.	Voltage is not approximately -0.6 volts.	Check A2Q13.
4. Check A2T1 and rectifier load circuit for opens or shorts. Then lift one lead of A2C13, A2C14, A2C15, A2C16, A2C17, A2C18, and turn instrument on again.	Oscillations occur.  Oscillations do not occur.	Replace capacitor leads one at a time until oscillations stop. The capacitor that stops oscillations is defective.  Trouble probably with transformer A2T1.

Table 8-2. Troubleshooting High-Voltage Supply, Incorrect Voltage

Procedure	Indication	Conclusion
1. Voltage too high. a. Lift one lead of A2R58	Output drops to zero	Check A2Q15.
b. Replace A2R58 lead, and lift one lead of A2R56.	Output remains at incorrect value.	Replace A2R56 with a resistor of approx. twice the present value.  Proceed to step 1.c.
c. Replace A2R56 lead, and compare voltages at gate and source of A2Q15.	Output remains at incorrect value.  Voltages are within 1 volt of being the same.	Trouble probably in divider network A2R61, A2R62, A2R63, R6, A2R73 thru A2R81.
2. Voltage too low. a. Compare voltages at gate and source of A2Q15.	Gate voltage more negative.	Trouble probably in divider network A2R61, A2R62, R6, A2R73 thru A2R81.
b. Check voltage at emitter of A2Q14.	Gate voltage more positive.	Check A2Q14 and A2Q15.
c. Steps a and b do not correct fault.	Voltage approx. -12 volts  Voltage remains too low.	Replace A2R57 with a 560 ohm resistor.  Perform troubleshooting procedure of Table 8-1.

probably a defective component in the rectifier filter/divider networks. If no waveform appears, use table 8-1.

8-58. If the high-voltage output is incorrect and cannot be adjusted to the correct value, use table 8-2.

8-59. If the -2350 volt supply seems to be operating properly, the 6.6 kV post-accelerator potential may be checked as follows:













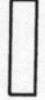



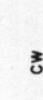
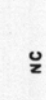

- a. Remove top and left side instrument cover.
- b. Remove high voltage connector block, A3-MP1, figure 6-4.
- c. Remove high voltage connector block cover and rubber insulation.
- d. Check 6.6 kV at high voltage lead pin connection.

**8-60. PULSE CIRCUIT.**  
8-61. A good knowledge of the operating procedures and an understanding of the principles of operation of the instrument are helpful when troubleshooting the pulse circuit. Refer to Section III for operating procedures and Section IV for principles of operation. Always perform the preliminary set up procedure given in Section V, Performance Check, if the instrument is not operating properly.

8-62. All dc voltages from the low-voltage supply are used in the pulse circuit. When a malfunction occurs, check all voltages connected to the pulse circuit board. If all low voltages are correct, check the high voltages at the high-voltage circuit board. These checks will, by elimination, isolate the trouble to one general circuit. If both supplies are correct, check the waveforms at test points shown on schematic diagram, figure 8-16.

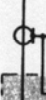
8-63. Check dc voltages to isolate defective components in a stage where an improper, or no, waveform is present. Conditions for measurements and waveforms for test points are given in figure 8-15.

Table 8-3. Schematic Diagram Notes

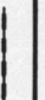
Model 141T		Refer to MIL-STD -15-1A for schematic symbols not listed in this table.	
	= Etched circuit board		= Field-effect transistor (P-type base)
	= Front-panel marking		= Field-effect transistor (N-type base)
	= Rear-panel marking		= Breakdown diode (voltage regulator)
	= Front-panel control	Unless otherwise indicated: resistance in ohms capacitance in picofarads inductance in microhenries	
	= Screwdriver adjustment		
	= Part of		
	= Clockwise end of variable resistor	(925)	= Wire colors are given by numbers in parentheses using the resistor color code [ (925) is wht-red-grn ]
	= No connection	0 - Black	5 - Green
	= Waveform test point (with number)	1 - Brown	6 - Blue
	= Common electrical point (with letter) not necessarily ground	2 - Red	7 - Violet
	= Single-pin connector on board	3 - Orange	8 - Gray
	= Pin of a plug-in board (with letter or number)	4 - Yellow	9 - White
	= Coaxial cable connected to snap-on jack		
	= Coaxial cable connected directly to board		
	= Wire connected to pressure-fit socket on board		
	= Main signal path		
	= Primary feedback path		
	= Secondary feedback path		

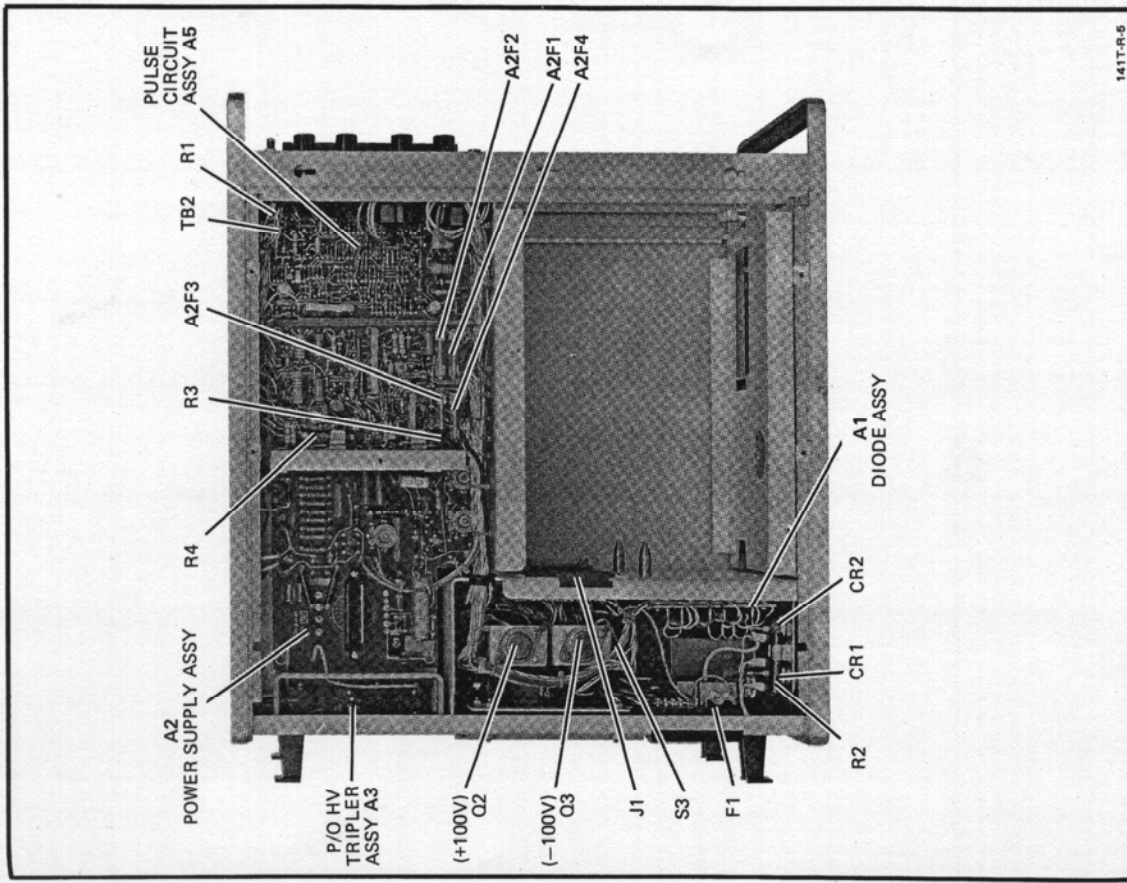

141T-R-5

Figure 8-3. Component Location, Bottom View

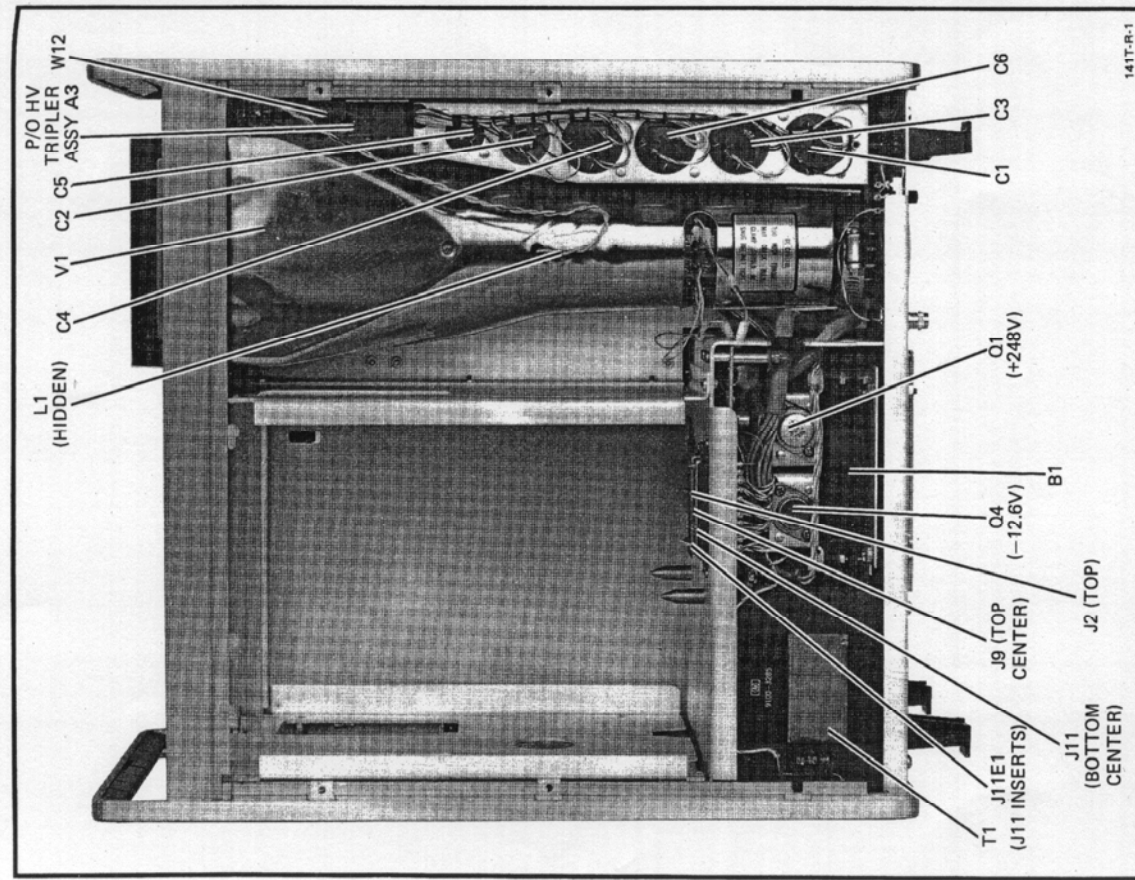

141T-R-1

Figure 8-2. Component Location, Top View



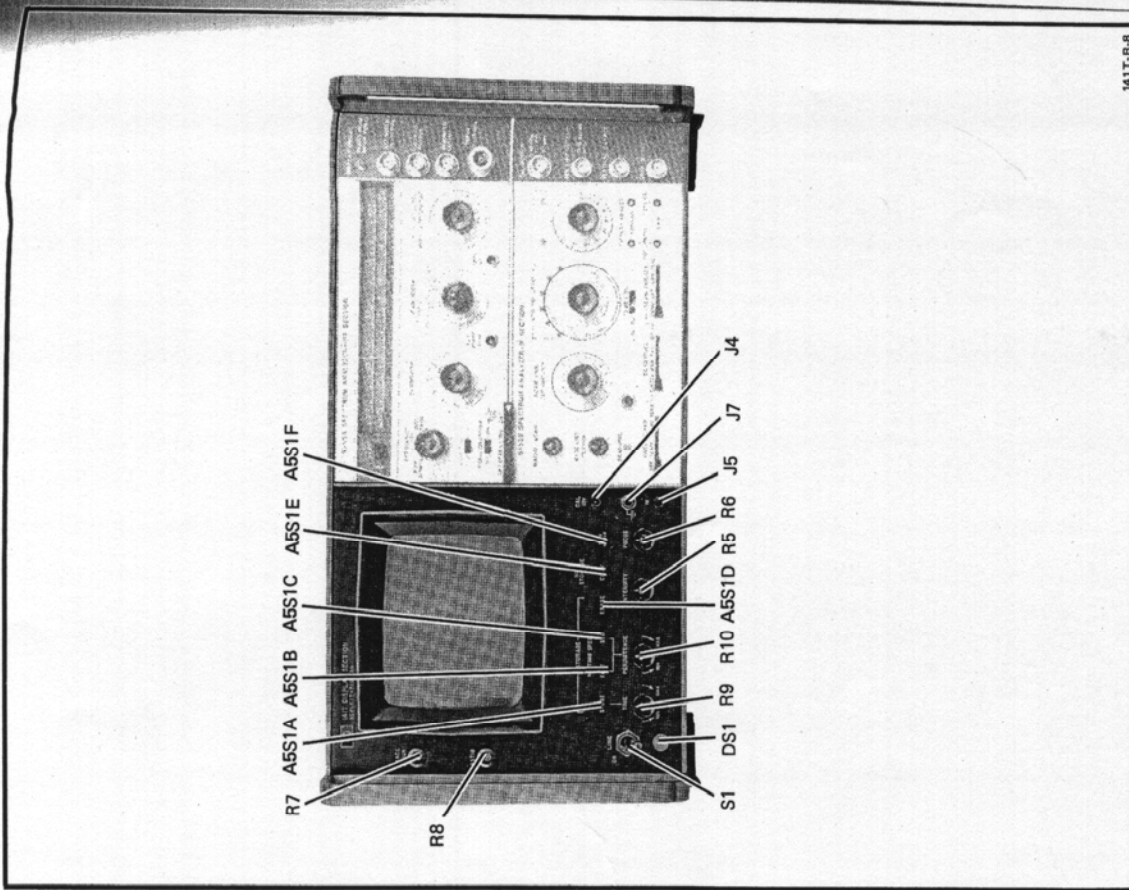

141T-R-8

Figure 8-4. Component Location, Front View

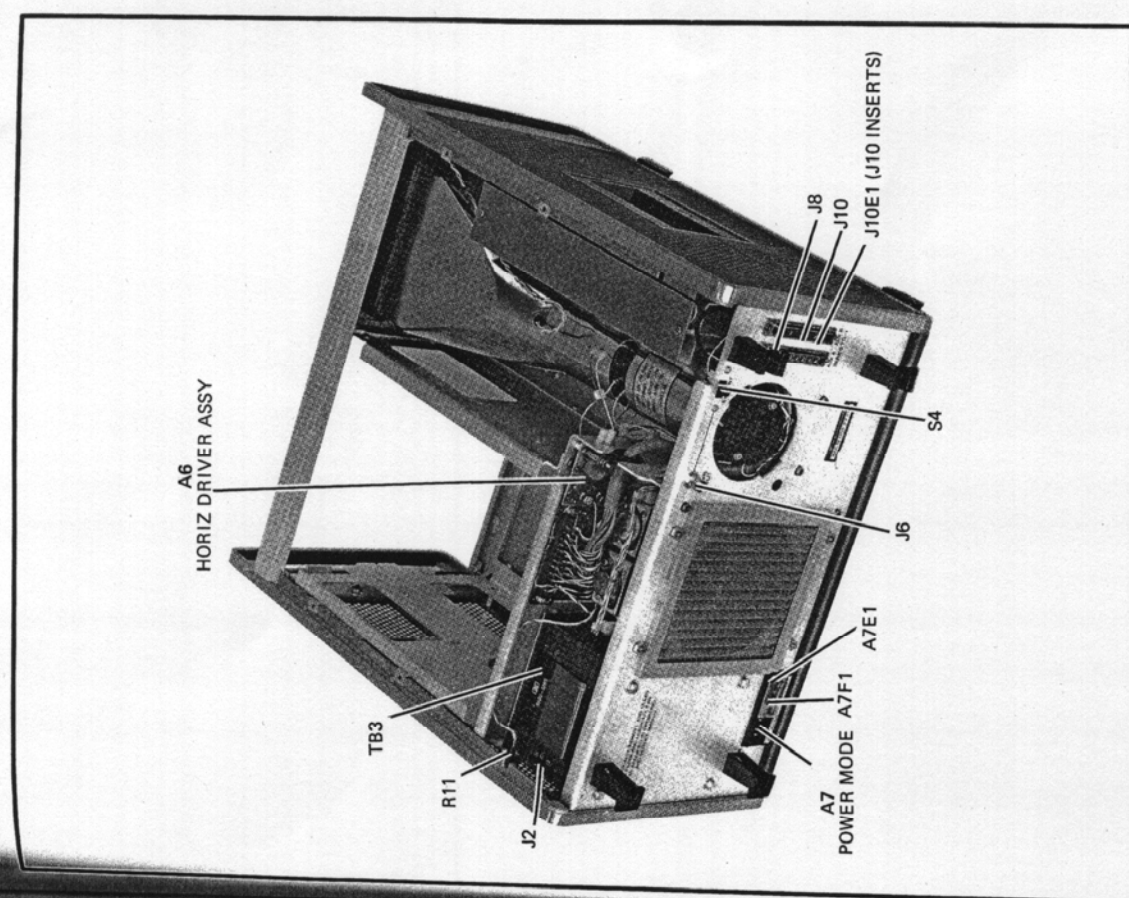

141T-R-7

Figure 8-5. Component Location, Rear View

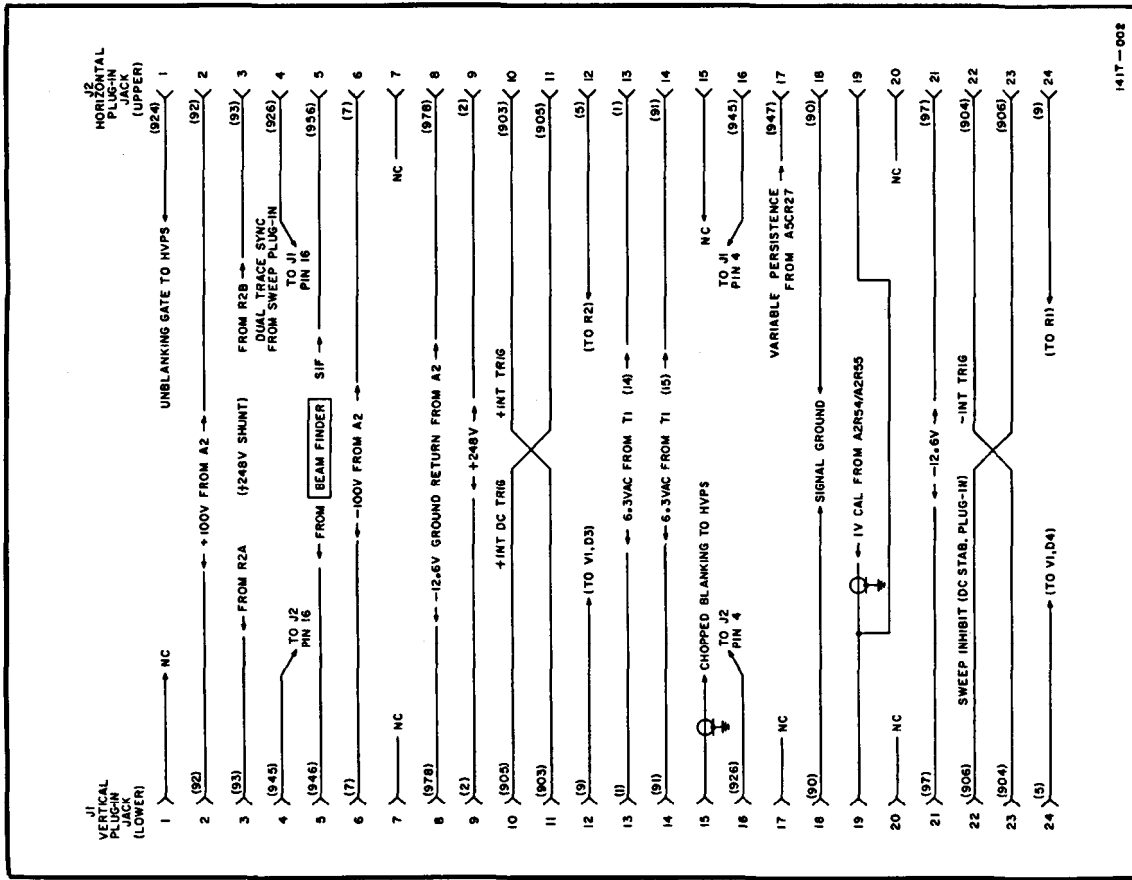

Figure 8-6. Plug-in Jack Connections

141T-008

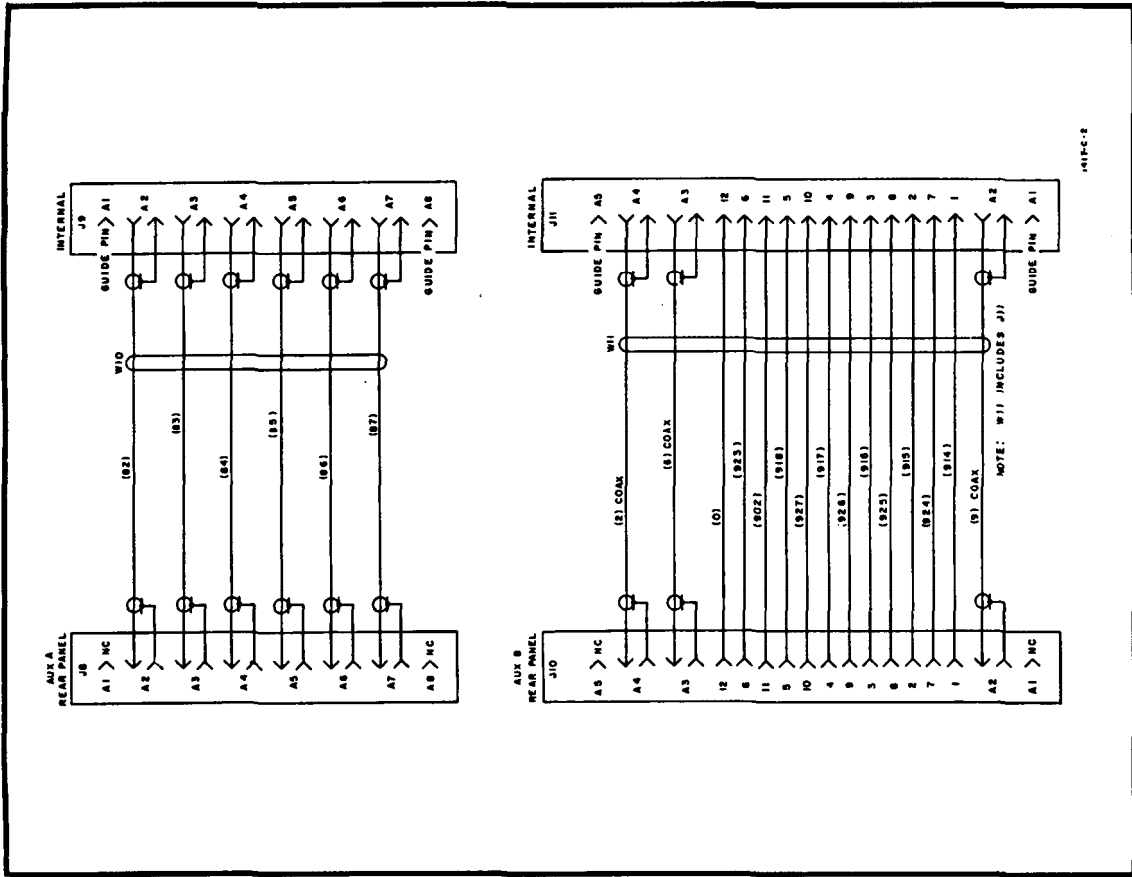
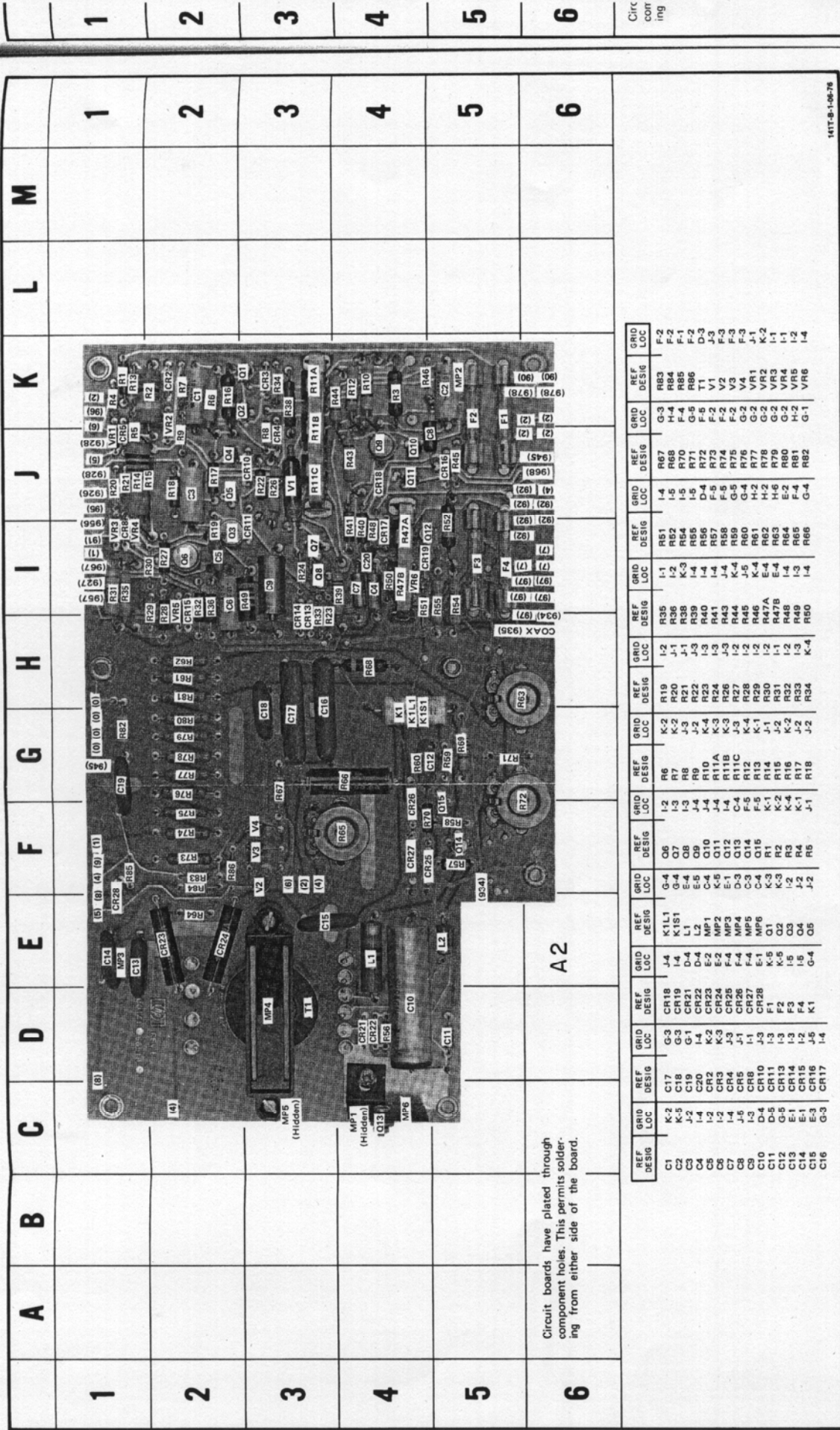

Figure 8-7. Auxiliary A and Auxiliary B Wiring Diagram

141T-2



Circuit boards have plated through component holes. This permits soldering from either side of the board.

REF DESIG	GRID LOC	REF DESIG	GRID LOC	REF DESIG	GRID LOC	REF DESIG	GRID LOC	REF DESIG	GRID LOC	REF DESIG	GRID LOC	REF DESIG	GRID LOC	REF DESIG	GRID LOC
C1	K-2	C17	G-3	CR18	I-4	K111	J-4	R19	I-2	R35	I-1	R51	I-4	R67	G-3
C2	K-3	C18	G-1	CR21	D-4	L1	D-4	R20	J-1	R36	I-2	R52	I-5	R68	H-4
C3	I-2	C19	I-4	CR22	E-2	L2	E-2	R21	J-3	R38	K-3	R54	I-5	R70	F-4
C4	I-2	C20	I-4	CR23	E-2	L3	E-2	R22	J-3	R40	I-4	R55	I-5	R71	G-5
C5	I-2	CR2	K-2	CR24	E-2	MP1	K-4	R23	I-3	R41	I-4	R56	D-4	R72	F-5
C6	I-2	CR3	K-3	CR25	F-4	MP2	K-3	R24	I-3	R42	I-4	R57	F-5	R73	F-3
C7	I-4	CR4	J-3	CR26	F-4	MP3	E-1	R25	I-3	R43	J-4	R58	F-5	R74	F-3
C8	J-6	CR5	J-1	CR27	F-4	MP4	C-4	R26	I-2	R44	K-4	R59	G-5	R75	V-3
C9	I-3	CR6	I-3	CR28	F-4	MP5	C-3	R27	I-2	R45	J-5	R60	G-4	R76	V-4
C10	D-5	CR7	J-3	CR29	F-4	MP6	C-4	R28	I-2	R46	K-4	R61	H-2	R77	G-2
C11	D-5	CR8	I-3	CR30	K-3	Q1	K-3	R29	I-2	R47A	E-4	R62	H-2	R78	G-2
C12	G-5	CR9	I-3	CR31	K-3	R2	K-2	R30	I-2	R47B	E-4	R63	H-2	R79	G-2
C13	E-1	CR10	I-3	CR32	I-2	R3	K-4	R31	I-1	R48	I-4	R64	F-4	R80	F-4
C14	E-1	CR11	I-2	CR33	I-2	R4	K-1	R32	I-2	R49	I-4	R65	F-4	R81	I-2
C15	E-3	CR12	J-6	CR34	J-2	R5	J-1	R33	K-4	R50	I-4	R66	G-4	R82	G-1
C16	G-3	CR17	I-4	CR35	I-4	OB	G-4	R34	K-4						

Figure 8-8. Component Identification, Power Supply A2

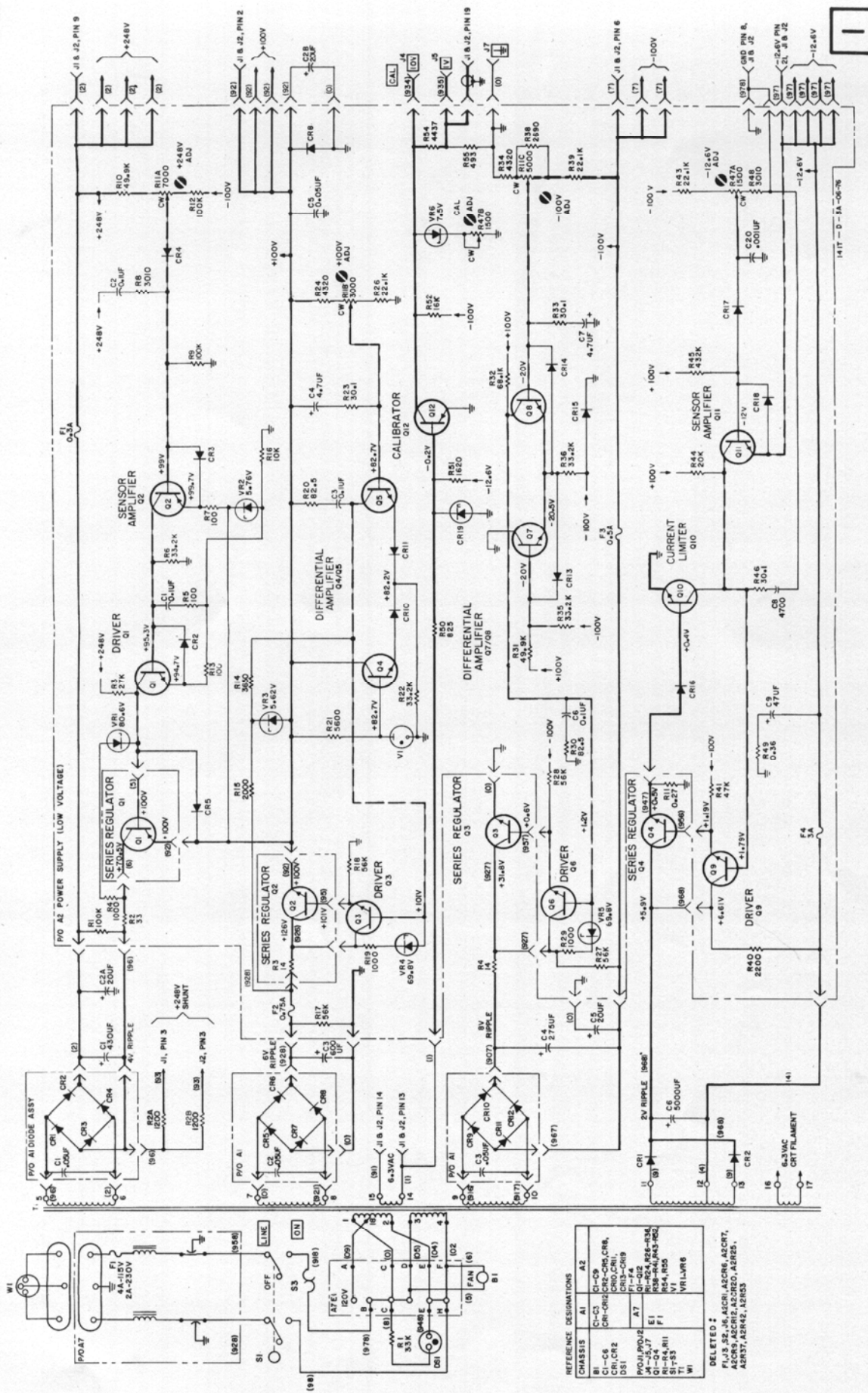

Figure 8-10.  
Low Voltage Schematic



er Connections

REFERENCE DESIGNATIONS

CHASSIS	A1	A2
C1-C6	CR1-CR11	CR12-CR19
DS1	Q1-Q12	Q13-Q20
PV01-PV02	E1-E17	F1
R1-R24, R26-R36	R1-R11, R13-R15	R16-R19
SI-33	V1	VR1-VR6
TI		

DELETED :  
F1J3, S2, J6, AS-CR1, AS-CR6, AS-CR7, AS-CR8, AS-CR9, AS-CR12, AS-CR20, AS-CR25, AS-CR37, AS-R42, AS-R53

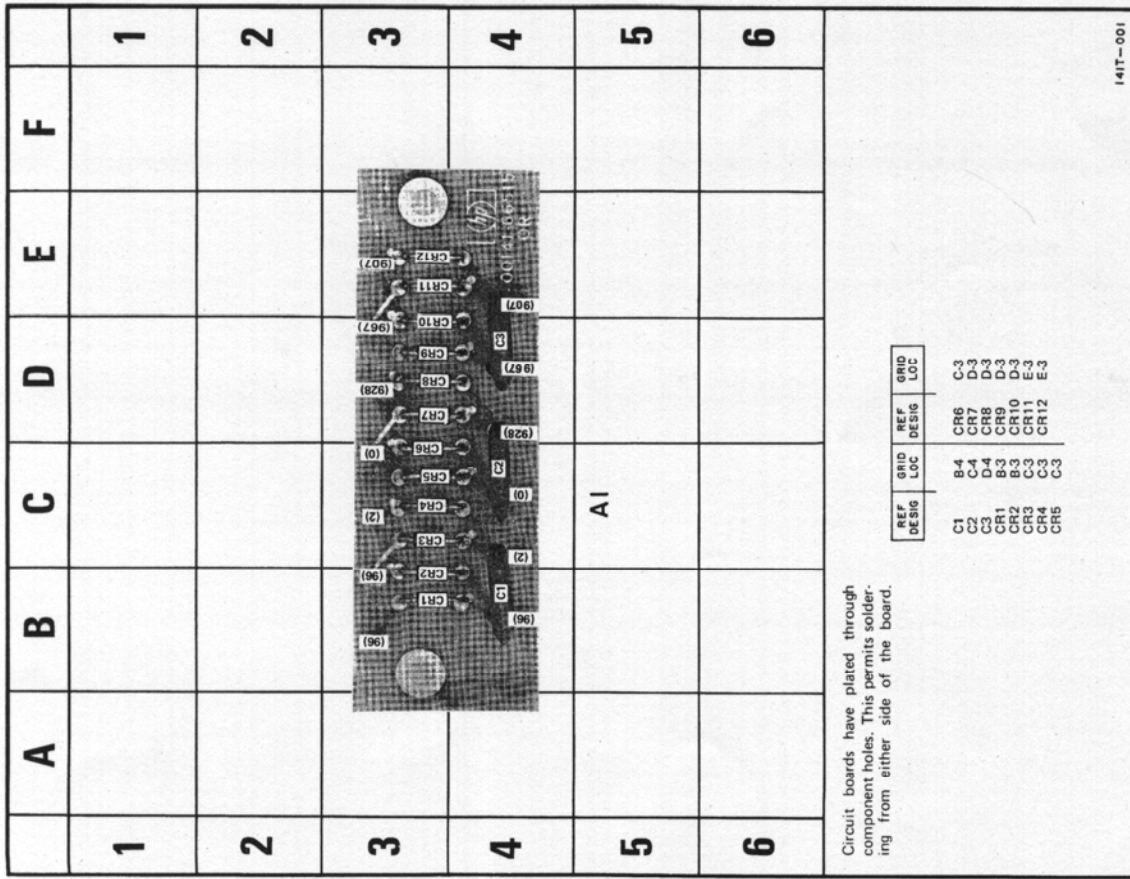

Circuit boards have plated through component holes. This permits soldering from either side of the board.

Figure 8-9. Component Identification, Diode Assy AI

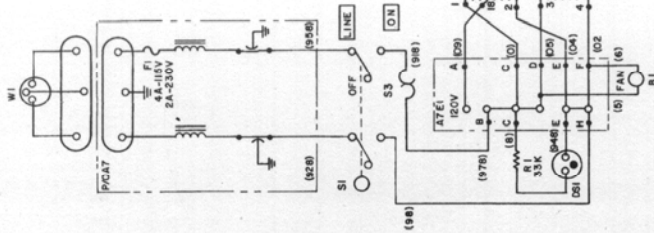

REFERENCE DESIGNATIONS

CHASSIS	A1	A2
B1	C1-C3	C1-C3
C1-C6	CR1-CR2	CR1-CR2-CR3-CR4-CR5-CR6-CR7-CR8-CR9-CR10-CR11-CR12
DS1	F1-F4	F1-F4
PCAT	PCAT	PCAT
PIVOT POINT	A7	A7
Q1-Q2	E1	E1
Q1-Q2	F1	F1
R1-R4/R11	R54, R55	R54, R55
T1-T53	V1	V1
W1	W1	W1

DELETED :

F1, J2, J6, J8, J9, J10, J11, J12, J13, J14, J15, J16, J17, J18, J19, J20, J21, J22, J23, J24, J25, J26, J27, J28, J29, J30, J31, J32, J33, J34, J35, J36, J37, J38, J39, J40, J41, J42, J43, J44, J45, J46, J47, J48, J49, J50, J51, J52, J53, J54, J55, J56, J57, J58, J59, J60, J61, J62, J63, J64, J65, J66, J67, J68, J69, J70, J71, J72, J73, J74, J75, J76, J77, J78, J79, J80, J81, J82, J83, J84, J85, J86, J87, J88, J89, J90, J91, J92, J93, J94, J95, J96, J97, J98, J99, J100

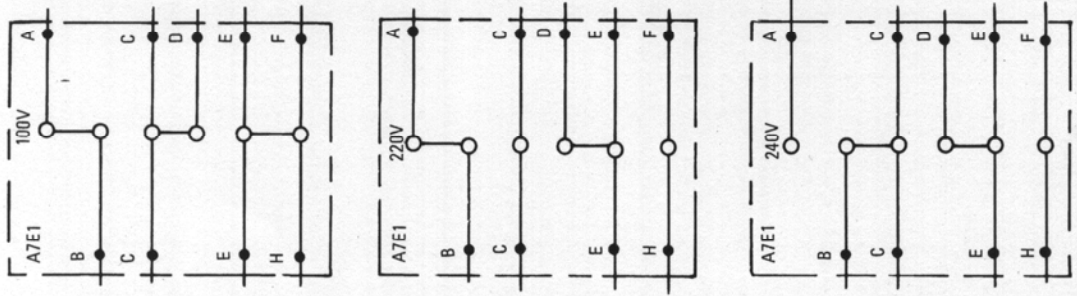

100V, 220V, and 240V Input Power Connections

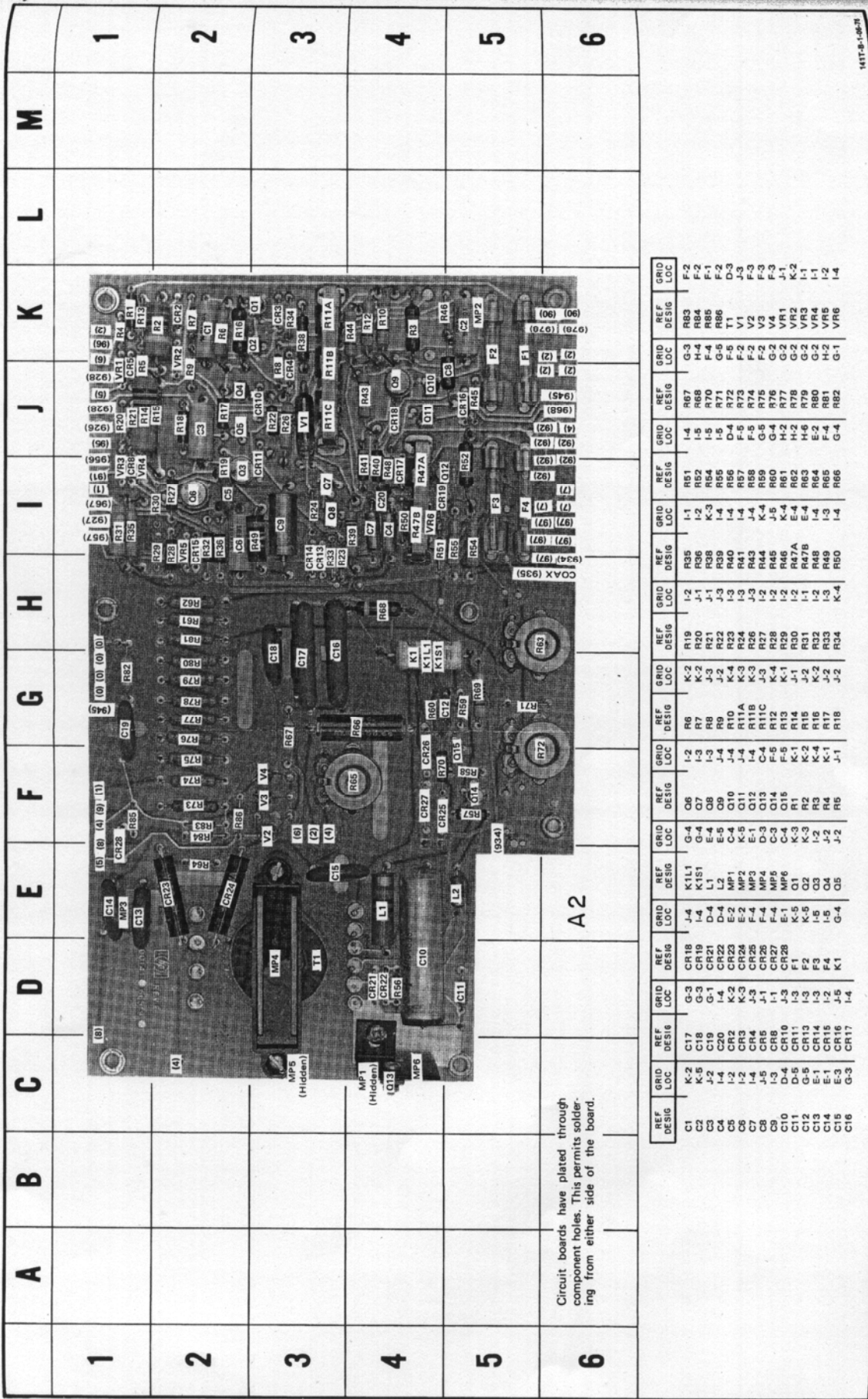

Circuit boards have plated through component holes. This permits soldering from either side of the board.

REF DESIG	GRID LOC	REF DESIG	GRID LOC	REF DESIG	GRID LOC	REF DESIG	GRID LOC	REF DESIG	GRID LOC	REF DESIG	GRID LOC	REF DESIG	GRID LOC	REF DESIG	GRID LOC
C1	K-2	C17	G-3	CR18	J-4	K1L1	G-4	O6	I-2	R6	K-2	R19	I-2	R95	I-1
C2	K-5	C18	G-3	CR19	I-4	K1S1	G-4	O7	I-3	R7	K-2	R20	J-1	R96	I-2
C3	J-2	C19	G-1	CR21	D-4	L1	E-4	O8	I-3	R8	J-3	R21	J-1	R98	K-3
C4	I-4	C20	I-4	CR22	D-4	L2	E-5	O9	J-4	R9	J-2	R22	J-3	R99	I-4
C5	I-2	C21	K-2	CR24	E-2	MP2	K-5	O10	J-4	R10	K-3	R23	I-3	R100	I-4
C6	I-2	CR3	K-2	CR25	F-4	MP3	K-5	O11	J-4	R11A	K-3	R24	I-3	R101	I-4
C7	I-4	CR4	J-3	CR26	F-4	MP4	E-1	O12	I-4	R11B	K-3	R26	J-3	R102	I-4
C8	J-5	CR5	J-1	CR26	F-4	MP5	D-3	O13	I-4	R11C	K-3	R27	J-3	R103	I-4
C9	I-3	CR8	I-1	CR27	F-4	MP6	C-3	O14	F-5	R12	K-1	R28	I-2	R104	I-2
C10	D-4	CR10	J-3	CR28	F-4	MP6	C-3	O15	F-5	R13	K-1	R29	I-2	R105	I-2
C11	D-5	CR11	I-3	F1	F-1	O1	K-3	R1	K-1	R14	J-1	R30	I-2	R106	I-2
C12	E-5	CR13	I-3	F2	F-1	O2	K-4	R2	K-1	R15	J-1	R31	I-2	R107	I-2
C13	E-1	CR15	I-2	F3	F-1	O3	K-2	R3	K-4	R16	K-2	R32	I-2	R108	I-2
C14	E-1	CR16	I-2	F4	F-1	O4	I-2	R4	K-1	R17	J-2	R33	I-3	R109	I-4
C15	E-3	CR16	J-5	F5	F-1	O5	J-2	R5	J-1	R18	J-2	R34	K-4	R110	I-4
C16	G-3	CR17	I-4												

Figure 8-11. Component Identification, Power Supply A2

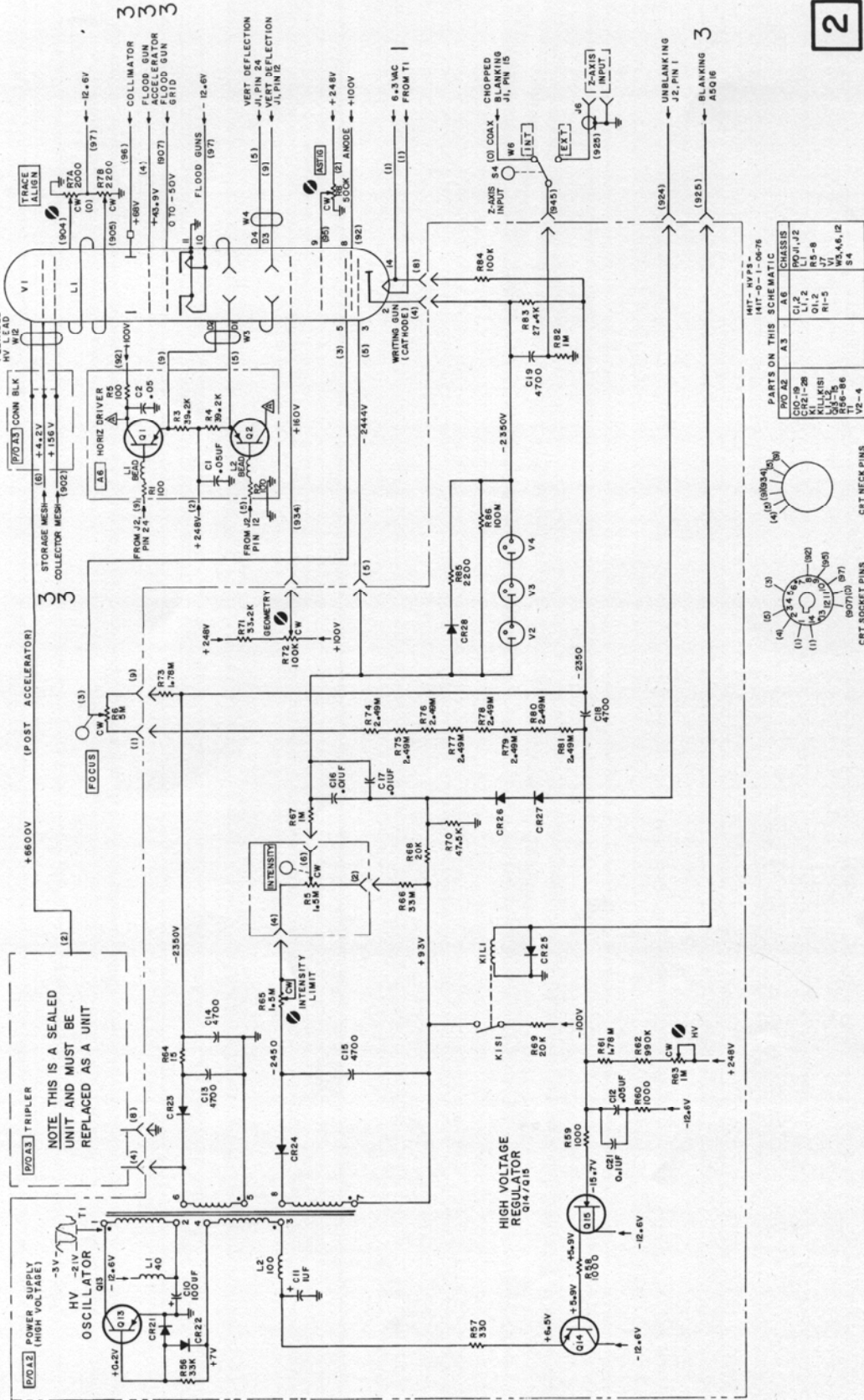

PARTS ON THIS SCHEMATIC

CR10-19	A3	CR10-19	A3
CR12-28	A6	CR12-28	A6
KILL-K151	L1,2	KILL-K151	L1,2
G14/G15	J7	G14/G15	J7
T106-96	R1-5	T106-96	R1-5
V2-4	W5, A6, I2	V2-4	W5, A6, I2
	S4		S4

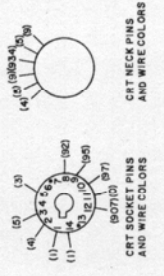

2

Figure 8-13. High Voltage Schematic 8-17

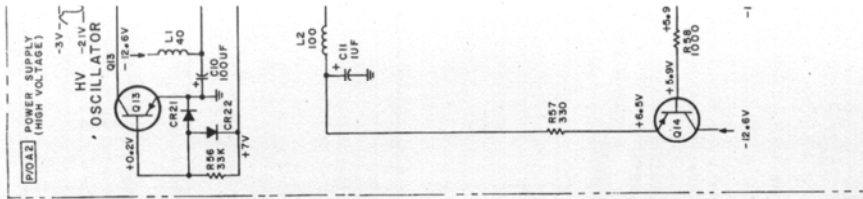
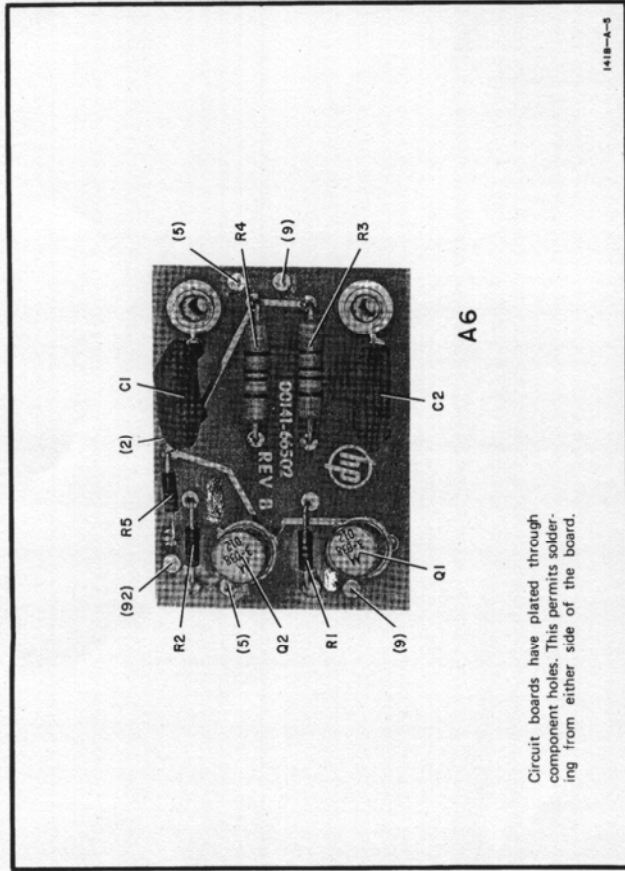

Figure 8-12. Component Identification, Horizontal Driver A6



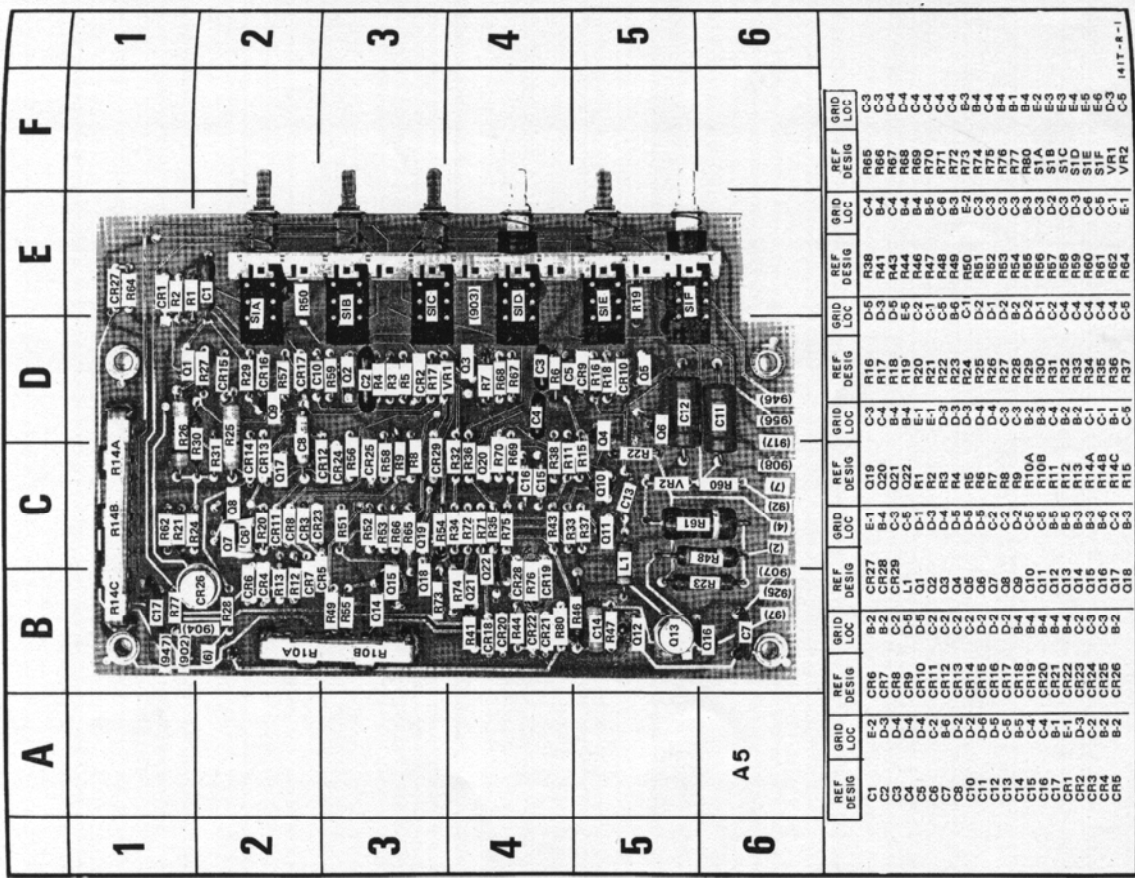

Figure 8-14. Component Identification, Pulse Circuit A5

CONDITIONS FOR WAVE]

1. Set the PERSISTENCE and INTENSITY controls fully cw and the sweep time and vertical deflection as indicated for each waveform. All waveforms are referenced to chassis ground.

NOT

Voltage levels showing waveform for reference only somewhat with 1 of each instrumen

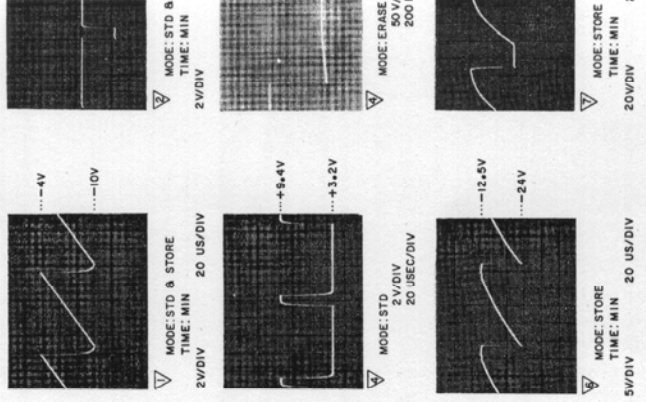
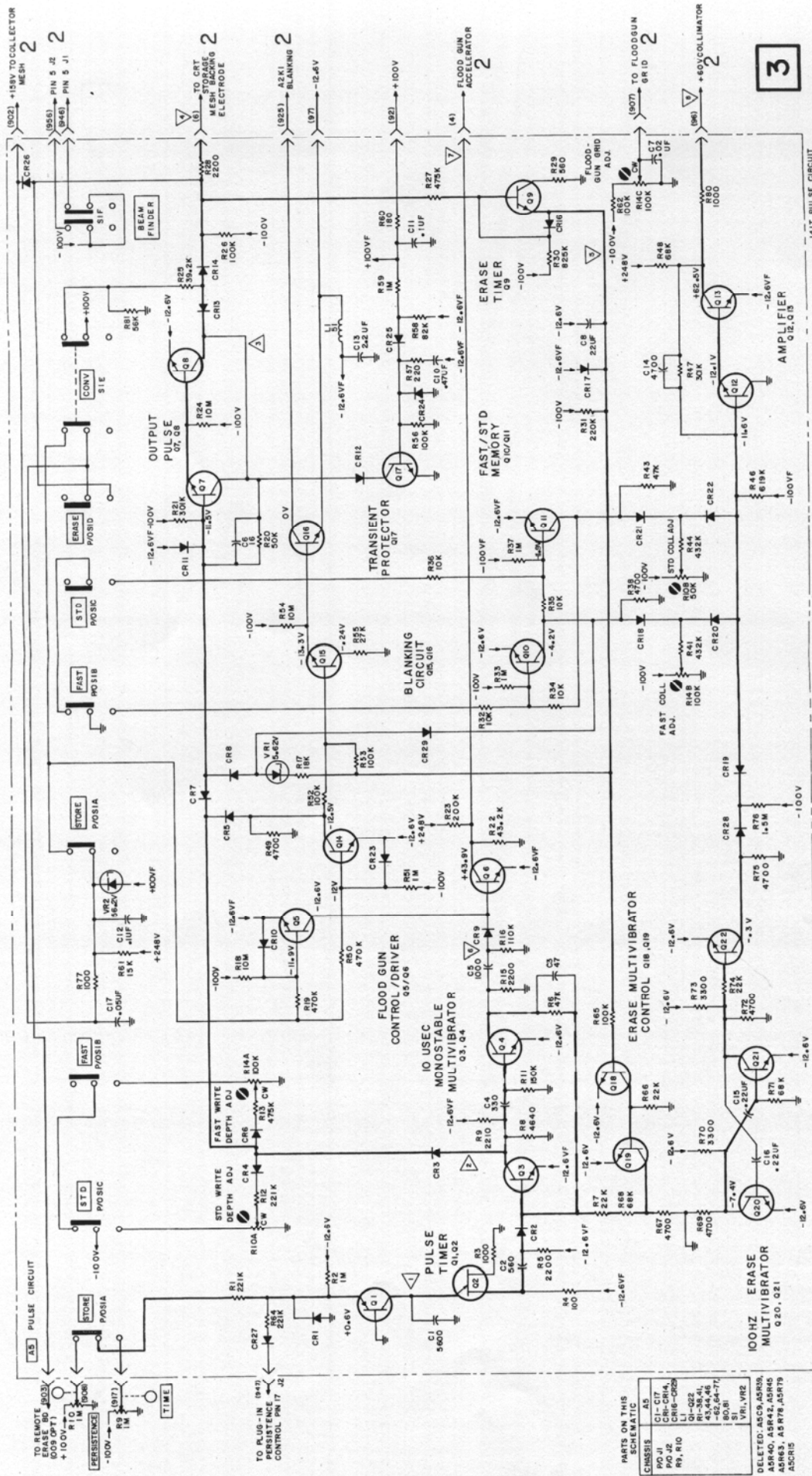

Figure 8-15.



PARTS ON THIS SCHEMATIC

CHASSIS	AS
6X4	6X4
6X5	6X5
6X6	6X6
6X7	6X7
6X8	6X8
6X9	6X9
6X10	6X10
6X11	6X11
6X12	6X12
6X13	6X13
6X14	6X14
6X15	6X15
6X16	6X16
6X17	6X17
6X18	6X18
6X19	6X19
6X20	6X20
6X21	6X21
6X22	6X22
6X23	6X23
6X24	6X24
6X25	6X25
6X26	6X26
6X27	6X27
6X28	6X28
6X29	6X29
6X30	6X30
6X31	6X31
6X32	6X32
6X33	6X33
6X34	6X34
6X35	6X35
6X36	6X36
6X37	6X37
6X38	6X38
6X39	6X39
6X40	6X40
6X41	6X41
6X42	6X42
6X43	6X43
6X44	6X44
6X45	6X45
6X46	6X46
6X47	6X47
6X48	6X48
6X49	6X49
6X50	6X50
6X51	6X51
6X52	6X52
6X53	6X53
6X54	6X54
6X55	6X55
6X56	6X56
6X57	6X57
6X58	6X58
6X59	6X59
6X60	6X60
6X61	6X61
6X62	6X62
6X63	6X63
6X64	6X64
6X65	6X65
6X66	6X66
6X67	6X67
6X68	6X68
6X69	6X69
6X70	6X70
6X71	6X71
6X72	6X72
6X73	6X73
6X74	6X74
6X75	6X75
6X76	6X76
6X77	6X77
6X78	6X78
6X79	6X79
6X80	6X80
6X81	6X81
6X82	6X82
6X83	6X83
6X84	6X84
6X85	6X85
6X86	6X86
6X87	6X87
6X88	6X88
6X89	6X89
6X90	6X90
6X91	6X91
6X92	6X92
6X93	6X93
6X94	6X94
6X95	6X95
6X96	6X96
6X97	6X97
6X98	6X98
6X99	6X99
6X100	6X100

DELETED: ASC9, ASR9, ASR40, ASR41, ASR42, ASR43, ASR44, ASR45, ASR46, ASR47, ASR48, ASR49, ASR50, ASR51, ASR52, ASR53, ASR54, ASR55, ASR56, ASR57, ASR58, ASR59, ASR60, ASR61, ASR62, ASR63, ASR64, ASR65, ASR66, ASR67, ASR68, ASR69, ASR70, ASR71, ASR72, ASR73, ASR74, ASR75, ASR76, ASR77, ASR78, ASR79, ASR80, ASR81, ASR82, ASR83, ASR84, ASR85, ASR86, ASR87, ASR88, ASR89, ASR90, ASR91, ASR92, ASR93, ASR94, ASR95, ASR96, ASR97, ASR98, ASR99, ASR100.

Figure 8-16  
Pulse Circuit Schematic  
8-19

	1	2	3	4	5	6
--	---	---	---	---	---	---

CONDITIONS FOR WAVEFORM MEASUREMENT

1. Set the PERSISTENCE and INTENSITY controls fully ccw and the sweep time and vertical deflection as indicated for each waveform. All waveforms are referenced to chassis ground.
2. DC voltage measurements shown on the schematic diagram are measured in the STD mode of operation and referenced to chassis ground. The PERSISTENCE and INTENSITY controls are set fully ccw.

NOTE

Voltage levels shown in the following waveforms are intended for reference only and may vary somewhat with the adjustment of each instrument.

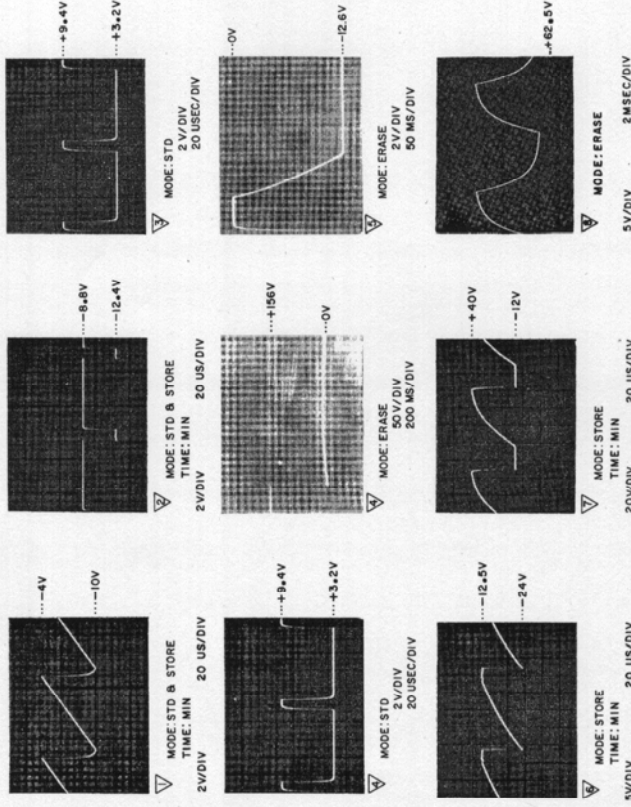

H1B-C-2  
CHANGED 7-75

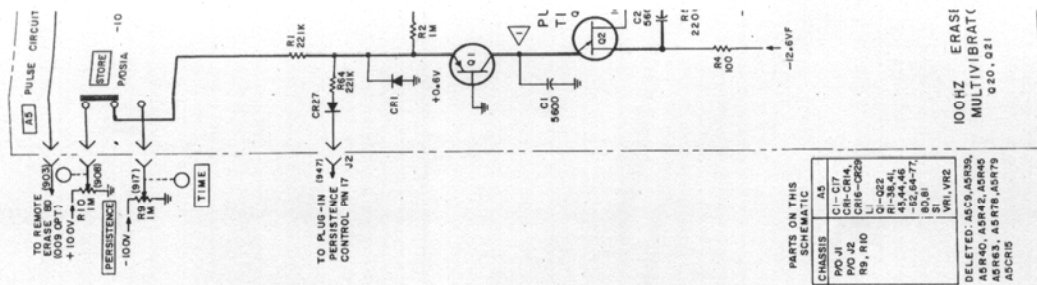

- PARTS ON THIS SCHEMATIC
- |         |          |
|---------|----------|
| CHASSIS | CI-67    |
| CR1     | CR1-CR4  |
| CR2     | CR2-CR6  |
| CR7     | CR7-CR8  |
| R1, R4  | R1, R4   |
| C1      | C1-C2    |
| T1      | T1       |
| S1      | S1       |
| SR1     | SR1, VR2 |
- DELETED: A0C9, A0R0, A0R1, A0R2, A0R3, A0R4, A0R5, A0R6, A0R7, A0R8, A0R9, A0S1, A0S2, A0S3, A0S4, A0S5, A0S6, A0S7, A0S8, A0S9, A0T1, A0T2, A0T3, A0T4, A0T5, A0T6, A0T7, A0T8, A0T9, A0V1, A0V2, A0V3, A0V4, A0V5, A0V6, A0V7, A0V8, A0V9, A0W1, A0W2, A0W3, A0W4, A0W5, A0W6, A0W7, A0W8, A0W9, A0X1, A0X2, A0X3, A0X4, A0X5, A0X6, A0X7, A0X8, A0X9, A0Y1, A0Y2, A0Y3, A0Y4, A0Y5, A0Y6, A0Y7, A0Y8, A0Y9, A0Z1, A0Z2, A0Z3, A0Z4, A0Z5, A0Z6, A0Z7, A0Z8, A0Z9

Figure 8-15. Waveforms