

Errata

Title & Document Type: 8620B Sweep Oscillator Service Note

Manual Part Number: 8620B-3

Revision Date: September 1974

About this Manual

We've added this manual to the Agilent website in an effort to help you support your product. This manual provides the best information we could find. It may be incomplete or contain dated information, and the scan quality may not be ideal. If we find a better copy in the future, we will add it to the Agilent website.

HP References in this Manual

This manual may contain references to HP or Hewlett-Packard. Please note that Hewlett-Packard's former test and measurement, life sciences, and chemical analysis businesses are now part of Agilent Technologies. The HP XXXX referred to in this document is now the Agilent XXXX. For example, model number HP8648A is now model number Agilent 8648A. We have made no changes to this manual copy.

Support for Your Product

Agilent no longer sells or supports this product. You will find any other available product information on the Agilent Test & Measurement website:

www.agilent.com

Search for the model number of this product, and the resulting product page will guide you to any available information. Our service centers may be able to perform calibration if no repair parts are needed, but no other support from Agilent is available.



Agilent Technologies

SERVICE NOTE

Supersedes:

NONE

HP MODEL 8620B SWEEP OSCILLATOR

All Serial Numbers

MODIFICATION REQUIRED FOR 86290A

2.0 - 18.0 GHz Plug-In Compatibility

All 8620B Sweep Oscillator mainframes must be modified to be compatible with the 86290A 2.0 to 18.0 GHz Plug-In.

The modification replaces the A1 Sweep Oscillator board assembly with HP Part Number 08620-60095. The new A1 assembly has a sweep inhibit function that is necessary for the 86290A, when used in the sequential sweep mode. If a 86290A is installed in an unmodified 8620B, the 2.0 to 18.0 GHz annunciator light will blink when band 4 Sequential Sweep is selected.

Additional modification to the 8620B may be necessary depending on the serial prefix. The table to the right should be used to determine which modifications are required.

8620B Serial Prefix		Modification Required
8620B	1135A and below	I, II and III
8620B	1309A and below	II and III
8620B	All	III

A Modification Kit, HP Part Number 08620-60100, contains all the parts and instructions necessary for these modifications. The kit is available through your nearest HP Sales Office.

PARTS INCLUDED IN MODIFICATION KIT 08620-60100

Qty.	Description	HP Part No.
1	A1 Sweep Generator Board	08620-60095
1	Wire Insulated, Brown 5 inches (127 mm) 5/4 inches (133 mm)	8150-0448
1	Wire, Insulated, Black 1 1/4 inches (45 mm)	8150-0447
1	Wire Insulated, White/Red/Violet 4 inches (102 mm)	8150-0485
1	2.0-6.2 GHz Dial Scale	86290-00018
1	6.0-12.4 GHz Dial Scale	86290-00019
1	12.0-18.0 GHz Dial Scale	86290-00032
1	2.0-18.0 GHz Dial Scale	86290-00033
1	Service Note, 8620B-3	

JA/ks/WN

9/74-45

HEWLETT  PACKARD

For more information, call your local HP Sales Office or East (201) 265-5000 • Midwest (312) 677-0400 • South (404) 436-6181 • West (213) 877-1281. Or, write: Hewlett-Packard, 1501 Page Mill Road, Palo Alto, California 94304. In Europe, Post Office Box 85, CH-1217 Meyrin 2, Geneva, Switzerland. In Japan, Yokogawa-Hewlett-Packard, 1-59-1, Yoyogi, Shibuya-Ku, Tokyo, 151.

Modification I for 8620B Serial Prefix 1135 and Below

This modification changes the wiring on the rear panel assembly to be compatible with the 08620-60095 A1 Sweep Board supplied with this Modification Kit. After this modification negative blanking is available at J9 Connector and the Penlift Signal is available at the Z-axis connector J5.

Procedure for Modification I:

1. Disconnect 8620B from the power line.
2. Remove the top cover.

3. Remove R8 1960 Ohm and R9 1100 Ohm resistors from the Z-axis J5 output connector.
4. Cut the white, red, green (925) wire from the Penlift output J8.
5. Connect the (925) wire just removed to the Z-axis output J5.
6. Modify the wiring to the blanking switch S-8 on the rear panel as described below. Figure 1 shows the pin numbering of S-8. S-8 is the three-position slide switch on the rear panel located nearest the fan.

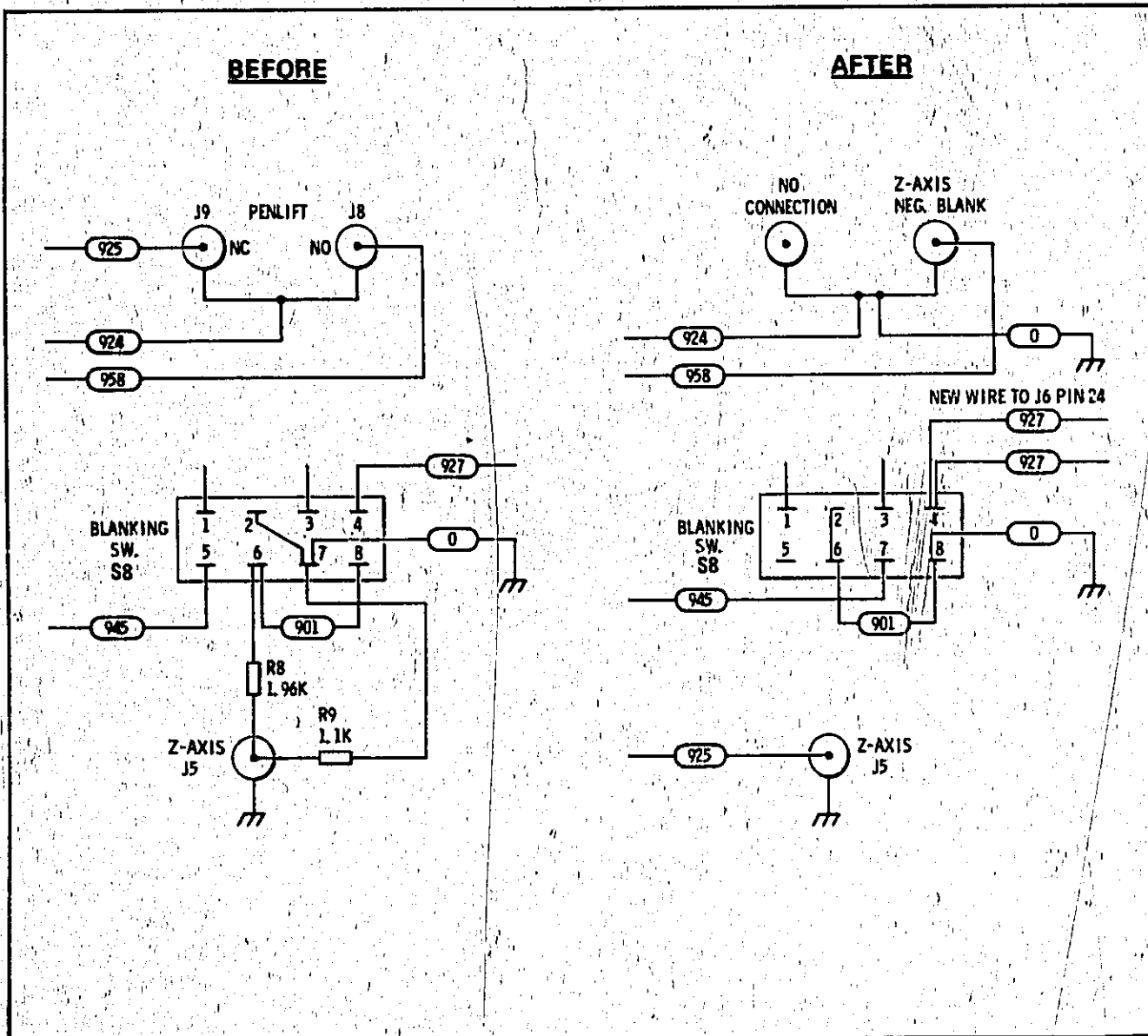

Figure 1. Blanking Switch Wiring Diagram Before And After Modification

- A. Cut the white/yellow/green (945) wire from pin 5.
 - B. Remove R8 1960 Ohm and R9 1100 Ohm resistors from pins 6 and 7.
 - C. Install a short bare wire jumper from Pin 2 to Pin 6. The end of the resistor just removed can be used.
 - D. Remove the bare wire jumper between pins 2 and 7.
 - E. Remove the black (0) wire from pin 7.
 - F. Connect the black wire just removed to pin 8.
 - G. Connect the (945) wire removed in Step A to pin 7.
 - H. Connect a black (0) wire from the junction of J8, J9, and the white/red/yellow (924) wire to chassis ground, the solder lug under the nut securing for J8.
 - I. Connect one end of the white/red/violet (927) wire from the Modification Kit to Pin 4.
7. The other end of the (927) wire from the Modification Kit connects to the RF section interface connector J6, Pin 24. To gain access to J6, the two screws securing it to the rear panel should be removed. The added wire should be routed with the main wiring harness.
 8. Do Modification II.

Modification II for 8620B Prefix 1309A and Below

This modification adds two jumpers to the A11 Master Board and removes three unused components from the A7 Operations Control Board Assembly.

Procedure for Modification II:

1. Disconnect 8620B from the power line.

2. Remove the bottom cover.
3. Install one of the brown wires from the Modification Kit between XA1, Pin D, and XA7, Pin P. (See Figure 2 for proper routing.)
4. Install the second brown wire between XA1, Pin M, and XA7, Pin 7.
5. Replace the bottom cover.
6. Remove the top cover.
7. Remove the A7 Operations Control Board Assembly.
8. Remove the following components from the A7 board Q7, R20, and R21. See Figure 3 for component location.
9. Do Modification III.

Modification III for 8620B, All Serials

This modification replaces the A1 Sweep Board Assembly. The new Sweep Board (HP Part Number 08620-60095) has a sweep inhibit function.

Procedure for Modification III:

1. Disconnect 8620B from the power line.
2. Remove top cover.
3. Remove and discard the A1 Sweep Board.
4. Before installing the A1 Sweep Board from the Modification Kit, ensure that the jumper wires are in the correct position for the particular mainframe being modified. See Figure 4 for correct jumper position.
5. After installing the A1 Board, it should be adjusted per the adjustment section of this Service Note.
6. Replace the top cover on the 8620B.
7. Correct your Operating and Service Manual by adding the attached schematic, parts list, and adjustment procedure for the 08620-60095 Sweep Board.

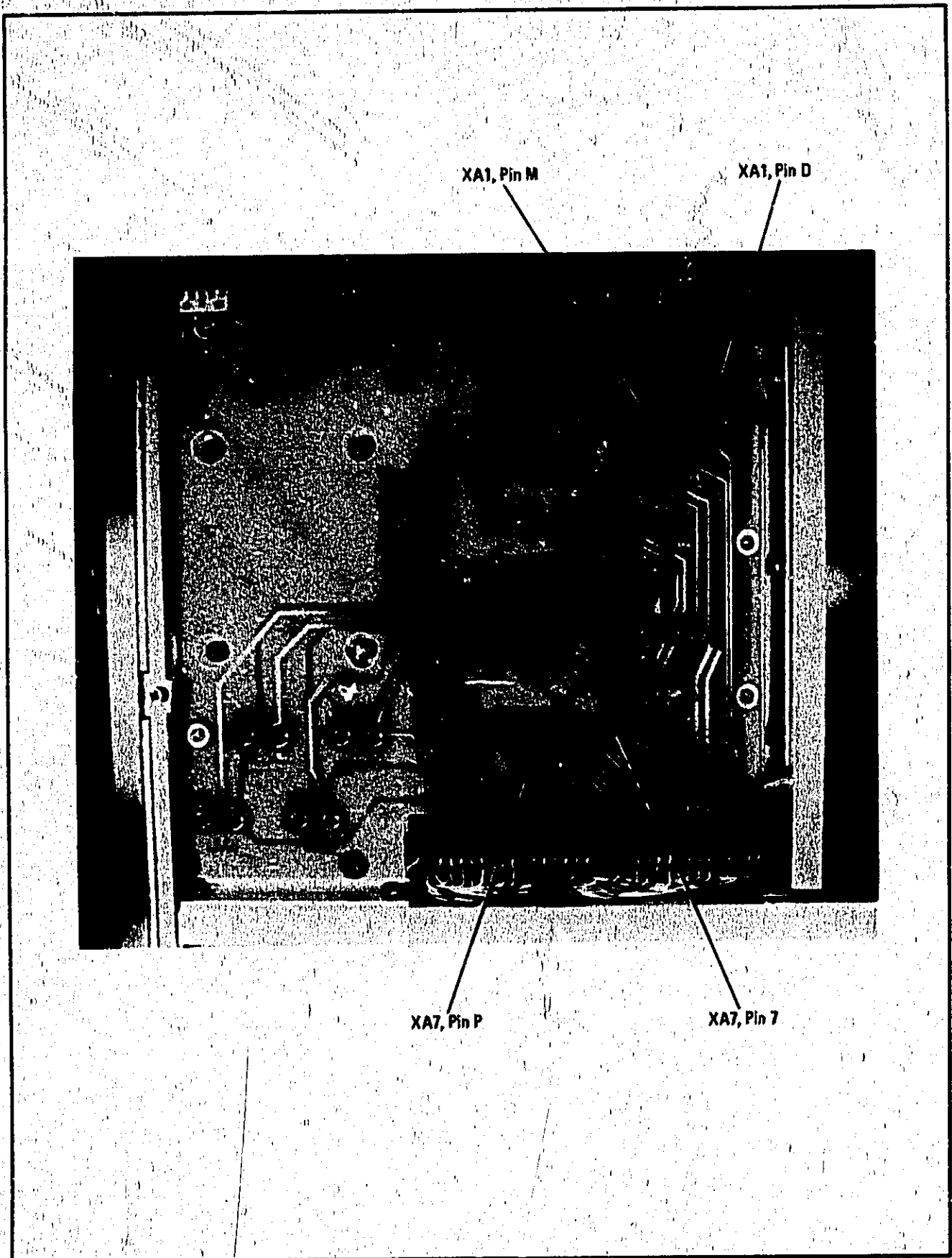

Figure 2. Master Board After Modification

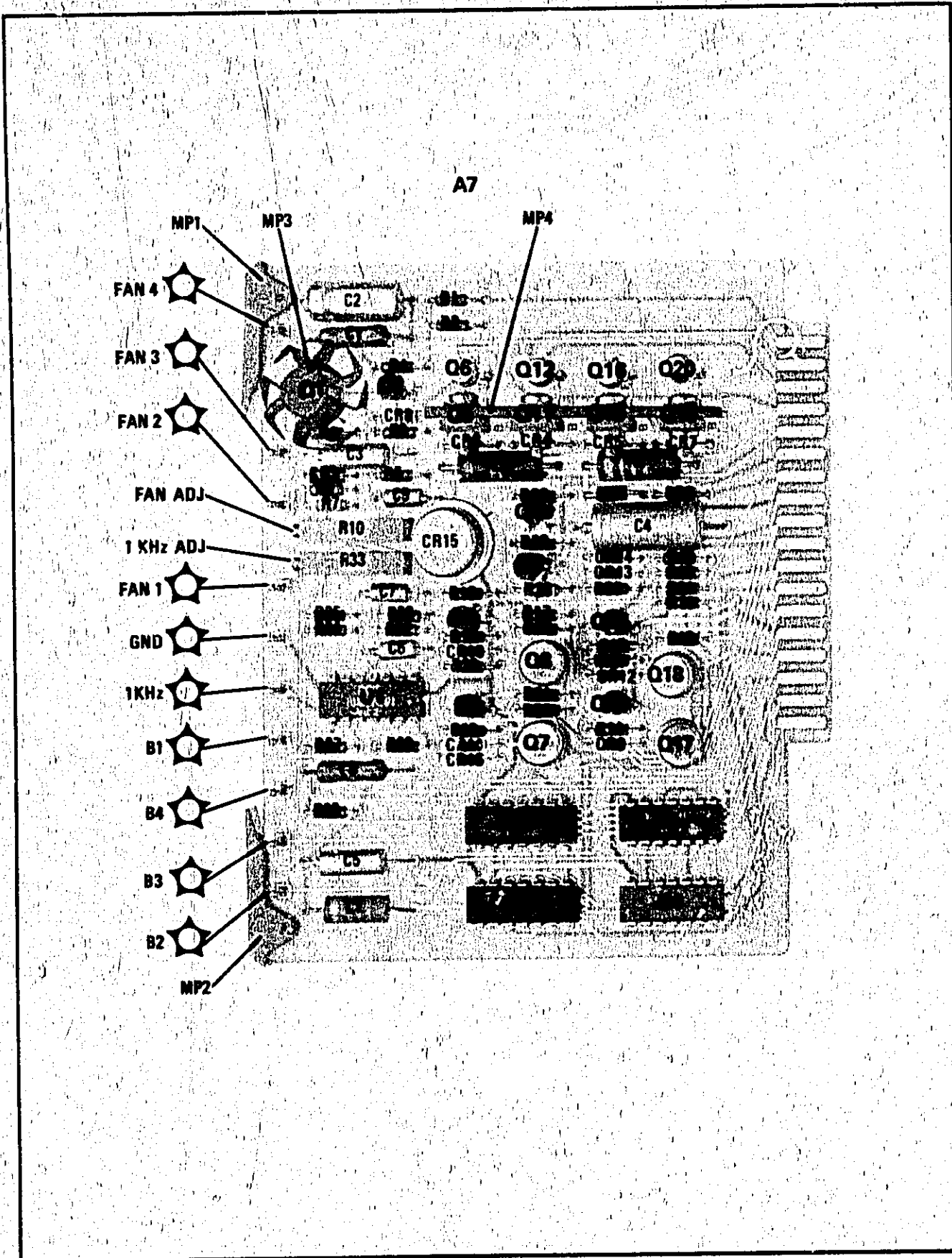
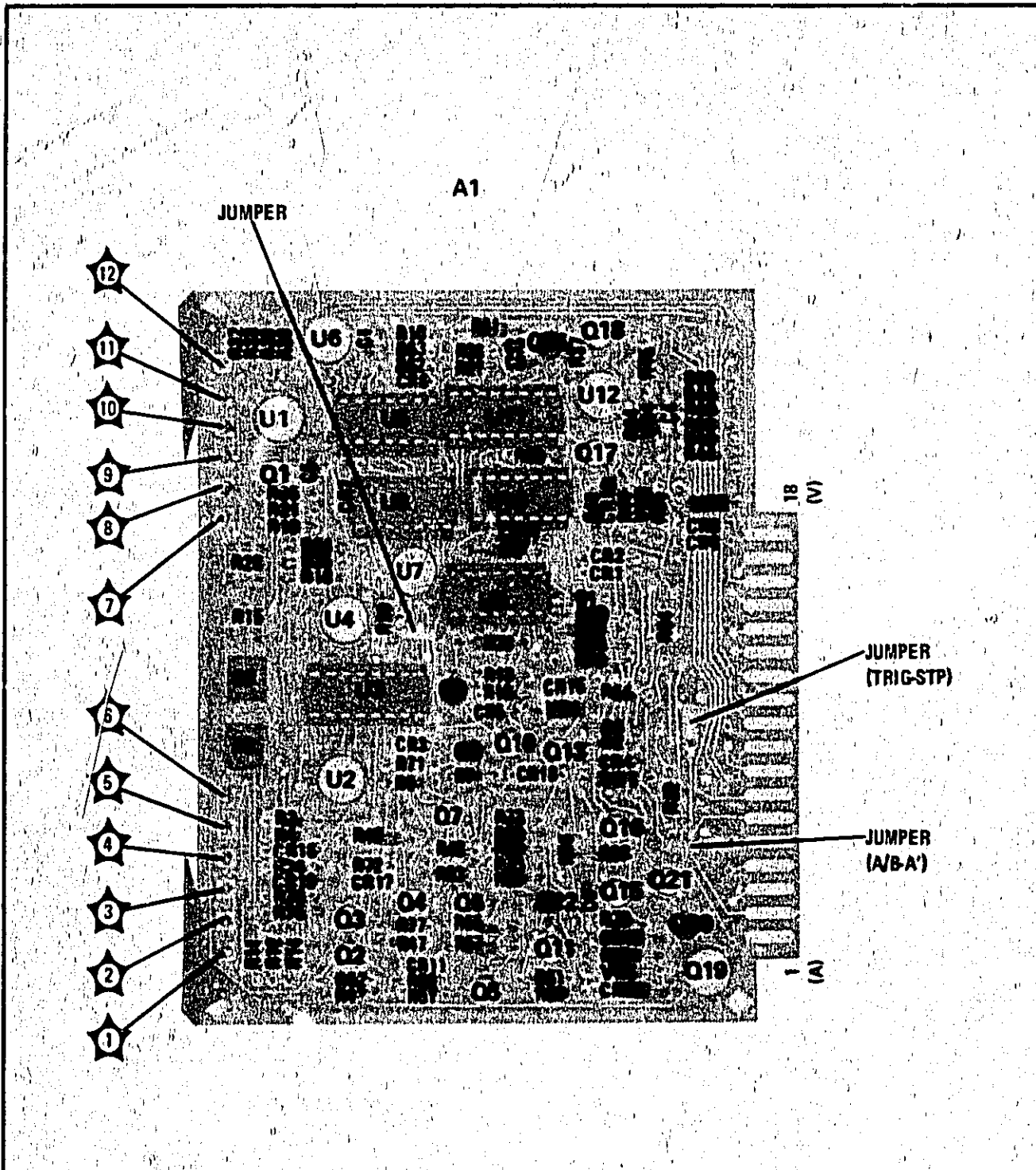

Figure 3. A7 Operations Control Board Assembly Component Locations



NOTE 1 JUMPER (A/B-A) should be in the A/B position when used in the 8620B as shown.

NOTE 2 JUMPER (TRIG-STP) should be in the TRIG position as shown.

Figure 4. A1 Sweep Generator Assembly, Jumper Position

MANUAL CHANGES FOR MODIFICATION III

Page 5-5/5-6:

Add the following after paragraph 5-14:

Reference Designation	Adjustment Paragraph	Name on Board	Function Adjusted
A1R9	5-15	SWP	Adjusts sweep time
A1R8	5-15	RET	Adjust sweep return time
A1R28	5-15	OFFFSET	Adjusts symmetry of sweep time to sweep return time
A1R15	5-15	RANGE	Adjusts minimum sweep time at slowest sweep-speed setting of TIME-SECONDS vernier.

Page 5-6:

Add Figure 5-3 in this SERVICE NOTE.

Page 5-5:

Add the following Adjustment Procedure after Paragraph 5-14:

5-15. SWEEP GENERATOR BOARD ADJUSTMENTS

REFERENCE:

Service Sheet 1, SWEEP GENERATOR ASSEMBLY.

DESCRIPTION:

Set correct sweep time, sweep return time, symmetry, and range of the negative blanking signal.

EQUIPMENT:

Oscilloscope HP 180A/1801A/1820A
 10:1 Probe HP 10004B
 1:1 Probe HP 10008B

PROCEDURE:

- a. Connect oscilloscope VERTICAL input to A1TP9 (10:1 probe), and ground lead to A1TP12.
- b. Connect oscilloscope EXT TRIGGER input to A1TP9 (1:1 probe), and set oscilloscope trigger controls to "EXT," "NORM," and "(−)" SLOPE.
- c. Set 8620B function switch S2 to S/S position.
- d. Set 8620B "TRIGGER" switch to "AUTO."
- e. Set 8620B "TIME" switch to "FAST," and turn sweep time vernier fully clockwise.

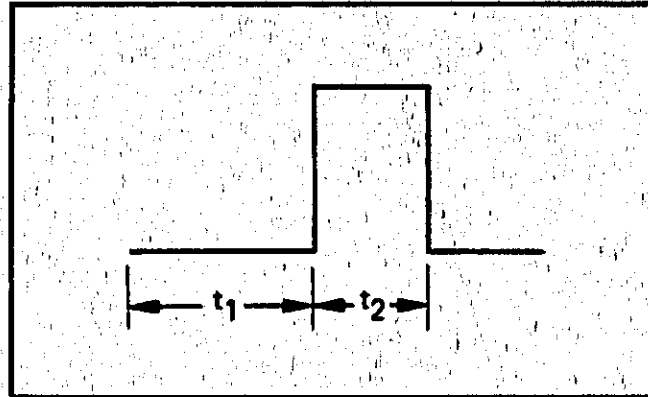

Figure 5-4. Oscilloscope Display of Waveform Symmetry

- f. Adjust oscilloscope for display as shown in Figure 5-4.
- g. Set A1R15 RANGE and A1R28 OFFSET controls to center of range.
- h. Adjust A1R9 SWP control for $t_1 = 10.8$ msec. Adjust A1R8 RET control for $t_2 = 5.4$ msec.
- i. Set 8620B TIME-SECONDS vernier fully counterclockwise. Connect a 19.6K 1% resistor between A1TP4 and A1TP12.
- j. Adjust oscilloscope sweep time so t_1 occupies 6.5 divisions of the display. Adjust A1R28 OFFSET control so t_2 occupies 1.0 division of the display. Symmetry is now 6.5:1.
- k. Remove 19.6K resistor. With oscilloscope sweep time in a calibrated mode, adjust A1R15 RANGE control for $t_1 = 648$ msec.
- l. Connect 19.6K resistor between A1TP4 and A1TP12. Verify symmetry between 6.5:0.7 and 6.5:1.3.
- m. Set 8620B sweep time vernier fully clockwise: t_1 should be between 32.5 ms and 37.5 ms (19.6K resistor still connected); if not, select a new value between 51.1K Ohm and 110K Ohm for A1R2.

Page 6-4, Table 6-3:

Replace Table 6-3 A1 Sweep Generator Assy with Table 6-3 A1 Sweep Generator Assy in this SERVICE NOTE.

Page 8-12:

Add Figure 8-11A (1 of 3) in this SERVICE NOTE.

Page 8-16, Figure 8-13:

Replace Figure 8-13 with Figure 8-13 in this SERVICE NOTE.

Page 8-17, Figure 8-14:

Replace Figure 8-14 with Figure 8-14A (1 of 2) in this SERVICE NOTE.

Page 8-17, Figure 8-14:

Add Figure 8-14B (2 of 2) in this SERVICE NOTE.

Page 8-31, Figure 8-28:

Replace Figure 8-28 with Figure 8-28A in this SERVICE NOTE.

Page 8-31, Figure 8-28:

Add Figure 8-28B in this SERVICE NOTE.

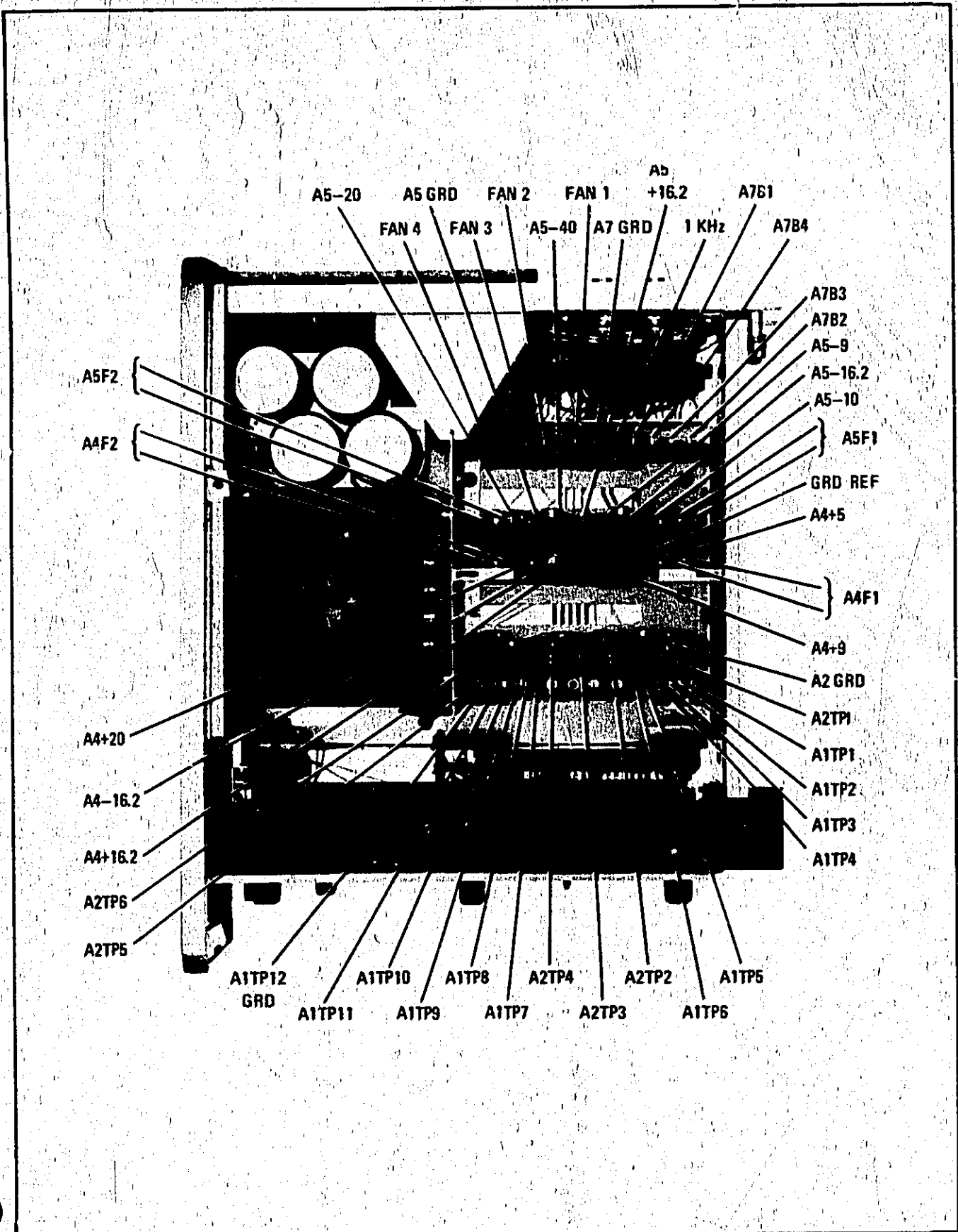

Figure 5-3. Location of Test Points

Table 6-3. Replaceable Parts (1 of 3)

Reference Designation	HP Part Number	Qty	Description	Mfr Code	Mfr Part Number
A1	00620-00035	1	BOARD Assy	28480	00620-00035
A1C1	0160-3879	1	CAPACITOR-FRD 1000PF 0-20V 100MVDC LEM	28480	0160-3879
A1C2	0160-0572	2	CAPACITOR-FRD 2000PF 0-20V 100MVDC LEM	28480	0160-0572
A1C3	0160-0572	2	CAPACITOR-FRD 2000PF 0-20V 100MVDC LEM	28480	0160-0572
A1C4	0180-1735	1	CAPACITOR-FALC 2200PF 100V 35VDC TA	50289	150E220K9035A2
A1C5	0160-3879	2	CAPACITOR-FRD 1000PF 0-20V 100MVDC LEM	28480	0160-3879
A1C6	0160-3879	2	CAPACITOR-FRD 1000PF 0-20V 100MVDC LEM	28480	0160-3879
A1C11	1901-0040	15	DIODE-SWITCHING 2AS 30V 50MA	28480	1901-0040
A1C12	1901-0040	15	DIODE-SWITCHING 2AS 30V 50MA	28480	1901-0040
A1C13	1901-0040	15	DIODE-SWITCHING 2AS 30V 50MA	28480	1901-0040
A1C14	1901-0040	15	DIODE-SWITCHING 2AS 30V 50MA	28480	1901-0040
A1C15	1901-0040	15	DIODE-SWITCHING 2AS 30V 50MA	28480	1901-0040
A1C16	1911-0040	15	DIODE-SWITCHING 2AS 30V 50MA	28480	1901-0040
A1C17	1901-0040	15	DIODE-SWITCHING 2AS 30V 50MA	28480	1901-0040
A1C18	1901-0040	15	DIODE-SWITCHING 2AS 30V 50MA	28480	1901-0040
A1C19	1901-0040	15	DIODE-SWITCHING 2AS 30V 50MA	28480	1901-0040
A1C20	1910-0010	2	DIODE-SWITCHING 1US 60V 50MA	28480	1910-0010
A1C21	1901-0040	15	DIODE-SWITCHING 2AS 30V 50MA	28480	1901-0040
A1C22	1901-0033	1	DIODE-GEN PNP 100V 200MA	28480	1901-0033
A1C23	1901-0033	1	DIODE-PWR RELT 500V 750MA	06713	501358-4
A1C24	1901-0010	2	DIODE-SWITCHING 1US 60V 50MA	28480	1910-0010
A1C25	1901-0040	15	DIODE-SWITCHING 2AS 30V 50MA	28480	1901-0040
A1C26	1901-0040	15	DIODE-SWITCHING 2AS 30V 50MA	28480	1901-0040
A1C27	1901-0040	15	DIODE-SWITCHING 2AS 30V 50MA	28480	1901-0040
A1C28	1901-0040	15	DIODE-SWITCHING 2AS 30V 50MA	28480	1901-0040
A1C29	1901-0040	15	DIODE-SWITCHING 2AS 30V 50MA	28480	1901-0040
A1P1	4040-0749	2	EXTRACTOR-PL 30A11, 8P016	28480	4040-0749
A1P2	4040-0749	2	EXTRACTOR-PL 30A11, 8P016	28480	4040-0749
A1S1	1854-0404	11	TRANSISTOR NPN SI 10-18 P=300M	28480	1854-0404
A1S2	1854-0404	11	TRANSISTOR NPN SI 10-18 P=300M	28480	1854-0404
A1S3	1854-0404	11	TRANSISTOR NPN SI 10-18 P=300M	28480	1854-0404
A1S4	1854-0404	11	TRANSISTOR NPN SI 10-18 P=300M	28480	1854-0404
A1S5	1854-0404	11	TRANSISTOR NPN SI 10-18 P=300M	28480	1854-0404
A1S6	1854-0404	11	TRANSISTOR NPN SI 10-18 P=300M	28480	1854-0404
A1S7	1854-0404	11	TRANSISTOR NPN SI 10-18 P=300M	28480	1854-0404
A1S8	1854-0404	11	TRANSISTOR NPN SI 10-18 P=300M	28480	1854-0404
A1S9	1854-0404	11	TRANSISTOR NPN SI 10-18 P=300M	28480	1854-0404
A1S10	1854-0404	11	TRANSISTOR NPN SI 10-18 P=300M	28480	1854-0404
A1S11	1854-0404	11	TRANSISTOR NPN SI 10-18 P=300M	28480	1854-0404
A1S12	1854-0404	11	TRANSISTOR NPN SI 10-18 P=300M	28480	1854-0404
A1S13	1854-0404	11	TRANSISTOR NPN SI 10-18 P=300M	28480	1854-0404
A1S14	1854-0404	11	TRANSISTOR NPN SI 10-18 P=300M	28480	1854-0404
A1S15	1854-0404	11	TRANSISTOR NPN SI 10-18 P=300M	28480	1854-0404
A1S16	1854-0404	11	TRANSISTOR NPN SI 10-18 P=300M	28480	1854-0404
A1S17	1854-0404	11	TRANSISTOR NPN SI 10-18 P=300M	28480	1854-0404
A1S18	1854-0404	11	TRANSISTOR NPN SI 10-18 P=300M	28480	1854-0404
A1S19	1854-0404	11	TRANSISTOR NPN SI 10-18 P=300M	28480	1854-0404
A1S20	1854-0404	11	TRANSISTOR NPN SI 10-18 P=300M	28480	1854-0404
A1S21	1854-0404	11	TRANSISTOR NPN SI 10-18 P=300M	28480	1854-0404
A1R1	0098-7230	0	RESISTOR 1K 25 0.5W F TUBULAR	24546	C3-1/8-TU-1001-G
A1R2	0098-7230	0	RESISTOR 1K 25 0.5W F TUBULAR	24546	C3-1/8-TU-1001-G
A1R3	0098-7230	0	RESISTOR 1K 25 0.5W F TUBULAR	24546	C3-1/8-TU-1001-G
A1R4	0098-7277	3	RESISTOR 1K 25 0.5W F TUBULAR	24546	C3-1/8-TU-5112-G
A1R5	0098-7230	0	RESISTOR 1K 25 0.5W F TUBULAR	24546	C3-1/8-TU-1002-G
A1R6	0098-7272	3	RESISTOR 1K 25 0.5W F TUBULAR	24546	C3-1/8-TU-3102-G
A1R7	0098-7204	1	RESISTOR 1K 25 0.5W F TUBULAR	24546	C3-1/8-TU-1212-G
A1R8	2100-2517	2	RESISTOR VARI 100K 500M 100 L	19701	E75C8503
A1R9	2100-2517	2	RESISTOR VARI 100K 500M 100 L	19701	E75C8503
A1R10	0098-7230	0	RESISTOR 1K 25 0.5W F TUBULAR	24546	C3-1/8-TU-1002-G
A1R11	0098-7247	2	RESISTOR 1K 25 0.5W F TUBULAR	24546	C3-1/8-TU-2071-G
A1R12	0098-7247	2	RESISTOR 1K 25 0.5W F TUBULAR	24546	C3-1/8-TU-2071-G
A1R13	0098-7273	1	RESISTOR 1K 25 0.5W F TUBULAR	24546	C3-1/8-TU-4722-G
A1R14	0098-7230	0	RESISTOR 1K 25 0.5W F TUBULAR	24546	C3-1/8-TU-1211-G
A1R15	2100-2517	1	RESISTOR VARI 100K 500M 100 L	19701	E75C8500
A1R16	0098-7230	0	RESISTOR 1K 25 0.5W F TUBULAR	24546	C3-1/8-TU-1002-G
A1R17	0098-7230	0	RESISTOR 1K 25 0.5W F TUBULAR	19701	MF4C1/8-TU-1001-B
A1R18	0098-7230	0	RESISTOR 1K 25 0.5W F TUBULAR	19701	MF4C1/8-TU-1001-B
A1R19	0098-7243	5	RESISTOR 1K 25 0.5W F TUBULAR	24546	C3-1/8-TU-1901-G
A1R20	0098-7230	0	RESISTOR 1K 25 0.5W F TUBULAR	01121	01121

Table 6-3. Replaceable Parts (2 of 3)

Reference Designation	HP Part Number	Qty	Description	Mfr Code	Mfr Part Number
A1H21	0698-7201	2	RESISTOR 10K 25 125W F TUBULAR	24546	C3-178-TU-1012-G
A1H22	0698-7277	1	RESISTOR 51.1K 25 125W F TUBULAR	24546	C3-178-TU-5112-G
A1H23	0698-7202	1	RESISTOR 10K 25 125W F TUBULAR	01121	LE1C65
A1H24	0698-7202	1	RESISTOR 1K 25 125W F TUBULAR	19701	MFAC178-19-1001-B
A1H25	0698-7202	1	RESISTOR 1K 25 125W F TUBULAR	19701	MFAC178-19-1001-B
A1H26	0698-7200	1	RESISTOR 10K 25 125W F TUBULAR	24546	C3-178-TU-1002-G
A1H27	0698-7200	1	RESISTOR 10K 25 125W F TUBULAR	24546	C3-178-TU-1002-G
A1H28	2100-2510	1	RESISTOR VARI 10K 25 125W F TUBULAR	28400	Z10L-2510
A1H29	0698-7200	1	RESISTOR 10K 25 125W F TUBULAR	24546	C3-178-TU-5021-B
A1H30	0698-7277	2	RESISTOR 51.1K 25 125W F TUBULAR	24546	C3-178-TU-5112-G
A1H31	0698-7200	1	RESISTOR 10K 25 125W F TUBULAR	01121	LE1C65
A1H32	0698-7200	1	RESISTOR 10K 25 125W F TUBULAR	24546	C3-178-TU-1002-G
A1H33	0698-7200	1	RESISTOR 10K 25 125W F TUBULAR	24546	C3-178-TU-1002-G
A1H34	0698-7200	1	RESISTOR 10K 25 125W F TUBULAR	24546	C3-178-TU-1002-G
A1H35	0698-7200	1	RESISTOR 10K 25 125W F TUBULAR	24546	C3-178-TU-1002-G
A1H36	0698-7277	1	RESISTOR 51.1K 25 125W F TUBULAR	24546	C3-178-TU-5112-G
A1H37	0698-7277	1	RESISTOR 51.1K 25 125W F TUBULAR	24546	C3-178-TU-5112-G
A1H38	0698-7277	1	RESISTOR 51.1K 25 125W F TUBULAR	24546	C3-178-TU-5112-G
A1H39	0698-7200	1	RESISTOR 10K 25 125W F TUBULAR	24546	C3-178-TU-1002-G
A1H40	0698-7200	1	RESISTOR 10K 25 125W F TUBULAR	24546	C3-178-TU-1002-G
A1H41	0698-7277	1	RESISTOR 51.1K 25 125W F TUBULAR	24546	C3-178-TU-5112-G
A1H42	0698-7216	1	RESISTOR 51.1K 25 125W F TUBULAR	24546	C3-178-TU-5112-G
A1H43	0698-7229	1	RESISTOR 51.1K 25 125W F TUBULAR	24546	C3-178-TU-5112-G
A1H44	0698-7200	1	RESISTOR 10K 25 125W F TUBULAR	24546	C3-178-TU-1002-G
A1H45	0698-7200	1	RESISTOR 10K 25 125W F TUBULAR	24546	C3-178-TU-1002-G
A1H46	0698-7204	3	RESISTOR 10K 25 125W F TUBULAR	24546	C3-178-TU-1002-G
A1H47	0698-7236	1	RESISTOR 10K 25 125W F TUBULAR	24546	C3-178-TU-1002-G
A1H48	0698-7200	1	RESISTOR 10K 25 125W F TUBULAR	24546	C3-178-TU-1002-G
A1H49	0698-7200	1	RESISTOR 10K 25 125W F TUBULAR	19701	MFAC178-TU-4003-F
A1H50	0698-7257	1	RESISTOR 10K 25 125W F TUBULAR	24546	C3-178-TU-1002-G
A1H51	0698-7204	3	RESISTOR 10K 25 125W F TUBULAR	24546	C3-178-TU-1002-G
A1H52	0698-7216	1	RESISTOR 51.1K 25 125W F TUBULAR	24546	C3-178-TU-5112-G
A1H53	0698-7216	1	RESISTOR 51.1K 25 125W F TUBULAR	24546	C3-178-TU-5112-G
A1H54	0698-7277	1	RESISTOR 51.1K 25 125W F TUBULAR	24546	C3-178-TU-5112-G
A1H55	0698-7277	1	RESISTOR 51.1K 25 125W F TUBULAR	24546	C3-178-TU-5112-G
A1H56	0698-7204	3	RESISTOR 10K 25 125W F TUBULAR	24546	C3-178-TU-1002-G
A1H57	0698-7204	3	RESISTOR 10K 25 125W F TUBULAR	24546	C3-178-TU-1002-G
A1H58	0698-7204	3	RESISTOR 10K 25 125W F TUBULAR	24546	C3-178-TU-1002-G
A1H59	0698-7204	3	RESISTOR 10K 25 125W F TUBULAR	24546	C3-178-TU-1002-G
A1H60	0698-7204	3	RESISTOR 10K 25 125W F TUBULAR	24546	C3-178-TU-1002-G
A1H61	0698-7204	3	RESISTOR 10K 25 125W F TUBULAR	24546	C3-178-TU-1002-G
A1H62	0698-7204	3	RESISTOR 10K 25 125W F TUBULAR	24546	C3-178-TU-1002-G
A1H63	0698-7204	3	RESISTOR 10K 25 125W F TUBULAR	24546	C3-178-TU-1002-G
A1H64	0698-7204	3	RESISTOR 10K 25 125W F TUBULAR	24546	C3-178-TU-1002-G
A1H65	0698-7204	3	RESISTOR 10K 25 125W F TUBULAR	24546	C3-178-TU-1002-G
A1H66	0698-7204	3	RESISTOR 10K 25 125W F TUBULAR	24546	C3-178-TU-1002-G
A1H67	0698-7204	3	RESISTOR 10K 25 125W F TUBULAR	24546	C3-178-TU-1002-G
A1H68	0698-7204	3	RESISTOR 10K 25 125W F TUBULAR	24546	C3-178-TU-1002-G
A1H69	0698-7204	3	RESISTOR 10K 25 125W F TUBULAR	24546	C3-178-TU-1002-G
A1H70	0698-7204	3	RESISTOR 10K 25 125W F TUBULAR	24546	C3-178-TU-1002-G
A1H71	0698-7204	3	RESISTOR 10K 25 125W F TUBULAR	24546	C3-178-TU-1002-G
A1H72	0698-7204	3	RESISTOR 10K 25 125W F TUBULAR	24546	C3-178-TU-1002-G
A1H73	0698-7204	3	RESISTOR 10K 25 125W F TUBULAR	24546	C3-178-TU-1002-G
A1H74	0698-7204	3	RESISTOR 10K 25 125W F TUBULAR	24546	C3-178-TU-1002-G
A1H75	0698-7204	3	RESISTOR 10K 25 125W F TUBULAR	24546	C3-178-TU-1002-G
A1H76	0698-7204	3	RESISTOR 10K 25 125W F TUBULAR	24546	C3-178-TU-1002-G
A1H77	0698-7204	3	RESISTOR 10K 25 125W F TUBULAR	24546	C3-178-TU-1002-G
A1H78	0698-7204	3	RESISTOR 10K 25 125W F TUBULAR	24546	C3-178-TU-1002-G
A1H79	0698-7204	3	RESISTOR 10K 25 125W F TUBULAR	24546	C3-178-TU-1002-G
A1H80	0698-7204	3	RESISTOR 10K 25 125W F TUBULAR	24546	C3-178-TU-1002-G
A1H81	0698-7270	1	RESISTOR 51.1K 25 125W F TUBULAR	24546	C3-178-TU-5112-G
A1H82	0698-7270	1	RESISTOR 51.1K 25 125W F TUBULAR	24546	C3-178-TU-5112-G
A1L1	1111-0011	1	IC LIN LM4024ZM AMPLIFIER	27014	LM4024ZM
A1L2	1120-0092	3	IC LIN AMPLIFIER	04713	PL7812CP
A1L3	1120-0070	1	IC DUAL SN74 74 N FLIP-FLOP	01295	SN7470M
A1L4	1120-0092	1	IC DUAL SN74 74 N FLIP-FLOP	06776	1C4-103-530
A1L5	1120-0092	1	IC LIN LM312M AMPLIFIER	27314	LM312M
A1L6	1120-0041	2	IC DUAL SN74 74 N FLIP-FLOP	04713	PC017P
A1L7	1120-0047	2	IC DUAL SN74 74 N FLIP-FLOP	06776	1C4-103-530
A1L8	1120-0047	2	IC DUAL SN74 74 N FLIP-FLOP	06776	1C4-103-530
A1L9	1120-0047	2	IC DUAL SN74 74 N FLIP-FLOP	27014	LM312M
A1L10	1120-0047	2	IC DUAL SN74 74 N FLIP-FLOP	04713	PC017P
A1L11	1120-0047	2	IC DUAL SN74 74 N FLIP-FLOP	04713	PC017P
A1L12	1120-0047	2	IC DUAL SN74 74 N FLIP-FLOP	04713	PC017P

Table 6-3. Replaceable Parts (3 of 3)

Reference Designation	HP Part Number	Qty	Description	Mfr Code	Mfr Part Number
ALVH1	1902-3002	1	DIODE-ZNR 2.37V 5% UL-7 PWR.4W TL-	04713	52 10939-2
ALVH2	1902-3005	1	DIODE-ZNR 10V 5% UL-7 PWR.5W TC=9.0C	04713	52 10939-162
ALVH3	1902-3082	2	DIODE-ZNR 4.04V 5% UL-7 PWR.4W TL-	04713	52 10939-86
ALVH4	1902-3082	1	DIODE-ZNR 4.04V 5% UL-7 PWR.4W TL-	04713	52 10939-86
ALVH5	1902-3203	1	DIODE-ZNR 14.7V 5% UL-7 PWR.4W TL-	04713	52 10939-230
ALVH6	1902-0061	1	DIODE-ZNR 5.11V 5% UL-7 PWR.4W TL-	04713	52 10939-98

Table 6-4. Code List of Manufacturers

MFR NO.	MANUFACTURER NAME	ADDRESS	ZIP CODE
00736	GETTIG ENGRG & MFG CO INC	SPRING MILLS PA	16875
00121	ALLEN BRADLEY CO	MILWAUKEE WI	53212
01295	TEXAS INSTR INC SEMICOND CMPNT DIV	DALLAS TX	75231
02735	RCA CORP SOLID STATE DIV	SOMMERVILLE NJ	08876
04713	MOTOROLA SEMICONDUCTOR PRODUCTS	PHOENIX AZ	85008
05775	ROBINSON NUGENT INC	NEW ALBANY IN	47150
15290	CORNING GL WK ELEC CMPNT DIV	RALEIGH NC	27604
19701	MEPCO/ELECTRA CORP	MINERAL WELLS TX	76067
24546	CORNING GLASS WORKS	BRADFORD PA	16701
27014	NATIONAL SEMICONDUCTOR CORP	SANTA CLARA CA	95051
28480	HEWLETT-PACKARD CO CORPORATE HQ	PALO ALTO CA	94304
30983	MEPCO/ELECTRA CORP	SAN DIEGO CA	92121
56289	SPRAGUE ELECTRIC CO	NORTH ADAMS MA	01247

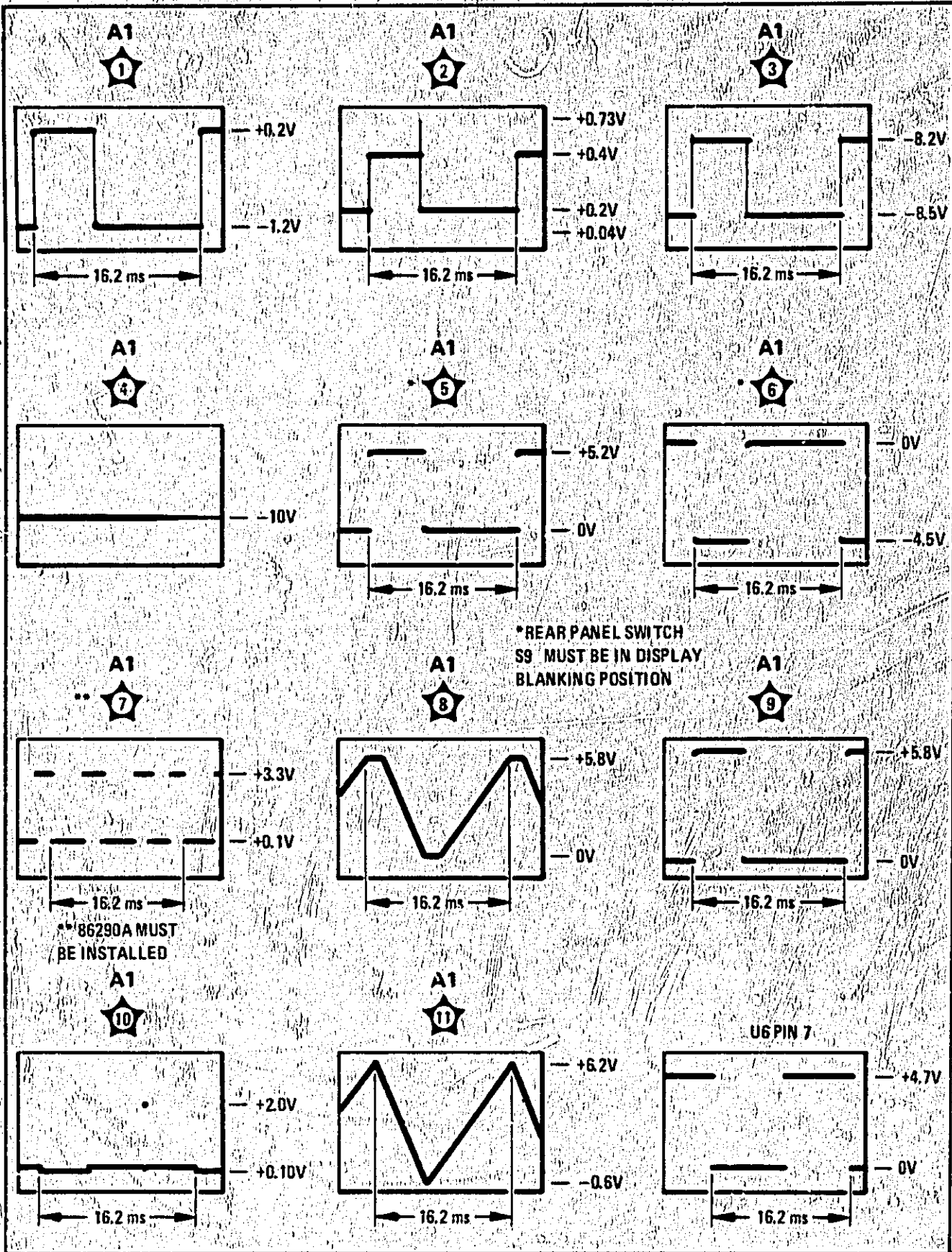

Figure 8-11A. Troubleshooting Block Diagram (1 of 3)

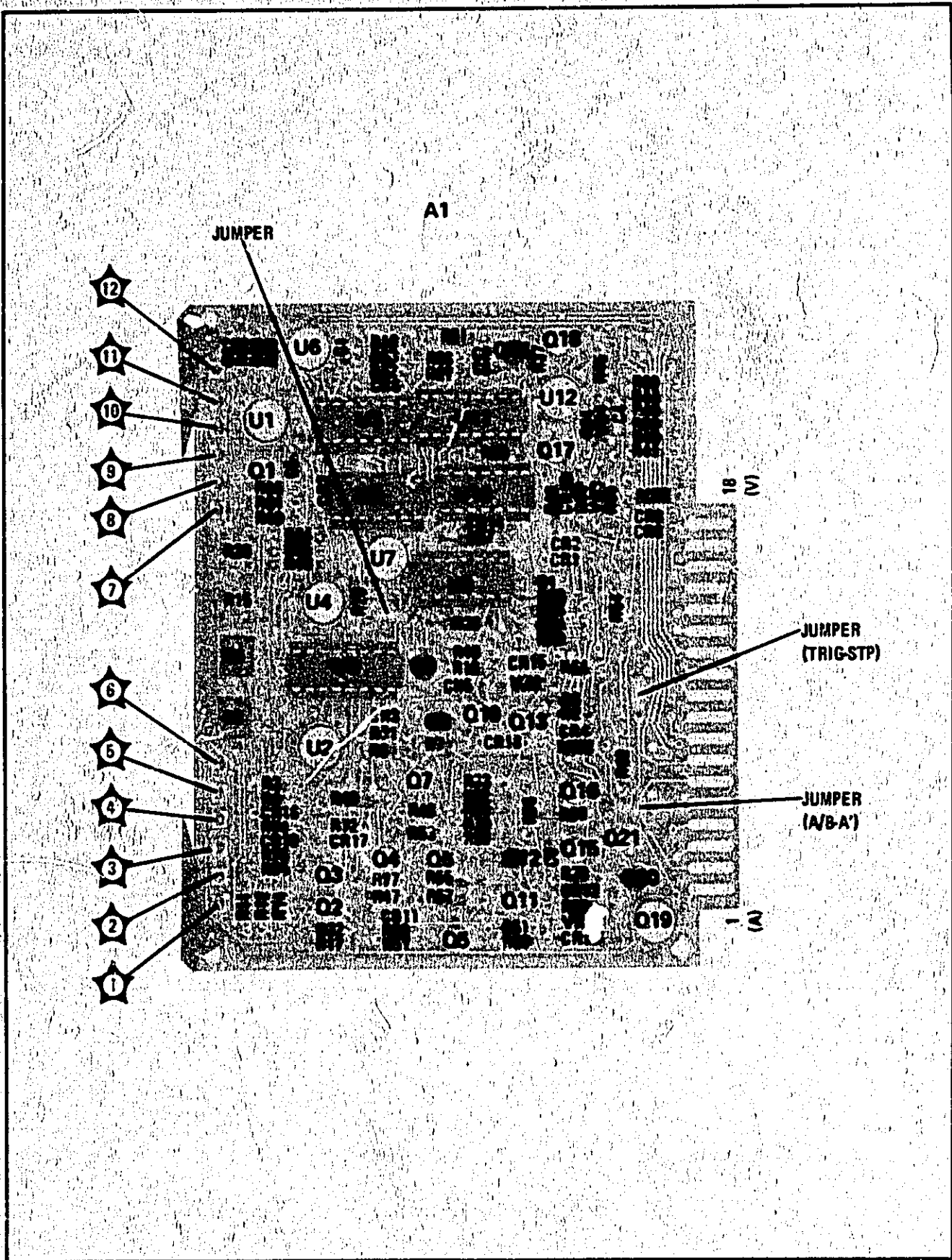
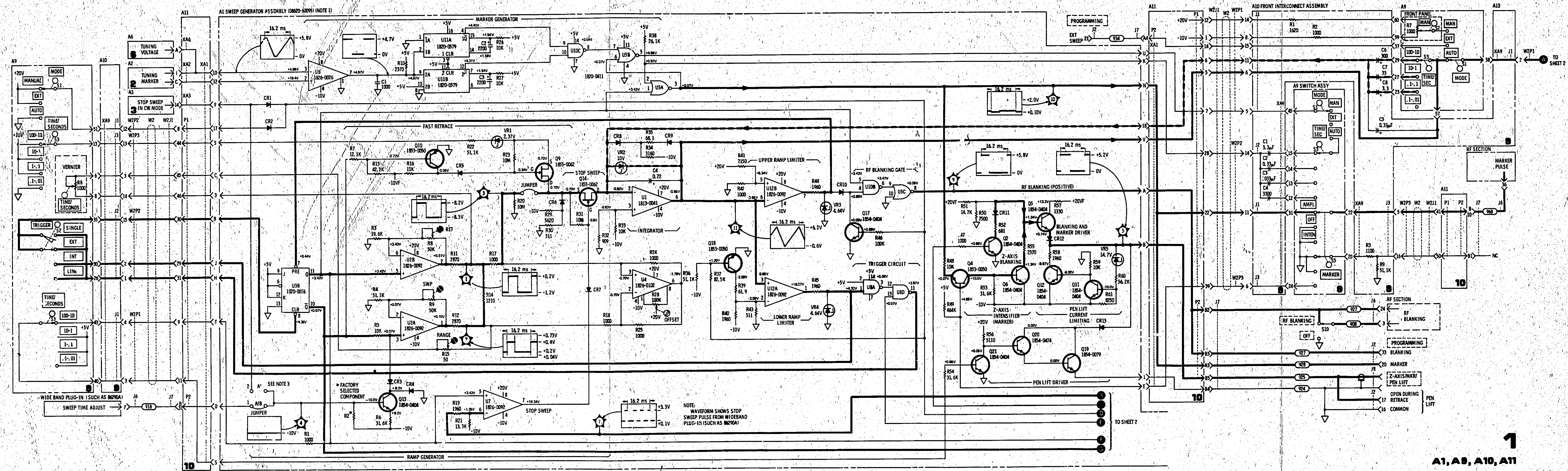
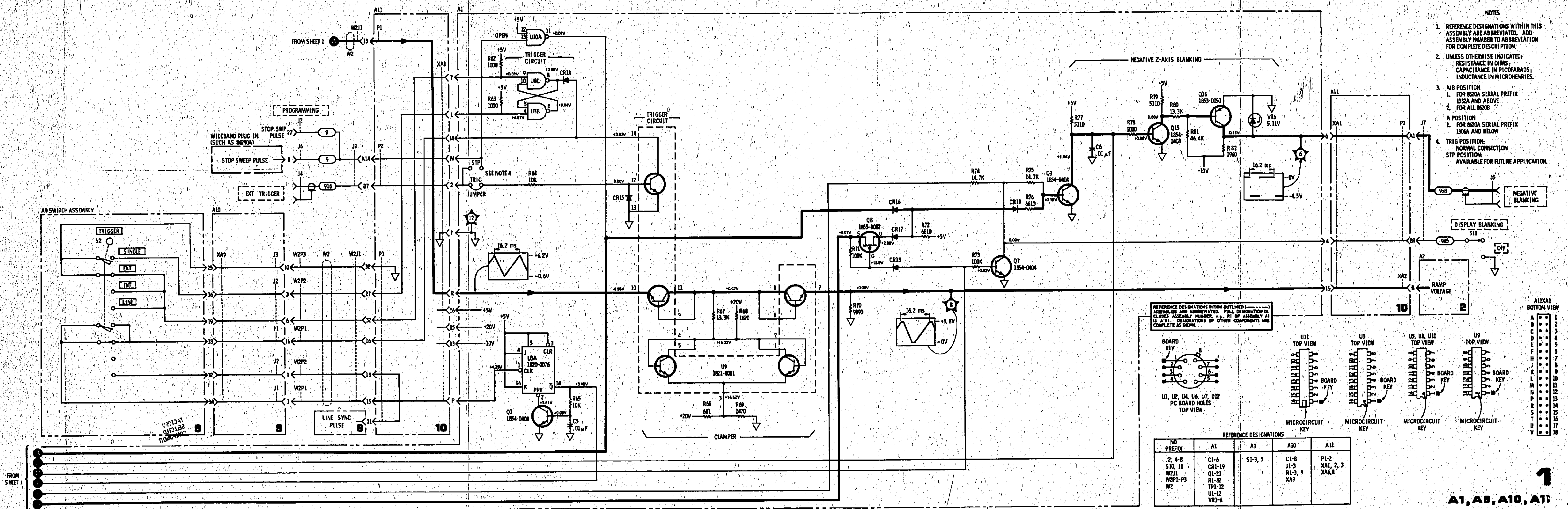

Figure 8-13. A1 Sweep Generator Assembly, Component Locations



A1, A8, A10, A11

Figure 8-14A. A1 Sweep Generator Assembly, Schematic (1 of 2)



- NOTES**
- REFERENCE DESIGNATIONS WITHIN THIS ASSEMBLY ARE ABBREVIATED. ADD ASSEMBLY NUMBER TO ABBREVIATION FOR COMPLETE DESCRIPTION.
 - UNLESS OTHERWISE INDICATED: RESISTANCE IN OHMS; CAPACITANCE IN PICOFARADS; INDUCTANCE IN MICROHENRIES.
 - A1B POSITION
1. FOR 820A SERIAL PREFIX 1332A AND ABOVE
2. FOR ALL 820B
A POSITION
1. FOR 820A SERIAL PREFIX 1306A AND BELOW
4. TRIG POSITION: NORMAL CONNECTION
STP POSITION: AVAILABLE FOR FUTURE APPLICATION.

REFERENCE DESIGNATIONS WITHIN OUTLINED ASSEMBLIES ARE ABBREVIATED. FULL DESIGNATION INCLUDES ASSEMBLY NUMBER, P.C. BOARD POSITION AND A1, A9, A10, A11 DESIGNATIONS OF OTHER COMPONENTS ARE COMPLETE AS SHOWN.

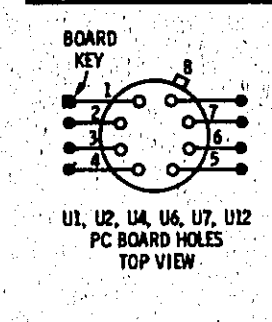

U1, U2, U4, U6, U7, U12
PC BOARD HOLES
TOP VIEW

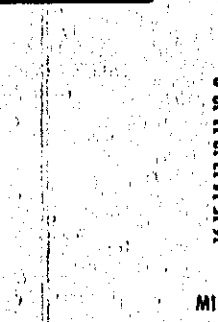

U11
TOP VIEW

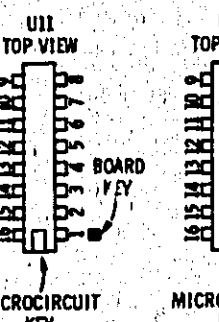

U3
TOP VIEW

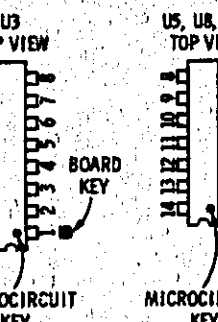

U5, U8, U10
TOP VIEW

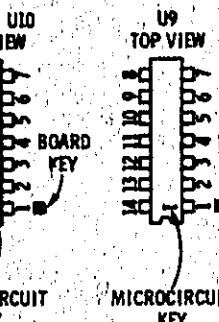

U9
TOP VIEW

NO PREFIX	A1	A9	A10	A11
J2, 4-8	CI-6	S1-3, 5	CI-8	PI-2
S10, 11	CI-19		JI-3	XAI, 2, 3
W21	Q1-21		RI-3, 9	XA6, 8
W2P1-P3	RI-82			
W2	TI-12			
	U1-12			
	VR1-6			

A1/A9/A10/A11	1	2	3	4	5	6	7	8	9	10	11	12	13	14	15	16	17	18	
A
B
C
D
E
F
G
H
J
K
L
M
N
P
R
S
T
U
V

A1, A9, A10, A11

Figure 8-14B. A1 Sweep Generator Assembly, Schematic (2 of 2)

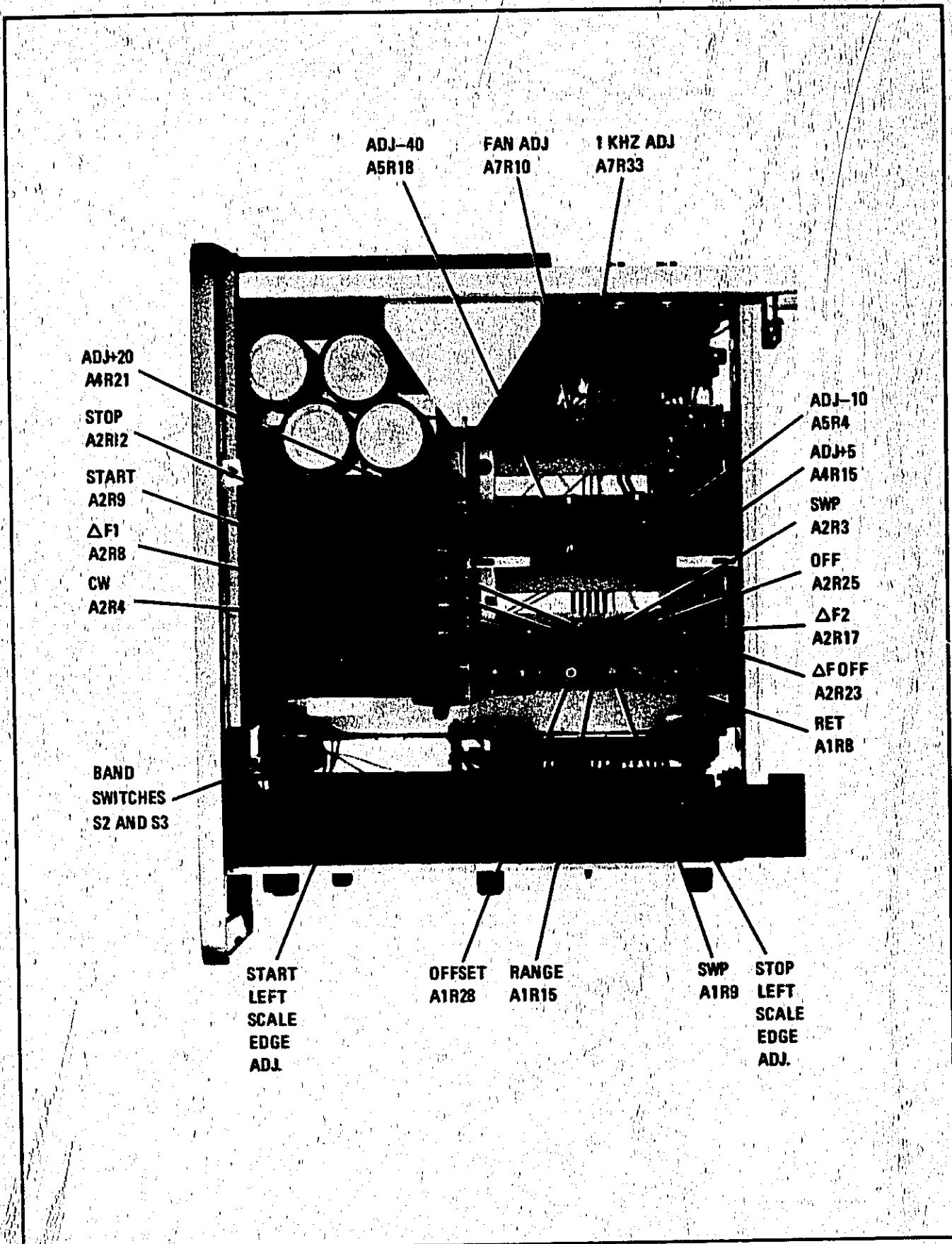

Figure 28A. Location of Adjustments

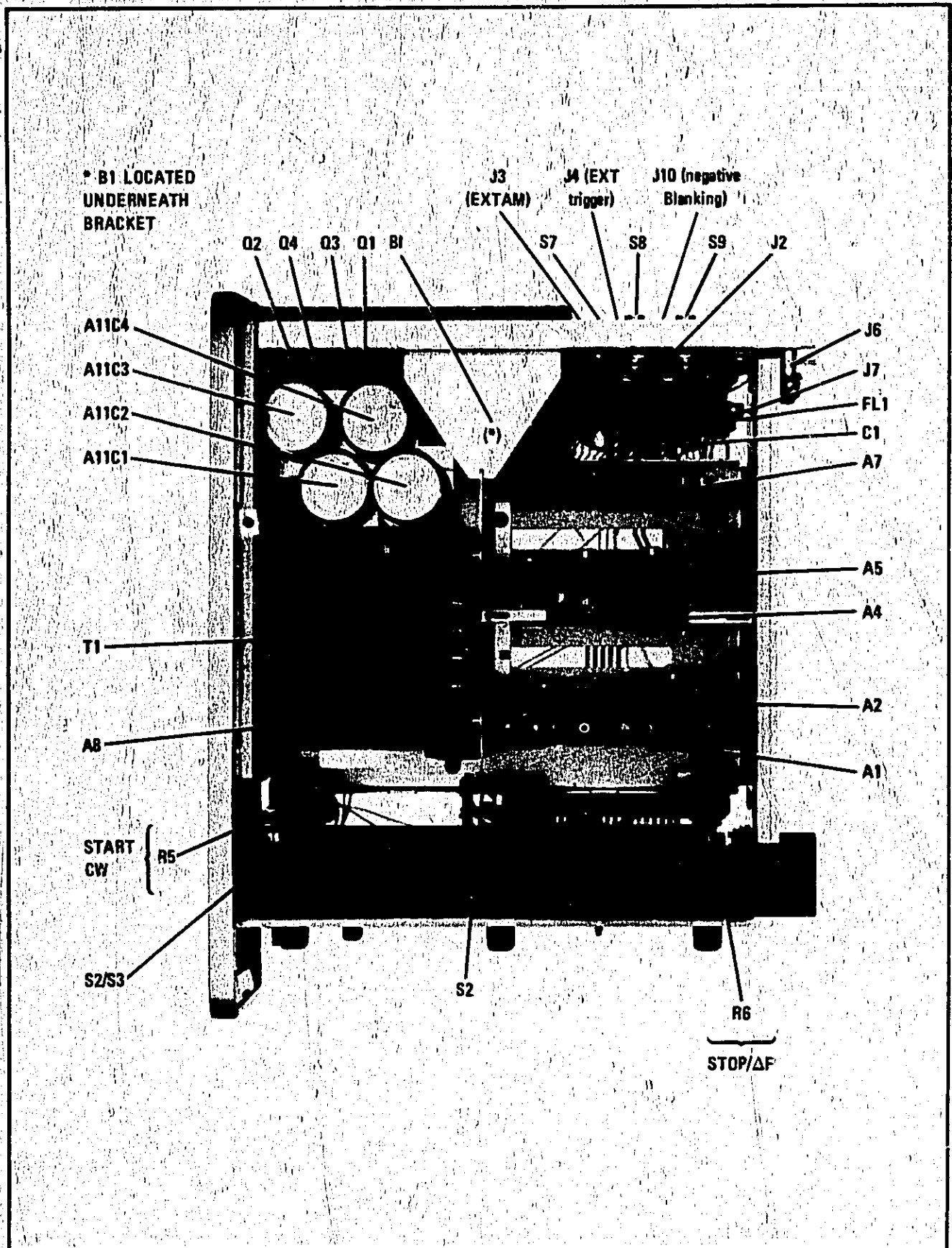

Figure 8-28B. Top View, Major Assembly and Component Locations