

Errata

Title & Document Type: 8755B Swept Amplitude Analyzer Operating and Service Manual

Manual Part Number: 08755-90070

Revision Date: April 1980

About this Manual

We've added this manual to the Agilent website in an effort to help you support your product. This manual provides the best information we could find. It may be incomplete or contain dated information, and the scan quality may not be ideal. If we find a better copy in the future, we will add it to the Agilent website.

HP References in this Manual

This manual may contain references to HP or Hewlett-Packard. Please note that Hewlett-Packard's former test and measurement, life sciences, and chemical analysis businesses are now part of Agilent Technologies. The HP XXXX referred to in this document is now the Agilent XXXX. For example, model number HP8648A is now model number Agilent 8648A. We have made no changes to this manual copy.

Support for Your Product

Agilent no longer sells or supports this product. You will find any other available product information on the Agilent Test & Measurement website:

www.agilent.com

Search for the model number of this product, and the resulting product page will guide you to any available information. Our service centers may be able to perform calibration if no repair parts are needed, but no other support from Agilent is available.

OPERATING AND SERVICE MANUAL

SWEPT AMPLITUDE ANALYZER

8755B

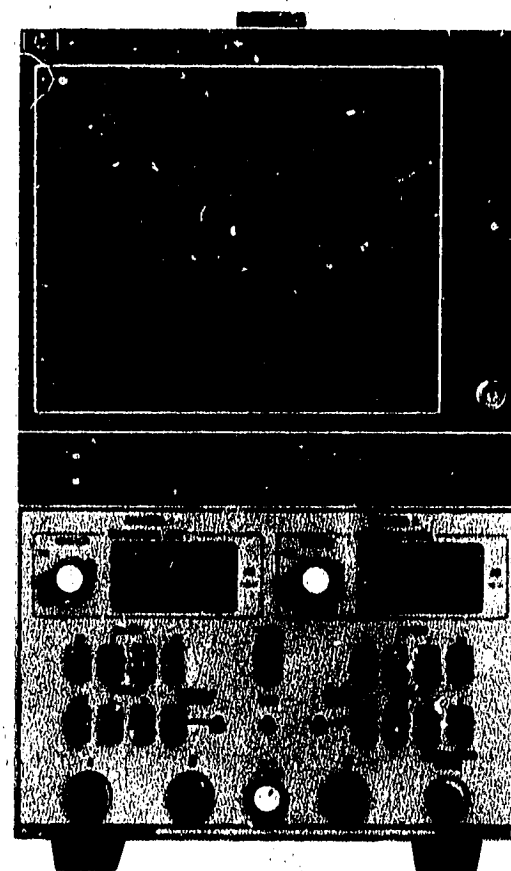

HEWLETT
PACKARD

SWEPT AMPLITUDE ANALYZER 8755B

SERIAL NUMBERS

This manual applies directly to instruments with serial numbers prefixed 1932A.

For additional important information concerning serial numbers, see INSTRUMENTS COVERED BY MANUAL in Section I.

© Copyright HEWLETT-PACKARD COMPANY 1980
1400 FOUNTAIN GROVE PARKWAY, SANTA ROSA, CALIFORNIA 95404

MANUAL PART NO. 08755-90070
Microfiche Part No. 08755-90071

Printed: APRIL 1980



CONTENTS

Section	Page	Section	Page
I GENERAL INFORMATION	1-1	IV PERFORMANCE TESTS	4-1
1-1. Introduction	1-1	4-1. Introduction	4-1
1-6. Instruments Covered By Manual	1-1	4-3. Equipment Required	4-1
1-11. Description	1-1	4-5. Test Record	4-1
1-14. Equipment Required But Not Supplied	1-1	4-7. Amplitude Accuracy	4-1
1-15. Detectors and Modulator	1-1	4-8. Frequency Response	4-4
1-17. Oscilloscope Display	1-2		
1-19. Equipment Required for Reflectometer Test Setup	1-2	V ADJUSTMENTS	5-1
1-21. Recommended Test Equipment	1-2	5-1. Instruction	5-1
		5-3. Equipment Required	5-1
II INSTALLATION	2-1	5-5. Related Adjustments	5-1
2-1. Introduction	2-1	5-7. Adjustment of +7.5V Supply	5-4
2-3. Initial Inspection	2-1	5-8. Adjustment of A7, A8, and A9 Log Amplifiers	5-4
2-5. Preparation For Use	2-1	5-9. Channel Balance	5-6
2-6. Blanking Polarity Switch	2-1		
2-8. Installation	2-1	VI REPLACEABLE PARTS	6-1
2-12. Interconnection	2-1	6-1. Introduction	6-1
2-14. Operating Environment	2-1	6-3. Replaceable Parts List	6-1
2-18. Storage and Shipment	2-1	6-6. Ordering Information	6-1
2-19. Environment	2-1		
2-21. Packaging	2-2	VII MANUAL BACKDATING CHANGES	7-1
		7-1. Introduction	7-1
III OPERATION	3-1	7-5. Manual Change Instructions	7-1
3-1. Introduction	3-1		
3-3. Panel Features	3-1	VIII SERVICE	8-1
3-5. Operator's Check	3-1	8-1. Introduction	8-1
3-7. Operating Instructions	3-1	8-3. Principles of Operation	8-1
		8-5. Troubleshooting	8-1
		8-8. Recommended Test Equipment	8-1
Figure	Page	Figure	Page
1-1. Model 8755B Swept Amplitude Analyzer	1-0	8-13. A7, A8, and A9 27.8 kHz Log Amplifier Parts Identification	8-13
3-1. Front Panel Controls and Connectors	3-2	8-14. A7, A8, and A9 27.8 kHz Log Amplifier Schematic	8-14
3-2. Operator's Check	3-4	8-15. Processor Board Input and Switching	8-14
3-3. Transmission, Reflection, and Power Measurements	3-6	8-16. Channel 1 (or 2) Processor Board Output	8-14
4-1. Amplitude Accuracy Test Setup	4-2	8-17. Display Switch Parts Location	8-14
4-2. Frequency Response Test Setup	4-5	8-18. A6 Processor Assembly, Parts Location	8-15
5-1. Adjustment Locations	5-1	8-19. A6 Processor and A4 Display Switches Schematic	8-15
5-2. Log Amplifier Adjustment Test Setup	5-3	8-20. Reference Level Switch	8-16
5-3. Graph for Log Amplifier Adjustment	5-5	8-21. A3 dB/Division Switch Parts Location	8-17
8-1. Major Assemblies Location	8-2	8-22. A3 dB/Division Switch and A1 and A2 Offset Switches Schematic	8-17
8-2. Schematic Diagram Notes	8-3	8-23. Dual "D" Flip Flop	8-18
8-3. Simplified Troubleshooting Block Diagram	8-7	8-24. A10 Modulator Driver, Parts Location	8-19
8-4. Model 8755B Typical Test Setup	8-9	8-25. A10 Modulator Driver Schematic	8-19
8-5. Model 8755B Simplified Block Diagram	8-9	8-26. A11 Normalizer Interface, Parts Location	8-21
8-6. Model 11664A Simplified Schematic	8-9	8-27. A11 Normalizer Interface, Schematic	8-21
8-7. Model 11664A Amplifier Schematic	8-9	8-28. Front Panel Parts Location	8-22
8-8. Model 8755B Block Diagram	8-9	8-29. A5 Interconnect Assembly, Parts Location	8-23
8-9. Troubleshooting Block Diagram	8-10	8-30. A12 Motherboard, A5 Interconnect Assembly and A11 Normalizer Interface Schematic	8-23
8-10. Positive and Negative Power Supplies	8-12		
8-11. -2.5V Supply Simplified Diagram	8-12		
8-12. +5V Supply Simplified Diagram	8-12		

TABLES

Table	Page	Table	Page
1-1. Specifications for Model 8755B	1-3	4-2. Frequency Response When Measuring the Ratio of Two Detector Signals	4-4
1-2. Supplemental Characteristics of 8755B	1-4	4-3. Performance Test Record	4-7
1-3. Recommended Test Equipment	1-5	5-1. Adjustment Controls	5-2
1-4. Connectors on 180T/TR, 181T/TR, 182T, and 180 Series Option 807 Mainframes	1-6	5-2. Control Settings for Log Amplifier Adjustment	5-6
1-5. Normalizer Interface Connector A11P1 Signals and Voltages.	1-7	6-1. Code List of Manufacturers	6-1
4-1. Amplitude Accuracy of Model 8755B Connected with Three Model 11664A Detectors.	4-1	6-2. Reference Designations and Abbreviations	6-2
		6-3. Replaceable Parts	6-3
		7-1. Manual Changes by Serial Number	7-1

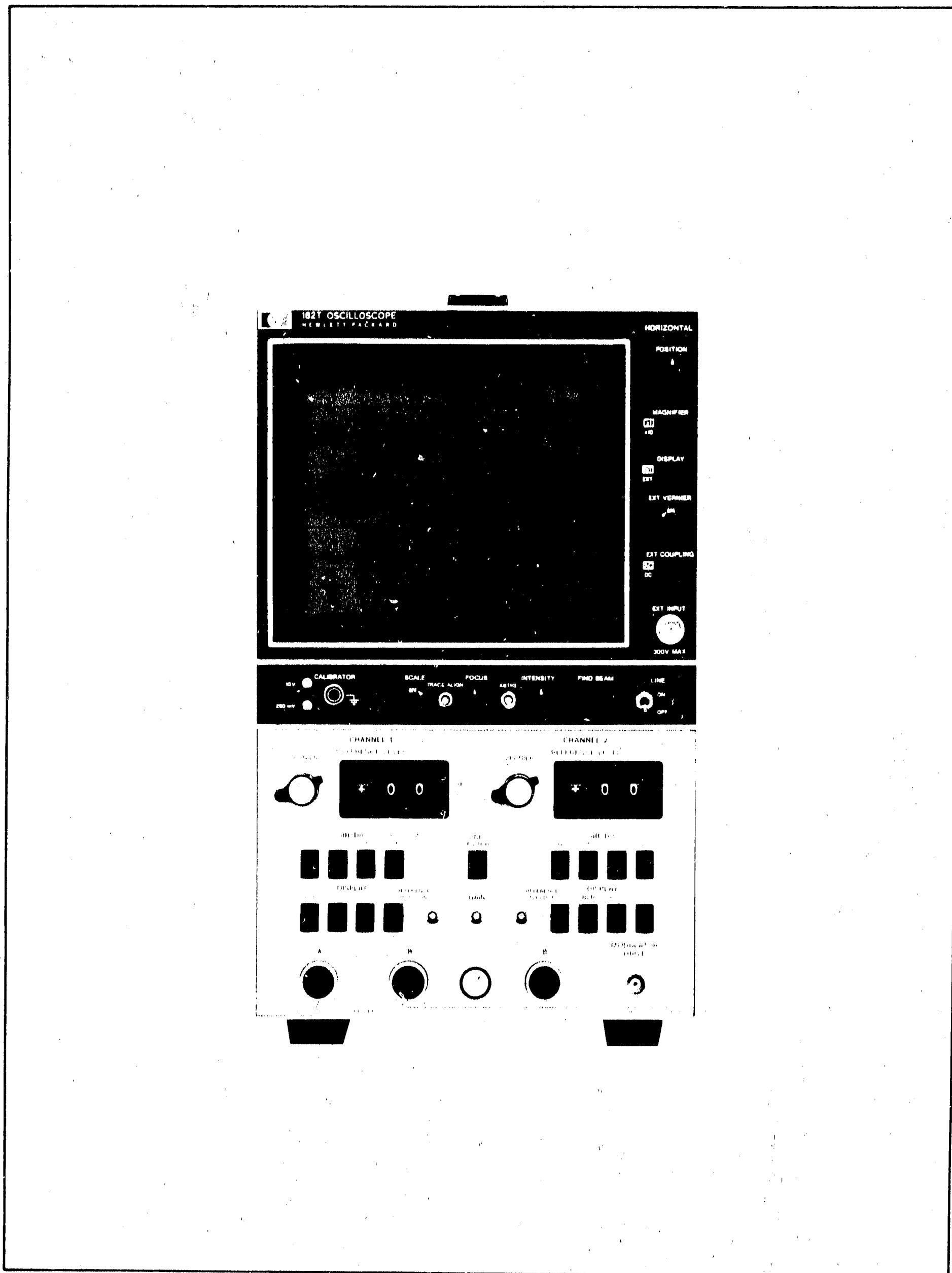

Figure 1-1. Model 8755A Swept Amplitude Analyzer

SECTION I GENERAL INFORMATION

1-1. INTRODUCTION

1-2. This operating and service manual applies to HP Model 8755B Swept Amplitude Analyzer and contains information necessary to install, operate, test, adjust, and service it.

1-3. Packaged with this manual is an Operating Information Supplement. This is simply a copy of the first three sections of this manual. This supplement should stay with the instrument for use by the instrument operator. Also included with the manual is an overall schematic diagram. Additional copies of both the Operating Information Supplement and the Overall Schematic Diagram may be ordered separately through your nearest Hewlett-Packard Office. The part numbers are listed on the title page of the manual and on each publication.

1-4. On the front cover of this manual, below the manual part number is a "Microfiche" part number. This number may be used to order 4- by 6-inch microfilm transparencies of the manual. Each 4- by 6-inch microfiche contains up to 60 photo duplicates of the manual pages. The microfiche package also includes the latest Manual Changes supplement as well as all pertinent Service Notes.

1-5. Instrument specifications are listed in Table 1-1. The specifications are the performance standards or limits against which the instrument may be tested. Table 1-2 lists supplemental characteristics. Supplemental characteristics are not specifications but are typical characteristics included for the information of the user.

1-6. INSTRUMENTS COVERED BY MANUAL

1-7. This instrument has a two-part serial number. The first four digits followed by a letter comprise the serial number prefix. The last five-digits form the sequential suffix that is unique to each instrument. The content of this manual applies directly to instruments having the same serial number prefix as those listed on the title page under SERIAL NUMBER.

1-8. An instrument manufactured after the printing of this manual may have a serial prefix that is not listed on the title page. An unlisted serial prefix indicates that the instrument is different from those documented in this manual. The manual for this instrument is supplied with a yellow

Manual Changes supplement that contains change information that documents the differences.

1-9. In addition to change information, the supplement may contain information for correcting errors in the manual. To keep this manual as current and accurate as possible, Hewlett-Packard recommends that you periodically request the latest Manual Changes supplement. The supplement for this manual is keyed to this manual's print date and part number, both of which appear on the title page. Complimentary copies of the supplement are available from Hewlett-Packard.

1-10. For information concerning a serial number prefix not listed on the title page or in the Manual Changes supplement, contact your nearest Hewlett-Packard office.

1-11. DESCRIPTION

1-12. The Model 8755B Swept Amplitude Analyzer makes swept measurements of return loss, insertion loss or gain, and power at microwave frequencies. The complete measurement system includes the Model 8755B Swept Amplitude Analyzer plugged into a 180-series Display mainframe. Included in a measurement system are three detectors and a modulator. A dual-directional coupler and a microwave swept signal source are also required in a typical reflectometer test setup. The complete specifications are given in Table 1-1 and Supplemental Characteristics are given in Table 1-2.

1-13. A 27.8 kHz signal from the 8755B modulates the Model 11665B modulator, providing a modulated RF envelope to the three Model 11664A detectors. The audio modulation technique applied in the 8755B measurement system provides the benefit of virtually drift-free operation, compared to crystal detectors operated without modulation.

1-14. EQUIPMENT REQUIRED BUT NOT SUPPLIED

1-15. Detectors and Modulator

1-16. Three Model 11664A Detectors and a Model 11665B Modulator are accessories needed to make a measurement with the Model 8755B. These accessories were designed specifically for use with the Model 8755B to achieve high performance

through the specified microwave range. See the individual Operating and Service Manuals for the 11664A Detector and 11665B Modulator for more detailed information on these accessories.

1-17. Oscilloscope Display

1-18. The Model 180-series Display is used for the display and mainframe for the Model 8755B. It supplies all the power required to operate the 8755B. In order to be completely compatible to the 8755B, the 180D and 182C Display must have Option 807 installed. This modification supplies retrace blanking and zero-offset recorder outputs, which are provided on the 180T/TR, 181T/TR, and 182T mainframes.

1-19. Equipment Required for Reflectometer Test Setup

1-20. A reflectometer configuration is used to

simultaneously measure both reflection and transmission gain or loss. A typical reflectometer test setup uses the following equipment:

a. Model 8755B Swept Amplitude Analyzer, three Model 11664A detectors, Model 11665B modulator, and 180-series oscilloscope display.

b. Dual Directional Coupler (Model 778D, 0.1-2 GHz; Model 11692, 2-18 GHz).

c. Sweep Oscillator (Model 8620A/B/C or 8690A/B) with plug-ins for bands of interest.

1-21. RECOMMENDED TEST EQUIPMENT

1-22. Equipment required to maintain the Model 8755B is listed in Table 1-3. Other equipment may be substituted if it meets or exceeds the critical specifications listed in the table.

Table 1-1. Specifications for Model 8755B

SPECIFICATIONS

Function: Plug-in for 180 series oscilloscope. Has three input circuits (R, A, B) which process the 11664A Detector or 11666A Reflectometer Bridge outputs.

Operating Frequency: 27.8 kHz

Modulator Drive: Provides nominal 16 V from 50-Ohm source impedance at 27.8 kHz.

Net Weight: 6 lb., 4 oz (2, 8 kg)

dB Change From Reference	Amplitude Accuracy
10 dB	$\leq \pm 0.9$ dB
20 dB	$\leq \pm 1.1$ dB
30 dB	$\leq \pm 1.1$ dB
40 dB	$\leq \pm 1.1$ dB
50 dB	$\leq \pm 1.1$ dB
60 dB	$\leq \pm 1.9$ dB

**MODEL 8755B OPERATING WITH
MODEL 11664A DETECTORS AND
MODEL 11665B MODULATOR**

Function: A complete instrument for making swept frequency response measurements of return loss, transmission gain or loss, and power.

Frequency Range: 15 MHz to 18 GHz.

Measurement Range: Single Detector Signal: +10 dBm to -50 dBm (noise level). NOTE: Damage Level is +20 dBm (100 mW) power and 10 Vdc. Ratio of Two Detector Signals: 60 dB

Frequency Response (Ratio Measurement):

See table below:

NOTE:

The frequency response error can be eliminated with standard grid line normalization techniques.

Frequency Range	Swept Measurement Uncertainty Due to Frequency Response Only
15 MHz to 8 GHz	$\leq \pm 0.15$ dB
15 MHz to 10 GHz	$\leq \pm 0.2$ dB
15 MHz to 12.4 GHz	$\leq \pm 0.3$ dB
15 MHz to 14 GHz	$\leq \pm 0.45$ dB
15 MHz to 15 GHz	$\leq \pm 0.5$ dB
15 MHz to 18 GHz	$\leq \pm 0.6$ dB

Ratio Measurement Accuracy:

See table below:

NOTE:

Accuracy figures show overall system uncertainty for a single detector measurement using the OFF-SET dB controls. It is also the accuracy of a ratio measurement when the power level to one detector does not change level. If both detectors of a ratio measurement change level, after calibration, the total measurement uncertainty is the sum of the two detector accuracy uncertainties. Figures do not include frequency response, mismatch, or coupler ambiguities.

GENERAL

Resolution: Independent for each channel in steps of 10, 5, 1, or 0.25 dB per division. With Model 182A display, resolution is 1.29 cm/division and with Model 180D display, resolution is 1 cm/division.

Offset: ± 99 dB in 1-dB steps. Each display channel is independent.

Recorder Outputs: 0.5 V/division with nominally 100 Ohms output impedance. (Option 807 must be installed in 180A/C/D, 181A/AR, 182A/C, and 184A/B mainframes.

Marking and Blanking: Accepts marker and blank inputs from HP 8620 and 8690 series Sweep Oscillators if Option 807 is installed in 180A/C/D, 181A/R, 182A/C, and 184A/B display mainframes. Blanking input from 8620 connects to Z-AXIS INPUT; 8690B connects to AUX C. NOTE: Damage level is 20v P-P.

Temperature Range: Operation 0 to 55 degrees C; storage, -40 degrees C to +75 degrees C.

Dimensions:

With 182 Series Display: 7-15/16 in. wide x 13-15/16 in. high x 19-5/8 in. deep overall (201, 6 x 338, 1 x 498, 5 mm).

With 180D/T/TR, 181AR/TR, and 184B Display: 16-3/4 in. wide x 5-7/32 in. high x 21-3/8 in. deep overall (425 x 132, 6 x 543 mm).

With 180A/C, 181A/T, and 184A Display: 7-7/8 in. wide x 11-3/8 in. high x 21-1/4 in. deep overall (200 x 349 x 530 mm).

Table 1-2. Supplemental Characteristics of 8755B

SUPPLEMENTAL CHARACTERISTICS

Ratio Measurement Accuracy:

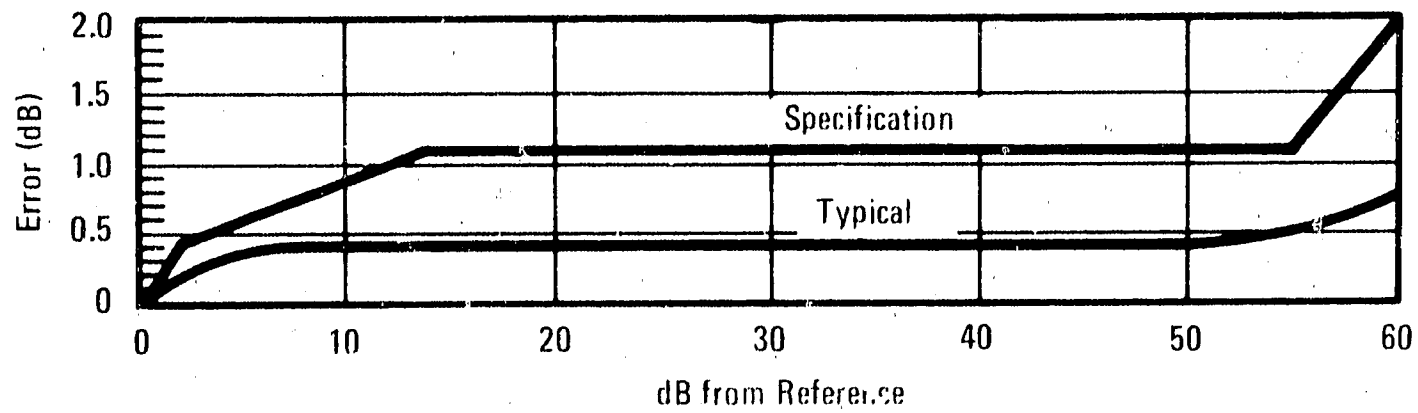

Accuracy curve shows overall system uncertainty for a single detector measurement using the OFF-SET dB controls; it is also the accuracy of a ratio measurement when the power level to one detector does not change level. If both detectors of a ratio measurement change level, after calibration, the total measurement uncertainty is the sum of the two detector accuracy uncertainties. Curve does not include frequency response, mismatch, or coupler ambiguities. The curve requires a calibration power level at +10 dBm.

Frequency Response (Ratio Measurement):

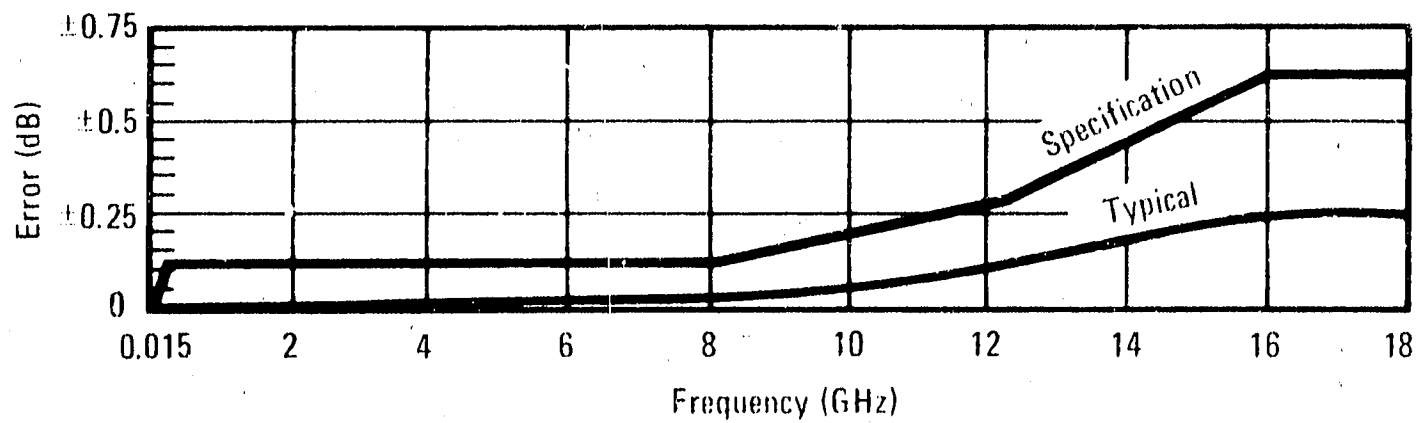

Note: The frequency response error can be eliminated with standard grid line normalization techniques.

Table 1-3. Recommended Test Equipment

Instrument	Critical Specifications	Recommended Model	Use*
Display mainframe for 8755R	HP 180T/TR, 181T/TR, 182T, and 180 series with Option 807	HP 180R/TR, 181T/TR, 182T, and 180 series with Option 807	P,A,T
Display	Vertical Bandwidth: 20 MHz minimum Vertical Sensitivity: 5 mV/DIV Horizontal Sweep Rate: 1 μ s/Div. max.	HP 180A/1801A/1820A	T
Detectors (3 required)	Model 11664A only	HP 11664A	P,A,T
Sweep Oscillator	CW and swept frequency signal in 0.1 to 18 GHz range	HP Model 8620C mainframe with: HP Model 8621B, 86320B (0.1-2.0 GHz), and 86290B (2.0-18.6 GHz)	P,A,T
Attenuators (2 required)	Attenuation: 10 dB Accuracy: \pm 0.5 dB of calibration value SWR: <1.5 Range: DC to 18 GHz	HP 8493B	P,A,T
Power Splitting Tee	Attenuation each leg: 6 dB Range: DC to 18 GHz	HP 11667A	P,A,T
Extractor Tool		HP 03950-1001	T
Extender Board	Pins: 15 each side	HP 5060-0049	T
DC Digital Voltmeter	Range: -50V to +50V Accuracy: 0.05%	HP 3460B	T
0-70 dB Step Attenuator (Calibrated)	Attenuation: 0 to 70 dB in 10 dB steps Input and Output Impedance: 50 Ohms Calibration Accuracy: \pm 4%	HP 8495B, Calibrated by Standards Laboratory	P,A,T
0-11 dB Step Attenuator (Calibrated)	Attenuation: 0 to 11 dB in 1 dB steps Input and Output Impedance: 50 Ohms Calibration Accuracy: \pm 0.1 dB	HP 8497B, Calibrated by Standards Laboratory	A,T
Directional Coupler	Frequency Range: 0.10 to 2. GHz Coupling Attenuation: 20 dB Nominal SWR: \leq 1.1	HP 778D	P
Power Meter and Thermistor Mount	Frequency: 100 MHz to 18 GHz Range: +10 dBm to -20 dBm	HP 432A/8478B	P,A,T
Extender Cable Assembly	No substitute. Allows trouble-shooting outside mainframe.	HP 5060-0303	A,T

* A = Adjustment; P = Performance Test; T = Troubleshooting

Table 1-4. Connectors on 180T/TR, 181T/TR, 182T, and 180 Series Option 807 Mainframes

180-Series Mainframe Connector	Equipment to Which It Connects	Function
EXT INPUT (front panel) AUX A AUX B	SWEEP OUT X-Y Recorder X-Y Recorder	Provides horizontal sweep voltage only when 8750A is NOT used. 8755B Channel 1 output 8755B Channel 2 output
<div style="border: 1px dashed black; padding: 2px; display: inline-block;">CAUTION</div> Marker and blanking signals must be < 20 V P-P or damage may result.		
Z-AXIS INPUT AUX C AUX D	8620 series Z-AXIS output (marker and blanking) or 8690 series MARKER output 8620 series Z-AXIS output (marker and blanking) or 8690 series BLANKING 8690 or 8620 series SWEEP OUT	Provides marker and blanking to CRT display only when NOT using 8750A. Provides marker to CRT display only when NOT using 8750A. Provides retrace blanking to 8755B when 8750A Storage-Normalizer or 8690 series sweeper is used. Provides horizontal sweep voltage when 8750A is used. May be used for sweep when 8750A is not used.

Table 1-5. Normalizer Interface Connector A11P1 Signals and Voltages

Pin on A11P1	Signal or Voltage
1	INT SWEEP to mainframe
2	N. C.
3	100V SWITCHED from mainframe
4	NORMALIZE ENABLE from 8750A
5	NORMALIZED VERTICAL IN from 8750A
6	ALT TRIGGER from mainframe (not used)
7	GROUND from mainframe (not used)
8	GROUND from mainframe
9	N. C.
10	not used
11	AUX D to mainframe rear panel
12	AUX C to mainframe rear panel
13	AUX B, channel 2 signal to mainframe rear panel
14	AUX A, channel 1 signal to mainframe rear panel
15	GROUND from mainframe (not used)
16	115 Vac from mainframe (not used)
17	INT BLANKING to mainframe
18	BLANKING to mainframe
19	N. C.
20	BLANKING GROUND to mainframe
21	BEAM FINDER from mainframe (- 12.6 Vdc normal, open for beam finder)
22	CHANNEL 1 OFF SENSE to 8750A
23	CHANNEL 2 OFF SENSE to 8750A
24	GROUND from mainframe
25	MARKER SENSE to 8750A
26	not used
27	100 Vdc from mainframe (not used)
28	12.6 Vdc from mainframe
29	+15 Vdc from mainframe
30	+100 Vdc from mainframe
31	20V p-p from mainframe (not used)
32	115 Vac from mainframe (not used)

INSTALLATION

SECTION II INSTALLATION

2-1. INTRODUCTION

2-2. This section covers initial inspection, installation of the instrument into a mainframe, and storage and shipping requirements.

2-3. INITIAL INSPECTION

2-4. If the shipping container or cushioning material is damaged it should be kept until the contents of the shipment have been checked for completeness and the instrument has been checked mechanically and electrically. The contents of the shipment should be as shown in Figure 1-1, and procedures for checking electrical performance are given in Section IV. If the contents are incomplete, if there is mechanical damage or defect, or if the instrument does not pass the electrical performance test, notify the nearest Hewlett-Packard office. If the shipping container is damaged, or the cushioning material shows signs of stress, notify the carrier as well as the Hewlett-Packard office. Keep the shipping materials for carrier's inspection. The HP office will arrange for repair or replacement without waiting for claim settlement.

2-5. PREPARATION FOR USE

2-6. Blanking Polarity Switch

2-7. The POS/NEG blanking polarity switch (A11S1) on the Normalizer Interface board must be set for the polarity of blanking pulses generated by the swept signal source being used. If an 8620 series sweeper is to be used, set S1 to the POS position. If an 8690 series sweeper will be used, set S1 to the NEG position. Also, set S1 to NEG if a 181 or 184 series mainframe is being used; if S1 is in the POS position with these mainframes, the PERSISTENCE control will be inoperative.

2-8. Installation

2-9. When properly installed, the Plug-in obtains all necessary power from the mainframe. The rear panel connector provides the interface.

2-10. To install the Plug-in into the mainframe:

- a. Set Model 180-series mainframe line switch to off.

- b. Slide the plug-in into place toward rear of the compartment.

- c. Turn the "lock" knob located at the center of the front panel clockwise until the plug-in is held solidly in the mainframe.

2-11. To install each of the three 11664A detectors to the front panel of the 8755B:

- a. Mate the 11664A cable connector to the 8755B detector input (A, B, or R).

- b. Turn connector lock-ring clockwise to lock detector cable to 8755B.

- c. Mount two matching plastic bands around each of the cables, one band near the connector and the other band near the detector.

2-12. Interconnection

2-13. The rear panel of the 180-series (Option 807) display contains connectors that provide various input and output functions to the 8755B as listed in Table 1-4. For 180-series displays without Option 807, a kit is available (HP Part Number 00180-69508) to modify the 180, 181 or 182 rear-panel connectors.

2-14. Operating Environment

2-15. Temperature. The instrument may be operated in temperatures from 0°C to +55°C.

2-16. Humidity. The instrument may be operated in environments with humidity up to 95 percent. However, the instrument should also be protected from temperature extremes which cause condensation within the instrument.

2-17. Altitude. The instrument may be operated at altitudes up to 25,000 feet.

2-18. STORAGE AND SHIPMENT

2-19. Environment

2-20. The instrument may be stored or shipped in environments within the following limits:

Temperature:	-40°C to +75°C
Humidity:	Up to 95 percent
Altitude:	Up to 25,000 feet

The instrument should also be protected from temperature extremes which cause condensation within the instrument.

2-21. Packaging

2-22. Original Packaging. Containers and materials identical to those used in factory packaging are available through Hewlett-Packard offices. If the instrument is being returned to Hewlett-Packard for servicing, attach a tag indicating the type of service required, return address, model number, and full serial number. Also, mark the container FRAGILE to assure careful handling. In any correspondence, refer to the instrument by model number and full serial number.

2-23. Other Packaging. The following general instructions should be used for re-packaging with commercially available materials:

a. Wrap the instrument in heavy paper or plastic. (If shipping to a Hewlett-Packard office or service center, attach a tag indicating the type of service required, return address, model number, and full serial number.)

b. Use a strong shipping container. A double-wall carton made of 350-pound test material is adequate.

c. Use enough shock-absorbing material (3- to 4-inch layer) around all sides of the instrument to provide firm cushion and prevent movement inside the container. Protect the control panel with cardboard.

d. Seal the shipping container securely.

e. Mark the shipping container FRAGILE to assure careful handling.

OPERATION

SECTION III OPERATION

3-1. INTRODUCTION

3-2. This section explains the function of the controls and indicators of the Model 8755B Swept Amplitude Analyzer.

3-3. PANEL FEATURES

3-4. Front panel features are described in Figure 3-1. Description numbers match the numbers on the illustration.

3-5. OPERATOR'S CHECK

3-6. Figure 3-2 is an operator's check procedure, allowing the operator to make a quick check of the main instrument functions prior to use. The operator's check assumes that the 8755B is installed in a 180-series oscilloscope mainframe. The test covers both the 8755B analyzer and mainframe; therefore, if the correct indications are not obtained, trouble may be in either unit. If the analyzer is suspected, use the performance test in Section IV to determine if the analyzer is working

correctly. Otherwise, follow the troubleshooting in Section VIII to isolate the problem.

3-7. OPERATING INSTRUCTIONS

3-8. Figure 3-3 provides instructions for making transmission and reflection measurements. The test setup in Figure 3-3 shows a typical reflectometer test setup for simultaneously measuring reflection and transmission characteristics of a device under test. This test setup may vary considerably depending on the application. Select a low-pass filter with cut-off just above the frequency band of interest. The low-pass filter reduces spurious signals above the band of interest which could cause measurement inaccuracies. Select a dual directional coupler that is as flat as possible through the band of interest. The dual directional coupler may be replaced by two directional couplers connected back-to-back. Also, if only a transmission measurement is to be made, the dual directional coupler may be replaced by a power splitting tee. Before a measurement is made, the front panel GAIN control should be adjusted as described in Figure 3-1, callout 8.

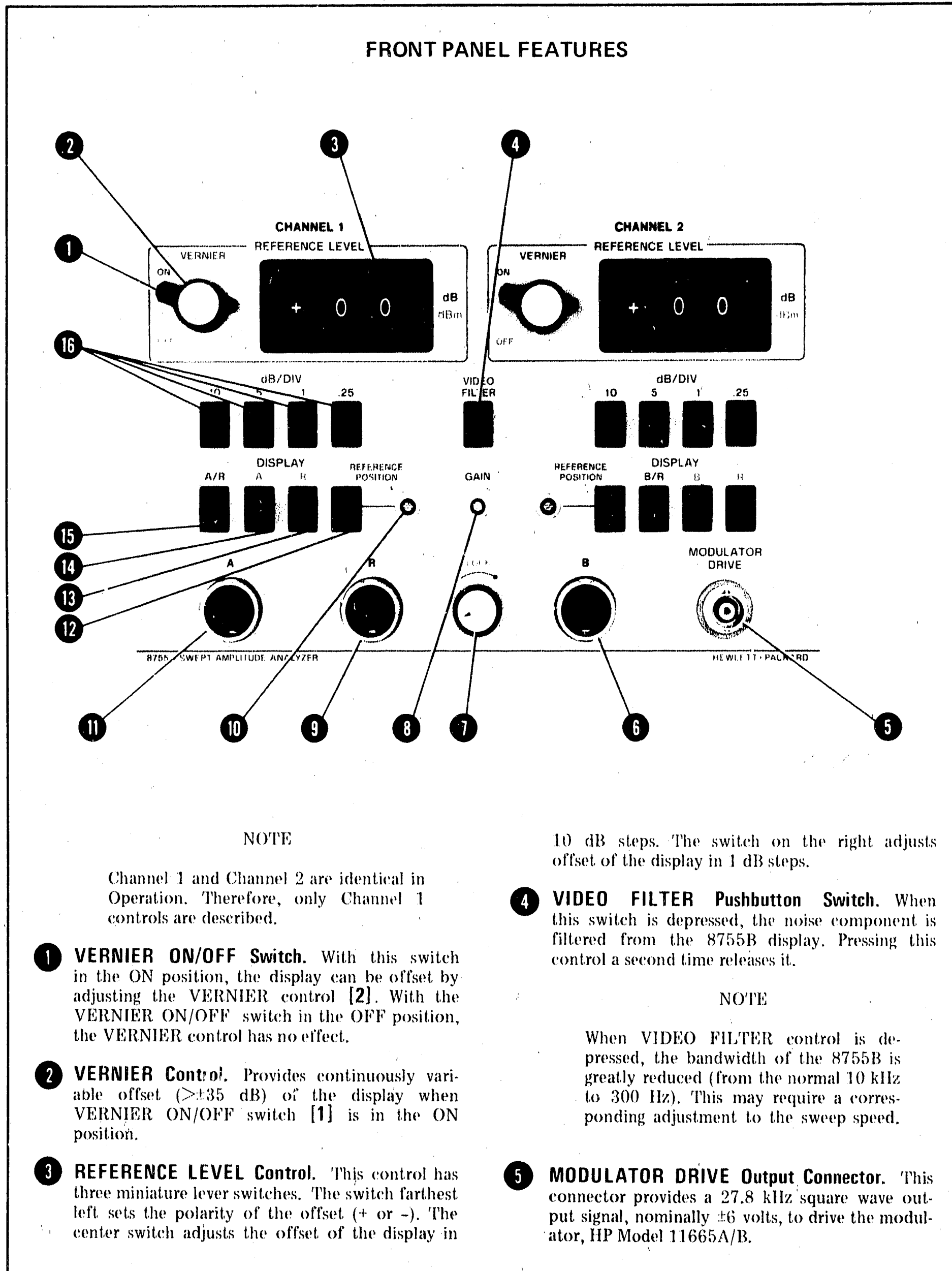
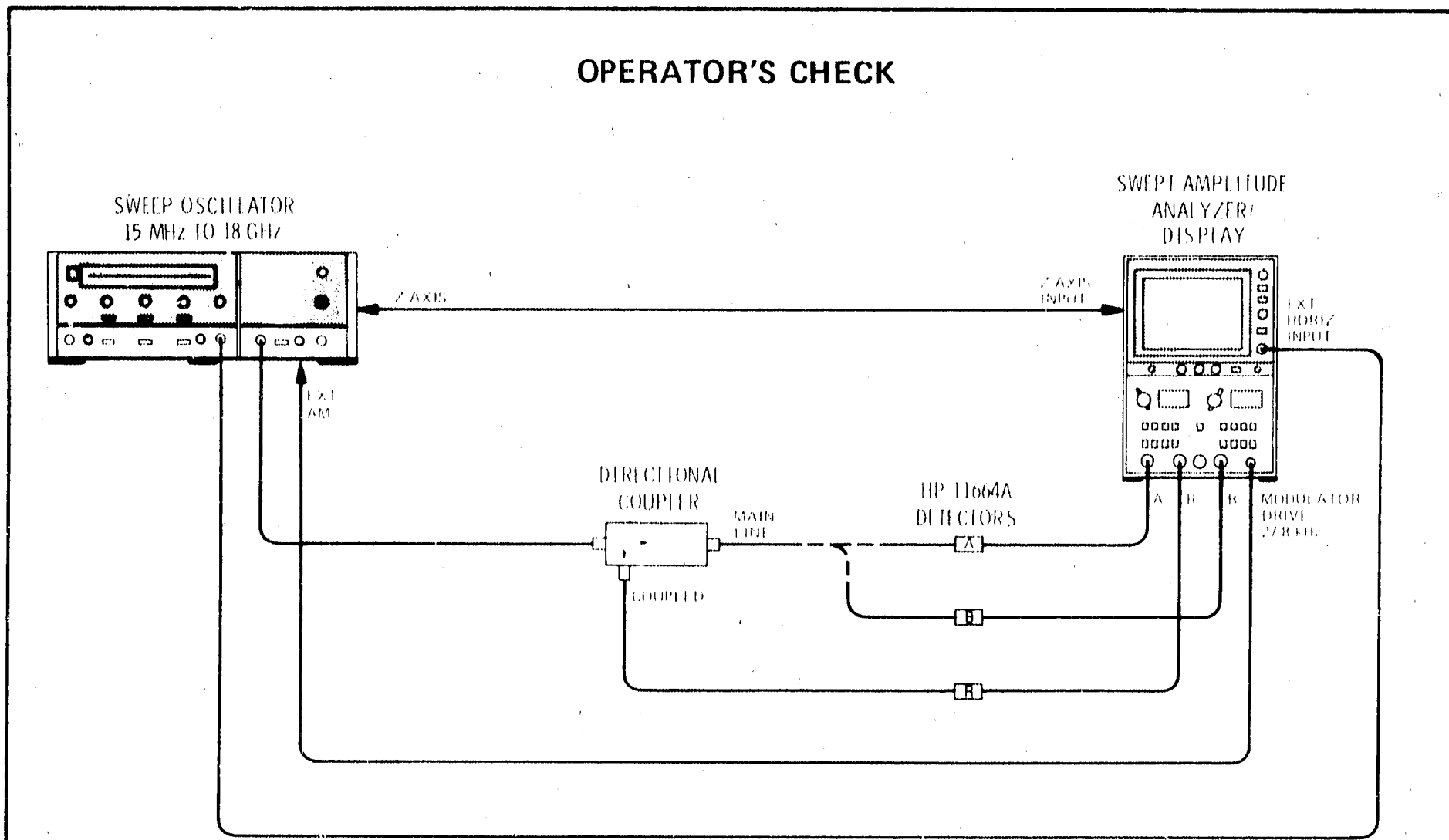

Figure 3-1. Front Panel Controls and Connectors (1 of 2)

FRONT PANEL FEATURES

- 6** **Detector B Input Connector.** Provides the input connection for the B detector, HP Model 11664A. This connector receives the detector output signal as well as supplying power through the detector cable to the preamplifier located within the detector.
- 7** **LOCKing Knob.** Turning this knob in the direction of the arrow locks the 8755B in the display mainframe. Turning this knob in the direction opposite the arrow releases the 8755B from the mainframe.
- 8** **GAIN Control.** Compensates for a difference in vertical gain of different display mainframes. The GAIN control is adjusted so the trace on the display moves exactly four divisions from the center graticule line when the REFERENCE LEVEL changes from +00 to +01 with the 8755B set for greatest resolution (.25 dB/DIV). When the polarity of the reference level is changed to minus (-01 set in REFERENCE LEVEL), the trace should move exactly four divisions to the opposite side of the center graticule line. This adjustment should be done with sweep oscillator set for minimum sweep width so a flat response is observed on the CRT display. Since the GAIN control is common to both channels, it may be adjusted, observing channel 1 display (A/R) or channel 2 display (B/R).
- 9** **Detector "R" (Reference) Input Connector.** Provides the input connection for the reference detector, HP Model 11664A. This connector receives the detector output signal as well as supplying power through the detector cable to the preamplifier located within the detector.
- 10** **DISPLAY REFERENCE POSITION Control.** When REFERENCE POSITION pushbutton [12] is depressed, the DISPLAY REFERENCE POSITION screwdriver adjustment may be adjusted for a trace positioned anywhere between the top and bottom extremes of the display screen. When the resolution is increased, the CRT trace will be expanded about the reference graticule line at which the position trace is adjusted.
- 11** **Detector "A" Input Connector.** Provides the input connection for the "A" detector, HP Model 11664A. This connector receives the detector output signal as well as supplying power through the detector cable to the preamplifier located within the detector.
- 12** **DISPLAY REFERENCE POSITION Pushbutton Switch.** When this switch is depressed, DISPLAY REFERENCE POSITION control [10] can be adjusted for a CRT trace positioned anywhere between the top and bottom extremes of the display screen for convenient reference. Also when this switch is depressed it overrides the VERNIER, REFERENCE LEVEL, resolution (dB/DIV) controls.
- 13** **DISPLAY R Pushbutton Switch.** When this switch is depressed, the 8755B displays the reference input signal level (from detector R input connector [9]).
- 14** **DISPLAY A Pushbutton Switch.** When this switch is depressed, the 8755B displays the signal level of input A (from detector A input connector [11]).
- 15** **DISPLAY A/R Pushbutton Switch.** When this switch is depressed, the 8755B displays the signal level of A in dB minus the signal level of R in dB ($A_{dB} - R_{dB} = A/R$). This mathematical relationship exists because the logarithmic function A/R is performed by simple subtraction.
- 16** **dB/DIV Resolution Pushbutton Switches.** These switches select channel vertical resolution of .25, 1, 5, or 10 dB per division.

Figure 3-1. Front Panel Controls and Connectors (2 of 2)



Operator's Check Test Setup

Initial Adjustment

- a. Connect equipment as shown in the test setup with 11664A with detector A connected to directional coupler. Refer to Table 1-4 for connections to the 180 mainframe if an 8690 series sweeper is used.

CAUTION

Set sweep oscillator POWER LEVEL fully counterclockwise (minimum power). If power level exceeds +15 dBm, damage to the 11664A detector may result.

- b. Set CHANNEL 1 and CHANNEL 2 controls as follows:

VERNIER.....	OFF
REFERENCE LEVEL.....	-00dB
dB/DIV.....	10
DISPLAY.....	POSITION
VIDEO FILTER.....	OFF(OUT)

- c. Set the sweep oscillator for the selected frequency band and External AM. Select the ΔF sweep mode and the narrowest sweep width.
- d. Press one of the CHANNEL 2 DISPLAY pushbuttons partially in to "pop" all of the switches out to turn off the CHANNEL 2 trace.

Figure 3-2: Operator's Check (1 of 2)

- e. Press CHANNEL 1 DISPLAY REFERENCE POSITION switch. Adjust CHANNEL 1 REFERENCE POSITION screwdriver adjustment to position the CRT trace on the center graticule line.

Detector "A" Test

- f. Press CHANNEL 1 DISPLAY A pushbutton. Adjust sweep oscillator POWER LEVEL control to place the CRT trace on the center graticule line. Press other CHANNEL 1 dB/DIV pushbuttons to select progressively more sensitive ranges and make fine adjustment of sweep oscillator POWER LEVEL control.

NOTE

This sweeper power setting places zero dBm at the "A" detector input. However, if this signal were measured with a power meter, the indication would be -3 dBm because of the symmetrical squarewave modulation. This modulation reduces the average power output by 3 dB (half power).

Vertical GAIN Adjustment

- g. Depress CHANNEL 1 10 dB/DIV pushbutton. Set CHANNEL 1 REFERENCE LEVEL to -40 dB. The trace should move to the top graticule line (4 divisions). Change REFERENCE LEVEL to $+40$. The trace should move to the bottom graticule line. If not, adjust GAIN screwdriver adjustment.

Detector "R" Test

- h. Set CHANNEL 1 REFERENCE LEVEL to -00 . Depress CHANNEL 1 10 dB/DIV and CHANNEL 1 DISPLAY R pushbuttons. The CRT trace should indicate the coupling factor of the directional coupler being used.

A/R Ratio Test

- i. Depress the CHANNEL 1 DISPLAY A/R pushbutton. With zero dBm applied to the A detector the ratio of A/R should indicate the coupling factor of the directional coupler being used.

Detector "B" Test

- j. Disconnect the "A" detector from the directional coupler and connect the "B" detector in its place.
- k. Press one of the CHANNEL 1 DISPLAY pushbuttons partially in to "pop" all of the switches out to turn off the CHANNEL 1 trace.
- l. Press CHANNEL 2 DISPLAY REFERENCE POSITION switch. Adjust CHANNEL 2 REFERENCE POSITION screwdriver adjustment to position the CRT trace on the center graticule line.
- m. Set CHANNEL 2 REFERENCE LEVEL TO -00 . Depress CHANNEL 2 10 dB/DIV and CHANNEL 2 DISPLAY B pushbuttons. The CRT trace should be near the center graticule line.

B/R Ratio Test

- n. Depress CHANNEL 2 DISPLAY B/R pushbutton and set CHANNEL 2 REFERENCE POSITION to equal the coupling factor of the directional coupler being used. The CRT trace should be near the center graticule line.

Figure 3-2. Operator's Check (2 of 2)

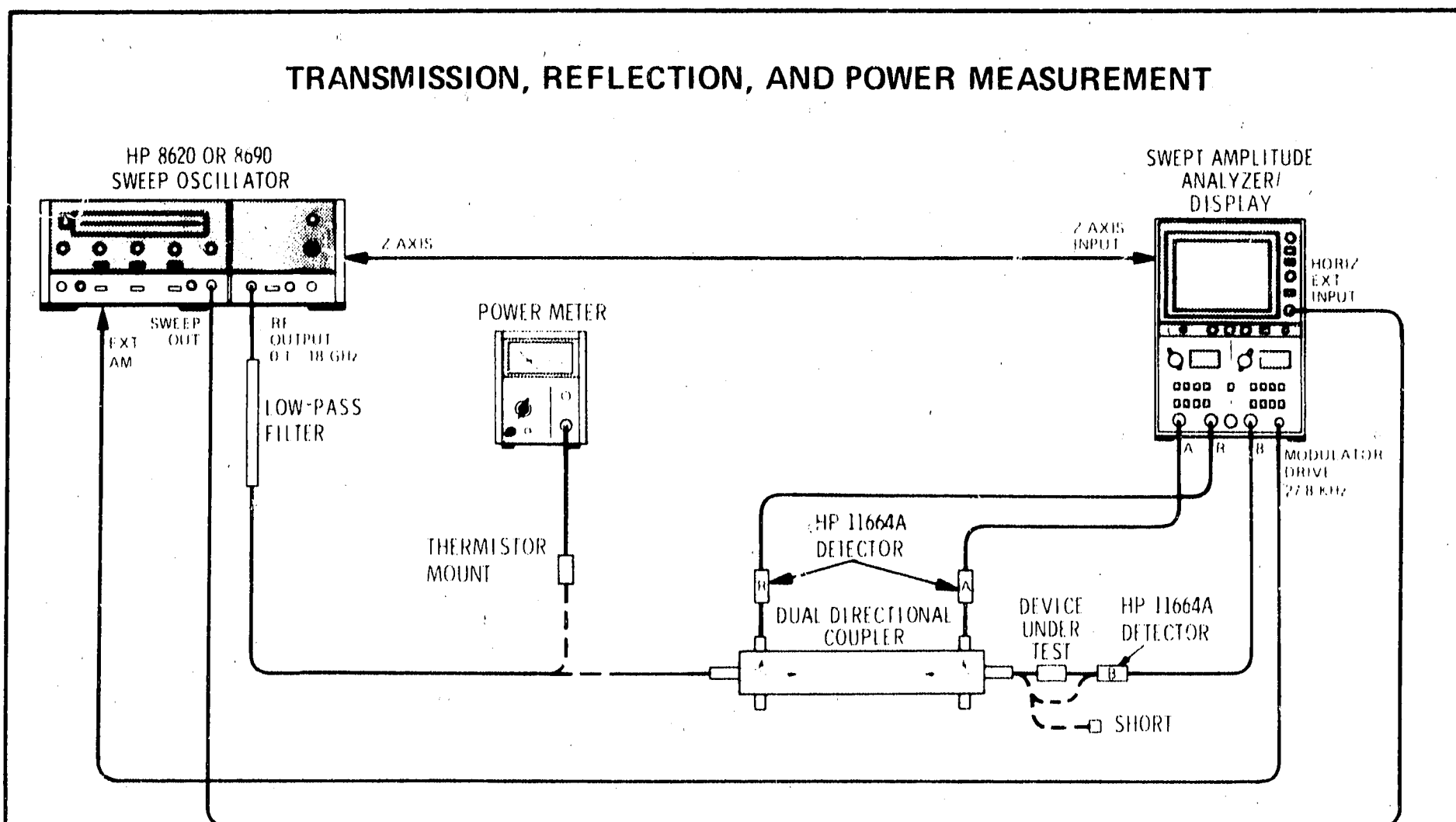

Model 8755B Typical Measurement Setup

TRANSMISSION MEASUREMENT

To Make a Transmission Measurement:

- a. Connect equipment as shown in the test setup with no device under test connected and the B detector connected directly to the output of the dual directional coupler. Refer to Table 1-4 for connections to the 180 mainframe if an 8690 series sweeper is used.
- b. Press one of the CHANNEL 1 DISPLAY pushbuttons part way in to "pop" all the CHANNEL 1 DISPLAY pushbuttons out to turn off the CHANNEL 1 display.
- c. On CHANNEL 2 panel, set VERNIER to OFF, REFERENCE LEVEL to -00 , and press 10 dB/DIV switch. Press DISPLAY REFERENCE POSITION SWITCH and adjust REFERENCE POSITION screwdriver adjustment to place the CRT trace on any convenient graticule line for a "reference." (If the device under test has attenuation or loss, place the reference line near the top of the CRT. If the device under test has gain, place the reference near the bottom of the CRT.)

CAUTION

The following equipment setup assumes that the device under test has less than 10 dB of gain. If not, the sweep oscillator power level must be reduced to prevent $>+15$ dBm signal at channel B 11664A detectors or damage may result.

- d. Press CHANNEL 2 DISPLAY B pushbutton. Increase sweep oscillator POWER LEVEL to place the CRT trace to the line one division above the reference graticule line. (This is approximately +10 dBm from the sweep oscillator.) If the sweep oscillator does not have sufficient power to obtain this level, set POWER LEVEL to maximum.

Figure 3-3. Transmission, Reflection, and Power Measurements (1 of 4)

TRANSMISSION, REFLECTION, AND POWER MEASUREMENT

- e. Press CHANNEL 2 DISPLAY B/R pushbutton. Set the VERNIER ON/OFF switch to ON and adjust VERNIER control to place one end of the CRT trace on the "reference" graticule line established in step c. To make fine adjustment, increase resolution by depressing .25 dB/DIV switch. The instrument is now ready to make a transmission measurement. Do not move the VERNIER control or calibration will be destroyed.
- f. Select 10 dB/DIV resolution. Connect a device under test between the output of the dual directional coupler and the channel B 11664A detector.
- g. Adjust CHANNEL 2 REFERENCE LEVEL switches to bring the trace back to near the "reference" graticule line. If the device under test has attenuation, the REFERENCE LEVEL switch setting will have a negative sign. Gain is indicated if the switch sign is positive. When measuring attenuation, the total attenuation of the device is obtained by adding the REFERENCE LEVEL setting to the attenuation indication of the CRT trace below the "reference" graticule line. (If the trace is above the "reference" line, subtract this amount from the REFERENCE LEVEL setting to obtain the net attenuation.) When calculating gain, add the REFERENCE LEVEL switch setting to the CRT display above the "reference" graticule line or subtract the amount below the "reference" graticule line.

REFLECTION MEASUREMENT

To Make a Reflection Measurement:

- a. Connect equipment as shown in the test setup with no device under test connected and a type-N short connected to the coupler main-line output connector. Refer to Table 1-4 for connections to the 180 mainframe if an 8690 sweeper is used.
- b. Press one of the CHANNEL 2 DISPLAY pushbuttons part way in to "pop" all of the CHANNEL 2 DISPLAY pushbuttons out to turn off the CHANNEL 2 display.
- c. On CHANNEL 1 panel, set VERNIER to OFF, REFERENCE LEVEL to -00, and press 10 dB/DIV switch. Press DISPLAY REFERENCE POSITION switch and adjust REFERENCE POSITION screwdriver adjustment to place the CRT trace on another "reference" graticule line near the top of the CRT.
- d. Press CHANNEL 1 DISPLAY A pushbutton and adjust sweep oscillator POWER LEVEL to place the CRT trace near the "reference" graticule line. If sweep oscillator does not have sufficient power to obtain this level, set POWER LEVEL to maximum. (If coupling of dual directional coupler is 20 dB, the trace should be approximately one division below the "reference" graticule line for +10 dBm output from the sweep oscillator.)
- e. Press CHANNEL 1 DISPLAY A/R pushbutton. Set VERNIER ON/OFF switch to ON. Adjust VERNIER to place the CRT trace on the "reference" graticule line. Select .25 dB/DIV to make fine adjustment. The instrument is now ready to make a reflection measurement.
- f. Select 10 dB/DIV resolution. Remove short from dual directional coupler output port and connect device under test to coupler. Adjust CHANNEL 1 REFERENCE LEVEL switches to place the CRT trace as close to the "reference" graticule line as possible. The return loss may be read directly by adding the setting of the CHANNEL 1 REFERENCE LEVEL switches to the trace position below the "reference" graticule line. If the trace is above the "reference" line, subtract that amount from the REFERENCE LEVEL switch setting.

Figure 3-3. Transmission, Reflection, and Power Measurements (2 of 4)

TRANSMISSION, REFLECTION, AND POWER MEASUREMENT

COMBINATION TRANSMISSION AND REFLECTION MEASUREMENT

The test setup shown allows simultaneous measurement of transmission and reflection. The reflection measurement is performed on the CHANNEL 1 side of the front panel and transmission measurement on CHANNEL 2 side. Make the calibration and adjustment described in steps a. through e. of the "TRANSMISSION MEASUREMENT" procedure. Do not change the sweep oscillator power setting after this point, but make all of the adjustments described in steps a. through e. of the "REFLECTION MEASUREMENT" procedure. Now the device under test may be placed in the test setup. Reflection is displayed by the CHANNEL 1 CRT trace and transmission is displayed by the CHANNEL 2 trace.

POWER MEASUREMENT

NOTE

The three 11664A Detectors and the 8755B are designed so that with no offset, the display indicates the power applied to the detectors. The power to the detectors is modulated with a symmetrical square wave; the average of the modulated signal is 3 dB below the unmodulated level. The 8755B display indicates the unmodulated power level + approximately 2 dB. Greater accuracy can be obtained by calibrating the display using a power meter as described in the second paragraph below.

NOTE

For brevity, only measurements with Detector "B" are described in the procedure. However, any one of the three detectors may be used for power measurements.

To Make a Power Measurement:

- a. Turn off the CHANNEL 1 display by pressing one of the CHANNEL 1 DISPLAY pushbuttons part way in to "pop" all of the CHANNEL 1 DISPLAY pushbuttons out.
- b. Press the CHANNEL 2 DISPLAY REFERENCE POSITION pushbutton and adjust REFERENCE POSITION screwdriver adjustment to place the CRT trace on the center graticule line. (With REFERENCE LEVEL switches at 00 dB and the VERNIER switch at OFF, the center graticule line is now zero dBm reference.)
- c. Set CHANNEL 2 VERNIER switch to OFF and REFERENCE LEVEL to 00. Press 10 dB/DIV and DISPLAY B pushbuttons.
- d. Connect the "B" detector to the device under test or any other signal point of interest at the Low Pass Filter output as shown in the test setup. Select a power point of interest on the CRT trace for a power measurement. Offset that point to the center graticule line with the CHANNEL 2 REFERENCE LEVEL switches. If the selected point on the CRT trace is now directly on the center line, the power level in dBm may be read directly from the REFERENCE LEVEL switch. (The REFERENCE LEVEL switch setting is the power level in dBm of the center graticule line.)

Figure 3-3. Transmission, Reflection, and Power Measurements (3 of 4)

TRANSMISSION, REFLECTION, AND POWER MEASUREMENT

- e. Increase the resolution of the reading by pressing the 5, 1 or .25 dB/DIV pushbuttons. If, for instance, .25 dB/DIV resolution were selected and the REFERENCE LEVEL switch were setting at -31 dBm, then the center line would be -31 dBm, one division above the center graticule line would be -30.75 dBm, and one division below the center line would be -31.25 dBm.

To Calibrate for Greater Accuracy:

- a. Turn off the CHANNEL 1 display by pressing one of the CHANNEL 1 DISPLAY pushbuttons part way in to "pop" all of the CHANNEL 1 DISPLAY pushbuttons out.
- b. Press the CHANNEL 2 DISPLAY REFERENCE POSITION pushbutton and adjust REFERENCE POSITION screwdriver adjustment to place the CRT trace on the center graticule line.
- c. Set sweep oscillator for ΔF operation over the narrowest sweep width.
- d. Connect power meter thermistor mount to the Low Pass Filter output. Adjust sweep oscillator POWER LEVEL control for a power meter indication of -3 dBm.
- e. Disconnect thermistor mount from Low Pass Filter and connect "B" detector to Low Pass Filter.
- f. Set CHANNEL 2 REFERENCE LEVEL switches to -00 and press 10 dB/DIV and DISPLAY B pushbuttons. Set CHANNEL 2 VERNIER switch to ON and adjust VERNIER control to place the CRT trace on the center graticule line. The center graticule line is now calibrated for zero dBm. To maintain calibration, do not adjust CHANNEL 2 VERNIER control again during test.
- g. Connect the "B" detector to the device under test or any other signal point of interest at the Low Pass Filter output as shown in the test setup. Select a power point of interest on the CRT trace for the power measurement. Offset the selected point to the center graticule line with the CHANNEL 2 VERNIER switches. If the point on the CRT trace is now directly on the center line, the power level in dBm may be read directly from the REFERENCE LEVEL switches. (The REFERENCE LEVEL switch setting is the power level in dBm of the center graticule line.)
- h. Increase the resolution of the reading by pressing the 5, 1 or .25 dB/DIV pushbuttons. If, for instance, .25 dB/DIV resolution were selected and the REFERENCE LEVEL switch were setting at -31 dB, then the center line would be -31 dBm; one division above the center graticule line would be -30.75 dBm, and one division below the center line would be -31.25 dBm.

Figure 3-3. Transmission, Reflection, and Power Measurements (4 of 4)

PERFORMANCE CHECK

SECTION IV PERFORMANCE TESTS

4-1. INTRODUCTION

4-2. The procedures in this section test the electrical performance of the instrument using the specifications of Table 1-1 as the performance standards. All tests can be performed without access to the interior of the instrument. A simpler operational test is included in Section III under Operator's Checks.

4-3. EQUIPMENT REQUIRED

4-4. Equipment required for the performance tests is listed under Recommended Test Equipment in Section I. Any equipment that satisfies the critical specifications given in the table may be substituted for the recommended equipment.

4-5. TEST RECORD

4-6. Results of the performance tests may be tabulated in the Test Record at the end of the section. The Test Record lists all of the tested specifications and their acceptable limits. Test results recorded at incoming inspection can be used for comparison in periodic maintenance and troubleshooting and after repairs or adjustments.

NOTE

These procedures assume that the 180-series display mainframe is fully calibrated to its specifications.

PERFORMANCE TESTS

4-7. AMPLITUDE ACCURACY

SPECIFICATION: Amplitude accuracy of the Model 8755B Swept Amplitude Analyzer together with three Model 11664A Detectors is shown in Table 4-1.

*Table 4-1. Amplitude Accuracy of Model 8755B
Connected with Three Model 11664A Detectors*

dB Change From Reference	Amplitude Accuracy
10 dB	$\leq \pm 0.9$ dB
20 dB	$\leq \pm 1.1$ dB
30 dB	$\leq \pm 1.1$ dB
40 dB	$\leq \pm 1.1$ dB
50 dB	$\leq \pm 1.1$ dB
60 dB	$\leq \pm 1.9$ dB

DESCRIPTION: The 8755B is connected as shown in Figure 4-1. An initial calibration of gain within the oscilloscope display is made. Then precision attenuators are used to vary the input level to the channel under test. With no attenuation, a reference level is set. Attenuators are then inserted in 10 dB steps and the resulting response is measured.

PERFORMANCE TESTS

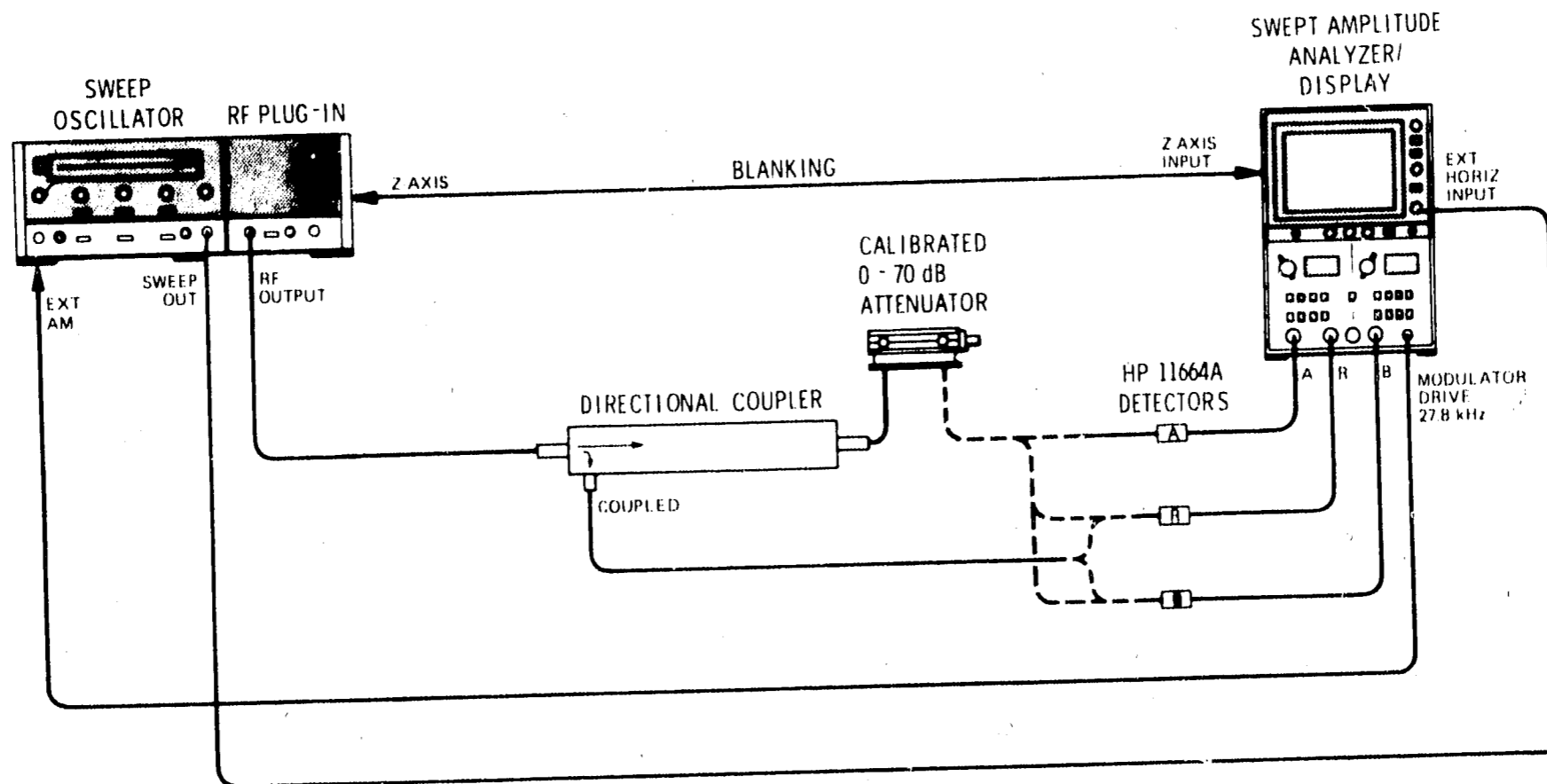

Figure 4-1. Amplitude Accuracy Test Setup

EQUIPMENT:

Swept Amplitude Analyzer Display.....	HP8755B/182A
Detectors (3 required).....	HP 11664A
Sweep Oscillator.....	HP Model 8620C Mainframe with 86290B
0-70 dB Attenuator.....	HP 8495B (calibrated)
Directional Coupler.....	HP 778D

PROCEDURE:

Initial Adjustment

- a. Connect equipment as shown in Figure 4-1 with detector R connected to incident coupled port of directional coupler and detector A connected to 0-60 dB attenuator. Set 0-60 dB attenuator to zero dB.
- b. Set Channel 1 controls as follows:

VERNIER.....	OFF
REFERENCE LEVEL.....	+10
dB/DIV.....	10
DISPLAY.....	REFERENCE POSITION
VIDEO FILTER.....	OFF (OUT)
- c. Set the sweep oscillator for 2.0 GHz. Select ΔF sweep mode and the narrowest sweep width.

PERFORMANCE TESTS

4-7. AMPLITUDE ACCURACY (cont'd)

- d. With CHANNEL 1 DISPLAY set to REFERENCE POSITION, adjust CHANNEL 1 REFERENCE POSITION screwdriver adjustment to position the CRT trace on the center graticule line.
- e. Press CHANNEL 1 DISPLAY A pushbutton. Adjust sweep oscillator POWER LEVEL control to place the CRT trace on the center graticule line. Press other CHANNEL 1 dB/DIV pushbuttons to select progressively more sensitive ranges and make fine adjustment of sweep oscillator POWER LEVEL control.

NOTE

This adjustment places +10 dBm at the detector input. However, if this signal were measured with a power meter, the indication would be +7 dBm because of the symmetrical square-wave modulation. This modulation reduces the average power output by 3 dB (half power).

NOTE

If the sweep oscillator does not provide +12 dBm output level, reduce the output to approximately +2 dBm. This should place the CRT trace approximately one division below the center graticule line. This does not allow testing the 0 to +10 dBm range of the 8755B. Therefore, use only up to 50 dB but not 60 dB of attenuation in steps h, j, and l of this test.

Gain Adjustment

- f. Press CHANNEL 1 5 dB/DIV switch and check that CHANNEL 1 REFERENCE LEVEL is at +10. Change REFERENCE LEVEL polarity switch from + to - and CRT trace should move four divisions. If not, adjust front panel GAIN screwdriver adjustment to obtain four divisions of change between + and - position.

Detector A Amplitude Accuracy Test

- g. Press CHANNEL 1 DISPLAY A/R pushbutton. Set CHANNEL 1 dB/DIV switch to 10. Set CHANNEL 1 VERNIER ON/OFF switch on ON and adjust control to place CRT trace on the line two divisions above the center line.

NOTE

If the sweep oscillator is set for +2 dBm output in step e, do not test with 60 dB of attenuation in step h.

- h. Insert 10, 20, 30, 40, 50, and 60 dB of attenuation with 0-60 dB attenuator. The CRT trace should move down one division for each added 10 dB of attenuation \pm the tolerance limits shown in Table 4-1 and \pm the calibration correction of the attenuator.

Detector B Amplitude Accuracy Test

- i. Switch output of 0-60 dB attenuator from Detector A input to Detector B input. Press CHANNEL 2 VERNIER ON/OFF switch to ON and adjust control to place CRT trace on the line two divisions above the center line.

PERFORMANCE TESTS

4-7. AMPLITUDE ACCURACY (cont'd)**NOTE**

If the sweep oscillator is set for +2 dBm output in step e, do not test with 60 dB of attenuation in step j.

- j. Insert 10, 20, 30, 40, 50, and 60 dB of attenuation with 0-60 dB attenuator. The CRT trace should move down one division for each added 10 dB of attenuation \pm the tolerance limits shown in Table 4-1 and \pm the calibration correction of the attenuator.

Detector R Amplitude Accuracy Test

- k. Reverse the B and R detectors in the test setup, connecting the R detector to the 0-60 dB attenuator and the B detector to the incident coupled port of the directional coupler. Press CHANNEL 2 DISPLAY B/R pushbutton. Set CHANNEL 2 dB/DIV switch to 10. Set CHANNEL 1 VERNIER ON/OFF switch to ON and adjust control to place the CRT trace on the line two divisions below the center line.

NOTE

If the sweep oscillator is set for +2 dBm output in step e, do not test with 60 dB of attenuation in step l.

- l. Insert 10, 20, 30, 40, 50, and 60 dB of attenuation with 0-60 dB attenuator. The CRT trace should move up one division for each added 10 dB of attenuation \pm the tolerance limits shown in Table 4-1 and \pm the calibration correction of the attenuator.
-

4-8. FREQUENCY RESPONSE

SPECIFICATION: Measurement uncertainty due to the frequency response of the 8755B, and 11664A in a two detector ratio measurement are shown in Table 4-2.

Table 4-2. Frequency Response When Measuring the Ratio of Two Detector Signals

Frequency Range	Swept Measurement Uncertainty Due to Frequency Response Only
100 MHz to 8 GHz	$\leq \pm 0.15$ dB
100 MHz to 10 GHz	$\leq \pm 0.2$ dB
100 MHz to 12.4 GHz	$\leq \pm 0.3$ dB
100 MHz to 14 GHz	$\leq \pm 0.45$ dB
100 MHz to 15 GHz	$\leq \pm 0.5$ dB
100 MHz to 18 GHz	$\leq \pm 0.6$ dB

DESCRIPTION: The ratio of two detectors is measured, using the greatest resolution (.25 dB/DIV) position. Variations of the CRT trace are measured. These represent measurement ambiguity due to the frequency response of the instrument over the swept band.

PERFORMANCE TESTS

4-8. FREQUENCY RESPONSE (cont'd)

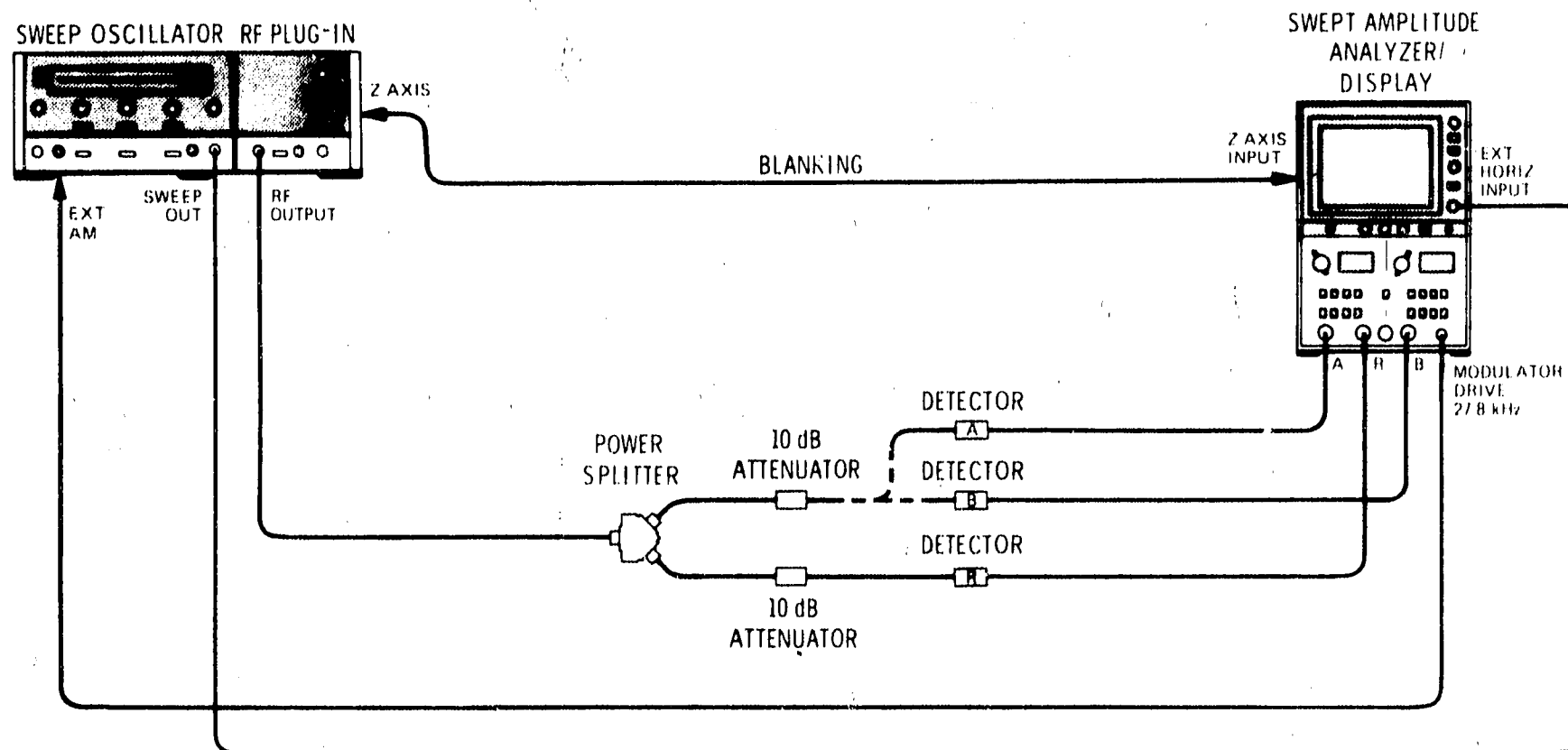

Figure 4-2. Frequency Response Test Setup

EQUIPMENT:

Swept Amplitude Analyzer/Display	HP8755B/182A
Detectors (3 required).....	HP 11664A
Sweep Oscillator	HP Model 8620C mainframe with: HP Model 8621B, HP 86320B with HP 86331C and HP 86290B
Power Splitter	HP 11667A
10 dB Attenuators (2 required).....	HP8493B, Opt. 010

PROCEDURE:

- a. Connect equipment as shown in Figure 4-2 with Detector A connected.
- b. Adjust sweep oscillator for swept mode across the widest band.
- c. Press one of the CHANNEL 2 DISPLAY pushbuttons partially in to pop all of the switch buttons out to turn off the Channel 2 trace.
- d. Set CHANNEL 1 VERNIER ON/OFF switch to OFF, REFERENCE LEVEL to -00, 10 dB/DIV switch depressed, and DISPLAY REFERENCE POSITION switch depressed. Adjust REFERENCE POSITION screwdriver adjustment to place the trace on the center graticule line of the CRT.

PERFORMANCE TESTS

4-8. FREQUENCY RESPONSE (cont'd)

- e. Press CHANNEL 1 DISPLAY A pushbutton. Adjust sweep oscillator POWER LEVEL control to place the CRT trace approximately one division below the center graticule line.

NOTE

Power level of +10 dBm from the sweep oscillator should place the CRT trace about one division below the center line.

- f. Press CHANNEL 1 DISPLAY A/R pushbutton and set VERNIER ON/OFF switch to ON. Adjust VERNIER control to place the CRT trace on the center graticule line. Select .25 dB/DIV to make final adjustment. The CRT trace should be within the specification limits shown in Table 4-2.
- g. Repeat the procedure for other frequency bands of interest.
- h. Repeat the procedure for Channel 2 and the B detector. The instructions are the same except use CHANNEL 2 controls instead of CHANNEL 1. Also connect the B detector to the attenuator and power splitting tee instead of the A detector.

Table 4-3. Performance Test Record

Hewlett-Packard Model 8755B Swept Amplitude Analyzer Serial No. _____	Test Performed By: _____ Date: _____																																																																																													
<p>4-7. AMPLITUDE ACCURACY</p> <p>h. A Detector Input</p> <p>10 dB</p> <p>20 dB</p> <p>30 dB</p> <p>40 dB</p> <p>50 dB</p> <p>60 dB</p> <p>i. B Detector Input</p> <p>10 dB</p> <p>20 dB</p> <p>30 dB</p> <p>40 dB</p> <p>50 dB</p> <p>60 dB</p> <p>R Detector Input</p> <p>10 dB</p> <p>20 dB</p> <p>30 dB</p> <p>40 dB</p> <p>50 dB</p> <p>60 dB</p> <p>4-8. FREQUENCY RESPONSE</p> <p>f. & g. Trace Variation A/R Ratio:</p> <p>100 MHz to 8 GHz</p> <p>100 MHz to 10 GHz</p> <p>100 MHz to 12.4 GHz</p> <p>100 MHz to 14 GHz</p> <p>100 MHz to 15 GHz</p> <p>100 MHz to 18 GHz</p> <p>h. Trace Variation B/R Ratio:</p> <p>100 MHz to 8 GHz</p> <p>100 MHz to 10 GHz</p> <p>100 MHz to 12.4 GHz</p> <p>100 MHz to 14 GHz</p> <p>100 MHz to 15 GHz</p> <p>100 MHz to 18 GHz</p>	<table border="1" style="width: 100%; border-collapse: collapse;"> <thead> <tr> <th style="width: 33%;">Lower Limit</th> <th style="width: 33%;">Measured Value</th> <th style="width: 33%;">Upper Limit</th> </tr> </thead> <tbody> <tr><td>9.1 dB</td><td>—</td><td>10.9 dB</td></tr> <tr><td>18.9 dB</td><td>—</td><td>21.1 dB</td></tr> <tr><td>28.9 dB</td><td>—</td><td>31.1 dB</td></tr> <tr><td>38.9 dB</td><td>—</td><td>41.1 dB</td></tr> <tr><td>48.9 dB</td><td>—</td><td>51.1 dB</td></tr> <tr><td>58.1 dB</td><td>—</td><td>61.9 dB</td></tr> <tr><td>9.1 dB</td><td>—</td><td>10.9 dB</td></tr> <tr><td>18.9 dB</td><td>—</td><td>21.1 dB</td></tr> <tr><td>28.9 dB</td><td>—</td><td>31.1 dB</td></tr> <tr><td>38.9 dB</td><td>—</td><td>41.1 dB</td></tr> <tr><td>48.9 dB</td><td>—</td><td>51.1 dB</td></tr> <tr><td>58.1 dB</td><td>—</td><td>61.9 dB</td></tr> <tr><td>9.1 dB</td><td>—</td><td>10.9 dB</td></tr> <tr><td>18.9 dB</td><td>—</td><td>21.1 dB</td></tr> <tr><td>28.9 dB</td><td>—</td><td>31.1 dB</td></tr> <tr><td>38.9 dB</td><td>—</td><td>41.1 dB</td></tr> <tr><td>48.9 dB</td><td>—</td><td>51.1 dB</td></tr> <tr><td>58.1 dB</td><td>—</td><td>61.9 dB</td></tr> <tr><td>-0.15 dB</td><td>—</td><td>+0.15 dB</td></tr> <tr><td>-0.2 dB</td><td>—</td><td>+0.2 dB</td></tr> <tr><td>-0.3 dB</td><td>—</td><td>+0.3 dB</td></tr> <tr><td>-0.45 dB</td><td>—</td><td>+0.45 dB</td></tr> <tr><td>-0.5 dB</td><td>—</td><td>+0.5 dB</td></tr> <tr><td>-0.6 dB</td><td>—</td><td>+0.6 dB</td></tr> <tr><td>-0.15 dB</td><td>—</td><td>+0.15 dB</td></tr> <tr><td>-0.2 dB</td><td>—</td><td>+0.2 dB</td></tr> <tr><td>-0.3 dB</td><td>—</td><td>+0.3 dB</td></tr> <tr><td>-0.45 dB</td><td>—</td><td>+0.45 dB</td></tr> <tr><td>-0.5 dB</td><td>—</td><td>+0.5 dB</td></tr> <tr><td>-0.6 dB</td><td>—</td><td>+0.6 dB</td></tr> </tbody> </table>	Lower Limit	Measured Value	Upper Limit	9.1 dB	—	10.9 dB	18.9 dB	—	21.1 dB	28.9 dB	—	31.1 dB	38.9 dB	—	41.1 dB	48.9 dB	—	51.1 dB	58.1 dB	—	61.9 dB	9.1 dB	—	10.9 dB	18.9 dB	—	21.1 dB	28.9 dB	—	31.1 dB	38.9 dB	—	41.1 dB	48.9 dB	—	51.1 dB	58.1 dB	—	61.9 dB	9.1 dB	—	10.9 dB	18.9 dB	—	21.1 dB	28.9 dB	—	31.1 dB	38.9 dB	—	41.1 dB	48.9 dB	—	51.1 dB	58.1 dB	—	61.9 dB	-0.15 dB	—	+0.15 dB	-0.2 dB	—	+0.2 dB	-0.3 dB	—	+0.3 dB	-0.45 dB	—	+0.45 dB	-0.5 dB	—	+0.5 dB	-0.6 dB	—	+0.6 dB	-0.15 dB	—	+0.15 dB	-0.2 dB	—	+0.2 dB	-0.3 dB	—	+0.3 dB	-0.45 dB	—	+0.45 dB	-0.5 dB	—	+0.5 dB	-0.6 dB	—	+0.6 dB
Lower Limit	Measured Value	Upper Limit																																																																																												
9.1 dB	—	10.9 dB																																																																																												
18.9 dB	—	21.1 dB																																																																																												
28.9 dB	—	31.1 dB																																																																																												
38.9 dB	—	41.1 dB																																																																																												
48.9 dB	—	51.1 dB																																																																																												
58.1 dB	—	61.9 dB																																																																																												
9.1 dB	—	10.9 dB																																																																																												
18.9 dB	—	21.1 dB																																																																																												
28.9 dB	—	31.1 dB																																																																																												
38.9 dB	—	41.1 dB																																																																																												
48.9 dB	—	51.1 dB																																																																																												
58.1 dB	—	61.9 dB																																																																																												
9.1 dB	—	10.9 dB																																																																																												
18.9 dB	—	21.1 dB																																																																																												
28.9 dB	—	31.1 dB																																																																																												
38.9 dB	—	41.1 dB																																																																																												
48.9 dB	—	51.1 dB																																																																																												
58.1 dB	—	61.9 dB																																																																																												
-0.15 dB	—	+0.15 dB																																																																																												
-0.2 dB	—	+0.2 dB																																																																																												
-0.3 dB	—	+0.3 dB																																																																																												
-0.45 dB	—	+0.45 dB																																																																																												
-0.5 dB	—	+0.5 dB																																																																																												
-0.6 dB	—	+0.6 dB																																																																																												
-0.15 dB	—	+0.15 dB																																																																																												
-0.2 dB	—	+0.2 dB																																																																																												
-0.3 dB	—	+0.3 dB																																																																																												
-0.45 dB	—	+0.45 dB																																																																																												
-0.5 dB	—	+0.5 dB																																																																																												
-0.6 dB	—	+0.6 dB																																																																																												

ADJUSTMENTS

SECTION V ADJUSTMENTS

5-1. INTRODUCTION

5-2. This section provides adjustment procedures for the Model 8755B Swept Amplitude Analyzer. Adjustments should be performed whenever the Model 8755B performance is out of tolerance. Allow 30 minutes warmup time before performing the adjustments. Adjustment locations are shown in Figure 5-1. Table 5-1 lists all of the adjustments and their functions.

5-3. EQUIPMENT REQUIRED

5-4. A list of equipment required to adjust the Swept Amplitude Analyzer is given in Figure 5-2 and also in Table 1-3.

5-5. RELATED ADJUSTMENTS

5-6. The adjustments should be performed in the order listed. However, if only one parameter is slightly out of tolerance, a single adjustment may be made. After any adjustment, the performance test in Section IV should be performed.

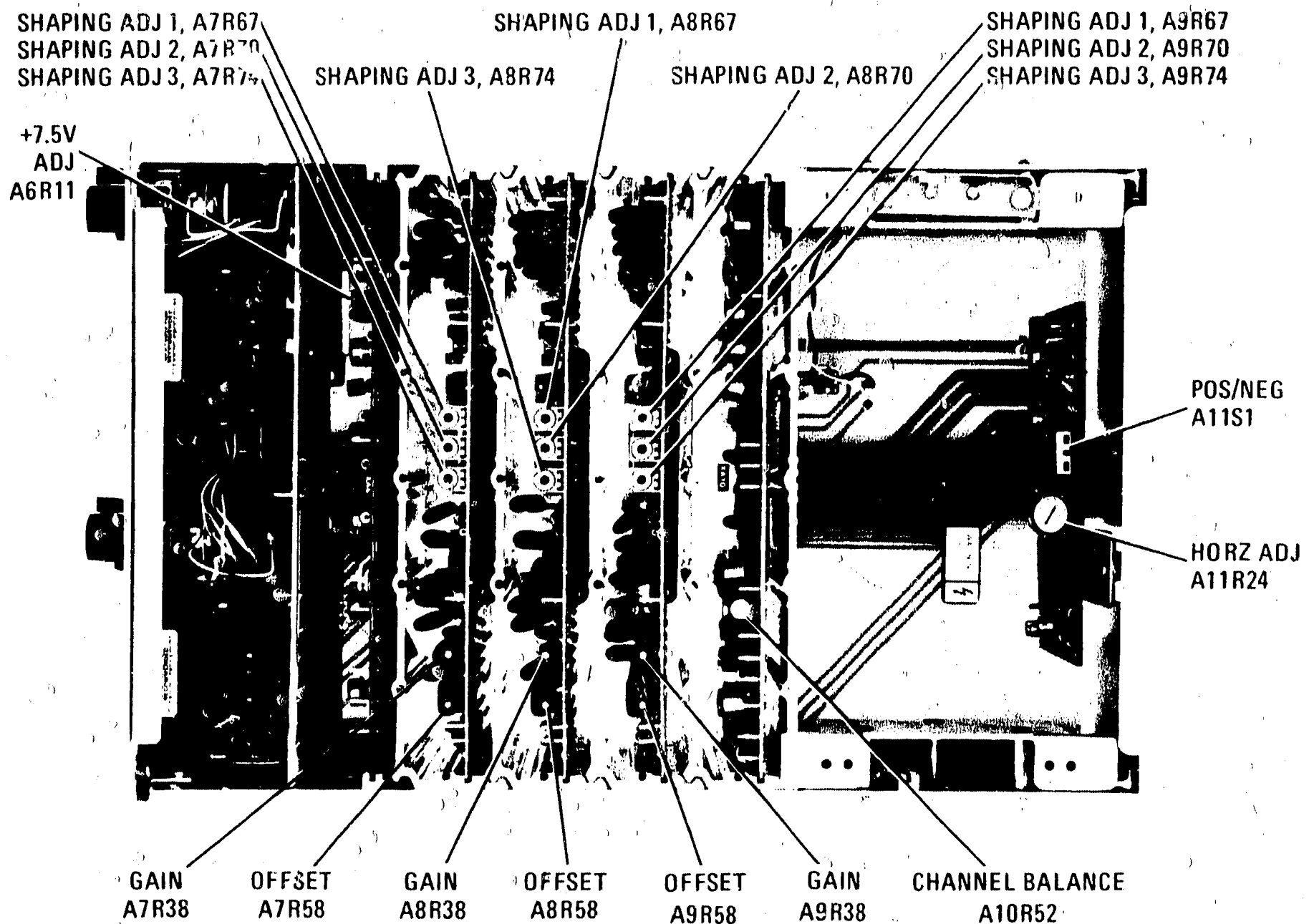
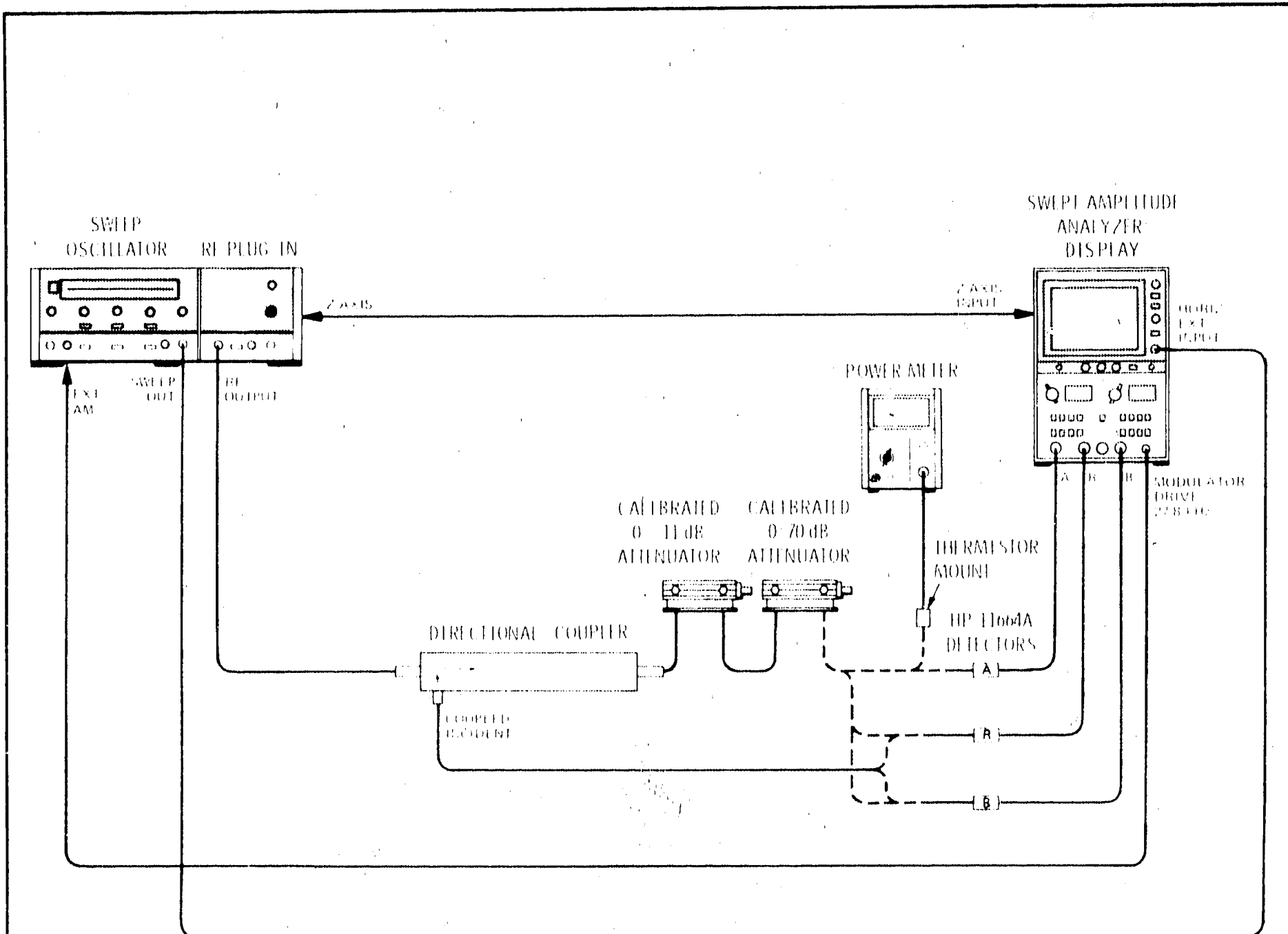

Figure 5-1. Adjustment Locations

Table 5-1. Adjustment Controls

Control Reference Designator	Name	Function
A6R11	+7.5 V ADJ	Adjust + and - 7.5V power supplies
A7R38	GAIN	Adjusts overall gain of detector "A" log amplifier
A7R58	OFFSET	Adjusts the dc offset of detector "A" log amplifier output signal
A7R67	SHAPING ADJ 1	Adjusts detector "A" log amplifier log-to-linear conversion with input range of zero dBm to +10 dBm
A7R70	SHAPING ADJ 2	Adjusts detector "A" log amplifier log-to-linear conversion with input range of -10 dBm to zero dBm
A7R74	SHAPING ADJ 3	Adjusts detector "A" log amplifier log-to-linear conversion with input range of -20 dBm to -10 dBm
A8R38	GAIN	Adjusts overall gain of detector "R" log amplifier
A8R58	OFFSET	Adjusts the dc offset of detector "R" log amplifier output signal
A8R67	SHAPING ADJ 1	Adjusts detector "R" log amplifier log-to-linear conversion with input range of zero dBm to +10 dBm
A8R70	SHAPING ADJ 2	Adjusts detector "R" log amplifier log-to-linear conversion with input range of -10 dBm to zero dBm
A8R74	SHAPING ADJ 3	Adjusts detector "R" log amplifier log-to-linear conversion with input range of -20 dBm to -10 dBm
A9R38	GAIN	Adjusts overall gain of detector "B" log amplifier
A9R58	OFFSET	Adjust the dc offset of detector "B" log amplifier output signal
A9R67	SHAPING ADJ 1	Adjusts detector "B" log amplifier log-to-linear conversion with input range of zero dBm to +10 dBm
A9R70	SHAPING ADJ 2	Adjusts detector "B" log amplifier log-to-linear conversion with input range of -10 dBm to zero dBm
A9R74	SHAPING ADJ 3	Adjusts detector "B" log amplifier log-to-linear conversion with input range of -20 dBm to -10 dBm
A10R52	CHANNEL BALANCE	Adjusts deflection balance between Channel 1 and Channel 2
A11R24	HORZ ADJ	Adjusts full screen horizontal deflection



EQUIPMENT:

Swept Amplitude Analyzer/Oscilloscope	HP 8755B/182A
Detectors (3 required)	HP 11664A
Sweep Oscillator	HP Model 8620C, Mainframe with: HP Model 8621B and 86330B
Directional Coupler	HP 778D
0-70 dB Step Attenuator (calibrated)	HP 8495B
0-11 dB Step Attenuator (calibrated)	HP 8494B
Power Meter and Thermistor Mount	HP 432A/8478B

WARNING

The adjustments in this section require the instrument to be removed from the display mainframe and connected through the extender cable assembly. Be very careful; the energy at some points in the instrument might, if contacted, cause personal injury. The adjustments in this section should be performed only by a skilled person who knows the hazard involved.

Figure 5-2. Log Amplifier Adjustment Test Setup

ADJUSTMENTS

5-7. ADJUSTMENT OF +7.5V SUPPLY

- a. Check the +15V and -12.6V from the display mainframe at the appropriate test points on the A11 Normalizer Interface. If either of these voltages are greater than ± 50 mV from their specified voltage, refer to the oscilloscope manual and adjust the voltage.
- b. Connect digital voltmeter (DVM) to A6TP1 (+7.5V) and adjust A6R11 +7.5V ADJ control for +7.5 Vdc ± 5 mVdc.
- c. Check the -7.5V supply at A6TP2. If the -7.5V is greater than ± 100 mV, troubleshoot the -7.5V supply.

5-8. ADJUSTMENT OF A7, A8, AND A9 LOG AMPLIFIERS**Equipment Setup**

- a. Connect equipment as shown in Figure 5-2 with the power meter thermistor mount connected to the 0-60 dB attenuator.
- b. Set the sweep oscillator for ΔF operation at 2.0 GHz center frequency with minimum sweep width.
- c. Set the 0-10 dB attenuator to 10 dB and the 0-60 dB attenuator to 0 dB. Adjust the sweep oscillator RF output level for a -3 dBm power meter indication.
- d. Disconnect the power meter from the 0-60 dB attenuator and connect the detectors as follows:
 1. When making the A7 (detector A logger) adjustments, connect the R detector to the coupled incident port of the directional coupler and the A detector to the 0-60 dB attenuator.
 2. When making the A8 (detector R logger) adjustments, connect the A detector to the coupled incident port of the directional coupler and the R detector to the 0-60 dB attenuator.
 3. When making the A9 (detector B logger) adjustments, connect the R detector to the coupled incident port of the directional coupler and the B detector to the 0-60 dB attenuator.
- e. Press CHANNEL 1 DISPLAY REFERENCE POSITION pushbutton and adjust REFERENCE POSITION screwdriver adjustment to place the CRT trace on the center graticule line.
- f. Press CHANNEL 2 DISPLAY REFERENCE POSITION pushbutton and adjust REFERENCE POSITION screwdriver adjustment to place the CRT trace on the center graticule line.

NOTE

All three 11664A detectors must be connected to the 8755B front panel even though only two detectors are being used.

- g. Turn off the CHANNEL 2 display when adjusting detector A or R loggers. Turn off the CHANNEL 1 display when adjusting detector B logger. To turn off a display, push one DISPLAY pushbutton part way in to pop all of the DISPLAY pushbuttons out.

ADJUSTMENTS

5-8. ADJUSTMENT OF A7, A8, AND A9 LOG AMPLIFIERS (cont'd)

Logger Adjustment

- h. Press the DISPLAY pushbuttons as follows:
1. When adjusting detector A or R logger, press the respective CHANNEL 1 DISPLAY A or R pushbutton.
 2. When adjusting detector B logger, press CHANNEL 2 DISPLAY B pushbutton.
- i. Set the 0-60 dB attenuator to 50 dB and set the appropriate DISPLAY OFFSET switch to -50 dB.
- j. Set the VERNIER ON/OFF switch to ON and adjust the trace with the VERNIER control to the graticule line. Press .25 dB/DIV pushbutton and make fine adjustment. Readjust the VERNIER control as necessary during the following adjustments to keep the amplitude response centered around the center graticule line.

NOTE

It is advisable to cover the controls of the Log Amplifier Assemblies that are not being adjusted to avoid adjusting the wrong assembly.

- k. Adjust the appropriate log amplifier internal GAIN and SHAPING controls to obtain the desired amplitude response. A response curve is shown in Figure 5-3 and Table 5-2 shows the adjustments. These are included as an aid in making these adjustments. Course adjustments should be made first and then finer adjustments made until the amplitude response is within ± 0.5 dB (\pm the tolerance of the calibrated attenuators) over the detector input range of $+10$ dBm to -50 dBm.

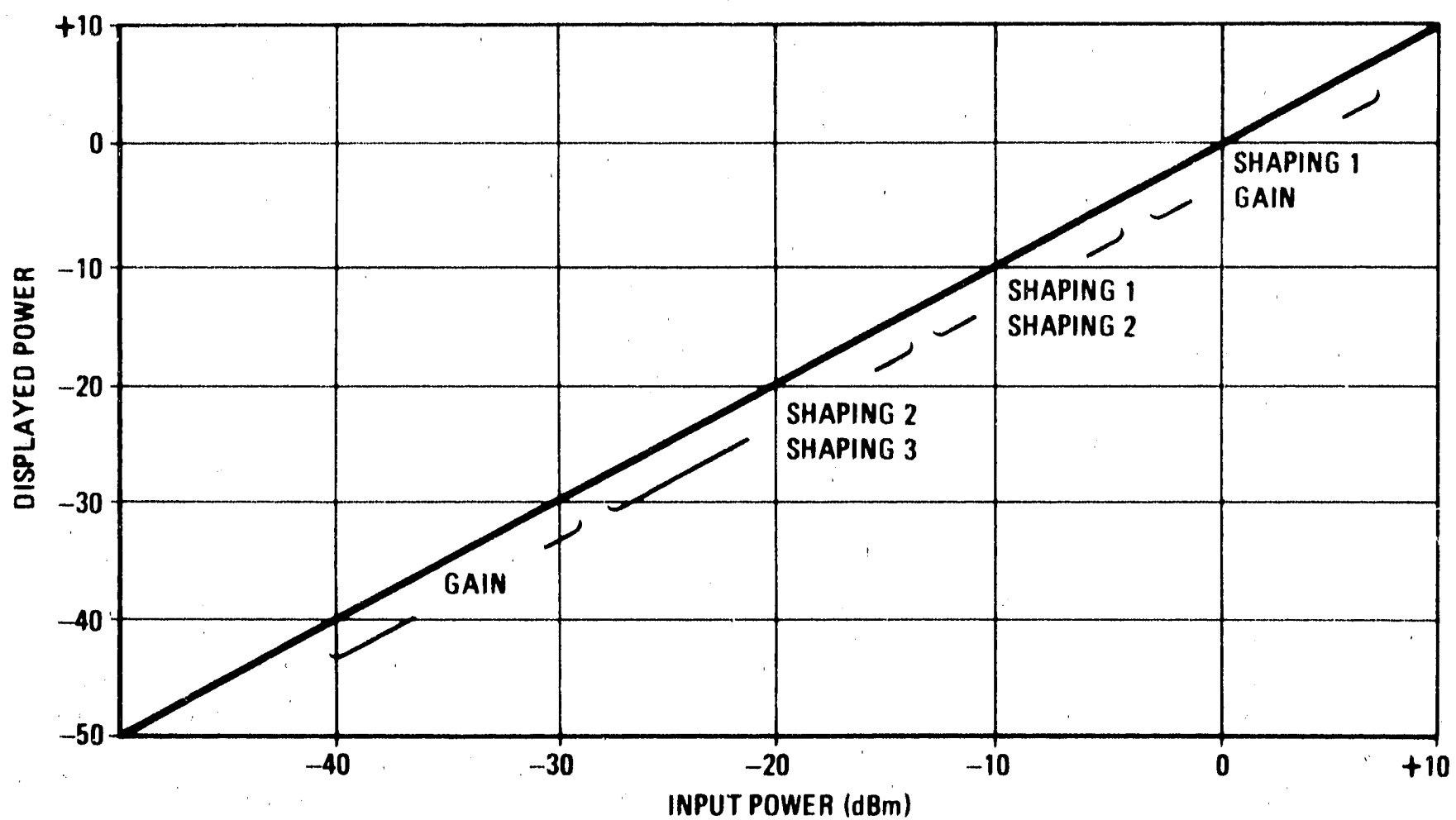

Figure 5-3. Graph for Log Amplifier Adjustment

ADJUSTMENTS

5.8. ADJUSTMENT OF A7, A8, AND A9 LOG AMPLIFIERS (cont'd)

Table 5-2. Control Settings for Log Amplifier Adjustment

Control Settings			Controls Adjusted to Bring the Trace to Within ± 0.4 dB of the Center Graticule Line	
0-60 dB Attenuator	0-10 dB Attenuator	8755B REFERENCE LEVEL		
50	10	-50	VERNIER	
40	10	-40	Gain	Adjust for Compromise
30	10	-30	Gain	
20	10	-20	Shaping 3 and Shaping 2 if necessary	
10	10	-10	Shaping 2 and Shaping 1 if necessary	
0	10	00	Shaping 1 and Gain if necessary	
0	0	+10	Shaping 1 and Gain if necessary	

Absolute Power Adjustment

- l. Select the 0-10 dB attenuator, 0-60 dB attenuator, and REFERENCE LEVEL switch setting combination in Table 5-2 that places the CRT trace closest the center graticule line.
- m. Set the VERNIER ON/OFF switch to OFF and adjust the log amplifier assembly OFFSET control to return the trace to the center graticule line.
- n. Repeat the above procedure to adjust the remaining two log amplifier assemblies.

5.9. CHANNEL BALANCE

- a. Connect equipment as shown in Figure 5-2 with R detector connected to 0-60 dB attenuator.
- b. Adjust sweep oscillator for 2.0 GHz, ΔF mode, and narrowest sweep band possible.
- c. Set both CHANNEL 1 and 2 VERNIER ON/OFF switches to OFF, REFERENCE LEVEL switches -20 dB, press 10 dB/DIV pushbuttons, and press DISPLAY REFERENCE POSITION pushbuttons.
- d. Adjust REFERENCE POSITION screwdriver adjustments to place the CHANNEL 1 and 2 CRT traces on the center graticule line superimposed on one another.
- e. Press both CHANNEL 1 and 2 DISPLAY R pushbuttons and adjust the sweep oscillator POWER LEVEL control to place the CHANNEL 2 CRT trace on the graticule line two divisions above the center line.
- f. Set CHANNEL 1 VERNIER ON/OFF switch to ON and adjust CHANNEL 1 trace so that it is superimposed on CHANNEL 2 trace.
- g. Change the polarity of both CHANNEL 1 and 2 REFERENCE LEVEL switches to + and the CRT traces should move down approximately four divisions (40 dB) and be superimposed on one another. If they are not superimposed, adjust A10 CHANNEL BALANCE, A10R52. If the traces did not move exactly four divisions, adjust the front panel GAIN screwdriver adjustment to calibrate for 10 dB/DIV.

ADJUSTMENTS

5-10. HORIZONTAL WIDTH ADJUSTMENT (REQUIRED ONLY WHEN USING AUX D INPUT)

- a. Connect SWEEP OUT of sweeper to AUX D connector on rear panel of 180 series mainframe.
- b. Press CHANNEL 1 REFERENCE POSITION pushbutton.
- c. Adjust sweep controls on sweeper and display controls on mainframe for a flicker-free trace on the CRT.
- d. If trace width is not 10 divisions, HORZ ADJ control A11R24 must be adjusted. Turn mainframe power off and remove the 8755B.
- e. If trace width is too small, turn HORZ ADJ (A11R24) clockwise. If the trace width should be reduced, turn the control counterclockwise.
- f. Replace 8755B in mainframe, turn power on and note trace width.
- g. Repeat steps e and f until trace width is 10 divisions.

PARTS LIST

SECTION VI REPLACEABLE PARTS

6-1. INTRODUCTION

6-2. This section contains information for ordering parts. Table 6-1 lists names and addresses that correspond to the manufacturer code numbers in the parts list. Table 6-2 includes a list of reference designations and a list of abbreviations used in the parts list. Table 6-3 lists all replaceable parts in alpha-numerical order by reference designation.

6-3. REPLACEABLE PARTS LIST

6-4. Table 6-3, the list of replaceable parts, is organized as follows:

1. Electrical assemblies and their components in alpha-numerical order by reference designation.
2. Miscellaneous parts, at end of list for each major assembly.
3. Chassis-mounted parts, in alpha-numerical order by reference designation, at end of parts list.

6-5. The following information is listed for each part:

1. The Hewlett-Packard part number.

2. The part number check digit (CD).
3. The total quantity (Qty) in the assembly. This quantity is given only once, at the first appearance of the part in the list.
4. The description of the part.
5. A typical manufacturer of the part in a five-digit code.
6. The manufacturer part number.

6-6. ORDERING INFORMATION

6-7. To order a part listed in the replaceable parts table, quote the Hewlett-Packard part number (with check digit), indicate the quantity required, and address the order to the nearest Hewlett-Packard office. The check digit will ensure accurate and timely processing of your order.

6-8. To order a part that is not listed in the replaceable parts table, include the instrument model number, instrument serial number, the description and function of the part, and the number of parts required. Address the order to the nearest Hewlett-Packard office.

Table 6-1. Code List of Manufacturers

MFR NO.	MANUFACTURER NAME	ADDRESS	ZIP CODE
00000	ANY SATISFACTORY SUPPLIER		
01295	TEXAS INSTR INC SEMICOND CMPNT DIV	DALLAS TX	75222
01928	RCA CORP SOLID STATE DIV	SOMERVILLE NJ	08876
02111	SPECTROL ELECTRONICS CORP	CITY OF IND CA	91745
03888	KOI PYROFILM CORP	WHIPPANY NJ	07981
04713	MOTOROLA SEMICONDUCTOR PRODUCTS	PHOENIX AZ	85062
19701	MEPCO/ELECTRA CORP	MINERAL WELLS TX	76067
24546	CORNING GLASS WORKS (BRADFORD)	BRADFORD PA	16701
27014	NATIONAL SEMICONDUCTOR CORP	SANTA CLARA CA	95051
28480	HEWLETT-PACKARD CO CORPORATE HQ	PALO ALTO CA	94304
30983	MEPCO/ELECTRA CORP	SAN DIEGO CA	92121
56289	SPRAGUE ELECTRIC CO	NORTH ADAMS MA	01247
71590	CENTRALAB ELEK DIV GLOBE-UNION INC	MILWAUKEE WI	50501
72136	ELECTRO MOTIVE CORP SUB IEC	HILLMANTIC CT	06226
98291	SEALECTRO CORP	MAMARONECK NY	10544

Table 6-3. Replaceable Parts

Reference Designation	HP Part Number	C D	Qty	Description	Mfr Code	Mfr Part Number
A1	3100-1620	0	2	SWITCH; MINIATURE LEVER	28480	3100-1620
A2	3100-1620	0		SWITCH; MINIATURE LEVER	28480	3100-1620
A3	08755-60006	6	1	BOARD ASSEMBLY; DB/DIV SWITCH	28480	08755-60006
A3C1	0180-0374	3	4	CAPACITOR-FXD 10UF+-10% 20VDC TA	56289	150D106X9020B2
A3C2	0180-0374	3		CAPACITOR-FXD 10UF+-10% 20VDC TA	56289	150D106X9020B2
A3C3	0180-0374	3		CAPACITOR-FXD 10UF+-10% 20VDC TA	56289	150D106X9020B2
A3C4	0180-0374	3		CAPACITOR-FXD 10UF+-10% 20VDC TA	56289	150D106X9020B2
A3R1	0698-7799	7	10	RESISTOR 2K .25% .125W F TC=0+-100	19701	MF4C1/8-T0-2001-C
A3R2	0698-7799	7		RESISTOR 2K .25% .125W F TC=0+-100	19701	MF4C1/8-T0-2001-C
A3R3	0698-8172	2	2	RESISTOR 4K .25% .125W F TC=0+-50	19701	MF4C1/8-T2-4001-C
A3R4	0698-8172	2		RESISTOR 4K .25% .125W F TC=0+-50	19701	MF4C1/8-T2-4001-C
A3R5	0698-3194	8	2	RESISTOR 20K .25% .125W F TC=0+-50	03888	PME55-1/8-T2-2002-C
A3R6	0698-3194	8		RESISTOR 20K .25% .125W F TC=0+-50	03888	PME55-1/8-T2-2002-C
A3R7	0698-3201	8	2	RESISTOR 80K 1% .125W F TC=0+-100	24546	C4-1/8-T0-8002-F
A3R8	0698-3201	8		RESISTOR 80K 1% .125W F TC=0+-100	24546	C4-1/8-T0-8002-F
A3S1	3101-1659	6	4	SWITCH-PB 4-STATION 12.5MM C-C SPACING	28480	3101-1659
A3S2	3101-1659	6		SWITCH-PB 4-STATION 12.5MM C-C SPACING	28480	3101-1659
A3S3	3101-1658	5	1	SWITCH-PB DPDT ALTN 1A 300VAC	28480	3101-1658
A3TP1	1251-0600	0	35	CONNECTOR-SGL CONT PIN 1.14-MM-RSC-SZ SQ	28480	1251-0600
A3TP2	1251-0600	0		CONNECTOR-SGL CONT PIN 1.14-MM-RSC-SZ SQ	28480	1251-0600
A3TP3	1251-0600	0		CONNECTOR-SGL CONT PIN 1.14-MM-RSC-SZ SQ	28480	1251-0600
A3TP4	1251-0600	0		CONNECTOR-SGL CONT PIN 1.14-MM-RSC-SZ SQ	28480	1251-0600
A4	08755-60007	7	1	BOARD ASSEMBLY, DISPLAY	28480	08755-60007
A4CR1	1910-0016	0	8	DIODE-GE 60V 60MA 1US DO-7	28480	1910-0016
A4CR2	1910-0016	0		DIODE-GE 60V 60MA 1US DO-7	28480	1910-0016
A4CR3	1910-0016	0		DIODE-GE 60V 60MA 1US DO-7	28480	1910-0016
A4CR4	1910-0016	0		DIODE-GE 60V 60MA 1US DO-7	28480	1910-0016
A4CR5	1910-0016	0		DIODE-GE 60V 60MA 1US DO-7	28480	1910-0016
A4CR6	1910-0016	0		DIODE-GE 60V 60MA 1US DO-7	28480	1910-0016
A4CR7	1910-0016	0		DIODE-GE 60V 60MA 1US DO-7	28480	1910-0016
A4CR8	1910-0016	0		DIODE-GE 60V 60MA 1US DO-7	28480	1910-0016
A4R1	0698-7799	7	16	RESISTOR 2K .25% .125W F TC=0+-100	19701	MF4C1/8-T0-2001-C
A4R2	0757-0461	0		RESISTOR 100 1% .125W F TC=0+-100	24546	C4-1/8-T0-101-F
A4R3	0698-7799	7		RESISTOR 2K .25% .125W F TC=0+-100	19701	MF4C1/8-T0-2001-C
A4R4	0698-7799	7		RESISTOR 2K .25% .125W F TC=0+-100	19701	MF4C1/8-T0-2001-C
A4R5	0698-7799	7		RESISTOR 2K .25% .125W F TC=0+-100	19701	MF4C1/8-T0-2001-C
A4R6	0757-0401	0		RESISTOR 100 1% .125W F TC=0+-100	24546	C4-1/8-T0-101-F
A4S1	3101-1659	6		SWITCH-PB 4-STATION 12.5MM C-C SPACING	28480	3101-1659
A4S2	3101-1659	6		SWITCH-PB 4-STATION 12.5MM C-C SPACING	28480	3101-1659
A5	08755-60031	7	1	BOARD ASSEMBLY, INTERCONNECT	28480	08755-60031
A5C1	0180-0197	8	23	CAPACITOR-FXD 2.2UF+-10% 20VDC TA	56289	150D225X9020A2
A5C2	0180-0197	8		CAPACITOR-FXD 2.2UF+-10% 20VDC TA	56289	150D225X9020A2
A5C3	0180-0197	8		CAPACITOR-FXD 2.2UF+-10% 20VDC TA	56289	150D225X9020A2
A5C4	0180-0197	8		CAPACITOR-FXD 2.2UF+-10% 20VDC TA	56289	150D225X9020A2
A5C5	0180-0197	8		CAPACITOR-FXD 2.2UF+-10% 20VDC TA	56289	150D225X9020A2
A5C6	0180-0197	8		CAPACITOR-FXD 2.2UF+-10% 20VDC TA	56289	150D225X9020A2
A5L1	9100-1664	7	12	COIL-MLD 3MH 5% Q=70 .215DX.56LG-NOM	28480	9100-1664
A5L2	9100-1664	7		COIL-MLD 3MH 5% Q=70 .215DX.56LG-NOM	28480	9100-1664
A5L3	9100-1664	7		COIL-MLD 3MH 5% Q=70 .215DX.56LG-NOM	28480	9100-1664
A5L4	9100-1664	7		COIL-MLD 3MH 5% Q=70 .215DX.56LG-NOM	28480	9100-1664
A5L5	9100-1664	7		COIL-MLD 3MH 5% Q=70 .215DX.56LG-NOM	28480	9100-1664
A5L6	9100-1664	7		COIL-MLD 3MH 5% Q=70 .215DX.56LG-NOM	28480	9100-1664
A5L7	9100-1664	7		COIL-MLD 3MH 5% Q=70 .215DX.56LG-NOM	28480	9100-1664
A5L8	9100-1664	7		COIL-MLD 3MH 5% Q=70 .215DX.56LG-NOM	28480	9100-1664
A5L9	9100-1664	7		COIL-MLD 3MH 5% Q=70 .215DX.56LG-NOM	28480	9100-1664
A5L10	9100-1664	7		COIL-MLD 3MH 5% Q=70 .215DX.56LG-NOM	28480	9100-1664
A5L11	9100-1664	7		COIL-MLD 3MH 5% Q=70 .215DX.56LG-NOM	28480	9100-1664
A5L12	9100-1664	7		COIL-MLD 3MH 5% Q=70 .215DX.56LG-NOM	28480	9100-1664

See introduction to this section for ordering information
 *Indicates factory selected value

Table 6-3. Replaceable Parts

Reference Designation	HP Part Number	C D	Qty	Description	Mfr Code	Mfr Part Number
A5R1	0757-0440	7	5	RESISTOR 7.5K 1% .125W F TC0+/-100	24546	C4-1/8-T0-7501-F
A5R2	0757-0440	7		RESISTOR 7.5K 1% .125W F TC0+/-100	24546	C4-1/8-T0-7501-F
A5R3	0698-6614	3	4	RESISTOR 7.5K .1% .125W F TC0+/-25	28480	0698-6614
A5R4	0698-6614	3		RESISTOR 7.5K .1% .125W F TC0+/-25	28480	0698-6614
A5R5	0698-3236	9	2	RESISTOR 15K .25% .125W F TC0+/-50	28480	0698-3236
A5R6	0698-3236	9		RESISTOR 15K .25% .125W F TC0+/-50	28480	0698-3236
A5R7	0698-3221	2	2	RESISTOR 30K .25% .125W F TC0+/-50	28480	0698-3221
A5R8	0698-3221	2		RESISTOR 30K .25% .125W F TC0+/-50	28480	0698-3221
A5R9	0698-8173	3	2	RESISTOR 37.5K .25% .125W F TC0+/-50	19701	MF4C1/8-T2-3752-C
A5R10	0698-8173	3		RESISTOR 37.5K .25% .125W F TC0+/-50	19701	MF4C1/8-T2-3752-C
A5R11	0698-8174	4	2	RESISTOR 75K .5% .125W F TC0+/-100	19701	MF4C1/8-T2-7502-D
A5R12	0698-8174	4		RESISTOR 75K .5% .125W F TC0+/-100	19701	MF4C1/8-T2-7502-D
A5R13	0698-3234	7	2	RESISTOR 150K .25% .125W F TC0+/-50	28480	0698-3234
A5R14	0698-3234	7		RESISTOR 150K .25% .125W F TC0+/-50	28480	0698-3234
A5R15	0698-3219	8	2	RESISTOR 300K .25% .125W F TC0+/-50	28480	0698-3219
A5R16	0698-3219	8		RESISTOR 300K .25% .125W F TC0+/-50	28480	0698-3219
A5R17	2100-3186	5	3	RESISTOR-VAR CONTROL CCP 2.5K 10% LIN	28480	2100-3186
A5R18	0757-0280	3	12	RESISTOR 1K 1% .125W F TC0+/-100	24546	C4-1/8-T0-1001-F
A5R19	0757-0420	3	7	RESISTOR 750 1% .125W F TC0+/-100	24546	C4-1/8-T0-751-F
A5R20	2100-3186	5		RESISTOR-VAR CONTROL CCP 2.5K 10% LIN	28480	2100-3186
A5R21	0757-0280	3		RESISTOR 1K 1% .125W F TC0+/-100	24546	C4-1/8-T0-1001-F
A5R22	0757-0420	3		RESISTOR 750 1% .125W F TC0+/-100	24546	C4-1/8-T0-751-F
A5R23	2100-3186	5		RESISTOR-VAR CONTROL CCP 2.5K 10% LIN	28480	2100-3186
A5R24	0698-6615	4	2	RESISTOR 3.75K .1% .125W F TC0+/-25	28480	0698-6615
A5R25	0698-6615	4		RESISTOR 3.75K .1% .125W F TC0+/-25	28480	0698-6615
A5TP1	1251-0600	0		CONNECTOR-SGL CONT PIN 1.14-MM-BSC-32 SQ	28480	1251-0600
A5TP2	1251-0600	0		CONNECTOR-SGL CONT PIN 1.14-MM-BSC-32 SQ	28480	1251-0600
A5W1	8159-0005	0	4	JUMPER	28480	8159-0005
A5W2	8159-0005	0		JUMPER	28480	8159-0005
A5W3	8159-0005	0		JUMPER	28480	8159-0005
A5W4	8159-0005	0		JUMPER	28480	8159-0005
A5XA1A	1251-1941	4	6	CONNECTOR-PC EDGE 6-CONT/ROW 1-ROW	28480	1251-1941
A5XA1B	1251-1941	4		CONNECTOR-PC EDGE 6-CONT/ROW 1-ROW	28480	1251-1941
A5XA1C	1251-1941	4		CONNECTOR-PC EDGE 6-CONT/ROW 1-ROW	28480	1251-1941
A5XA2A	1251-1941	4		CONNECTOR-PC EDGE 6-CONT/ROW 1-ROW	28480	1251-1941
A5XA2B	1251-1941	4		CONNECTOR-PC EDGE 6-CONT/ROW 1-ROW	28480	1251-1941
A5XA2C	1251-1941	4		CONNECTOR-PC EDGE 6-CONT/ROW 1-ROW	28480	1251-1941
A5XA3	1251-0213	1	4	CONNECTOR-PC EDGE 15-CONT/ROW 1-ROW	28480	1251-0213
A5XA4	1251-2034	1	1	CONNECTOR-PC EDGE 10-CONT/ROW 2-ROWS	28480	1251-2034
A6	08755-60002	2	1	BOARD ASSEMBLY, PROCESSOR	28480	08755-60002
A6C1	0180-0116	1	4	CAPACITOR-FXD 6.8UF+/-10% 35VDC TA	56289	150D685X9035B2
A6C2	0180-0116	1		CAPACITOR-FXD 6.8UF+/-10% 35VDC TA	56289	150D685X9035B2
A6C3	0180-0116	1		CAPACITOR-FXD 6.8UF+/-10% 35VDC TA	56289	150D685X9035B2
A6C4	0180-0116	1		CAPACITOR-FXD 6.8UF+/-10% 35VDC TA	56289	150D685X9035B2
A6C5	0160-2207	3	1	CAPACITOR-FXD 300PF +/-5% 300VDC MICA	28480	0160-2207
A6C6	0160-2199	2	2	CAPACITOR-FXD 30PF +/-5% 300VDC MICA	28480	0160-2199
A6CR1	1902-0048	1	4	DIODE-ZNR 6.81V 5% DO-7 PD=.4W TC=+.043%	28480	1902-0048
A6CR2	1902-0048	1		DIODE-ZNR 6.81V 5% DO-7 PD=.4W TC=+.043%	28480	1902-0048
A6CR3	1902-0048	1		DIODE-ZNR 6.81V 5% DO-7 PD=.4W TC=+.043%	28480	1902-0048
A6CR4	1902-0048	1		DIODE-ZNR 6.81V 5% DO-7 PD=.4W TC=+.043%	28480	1902-0048
A6CR5	1902-0761	5	1	DIODE-ZNR 1N821 6.2V 5% DO-7 PD=.4W	04713	1N821
A6Q1	1853-0020	4	5	TRANSISTOR PNP JI PD=300MW FT=150MHZ	28480	1853-0020
A6Q2	1854-0071	7	16	TRANSISTOR NPN SI PD=300MW FT=200MHZ	28480	1854-0071
A6R1	0698-7799	7		RESISTOR 2K .25% .125W F TC0+/-100	19701	MF4C1/8-T0-2001-C
A6R2	0698-7799	7		RESISTOR 2K .25% .125W F TC0+/-100	19701	MF4C1/8-T0-2001-C
A6R3	0698-7799	7		RESISTOR 2K .25% .125W F TC0+/-100	19701	MF4C1/8-T0-2001-C
A6R4	0698-7799	7		RESISTOR 2K .25% .125W F TC0+/-100	19701	MF4C1/8-T0-2001-C
A6R5	0757-0401	0		RESISTOR 100 1% .125W F TC0+/-100	24546	C4-1/8-T0-101-F
A6R6	0757-0401	0		RESISTOR 100 1% .125W F TC0+/-100	24546	C4-1/8-T0-101-F
A6R7	0757-0401	0		RESISTOR 100 1% .125W F TC0+/-100	24546	C4-1/8-T0-101-F
A6R8	0757-0401	0		RESISTOR 100 1% .125W F TC0+/-100	24546	C4-1/8-T0-101-F
A6R9	0757-0280	3		RESISTOR 1K 1% .125W F TC0+/-100	24546	C4-1/8-T0-1001-F
A6R10	0757-0401	0		RESISTOR 100 1% .125W F TC0+/-100	24546	C4-1/8-T0-101-F
A6R11	2100-3095	5	1	RESISTOR-TRMR 200 10% C SIDE-ADJ 17-TRN	02111	43P201
A6R12	0698-6614	3		RESISTOR 7.5K .1% .125W F TC0+/-25	28480	0698-6614
A6R13	0698-6614	3		RESISTOR 7.5K .1% .125W F TC0+/-25	28480	0698-6614
A6R14	0757-1090	5	1	RESISTOR 261 1% .5W F TC0+/-100	28480	0757-1090
A6R15	0698-0083	8	4	RESISTOR 1.96K 1% .125W F TC0+/-100	24546	C4-1/8-T0-1961-F
A6R16	0757-0802	5	1	RESISTOR 162 1% .5W F TC0+/-100	28480	0757-0802
A6R17	0698-0083	8		RESISTOR 1.96K 1% .125W F TC0+/-100	24546	C4-1/8-T0-1961-F
A6R18	0757-0280	3		RESISTOR 1K 1% .125W F TC0+/-100	24546	C4-1/8-T0-1001-F

See introduction to this section for ordering information
 *Indicates factory selected value

Table 6-3. Replaceable Parts

Reference Designation	HP Part Number	C D	Qty	Description	Mfr Code	Mfr Part Number
A6TP1	1251-0600	0		CONNECTOR-SGL CONT PIN 1,14-MM-B9C-8Z SQ	28480	1251-0600
A6TP2	1251-0600	0		CONNECTOR-SGL CONT PIN 1,14-MM-B9C-8Z SQ	28480	1251-0600
A6TP3	1251-0600	0		CONNECTOR-SGL CONT PIN 1,14-MM-B9C-8Z SQ	28480	1251-0600
A6TP4	1251-0600	0		CONNECTOR-SGL CONT PIN 1,14-MM-B9C-8Z SQ	28480	1251-0600
A6TP5	1251-0600	0		CONNECTOR-SGL CONT PIN 1,14-MM-B9C-8Z SQ	28480	1251-0600
A6TP6	1251-0600	0		CONNECTOR-SGL CONT PIN 1,14-MM-B9C-8Z SQ	28480	1251-0600
A6TP7	1251-0600	0		CONNECTOR-SGL CONT PIN 1,14-MM-B9C-8Z SQ	28480	1251-0600
A6TP8	1251-0600	0		CONNECTOR-SGL CONT PIN 1,14-MM-B9C-8Z SQ	28480	1251-0600
A6TP9	1251-0600	0		CONNECTOR-SGL CONT PIN 1,14-MM-B9C-8Z SQ	28480	1251-0600
A6U1	1A20-0223	0	5	IC OP AMP GP TO-99	04713	MLM301AG
A6U2	1A20-0223	0		IC OP AMP GP TO-99	04713	MLM301AG
A6U3	1A26-0261	8	6	IC OP AMP LOW-NOISE TO-99	28480	1826-0261
A6U4	1A26-0261	8		IC OP AMP LOW-NOISE TO-99	28480	1826-0261
A6U5	1A26-0261	8		IC OP AMP LOW-NOISE TO-99	28480	1826-0261
A6U6	1A26-0261	8		IC OP AMP LOW-NOISE TO-99	28480	1826-0261
A7	0A755-60001	1	1	BOARD ASSEMBLY, 27.8 KHZ LOG AMPLIFIER	28480	0A755-60001
A7C1	0160-0197	8		CAPACITOR-FXD 2.2UF +-10% 20VDC TA	56289	150D225X9020A2
A7C2	0160-0127	2	5	CAPACITOR-FXD 1UF +-20% 25VDC CER	28480	0160-0127
A7C3	0160-0127	2		CAPACITOR-FXD 1UF +-20% 25VDC CER	28480	0160-0127
A7C4	0160-1746	5	5	CAPACITOR-FXD 15UF +-10% 20VDC TA	56289	150D156X9020B2
A7C5	0160-1746	5		CAPACITOR-FXD 15UF +-10% 20VDC TA	56289	150D156X9020B2
A7C6	0160-0197	8		CAPACITOR-FXD 2.2UF +-10% 20VDC TA	56289	150D225X9020A2
A7C7	0160-0197	8		CAPACITOR-FXD 2.2UF +-10% 20VDC TA	56289	150D225X9020A2
A7C8	0160-3292	8	2	CAPACITOR-FXD 1300PF +-1% 100VDC MICA	28480	0160-3292
A7C9	0160-3292	8		CAPACITOR-FXD 1300PF +-1% 100VDC MICA	28480	0160-3292
A7C10	0160-3047	1	2	CAPACITOR-FXD 3280PF +-1% 100VDC MICA	28480	0160-3047
A7C11	0160-3047	1		CAPACITOR-FXD 3280PF +-1% 100VDC MICA	28480	0160-3047
A7C12	0140-0221	5	2	CAPACITOR-FXD 220PF +-1% 300VDC MICA	72136	DM15F221F0300WVIC
A7C13	0140-0221	5		CAPACITOR-FXD 220PF +-1% 300VDC MICA	72136	DM15F221F0300WVIC
A7C14	0160-0197	8		CAPACITOR-FXD 2.2UF +-10% 20VDC TA	56289	150D225X9020A2
A7C15	0160-0218	2	6	CAPACITOR-FXD 2400PF +-1% 300VDC MICA	28480	0160-0218
A7C16	0160-0218	2		CAPACITOR-FXD 2400PF +-1% 300VDC MICA	28480	0160-0218
A7C17	0160-0218	2		CAPACITOR-FXD 2400PF +-1% 300VDC MICA	28480	0160-0218
A7C18	0160-0218	2		CAPACITOR-FXD 2400PF +-1% 300VDC MICA	28480	0160-0218
A7C19	0160-0218	2		CAPACITOR-FXD 2400PF +-1% 300VDC MICA	28480	0160-0218
A7C20	0160-0218	2		CAPACITOR-FXD 2400PF +-1% 300VDC MICA	28480	0160-0218
A7C21	0160-2206	4	3	CAPACITOR-FXD 60UF +-10% 6VDC TA	56289	150D606X9006B2
A7C22	0160-0197	8		CAPACITOR-FXD 2.2UF +-10% 20VDC TA	56289	150D225X9020A2
A7C23	0160-0197	8		CAPACITOR-FXD 2.2UF +-10% 20VDC TA	56289	150D225X9020A2
A7C24	0160-0197	8		CAPACITOR-FXD 2.2UF +-10% 20VDC TA	56289	150D225X9020A2
A7C25	0160-0197	8		CAPACITOR-FXD 2.2UF +-10% 20VDC TA	56289	150D225X9020A2
A7C26	0160-0127	2		CAPACITOR-FXD 1UF +-20% 25VDC CER	28480	0160-0127
A7C27	0160-2055	9	1	CAPACITOR-FXD .01UF +-60-20% 100VDC CER	28480	0160-2055
A7C28	0160-0197	8		CAPACITOR-FXD 2.2UF +-10% 20VDC TA	56289	150D225X9020A2
A7C29	0160-0127	2		CAPACITOR-FXD 1UF +-20% 25VDC CER	28480	0160-0127
A7C30	0160-0127	2		CAPACITOR-FXD 1UF +-20% 25VDC CER	28480	0160-0127
A7C31	0160-2261	9	1	CAPACITOR-FXD 15PF +-5% 500VDC CER 0+-30	28480	0160-2261
A7C32	0140-0196	3	3	CAPACITOR-FXD 150PF +-5% 300VDC MICA	72136	DM15F151J0300WVIC
A7C33	0140-0192	9	1	CAPACITOR-FXD 68PF +-5% 300VDC MICA	72136	DM15E680J0300WVIC
A7C34	0160-0197	8		CAPACITOR-FXD 2.2UF +-10% 20VDC TA	56289	150D225X9020A2
A7C35	0160-2206	4		CAPACITOR-FXD 60UF +-10% 6VDC TA	56289	150D606X9006B2
A7C36	0160-2206	4		CAPACITOR-FXD 60UF +-10% 6VDC TA	56289	150D606X9006B2
A7C37	0160-0197	8		CAPACITOR-FXD 2.2UF +-10% 20VDC TA	56289	150D225X9020A2
A7C38	0160-3457	7	1	CAPACITOR-FXD 2000PF +-10% 250VDC CER	28480	0160-3457
A7C39	0140-0196	3		CAPACITOR-FXD 150PF +-5% 300VDC MICA	72136	DM15F151J0300WVIC
A7C40	0160-0197	8		CAPACITOR-FXD 2.2UF +-10% 20VDC TA	56289	150D225X9020A2
A7C41	0160-4835	7	1	CAPACITOR-FXD .1UF +-10% 50VDC CER	28480	0160-4835
A7C42	0140-0235	1	3	CAPACITOR-FXD 2250PF +-1% 300VDC MICA	72136	DM20F2250RF0300WVIC
A7C43	0140-0235	1		CAPACITOR-FXD 2250PF +-1% 300VDC MICA	72136	DM20F2250RF0300WVIC
A7C44	0140-0235	1		CAPACITOR-FXD 2250PF +-1% 300VDC MICA	72136	DM20F2250RF0300WVIC
A7C45	0160-0197	8		CAPACITOR-FXD 2.2UF +-10% 20VDC TA	56289	150D225X9020A2
A7C46	0160-2199	2		CAPACITOR-FXD 30PF +-5% 300VDC MICA	28480	0160-2199
A7CR1	1901-0040	1	13	DIODE-SWITCHING 30V 50MA 2NS DO-35	28480	1901-0040
A7CR2	1901-0040	1		DIODE-SWITCHING 30V 50MA 2NS DO-35	28480	1901-0040
A7CR3	1901-0040	1		DIODE-SWITCHING 30V 50MA 2NS DO-35	28480	1901-0040
A7CR4	1901-0040	1		DIODE-SWITCHING 30V 50MA 2NS DO-35	28480	1901-0040
A7CR5	1901-0040	1		DIODE-SWITCHING 30V 50MA 2NS DO-35	28480	1901-0040
A7CR6	1901-0040	1		DIODE-SWITCHING 30V 50MA 2NS DO-35	28480	1901-0040
A7CR7	1901-0040	1		DIODE-SWITCHING 30V 50MA 2NS DO-35	28480	1901-0040
A7CR8	1901-0040	1		DIODE-SWITCHING 30V 50MA 2NS DO-35	28480	1901-0040
A7CR9	1902-0551	1	1	DIODE-ZNR 6.19V 5% DO-15 PD=1W TC=+.022%	28480	1902-0551

See introduction to this section for ordering information
 *Indicates factory selected value

Table 6-3. Replaceable Parts

Reference Designation	HP Part Number	C D	Qty	Description	Mfr Code	Mfr Part Number
A7L1	9140-0210	1	3	COIL-MLD 100UH 5X Q#50 .155DX.375LG-NOM	28480	9140-0210
A7L2	9140-0210	1		COIL-MLD 100UH 5X Q#50 .155DX.375LG-NOM	28480	9140-0210
A7L3	9100-2578	4	1	COIL-MLD 2.7MH 10X Q#45 .156DX.375LG-NOM	28480	9100-2578
A7L4	9140-0210	1		COIL-MLD 100UH 5X Q#50 .155DX.375LG-NOM	28480	9140-0210
A7Q1	1854-0023	9	1	TRANSISTOR NPN SI TO-18 PD=360MW	28480	1854-0023
A7Q2	1853-0451	5	1	TRANSISTOR PNP 2N3799 SI TO-18 PD=360MW	01295	2N3799
A7Q3	1854-0071	7		TRANSISTOR NPN SI PD=300MW FT=200MHZ	28480	1854-0071
A7Q4	1854-0071	7		TRANSISTOR NPN SI PD=300MW FT=200MHZ	28480	1854-0071
A7Q5	1854-0071	7		TRANSISTOR NPN SI PD=300MW FT=200MHZ	28480	1854-0071
A7Q6	1853-0020	4		TRANSISTOR PNP SI PD=300MW FT=150MHZ	28480	1853-0020
A7Q7	1854-0071	7		TRANSISTOR NPN SI PD=300MW FT=200MHZ	28480	1854-0071
A7Q8	1853-0020	4		TRANSISTOR PNP SI PD=300MW FT=150MHZ	28480	1853-0020
A7Q9	1854-0404	0	4	TRANSISTOR NPN SI TO-18 PD=360MW	28480	1854-0404
A7Q10	1853-0007	7	1	TRANSISTOR PNP 2N3251 SI TO-18 PD=360MW	04713	2N3251
A7Q11	1854-0071	7		TRANSISTOR NPN SI PD=300MW FT=200MHZ	28480	1854-0071
A7Q12	1854-0071	7		TRANSISTOR NPN SI PD=300MW FT=200MHZ	28480	1854-0071
A7Q13	1853-0020	4		TRANSISTOR PNP SI PD=300MW FT=150MHZ	28480	1853-0020
A7R1	0698-3456	5	1	RESISTOR 287K 1X .125W F TC=0+-100	24546	C4-1/8-T0-2873-F
A7R2	0698-3450	9	5	RESISTOR 42.2K 1X .125W F TC=0+-100	24546	C4-1/8-T0-4222-F
A7R3	0757-0467	8	1	RESISTOR 121K 1X .125W F TC=0+-100	24546	C4-1/8-T0-1213-F
A7R4	0698-3450	9		RESISTOR 42.2K 1X .125W F TC=0+-100	24546	C4-1/8-T0-4222-F
A7R5	0698-3441	8	2	RESISTOR 215 1X .125W F TC=0+-100	24546	C4-1/8-T0-215R-F
A7R6	0757-0200	7	2	RESISTOR 5.62K 1X .125W F TC=0+-100	24546	C4-1/8-T0-5621-F
A7R7	0698-0085	0	1	RESISTOR 2.61K 1X .125W F TC=0+-100	24546	C4-1/8-T0-2611-F
A7R8	0698-3441	8		RESISTOR 215 1X .125W F TC=0+-100	24546	C4-1/8-T0-215R-F
A7R9	0698-3437	2	2	RESISTOR 133 1X .125W F TC=0+-100	24546	C4-1/8-T0-133R-F
A7R10	0698-3151	7	7	RESISTOR 2.87K 1X .125W F TC=0+-100	24546	C4-1/8-T0-2871-F
A7R11	0698-0084	9	6	RESISTOR 2.15K 1X .125W F TC=0+-100	24546	C4-1/8-T0-2151-F
A7R12	0698-3154	0	3	RESISTOR 4.22K 1X .125W F TC=0+-100	24546	C4-1/8-T0-4221-F
A7R13	0698-3437	2		RESISTOR 133 1X .125W F TC=0+-100	24546	C4-1/8-T0-133R-F
A7R14	0698-3447	4	9	RESISTOR 422 1X .125W F TC=0+-100	24546	C4-1/8-T0-422R-F
A7R15	0698-3151	7		RESISTOR 2.87K 1X .125W F TC=0+-100	24546	C4-1/8-T0-2871-F
A7R16	0698-3151	7		RESISTOR 2.87K 1X .125W F TC=0+-100	24546	C4-1/8-T0-2871-F
A7R17	0698-3151	7		RESISTOR 2.87K 1X .125W F TC=0+-100	24546	C4-1/8-T0-2871-F
A7R18	0698-3151	7		RESISTOR 2.87K 1X .125W F TC=0+-100	24546	C4-1/8-T0-2871-F
A7R19	0757-0274	5	4	RESISTOR 1.21K 1X .125W F TC=0+-100	24546	C4-1/8-T0-1213-F
A7R20	0698-3151	7		RESISTOR 2.87K 1X .125W F TC=0+-100	24546	C4-1/8-T0-2871-F
A7R21	0698-3154	0		RESISTOR 4.22K 1X .125W F TC=0+-100	24546	C4-1/8-T0-4221-F
A7R22	0698-3156	4	1	RESISTOR 23.7K 1X .125W F TC=0+-100	24546	C4-1/8-T0-2372-F
A7R23	0757-0200	7		RESISTOR 5.62K 1X .125W F TC=0+-100	24546	C4-1/8-T0-5621-F
A7R24	0698-3152	8	3	RESISTOR 3.48K 1X .125W F TC=0+-100	24546	C4-1/8-T0-3481-F
A7R25	0698-3154	0		RESISTOR 4.22K 1X .125W F TC=0+-100	24546	C4-1/8-T0-4221-F
A7R26	0757-0274	5		RESISTOR 1.21K 1X .125W F TC=0+-100	24546	C4-1/8-T0-1213-F
A7R27	0698-3152	8		RESISTOR 3.48K 1X .125W F TC=0+-100	24546	C4-1/8-T0-3481-F
A7R28	0757-0199	3	5	RESISTOR 21.5K 1X .125W F TC=0+-100	24546	C4-1/8-T0-2152-F
A7R29	0757-0274	5		RESISTOR 1.21K 1X .125W F TC=0+-100	24546	C4-1/8-T0-1213-F
A7R30	0757-0199	3		RESISTOR 21.5K 1X .125W F TC=0+-100	24546	C4-1/8-T0-2152-F
A7R31	0757-0394	0	4	RESISTOR 51.1 1X .125W F TC=0+-100	24546	C4-1/8-T0-51R1-F
A7R32	0757-0279	0	5	RESISTOR 3.16K 1X .125W F TC=0+-100	24546	C4-1/8-T0-3161-F
A7R33	0757-0394	0		RESISTOR 51.1 1X .125W F TC=0+-100	24546	C4-1/8-T0-51R1-F
A7R34	0698-0084	9		RESISTOR 2.15K 1X .125W F TC=0+-100	24546	C4-1/8-T0-2151-F
A7R35	0757-0401	0		RESISTOR 100 1X .125W F TC=0+-100	24546	C4-1/8-T0-101-F
A7R36	0757-0401	0		RESISTOR 100 1X .125W F TC=0+-100	24546	C4-1/8-T0-101-F
A7R37	0757-0420	3		RESISTOR 750 1X .125W F TC=0+-100	24546	C4-1/8-T0-751-F
A7R38	2100-3123	0	1	RESISTOR-TRMR 500 10X C SIDE-ADJ 17-TRN	02111	43P501
A7R39	0757-0420	3		RESISTOR 750 1X .125W F TC=0+-100	24546	C4-1/8-T0-751-F
A7R40	0698-0084	9		RESISTOR 2.15K 1X .125W F TC=0+-100	24546	C4-1/8-T0-2151-F
A7R41	0757-0401	0		RESISTOR 100 1X .125W F TC=0+-100	24546	C4-1/8-T0-101-F
A7R42	0757-0442	9	15	RESISTOR 10K 1X .125W F TC=0+-100	24546	C4-1/8-T0-1002-F
A7R43	0757-0199	3		RESISTOR 21.5K 1X .125W F TC=0+-100	24546	C4-1/8-T0-2152-F
A7R44	0757-0394	0		RESISTOR 51.1 1X .125W F TC=0+-100	24546	C4-1/8-T0-51R1-F
A7R45	0757-0401	0		RESISTOR 100 1X .125W F TC=0+-100	24546	C4-1/8-T0-101-F
A7R46	0757-0316	6	1	RESISTOR 42.2 1X .125W F TC=0+-100	24546	C4-1/8-T0-42R2-F
A7R47	0757-0401	0		RESISTOR 100 1X .125W F TC=0+-100	24546	C4-1/8-T0-101-F
A7R48	0757-0442	9		RESISTOR 10K 1X .125W F TC=0+-100	24546	C4-1/8-T0-1002-F
A7R49	0757-0442	9		RESISTOR 10K 1X .125W F TC=0+-100	24546	C4-1/8-T0-1002-F
A7R50	0698-0083	8		RESISTOR 1.96K 1X .125W F TC=0+-100	24546	C4-1/8-T0-1961-F
A7R51	0757-0274	5		RESISTOR 1.21K 1X .125W F TC=0+-100	24546	C4-1/8-T0-1213-F
A7R52	0698-3155	1	1	RESISTOR 4.64K 1X .125W F TC=0+-100	24546	C4-1/8-T0-4641-F
A7R53	0757-0199	3		RESISTOR 21.5K 1X .125W F TC=0+-100	24546	C4-1/8-T0-2152-F
A7R54	0757-0442	9		RESISTOR 10K 1X .125W F TC=0+-100	24546	C4-1/8-T0-1002-F
A7R55	0757-0394	0		RESISTOR 51.1 1X .125W F TC=0+-100	24546	C4-1/8-T0-51R1-F
A7R56	0698-3438	3	1	RESISTOR 147 1X .125W F TC=0+-100	24546	C4-1/8-T0-147R-F
A7R57	0698-3243	8	1	RESISTOR 178K 1X .125W F TC=0+-100	24546	C4-1/8-T0-1783-F
A7R58	2100-3054	6	1	RESISTOR-TRMR 50K 10X C SIDE-ADJ 17-TRN	02111	43P503
A7R59	0757-0442	9		RESISTOR 10K 1X .125W F TC=0+-100	24546	C4-1/8-T0-1002-F
A7R60	0757-0401	0		RESISTOR 100 1X .125W F TC=0+-100	24546	C4-1/8-T0-101-F

See introduction to this section for ordering information
 *Indicates factory selected value

Table 6-3. Replaceable Parts

Reference Designation	HP Part Number	C D	Qty	Description	Mfr Code	Mfr Part Number
A7R61	0757-0440	7	1	RESISTOR 7.5K 1% .125W F TC=0+-100	24546	C4-1/8-T0-7501-F
A7R62	0757-0199	3		RESISTOR 21.5K 1% .125W F TC=0+-100	24546	C4-1/8-T0-2152-F
A7R63	0757-0346	2		RESISTOR 10 1% .125W F TC=0+-100	24546	C4-1/8-T0-10R0-F
A7R64	0698-0084	9		RESISTOR 2.15K 1% .125W F TC=0+-100	24546	C4-1/8-T0-2151-F
A7R65	0757-0442	9		RESISTOR 10K 1% .125W F TC=0+-100	24546	C4-1/8-T0-1002-F
A7R66	0757-0428	1	2	RESISTOR 1.02K 1% .125W F TC=0+-100	24546	C4-1/8-T0-1021-F
A7R67	2100-2521	0		RESISTOR-TRMR 2K 10% C SIDE-ADJ 1-TRN	30983	ET50X202
A7R68	0757-0442	9		RESISTOR 10K 1% .125W F TC=0+-100	24546	C4-1/8-T0-1002-F
A7R69	0698-3152	8		RESISTOR 3.48K 1% .125W F TC=0+-100	24546	C4-1/8-T0-3481-F
A7R70	2100-2489	9		RESISTOR-TRMR 5K 10% C SIDE-ADJ 1-TRN	30983	ET50X502
A7R71	0698-3450	9	1	RESISTOR 42.2K 1% .125W F TC=0+-100	24546	C4-1/8-T0-4222-F
A7R72	0698-3151	7		RESISTOR 2.87K 1% .125W F TC=0+-100	24546	C4-1/8-T0-2871-F
A7R73	0757-0442	9		RESISTOR 10K 1% .125W F TC=0+-100	24546	C4-1/8-T0-1002-F
A7R74	2100-2514	1		RESISTOR-TRMR 20K 10% C SIDE-ADJ 1-TRN	30983	ET50W203
A7R75	0698-3450	9		RESISTOR 42.2K 1% .125W F TC=0+-100	24546	C4-1/8-T0-4222-F
A7U1	1A13-0001	7	1	IC LOG-AMPL/ELEM 24-DIP-C	28480	1A13-0001
A7U2	1A20-0223	0		IC OP AMP GP T0-99	04713	MLM301AG
A7U3	1A20-0223	0		IC OP AMP GP T0-99	04713	MLM301AG
A7U4	1A20-0223	0		IC OP AMP GP T0-99	04713	MLM301AG
A7U5	1A26-0261	8		IC OP AMP LOW-NOISE T0-99	28480	1A26-0261
A7U6	1A26-0261	8	IC OP AMP LOW-NOISE T0-99	28480	1A26-0261	
A7XU1	1200-0462	5	1	SOCKET-IC 1-CONT STRIP DIP-SLDR	28480	1200-0462
A7Z1	9170-0057	1	2	COIL SHIELDED BEAD	28480	9170-0057
A7Z2	9170-0057	1		COIL SHIELDED BEAD	28480	9170-0057
AB,AA				SAME AS A7Z ONE PRELIMINARY		
A10	0A755-60003	3	1	BOARD ASSEMBLY, MODULATOR DRIVER	28480	0A755-60003
A10C1	0160-2387	0	1	CAPACITOR-FXD 1000PF +-1% 500VDC MICA	28480	0160-2387
A10C2	0160-2206	2		CAPACITOR-FXD 160PF +-5% 300VDC MICA	28480	0160-2206
A10C3	0180-1746	5		CAPACITOR-FXD 15UF+-10% 20VDC TA	56289	150D156X9020B2
A10C4	0180-1746	5		CAPACITOR-FXD 15UF+-10% 20VDC TA	56289	150D156X9020B2
A10C5	0180-1746	5		CAPACITOR-FXD 15UF+-10% 20VDC TA	56289	150D156X9020B2
A10C6	0160-2221	1	1	CAPACITOR-FXD 1300PF +-5% 300VDC MICA	28480	0160-2221
A10C7	0180-0197	8		CAPACITOR-FXD 2.2UF+-10% 20VDC TA	56289	150D225X9020A2
A10C8	0140-0196	3		CAPACITOR-FXD 150PF +-5% 300VDC MICA	72136	DM15F151J0300WV1CR
A10C9	0180-0058	0		CAPACITOR-FXD 50UF+75-10% 25VDC AL	56289	30D506G025CC2
A10C10	0180-0058	0		CAPACITOR-FXD 50UF+75-10% 25VDC AL	56289	30D506G025CC2
A10C11	0180-0058	0	1	CAPACITOR-FXD 50UF+75-10% 25VDC AL	56289	30D506G025CC2
A10C12	0180-0058	0		CAPACITOR-FXD 50UF+75-10% 25VDC AL	56289	30D506G025CC2
A10C13	0140-0198	5		CAPACITOR-FXD 200PF +-5% 300VDC MICA	72136	DM15F201J0300WV1CR
A10C14	0160-2201	7		CAPACITOR-FXD 51PF +-5% 300VDC MICA	28480	0160-2201
A10C15	0180-0269	5		CAPACITOR-FXD 1UF+50-10% 150VDC AL	56289	30D105G150BA2
A10C16	0180-0197	8	1	CAPACITOR-FXD 2.2UF+-10% 20VDC TA	56289	150D225X9020A2
A10CR1	1902-0579	3	1	DIODE-ZNR 5.11V 5% DO-15 PD=1W TC=-.009X	28480	1902-0579
A10CR2	1901-0040	1		DIODE-SWITCHING 30V 50MA 2NS DO-35	28480	1901-0040
A10CR3	1901-0040	1		DIODE-SWITCHING 30V 50MA 2NS DO-35	28480	1901-0040
A10CR4	1901-0040	1		DIODE-SWITCHING 30V 50MA 2NS DO-35	28480	1901-0040
A10CR5	1901-0040	1		DIODE-SWITCHING 30V 50MA 2NS DO-35	28480	1901-0040
A10CR6	1901-0040	1	1	DIODE-SWITCHING 30V 50MA 2NS DO-35	28480	1901-0040
A10CR7	1910-0022	8		DIODE-GE 5V 60MA 3.5NS DO-7	28480	1910-0022
A10L1	9140-0137	1	2	COIL-MLD 1MH 5% Q=60 .19DX.44LG-NOM	28480	9140-0137
A10L2	9100-1654	5		COIL-MLD 1.1MH 5% Q=60 .215DX.56LG-NOM	28480	9100-1654
A10L3	9140-0137	1		COIL-MLD 1MH 5% Q=60 .19DX.44LG-NOM	28480	9140-0137
A10L4	9100-1648	7		COIL-MLD 560UH 5% Q=65 .19DX.44LG-NOM	28480	9100-1648
A10L5	9100-1666	9		COIL-MLD 3.6MH 5% Q=70 .215DX.56LG-NOM	28480	9100-1666
A10L6	9100-1666	9	1	COIL-MLD 3.6MH 5% Q=70 .215DX.56LG-NOM	28480	9100-1666
A10L7	9100-1666	9		COIL-MLD 3.6MH 5% Q=70 .215DX.56LG-NOM	28480	9100-1666
A10L8	9100-1666	9		COIL-MLD 3.6MH 5% Q=70 .215DX.56LG-NOM	28480	9100-1666
A10Q1	1A54-0019	3	1	TRANSISTOR NPN SI T0-18 PD=360MW	28480	1A54-0019
A10Q2	1A54-0071	7		TRANSISTOR NPN SI PD=300MW FT=200MHZ	28480	1A54-0071
A10Q3	1A54-0071	7		TRANSISTOR NPN SI PD=300MW FT=200MHZ	28480	1A54-0071
A10Q4	1A54-0232	2		TRANSISTOR NPN SI T0-39 PD=1W FT=15MHZ	28480	1A54-0232
A10Q5	1A54-0232	2		TRANSISTOR NPN SI T0-39 PD=1W FT=15MHZ	28480	1A54-0232
A10Q6	1A54-0019	7	2	TRANSISTOR NPN 2N3053S SI T0-39 PD=1W	01928	2N3053S
A10Q7	1A53-0001	1		TRANSISTOR PNP SI T0-39 PD=600MW	28480	1A53-0001
A10Q8	1A54-0039	7		TRANSISTOR NPN 2N3053S SI T0-39 PD=1W	01928	2N3053S
A10Q9	1A53-0020	4		TRANSISTOR PNP SI PD=300MW FT=150MHZ	28480	1A53-0020
A10Q10	1A54-0071	7		TRANSISTOR NPN SI PD=300MW FT=200MHZ	28480	1A54-0071
A10Q11	1A54-0232	2	2	TRANSISTOR NPN SI T0-39 PD=1W FT=15MHZ	28480	1A54-0232
A10Q12	1A54-0232	2		TRANSISTOR NPN SI T0-39 PD=1W FT=15MHZ	28480	1A54-0232
A10Q13	1A54-0071	7		TRANSISTOR NPN SI PD=300MW FT=200MHZ	28480	1A54-0071
A10Q14	1A54-0475	5		TRANSISTOR-DUAL NPN PD=750MW	28480	1A54-0475
A10Q15	1A54-0475	5		TRANSISTOR-DUAL NPN PD=750MW	28480	1A54-0475

See introduction to this section for ordering information
 *Indicates factory selected value

Table 6-3. Replaceable Parts

Reference Designation	HP Part Number	C D	Qty	Description	Mfr Code	Mfr Part Number
A10Q16	1A54-0071	7		TRANSISTOR NPN 8I PD=300MW FT=200MHZ	28480	1A54-0071
A10Q17	1A54-0071	7		TRANSISTOR NPN 8I PD=300MW FT=200MHZ	28480	1A54-0071
A10Q18	1A54-0071	7		TRANSISTOR NPN 8I PD=300MW FT=200MHZ	28480	1A54-0071
A10Q19	1A54-0071	7		TRANSISTOR NPN 8I PD=300MW FT=200MHZ	28480	1A54-0071
A10Q20	1A54-0071	7		TRANSISTOR NPN 8I PD=300MW FT=200MHZ	28480	1A54-0071
A10R1	0757-0279	0		RESISTOR 3.16K 1% .125W F TC=0+-100	24546	C4-1/8-T0-3161-F
A10R2	0698-3268	7	2	RESISTOR 11.5K 1% .125W F TC=0+-100	24546	C4-1/8-T0-1152-F
A10R3	0698-3620	5	1	RESISTOR 100 5% 2W MO TC=0+-200	28480	0698-3620
A10R4	0698-0084	9		RESISTOR 2.15K 1% .125W F TC=0+-100	24546	C4-1/8-T0-2151-F
A10R5	0698-3268	7		RESISTOR 11.5K 1% .125W F TC=0+-100	24546	C4-1/8-T0-1152-F
A10R6	0757-0280	3		RESISTOR 1K 1% .125W F TC=0+-100	24546	C4-1/8-T0-1001-F
A10R7	0757-0444	1	1	RESISTOR 12.1K 1% .125W F TC=0+-100	24546	C4-1/8-T0-1212-F
A10R8	0698-3157	3	2	RESISTOR 19.6K 1% .125W F TC=0+-100	24546	C4-1/8-T0-1962-F
A10R9	0757-0280	3		RESISTOR 1K 1% .125W F TC=0+-100	24546	C4-1/8-T0-1001-F
A10R10	0757-0280	3		RESISTOR 1K 1% .125W F TC=0+-100	24546	C4-1/8-T0-1001-F
A10R11	0757-0280	3		RESISTOR 1K 1% .125W F TC=0+-100	24546	C4-1/8-T0-1001-F
A10R12	0757-0440	7		RESISTOR 7.5K 1% .125W F TC=0+-100	24546	C4-1/8-T0-7501-F
A10R13	0757-0442	9		RESISTOR 10K 1% .125W F TC=0+-100	24546	C4-1/8-T0-1002-F
A10R14	0757-0280	3		RESISTOR 1K 1% .125W F TC=0+-100	24546	C4-1/8-T0-1001-F
A10R15	0757-0438	3	5	RESISTOR 5.11K 1% .125W F TC=0+-100	24546	C4-1/8-T0-5111-F
A10R16	0698-3450	9		RESISTOR 42.2K 1% .125W F TC=0+-100	24546	C4-1/8-T0-4222-F
A10R17	0757-0159	5	1	RESISTOR 1K 1% .5W F TC=0+-100	28480	0757-0159
A10R18	0757-0401	0		RESISTOR 100 1% .125W F TC=0+-100	24546	C4-1/8-T0-101-F
A10R19	0757-0401	0		RESISTOR 100 1% .125W F TC=0+-100	24546	C4-1/8-T0-101-F
A10R20	0757-0795	5	4	RESISTOR 75 1% .5W F TC=0+-100	19701	MF-1/2-T0-75R0-F
A10R21	0757-0795	5		RESISTOR 75 1% .5W F TC=0+-100	19701	MF-1/2-T0-75R0-F
A10R22	0757-0795	5		RESISTOR 75 1% .5W F TC=0+-100	19701	MF-1/2-T0-75R0-F
A10R23	0757-0795	5		RESISTOR 75 1% .5W F TC=0+-100	19701	MF-1/2-T0-75R0-F
A10R24	0757-0317	7	1	RESISTOR 1.33K 1% .125W F TC=0+-100	24546	C4-1/8-T0-1331-F
A10R25	0757-0416	7	1	RESISTOR 511 1% .125W F TC=0+-100	24546	C4-1/8-T0-5111-F
A10R26	0757-0428	1		RESISTOR 1.62K 1% .125W F TC=0+-100	24546	C4-1/8-T0-1621-F
A10R27	0698-0083	8		RESISTOR 1.96K 1% .125W F TC=0+-100	24546	C4-1/8-T0-1961-F
A10R28	0757-0422	5	1	RESISTOR 909 1% .125W F TC=0+-100	24546	C4-1/8-T0-909R-F
A10R29	0698-3447	4		RESISTOR 422 1% .125W F TC=0+-100	24546	C4-1/8-T0-422R-F
A10R30	0757-0465	6	3	RESISTOR 100K 1% .125W F TC=0+-100	24546	C4-1/8-T0-1003-F
A10R31	0757-0447	4	2	RESISTOR 16.2K 1% .125W F TC=0+-100	24546	C4-1/8-T0-1622-F
A10R32	0698-3447	4		RESISTOR 422 1% .125W F TC=0+-100	24546	C4-1/8-T0-422R-F
A10R33	0757-0420	3		RESISTOR 750 1% .125W F TC=0+-100	24546	C4-1/8-T0-751-F
A10R34	0757-1094	9	1	RESISTOR 1.47K 1% .125W F TC=0+-100	24546	C4-1/8-T0-1471-F
A10R35	0757-0438	3		RESISTOR 5.11K 1% .125W F TC=0+-100	24546	C4-1/8-T0-5111-F
A10R36	0757-0440	7		RESISTOR 7.5K 1% .125W F TC=0+-100	24546	C4-1/8-T0-7501-F
A10R37	0698-0082	7	2	RESISTOR 464 1% .125W F TC=0+-100	24546	C4-1/8-T0-4640-F
A10R38	0757-0279	0		RESISTOR 3.16K 1% .125W F TC=0+-100	24546	C4-1/8-T0-3161-F
A10R39	0757-0421	4	2	RESISTOR 825 1% .125W F TC=0+-100	24546	C4-1/8-T0-825R-F
A10R40	0698-3348	4	3	RESISTOR 4.64K 1% .5W F TC=0+-100	28480	0698-3348
A10R41	0698-3447	4		RESISTOR 422 1% .125W F TC=0+-100	24546	C4-1/8-T0-422R-F
A10R42	0698-3445	2	2	RESISTOR 348 1% .125W F TC=0+-100	24546	C4-1/8-T0-348R-F
A10R43	0757-0442	9		RESISTOR 10K 1% .125W F TC=0+-100	24546	C4-1/8-T0-1002-F
A10R44	0757-0465	6		RESISTOR 100K 1% .125W F TC=0+-100	24546	C4-1/8-T0-1003-F
A10R45	0698-3348	4		RESISTOR 4.64K 1% .5W F TC=0+-100	28480	0698-3348
A10R46	0698-3348	4		RESISTOR 4.64K 1% .5W F TC=0+-100	28480	0698-3348
A10R47	0698-3447	4		RESISTOR 422 1% .125W F TC=0+-100	24546	C4-1/8-T0-422R-F
A10R48	0698-3445	2		RESISTOR 348 1% .125W F TC=0+-100	24546	C4-1/8-T0-348R-F
A10R49	0698-3157	3		RESISTOR 19.6K 1% .125W F TC=0+-100	24546	C4-1/8-T0-1962-F
A10R50	0757-0279	0		RESISTOR 3.16K 1% .125W F TC=0+-100	24546	C4-1/8-T0-3161-F
A10R51	0757-0421	4		RESISTOR 825 1% .125W F TC=0+-100	24546	C4-1/8-T0-825R-F
A10R52	2100-2489	9		RESISTOR-YRMR 5K 10% C SIDE-ADJ 1-TRN	30983	EY50X502
A10R53	0698-0082	7		RESISTOR 464 1% .125W F TC=0+-100	24546	C4-1/8-T0-4640-F
A10R54	0757-0279	0		RESISTOR 3.16K 1% .125W F TC=0+-100	24546	C4-1/8-T0-3161-F
A10R55	0757-0401	0		RESISTOR 100 1% .125W F TC=0+-100	24546	C4-1/8-T0-101-F
A10R56	0698-3447	4		RESISTOR 422 1% .125W F TC=0+-100	24546	C4-1/8-T0-422R-F
A10R57	0698-3447	4		RESISTOR 422 1% .125W F TC=0+-100	24546	C4-1/8-T0-422R-F
A10R58	0757-0447	4		RESISTOR 16.2K 1% .125W F TC=0+-100	24546	C4-1/8-T0-1622-F
A10R59	0757-0420	3		RESISTOR 750 1% .125W F TC=0+-100	24546	C4-1/8-T0-751-F
A10R60	0757-0278	9	1	RESISTOR 1.78K 1% .125W F TC=0+-100	24546	C4-1/8-T0-1781-F
A10R61	0757-0280	3		RESISTOR 1K 1% .125W F TC=0+-100	24546	C4-1/8-T0-1001-F
A10R62	0698-3150	6	1	RESISTOR 2.37K 1% .125W F TC=0+-100	24546	C4-1/8-T0-2371-F
A10R63	0698-3161	9	1	RESISTOR 38.3K 1% .125W F TC=0+-100	24546	C4-1/8-T0-3832-F
A10R64	0698-3447	4		RESISTOR 422 1% .125W F TC=0+-100	24546	C4-1/8-T0-422R-F
A10R65	0698-3447	4		RESISTOR 422 1% .125W F TC=0+-100	24546	C4-1/8-T0-422R-F
A10TP1	1251-0600	0		CONNECTOR-SGL CONT PIN 1.14-MM-BSC-SZ 30	28480	1251-0600
A10TP2	1251-0600	0		CONNECTOR-SGL CONT PIN 1.14-MM-BSC-SZ 30	28480	1251-0600
A10TP3	1251-0600	0		CONNECTOR-SGL CONT PIN 1.14-MM-BSC-SZ 30	28480	1251-0600
A10TP4	1251-0600	0		CONNECTOR-SGL CONT PIN 1.14-MM-BSC-SZ 30	28480	1251-0600
A10TP5	1251-0600	0		CONNECTOR-SGL CONT PIN 1.14-MM-BSC-SZ 30	28480	1251-0600

See introduction to this section for ordering information
 *Indicates factory selected value

Table 6-3. Replaceable Parts

Reference Designation	HP Part Number	C D	Qty	Description	Mfr Code	Mfr Part Number
A10TP6	1251-0600	0		CONNECTOR-SGL CONT PIN 1,14-MM-BSC-SZ SQ	28480	1251-0600
A10TP7	1251-0600	0		CONNECTOR-SGL CONT PIN 1,14-MM-BSC-SZ SQ	28480	1251-0600
A10TP8	1251-0600	0		CONNECTOR-SGL CONT PIN 1,14-MM-BSC-SZ SQ	28480	1251-0600
A10TP9	1251-0600	0		CONNECTOR-SGL CONT PIN 1,14-MM-BSC-SZ SQ	28480	1251-0600
A10TP10	1251-0600	0		CONNECTOR-SGL CONT PIN 1,14-MM-BSC-SZ SQ	28480	1251-0600
A10TP11	1251-0600	0		CONNECTOR-SGL CONT PIN 1,14-MM-BSC-SZ SQ	28480	1251-0600
A10U1	1820-0077	2	1	IC FF TTL D-TYPE POS-EDGE-TRIG CLEAR	01295	SN7474N
A10U2	1820-0269	4	1	IC GATE TTL NAND QUAD 2-INP	01295	SN7403N
A10U3	1826-0281	2	1	IC V RGLTR TO-92	04713	MC79L15ACP
A11	08755-60025	9	1	BOARD ASSEMBLY, NORMALIZER INTERFACE	28480	08755-60025
A11C1	0180-0197	8		CAPACITOR-FXD 2,2UF+-10% 20VDC TA	56289	150D225X9020A2
A11C2	0160-3879	7	1	CAPACITOR-FXD .01UF +-20% 100VDC CER	28480	0160-3879
A11C3	0180-0197	8		CAPACITOR-FXD 2,2UF+-10% 20VDC TA	56289	150D225X9020A2
A11CR1	1901-0539	3	1	DIODE-SCHOTTKY	28480	1901-0539
A11CR2	1901-0050	3	1	DIODE-SWITCHING 80V 200MA 2NS DO-35	28480	1901-0050
A11P1	1251-0136	7	1	CONNECTOR 32-PIN M BLUE RIBBON	28480	1251-0136
A11Q1	1854-0404	0		TRANSISTOR NPN SI TO-18 PD=360MW	28480	1854-0404
A11Q2	1854-0404	0		TRANSISTOR NPN SI TO-18 PD=360MW	28480	1854-0404
A11Q3	1854-0404	0		TRANSISTOR NPN SI TO-18 PD=360MW	28480	1854-0404
A11R1	0698-7703	1	2	RESISTOR 9.9K .25% .125W F TC=0+-100	19701	MF4C1/8-T0-9901-C
A11R2	0698-3193	7	6	RESISTOR 10K .25% .125W F TC=0+-50	28480	0698-3193
A11R3	0698-3156	2	3	RESISTOR 14.7K 1% .125W F TC=0+-100	24546	C4-1/8-T0-1472-F
A11R4	0698-3193	7		RESISTOR 10K .25% .125W F TC=0+-50	28480	0698-3193
A11R5	0698-3193	7		RESISTOR 10K .25% .125W F TC=0+-50	28480	0698-3193
A11R6	0757-0420	3		RESISTOR 750 1% .125W F TC=0+-100	24546	C4-1/8-T0-751-F
A11R7	0698-7793	1		RESISTOR 9.9K .25% .125W F TC=0+-100	19701	MF4C1/8-T0-9901-C
A11R8	0698-3193	7		RESISTOR 10K .25% .125W F TC=0+-50	28480	0698-3193
A11R9	0698-3156	2		RESISTOR 14.7K 1% .125W F TC=0+-100	24546	C4-1/8-T0-1472-F
A11R10	0698-3193	7		RESISTOR 10K .25% .125W F TC=0+-50	28480	0698-3193
A11R11	0698-3193	7		RESISTOR 10K .25% .125W F TC=0+-50	28480	0698-3193
A11R12	0757-0442	9		RESISTOR 10K 1% .125W F TC=0+-100	24546	C4-1/8-T0-1002-F
A11R13	0757-0442	9		RESISTOR 10K 1% .125W F TC=0+-100	24546	C4-1/8-T0-1002-F
A11R14	0757-0438	3		RESISTOR 5.11K 1% .125W F TC=0+-100	24546	C4-1/8-T0-5111-F
A11R15	0757-0438	3		RESISTOR 5.11K 1% .125W F TC=0+-100	24546	C4-1/8-T0-5111-F
A11R16	0757-0442	9		RESISTOR 10K 1% .125W F TC=0+-100	24546	C4-1/8-T0-1002-F
A11R17	0757-0442	9		RESISTOR 10K 1% .125W F TC=0+-100	24546	C4-1/8-T0-1002-F
A11R18	0757-0280	3		RESISTOR 1K 1% .125W F TC=0+-100	24546	C4-1/8-T0-1001-F
A11R19	0757-0438	3		RESISTOR 5.11K 1% .125W F TC=0+-100	24546	C4-1/8-T0-5111-F
A11R20	0698-3156	2		RESISTOR 14.7K 1% .125W F TC=0+-100	24546	C4-1/8-T0-1472-F
A11R21	0757-0442	9		RESISTOR 10K 1% .125W F TC=0+-100	24546	C4-1/8-T0-1002-F
A11R22	0757-0280	3		RESISTOR 1K 1% .125W F TC=0+-100	24546	C4-1/8-T0-1001-F
A11R23	0757-0465	6		RESISTOR 100K 1% .125W F TC=0+-100	24546	C4-1/8-T0-1003-F
A11R24	2100-1760	7	1	RESISTOR-TRMR 5K 5% HW SIDE-ADJ 1-TRN	28480	2100-1760
A11R25	0698-0084	9		RESISTOR 2.15K 1% .125W F TC=0+-100	24546	C4-1/8-T0-2151-F
A11R26	0757-0458	7	1	RESISTOR 51.1K 1% .125W F TC=0+-100	24546	C4-1/8-T0-5112-F
A11S1	3101-1273	0	1	SWITCH-SL DPDT SUBMIN 2A 120VAC PC	28480	3101-1273
A11TP1	1251-0600	0		CONNECTOR-SGL CONT PIN 1,14-MM-BSC-SZ SQ	28480	1251-0600
A11TP2	1251-0600	0		CONNECTOR-SGL CONT PIN 1,14-MM-BSC-SZ SQ	28480	1251-0600
A11TP3	1251-0600	0		CONNECTOR-SGL CONT PIN 1,14-MM-BSC-SZ SQ	28480	1251-0600
A11TP4	1251-0600	0		CONNECTOR-SGL CONT PIN 1,14-MM-BSC-SZ SQ	28480	1251-0600
A11TP5	1251-0600	0		CONNECTOR-SGL CONT PIN 1,14-MM-BSC-SZ SQ	28480	1251-0600
A11TP6	1251-0600	0		CONNECTOR-SGL CONT PIN 1,14-MM-BSC-SZ SQ	28480	1251-0600
A11TP7	1251-0600	0		CONNECTOR-SGL CONT PIN 1,14-MM-BSC-SZ SQ	28480	1251-0600
A11U1	1826-0092	3	3	IC OP AMP GP DUAL TO-99	28480	1826-0092
A11U2	1826-0092	3		IC OP AMP GP DUAL TO-99	28480	1826-0092
A11U3	1820-1941	1	1	IC SWITCH ANLG QUAD 16-DIP-P	27014	LF1320N
A11U4	1826-0092	3		IC OP AMP GP DUAL TO-99	28480	1826-0092
A11U5	1820-1199	1	1	IC INV TTL LS HEX 1-INP	01295	SN74LS04N
A11U6	1820-1197	9	1	IC GATE TTL LS NAND QUAD 2-INP	01295	SN74LS00N
A11VR1	1902-0041	4	1	DIODE-ZNR 5.11V 5% DO-7 PD=.4W TC=-.009%	28480	1902-0041
A11VR2	1902-3048	7	1	DIODE-ZNR 3.48V 5% DO-7 PD=.4W TC=-.058%	28480	1902-3048
A11VR3	1902-3082	9	1	DIODE-ZNR 4.64V 5% DO-7 PD=.4W TC=-.023%	28480	1902-3082
A11VR4	1902-0025	4	3	DIODE-ZNR 10V 5% DO-7 PD=.4W TC=+.06%	28480	1902-0025
A11VR5	1902-0025	4		DIODE-ZNR 10V 5% DO-7 PD=.4W TC=+.06%	28480	1902-0025
A11VR6	1902-0025	4		DIODE-ZNR 10V 5% DO-7 PD=.4W TC=+.06%	28480	1902-0025
A11Z1	9170-0016	8	2	CORE-SHIELDING BEAD	28480	9170-0016
A11Z2	9170-0016	8		CORE-SHIELDING BEAD	28480	9170-0016

See introduction to this section for ordering information
 *Indicates factory selected value.

Table 6-3. Replaceable Parts

Reference Designation	HP Part Number	C D	Qty	Description	Mfr Code	Mfr Part Number
A12	08755-60024	8	1	ASSEMBLY, RUTHIE BOARD	28480	08755-60024
A12J1	1250-0836	2	4	CONNECTOR-RF 8MC M PC 50-OHM	28480	1250-0836
A12J2	1250-0836	2		CONNECTOR-RF 8MC M PC 50-OHM	28480	1250-0836
A12J3	1250-0836	2		CONNECTOR-RF 8MC M PC 50-OHM	28480	1250-0836
A12J4	1250-0836	2		CONNECTOR-RF 8MC M PC 50-OHM	28480	1250-0836
A12MP1	0380-0745	6	3	STANDOFF-RVT-ON .187-IN-LG 6-32THD	00000	ORDER BY DESCRIPTION
A12MP2	0380-0745	6		STANDOFF-RVT-ON .187-IN-LG 6-32THD	00000	ORDER BY DESCRIPTION
A12MP3	0380-0745	6		STANDOFF-RVT-ON .187-IN-LG 6-32THD	00000	ORDER BY DESCRIPTION
A12P1	1251-0600	0		CONNECTOR-SGL CONT PIN 1.14-MM-89C-32 30	28480	1251-0600
A12P2	1251-0600	0		CONNECTOR-SGL CONT PIN 1.14-MM-89C-32 30	28480	1251-0600
A12XA5	1251-2035	9	3	CONNECTOR-PC EDGE 15-CONT/ROW 2-ROWS	28480	1251-2035
A12XA6	1251-2035	9		CONNECTOR-PC EDGE 15-CONT/ROW 2-ROWS	28480	1251-2035
A12XA7	1251-0213	1		CONNECTOR-PC EDGE 15-CONT/ROW 1-ROW	28480	1251-0213
A12XA8	1251-0213	1		CONNECTOR-PC EDGE 15-CONT/ROW 1-ROW	28480	1251-0213
A12XA9	1251-0213	1		CONNECTOR-PC EDGE 15-CONT/ROW 1-ROW	28480	1251-0213
A12XA10	1251-2035	9		CONNECTOR-PC EDGE 15-CONT/ROW 2-ROWS	28480	1251-2035
A12XA11	1251-1626	2	1	CONNECTOR-PC EDGE 12-CONT/ROW 2-ROWS	28480	1251-1626

See introduction to this section for ordering information
 *Indicates factory selected value

Table 6-3. Replaceable Parts

Reference Designation	HP Part Number	C D	Qty	Description	Mfr Code	Mfr Part Number
CHASSIS PARTS						
J1	1251-1864	0	3	SOCKET-5-FEMALE CONTACTS (DETECTOR CABLE A)	28480	1251-1864
J2	1251-1864	0		SOCKET-5-FEMALE CONTACTS (DETECTOR CABLE R)	28480	1251-1864
J3	1251-1864	0		SOCKET-5-FEMALE CONTACTS (DETECTOR CABLE B)	28480	1251-1864
J4	1250-0118	3	1	CONNECTOR-RF BNC FEM SGL-HOLE-FR 50-OHM (MODULATOR DRIVE)	28480	1250-0118
J5	1251-0198	1	1	CONNECTOR-PC EDGE 6-CONT/ROW 2-ROWS	28480	1251-0198
P1	08755-00007	1	1	DEFLECTION OUTPUT CONNECTOR	28480	08755-00007
R1	2100-3192	3	2	RESISTOR-VAR PREC HW 10-TRN 5K 5X CHANNEL 1 VERTICAL ORDER REPLACEMENT KIT, 08755-60019	28480	2100-3192
R2	2100-3192	3		RESISTOR-VAR PREC HW 10-TRN 5K 5X CHANNEL 2 VERTICAL ORDER REPLACEMENT KIT, 08755-60019	28480	2100-3192
S1	3100-3057	0	2	SWITCH, ROTARY CHANNEL 1 VERTICAL, 01/01/01 ORDER REPLACEMENT KIT, 08755-60019	28480	3100-3057
S2	3100-3057	0		SWITCH, ROTARY CHANNEL 2 VERTICAL, 01/01/01 ORDER REPLACEMENT KIT, 08755-60019	28480	3100-3057
	5040-0345	7	1	INSULATOR:CONNECTOR	28480	5040-0345
W1	08755-60015	7	1	CABLE ASSEMBLY, YELLOW	28480	08755-60015
W2	08755-60016	8	1	CABLE ASSEMBLY, RED	28480	08755-60016
W3	08755-60017	9	1	CABLE ASSEMBLY, BLUE	28480	08755-60017
W4	08755-60018	0	1	CABLE ASSEMBLY, WHITE	28480	08755-60018

See introduction to this section for ordering information
*Indicates factory selected value

Table 6-3. Replaceable Parts

Reference Designation	HP Part Number	C D	Qty	Description	Mfr Code	Mfr Part Number
MISCELLANEOUS PARTS						
	7120-4163	7	7	LABEL WARNING	28480	7120-4163
	0360-1190	5	1	TERMINAL-BLDR LUG PL-MTG FOR-#3/R-SCR	28480	0360-1190
	0370-0432	7	2	KNOB LEVER SWITCH .200 X .220 X .375IN	28480	0370-0432
	0370-0450	9	17	KNOB-PB,.425HI,.394W,.216DP,BLK PLSTC	71590	J52305 BLANK
	0370-0451	0	17	SEIZE PUSHBUTTON KNOB BLY NYLON	28480	0370-0451
	0380-0022	2	2	SPACER-RND .375-IN-LG .128-IN-ID	28480	0380-0022
	0380-0970	9	2	STANDOFF-HEX .375-IN-LG 4-40TMD	28480	0380-0970
	0510-0045	6	1	RETAINER-RING E-R EXT .188-IN-DIA STL	28480	0510-0045
	0510-0160	6	2	NUT-HEX-DBL-CHAM 4-40-THD .122-IN-TMK	00000	ORDER BY DESCRIPTION
	0590-0043	2	3	NUT-HEX-DBL-CHAM 1/4-32-THD .375-IN-TMK	00000	ORDER BY DESCRIPTION
	1400-0053	4	4	CLAMP-CABLE .172-DIA .375-WD NYL (FRONT PANEL)	28480	1400-0053
	1400-0866	7	1	CLAMP, CABLE (MOTHERBOARD)	28480	1400-0866
	1480-0004	3	1	PIN-ROLL .094-IN-DIA .375-IN-LG 38T	28480	1480-0004
	1480-0209	0	1	PIN-SPL .094-IN-DIA .25-IN-LG 33T-300	28480	1480-0209
	1490-0848	4	3	RUSHING-PNL .126-ID .3-LG 1/4-32-THD (SEE POSITION AND GAIN)	28480	1490-0848
	2190-0369	9	2	WASHER-FL NM 1/4 IN .253-IN-ID	28480	2190-0369
	3050-0124	9	1	WASHER-FL MYLC NO. 5 .13-IN-ID	28480	3050-0124
	3050-0762	1	1	WASHER-FL NM NO. 4 .125-IN-ID .438-IN-OD	28480	3050-0762
	7120-2359	9	1	PLATE SERIAL (SER OPT)	28480	7120-2359
	0624-0203	9	6	SCREW-TPG 4-40 .375-IN-LG 82 DEG	00000	ORDER BY DESCRIPTION
	0624-0359	6	10	SCREW-TPG 5-40 .375-IN-LG PAN-HD-POZI	00000	ORDER BY DESCRIPTION
	1250-0118	3	1	CONNECTOR-RF BNC FEM 3GL-HOLE-FR 50-OHM	28480	1250-0118
	1251-0198	1	1	CONNECTOR-PC EDGE 6-CONT/ROW 2-ROWS	28480	1251-0198
	1251-1864	0	3	CONNECTOR 5-PIN F CIRC AUDIO	28480	1251-1864
	1400-0053	4	4	CLAMP-CABLE .172-DIA .375-WD NYL	28480	1400-0053
	5040-0345	7	2	INSULATORICCONNECTOR	28480	5040-0345
	1251-1164	3	4	CONNECTOR-A: PWR M3 MALE CA-MTG	28480	1251-1164
	1250-1169	6	4	NUT-RF CONN,SUB MIN,50 OHM,REAR ASSY FOR	98291	9835-94
	1250-1172	1	4	CONTACT-RF CONN SUBMIN SERIES	98291	3000-14
	1250-1173	2	4	INSUL-RF CONN,SUB MIN,50 OHM,FRONT INSUL	98291	3000-10
	1250-1175	4	4	SLEEVE-RF CONN 0.150IN OD; 0.122 IN	98291	6100-42
	08755-00002	6	1	PANEL;SUB-FRONT	28480	08755-00002
	08755-00003	7	1	PANEL;REAR	28480	08755-00003
	08755-00004	8	2	PANEL;SIDE	28480	08755-00004
	08755-00005	9	1	GUIDE	28480	08755-00005
	08755-00006	0	1	COVER	28480	08755-00006
	08755-00008	2	8	NUT;PLATE	28480	08755-00008
	08755-00019	5	1	PANEL;FRONT	28480	08755-00019
	08755-20009	5	4	MODULE SECTION	28480	08755-20009
	08755-20010	8	1	MODULE;END	28480	08755-20010
	00180-05002	5	2	LEVER; HORIZONTAL POSITION (VERTER)	28480	00180-05002
	00220-67403	9	2	KNOB	28480	00220-67403
	0855A-00047	0	2	CAM;LATCH	28480	08558-00047
	0855A-20041	6	1	GUIDE RAIL;BOTTOM	28480	08558-20041
	0855A-20092	7	1	SHAFT;LATCH	28480	08558-20092
	0855A-20093	8	1	KNOB;LATCH	28480	08558-20093
	0855A-00048	1	1	CATCH	28480	08558-00048
	0855A-40015	6	1	HOUSING;LATCH	28480	08558-40015
	08755-20011	9	4	NOTE: MOUNTED (VERTER)	28480	08755-20011
	08755-00008	2	1	PLATE;INUT	28480	08755-00008
	08755-00007	1	1	CONTACT ASSEMBLY	28480	08755-00007

See introduction to this section for ordering information
*Indicates factory selected value

**BACK DATING
MANUAL
CHANGES**

SECTION VII MANUAL CHANGES

7-1. INTRODUCTION

7-2. This section contains information for adapting this manual to instruments for which the content does not apply directly.

7-3. To adapt this manual to your instrument, refer to Table 7-1 and make all of the manual changes listed opposite your instrument serial number. Make

these changes in the alphabetical sequence listed.

7-4. If your instrument serial number is not listed on the title page of this manual, or in Table 7-1 below, it might be documented in a yellow **MANUAL CHANGES** supplement. For additional important information about serial number coverage, refer to **INSTRUMENTS COVERED BY MANUAL** in Section I.

Table 7-1. Manual Changes by Serial Number

Serial Prefix or Number	Make Manual Changes
1903A	A
1703A02661 through 1703A02680; 1827A; 1903A through 1903A03361	A, B
1209A	A - C

7-5. MANUAL CHANGE INSTRUCTIONS

CHANGE A

Page 1-3, Table 1-1:

Under Offset, change ± 99 dB to ± 59 dB.

Page 3-2, Figure 3-1:

Under REFERENCE LEVEL, change "miniature lever switches" to "thumbwheels." Change "switch" to "thumbwheel."

Page 6-3, Table 6-3:

Change A1 and A2 to HP Part Number 3100-3051, SWITCH: MINIATURE THUMB WHEEL.

Change A5 to HP Part Number 08755-60005.

Page 6-4, Table 6-3:

Delete A5R24 and A5R25.

Page 8-16:

Replace Page 8-16 with Page 8-16 (CHANGE A) in this section.

Page 8-17, Figure 8-22:

Replace with Figure 8-22 (CHANGE A) in this section.

Page 8-23, Figure 8-29:

Replace with Figure 8-29 (CHANGE A) in this section.

CHANGE B

Page 6-6, Table 6-3:

Change A7Q1 to HP Part Number 1854-0019, Check Digit 3, TRANSISTOR NPN SI TO-18
PD=360MW.

Change A7Q2 to HP Part Number 1853-0007, Check Digit 7, TRANSISTOR PNP 2N3251 SI TO-18
PD=360MW.

CHANGE C

Page 6-7, Table 6-3:

Delete A7Z1 and A7Z2.

Page 8-13, Figure 8-14:

At base lead of A7Q1, delete ferrite bead A7Z1.

At base lead of A7Q2, delete ferrite bead A7Z2.

SERVICE SHEET 3

CIRCUIT DESCRIPTION

Figure 8-20 shows a simplified schematic of the offset circuit. The offset circuit feeds current to the summing junction that simulate input signals to offset the display. Fixed offsets of up to 59 dB may be obtained by selecting the appropriate front-panel polarity and OFFSET switches. A variable offset of up to 40 dB may be obtained by adjusting the front-panel VERNIER adjust. The input signals plus the offset applied to the summing junctions.

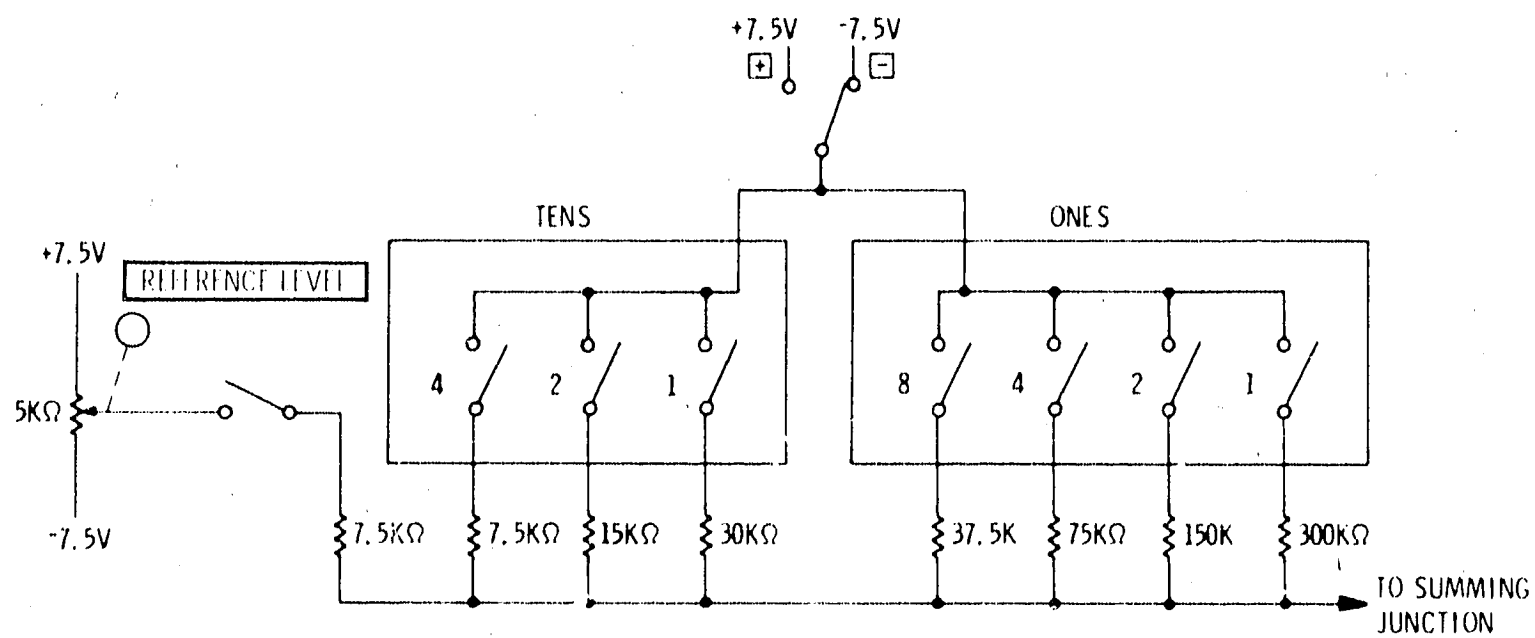
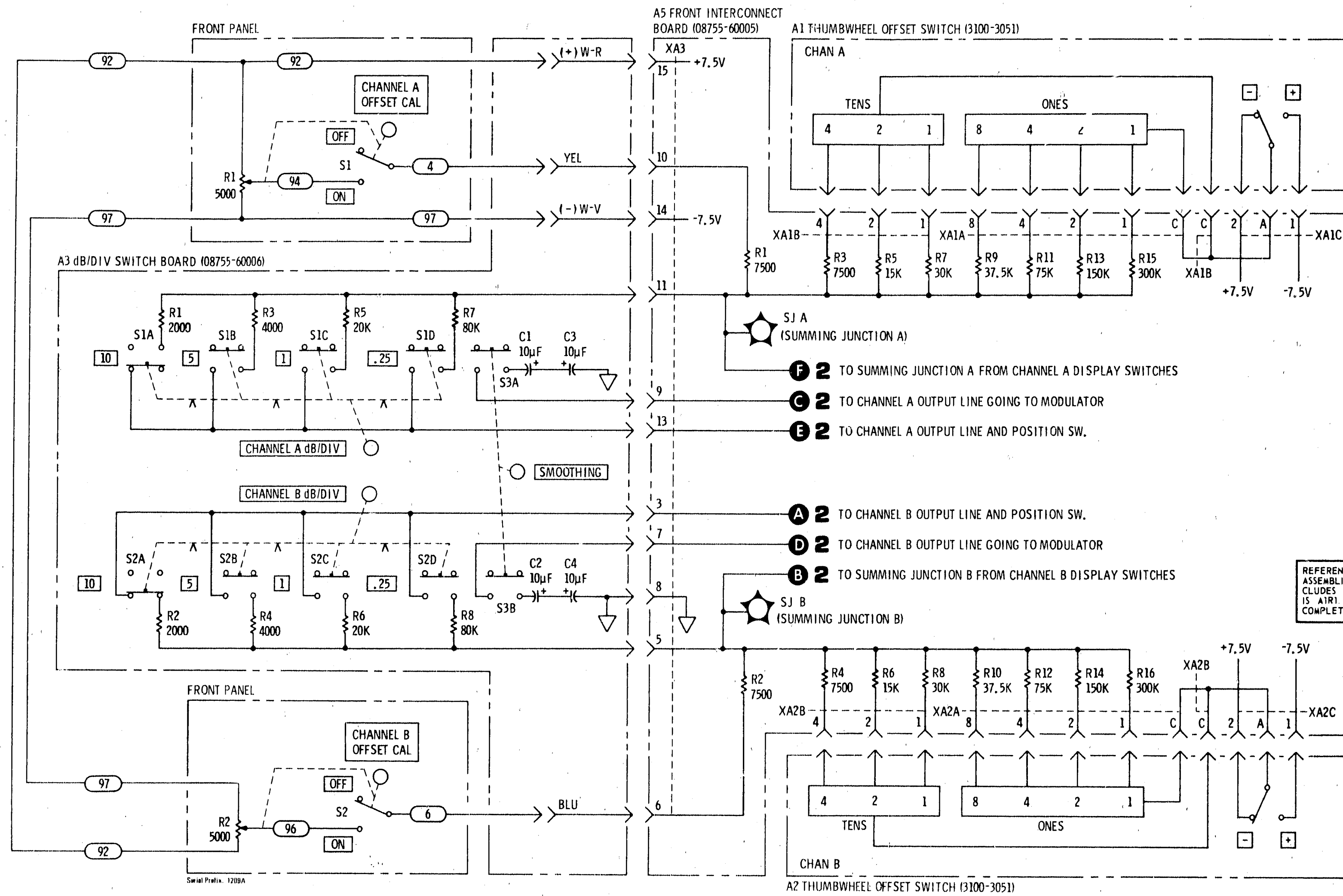

Figure 8-20. Reference Level Switch (Change A)



REFERENCE DESIGNATIONS WITHIN OUTLINED (---) ASSEMBLIES ARE ABBREVIATED. FULL DESIGNATION INCLUDES ASSEMBLY NUMBER; e.g., R1 OF ASSEMBLY A1 IS A1R1. DESIGNATIONS OF OTHER COMPONENTS ARE COMPLETE AS SHOWN.

NOTE: CONDITIONS FOR WAVEFORMS AND VOLTAGES ARE GIVEN IN FIGURE 8-2.

REFERENCE DESIGNATIONS	
A1	A5
A2	R1-16
A3	XA1A, B, C
C1-4	XA2A, R, C
R1-8	CHASSIS
S1A-S1D	R1, 2
S2A-S2D	S1, 2
S3A, B	

3

A1, A2, A3, A5

Figure 8-22A. A3 dB/Division Switch and A1 and A2 Offset Switch, Schematic

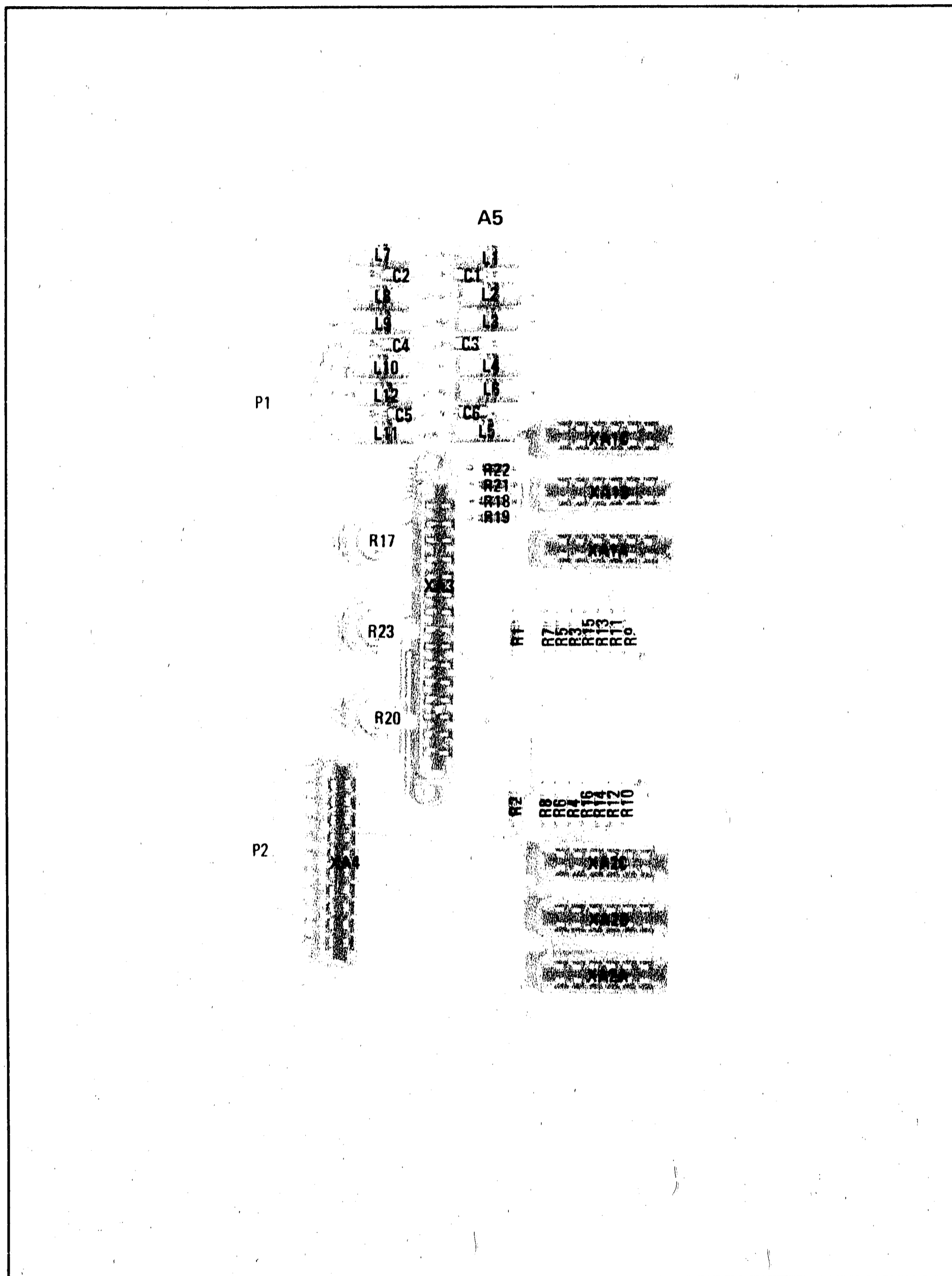

Figure 8-29. A5 Interconnect Assembly, Parts Location, Change A

**SERVICE
INFORMATION**

SECTION VIII

SERVICE

8-1. INTRODUCTION

8-2. This section provides instructions for testing, troubleshooting, and repairing the Model 8755B Swept Amplitude Analyzer.

8-3. PRINCIPLES OF OPERATION

8-4. Detailed circuit description for each individual schematic diagram is placed on the facing left-hand foldout page. This places material needed for printed-circuit level diagnosis in one location and allows easy correlation between function and specific circuit.

8-5. TROUBLESHOOTING

8-6. Troubleshooting is generally divided into two maintenance levels in this manual. The first is the

assembly level, which isolates the cause of a malfunction to a circuit or assembly.

8-7. The second maintenance level isolates the trouble to the component level. Schematic diagrams are provided of each individual assembly plus a detailed circuit description to aid in troubleshooting down to the component level within the assembly.

8-8. RECOMMENDED TEST EQUIPMENT

8-9. Test equipment and accessories required to maintain the Model 8755B are listed in Table 1-3. If the equipment listed is not available, equipment that meets the minimum specifications shown may be substituted.

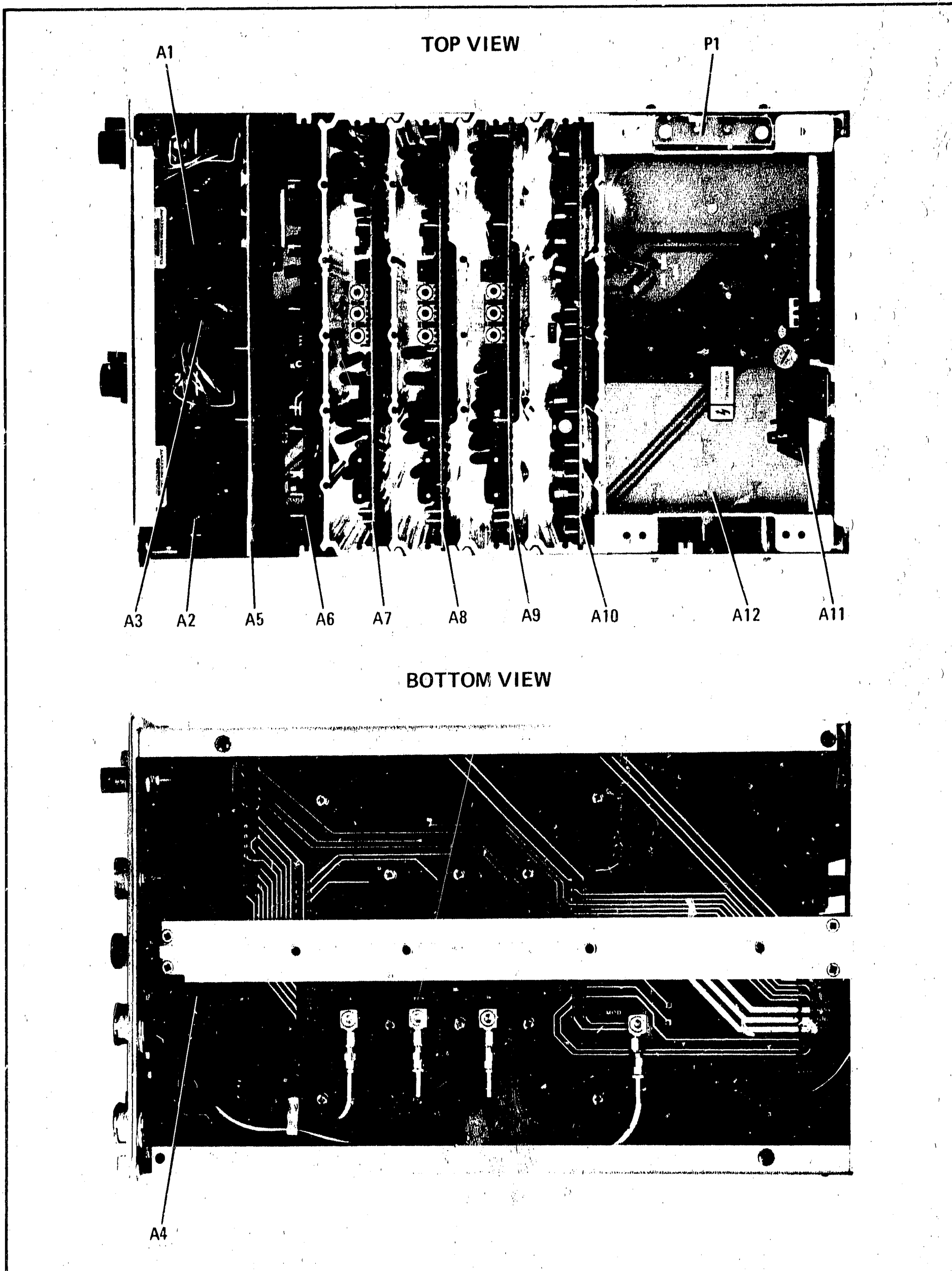

Figure 8-1. Major Assemblies Locations

SCHMATIC DIAGRAM NOTES

For symbols not shown, refer to USA Standard Y32.2--1967 "Graphic Symbols for Electrical and Electronic Diagrams."

Logic Symbols used conform to MIL-STD-806B (Military Standard 806B) "Graphic Symbols for Logic Diagrams."

Resistance is in ohms, capacitance is in picofarads, and inductance is in microhenries unless otherwise noted.

P/O = part of.

* Asterisk denotes a factory-selected value. Value shown is typical. Capacitors may be omitted or resistors jumpered.













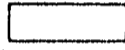
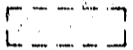

	Screwdriver adjustment		Panel control
	Encloses front panel designations		Encloses rear panel designation
	Circuit assembly borderline		
	Other assembly borderline		
	Heavy line with arrows indicates path and direction of main signal.		
	Heavy dashed line with arrows indicates path and direction of main feedback.		
	Wiper moves toward CW with clockwise rotation of control as viewed from shaft or knob.		
	Numbers in stars on circuit assemblies show locations of test points.		
	Encloses wire color code. Code used (MIL-STD-681) is the same as the resistor color code. First number identifies the base color, second number the wider stripe, and the third number identifies the narrower strip, e.g.,  denotes white base, yellow wide stripe, violet narrow stripe.		
	Light-emitting diode.		
	Voltage regulator (breakdown diode).		
	Denotes Field Effect transistor (FET) with N-type base.		
	Denotes FET with P-type base.		

Figure 8-2. Schematic Diagram Notes (1 of 4)

SCHEMATIC DIAGRAM NOTES

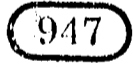

Operational Amplifier (integrated circuit).

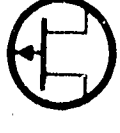
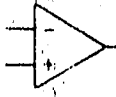
Voltages noted within circuits are measured with respect to chassis ground and have a $\pm 10\%$ tolerance.

Conditions for waveforms and dc voltages on schematics are as follows:

- a. Connect equipment as shown in test setup below with thermistor mount connected to modulator.
- b. Set 8620A for fast sweep across the band of interest. Adjust 8621A POWER LEVEL control for -3 dBm indication on power meter.
- c. Disconnect thermistor mount and reconnect Detector R to modulator.
- d. Set 8755B controls for both Channel 1 and 2 as follows:

VERNIER ON-OFF Switch	OFF
REFERENCE LEVEL Switches	-00
dB/DIV10
DISPLAY	POSITION
VIDEO FILTER	Out
- e. Adjust CHANNEL 1 REFERENCE POSITION screwdriver adjustment to place the trace two large divisions below the center graticule line.
- f. Adjust CHANNEL 2 REFERENCE POSITION screwdriver adjustment to place the trace two large divisions above the center graticule line.
- g. Press both DISPLAY R pushbuttons.

Figure 8-2. Schematic Diagram Notes (2 of 4)

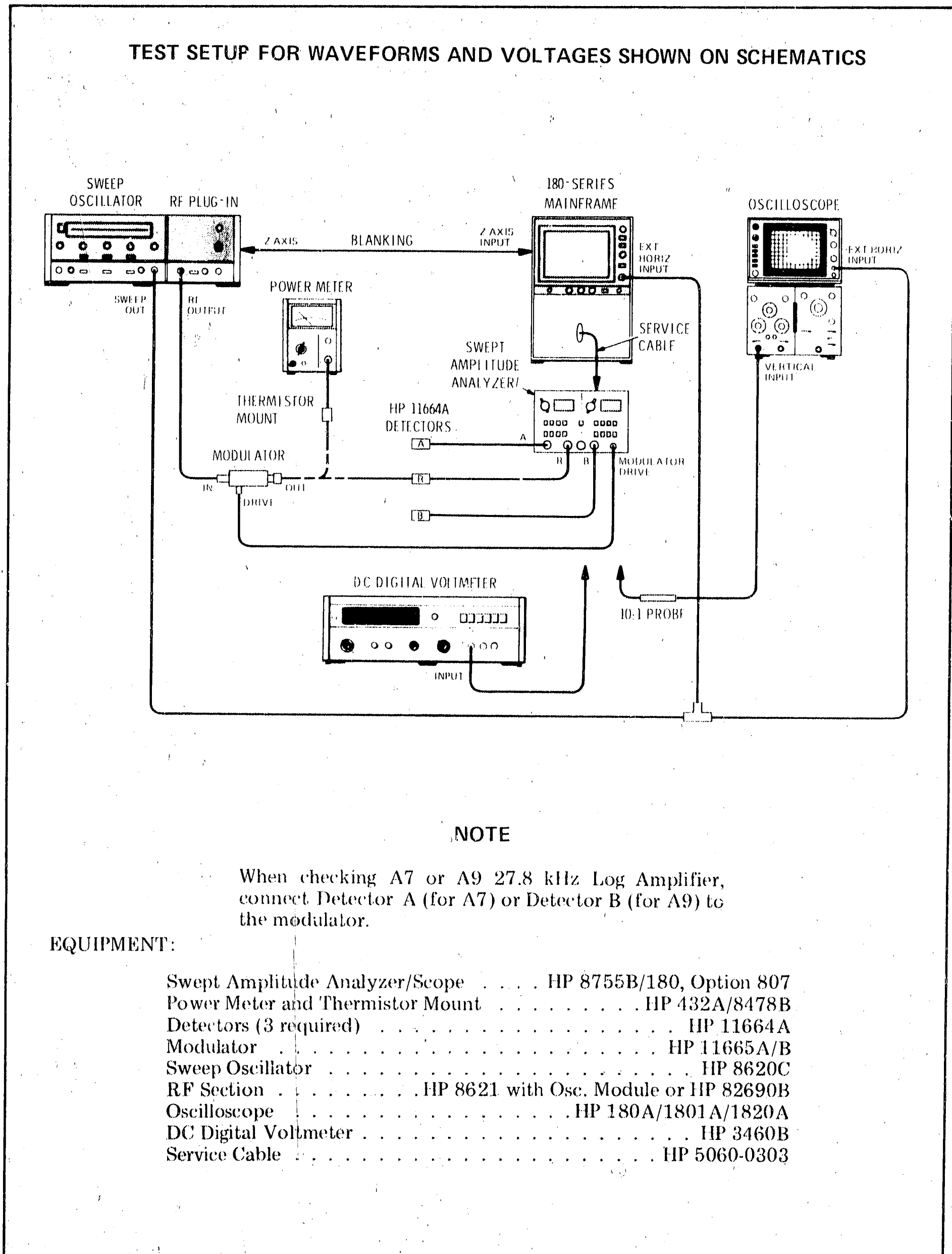

NOTE

When checking A7 or A9 27.8 kHz Log Amplifier, connect Detector A (for A7) or Detector B (for A9) to the modulator.

EQUIPMENT:

Swept Amplitude Analyzer/Scope	HP 8755B/180, Option 807
Power Meter and Thermistor Mount	HP 432A/8478B
Detectors (3 required)	HP 11664A
Modulator	HP 11665A/B
Sweep Oscillator	HP 8620C
RF Section	HP 8621 with Osc. Module or HP 82690B
Oscilloscope	HP 180A/1801A/1820A
DC Digital Voltmeter	HP 3460B
Service Cable	HP 5060-0303

Figure 8-2. Schematic Diagram Notes (3 of 4)

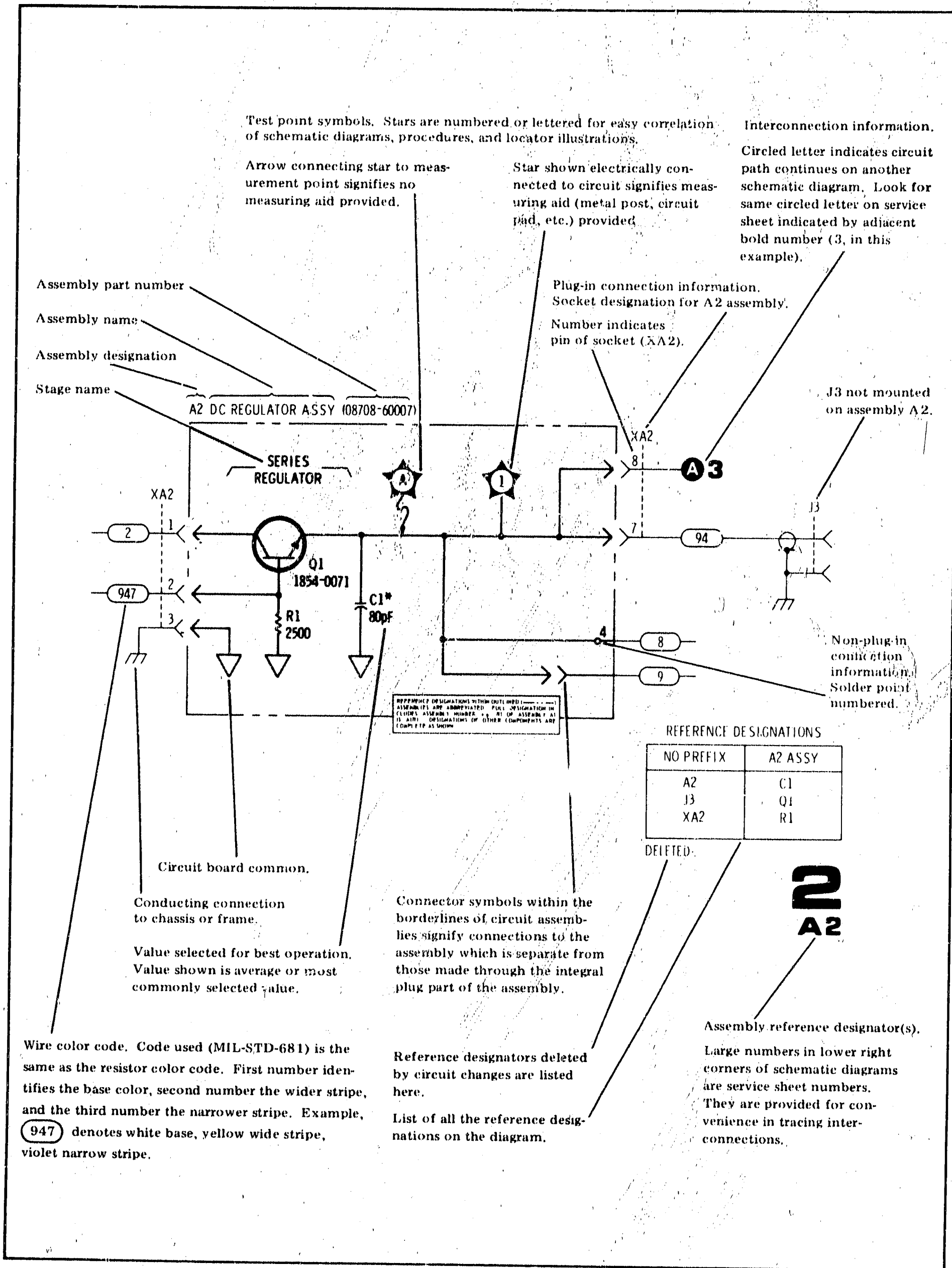

Figure 8-2. Schematic Diagram Notes (4 of 4)

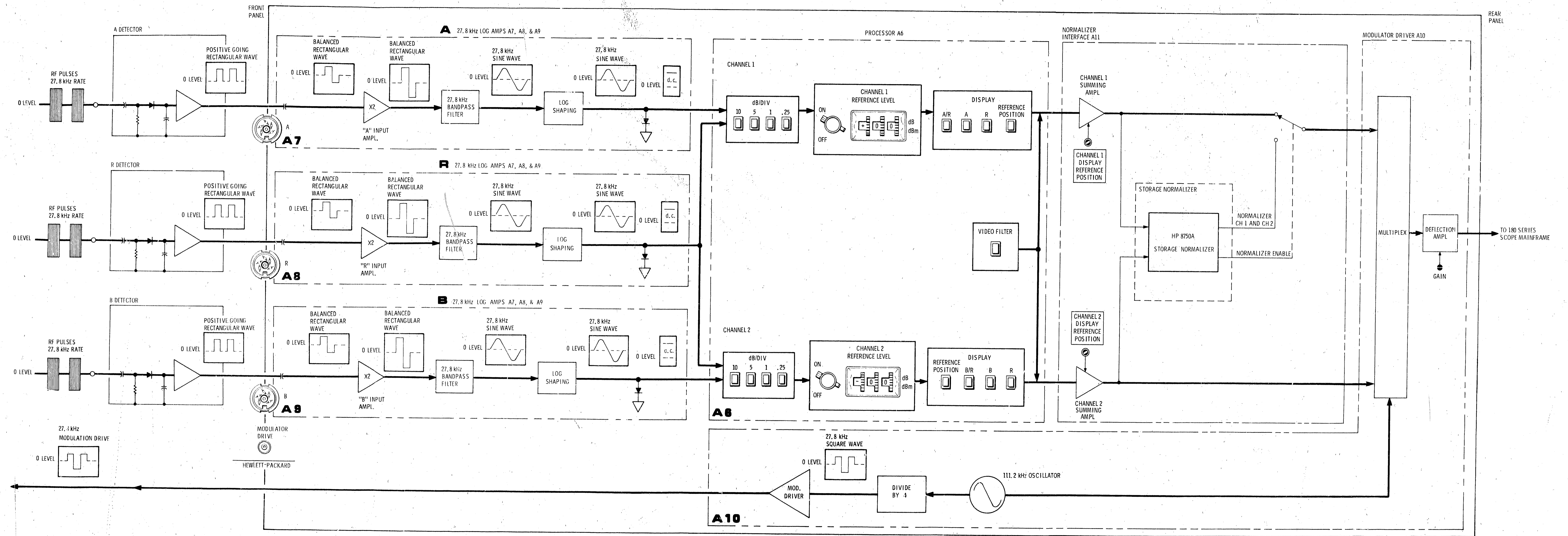

Figure 8-3. Simplified Troubleshooting Block Diagram

MODEL 8755B OVERALL CIRCUIT DESCRIPTION

Measurement Test Setup

A typical test setup of the 8755B, together with the 11665A/B Modulator and three 11664A Detectors is shown in Figure 8-4. The Sweep Oscillator RF output is applied to the Model 11665A/B Modulator. The RF signal is then amplitude modulated at 27.8 kHz rate. The modulated signal is fed to a dual directional coupler or reflectometer. Three Model 11664A Detectors are used to detect the modulation. The incident signal is detected by the reference detector. The reflected signal is detected by either the A or B detector. However, channel A is normally used for the reflected signal. The device under test is connected to the directional coupler's main line output. If the device under test is a two port device, the B detector is connected to its output port. The ratio of the A detector signal to the R (reference) detector signal is reflection coefficient and the ratio of the B detector signal to the reference channel signal is insertion loss (or gain) of the device under test. Therefore, reflection coefficient (return loss) and insertion loss may be displayed simultaneously.

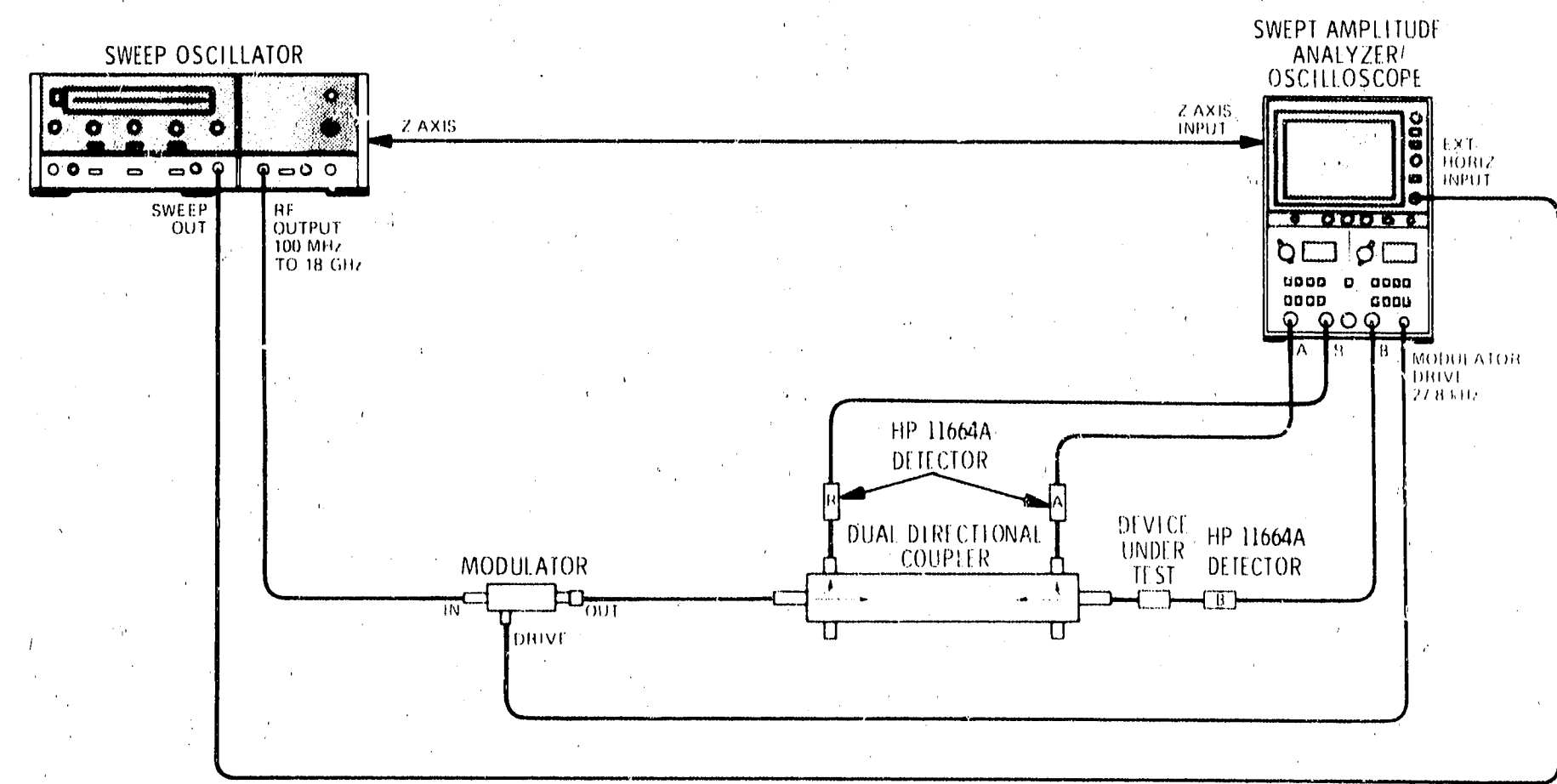

Figure 8-4. Model 8755B Typical Test Setup

Figure 8-5 shows a simplified block diagram of the 8755B. The 27.8 kHz signals from the three detectors are applied to three identical amplifiers in the 8755B. The output signals of the three amplifiers are dc voltages. These dc voltages are applied to a processor assembly which contains the switching, offsetting, and display control functions. After processing, the dc voltages are applied to a driver assembly which contains the multiplex function, the CRT deflection drivers, and a 27.8 kHz modulation driver.

MODEL 8755B OVERALL CIRCUIT DESCRIPTION (cont'd)

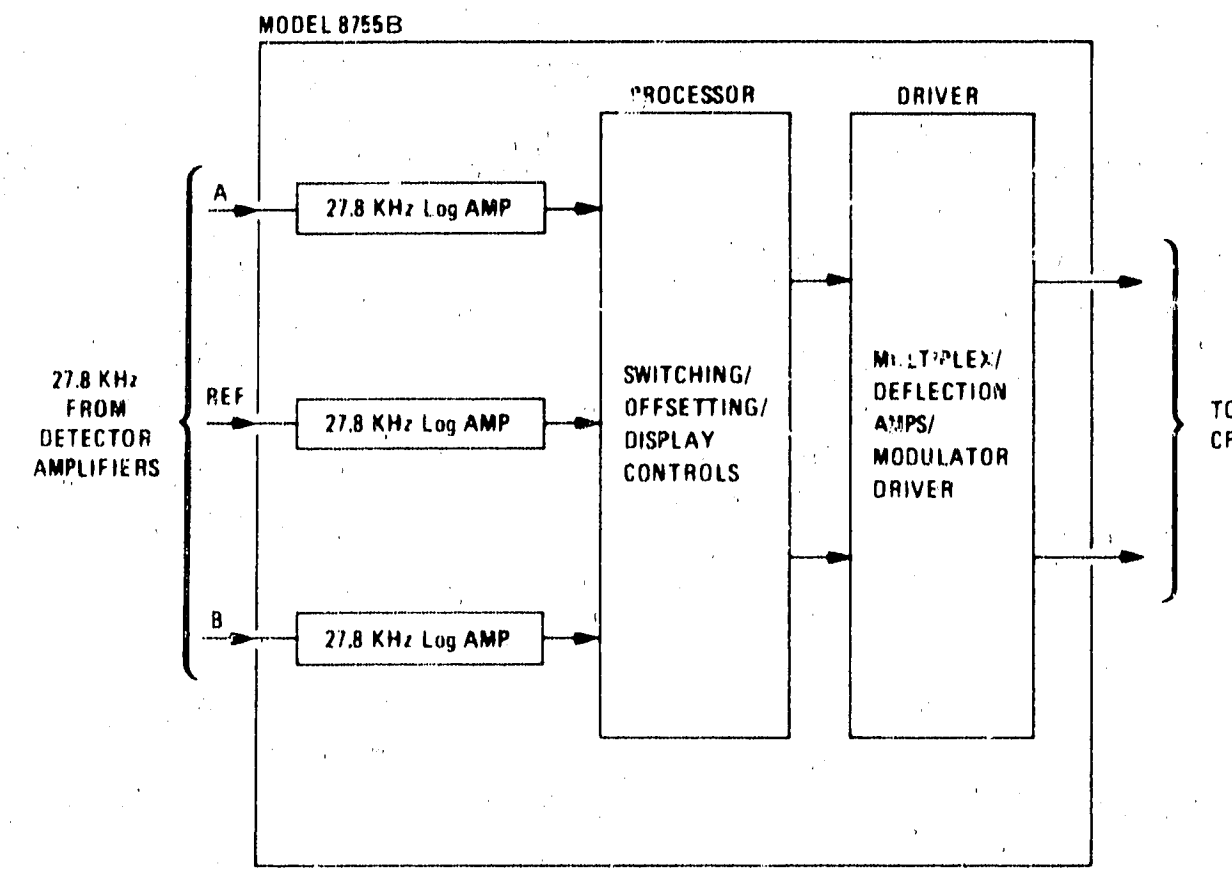

Figure 8-5. Model 8755B Simplified Block Diagram

Model 11664 Detector Circuit Description

Figure 8-6 shows a simplified schematic of one of the 11664A Detectors. The three detectors are identical and may be interchanged. They consist of a hot Carrier Diode, impedance matching components, and an amplifier or pre-amp.

A more detailed schematic of the Model 11664A is shown in Figure 8-7.

Q1 and Q2 form a feedback pair whose gain is about three mainly determined by R3 and R6.

Q3 and Q4 is a current driver which permits the use of a long cable (up to 50 feet) between the detector and the 8755B.

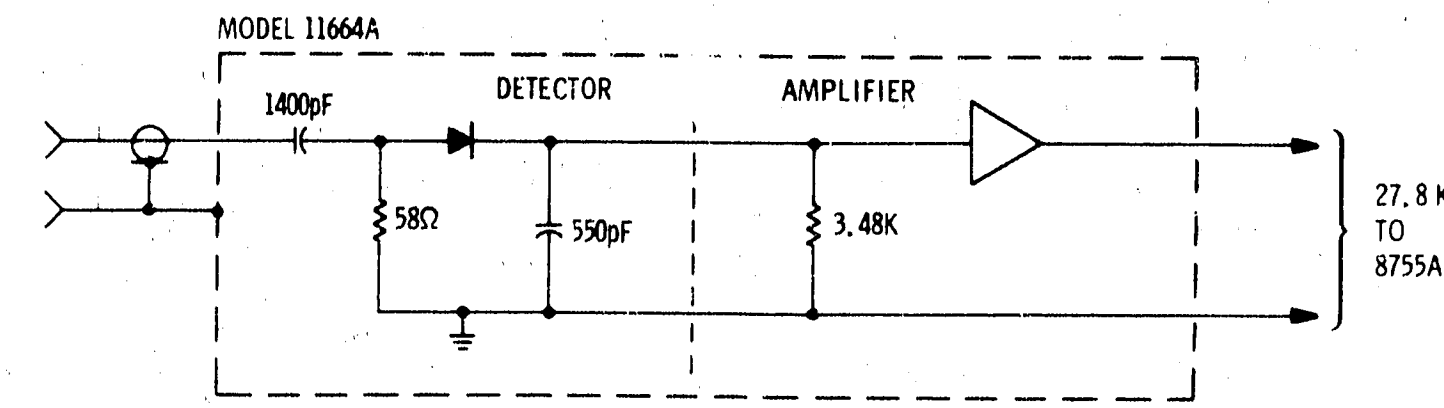

Figure 8-6. Model 11664A Simplified Schematic

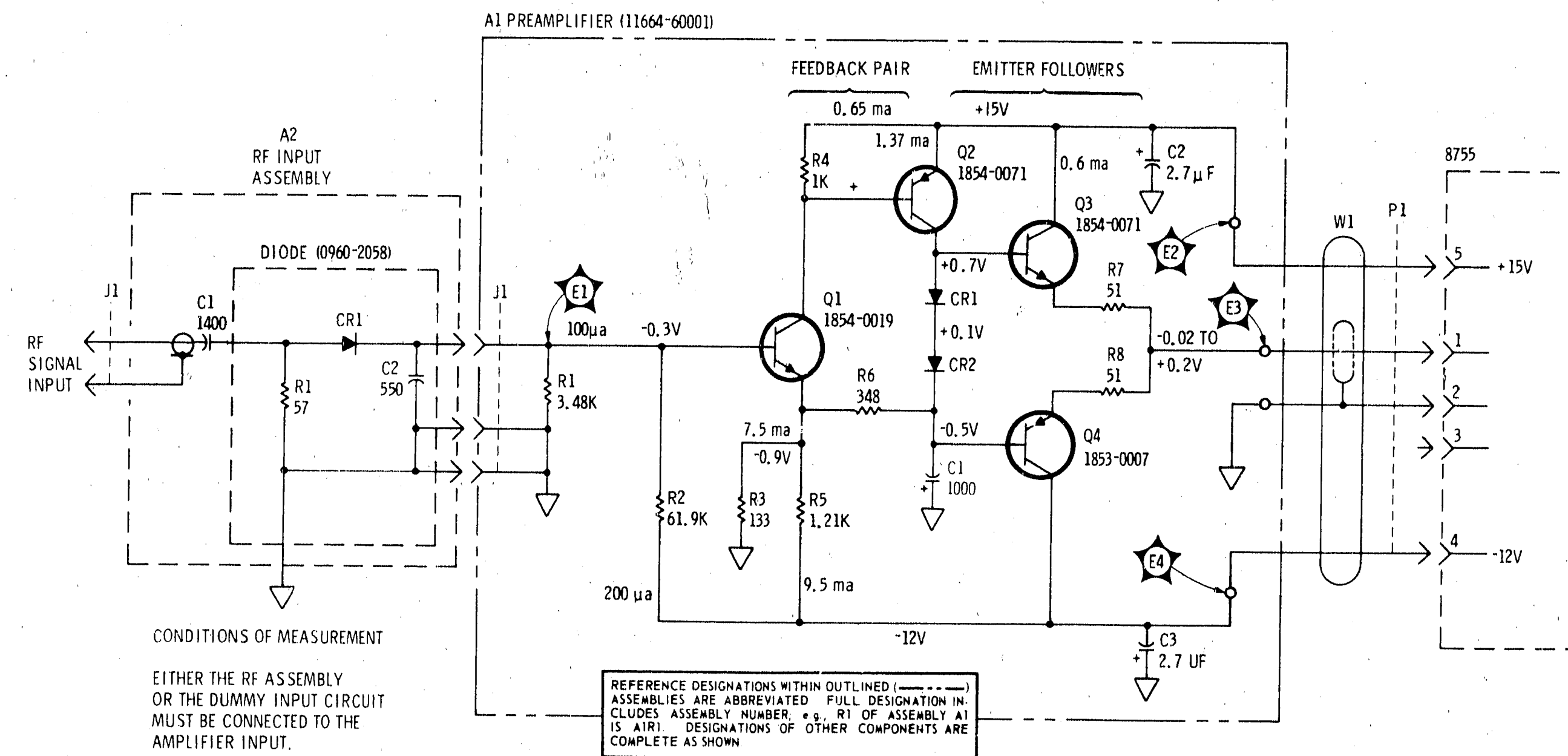

Figure 8-7. Model 11664A Amplifier Schematic

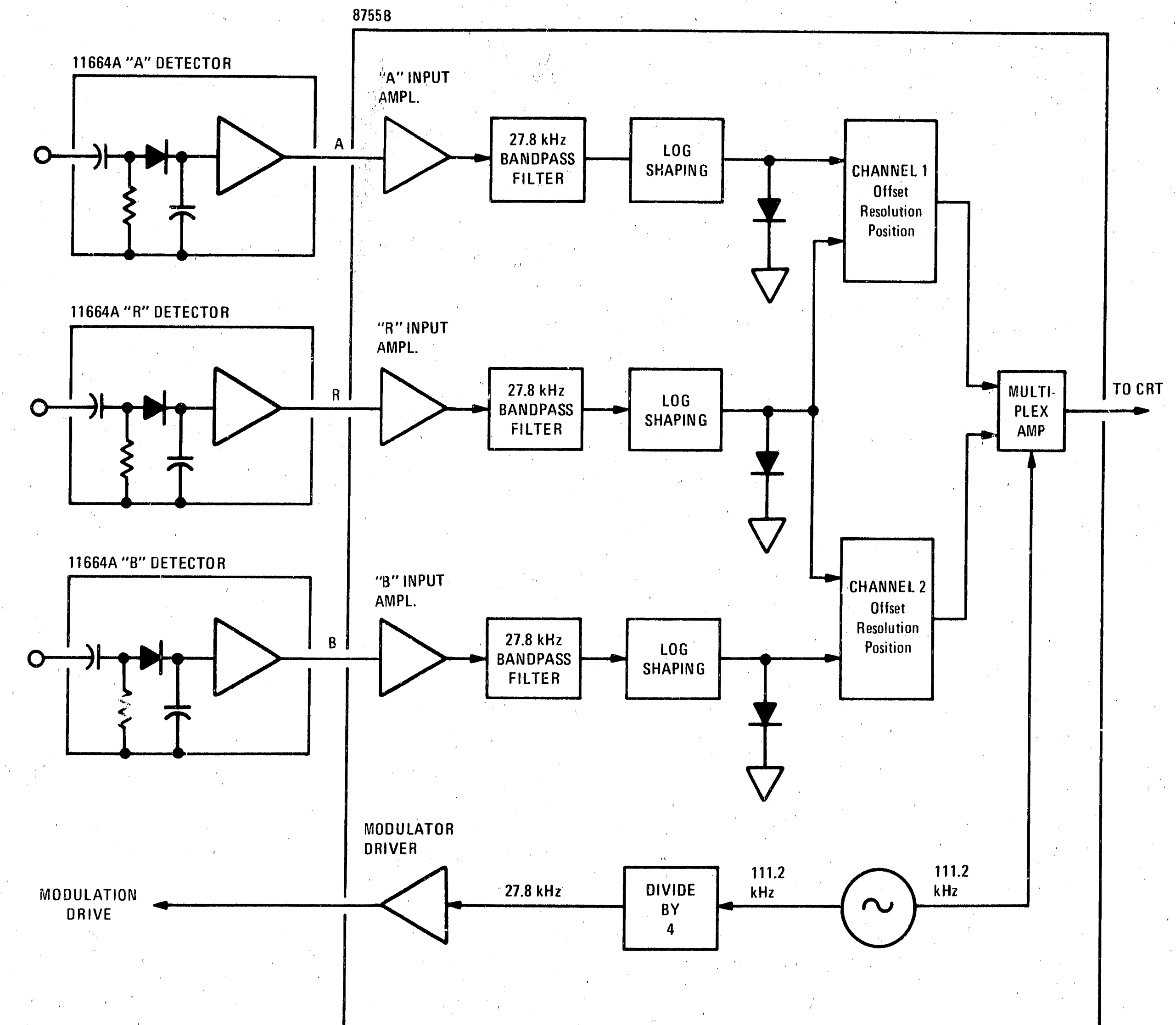

Figure 8-8. Model 8755B Block Diagram

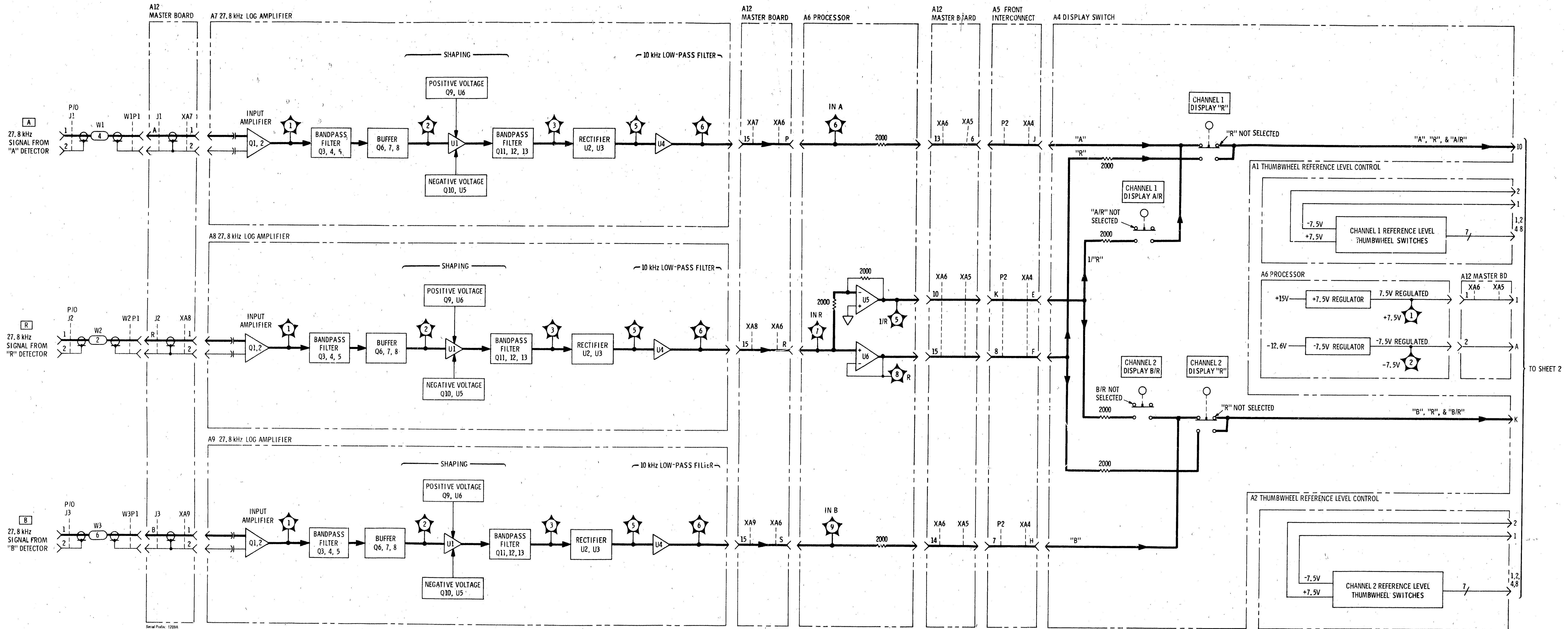
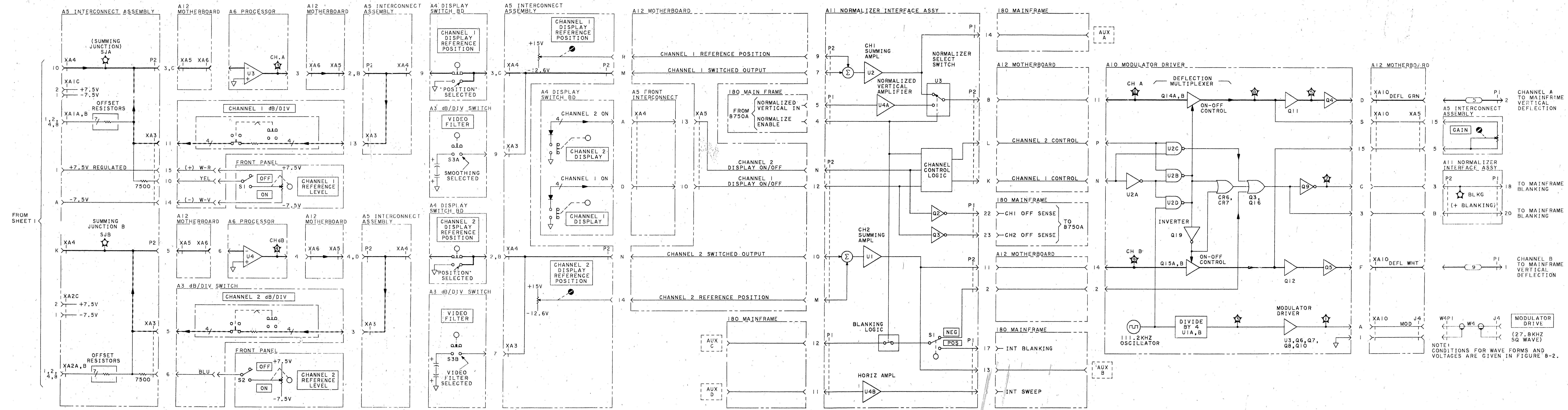

Figure 8-9. Troubleshooting Block Diagram (1 of 2)

MODEL 8755B BLOCK DIAGRAM
Figure 8-8. Model 8755B Block Diagram



NOTE:
CONDITIONS FOR WAVE FORMS AND
VOLTAGES ARE GIVEN IN FIGURE 8-2.

Figure 8-9. Troubleshooting Block Diagram (2 of 2)
8-11

SERVICE SHEET 1

CIRCUIT DESCRIPTION

Input Amplifier

The 27.8 kHz signal from the 11664 Detector is fed to one of three identical amplifiers: A7, A8, or A9 in the 8755B. The signals are taken through front panel connectors to the amplifiers and applied to the input stage, Q1, Q2, and Q3, which has an overall gain of about 2. Q1 and Q2 is a differential amplifier which has good common mode rejection. Any signal that comes in on pins 1 and 2 in common will have no effect.

27.8 kHz Amplifier Bandpass Filter

R16 through C13 and emitter follower Q4 form an active low pass filter. C15 through R30 and Q5 and Q6 form an active high pass filter. Together they form a bandpass filter at 27.8 kHz with a passband 10 kHz wide. Q4 has a gain of about one and forms one pole of the low pass filter. Q5 and Q6 together have a gain of about one and form one pole of the high pass filter. Q7 and Q8 provide the drive to the logger (U1).

Log Amplifier

U1 is a log amplifier. It provides an output signal which changes linearly with the RF power applied to the Detectors. For low power levels (up to ≈ -20 dBm) the output signal from the hot carrier diode detector is proportional to the RF input power. In this region, U1 acts as a true logarithmic converter. As the RF level increases, the output signal of the detector increases less than linearly, and finally approaches the region where it only changes as the square root of the RF power. For those signal levels, the amplifier (U1) has to provide a gain which is greater than the true logarithm in order to make up for signal compression in the detector. The output signal of U1 changes 50 mV per dB change in RF power applied to the detector over a range of 60 dB (which corresponds to approximately 100 dB change in detector output level).

The output level of U1 will vary from 0 to 4V peak-to-peak for a variation of 100 dB at its input.

The hybrid IC Log Amp contains 12 log amplifiers and 4 voltage amplifiers. Five log stages are fed by the input signal through a divider string. The remaining stages are fed through voltage amplifiers. As each log amplifier reaches the upper limit of its log region, the next log amplifier is turned on. R67, R70, and R74 are used to adjust the point at which some of the log amplifiers turn on and thus affect the overall shape of the input/output characteristic. The output of all the log stages are summed, amplified and appear at the IC's output. The gain of the voltage amplifier is temperature

SERVICE SHEET 1 (cont'd)

compensated by controlling the supply voltage using two temperature sensing diodes located on the IC chip. In order to reduce crosstalk between the three channels, each hybrid log amplifier is decoupled from the main supply line by its own power supply.

Rectifier

U2, U3, and the associated circuitry form a full wave rectifier. The 27.8 kHz signal is applied to U2's inverting input. The positive portion of U2's output is passed through CR8 and fed back to the input through R53. The gain of U2 for the positive going output is R53/R43 or about 1. The negative portion of U2's output is fed back through CR7. The gain for the negative output is about zero. The output of U2 (input to U3) is then a half wave rectified signal which is the opposite polarity of the negative portion of the input signal. The input signal is also fed to U3 through R49 and R54. U3 then has two input signals. The gain of U3 for the signal from U2 is R62/R59 or about 2. The gain of U3 for the signal which bypasses U2 is R62/R54 + R49 or about 1. The signal from U2 which is amplified by 2 occurs at the same time as the negative portion of the bypassed signal. The result is a full wave rectified signal at TP5 with a ripple frequency of 2 time 27.8 kHz. If the two signals at the input to U3 have the proper amplitude and phase relationship there will be no component of the original 27.8 kHz frequency. The proper amplitude relationship is maintained by the gain of U2. The phase relationship is maintained by designing R49, R54, and C33 for a phase shift to compensate for the delay through U2.

U2's response when the signal is passing through the zero crossover point is improved by forward coupling the input signal through C32 into the IC.

R58 provides a variable negative bias to U3's inverting input. The amount of offset is adjusted to obtain a zero dBm indication with 0 dBm peak power applied to the Model 11664A Detector. (This signal would actually measure -3 dBm average power on a power meter because it is square-wave modulated in the modulator.)

10 kHz Low Pass Filter

R65 through C44 and U4 is an active low pass filter with a 3 dB cut off frequency of 10 kHz. Although attenuated, any signal at 27.8 kHz could still pass through this filter. However, the full wave rectified ripple frequency of 55.6 kHz will be greatly attenuated and should not appear at the output at TP6.

SERVICE SHEET 1 (cont'd)

Positive and Negative Regulated Power Supplies with Temperature Compensation

Figure 8-10 shows the positive and negative power supply circuit. The -2.5V and +5V power supplies for the logger decouple the logger from the mainframe power supplies to reduce any 27.3 kHz signal on the mainframe power supplies from affecting the logger output. In addition to decoupling, the logger power supplies also compensate for temperature variations in the logger. Without compensation, any increase in temperature would cause the logger gain to increase. However, by changing the power supply voltages, inversely proportional to temperature, the logger gain will remain constant.

The negative supply output is in the emitter circuit of Q10. The emitter circuit provides the logger and the positive supply with about -2.5 Vdc. The -2.5V is also the reference voltage for Operational Amplifier U5 through a feedback path consisting of R14, R22, and the two temperature sensing diodes. U5 pin 2 is a virtual ground. Feedback current is determined primarily by +15V/R23 or about 2.67 mA. Because of the high input impedance of U5, this current flows through R14 and the temperature sensing diodes. About 1.13V is dropped across R14 and about 1.32V across the diodes when the output voltage is -2.5V. The output voltage is then $E_o = I_o R14 + \text{Voltage across the diodes}$. The current is relatively constant and the voltage drop across the diodes changes inversely with temperature. Therefore, an increase in temperature will cause the -2.5V supply to go in a positive direction.

Figure 8-11 shows a simplified diagram of the -2.5V supply and Figure 8-12 shows the +5V supply. The -2.5V supply output voltage is the input to the +5V supply. The gain of this supply is R52/R50 or about 2.37. The output at the junction of R44 and R52 is about 6V. About 1V is dropped across R55 and R56 so the output to the logger is about 5V. As the output of the -2.5V supply goes toward zero as a result of temperature increase the +5V output also goes toward zero. The combined action of both supplies will maintain the logger gain constant.

SERVICE SHEET 1 (cont'd)

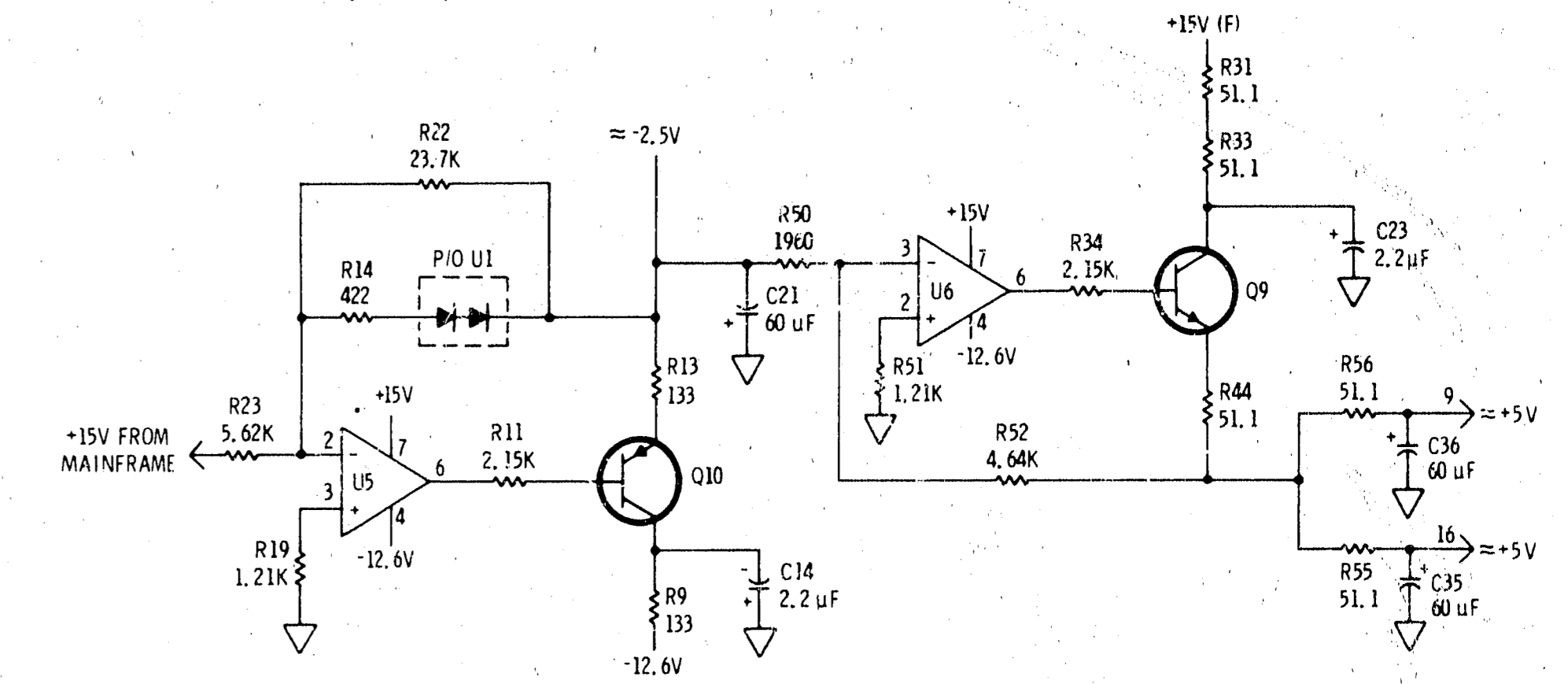

Figure 8-10. Positive and Negative Power Supplies

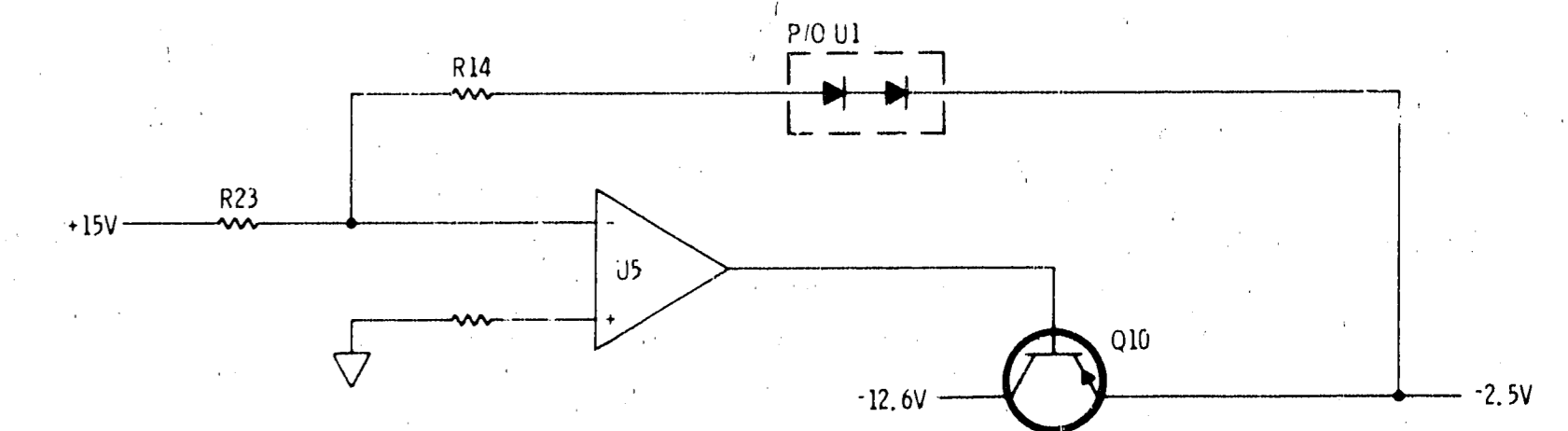

Figure 8-11. -2.5V Supply Simplified Diagram

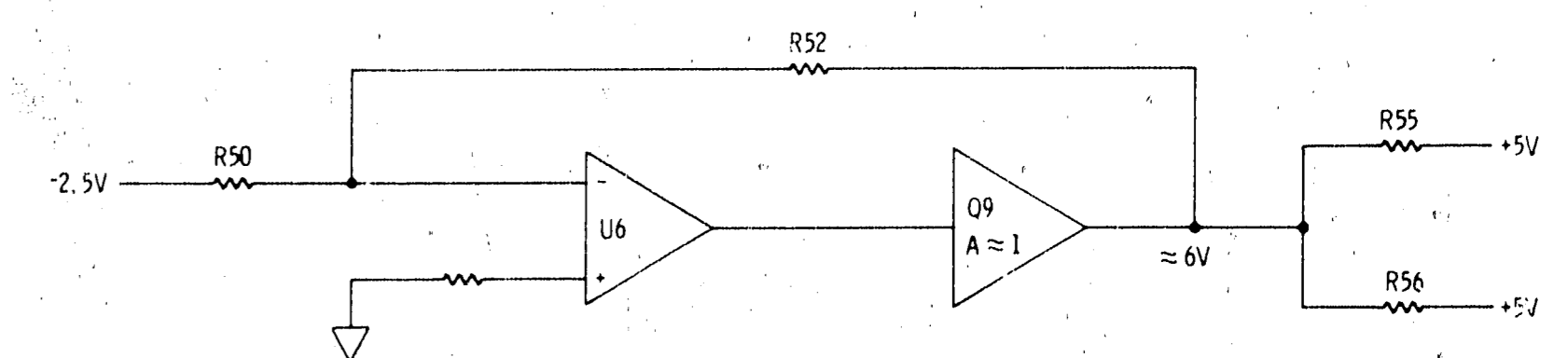

Figure 8-12. +5V Supply Simplified Diagram

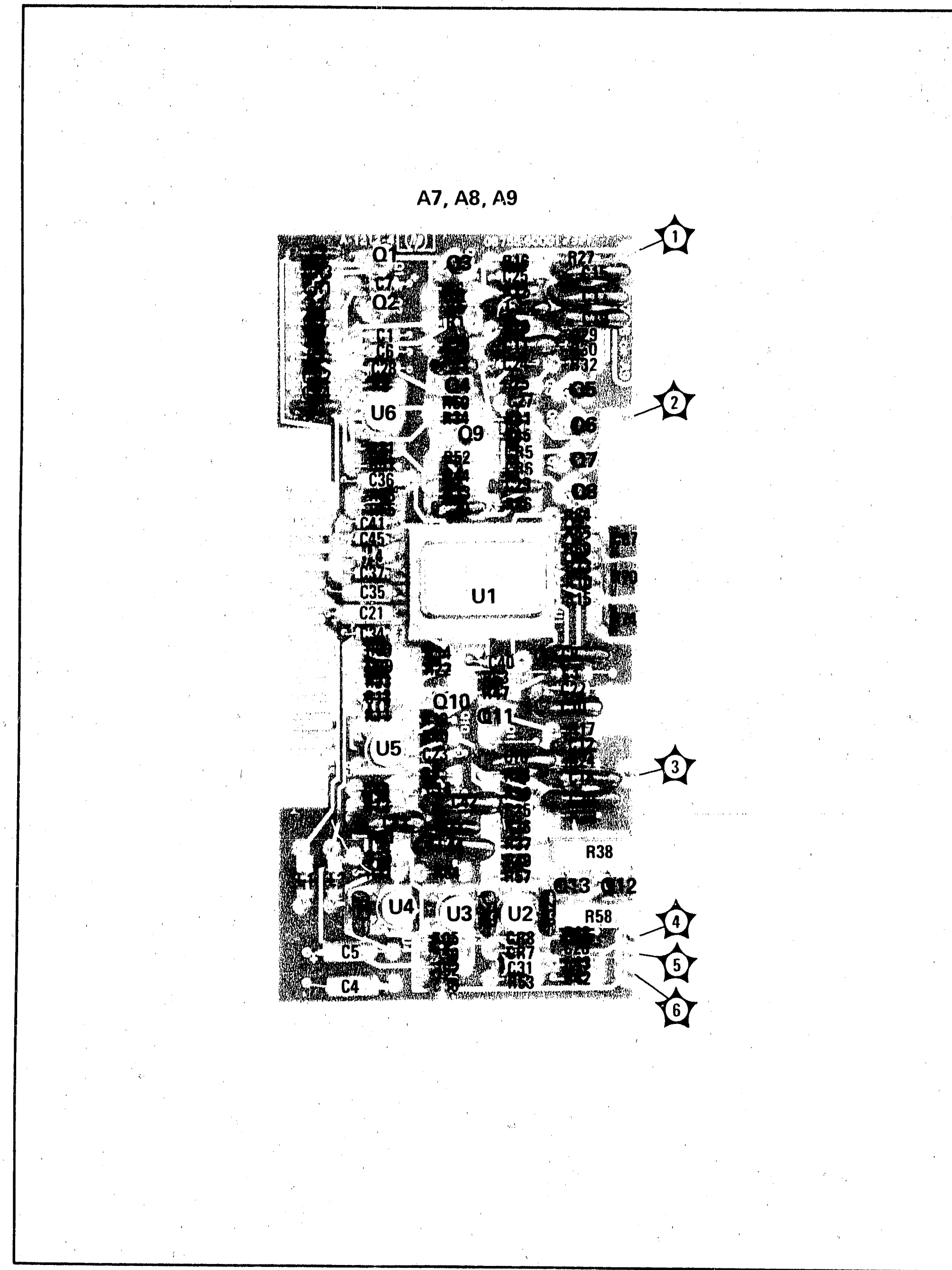
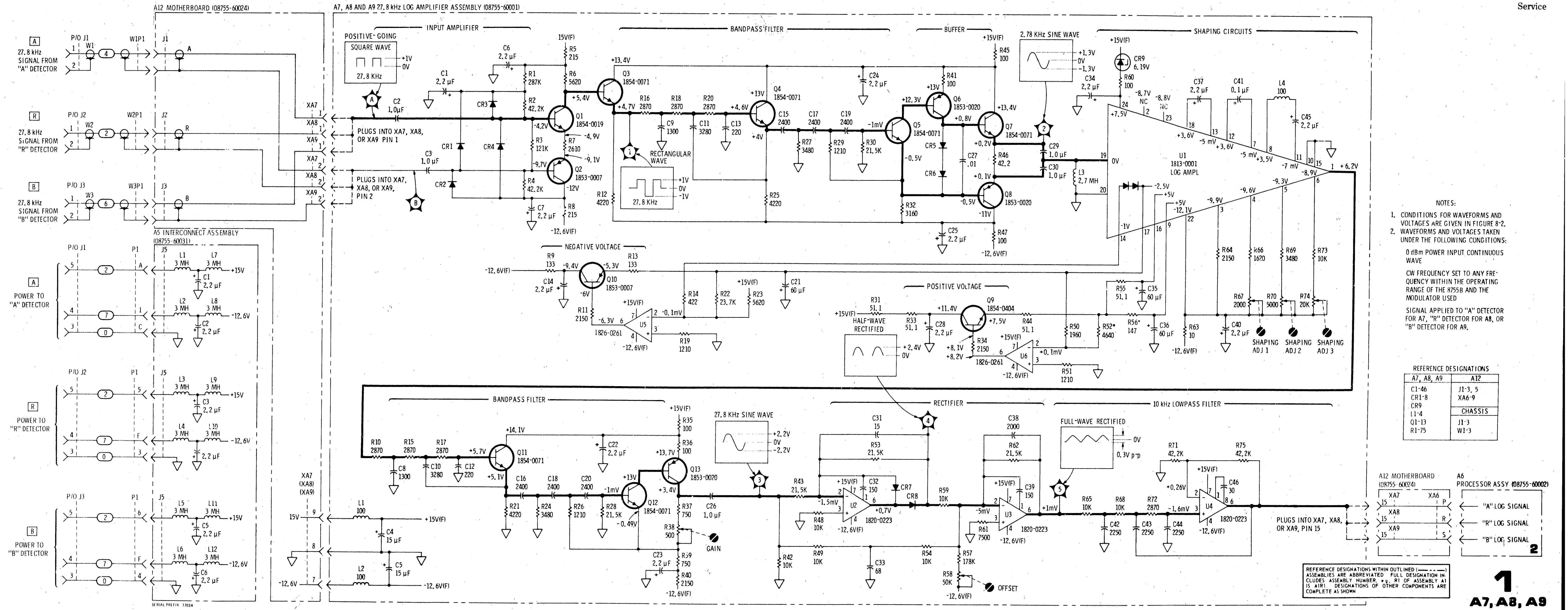

Figure 8-13. A7, A8 and A9 27.8 kHz Log Amplifier Parts Identification



- NOTES:
- CONDITIONS FOR WAVEFORMS AND VOLTAGES ARE GIVEN IN FIGURE 8-2.
 - WAVEFORMS AND VOLTAGES TAKEN UNDER THE FOLLOWING CONDITIONS:
0 dBm POWER INPUT CONTINUOUS WAVE
CW FREQUENCY SET TO ANY FREQUENCY WITHIN THE OPERATING RANGE OF THE 8755B AND THE MODULATOR USED
- SIGNAL APPLIED TO "A" DETECTOR FOR A7, "R" DETECTOR FOR A8, OR "B" DETECTOR FOR A9.

REFERENCE DESIGNATIONS

A7, A8, A9	A12
C1-46	J1-3, 5
CR1-8	XA6-9
CR9	CHASSIS
L1-4	J1-3
Q1-13	J1-3
R1-75	W1-3

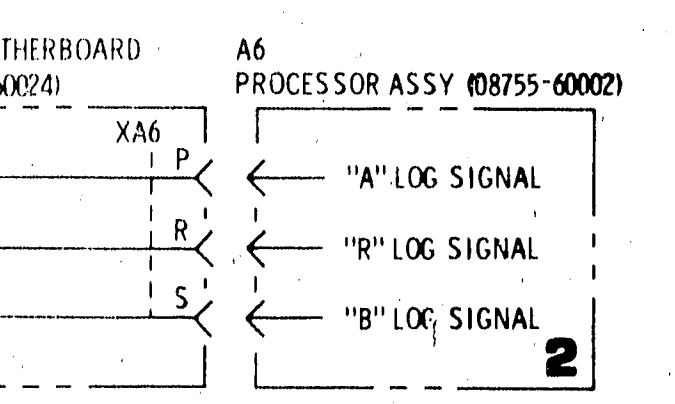

REFERENCE DESIGNATIONS WITHIN OUTLINED ASSEMBLIES ARE ABBREVIATED. FULL DESIGNATION INCLUDES ASSEMBLY NUMBER, P.C. NO. OF ASSEMBLY AND IS AIRTEL DESIGNATIONS OF OTHER COMPONENTS ARE COMPLETE AS SHOWN.

1
A7, A8, A9

Figure 8-14. A7, A8, A9 27.8 kHz Log Amplifier Schematic

SERVICE SHEET 2

CIRCUIT DESCRIPTION

±7.5V Power Supplies

The Plus and Minus 7.5V Power Supplies are shown on Schematic 2. The input of the -7.5V supply at U2 pin 2 is the output of the +7.5V supply. Since U2 has a gain of one (R12/R13), the output of the -7.5V supply is the input level with the opposite polarity.

The input of the +7.5V supply at U1 pin 3 is referenced to the -7.5V output through R10, R11, and CR5. The input voltage and the gain of U1 is adjusted using R11 for a +7.5V output.

If the +7.5 volts increases, the -7.5V will go more negative, decreasing the input to U1. With no polarity inversion in U1 and with a gain of about 6, the output of U1 will return to +7.5V which will return the output of U2 to -7.5V.

If U1 opens, both supplies will go to zero. If U2 opens, the -7.5V would go to zero but the +7.5V supply would go to +15V.

SERVICE SHEET 2 (cont'd)

Processor Assembly

The dc output of each 27.8 kHz Amplifier Assembly is fed to the Processor Board. These outputs go through the Motherboard to front-panel assembly switches and then back to the Processor Board. The "A" and "B" inputs go through switches and then to summing junctions. The "R" input is applied to two Op. Amps. One is non-inverting and its output is then R. The other is an inverting amp and its output is 1/R. By selecting the appropriate switch, 1/R may be summed with the A input or the B input. Because these signals have logarithmic relationship to the detected RF signal, A + 1/R (or A - R) for instance, is A/R. The same switches that select "A" and "B" may also select "R" only. Regardless of the switch positions there are only two channels fed to the summing junction.

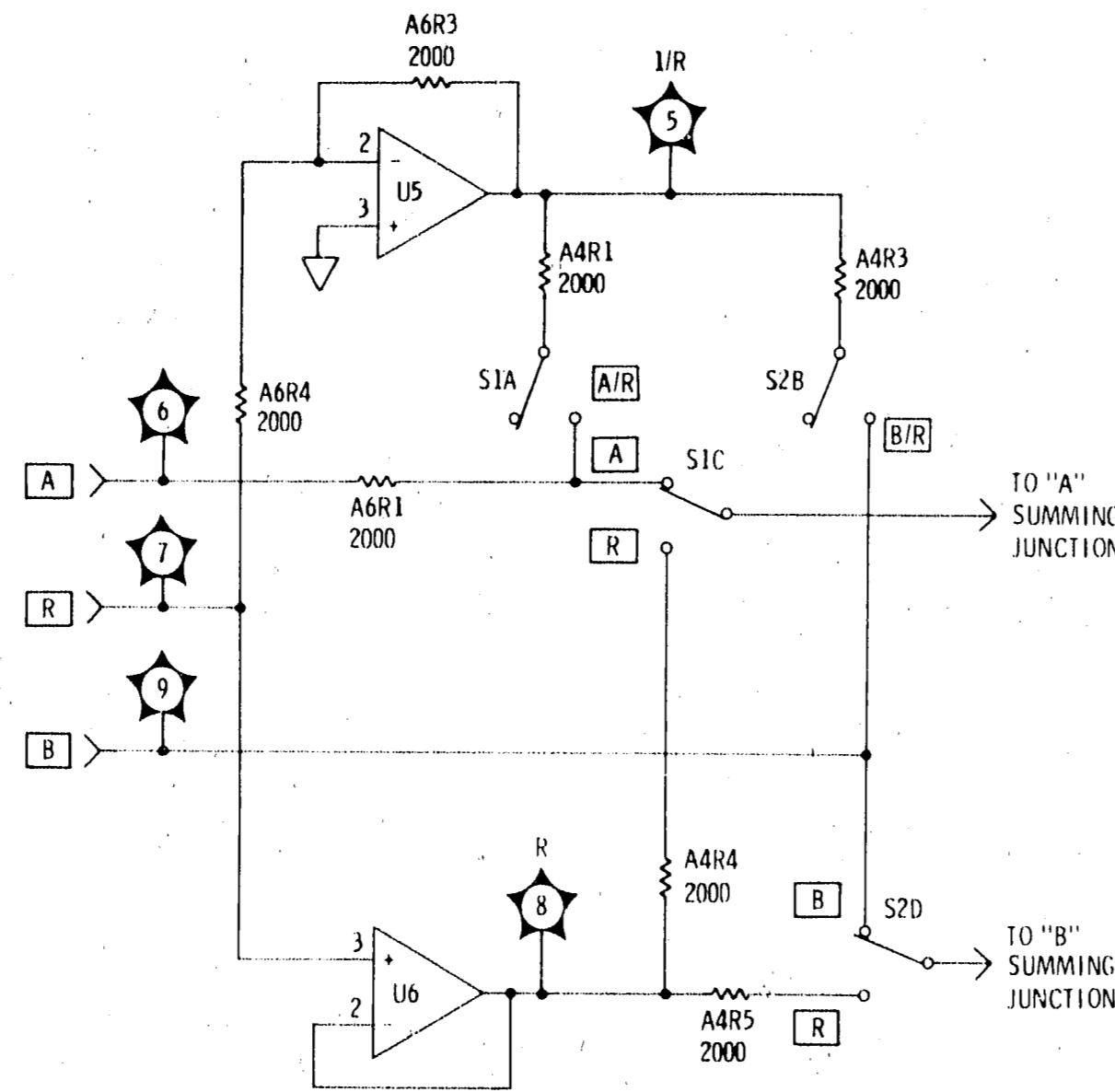

Figure 8-15. Processor Board Input and Switching

SERVICE SHEET 2 (cont'd)

Channel 1 and Channel 2 Processor Board output stages are identical. The display sensitivity (dB/Div) is selected by switching in alternate feedback resistors for the Op. Amp. Diodes CR1 through A6CR4 limit the maximum input to the Op. Amp. The output signal at A6TP3 and A6TP4 can be filtered or smoothed by switching in filter capacitors with the front-panel VIDEO FILTER switch. Also, the signal path is grounded when the front-panel REFERENCE POSITION switch is pressed. This prevents any input signal from affecting the positioning of the display trace.

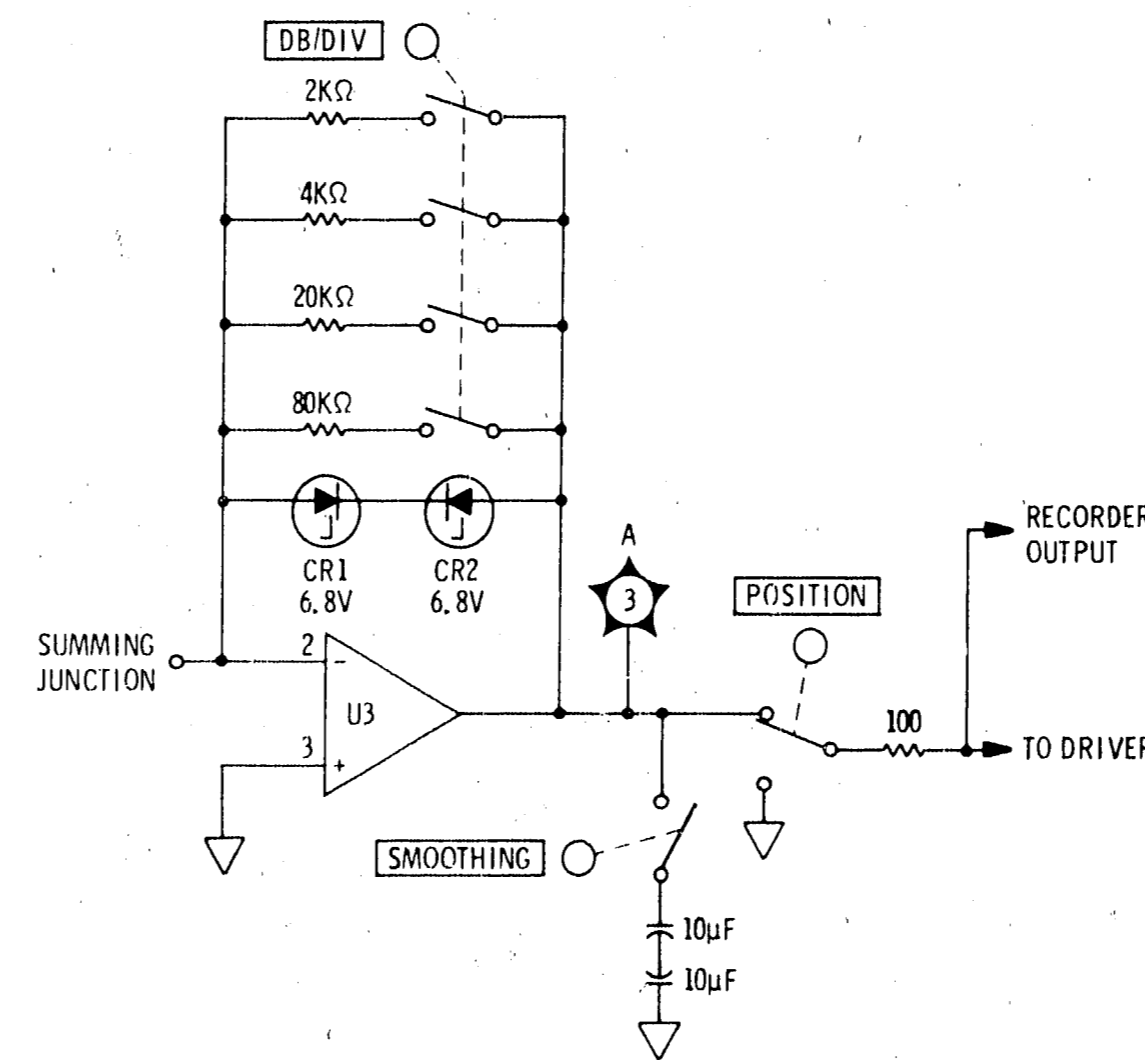

Figure 8-16. Channel 1 (or 2) Processor Board Output

SERVICE SHEET 1

Figure 8-14. A7, A8 and A9 27.8 kHz Log Amplifier Schematic

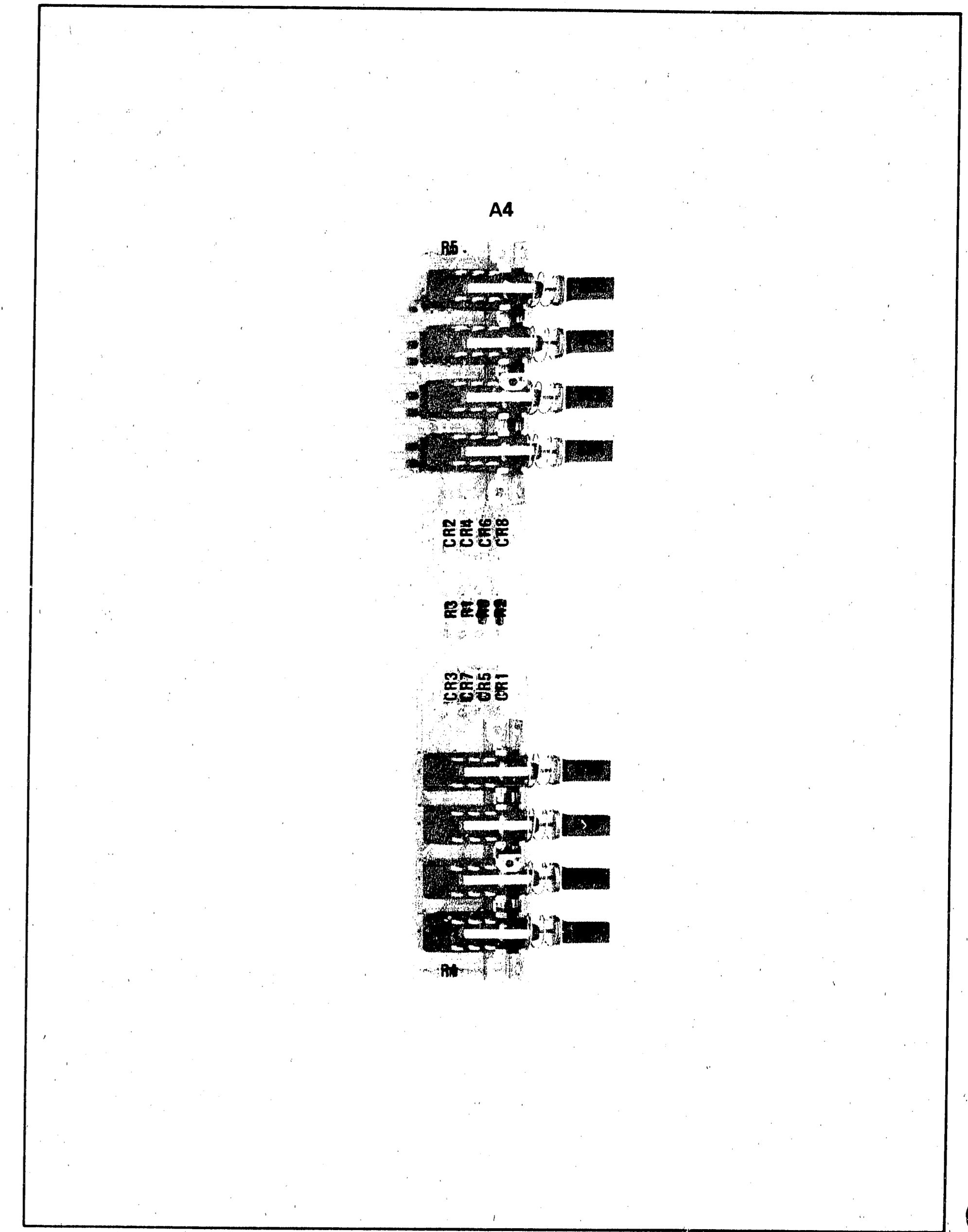

Figure 8-17. Display Switch, Parts Location

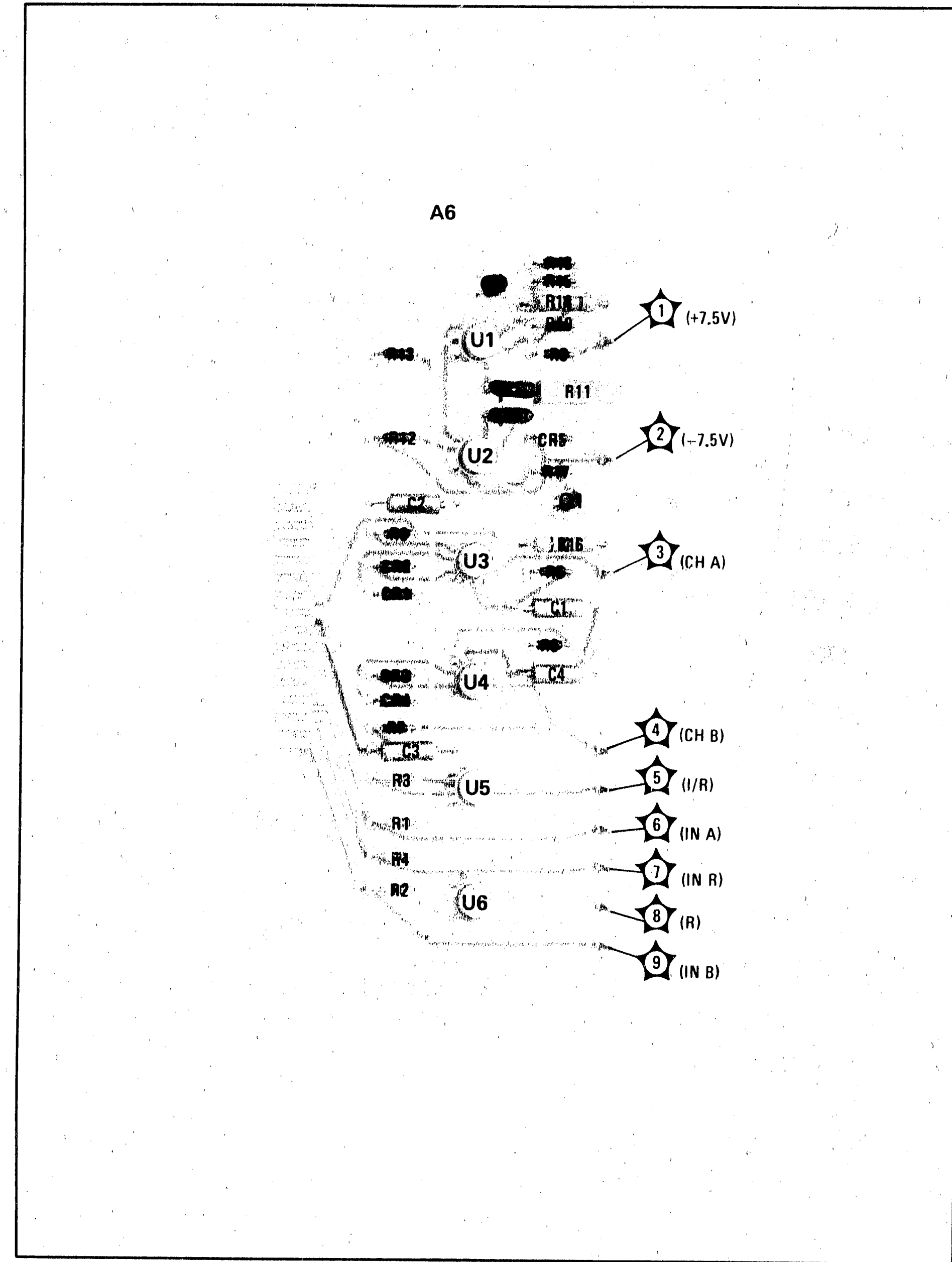

Figure 8-18. A6 Processor Assembly, Parts Location

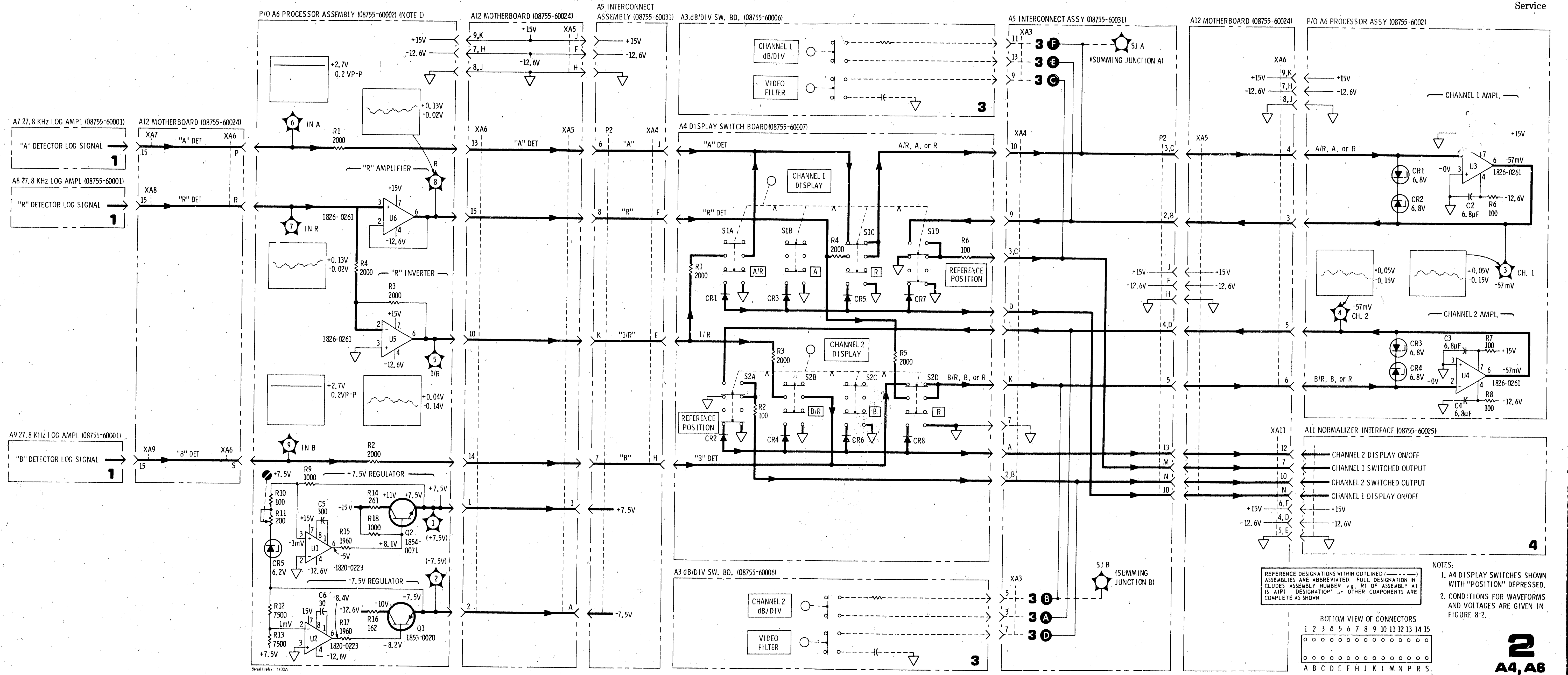

Figure 8-19. A6 Processor and A4 Display Switches Schematic

SERVICE SHEET 3

CIRCUIT DESCRIPTION

Figure 8-20 shows a simplified schematic of the offset circuit. The offset circuit feeds current to the summing junction that simulates input signals to offset the display. Fixed offsets of up to 99 dB may be obtained by selecting the appropriate front-panel polarity and OFFSET switches. A variable offset of up to 40 dB may be obtained by adjusting the front-panel OFFSET CAL adjust. The input signals plus the offset are applied to the summing junctions.

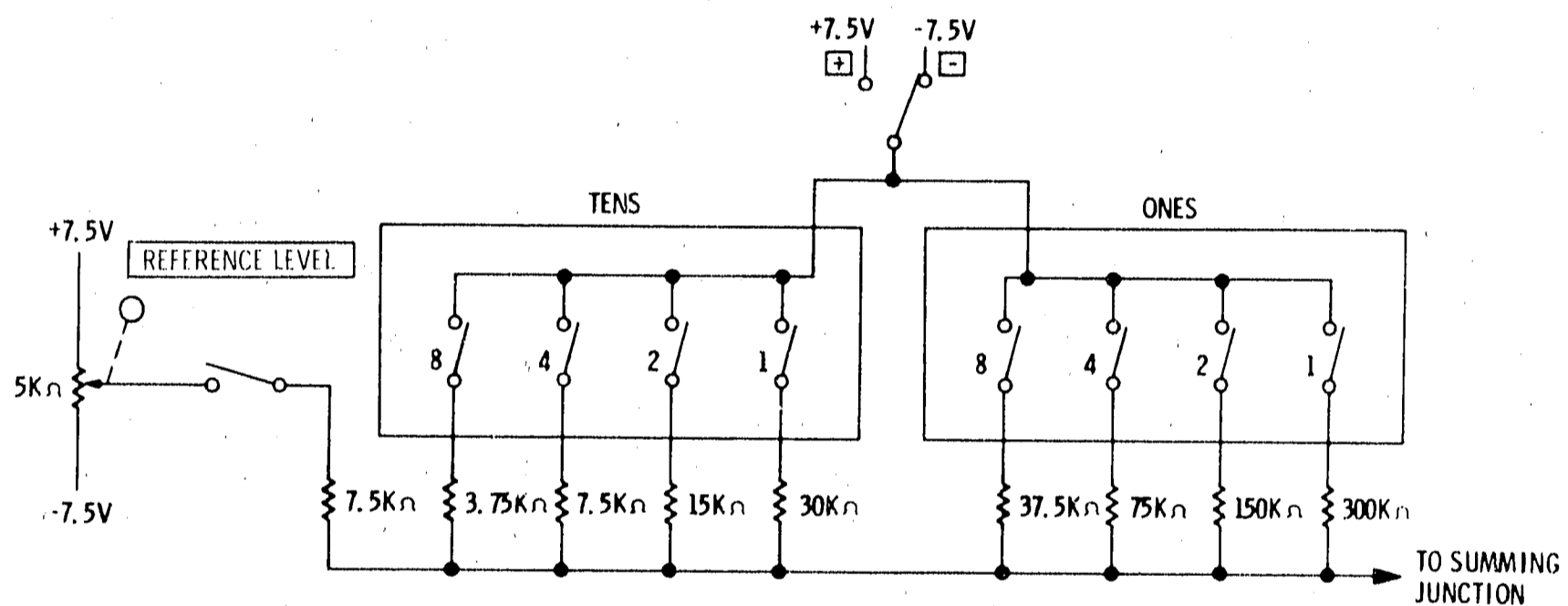

Figure 8-20. Reference Level Switch

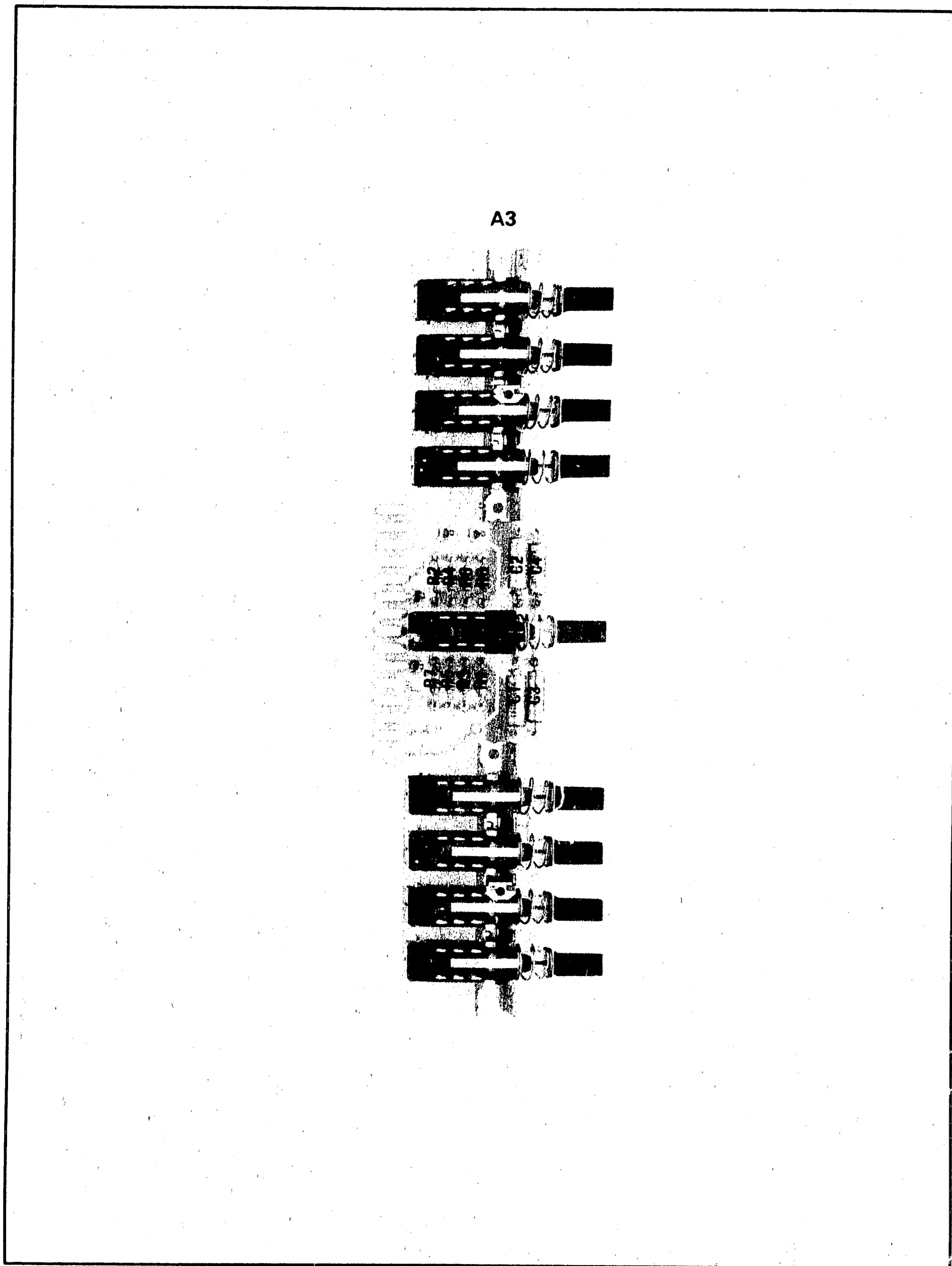

Figure 8-21. A3 dB/Division Switch, Parts Location

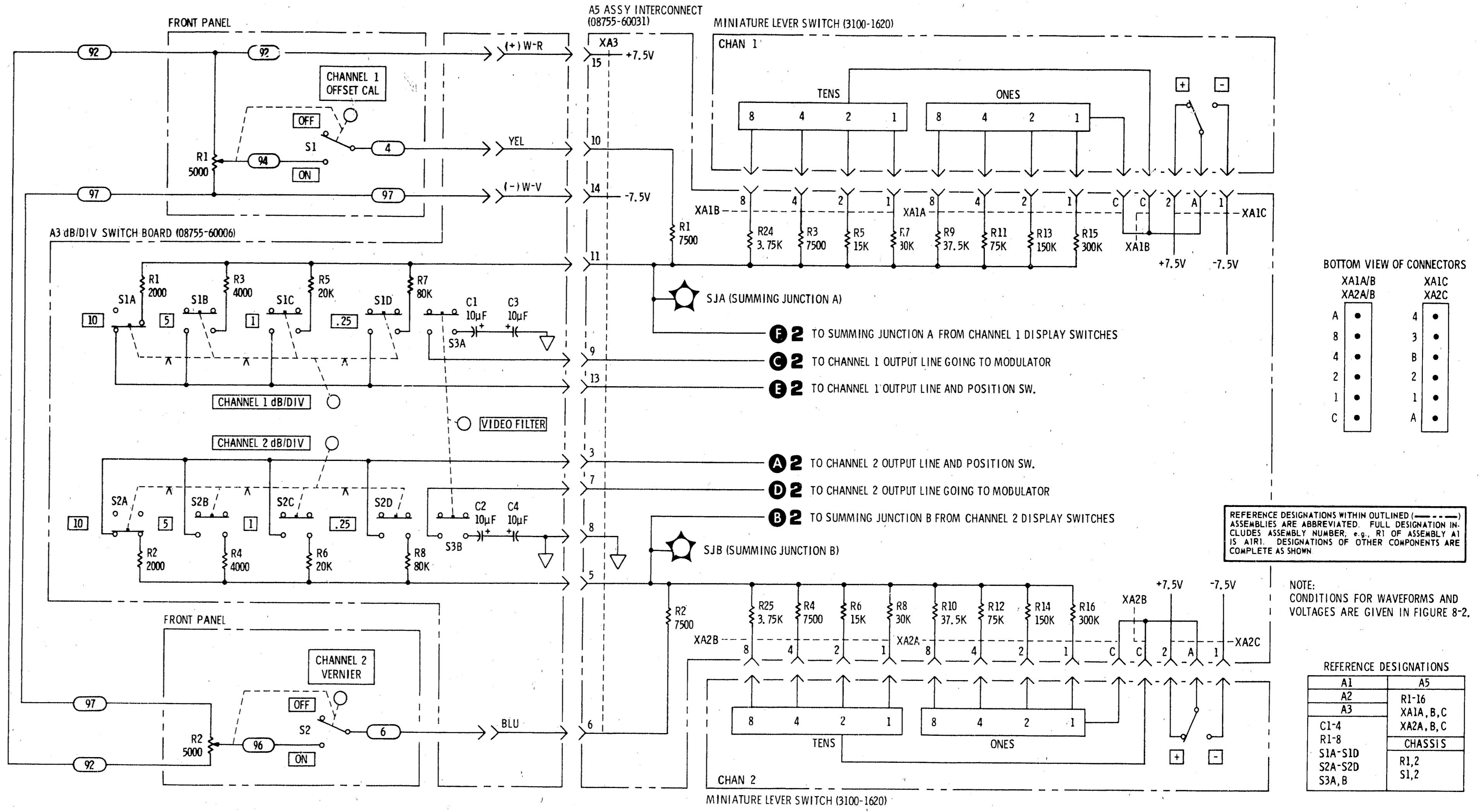

Figure 8-22. A3 dB/Division Switch and A1 and A2 Offset Switches, Schematic

3

A1, A2, A3, A5

SERVICE SHEET 4

CIRCUIT DESCRIPTION

111.2 kHz Oscillator

Q1 and Q2 form a 111.2 kHz ± 4 kHz oscillator (4 X 27.8 kHz). The frequency is determined by C1 and R5. Q13 is a buffer to prevent oscillator pulling. The oscillator output from the buffer is applied to the multiplex driver circuit which selects the display (Channel 1 only, Channel 1 only, or chopped) and to the modulator Dual-D Flip Flop which is a divide by 4 circuit to provide the 27.8 kHz modulation signal.

Chopper Blanking

The chopper blanking circuit blanks the display during the transition time in the chopped mode. It also will accept a -5V retrace blanking pulse from an 8690 Series Sweep Oscillator to blank the display during retrace. A modification to the 180 is required to route this input to the 8755B.

When dual or chopped mode is selected, the chopper circuit feeds a signal from the 111.2 kHz oscillator to TP11 through Q19. One output is taken from the emitter of Q19 and at the same time a signal of opposite polarity is taken from the collector. These two signals are differentiated in the chopper blanking circuit. A negative trigger is then developed for each transition of the input waveforms. Each negative trigger turns the blanker on which supplies a current pulse to the Model 180 Mainframe to blank the display during the transition time.

Q16 acts as a switch to send a negative pulse from an 8690 Series Sweep Oscillator to the blanker. For sweep oscillators with a positive blanking pulse, retrace blanking is connected directly from the sweep oscillator to the 180 Z-axis input.

Deflection Multiplex Driver

The Multiplex Driver turns the Deflection Multiplexer on and off to select the channel to be displayed.

Each front-panel DISPLAY pushbutton switch has two sections. One section of each switch selects a diode which is connected to ground. With no front panel DISPLAY pushbutton pressed, the Multiplex Driver input is open (High). With any DISPLAY pushbutton pressed, the Multiplex Driver input for the channel selected is grounded (Low). The following table can be used to determine if the Multiplex Driver is operating properly.

SERVICE SHEET 4 (cont'd)

Channel 1 (XA10-N)	Channel 2 (XA10-P)	U2B			U2A			U2D			TP11	CRT
		5	4	6	1	2	3	13	12	11		
H	H	H	L	H	H	H	L	L	□	H	H	Blanked
H	L	L	L	H	H	H	L	L	□	H	H	Ch. 2 Trace Only
L	H	H	H	L	L	H	H	H	□	L*	L	Ch. 1 Trace Only
L	L	L	H	□	L	H	H	H	□	□	□	Chopped Mode

□ = Squarewave

* = Affected by both sections B and D inputs

Deflection Multiplexer

Q18 is a current source for differential ampl. Q17 and Q20. A high (or positive) at TP11 turns Q20 on and Q17 off. When turned on, Q20 is a current source for the B channel differential amplifier Q15A and Q15B. A dc voltage from the position control is applied to the B channel diff-amp at TP10 and the B channel signal is applied at TP9. Each of the two outputs of this diff-amp are fed through a common base voltage amp, Q11 or Q12, and then through the emitter followers, Q4 and Q5 to the CRT deflection plates.

The position control is normally adjusted with no input at TP9. After adjusting the position control, a positive input at TP9 would result in a negative going voltage on the lower deflection plate. At the same time conduction through Q15B would decrease conduction through Q12 which would result in a positive going voltage on the upper deflection plate causing the CRT electron beam to deflect up. Because of the differential action of Q15A and Q15B, moving the position control with signal applied will cause the displayed trace to move; however, even though the base line is not visible, the magnitude between the displayed trace and the base line would remain the same.

When Q20 is turned off and Q17 is turned on, the action of the channel A circuits are the same as the corresponding circuits in channel B.

Divide by 4

The divide by four circuit in the 8755B is a dual "D" type flip-flop. In a "D" type flip-flop, a low at either the set or clear input will prevent the flip-flop from changing states. In this case these inputs are tied to +5 volts so the flip-flop is enabled at all times.

Each "D" type flip-flop will only change state when its input signal or trigger input goes negative. Therefore, each "D" type flip-flop is a divide by two circuit or the dual "D" flip-flop is a divide by four circuit.

SERVICE SHEET 4 (cont'd)

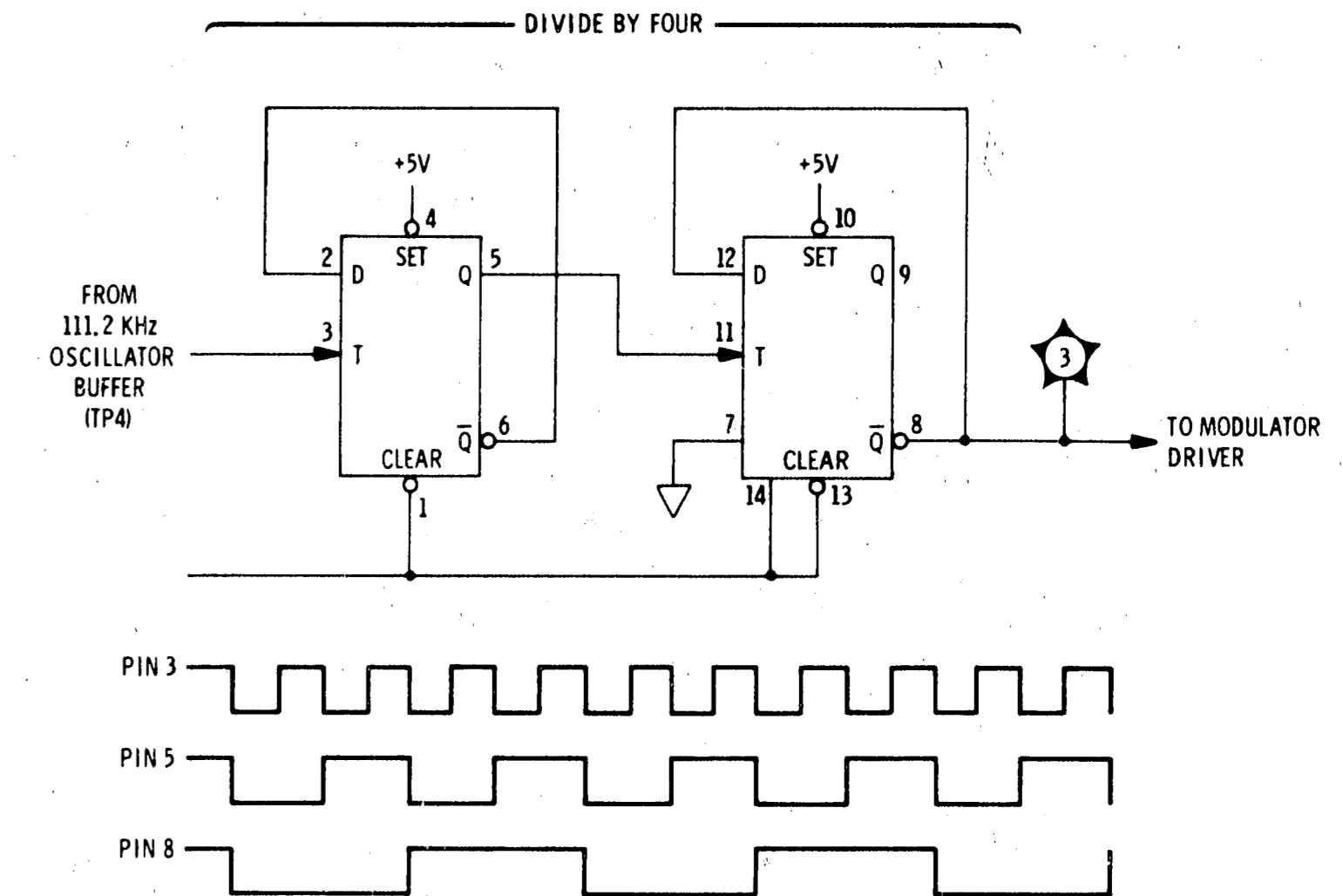

Figure 8-23. Dual "D" Flip-Flop

Modulator Driver

The output of the Dual "D" Flip-Flop is fed to a filter to increase the rise and decay time of the 27.8 kHz square wave. The signal is then applied to Differential Amplifier U3. The input to this IC is about 4V pk-pk and the output is about 12V pk-pk. The output is fed to a Darlington Pair, Q10 and Q8. The Darlington Pair and the output drivers Q6 and Q7 provide current gain to drive the modulator. The driver output is fed to the modulator through a coaxial cable which is floating. The current return path is through the shield of the coaxial cable. All of the current must return through this shield and the shield must not make contact with ground or ground loops may occur and reduce the instrument's dynamic range.

◀ **SERVICE SHEET 3**

Figure 8-22. A3 dB/Division Switch and A1 and A2 Offset Switches Schematic

SERVICE SHEET 5**A11 NORMALIZER INTERFACE****CIRCUIT DESCRIPTION**

The Normalizer Interface board provides interface between the 180 mainframe and the 8755B and permits the multiplexing of a remote vertical deflection signal from the 8750A Storage-Normalizer to the Deflection Multiplexer on the A10 Board of the 8755B. Because the 8750A delivers vertical deflection information serially (alternate sweep mode), only one channel of the 8755B is used to display both information channels when under Storage-Normalizer control.

Summing Amplifiers

Dual OP AMPL U2 sums the channel 1 vertical deflection voltage (500mV/div) to the voltage from the CHANNEL 1 REFERENCE POSITION control. The output of U2 is switched by U3 to the Deflection Multiplexer on the A10 board. The channel 2 deflection signal and REFERENCE POSITION voltage are summed by U1 and fed directly to the A10 board. The remote deflection information from the 8750A is fed to a x2 amplifier, U4A. Pins 2, 3, 6, and 7 of Analog Switch U3 form a SPDT switch on the channel 1 input of the Deflection Multiplexer. This switch is controlled by the 8750A via the NORMALIZE ENABLE line and will select either the output of U2 or U4A (the normalized signal). A low level applied to a control line (pin 8, 1, 16, or 9) of U3 closes the switch associated with that line.

Blanking and Marker Processing

When switch S1 is in the NEG Position, blanking from the 8690 series Sweep Oscillators (-4V blanked), applied to the AUX C input of the 180 mainframe, is routed to the blanking circuitry on the A10 Board. When S1 is in the POS position, blanking and intensity marker pulses from the 8620 series Sweep Oscillators enter the 180 mainframe through AUX C and are returned to the mainframe via the INT BLANKING line (P1 Pin 17). Analog Switch U3 is controlled by the Storage-Normalizer and will disable the blanking and marker signals going to the 180 mainframe when the 8755B is under 8750A control. Q1 and associated components detect negative-going marker pulses on the AUX C input. When the AUX C line goes negative, Q1 turns on and drives U3, connecting Pins 10 and 11 to supply +5V to the MARKER SENSE line (Pin 1 Pin 25) for Storage Normalizer use. The MARKER SENSE line is switched at S1 and connected to this supply voltage only when S1 is in the POS position.

Channel Control

Two lines from the front panel DISPLAY pushbuttons, CHANNEL 1 DISPLAY ON/OFF (P2 Pin N) and CHANNEL 2 DISPLAY ON/OFF (P2 Pin 12), indicate when a channel is turned off (all pushbuttons out). These lines control open-collector drivers Q2 and Q3, which provide this channel information to the 8750A. They are also gated with the NORMALIZE ENABLE line by U5 and U6 to produce control signals (CHANNEL 1 CONTROL and CHANNEL 2 CONTROL) for the Deflection Multiplexer on the A10 board of the 8755B. When an 8750A is not used, the NORMALIZE ENABLE line (P1 Pin 4) is held HIGH by R23 and the NAND gates U6A and U6C permit the CHANNEL 1 and CHANNEL 2 DISPLAY ON/OFF signals to pass unmodified through the A11 board. If an 8750A is used, the CHANNEL 1 and CHANNEL 2 CONTROL lines to the A10 board are held at LOW and HIGH, respectively, when stored trace is displayed (NORMALIZE ENABLE is taken low by the 8750A).

Horizontal Amplifier

U4B is a non-inverting buffer for the horizontal sweep voltage applied at AUX D on the 180 mainframe. The HORZ ADJ control (R24) and limiting resistor R25 set the full screen deflection sensitivity by establishing a maximum deflection current of about 3mA into J1 Pin 1 (INT SWEEP) with either a +10V and +15V sweep amplitude from the 8620 or 8690 series sweepers, respectively.

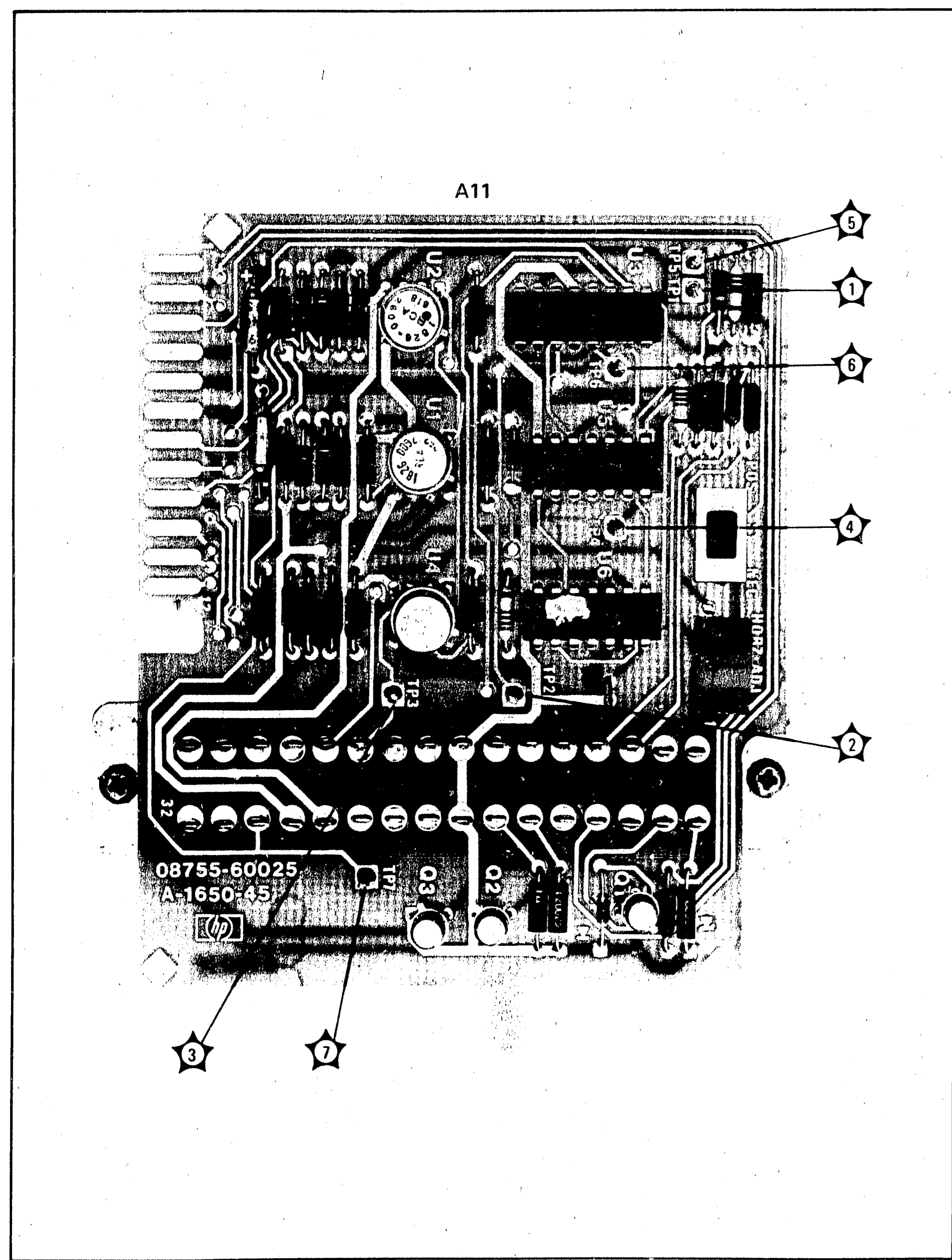

Figure 8-26. A11 Normalizer Interface, Parts Location

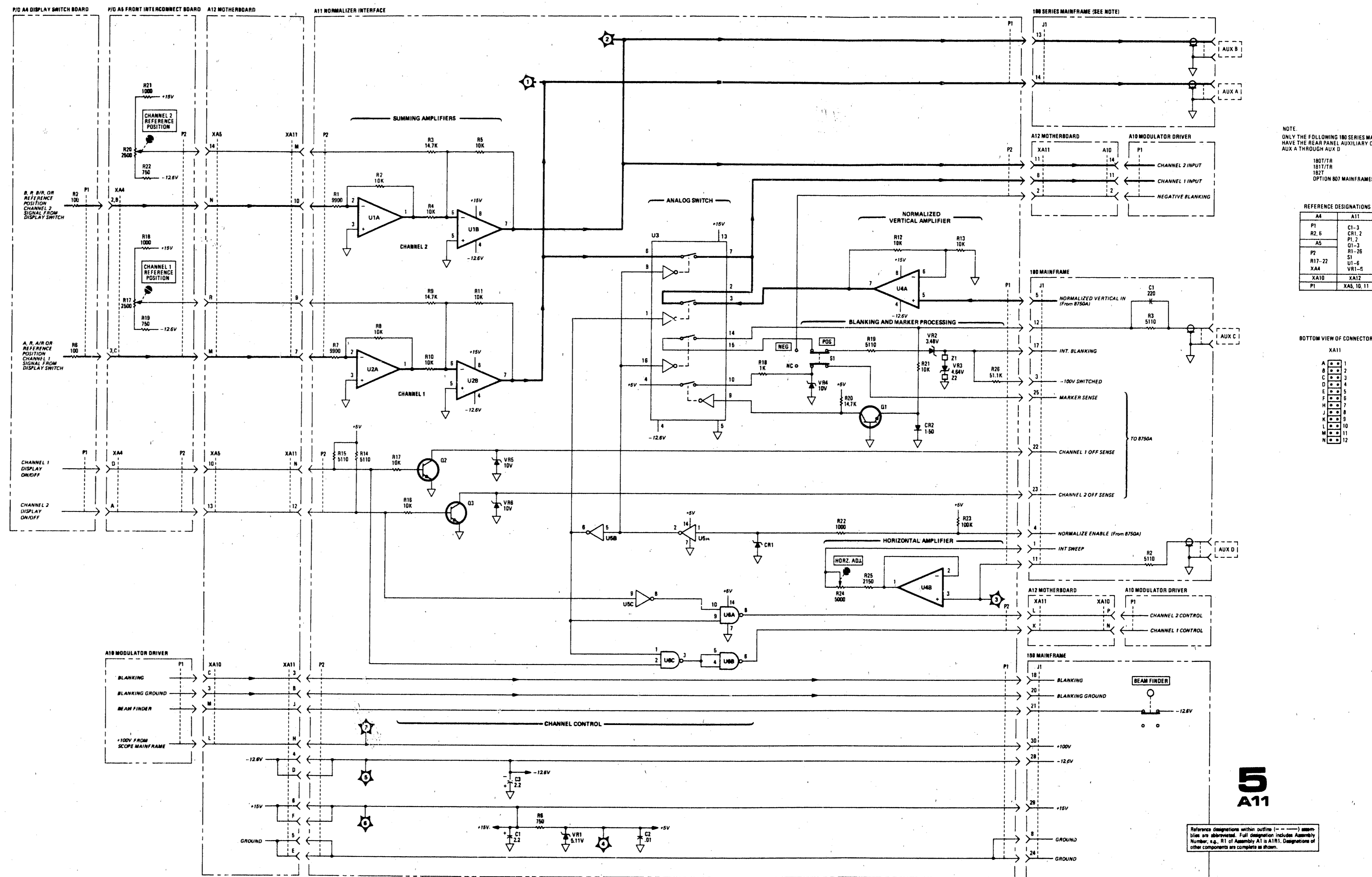

Figure 8-27. A11 Normalizer Interface, Schematic

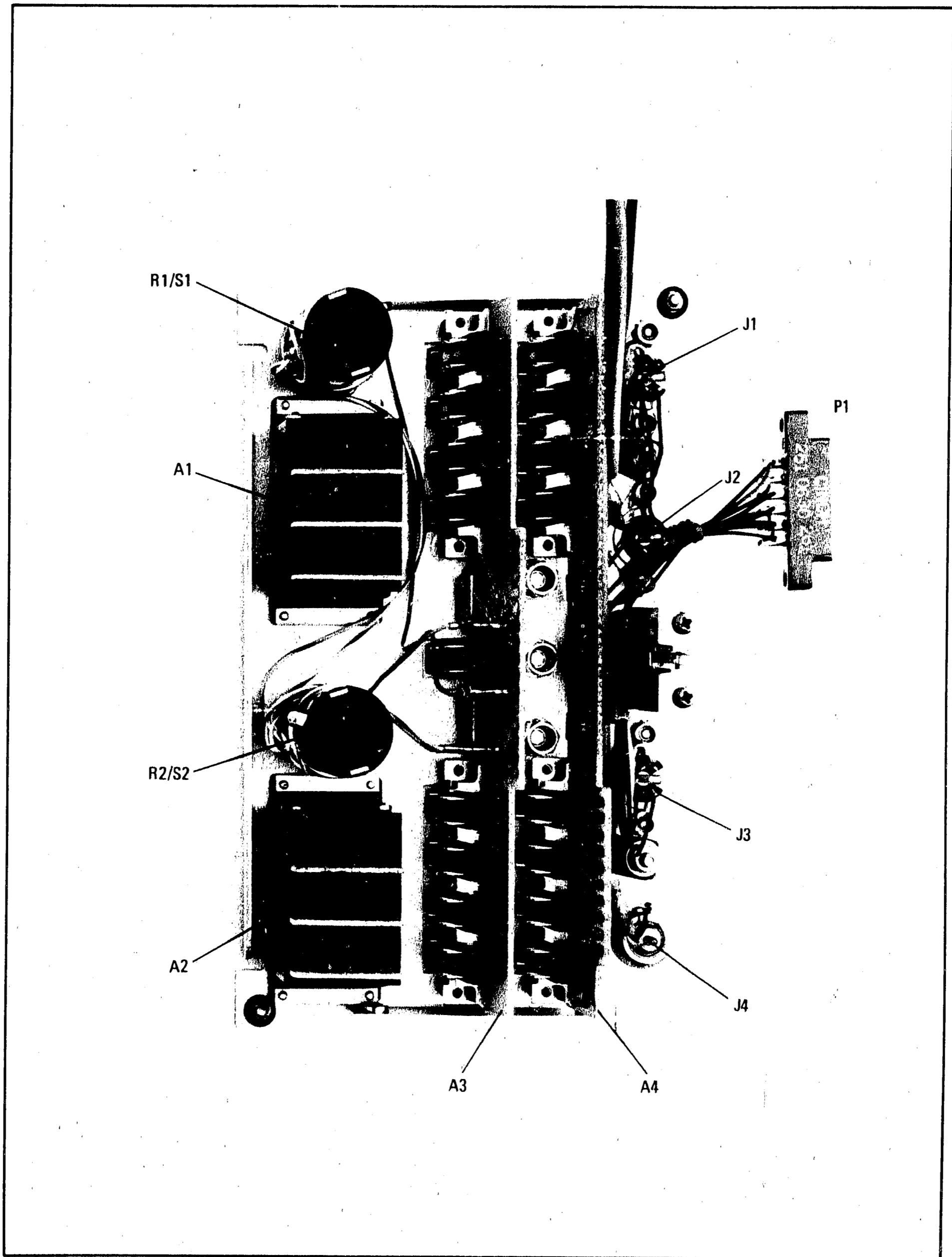

Figure 8-28. Front Panel, Parts Location

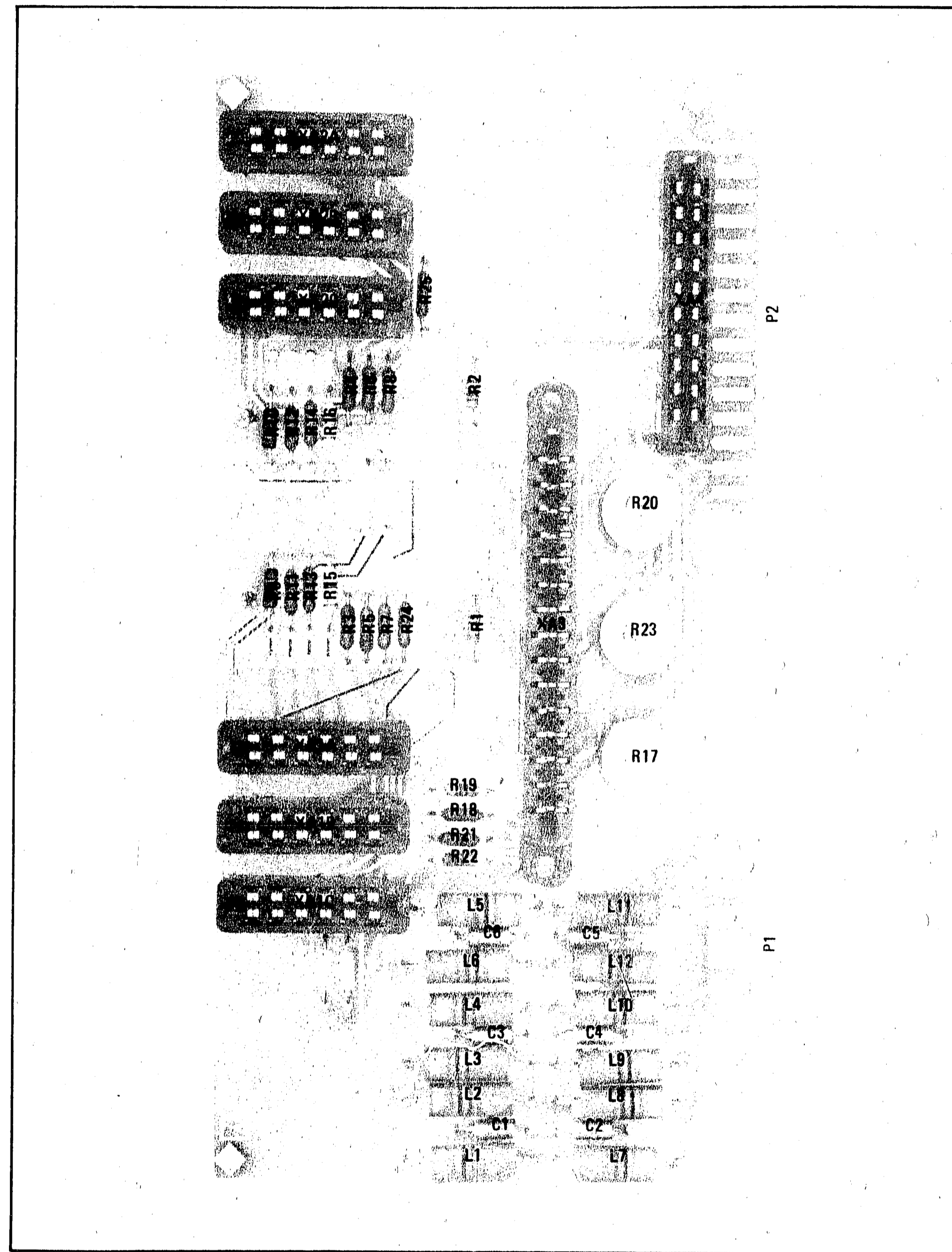

Figure 8-29. A5 Front Interconnect Parts Locations

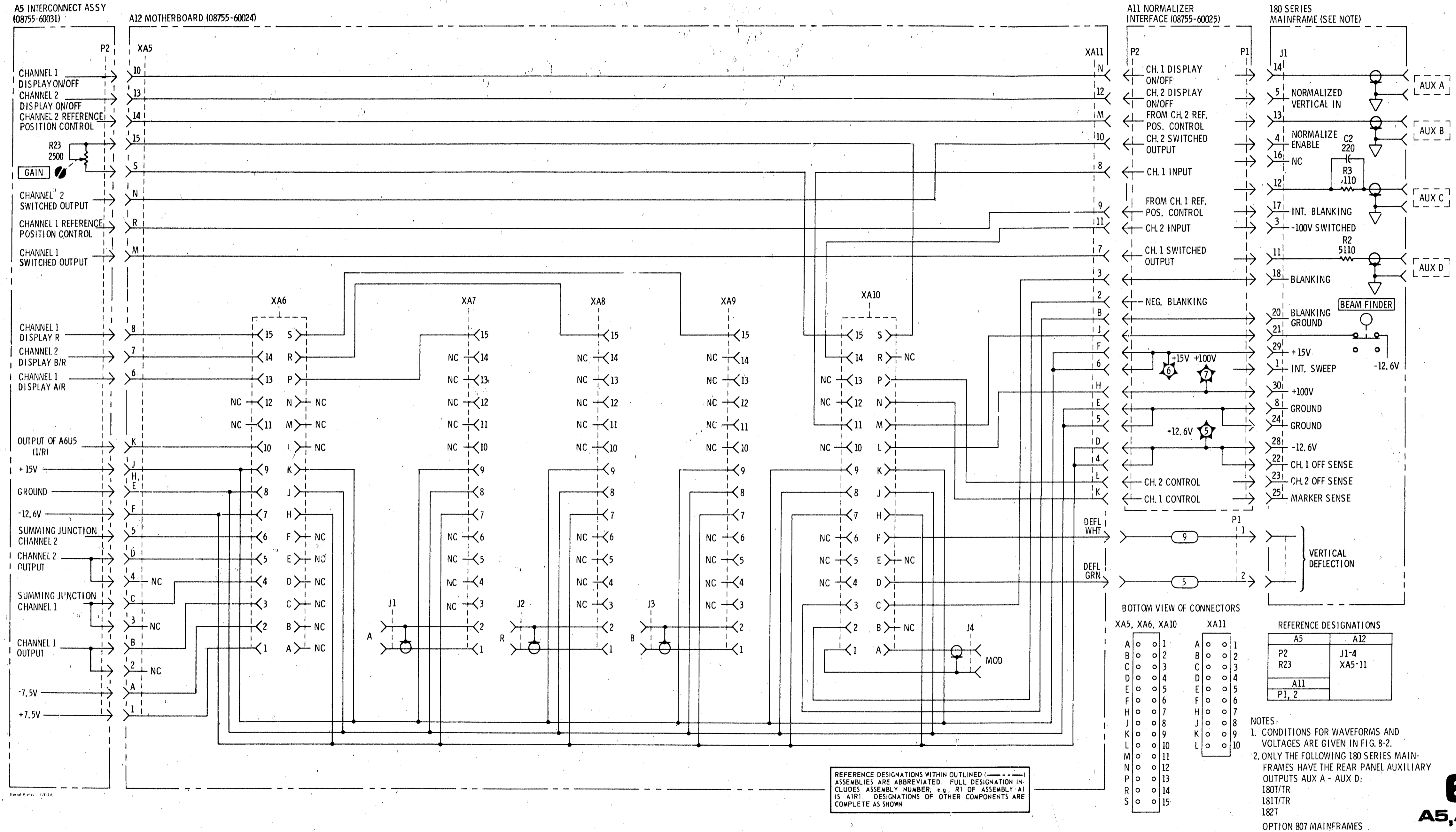
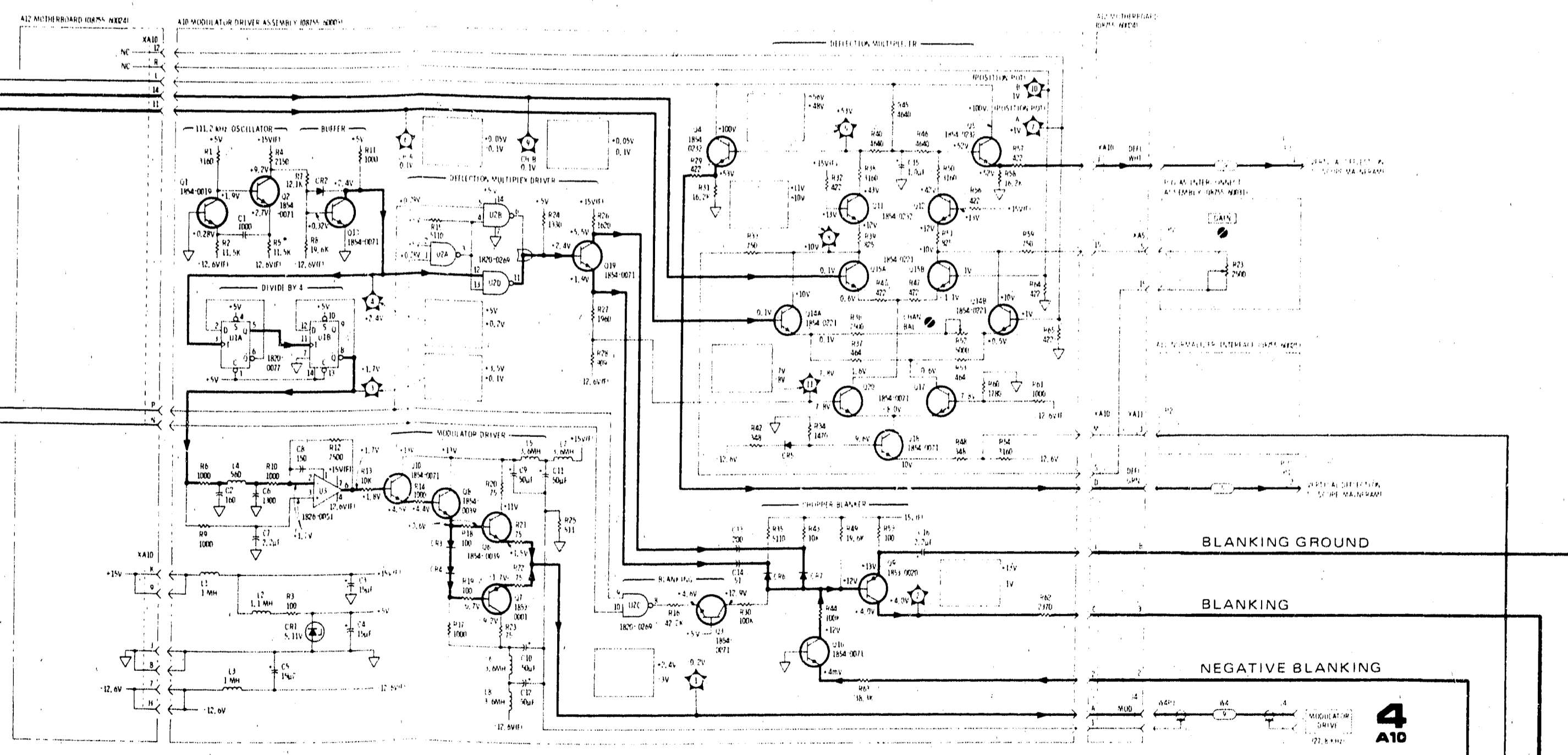
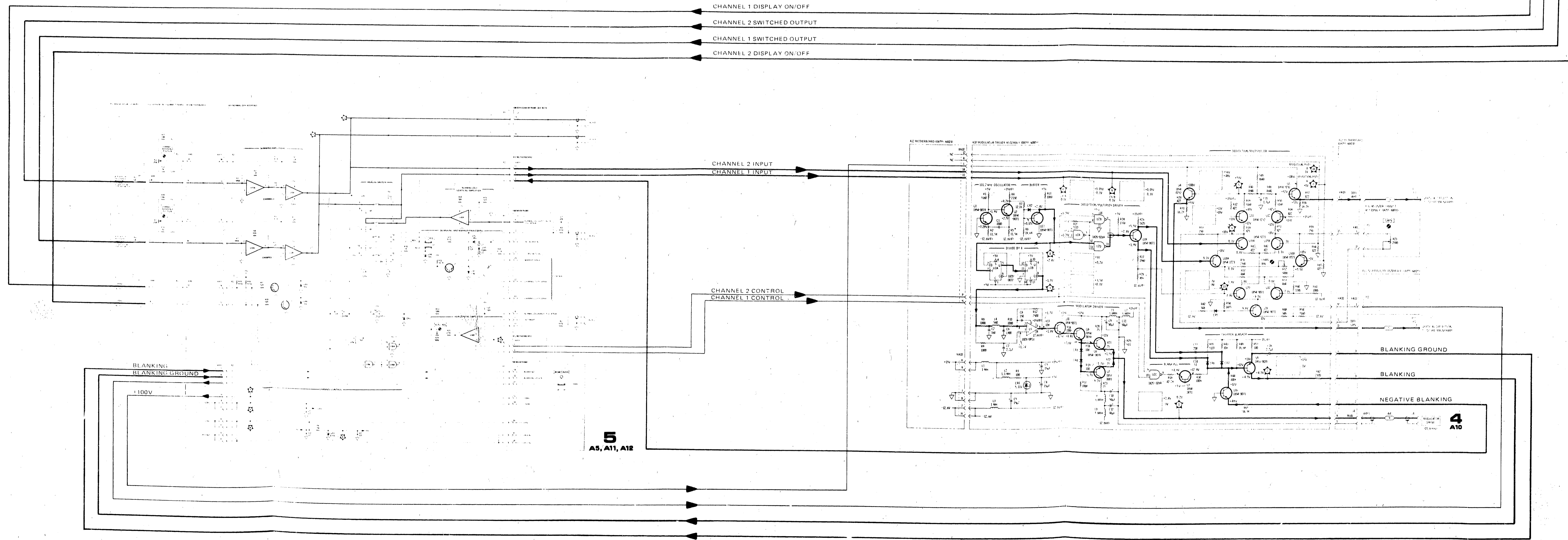
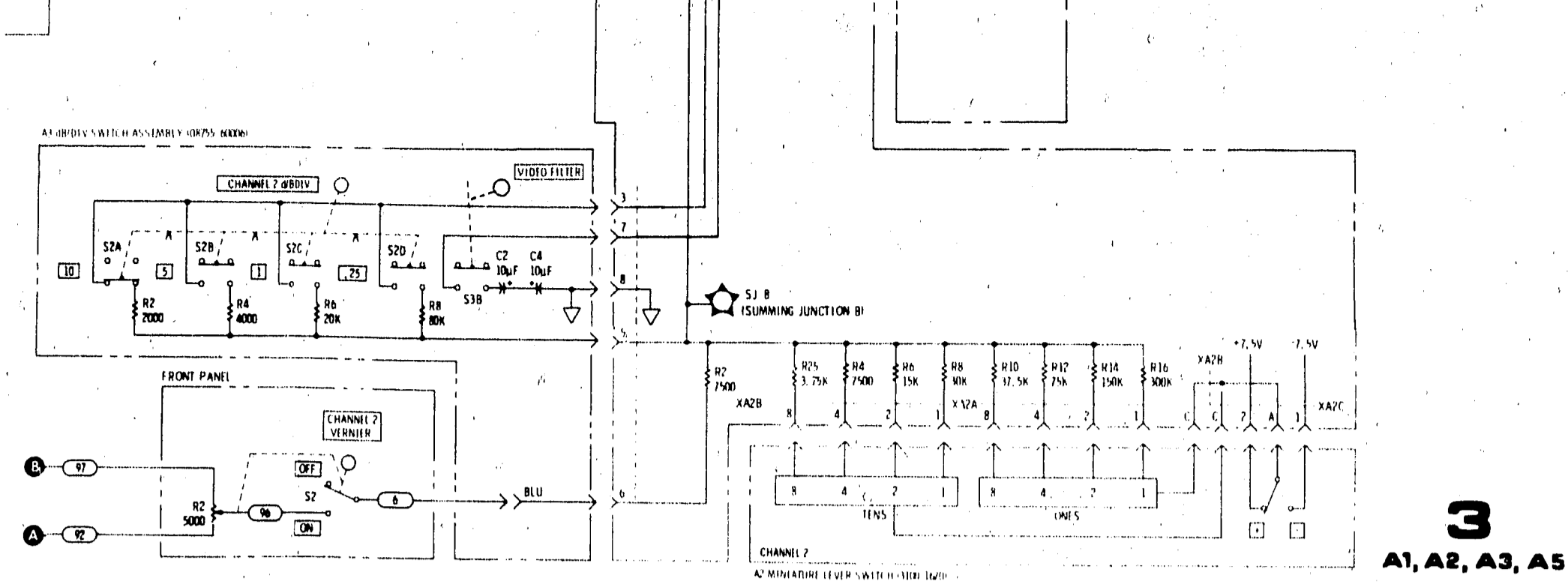
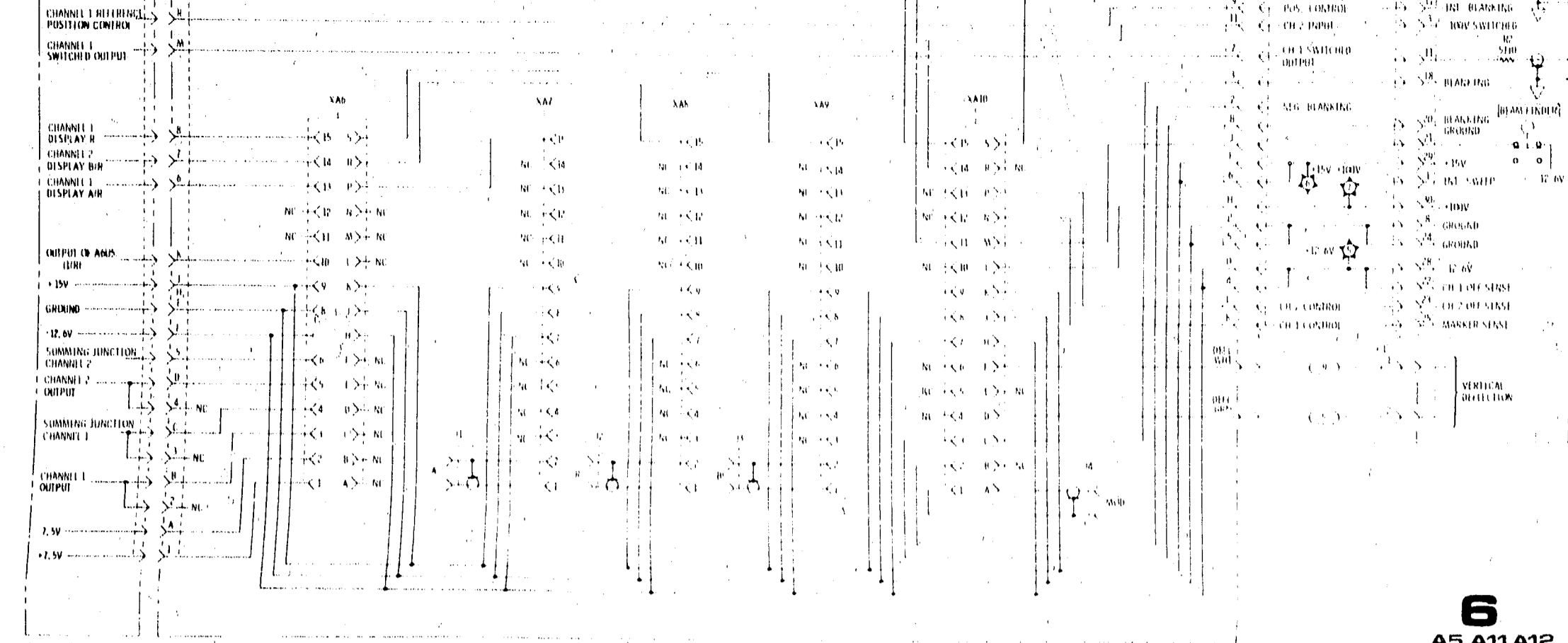

Figure 8-30. A12 Motherboard, A5 Interconnect Assembly, A11 Normalizer Interface, and Interconnection Diagram

SCHEMATIC DIAGRAMS



**HEWLETT-PACKARD
MODEL 8755B OVERALL SCHEMATIC
SWEEP AMPLITUDE ANALYZER
SERIAL PREFIX 1932A**

THIS DIAGRAM IS A SUPPLEMENT FOR THE MODEL 8755B OPERATING AND SERVICE MANUAL PRINTED MAY 1980. HP PART NUMBER 08755-90070.