

Errata

Document Title: Swept Frequency Techniques (AN 65)

Part Number: 5951-0065

Revision Date: August 1965

HP References in this Application Note

This application note may contain references to HP or Hewlett-Packard. Please note that Hewlett-Packard's former test and measurement, semiconductor products and chemical analysis businesses are now part of Agilent Technologies. We have made no changes to this application note copy. The HP XXXX referred to in this document is now the Agilent XXXX. For example, model number HP8648A is now model number Agilent 8648A.

About this Application Note

We've added this application note to the Agilent website in an effort to help you support your product. This manual provides the best information we could find. It may be incomplete or contain dated information, and the scan quality may not be ideal. If we find a better copy in the future, we will add it to the Agilent website.

Support for Your Product

Agilent no longer sells or supports this product. You will find any other available product information on the Agilent website:

www.agilent.com

Search for the model number of this product, and the resulting product page will guide you to any available information. Our service centers may be able to perform calibration if no repair parts are needed, but no other support from Agilent is available.

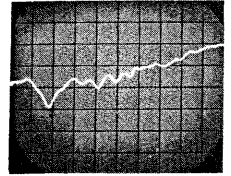

ATTENUATION

SWEPT FREQUENCY TECHNIQUES

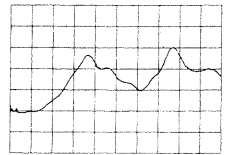

IMPEDANCE
REFLECTION
COEFFICIENT

APPLICATION NOTE 65

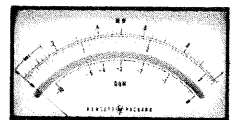

POWER

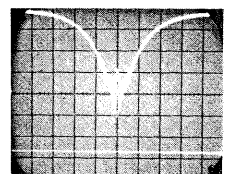

FREQUENCY



APPLICATION NOTE 65

SWEPT FREQUENCY
TECHNIQUES

HEWLETT-PACKARD COMPANY
1501 Page Mill Road, Palo Alto, California, U.S.A.
Cable "HEWPACK" Telephone (415) 326-7000

Printed: AUG 1965

TABLE OF CONTENTS

| | Page |
|---|------|
| INTRODUCTION | 1 |
| History | 1 |
| Basic Concepts | 2 |
| Leveled Systems | 6 |
| ATTENUATION. | 15 |
| General. | 15 |
| Measurements in Waveguide. | 15 |
| Waveguide System Accuracy. | 19 |
| Directivity Measurement | 20 |
| Measurements in Coax | 22 |
| Coaxial System Accuracy | 22 |
| IMPEDANCE. | 23 |
| General. | 23 |
| Measurements in Waveguide | 23 |
| X-Y Recording Reflection Tests | 26 |
| RF Pre-Insertion - X-Y Recorder Technique | 26 |
| Waveguide System Accuracy. | 27 |
| Measurements in Coax - 500 Mc to 8 Gc | 28 |
| Coaxial System Accuracy | 28 |
| Measurements in Coax - 8.2 to 12.4 Gc | 29 |
| Special Techniques | 29 |
| POWER | 31 |
| General. | 31 |
| Thermistor Mount Efficiency Testing | 31 |
| TWT Amplifier Gain Test | 33 |
| High Resolution Attenuation Tests | 33 |
| FREQUENCY | 37 |
| General. | 37 |
| Wavemeter Calibration. | 37 |
| System Accuracy | 39 |
| Cavity Q Measurements | 40 |
| NOISE FIGURE | 41 |

INTRODUCTION

The scope of microwave measurements now possible with swept-frequency techniques is an important consideration to the engineer and scientist. No matter which parameter he chooses to measure, there is a good chance swept methods can be applied for quickly obtaining accurate and complete data.

Knowing which applications are best served with swept techniques and implementing appropriate systems is a continuous challenge, since equipment and methods are constantly being improved. This Application Note describes recently developed systems and techniques that accomplish two major objectives:

1. Provide continuous broadband displays of microwave performance, enabling dynamic adjustments to test devices and speeding measurements, and
2. Eliminate or reduce errors in swept frequency measurements so that "double checking" with spot-frequency methods is unnecessary.

HISTORY

Since the introduction of the first broadband, high directivity directional coupler by Hewlett Packard ¹ there has been a continuous effort toward developing more efficient measuring systems using swept techniques. High directivity couplers were first used in fixed-frequency reflectometer systems ² where the forward and reverse signal levels were detected and noted on separate meters. The ratio of the two meter readings was then calculated to determine reflection coefficient (ρ) of devices in test. Then, in 1954, the hp model 670 Sweep Oscillator introduced a new dimension to microwave testing ³. This instrument produced a swept RF signal through the use of a motor-driven, mechanically tuned klystron. Another new instrument, the hp 416A Ratio Meter, automatically indicated the heretofore calculated ratio of forward to reverse signal level so complete broadband tests could be made in less than 30 seconds. HP Application Notes ⁴ described complete swept frequency systems for broadband reflection and attenuation tests using the newly developed instruments.

By 1957 the mechanically-tuned klystron gave way to the electronically-tuned Backward Wave Oscillator tube incorporated in the hp 680 Sweep Oscillator. The 680 lifted various source encumbrances such as klystron mode-switching and tracking, long sweep times, and the wear involved with mechanical tuning. Improved test methods such as the calibration grid-X-Y recorder techniques ⁵ helped overcome the combined effects of scalar errors produced by directional couplers, detectors, and ratio meter. As better methods were introduced, swept-frequency testing continued to assume importance as it replaced less efficient fixed-frequency reflection, gain, and attenuation tests.

Further development work at HP led to a completely new design of sweep oscillator; the 690A/B series. Introduced in 1963 ⁶, these newly designed "sweepers" were greatly enhanced by the experience gained over many years of swept-frequency testing in HP production lines. One of the most important new features of the 690 was its ability to level output power at any point in the RF circuit through the use of a feedback system and PIN diode attenuator. With forward power held constant as a function of frequency and/or load impedance variation, readout of only one signal level was required for transmission and reflection tests. Thus, a ratio meter was no longer required and faster

¹ HP Journal, Vol. 3, No. 7-8, March 1952

² HP Journal, Vol. 4, No. 5-6, January 1953

³ HP Journal, Vol. 6, No. 1-2, Sept. - Oct. 1954

⁴ HP Application Note 42

⁵ HP Application Note 54

⁶ HP Journal, Vol. 15, No. 4, December 1963

sweeps could be employed with convenient oscilloscope readout. To complement this new sweeper, crystal detectors of exceptionally flat frequency response and close square-law adherence were developed by HP for broadband detection.

More recent additions to the total swept frequency system concept pioneered by HP include the 1416A Swept Frequency Indicator plug-in for the hp 140A Oscilloscope. This unit is designed specifically to meet the readout needs of leveled swept-frequency systems. The newer 690C/D sweep oscillators shown in this Note are refinements of the 690A/B series. Operation of both series of instruments is the same however, so either may be used in the applications that follow.

The applications and equipment shown in this Note are representative of HP's continuous effort to develop not only individual parts, but complete measurement systems from source to readout for best total performance.

BASIC CONCEPTS

Several basic concepts are common to all swept measurements shown in this Note. A discussion of these concepts may suggest methods in which systems can be varied to suit other applications. In each system, three basic functions are performed:

1. Signal generation
2. Detection
3. Readout

Signal Generation. Producing a swept RF signal is just one of many requirements placed on the source in modern swept-frequency systems. Improved accuracy and convenience depends largely on a number of important contributions made by the hp 690C/D sweep oscillators. Major improvements over other sources include:

- a. Ability to level power in the external circuit for achieving good source match.
- b. Accurate sweep and marker frequency calibration with linear sweeps in both leveled and unleveled operation.
- c. Clean RF signals that are low in spurious and residual output.
- d. Straightforward control functions that simplify overall system calibration.
- e. Frequency and amplitude stability when various conditions are changed such as sweep width and rate, line voltage, load impedance, or output power.

The hp 690C/D generates swept RF signals in 1.5:1 and 2:1 frequency bands from 500 Mc to 40 Gc using a backward wave oscillator (BWO) and its associated circuits. The 690D series, available in bands from 1 Gc to 12.4 Gc, contain PIN diode attenuators for amplitude modulating and/or leveling the RF output. The PIN line absorbs RF power out of the BWO proportional to an applied DC bias voltage or modulating signal. Since the BWO grid-cathode voltage is not varied for modulation or leveling, excellent amplitude and frequency stability is achieved with freedom from incidental FM.

The 690C series of grid-cathode modulated sweepers cover the entire 500 Mc - 40 Gc spectrum and are used in the bands above 12.4 Gc where PIN lines are not available or in lower bands where modulation requirements are less demanding. All other functions operate the same as the D series.

All 690C/D sweepers contain an automatic leveling circuit (ALC) consisting of a DC amplifier whose output is connected to the PIN line or BWO grid-cathode circuit. The ALC input is a DC feedback voltage derived from either a crystal detector or a power meter monitoring the RF level at some point in the measurement system. In a basic leveling system, as shown in Figure 1, the feedback loop is arranged so forward power is held constant with frequency and load impedance variation. The leveling amplifier has a differential input with an adjustable reference voltage that sets the operating power level. Increasing this voltage calls for more detector voltage, hence more RF output to satisfy the leveler amplifier. The overall loop gain of the ALC system is adjusted

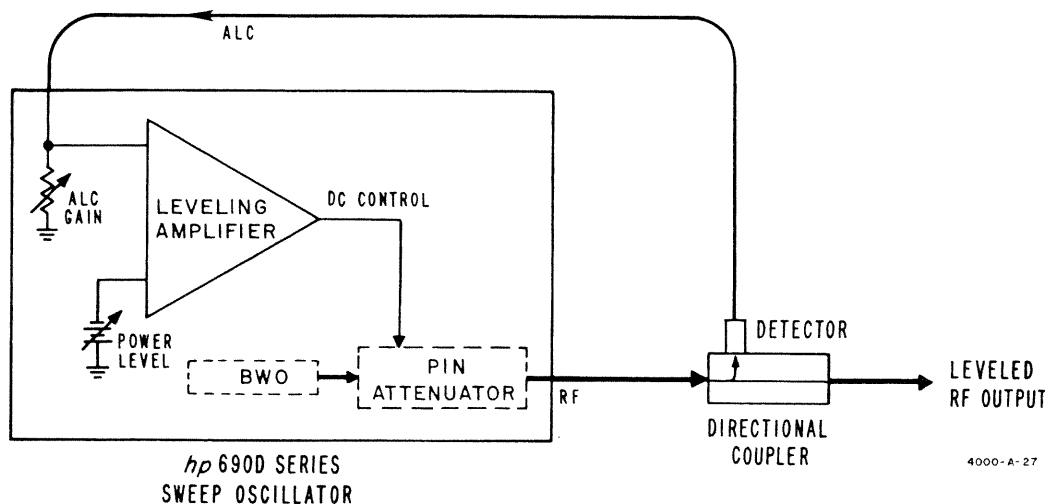

Figure 1. Basic leveling circuit for hp sweep oscillators using internal PIN diode attenuator. DC control voltage is fed to BWO grid-cathode circuit instead of a PIN attenuator in 690C series. Detector can be either crystal type or temperature-compensated thermistor with power meter (hp 431B).

by a variable resistance at the other input to the differential amplifier. Increasing the gain control increases negative feedback, reducing power peaks, and improving leveling. Excessive gain causes the feedback loop to be unstable and oscillations can occur.

Reflections from connectors, cables, etc. within the leveling loop are compensated by the ALC system so that ideally, source mismatch is cancelled and system accuracy improved.

Another advantage to closed loop leveling (in conjunction with flat frequency response in detectors) is that readout calibration remains constant with frequency eliminating need for ratio meters and grease pencil markings. Remote programming of power level and special leveling configurations can also be employed making this feature indispensable for swept measurements. All 690C/D sweep oscillators provide flexible sweep modes and convenient operation as summarized in Figure 2.

Detection. Detection for leveling and readout of data is accomplished by either crystal detectors or temperature compensated power meters. When fast sweeps with oscilloscope readout is desired, the hp 423A coax or 424A-series waveguide crystal detectors are used for ALC and readout detection. Where good square-law characteristics are required over a large dynamic range, these detectors are used with their matching square-law load resistor (option 02). Improved accuracy and convenience made possible by the hp 423A and 424A-series crystal detectors include:

- a. Flat frequency response
- b. Low reflection coefficient over the full band
- c. High sensitivity
- d. Good square-law response

When the option 02 load is used with the 423A or 424A, sensitivity is $0.1\text{mv}/\mu\text{w}$ of applied RF. Deviation from square law is less than ± 0.5 db from low level up to 50 mv out of the detector/load combination (approximately -3 dbm of RF input). This configuration gives maximum square-law dynamic range and is used extensively for readout detection in the swept systems in this Note. Without the option 02 load, the 423A or 424A sensitivity increases to $0.4\text{mv}/\mu\text{w}$ of applied RF. Good square-law performance without the option 02 load, can be expected up to about -20 dbm. In certain applications where low source power is a problem, the unloaded crystal may be preferred for its higher sensitivity and good square-law range below -20 dbm. ALC detectors need not be loaded since they operate at a constant power level within the feedback loop and square-law dynamic range is not required. Good frequency response and low reflection, however,

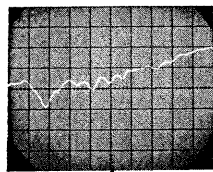

START/STOP sweep limits indicated by large slide rule dial for broadband tests.

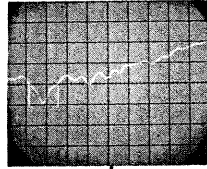

DIGITAL MARKERS identify frequencies and bands of special interest.

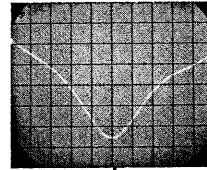

MARKER SWEEP selects sweep limits set up by markers for magnified frequency displays.

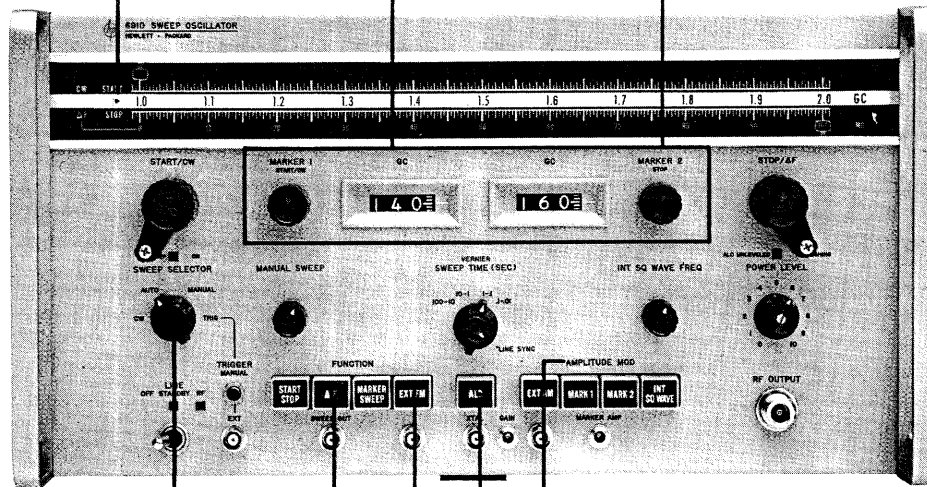

PIN ATTENUATOR in 690D series for modulating and/or leveling without incidental FM or frequency shift.

AUTOMATIC LEVELING CIRCUIT for constant output power independent of frequency or load impedance.

EXT FM for remote frequency programming and special FM tests.

ΔF for calibrated narrow band symmetrical sweeps for FM tests.

VERSATILE SWEEP MODES for automatic, manual, or triggered operation.

4000-A-27

Figure 2. Flexibility and accuracy of hp 690-series sweep oscillators increases their usefulness for all swept applications. Oscilloscope displays illustrate simplicity of system readout when hp sweeper and auxiliary equipment is used.

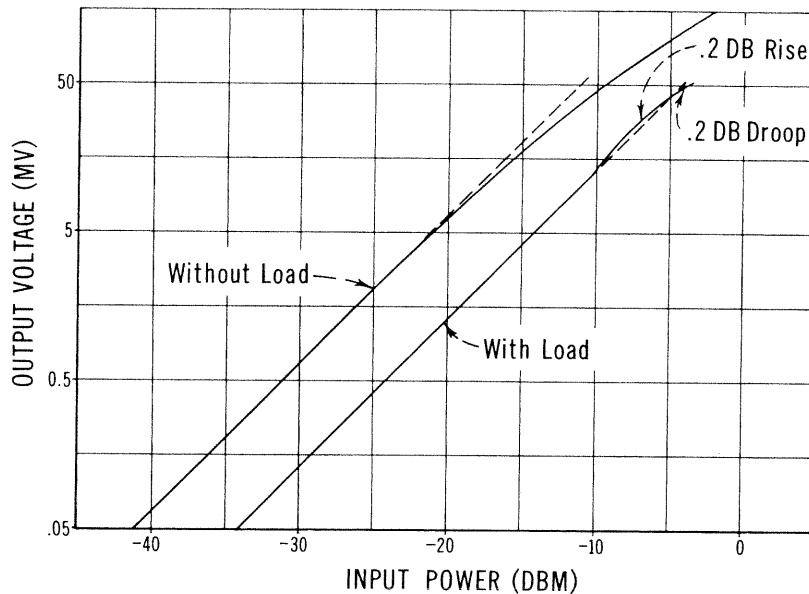

Figure 3. Square-law response of typical Model 423A or 424A Detector with and without matched square-law load resistor (option 02).

remain important considerations for the ALC detector. Figure 3 shows the square-law characteristics and sensitivity of 423A and 424A detectors for loaded and unloaded conditions.

Where knowledge of absolute power level is required, the hp 431B power meter and 478A coax or 486A waveguide series of temperature compensated thermistor mounts are used for ALC or readout detection. Longer sweep time is required with power meter detection so an X-Y recorder readout is used instead of an oscilloscope. A dc current proportional to the 431B meter deflection (RECORDER OUTPUT) is used for ALC or recording purposes. The thermistor mount/Power Meter combination is a good square-law detector, has good broadband impedance characteristics and is compensated to reduce thermal drift by a factor of 100:1 over uncompensated types.

Readout. One of the most important advantages made possible by source and detector improvements is the continuous display of data on an oscilloscope. Because sweeper power is leveled, a ratiometer is not necessary for reflection and attenuation tests. By eliminating the ratiometer, with its narrow band audio amplifier, faster sweeps without AM are possible (when crystal leveling). Now a dc voltage out of the detector, proportional to RF level, can be displayed on an oscilloscope as a function of frequency. The rapid sweeps eliminate flicker yet the detector response time is fast enough to faithfully reveal even sharp discontinuities or attenuation changes in test devices.

The hp 140A Oscilloscope with 1416A Swept Frequency Indicator plug-in shown in Figure 4, is designed specifically for leveled swept frequency measurements, providing direct readout in db/cm through the use of a logarithmic vertical amplifier. The log amplifier provides calibrated sensitivities from 10 db/cm to 0.5 db/cm for high resolution of attenuation or return loss (ρ). The log amplifier is designed to operate directly from square-law loaded 423A or 424A crystal detectors over their 30 db square-law range from 50 mv down to low level. Features such as the retrace blanking input and adjustable amplifier bandwidth speed measurements and minimize readout error. For added versatility, the vertical input may be switched from logarithmic operation to linear, providing calibrated vertical sensitivities from 10 mv/cm to 50 μ v/cm when db readout is not desired.

Provision is made on the 1416A for fast calibration and operation with an X-Y recorder if desired. A dc calibrating voltage out of the 1416A provides 0, -10, -20 and -30 db reference levels for calibrating the X-Y recorder vertical span to linear graph paper.

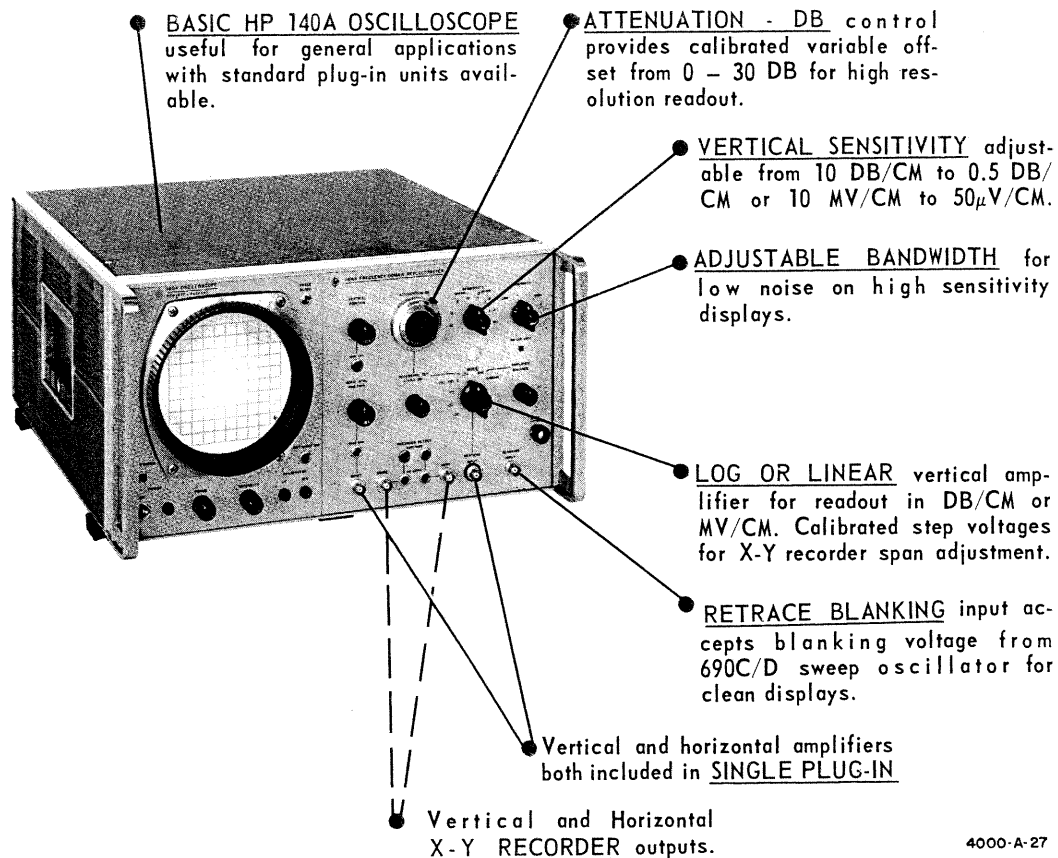

Figure 4. HP 140A Oscilloscope with 1416A Swept-Frequency Indicator simplifies swept attenuation and reflection tests - providing 30 db dynamic range and high resolution (up to 0.5 db/cm).

With leveled source power and good square-law response in the readout detector, direct correlation exists between the calibrating voltage and actual test voltages thus eliminating the need for plotting a calibration grid on the recorder. Readout is thus directly in db/division on the graph paper over a 30 db dynamic range. The 1416A horizontal amplifier accepts the dc sweep voltage from the 690C/D and has variable gain for setting overall display width.

Direct readout on conventional high gain dc oscilloscopes is also possible over a 10 db dynamic range using the transparent CRT scales supplied with this Note. Total attenuation (or return loss) range may be increased from 10 db to about 24 db with the oscilloscope's calibrated vertical sensitivity control. The hp 140A Oscilloscope with 1400A and 1420A plug-in units, or the hp 130C Oscilloscope are suitable alternates to the 140A/1416A that provide 20 to 24 db total range. Note there are two sets of SWR and attenuation scales printed on the transparent foil. One set is for direct viewing of standard oscilloscope displays. The other set is calibrated for photographing oscilloscope displays on internal graticule CRT's. Instructions for using the scales are included in the attenuation and impedance applications described later.

X-Y recording using an RF pre-insertion technique and tuned audio amplifier is required in a few applications where signal levels are very low. This technique is described in the Attenuation Section for measuring directional coupler directivities over 40 db.

LEVELED SYSTEMS

Crystal Leveling in Coax and Waveguide. With the basic operation of the leveling loop of Figure 1 now in mind, we can turn to specific leveling configurations. Figure 5 shows the equipment set-up for obtaining leveled swept frequency signals in coax from 500 Mc

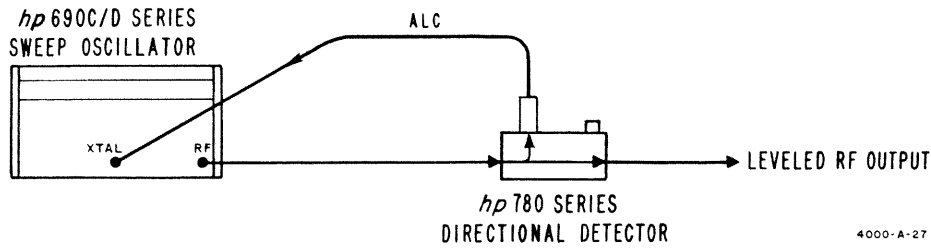

| INSTRUMENT | FREQUENCY - GC | | | | |
|--|---|---------------|---------------|---------------|---------------|
| | 0.5 - 1.0 | 1 - 2 | 2 - 4 | 4 - 8 | 8 - 12.4 |
| Sweep Oscillator | H10-691C | 691C/D | 692C/D | 693C/D | 694C/D |
| Directional Detector | Narda 3041-10 with hp 423A Crystal Detector | 786D | 787D | 788C | 789C |
| Leveled Power Available - mw \geq | 40 | 100/70 | 70/40 | 30/15 | 40/25 |
| Leveled Power Variation* (db) | $\pm 0.5/0.4$ | $\pm 0.4/0.3$ | $\pm 0.4/0.3$ | $\pm 0.5/0.4$ | $\pm 0.7/0.6$ |
| * Maximum variation includes directional detector frequency response, ALC amplifier and measurement ambiguity. Typical variation is considerably less. | | | | | |

Figure 5. System for obtaining crystal leveled sweep oscillator output in coaxial (type N) transmission line, 500 Mc to 12.4 Gc. All systems from 1 to 12.4 Gc use hp 780 series directional detectors comprising a directional coupler and crystal detector matched for flat frequency response.

to 12.4 Gc. The ALC feedback voltage is derived from the hp 780-series directional detector in all but the lowest frequency band. The directional detector consists of a directional coupler with a crystal detector mounted directly on the secondary arm. While a separate directional coupler and crystal detector may be used, tighter correlation between output power and detector voltage is achieved by combining the two in a single integrated unit.⁷ The equipment required for each band, along with the maximum leveled power available and leveling variation, is shown in the table of Figure 5.

Coaxial reflectometers described later in the Impedance Section of this Note utilize a dual directional coupler and two separate detectors instead of a directional detector. In this case, the frequency response characteristics of the coupler's forward arm is essentially the same as the reverse arm and the net variation in the readout is small. See "Measurements in Coax - 500 Mc to 8 Gc" in the IMPEDANCE Section.

Figure 6 shows a super-leveled waveguide system for obtaining constant power from 2.6 to 40 Gc. As in the coax system of Figure 5, crystal detection is used to derive the ALC feedback voltage. In this system a 3 db directional coupler and secondary arm termination are placed between the 10 db directional coupler and ALC detector. The inverse coupling characteristics of the 3 db coupler main arm compensates for coupling variations of the 10 db coupler auxiliary arm. The net result is cancellation of coupling variations that would otherwise affect the leveling loop and output power.

⁷ HP Journal Vol. 16, No. 6, February 1965

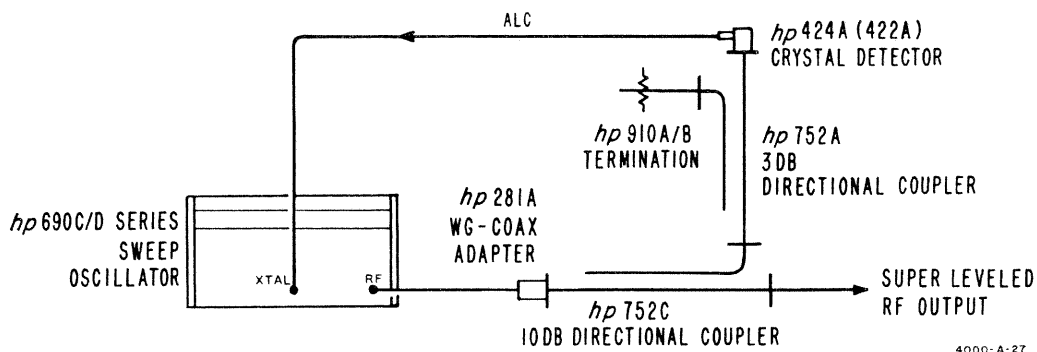

| INSTRUMENT | BAND (FREQUENCY - GC) | | | | | | | | | |
|---|-----------------------|--------------------|---------------|---------------|---------------|---------------|-----------|-----------|------------|-----------|
| | S | G | J | H | X | M | P | K | R | |
| | 2.6 - 3.95 | 3.95 - 5.85 | 5.3 - 8.2 | 7.05 - 10 | 8.2 - 12.4 | 10 - 15 | 12.4 - 18 | 18 - 26.5 | 26.5 - 40 | |
| Sweep Oscillator | 692C/D | 693C/D H01-693D | | 693C/D | 694C/D | 694C/D | H09-695C | 695C | 696C | 697C |
| Waveguide-to-Coax Adapter | S281A | G281A | J281A | H281A | --- | none required | | | | |
| 10-db Directional Coupler | S752C | G752C | J752C | H752C | X781A* | M752C | P752C | K752C | R752C | |
| 3-db Directional Coupler | S752A | G752A | J752A | H752A | --- | M752A | P752A | K752A | R752A | |
| Waveguide Termination | S910A | G910A | J910A | H910A | --- | M914A | P910A | K914B | R914B | |
| Crystal Detector | S424A | G424A | J424A | H424A | --- | M424A | P424A | K422A | R422A | |
| Leveled Power Available - mw \geq | 70/40 | 30/15 5 | | 30/15 | 40/25 | 40/25 | 10 | 40 | 10 | 5 |
| Leveled Power** Variation (db - approx) | $\pm 0.7/0.6$ | $\pm 0.7/0.6$ | $\pm 0.7/0.6$ | $\pm 0.7/0.6$ | $\pm 0.7/0.6$ | $\pm 0.7/0.6$ | ± 1.1 | ± 1.1 | ± 2.75 | ± 2.8 |

* HP X781A Directional Detector eliminates need for separate components in leveling loop.

** Includes effects of coupling variation, detector response, detector/coupler mismatch and ALC amplifier. Typical variation is less than indicated because errors do not add arithmetically. Complete leveled systems may be special-ordered from Hewlett-Packard to meet specific leveling requirements.

Figure 6. Super-leveled sweep oscillator systems for waveguide, 2.6 to 40 Gc using crystal ALC detector. Two coupler arrangement shown results in mutual compensation of coupling variation with frequency improving leveled performance.

Note from the equipment table, an hp model X781A directional detector is available which replaces all leveling components of Figure 6 external to the sweep oscillator. The coupling mechanism of the X781A consists of a 10 db directional coupler with a 3 db directional coupler and load compensating the auxiliary arm in a compact configuration. The crystal detector is an integral part of the X781A, providing an overall frequency response of ± 0.5 db or better. The waveguide reflectometers described later do not use the super-leveled setup because forward and reverse coupler characteristics are nearly the same. This results in mutual compensation and flat response in the readout display. The leveling adjustment procedure however, is the same for both the super-leveled source, and the leveled reflectometer.

Crystal Leveling Instructions. Because the ALC system utilizes a feedback amplifier, the circuit must be properly adjusted to the leveling components for maximum gain without oscillations in the feedback loop. If loop gain is too low, the leveling circuit will be ineffective as shown by the power variations in Figure 7(a).

If loop gain is too high, the system will become unstable and oscillations such as shown in Figure 7(b) will occur. Improper operation of the ALC loop can be readily observed in measuring systems using oscilloscope readout.

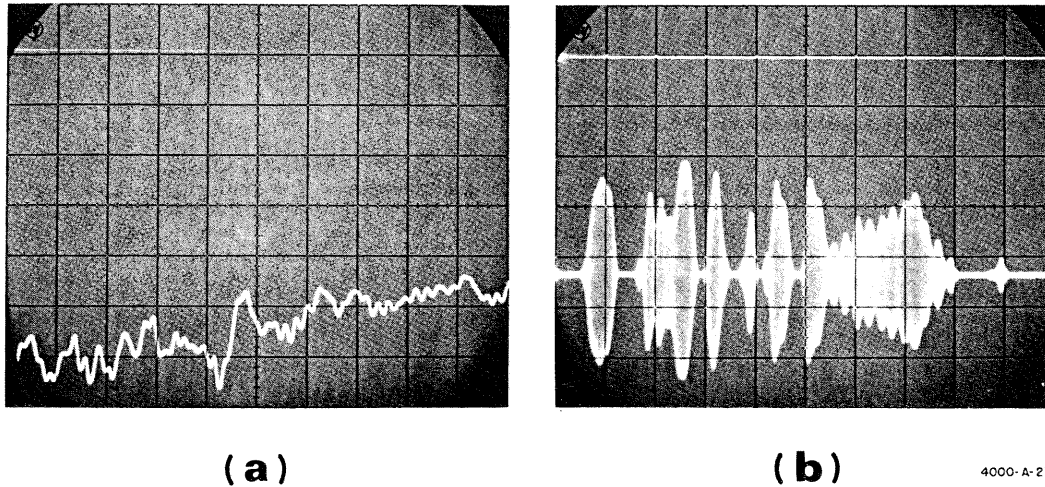

4000-A-27

Figure 7. Oscilloscope patterns for (a) insufficient ALC gain - power output unlevelled (b) excessive ALC gain for power level setting; oscillations occur in ALC feedback loop.

When other types of readout are being used, (e. g. X-Y Recorder) connect an oscilloscope to the 690C/D rear panel jack marked POWER METER. Connect the oscilloscope horizontal input to the SWEEP output on the 690C/D front panel. Proceed as follows:

1. Setup controls for an automatic rapid sweep over the desired band with LINE switch in STANDBY.
2. Set ALC POWER LEVELING INPUTS switch to CRYSTAL, and depress ALC button.
3. Set POWER LEVEL to 5 and coarse power level (screwdriver adjust) fully counter-clockwise. Set ALC "GAIN" fully clockwise.
4. Set LINE to RF and slowly increase the coarse POWER LEVEL control for an output power indication on the oscilloscope across the full operating band. Backoff ALC "GAIN" until oscillations in the feedback loop just cease as observed on the oscilloscope.
5. Continue increasing coarse POWER LEVEL control until leveling light on the front panel of the sweeper begins to flash or the desired power level is reached, as monitored in the RF output circuit. Reduce GAIN as necessary if oscillations should result.
6. Backoff the power level control until the leveling light just glows steadily. The sweeper is now operating at optimum feedback gain and maximum leveled power out.

Once a system has been adjusted, readjustment of the gain control is normally not required unless different couplers or detectors are substituted in the leveling loop. The calibrated power level control may be simply adjusted each time the system is turned on for proper leveling as indicated by the front panel leveling indicator.

Power Meter Leveling: The design of the hp 431B temperature compensated power meter and associated thermistor mounts provides the required stability and metering configuration for a recorder output current proportional to meter deflection. This current (0-1 ma dc into 1 K ohm) is suitable for either recording purposes or driving the ALC circuit in any hp 690-series sweeper for leveling power output.

In addition to a constant output across the band, power meter leveling provides a continuous indication of the absolute power output which is useful in setting up specific test conditions. Because of excellent zero carryover*, the 431B range switch and zero controls make effective variable attenuators since they control the ALC loop in a precisely

* Zero carryover is the ability of the power meter to remain zeroed when switching from range-to-range after making an initial adjustment on the most sensitive range to be used. The 431B maintains 0.5% zero carryover.

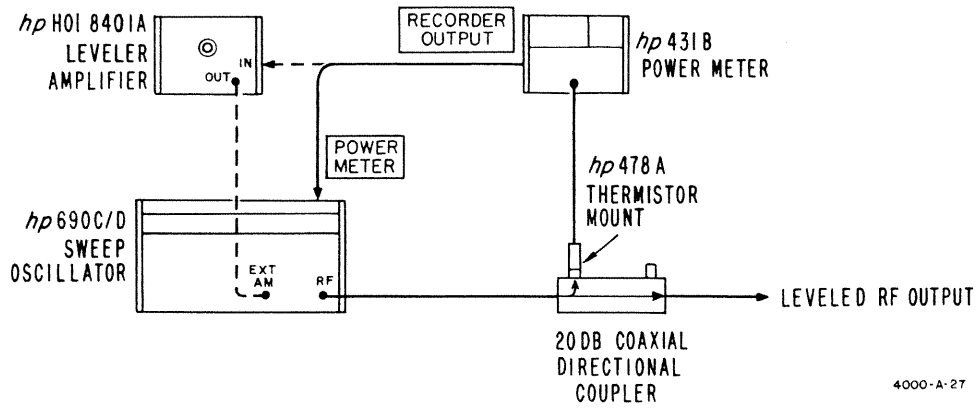

4000-A-27

| INSTRUMENT | FREQUENCY - GC | | | |
|---|-------------------------|----------|------------|------------|
| | 0.5 - 1.0 | 1 - 2 | 2 - 4 | 4 - 8 |
| Sweep Oscillator | H10-691C | 691C/D | 692C/D | 693C/D |
| Directional Coupler | Narda 3041-10 | 796D | 797D | 798C |
| Thermistor Mount | ←————— 478A —————→ | | | |
| Power Meter | ←————— 431B —————→ | | | |
| Leveler Amplifier (optional) | ←————— H01-8401A —————→ | | | |
| Leveled Power Available - mw ≥ | 40 | 100/70 | 70/40 | 30/15 |
| Leveled Power Variation (db - approx)* | ±0.5/0.4 | ±0.5/0.4 | ±0.52/0.42 | ±0.62/0.52 |
| * Maximum variation includes coupling variations, thermistor/coupler mismatch, ALC amplifier and measurement ambiguity. Typical variation is considerably less. | | | | |

Figure 8. General system for power meter leveling sweep oscillators in coax - 500 Mc to 8.0 Gc.

known manner. This feature can be used to accurately control output power from the sweeper or calibrate an X-Y recorder in db or power.

The dc substitution feature on the 431B allows very accurate dc power level changes to be made in the thermistor using an external supply. When the 431B is used in the ALC loop, a precise dc power change in the thermistor causes a precise RF output change from the sweeper. This capability is described in the Power section of this Note under "High Resolution Attenuation Tests". Examples of other useful applications for power meter leveling are also shown in the Power section.

Two basic systems for power meter leveling are shown in Figures 8 and 9. For leveled power in waveguide use the systems shown in Figure 9. The power available for each band plus the approximate power variations that can be expected are also shown in the tables. In critical applications, fine grain power variations may be further reduced with additional ALC feedback amplifier gain. The hp H01-8401A Leveler Amplifier may be added to the basic leveling setups of Figures 8 and 9 for this purpose. When the H01-8401A is used, the 431B recorder output is connected to the amplifier input as shown by the dashed lines. The amplifier output connects to the 690C/D external AM input.

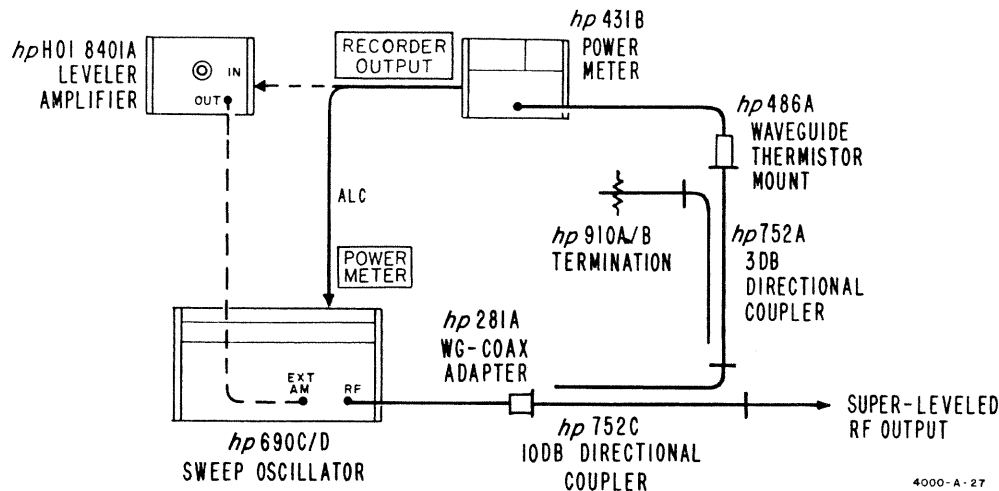

| INSTRUMENT | BAND (FREQUENCY - GC) | | | | | | | | | |
|--|-----------------------|------------------|----------------|----------------|-----------------|---------------|----------------|----------------|----------------|------|
| | S 2.6 - 3.95 | G 3.95 - 5.85 | J 5.3 - 8.2 | H 7.05 - 10 | X 8.2 - 12.4 | M 10 - 15 | P 12.4 - 18 | K 18 - 26.5 | R 26.5 - 40 | |
| Sweep Oscillator | 692C/D | 693C/D | | 693C/D | 694C/D | 694C/D | H09-695C | 695C | 696C | 697C |
| Waveguide-to-Coax Adapter | S281A | G281A | J281A | H281A | X281A | none required | | | | |
| 10-db Directional Coupler | S752C | G752C | J752C | H752C | X752C | M752C | P752C | K752C | R752C | |
| 3-db Directional Coupler | S752A | G752A | J752A | H752A | X752A | M752A | P752A | K752A | R752A | |
| Waveguide Termination | S910A | G910A | J910A | H910A | X910B | M914A | P910A | K914B | R914B | |
| Thermistor Mount | S486A | G486A | J486A | H486A | X486A | M486A | P486A | K486A | R486A | |
| Power Meter | ← 431 B → | | | | | | | | | |
| Leveler Amplifier (optional) | ← H01-8401A → | | | | | | | | | |
| Leveled Power Available - mw ≥ | 70/40 | 30/15 5 | | 30/15 | 40/25 25/15 | 40/25 | 10 | 40 | 10 | 5 |
| Leveled Power Variation* (db - approx) | ±0.5/0.4 | ±0.56/0.46 | ±0.56/0.46 | ±0.56/0.46 | ±0.56/0.46 | ±0.56 | ±0.56 | ±0.8 | ±0.8 | |

* Includes effects of coupling variation, thermistor/coupler mismatch and ALC amplifier. Typical variation is less because errors do not add arithmetically.

Figure 9. Super leveled sweep oscillator in waveguide using power meter leveling.

Thermistors inherently have long thermal time constants, slowing their response to sudden power variations. This factor must be considered when power meter leveling a sweep oscillator. The amplifier-feedback arrangement used in the hp 431B power meter reduces thermal response time in the 478A and 486A thermistor mounts to about 0.1 second so that exceedingly long sweep times are not required. The bandwidth of this feedback circuit however, is narrow compared to crystal leveling so sweep time must be longer. If the sweep is too rapid, the leveling loop will not have time to respond to fine grain variations in output power, and the leveling will be ineffective. A good rule of thumb when power meter leveling the hp 690 sweepers with the 431B is 20-30 seconds for a full band sweep. This time is compatible with an X-Y recorder time constant.

Power Meter Leveling Instructions: With the equipment set up for power meter leveling, preset the 690C/D controls as directed in step 1 and make adjustments that follow:

1. With the LINE in STANDBY, set desired sweep limits and select the MANUAL SWEEP mode. Set ALC POWER LEVELING INPUTS switch on rear panel to POWER METER. Depress ALC button.

2. Null and zero 431B according to the instrument Operating and Service Manual.
3. For maximum leveled power out of the system, set 431B RANGE as follows: Note leveled power rating listed in the equipment table of Figure 8 or 9 for the specific system being set up. Allow for the attenuation introduced by the directional coupler and calculate the equivalent power meter reading. Set 431B RANGE so the calculated power level will read in the upper 2/3 of the meter scale.

EXAMPLE:

Suppose the super-leveled system of Figure 9 is being set up in S-Band using a 692D sweep oscillator. The table in Figure 9 indicates a leveled power rating of 40 mw. Allowing for the 13 db total coupling attenuation introduced between the sweeper and thermistor, the 431B should indicate 2 mw at the rated system power level. In this case, the proper range setting for the 431B is 3 mw which places the 2 mw reading upscale.

4. Preset 690C/D POWER LEVEL to "5" and the center screwdriver adjust fully counterclockwise. Set ALC "GAIN" fully clockwise.
5. Turn 690C/D LINE to RF and slowly increase the screwdriver POWER LEVEL control until the 431B indicates power reading calculated in step 3. The leveling indicator lamp on the 690C/D should glow steadily.
6. Ordinarily, oscillations in the ALC circuit will not occur with power meter leveling unless the H01-8401A Leveler Amplifier is used. To verify freedom from oscillations, connect an oscilloscope to the crystal input jack of the 690C/D. If oscillations are present, slowly turn ALC "GAIN" counterclockwise until oscillations on oscilloscope just disappear.
7. Increase POWER LEVEL control until the reference power reading on the 431B is restored. Check and readjust ALC "GAIN" and/or POWER LEVEL to obtain maximum leveled power without oscillation as the MANUAL SWEEP is rotated throughout its entire range. In most cases, the maximum leveled power will be greater than the values given in the table and the power meter may have to be up-ranged to maintain an on-scale reading. The 690C/D is now operating at maximum leveled power. If something less than maximum power is desired, simply calculate the equivalent power meter reading and make all GAIN and POWER LEVEL adjustments to the new value.

If the leveled power is to be varied in precise 5 db steps by changing the 431B range switch, optimum leveling conditions must be set up on the most sensitive power meter range to be used. This is because the ALC loop gain is maximum on the most sensitive range setting and oscillations can occur in the feedback loop. The practical range of power meter switching (after a leveled power has been set up) is about 20 db, limited at the high power end by the maximum leveled power available from the sweep oscillator and limited on the low end by excessive loop gain in the ALC circuit.

Power Meter Leveling With the H01-8401A Leveler Amplifier: In applications where maximum leveling flatness is required using power meter leveling, connect the recorder output jack of the 431B power meter to the input of the hp H01-8401A Leveler Amplifier as shown by the dashed lines in Figure 8 and 9. Connect the amplifier output to the sweeper EXTERNAL AM input and depress the EXTERNAL AM button. Release the ALC button on the sweeper front panel since the leveling amplifier in the sweep oscillator is not used in this configuration. Turn 690C/D POWER LEVEL coarse adjust fully clockwise. Determine the proper range switch setting for the 431B power meter as described in the previous discussion on power meter leveling. Adjust the H01-8401A GAIN and POWER LEVEL for maximum gain, without oscillation, at the desired power level as described previously. Leveling performance with the H01-8401A may be expected to be about ± 0.1 db better than power meter leveling without the amplifier. This improvement may be significant in certain high resolution measurements.

Leveled One Watt Sources: The maximum leveled power from any of the 1 to 12.4 Gc systems previously described can be increased to 1 watt using suitable traveling wave tube (TWT) amplifiers. An example of a crystal leveled, 1 watt system is shown in Figure 10. Note the system uses the same sweep oscillators and directional detectors as

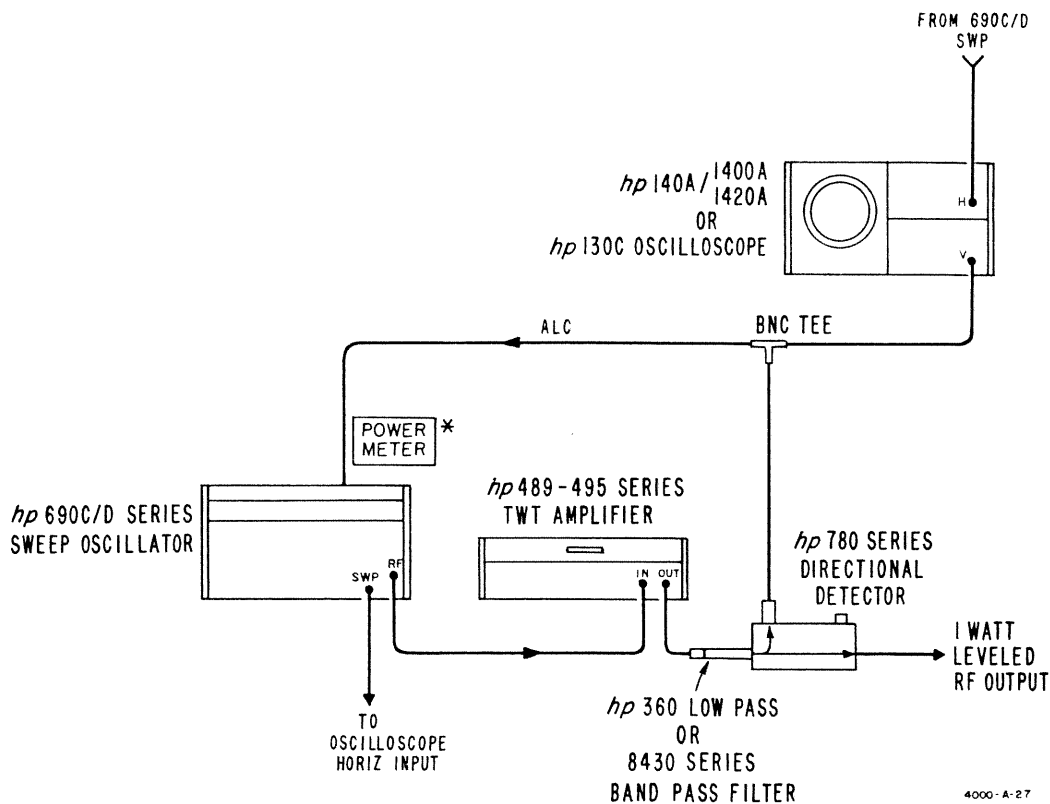

* ALC connects to 690C/D "POWER METER" input. Set ALC POWER LEVELING INPUTS to XTAL. See text.

| INSTRUMENT | FREQUENCY - GC | | | |
|---|----------------|----------|----------|----------|
| | 1 - 2 | 2 - 4 | 4 - 8 | 8 - 12.4 |
| Sweep Oscillator | 691C/D | 692C/D | 693C/D | 694C/D |
| Filter | 360C | 360D | 8435A | 8436A |
| Traveling-Wave Tube Amplifier | 489A | 491C | 493A | 495A |
| Directional Detector | 786D | 787D | 788C | 789C |
| Approx. Leveled Power Available (into 50 Ω) | 1 w | 1 w | 1 w | 1 w |
| Leveled Power Variation** (db - approx) | ±0.4/0.3 | ±0.4/0.3 | ±0.5/0.4 | ±1.0 |

** Leveling is typically better than listed over most of the band except for variations at low-band edges of 1 - 8 Gc systems. Slightly larger variations are due to high frequency cutoff characteristics of filters.

Figure 10. Crystal leveled 1-watt sources from 1 to 12.4 Gc in coax. Waveguide systems from 2.6 to 12.4 Gc may also be assembled by substituting appropriate waveguide components for coupling and detection in the ALC loop.

shown previously in Figure 5. A low pass or bandpass filter prevents second harmonics out of the TWT from entering the ALC loop and affecting output power leveling performance.

Since the directional detector operates at substantially higher power in the 1 watt system, the POWER METER ALC input (1K ohm) is used instead of the CRYSTAL (10K ohm) input on the 690C/D. The power meter input load on the ALC detector reduces loop gain to a more convenient range for adjustment. The ALC POWER LEVELING INPUTS switch, however, is placed in the CRYSTAL position to maintain proper frequency response in the ALC amplifier.*

For 1 watt leveled power in waveguide, substitute the appropriate waveguide components for the coax directional detector shown in Figure 10. In general, the waveguide configuration shown in Figure 6 can be followed for the 1 watt system except that a 20 db directional coupler (hp 752D-series) is used instead of the 10 db coupler and a filter is added. The 3 db coupler is retained for super-leveling as before.

One Watt Leveling Instructions: Adjustments of the sweeper POWER LEVEL and ALC GAIN are mutually inter-dependent and become somewhat more critical when the gain of a TWT amplifier is added to the ALC loop. Excess power at the TWT input can drive the amplifier into saturation so that further increase of power input causes a reduction in TWT output power. Under this condition, the ALC feedback is positive and oscillations occur in the ALC loop. Stable operating conditions can be reached in the leveled 1 watt systems described by using the following adjustment procedure:

1. Preset 690C/D POWER LEVEL to "5", ALC "GAIN" and coarse POWER LEVEL (screwdriver adjust) fully counterclockwise. Set TWT "GAIN" for "RATED POWER" on the CATHODE CURRENT meter.
2. Observing the full band sweep on the oscilloscope, slowly increase ALC GAIN until pattern is level. If oscillations occur, continue increasing ALC GAIN until oscillations just cease.
3. Increase POWER LEVEL until 690C/D leveling indicator begins flashing then back off adjustment slightly for a steady indication.
4. If oscillations occur after the adjustment of step 3, reduce ALC GAIN as required to restore leveled operation. If oscillations do not occur after step 3, increase ALC GAIN for best leveling at the desired power level without oscillations.

Note: When crystal leveling, a suitable power meter such as the hp 431B connected to the system output will assist in optimizing leveling to the desired power. Use a 20 - 30 second sweep time on the 690C/D for an accurate power indication on the 431B and 20 db of attenuation ahead of the 478A or 486A thermistor mount.

Better Leveling: The leveling capability of the systems illustrated in Figure 5 through 10, and later in the applications sections, is determined by several factors. Where directional detectors are used, leveling depends upon the overall frequency response of the detector and the gain of the ALC amplifier. Where separate couplers and detectors (crystal or thermistor) are shown, leveling performance is dependent upon coupling variation, detector frequency response (crystal), coupler-detector mismatch, and ALC amplifier gain.

The level variations shown for each system are those resulting from the maximum effect of the error sources present in the leveling loops assembled from the components shown. However, the error effects in such leveling loops are primarily vector quantities having phase relationships which vary with frequency and do not always cause maximum error. Rather, total error is more usually the rms of the error quantities. Therefore, leveling is typically better than indicated, but the figures given permit comparison of the various systems illustrated.

On special order, HP will supply complete leveling systems with better leveling performance guaranteed. Inquiries on such systems may be directed to your HP Sales Office. A complete listing of HP Sales Offices may be found at the end of this Application Note.

* See Operating and Service Manual on hp 690C/D for circuit detail.

ATTENUATION

GENERAL

Attenuation is defined as the decrease in power level (at the load) caused by inserting a device between a Z_0 source and load^{8,9}. Under this condition, the measured value is a property of the device alone so that this is the "ideal system" in which to make measurements. The term Z_0 is used to describe a unity SWR condition where the load and source impedances equal the transmission line impedance.

There are three common methods for measuring RF attenuation: 1) square-law detection with audio substitution, 2) linear detection with IF substitution, and 3) direct RF substitution using attenuators calibrated with either of the first two methods. Accurate square-law measurements over a range of 30 db in a single step are possible using modern crystal detectors such as the hp 423A coax, and 424A-waveguide series. With partial RF substitution this range can be extended to about 45 or 50 db. With direct RF substitution a 45 or 50 db range is possible using the same detectors without square-law loading for highest sensitivity. The 423A and 424A Detectors are well suited to swept-frequency attenuation tests with either method 1 or 3 listed above because of their flat frequency response and low reflection coefficient (ρ) across the band.

Linear detection with IF substitution is capable of accurately measuring larger single step and total attenuation but is generally limited to fixed frequency operation and therefore, will not be discussed further in this Note.

A number of factors affect the range and accuracy of square law or RF substitution attenuation measurements, each of which must be evaluated for the particular setup used. The measuring system must have low source and load reflections to minimize mismatch error. Tuners cannot be used to cancel source or load reflections in swept frequency measurements because the tuning is effective only at single frequencies. Pads or isolators could be employed at the source but closed loop leveling is a much more effective way to reduce source mismatch using hp 690 Sweep Oscillators. By leveling the output power of the sweeper at the point of measurement, source impedance is effectively maintained very close to Z_0 ¹⁰. With this arrangement, impedance variations in connecting cables, connectors, and adapters are effectively cancelled since they are within the leveling loop.

Low reflections in the crystal detector are important for reducing mismatch error at the load in the measurement system. All hp detectors are swept frequency tested to assure low reflections throughout their specified band. The following system configurations are arranged to further reduce load mismatch by padding the detector. By keeping source and load reflections low over a broad band, we can approach the "ideal system" for swept frequency attenuation measurements. Typical figures for accuracy and range will be given in the examples that follow.

MEASUREMENTS IN WAVEGUIDE

A. Basic Operation. Figure 11 shows a waveguide system for swept attenuation measurements of 30 to 40 db. Source power is leveled using a single 10-db directional coupler in the ALC loop. Coupling variation versus frequency in the leveling loop results in a leveled power variation of about 1 db at the point of test-device insertion. This power variation is nearly equal to but opposite the coupling variation in the readout coupler. The net variation in readout calibration is therefore mutually compensated to within about 0.3 db in X-band depending primarily on coupler tracking.

⁸ Beatty, R. W., "Intrinsic Attenuation," Trans. IEEE, Vol. MTT-11, No. 3, May 1963, p. 179

⁹ Beatty, R. W., "Insertion Loss Concepts", Proc. IEEE, Vol. 52, No. 6, June 1964, p. 663

¹⁰ Engen, G. F., "Amplitude Stabilization of a Microwave Signal Source." IRE Trans on MT and T, April 1958, p. 202.

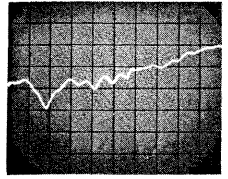

ATTENUATION

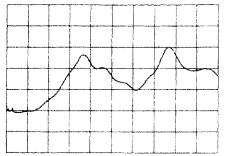

IMPEDANCE
REFLECTION
COEFFICIENT



POWER

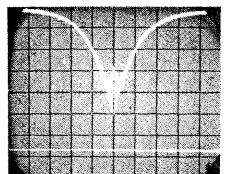

FREQUENCY

included with this Note. Place scale over the CRT carefully aligning the 3 db mark with the center graticule line. Use electrostatic charge or a few small spots of rubber cement to secure scale to CRT face. The oscilloscope is now calibrated for db readout.

C. Measurement.

- Insert the test device into the system as indicated in Figure 11.
- When using the 140A/1416A, the ATTENUATION-DB control may be used for readout in two ways depending on the application and preference of the operator. For high resolution measurements at specific points on the display, increase VERTICAL SENSITIVITY as desired (0.5 db/cm maximum) and increase ATTENUATION-DB until the trace is coincident with the reference level. Read attenuation directly from the calibrated ATTENUATION-DB dial. For fast measurements such as go-no-go tests, leave the ATTENUATION-DB control at zero. Attenuation of the test device is now the amplitude decrease from the vertical reference as read from the calibrated CRT graticule. Figure 12(a) is a typical presentation of attenuation across X-Band as viewed on the 140A/1416A.
- When using a conventional oscilloscope, read attenuation directly from the transparent db scale. For best resolution, increase VERTICAL SENSITIVITY in calibrated steps to position the trace near, but still above, the 0 db mark. Calculate the ratio of vertical sensitivity increase, and add the corresponding correction in db from Table 1 to the reading indicated on the scale. Figure 12(b) shows the type of presentation obtained with a standard oscilloscope and the db scale overlay.

TABLE 1

| Ratio of Sensitivity Increase - E_2/E_1^* | Correction in DB (add to scale reading) |
|---|---|
| 1.0 | 0 |
| .5 | 3 |
| .2 | 7 |
| .1 | 10 |
| .05 | 13 |
| .04 | 14 |
| .02 | 17 |
| .01 | 20 |

* E_1 = Vertical sensitivity in mv/cm for reference setting.
 E_2 = Vertical sensitivity in mv/cm giving best test resolution.

D. Extended Range. An additional 6 to 10 db of attenuation range can be obtained with somewhat lower accuracy by adding one instrument to the setup in Figure 11. All steps of the foregoing procedure remain unchanged except that an hp 382A variable attenuator is inserted ahead of the leveling detector and set to zero db. When the test device is inserted into the system and attenuation is greater than the available range of readout, the 382A is increased by an amount necessary (up to about 10 db on 690D series and about 6 db on 690C) to get on-scale readings. This increases the RF power out of the sweeper by an amount equal to the attenuation increase. The amount of db increase on the 382A is added to the db reading noted on the oscilloscope for total attenuation of the test device.

E. X-Y Recording the 140A/1416A Display. After the measurement system is adjusted for normal operation with the 140A/1416A oscilloscope, an X-Y plot of attenuation versus frequency may be made on linear graph paper as follows:

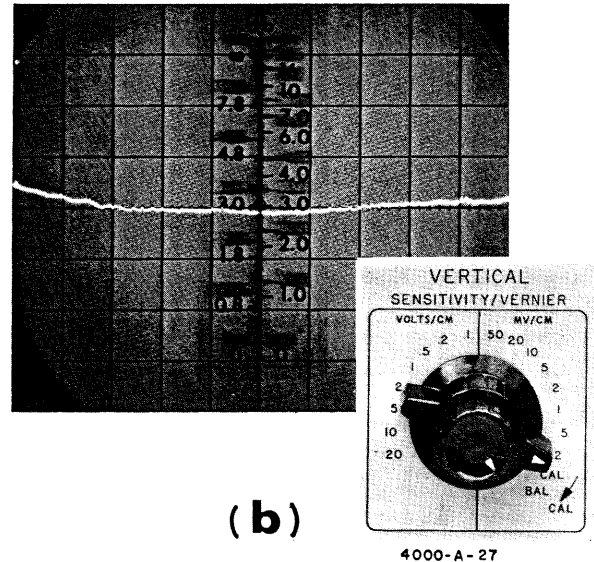
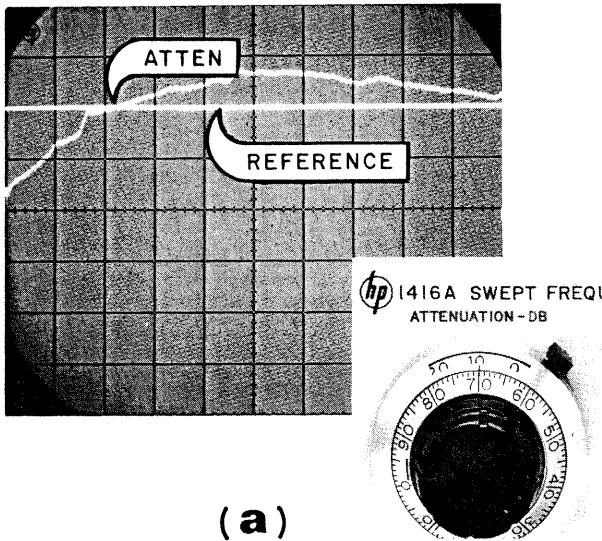

Figure 12. (a) Swept attenuation test of an hp X375A Variable Attenuator as viewed on hp 140A/1416A. Vertical Sensitivity is 0.5 db/cm - Reference: 17 db. (b) Same device with readout on hp 130C using db scale overlay. Add 14 db to scale reading because of vertical sensitivity increase from 5 mv/cm to 200 μ v/cm from Calibrate to Test conditions.

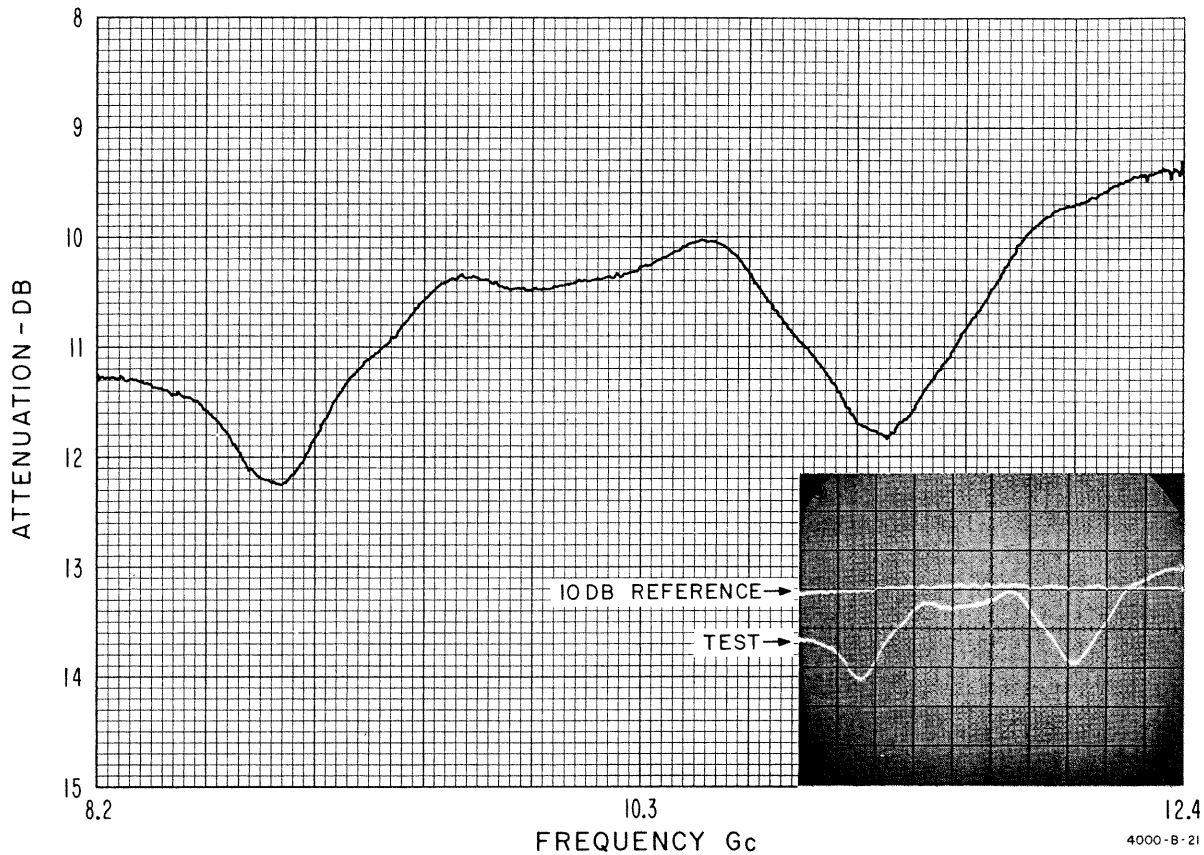

Figure 13. X-Y plot of attenuation on linear graph paper.

- With the recorder turned OFF, connect the X and Y inputs to the 1416A HORIZ and VERT outputs. Set 690C/D SWEEP SELECTOR to MANUAL SWEEP and MANUAL SWEEP fully counter-clockwise.
- Set 1416A MODE to CAL(db) - 0 and sensitivity to 10 db/cm. Preset RECORDER OUTPUT AMPLITUDE and DC LEVEL controls to mid-range.
- Set X-Y recorder VERTICAL SENSITIVITY to approximately 0.1 v/inch (or about 50 mv/cm on metric scaled recorders) and HORIZONTAL SENSITIVITY to 50 mv/inch (approximately 20 mv/cm). *
- Turn ON the X-Y recorder and position the pen over the desired 0 db (vertical) and start-frequency (horizontal) reference point on the graph paper using the recorder zero controls or 1416A DC LEVEL controls.
- Turn 690C/D MANUAL SWEEP fully clockwise and adjust 1416A horizontal AMPLITUDE to

position pen to desired STOP-FREQUENCY reference. Check and readjust zero at START-FREQUENCY reference if necessary. The recorder horizontal span is now calibrated.

- Set 1416A MODE successively to -10, -20 and -30 db and adjust 1416A RECORDER OUTPUT vertical AMPLITUDE so pen moves the desired number of vertical divisions on the graph paper. Check and readjust vertical zero (at 0 db) if necessary.
- Set 1416A MODE to LOG. The recorder vertical span is now calibrated in db/division corresponding to the 1416A SENSITIVITY. The recorder's vertical zero point may now be readjusted to any desired reference on the graph.
- Insert the test device into the measurement system and set the 690C/D SWEEP SELECTOR to TRIGGER. Set SWEEP TIME for about 20-30 seconds.
- With the 1416A SENSITIVITY set to the desired vertical calibration, push the MANUAL TRIGGER on the 690C/D and record the test results. Attenuation at any frequency in the sweep is read directly in db from the graph.

*The recorder output voltages furnished by the 1416A are continuously variable from 0 to 200 mv/cm of oscilloscope vertical display, and 0 to 100 mv/cm horizontal. This allows use of low-cost single range X-Y recorders instead of multi-range instruments if preferred.

Figure 13 shows an attenuation measurement in X-Band made on standard graph paper using the 140A/1416A

and Moseley 135C X-Y Recorder. The same recorder calibration technique applies to the readout in db of Return Loss with the 140A/1416A described in the Impedance section of this Note.

F. Increased Resolution. Attenuation measurements to about 10 db can be made with 0.1 db resolution using power meter leveling and readout. See "High Resolution Attenuation Tests" in the Power section of this Note for system description.

G. RF Pre-insertion - X-Y Recorder Technique. Swept attenuation measurements up to 45 or 50 db can be made using the RF pre-insertion - X-Y recorder system shown in Figure 14. The leveling arrangement is identical to that shown in Figure 11, but coupler tracking and detector errors are eliminated by plotting a calibration grid on the X-Y recorder prior to the actual measurement. In addition to being leveled, the sweeper is internally amplitude modulated at 1 kc to drive the 415D amplifier. The 415D, after amplifying the 1 kc signal, feeds a proportional dc voltage to the recorder Y-input. The dc sweep voltage from the 690C/D drives the recorder X-input directly.

Calibration grid lines are plotted by setting in specific values of attenuation on the 382A near the anticipated test device attenuation and triggering single 30 second sweeps on the 690C/D. The 382A is then set to 0 db and the test device inserted as shown in Figure 14. A final sweep is triggered on the 690C/D and attenuation of the test device plotted over the calibration grid.

This system does not rely on square-law performance in the readout detector because of the calibration grid plotted with known attenuation levels set by the 382A. For this reason, the option 02 square-law load is not connected to the 424A readout detector and higher sensitivity is obtained.

WAVEGUIDE SYSTEM ACCURACY

Accuracy of an X-Band attenuation measurement using the system shown in Figure 11 will typically be better than $\pm(0.5 \text{ db} + \text{readout error})$. Sources of error include: Effective source ρ , Load ρ , detector square-law deviation, and coupler-detector tracking (frequency response).

When using the 382A attenuator for extended range operation, the accuracy decreases to about 0.8 db + readout error because of mismatch considerations and error in the attenuator calibration.

Using the RF pre-insertion - X-Y recorder system of Figure 14, attenuation accuracy in X-Band is typically better than $\pm(0.5 \text{ db} \pm 0.02\alpha)$, where α is the measured attenuation in db. Readout error is removed because of the calibration grid but mismatch and attenuation errors of the 382A must be considered.

Mismatch error in the auxiliary arm of the readout coupler can be reduced considerably by using a 10 db minimum reference setting on the 382A instead of 0 db.

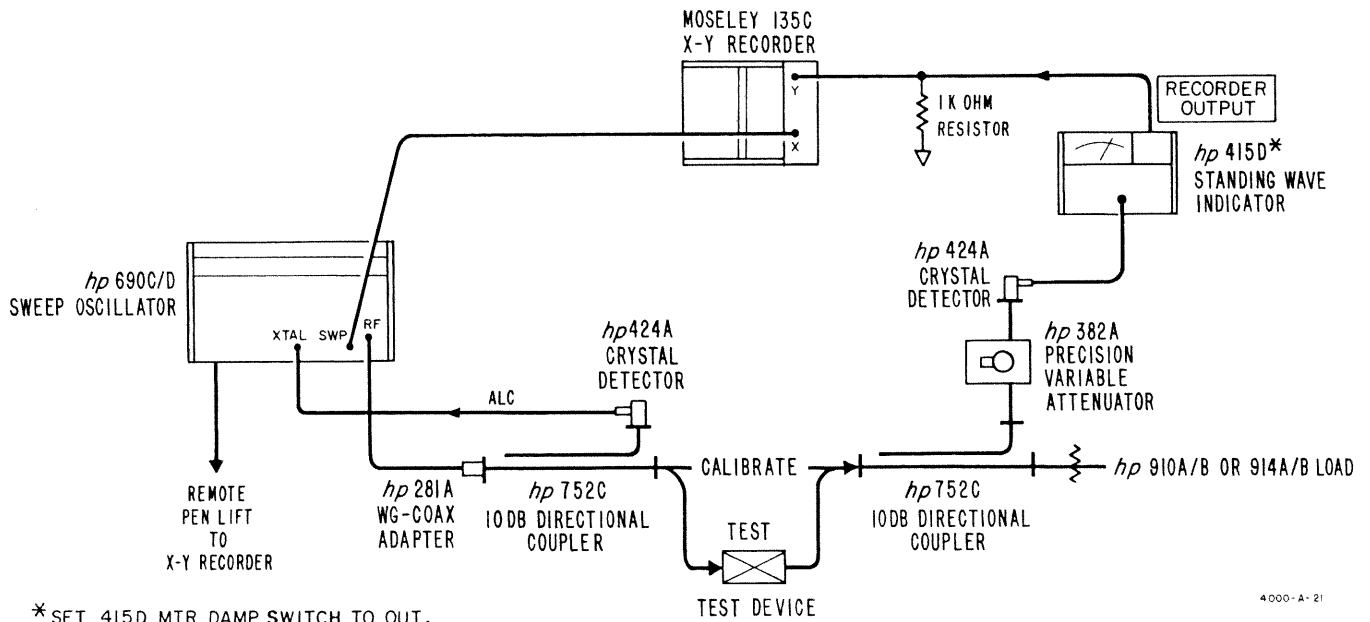

Figure 14. RF pre-insertion technique for swept attenuation measurements in waveguide up to 45 - 50 db. Calibration grid lines are plotted on X-Y Recorder by setting 382A attenuator to specific values and triggering single sweeps on 690C/D. Attenuator is then set to 0 db and test device inserted as shown. Final sweep is then triggered and attenuation plotted over the calibration grid. Sweeper is amplitude modulated at 1 kc to drive 415D Amplifier for high sensitivity readout.

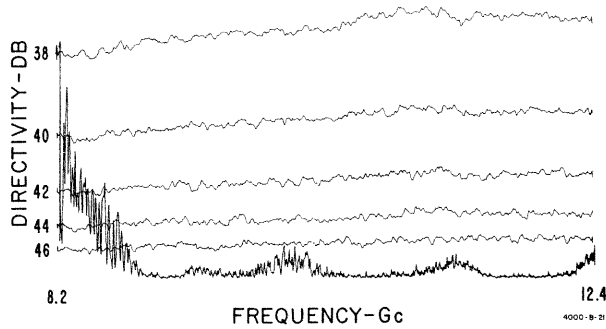

Figure 16. Typical swept frequency directivity test on precision multi-hole directional coupler. Calibration grid is plotted on X-Y Recorder using hp 382A Attenuator.

combination of 382A decrease and 415D reading. Take the difference in db between the two levels noted and enter the ordinate of the separation chart of Figure 17. Intersect the two curved coordinates in the chart and note the correction in db below each intersection.

Add these two corrections separately to the MINIMUM DB reading noted in the sliding load test. The two figures resulting represent the actual values of the coupler directivity, and the load return loss. If both values plus the coupler transmission loss effect are greater than the specified directivity of the coupler, no further tests are required. If one reading does not meet the desired specification, repeat the sliding load test with another load or coupler. One reading from each pair of separated signal levels will agree, thus identifying the component retained in both tests. A logical point in Figure 16 for this latter test would be at the low-band edge where directivity is questionable on the swept test.

reading on the 415D noting each level in total db below the original reference level, the total being the

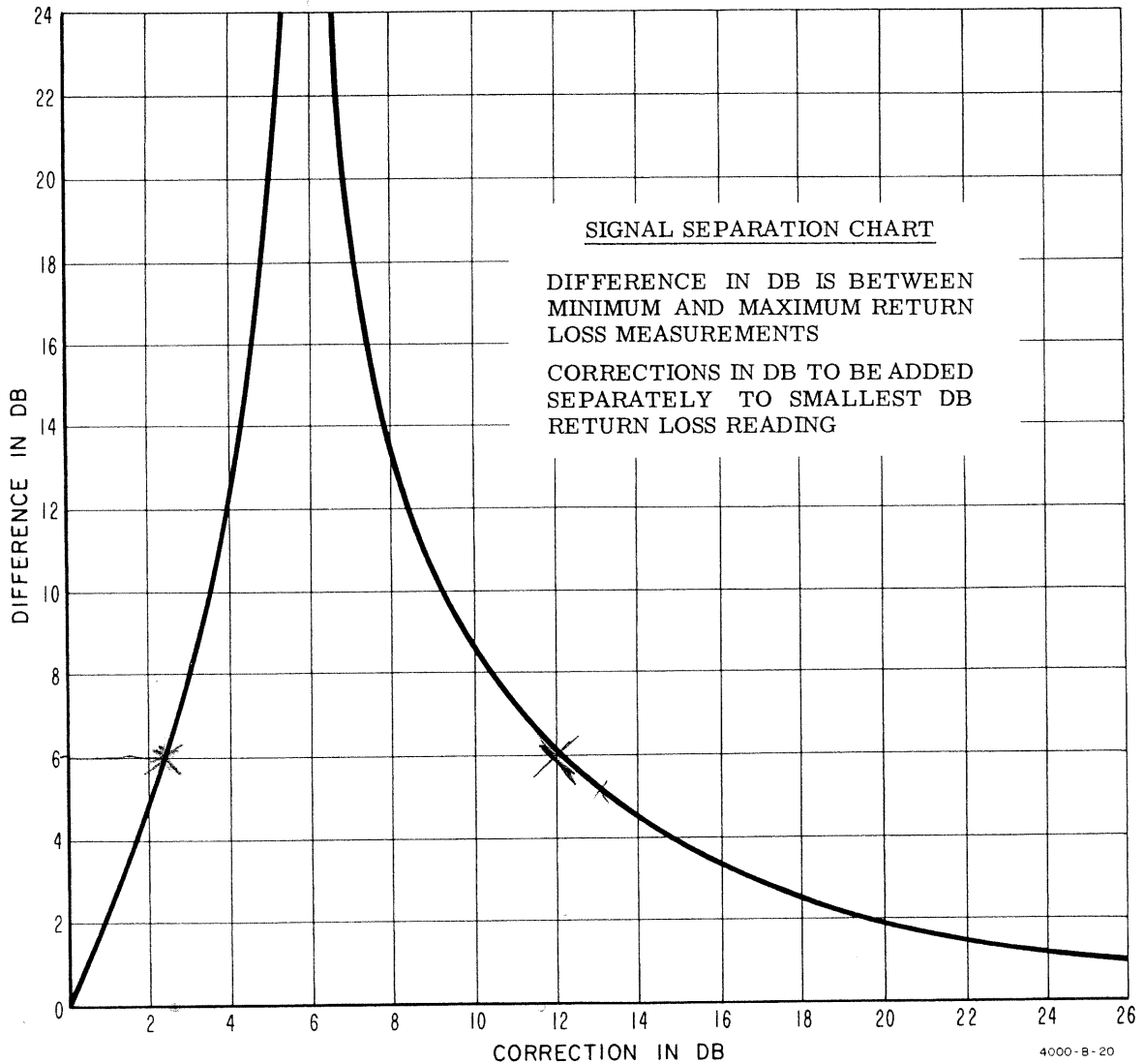

Figure 17. Chart for separating two signals when their sum and difference is known.

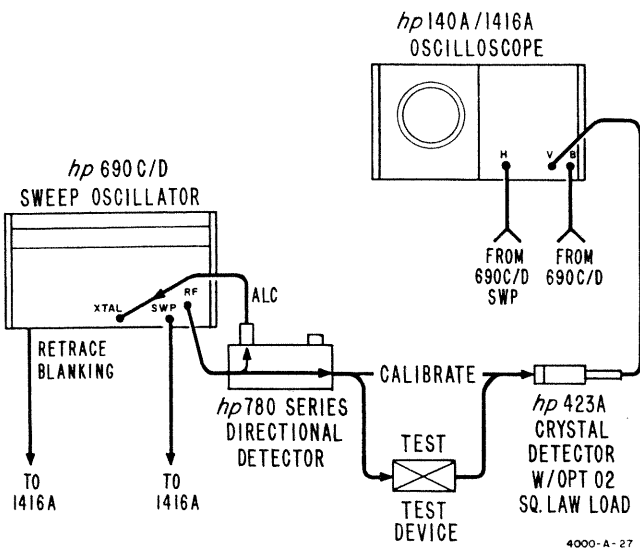

Figure 18. Coaxial attenuation tests to 30 db can be made using hp sweep oscillators and directional detectors in any of four bands from 1 to 12.4 Gc. Separate coupler and detector may be used for 500 Mc - 1 Gc range.

MEASUREMENTS IN COAX

Figure 18 shows a general set up for swept attenuation measurements of coaxial devices over a 30 db range, from 500 Mc to 12.4 Gc in five bands. Essentially constant output power is maintained at the reference point by leveling the sweeper output. The leveling feedback signal is derived from an hp 780 series directional detector in all but the lowest band. The leveling arrangement of Figure 18 effectively reduces source ρ to that of the directional detector main line ρ . Flat frequency response in the directional detector minimizes power variations in the reference output providing constant calibration of the oscilloscope display across the band. Measuring and readout procedures are identical to those described earlier for waveguide systems.

COAXIAL SYSTEM ACCURACY

Typical accuracy of a coaxial attenuation measuring system as shown in Figure 18 will be on the order of $\pm(0.8 \text{ db} + \text{readout error})$. Sources of error include: Effective source ρ , load ρ , and deviation from square-law detection.

IMPEDANCE

GENERAL

One of the most widely used swept frequency systems is the reflectometer for measuring reflection coefficient (or SWR) in coax and waveguide. The basic function of the reflectometer is to sample the individual magnitudes of the incident and reflected signals in a transmission line feeding an unknown load impedance. The ratio of these signals indicates how well the load impedance matches that of the transmission line. Equations 1, 2 and 3 relate the common expressions used in reflectometer measurements.

$$\text{Reflection Coefficient Magnitude } \rho = \frac{|E_{\text{reflected}}|}{|E_{\text{incident}}|} \quad (1)$$

$$\text{Standing Wave Ratio } \text{SWR} = \frac{(1 + \rho)}{(1 - \rho)} \quad (2)$$

$$\text{Return Loss* } \text{DB} = -20 \log_{10} \rho \quad (3)$$

*Return loss expresses the relative amplitude decrease in the reflected signal level when a 100% reflection is replaced by the load in test.

From this fundamental discussion, it may be noted that the directional couplers separating and sampling the incident and reflected signals must have high directivity and low port reflections to achieve accurate results. Furthermore, the couplers should maintain these qualities over broadbands in order to work with swept techniques. For waveguide measurements in the 2.6 to 40 Gc bands, the hp 752 series of directional couplers are recommended. These couplers provide at least 40 db directivity across the band with a main guide SWR of 1.05 or less. For coax measurements in the ranges up to 4 Gc, use the hp 770 series of coax dual directional couplers. These couplers provide incident and reflected sampling in one integrated unit which eliminates large coax connector ambiguities between two individual couplers. All hp directional couplers are swept frequency tested in production to assure that they meet specifications at all points within the band; a pre-requisite for accurate swept reflectometers.

Special techniques may be used to adapt high directivity waveguide couplers for coax measurements at higher frequencies where coax coupler directivity is typically too low for accurate results. These techniques are used in the hp X8440A Reflection Coefficient Bridge for accurate swept reflection tests in coax at X-Band frequencies.

The accuracy of a reflectometer measurement depends not only on how all instruments perform individually, but as a system as well. For example, close tracking between the forward and reverse couplers and detectors in the reflectometer is essential to effective leveling. Consistently high directivity in both couplers is required to minimize ambiguities in separating incident and reflected waves. With load impedance varying anywhere from a short to nearly reflectionless terminations, sweeper leveling performance must be stable over a large range to prevent frequency and amplitude calibration shift during a measurement. Accurate reflection measurement systems, as shown in this section, can be assembled from unselected HP instruments because of their design and consistent manufacture. However, for special applications, HP also offers complete systems that are matched for best overall performance. Contact your HP Sales Office listed at the end of this Note for system information.

MEASUREMENTS IN WAVEGUIDE

A. Basic Operation. The system shown in Figure 19 is the most straightforward method for waveguide reflection measurements and uses the same equipment shown earlier in Figure 11 for swept attenuation tests. A waveguide short for calibration purposes is the only additional equipment necessary.

The basic idea of this system is to hold forward power constant by leveling and measure RETURN LOSS of a given load rather than a direct ratio of the incident and reflected signals. This technique eliminates need for a ratiometer and 1 kc amplitude modulation of the sweeper output which was typical in older reflectometer setups. The calibrating

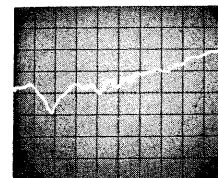

ATTENUATION

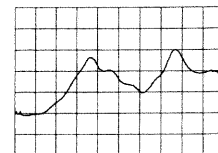

IMPEDANCE
REFLECTION
COEFFICIENT



POWER

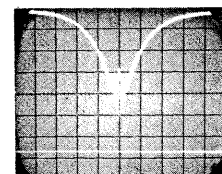

FREQUENCY

C. Measurement. After completing the calibration procedure of paragraph B, remove the calibrating short and proceed as follows:

- Connect the test load to the reflectometer output as shown in Figure 19 for "TEST".
- When using the 140A/1416A, read RETURN LOSS in db directly from the calibrated display (decrease of trace from reference), or use the ATTENUATION DB dial to return trace to the reference level at the point of interest and note db return loss from the dial calibration. Increase vertical sensitivity as required to obtain desired resolution.

For other oscilloscopes, increase vertical sensitivity until the entire trace is near, but still above the lower 3 cm graticule line. Note the ratio of sensitivity increase required on the oscilloscope VERTICAL SENSITIVITY control.

- Select the corresponding SWR scale from Table 2 and cut it from the transparent foil for either visual observation or CRT photography. Place scale over main CRT graticule using electrostatic charge or a few small spots of rubber cement to secure it in place. Be sure to align the small circle at the scale center with the center graticule lines of the CRT. Read SWR from scale at point of interest.

Example 1, Return Loss Measurement on hp Models 140A/1416A: With the reflectometer output shorted, a reference trace is established on the oscilloscope as shown by the upper trace in Figure 20(a). The short is replaced by the test load and the amplitude decrease noted from the calibrated graticule in db/cm. For higher resolution, the vertical sensitivity is increased to 2 db/cm and the ATTENUATION DB control increased until the trace position is restored to the reference level as shown in Figure 20(b). The calibrated ATTENUATION DB dial now reads RETURN LOSS at

TABLE 2

| Ratio of Sensitivity Increase - E_2/E_1^* | Use SWR Scale Marked |
|---|----------------------|
| 1.0 | 0 DB |
| .1 | 10 |
| .05 | 13 |
| .04 | 14 |
| .02 | 17 |
| .01 | 20 |

* E_1 = Vertical Sensitivity in mv/cm for reference setting.
 E_2 = Vertical Sensitivity in mv/cm giving best test resolution.

the frequency of coincidence between the reference and test traces.

Return loss is now converted to ρ (or SWR) with the HP Reflectometer Calculator as shown in Figure 21 or calculated as follows:

$$\text{from equation (3) } DB = -20 \log_{10} \rho ;$$

transposing and substituting, the value of return loss measured

$$\rho = \log_{10}^{-1} \left(-\frac{17}{20} \right) \text{ or } .141 \text{ (SWR} = 1.33\text{)}.$$

Example 2, Direct SWR Readout Using Oscilloscope CRT Scales: Figure 22(a) is a double exposure showing the two trace positions for RF - off and 100% reflection conditions. When the calibrating short is replaced by the test load, the oscilloscope's vertical sensitivity is increased from 5 mv/cm to 0.2 mv/cm to obtain the trace shown in Figure 22(b). The RATIO of sensitivity increase is thus 0.04, calling for the SWR scale marked 14 db as indicated by Table 2. The SWR scale is placed on the CRT giving direct readout at any

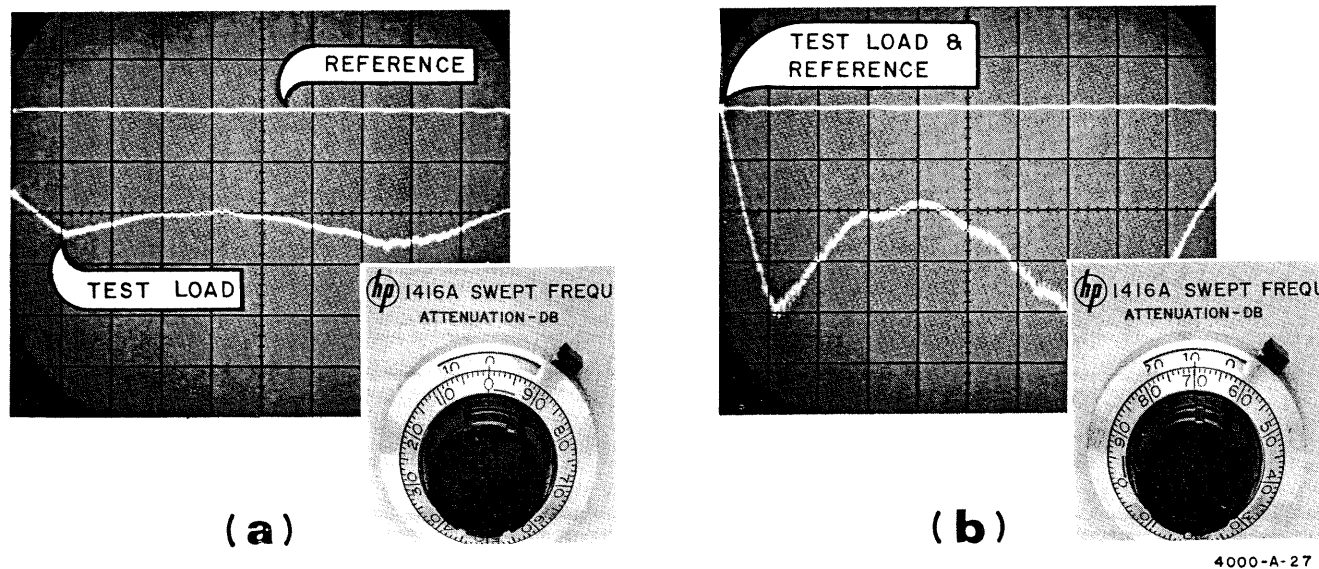

Figure 20. (a) Swept reflection test of a waveguide thermistor mount on hp 140A/1416A. Vertical Sensitivity is 10 db/cm - Reference: 0 db. (b) The same mount with vertical sensitivity increased to 2 db/cm and reference offset to 17 db.

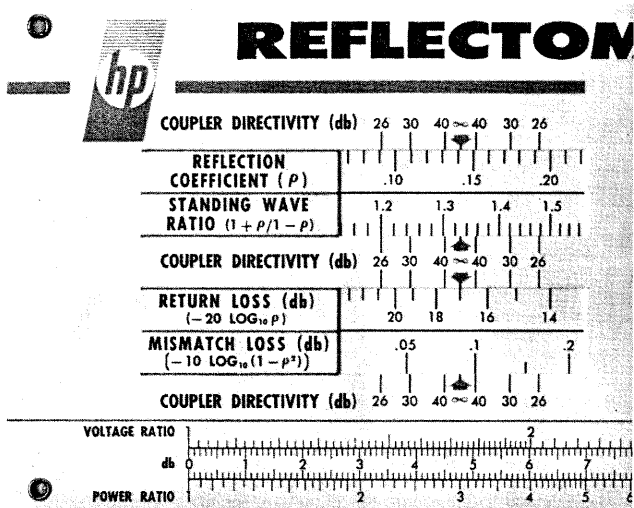

Figure 21. HP Reflectometer Calculator is used to convert 17 db return loss measured in example 1 to ρ or SWR.

frequency of interest. If desired, SWR may be converted to ρ with the Reflectometer Calculator.

X-Y RECORDING REFLECTION TESTS

In certain applications it is desirable to record reflectometer test results for future reference or detailed examination. In some cases, a photo of the oscilloscope display will satisfy the requirement. Many times, however, the high resolution and low cost of X-Y recording is preferable. After calibrating the reflectometer to the 140A/1416A display, an X-Y recorder may be connected as shown by the dashed line in Figure 19.

The recorder readout is conveniently set up to correspond to the oscilloscope display as outlined in the ATTENUATION section, paragraph "E". Now X-Y recordings of db return loss may be made on linear scaled graph paper by triggering a single 20 - 30 second sweep on the 690C/D. The ability to record on graph paper, as opposed to plotting a calibration grid, allows accurate readout of return loss without interpolating and also saves setup time.

RF PRE-INSERTION - X-Y RECORDER TECHNIQUE

Another accurate method for X-Y recording swept-reflection tests is to use a precision variable attenuator for calibration as shown in Figure 23. The sweeper output is amplitude modulated at 1 kc (to drive the 415D) and adjusted for a leveled indication while sweeping the band*. With the reflectometer output shorted, the 382A attenuator is adjusted to pre-insert specific values of RETURN LOSS to the reverse arm detector. Grid lines are sequentially plotted on the X-Y recorder at each attenuator setting by manually triggering single sweeps on the 690C/D. When using a sliding short such as the hp 923A, rapid phasing is possible during the slow calibrating sweeps. By continuously phasing the short during each calibrating sweep, all phases of source mismatch error signals are encountered at the reverse arm detector. The result is a fine grain variation on the grid lines which defines source mismatch limits within the ambiguity limits of the coupler directivity. Using the mean of the fine grain variations as the true return loss for each grid line, source mismatch error is removed and

*Leveled power out of some low band sweepers is sufficient to operate the readout detector at a high output level. In such cases the 415D may be eliminated from the setup and the sweeper left unmodulated.

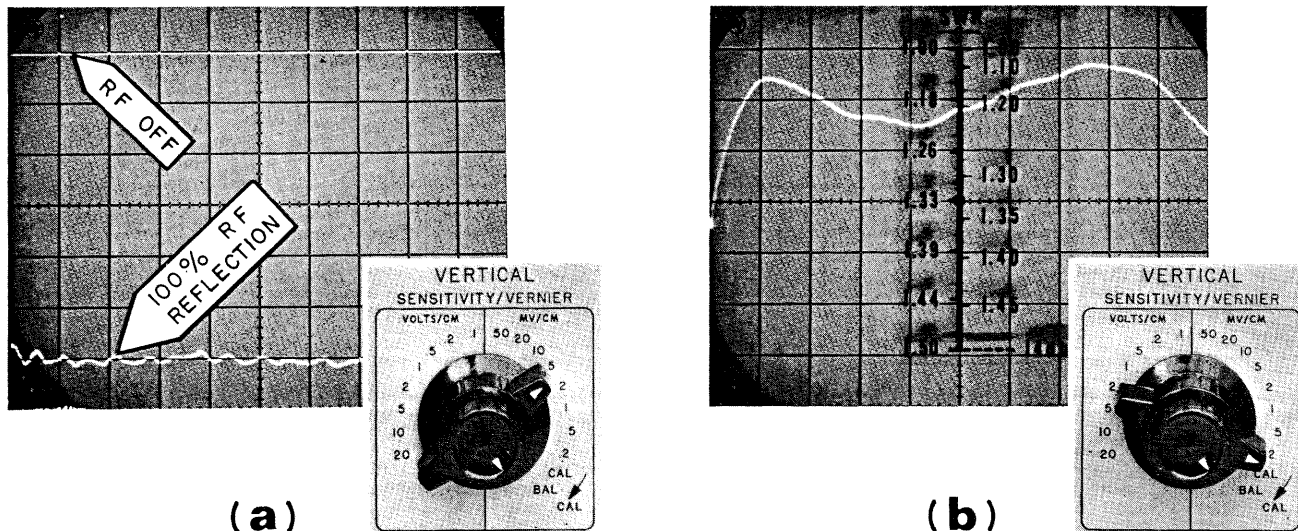

Figure 22. (a) Calibration traces for swept SWR tests using scale overlays, as viewed on hp 130C oscilloscope. Vertical sensitivity (inset) is set to 5 mv/cm and trace positioned 3 cm up, with RF off. Reflectometer is then shorted and RF power increased for trace deflection 3 cm down. (b) Swept SWR test of an hp X486A Thermistor Mount after oscilloscope has been calibrated. Vertical sensitivity (inset) is increased to 200 μ v/cm for better resolution. Ratio of sensitivity increase determines SWR scale used.

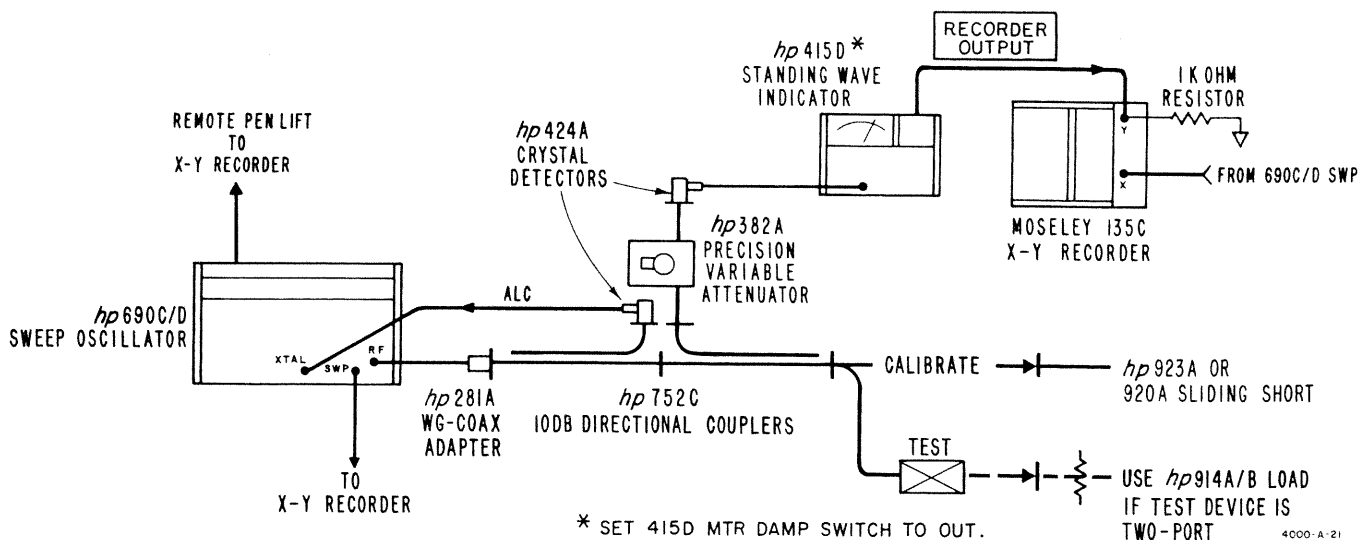

Figure 23. RF pre-insertion - X-Y Recorder setup for ρ tests.

better accuracy obtained in the measurement. In X-band, using the 923A short and other equipment shown, the improvement is about 0.6 db in the return loss measurement. The attenuator is then returned to zero and the short replaced with the test device.

Now the final sweep is triggered and return loss of the test device recorded over the calibration grid as shown in Figure 24. The calibration grid, once plotted, can be used as an underlay for many swept reflection tests by using translucent paper for the actual record of each device tested. Grid line calibration should be checked periodically during long hours of testing and a new grid always plotted when the system has been turned off.

This system, while slower than the oscilloscope readout, has the advantage of greater dynamic range due to the 415D amplification of the reflected signal. Return losses to 40 db ($\rho = .01$) can be measured, limited primarily by the system accuracy rather than resolution. Another advantage of this system is that it does not rely on the square-law characteristics of the

detector since the crystal operates near the same RF level for both CALIBRATE and TEST conditions. The attenuator, however, does introduce certain errors of its own which are subsequently discussed under "Waveguide System Accuracy".

WAVEGUIDE SYSTEM ACCURACY

For reflection coefficients less than 0.5, overall accuracy of the reflectometer shown in Figure 19 for X-Band is typically $\pm(.01 + .04\rho_L + K\rho_L)$ when the calibrating short is phased; where ρ_L is the actual load reflection coefficient and K is the decimal readout error of the indicating device, e.g., overall error for a .05 reflection coefficient using a 3% oscilloscope would be $\pm[.01 + .04(.05) + .03(.05)]$ or $\pm.0135$. This decreases to $\pm(.01 + .07\rho_L + K\rho_L)$ when the short is not phased. Sources of error include effective source ρ , reverse coupler directivity, imperfect short, detector deviation from square law and differences of coupling coefficients and detector frequency response between forward and reverse detector/coupler system.

Detector square-law error may be eliminated by using the RF pre-insertion technique shown in Figure 23. However, the variable attenuator used for calibration introduces error of its own which must be accounted for. Overall accuracy of the reflectometer system shown in Figure 23 is approximately $\pm(.01 + .05\rho_L)$ when the calibrating short is phased during the grid line plots. When a fixed short is used for calibration, the accuracy decreases to about $\pm(.01 + .08\rho_L)$. Sources of error include effective source ρ , reverse coupler directivity, imperfect short, attenuator error, and mismatch error of the reverse detector.

It may be noted that the typical leveled reflectometer accuracy given above is as good as any HP slotted line measurement which gives only spot frequency data. For this reason, swept frequency tests no longer need to be verified at spot frequencies with a slotted line as was often done in older systems.

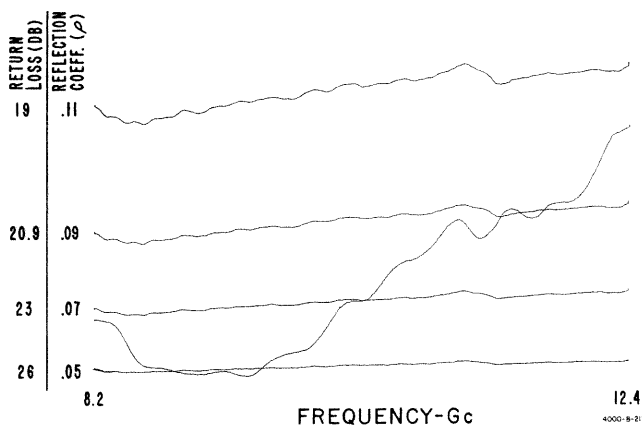

Figure 24. X-Y plot of return loss using RF pre-insertion technique

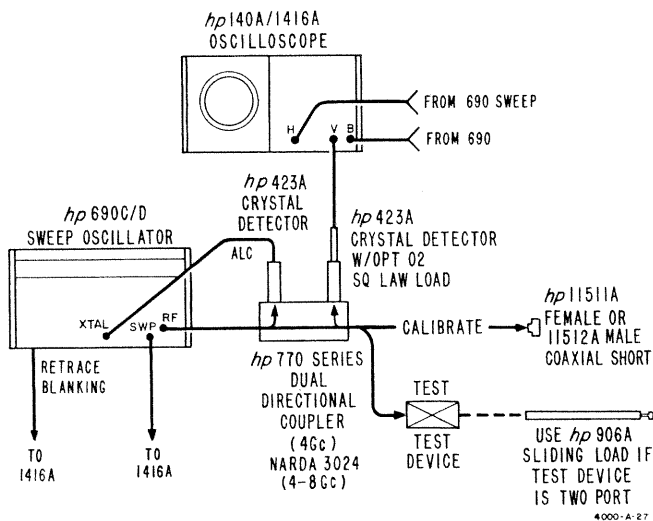

Figure 25. General system for swept reflection measurements in coax from 500 Mc to 8 Gc

MEASUREMENTS IN COAX - 500 MC TO 8 GC

A Coaxial Reflectometer, as shown in Figure 25, can be used for swept reflection measurements in the 500 Mc to 8 Gc region with the same advantages of oscilloscope readout, closed loop leveling, and straightforward operation described for waveguide systems.

Incident and reflected power in the main line is sampled by an hp 770-series dual directional coupler and detected by 423A crystal detectors. Incident power to the test load is held constant by closed loop leveling the sweeper output with the detected incident signal. The reflected signal, detected by the 423A with matching square-law load (option 02), is read on the Model 140A/1416A Oscilloscope directly in DB Return Loss

or on a conventional oscilloscope using the SWR scales supplied with this Note.

To calibrate the system, a coaxial short is connected to the reflectometer output as shown in Figure 25 and a zero db return loss reference established on the oscilloscope. The short is then replaced by the unknown load and the amplitude decrease measured using the same procedure outlined under "Measurements in Waveguide" for waveguide reflection tests.

COAXIAL SYSTEM ACCURACY

The sources of error found in coax reflectometers are basically the same as those found in waveguide systems. The reflections of type N connectors, however, cause larger uncertainties in coax measurement so overall accuracy is not as high.

When measuring reflection coefficients of 0.5 or less overall accuracy of the coax reflectometer shown in Figure 25 can be expected to be about as follows:

| | |
|----------------|------------------------------------|
| 500 Mc - 2 Gc, | $\pm(.01 + .07\rho_L + K\rho_L)$; |
| 2 Gc - 4 Gc, | $\pm(.03 + .10\rho_L + K\rho_L)$; |
| 4 Gc - 8 Gc, | $\pm(.06 + .14\rho_L + K\rho_L)$; |

Where ρ_L is the load reflection coefficient and K is the decimal readout error of the indicating device.

Sources of error include effective source ρ , coupler directivity, imperfect short, detector deviation from square law, and frequency response of the coupler and detectors.

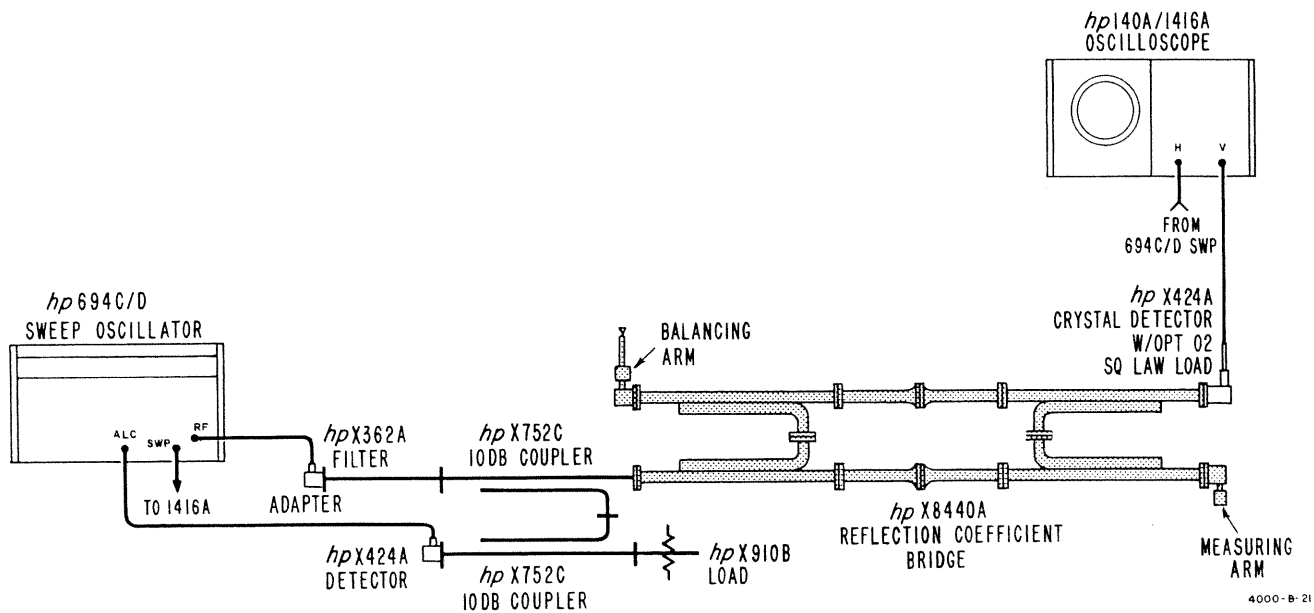

Figure 26. High accuracy swept reflection tests are now possible in coax from 8.2 to 12.4 Gc using hp X8440A Reflection Coefficient Bridge (shaded).

MEASUREMENTS IN COAX - 8.2 TO 12.4 GC

The type N connector commonly used in microwave is the primary factor limiting coax reflectometer usefulness much above 4 Gc. Closely related to the connector problem is the low directivity typically found in coax directional couplers designed for higher frequencies. As frequency increases, measurement uncertainties increase until, at X-band, the coax reflectometer has an equivalent residual ρ of 0.18 (SWR = 1.44:1). This is unacceptable for most applications. For accurate swept reflection tests in the 8.2 to 12.4 Gc band, the hp X8440A Reflection Coefficient Bridge and peripheral equipment shown in Figure 26 is recommended. The bridge (shaded portion) uses waveguide directional couplers for their high directivity and a waveguide-to-coax adapter to connect the test device. Waveguide-to-coax adapter reflection is effectively cancelled by a balancing scheme that reduces uncertainties considerably. Bridge accuracy in terms of reflection coefficient is $\pm(.03 + .16\rho^2)$, where ρ is the unknown load reflection coefficient. This is equivalent to a residual system SWR of 1.06:1 which is better than most X-band coax slotted lines.

Calibration and readout of the bridge is essentially the same as used with a coax reflectometer. The bridge measuring arm is alternately shorted and opened to establish a zero db return loss reference on the oscilloscope. The unknown load is then connected to the measuring arm and return loss measured by the amplitude decrease of the oscilloscope trace. Readout of the bridge can also be X-Y recorded if desired. HP Application Note 66 gives detailed theory and operation of the X8440A plus information for assembling and testing bridges in other waveguide bands where coax coupler directivity is low.

SPECIAL TECHNIQUES

Reflections in Long Waveguide Runs. Swept frequency techniques can be applied to locating and evaluating individual discontinuities in long waveguide runs such as used for antenna feed lines.

Figure 27 shows a simplified diagram of a system^{11,12} which operates on a chirp radar principle to locate reflections on the order of 1% with a resolution of 1 foot. The system has been used successfully on runs of 12 to 125 feet and more. Using the sweep rate and RF excursion giving best resolution of the individual waveguide reflections, the sweep oscillator energy is fed past a balanced mixer and down the waveguide run. Reflected energy from any discontinuity in the guide returns to the mixer and heterodynes with the incident wave which has changed frequency (because the source is sweeping) during the propagation interval between leaving the mixer and returning. The mixer output frequency is thus proportional to the time interval, and therefore the distance, to the discontinuity. The amplitude of the heterodyne output is proportional to the reflection coefficient of the particular discontinuity producing the response.

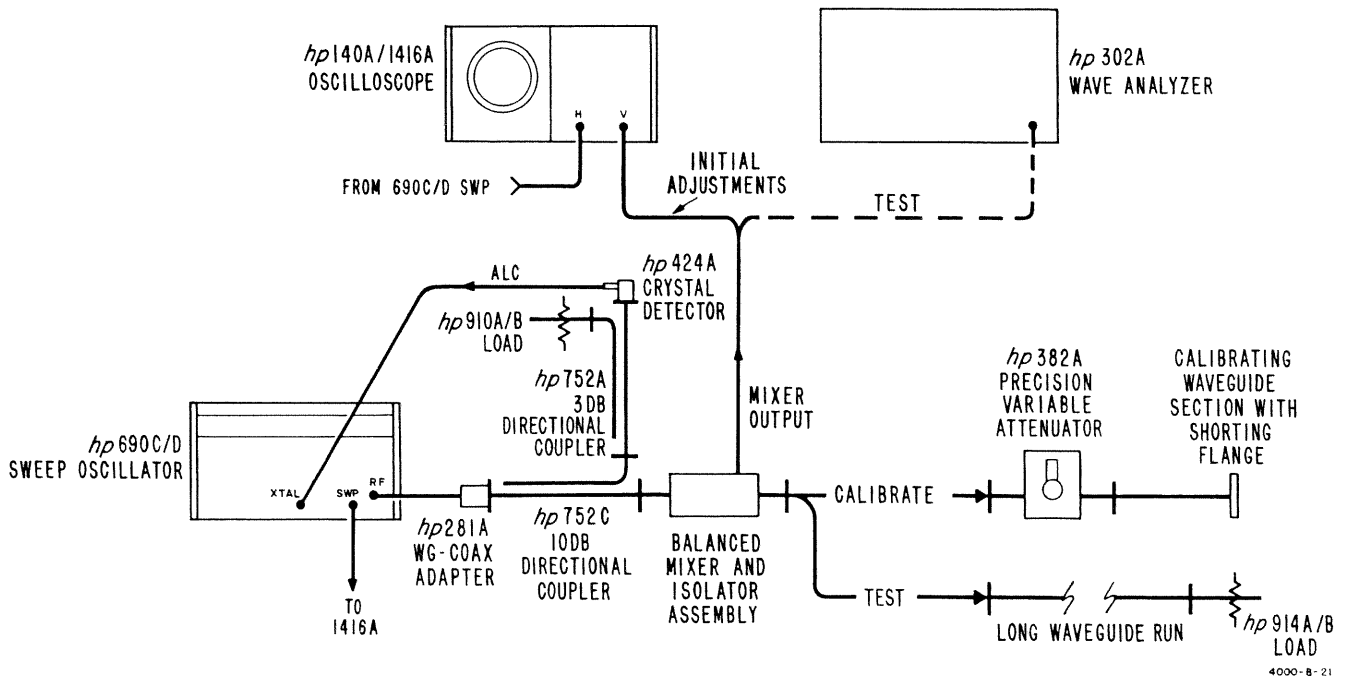

- 11 E. Aronoff, "Measurement of Discontinuities in Waveguides," IEEE Trans. Paper No. 63-53, January 27 - February 1, 1963.
- 12 W. A. Rawlinson et al, "A Swept Frequency Method of Locating Faults in Waveguide Aerial Feeders," Res. Report 20209, Post Office Research Station, Dollis Hill, London, N.W. 2, June 1959.

Figure 27. Simplified diagram of reflection measuring system for long waveguide sections

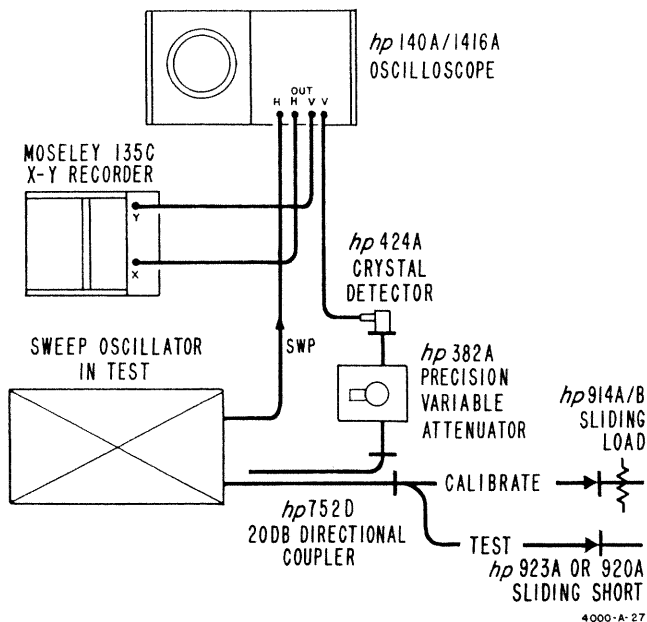

Figure 28. System for checking source SWR on sweep oscillator without leveling

The mixer output is first displayed on the oscilloscope to optimize system adjustments and then applied to the input of the hp 302A Wave Analyzer for calibration with a known length of guide. The 382A Variable Attenuator is used to calibrate the mixer output amplitude in return loss relative to the 100% reflection of the shorting flange. After calibration, the unknown guide is connected to the mixer output in place of the calibration section and the test is made. The frequencies and relative amplitudes read on the wave analyzer indicate the location and magnitude of the individual waveguide discontinuities.

In order to minimize errors caused by source frequency pulling, use the 690D series of PIN leveled sweepers wherever possible. This ensures that the leveling action does not shift the mixer output frequency calibration during a measurement.

Source SWR Tests. Output SWR on sweep oscillators and other microwave sources can be checked easily with equipment setup of Figure 28*. The system shown utilizes the oscillator in test to supply the required signals thus eliminating the need for another source in the same band. With the output terminated in the hp 910 or 914A/B load, a calibration grid is plotted on the X-Y Recorder using 382A attenuator settings of return loss corresponding to specific source SWR values. After plotting a calibration grid, the load is replaced by a waveguide short which reflects the incident wave back to the source. A portion of the reflected signal is reflected by the source mismatch up through the directional coupler to the detector, adding in random phase

* Note: In the setup shown, the sweeper is not leveled because the basic source match is being tested. The effectiveness of leveling to improve source match can also be checked using the same procedure but with a leveling coupler/detector loop between the sweeper and waveguide components shown.

with the incident signal. When using the 920A short, single sweeps are triggered and recorded for several small incremental changes in the short position over $\lambda/4$ at the lowest frequency, taking into account various phases of source reflections. When the hp 923A short is used, only one test sweep is required while rapidly phasing the short. The envelope of the resulting plot represents source SWR as a function of frequency. Attenuator settings for the calibration grid are determined from the following equations:¹³

$$-DB_1 = 20 \log_{10} 2(1 - \rho_g) \quad (4)$$

$$-DB_2 = 20 \log_{10} 2(1 + \rho_g) \quad (5)$$

where ρ_g = simulated generator reflection coefficient.

Example:

A sweep oscillator with a maximum specified output SWR of 2:1 is connected for test as shown in Figure 28. By the relationship of equation 2 given earlier, a 2:1 SWR is approximately equal to a ρ of 0.33. Substituting for ρ_g in equations 4 and 5 and rounding off to the nearest tenth:

$$-DB_1 = 20 \log_{10} 2(1 - 0.33) = 2.5$$

$$-DB_2 = 20 \log_{10} 2(1 + 0.33) = 8.5$$

Using either equation 4 or 5, the attenuator setting corresponding to a source SWR of unity is found to be 6 db. Grid lines are plotted for the three attenuator settings and the attenuator returned to -6 db. The final plots are then made using the movable short, resulting in a record similar to Figure 29. Since the envelope of the plot remains inside the 2:1 SWR limits, the sweeper output system meets specifications.

This same general technique can also be applied to check output SWR of other broadband sources such as the hp 938A and 940A Harmonic Doublers. In this case the doubler in test is driven by a leveled sweep oscillator and the waveguide components of Figure 28 connected to the doubler output. Coax output systems are not as readily tested with this method because of the ambiguity introduced by a waveguide to coax adapter between the output port and directional coupler.

¹³ HP Journal, Vol. 12, No. 4, Page 5, (December 1960).

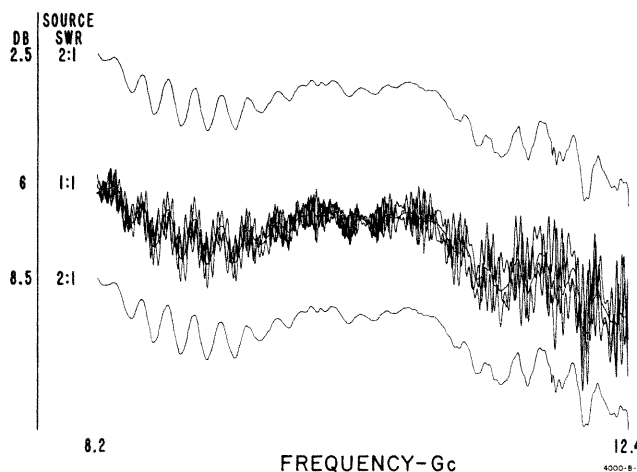

Figure 29. Swept SWR plot of signal source

POWER

GENERAL

Power measurement is usually associated with fixed frequency techniques rather than swept, though modern thermistor mounts will operate over broad bands without tuning. Many applications, of course, require fixed frequency power measurement because of the device in test, (e.g., checking a signal generator or transmitter output). There are, however, a number of useful swept-power techniques that can be used to great advantage. For example, full range tests of TWT amplifier gain, antenna frequency response, and thermistor mount efficiency can be readily performed using appropriate sweepers and power meter leveling arrangements.

THERMISTOR MOUNT EFFICIENCY TESTING

A variation of power meter leveling is shown in Figure 30 where a thermistor mount is being tested for effective efficiency on a swept frequency basis. Effective efficiency (η_e) of a thermistor mount is the ratio: $\eta_e = \frac{P_{dc \text{ substituted}}}{P_{\mu \text{ wave absorbed}}}$, where $P_{dc \text{ substituted}}$ is the

dc (or audio) power substituted in the thermistor element and $P_{\mu \text{ wave absorbed}}$ is the total microwave power dissipated in the mount.

Incident and reflected power at the test mount are sampled by two directional couplers feeding a pair of temperature-compensated thermistor mounts and hp 431B power meters. The recorder output of each meter is connected to the input of a differential leveling amplifier in the Efficiency Calibrator where a feedback voltage proportional to net forward

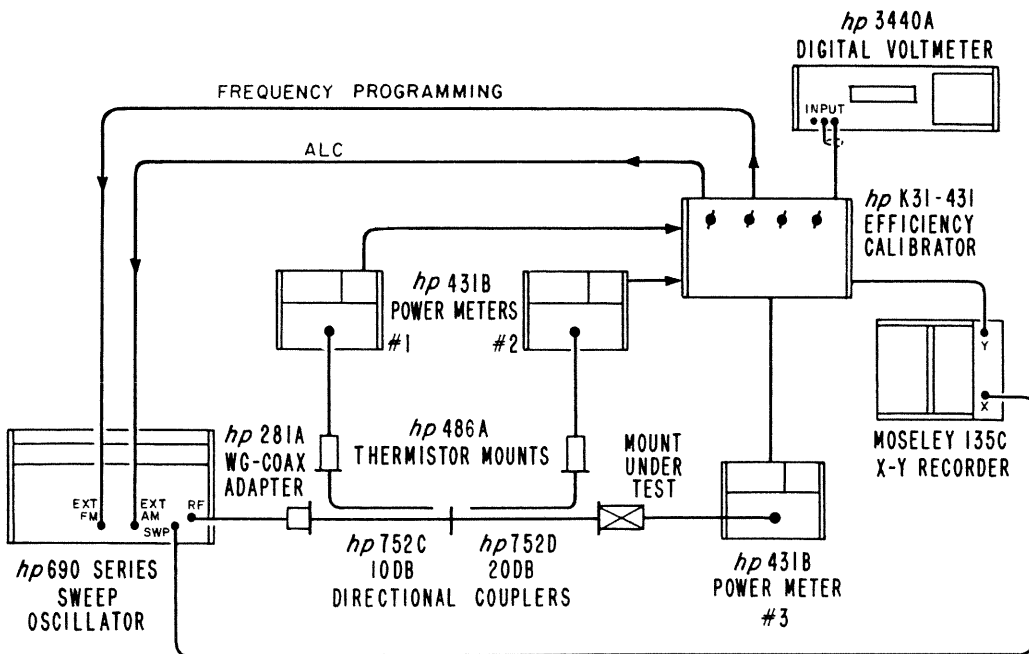

4000-A-21

Figure 30. Thermistor Mount Efficiency Calibration System

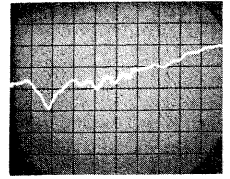

ATTENUATION

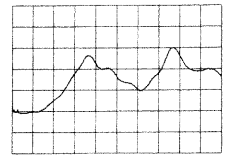

IMPEDANCE
REFLECTION
COEFFICIENT

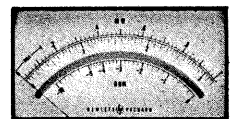

POWER

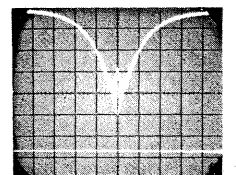

FREQUENCY

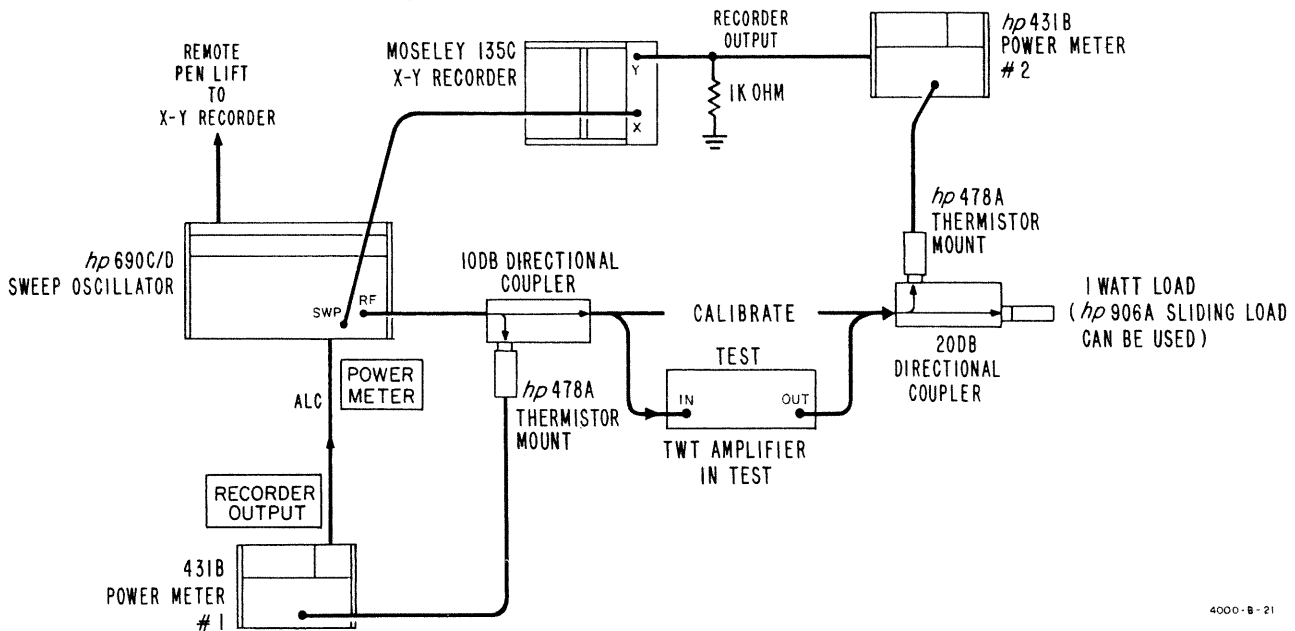

Figure 31. Frequency response and gain test on traveling wave tube amplifier uses power meter leveling and readout to monitor actual power levels. Zero-carryover of 0.5% on hp 431B Power Meters allows use of range switch as a precision attenuator for precalibrating X-Y Recorder.

power is developed. The feedback voltage controls the sweeper output via the EXTERNAL AM* input, resulting in a constant power dissipated within the test mount independent of mount SWR or operating frequency.

With constant power dissipated in the test mount, the indication on #3 power meter becomes directly proportional to the effective efficiency of the test mount. The output of meter #3 may be recorded on the X-Y Recorder for a swept plot of relative efficiency**, or read out in digital form at fixed frequencies on the DVM.

Because samples of forward and reverse power are available, the system readily adapts to swept reflection tests. A switching arrangement in the calibrator causes the sweeper to level on forward power only (meter #2 instead of the differential of #1 and #2) and the X-Y recorder reads the output of meter #1. By setting up a 100% reflection at the system output and sweeping the band at various RANGE settings on meter #1, a calibration grid is drawn on the X-Y recorder.

*Normally the crystal or power meter ALC input would be used for leveling feedback, but in this case a special leveling amplifier is being used external to the sweeper.

**Test mount is compared to a pre-calibrated control mount of consistently high efficiency across the band. Both NBS and the HP Standards Lab offer control mount efficiency calibrations. See HP Application Note 64.

Return loss is simulated by up-ranging meter #1 from the normal operating range in specific steps as follows:

Meter #1 normally operates on the 0.1 mw (-10 dbm) range when a test mount is connected to the system output. When the calibrating short is connected, a return loss of 15 db ($\rho = 0.18$) can be simulated by up-ranging the meter to the 3.0 mw (+5 dbm) range which causes the meter indication to decrease precisely 15 db. With the indication down 15 db, the recorder output drops proportionately and a calibration line is swept. The meter is then further up-ranged to the 10 mw (+10 dbm) scale and a 20 db return loss is drawn. For return loss references between even 5 db points, the meter zero control may be used to offset the indication by the desired number of db. After the calibration is complete, the meter is re-zeroed (with RF power off) and the range switch returned to 0.1 mw. The short is replaced by the test mount and the final test sweep triggered on the 690. Mount ρ versus frequency is then read from the X-Y plot relative to the calibration grid previously drawn. This completes the swept efficiency and ρ test.

The technique of differential leveling can also be applied to broadband antenna testing where a constant launched power is desired independent of antenna mismatch. Instead of feeding the main power to the thermistor mount and power meter #3 as in the mount efficiency setup, power is launched from a standard horn toward an antenna in test. With the radiated power from the horn held constant by differential leveling, the frequency response of the test antenna can be checked.

TWT AMPLIFIER GAIN TEST

Figure 31 shows a Traveling Wave Tube amplifier being tested for gain throughout its full operating band using a sweep oscillator with power meter leveling. Power at the TWT input is monitored and held constant by power meter #1 while meter #2 and the X-Y Recorder indicate gain versus frequency at the TWT output. The zero-carryover feature of the 431B Power Meter allows use of the range switch to calibrate the X-Y Recorder span in db of gain.

The procedure is as follows:

- With the sweeper LINE switch in STANDBY, null and zero the power meters following the procedure outlined in the 431B Operating and Service Manual.
- Set #1 and #2 meter RANGE to 1 mw and 0.1 mw respectively.
- Connect the 10 db directional coupler to the 20 db directional coupler input as shown in Figure 31 for the CALIBRATE configuration, and turn the 690 LINE to RF.
- With the 690 slowly sweeping the full frequency range of the TWT, adjust the sweeper POWER LEVEL and ALC GAIN for a leveled indication of 0.05 mw on meter #2.
- Set up the X-Y Recorder for on-scale operation and negative vertical input, positioning the pen near the bottom of the paper. Set 690 C/D SWEEP SELECTOR to TRIGGER and plot a 30 db gain reference trace on the recorder by pushing the MANUAL trigger button on the 690.
- By setting meter #2 to full scale (3 db increase) with its zero control, a second calibration line of 33 db can be plotted. Be sure to return the zero control of meter #2 to half scale after the plot is made.
- Set meter #1 and #2 RANGE to 0.1 mw and 10 mw respectively. Because of zero-carryover, the leveled power at the 10 db coupler will drop precisely 10 db to maintain the mid-scale reading on meter #1. Calibration sensitivity of the X-Y recorder readout will drop precisely 20 db by the up-ranging of meter #2. Thus, the combined effect of the 20 db sensitivity decrease and 10 db power drop equals the anticipated 30 db gain of the TWT amplifier in test.
- Now insert the TWT amplifier into the setup as shown in Figure 31 for "TEST" and turn up the amplifier GAIN. (Do not exceed 1 watt output.) Again manually trigger the sweeper and record the gain versus frequency of the amplifier. If the amplifier exceeds 30 db of gain, the RECORDER TRACE will remain above the 30-db calibration line previously drawn. Figure 32 shows a swept TWT gain test from 7 to 10 Gc.

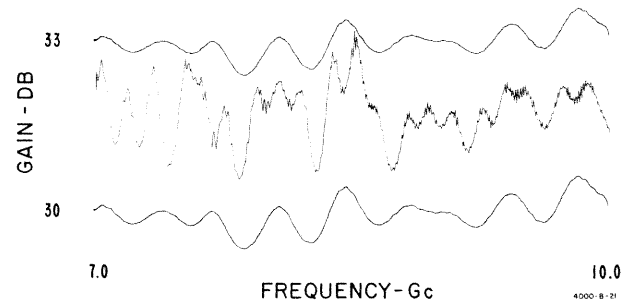

Figure 32. X-Y Plot of TWT Gain Test

HIGH RESOLUTION ATTENUATION TESTS

The dc substitution feature on the hp 431B Power Meter, plus its leveling capability can be combined for high resolution swept attenuation tests using the setup of Figure 33. RF power from the sweeper is controlled by the leveling feedback derived from the total power sensed in the thermistor mount of meter #1. This power can be RF, dc, or a combination of the two producing a constant reading on the 431B. When a dc power increase is applied to the thermistor from the hp 8402A Power Meter Calibrator, after a leveled RF power has first been established, a corresponding decrease in RF output power occurs. This correlation of RF power decrease with dc power increase provides a high resolution readout calibration that can be used with an X-Y Recorder for attenuation measurements to about 10 db.

Figure 34 shows the results of two attenuation tests made with the system described. The 10 db test in (a) clearly shows the 1 db variation of a flap attenuator over a large portion of an 8-1/2 x 11" X-Y record. The low loss test in (b) demonstrates the ability of the system to detect even sharp variations in attenuation. For this test, an hp X532B Absorption Wavemeter was inserted as the test device and set to 10.0 Gc. Sweep time was 30 seconds. While the readout reaction time was not fast enough to measure the power dip accurately at wavemeter resonance, the test did reveal an extremely narrow point (approximately 2 Mc wide) that could be retraced more slowly with the 690C/D MANUAL SWEEP. Another procedure would be to narrow the total sweep over the area of resonance allowing full reaction to the true attenuation.

System calibration and operation is as follows:

- With dc substitution power (hp 8402A) off, a leveled RF power indication of 0.5 mw is established on #1 431B Power Meter. The H01-8401A Leveler Amplifier is adjusted for maximum feedback loop gain without oscillation as frequency is swept through the band.
- With the equipment connected in the CALIBRATE configuration, #2 431B Power Meter and the X-Y Recorder range is set for on-scale operation. The 0.5 mw reading on meter #1 is checked and

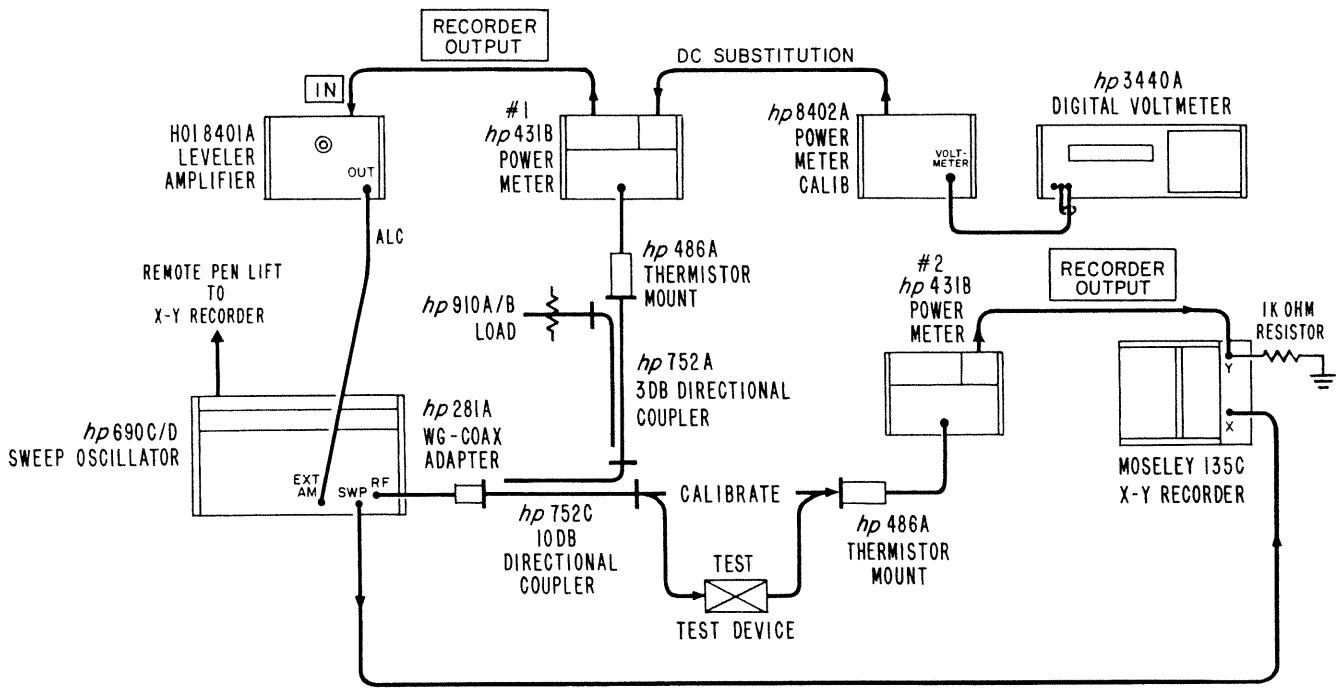

Figure 33. High resolution swept attenuation test setup using dc substitution provision in hp 431B Power Meter.

readjusted if necessary, and a zero db reference line is plotted on the X-Y Recorder. Additional reference lines are plotted near the anticipated values of attenuation to be measured by applying accurately known values of dc power to #1 power meter with the 8402A Power Meter Calibrator. Table 3 lists dc voltage readings indicated by the hp 3440A DVM for corresponding values of attenuation simulated (from 0.5 mw reference on meter #1).

- The dc substitution from the 8402A is then turned off and the test device inserted into the system and swept.

In Figure 34(a) the zero db reference was offset using the recorder ZERO in order to obtain best resolution. Note overall flatness and minimal fine grain variations in the calibration grid allowing easy readout of test results. The directional couplers in the super-leveling array were not specially matched for this test.

DVM readings for attenuation calibration with other than 0.5 mw reference on meter #1 may be calculated from the following equations:

1. For hp 8402A ranges of 0.01 to 1 mw;

$$E_{dvm} = 63.2 \sqrt{\frac{P_1 \left[1 - \log^{-1} \left(\frac{-db}{10} \right) \right]}{R_m}} \quad (6)$$

2. For hp 8402A ranges of 3 and 10 mw;

$$E_{dvm} = 20 \sqrt{\frac{P_1 \left[1 - \log^{-1} \left(\frac{-db}{10} \right) \right]}{R_m}} \quad (7)$$

Where: E_{dvm} = Digital voltmeter reading in volts

-db = Attenuation simulated

P_1 = Reference power level (mw) read on meter #1

R_m = Meter #1 thermistor mount resistance in ohms, e.g., 100 or 200 ohms

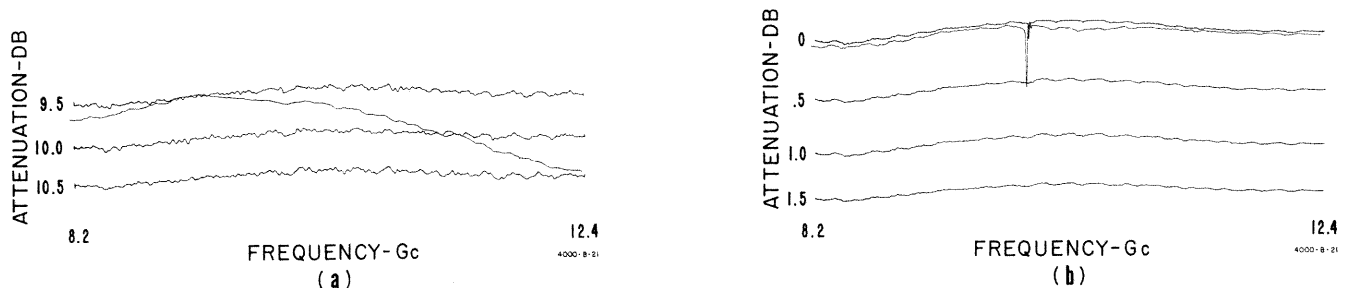

Figure 34. (a) High resolution X-Y plot of hp 375A Attenuator set at 10 db. (b) High resolution X-Y plot of hp 532B Wavemeter set at 10.0 Gc showing system reaction to sharp "holes".

TABLE 3

DC output voltage of 8402A versus RF attenuation from 0.5 mw reference. Use with system shown in Figure 33 for accurately calibrating X-Y Recorder span over desired attenuation range.

| 100 Ohm Thermistor Mount | | | | 200 Ohm Thermistor Mount | | | |
|--------------------------|--------------|----------------------------|-----------------------|--------------------------|--------------|----------------------------|-----------------------|
| Attenuation DB | DVM Volts | Attenuation DB (cont'd) | DVM Volts (cont'd) | Attenuation DB | DVM Volts | Attenuation DB (cont'd) | DVM Volts (cont'd) |
| 0 | 0 | 5.5 | 3.790 | 0 | 0 | 5.5 | 2.680 |
| 0.5 | 1.475 | 6.0 | 3.869 | 0.5 | 1.043 | 6.0 | 2.736 |
| 1.0 | 2.028 | 6.5 | 3.939 | 1.0 | 1.434 | 6.5 | 2.786 |
| 1.5 | 2.417 | 7.0 | 4.001 | 1.5 | 1.709 | 7.0 | 2.829 |
| 2.0 | 2.716 | 7.5 | 4.055 | 2.0 | 1.921 | 7.5 | 2.867 |
| 2.5 | 2.958 | 8.0 | 4.102 | 2.5 | 2.092 | 8.0 | 2.900 |
| 3.0 | 3.158 | 8.5 | 4.144 | 3.0 | 2.233 | 8.5 | 2.930 |
| 3.5 | 3.326 | 9.0 | 4.180 | 3.5 | 2.352 | 9.0 | 2.956 |
| 4.0 | 3.469 | 9.5 | 4.213 | 4.0 | 2.453 | 9.5 | 2.980 |
| 4.5 | 3.592 | 10.0 | 4.242 | 4.5 | 2.540 | 10.0 | 3.000 |
| 5.0 | 3.698 | 10.5 | 4.267 | 5.0 | 2.614 | 10.5 | 3.017 |



FREQUENCY

GENERAL

Frequency measurements fall into two general classifications, active and passive. Active measurements are those in which the frequency of an active source such as a signal generator, transmitter, or local oscillator is being checked. The hp 5245L/5254A Electronic Counter measures active sources directly to frequencies well into the microwave region with accuracies of a few parts in 10^8 . Frequencies above the counter range may be measured indirectly using the hp 540B Transfer Oscillator or 2590A Microwave Frequency Converter, in conjunction with the 5245L/5253B Counter. The counter/transfer oscillator has become the mainstay of microwave frequency measurements requiring high accuracy.

In certain applications where accuracy requirements are not as critical, the simplicity and low cost of passive frequency measurements may be enjoyed. Cavity wavemeters such as the hp 532, 536A, and 537A are two port passive devices that absorb part of the input power in a tunable resonant cavity. When the cavity is tuned to resonate at the input frequency, a dip occurs in the output power level which is detected and indicated by a meter or oscilloscope. Frequency is then read directly on a calibrated dial driven by the cavity tuning mechanism. The accuracy of cavity wavemeters depends upon the cavity Q, tuning dial calibration, backlash and the effects of temperature and humidity variation. The hp waveguide and coax frequency meters, 532 series, 536A and 537A, achieve accuracies of a few parts in 10^4 .

Swept techniques with a counter/transfer oscillator reference, can be used to great advantage in calibrating passive devices such as the wavemeters described.

WAVEMETER CALIBRATION

A system for calibrating several wavemeters with great speed is shown in Figure 35. Using the ΔF sweep mode, the 690C/D is set for a leveled, rapidly sweeping output across a small segment of the wavemeter's band with the main power being fed through the wavemeters to a crystal detector. The detected wavemeter dip is fed to the vertical input of an oscilloscope and subsequently displayed on the CRT. This constitutes the measurement channel of the system. The reference channel is formed by coupling a portion of the sweeper output to the input of the 540B Transfer Oscillator. Harmonics of the transfer oscillator mix with the sweeping input signal producing heterodyne "birdies" at intervals equal to the transfer oscillator fundamental frequency. For example, if the transfer oscillator frequency is 200 Mc, and the input frequency is sweeping from 8.2 to 12.4 Gc, birdies will appear every 200 Mc throughout the swept band. The horizontal input of the oscilloscope is driven by the dc sweep voltage from the 690C/D.

The frequency interval of the birdies may be precisely set using the 5245L counter to monitor the transfer oscillator fundamental frequency. The birdies are fed through a BNC Tee connector to the oscilloscope vertical input and superimposed with the wavemeter dip. Now each wavemeter may be adjusted in turn for coincidence of the dip and reference birdies, noting the accuracy of dial calibration at each point. Frequency resolution of the display may be adjusted with the sweeper's STOP/ ΔF control which determines the sweep excursion. The center frequency of the sweep is set by the START/CW control when operating in the ΔF sweep mode. The START/CW control is used to progressively tune across the wavemeter band, stopping at each birdie and superimposing the wavemeter dip. Figure 36(a) shows a wide sweep displaying several birdies for rapid initial tuning of the wavemeter dip. Figure 36(b) shows the resulting display on a narrow sweep when the wavemeter dip and reference birdie coincide.

In most cases the wavemeter dial calibration will be accurate enough so that the absolute frequency of a birdie need not be measured, only its interval as provided by the display. When positive identification of birdie frequency is desired, the transfer oscillator is alternately set to adjacent zero beats with the 690C/D STOP/ ΔF set near zero. The counter readings at each beat are then used for unique determination of the birdie frequency. All other birdie frequencies are then easily determined by adding (or subtracting) the frequency interval to the birdie measured. Since frequency increases from left to right on the oscilloscope display, the easiest method is to measure the absolute frequency of

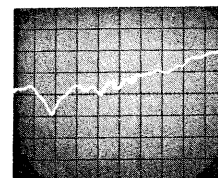

ATTENUATION

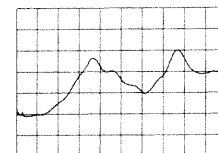

IMPEDANCE
REFLECTION
COEFFICIENT



POWER

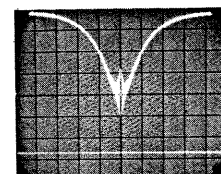

FREQUENCY

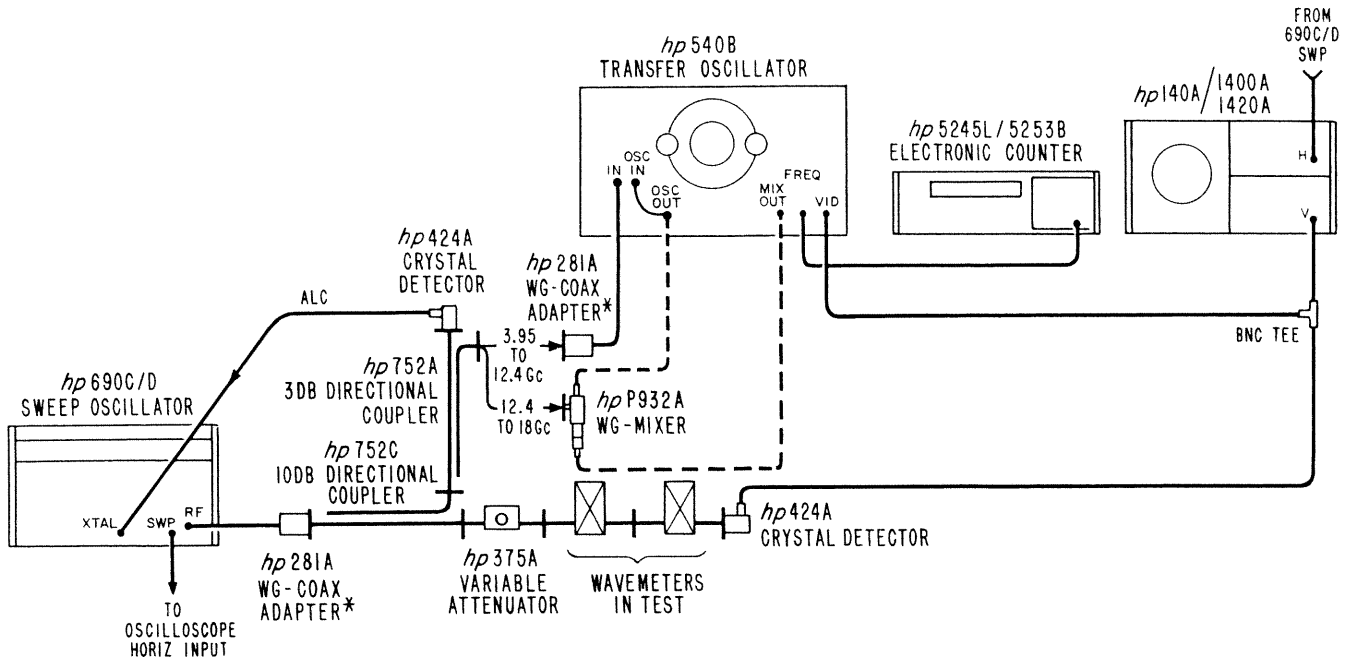

* WG-COAX ADAPTER NOT REQUIRED FOR 12.4-18Gc BAND

4000-B-21

Figure 35. Swept system for rapid frequency testing passive devices to 18.0 Gc. Internal mixer in 540B is used to 12.4 Gc. HP P932A Waveguide Mixer operates external to 540B to cover 12.4 to 18.0 Gc range.

the birdie closest to the left edge of the display and simply add the interval frequency for each birdie progressively to the right. To do this proceed as follows:

- Carefully set the transfer oscillator fundamental frequency to 200 Mc as read on the counter.
- Observing the oscilloscope display, reduce the 690C/D sweep width with the STOP/ Δ F control until the zero beat is about 1 cm wide. Re-adjust the START/CW control as required to position the lowest frequency birdie in the center of the display.

- Note the transfer oscillator fundamental frequency as read on the counter.
- Carefully adjust the transfer oscillator frequency to the adjacent zero beat, placing it exactly at center screen on the oscilloscope, and again note the counter reading.
- Calculate the harmonic number (N) from the equation

$$N_1 = \frac{F_2}{F_1 - F_2}, \quad (8)$$

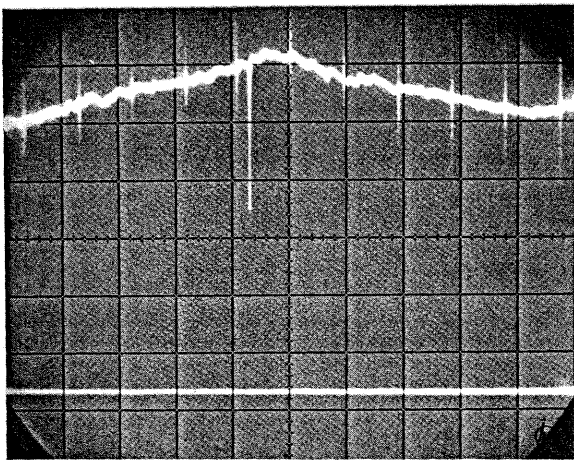

(a)

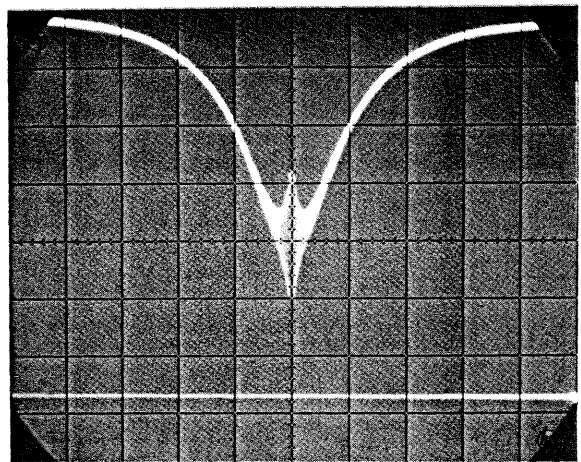

(b)

4000-A-27

Figure 36. (a) CRT photo of wavemeter dip and several birdies for rapid adjustment. (b) CRT photo of wavemeter dip and single birdie for high resolution.

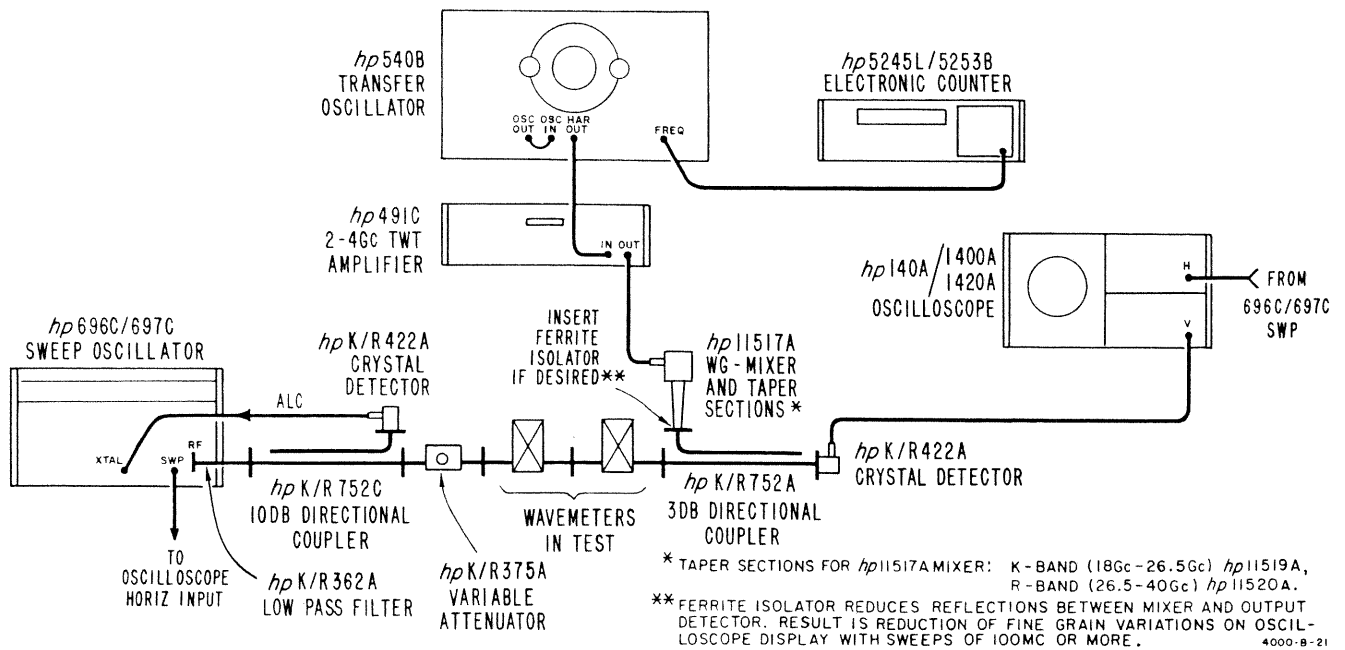

Figure 37. Swept system for passive frequency measurements from 18.0 to 26.5 Gc (K-band) and 26.5 to 40.0 Gc (R-band). TWT Amplifier boosts harmonic output from hp 540B in 2 - 4 Gc region. External harmonic generator then produces K or R-band harmonics for mixing with sweeper output.

where N_1 is always a whole number and F_1 is the larger of the two fundamental frequencies measured. The birdies frequency then is $F_x = N_1 F_1$. (9)

Example: $F_1 = 200$ Mc

$F_2 = 195.238$ Mc

$$N_1 = \frac{195.238}{(200 - 195.238)} = 41$$

$F_x = (41) \times 200$ Mc = 8.2 Gc

Between 12.4 and 18.0 Gc, the hp P932A Waveguide Mixer is used external to the transfer oscillator as shown in Figure 35 by the dashed line connections. After connecting the external mixer, the measuring procedure is identical to that described for frequencies below 12.4 Gc.

From 18.0 to 40.0 Gc the system configuration is altered and an amplifier added to boost the higher harmonic output of the transfer oscillator.

In the test setup of Figure 37, the K or R-Band sweep oscillator power is leveled and fed through a variable attenuator to the wavemeters in test. The attenuator is set to about 20 db to reduce source power and pad effects of the wavemeter reaction at resonance. The wavemeter dip is detected by the hp 422A detector and displayed on the oscilloscope. Vertical sensitivity of the oscilloscope is set to about 200 μ v/cm with a bandwidth of 400 kc. Harmonics generated by the 540B Transfer Oscillator are amplified in the 2-4 Gc region by the TWT amplifier and fed to the hp 11517A Waveguide Mixer at a level of about 250 mw.

Before connecting the TWT output to the mixer, the power level should be adjusted using the TWT gain control. An hp 431B/478A Power Meter and 20 db coaxial

attenuator connected to the TWT output allows convenient adjustment to be made for a reading of 2.5 mw (+ 20 db correction for pad = 250 mw). The TWT output is now connected to the coax input of the mixer resulting in harmonic generation in the 18 to 40 GC region. Harmonics are at frequency intervals equal to the transfer oscillator fundamental frequency as measured by the counter. The harmonics are combined with the wavemeter dip and detected by the 422A Detector with subsequent display on the oscilloscope. Optimum birdie amplitude with relation to the wavemeter dip is affected by the oscilloscope vertical sensitivity and bandwidth, 375A attenuation setting, and TWT gain. Slight readjustment of TWT gain may be required to peak the birdie amplitude after initial adjustments have been made.

Note in Figure 37, that a ferrite isolator between the harmonic mixer and 3 db coupler is optional. The isolators will reduce fine grain power variations in the display caused by mixer reflections as shown in Figure 38. The isolator does not increase accuracy but may be desirable from a readout convenience standpoint.

SYSTEM ACCURACY

The overall accuracy of the measuring system just described is determined primarily by 1) the accuracy of the birdie markers and 2) the accuracy in comparing the wavemeter dip to the birdies.

Birdie accuracy depends on the transfer oscillator stability and the counter accuracy. Comparison accuracy is determined by the wavemeter Q and overall system resolution.

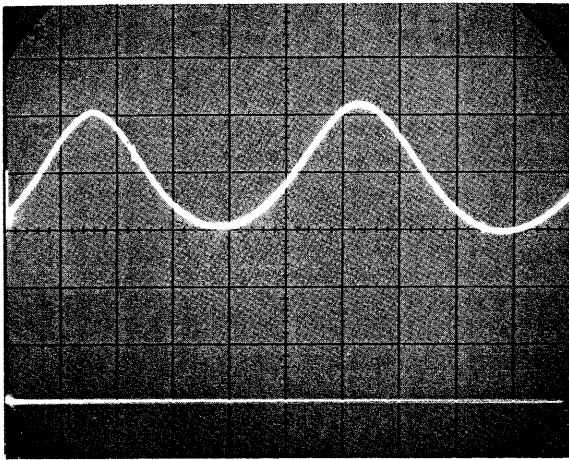

(a)

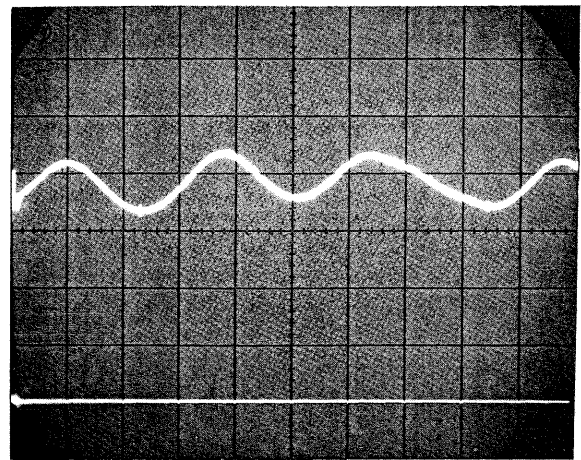

(b)

4000-A-27

Figure 38. (a) Power variations in R-band wavemeter calibration setup without ferrite isolator between harmonic mixer hp 11517A and 3-db coupler. (b) Power variations with ferrite isolator. Vertical sensitivity for both photos is 2 mv/cm, birdie interval at 200 Mc.

The various sources of error for a typical system in K-Band, using the equipment and procedure previously described, are as follows:

Birdie Accuracy*: HP 5245L Counter (± 1 count ambiguity \pm time base stability) = $(\pm 1/10^8 \pm 3/10^9) = 13/10^9$.

HP 540 B transfer oscillator stability = $2/10^7$ short term.

Comparison Accuracy: With a 40 Mc sweep (one birdie displayed) and a wavemeter Q of approximately 4000, resolution is about 1 Mc or $4/10^5$.

*After equipment reaches thermal equilibrium.

Note that resolution is the primary limiting factor, so the usual procedure is to initially tune the wavemeter dip to the birdie with a convenient wide sweep, then make the final adjustment on a smaller sweep such as 40 Mc in K-Band. This provides the convenience and resolution necessary for checking the wavemeter accuracy.

CAVITY Q MEASUREMENTS

Cavity Q is defined as the ratio:

$$Q = \frac{f_0}{f_1 - f_2}, \quad (10)$$

where f_0 = resonant frequency of the cavity $\approx \frac{f_1 + f_2}{2}$.

f_1 & f_2 = frequencies above and below resonance, respectively, corresponding to the half power points of the cavity response.

Using the relationship of equation 10, cavity Q may easily be measured with the system shown in Figure 35 or 37. The birdie in Figure 36(b) may be alternately set to the half amplitude points* on the dip by carefully tuning the transfer oscillator frequency. Cavity Q is then calculated directly from the two transfer oscillator fundamental frequencies as read on the counter. There is no need to determine the harmonic number and actual microwave frequencies.

$$Q = \frac{f_1' + f_2'}{2(f_1' - f_2')} \quad (11)$$

Where f_1' and f_2' = transfer oscillator fundamental frequencies at cavity half power points.

* Half amplitude on the display corresponds to half power when the detector is operating in square law.

NOISE FIGURE

Swept frequency noise figure analysis may be made on broadband microwave devices such as traveling wave tube amplifiers by providing a sweeping receiver and using an automatic noise figure meter. Figures 39 and 40 show the system diagram and a swept frequency plot of noise figure for traveling wave tube amplifiers at specific electrode potentials. The IF amplifier shown has a bandwidth of 1 Mc, and since the sweeping receiver has full image response, the noise figure meter responds to the average of two 1 Mc windows spaced ± 30 Mc from the local oscillator frequency. This is normally adequate for measurements where the swept frequency plot is not changing rapidly.

For proper accuracy, it is necessary to make a calibrating run on the receiver itself to assure that its noise contribution is negligible. In Figure 39 shown, the receiver noise figure remained below 15 db across the band, and thus adds no error to the TWT contribution of approximately 25 - 30 db.

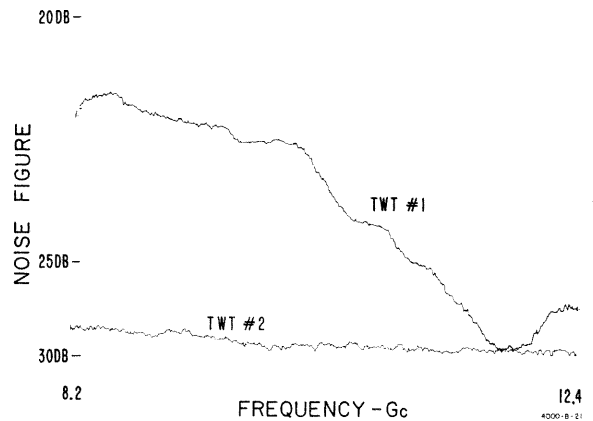
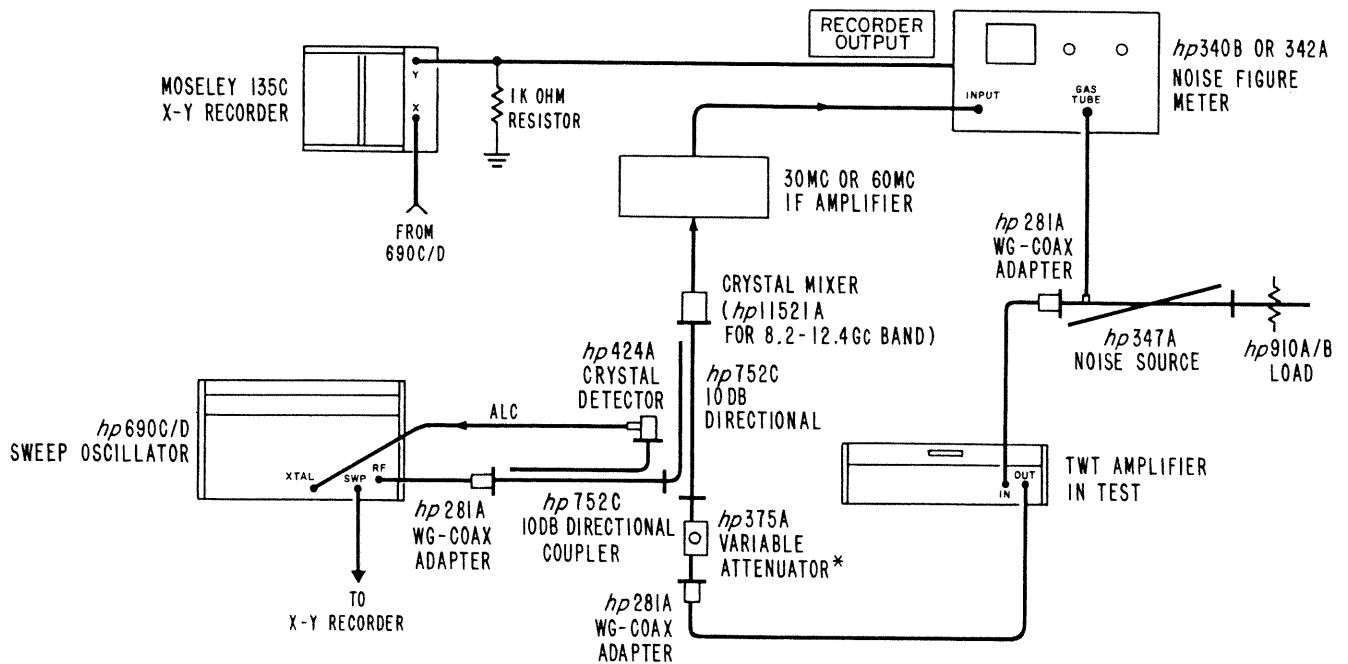

Figure 40. X-Y plot of noise figure for two TWT amplifiers measured with system shown in Figure 39.



* 375 VARIABLE ATTENUATOR OPTIONAL

NOTE: SWEEPER LEVELING AND TWT OUTPUT SIGNAL MIXING CAN BE ACCOMPLISHED WITH COAX COMPONENTS BELOW X-BAND.

4000-B-21

Figure 39. The noise figure for such broadband microwave devices as traveling wave tube amplifiers can be analyzed with system shown above. Receiver noise figure is negligible compared to the TWT contribution.



REFLECTION AND ATTENUATION SCALES FOR LINEAR OSCILLOSCOPES

USE IN ACCORDANCE WITH HP APPLICATION NOTE 65

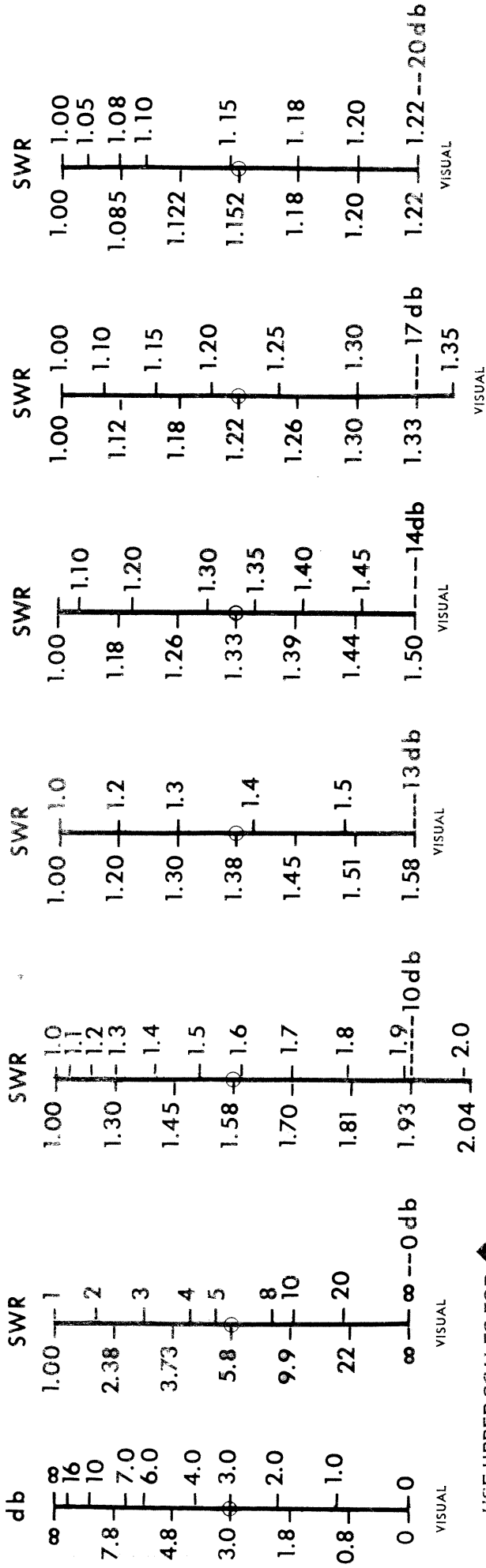

USE UPPER SCALES FOR DIRECT VIEWING



USE LOWER SCALES FOR PHOTOGRAPHY ON INTERNAL GRATICULE CRT WITH HP 196B

