

Agilent AN 1316

Optimizing Spectrum Analyzer Amplitude Accuracy

Application Note

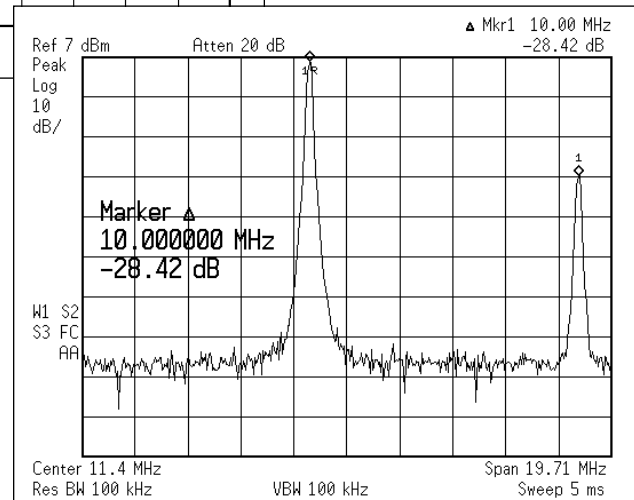
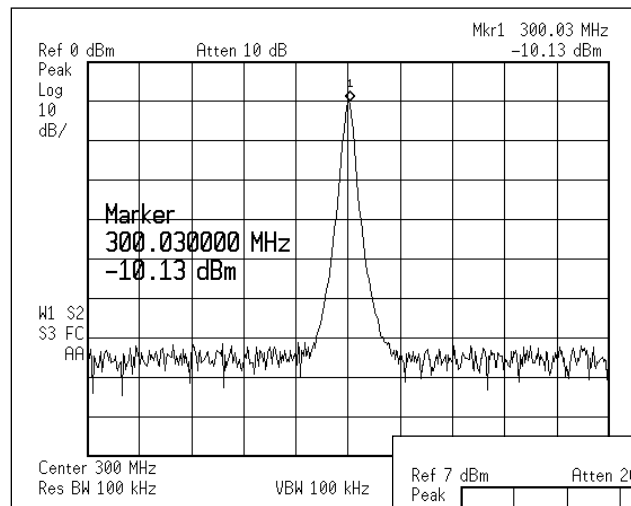

RF & Microwave Spectrum Analyzers



Agilent Technologies

Innovating the HP Way

Table of Contents

3	Introduction
3	Absolute versus relative measurements
4	Factors affecting measurement uncertainty
4	Sources of uncertainty
5	Relative amplitude uncertainty factors
7	Absolute amplitude uncertainty factors
8	Calculating total uncertainty
8	Examples
13	Errors
13	Overall amplitude accuracy
14	Reducing overall uncertainty
16	Summary
16	References

Introduction

This application note covers the factors affecting the accuracy (or uncertainty) of amplitude measurements made with spectrum analyzers, and explains how to calculate worst-case uncertainty in general situations. It will help you analyze a measurement and decide what procedure to follow to minimize overall uncertainty. Also, you will learn the most important accuracy-related features and specifications to consider when choosing a spectrum analyzer. This note does not cover specialized measurement procedures for certain types of signals that introduce additional sources of uncertainty, such as noise, pulsed RF, and EMI. Refer to the References for additional reading.

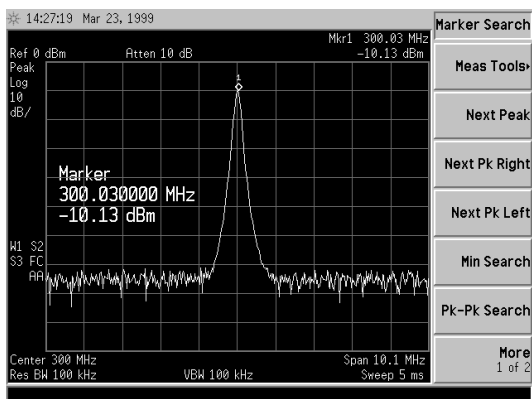

Figure 1. Absolute measurement (one signal level measured with a single marker)

Absolute versus relative measurements

Amplitude measurements are either absolute (Figure 1) or relative (Figure 2). Absolute amplitude is the power or voltage level of a signal. For example, measuring the power level of a carrier in dBm is an absolute measurement. Relative amplitude is the difference between two levels, typically expressed in dB. Relative measurements use one signal or signal component as a reference. For example, a harmonic distortion measurement uses the fundamental as the reference, and the harmonic is usually measured in dBc (decibels relative to the carrier level). Most spectrum analyzer applications involve relative amplitude measurements.

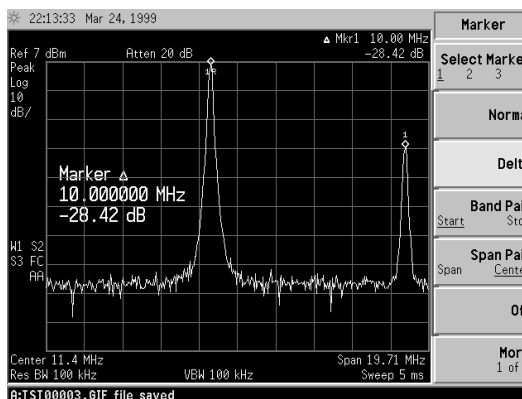

Figure 2. Relative measurement (difference between two signal levels measured with the delta marker)

Factors affecting measurement uncertainty

Let's look first at the factors affecting measurement uncertainty. Later sections will show how to calculate the uncertainty of an amplitude measurement by considering each of these factors, and how to obtain the best accuracy for a measurement.

Sources of uncertainty

The simplified block diagram in Figure 3 shows the elements of a typical spectrum analyzer. Some of these elements can contribute uncertainty to amplitude measurements. These contributions are called amplitude uncertainty factors in this application note, and are specified for most spectrum analyzers.

Table 1 lists the amplitude uncertainty factors of a typical spectrum analyzer. The range of values for each factor covers a variety of spectrum analyzers. Most spectrum analyzers have specifications for both absolute and relative uncertainties. Since relative uncertainties affect the accuracy of both relative and absolute measurements, let's look first at those factors affecting relative measurement uncertainty.

Table 1. Amplitude Uncertainty Factors

Relative	±dB
Frequency response (flatness)	0.5 to 4
Band switching	0.5 to 1
Scale fidelity	0.5 to 2
Reference level (IF gain)	0.1 to 1
Input attenuator switching	0.5 to 2
Resolution bandwidth switching	0.1 to 1
Display scale switching	0.0 to 1
Absolute	
Frequency response	0.5 to 4
Calibrator	0.2 to 1

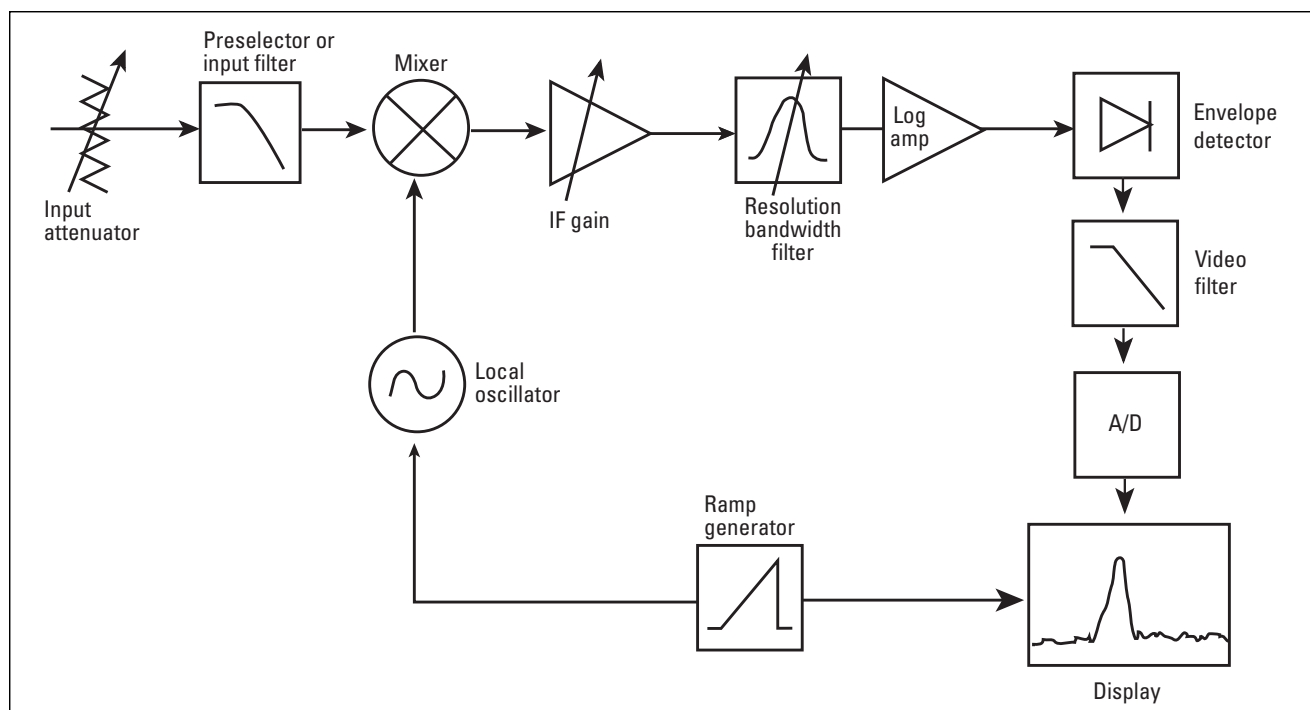

Figure 3. Elements of a typical superheterodyne spectrum analyzer

Relative amplitude uncertainty factors

Frequency response (flatness)

Frequency response uncertainty, or flatness, represents a window of uncertainty over the specified frequency range (sometimes called a band). See Figure 4.

Spectrum analyzer frequency response is often the single highest contributor to uncertainty. It is a function of input attenuator flatness, mixer conversion loss, and preselector flatness (if applicable). Frequency response affects the displayed amplitudes of signals at different frequencies. It is frequency range dependent and specified as $\pm n$ dB over a frequency range (typically a harmonic band) at a given attenuator setting.

Frequency response uncertainty is usually specified for both relative and absolute measurements. Relative frequency response uncertainty describes the largest possible amplitude uncertainty over a given frequency range relative to the midpoint between the amplitude response extremes within that frequency range.

The relative frequency response specification for a given frequency range tends to be lower than the absolute frequency response specification (defined below) for the same frequency range. However, to obtain the frequency response uncertainty for relative amplitude measurements within a band, the relative frequency response specification must be doubled to reflect the peak-to-peak frequency response. This peak-to-peak frequency response

uncertainty is often greater than the absolute frequency response specification.

A low-frequency RF analyzer might have a relative frequency response uncertainty of ± 0.5 dB. A microwave spectrum analyzer tuning in the 20-GHz range could well have an uncertainty in excess of ± 4 dB. In our calculations, we assume the worst-case situation, where the frequency response varies over the full amplitude uncertainty range. As shown in Figure 4, the worst-case response varies from plus 1 dB to minus 1 dB for a specification of ± 1 dB. We will see practical application of these specifications later.

Some spectrum analyzers require you to “peak” the preselector (“preselector centering” in the Agilent ESA series analyzers) for the frequency response specifications to be valid. On spectrum analyzers that require peaking of the signal amplitude, such as the Agilent 8593E, 8595E, and 8596E, using preselector peak prior to measuring a signal yields the most accurate amplitude reading at the specified frequency. The preselector peak function automatically adjusts the preselector tracking to peak the signal at the active marker. While preselector peak maximizes the peak response of the signal of interest, it may degrade the frequency response at other frequencies. So, it is important to set the preselector-peak values to their defaults before measuring a signal at another frequency. Some spectrum analyzers, such as the Agilent 8560 series, do not require preselector peaking.

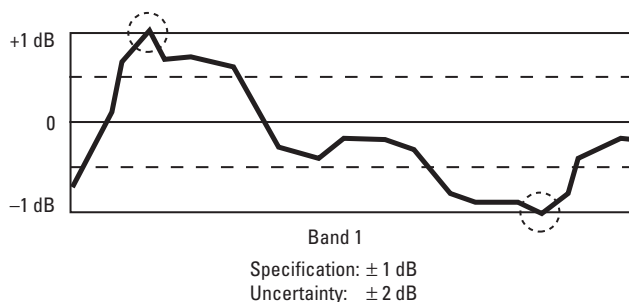

Figure 4. Typical in-band frequency response uncertainty

Band switching

Mixing the input signal with harmonics of the local oscillator (LO) allows measurements over a very wide frequency range. Each LO harmonic provides a different harmonic frequency band within the analyzer's overall frequency range. When signals in different harmonic bands are measured, additional uncertainties arise when the analyzer switches from one band to another. On some spectrum analyzers, the band-switching points are visible as discontinuities in the displayed noise floor. To see if your measurement involves more than one band, refer to your analyzer's specifications for the frequency ranges related to each harmonic band. Although not always specified, a typical band-switching uncertainty is ± 1 dB.

Scale fidelity

Scale fidelity uncertainty applies when a signal at one vertical position on the display graticule is measured with respect to another signal at a different vertical position; for example, when delta markers are placed at the peaks of two signals of unequal amplitude. Scale fidelity depends upon the detector's linearity, digitizing circuit linearity, and the log/linear and vertical amplifiers' ability to transform different signal voltages into their appropriate relative power (log) or voltage (linear) levels on the display. With most spectrum analyzers, the accuracy of the log amplifier degrades near the bottom of the measurement range. The display itself is not a factor for analyzers using digital techniques and offering digital markers because the marker information is taken from trace memory, not the display.

For log mode, scale fidelity is better over small amplitude differences, and ranges from a few tenths of a dB for signals close together to 2 dB for large amplitude differences. A typical scale fidelity specification is ± 0.4 dB/4 dB to a maximum of ± 1.0 dB. The ± 0.4 dB/4 dB specification is applied when the two signals are close in amplitude; the cumulative specification applies to larger amplitude differences.

The remaining relative factors in Table 1 involve controls that can be changed during a measurement.

Reference level (IF gain)

The amplitude represented by the top line of the graticule is the reference level. It is a function of the input attenuation and the IF gain. The reference level control determines the IF gain. Uncertainty in the amount of IF gain at a particular reference level setting affects the accuracy of the reference level amplitude. Any changes in the reference level control introduce uncertainty. On spectrum analyzers that can be calibrated in linear voltage, the reference level control determines the amplitude per division scaling from the bottom line of the graticule. For 8560 series portable spectrum analyzers, the specification for this factor is "IF gain uncertainty," but for ESA series and 8590 series analyzers it is "reference level accuracy." An example of a reference level uncertainty specification is ± 0.3 dB at -20 dBm, with some incremental uncertainty the further you are from -20 dBm.

Input attenuator switching

Input attenuation has inherent uncertainty that reduces reference level accuracy only if you change the attenuator setting between reference level calibration and the measurement. Because the input attenuator operates over the entire frequency range of the analyzer, its step accuracy is a function of frequency. At low frequencies, expect the attenuator to be quite good; at 20 GHz, not as good. (Since the IF gain operates at only one frequency, it is not surprising that its uncertainty is less than that of the input attenuator.) A typical input attenuator switching uncertainty is ± 1 dB.

Resolution bandwidth switching

Different resolution bandwidth (RBW) settings have different insertion loss characteristics. This may cause amplitude changes when the same signal is measured with different settings. Changing the bandwidth setting between amplitude measurements degrades accuracy. A typical RBW switching uncertainty is ± 0.4 dB.

Display scale switching

Changing the per division scaling factor—for example, from 10 dB/division to 1 dB/division or to linear—introduces uncertainty associated with the relative calibration characteristics of the log/linear amplifiers. Avoid adding this uncertainty by not changing the scale. A typical linear-to-log switching uncertainty is ± 0.25 dB at the reference level. This may not be a factor for spectrum analyzers that store trace data into memory and then display data from the memory.

Impedance mismatch

Although not included in Table 1 (since it depends on the signal source as well as the analyzer), impedance mismatch is another factor in measurement uncertainty. The spectrum analyzer tries to measure the signal level across a 50 Ω load (or 75 Ω load if your analyzer has a 75 Ω input), but the spectrum analyzer input impedance is not exactly the characteristic impedance, so uncertainties may arise. In some cases, uncertainty due to mismatch

is small. For example, if the analyzer's input VSWR is 1.3 and the source's VSWR is 1.2, the maximum uncertainty due to mismatch is ± 0.1 dB. On the other hand, if both the analyzer and the source have VSWRs of 2.0, mismatch uncertainty approaches ± 1 dB.

Absolute amplitude uncertainty factors

Frequency response

Absolute frequency response uncertainty describes the largest possible amplitude uncertainty over a given frequency range relative to the amplitude of an amplitude reference signal (for example, the 50 MHz amplitude reference of Agilent ESA series analyzers or the 300 MHz reference of Agilent 8560 series and 8590 series analyzers).

Calibrator

Absolute measurements are measurements made relative to a calibration signal, which has a known amplitude. Most spectrum analyzers have a built-in calibrator ("amplitude reference" on ESA series analyzers) that provides a signal with specified amplitude at one frequency. A typical calibrator has an uncertainty of ± 0.3 dB. The calibrator provides absolute calibration for the top line of the graticule. Since the calibrator source typically operates at a single frequency, we rely upon the relative accuracy of the analyzer to translate the absolute calibration to other frequencies and amplitudes.

Since our signal to be measured is usually at a different frequency than the calibrator, we may need to change the frequency control. Since it's typically at a different amplitude as well, we may need to change the reference level to bring the signal to the top graticule line for best accuracy (if IF gain uncertainty is less than scale fidelity uncertainty). These changes contribute relative amplitude uncertainty to the measurement.

Calculating total uncertainty

Let's see how to calculate measurement uncertainty for a few general situations.

Examples

Relative measurement (delta marker) within a band

When comparing two signals in the same frequency band, the relevant uncertainties are frequency response (relative) and scale fidelity.

Figure 5 shows a 900 MHz signal at the reference level and its second harmonic at 1.8 GHz with an amplitude below the reference level. If the signals are in the same band, the frequency response uncertainty when comparing them is two times the specification (for example, two times ± 1 dB = 2 dB peak-to-peak), since the amplitude uncertainty at each signal's position could fall on the plus or

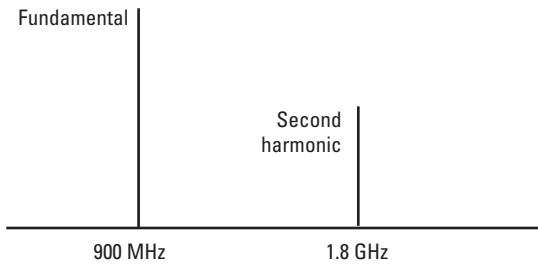

Figure 5. Fundamental and second harmonic in the same frequency band

minus extreme of the specification window (refer to Figure 4). Specification values for three different instruments are given in Table 2.

Table 2. Accuracy Specifications for In-Band Relative Measurements

Factor	8593E Specification (\pm dB)	8563E Specification (\pm dB)	E4407B Specification (\pm dB)
Frequency response	1.0 to 2.0 (relative)	1.0 to 3.3 (relative)	0.5 to 2.0 (relative)
Scale fidelity	1.1 max (over 70 dB range)	0.85 max (over 90 dB range)	1.15 max (over 85 dB range; RBW \geq 1 kHz) 1.28 max (over 98 dB range, RBW \leq 300 Hz)

In general, unless the signals you are measuring are above 20 GHz, frequency response uncertainty will not be significant unless the signals are separated by 50 MHz or more. As an example, let's apply these uncertainties to a TOI (third-order intercept) measurement for two 2 GHz signals separated by 50 kHz with third-order distortion at -80 dBc (see Figure 6).

The uncertainty calculation when making the measurement with an 8560E is shown in Table 3.

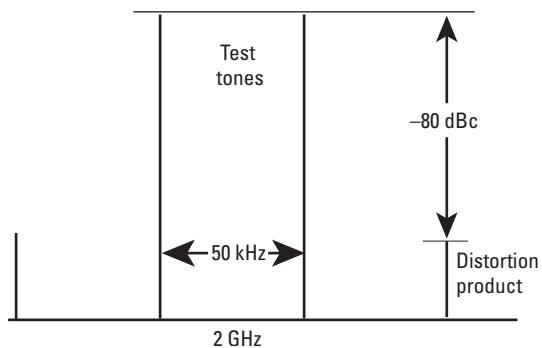

Figure 6. TOI measurement

Table 3. Uncertainty Calculation for an In-Band TOI Measurement

8560E		
Factor	Specification (\pm dB)	Uncertainty (\pm dB)
Frequency response (input tone)	1.0	N/A
Frequency response (distortion product)	1.0	N/A
Scale fidelity	0.85 max (over 90 dB range)	0.85
Total uncertainty		0.85

Relative measurement (delta marker) across two or more bands

If comparing signals in different bands (between-band measurements), add the frequency response uncertainties of each band (see Figure 7). If the band-switching uncertainty is specified, add it to the frequency response. If band-switching uncertainty is not specified, use the absolute frequency response (relative to the calibrator) instead of the relative frequency response uncertainty for each band.

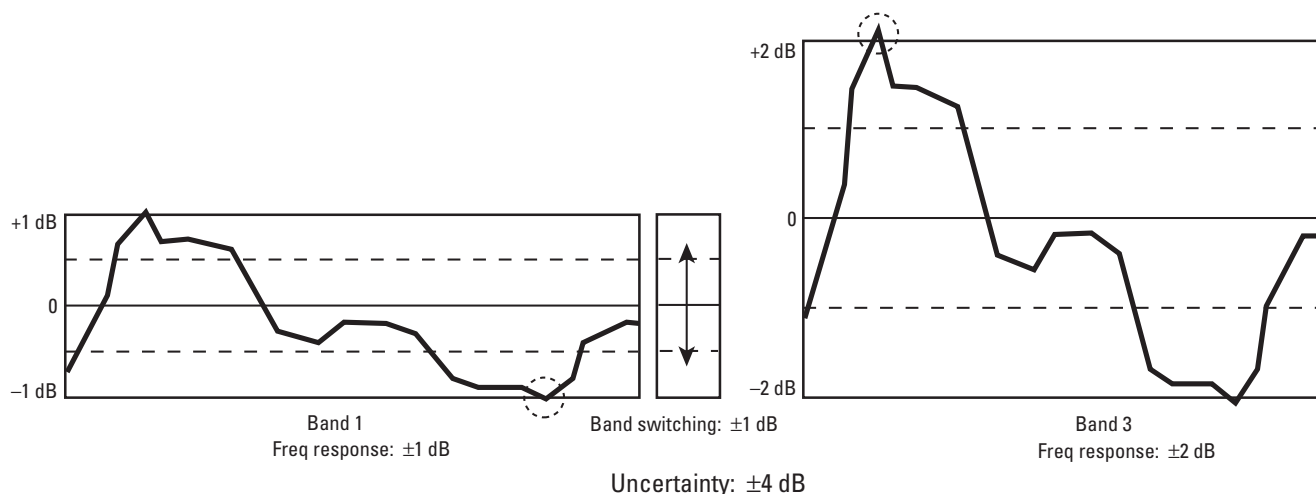

Figure 7. Frequency response uncertainty for a between-band measurement

The relevant specifications for three different analyzers are given in Table 4.

Let's look at an example of measuring a second harmonic with two different instruments. The fundamental is at 10 GHz and the level of the second harmonic is -85 dBc. Using the Agilent 8563E specifications for the calculation:

Frequency response at 10 GHz	= ±2.2 dB
Frequency response at 20 GHz	= ±2.5 dB
Band-switching uncertainty	= ±1.0 dB
Scale fidelity	= ±0.85 dB
<hr/>	
Total uncertainty	= ±6.55 dB

Let's make the calculation for the 8593E. Use absolute frequency response because this is a between-band measurement and band-switching uncertainty is not specified. Frequency response uncertainty is ±2.5 dB at 10 GHz and ±3.0 dB at 20 GHz. Notice the scale fidelity specification is for the range 0 to -70 dB. Since we need to measure -85 dBc, we must use a different measurement procedure than the one used with the 8563E. After measuring the fundamental, change the reference level to -20 dBm (assume the fundamental was measured with 0 dBm reference level). Though this introduces IF gain uncertainty, we can now make the measurement. Let us calculate total uncertainty:

Frequency response at 10 GHz (0 dBm reference level)	= ±2.5 dB
Frequency response at 20 GHz (-20 dBm reference level)	= ±3.0 dB
Scale fidelity (-65 dBc)	= ±1.05 dB
Reference level uncertainty (at 0 dBm) = 0.3 dB + 0.1 X 20	= ±0.5 dB
<hr/>	
Total uncertainty	= ±7.05 dB

See Table 5 for a summary of these calculations. Note that the 8593E can make the measurement, but the wider display range on the 8563E allows the measurement to be made with less uncertainty, since the reference level doesn't have to change. The Agilent E4407B can make the measurement with the least amount of uncertainty.

Table 4. Accuracy Specifications for Between-Band Relative Measurements

Factor	8593E Specification (±dB)	8563E Specification (±dB)	E4407B Specification (±dB)
Band switching	No specification	1.0	None
Frequency response	1.5 to 5.0 (absolute)	1.0 to 3.3 (relative)	0.5 ¹ to 3.0 ² (absolute)
Scale fidelity	1.1 max (over 70 dB range)	0.85 max (over 90 dB range)	1.15 max (over 85 dB range; RBW ≥ 1 kHz) 1.28 max (over 98 dB range, RBW ≤ 300 Hz)

1. 20 to 30 °C
2. 0 to 55 °C

Table 5. Uncertainty Calculations for a Between-Band Relative Measurement

Factor	8593E Specification	Uncertainty	8563E Specification	Uncertainty	E4407B Specification	Uncertainty
Frequency response (@10 GHz)	±2.5 dB (absolute)	±2.5 dB	±2.2 dB (relative)	±2.2 dB (relative)	±2.0 dB (absolute)	±2.0 dB (absolute)
Frequency response (@20 GHz)	±3.0 dB (absolute)	±3.0 dB	±2.5 dB (relative)	±2.5 dB (relative)	±2.0 dB ¹ (absolute)	±2.0 dB ¹ (absolute)
Band switching	No specification		±1.0 dB	±1.0 dB	No specification	
Scale fidelity	±1.1 dB max (over 70 dB range)	±1.05 dB (-65 dBc)	±0.85 dB max (over 90 dB range)	±0.85 dB max	±1.15 dB max (over 85 dB range) ±1.28 dB (over 98 dB range)	±1.15 dB (-85 dBc)
Reference level		±0.5 dB		N/A		N/A
Total uncertainty		±7.05 dB		±6.55 dB		±5.15 dB

1. 20 to 30° C (±2.5 dB for 0 to 55° C)

As another example of a between-band measurement, suppose you need to make a spur measurement from 22 GHz to 26.5 GHz with a carrier at 10 GHz. The spurs must be -70 dBc or lower (see Figure 8). You want to know how accurately you can measure the spurs from 22 GHz to 26.5 GHz relative to the 10 GHz carrier. The factors to consider are the frequency response (relative) for the two bands, band-switching uncertainty, and scale fidelity. Using the 8563E specifications in Table 6, the frequency response (relative) for the 6.46 GHz to 13.2 GHz band is ±2.2 dB, the frequency response for the 22 to 26.5 GHz band is ±3.3 dB, band-switching uncertainty is ±1 dB, and scale fidelity (log) is ±0.85 dB, for a total uncertainty of ±7.35 dB.

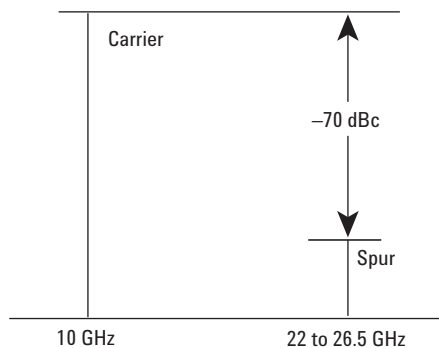

Figure 8. Spur measurement

Table 6. Uncertainty Calculation for a Between-Band Spur Measurement

Factor	8563E Specification (±dB)	Uncertainty (±dB)
Frequency response (6.46 to 13.2 GHz)	2.2	2.2
Frequency response (22 to 26.5 GHz)	3.3	3.3
Band switching	1.0	1.0
Scale fidelity	0.85 max (over 90 dB range)	0.85
Total uncertainty		7.35

Absolute measurement (single marker)

If only frequency and amplitude controls are changed, absolute accuracy depends on these three factors: calibrator accuracy, absolute frequency response from the signal to the calibrator, and IF gain uncertainty (“reference level accuracy” for Agilent ESA series and 8590 series analyzers) due to changes from the calibrator level. For a signal measured at the reference level of the analyzer, the absolute amplitude uncertainty equals the calibrator uncertainty plus the absolute frequency response uncertainty. For a signal at a level other than the reference level, change the reference level control to bring the signal to the reference level for best accuracy (if IF gain uncertainty is less than scale fidelity uncertainty). In this case, absolute amplitude uncertainty is the sum of the reference level, absolute frequency response, and calibrator uncertainties.

Suppose you need to measure a 2 GHz signal at -10 dBm. Using the Agilent 8560E specifications in Table 7 as an example, the calibrator uncertainty is ± 0.3 dB. The IF gain uncertainty of ± 1.0 dB can be left out since the calibrator level is -10 dBm in the 8560E. The absolute frequency response uncertainty is ± 1.5 dB, for a total uncertainty of ± 1.8 dB.

Table 7. Uncertainty Calculation for an Absolute Amplitude Measurement

Factor	8560E	
	Specification (\pm dB)	Uncertainty (\pm dB)
Calibrator	0.3	0.3
Reference level	1.0	N/A at reference level
Frequency response	1.5 (absolute)	1.5
Total uncertainty		1.8

When choosing a spectrum analyzer, you need to determine if a particular instrument can make your measurement. Suppose you need to make a spur measurement at 10 GHz, where the spur is offset from the carrier by 10 kHz; the spur must be at -70 dBc or lower and the carrier level must be measured to ± 3 dB. In measuring the absolute level of the carrier, the factors to consider are calibrator accuracy, IF gain uncertainty, and absolute frequency response uncertainty at 10 GHz. For the 8563E, the specifications are ± 0.3 , ± 1.0 dB, and ± 2.9 dB, respectively, for a total amplitude uncertainty of ± 4.2 dB. This is greater than the ± 3 dB requirement. However, Ampcor (see page 15) can reduce the frequency response uncertainty of this analyzer to an acceptable level. Since the largest uncertainty contributor is typically frequency response, steps taken to reduce uncertainty should first focus on reducing frequency response uncertainty, as described below.

Errors

Up to now we have discussed uncertainties. Uncertainties differ from errors in that we can correct for errors in our measurement. The following is a source of error that you should be aware of when measuring amplitude.

Signal plus noise

The amplitude at any point on the spectrum analyzer display is the sum of all energy present in the IF passband. Therefore, the displayed amplitude of a signal is actually the signal level plus the noise level. That is, the displayed signal is higher than its true value because of the added noise. Measurements of signals close to the displayed average noise level (DANL) are subject to an amplitude error due to the addition of noise. This error may be large or insignificant depending on the signal-to-noise ratio, and can be corrected. See Reference 3 for a discussion of measuring signals near noise. For signals that appear 10 dB or more above the noise, the error is negligible.

A similar error can occur when measuring closely spaced signals of unequal amplitude. This happens when both signals pass through the analyzer's IF and are detected together. The displayed amplitude of the smaller signal may be incorrect. This error is less than ± 0.5 dB and occurs if the smaller signal is less than 10 dB above the larger signal's skirt.

Overall amplitude accuracy

Some modern spectrum analyzers specify overall absolute amplitude accuracy. This specification provides a single number that you add to the absolute frequency response uncertainty to easily determine amplitude accuracy when you are making a measurement within certain boundary conditions. For example, the specification for overall absolute amplitude accuracy of the Agilent ESA-E series analyzers is $(\pm 0.54 \text{ dB} + \text{absolute frequency response})^1$. Table 8 shows the amplitude uncertainty of this analyzer family using the overall amplitude accuracy specification.

Table 8. Uncertainty Calculations for Absolute Amplitude Measurements Using Overall Absolute Amplitude Accuracy Specification

Frequency range	ESA-E series	
	Absolute frequency response specification ² (\pm dB)	Uncertainty ¹ (\pm dB)
9 kHz to 3.0 GHz	0.5	1.04
3.0 GHz to 6.7 GHz	1.5	2.04
6.7 GHz to 13.2 GHz	2.0	2.54
13.2 GHz to 25 GHz	2.0	2.54
25 GHz to 26.5 GHz	2.0	2.54

1. For reference levels 0 to -50 dBm; RBW = 1 kHz; video BW = 1 kHz; log scale; 0 to 50 dB log range; coupled sweep time; sample detector; 0 to -50 dBm input signal; span ≤ 20 kHz; 20 to 30° C.

2. 20 to 30° C

Reducing overall uncertainty

Minimize changes

Before taking any data, step through a measurement to see if any controls can be left unchanged. If a single input attenuator setting, resolution bandwidth, and display scaling can be used for the measurement, then the uncertainties associated with changing these controls can be ignored. For best accuracy, calibrate the analyzer with the controls in the same state in which the measurements will be made.

Substitute IF gain for scale fidelity

If the reference level (IF gain) uncertainty is less than the scale fidelity, you can minimize the uncertainty of a relative measurement by using the reference level control to measure both signals at the same vertical position, eliminating scale fidelity. Place the first signal at a reference amplitude using the reference level control, and use the marker to read the amplitude value. Then adjust the reference level to bring the second signal to the same reference amplitude (measured with the marker), and calculate the difference between the two reference level settings to obtain the relative amplitude.

Self calibration

Many of today's spectrum analyzers have self-calibration routines (such as the auto-alignment function in the ESA series analyzers). These routines generate error coefficients (for example, amplitude changes versus resolution bandwidth) that the analyzer uses to correct measured data. These routines help to ensure accurate amplitude measurements and give more freedom to change controls during a measurement. However, the uncertainty specifications assume self calibration has been done; therefore, self calibration is required to achieve specified accuracy.

Characterization

Characterizing your analyzer can reduce frequency response and calibrator uncertainties. If you have a more accurate calibration signal, or one closer to the frequency of interest, you can use that instead of the built-in calibrator. To reduce calibrator uncertainty, use a signal source and a precision power meter to calibrate the reference level (top line of the graticule). To reduce frequency response uncertainty, use a signal source having the same frequency as the signal-under-test to calibrate the reference level. Use data from a point-to-point calibration of the spectrum analyzer's frequency response for measurement correction over a frequency range.

Ampcor

Some spectrum analyzers have a built-in amplitude correction routine (such as Ampcor) that stores point-to-point frequency response characterization data in a table and automatically applies it to the measured data to yield corrected display information. Using a spectrum analyzer with Ampcor, a signal source and a power meter, you can also correct the input signal for unwanted variations due to the cables and adapters between the device-under-test and the analyzer (see Reference 2). Ampcor uses the table of frequency-amplitude pairs that you enter to make a correction curve to offset the variations in the input signal. The resulting signal trace represents the actual signal amplitude at the output of the device-under-test (see Figure 9).

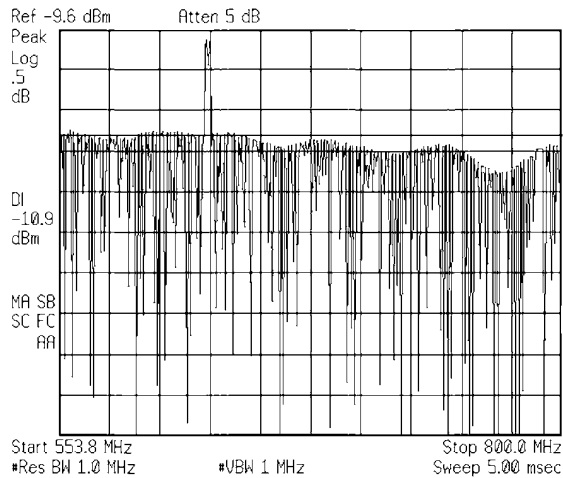

Figure 9a. Original signal

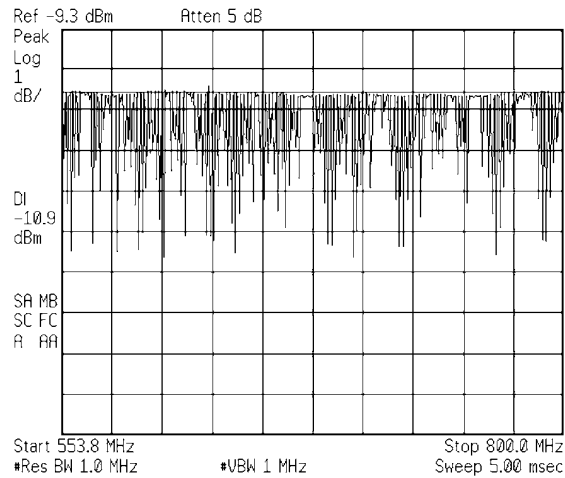

Figure 9b. Signal corrected by Ampcor

Improving sensitivity

As mentioned earlier, displayed signal amplitude is the sum of the signal and noise present in the pass-band. For signals close to the analyzer's noise floor (within 10 dB), the error between the displayed amplitude and the true amplitude is significant (Reference 3 gives the equation for correcting this error).

Therefore, when measuring low-level signals, the noise level of the analyzer should be as low as possible. Since the noise level depends on bandwidth, make the measurement with as narrow a resolution bandwidth as possible. Of course, you may not always be able to use a narrow resolution bandwidth; you will have to weigh this against the longer sweep time. However, digital resolution bandwidth filters allow you to use very narrow resolution bandwidths with shorter sweep times than analog filters.

When measuring signals close to the noise level, use video filtering for a more stable, and therefore more repeatable measurement. When narrower video bandwidths are not available, use video averaging to digitally smooth the trace over multiple sweeps.

Any equipment connected between the device-under-test and the analyzer input (such as an external attenuator) may reduce the available sen-

sitivity depending on its insertion loss and mismatch. Furthermore, the frequency response characteristics of the insertion loss/gain and mismatch will introduce additional flatness uncertainty into the measurement. Using Ampcor, you can correct for this uncertainty.

Preamplification

Because of limited IF gain, small signals cannot be raised to the reference level of a log display. Scale fidelity uncertainty will therefore be a factor when measuring these signals. Some spectrum analyzers have a built-in preamplifier that increases the signal level so that smaller signals can be measured at the top graticule line. However, the preamplifier's gain flatness and mismatch may reduce the overall flatness. Also, since the preamplifier's gain must be subtracted from the measured signal level to determine true signal level, preamplifier gain uncertainty further affects total measurement uncertainty. These added uncertainties can be greater than the scale fidelity uncertainty.

Reduce mismatch

Reduce mismatch uncertainty by attaching a well-matched pad (attenuator) to the analyzer input. Since an analyzer's match is worst with its input attenuator set to 0 dB, avoid the 0 dB setting whenever possible.

Summary

Amplitude measurements with spectrum analyzers are subject to both relative and absolute uncertainties. The overall uncertainty of a measurement can be calculated by referring to the analyzer's accuracy or uncertainty specifications and adding those factors that apply to that measurement. Total uncertainty can be minimized by careful attention to measurement technique. In general, this means limiting the number of changes to analyzer control settings and substituting smaller uncertainties for larger ones. Uncertainty can be further reduced by characterization and amplitude correction.

References

1. *Agilent Application Note 150: Spectrum Analysis Basics*, literature number 5952-0292.
2. *Agilent Application Note 1286-1: 8 Hints for Making Better Spectrum Analyzer Measurements*, literature number 5965-7009E.
3. *Agilent Application Note 1303: Spectrum Analyzer Measurements and Noise*, literature number 5966-4008E.
4. *Amplitude Accuracy Enhancement Techniques for the Agilent 8566A/B and 8568A/B Spectrum Analyzers* (Agilent white paper).
5. *Spectrum Analyzer Basics* (part of Agilent Back-to-Basics Seminar), literature number 5965-7920E.
6. *Spectrum Analyzer Frequency and Amplitude Accuracy* (Agilent SR112 Fundamentals Product Training).
7. *Agilent ESA-E Series Spectrum Analyzers Data Sheet*, literature number 5968-3386E.
8. *Agilent 8560 E-Series Spectrum Analyzers Data Sheet*, literature number 5965-8078E.
9. *Agilent 8590 E-Series Portable Spectrum Analyzers Data Sheet*, literature number 5963-6909E.

By internet, phone, or fax, get assistance with all your test and measurement needs.

Online Assistance

www.agilent.com/find/assist

Phone or Fax

United States:

(tel) 1 800 452 4844

Canada:

(tel) 1 877 894 4414

(fax) (905) 206 4120

Europe:

(tel) (31 20) 547 2323

(fax) (31 20) 547 2390

Japan:

(tel) (81) 426 56 7832

(fax) (81) 426 56 7840

Latin America:

(tel) (305) 269 7500

(fax) (305) 269 7599

Australia:

(tel) 1 800 629 485

(fax) (61 3) 9210 5947

New Zealand:

(tel) 0 800 738 378

(fax) (64 4) 495 8950

Asia Pacific:

(tel) (852) 3197 7777

(fax) (852) 2506 9284

Product specifications and descriptions in this document subject to change without notice.

Copyright © 1999, 2000 Agilent Technologies

Printed in U.S.A. 8/00

5968-3659E



Agilent Technologies

Innovating the HP Way