

# Agilent 8 Hints for Making and Interpreting EVM Measurements

## Application Note

### Introduction

Error vector magnitude (EVM) measurements can provide a great deal of insight into the performance of digital communications transmitters and receivers. With proper use, EVM and related measurements can pinpoint exactly the type of degradations present in a signal and can even help identify their sources.

Primarily a measure of signal quality, EVM provides both a simple, quantitative figure-of-merit for a digitally modulated signal, and a far-reaching methodology for uncovering and attacking the underlying causes of signal impairments and distortion. EVM measurements are growing rapidly in acceptance, being already the required modulation quality measurement in such important technology standards as 3GPP W-CDMA and IEEE 802.11a/b/g WLAN, and they are poised to appear in several upcoming standards.

This application note provides useful tips that will assist in accurately making and understanding EVM measurements.

### Defining EVM

The error vector is the vector difference at a given time between the ideal reference signal and the measured signal. Expressed another way, it is the residual noise and distortion remaining after an ideal version of the signal has been stripped away. EVM is the root-mean-square (RMS) value of the error vector over time at the instants of the symbol (or chip) clock transitions.

Depending on the technology, EVM is reported as a percentage of the square root of the mean power of the ideal signal, as a percentage of the square root of the average symbol power, or as a percentage of the square root of the peak signal level, usually defined by the constellation's corner states. The EVM value can also be reported in units of dB and some wireless networking standards use the term "relative constellation error" (RCE) instead of EVM.

While the error vector has a phase value associated with it, this angle generally turns out to be random, because it is a function of both the error itself (which may or may not be random) and the position of the data symbol on the constellation (which, for all practical purposes, is random). A more useful angle is measured between the actual and ideal phasors (I-Q error phase or phase error), which contains information useful in troubleshooting signal problems. Likewise, I-Q error magnitude, or magnitude error, shows the magnitude difference between the actual and ideal signals.

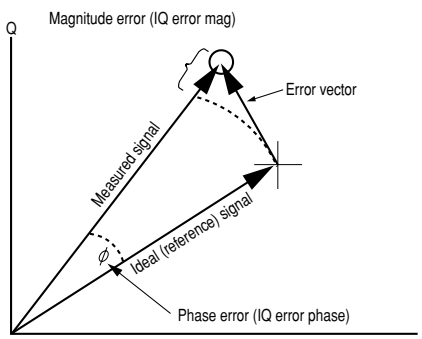

Figure 1. Error vector magnitude (EVM) and related quantities

The magnitude of the error vector versus time measurement shows the error vector magnitude variations as a signal changes over time—that is, at and between symbol decision timing points.

The spectrum of the error vector (or error vector spectrum) is the frequency spectrum of the error vector time.

The EVM troubleshooting tree shown in Figure 2 is a useful tool for analyzing vector modulated signals with EVM measurements.

### EVM troubleshooting tree

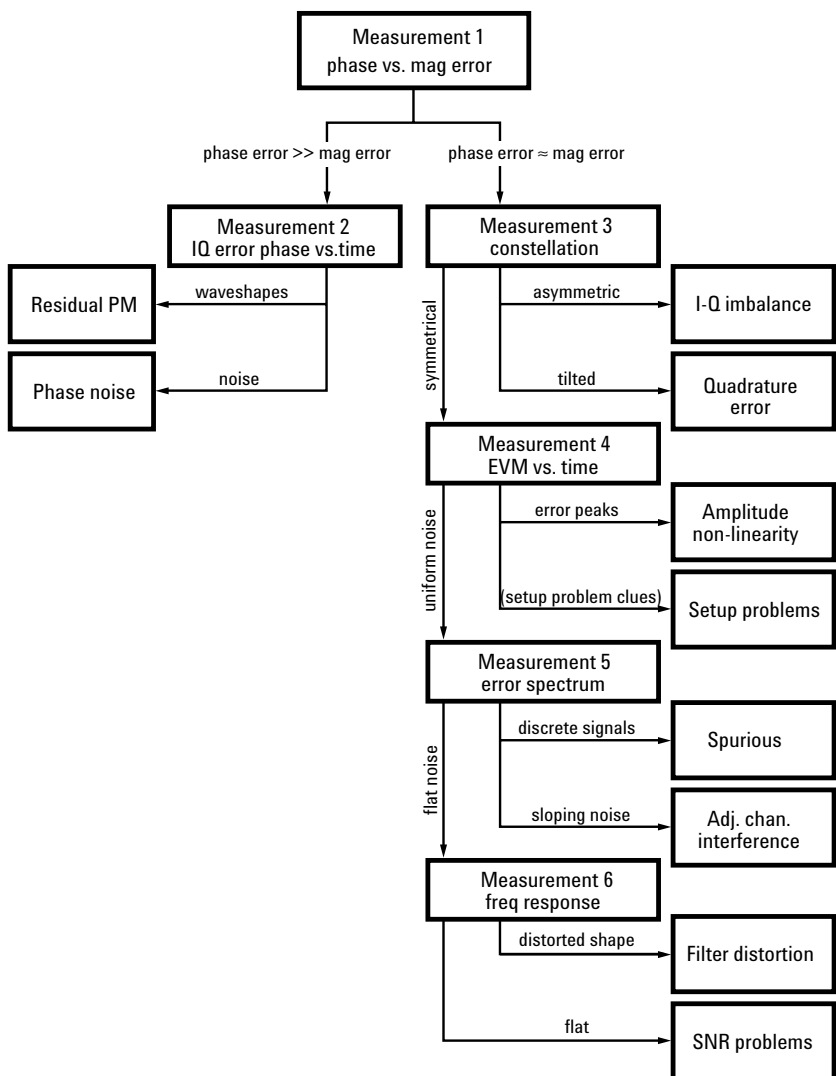

Figure 2. Flow chart for analyzing vector modulated signals with EVM measurements

## Hint #1

**EVM and the various related measurement displays are sensitive to any signal flaw that affects the magnitude and phase trajectory of a signal for any digital modulation format.**

EVM and the various related displays, I/Q constellation, I/Q polar or vector diagram, magnitude of the error vector versus time, the spectrum of the error vector (error vector spectrum), I/Q error phase versus time, and I/Q error magnitude versus time, etc are sensitive to any signal flaw that affects the magnitude and phase trajectory of a signal for any digital modulation format. Large error vectors, both at the symbol points and at the transitions between symbols, can be caused by problems at the baseband, IF or RF sections of the transmitter. Different modulation quality displays and tools can help reveal or troubleshoot various problems in the transmitter. For instance, the I/Q constellation can be used to easily identify I/Q gain imbalance errors. Small symbol rate errors can be easily identified by looking at the magnitude of the error vector versus time display. The error vector spectrum can help locate in-channel spurious.

## Hint #2

### Measurements of EVM to quantify the errors in digital demodulation can provide powerful insight into the performance of a digital radio receiver.

BER is the preferred measurement to verify receiver performance. When BER testing is not possible or practical in the subsystems of a digital radio receiver, an alternative is to examine the quality of a demodulated signal using EVM.

When EVM is normalized to the square root of the average symbol power, it can be related to the SNR:

$$\text{SNR} = -20 * \log (\text{EVM} / 100\%)$$

The importance of the above equation is that it relates EVM to BER through the SNR. Many textbooks have standard curves that relate BER to SNR, as in Figure 3. Generally, these curves assume that the noise is Additive White Gaussian Noise (AWGN) with a finite peak-to-average ratio, or crest factor. The assumptions made in generating textbook plots of BER versus SNR will not necessarily apply to a particular receiver. The noise in a receiver under test, for example, may not be AWGN but may instead have a strong spectral component.

In addition, the steep slope of BER curves makes BER estimations from measured SNR (or EVM) more prone to error. However, EVM provides an easily measured figure-of-merit that can be used to monitor design changes, locate design problems and, when baselined against a BER measurement, indicate the likelihood that a design will meet the required specifications.

Hence, the connection of BER to EVM is through the SNR, the more general indicator of likely signal quality, see Figure 4. Measurements of EVM and related quantities can provide powerful insight into the performance of a digital radio receiver. When properly applied, these signal quality measurements can pinpoint sources of error by identifying the exact type of degradation in a signal.

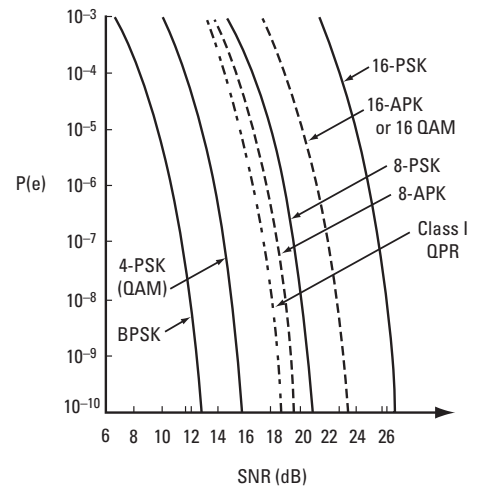

Figure 3. Probability of Error Versus SNR

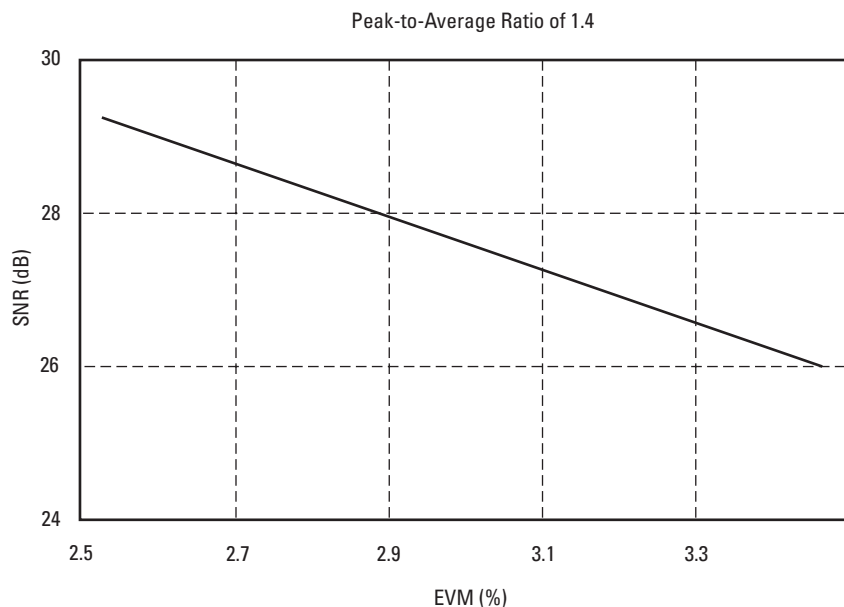

Figure 4. SNR versus EVM for crest factor of 1.4

### Hint #3

## Enhance the value of EVM as an indicator of modulation quality by using equalization in the measuring instrument.

Equalization is commonly used in digital communications receivers. Although its primary function is to reduce the effects of multipath, it also compensates for certain signal imperfections generated in both the transmitter and receiver. For this reason, it is useful to have an equalizer in the measuring instrument. An instrument with an equalizer will better emulate a receiver; that is, the impairments that the equalizer of the receiver removes are also removed by the measuring instrument.

Therefore, the impairments that have little effect on system performance also minimally impact the measured EVM. Figure 5 shows the magnitude of the error vector versus time with and without equalization.

With equalization the constellation looks much better and the magnitude of the error vector versus time is lower. The signal has not changed, only the measurement technique.

Equalization removes only linear distortion, so it is a very useful troubleshooting tool to distinguish linear from non-linear errors. If linear errors are present, equalization improves the quality of the signal by removing them, allowing for easier identification of non-linear errors. Once equalization has been applied, the inverse transfer function of the equalizer, which represents the linear distortion elements of the device under test can be displayed and measured.

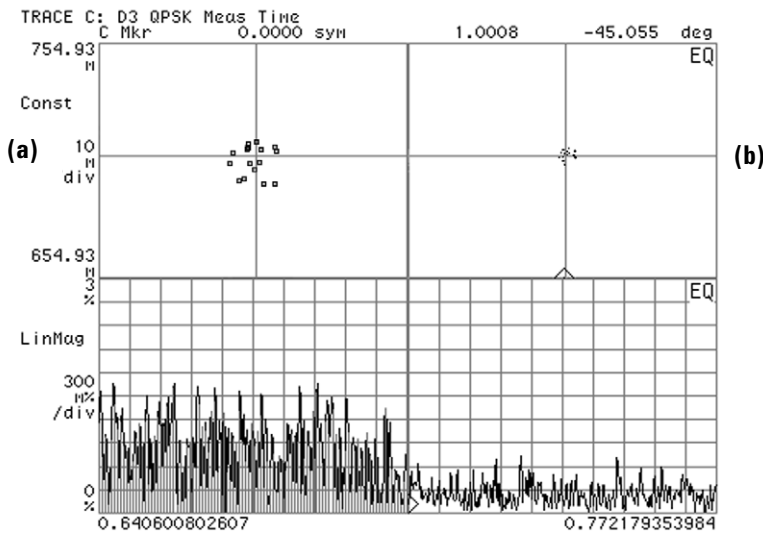

Figure 5. Constellation (zoomed) and magnitude of the error vector versus time (a) without equalization and (b) with equalization

## Hint #4

**Quickly confirm or rule out phase noise, incidental phase modulation and residual AM problems, by resolving EVM into its magnitude and phase error components and comparing their relative sizes.**

Different error mechanisms will affect a signal in different ways, perhaps in magnitude only, phase only, or both simultaneously. Knowing the relative amounts of each type of error can quickly confirm or rule out certain types of problems. Thus, the first diagnostic step is to compare the relative sizes of the phase error and the magnitude error.

When the average phase error (in degrees) is larger than the average magnitude error (in percent) by a factor of about five or more, this indicates that some sort of unwanted phase modulation is the dominant error mode. Proceed with further measurements to look for noise, spurs, or cross-coupling problems in the frequency reference, phase-locked loops, or other frequency-generating stages. Residual AM is evidenced by magnitude errors that are significantly larger than the phase angle errors.

In many cases, the magnitude and phase errors will be roughly equal. This indicates a broad category of other potential problems including compression, clipping, and zero-crossing non-linearities.

## Hint #5

The best way to verify most I/Q impairments is to magnify the scale of the constellation and look at the EVM metrics.

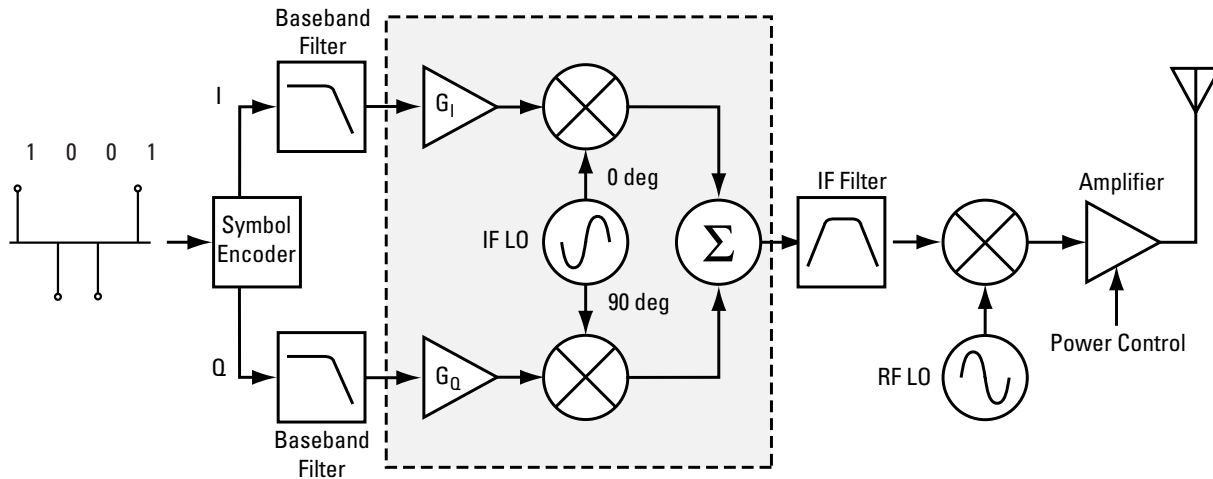

Figure 6. I/Q modulator

I/Q gain imbalance results in an asymmetric constellation, as seen in Figure 6. Quadrature errors result in a “tipped” or skewed constellation, as seen in Figure 7. For both errors the constellation may tumble randomly on the screen. This effect is caused by the fact that the measuring instrument decides the phases for I and Q periodically, based on the data measured, and arbitrarily assigns the phases to I or Q.

Using an appropriate sync word as a trigger reference makes the constellation stable on the screen, permitting the correct orientation of the symbol states to be determined. Therefore, the relative gains of I and Q can be found for gain imbalance impairments, and the phase shift sign between I and Q can be determined for quadrature errors.

I/Q offset errors may be compensated by the measuring instrument when calculating the reference. In this case, they appear as an I/Q offset metric. Otherwise, I/Q offset errors result in a constellation whose center is offset from the reference center, as seen in Figure 8. The constellation may tumble randomly on the screen unless a sync word is used as a trigger, for the same reason indicated above.

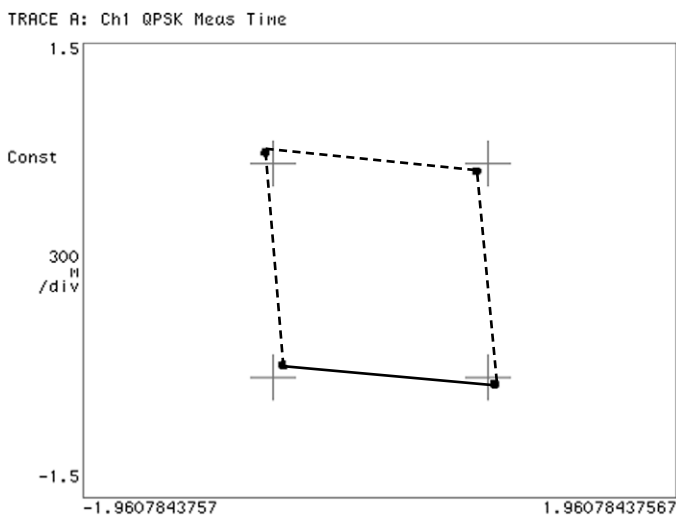

Figure 7. Quadrature error

## Hint #5, continued...

Delays in the I or Q paths also distort the measured constellation. However, if the delay is an integer number of samples, the final encoded symbols transmitted appear positioned correctly but are incorrect. The error cannot be detected unless a known sequence is measured. Mathematical functions in the measuring instrument can help compensate for delays between I and Q, by allowing you to introduce delays in the I or Q paths. In this way, you can confirm and measure the delay.

For any of these errors, magnifying the scale of the constellation can help detect subtle imbalances visually. Since the constellation is affected, these errors deteriorate EVM.

I/Q swapped results in an inverted spectrum. However, because of the noise-like shape of digitally-modulated signals, the inversion is usually undetectable in the frequency domain. In the modulation domain, the data mapping is inverted, as seen in Figure 9, but the error cannot be detected, unless a known sequence is measured. If the measurement algorithm is by default a synchronized measurement, I/Q swapped errors result in an unlock measurement condition. Some instruments allow you to invert the spectrum to be able to make the measurement, which will confirm the I/Q swapped impairment.

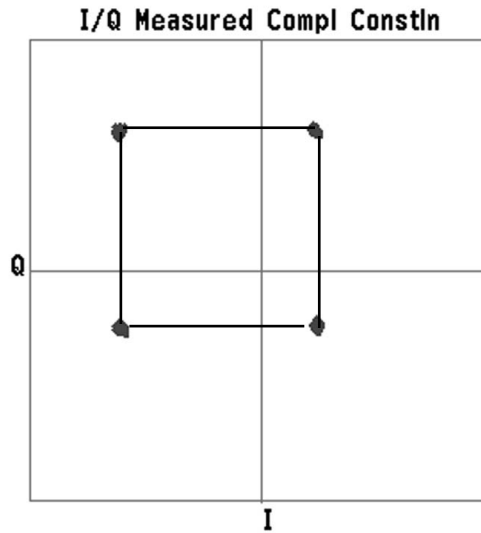

Figure 8. I/Q offsets

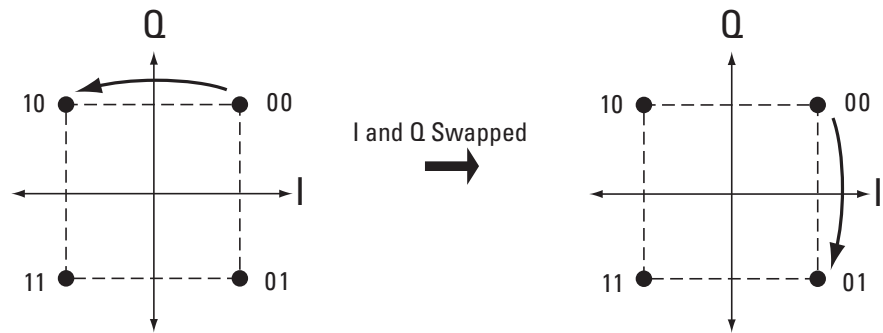

Figure 9. I/Q swapped



## Hint #6

**Small errors in the symbol rate can be characterized by a 'V' shape seen on the magnitude of the error vector versus time display.**

The best way to verify small errors in the symbol rate is by looking at the magnitude of the error vector versus time display. If the symbol rate is slightly off, this display shows a characteristic 'V' shape, as in Figure 10.

This effect can be understood by studying Figure 11. For simplicity, a sinewave is used instead of a digitally-modulated signal, and its frequency (symbol rate) is slightly higher than the specified sample frequency (symbol rate chosen in the measuring instrument). At one arbitrary reference sample (called 0) the signal will be sampled correctly. Since the symbol rate is slightly off, any other sample in the positive or negative direction will be slightly off in time. Therefore, the signal will deviate by some amount from the perfect reference signal.

This deviation or error vector grows linearly (on average) in both the positive and negative directions. Therefore, the magnitude of the error vector versus time shows a characteristic 'V' shape.

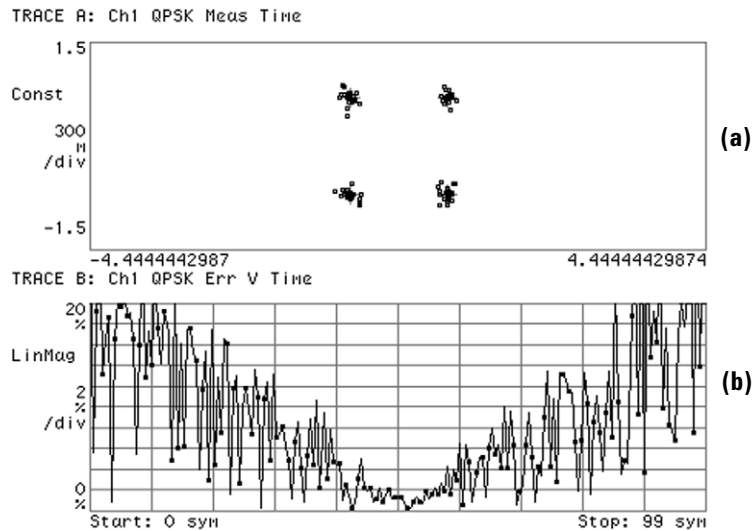
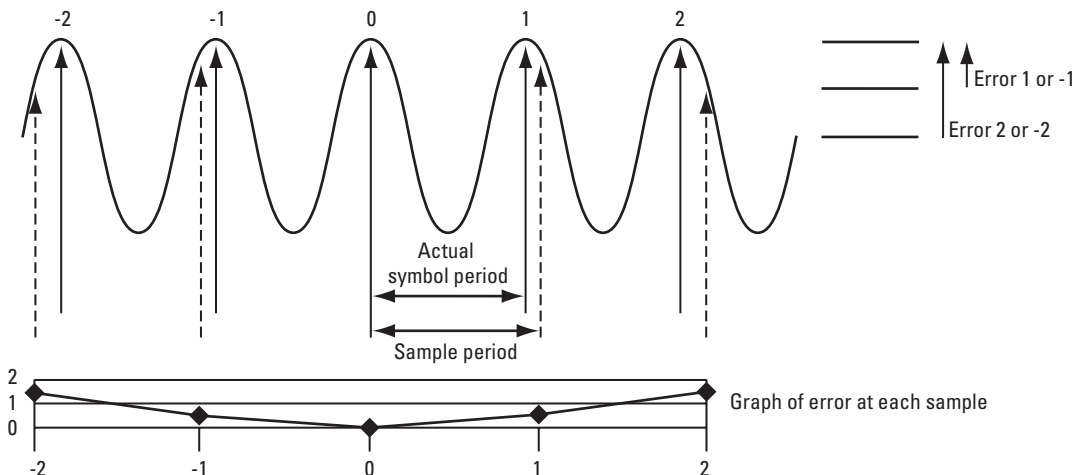

**Figure 10. (a) Constellation and (b) magnitude of the error vector versus time with "V" shape caused by incorrect symbol rate**

The smaller the symbol rate error, the more symbols are required to detect the error (that is, to form the 'V' shape). For instance, in Figure 8, for a QPSK system with a symbol rate specified at 1 MHz, 100 symbols are measured to form a "V" shape in the magnitude of the error vector versus time display for an actual symbol rate of 1.0025 MHz. In the same case,

about 500 symbols are required to form a similar 'V' shape for an actual symbol rate of 1.00025 MHz.

The actual transmitted symbol rate can be found by adjusting the symbol rate in the measuring instrument by trial and error until magnitude of the error vector versus time looks flat.



**Figure 11. Symbol rate slightly higher than specified.**

## Hint #7

**The main indicator of a wrong alpha coefficient and incorrect windowing is large EVM between the symbols and small EVM at the symbol points on the display of magnitude of the error vector versus time.**

The main indicator of a wrong alpha coefficient and incorrect windowing is the display of magnitude of the error vector versus time. In systems that use Nyquist filtering, an incorrect alpha (or a mismatch in alpha between transmitter and receiver) causes incorrect transitions while the symbol points themselves remain mostly at the correct locations.

Therefore, the EVM is large between the symbols, while it remains small at the symbol points. Figure 12 shows that effect for a mismatch between the transmitter filter (alpha = 0.25) and the receiver filter in the measuring instrument (alpha = 0.35, as specified for a particular system).

Incorrect windowing has the same effect, since the actual baseband response of the transmitter and the baseband response applied in the measuring instrument no longer match. The amplitude overshoot of the baseband signal depending on the alpha can be observed in the I/Q polar or vector diagram.

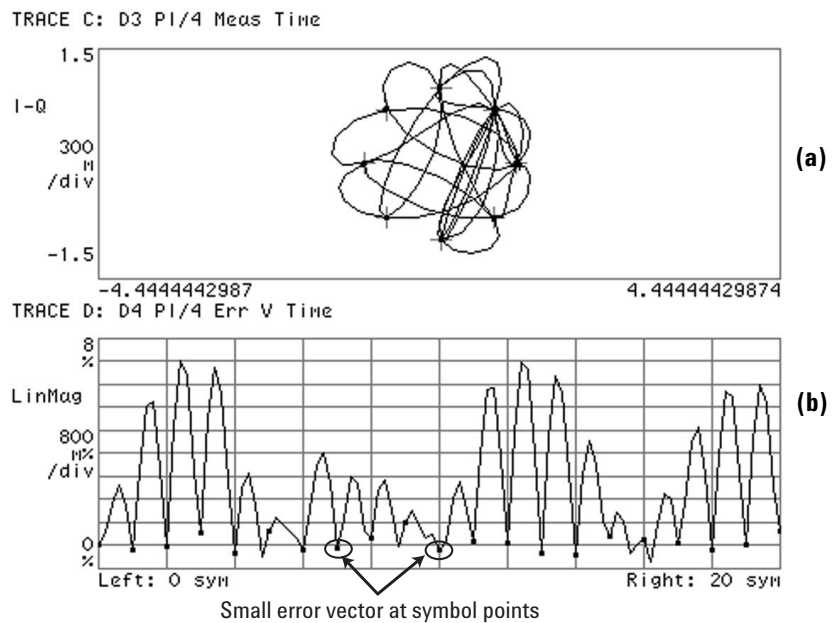
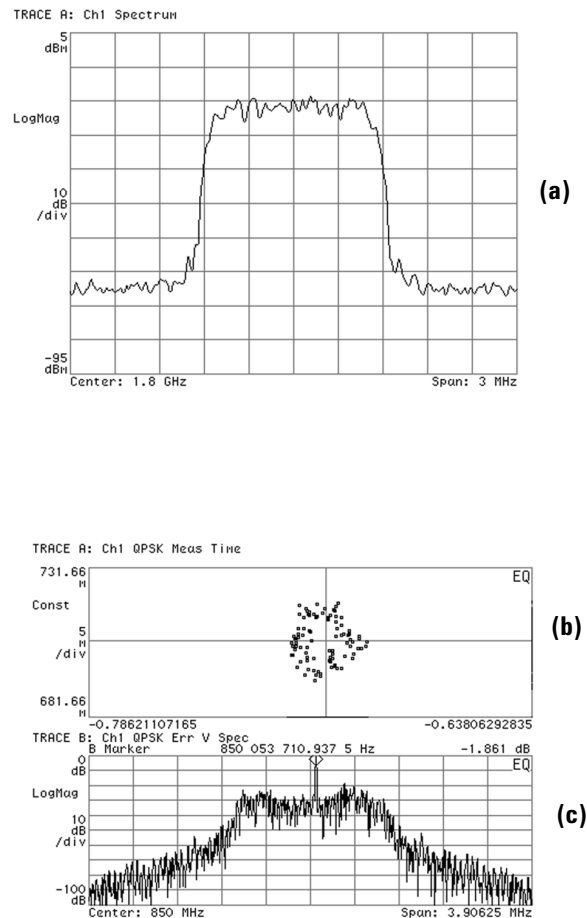

**Figure 12. (a) Polar diagram and (b) magnitude of the error vector versus time for incorrect alpha. The error vector is large between symbol points and small at the symbol points**

## Hint #8

**The best way to determine if an in-channel spur is present is by looking at the error vector spectrum display.**

In-channel spurious cause interference in the modulation. A single spur combines with the modulated signal, and the result depends on their phase relationship. The spur is rarely high enough to be detected in the frequency domain, as shown in Figure 13(a), but it may be identified in the constellation because it forms circles around the reference points. The radius of the circle corresponds to the magnitude relationship between the interfering tone and the desired I/Q signal. There may be some randomness caused by noise and, if the spur is very small, the circle might not be clear, even when zooming onto a single constellation point, as in Figure 13(b). The best way to determine if an in-channel spur is present is by looking at the error vector spectrum. The magnitude and frequency offset of the spur from the unmodulated carrier can be measured from this display. For instance, the error vector spectrum in Figure 13(c) shows a spur at 850.053710 MHz (53.710 kHz away from the unmodulated carrier frequency).



**Figure 13. In-channel interfering tone not visible in (a) the frequency domain, but detectable in (b) the constellation and (c) error vector spectrum**

## References

5968-3578E *Application Note 1313, Testing and Troubleshooting Digital RF Communications Transmitter Designs*

5965-2898E *Agilent PN 89400-14, Using Error Vector Magnitude Measurements to Analyze and Troubleshoot Vector-Modulated Signals*

5968-3579E *App Note 1314, Testing and Troubleshooting Digital RF Communications Receiver Designs*



### Agilent Email Updates

[www.agilent.com/find/emailupdates](http://www.agilent.com/find/emailupdates)

Get the latest information on the products and applications you select.



### Agilent Open

[www.agilent.com/find/open](http://www.agilent.com/find/open)

Agilent Open simplifies the process of connecting and programming test systems to help engineers design, validate and manufacture electronic products. Agilent offers open connectivity for a broad range of system-ready instruments, open industry software, PC-standard I/O and global support, which are combined to more easily integrate test system development.



### Agilent Direct

[www.agilent.com/find/agilentdirect](http://www.agilent.com/find/agilentdirect)

Quickly choose and use your test equipment solutions with confidence.

## www.agilent.com

### Agilent Technologies' Test and Measurement Support, Services, and Assistance

Agilent Technologies aims to maximize the value you receive, while minimizing your risk and problems. We strive to ensure that you get the test and measurement capabilities you paid for and obtain the support you need. Our extensive support resources and services can help you choose the right Agilent products for your applications and apply them successfully. Every instrument and system we sell has a global warranty. Two concepts underlie Agilent's overall support policy: "Our Promise" and "Your Advantage."

#### Our Promise

Our Promise means your Agilent test and measurement equipment will meet its advertised performance and functionality. When you are choosing new equipment, we will help you with product information, including realistic performance specifications and practical recommendations from experienced test engineers. When you receive your new Agilent equipment, we can help verify that it works properly and help with initial product operation.

#### Your Advantage

Your Advantage means that Agilent offers a wide range of additional expert test and measurement services, which you can purchase according to your unique technical and business needs. Solve problems efficiently and gain a competitive edge by contracting with us for calibration, extra-cost upgrades, out-of-warranty repairs, and onsite education and training, as well as design, system integration, project management, and other professional engineering services. Experienced Agilent engineers and technicians worldwide can help you maximize your productivity, optimize the return on investment of your Agilent instruments and systems, and obtain dependable measurement accuracy for the life of those products.

#### Agilent T&M Software and Connectivity

Agilent's Test and Measurement software and connectivity products, solutions and developer network allows you to take time out of connecting your instruments to your computer with tools based on PC standards, so you can focus on your tasks, not on your connections. Visit [www.agilent.com/find/connectivity](http://www.agilent.com/find/connectivity) for more information.

**For more information on Agilent Technologies' products, applications or services, please contact your local Agilent office.**

#### Phone or Fax

##### United States:

(tel) 800 829 4444  
(fax) 800 829 4433

##### Canada:

(tel) 877 894 4414  
(fax) 800 746 4866

##### China:

(tel) 800 810 0189  
(fax) 800 820 2816

##### Europe:

(tel) 31 20 547 2111

##### Japan:

(tel) (81) 426 56 7832  
(fax) (81) 426 56 7840

##### Korea:

(tel) (080) 769 0800  
(fax) (080)769 0900

##### Latin America:

(tel) (305) 269 7500

##### Taiwan:

(tel) 0800 047 866  
(fax) 0800 286 331

##### Other Asia Pacific

##### Countries:

(tel) (65) 6375 8100  
(fax) (65) 6755 0042

Email: [tm\\_ap@agilent.com](mailto:tm_ap@agilent.com)

Contacts revised: 05/05/05

**The complete list is available at:  
[www.agilent.com/find/contactus](http://www.agilent.com/find/contactus)**

Product specifications and descriptions in this document subject to change without notice.

© Agilent Technologies, Inc. 2005  
Printed in USA, May 20, 2005  
5989-3144EN



Agilent Technologies