



Agilent Power Meters and Power Sensors

High performance solutions for peak and average power measurements



Agilent Technologies

Introducing Agilent Power Meters and Sensors



Reliable, high-performing solutions

Every power meter and sensor from Agilent consistently delivers great results.



A sure investment for many years to come

Code-compatibility between power meters reduces the need for re-coding. Not only that, all Agilent power meters are backward-compatible with most legacy power sensors.



One specific application: One right solution

Agilent offers a wide selection of power meters and sensors for practically all application needs—wireless communications, radar pulse measurements, component test and more.



Global network support

No matter where you are, Agilent is committed to giving you the 24-hour support you need regarding our products, applications or services.

Explore Agilent Power Solutions Further

Peak Power Measurements and Analysis	
For Faster Measurement Speed and Greater Measurement Accuracy	3
Peak and Average Power Measurements	
For Compact ATE Systems	6
For Effective Capture of Wireless Signals	9
For Testing of Complex Modulation Formats	13
Average Power Measurements	
For Metrology and Calibration Laboratories	16
For Flexible Testing: On the Rack and On the Go	17
For Mobile Testing that's Plug-and-Play Easy	19
For Portable RF Measurements	21
Power Measurement Software	
For Easy Monitoring and Troubleshooting	23
Power Meters Selection Chart for Wireless Communication	25
Power Sensors Selection Chart for Wireless Communication	26
Power Meters and Sensors Compatibility Table	27
Related Agilent Literature	29
Warranty Information	Back cover
Contact Agilent	Back cover

Peak Power Measurements and Analysis For Faster Measurement Speed and Greater Measurement Accuracy

Agilent 8990B peak power analyzer

The 8990B peak power analyzer comes with two RF channels and two video channels and, when used with a compatible power sensor, measures the dynamic time-dependent aspects of RF and microwave power. Combined with the N1923A/N1924A wideband power sensors, the 8990B achieves 5 nanoseconds RF pulse rise time/fall time. The 8990B provides internal and external trigger functions and the peak power analyzer's video input allows for the simultaneous analysis of time-domain control signals.

Designed with both ease of use and high performance in mind, the 8990B peak power analyzer does more than just measure and analyze – it saves you time and effort, letting you focus on the important details.

The 8990B peak power analyzer has been named one of *Test & Measurement World's* Top 50 products for 2011.

Highlights

- Achieve 5 nanosecond rise time/fall time – the fastest in the peak power measurement market
- Set, trigger and measure pulse measurements easily
- Perform accurate and more detailed pulse measurements, faster
- Verify design problems quickly with a 15 inch XGA color display
- Compatible with U2000 Series USB power sensors for additional channels



Features

Models

- 8990B peak power analyzer

Specifications

- 150 MHz video bandwidth
- 100 Msamples/s continuous sampling rate

Measurement type

- Peak, average, peak-to-average ratio power measurements
- CCDF statistical analysis in graphical and tabular formats
- Rise time, fall time, pulse width, duty cycle, PRI and PRF
- Automated delay measurement
- Automated droop measurement
- Pulse spacing measurement

Calibration

- Calibration and correction factors in EEPROM (N1923A/N1924A wideband power sensors and P-Series power sensors)
- Internal zeroing and calibration (N1923A/N1924A wideband power sensors and P-Series power sensors)

Remote programmability

- SCPI standard interface command
- LAN and USB interfaces
- GPIB (with N4865A GPIB to LAN adapter)

Peak Power Measurements and Analysis For Faster Measurement Speed and Greater Measurement Accuracy

Delay measurement

Perform delay measurements by pressing the Delay Measurement button on the soft panel key and two vertical markers will automatically detect the first pulse of the traces. The time delay between the two traces will be displayed in the measurement panel below the graphical window.

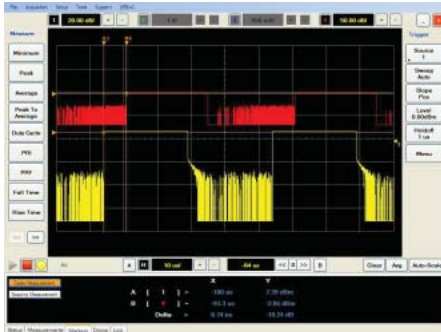

Drop measurement

The 8990B is the first peak power analyzer on the market to offer automated Pulse Drop measurement, which measures the amplitude degradation of the pulse top. This eliminates the need to manually manipulate the horizontal markers to make this measurement. Access the Pulse Drop measurement via the soft panel key.

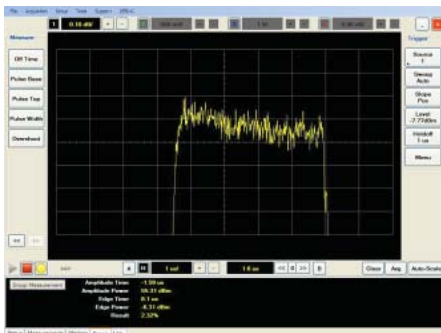

Spacing measurement

Easily measure the space between pulses when a long pulse train occurs and detect abnormalities in certain pulse groups. The 8990B allows users to select the starting pulse and the end pulse, a function that is important in pulse block validation.

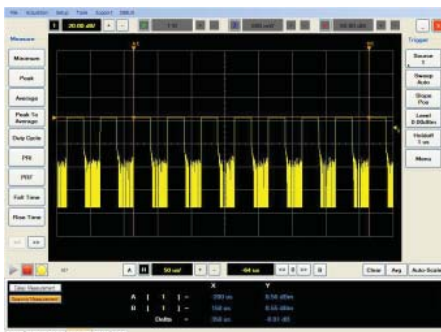

Peak Power Measurements and Analysis For Faster Measurement Speed and Greater Measurement Accuracy

Zoom screen

When the dual window zoom capability function is enabled, the 8990B's top screen will display the original signal, while the bottom screen displays the enlarged signal trace. To focus and zoom in on a particular segment of the signal trace, use the white zoom box to select the area of interest on the original signal trace. The measurement panel below will display the results of the selected signal segment.

The dual zoom window capability allows users to observe the original trace while focusing in on the selected signal segment instead of flipping between screens or losing the original trace after zooming in on the segment.

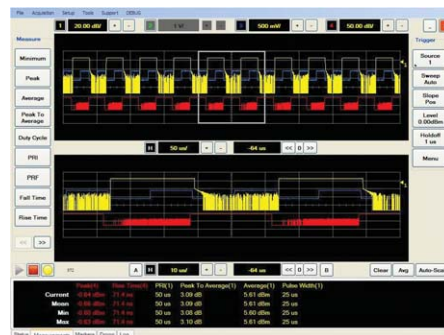

Compatible power sensors/software



N1923A wideband power sensor (50 MHz to 18 GHz; -35 dBm to +20 dBm)
N1924A wideband power sensor (50 MHz to 40 GHz; -35 dBm to +20 dBm)



P-Series power sensors (50 MHz to 40 GHz; -35 dBm to +20 dBm)



U2000 Series USB power sensors (9 kHz to 24 GHz; -60 dBm to +44 dBm)

* Frequency and power ranges are wider with options. Please visit our Web site at www.agilent.com/find/powermeters to find out the options available for each sensor.

Peak and Average Power Measurements For Compact ATE Systems

Agilent N8262A P-Series modular power meter

The N8262A is a dual-channel, LXI Class C compliant power meter that's designed to support LAN-based ATE systems. With its slim, half-rack build, the N8262A enables a smaller test system and ensures easier deployment.



Highlights

- Deploy test systems more easily
- Lower test system startup cost
- Integrate easily into existing systems
- Perform remote access and control from anywhere

Features

Dimension

- 1U half-rack size

Specifications

- 30 MHz video bandwidth
- 100 Msamples/s continuous sampling rate

Measurement type

- Peak, average, peak-to-average ratio power measurements
- Time-gated and free-run measurement modes
- CCDF statistical analysis
- Rise time, fall time, pulse width, time to positive occurrence and time to negative occurrence measurements
- Includes predefined configurations for WLAN, radar and MCPA

Calibration

- Calibration and correction factors in EEPROM (P-Series, E-Series sensors)
- Internal zeroing and calibration (P-Series sensors) * Refer to page 13

Remote programmability

- SCPI standard interface command
 - * Also programmable in other languages. See "System-ready software" below.
- 10/100BaseT LAN interface

System-ready software

- Bundled Synthetic Instrument Finder works with all LXI-compliant instruments
- Instrument Web page is accessible with any standard Web browser
- Bundled Power Meter GUI is also compatible with P-Series power meters
- Bundled IVI driver enables programming in your choice of environment, including Agilent VEE, LabVIEW, C, C#, C++, Microsoft® Visual Basic®, and MATLAB®

Backward-compatibility

- Code-compatible with N1912A P-Series power meter

Peak and Average Power Measurements For Compact ATE Systems

Deploy test systems more easily

With its 1U half-rack size, the N8262A eases deployment of test systems wherever duty calls.

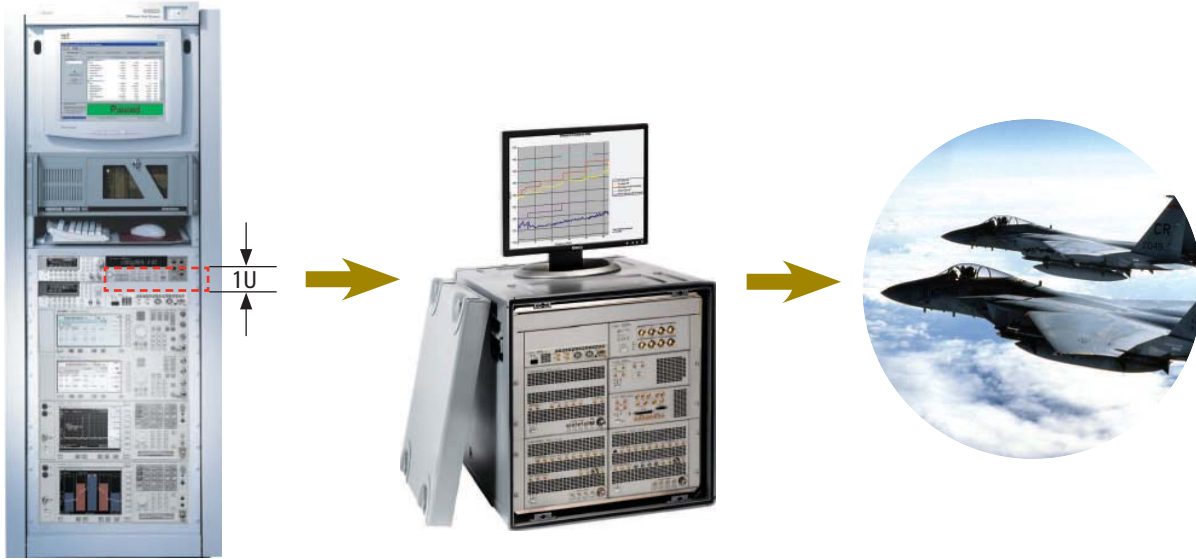

Smaller test systems are possible with the 1U N8262A, making it more readily deployable

Integrate easily into an existing system at a lower startup cost

The N8262A can operate without imposing expensive overhead—from card-cages, system controllers or power supplies—on your test system. Once an N8262A is detected on the network, you can access and configure its settings through any standard Web browser, and start measurements right away with the bundled Power Meter GUI soft front panel. With programming flexibility, use your preferred programming language (including SCPI, Agilent VEE and C) instead of spending time re-coding in an unfamiliar language.

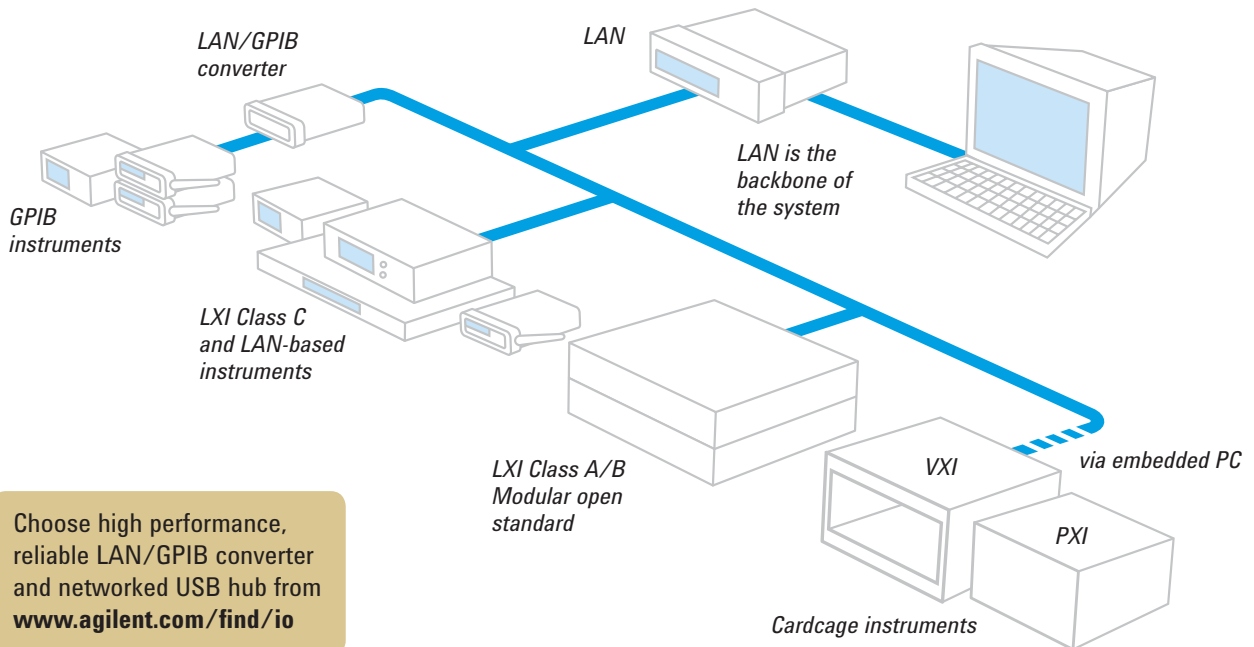

Choose high performance, reliable LAN/GPIB converter and networked USB hub from www.agilent.com/find/io

Peak and Average Power Measurements For Compact ATE Systems

Remote access and control
from anywhere

With the convenience of LAN, neither place nor distance is a limit to power measurements with the N8262A.

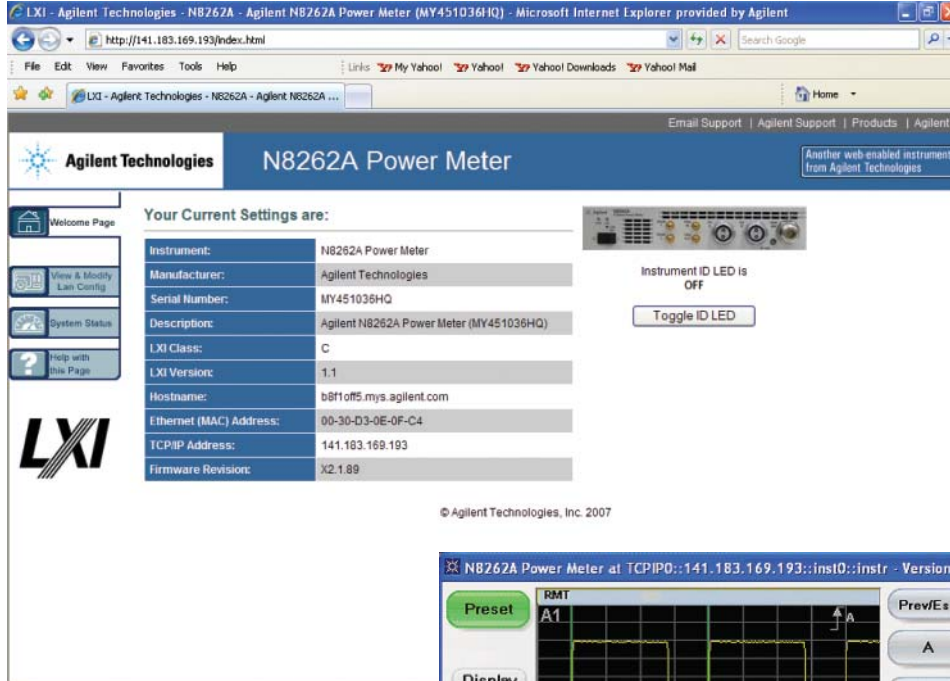





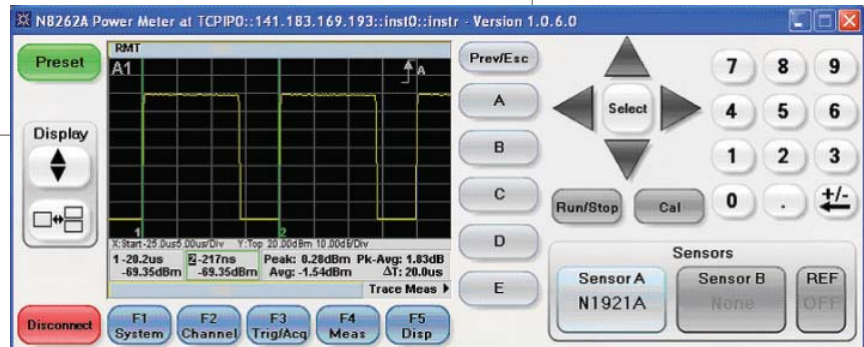

Whenever you need to view or modify an N8262A's current proxy settings, you can do so with its built-in Web page.

Control an N8262A and view measurement results through the Power Meter GUI soft front panel, the way you would a P-Series power meter from its front panel.



Compatible power sensors/software

	P-Series power sensors (50 MHz to 40 GHz; -35 dBm to +20 dBm)
	E9320 E-Series power sensors (50 MHz to 18 GHz; -65 dBm to +20 dBm)
	E4410 and E9300 E-Series power sensors (9 kHz to 26.5 GHz; -70 dBm to +44 dBm)
	N8480 Series thermocouple and waveguide power sensors (100 kHz to 67 GHz; -35 dBm to +44 dBm)
	8480 Series diode, thermocouple and waveguide power sensors (100 kHz to 110 GHz; -70 dBm to +20 dBm)
	N1918A Power Analysis Manager software

* Frequency and power ranges are wider with options. Please visit our Web site at www.agilent.com/find/powermeters to find out the options available for each sensor.

Peak and Average Power Measurements For Effective Capture of Wireless Signals

Agilent N1911A/12A P-Series power meters

The P-Series power meters are LXI Class C compliant, designed for high performance measurement of wireless signals such as WiMAX™ and radar. Predefined settings in the P-Series power meters enable effective capture of unpredictable wireless signals, with their high burst rates and fast, time-varying power levels.



Highlights

- Quick set up with 22 radio presets
- Automatic pulse capture
- Wide VBW and high sampling rate
- High resolution color display
- External triggerable when used with E-Series average power sensors

Features

Models

- Single-channel N1911A
- Dual-channel N1912A

Specifications

- 30 MHz video bandwidth
- 100 Msamples/s continuous sampling rate

Measurement type

- Peak, average, peak-to-average ratio power measurements
- Time-gated and free-run measurement modes
- CCDF statistical analysis in graphical and tabular formats
- Rise time, fall time, pulse width, time to positive occurrence and time to negative occurrence measurements
- Includes predefined configurations for WiMAX, HSDPA and DME

Calibration

- Calibration and correction factors in EEPROM (P-Series, E-Series sensors and N8480 Series)
- Internal zeroing and calibration (P-Series sensors) * Refer to page 13

Remote programmability

- SCPI standard interface commands
* Also programmable in other languages. See below
- GPIB, LAN and USB interfaces

System-ready software

- Bundled IVI driver enables programming via your choice of environment, including Agilent VEE, LabVIEW, LabWindows, C, C++, and MATLAB

Backward-compatibility

- Code-compatible with EPM-P and EPM Series power meters

Peak and Average Power Measurements For Effective Capture of Wireless Signals

High sampling rate for WiMAX and WLAN testing

Apart from WiMAX and WLAN presets, the P-Series power meters also offer 100 Msamples/s continuous sampling that ensures glitches are not missed.

- The P-Series power meters' 30 MHz wide video bandwidth enables the capture of WiMAX signals
- With their auto trigger hold-off capability, you can capture the complete Downlink or Uplink subframe burst desired within a fixed time span
- Time-gated peak, average and peak-to-average ratio power measurements are automatically displayed to ease analysis of signals

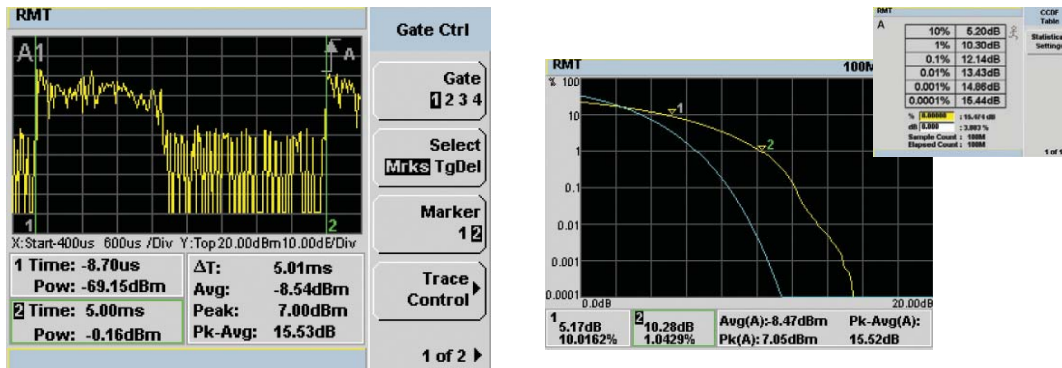

CCDF statistical analysis is viewable in both tabular and graphical formats

Autoscaling and autogating for radar testing

Setting up for radar signal measurements is faster and easier with the P-Series preset. Capture of a radar pulse is further simplified with autoscaling and autogating functions. With autogating set to "perpetually on," the gates reposition themselves automatically when pulse width changes.

- Up to four independent time gates can be set for individual measurements on one or multiple pulses
- With a frequency range of up to 40 GHz and rise/fall times of ≤ 13 ns, you have more than enough to profile high-frequency radar signals in most applications

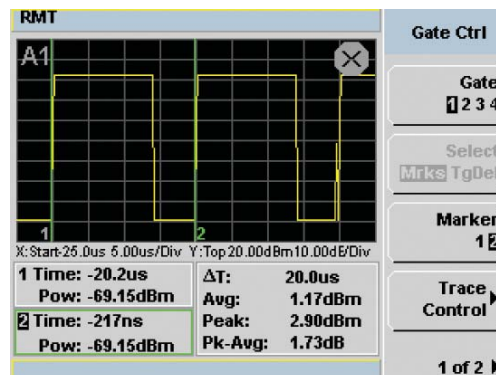

Peak and Average Power Measurements For Effective Capture of Wireless Signals

Wide video bandwidth for MCPA testing

In designing multi-carrier power amplifiers (MCPA), a wide-bandwidth power meter such as the P-Series helps you ensure that your device stays within its maximum power specification. The P-Series power meter's 30 MHz video bandwidth allows up to six 3G carriers over a wide dynamic range.

- CCDF and peak-to-average power measurements verify if MCPA is clipping
- 100 MSamples/s continuous sampling ensures easier detection of glitches
- Rise/fall time measurements help in checking the signal's burst profile and in identifying power transition problems
- High resolution color display ease viewing and differentiation of the four traces

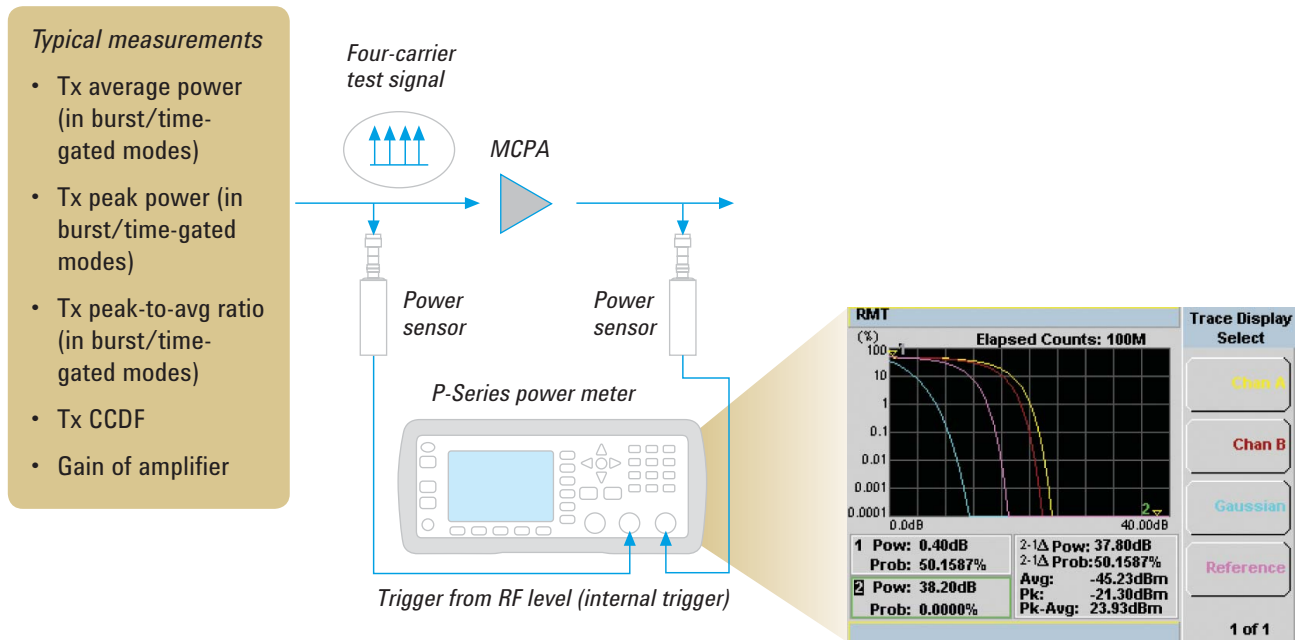

A sample setup for MCPA testing

Peak and Average Power Measurements For Effective Capture of Wireless Signals



The P-Series power sensors' internal zeroing and calibration

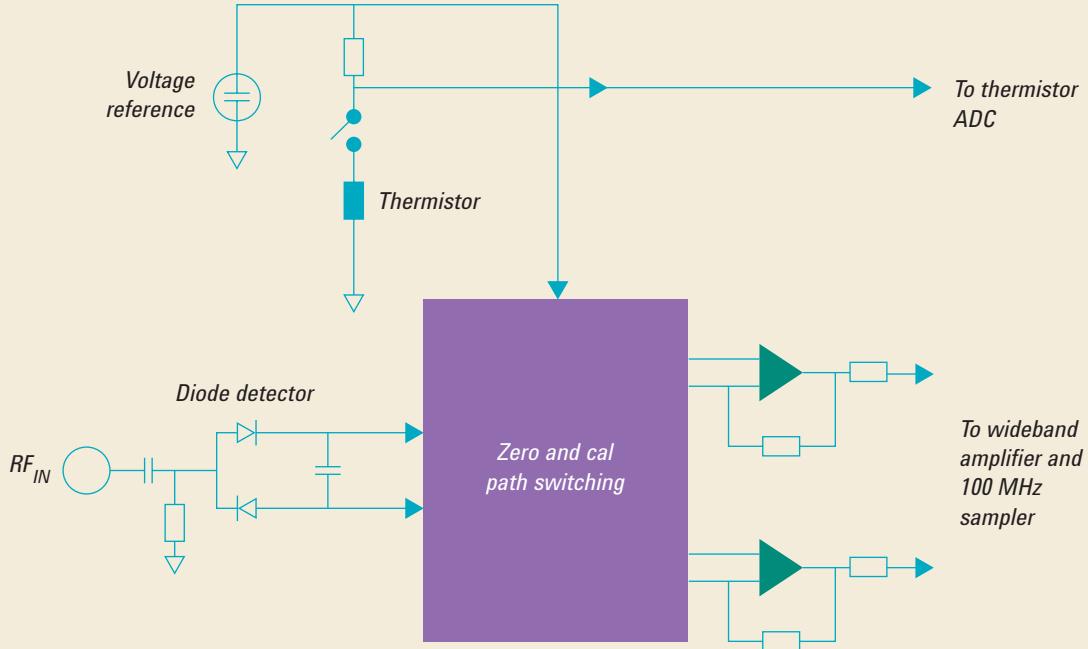

- Integrates DC reference source and switching circuits into sensor
- Eliminates the need for calibration with an external reference source
- Eliminates the need to connect/disconnect from calibration source and test fixtures
- Reduces test times, measurement uncertainty and wear-and-tear on connectors

Compatible power sensors/software



P-Series power sensors (50 MHz to 40 GHz; -35 dBm to +20 dBm)



E9320 E-Series power sensors (50 MHz to 18 GHz; -65 dBm to +20 dBm)



E4410 and E9300 E-Series power sensors (9 kHz to 26.5 GHz; -70 dBm to +44 dBm)



N8480 Series thermocouple and waveguide power sensors (100 kHz to 67 GHz; -35 dBm to +44 dBm)



8480 Series diode, thermocouple and waveguide power sensors (100 kHz to 110 GHz; -70 dBm to +20 dBm)



N1918A Power Analysis Manager software

* Frequency and power ranges are wider with options. Please visit our Web site at www.agilent.com/find/powermeters to find out the options available for each sensor.

Peak and Average Power Measurements For Testing of Complex Modulation Formats

Agilent E4416A/17A EPM-P Series power meters

The EPM-P Series power meters operate with the E9320 Series peak-and-average power sensors for testing various complex modulation formats in wireless communication systems, such as TDMA and CDMA.

Highlights

- Optimize dynamic range for peak power measurement
- Complete TDMA and CDMA characterization



Features

Models

- Single-channel E4416A
- Dual-channel E4417A

Specifications

- 5 MHz video bandwidth
- 20 Msamples/s continuous sampling rate

Measurement type

- Peak, average, peak-to-average ratio power measurements
- Time-gated and free-run measurement modes
- Includes predefined configurations for GSM, EDGE, NADC, iDEN, Bluetooth®, IS-95 CDMA, W-CDMA and cdma2000®

Calibration

- Calibration and correction factors in EEPROM (E-Series sensors and N8480 Series)

Remote programmability

- SCPI standard interface commands
- GPIB, RS-232/422 interfaces

System-ready software

- EPM-P analyzer software

Backward-compatibility

- Code-compatible with EPM Series power meters

Peak and Average Power Measurements For Testing of Complex Modulation Formats

Optimize dynamic range with E9320 Series sensors

Wider bandwidths allow you to profile fast-changing signals, but at the expense of dynamic range. That's why each E9320 Series power sensor comes with three variable bandwidth settings. This helps you select the best bandwidth for your application, yet still maintain the widest possible dynamic range.

Sensor model	Video bandwidth/maximum peak power dynamic range			
	Off	High	Medium	Low
E9321A E9325A	300 kHz/ -40 dBm to +20 dBm	300 kHz/ -42 dBm to +20 dBm	100 kHz/ -43 dBm to +20 dBm	30 kHz/ -45 dBm to +20 dBm
E9322A E9326A	1.5 MHz/ -36 dBm to +20 dBm	1.5 MHz/ -37 dBm to +20 dBm	300 kHz/ -38 dBm to +20 dBm	100 kHz/ -39 dBm to +20 dBm
E9323A E9327A	5 MHz/ -32 dBm to +20 dBm	5 MHz/ -32 dBm to +20 dBm	1.5 MHz/ -34 dBm to +20 dBm	300 kHz/ -36 dBm to +20 dBm

Complete TDMA/CDMA analysis with bundled analyzer software

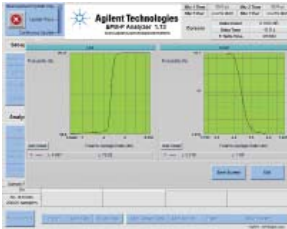
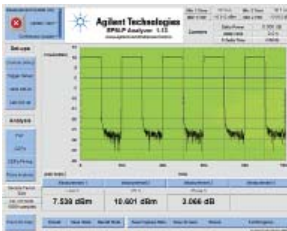

Pulse analysis





Versatile markers offer complete power and timing characterization of pulsed signals, to provide easy testing of TDMA component parameters and system performance. In addition to measuring peak, average and peak-to-average ratio power, the Agilent EPM-P analyzer software measures the following pulse characteristics automatically:

- Power: pulse top, pulse base, distal, mesial, proximal, overshoot and burst average
- Frequency and time: Pulse Repetition Frequency (PRF), Pulse Repetition Interval (PRI), pulse width, off-time, rise time and fall time

Statistical analysis

For today's noise-like CDMA and W-CDMA formats, statistical analysis of the power distribution helps you optimize system design by providing essential characterizations such as amplifier compression. The Agilent EPM-P analyzer software provides the capability to determine the PDF, CDF and CCDF.

Compatible power sensors/software

	E9320 E-Series power sensors (50 MHz to 18 GHz; -65 dBm to +20 dBm)
	E4410 and E9300 E-Series power sensors (9 kHz to 26.5 GHz; -70 dBm to +44 dBm)
	N8480 Series thermocouple and waveguide power sensors (100 kHz to 67 GHz; -35 dBm to +44 dBm)
	8480 Series diode, thermocouple and waveguide power sensors (100 kHz to 110 GHz; -70 dBm to +20 dBm)

* Frequency and power ranges are wider with options. Please visit our Web site at www.agilent.com/find/powermeters to find out the options available for each sensor.

Peak and Average Power Measurements For Testing of Complex Modulation Formats

EPM-P analyzer software

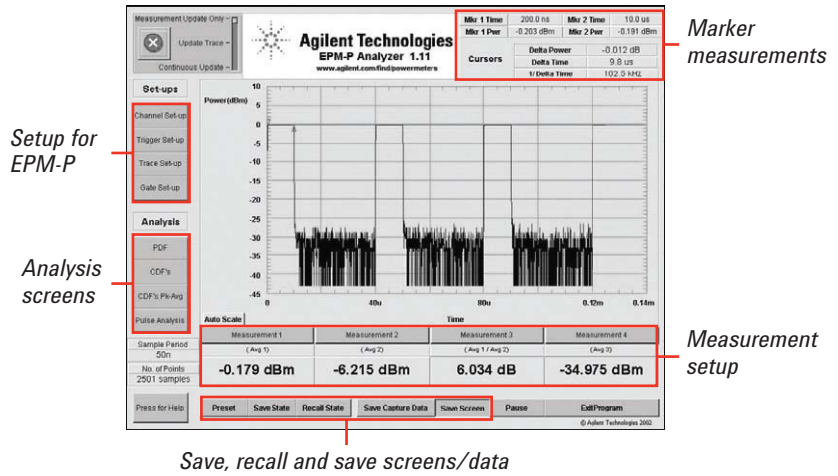

Setups for EPM-P

This software controls the power meter and is used to set up the Channel, Trigger and Gate Setups as shown through the front panel.

Analysis screens

After the power meter is configured, the trace is captured to allow for analysis of the captured trace data. There are various analysis screens covering statistical analysis such as Probability Density Function (PDF) and Complementary Cumulative Distribution Function (CCDF or 1-CDF) measurements and pulse analysis.

Marker measurements

When the trace is captured, the marker measurements can be used to provide time and power information, and the trace can also be zoomed in to look closely at areas of interest.

Measurement setup

The display can show up to four real-time power measurements, which are configured in a similar manner to the power meter display, and allows time-gated average, peak, peak-to-average ratio measurements, as well as combination measurements to be displayed.

Save, recall and save screens/data

If the analyzer display is required for reports or import into other applications, the screen can be saved as a JPG or BMP file and the power and time data from the captured trace can also be saved in a CSV file. The analyzer software allows 10 states to be stored and recalled. This ensures easy set up of the analyzer software and allows repeatable measurements to be obtained. These states are saved in a separate file, and stored on the PC or a disc, ensuring users on different PCs are operating the same setups and therefore making the same measurements.

Average Power Measurements For Metrology and Calibration Laboratories

Agilent N432A thermistor power meter

The N432A is a single-channel, average RF power meter that's ideal for high-accuracy measurement applications, particularly metrology and calibration laboratory environments.

Highlights

- High accuracy ($\leq 0.2\% \pm 0.5 \mu\text{W}$)
- Built-in 6.5-digit ADC eliminates the need for an external DMM
- DC substitution measurement, traceable to the U.S. National Institute of Standards and Technology (NIST)
- Selectable bridge resistance
- Digital color LCD display, and user-friendly interface



Features

Measurement type

- Average power measurements

Calibration

- Built-in calibration factor table

Remote programmability

- SCPI standard interface commands

Highly accurate RF measurements for metrology and calibration

The N432A's high 0.2% accuracy, coupled with Agilent 478A-H75/H76 thermistor sensors, makes it excellent for 1 mW transfer calibration.



Compatible power sensors/software



478A coaxial thermistor mount power sensor (10 MHz to 10 GHz; -30 dBm to +10 dBm)



8478B coaxial thermistor mount power sensor (10 MHz to 18 GHz; -30 dBm to +10 dBm)

* Frequency and power ranges are wider with options. Please visit our Web site at www.agilent.com/find/powermeters to find out the options available for each sensor.

Average Power Measurements For Flexible Testing: On the Rack and On the Go

Agilent N1913A/14A EPM Series power meters

The Agilent N1913A/14A EPM Series power meters are versatile, user-friendly replacements for the popular E4418B/19B EPM power meters. They deliver fast, repeatable, reliable results for both bench/rack and field applications.



Highlights

- Up to four-channel power measurements
- Fast measurement speed of 400 readings/second
- Industry's first color LCD screen in an average power meter
- Convenient field usage with operating case and battery option
- Optional external trigger feature for automatic frequency/power sweep measurements
- VGA output option for connection to external monitor

Features

Models

- Single-channel N1913A
- Dual-channel N1914A
Note: Two optional USB channels available for purchase

Measurement type

- Average power measurements

Calibration

- Calibration and correction factors in EEPROM (E-Series and N8480 Series)

Remote programmability

- SCPI standard interface commands
- GPIB, USB and LAN/LXI-C interfaces

Backward-compatibility

- Code-compatible with legacy E4418B/9B EPM Series, 436A, 437B and 438A power meters (43X compatibility only with Option N191xA-200)

Average Power Measurements

For Flexible Testing: On the Rack and On the Go

View measurements better in any lighting and angle

The new EPM Series come with the industry's first color LCD in an average power meter. With its high-resolution color and wide viewing angle, you can see your test results more easily—no matter where you are.



Perform field measurements conveniently

You can easily carry an EPM Series power meter in its operating case when you need to travel between stations. This meter is also available with a battery option and one-button battery power level check so you can keep your power meters at its optimum capacity before your next field task. To ensure continuous power, you can opt for a spare battery pack (Option N191xA-300).



Compatible power sensors/software



U2000 Series USB power sensors (9 kHz to 24 GHz; -60 dBm to +44 dBm)



E4410 and E9300 E-Series power sensors (9 kHz to 26.5 GHz; -70 dBm to +44 dBm)



N8480 Series thermocouple and waveguide power sensors (100 kHz to 67 GHz; -35 dBm to +44 dBm)



8480 Series diode, thermocouple and waveguide power sensors (100 kHz to 110 GHz; -70 dBm to +20 dBm)

* Frequency and power ranges are wider with options. Please visit our Web site at www.agilent.com/find/powermeters to find out the options available for each sensor.

Average Power Measurements

For Mobile Testing that's Plug-and-Play Easy

Agilent U2000 Series USB power sensors

Standalone USB-based U2000 Series power sensors enable power measurements without power meters. Using USB power and providing built-in triggering, these power sensors don't need external power adapters or triggering modules for synchronization with external instruments or events. All these make the U2000 Series an ideal choice for high performance mobile power measurements.

Highlights

- Travel with lighter-weight instruments
- Set-up easily with USB, and measure from practically anywhere beyond USB cable length
- Save time connecting/disconnecting sensor with internal zeroing
- RF burst signal measurement with time-gating
- NEW! Built-in internal triggering and trace graph display

Features

Measurement type

- Average power measurements
- Frequency range: 9 kHz to 24 GHz
- Dynamic range: -60 dBm to 44 dBm

Remote programmability

- USB interface

System-ready software

- N1918A Power Analysis Manager software

Backward-compatibility

- Code-compatible with E4418B EPM Series power meter

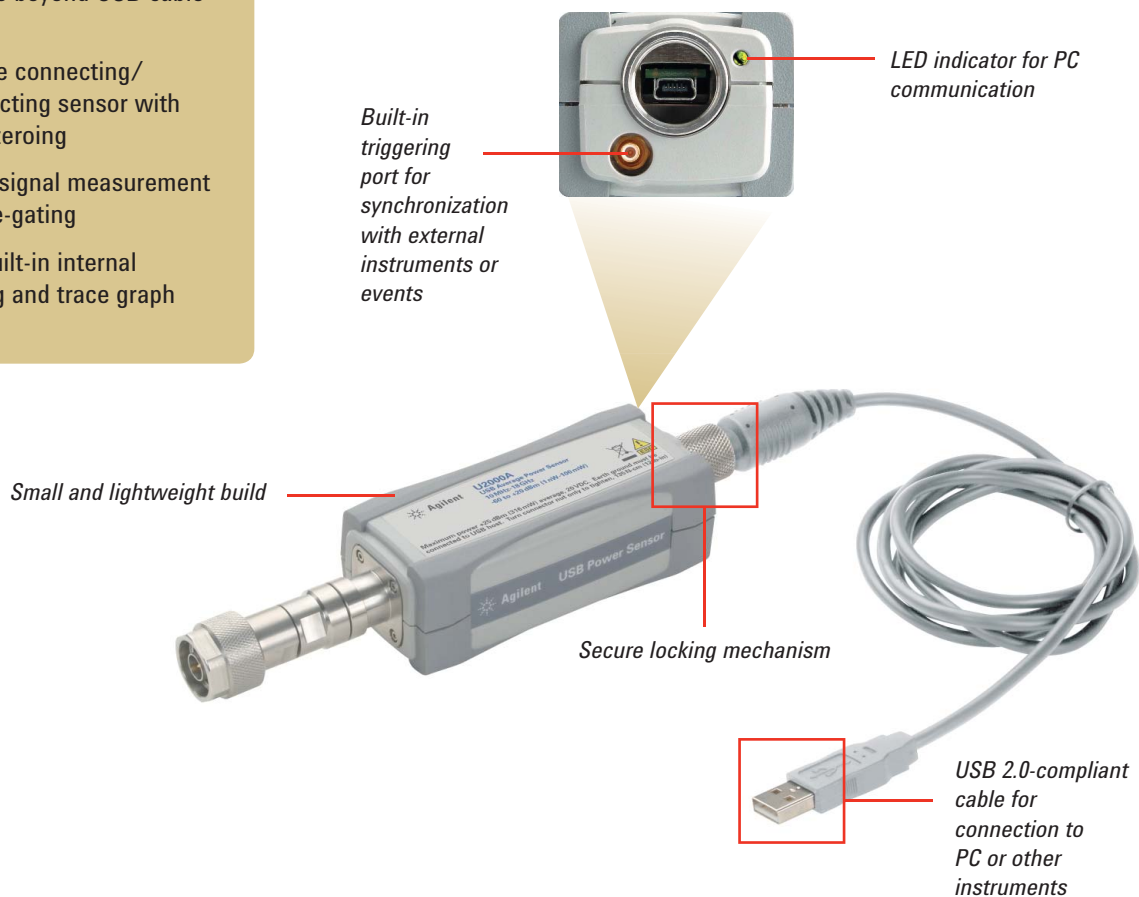

Average Power Measurements For Mobile Testing that's Plug-and-Play Easy

Other solution

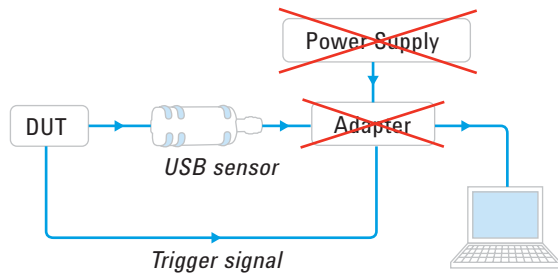

Agilent's solution

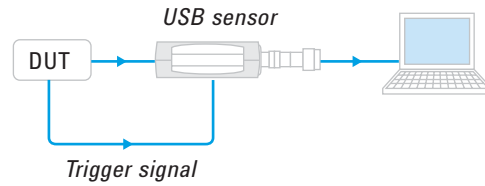

A U2000 USB power sensor's setup is simple, unlike the complicated setup of other USB-based power measurement solutions

Perform antenna testing across any distance

When a U2000 Series sensor's USB cable is connected to the Agilent E5813A USB-to-LAN hub, you can perform measurements beyond the limits of USB cable length. Conveniently leave your sensor connected to the power tap-off—even while performing zeroing—and monitor your measurements remotely.

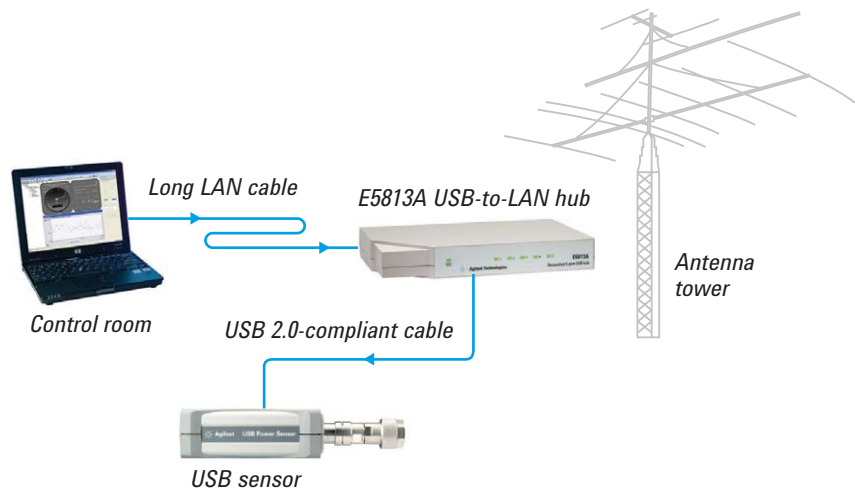

Perform base station testing without the usual bulkiness

When you need to take power measurements on the road or up a base station tower, smaller, lighter and fewer is better. With the U2000 Series USB power sensors, the only other thing you'll need is a laptop with the N1918A Power Analysis Manager installed.

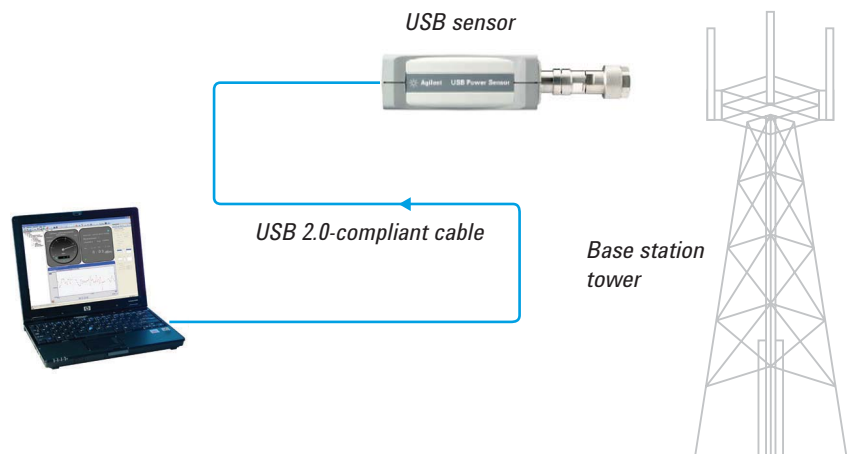

Average Power Measurements

For Mobile Testing that's Plug-and-Play Easy



Reduce sensor connection/disconnection

With a U2000 Series sensor's internal zeroing capability, you don't need to poweroff the device-under-test or disconnect the sensor. This saves test time and reduces sensor wear-and-tear—advantages that are especially crucial in applications where every second counts, such as manufacturing test. With internal zeroing, the sensor can be left connected to the test fixture.

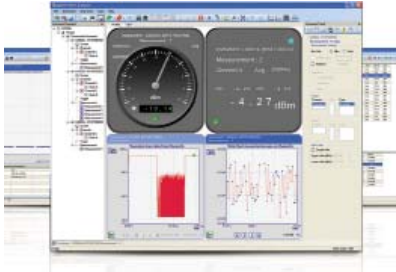

View multiple display formats, set limits and alerts, and more...

The N1918A Power Analysis Manager software displays measurements with the U2000 Series power sensors. Besides monitoring signals, this feature-packed software also enables further analysis through functions such as time-gated capability, waveform math, autoscaling, zooming, record and save capabilities.



Add power measurements to other instruments

Sometimes you may want to perform accurate average power measurements with an Agilent network analyzer or spectrum analyzer. You could literally have a power meter next to you—or instead, turn select Agilent instruments into power meters with the U2000 Series. Even with the U2000 connected, you can switch between power measurements and the instrument's original function at any time.

Compatible power sensors/software



N1918A Power Analysis Manager software

Average Power Measurements For Portable RF Measurements

Agilent V3500A handheld RF power meter

The V3500A is a portable, palm-sized power meter with an integrated power sensor and built-in display. Compact with essential average power measurement capabilities, the V3500A is a handy tool for installation and maintenance or R&D lab environments.

Highlights

- Small and lightweight form that fits in your palm, no separate power sensor or display needed
- Internal power reference enables self-calibration
- Absolute accuracy up to ± 0.21 dB.
- Multiple power-up methods: AA batteries, computer via USB interface, AC-DC converter module (Option PWR)

Features

Measurement type

- Average power measurements
- Frequency range: 10 MHz to 6 GHz
- Dynamic range: -63 dBm to 20 dBm

Remote programmability

- Programming languages: Microsoft Visual Studio[®].NET, Microsoft Visual Basic, and Microsoft Visual C++
- USB interface



Truly portable for field measurements

The V3500A provides an optional loop holster carrying case with a shoulder strap. The handheld comes with a backlit display and illuminated keypad to help you make measurements in poorly lit conditions.

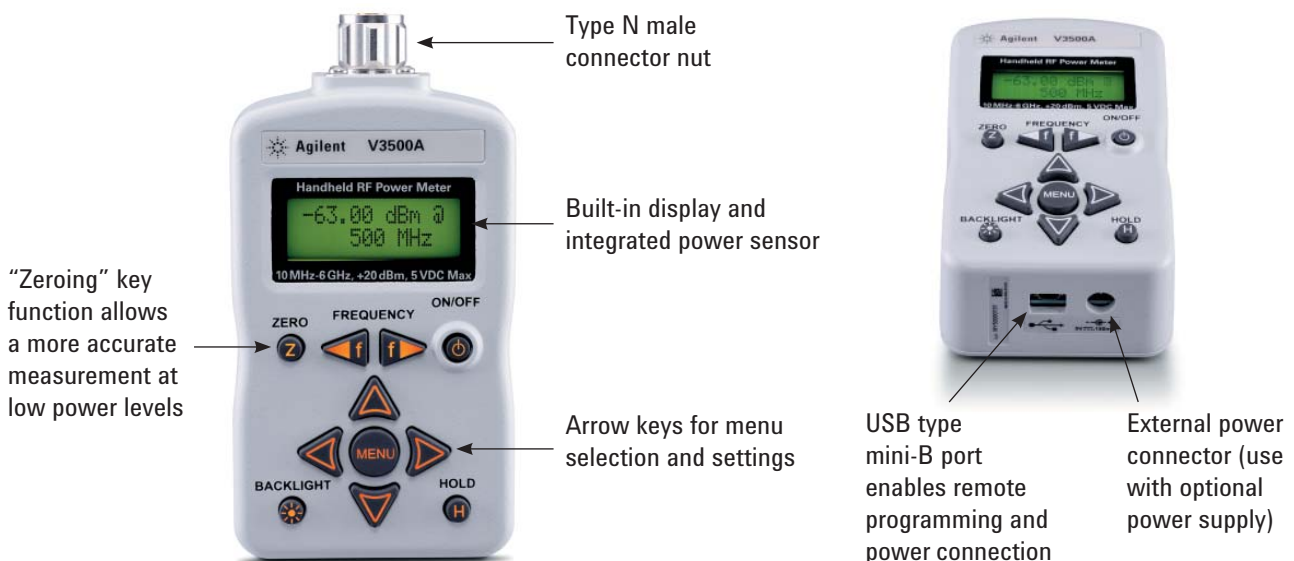

Power Measurement Software For Easy Monitoring and Troubleshooting

N1918A Power Analysis Manager

The N1918A Power Analysis Manager is compatible with the U2000 Series USB power sensors, N1911/12A P-Series power meters and N8262A P-Series modular power meter. This feature-packed software not only enables performance monitoring and data collection, but also simplifies post-data analysis and speeds up troubleshooting.

- Highlights**
- Multiple viewing types, including multiple-channel list (> 20 channels)
 - Overlay trace graph and waveform mathematics for easy signals computation
 - Record and save for easy troubleshooting
 - Limit and alert settings for multiple channels monitoring
 - Complete 15-point pulse characterization for peak power analysis
 - PDF, CDF and CCDF tables and graphs for statistical analysis

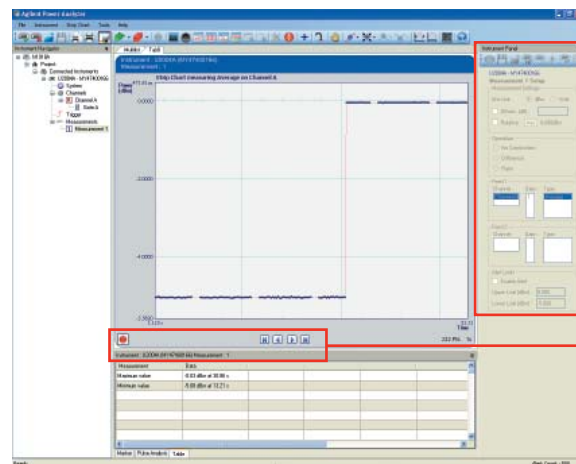
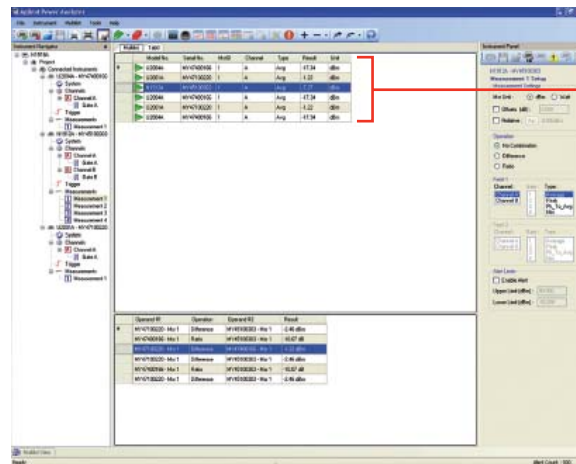
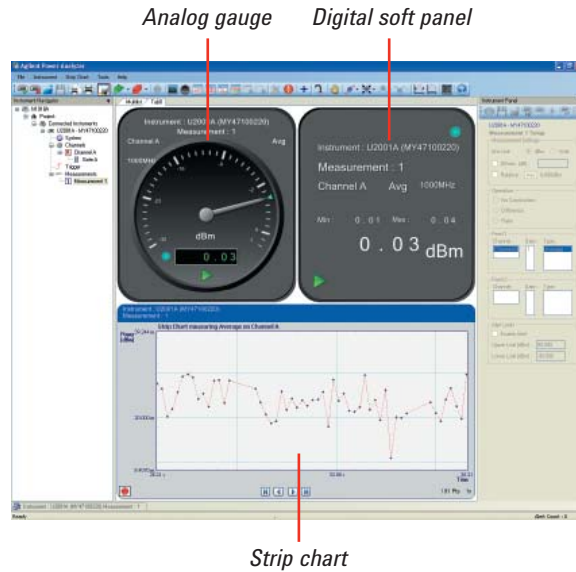

Power Measurement Software

For Easy Monitoring and Troubleshooting

The N1918A software is available in two versions: the basic Power Panel and the advanced Power Analyzer, which provides full access to the software's complete features and capabilities. Power Panel can be accessed immediately upon installation, while Power Analyzer's licenses (N1918A-100 and N1918A-200) are available separately.

	Power Panel (basic)	Power Analyzer (advanced)
Measurement displays		
Soft panel (digital) display	✓	✓ Enhanced with limits and alerts
Gauge (analog) display	✓	✓ Enhanced with limits and alerts
Strip chart display	✓	✓
Trace graph display	✓ ³	✓
Multiple tabs	✗	✓
Multiple displays per tab	✓	✓
Multilist (List view of multiple channels)	✓	✓
Compact mode display	✓	✓ Applies to soft panel, gauge and strip chart
Graph functions		
Single marker	✓ Up to 2 markers per graph	✓ Up to 10 markers per graph
Dual marker	✓ ³	✓ Up to 5 sets of markers per graph
Graph autoscaling	✓	✓
Graph zooming	✓	✓
Measurement math	✓ Delta, Ratio	✓ Delta, Ratio
Pulse characterization functions¹		
15-point pulse characterization	✗	✓
Gate measurement analysis	✗	✓ 4 per trace graph
Overlay graph	✗	✓
Waveform math	✗	✓ Delta, Sum, Ratio
Statistical analysis function¹		
CCDF graph display	✗	✓
Save/Load file functions		
Save/Load project configuration	✓	✓
Save measurement data (with timestamp)	✓ Applies to strip chart displays; up to 10,000 data points	✓ Applies to strip chart, trace graph and CCDF graph displays
Load measurement data	✓ Applies to strip chart displays	✓ Applies to strip chart, trace graph and CCDF graph displays
Data recording ² (with timestamp)	✗	✓ Applies to soft panel, gauge, strip chart and trace graph displays
Save instrument screen image ¹	✓	✓
Measurement limit and alert functions		
Limit and alert notifications	✗	✓
Alert summary	✗	✓
Instrument setting options		
Save/Restore instrument settings	✓	✓
Timed-gated measurements	✓	✓
Instrument preset settings	✓	✓
FDO table parameters	✓	✓
Supporting function		
Print application screen	✓	✓

1. Applies to usage with P-Series power meters

2. Recording time for trace graphs may vary based on trace graph settings

3. Applies to usage with U2000 Series sensors

Power Meters Selection Chart for Wireless Communication

Peak Power Measurement

EPM-P E4416A/17A
(VBW: 5 MHz)



Power sensor options

- E932x Peak-and-Average Sensors (300 kHz, 1.5 MHz, 5 MHz)
- * Also compatible with all average power sensors*

P-Series N1911A/12A
(VBW: 30 MHz)



P-Series modular N8262A
(VBW: 30 MHz)



Power sensor options

- N192x Wideband Sensors (30 MHz)
- E932x Peak-and-Average Sensors (300 kHz, 1.5 MHz, 5 MHz)
- * Also compatible with all average power sensors*

8990B peak power analyzer
(VBW: 150 MHz)



	Video BW	5 MHz	20 MHz	30 MHz	100 MHz	150 MHz
Cellular	GSM/GPRS/EDGE					
	W-CDMA					
	HSDPA/HSUPA (FDD)					
	LTE					
	TD-SCDMA					
	HSDPA (TD-SCDMA)					
	cdmaOne					
	cdma2000®					
1xEV-DO						
						LTE Advanced
Two-Way Trunked	iDEN/WiDEN					
	TETRA/TEDES					
	APCO 25					
Personal Area Network	RFID					
	ZigBee					
	Bluetooth 1.2 & EDR					
	Ultra-Wideband (Bluetooth Future)					
Mobile Broadcast	DVB-H					
	ISDB-T					
	MediaFLO					
	T-DMB					
Broadband	WiBro					
	WiMAX					
	WLAN					
	MMDS					
	LMDS					
	MIMO					
Navigation	GPS					
	Pt-Pt					
	Radar					

Average Power Measurement

EPM N1913A/14A



Power sensor options

- 848x Diode and Thermocouple Sensors
- N848x Thermocouple Sensors
- N848x and 848x Waveguide Sensors
- E441x 1-Path Diode CW-only Sensors
- E930x 2-Path Diode True-Average Sensors
- U200x USB Sensors

N432A Thermistor power meter



Power sensor options

- 478A Thermistor Sensor
- 8478B Thermistor Sensor

U2000 Series USB power sensors



V3500A handheld RF power meter



Power Sensors Selection Chart for Wireless Communication

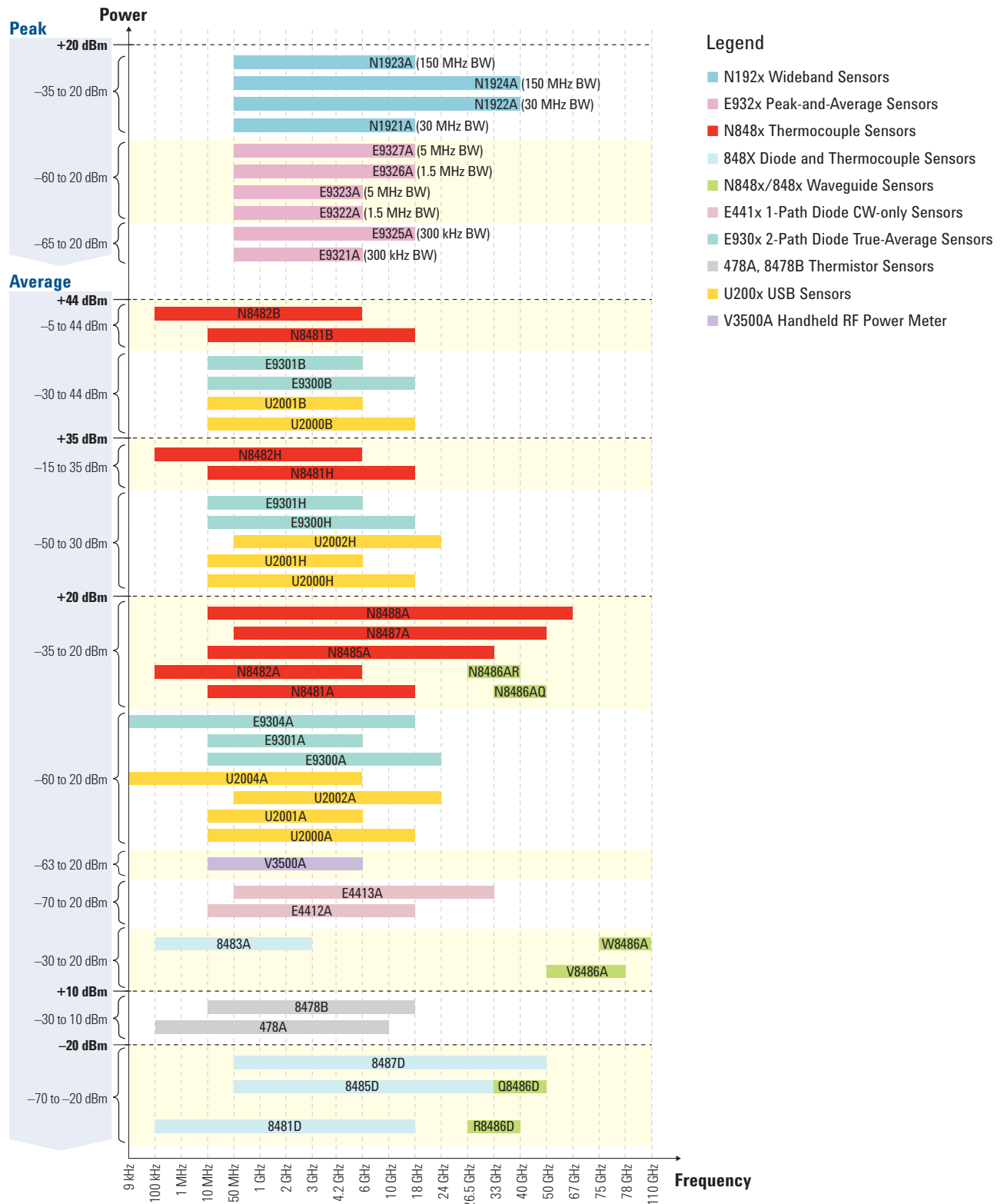

Power Meters and Sensors Compatibility Table

		POWER METERS							Product Description / Sensor Tech.	Frequency Range	Power Range
		N432A/432A ¹	E4416A/17A EPM-P	N1913A/14A E4418B/9B EPM ²	E1416A VXI	N1911A/12A N8262A P-Series	8990B				
POWER SENSORS	Wideband power sensors	N1923A	-	-	-	-	-	√	Diode Power Sensor	50 MHz to 18 GHz	-35 dBm (316 nW) to +20 dBm (100 mW)
		N1924A	-	-	-	-	-	√	Diode Power Sensor	50 MHz to 40 GHz	-35 dBm (316 nW) to +20 dBm (100 mW)
	P-Series Wideband sensors	N1921A	-	-	-	-	√	√	Diode Power Sensor	50 MHz to 18 GHz	-35 dBm (316 nW) to +20 dBm (100 mW)
		N1922A	-	-	-	-	√	√	Diode Power Sensor	50 MHz to 40 GHz	-35 dBm (316 nW) to +20 dBm (100 mW)
	E-Series Peak-and-Average sensors	E9321A	-	√	-	-	√	-	Diode Power Sensor	50 MHz to 6 GHz	-65 dBm (320 pW) to +20 dBm (100 mW)
		E9322A	-	√	-	-	√	-	Diode Power Sensor	50 MHz to 6 GHz	-60 dBm (1 nW) to +20 dBm (100 mW)
		E9323A	-	√	-	-	√	-	Diode Power Sensor	50 MHz to 6 GHz	-60 dBm (1 nW) to +20 dBm (100 mW)
		E9325A	-	√	-	-	√	-	Diode Power Sensor	50 MHz to 18 GHz	-65 dBm (320 pW) to +20 dBm (100 mW)
		E9326A	-	√	-	-	√	-	Diode Power Sensor	50 MHz to 18 GHz	-60 dBm (1 nW) to +20 dBm (100 mW)
		E9327A	-	√	-	-	√	-	Diode Power Sensor	50 MHz to 18 GHz	-60 dBm (1 nW) to +20 dBm (100 mW)
	E-Series True Average sensors	E9300A	-	√	√	-	√	-	Diode Power Sensor	10 MHz to 18 GHz	-60 dBm (1 nW) to +20 dBm (100 mW)
		E9301A	-	√	√	-	√	-	Diode Power Sensor	10 MHz to 6 GHz	-60 dBm (1 nW) to +20 dBm (100 mW)
		E9304A	-	√	√	-	√	-	Diode Power Sensor	9 kHz to 6 GHz	-60 dBm (1 nW) to +20 dBm (100 mW)
		E9300B	-	√	√	-	√	-	Diode Power Sensor	10 MHz to 18 GHz	-30 dBm (1 μW) to +44 dBm (25 W)
		E9301B	-	√	√	-	√	-	Diode Power Sensor	10 MHz to 6 GHz	-30 dBm (1 μW) to +44 dBm (25 W)
		E9300H	-	√	√	-	√	-	Diode Power Sensor	10 MHz to 18 GHz	-50 dBm (10 nW) to +30 dBm (1 W)
	E-Series CW-only sensors	E4412A	-	√	√	-	√	-	Diode Power Sensor	10 MHz to 18 GHz	-70 dBm (100 pW) to +20 dBm (100 mW)
		E4413A	-	√	√	-	√	-	Diode Power Sensor	50 MHz to 26.5 GHz	-70 dBm (100 pW) to +20 dBm (100 mW)
	N8480 / 8480 Series Thermocouple and Diode sensors	N8481A	-	√	√	-	√	-	Thermocouple Power Sensor	10 MHz to 18 GHz	-35 dBm (316 nW) to +20 dBm (100 mW)
		N8482A	-	√	√	-	√	-	Thermocouple Power Sensor	100 kHz to 6 GHz	-35 dBm (316 nW) to +20 dBm (100 mW)
		8483A	-	√	√	√	√	-	Thermocouple Power Sensor	100 kHz to 2 GHz	-30 dBm (1 μW) to +20 dBm (100 mW)
		N8485A	-	√	√	-	√	-	Thermocouple Power Sensor	10 MHz to 26.5 GHz	-35 dBm (316 nW) to +20 dBm (100 mW)
		N8487A	-	√	√	-	√	-	Thermocouple Power Sensor	50 MHz to 50 GHz	-35 dBm (316 nW) to +20 dBm (100 mW)
		N8488A	-	√	√	-	√	-	Thermocouple Power Sensor	10 MHz to 67 GHz	-35 dBm (316 nW) to +20 dBm (100 mW)
N8481B		-	√	√	-	√	-	High Power Thermocouple Sensor	10 MHz to 18 GHz	-5 dBm (316 μW) to +44 dBm (25 W)	
N8482B		-	√	√	-	√	-	High Power Thermocouple Sensor	100 kHz to 6 GHz	-5 dBm (316 μW) to +44 dBm (25 W)	
N8481H		-	√	√	-	√	-	High Power Thermocouple Sensor	10 MHz to 18 GHz	-15 dBm (32 μW) to +35 dBm (3 W)	

1. The 432A model is superseded by the N432A.
2. The E4418B/19B models are superseded by the N1913A/14A.

* For the complete list of sensor options, please visit our Web site at www.agilent.com/find/powermeters.

Power Meters and Sensors Compatibility Table

		POWER METERS							Product Description / Sensor Tech.	Frequency Range	Power Range
		N432A/432A 1	E4416A/17A EPM-P	N1913A/14A E4418B/9B EPM 2	E1416A VXI	N1911A/12A N8262A P-Series	8990B				
POWER SENSORS	N8480 / 8480 Series Thermocouple and Diode sensors	N8482H	-	√	√	-	√	-	High Power Thermocouple Sensor	100 kHz to 6 GHz	-15 dBm (32 μW) to +35 dBm (3 W)
		8481D	-	√	√	√	√	-	Diode Power Sensor	10 MHz to 18 GHz	-70 dBm (100 pW) to -20 dBm (10 μW)
		8485D	-	√	√	√	√	-	Diode Power Sensor	50 MHz to 26.5 GHz	-70 dBm (100 pW) to -20 dBm (10 μW)
		8487D	-	√	√	√	√	-	Diode Power Sensor	50 MHz to 50 GHz	-70 dBm (100 pW) to -20 dBm (10 μW)
	Waveguide sensors	R8486D	-	√	√	√	√	-	Waveguide Power Sensor	26.5 GHz to 40 GHz	-70 dBm (100 pW) to -20 dBm (10 μW)
		Q8486D	-	√	√	√	√	-	Waveguide Power Sensor	33 GHz to 50 GHz	-70 dBm (100 pW) to -20 dBm (10 μW)
		N8486AR	-	√	√	-	√	-	Thermocouple Waveguide Power Sensor	26.5 GHz to 40 GHz	-35 dBm (316 μW) to +20 dBm (100 mW)
		N8486AQ	-	√	√	-	√	-	Thermocouple Waveguide Power Sensor	33 GHz to 50 GHz	-35 dBm (316 μW) to +20 dBm (100 mW)
		V8486A	-	√	√	√	√	-	V-band Power Sensor	50 GHz to 75 GHz	-30 dBm (1 μW) to +20 dBm (100 mW)
		W8486A	-	√	√	√	√	-	Waveguide Power Sensor	75 GHz to 110 GHz	-30 dBm (1 μW) to +20 dBm (100 mW)
	Thermistor mount sensors	478A	√	-	-	-	-	-	Coaxial Thermistor Mount	10 MHz to 10 GHz	-30 dBm (1 μW) to +10 dBm (10 mW)
		8478B	√	-	-	-	-	-	Coaxial Thermistor Mount	10 MHz to 18 GHz	-30 dBm (1 μW) to +10 dBm (10 mW)
	USB sensors	U2000A	-	-	√ ³	-	-	√	Diode Power Sensor	10 MHz to 18 GHz	-60 dBm (1 nW) to +20 dBm (100 mW)
		U2001A	-	-	√ ³	-	-	√	Diode Power Sensor	10 MHz to 6 GHz	-60 dBm (1 nW) to +20 dBm (100 mW)
		U2002A	-	-	√ ³	-	-	√	Diode Power Sensor	50 MHz to 24 GHz	-60 dBm (1 nW) to +20 dBm (100 mW)
		U2004A	-	-	√ ³	-	-	√	Diode Power Sensor	9 kHz to 6 GHz	-60 dBm (1 nW) to +20 dBm (100 mW)
		U2000B	-	-	√ ³	-	-	√	Diode Power Sensor	10 MHz to 18 GHz	-30 dBm (1 μW) to +44 dBm (25 W)
		U2001B	-	-	√ ³	-	-	√	Diode Power Sensor	10 MHz to 6 GHz	-30 dBm (1 μW) to +44 dBm (25 W)
		U2000H	-	-	√ ³	-	-	√	Diode Power Sensor	10 MHz to 18 GHz	-50 dBm (10 nW) to +30 dBm (1 W)
		U2001H	-	-	√ ³	-	-	√	Diode Power Sensor	10 MHz to 6 GHz	-50 dBm (10 nW) to +30 dBm (1 W)
		U2002H	-	-	√ ³	-	-	√	Diode Power Sensor	50 MHz to 24 GHz	-50 dBm (10 nW) to +30 dBm (1 W)
	Discontinued 848x sensors	8481/2/5/7A	-	√	√	√	√	-	Thermocouple Power Sensor	100 kHz to 50 GHz	-30 dBm (1 μW) to +20 dBm (100 mW)
		848xB/H	-	√	√	√	√	-	High Power Thermocouple Sensor	100 kHz to 18 GHz	-10 dBm (100 μW) to +44 dBm (25 W)
		R8486A	-	√	√	√	√	-	Thermocouple Waveguide Power Sensor	26.5 GHz to 40 GHz	-30 dBm (1 μW) to +20 dBm (100 mW)
		Q8486A	-	√	√	√	√	-	Thermocouple Waveguide Power Sensor	33 GHz to 50 GHz	-30 dBm (1 μW) to +20 dBm (100 mW)

1. The 432A model is superseded by the N432A.
2. The E4418B/19B models are superseded by the N1913A/14A.
3. Only with N1913A/14A.

* For the complete list of sensor options, please visit our Web site at www.agilent.com/find/powermeters.

Related Agilent Literature

Publication title	Pub number
Application Notes	
<i>Agilent P-Series Power Sensor Internal Zeroing and Calibration for RF Power Sensors Application Note</i>	5989-6509EN
<i>Agilent N1911A/N1912A P-Series Power Meters For WiMAX™ Signal Measurements Demo Guide</i>	5989-6423EN
<i>Agilent 4 Steps for Making Better Power Measurements Application Note 64-4D</i>	5965-8167E
<i>Agilent Choosing the Right Power Meter and Sensor Product Note</i>	5968-7150E
<i>Agilent Fundamentals of RF and Microwave Power Measurements Application Notes 1449-1/2/3/4</i>	5988-9213/4/5/6EN
<i>Agilent EPM-P Series Power Meters Used in Radar and Pulse Applications Application Note 1438</i>	5988-8522EN
<i>Agilent Compatibility of the U2000 Series USB Power Sensors with Agilent Instruments Application Note</i>	5989-8743EN
<i>Agilent N1918A Radar Pulse Measurement Application Note</i>	5990-3415EN
<i>MIMO Measurement Tips with Agilent P-Series Power Meters and U2000 Series USB Power Sensors Application Note</i>	5990-3546EN
<i>Agilent P-Series and EPM-P Power Meters for Bluetooth Testing Technical Overview and Self-Guided Demonstration</i>	5989-8459EN
<i>Agilent Maximizing Measurement Speed Using P-Series Power Meters Application Note</i>	5989-7678EN
<i>Agilent Using Linux® To Control the U2000 Series USB Power Sensors Product Note</i>	5989-8744EN

Measurement Automation—Quick and Easy

Whatever instrument you're programming—whether an RF analyzer, oscilloscope, power supply or DMM—Agilent VEE graphical language software and I/O connectivity provide you the ease and flexibility to set up and automate the way you want for your application need. Make measurements quickly, easily and affordably today.





Agilent Email Updates

www.agilent.com/find/emailupdates

Get the latest information on the products and applications you select.



www.lxistandard.org

LAN eXtensions for Instruments puts the power of Ethernet and the Web inside your test systems. Agilent is a founding member of the LXI consortium.

Agilent Channel Partners

www.agilent.com/find/channelpartners

Get the best of both worlds: Agilent's measurement expertise and product breadth, combined with channel partner convenience.

Microsoft is a registered trademark of Microsoft Corporation in the United States and/or other countries.

Visual Basic is a registered trademark of Microsoft Corporation in the United States and/or other countries.

Visual Studio is a registered trademark of Microsoft Corporation in the United States and/or other countries.

MATLAB is a registered trademark of The MathWorks, Inc.

Bluetooth is a trademark owned by Bluetooth SIG, Inc., U.S.A. and licensed to Agilent Technologies, Inc.

cdma2000 is a registered certification mark of the Telecommunications Industry Association. Used under license.

WiMAX is a trademark of the WiMAX Forum.



Agilent Advantage Services is committed to your success throughout your equipment's lifetime. To keep you competitive, we continually invest in tools and processes that speed up calibration and repair and reduce your cost of ownership. You can also use Infoline Web Services to manage equipment and services more effectively. By sharing our measurement and service expertise, we help you create the products that change our world.

www.agilent.com/find/advantageservices



www.agilent.com/quality

www.agilent.com

www.agilent.com/find/powermeters

For more information on Agilent Technologies' products, applications or services, please contact your local Agilent office. The complete list is available at:

www.agilent.com/find/contactus

Americas

Canada	(877) 894 4414
Brazil	(11) 4197 3500
Mexico	01800 5064 800
United States	(800) 829 4444

Asia Pacific

Australia	1 800 629 485
China	800 810 0189
Hong Kong	800 938 693
India	1 800 112 929
Japan	0120 (421) 345
Korea	080 769 0800
Malaysia	1 800 888 848
Singapore	1 800 375 8100
Taiwan	0800 047 866
Other AP Countries	(65) 375 8100

Europe & Middle East

Belgium	32 (0) 2 404 93 40
Denmark	45 70 13 15 15
Finland	358 (0) 10 855 2100
France	0825 010 700*
	*0.125 €/minute
Germany	49 (0) 7031 464 6333
Ireland	1890 924 204
Israel	972-3-9288-504/544
Italy	39 02 92 60 8484
Netherlands	31 (0) 20 547 2111
Spain	34 (91) 631 3300
Sweden	0200-88 22 55
United Kingdom	44 (0) 131 452 0200

For other unlisted countries:

www.agilent.com/find/contactus

Revised: June 8, 2011

Product specifications and descriptions in this document subject to change without notice.

© Agilent Technologies, Inc. 2010, 2011
Published in USA, October 25, 2011
5989-6240EN



Agilent Technologies