

Using SystemVue's Radar Library to Generate Signals for Radar Design and Verification

Application Note

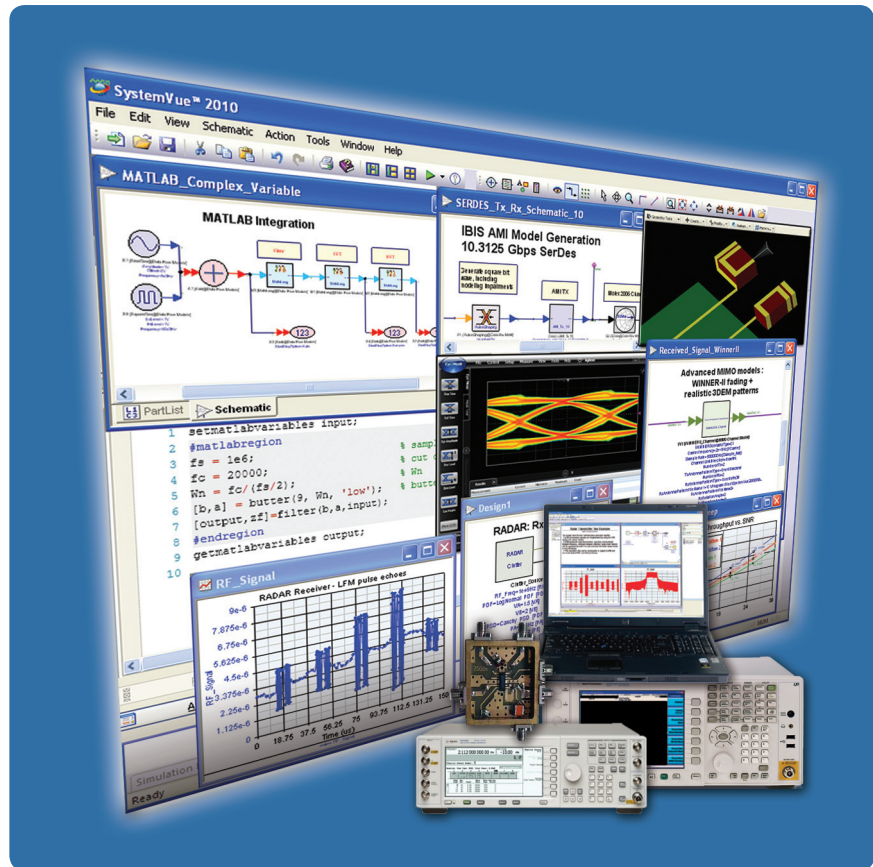

Agilent Technologies

1.0 Introduction

Modern radar systems use more complex signal formats working in wide or ultra-wide bandwidths, and operating in different frequencies (e.g., X, Ku and Ka bands). They also use advanced digital signal processing techniques to disguise their operation and overcome strong clutter and jamming in their environment. Addressing this complexity requires the generation of realistic test signals and system-level scenarios that can be used to create and verify the radar signal processing algorithms. While dedicated hardware simulators and field testing are typically used to generate these test signals, both are costly, time consuming and apply later in the design process. This application note presents a less expensive option for generating test signals early in system development. This approach to system-level design and verification uses the Agilent SystemVue environment, a Radar Model Library and commercial off-the-shelf test equipment for generation of continual and pulse radar waveforms, for both algorithm and hardware verification.

2.0 Design Problem

Radar signal processing algorithms play a critical role in advanced radar, especially high-performance multi-mode systems. Radar designers require custom reference waveforms with precise amounts of impairment and field conditions when testing or verifying radar components (both baseband and RF). The signal scenarios are used both for troubleshooting and block-level diagnostics, as well as for initial platform integration and validation.

Unfortunately, signal processing algorithm creation is complicated, with all resulting algorithms needing to be verified in the complex external environment. Greater interaction between algorithms and signal sources provides a realistic radar environment that allows early maturity and confidence in the radar system. Creating the advanced algorithms therefore, requires the availability of a sufficient set of models for the various radar elements and functions, including signal generation, transmission, antenna, T/R switching, clutter, noise, jamming, receiving, signal processing, and measurements.

3.0 Common Approaches to Radar System Design

The two methods commonly employed by radar designers to generate the required signals for algorithm creation are accelerated, dedicated hardware simulation and direct field testing.

3.1 Hardware simulation

Scenario-based verification is typically performed using expensive, high-end hardware simulators that create real-time scenarios of realistic fidelity. Unfortunately, such simulators are not available early enough in the design process (during the algorithm stage prior to hardware implementation), to provide meaningful insight for the algorithm developer. They also don't integrate well with model-based design practices or provide the level of scripting needed in early development for low-level, block-level verification. Because simulation takes place later in the design cycle, making design changes at this stage can be both costly and time consuming. Design engineers can benefit from earlier algorithmic validation of their key ideas.

3.2 Field testing

Another way to generate the required signals is to physically go into the field to make environmental measurements of the radar hardware operating under realistic conditions. While there are many reasons for utilizing this approach, because it comes late in the design process it rarely connects to the original algorithmic development environment. In addition, this method is costly, sometimes inconvenient and time consuming.

4.0 A More Practical, Less Expensive Option

For early development, a robust and inexpensive alternative uses a convenient software simulation-based radar library to generate the reference waveforms needed for radar signal processing algorithm development. Early access to these signals enables the design of superior system architectures and facilitates early hardware verification at different layers of abstraction, as the model-based design matures.

4.1 The Agilent radar library application

As can be seen from Table 4-1, the Agilent W1905 Radar Model Library is an advanced simulation block set of over 35 highly-parameterized primitive blocks and higher-level reference designs. It can be used for modeling different types of radar systems, creating radar signal processing algorithms, evaluating system's performance and providing proof-of-concept designs. The block set and its example workspaces serve as algorithmic and architectural reference designs to verify radar performance under different conditions. These include target and radar cross section (RCS) scenarios, clutter conditions, jamming (intentional) and environmental interference, and the effect of various receiver algorithms. It is ideal for radar designers who need to generate precise signals for algorithm and hardware verification, or study the performance of their radar systems under various conditions.

Table 4-1. The W1905 radar model library block list

Signal sources	LFM – Linear FM wave generator NLFM – Nonlinear FM wave generator BarkerCode – Poly-phase code wave generator FrankCode – Frank code wave generator ZCCode – Zadoff–Chu code wave generator MatchedSrc – Generates the matched source signal for pulse compression
Signal processing	Detector – Video signal detector FFT – Complex fast Fourier transform PC – Pulse compression processing PD – Pulse Doppler processing MTI – Moving target indication MTD – Moving target detection CFAR – Constant false-alarm rate process Window – Windowing for sidelobe control
Transmitter	CICInterp – Interpolation with cascaded CIC filters DUC – Digital up-converter, baseband to intermediate frequency UpSample – Up sampler with poly-phase filter Tx – Transmitter front end
Receiver	CICDecimate – decimation with cascaded CIC filters DDC – Digital down-converter, intermediate frequency to baseband DownSample – Down sampler with poly-phase filter Rx – Receiver front end
Environment	RCS – Radar cross-section modeling Target – Target modeling, including RCS, Doppler effect, delay, attenuation Clutter – Clutter modeling
Antenna	Tx Ant – Transmitter antenna Rx Ant – Receiver antenna
Measurement	Pd Measurement – Detection probability estimation Pf Measurement – False-alarm rate estimation

The W1905 works within the SystemVue system-level design environment. SystemVue is an open modeling environment focused on physical-layer baseband/ RF architectures that replaces general-purpose digital, analog and math environments, and connects to a variety of FPGA and embedded hardware design flows. Together SystemVue and the W1905 create a system-level platform for design and verification that meets the requirements for signal processing algorithm creation (Figure 4-1).

Generate waveforms - Return signals with clutters + jamming

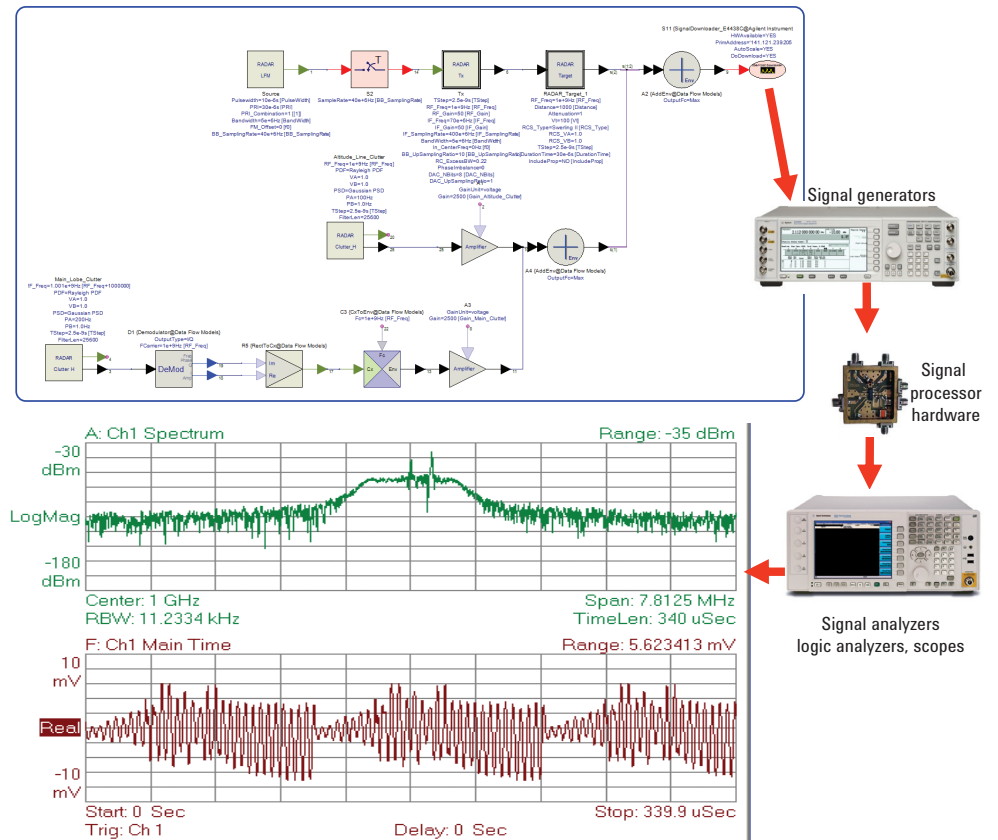
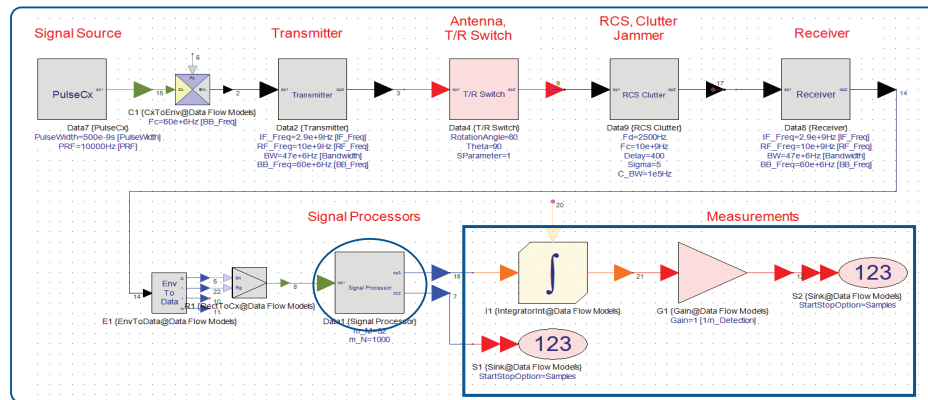

Figure 4-1. The W1905 Radar Model Library and SystemVue system platform

The platform provides a user-friendly algorithm modeling and debug environment that supports a variety of languages (e.g., C++ and math language), as well as an algorithm design and verification environment for signal generation and performance measurements (Figures 4-2 and 4-3). From the block diagram in Figure 4-2, the main models include: signal source, transmitter, antenna, T/R switch, RCS, clutter, jammer, receiver, signal processors, and measurements. SystemVue enables the creation of new and customized algorithms for the specific applications of the radar system under design. Many of the available sub-libraries are listed.



- | Tx waveform library | T/R component | Antenna library | Radar environment | Radar signal processing |
|---|--|--|---|---|
| <ul style="list-style-type: none"> Radar pulse generator Coherent signal generator for single or multiple channel | <ul style="list-style-type: none"> DAC PA Up converter Filter DDS LNA Down converter ADC | <ul style="list-style-type: none"> Antenna models T/R antenna array Antenna propagation | <ul style="list-style-type: none"> Target Clutter Jammer Interference | <ul style="list-style-type: none"> Digital pulse compression Moving Target Indication (MTI) Moving Target Detection (MTD) Constant False Alarm Rate (CFAR) Digital beamformer Space-Time Adaptive Processing (STAP) |

Figure 4-2. SystemVue combined with the optional W1905 Radar Model Library is a platform for radar system design.

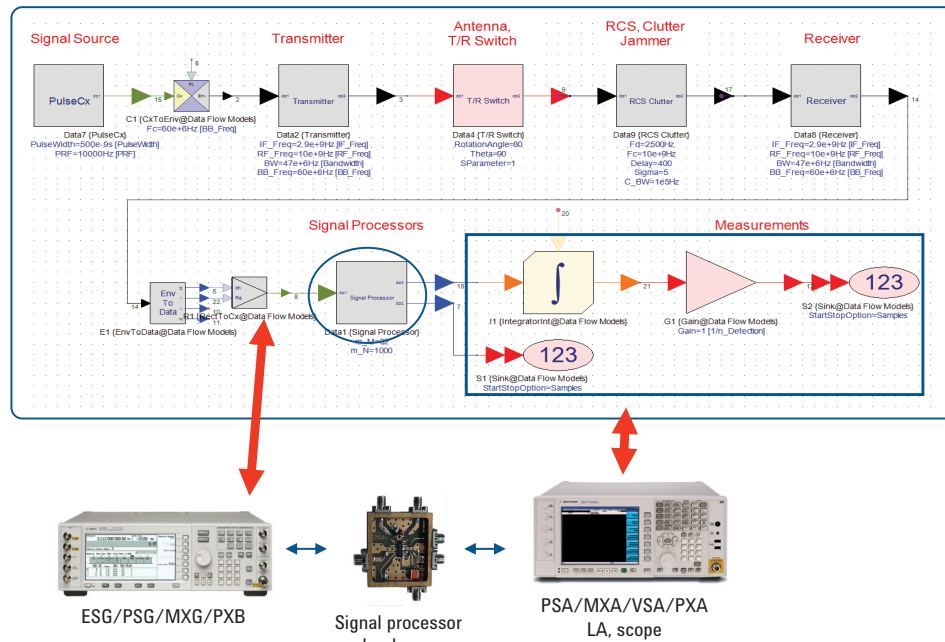

Figure 4-3. A platform for radar verification

As shown in Figure 4-3, radar components can be connected to instruments and test hardware based on the created algorithm.

To better understand how the W1905 Radar Model Library and SystemVue platform generate radar test signals, consider the test setup in Figure 4-4. Here, an interface model (Sink) in SystemVue connects to one of the Agilent ESG/PSG/MXG families of vector signal generators. SystemVue generates radar waveforms in simulation that are automatically downloaded at run-time into the instruments for use as RF/IF test signals during hardware testing. Waveforms captured by the vector signal analyzer can then be automatically returned to SystemVue. Acquired waveforms can be further processed in SystemVue.

Effectively, a smart simulation platform (SystemVue with the Radar Model Library) surrounded by wideband stimulus/response equipment can be used to manually imitate missing hardware blocks, in order to complete a working radar system. This allows system-level validation to continue at an earlier date, based on partially-implemented hardware. As real hardware becomes available, the simulation platform withdraws to function more effectively with the test equipment to provide targeted radar signals for testing. By working early within the radar block diagram, SystemVue serves a variety of R&D needs as a design transitions from concept to working prototype, eventually assisting with hardware testing. This serves an expanded function relative to the Agilent Signal Studio for pulse building software, which is focused specifically on test signal creation using Agilent signal generators, for final hardware validation.

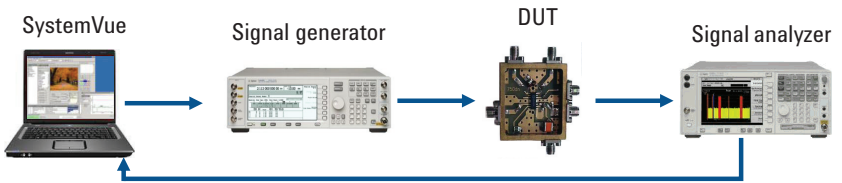

Figure 4-4. Platform for radar test signal generation

The SystemVue platform provides an interface to a range of test equipment to help verify the implemented hardware (compared to the original pure algorithm). Supported algorithmic reference sources include radar signal generation with RCS, clutter, jamming, and Doppler frequency offset. Supported measurements include waveforms, spectra, detection rate, and false alarm rate (FAR).

Some of the test equipment that can be connected to SystemVue includes signal analyzers, logic analyzers and scopes (e.g., Agilent’s Infiniium 90000 X-Series high-performance oscilloscope). As an example, consider Figure 4-5. Here, a radar target return signal with clutter and RCS target echoes are generated by SystemVue and downloaded to Agilent’s PXI M9392A, the industry’s first single-vendor PXI microwave vector signal analyzer (VSA).

The Agilent 89600 Vector Signal Analysis (VSA) software can also be connected to the W1905 and SystemVue platform. Designed for the engineering environment, it provides advanced general-purpose and standards-based tools for measuring signal spectrum, modulation and time characteristics. It also gathers the data needed to find and resolve physical layer signal problems.

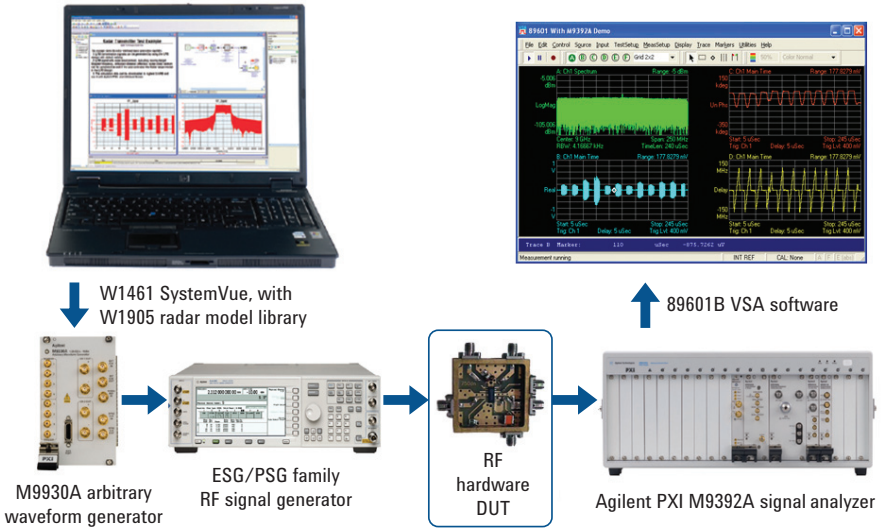

Figure 4-5. A return signal in the radar detection environment is generated by SystemVue and downloaded to Agilent’s new modular PXI instruments for wideband hardware testing.

4.2 Value proposition

There are multiple benefits that come from using the W1905 Radar Model Library with SystemVue software. These benefits include:

Increased productivity

Access to over 35 highly-parameterized primitive blocks and higher-level reference designs allows radar designers to more quickly and easily create radar systems. Using the W1905 within the SystemVue environment brings functional verification into the design environment, while also providing access to a range of instruments for additional measurements. This ensures that hardware design is performed with higher confidence and accuracy and with reduced need for exhaustive design verification farther downstream.

Time and cost savings

The W1905 saves time and cost in multiple ways. Time savings come from the ability to use primitive blocks to quickly build a radar system and to verify algorithms prior to targeted hardware implementation. Cost savings stems from reducing the need for expensive simulators and field testing in the early phases of design, as well as the NRE and scripting associated with regression suites of simulated scenarios.

“Drive test” fidelity

The W1905 and SystemVue together create an open modeling platform that connects to a variety of design flows and can easily bridge the gap between design and verification. Bridging this gap brings “drive test” fidelity into the architectural design phase, providing radar designers with the tools they need to design and verify superior system architectures early in the design process.

Versatile verification

Using the W1905, designers can analyze system vulnerabilities, algorithm robustness, and generate and receive hardware test vectors, which can be downloaded to live test equipment and processed in SystemVue for additional measurements. This versatility saves time, efficiently leverages equipment assets and eliminates expensive visits to hardware simulators and testing ranges early in the R&D design process.

5.0 Radar Component Test Examples

To test radar components in a transmitter and receiver, the W1905 can be used to generate various types of test signals including radar transmission signals such as LFM, NFM, Coded FM, return (RCS) signals, and return signals with clutter. An example of return signals with clutter is shown in Figures 5-1 to 5-4.

Generate waveforms - Radar transmission (LFM) signals

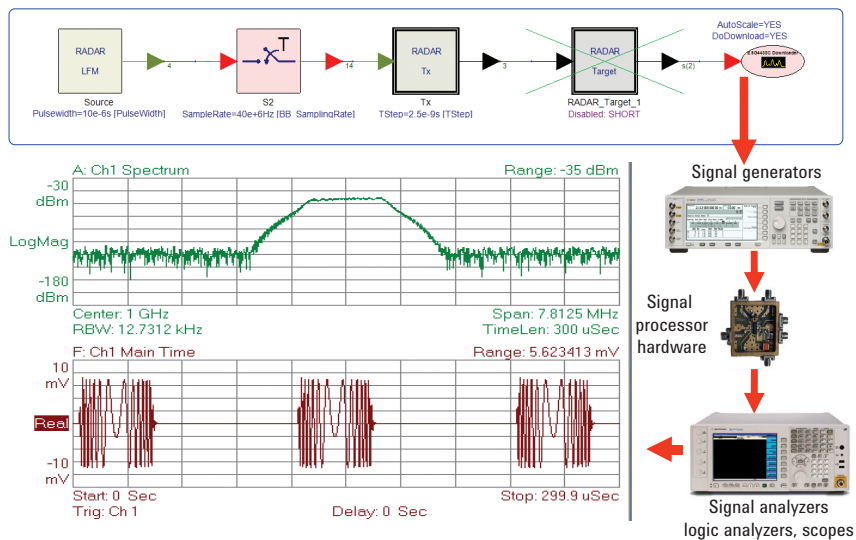

Figure 5-1. This diagram shows how a LFM radar transmission signal can be generated in SystemVue and then downloaded to Agilent's ESG/MSG/PSG vector signal generator. The LFM transmission signal can be used for radar component test.

Generate waveforms - Return (RCS) signals

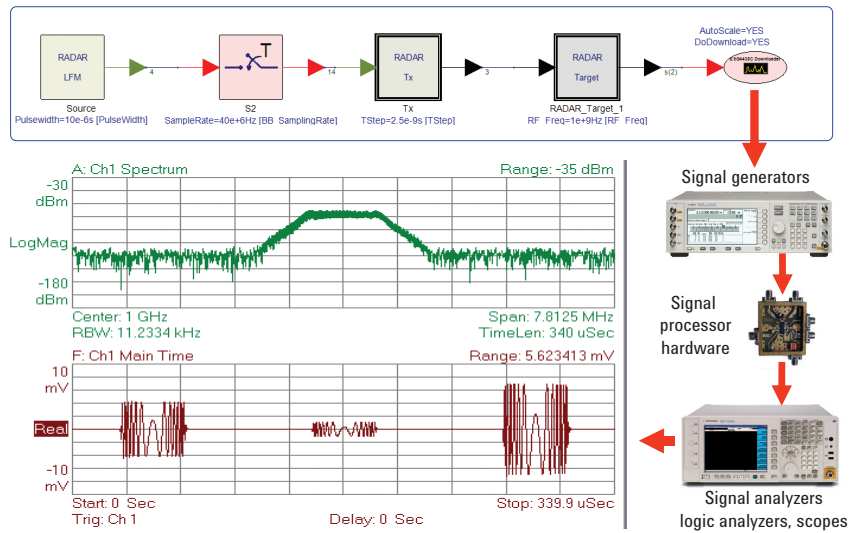

Figure 5-2. This diagram depicts how to generate the radar receiver test signal. Users can use the SystemVue Radar Target model to specify target range, velocity and radar cross section models. The receiver signal can be used to test radar receiver detection algorithms.

Generate waveforms - Return signals with clutters

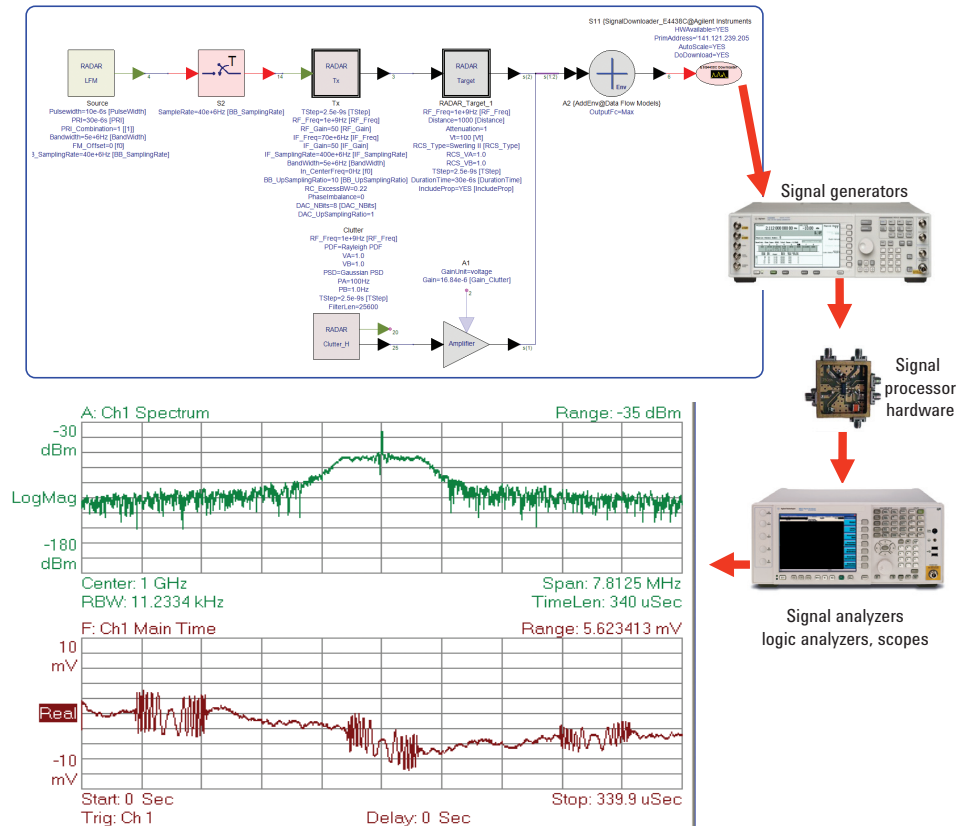

Figure 5-3. The resulting radar received signal with RCS and clutter describes the radar environment details.

Generate waveforms - Return signals with clutters + jamming

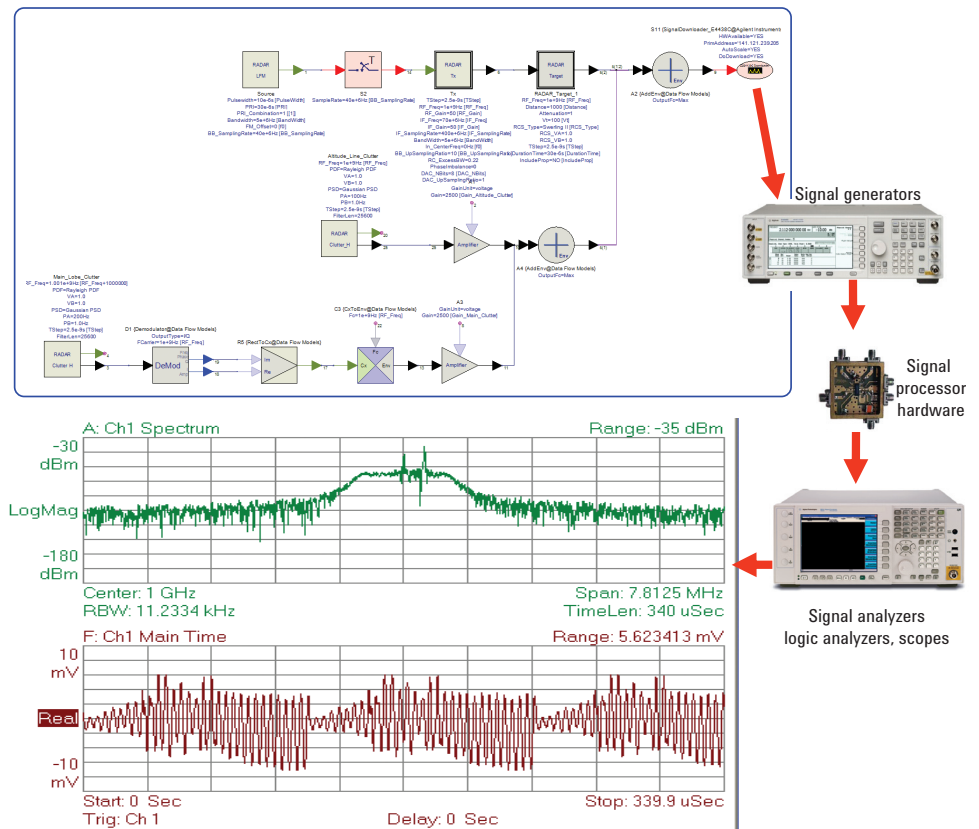

Figure 5-4. Here, the radar received signal has not only RCS and clutter, but jamming as well for describing the radar's complex environment details.

The W1905 can also be used to generate wideband and ultra wideband signals using the setup shown in Figure 5-5. In this case, SystemVue generates radar baseband I/Q data that is downloaded to the N6030 or N81180 arbitrary waveform generator—a 4.2 GSa/s arbitrary waveform generator with 12-bit vertical resolution for complex real-world signals. The wideband radar signals formed in the N6030 or N81180 are then sent to the wideband PSG I/Q modulator inputs, which in turn sends RF wideband signals to the DUT to test the RF radar components. Next, the output DUT is captured using the Infiniium 90000 X-Series scope and sent back to the PC for either direct analysis using the VSA software or for further analysis using SystemVue. A generated radar received LFM signal with RCS is shown in Figure 5-6.

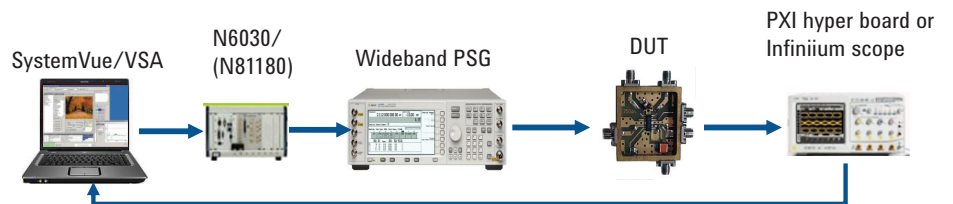

Figure 5-5. Test setup for wideband signal generation

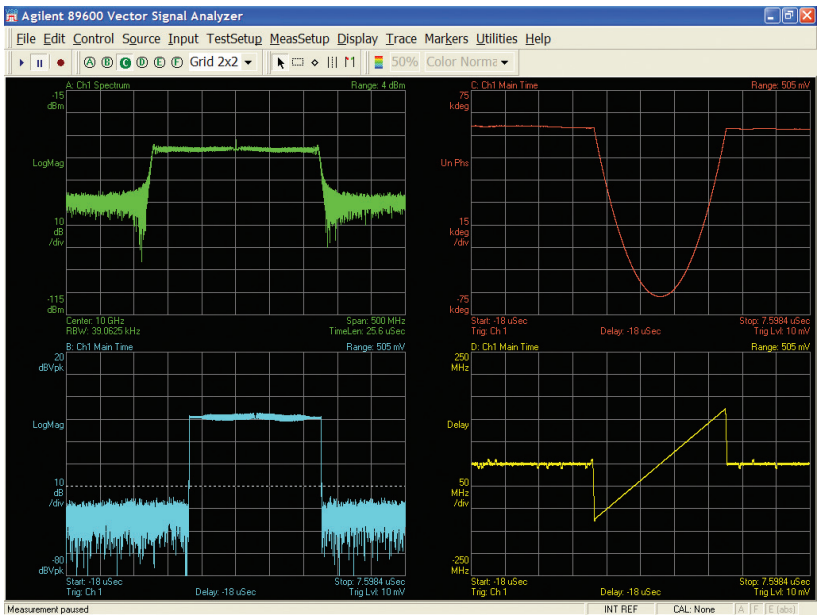
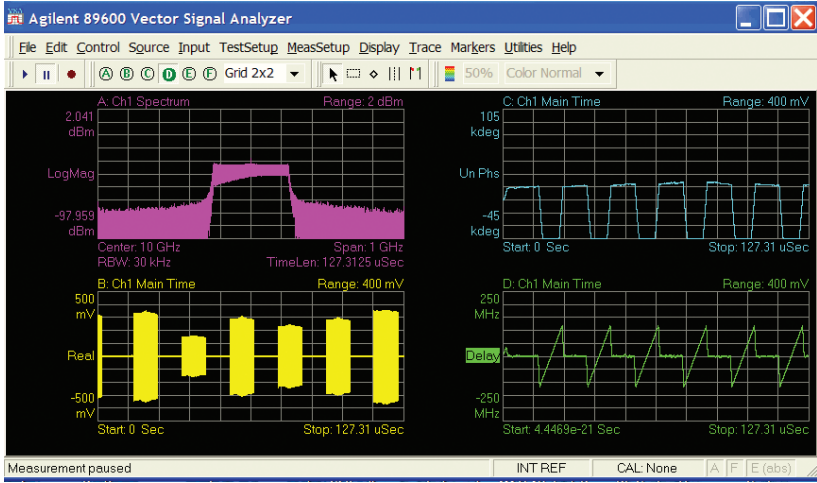

Figure 5-6. This wideband signal (radar received LFM signal with RCS) was generated using SystemVue, the N6030 and PSG. The signal was measured using VSA software.

Another type of waveform that is created with the W1905 radar library are target return signals with clutter. Figure 4-6 shows how that type of signal and RCS target echoes are generated by SystemVue and downloaded to a modular PXI instrument (e.g., a baseband pattern generator or wideband arb in modern RF signal generators) for hardware testing.

6.0 Conclusion

The complexity of advanced radar systems puts added focus on the radar signal processing algorithms which are critical to their development. Creating these algorithms requires generation of test signals. While this is typically done using high-performance hardware simulators or range testing, Agilent's W1905 Radar Model Library offers a more practical, quicker and drastically less expensive alternative. When used with the SystemVue environment, this application provides the basic information needed to create the required test signals earlier in the design cycle, enabling superior system architecture design and facilitating early hardware verification at several layers of abstraction as a design matures. Examples of generated test signals (return signals with clutter and radar received FM signal with RCS) demonstrate the validity of this solution.

7.0 Additional Resources

1. "Agilent SystemVue W1905 Radar Model Library,"
<http://cp.literature.agilent.com/litweb/pdf/5990-6347EN.pdf>
2. McClearnon, D. (2010), "Defining a New Methodology for Radar System Design," Microwave Product Digest,
<http://www.mpdigest.com/issue/Articles/2010/oct/Agilent/Default.asp>
3. <http://www.agilent.com/find/eesof-systemvue-radar-library>

www.agilent.com
www.agilent.com/find/ad

 **Agilent Email Updates**

www.agilent.com/find/emailupdates

Get the latest information on the products and applications you select.

For more information on Agilent Technologies' products, applications or services, please contact your local Agilent office. The complete list is available at:

www.agilent.com/find/contactus

Americas

Canada	(877) 894 4414
Brazil	(11) 4197 3500
Mexico	01800 5064 800
United States	(800) 829 4444

Asia Pacific

Australia	1 800 629 485
China	800 810 0189
Hong Kong	800 938 693
India	1 800 112 929
Japan	0120 (421) 345
Korea	080 769 0800
Malaysia	1 800 888 848
Singapore	1 800 375 8100
Taiwan	0800 047 866
Other AP Countries	(65) 375 8100

Europe & Middle East

Belgium	32 (0) 2 404 93 40
Denmark	45 70 13 15 15
Finland	358 (0) 10 855 2100
France	0825 010 700*
	*0.125 €/minute
Germany	49 (0) 7031 464 6333
Ireland	1890 924 204
Israel	972-3-9288-504/544
Italy	39 02 92 60 8484
Netherlands	31 (0) 20 547 2111
Spain	34 (91) 631 3300
Sweden	0200-88 22 55
United Kingdom	44 (0) 118 9276201

For other unlisted Countries:

www.agilent.com/find/contactus

Revised: October 14, 2010

Product specifications and descriptions in this document subject to change without notice.

© Agilent Technologies, Inc. 2011
Printed in USA, January 25, 2011
5990-6919EN



Agilent Technologies