

BENCH BRIEFS

SERVICE INFORMATION FROM HEWLETT-PACKARD

MARCH-APRIL 1974

TROUBLESHOOTING LOGICALLY

by Neil Neilson

Problem solving is a continually daily problem for most people. The person who is well organized in his approach to problem solving is much more efficient than those who are not.

Organized or not, most of us use some procedure in solving our problems. Such problems arise when a technician is faced with troubleshooting an unfamiliar electronic instrument. Here successful problem solving techniques provide him with the most efficient and economical way of repairing the instrument. Such an approach to troubleshooting is described below.

The first part of the procedure contains a set of questions to be answered by the technician.

Question 1: What is the device and what is it supposed to do?

The answer is located in the specifications for the unit under test. Understanding what the unit does makes the selection of test equipment easier.

Question 2: Does the instrument do what it was designed to do?

Most service manuals contain a detailed performance test procedure. If no procedure is available, use the specifications and devise your own. If the unit under test meets specifications, it is a good indication that you need more information or that the unit has no problem. Search for more information! Question the user. Heat, cool and shake the unit to determine if the problem is intermittent. But, by all means, discover the problem.

Question 3: Has anyone seen the problem before?

The answer can be found in several sources: troubleshooting trees in the service manual, service notes, or other

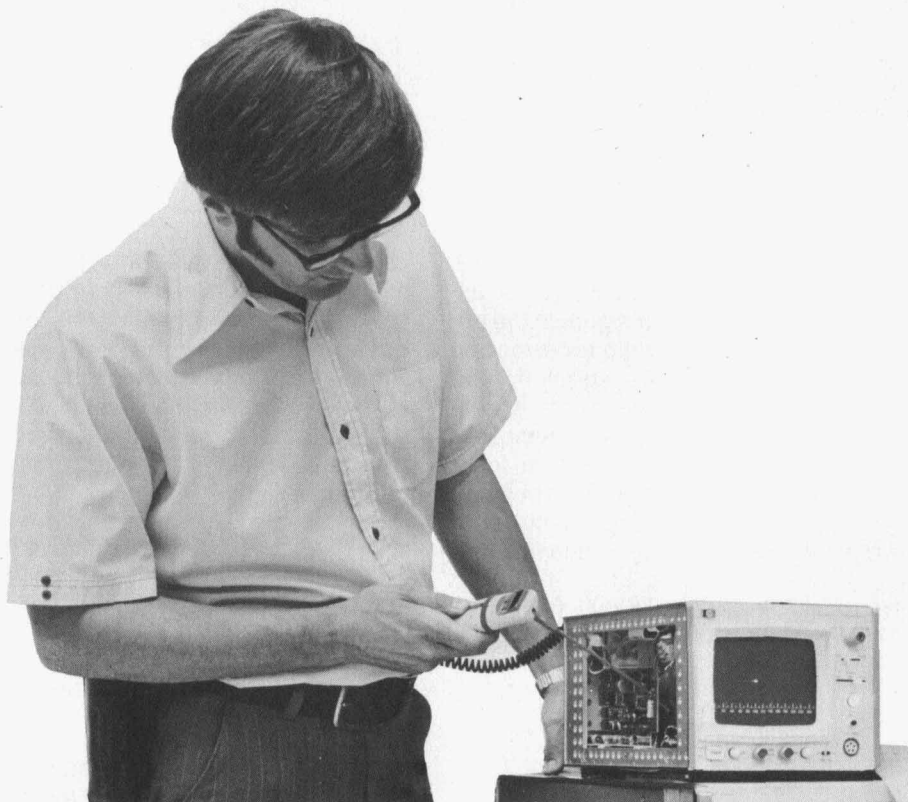

Where should the next measurement be made? Having a logical procedure will help you find the failure with the least number of measurements. This article tells how.

documents from the manufacturer. Another technician is also a good source of information. This is where the professional stands out—he (or she) knows that it is impossible to have all of the answers and willingly asks for help.

If no one else has seen the problem, he must solve it himself. At this stage, he applies the Rules of Logical Troubleshooting. This consists of "milking" the front panel for all symptoms available. Are lights lit? Readouts active? The symptoms are next sorted by functions—trying to localize the fault to a particular function. Many times this can be done by using the switches on the front panel. With practice, the technician can become quite skilled at isolating the fault to a function and sometimes to a particular

block or circuit within the functional circuitry. With the symptom determined, the abnormal path of circuitry is identified. The technician can now isolate the problem with a technique called "bracketing." Bracketing is simply a

IN THIS ISSUE

READER SURVEY
(see page 7)

SERVICE TIPS
Logical Troubleshooting
3489A-L10 Test Card
8660A/B Update Kit
5300 Modules Modification

NEW SERVICE NOTES
RACING QUIZ SOLUTION

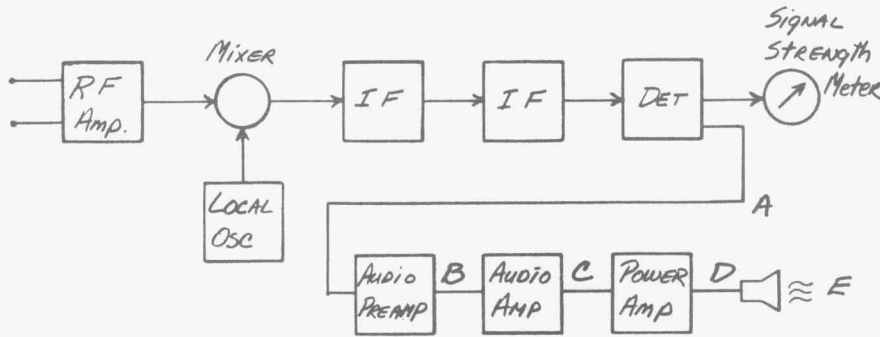

FIGURE 1. RADIO RECEIVER

means of establishing the broad limits around the areas to be tested. For example, if you connect a signal to the antenna terminals of a radio receiver and hear no output in the speaker, you know that the problem exists somewhere between the antenna circuits and the speaker cone (i.e. the entire receiver). See Figure 1. If, however, you notice that the signal strength meter shows a strong indication, the

circuits from the antenna terminals to the detector are probably good (since the signal strength meter is usually driven from one output of a detector). Therefore, the problem is now isolated to the audio section. We also know that at least some of the power supplies are working, and this is valuable information.

As checks are made, the area between the brackets becomes smaller and smaller until the defect is pinpointed. Bracketing defines the limits of the defective circuit and we must make measurements to further isolate the problem.

In our example, we know the problem exists somewhere between the detector and loudspeaker. Where should we make our first measurement? One technique used all too often is to measure point A (to verify that the detector is really working) and then to make measurements at B, C and D until the defective stage is isolated. While this method works, a faster approach is to

use a technique called "half-splitting."

The main principle of half-splitting is that a check is made at the midpoint of the remaining part of the circuit that has not yet been checked.

Looking back at Figure 1, we know that there is no audio output (point E) and we suspect that a signal exists at point A (we know for certain that one output of the detector is ok because of the signal strength meter reading). Now what???

We should measure at point C because this is halfway between the abnormal path. If the signal at point C is ok, the trouble is isolated to either the audio power amplifier or the loudspeaker. A measurement at point D would indicate the defective area. Additional measurements may be needed to determine the defective component.

Figures 2 through 5 display circuitry other than a linear path and the troubleshooting rules utilized for each. As-

CHECK PT OF DIVERGENCE. IF OUTPUT IS NORMAL, CHECK DIVERGENT PATHS.

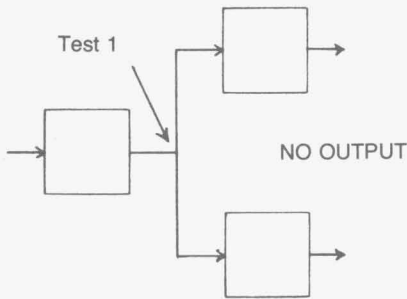

FIGURE 2. DIVERGENT PATH

MODIFY FEEDBACK

IF OUTPUT CHANGED, TROUBLESHOOT FEEDBACK PATH

IF OUTPUT UNCHANGED, TROUBLESHOOT LINEAR PATH

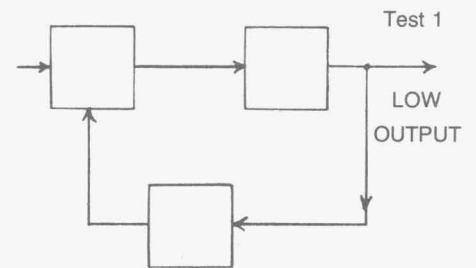
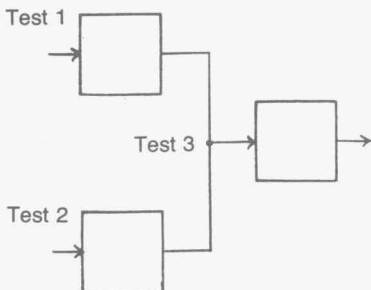

FIGURE 4. FEEDBACK PATH

A. SUMMATIVE (both inputs give output)



CHECK EACH INPUT: IF OUTPUT IS NORMAL, CHECK CONVERGENT STAGE

B. ALTERNATIVE (either input gives output)



CHECK ONE INPUT: IF OUTPUT IS NORMAL, CHECK CONVERGENT STAGE

FIGURE 3. CONVERGENT PATH

MOVE SWITCH TO ALTERNATE POSITION IF BAD OUTPUT, TROUBLE IS LOCATED IN BOTH SIGNAL PATHS.

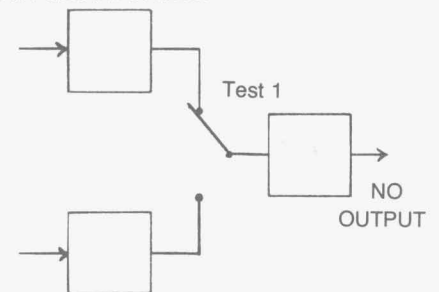

FIGURE 5. SWITCHING PATHS

suming that all circuits shown reveal no or low output, Test 1 is made. Oftentimes, the remaining portion of the circuit under test is a linear path. In this case, the half-splitting technique can be readily used to troubleshoot the rest of the circuit.

Discovering where to measure is only half of the troubleshooting technique—the other half is knowing what type of

measurement to make. Generally speaking, the technician should start with the most general measurement of waveform and proceed to the more specific measurements of voltage and resistance.

Such is the modis operendi of a Logical Troubleshooter—knowing where to find information, what type of measurement to make and where to make it.

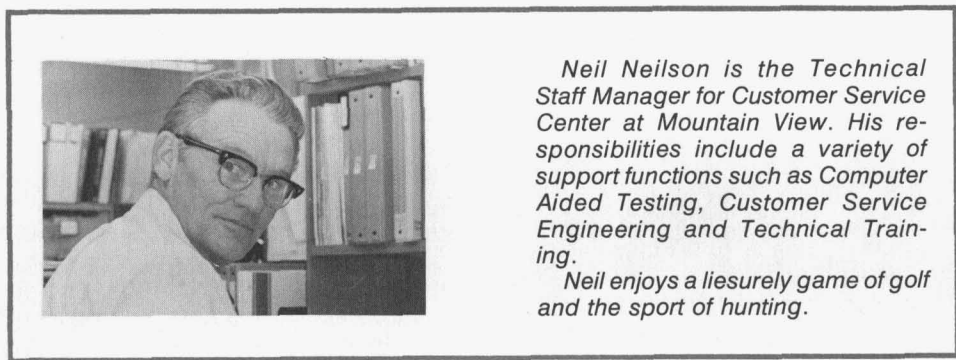

Neil Neilson is the Technical Staff Manager for Customer Service Center at Mountain View. His responsibilities include a variety of support functions such as Computer Aided Testing, Customer Service Engineering and Technical Training. Neil enjoys a lieisurely game of golf and the sport of hunting.

APPLICATION NOTES— A LEARNING AID FROM HEWLETT-PACKARD

A series of publications are available from HP that may help you obtain more benefit from your HP purchases. Many Hewlett-Packard engineers and customers have collaborated in preparing Application Notes, HP publications that give detailed information on selected subjects.

Some Application Notes are tutorial in nature, while other describe very specific "how to" procedures.

We have selected several Application Notes that may be of interest to service personnel.

Time Interval Averaging - AN 162

This AN provides the basic theoretical foundation of time interval averaging, showing how this technique provides such significant improvement in accuracy and resolution.

Noise Figure Primer - AN 57

This application note discusses noise figure and explains how it can be measured.

Selecting the Right DVM - AN 158

This is a guide to help the user select the right DVM to match his application with the various DVM characteristics.

Techniques for Digital Troubleshooting - AN 163-1

This covers the fundamental differences between discrete analog circuits and those built from digital IC's. An analysis of the failure modes of digital IC's suggest an algorithm which can be used with HP's IC Troubleshooters to significantly increase the efficiency of people repairing digital circuits.

Sampling Oscillography - AN 36

This note explains the theory behind sampling oscillography, including sampling efficiency vs frequency response.

One copy of an Application Note is available free of charge; just check the desired Application Note number in the space provided on the order form on the last page.

ELECTRONIC EQUIPMENT CATALOG FOR TECHNICAL EDUCATION

A new 24-page catalog from Hewlett-Packard describes test and measuring equipment appropriate for technical education. Student use of this equipment provides excellent preparation for what will later be encountered in science and industry. Among the newer items is a laboratory to teach digital logic, complete with texts and workbooks. Instruments include voltmeters, counters, oscillators, pulse and function generators, and recorders.

Video tape training courses on transistors, digital electronics communications, and instrument technology are offered, and a listing of available application notes on useful measurement techniques is given.

"Electronic Test and Measuring Equipment for Technical Education" is available without cost. Please contact your local HP office.

TEST CARD AVAILABLE FOR MODEL 3489A DATA PUNCH

A troubleshooting aid is available for diagnosing a 3489A Data Punch. A Test Card, identified by Model Number 3489A-L10, connects directly to the BCD Input of the 3489A and simulates a typical Data Source. It will be extremely useful in isolating malfunctions to the data source or the 3489A.

Two separate program modes are provided: (1) the identification of individual BCD input columns vs. output characters; (2) the ability to externally toggle in any 8421 input code in all BCD input columns. In addition, the control logic and most of the internal formatting may be checked with this Test Card. Altogether, this Test Card will provide a method to perform a complete operational check of the 3489A Data Punch.

The test board, which comes complete with instructions, has a U.S. price of \$50. To order your 3489A-L10, please contact your local HP office.

OWN A 8660A OR 8660B???

Hewlett-Packard attempts to provide the best solution to your measurement problem. Products undergo almost constant evaluation for possible im-

provements and changes are made regularly. (These are indicated by a change in the serial prefix.)

Some design changes made on units currently being manufactured are recommended for inclusion in products already in use. A Service Note is written describing the recommended modification.

Occasionally several changes may be recommended on a product and for convenience in obtaining parts, all the required parts plus installation instructions are available from HP by ordering one part number.

Hewlett-Packard is offering a free Field Update Kit to any owner of an 8660A or 8660B Synthesized Signal Generator with serial prefix 1349A and below. The kit includes, among other things, a new larger exhaust fan assembly for better cooling of the instrument. Complete installation instructions are also provided. It is expected that the improved cooling will increase the long term reliability of the equipment. The kit Part Number is 08660-60273 to update a standard (50-60 Hz) instrument. If your instrument is designed for 50-400 Hz power line operation (option 003), you need kit 08660-60274 instead. Check the rear panel of your instrument for an "Option 003" label. Either kit may be obtained free of charge through your local HP office by indicating the kit number and the model and serial number of the unit in which it is to be installed. Installation is straight-forward and should present no problem to electronic service personnel.



Several minor modifications can be made on your 8660A or 8660B .

RACING QUIZ SOLUTION

Successfully solving the racing quiz in the last issue requires use of the skills normally required for successful service work—a logical approach and some ingenuity.

Let's start with the table and fill in the known information: Chev in 5th place and Italian the winner. That places the Englishman in second place since he beat three others (statement o).

The Fiat must be in 3rd or 4th place (statement o). Since the Datsun finished behind the Fiat (statement b), the Datsun must have finished in 4th place and the Fiat in 3rd place. That makes the Datsun labeled #1 (statement o). There are now two cars not placed, the Triumph and the VW. The Englishman cannot drive the Triumph, and therefore he must have driven the VW. Thus the Triumph won the race (a).

Car #3 did not finish in 1st or 2nd place (statement e) or in 3rd place (statement g). Therefore #3 came in last.

The American did not finish in 4th place (statement j), nor in last place in the Chev (statement a). Therefore the American came in 3rd. That leaves the German and the Japanese. The German must have finished in 4th place since the Japanese cannot drive the Datsun (statement a).

The winning car could have been labeled #2, #4, or #5. The 2nd place car could have been #4 or #5 and the 3rd place car could have been #2, #4 or #5 (statement g).

The American was not driving #2 (statement m) and was not driving #4 (statement n). Therefore he was driving car #5.

Thus the second place car is #4 and that leaves #2 the winner.

	Make of Car	Number labeled on Car	Nationality of Driver
Winner	Triumph (a)	#2	Italian (d)
2nd Place	VW (a)	#4	Englishman (o)
3rd Place	Fiat (o & b)	#5 (m & n)	American (j & a)
4th Place	Datsun (b)	#1 (o)	German (a)
Last	Chev (l)	#3 (e & g)	Japanese (a)

supplement to

BENCH BRIEFS

SERVICE NOTE

INDEX

Here's the latest listing of Service Notes available for Hewlett-Packard products. Service Notes contain information that will help you get the most out of your purchases.

Many times design changes or other improvements are made in products currently being manufactured. HP often recommends including these changes in products previously sold; this is done by writing a Service Note for the product.

Service Notes for your instruments can be obtained by using the Service Note Order Form. Remove the order form and mail it to the HP distribution center nearest you. European customers should mail it to this address:

Hewlett-Packard S.A.
Central Mailing Department
P.O. Box 7550
Freeport Building
SCHIPHOL-Centrum
The Netherlands

For the U.S. and elsewhere, mail it to:

Hewlett-Packard Company
195 Page Mill Road
Palo Alto, California 94306

KS-20626 (WESTERN ELECTRIC) IF-RF SWEEP OSC (HP MODEL 8605Z)

KS-20626-2 Serial prefix 1233A and below. Modification to improve frequency stability.

130C OSCILLOSCOPE

130C-10 All Serials. Amplifier balance problems.
130C-11 All Serials. Q3, Q4, Q203 and Q204 replacement.

191A TV WAVEFORM MONITOR

191A-3 All Serials. Required vertical amplifier balance procedure.

419A DC NULL VOLTMETER

419A-3C Serial numbers 636-01275 and below. Ammeter modification kit. HP Part No. 00419-64301.

477B THERMISTOR MOUNT

477B-2 All Serials. RF connector assembly and thermistor assembly replacement.

1331A/C X-Y DISPLAY

1331A/C-5 All Serials. Improving reliability of collimator connection.
1331C-2 Serial prefix 1318A and below. Intermittent erasing.

1401A DUAL TRACE AMPLIFIER

1401-2 All Serials. Replacement for HP p/n 1850-0103.

1703A OSCILLOSCOPE

1703A-4 Serials prefix 1331A and below. Brown-out and transient LVPS modification.
1703A-5 All Serials. Improved single sweep reset operation.

1707B OSCILLOSCOPE

1707B-1 Serial prefix 1325A and below. Brown-out and transient LVPS modification.
1707B-3 All Serials. Improved single sweep reset operation.

1810A DUAL CHANNEL SAMPLER

1810-1 1810A Serial prefix 1246A. 1811A Serial prefix 1245A and below. Marker dot intensity modification.

1925A WORD GENERATOR

1925A-3A Serial prefix 1232A and below. Word count errors.

3050A AUTO DATA ACQUISITION SYSTEM

3050A-1 All Serials. Troubleshooting.

3460B DIGITAL VOLTMETER

3460B-9 All Serials. Troubleshooting reed relays in the digital-to-analog converter.

34702A MULTIMETER

34702A-1/34740A-1/34750A-1 All Serials. Modification to reduce AC zero offset.

34703A DCV/DCA/ΩMETER

34703A-1 All Serials. Mnemonics glossary.

34740A DISPLAY

34702A-1/34740A-1/34750A-1 Serial numbers 1213A-03935 and below. Modification to reduce zero offset.

34750A DISPLAY

34702A-1/34740A-1/34750A-1 Serial numbers 1304A-00750 and below. Modification to reduce AC zero offset.
34750A-2 Serial numbers 1304A-00750 and below. Failure of the -12 Volt Power Supply.

3570A NETWORK ANALYZER

3570A-1 Serial numbers 1251A00245 and below. Improved temperature stability board kit.
3570A-2 All Serials. New 03570-66555 log amplifier/3570-66556 output buffer boards and adjustment procedures.
3570A-3 All Serials. Replacement parts changes.
3570A-4 All Serials. New 03570-66551 (50 ohms) 66558 (75 ohms) input amplifier and adjustment procedures.

5300A FREQUENCY COUNTER MODULES

5300A-3 This service note applies to modules 5301A, 5302A, 5303B, 5304A, 5306A, 5307A, 5310A, 5311A. All Serials. Modification to ensure proper safety ground.

5306A MULTIMETER

5306A-3 Serials 1332A00761 and below. Modification to ensure high sensitivity.

5526A LASER INTERFEROMETER SYSTEM

5500A/B/C LASER HEAD, 5505A LASER DISPLAY
5526A-3 All Serials. Laser safety regulation in U.S.A.
5505A-1 Serials 1312 and below. Solution for decade noise problem.

7035A X-Y RECORDER

7035A-2B All Serials. Recommended replacement for X-axis Servo Motor.

7100B/7101B/7127A/7128A STRIP CHART RECORDERS

7100-7/7101-7/7127-7/7128-7 All Serials. Disposable pen tip kit.

7203A BINARY GRAPHIC PLOTTER

7203A-1 All Serials. Recommended spare parts.

7260A OPTICAL MARK READER

7260A-3 Serials prefix 1406A. Modification to improve external command timing.

7260A/7261A OPTICAL MARK READERS

7260A/7261A-4 All Serials. Read head lamp substitution.

8003A PULSE GENERATOR

8003A-3A Serial prefix 1233A and below. Line interference in the gated mode.

8556A SPECTRUM ANALYZER IF SECTION

8556A-3 Serial prefix 1250A and below. Preferred replacement for A5C5 (A5 Pre-attenuator/pre-amplifier Bd.)

8558B SPECTRUM ANALYZER

8558B-1 All Serials. Bandwidth filter board replacement.
8558B-2 Serial prefix 1321A and below. Improved frequency tuning pot.
8558B-3 Serial prefix 1334A and below. Prevention of single sweep triggering by erase function.

8558B-4 Serial prefix 1334A and below. New front panel latch housing.

8605A COMMUNICATIONS SWEEP OSCILLATOR

8605A-3 Serial prefix 1233A and below. Improved frequency stability.

8605Z WESTERN ELECTRIC KS-20626 IF-RF SWEEP OSCILLATOR

8605Z-2 Serial prefix 1233A and below. Improved frequency stability.

8640A/B SIGNAL GENERATOR

8640A/B-13. 8640A Serial prefix 1244A and below. 8640B Serial prefix 1243A and below. Installation of FM gain compensation circuit and potentiometer.
8640A/B-14. All serials. Field installation procedure for Option 001 (Variable Frequency Modulation Oscillator).

8660A SYNTHESIZED SIGNAL GENERATOR

8660A-16A All Serials. Internal crystal oscillator installation.
8660A-18 Serial prefix 1330A and below. L.F. section transistor replacement.
8660A-19 Serial prefix 1352A and below. Transformer compatible with 4 voltage operation.

8660B SYNTHESIZED SIGNAL GENERATOR

8660B-12A All Serials. Internal crystal oscillator installation.
8660B-16 Serials prefix 1320A and below. L.F. section transistor replacement.
8660B-17 Serial prefix 1349A and below. Transformer compatible with 4 voltage operation.

9869A CALCULATOR CARD READER

9869A-2 Serial 00286 and below. Read head sensitivity (when readers are equipped with option 003).

5300A MODULES MODIFICATION

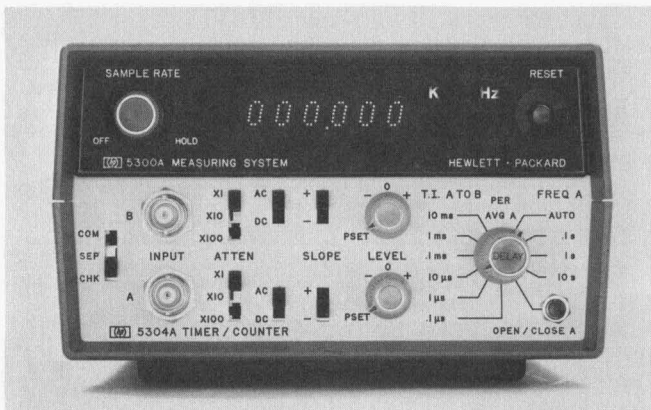

A modification is strongly recommended for several plug-on modules to the 5300A measurement system. The modules affected are 5301A, 5302A, 5303B, 5304A, 5306A, 5307A, 5310A and 5311A. This modification increases the current carrying capacity of the chassis ground circuit.

There have been several instances where operators have inadvertently caused severe damage to the instrument while making measurements on power lines.

They inadvertently connected the "hot" side of the power line to the chassis terminal of input connector on the plug-on. The resulting short circuit current caused extensive damage to the instrument. The recommended modification increases the current carrying capability of the chassis circuit which

will cause the power line circuit breaker to trip faster. This decreases the extent of damage caused by such operator error.

For more details, order Service Note 5300A-3 on the Service Note Order Form.

HP attempts to have products and a warranty policy second to none. Operator error such as connecting 115v (or 230v) to chassis is not covered by warranty, of course.

While making measurements on power lines, exercise extreme caution.

A future article in Bench Briefs will discuss some of the techniques (such as an isolation transformer) that can be used to safely make measurements on power lines.

MINICALCULATOR REPAIRS

The last issue of Bench Briefs announced the availability of minicalculator repairs at the HP Fullerton, California, office. These repairs are now handled at
6315 Arizona Place
Los Angeles, Cal 90045
Telephone (213) 776-7500.

When returning your HP-35, 45 or 80 for repair, please enclose the service card provided in the back of the operating manual.



See Page 7

REPAIRING A 34550A/B

Part number 1820-0426, which is used on A13 for IC1 through IC5, can no longer be obtained. The recommended replacement for this IC in a 3450A or 3450B is 1820-0707.

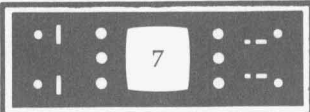

THE EDITORIAL STAFF WOULD LIKE YOUR OPINION

Would you take a few moments to indicate YOUR preference for future Bench Briefs articles? This will be a tremendous help in choosing what gets published. Hewlett-Packard has extensive expertise in many areas, and these experts are available to contribute articles to Bench Briefs. What would YOU like to see? Please fill in the survey and return to the correct address shown on the reverse side.

Reader survey
Cut along this line

1. Would you like to see Bench Briefs contain articles about these items:

Definitely yes
Probably
Uncertain
Probably not
Definitely not

- new video tapes
- hand tools, extender boards, and other service aids available for repairing HP products
- cables, connectors and adaptors available for repairing HP products
- new HP products
- cross references of HP part numbers to industry numbers
- new service notes
- new service manuals
- Would you be interested in buying a book containing articles about the items above?

2. Would you like to see detailed explanation of these devices in future issues of Bench Briefs:

Definitely yes
Probably
Uncertain
Probably not
Definitely not

- Vacuum Tubes
- BWO's
- TWT's
- Diodes
- Transistors
- Analog IC's (operational amplifiers, diff-amps, etc.)
- Digital IC's (gates, flip-flops, counters, ROM's, etc.)
- CMOS
- Would you be interested in buying a book containing an explanation of the above devices?

3. Would you like to see a detailed explanation of these circuits and techniques in future issues of Bench Briefs:

Definitely yes
Probably
Uncertain
Probably not
Definitely not

- Power supplies
- Switching regulators
- Tuned filters (active and passive)
- YIG oscillators
- PIN modulators
- Mixers
- High frequency attenuators
- Shaping and trigger circuits
- V to F converters
- D to A converters
- A to D converters
- Phase lock loops
- Recorder servo systems
- Strobed displays
- Character generators
- Heterodyning techniques
- S parameters
- Computer programming
- Would you be interested in buying a book containing a detailed explanation of the above circuits and techniques?

4. Would you like to see a detailed explanation of how these instruments function in future issues of Bench Briefs?

Definitely yes
Probably
Uncertain
Probably not
Definitely not

- Frequency synthesizers
- Analog voltmeters
- Digital voltmeters
- Lasers
- Miniature calculators
- Frequency counters
- Oscilloscopes
- Pulse generators
- Wave and distortion analyzers
- Spectrum analyzers
- Automated test systems
- Computer systems
- Would you be interested in buying a book containing an explanation of these instruments?

Thanks for your cooperation.

ORDER FORM

Please print your name and address clearly.
This will be used as a shipping label. ➡

Check here to receive a qualification form for
a free subscription to Bench Briefs.

NAME _____

COMPANY NAME _____

ADDRESS _____

CITY _____

STATE _____ ZIP _____

Please check below the numbers of any desired service notes:

- | | | | |
|-------------------------------------|---|--|------------------------------------|
| <input type="checkbox"/> KS-20626-2 | <input type="checkbox"/> 3460B-9 | <input type="checkbox"/> 7203A-1 | <input type="checkbox"/> 8660B-12A |
| <input type="checkbox"/> 130C-10 | <input type="checkbox"/> 34702A-1/34740A-1/ | <input type="checkbox"/> 7260A-3 | <input type="checkbox"/> 8660B-16 |
| <input type="checkbox"/> 130C-11 | 34750A-1 | <input type="checkbox"/> 7260A/7261A-4 | <input type="checkbox"/> 8660B-17 |
| <input type="checkbox"/> 191A-3 | <input type="checkbox"/> 34703A-1 | <input type="checkbox"/> 8003A-3A | <input type="checkbox"/> 9869A-2 |
| <input type="checkbox"/> 419A-3C | <input type="checkbox"/> 34750A-2 | <input type="checkbox"/> 8556A-3 | <input type="checkbox"/> AN 36 |
| <input type="checkbox"/> 477B-2 | <input type="checkbox"/> 3570A-1 | <input type="checkbox"/> 8558B-1 | <input type="checkbox"/> AN 57 |
| <input type="checkbox"/> 1331A/C-5 | <input type="checkbox"/> 3570A-2 | <input type="checkbox"/> 8558B-2 | <input type="checkbox"/> AN 158 |
| <input type="checkbox"/> 1331C-2 | <input type="checkbox"/> 3570A-3 | <input type="checkbox"/> 8558B-3 | <input type="checkbox"/> AN 162 |
| <input type="checkbox"/> 1401-2 | <input type="checkbox"/> 3570A-4 | <input type="checkbox"/> 8558B-4 | <input type="checkbox"/> AN 163-1 |
| <input type="checkbox"/> 1703A-4 | <input type="checkbox"/> 5300A-3 | <input type="checkbox"/> 8605A-3 | |
| <input type="checkbox"/> 1703A-5 | <input type="checkbox"/> 5306A-3 | <input type="checkbox"/> 8605Z-2 | |
| <input type="checkbox"/> 1707B-1 | <input type="checkbox"/> 5526A-3 | <input type="checkbox"/> 8640A/B-13 | |
| <input type="checkbox"/> 1707B-3 | <input type="checkbox"/> 5505A-1 | <input type="checkbox"/> 8640A/B-14 | |
| <input type="checkbox"/> 1810-1 | <input type="checkbox"/> 7035A-2B | <input type="checkbox"/> 8660A-16A | |
| <input type="checkbox"/> 1925A-3A | <input type="checkbox"/> 7100-7/7101-7/ | <input type="checkbox"/> 8660A-18 | |
| <input type="checkbox"/> 3050A-1 | 7127-7/7128-7 | <input type="checkbox"/> 8660A-19 | |

Reader Opinion Survey

See page 7

HEWLETT-PACKARD COMPANY

195 Page Mill Road
Palo Alto, California 94306

BENCH BRIEFS

MARCH-APRIL 1974 Volume 14 Number 2

Bench Briefs is published periodically by Hewlett-Packard for customers engaged in Repair, Calibration, Maintenance, Test and related areas. To obtain a qualification form for a free subscription, send your request to the above address.

Customers in Europe (ONLY) should instead write to:

Hewlett-Packard Central Mailing Dept.
P.O. Box 7550, Freeport Building
Schiphol-Centrum
The Netherlands

Reader comments or technical article contributions are welcomed.
Please send them to the correct address for your area.

Staff for this issue:

Editor: Dick Gasperini, HP Palo Alto, California
Contributing Editor: Donna Merlino, HP Mountain View, California
Contributing Authors: Neil Neilson, HP Mountain View, California;
Steve Thomas, HP Palo Alto, California
Photography: Steve Thomas and the Editor
Layout and paste-up: Christina Freeman

Bulk Rate
U.S. Postage
PAID
Menlo Park, Ca.
Permit No.
317

352108COMM290PLOSAAA 181
MR GEORGE G PLOSSER
PIPEHORN UTILITY TOOL CO
2900 COMMERCE BLVD
BIRMINGHAM AL 35210

Address Correction Requested

Printed in U.S.A.