

# BENCH BRIEFS

SERVICE INFORMATION FROM HEWLETT-PACKARD

MAY-JUNE 1975

## DIGITAL VS ANALOG

by Dick Gasperini, Editor

It seems that just about every new piece of electronic gear coming into the repair shop these days is 'digital'. Computers have been of a digital nature almost from their beginning and some other instrumentation has traditionally had a digital design. But what about voltmeters, signal generators, power meters and even oscilloscopes?

Many everyday consumer items such as watches and calculators are digital. What lies in the future, is everything going digital? Whatever happened to 6SN7 tubes, low distortion amplifiers and feedback circuits?

Digital may seem confusing, but it need not be; digital items (more properly called binary) have surrounded us for years and we feel quite comfortable with them. Digital is easier to analyze than analog because we are not concerned with exact amplitude, distortion, clipping, overshoot and all of those other nasty problem areas that were such a concern in analog circuits.

The simplicity of a digital circuit results from its two possible states—it is either "on" or "off".

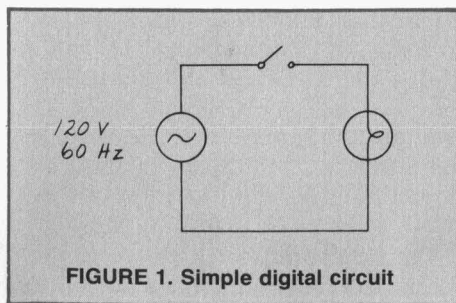
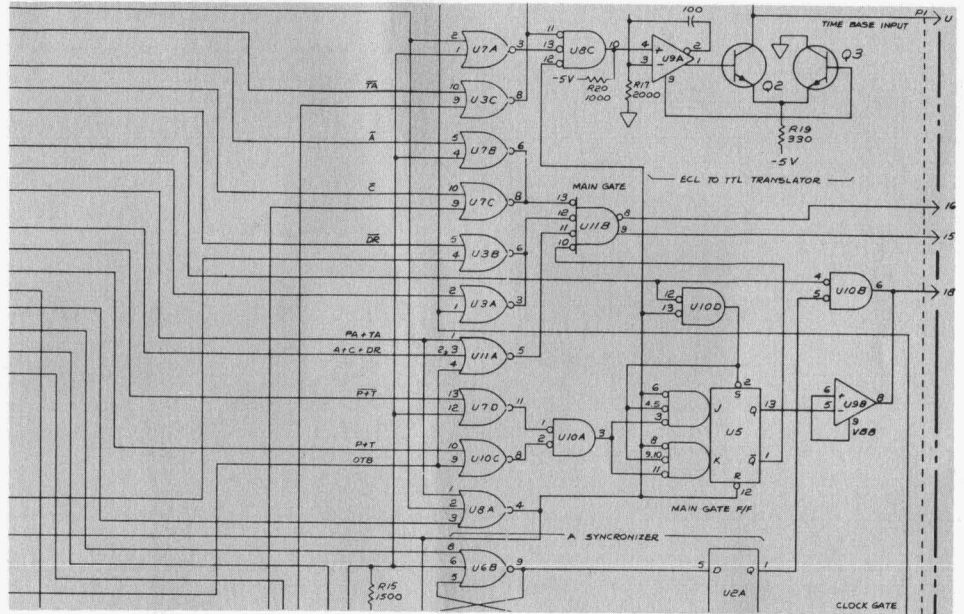

FIGURE 1. Simple digital circuit

There are a lot of familiar items that are digital in operation. A light



Learning digital circuits is no longer a matter of choice for service personnel; a firm understanding of digital is essential. This article is the first in a series on digital circuitry.

switch is one of the most common. There are only two possibilities. The light is either on or off. See Figure 1. A television power switch is either on or off. An automobile starter is either energized or sitting idle. Same thing with a car's horn. Brake lights are lit or dark, and so are tail lights... and the list continues.

Of course, there are a lot of analog circuits around too. The light dimmer on your car's dashlights is an analog control circuit. This allows more possibilities than a simple toggle switch—the lights could be off or on very dim, or somewhat brighter, still brighter, or fully lit. A light dimmer in a home is also an analog control; there are an unlimited number of settings for the control potentiometer. The volume control on a TV or radio is another example of analog—an unlimited number of possible settings exist here also.

Other analog circuits include TV color, tint, brightness and tone controls. An electric drill with a speed control gives an unlimited number of possible speeds and therefore it is an analog control circuit.

### IN THIS ISSUE

DIGITAL VS ANALOG

WHAT IS MTBF?

QUIZ SOLUTION

NEW SERVICE NOTES

READERS CORNER

970 probe tip transistor failure

**Table 1. Common Digital Circuits**

AUTOMOBILE	HOME
Starter Motor	Power switch on TV
Brake lights	Garbage disposal
Directional lights	Refrigerator compressor
Tail lights	Dishwasher
Radio Power Switch	Doorbell
Ignition breaker points	Clothes dryer
Interior light	Electric drill (single speed)
Horn	Electric sander
Seat belt buzzer	Furnace
Hot engine warning light	Electric oven
Low oil pressure warning light	Electric skillet
Low fuel warning light	Toaster
	Pressing iron
	Electric shaver

There are many examples of digital control circuits that we work with daily, such as those listed in Table 1.

Items that have a thermostat are generally digital in nature, although some people might argue that they are analog. The answer can be determined by examining the power consumed by the appliance. An electric skillet, for example, will either be consuming maximum power or none at all. Generally a light will be on when heat is being applied. That is, the heating element

is either on or off. Same with a clothes iron, baking oven and a home furnace, even though these have a temperature dial that is analog—that is, one that can have an infinite number of settings. The thermostat circuit determines if the temperature is above or below the thermostat setting and then either turns on the heating element at full power or keeps it off. What we are doing with the thermostat is setting the threshold (more on this later). See Figure 2.

There is another category of products that we may have difficulty classifying. Earlier, we agreed that devices such as the toggle switch that had only two possible states would be called digital. Items such as the volume control that had an unlimited number of settings would be called analog. How about the seven speed blender in the kitchen? Or the electric stove with eight pushbuttons? Or the three speed heater blower in your car? These don't seem to fit either the analog or digital category. Since there are several definite repeatable steps in each of the examples, this category has been termed staircase.

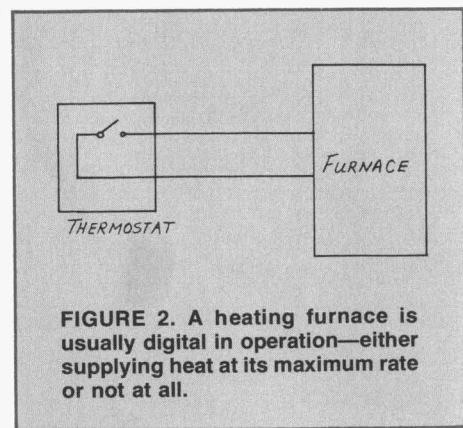

**FIGURE 2.** A heating furnace is usually digital in operation—either supplying heat at its maximum rate or not at all.

**DATA TRANSFER**

Let's suppose that we have a frequency meter (counter) that can measure any signal from 1 kHz up to 10 kHz. It is measuring the frequency of a signal (such as an oscillator at a radio station) and we want to obtain a plot of the variations in frequency on a strip chart recorder, as shown in Figure 3. One way to accomplish this is to output a voltage to the strip chart recorder that is proportioned to the frequency. For example, 1 Volt could signify 1 kHz, 2V would mean 2 kHz, etc. up to 10V for the full scale deflections of 10 kHz.

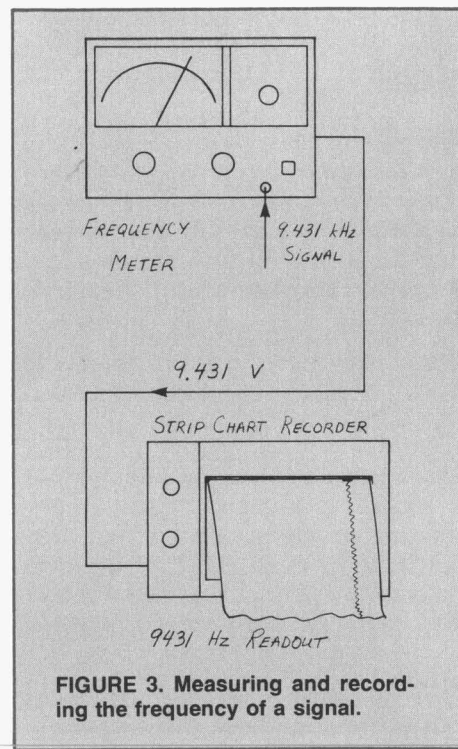
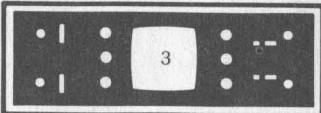

**FIGURE 3.** Measuring and recording the frequency of a signal.

While this method works, it has its limitations. A change of 100 Hz in frequency will move the pen on the recorder only 1% of full scale. A change of 1 Hz will not even be perceptible. Therefore, this method lacks resolution that may be desired.

An improvement will be to replace the strip chart with a digital printer and to have four signal lines—one for each digit. For our measurement of 9431 Hz, the four wires will have 9V, 4V, 3V and 1V on them respectively.





The digital recorder would thus print 9431. If the frequency changed to 8.965 kHz, the four output lines would have voltages on them of 8V, 9V, 6V and 5V, respectively, and the digital recorder would print 8965. This system, which gives the resolutions desired while retaining the full operating range, is called the staircase method of transferring data and was used for many years.

It fell into disuse because of the difficulties of decoding the signal. That is, generating the correct staircase signal (for example 4V) is relatively easy, but the digital recorder has difficulty monitoring the signal and determining if a 4 should be printed (or is at a 3 or a 5?).

The staircase method of data transfer can correctly be termed "digital" since a unique definite repeatable number (digit) is being indicated by a definite voltage level. That is, the voltage on one wire will indicate one of ten possible digits. When the possible number of digits

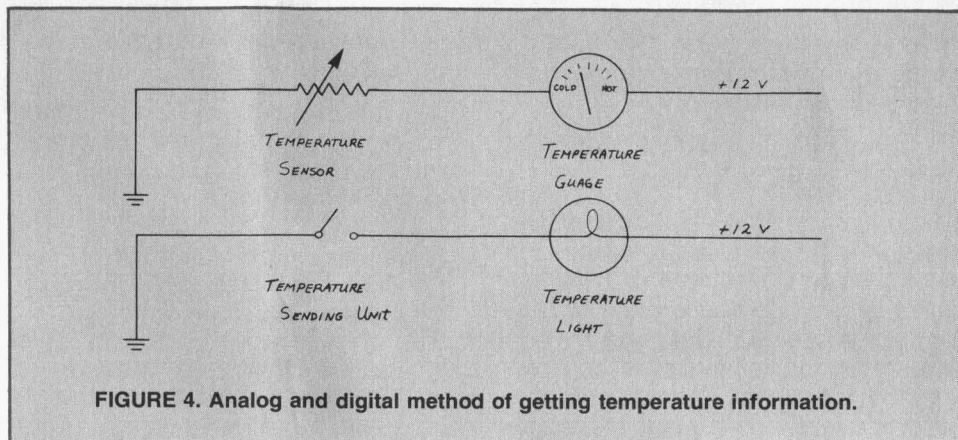

FIGURE 4. Analog and digital method of getting temperature information.

was reduced to two (0 and 1) in the binary number system, the term "digital" was still used to describe this. The name has been retained and will very likely never change, even though we really ought to call this binary.

The top circuit in Figure 4 is an analog solution for monitoring the temperature in an auto engine.

The digital solution to a temperature

indicator is a "hot engine" light. If a hot engine condition exists, the switch will close, turning on the light.

This is a very simple circuit, but we will use it to build more complex circuits in the next issue of *BENCH BRIEFS*.

This article copyrighted 1975 by Richard E. Gasperini for publication in a book on Digital Troubleshooting.

## MTBF — WHAT DOES IT MEAN?

by Rod Parks

Reliability and Mean Time Between Failure (MTBF) data is often mistakenly thought of as an absolute number. The person (HP customer) who uses the MTBF figure for the purpose of deciding to buy HP's or a competitor's instrument must be cautioned that MTBF calculations are very subjective. Due to underlying assumptions made by the manufacturers (HP or competitor), as much as a 3 or 4-to-1 difference in MTBF calculations may result. Generally, there are two types of MTBF calculations: a) prediction based on component count, and b) actual history.

### PREDICTION TECHNIQUE

The prediction technique uses a method that represents the expected

failure modes of the instrument. (HP applies this method to new instruments to predict the failure rate.)

$$MTBF = \frac{1}{\sum (\text{No. of ea. type of component}) \times (\text{expected failure rate of component})} \times \text{No. of hours of operation per year}$$

The process of deriving a theoretical model that will accurately predict (or specify) the reliability of a product is one of simplifications (subjective).

For example, assume that we want to calculate the failure rate for a new product. This instrument consists of only the following parts:

- 100 IC's
- 60 Transistors
- 50 Resistors
- 50 Capacitors

Past history will have established av-

erage failure rates for these parts. Let's assume that ICs and transistors fail at a rate of 0.1% per year, and assume capacitors and resistors fail at 0.01% per year. Most reliability models assume a "chain" of components. That is, a failure of any one component constitutes a failure in the instrument. Therefore, we compute the failure rate by simply computing the summation of the quantity of parts times the failure rate. For our example:

$$\begin{aligned} 100 \times 0.1\% &= 10\% \\ 60 \times 0.1\% &= 6\% \\ 50 \times 0.01\% &= 0.5\% \\ 50 \times 0.01\% &= 0.5\% \end{aligned}$$

Predicted failure rate: 17% per year.

Of course an actual calculation would be more refined than our simple example. We would probably use failure rates for categories of parts or we may use the failure rate for each particular component (e.g. one IC may have a failure rate of

0.02% and another may fail at a 1% rate). Refining the prediction process in this manner would give increased accuracy.

There are two main sources of error with this prediction method.

The reliability of a newly developed component is not always known and we will have to estimate it. Also, so-called known components are not actually known for the application (stress). In addition to controlled stresses, the actual instrument operating at 50°C ambient will very likely fail more often than one operating at 20°C. There are other second order effects:

1. Multiple component failures
2. Mechanical failure
3. Overstress caused by the failure of another component

Essentially, theoretical MTBF is calculated based on component count and anticipated component reliability.

### MTBF'S BASED ON EMPIRICALLY DERIVED DATA

The second way to determine MTBF is to monitor the actual failure rate of products. (HP applies this method on older instruments which have established a record of failures.)

$$\text{MTBF} = \frac{\text{Total no. of units in operation}}{\text{No. of units failed}} \times \frac{\text{No. of hours operation per year}}{\text{No. of units failed}}$$

MTBF's based on empirically derived data assumes that the manufacturer has the "facts".

However, the problem now becomes one of interpreting the empirical data. Subjectivity may cloud the results. For example:

1. What constitutes a failure? (Certainly a bona fide component failure should be counted.)
  - a. Failure to meet specs?
  - b. Operator misinterpretation of the specs?
  - c. Mechanical failure? How about if the product is dropped and requires repair? Should this be counted?
2. What percent of actual failures are reported to the manufacturer? A known fact is that simple instruments are more likely to be repaired by the customer. This fact leads to the conclusion that the more complex the instrument, the more accurately the failure rate can be determined since all the failures are reported to the factory. In the case of simple instruments, some assumptions must be made in order to estimate a failure rate. These assumptions are typically made using repair information the manufacturer has on the instruments they use in their own operation and from large

users' repair histories. In some cases, the actual failure rate may be a factor of 10 or 15 times the reported failure rate.

### 3. Multiple failure.

An instrument fails this month and is "repaired". Next month, the same instrument fails with the same symptoms and is repaired again. The manufacturer may interpret this data as one failure on the basis that the repairing technician did not actually fix the problem the first time.

### 4. Fixes for known problems.

A production change removes a known problem for future instruments. Should failures of older (unmodified) instruments be included after the production change is made?

### 5. How many hours of operation are expected in one year? (HP uses 2,000 hours per year.)

The 2,000 hours per year is based on 40 hours of operation per week with 50 weeks per year. If 24 hours of operation per day were assumed, the MTBF would look 3 times as good as with the 2,000 hour assumption.

These examples (and there are more) give you some idea of the

### IC SOCKETS — YES OR NO?

We occasionally get questions concerning IC sockets. Like most other design considerations, this is also a trade-off. Sockets are a trade-off of serviceability vs. cost and reliability.

Sockets ease the job of changing a defective IC and may speed troubleshooting by allowing easy substitution of parts.

But sockets are also expensive; in fact, it is not unusual for the socket (plus installation expense) to cost more than the IC. Thus, having IC sockets

may require an appreciable price increase for the product.

Another consideration is reliability. Like any other part, sockets do fail. Contacts get oxidized, and springs lose their resilience.

Does the increase in serviceability offset the increased cost and slight decrease in reliability? Many times not.

Consequently, you may see sockets used only in selected areas, where the IC is expensive or for other reasons where the ease of changing the part is important.

potential for subjective interpretation of reliability data.

For example, HP has a voltmeter that has a predicted MTBF of 4,000 hours. Another company sells a similar voltmeter and they state an MTBF of 10,000 hours. Now this number may be realistic, but it is not valid to conclude that HP's product is 2½ times less reliable since these numbers were determined using totally different assumptions.

(In fact, the reverse may be true. Using HP's conservative method of predicting MTBF, an MTBF of 3,000 hours was predicted for this competitive instrument.)

Thus, MTBF figures can be used to compare the reliability of various

Rod Parks, who has been with Hewlett-Packard for 5 years, is currently a Product Manager for Digital Voltmeters at the Loveland Instrument Division in Loveland, Colorado. (The Loveland Division primarily manufactures voltmeters, sources and analyzers.)

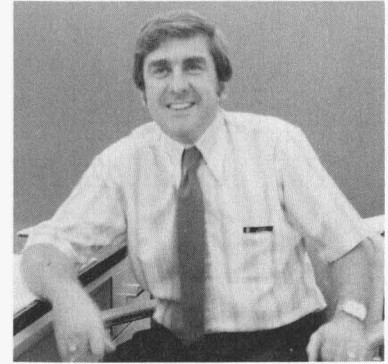

Rod is interested in all types of spectator sports as well as participating in softball and basketball. He is married and has two boys.

equipment; but be certain that the same assumptions were used in determining the numbers.

Recognizing the limitations behind MTBF figures will help make the numbers more meaningful.

## QUIZ SOLUTION

An easy way to solve the baseball quiz in the last issue is to build a matrix of names and positions and then place an X in the matrix when the clues rule out that particular combination. The number in parenthesis is the number of the clue. Marital status is also included.

With some analysis, some positions become evident.

These are indicated with boxes. Letters were placed inside to indicate the sequence. As positions were deduced, other possibilities were ruled out, and these were indicated with an X.

Therefore, Allen is the catcher, Harry is the pitcher, 1st baseman is Paul, Jerry covers 2nd, Ed is shortstop, with Andy at 3rd base. Rightfielder is Mike and center is Bill. Sam covers left field.

	CATCHER married (12)	PITCHER married (7)	1ST BASE	2ND BASE single (2)	SHORTSTOP	3RD BASE married (12)	RIGHT FIELD single (13)	CENTER FIELD single (13)	LEFT FIELD
ANDY	X(1)	X(C)	X(c)	X(c)	X(9)	<input type="checkbox"/> c	X(8)	X(8)	X(8)
ED single (13)	X(12,13)	X(7,13)	X(f)	X(2)	<input type="checkbox"/> f	(X12,13)	X(6,13)	X(6,13)	X(6)
HARRY	X(10)	<input type="checkbox"/> d	X(d)	X(10)	X(d)	X(4)	X(8)	X(8)	X(8)
PAUL single (13)	X(10)	X(5)	<input type="checkbox"/> g	X(10)	X(9)	X(12,13)	X(13)	X(13)	
ALLEN	<input type="checkbox"/> b	X(5)	X(b)	X(b)	X(b)	X(b)	X(8)	X(8)	X(8)
BILL	X(10)	X(16,3,a)	X(16,3,a)	X(10)	X(14)	X(14)		<input type="checkbox"/> 16,3,a	
SAM married (11)	X(8)	X(8)	X(8)	X(8)	X(8)	X(8)	X(11,13)	X(11,13)	<input type="checkbox"/> a
JERRY single (13)	X(12,13)	X(7,13)	X(e)	<input type="checkbox"/> e	X(e)	X(12,13)	X(13)	X(13)	
MIKE			X(15,8)				<input type="checkbox"/> 16,3,a		X(a)



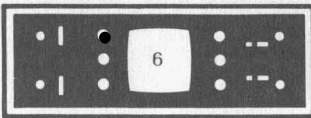

supplement to  
**BENCH BRIEFS**  
SERVICE NOTE INDEX

## NEED ANY SERVICE NOTES?

Here's the latest listing of Service Notes available for Hewlett-Packard products. To obtain information for instruments you own, remove the order form and mail it to the HP distribution center nearest you.

### 310A WAVE ANALYZER

310A-9. Serial numbers 0948A03309 and below. New inductor on local oscillator assembly.

### 331/332/333/334A DISTORTION ANALYZER

331/32A-8A, 333/334A-7A. 331A serial numbers 982-04451 to 1149A06575; 332A s/n 985-01911 to 1145A22750; 333A s/n 980-01886 to 1137A02945; 334A s/n 993-02841 to 1140A05365. Modification kit to eliminate RFI induced through the floating sensitivity switch. Supersedes 331/332A-8, 333/334A-7.

331/332A-9. 331A serial numbers 827-03300 to 1149A06500; 332A s/n 909-01486 to 1145A22750. Inductor added to power line ground lead.

333/334A-8. 333A serial numbers 910-01351 to 1137A02945; 334A s/n 908-01866 to 1140A05365. Inductor added to power line ground lead.

### 419A DC NULL VOLTMETER

419A-8. Battery replacement.

### 651B/652A TEST OSCILLATORS

651B-2B. All serials. 75 OHM output conversion. Supersedes 651B-2A.

651B-7. 651B serial numbers 1230A07800 and below; 652A s/n 1226A03820 and below. Transistor socket for A2Q11 and A2Q12.

651B-8. 651B serial numbers 1230A07905 and below (USA), 1230U07940 and below (UK); 652A s/n 1226A04120 and below (USA), 1307U01205 and below (UK). Replacement of the power supply assembly (A1).

### 745A AC CALIBRATOR

745A-9A. Serial numbers below 1319A01445. More rigid mounting of the front panel switches to eliminate incorrect range selection. Supersedes 745A-9.

745A-11. Serial numbers below 131A01481. Protection of the error detection thermocouple.

### 1331A/C STORAGE DISPLAYS

1331A/C-15. Serial prefix 1424A through 1503A. Green background remaining on screen after erasing in maximum persistence.

### 1332A DISPLAY

1332A-1. Serial prefix 1414A or below. Possible lack of sufficient range of intensity limit adjustment if CRT is replaced.

### 1710B/1712A/1720A/1722A OSCILLOSCOPES

1710B-2. Serial prefix 1420A and below. Increased intensity in delayed sweep operation.

1712A-1. Serial prefix 1452A and below. Increased intensity in delayed sweep operation.

1720A-5. Serial prefix 1425A and below. Increased intensity in delayed sweep operation.

1722A-1. Serial prefix 1507A and below. Increased intensity in delayed sweep operation.

### 3050A/B DATA ACQUISITION SYSTEM

3050A-3A. Leeds & Northrup. Mechanical part numbers for 2740 Scanner. Supersedes 3050A-3.

3050A-4A. Leeds & Northrup. Electrical part numbers for 2740 Scanner. Supersedes 3050A-4.

3050A-5A. Leeds & Northrup 2740 Scanner. HP to L&N part number cross reference. Supersedes 3050A-5.

3050A-7. Model 3050A, all serials. L&N Scanner lockup with 9830A Calculator.

3050A-8. Model 3050A, all serials. How the 3490A intermittently locks up HP-IB.

3050B-1. Model 3050B, all serials. How the 3490A intermittently locks up HP-IB.

### 3300A FUNCTION GENERATOR

3300A-9. Serial numbers 0939A06521 to 0939A-06545. Ferrite beads on Q5 and Q6 emitter leads.

### 3330A/B AUTOMATIC SYNTHESIZER

3330A/B-7. All serials. Identification and use of old and new style controller boards.

### 3403A/B/C TRUE RMS VOLTMETER

3403A/B-1, 3403C-5. 3403A/B all serials; 3403C serial numbers 1452A01206 and below. Banana adapter miswiring.

3403C-4, 3469B-5, 3575A-3. 3403C RMS Voltmeter, 3469B Multimeter, 3575A Gain-Phase Meter. Digital panel meter repairs.

### 3460A/B DIGITAL VOLTMETER

3460A/B-10A. All serials. Replacement oven assembly. Supersedes 3460A/B-10.

### 3469A MULTIMETER

3469A-5. All serials. Panel Meter repair.

### 3480A/B DIGITAL VOLTMETER

3480A/B-8. All serials. Reduction of errors in the thousands digit in optically isolated BCD boards.

### 3490A MULTIMETER

3490A-1A. All serials. Improvement of reliability in optical isolation assemblies. Supersedes 3490A-1.

### 3580A SPECTRUM ANALYZER

3580A-1. Serial numbers 1409A00515 and below. Improved high voltage power supply.

### 3690 PORTABLE INSTRUMENTATION TAPE RECORDER

3690A-25. Serial prefix below 1512A. Servo Amplifier reliability improvement.

### ALL RECTANGULAR STORAGE CRTs

5083-1. All rectangular storage cathode ray tubes. Removal of charged particles.

5083-2. Effect of magnetization.

### 5245L ELECTRONIC COUNTER

5245L-8. Oven heater transistor (Q1) replacement.

### 6269B DC POWER SUPPLY

6269B-3. DC Power Supply LVR-B series. Serial numbers below 1513A01511 and 1143G00430. Modifications to improve reliability in severe environments.

### 6920B AC/DC METER CALIBRATION

6920B-5. Modification to minimize lockdown in AC mode.

### 7155 PORTABLE STRIP CHART RECORDER

7155A-3. Serial prefix 1432 and below. Electronic interaction on the servo pen while event marker actuating.

### 8005B PULSE GENERATOR

8005B-G1. Serial numbers 1341G00300 and below. Improved asynchron gating.

8005B-G2. Serial numbers 1341G00363, and 365, 366, 368, 374, 377, 378, 381, 382, 384, 386, 388, 390, and all serial numbers below 1341G00361. Recommended resistor changes.

### 8481A POWER SENSOR

8481A-1. All serials. Power sensor precautions.

### 8555A/B SPECTRUM ANALYZER - RF SECTION

8555A-4. Serial number 1436A04335 and below. Zero dB lockout modification and input attenuator.

8555B-7. Serial prefix 1504A and below. Prevent REF LEVEL FINE control damage.

### 8660A/B/C SYNTHESIZED SIGNAL GENERATOR

8660A-5C. Serial number 1445A00690 and below. Reference level output levels increased. Supersedes 8660A-5B.

8660A-22A. Serial numbers 1445A00691 and below. Power supply fuse changes. Supersedes 8660A-22.

8660B-20A. Serial numbers 1439A00950 and below. Power supply fuse changes. Supersedes 8660B-20.

8660B-29. All serials. A1A15 keyboard repair and parts replacement.

### 8745A S-PARAMETER TEST SET

8745A-2. Serial numbers 978A00050 to 1142A01165. Elimination of potential shock hazard.

### 11661A FREQUENCY EXTENSION MODULE

11661A-8. All serials. Intermittent failures in YIG loop.

### 34703A DCV/DCA/OHM METER

34703A-6. Serial numbers 1251A01500 and below. Input circuit modification to improve reliability.

34703A-7. Serial numbers 1251A01651 and below. Temperature sensitive OHMs operation.

34703A-8. Serial numbers 1251A01351 and below. Failure of auto mode test 8.

### 86341A/B OSCILLATOR MODULE

86341A/B-2. 86341A all serials; 86341B serial numbers 1410A00613 and below. Modification for 8410B compatibility.

### 86601A RF SECTION

86601A-1B. Serial numbers 1223A00320 and below. 86601A meter replacement kits. Supersedes 86601A-1A.

86601A-6. Serial numbers 1307A00420 and below. Improved RF connector grounding.

86601A-7A. Serial numbers 1443A00781 and below. Attenuator driver assembly. Supersedes 86601A-7.

# ORDER FORM

Please print your name and address clearly.  
This will be used as a shipping label. →

Check here to receive a qualification form for  
a free subscription to Bench Briefs.

NAME \_\_\_\_\_  
COMPANY NAME \_\_\_\_\_  
ADDRESS \_\_\_\_\_  
CITY \_\_\_\_\_  
STATE \_\_\_\_\_ ZIP \_\_\_\_\_

Please check below the numbers of any desired service notes:

Cut off this page and return to:

Hewlett-Packard  
195 Page Mill Road  
Palo Alto, California 94306

- 3580A-1
- 3960A-25
- 5083-1
- 5083-2
- 5245L-8

For European customers (ONLY),  
please send it to:

Hewlett-Packard  
Central Mailing Dept.  
P.O. Box 7550  
Freeport Building  
SCHIPHOL - Centrum  
The Netherlands

- 1331A/C-15
- 1332A-1
- 1710B-2
- 1712A-1
- 1720A-5
- 6269B-3
- 6920B-5
- 7155A-3
- 8005B-G1
- 8005B-G2

Hewlett-Packard  
Central Mailing Dept.  
P.O. Box 7550  
Freeport Building  
SCHIPHOL - Centrum  
The Netherlands

- 1722A-1
- 3050A-3A
- 3050A-4A
- 3050A-5A
- 3050A-7
- 8481A-1
- 8555A-4
- 8555B-7
- 8660A-5C
- 8660A-22A

- 310A-9
- 331/32A-8A,  
333/334A-7A
- 331/332A-9
- 333/334A-8
- 419A-8

- 3050A-8
- 3050B-1
- 3300A-9
- 3330A/B-7
- 3403A/B-1,  
3403C-5
- 8660B-20A
- 8660B-29
- 8745A-2
- 11661A-8
- 34703A-6

- 651B-2B
- 651B-7
- 651B-8
- 745A-9A
- 745A-11

- 3403C-4, 3469B-5  
3575A-3
- 3460A/B-10A
- 3469A-5
- 3480A/B-8
- 3490A-1A
- 34703A-7
- 34703A-8
- 86341A/B-2
- 86601A-1B
- 86601A-6
- 86601A-7A

Please photocopy this order form if  
you do not want to cut the page  
off.

Order Form  
Supplement to Service Note Index  
Cut along this line

# READERS CORNER

Here's your chance to share your ideas and views with other *Bench Briefs* recipients. In Reader's Corner, we will print letters to the Editor, troubleshooting tips, modification information, and new tools and products that have made your job easier. In short, Reader's Corner will feature anything from readers that is of general interest to electronic service personnel.

If there is something you have to share with other *Bench Briefs* readers, let us hear from you.

Dear Mr. Gasperini:

In regards to Dave Foss' problem with the 970A PDM tips (March-April *BENCH BRIEFS*), here's another solution.

The 970A's tip accommodates banana connectors and this allows any test lead with a banana connector to be used.

Simply choose the type of tip needed and attach it to a lead terminated in a single banana connector. Plug this into the 970A and it is ready for use.

The advantage of this is that the length of cord is variable and the type of probe tip is up to the user. This also avoids the problem of having sharp, easily damaged tips.

If a single banana connector is not available, a dual banana connector can be used. Plug the positive side into the 970A and clip the 970A's ground lead onto the ground side of the connector. When the 970A is connected in this manner, it can rest on the bench during use while only the test lead is moved.

These methods give the user a greater range of options and more flexibility in use.

Best regards,

Troy Lindsey  
Hewlett-Packard Company  
Customer Service Center - QA  
Mountain View, California

Dick:

Here's a note about an unusual transistor failure that I've encountered only twice in the 2 years I've been with Hewlett-Packard as bench tech.

It consists of isolating the malfunction to a transistor that won't turn on although the base drive is there. Open emitter/base junction, right? Wrong! The transistor checks good (leakage and gain) on several different transistor checkers including the one described in a previous issue of *BENCH BRIEFS*!

The lack of failure conformation can be a real headache when a replacement device is not at hand.

The failure mode involves an increase in the transistor's emitter-base forward bias voltage (typically 1.5 volts or greater). Evidently, many transistor checkers can supply enough potential to forward bias the faulty junction but a properly designed circuit cannot.

Identification of this fault can be accomplished with a low voltage power supply, a resistor and a voltmeter.

Remove the suspected transistor from the circuit and connect the supply through a current limiting resistor to forward bias the emitter-base junction. Connect the voltmeter between the emitter-base and slowly increase the voltage applied. If the junction is faulty as described above, the forward voltage drop across the emitter-base will be greater than the correct .6 to .7 volt.

Sincerely,

Leon Fink  
HP Sales-Service Office  
Kenner, Louisiana

*Has anyone else seen a failure like this?*

Editor

## HEWLETT-PACKARD COMPANY

195 Page Mill Road  
Palo Alto, California 94306

## BENCH BRIEFS MAY-JUNE 1975

Volume 15 Number 3

Bench Briefs is published periodically by Hewlett-Packard for customers engaged in Repair, Calibration, Maintenance, Test and related areas. To obtain a qualification for a free subscription, send your request to the above address. Requests for Service Notes should also be mailed to the above address.

Customers in Europe (ONLY) should instead send all correspondence to:

Hewlett-Packard Central Mailing Dept.  
P.O. Box 7550, Freesport Building  
Schiphol-Centrum  
The Netherlands

Reader comments or technical article contributions are welcomed. Please send them to the correct address for your area.

### Staff for this Issue:

Editor: Dick Gasperini, HP Palo Alto, California  
Contributing Author: Rod Parks, HP Loveland, Colorado  
Layout and paste-up: Christina Cruze, HP Palo Alto, California  
Typesetting: Kathy Aquino, HP Santa Clara, California

Bulk Rate  
U.S. Postage  
PAID  
Menlo Park, CA.  
Permit No.  
317

352108COMM290PLOSAAA 181

MR GEORGE G PLOSSER  
PIPEHORN UTILITY TOOL CO  
2900 COMMERCE BLVD  
BIRMINGHAM AL 35210

Address Correction Requested

Printed in U.S.A.