

## REFERENCE FILE COPY

### PLEASE DO NOT REMOVE

#### Printed Circuit Board Rework, Repair, and Cleaning

*Jim Bechtold, Editor*

### Introduction

Since there are recognized procedures for logical troubleshooting, there should also be recognized procedures for removing the defective components, installing new ones, and in general, repairing defective printed circuit (PC) boards. There are accepted procedures, and this article will describe some of Hewlett-Packard's standards and methods for PC board repair and cleanup.

What is so hard about replacing an IC you ask? As you can see in Figure 1, some people do need help. It

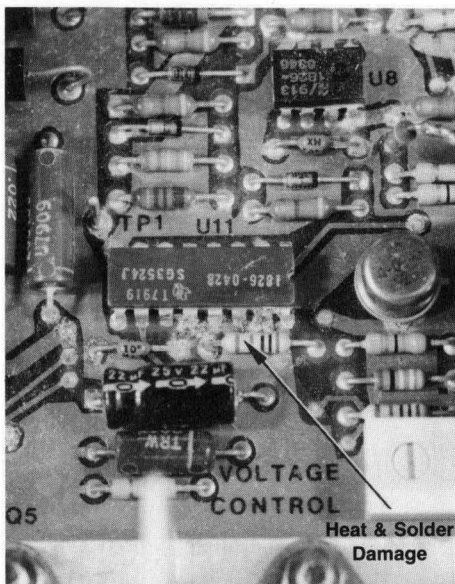

**Figure 1.** Note the overheated area indicated by the arrow. This board had been "reworked" in many other areas with the same quality of workmanship.

looks as though this person used a 100-watt soldering gun in the area indicated by the arrow. Figure 2 shows a different repaired area with good solder techniques; but then the person made the mistake of trying to remove the flux with a sharp-pointed tool.

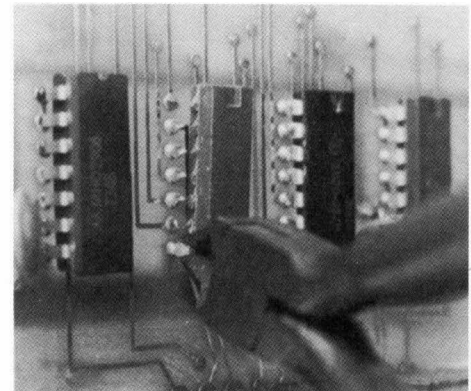

**Figure 2.** After soldering a new component in place, this person tried to remove the excess solder flux by scraping with a sharp tool. Definitely not acceptable.

### Component Removal

Once you find the fault, the first step is to remove the defective part. One method is to simply clip the part out (as long as you don't intend to reinstall it), and then remove the pins or leads one at a time with a

grounded soldering iron and needle-nose pliers (see Figures 3 and 4). This method is very effective since it minimizes the chance of overheating and damaging the PC board.



**Figure 3.** "Clip Out Method." Each lead is cut off as close to the body of the component as possible.

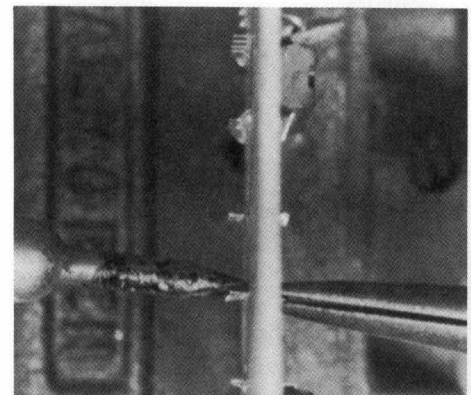

**Figure 4.** The leftover pins are removed with soldering iron and needle-nose pliers. A little new solder applied to the connection will improve the heat transfer and make the pin easier to remove.

Another method is to unsolder each lead by heating it on one side and removing the solder from the other side with an antistatic soldersucker<sup>1</sup> (see Figure 5). But be careful! The wrong soldersucker (plastic) can

produce static potentials in excess of 5 kV—more than enough to wipe out most IC devices.

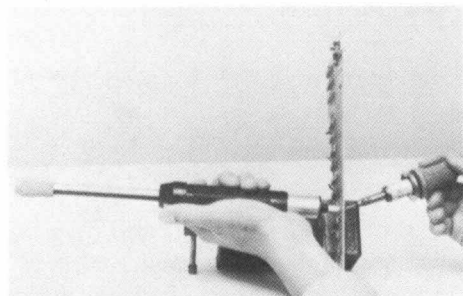

**Figure 5.** Excess solder is removed from the holes with a hand-operated vacuum device. A little new solder applied to the connection will cause a quicker flow and make the solder easier to remove.

No matter which method you use, when you heat the hole to remove either the pin or solder, add a little new solder to the pad. This will cause the solder to flow quickly (due to efficient heat transfer) and make the pin/solder easier to remove.

## Component Installation

### Mounting Requirements

A replacement component should always be mounted in a manner similar to the original component. You should mount components so that the body of the part is as close as practical to the board. If the component is coated (such as the capacitor shown in Figure 6), the lead coating can extend into the hole provided that the lead has wet properly on the circuit side of the board and exhibits an acceptable solder fillet (see Figure 21). A better alternative is to use beads to keep the coating out of the hole (see Figure 6).

### Lead Forming and Stress Relief

The component leads should be formed before inserting into the board. The leads should be supported with a tool during forming to prevent transmitting stress forces into the component and causing an internal fracture. Many technicians use needle-nose pliers between the

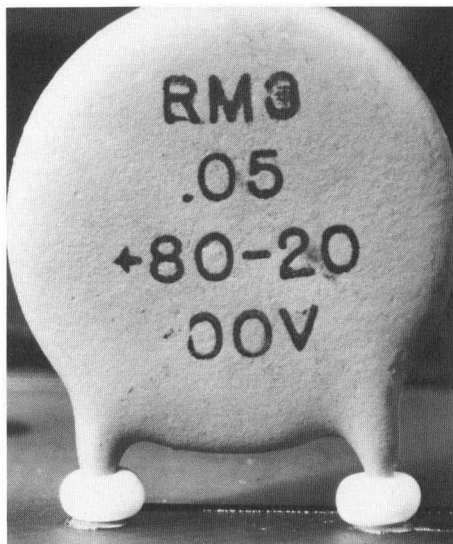

**Figure 6.** This capacitor uses beads to keep the coating out of the hole.

bend and component to take the stress. The component lead should extend straight out from the body of the component a minimum distance equal to the diameter of the lead before the start of the bend, and the radius of the bend should be greater than one-half the diameter of the lead. Figure 7 shows the recommended lead orientation. Note that the lead enters the hole approximately parallel to the axis of the hole. This provides sufficient stress relief to allow for contraction and flex of the PC board.

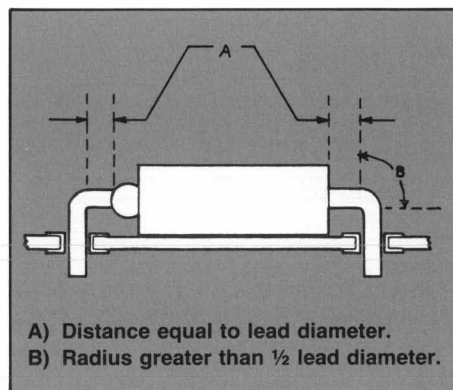

**Figure 7.** Recommended lead bending and orientation.

It is not recommended (although acceptable) that component leads be bent under the component to match mounting holes that are too close together (see Figure 8). An alternative is to vertically mount the

component so its axes are as parallel or perpendicular to the mounting base as practical (see Figure 9). To avoid lead stressing, components should not be bent into position after one end of the component has been soldered in place.

### Component Lead Damage

Extreme care must be taken when forming bends to prevent shaving or distortion of the component leads. Any nicking of the lead where damage to the base metal exceeds 25% of the lead diameter is unacceptable (see Figure 10).

### Adding New Components

The addition of components to modify the performance of a circuit may be specified in an update procedure. In general, the mounting of new components must utilize existing plated-through holes, installed eyelets or standoffs, hollow pins, a socket, or only as a last resort, the lead of another component. Component leads should not be solder "tacked" to a circuit trace, with the exception of components that are designed for surface connections, such as IC flat packs.

Industry standards do not allow the termination of more than one jumper or component lead to one hole. In other words, don't try to jam two leads into a hole that was designed (drilled) for just one. However, there are special "cloverleaf" terminals, or multiple hole connectors that can be inserted into the board for accepting up to five leads.

### Damaged Components

Breaks, chips, or scratches on any component are acceptable provided they do not electrically degrade operation. Resistors and capacitors are frequently susceptible to this type of damage and should be closely inspected. Figures 11 and 12 are examples of typical body damage to these components.

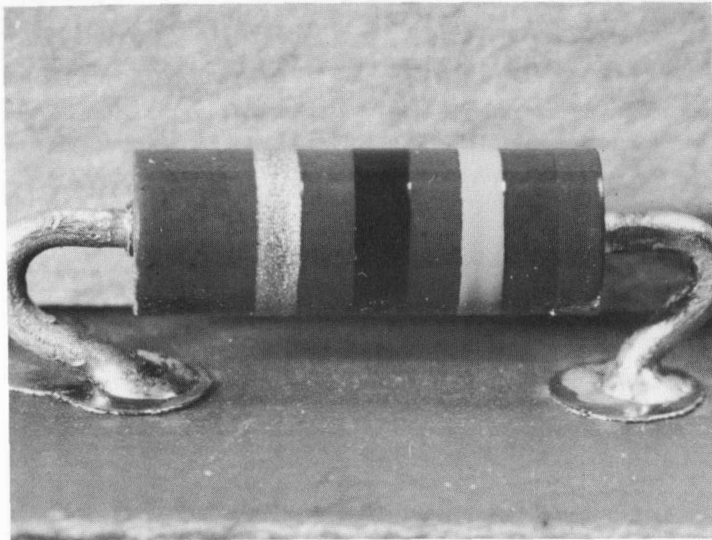

Figure 8. The mounting holes are too close together for this resistor. This mounting is acceptable although not recommended. A better alternative is shown in Figure 9.

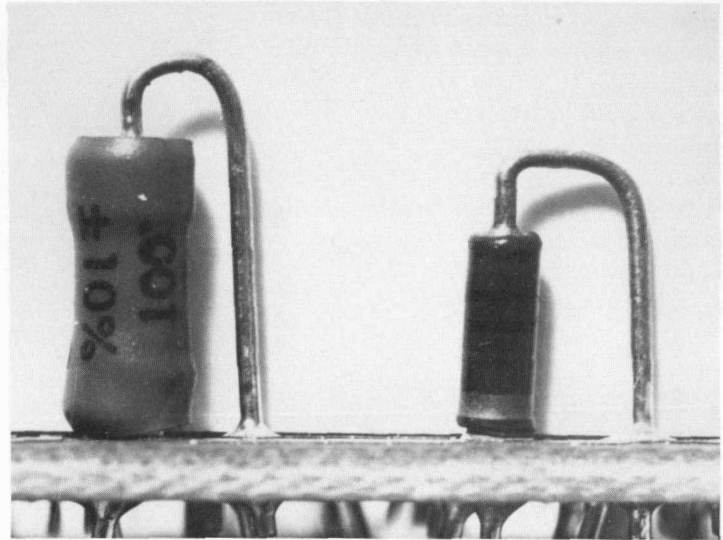

Figure 9. Acceptable end mounting when the holes are too close together. The use of insulation beads to space components away from the PC board is recommended.

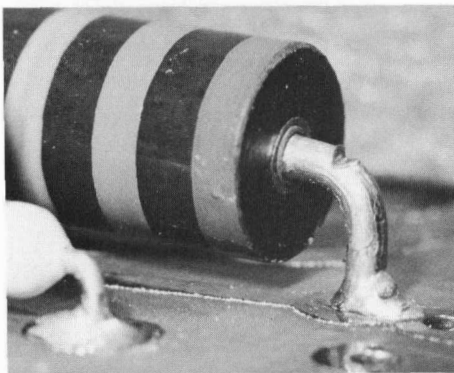

Figure 10. Example of a nicked resistor lead. The technician probably used side cutters to hold the lead while bending.

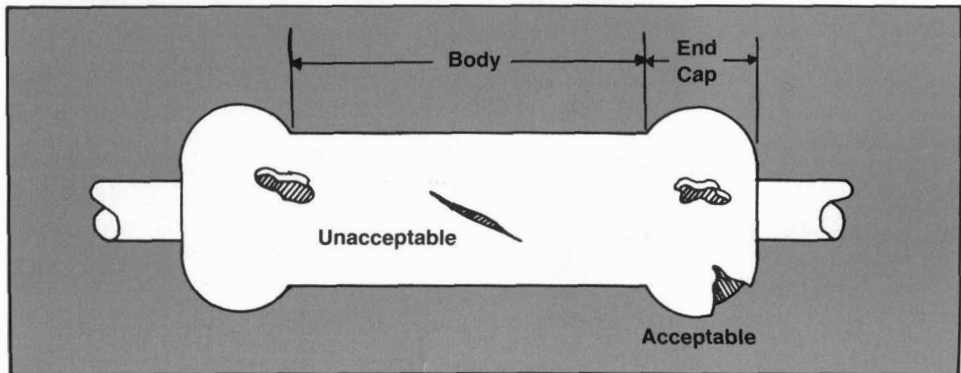

Figure 11. Examples of resistor damage in certain areas that is acceptable and other areas that is unacceptable.

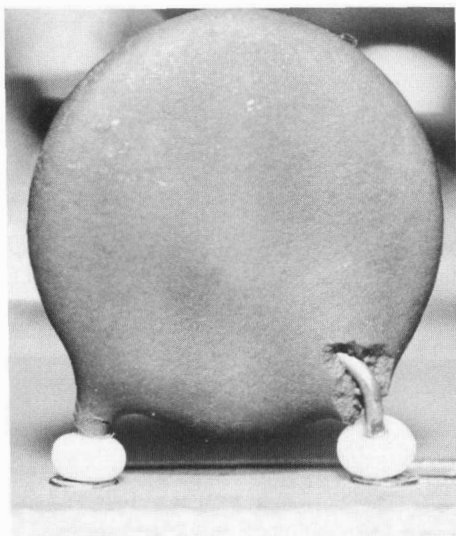

Figure 12. Example of capacitor damage that is unacceptable.

## Soldering

Soldering is an art and each individual has his or her own level of skill and personal touch. However, too heavy a touch or too hot an iron and a pad can be overheated, causing it to become delaminated from the board with probable damage to the component. And too light a touch or too cold an iron results in a cold solder joint, which can later become intermittent.

### Finished Solder Joint

A finished connection should show a solid bond between the lead and the circuit trace pad. Figure 13

shows a perfect solder joint slightly concave with good flow. Figure 14 shows an acceptable flat joint with a minimum of solder, but still with good flow. Figure 15 is acceptable with a maximum of solder forming a convex joint and still with good flow. Notice that in all the good joints you can see the lead sticking through. This is one of the signs of a good joint since it assures you that the lead is there. Look at the joint in Figure 16. Nice blob of solder, but is it attached to a lead? This joint, though not recommended, is acceptable, providing that on the component side, the lead and pad have wet properly (look ahead to Figure 22).

Now look at Figures 17 and 18. Figure 17 shows a good example of a "cold solder joint" where the lead was moved before the solder cooled. Figure 18 is another "cold solder joint" where either not enough heat was applied or the pad was not clean. Figure 19 shows an unacceptable method of removing excess solder buildup on the trace.

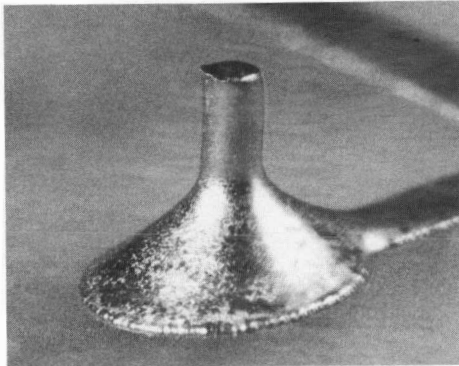

Figure 13. Best solder joint. Good flow, concave with ideal amount of solder, and the lead is visible.

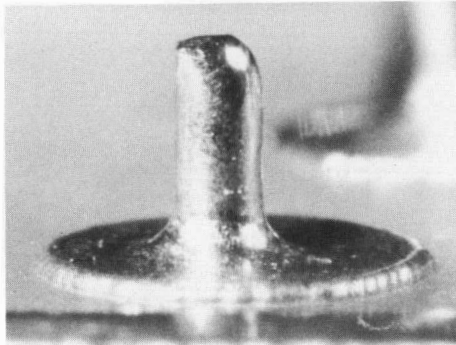

Figure 14. Acceptable solder joint. Good flow, flat with minimum of solder, and the lead is visible.

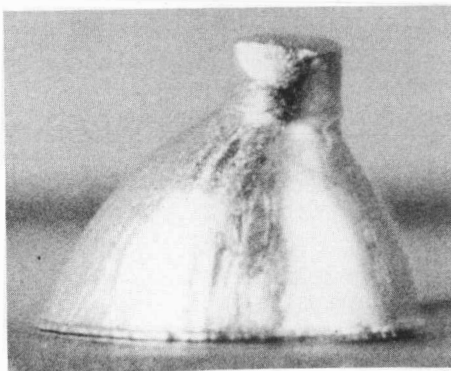

Figure 15. Acceptable solder joint. Good flow, convex with a maximum of solder, and the lead is visible.

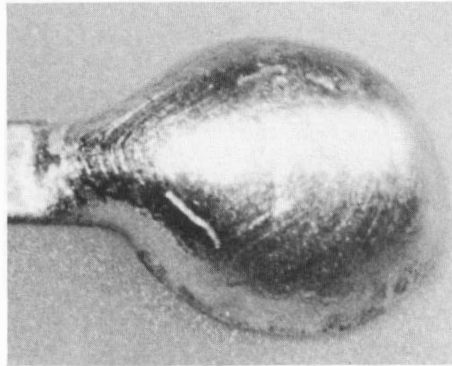

Figure 16. Normally unacceptable solder joint. Lead is not visible and may not be making contact with the solder. Refer to Figure 22 for example of when this joint is acceptable.



Figure 17. Unacceptable cold solder joint. Lead was moved before solder cooled.

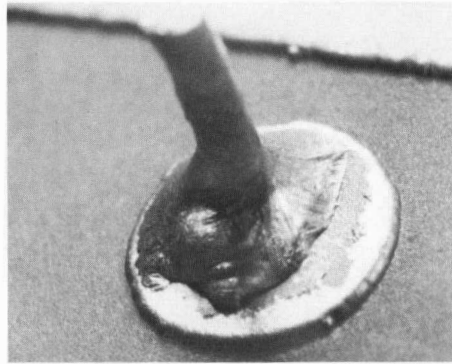

Figure 18. Unacceptable cold solder joint. Not enough heat or not properly cleaned to make solder flow.

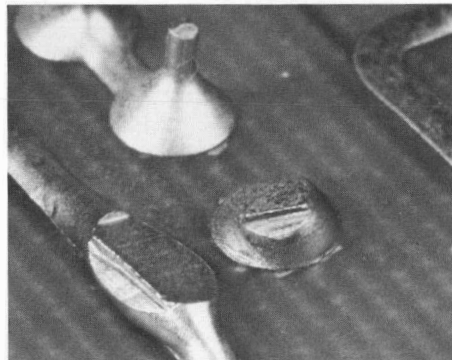

Figure 19. Unacceptable lead and solder clipping.

## Sufficient Solder?

A finished connection should exhibit feathered filleting between the lead and either circuit or component pad as shown in Figure 20. The minimum solder is where the solder fills at least half of the hole and the lead and pad have wet properly on the reverse side as shown in Figure 21. Note that you can see the lead. Minimum solder as shown in Figure 22 is also acceptable as long as the fillet is maintained on the component side of the board. Note that the lead is not visible on the solder side.

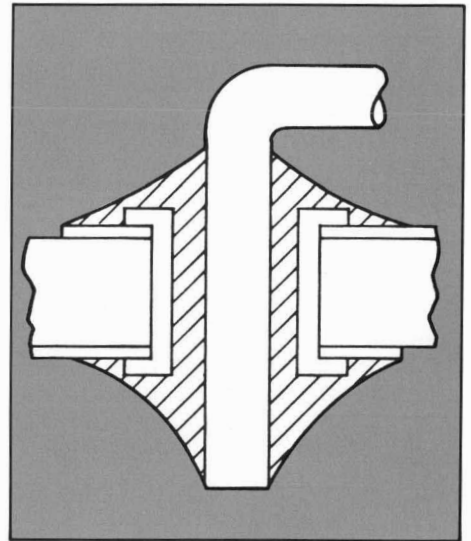

Figure 20. Example of good eyelet to circuit trace solder fillet. In addition to lead bonding, solder fillet must insure bonding of the eyelet to pad on both sides of the board.

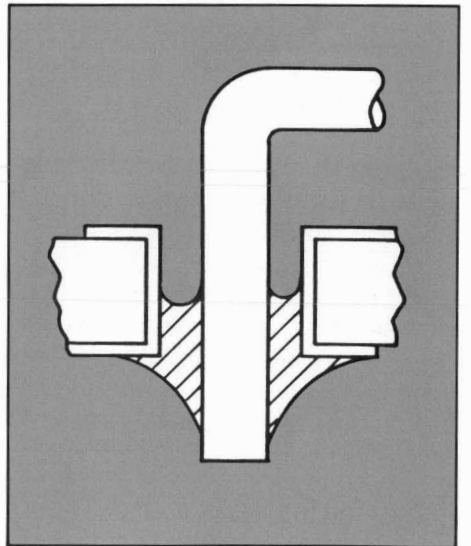

Figure 21. Acceptable solder fillet only because there is no eyelet.

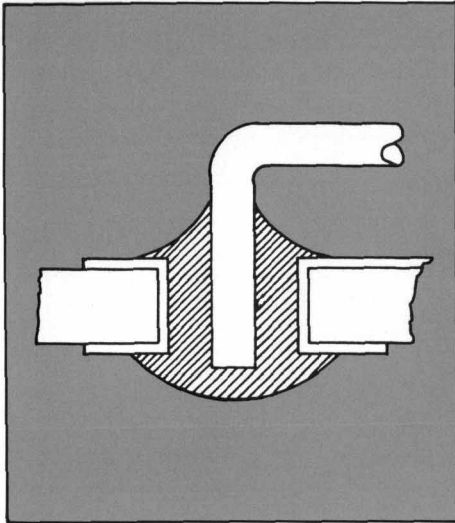

Figure 22. Acceptable solder fillet and lead placement. Note that the lead is not visible.

## Heat Damage

PC boards are susceptible to heat damage due to their glass epoxy laminated construction. In the wave solder assembly process the heat required to melt solder is usually closely controlled and does not cause any problems. However, when removing or inserting individual components by hand with a soldering iron, the heat required to melt solder comes from a concentrated source and is subject to human error. Consequently, heat damage can range from the minimum form of "measling," as shown in Figure 23, to the worst case of a lifted pad or trace, as shown in Figure 24.

Measling is defined as a condition existing in the base laminate in the form of discrete white spots or "crosses" below the surface of the base laminate, reflecting separation of fibres in the glass cloth at the weave intersection. Measling is unacceptable if there is a continuous path between two conductors or pads (see Figure 25).

Another form of heat damage is called "haloing." This is a condition existing in the base laminate in the form of a light area around holes on



Figure 23. Acceptable measling. Delamination localized around pad and does not bridge to adjacent trace.

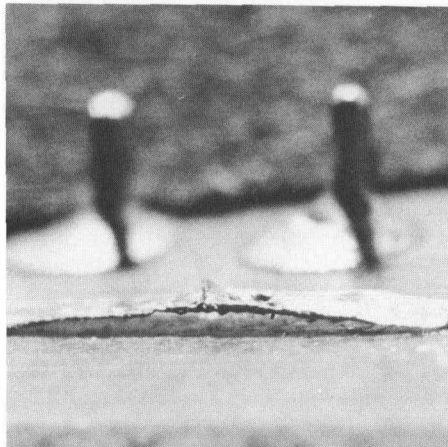

Figure 24. Example of unacceptable lifted trace.

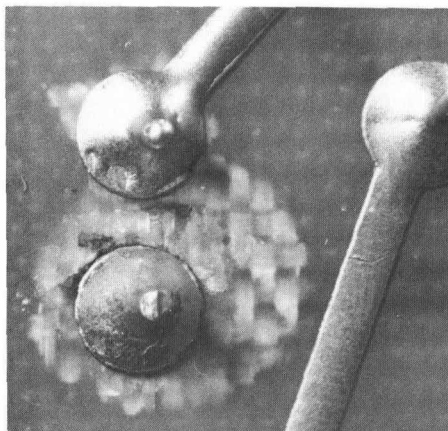

Figure 25. Unacceptable measling. Delaminated area bridges two pads.

or below the surface of the base laminate. Notice that both measling and haloing denote delamination of the board material. Besides being aesthetically undesirable, they weaken the circuit structure and introduce paths for leakage and contamination.

## Trace and Pad Repairs

The decision to repair a trace or a pad must not be made lightly. The basic criterion is that the repair return the board to its original operating condition. When you make the decision to repair or alter a circuit, the following must be considered.

- Will the repair adversely affect the designed performance and reliability of the circuit?
- Can the repair be made neatly and logically?
- Will your confidence in the product be reduced by the resulting appearance?
- Will the field be adversely affected by the repair?

### Definitions of Damaged Traces That Require Repair

What type of trace damage warrants repair? The following is a checklist.

- Lifted from the board.
- Complete break.
- One-third or more of the trace is missing because of a nick, hole, burn, etc. (see Figure 26).
- The trace is scratched and copper is visible.
- Any internal traces on a multi-layer board that are connected to the feedthrough of a lifted pad must be duplicated. However, under normal circumstances, these boards would probably be scrapped, since the labor costs would exceed the cost of a new board.

## Definitions of Damaged Pads That Require Repair

The following is a list of pad damage that warrants repair.

- One-third or more of the pad that has a trace attached is missing or lifted.
- Complete break in which the pad is separated from a trace.

- An eyelet, barrel, or feedthrough in which any part of the barrel is missing.

## Acceptable Methods of Trace and Pad Repair

The two common methods of repairing traces use wire jumpers or welded gold ribbon. Welded gold

ribbon results in a better final appearance; however, it requires special tools and procedures, which are usually not available at the bench repair station.

## Wire Jumper Repair

The wire jumper may not be used to repair breaks more than half the width of the trace.

## Basic Principles of Soldering

The principle of soldering is to form a metallurgical bond between metals using a filler metal (solder) which melts below 800°F (427°C). Bond strength of the joint depends on wetting (diffusion) of the base metal by the solder.

It would be safe to say that while most technicians can melt solder and form a good joint, they have no idea what the tip temperature of their soldering iron is, or precisely what type of flux their flux-core wire solder contains—probably the two most important factors in performing a good soldering job. These two factors are usually evaluated after the job is done by comparing the positive vs negative results.

### Temperature

There are several temperatures to consider: the temperature the solder melts at, the tip temperature of the soldering iron (in degrees, not watts), and the maximum safe soldering temperature of the parts to be joined. In considering the maximum safe temperature of the parts, remember that the proper soldering temperature is typically 60° to 160°F (16°–71°C) above the solidus temperature. This is because solder heated just above its melting

point may not adequately wet the base metal. And overheated solder may become oxidized or dissolve small quantities of base metal, resulting in a sluggish, grainy melt or weakness in the finished joint.

The flux-core wire solder Hewlett-Packard recommends for general PC board rework is RMA P2 63/37 tin/lead<sup>2</sup> with a flow point of 361°F (182.8°C). The Weller WTCP series soldering stations Hewlett-Packard uses have available a variety of different shaped tips in 600°, 700°, and 800°F temperatures (315°, 371°, and 426.5°C). A 1/16" diameter screwdriver-type tip with a 700°F control tip temperature (PTA7) is normally provided with the soldering station and is the one HP generally uses. There are many good soldering stations available, but do not use soldering guns. Soldering guns generate far too much heat and should never be used for hand soldering PC boards.

Since soldering takes place below 800°F, and the solder flows at ~360°F, simple arithmetic shows the following:

$$\begin{array}{r} 360^{\circ}\text{F solder melt temp.} \\ + 160^{\circ}\text{F wet temp.} \\ \hline 520^{\circ}\text{F min. req. tip temp.} \\ \\ 700^{\circ}\text{F available tip temp.} \\ - 520^{\circ}\text{F min req.} \\ \hline 180^{\circ}\text{F cushion} \end{array}$$

The 180-degree cushion will be lowered substantially when the tip is dragged across the wet sponge for cleaning, and further lowered when the tip is applied to the joint. Therefore, 700°F seems to be the optimum temperature for the tip. A note of caution: the more times you wipe your iron across a wet sponge to clean the tip, the lower the tip temperature plunges. This can result in cold solder joints or severely overheated components (holding the iron in place too long waiting for the solder to melt).

### Flux

Flux aids soldering. In fact, except under special conditions, soldering is usually not possible without it. Most of the solder used in PC board repair is 63/37 (tin/lead) flux-core solder. The advantage of flux-core solder is that it automatically ensures the correct flux/solder ratio if the proper solder has been selected. Flux-core solder comes in a variety of diameters and is filled with three types of fluxes: rosin-based, organic acid (water soluble), and inorganic acid. Flux performs four vital functions in soldering:

- It chemically removes tarnish films from the base metal.

1. Clean both sides of the break at least 1/4 inch away from the break.
2. Cut a piece of No. 22 or 24 AWG solid tinned copper wire a minimum of 1/4 inch longer than the break.
3. Hold the wire on the center line of the trace across the break and solder in place (see Figure 27).

4. Flow a small amount of clear epoxy cement neatly over the entire repair and allow for proper cure.

### Pad Repairs

The most common pad repair is replacing a lifted or separated pad on a single-layer board. Note that if a pad is damaged on a multilayer

board and has no external traces attached, the pad generally does not have to be replaced, but all internal traces must be duplicated. However, under normal circumstances, these boards would probably be scrapped, since the labor costs would exceed the cost of a new board.

1. Drill through the existing hole to the size of the desired eyelet. Be

- It displaces adsorbed air and prevents reoxidation of the metal surface.
- It facilitates wetting of the solder to the base metal.
- It aids in heat transfer.

In order for the flux to be effective, it must be operated in the proper temperature range. If the soldering temperature is too low, the chemical activators in the flux will not be released and the tarnish will not be removed. Excessive heating can cause the flux to lose its wetting capabilities and decompose, leaving a residue that may be very difficult to remove.

The three types of flux in common use are:

- Rosin-based. A combination of several compounds distilled from the sap of pine trees.
- Organic acid (water soluble). More active and more corrosive than rosin-based types. They are normally considered too corrosive for hand soldering and are used mainly in wave soldering machines that incorporate thorough cleaning/neutralizing cycles.
- Inorganic acid. Uses a strong acid such as hydrochloric, hydrofluoric or orthophosphoric as the active agent. Used for soldering heavily corroded or otherwise difficult-to-solder materials (such as galvanized tin). It is very corrosive and should never be used for electrical work.

### Rosin-based Flux

Rosin-based flux comes in three primary varieties.

- R-type flux is pure rosin dissolved in a solvent vehicle. Pure rosin has all the qualities of a good solder flux except that it reduces surface oxides only very weakly. It is completely noncorrosive and nonconductive and is suitable for soldering freshly cleaned shiny copper. Rosin also has the property that when set, it does not absorb water.
- RMA-type flux (Rosin Mildly Activated) has a mild chemical activator added to remove moderate oxide films from the metal to be soldered. It is essentially noncorrosive after soldering.
- RA-type flux (Rosin, Fully Activated) has more powerful activators for tougher soldering jobs. It is generally not recommended for hand soldering high-reliability PC boards.

When selecting a flux, the idea is to use the lowest activation level that will do the job. If you are having trouble with inadequate solderability, you could try a more highly activated flux (although cleaning the leads and/or improving the heat transfer are usually far better solutions). Corrosion or electrical leakage problems might suggest going to a less activated material. Hewlett-Packard recommends RMA-P2-type solder for all printed circuit board repairs.

Rosin fluxes are also graded according to density, which is the percentage of solids in the flux. Low-density fluxes flow better while high-density fluxes cover better. Inadequate coverage would suggest a higher density while inadequate removal of flux residue during the cleaning process may indicate a lower density. The P2 in the RMA solder HP recommends contains 2.2% solids.

### To Clean or Not To Clean

Clean PC boards are vital to circuit reliability. The activators used in flux contain a number of ionic contaminants (primarily chlorides) that corrode circuit traces and promote current leakage under conditions of high humidity.

However, R- and RMA-type fluxes may safely be left on the board after hand soldering. RA-type fluxes should not be used for hand soldering of high-reliability equipment. Should RA flux be absolutely necessary for the soldering job at hand, or if the flux must be removed for cosmetic or other reasons, the cleaning procedure must include washing with a bipolar solvent to remove the rosin and then careful washing in several baths of progressively cleaner alcohol/water to remove the contaminants. A final rinse of distilled or deionized water is also recommended.

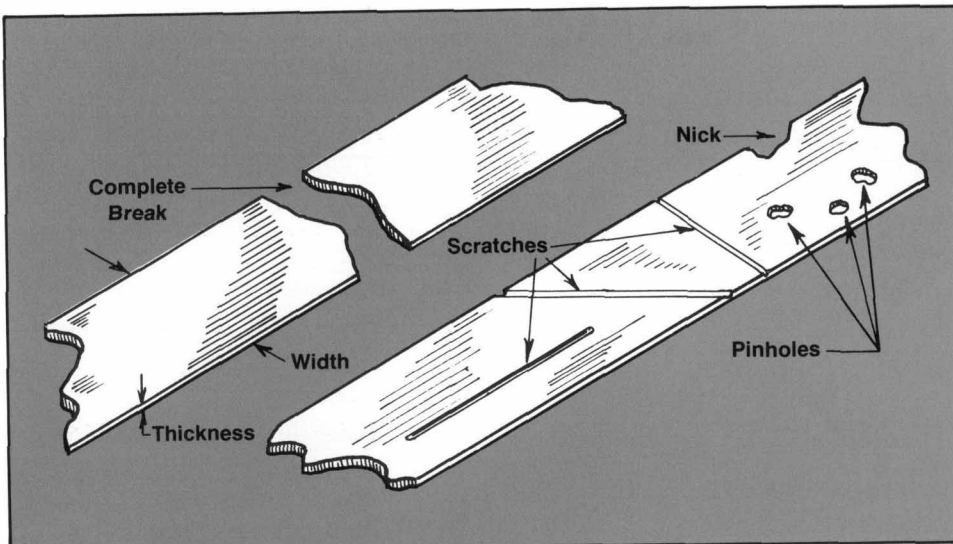

Figure 26. Example of trace damage that can be repaired.

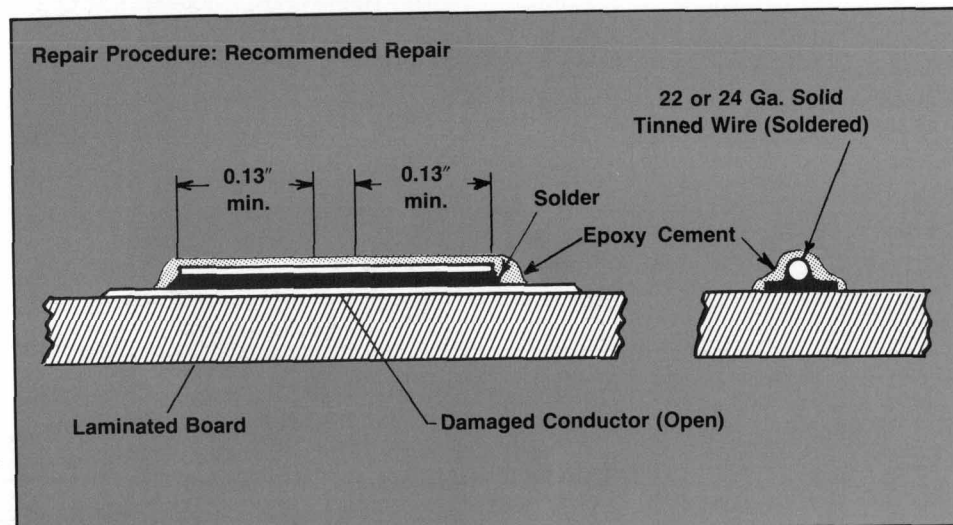

Figure 27. Wire jumper repair on damaged trace.

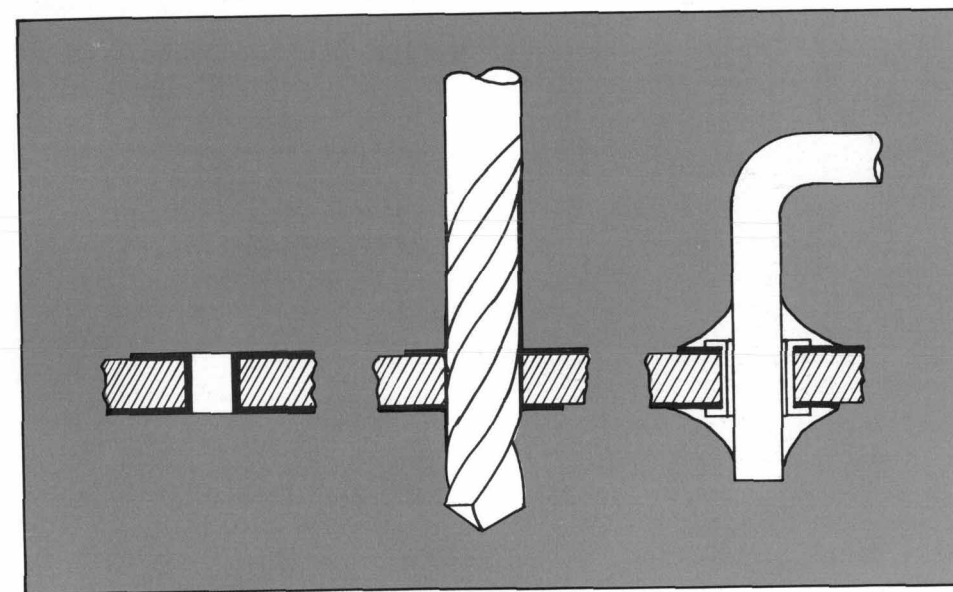

Figure 28. Pad repair using a new eyelet. Note that the solder fillet insures electrical connection from eyelet to pad on both sides of the board.

sure that the trace on the opposite side is not damaged or delaminated by the drilling operation (see Figure 28).

2. Insert and stake the eyelet firmly to the existing pad surfaces.
3. Solder the eyelet to the pad on both surfaces of the board as shown in Figures 20 and 28.

## PC Board Cleaning

There are two major reasons for cleaning an instrument, assembly, and PC board—to get rid of intermittents and to improve cosmetic appearance. A thoroughly cleaned unit is viewed by many technicians and customers as the sign of a quality repair. However, beauty is often only skin deep. A PC board that appears clean to the naked eye might be covered with contaminants (from improper cleaning) that can combine with airborne moisture to cause extensive corrosion.

And what about intermittents? Bump the instrument and it quits; wiggle or reseal the PC boards and the instrument starts working again; wiggle a cable, connector, or switch and the display jumps. Many of these types of intermittents are the result of dirt and/or corrosion between movable metal contact surfaces. A good cleaning could solve a lot of your intermittent problems.

Obviously the instrument and related PC boards should be cleaned of dust, dirt, oil, corrosion products, and any other contaminants that could affect surface resistivity or otherwise degrade their performance. However, cleaning a contaminated PC board should be an all-or-nothing proposition. Here is why. Solvents (including alcohol), applied to a PC board will dissolve trace contaminants and spread them over the board surface. These contaminants, if not completely removed by a thorough cleaning and rinsing, can cause serious long-term problems such as corrosion and intermittent connections. A cursory spot cleaning might improve the



cosmetic appearance of a board, but reliability is almost certain to suffer.

### Solder Flux Rosin Removal— Not Recommended and Why

Hewlett-Packard recommends that solder flux rosin from RMA-P2<sup>2</sup> solder not be disturbed and that it be left on the board following a component replacement.

Recent research here at HP has revealed that solder flux from RMA-P2 solder does no harm if left in place on a PC board after a hand soldering operation; the rosin is inert and nonconductive. However, when you dissolve it with a chemical, attempting to remove it from the board, it is like pouring oil on water; the rosin flux dissolves and spreads all over the board, releasing

its activators (chlorides, bromides, etc.). Now, instead of having a harmless blob of rosin flux with the activators trapped, you have a potential time bomb ticking away. The activators are water soluble. If the instrument is stored in a humid environment, all it takes is a little time and moisture to start the corrosion process. This is why many Hewlett-Packard manufacturing divisions have switched to RMA-P2 solder exclusively for hand soldering components, since it contains far fewer chlorides than RA<sup>3</sup> solder. Refer to the insert on "Soldering" for more information on solder and fluxes.

And in most cases you cannot see the residue with your naked eye. The board looks clean but it is not. Under these conditions, it is very possible that a board that looks clean is actually of lesser quality than one with blobs of undisturbed solder flux. Refer to Figure 29 for an example of leftover flux, and to Figure 30 for an example of corrosion caused by the activators.

### Other Cleaning Techniques Not Recommended

Several common cleaning techniques and materials have been found to hurt PC board reliability and should be avoided. For example:

- Dipping loaded PC boards is not recommended because of potential solvent contamination and damage to some components. The dirty solution flows into all the hard-to-clean areas (switches, relays and other enclosed parts) that can't be adequately rinsed. The solution can also attack electrolytic capacitors and other plastic components.
- Vapor degreasing of loaded PC boards is not recommended for the same reasons as dipping. Vapors can penetrate hard-to-clean areas just as easily as the liquid solvent.
- Ultrasonic cleaning of PC boards is not recommended because the vibration can cause IC internal bond wire failures.

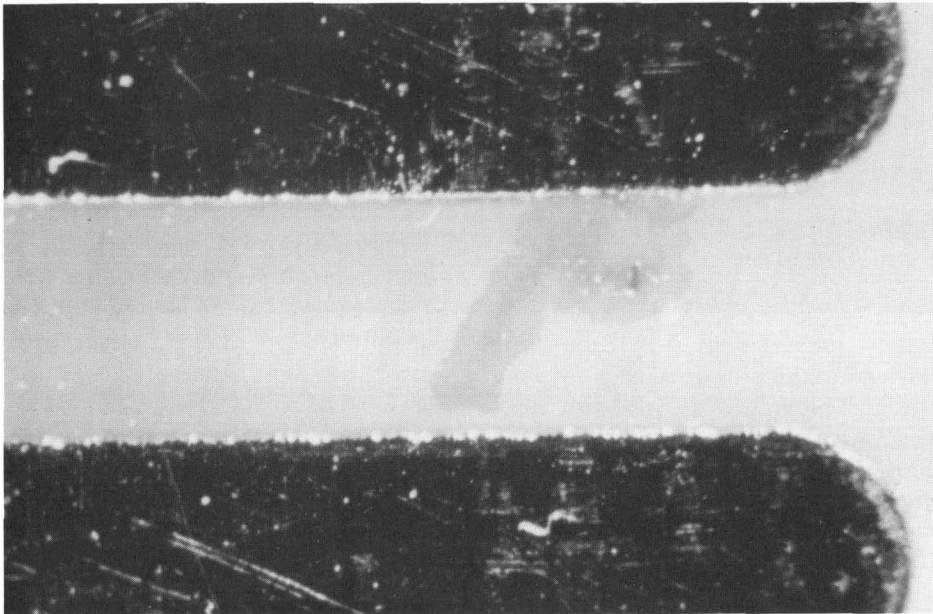

Figure 29. Example of residue flux left on the board from improper cleaning.

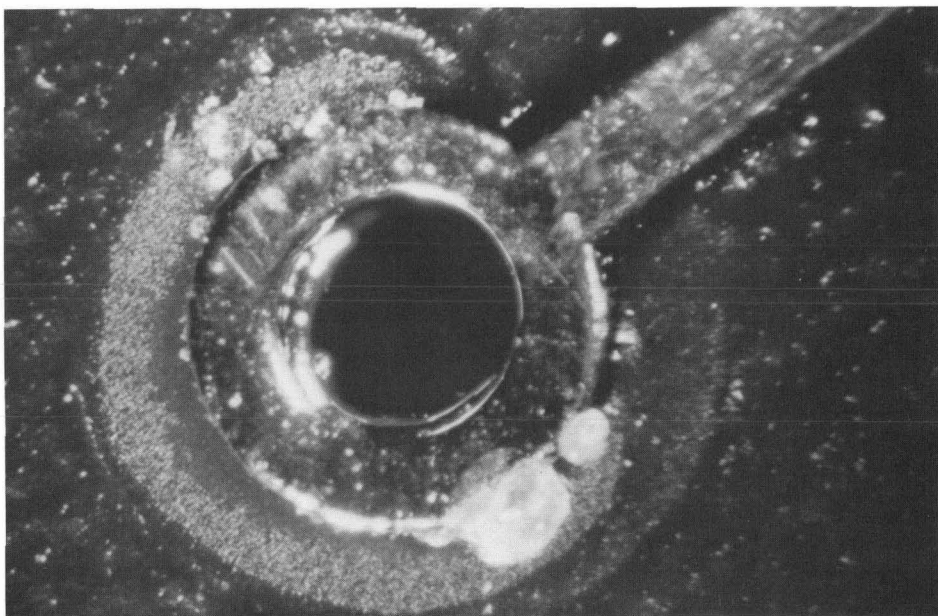

Figure 30. Example of corrosion from the activators in solder flux on a board that was improperly cleaned.

- Cotton-tipped swabs are not recommended for cleaning because of the fibers they leave behind. Foam-tipped swabs<sup>7</sup> are better.
- Paper-type cloths (e.g., Kimwipes) are not recommended for cleaning because they tear, disintegrate and leave fibers behind. Lint-free cloth<sup>8</sup> is considerably better.

### General Cleaning Procedures

The following cleaning procedures are meant to be general in nature and applicable to the majority of PC boards. The steps are graduated from simple cleaning (assuming only a dusty board), up to major washing with strong solvent for flux removal. Pick the minimum step that suits your cleaning needs.

1. Dust and residue can often be removed from the surface of a PC board using compressed air. But first check that the air is adequately filtered; compressors are notorious for adding oil and water to the air they compress.
2. If it is necessary (and feasible) to wash the PC board, use a mild, low-foaming, nonionic soap that can be completely rinsed off the board. Be sure to clean the board thoroughly and then rinse it several times with clean water. Note that this type of wash will not remove the rosin flux.
3. After all the washing, remove as much water as possible with clean air and bake at approximately 70°F (150°C) for one hour to dry.
4. For spot cleaning slide and rotary switches use aerosol solvent MS-180<sup>5</sup> followed by a light application of electronics-grade contact oil such as Cramolin<sup>6</sup> or No Noise<sup>6</sup>. These products do a minor amount of cleaning, in dissolving oxidation or tarnish, but do not attack metal, including gold or silver plating. A vapor-thin film is all that is required to seal the pores in the metal

surface and lower contact resistance. Always wipe off excess contact oil, leaving behind a vapor-thin film. Less works better.

5. To clean BNC connectors use a round pointed toothpick and apply a small amount of MS-180 or Cramolin to the point. Gently insert the point into the center conductor of the BNC connectors and spin the toothpick between your fingers.
6. The final step is to clean the edge connector. Refer to that heading for the instructions.

### Solder Flux Rosin Removal—When You Must

Proper flux removal is a three-step process; it takes one wash and two rinses. The following solvents are recommended because they are bipolar. That means they contain two kinds of solvent, one to dissolve the rosin and one to dissolve the activators in the rosin. Once you have them both dissolved and spread all over the board, then you have to remove the rosin, the activators, and the bipolar solvent.

1. When applying the solvent, hold the edge connector up. This prevents the dissolved flux from running onto the connectors and possibly causing future intermittents and corrosion. Use Reliasolve No. 564<sup>9</sup> or MS-190HD<sup>9</sup> to dissolve the solder flux. Use a short-bristled brush and rub the area vigorously.
2. Next, generously rinse the repaired area with an 80/20 solution of isopropyl alcohol<sup>4</sup> and deionized water, keeping the board's edge connector up. This rinse should flood the entire PC board and always be done with a clean and fresh alcohol/water solution. You should rinse the board several times, holding it over a large container to catch the excess runoff. Allow at least two minutes for final air dry.

#### NOTE

From this point on, the PC board should only be handled by its edges. Never touch the circuit traces with your fingers—they leave oily fingerprints, which cause corrosion (see Figure 31). We do not recommend the use of gloves unless they are clean and fresh.

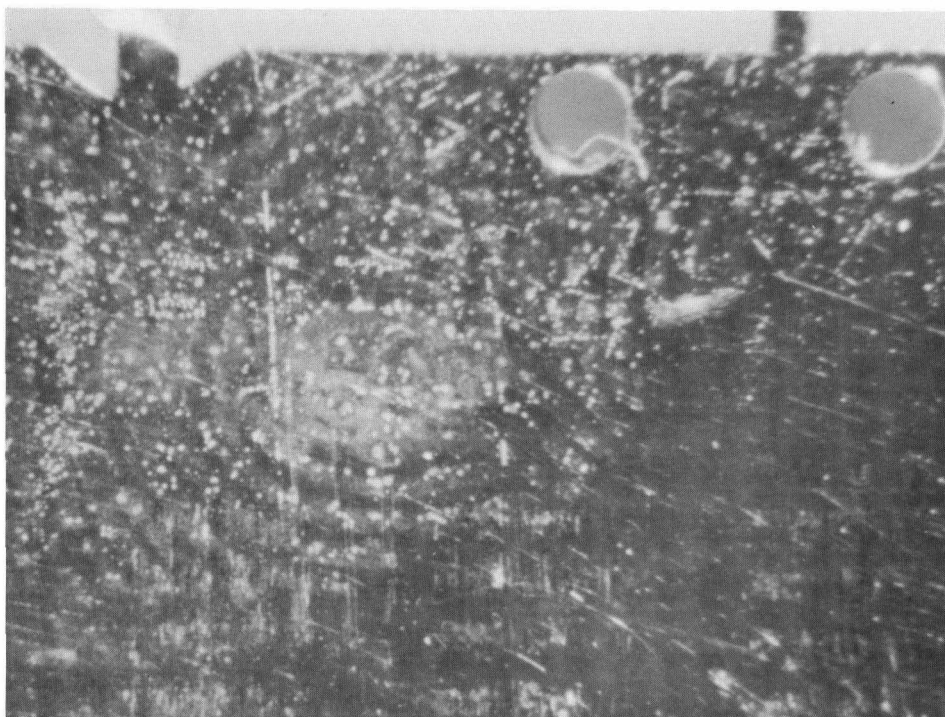

Figure 31. Example of the corrosion process started by a fingerprint.

In many cases the gloves (through constant use) are actually more dirty and contaminated than your bare fingers.

3. Generously rinse the PC board several times with clean and fresh DI (deionized) or distilled water. Both must be stored in poly plastic bottles. Again, hold the board by its edges over a large container to catch the excess runoff. Allow five minutes for drying, or in some cases, it may be necessary to oven dry the board to remove all traces of moisture. Allow one hour at 70°C (158°F).

### PC Board Edge Connector Cleaning

Perhaps one of the most critical areas in your instrument, the PC board edge connector contacts and mating female sockets are most susceptible to contamination causing intermittents. Look at Figures 32 through 36 for examples of why you want to thoroughly clean the edge connectors. Remember that these are magnified photographs—you normally cannot see this contamination with your naked eye.

### Alcohol/Water and Contact Oil

In the event that dissolved solder flux rosin and accompanying activators have found their way to the edge connector area, the alcohol/water combination is the first step in the cleaning process. 100% alcohol will not dissolve all components of the contamination, since the flux activators are water soluble. We have found that an 80/20 solution of alcohol/water is the optimum mix. 20% water is enough to dissolve the activators but not enough to generate damaging static electricity.

Electronics-grade contact oils such as Cramolin<sup>6</sup> or No Noise<sup>6</sup> do a minor amount of cleaning, in dissolving oxidation or tarnish, but do not

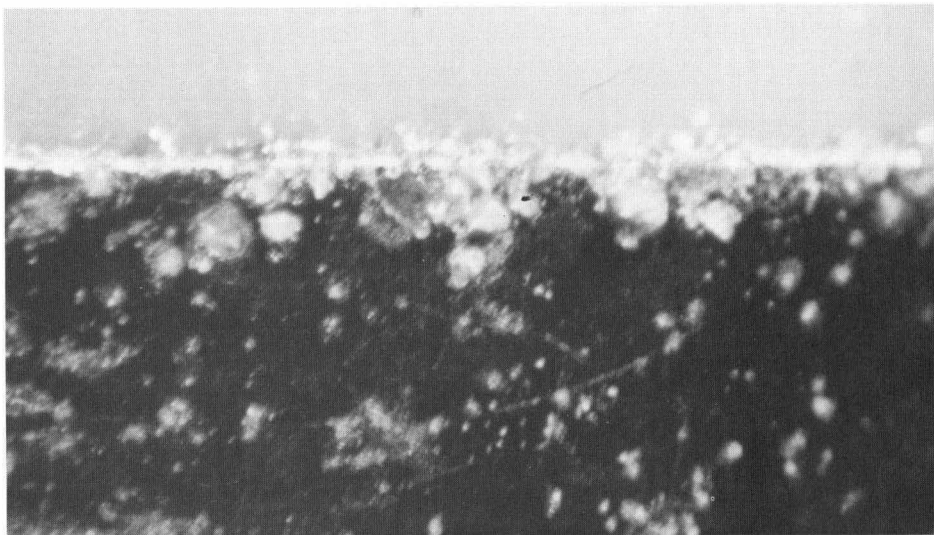

Figure 32. Example of corrosion (from the activators in solder flux) next to an edge connector.



Figure 33. Example of dirty edge connector. Note the crushed fibers and lint from a cotton swab and paper-type cloth.

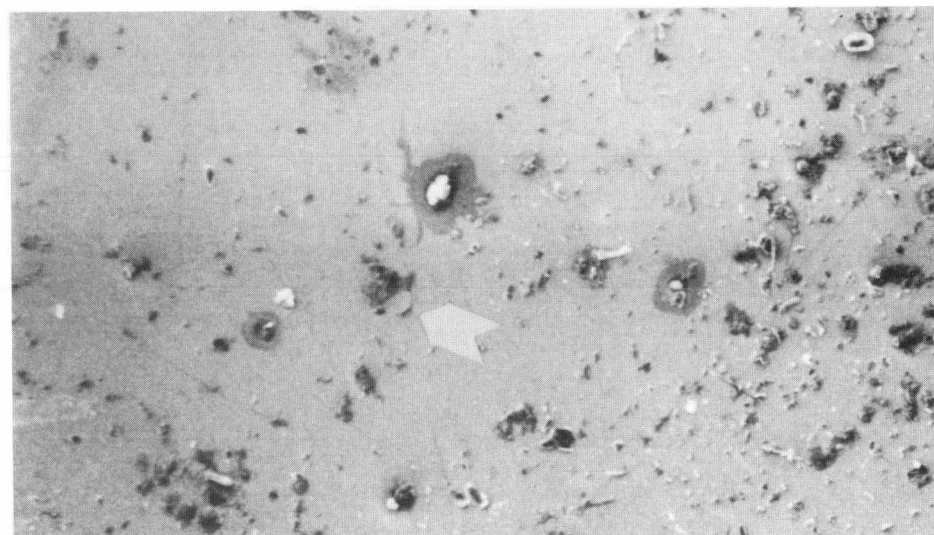

Figure 34. Example of pore corrosion (mag 50x) on edge connector. The arrow points to an eruption.

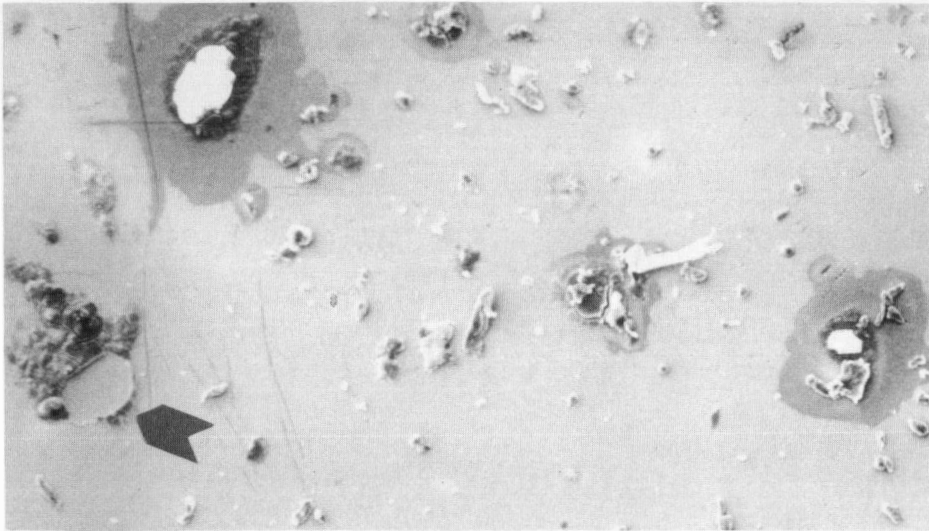

Figure 35. Same example of pore corrosion as Figure 34 (mag 160x). The arrow is pointing to the same eruption as in Figure 34.

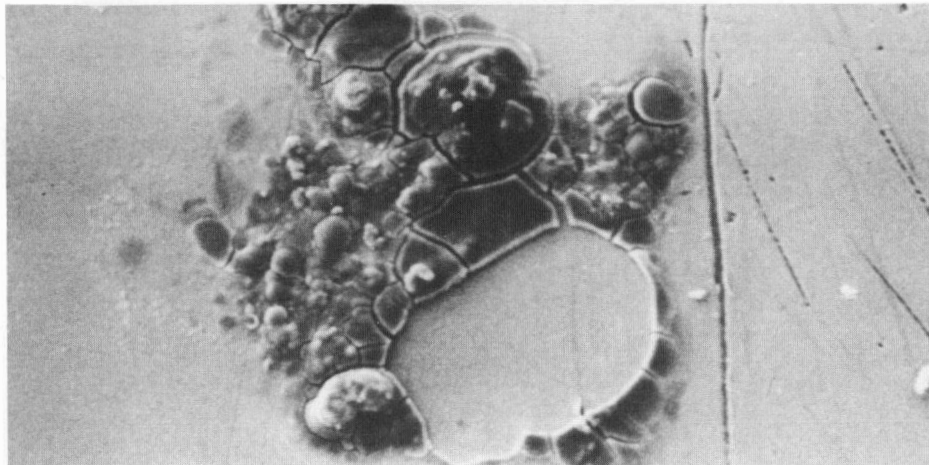

Figure 36. This is the eruption magnified 350 times. This bud of corrosion will jack the plug finger in the edge connector socket off the pad resulting in an open or intermittent connection. Move the board, break the piece of corrosion off and contact is reestablished — for a while. The edge connector cleaning process in the article will remove this corrosion and keep it from reoccurring for a very long time.

attack metal, including gold or silver plating. A vapor-thin film is all that is required to seal the pores in the gold surface and lower contact resistance. Lubrication is desired in the event the female sockets contain a few tight contacts that could wear the gold off—thus losing the basic original advantages of gold plating. Always wipe off excess contact oil, leaving behind a vapor-thin film. Less works better.

#### CAUTION

Do not use any oil that contains silicone.

1. Start out with the large squares of lint-free cloth<sup>8</sup> and cut them into smaller 4 x 4-inch squares.
2. Saturate a small square of cloth with an 80/20 mixture of isopropyl alcohol and water and shine the edge connector with the cloth.
3. Wet (sparingly) another piece of cloth or foam-tipped swab with contact oil and wipe the contacts. Because of the lint problem, do not use a cotton swab. Allow the coating to remain for a short period of time to dissolve any remaining hard particles of corrosion.
4. While you are waiting for the contact oil to dissolve any corrosion on the PC board contacts, you can clean the mating female connectors. Apply a small amount of MS-180 to a foam-tipped swab. Insert the swab into the female connectors, working it back and forth to clean the contacts. Another method is to wrap the lint-free cloth over the edge of a dummy PC board, soak the cloth with cleaner, and insert it into the socket several times. Watch out for PC card alignment keys in the sockets.
5. Back to the PC board. Wipe off the contact oil with another piece of clean cloth. There will be times that the lint-free cloth will show dark residues picked up from the contacts. This is the oxide being removed. If there appears to be more oxide film on the contacts,

Work the cloth back and forth parallel to the contacts so any contamination is not pushed up against the edge of the contact. The lint-free cloth provides the mechanical action needed to polish the contacts and free the area between the contacts of most all contamination. Discard the cloth.

reapply the contact oil and leave it in place a few more minutes. Wipe it off again to see if more residue comes off.

- Use a foam-tipped swab and lightly apply a thin coating of contact oil to the contact surfaces. Insert the card into the female socket several times—the contact oil will migrate to the female contacts. Remove the PC card and wipe off any excess oil, leaving only a vapor-thin coating. Remember, less is better.

### CAUTION

Do not use an eraser—any type of eraser—to clean contacts. An eraser is highly abrasive and will remove the precious metal plating.

Also, the glue in the eraser leaves behind a film that is extremely difficult to remove and can later cause intermittents.

Also, rubbing an eraser back and forth across the contacts is a potential static generator.

TABLE OF REFERENCES				
REF. NO.	DESCRIPTION	MFR. NO.	MFR. NAME	HP PART NO.
1	low static solder sucker repl. tips	AS 196	Soldapullit	8690-0227
			Soldapullit	8690-0253
2	solder, RMA (rosin mildly active) 63/37 lead/tin .032 dia.	RMA P2	Alpha Metals	8090-0098
3	solder, RA (rosin active) 60/40 lead/tin .050 dia.	RA P3	Alpha Metals	8090-0027
4	isopropyl alcohol, 99.5% pure, semi-conductor grade	NA	NA	8500-1163
5	gen. purpose solvent	MS-180 Freon TF	Miller-Stephenson	8500-0232
6	contact cleaner and protector	Cramolin Red FSN-6850-880-7007	Caig Laboratories	6010-0491
		No Noise	Electronic Chem. Corp.	6030-0063
7	foam-tipped swab	NA	NA	9300-0707
8	lint-free industrial woven cloth	TX 309	Texwipe Co.	9310-0039
9	flux remover	Reliasolv No. 564	Alpha Metals Inc.	8500-1803
		MS-190HD	Miller-Stephenson	8500-0735
		V-200	Baron-Blakeslee	8500-0735

## supplement to BENCH BRIEFS SERVICE NOTE INDEX

### Need Any Service Notes?

They're free!

Here's the latest listing of Service Notes. They recommend modifications to Hewlett-Packard instruments to increase reliability, improve performance, or extend their usefulness.

Use the order form at the rear of Bench Briefs to select the notes that relate to your instruments.

#### 141T DISPLAY SECTION

- 141T-7B-S. Serials 1502A and below. Elimination of potential safety hazard.
- 141T-12. Serials 1145A through 1802A. Directions for replacing the 00141-66519 Low Voltage Power Supply Board.
- 141T-13-S. All serials. Elimination of potential safety hazard.

#### 346B NOISE SOURCE

- 346B-2. Serials 2037A00994 to 2037A01454. Serial number label installed backwards.

#### 428B CLIP-ON DC MILLIAMMETER

- 428B-2. Serials 0994A06225 and below. Preferred replacement for L7.

#### 436A POWER METER

- 436A-4. All serials. Troubleshooting for noise.

#### 1304A X-Y DISPLAY

- 1304A-7. All serials. Defective component alert.

#### 1332A X-Y DISPLAY

- 1332A-15. All serials. Modification to improve reliability of the power supplies.
- 1332A-16. All serials. Clarification of display bandwidth.

#### 1335A X-Y DISPLAY

- 1335A-15. Serials 1949A and above. Clarification of the intensity limit adjustment.

#### 1336A X-Y DISPLAY

- 1336A-3. Serials 1809 and below. Intensity limit circuit modification.

#### 1340A X-Y DISPLAY

- 1340A-2A. All serials. Improved CRT for model 1340A X-Y displays.
- 1340A-4. All serials. Proper input attenuator settings and compensation adjustment.

#### 1611 LOGIC STATE ANALYZER

- 10266A-1. Option A09 (6809 Microprocessors) serials 2227A and below. New A9 personality board to correct synchronization.

#### 1727A OSCILLOSCOPE

- 1727A-1. Serials 2137A00450 and below. Modification to prevent CRT movement.

#### 1740A OSCILLOSCOPE

- 1740A-20. All serials. Troubleshooting tip to correct low bandwidth and slow risetime caused by contaminated delay line.

### 1741A OSCILLOSCOPE

- 1741A-3A. All serials. Modification instructions for state display, option 101 kit, p/n 01741-69501.  
1741A-13. All serials. Troubleshooting tip to correct low bandwidth and slow risetime caused by contaminated delay line.

### 1742A OSCILLOSCOPE

- 1742A-5. All serials. Troubleshooting tip to correct low bandwidth and slow risetime caused by contaminated delay line.

### 1743A OSCILLOSCOPE

- 1743A-6. All serials. Troubleshooting tip to correct low bandwidth and slow risetime caused by contaminated delay line.

### 1744A OSCILLOSCOPE

- 1744A-6. All serials. Preferred replacement for A16CR3 bridge rectifier.  
1744A-7. All serials. Troubleshooting tip to correct low bandwidth and slow risetime caused by contaminated delay line.

### 3060A CIRCUIT TEST SYSTEM

- 3060A-0B. Service note index for the 3060 system.  
3060A-23A. All serials. System support package for 3060A board test system.  
3060A-38B. All serials. Improved option 008 (signature analysis) confirmation test.  
3060A-39B. All serials. List of configuration/confirmation/diagnostics software revisions.  
3060A-47. All serials. Modification to prevent option 100 stimulus input and ground relay confirmation failures.  
3060A-48. All serials. Correct installation of option 100 stimulus cable.  
3060A-49. All serials. Addition of a low impedance logic ground connection to eliminate spontaneous FAOFFS and FBOFFS during board testing.  
3060A-50. All serials. Improved field diagnostic of analog relay failures.

### 3325A SYNTHESIZER/FUNCTION GENERATOR

- 3325A-10A. Serials 1748A-04251 and above for parts 8120-3108 and 1251-6567. Serials 1748-04401 and above for parts 8120-3216 and 1251-5064. List of new PC board connectors and cables.

### 3453A DIGITAL STIMULUS RESPONSE UNIT

- 3453A-3A. All serials. Modification to improve the reliability of the synchronization circuit which synchronizes the DSRU actions in a dual DSRU 3060A System.

### 3456A DIGITAL VOLTMETER

- 3456A-13. Serials 2201A05331 and below. Modification to improve digital circuitry performance.  
3456A-15. Serials 2201A04796 and below. Modification to improve performance of main controller board (A4).  
3456A-16. Serials 2201A and below. Modification to make A3 PC board assembly compatible with the listed serials.

### 3465B DIGITAL MULTIMETER

- 3465B-5. All serials. Charging instructions to extend battery life.

### 3468A MULTIMETERS

- 3468A-1. All serials. Battery retrofit kit installation instructions.

### 3478A DIGITAL MULTIMETER

- 3478A-2. Serials 2136A00101 through 2136A00845. Explanation of 3478A error messages at turn-on.

### 3495A SCANNER

- 3495A-7. All serials. Spare parts and troubleshooting information.

### 3496A SCANNER

- 3496A-1B. Serials 1740A00343 and below. Prevention of serious scanner damage.  
3496A-4C. All serials. Improved option 008 (signature analysis) confirmation test.  
3496A-5A. Serials 1801A00819 and up. New scanner analog board design and new scanner center bar design.

### 3497A DATA ACQUISITION/CONTROL UNIT

- 3497A-10. All serials. Operational verification of the thermocouple compensated option 020.

### 3580A SPECTRUM ANALYZER

- 3580A-10. All serials. Instructions for ordering replacement A2 local oscillator and A16 combining boards.

### 3581A/C WAVE ANALYZER

- 3581A/C-8. 3581A serials 1352A02090 and below; 3581C serials 2114A01525 and below. Instructions for ordering replacement A2 local oscillator and A16 combining boards.

### 3585A SPECTRUM ANALYZER

- 3585A-2B. All serials. Replacement procedure for relays A1K1 through K9 and A1K11 through K14 on the A1 board.

### 3724A BASEBAND ANALYZER

- 3724A-1. Serials 2212U-00156 and below. Modification to prevent erroneous results in scan mode when using 40Hz bandwidth.

### 3746A SLMS

- 3746A-1. All serials. Preferred replacement for A5Q1, Q3, Q5 and A10Q2, Q4, Q5.  
3746A-2. All serials. 10 MHz precision frequency reference assembly (option 013) retrofit kit.

### 3747A/B SLMS

- 3747A/B-25. Serials 2143U-00136 and below. A315 broadband power detector — thermopile protection retrofit kit.

### 3763A ERROR DETECTOR

- 3763A-6. Serial 2150U00706 and below. Addition of delay to ensure that printer prints local time and data reading.

### 3771A/B DATA LINE ANALYZER

- 3771A/B-22A. 3771A serials 2217U-00380 and below; 3771B serials 2227U-00163 and below. Modification to eliminate possible HP-IB malfunction in the parallel poll mode.  
3771A/B-25. 3771A serials 2217U-00380 and below; 3771B serials 2227U-00163 and below. Modification to ensure enough range in A35R53 amplitude to phase conversion for phase jitter measurements adjustment.

### 3777A CHANNEL SELECTOR

- 3777A-4. Serials 2147U and below. Modification to eliminate a race hazard in the HP-IB handshaking routine between 3779 and 3777A.

### 3779C PRIMARY MULTIPLEX ANALYZER

- 3779C-1. All serials. Modification to improve compatibility between 3779C and 3779A for single channel looping.  
3779C-2. Serials 2144U and below. Modification to improve low level gain measurements.  
3779C-3. Serials 2215U and below. Protection of relays at switch-on.  
3779C-4. Serials 2215U-00193 and below. Incorrect power rating on termination resistors.

### 3779D PRIMARY MULTIPLEX ANALYZER

- 3779D-1. All serials. Compatibility between 3779D and 3779B for single channel looping.  
3779D-2. Serials 2146U and below. Modification to improve low level gain measurements.  
3779D-3. Serials 2213U and below. Protection of relays at switch-on.  
3779D-4. Serials 2213U-00193 and below. Incorrect power rating on termination resistors.

### 3780A PATTERN GENERATOR

- 3780A-24. Serials 2020U01730 and below. Preferred replacement of resistors A30R1, and A30R2.  
3780A-25. All serials. Modification to improve performance.  
3780A-26. Serials 2020U01730 and below. Directions for replacing diodes A30CR1, CR2, 3, 4, 5, 26, 27, 28 or CR29.

### 3783A 30CH PCM ALIGNMENT MONITOR AND ERROR DETECTOR

- 3783A-1. Serials 1947U-00151 and below. Possible instrument malfunction in noisy environment when option 002 is fitted.  
3783A-2. All serials. Preferred replacement for rechargeable battery.

### 3785 A/B JITTER GENERATOR & RECEIVER

- 3785A-1. Serials 2128U-00116 and below. Modification to limit the bias on capacitors A36C1, C2 (and C3 for OPT 001) under no signal conditions to reduce the possibility of degradation of these components.  
3785B-1. Serials 2131U-00111 and below. Modification to limit the bias on capacitors A36C1, C2 and C3 under no signal conditions to reduce the possibility of degradation of these components.

### 4935A TRANSMISSION IMPAIRMENT MEASURING SET

- 4935A-3A. All serials. Battery retrofit.  
4935A-5. Serials 2206A and above. New A4 Transmitter board to improve performance.  
4935A-6. Serials 2206A and below. Modification to prevent fuse blowing.

### 4942A TRANSMISSION IMPAIRMENT MEASURING SET

- 4942A-8. All serials. A23 power supply modification to improve performance.

### 4943A TRANSMISSION IMPAIRMENT MEASURING SET

- 4943A-11. Serials 2015A and below. A23 power supply modification to improve performance.

### 5001D MICROPROCESSOR EXERCISER

- 5001D-1. Serial numbers listed in text of note. Modification to correct instrument.

### 5045A IC TESTER

- 5045A-26. All serials. Change to A26Q2 to improve reliability of printer paper advance circuit.

### 5061A CESIUM BEAM FREQUENCY STANDARD

- 5061A-11A. All serials. Replacement kit for A10 oscillator assembly part number 05061-6170.  
5061A-12. Serials 2120A01869 and below. Replacement for A15 power regulator assemblies part numbers 05061-6099 and 05061-6017.

### 5245L ELECTRONIC COUNTER

- 5245L-10. All serials. Recommended Readout Display replacement for the 5245L-4B and 05245-60040 readouts, which are no longer available.

**5303B 525 MHz COUNTER**

5303B-2. Serials 1940 and below. Replacement part for high frequency binary, part number 1820-0736.

**5316A UNIVERSAL COUNTER**

5316A-1A. Serials 2120 and below. Improved Channel C Relay, part number 0490-1317.

**5327A UNIVERSAL TIMER COUNTER**

5327B-11. All serials. Preferred replacement part for high frequency binary IC A18U4 (P/N 1820-0736).

**5327B TIMER-COUNTER-DVM**

5327B-11. All serials. Preferred replacement part for high frequency, binary IC A18U4 (P/N 1820-0736).

**5327C MULTIFUNCTION COUNTER**

5327B-11. All serials. Preferred replacement part for high frequency binary IC A18U4 (P/N 1820-0736).

**5328A/H99, 5328AF/096, 5328AF/098, 5328A/H42, C96-5328A 500 MHz UNIVERSAL COUNTER**

5328A-34B. All serials. HP-IB verification program using the HP 85A controller.

**5335A UNIVERSAL COUNTER**

5335A-7B. All serials. 5335A HP-IB verification program using the HP 85A controller.

5335A-10A. All serials. Modification to enhance interpolator performance.

5335A-11. All serials. Modification to prevent front panel lockup problem.

5335A-12. Serials 2120 and above. Adjustment procedure for new A6 rear panel assembly part number 05335-61006.

5335A-13. Serials 2120 and below. Modification to make the new A3 input amplifier assembly (p/n 05335-60003) compatible with the A2 amplifier support (p/n 05335-60002).

5335A-14. All serials. Field installation procedures for option 040.

**5340A MICROWAVE FREQUENCY COUNTER**

5340A-14A. Serials 2008A06750 and below. Conversion to LED digital display.

**5342A MICROWAVE FREQUENCY COUNTER**

5342A-34. Serials 1808A-00525 and below. Recommended replacement for the A16 Amplitude Option board (05342-60016).

5342A-35. All serials. Front panel replacement parts and procedure.

5342A-36. Serials 2207A and below. Additional capacitor required when changing IC A3U5 (part number 1820-0982) on the A3 Direct Count Boards with board series numbers 2202 and below to prevent miscounts in the frequency range 1 MHz to 25 MHz.

**5343A MICROWAVE FREQUENCY COUNTER**

5343A-12. All serials. Front panel replacement parts and procedure.

5343A-13. Serials 2207A and below. Additional capacitor required when changing IC A3U5 (part number 1820-0982) on the A3 Direct Count Boards with board series numbers 2202 and below to prevent miscounts in the frequency range 1 MHz to 25 MHz.

**5383A 520 MHz FREQUENCY COUNTER**

5383A-2. Serials 2116 and below. Preferred replacement part for high frequency binary, IC A1U1 (part number 1820-0736).

**5420A/B DIGITAL SIGNAL ANALYZER**

5420A-27A. Serials 2116A00766 and below. Preferred on/off power switch P/N 3101-2329.

5420A-28. All serials. Modification to improve HP 5420A/HP-IB controller compatibility.

5420B-1. All serials. Modification to improve HP 5420B/HP-IB controller compatibility.

**5423A STRUCTURAL DYNAMICS ANALYZER**

5423A-2. All serials. Modification to improve HP 5423A/HP-IB controller compatibility.

**5427A VIBRATION CONTROL SYSTEM**

5427A-9A. All serials. Modification to prevent 54451B C-Supply power-up problem.

**5451C FOURIER ANALYZER SYSTEM**

5451C-2A. All serials. Special bottom cover to eliminate electromagnetic interference in the HP model 181AR variable persistence oscilloscope.

**6140A DIGITAL CURRENT SOURCE**

6140A-3. Serials 2118A-00424 and below. Modification to avoid parasitic oscillations.

**6453A SCR-3 POWER SUPPLY**

6253A-3/6456B-3/6459A-3. Serials 2038A00805 and below. Installation of new AC power connectors for 250 VAC (opt. 001, 002) and 480VAC (opt. 003, 031, 032).

**6456B SCR-3 POWER SUPPLY**

6253A-3/6456B-3/6459A-3. Serials 2042A01383 and below. Installation of new AC power connectors for 250 VAC (opt. 001, 002) and 480 VAC (opt. 003, 031, 032).

**6459A SCR-3 POWER SUPPLY**

6253A-3/6456B-3/6459A-3. Serials 2043A01704 and below. Installation of new AC power connectors for 250 VAC (opt. 001, 002) and 480 VAC (opt. 003, 031, 032).

**6942 MULTIPROGRAMMER**

6942A-7. Announcement of HP 14711A field service kit for the 6942A multiprogrammer.

**8012B PULSE GENERATOR**

8012B-6. Serials 2110A and below. Preferred replacements for A6 resistors.

**8552A/B SPECTRUM ANALYZER, IF SECTION**

8552A-14. All serials. Procedure for converting the LOG mode scale factors in the IF Section to read directly in dB $\mu$ V.

**8553B SPECTRUM ANALYZER**

8553B-3. Serials 1937A and below. Modification to improve frequency response below 100 kHz.

**8558B SPECTRUM ANALYZER**

8558B-21. Serials 1914A through 2147A. Preferred replacement for the A11/A13 bandwidth filter board.

8558B-22. Serials 2118A and below. Recommended replacement for third converter assembly A9.

**8656A SIGNAL GENERATOR**

8656A-15A. Serials 2141A, 2135A, 2131A, 2127A and below. Modification to improve the +24 Vdc fuse, A10F1.

**8662A SYNTHESIZED SIGNAL GENERATOR**

8662A-6. Serials 2201A00950 and below. Reference oscillator shield.

**8672A SYNTHESIZED SIGNAL GENERATOR**

8672A-11. Serials 2211A and below. Modification kit to retrofit option H34.

8672A-12. K22 Downconverter option. All serials. Fuse rating change for 220-240 Vac operation.

8672A-13. Serials 2211A and below. Modification kit to retrofit option H38.

**8684A/B SIGNAL GENERATOR**

8684A-1. Serials 2203A and below. New cables are required when A14 oscillator replaced.

8684B-1. Serials 2201A and below. New cables are required when A14 oscillator replaced.

**9571A DTS-70**

9571A-18B. All serials. List of components in the product support package for the 9571A.

9571A-22. All serials. Modification to the probe card to improve detection capability when searching for short or long pulses.

**10266A PERSONALITY MODULE (1611A Option A09 (6809 Microprocessor) Logic State Analyzer)**

10266A-1. Serials 2227A and below. New A9 personality board to correct synchronization.

**10275A PDP11 UNIBUS INTERFACE**

10275A-1. All models shipped prior to 3/22/82. Modification to correct monitor selection switch S1 failure.

**37203A HP-IB EXTENDER**

37203A-7. Serials 2040U04080 and below. Modification to prevent possible HP-IB bus lock-up.

**44422A THERMOCOUPLE COMPENSATED RELAY MULTIPLEXER ASSEMBLY**

44422A-1. All serials. Operational verification procedure of the thermocouple.

**59300-10002 HP 85A HP-IB TEST TAPE (REV. D)**

59300A-2B. All serials. List of HP-IB test tapes and instructions for counter-type products from HP Santa Clara Division.

**64100A LOGIC DEVELOPMENT STATION**

64100A-10. Serials 2149A thru 2212A and 2150G. Wavy display caused by ripple on the +12v supply.

64100A-12. Serials 2149A02177 thru 2212A03000. Unspecific intermittent problems.

**64110A MAINFRAME**

64110A-1A. All serials. Media not recognized during boot from Flexible Disc.

**64262A 8048 EMULATOR SUBSYSTEM**

64262A-1. Emulator Pod Serials 2201 and below. Hardware and software modifications to prevent user interrupts from being acknowledged during emulator background operations.

64262A-2. Emulator Pod Serials 2208 and below with Serial Suffix 00210 and below. Modification to clear port 2 when using an Intel 8243 I/O expander chip.

**645XX PROM PROGRAMMER**

64510A-1. All serials. Modification to correctly read data from the 8741 EPROM.

**64601A TIMING ANALYZER CONTROL BOARD**

64601A-1. Serials 2148A00206 and below. Modification to correctly locate SA test point TP 12.

**64941A FLEXIBLE DISC DRIVE**

64941A-1. All serials. Correct procedure when booting from the Flexible Disc.

# Service Note Order Form

If you want service notes, please check the appropriate boxes below and return this form separately to one of the following addresses.

Hewlett-Packard  
1820 Embarcadero Road  
Palo Alto, California 94303

For European customers (ONLY)

Hewlett-Packard  
Central Mailing Dept.  
P. O. Box 529  
Van Hueven Goedhartlaan 121  
AMSTELVEEN—1134  
Netherlands

Name \_\_\_\_\_  
Firm \_\_\_\_\_  
Address \_\_\_\_\_  
City \_\_\_\_\_  
State \_\_\_\_\_ Zip \_\_\_\_\_

- |                                    |                                    |                                      |                                    |                                    |                                                          |                                    |
|------------------------------------|------------------------------------|--------------------------------------|------------------------------------|------------------------------------|----------------------------------------------------------|------------------------------------|
| <input type="checkbox"/> 141T-7B-S | <input type="checkbox"/> 1744A-7   | <input type="checkbox"/> 3496A-5A    | <input type="checkbox"/> 3779D-4   | <input type="checkbox"/> 5327B-11  | <input type="checkbox"/> 5451C-2A                        | <input type="checkbox"/> 10266A-1  |
| <input type="checkbox"/> 141T-12   | <input type="checkbox"/> 3060A-0B  | <input type="checkbox"/> 3497A-10    | <input type="checkbox"/> 3780A-24  | <input type="checkbox"/> 5328A-34B | <input type="checkbox"/> 6140A-3                         | <input type="checkbox"/> 10275A-1  |
| <input type="checkbox"/> 141T-13-S | <input type="checkbox"/> 3060A-23A | <input type="checkbox"/> 3580A-10    | <input type="checkbox"/> 3780A-25  | <input type="checkbox"/> 5335A-7B  | <input type="checkbox"/> 6253A-3/<br>6456B-3/<br>6459A-3 | <input type="checkbox"/> 37203A-7  |
| <input type="checkbox"/> 346B-2    | <input type="checkbox"/> 3060A-38B | <input type="checkbox"/> 3581A/C-8   | <input type="checkbox"/> 3780A-26  | <input type="checkbox"/> 5335A-10A |                                                          | <input type="checkbox"/> 44422A-1  |
| <input type="checkbox"/> 428B-2    | <input type="checkbox"/> 3060A-39B | <input type="checkbox"/> 3585A-2B    | <input type="checkbox"/> 3783A-1   | <input type="checkbox"/> 5335A-11  |                                                          | <input type="checkbox"/> 59300A-2B |
| <input type="checkbox"/> 436A-4    | <input type="checkbox"/> 3060A-47  | <input type="checkbox"/> 3724A-1     | <input type="checkbox"/> 3783A-2   | <input type="checkbox"/> 5335A-12  | <input type="checkbox"/> 6942A-7                         | <input type="checkbox"/> 64100A-10 |
| <input type="checkbox"/> 1304A-7   | <input type="checkbox"/> 3060A-48  | <input type="checkbox"/> 3746A-1     | <input type="checkbox"/> 3785A-1   | <input type="checkbox"/> 5335A-13  | <input type="checkbox"/> 8012B-6                         | <input type="checkbox"/> 64100A-12 |
| <input type="checkbox"/> 1332A-15  | <input type="checkbox"/> 3060A-49  | <input type="checkbox"/> 3746A-2     | <input type="checkbox"/> 3785B-1   | <input type="checkbox"/> 5335A-14  | <input type="checkbox"/> 8552A-14                        | <input type="checkbox"/> 64110A-1A |
| <input type="checkbox"/> 1332A-16  | <input type="checkbox"/> 3060A-50  | <input type="checkbox"/> 3747A/B-25  | <input type="checkbox"/> 4935A-3A  | <input type="checkbox"/> 5340A-14A | <input type="checkbox"/> 8553B-3                         | <input type="checkbox"/> 64262A-1  |
| <input type="checkbox"/> 1335A-15  | <input type="checkbox"/> 3325A-10A | <input type="checkbox"/> 3763A-6     | <input type="checkbox"/> 4935A-5   | <input type="checkbox"/> 5342A-34  | <input type="checkbox"/> 8558B-21                        | <input type="checkbox"/> 64262A-2  |
| <input type="checkbox"/> 1336A-3   | <input type="checkbox"/> 3453A-3A  | <input type="checkbox"/> 3771A/B-22A | <input type="checkbox"/> 4935A-6   | <input type="checkbox"/> 5342A-35  | <input type="checkbox"/> 8558B-22                        | <input type="checkbox"/> 64510A-1  |
| <input type="checkbox"/> 1340A-2A  | <input type="checkbox"/> 3456A-13  | <input type="checkbox"/> 3771A/B-25  | <input type="checkbox"/> 4942A-8   | <input type="checkbox"/> 5342A-36  | <input type="checkbox"/> 8656A-15A                       | <input type="checkbox"/> 64601A-1  |
| <input type="checkbox"/> 1340A-4   | <input type="checkbox"/> 3456A-15  | <input type="checkbox"/> 3777A-4     | <input type="checkbox"/> 4943A-11  | <input type="checkbox"/> 5343A-12  | <input type="checkbox"/> 8662A-6                         | <input type="checkbox"/> 64941A-1  |
| <input type="checkbox"/> 1727A-1   | <input type="checkbox"/> 3456A-16  | <input type="checkbox"/> 3779C-1     | <input type="checkbox"/> 5001D-1   | <input type="checkbox"/> 5343A-13  | <input type="checkbox"/> 8672A-11                        |                                    |
| <input type="checkbox"/> 1740A-20  | <input type="checkbox"/> 3465B-5   | <input type="checkbox"/> 3779C-2     | <input type="checkbox"/> 5045A-26  | <input type="checkbox"/> 5383A-2   | <input type="checkbox"/> 8672A-12                        |                                    |
| <input type="checkbox"/> 1741A-3A  | <input type="checkbox"/> 3468A-1   | <input type="checkbox"/> 3779C-3     | <input type="checkbox"/> 5061A-11A | <input type="checkbox"/> 5420A-27A | <input type="checkbox"/> 8672A-13                        |                                    |
| <input type="checkbox"/> 1741A-13  | <input type="checkbox"/> 3478A-2   | <input type="checkbox"/> 3779C-4     | <input type="checkbox"/> 5061A-12  | <input type="checkbox"/> 5420A-28  | <input type="checkbox"/> 8684A-1                         |                                    |
| <input type="checkbox"/> 1742A-5   | <input type="checkbox"/> 3495A-7   | <input type="checkbox"/> 3779D-1     | <input type="checkbox"/> 5245L-10  | <input type="checkbox"/> 5420B-1   | <input type="checkbox"/> 8684B-1                         |                                    |
| <input type="checkbox"/> 1743A-6   | <input type="checkbox"/> 3496A-1B  | <input type="checkbox"/> 3779D-2     | <input type="checkbox"/> 5303B-2   | <input type="checkbox"/> 5423A-2   | <input type="checkbox"/> 9571A-18B                       |                                    |
| <input type="checkbox"/> 1744A-6   | <input type="checkbox"/> 3496A-4C  | <input type="checkbox"/> 3779D-3     | <input type="checkbox"/> 5316A-1A  | <input type="checkbox"/> 5427A-9A  | <input type="checkbox"/> 9571A-22                        |                                    |

Please photocopy this order form if you do not want to cut off the page.

HEWLETT-PACKARD COMPANY  
1820 Embarcadero Road  
Palo Alto, California 94303

**BENCH BRIEFS**  
**JULY-OCT 1982**  
Volume 22 Number 4

Service information from  
Hewlett-Packard Company

To obtain a qualification form for a free  
subscription, send your request to the  
above address.

Reader comments or technical article  
contributions are welcomed.  
Please send them to the  
Bench Briefs Editor.

Editor: Jim Bechtold  
Hewlett-Packard  
690 E. Middlefield Rd.  
Mt. View, CA 94042

Bulk Rate  
U.S. Postage  
PAID  
Sunnyvale, CA.  
Permit No.  
317

All rights reserved. Permission to reprint Bench Briefs granted upon written request to the Editor.

Printed in U.S.A.