

HP Archive

This vintage Hewlett Packard document was preserved
and distributed by

[www. hparchive.com](http://www.hparchive.com)

Please visit us on the web !

Thanks to on-line curator: Kenneth Kuhn for supplying and
scanning this vintage document.

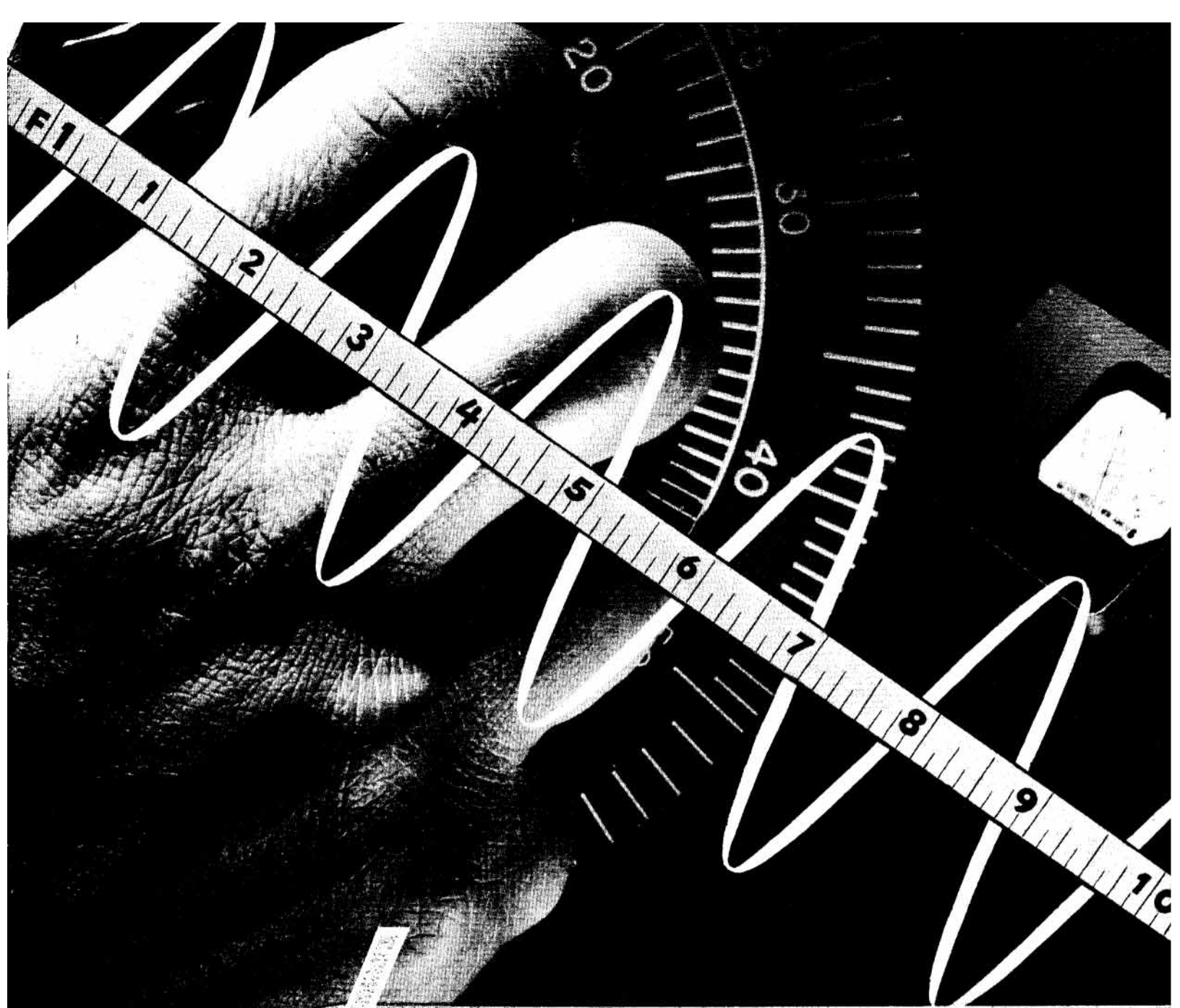

**LABORATORY INSTRUMENTS
FOR SPEED AND ACCURACY**

HEWLETT-PACKARD COMPANY • PALO ALTO, CALIFORNIA

CATALOG NO. 18A

FUNCTION	INSTRUMENT	FREQUENCY	CALIBRATION	PAGE NUMBERS
AUDIO OSCILLATORS	200A	35 cps to 35 kc	Dial Scale—35-350 cps Calibration Points—48 Ranges—3 (1, 10, 100 times dial calibration)	Page 4-5-6-7
	200B	20 cps to 20 kc	Dial Scale—20-200 cps Calibration points—41 Ranges—3 (1, 10, 100 times dial calibration)	Page 4-5-6-7
	200C	20 cps to 200 kc	Dial Scale—20-200 cps Calibration Points—41 Ranges—4 (1, 10, 100, 1000 times dial calibration)	Page 4-5-6-7
	200D	7 cps to 70 kc	Dial Scale—7-70 cps Calibration Points—78 Ranges—4 (1, 10, 100, 1000 times dial calibration)	Page 4-5-6-7
	202D	2 cps to 70 kc	Dial Scale—7-70 cps Calibration Points—78 Ranges—4 (1, 10, 100, 1000 times dial calibration) Dial Scale A—2.50 cps Calibration Points—81	Page 4-5-6-7
	200I	6 cps to 6 kc	Dial Scale A—6-20 cps Calibration Points—168 Ranges—3 (1, 10, 100 times dial calibration) Dial Scale B—20-60 cps Calibration Points—109 Ranges—3 (1, 10, 100 times dial calibration)	Page 4-5-6-7
	201B	20 cps to 20 kc	Dial Scale—20-200 cps Calibration Points—95 Ranges—3 (1, 10, 100 times dial calibration)	Page 8-9
AUDIO SIGNAL GENERATORS	205A	20 cps to 20 kc	Dial Scale—20-200 cps Calibration Points—80 Ranges—3 (1, 10, 100 times dial calibration)	Page 12-13
	205AG	20 cps to 20 kc	Dial Scale—20-200 cps Calibration Points—80 Ranges—3 (1, 10, 100 times dial calibration)	Page 12-13
	205AH	1 kc to 100 kc	Dial Scale—1-10 kc Calibration Points—130 Ranges—2 (1, 10 times dial calibration)	Page 12-13

FUNCTION	INSTRUMENT	FREQUENCY	ACCURACY	PAGE NUMBERS
LOW FREQUENCY STANDARD	100A	Output— 100 kc, 10 kc, 1 kc, 100 cps	±0.01% over room temperature variation of 33° C	Page 26-27
	100B	Output— 100 kc, 10 kc, 1 kc, 100 cps	±0.001% from ±10° C to ±50° C	Page 26-27
SQUARE WAVE GENERATOR	210A	Input— 20 cps to 100 kc	Square within ±1% from 20 cps to 10 kc	Page 24-25
WAVE ANALYZER	300A	Measurement Range— 30 cps to 16 kc	Frequency—±3% Voltage overall—±5%	Page 20-21
	320A	Measures at— 400 cps and 5 kc	Less than ±5% [at distortions of 30% or less]	Page 18-19
	320B	Measures at— 50 cps, 100 cps, 400 cps, 1 kc, 5 kc and 7.5 kc	Less than ±5% [at distortions of 30% or less]	Page 18-19
DISTORTION ANALYZERS	325B	Measures at— 30 cps, 50 cps, 100 cps, 400 cps; 1 kc, 5 kc, 7.5 kc, 15 kc	Voltmeter Overall—±3% Distortion—Less than ±5% [at distortion of 30% or less]	Page 14-15
	330B	Measurement Range— 20 cps to 20 kc	Voltmeter overall—±3% Distortion—±3% for distortion levels as low as 0.5%	Page 16-17
	350A	Max. input—100 kc	Each Resistor—±0.5% Response—Accumulative Error at 100 kc approx. 1 db in 50 db	Page 28-29
VACUUM TUBE VOLTMETERS	400A	Measurement Range— 10 cps to 1 mc	10 cps to 100 kc—±3% 100 kc to 1 mc—±5%	Page 10-11
	410A	Measurement Range— 20 cps to 700 mc	±3% AC and DC Frequency Response flat within 1 decibel 20 cps to 700 mc	Page 30-31
ELECTRONIC FREQUENCY METER	500A	Measurement Range— 5 cps to 50 kc in 10 ranges	±2% of full scale	Page 22-23
ELECTRONIC TACHOMETER	505A	An Electronic Frequency Meter and a Tachometer Assembly calibrated to measure speeds up to 3,000,000 RPM.		Page 23
REGULATED POWER SUPPLY	710A			Page 32

INSTRUMENT	FUNCTION	FREQUENCY	CALIBRATION	FREQUENCY RESPONSE	STABILITY	ACCURACY OF CALIBRATION	POWER OUTPUT INTO RATED LOAD	LOAD IMPEDANCE
200-A	Resistance-Tuned Audio Oscillator	35 cps to 35 kc	Dial Scale—35-350 cps Calibration Points—48 Ranges—3 (1, 10, 100 times dial calibration)	±1 decibel, 20 cps to 15 kc	±2%	±2%	1 watt	500 ohms
200-B	Resistance-Tuned Audio Oscillator	20 cps to 20 kc	Dial Scale—20-200 cps Calibration Points—41 Ranges—3 (1, 10, 100 times dial calibration)	±1 decibel, 20 cps to 15 kc	±2%	±2%	1 watt	500 ohms
200-C	Resistance-Tuned Oscillator	20 cps to 200 kc	Dial Scale—20-200 cps Calibration Points—41 Ranges—4 (1, 10, 100, 1000 times dial calibration)	±1 decibel, 20 cps to 150 kc	±2%	±2%	100 milliwatts	1000 ohms
200-D	Resistance-Tuned Oscillator	7 cps to 70 kc	Dial Scale—7-70 cps Calibration Points—78 Ranges—4 (1, 10, 100, 1000 times dial calibration)	±1 decibel, 7 cps to 70 kc	±2%	±2%	100 milliwatts	1000 ohms
202-D	Resistance-Tuned Oscillator	2 cps to 70 kc	Dial Scale—7-70 cps Calibration Points—78 Ranges—4 (1, 10, 100, 1000 times dial calibration) Dial Scale A—2-50 cps Calibration Points—81	±1 decibel, 7 cps to 70 kc ±2 decibels, 2 cps to 7 cps	±2%	±2%	100 milliwatts	1000 ohms
200-I	Resistance-Tuned Spread Scale Audio Oscillator	6 cps to 6 kc	Dial Scale A—5-20 cps Calibration Points—68 Ranges—3 (1, 10, 100 times dial calibration) Dial Scale B—20-60 cps Calibration Points—109 Ranges—3 (1, 10, 100 times dial calibration)	±1 decibel, 6 cps to 6 kc	±2% or ±1% with Standardization	±2%	100 milliwatts	1000 ohms
201-B	Resistance-Tuned Spread-Scale Audio Oscillator	20 cps to 20 kc	Dial Scale—20-200 cps Calibration Points—95 Ranges—3 (1, 10, 100 times dial calibration)	±1 decibel, 20 cps to 20 kc	±2% or 1% with Standardization	±2%	3 watts	600 ohms
205-A	Resistance-Tuned Audio Signal Generator	20 cps to 20 kc	Dial Scale—20-200 cps Calibration Points—80 Ranges—3 (1, 10, 100 times dial calibration)	Down 2.0 decibels at 20 cps Down 1.0 decibel at 20 kc at full output	±2% or ±1% with Standardization	±2%	5 watts	50, 200, 500, 5000 (all ct)
205-AG	Resistance-Tuned Audio Signal Generator with 49 db Voltmeter	20 cps to 20 kc	Dial Scale—20-200 cps Calibration Points—80 Ranges—3 (1, 10, 100 times dial calibration)	Generator—down 2.0 db at 20 cps Down 1.0 db at 20 kc at full output. Voltmeter—within ±0.2 db of 400 cps ref. from 20 cps to 20 kc	±2% or ±1% with Standardization	±2%	5 watts	Generator—50, 200, 500 ohms (all ct) Voltmeter—5000 ohms impedance
205-AH	Resistance-Tuned Signal Generator	1 kc to 100 kc	Dial Scale—1-10 kc Calibration Points—130 Ranges—2 (1, 10 times dial calibration)	±1 db from 10 kc ref. 1 kc to 100 kc at full output	±1% after ½ hour warm-up	±2%	5 watts	50, 200, 500, 5000 (all ct)

INSTRUMENT	FUNCTION	FREQUENCY	ACCURACY	VOLTAGE	IMPEDANCE	
100-A	Low Frequency Standard	Output—100 kc, 10 kc, 1 kc, 100 cps	±0.01% over room temperature variation of 33° C	Output—5 volts into 1000 ohms	Load—Not less than 1000 ohms	
100-B	Low Frequency Standard	Output—100 kc, 10 kc, 1 kc, 100 cps	±0.001% from ±10° C to ±50° C	Output—5 volts into 1000 ohms	Load—Not less than 1000 ohms	
210-A	Square Wave Generator	Input—20 cps to 100 kc	Square within ±1% from 20 cps to 10 kc	Input—min. 2; max. 200 Output—60 v peak to peak on open circuit	Input—25,000 ohms Internal—Each side, 500 ohms to ground	
300-A	Harmonic Wave Analyzer	Measurement Range—30 cps to 16 kc	Frequency—±3% Voltage overall—±5%	Input—1 mv to 500 v	Input—200,000 ohms	
320-A	Distortion Analyzer	Measures at—400 cps and 5 kc	Less than ±5% [at distortions of 30% or less]	Max. Input—100 v	Analyzer Input—20,000 ohms Detector Input—Should be not less than 100,000 ohms	
320-B	Distortion Analyzer	Measures at—50 cps, 100 cps, 400 cps, 1 kc, 5 kc and 7.5 kc	Less than ±5% [at distortions of 30% or less]	Max. Input—100 v	Analyzer Input—20,000 ohms Detector Input—Should be not less than 100,000 ohms	
325-B	Noise and Distortion Analyzer	Measures at—30 cps, 50 cps, 100 cps, 400 cps; 1 kc, 5 kc, 7.5 kc, 15 kc	Voltmeter Overall—±3% Distortion—Less than ±5% [at distortion of 30% or less]	Voltmeter Measurement Range—.01 v to 300 v in 9 ranges Distortion—min. input 1 v for .1% distortion Noise—min. input .003 volts for full scale	Amplifier Input—200,000 ohms shunted by approx. 24 mmfd Voltmeter Input—1 megohm (min.) shunted by approx. 32 mmfd	
330-B	Distortion Analyzer	Measurement Range—20 cps to 20 kc	Voltmeter overall—±3% Distortion—±3% for distortion levels as low as 0.5%	Voltmeter measurements—.01 v to 300 v in 9 ranges Distortion—min. input 1 v for .1% distortion Noise—minimum input—0.0003 v for full scale	Amplifier Input—200,000 ohms shunted by approx. 24 mmfd Voltmeter Input—1 megohm (min.) shunted by approx. 32 mmfd	
350-A	Attenuator	Max. input—100 kc	Each Resistor—±0.5% Response—Accumulative Error at 100 kc approx. 1 db in 50 db	Maximum Input—50 v	Input—500 ohms—one side grounded Output—500 ohms—one side grounded	
400-A	Vacuum Tube Voltmeter	Measurement Range—10 cps to 1 mc	10 cps to 100 kc—±3% 100 kc to 1 mc—±5%	Measurement Range—.01 v to 300 v in 9 ranges	Input—1 megohm (min.) shunted by approx. 16 mmfd	
410-A	High Frequency Vacuum Tube Voltmeter, DC Voltmeter, Ohmmeter	Measurement Range—20 cps to 700 mc	±3% AC and DC Frequency Response flat within 1 decibel 20 cps to 700 mc	Measurement Range—1 to 300 VAC in 6 ranges 1 to 1000 VDC in 7 ranges	Input—AC—8 megohms in parallel with 1.3 mmf at frequencies below 10 mc Input—DC—100 Megohms	
500-A	Electronic Frequency Meter	Measurement Range—5 cps to 50 kc in 10 ranges	±2% of full scale	Input—0.5 v to 200 v	Input—50,000 ohms	
505-A	Electronic Tachometer	An Electronic Frequency Meter and a Tachometer Assembly calibrated to measure speeds up to 3,000,000 RPM.				
710-A	Regulated Power Supply			180 to 360 VDC (regulated) 6.3 VAC ct (unregulated)	Output	

ACCURACY	ACCURACY OF CALIBRATION	POWER OUTPUT INTO RATED LOAD	LOAD IMPEDANCE	DISTORTION AT RATED OUTPUT	HUM LEVEL BELOW RATED OUTPUT	POWER REQUIREMENTS	SIZE	PAGE NUMBERS
%	±2%	1 watt	500 ohms	less than 1%	60 db	115 volts 50-60 cyc 60 watts	Length 16 ins. Height 8 ins. Depth 9 ins. Weight 32 lbs.	Page 4-5-6-7
%	±2%	1 watt	500 ohms	less than 1%	60 db	115 volts 50-60 cyc 60 watts	Length 16 ins. Height 8 ins. Depth 9 ins. Weight 32 lbs.	Page 4-5-6-7
%	±2%	100 milliwatts	1000 ohms	less than 1% 20 cps to 20 kc	60 db	115 volts 50-60 cyc 60 watts	Length 16 ins. Height 8 ins. Depth 9 ins. Weight 30 lbs.	Page 4-5-6-7
%	±2%	100 milliwatts	1000 ohms	less than 1% 10 cps to 20 kc	60 db	115 volts 50-60 cyc 60 watts	Length 17 ins. Height 8 3/4 ins. Depth 11 ins. Weight 32 lbs.	Page 4-5-6-7
%	±2%	100 milliwatts	1000 ohms	less than 2% 7 cps to 70 kc	60 db	115 volts 50-60 cyc 60 watts	Length 17 ins. Height 8 3/4 ins. Depth 11 ins. Weight 32 lbs.	Page 4-5-6-7
±1% distortion	±2%	100 milliwatts	1000 ohms	less than 1% 10 cps to 6 kc	60 db	115 volts 50-60 cyc 60 watts	Length 17 ins. Height 8 3/4 ins. Depth 11 ins. Weight 28 lbs.	Page 4-5-6-7
±1% distortion	±2%	3 watts	600 ohms	Less than 1% at 3 watts (Less than 1/4% at 1 watt)	60 db	115 volts 50-60 cyc 75 watts	Length 17 ins. Height 8 3/4 ins. Depth 11 ins. Weight 32 lbs.	Page 8-9
±1% distortion	±2%	5 watts	50, 200, 500, 5000 ohms (all ct)	less than 1% 30 cps to 20 kc at rated output	60 db below output or 90 db below zero level whichever is larger	115 volts 50-60 cyc 125 watts	Length 21 1/2 ins. Height 11 1/2 ins. Depth 14 1/2 ins. Weight 70 lbs.	Page 12-13
±1% distortion	±2%	5 watts	Generator—50, 200, 500, 5000 ohms (all ct) Voltmeter—5000 ohms input impedance	less than 1% 30 cps to 20 kc at rated output	60 db below output or 90 db below zero level whichever is larger	115 volts 50-60 cyc 125 watts	Length 21 1/2 ins. Height 11 1/2 ins. Depth 14 1/2 ins. Weight 73 lbs.	Page 12-13
1/2 hour -up	±2%	5 watts	50, 200, 500, 5000 ohms (all ct)	less than 1% at 1 watt 3% at 5 watts	65 db below output or 65 db below zero level whichever is larger	115 volts 50-60 cyc 125 watts	Length 21 1/2 ins. Height 11 1/2 ins. Depth 14 1/2 ins. Weight 63 lbs.	Page 12-13

IMPEDANCE	MISCELLANEOUS CHARACTERISTICS	POWER REQUIREMENTS	SIZE	PAGE NUMBERS
Load—Not less than 1000 ohms	Wave Shape—Sinusoidal— total distortion not more than 4% on open circuit	115 volts 50-60 cyc 100 watts	Length 21 1/2 ins. Height 11 1/2 ins. Depth 14 ins. Weight 53 lbs.	Page 26-27
Load—Not less than 1000 ohms	Wave Shape—Sinusoidal— total distortion not more than 4% on open circuit	115 volts 50-60 cyc 105 watts	Length 21 1/2 ins. Height 11 1/2 ins. Depth 14 ins. Weight 53 lbs.	Page 26-27
Input—25,000 ohms Internal—Each side, 500 ohms to ground	Wave Shape—Squares (1 microsecond to 90% of maximum) Attenuator—70 db in 5 db steps	115 volts 50-60 cyc 85 watts	Length 16 ins. Height 8 ins. Depth 9 ins. Weight 30 lbs.	Page 24-25
Input—200,000 ohms	Variable Selectivity at 40 db down from resonance (max. selectivity is 30 cps (min. selectivity is 145 cps) Dial Calibration Points—62	115 volts 50-60 cyc 105 watts	Length 21 1/2 ins. Height 24 ins. Depth 14 1/2 ins. Weight 78 lbs.	Page 20-21
Analyzer Input—20,000 ohms Detector Input—Should be not less than 100,000 ohms	Max. Attenuation: Fundamental—more than 60 db (.1%) Second and higher harmonics—less than 5% Filters—Tuned to nominal frequencies within ±5% (non-adjustable) Attenuator—70 db in 1 db steps		Length 13 ins. Height 9 ins. Depth 8 ins. Weight 15 lbs.	Page 18-19
Analyzer Input—20,000 ohms Detector Input—Should be not less than 100,000 ohms	Max. Attenuation: Fundamental—more than 60 db (.1%) Second and higher harmonics—less than 5% Filters—Tuned to nominal frequencies within ±5% (non-adjustable) Attenuator—70 db in 1 db steps		Length 13 ins. Height 9 ins. Depth 8 ins. Weight 17 1/2 lbs.	Page 18-19
Amplifier Input— 200,000 ohms shunted by approx. 24 mmfd Voltmeter Input— 1 megohm (min.) shunted by approx. 32 mmfd	Max. Attenuation: Fundamental—more than 60 db (.1%) Second and higher harmonics—less than 5% Filters—Tuned to nominal frequencies within ±5% (adjustable -1%) Voltmeter—Average Reading (calibrated in rms volts and in db above a 1 mw, 600 ohm level)	115 volts 50-60 cyc 65 watts	Length 21 1/2 ins. Height 11 1/2 ins. Depth 14 ins. Weight 66 lbs.	Page 14-15
Amplifier Input—200,000 ohms shunted by approx. 24 mmfd Voltmeter Input—1 megohm (min.) shunted by approx. 32 mmfd	Max. Attenuation: Fundamental—more than 60 db (0.1%) Second and higher harmonics—less than 10% Voltmeter—Average reading (calibrated in rms volts and db above a 1 mw, 600 ohm level)	115 volts 50-60 cyc 90 watts	Length 19 ins. Height 10 1/2 ins. Depth 13 ins. Weight 60 lbs.	Page 16-17
Input—500 ohms—one side grounded Output—500 ohms—one side grounded	Attenuation—110 db in 1 db steps		Length 8 ins. Height 6 ins. Depth 4 1/2 ins. Weight 4 lbs.	Page 28-29
Input— 1 megohm (min.) shunted by approx. 16 mmfd	Voltmeter—Average Reading (calibrated in rms volts and in db above a 1 mw, 600 ohm level)	115 volts 50-60 cyc 40 watts	Length 7 1/2 ins. Height 9 1/2 ins. Depth 10 1/2 ins. Weight 15 lbs.	Page 10-11
Input—AC—8 megohms in parallel with 1.3 mmf at frequencies below 10 mc Input—DC—100 Megohms	AC Voltmeter—Peak reading instrument will indicate voltage to 3000 mc Ohmmeter: 0.2 ohms to 500 megohms in 7 ranges	115 volts 50-60 cyc 40 watts Two 1.5 v flashlight cells supply ohmmeter	Length 7 1/2 ins. Height 12 1/2 ins. Depth 6 1/2 ins. Weight 16 lbs.	Page 30-31
Input—50,000 ohms	Separate External Attachments— 1. Photocell Input (jack provided) 2. Esterline-Angus 1 mil, 1400 ohm Automatic Recorder (jack provided)	115 volts 50-60 cyc 65 watts	Length 17 1/2 ins. Height 8 3/4 ins. Depth 11 1/2 ins. Weight 28 lbs.	Page 22-23
				Page 23
	Output constant within approx. 1% for loads from 0 to 75 ma and for line- voltage variations of ±0%. Noise and hum less than 0.005 v	115 volts 50-60 cyc 90 watts full load	Length 7 1/2 ins. Height 8 ins. Depth 11 3/4 ins. Weight 18 lbs.	Page 32

SPEED AND ACCURACY ARE INTEGRAL PARTS OF EVERY *-hp-* INSTRUMENT

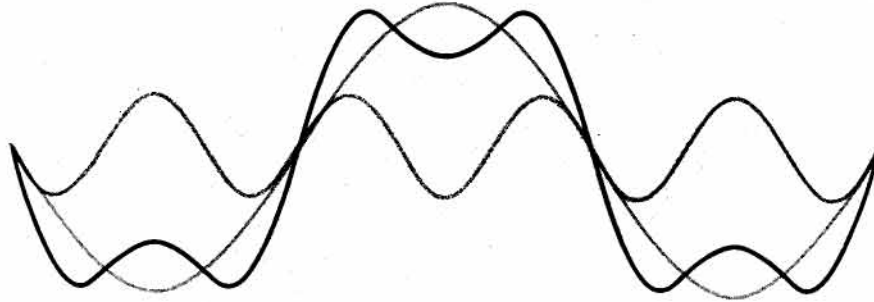

NEW ease and sureness in all types of laboratory and production testing are made possible by the use of *-hp-* instruments. Although each is tailored for very specific jobs, *-hp-* laboratory instruments have certain outstanding "family" characteristics. No zero setting, little or no adjustment during operation, virtual independence of line and tube characteristics, full protection against overloads, simple, accurate calibration, and streamlined circuits for clean and trouble-free performance are qualities you will find throughout the *-hp-* line.

-hp- instruments are essential and versatile tools in the fields of television, frequency modulation, radar, industrial heating, communications, carrier current, equipment manufacture, experimental work, broadcasting, industrial testing. Here is a partial list of the measurements that can be made with standard *-hp-* instruments: distortion, frequency, gain, voltage, network response, harmonic analysis, amplifier frequency response. They are also useful to establish standard frequencies, establish standard ratios by attenuation, and provide voltage for bridge measurements. Let *-hp-* instruments, products of sound engineering and precision manufacture, solve your testing and measuring problems.



Lord Kelvin

HAD A WORD FOR IT



"I often say that when you can measure what you are speaking about, and express it in numbers, you know something about it; but when you cannot measure it, when you cannot express it in numbers, your knowledge is of a meager and unsatisfactory kind; it may be the beginning of knowledge, but you have scarcely, in your thoughts, advanced to the stage of science, whatever the matter may be."

LORD KELVIN
1883

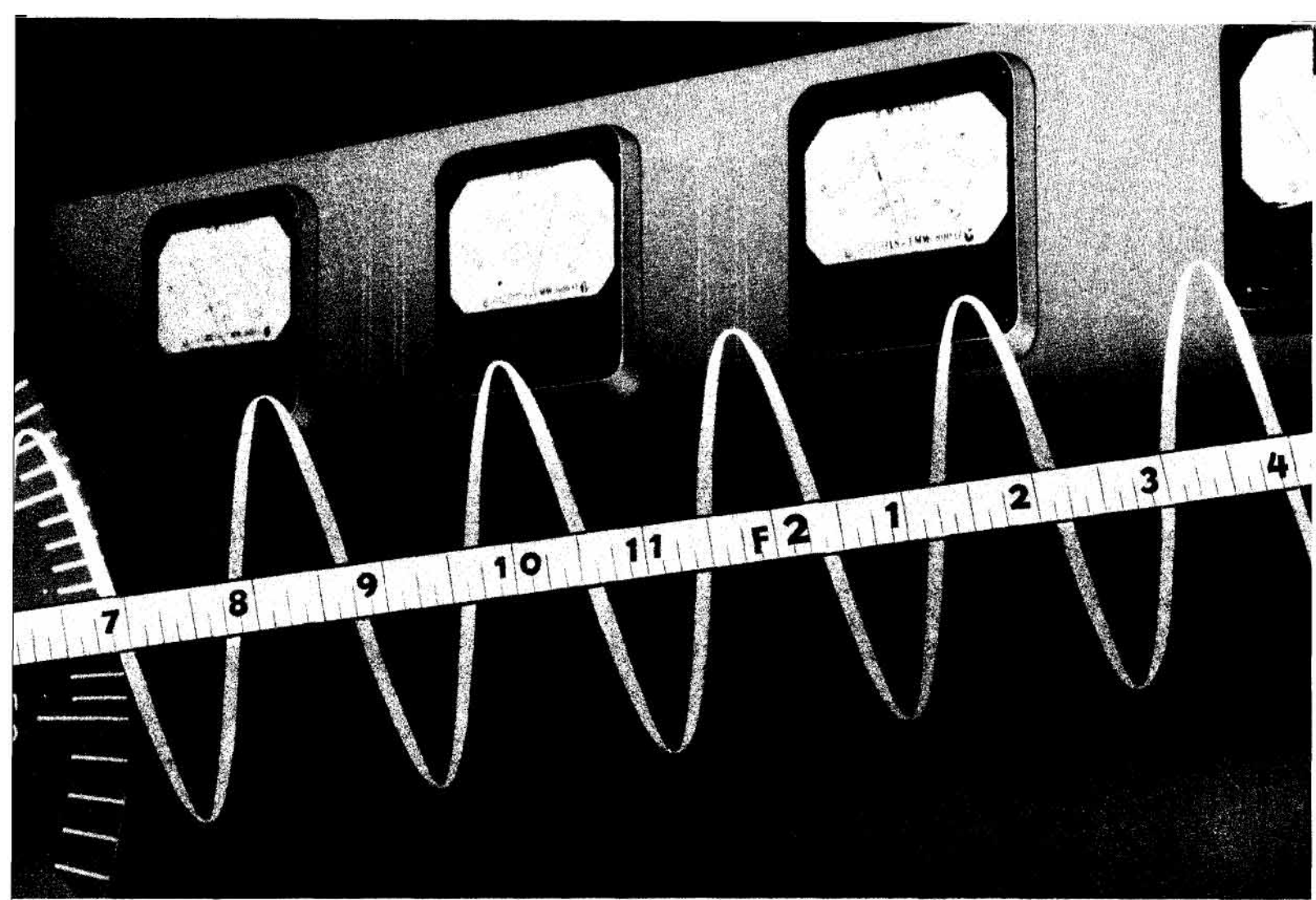

ENGINEERING TIME IS AN EXPENSIVE COMMODITY...

Probably in no other field is proper instrumentation so vitally important as in electronics. Lacking the proper instruments, it is not only difficult to design equipment correctly in the first place, but often impossible to tell whether it is behaving properly when completed.

To describe fully the performance of one of the simplest electronic devices—a single-stage amplifier—requires the measurement of operating voltages and currents, gain, frequency response, overload points, harmonic distortion, and noise level. In more complex apparatus the list would be greatly expanded. Many of these measurements must be made in high-impedance circuits where great care and judgment must

be exercised, not only in making the measurements themselves, but in interpreting the results.

Engineering time is a very expensive commodity. To employ it most efficiently, too much thought cannot be given to the selection of the proper tools. *-hp-* instruments are designed with convenience second only to accuracy in their requirements. By minimizing the time needed for routine measurements, and by guaranteeing the accuracy of the results, *-hp-* instruments render an outstanding service toward the advancement of the science of electronics. On the following pages you will find complete descriptions of a great many *-hp-* instruments. Please feel free to write us for any assistance or further information which you may require.

AUDIO OSCILLATORS

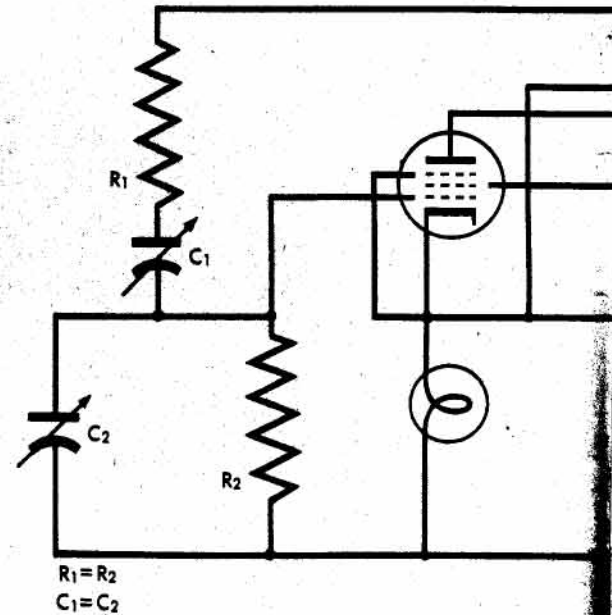

ADVANTAGES:

- No zero setting • Great stability
- Constant output
- Wide frequency range
- Logarithmic scale
- Low distortion • Light weight

USE THEM FOR:

- Amplifier testing
- Broadcast transmitter audio response
- Source of voltage for bridge measurements
- Modulating signal generators
- Supersonic voltage source
- Driving mechanical systems
- Synchronizing pulse generators
- Loud speaker resonance tests

RESISTANCE-TUNED PRINCIPLE

HERE is a sound research story behind this revolutionary *-hp-* Resistance-tuned Audio Oscillator. Although audio-frequency oscillators have always been standard equipment throughout the communications and electronics fields, there were many "bugs" in types commonly available. These disadvantages included low stability, especially in the lower frequency ranges; need for constant resetting to insure accuracy; low portability, because of the essential weight and bulk of the instrument. So *-hp-* engineers set out to design and perfect an audio-frequency oscillator which would combine the high stability and very wide range of the coil-condenser type with the flexibility of operation of the beat frequency type. The result is the basically new Resistance-tuned Audio-frequency Oscillator, based on a new fundamental circuit and resulting in new speed and accuracy for electronic tests and measurements.

The fundamental resistance-tuned circuit of *-hp-* Audio Oscillators is shown above. The resonant frequency of this network is inversely proportional to the product of resistance and capacity. Thus the change in resonant frequency of this circuit is three times as great as that of the coil and condenser circuit. A ten to one frequency change is easily possible with the resistance-tuned circuit.

The resistance-capacity (frequency determining) network is operated in conjunction with a stabilized amplifier. Positive feedback is applied to this amplifier through the resistance-tuned network, resulting in a very high effective Q for the circuit. See figure 1. Negative feedback is also used, and operates in conjunction with a non-linear resistor to limit amplitude and decrease distortion. It also helps in providing a constant and extremely stable output over the entire range. See figure 2.

NO ZERO SETTING

The excellent physical layout of *-hp-* Audio Oscillators has much to do with their satisfactory performance. Thermal drift is kept at a minimum by proper placement of components, and by means of low temperature coefficient elements in the resistance network. Furthermore, this thermal drift is not magnified, as is the case with the beat frequency type oscillator. Thus calibration is accurate under all operating conditions, without the inconvenience of constant zero setting, even within the first few minutes of operation. The constant output of these oscillators makes it easy to check the frequency response of the apparatus quickly, easily, accurately.

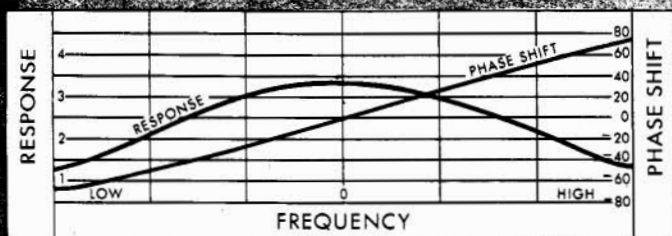

ONLY THREE DIALS

There are only three controls on the panel. They are the main frequency dial which covers a frequency range of 10 to 1; a range switch which selects the desired frequency band, and an amplitude control to vary the output signal level.

USES

The primary function of an audio-frequency oscillator is to generate an accurately controlled signal of known frequency. This signal may be used to check the performance of audio amplifiers, broadcast transmitters, and similar equipment. Although applications in the related fields of electronics are of first importance, the usefulness of the *-hp-* Resistance-tuned Audio Oscillator is by no means limited to the electrical engineering fields. They may be used, for example, to drive mechanical systems, in order to measure resonance and stability. Other measurements of mechanical equipment include measurements of the output frequency of rotating equipment, such as generators and dynamotors.

-hp- Resistance-tuned Audio Oscillators provide an excellent source of voltage for accurate bridge measurements. The output is sufficient to drive signal generators and other equipment requiring considerable power. Certain models are also adapted to work in the supersonic range.

The usefulness of these oscillators is greatly increased because they are small and light in weight; thus easy to carry around. In short, the speed and accuracy of *-hp-* Resistance-tuned Audio Oscillators make them ideal for an almost endless number of exacting jobs.

SPECIFICATIONS

Six standard models are available. The Models 200A and 200B have a transformer-coupled output amplifier which will deliver 1 watt into a matched load and are principally designed for use in audio testing. The Models 200C and 200D have a resistance-coupled output amplifier to provide uniform output voltage over their wide frequency range; they are principally useful when handling a wide range of frequencies, where a smaller amount of power is sufficient. Model 202D is a modification of Model 200D, with the frequency range extended down to 2 cycles per second. It is particularly useful where it is necessary to generate an extremely wide range and where low frequencies are involved, as in mechanical vibration problems. The Model 200I is an oscillator of the band spread type. It is intended for interpolation work and for applications where it is necessary that the frequency of oscillation be known very accurately. These oscillators are supplied in a relay rack mounting, as the 200AR, 200BR, 200CR, 200DR, 202DR, and 200IR.

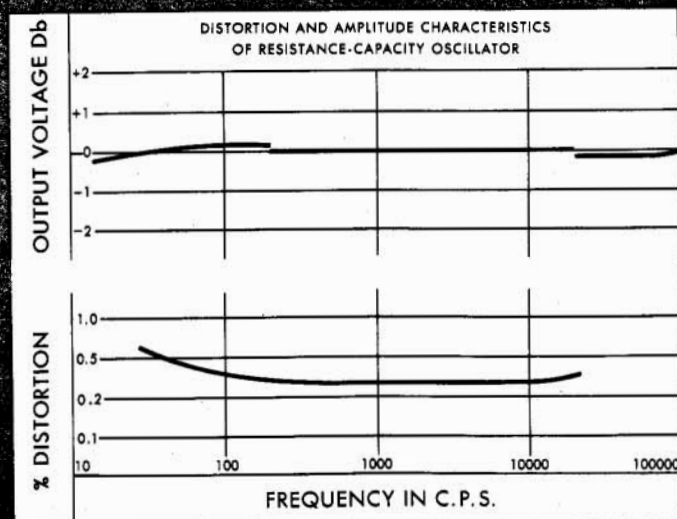

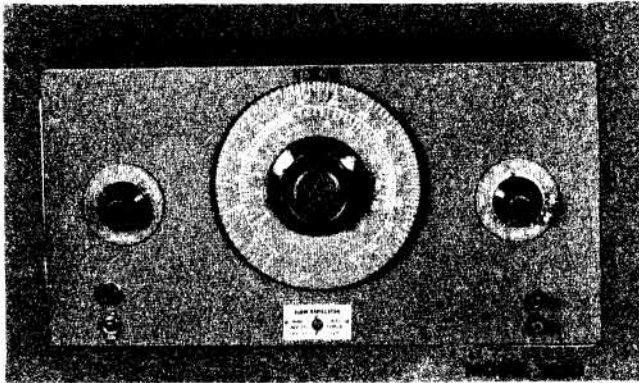

FREQUENCY RANGE

Model 200A	35 cps to 35 kc
Model 200B	20 cps to 20 kc
Model 200C	20 cps to 200 kc
Model 200D	7 cps to 70 kc
Model 202D	2 cps to 70 kc
Model 200I	6 cps to 6 kc

Calibration: The dial is calibrated directly in cycles for the lowest range. A switch selects the range and indicates the proper multiplying factor. The dial calibration of Models 200A, 200B, and 200C covers approximately 180 degrees, with an equivalent scale length of 20 to 30 inches. Models 200D and 202D have dial calibrations covering approximately 300 degrees with a scale length of about 60 inches. Model 200I is calibrated over approximately 300 degrees, and has a scale length of approximately 90 inches.

	200A	200B
Range 1	. . . 35 - 350 cps	20 - 200 cps
Range 2	. . . 350 - 3500 cps	200 - 2000 cps
Range 3	. . . 3500 cps - 35 kc	2000 cps - 20 kc

	200C	200D
Range 1	. . . 20 - 200 cps	7 - 70 cps
Range 2	. . . 200 - 2000 cps	70 - 700 cps
Range 3	. . . 2000 cps - 20 kc	700 - 7000 cps
Range 4	. . . 20 - 200 kc	7000 cps - 70 kc

Model 202D is similar to Model 200D, with the addition of a 2-50 cps band covering approximately 200 degrees on the main tuning dial.

200 I			
Ax1	. . . 6 - 20 cps	Bx10	. . . 200 - 600 cps
Bx1	. . . 20 - 60 cps	Ax100	. . . 600 - 2000 cps
Ax10	. . . 60 - 200 cps	Bx100	. . . 2000 - 6000 cps

Stability: Under normal conditions the frequency drift is less than $\pm 2\%$ even including initial warm-ups. Plus or minus 20% line voltage variations change the frequency less than $\pm 0.2\%$ at 1 kc. No zero setting is necessary on these oscillators. On Model 200I, if the ranges are standardized against a suitable frequency standard from time to time, accuracy better than 1% can be maintained.

Output: The Models 200A and 200B will supply one watt or 22.5 volts output into a matched resistance load of 500 ohms, and 25 volts on open circuit. Models 200C, 200D, 202D, and 200I will deliver 100 milliwatts or 10 volts into a 1000 ohm load. The internal impedance of the output amplifier is about 50 ohms at 1000 cps.

Frequency Response: The output voltages of Models 200A and 200B are constant within plus or minus one decibel from 20 cps to 15 kc. The output voltage of the Model 200C is constant within plus or minus one decibel from 20 cps to 150 kc. The output voltages of the Models 200D and 202D are constant within plus or minus one decibel from 7 cps to 70 kc. The Model 202D will be within plus or minus 2 decibels from 2 cps to 7 cps. The frequency response of the 200I is plus or minus one decibel from 6 cps to 6,000 cps.

Distortion: The total rms distortion contained in the waveform of the various models is within the following limits: Models 200A and 200B, less than 1% distortion from 35 cps to 20 kc. Model 200C, less than 1% distortion from 20 cps to 20 kc. Model 200D, less than 1% distortion from 10 cps to 20 kc. Model 202D, less than 2% at rated output voltage from 10 cps to 70 kc. Model 200I, distortion less than 1% above 10 cps, and only slightly more than this at lower frequencies.

Hum Voltage: On all models, the hum voltage is less than 0.1% of maximum output voltages.

Power Supply: 115 volts, 50/60 cycles, 50 watts.

Mounting: The cabinet models are mounted in an attractive steel cabinet finished in wrinkle gray.

The relay rack mounting fits the standard 19" relay rack with $\frac{3}{4}$ " spacing. The dust cover mounts on the chassis and is removable from the rear.

Model	Mounting	Length	Height	Depth	Weight
200A	Cabinet	16"	8"	9"	32 lbs.
200B	Cabinet	16"	8"	9"	32 lbs.
200C	Cabinet	16"	8"	9"	30 lbs.
200D	Cabinet	17"	8 $\frac{3}{4}$ "	11"	32 lbs.
202D	Cabinet	17"	8 $\frac{3}{4}$ "	11"	32 lbs.
200I	Cabinet	17"	8 $\frac{1}{2}$ "	10 $\frac{3}{8}$ "	32 lbs.
200AR	Relay Rack	19"	7"	9"	35 lbs.
200BR	Relay Rack	19"	7"	9"	35 lbs.
200CR	Relay Rack	19"	7"	9"	35 lbs.
200DR	Relay Rack	19"	8 $\frac{3}{4}$ "	11"	37 lbs.
202DR	Relay Rack	19"	8 $\frac{3}{4}$ "	11"	37 lbs.
200IR	Relay Rack	19"	8 $\frac{3}{4}$ "	11"	37 lbs.

Average shipping weight 42 lbs.

Data subject to change without notice.

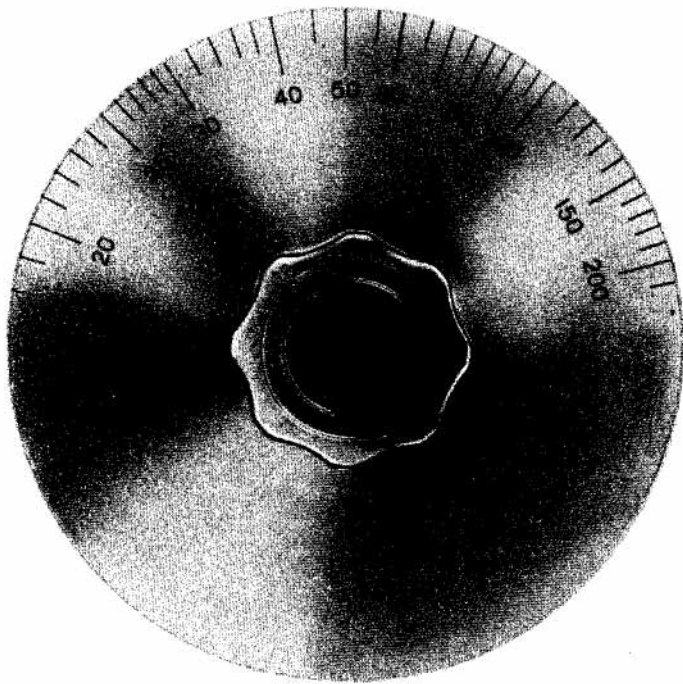

200B AND 200C

Here is the main tuning dial of *-hp-* Models 200B and 200C Audio Oscillators. Range is 20 cps to 20 kc on 200B, with dial calibrated over approximately 180° and effective scale length of about 20"; 200C has range of 20 cps to 200 kc and effective scale length of about 26".

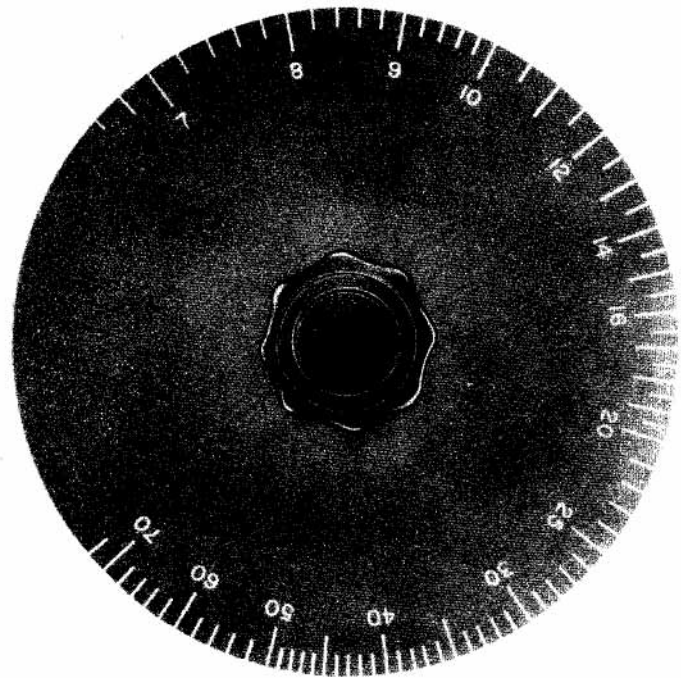

200D

Main tuning dial of *-hp-* Model 200D is calibrated over approximately 300° and has an effective scale length of about 60". This wide range instrument (from 7 cps to 70 kc) owes much of its speed and accuracy of operation to the precisely calibrated and easily controlled tuning dial pictured above.

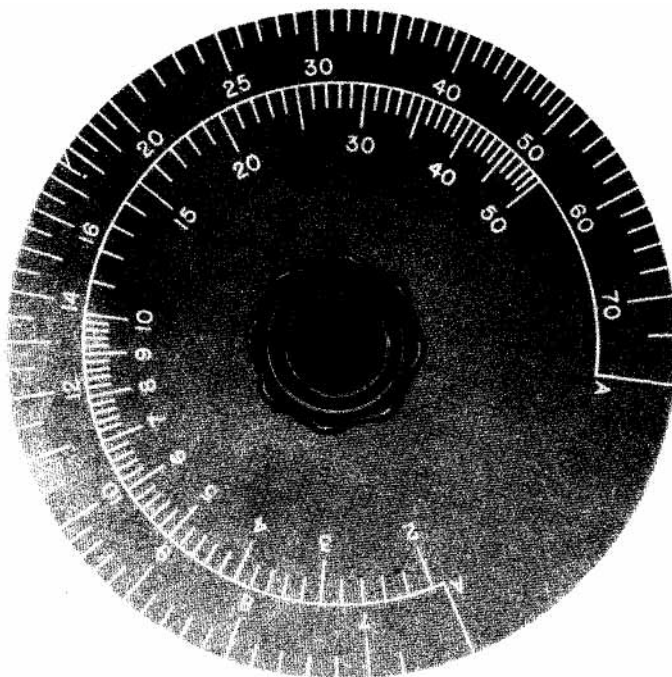

202D

The *-hp-* Model 202D is a modification of the 200D, which extends the range down to 2 cps. The tuning dial is calibrated over approximately 300°; the effective scale length is about 75". Before calibration, all *-hp-* Audio Oscillators are operated for a long period so as to be completely stabilized.

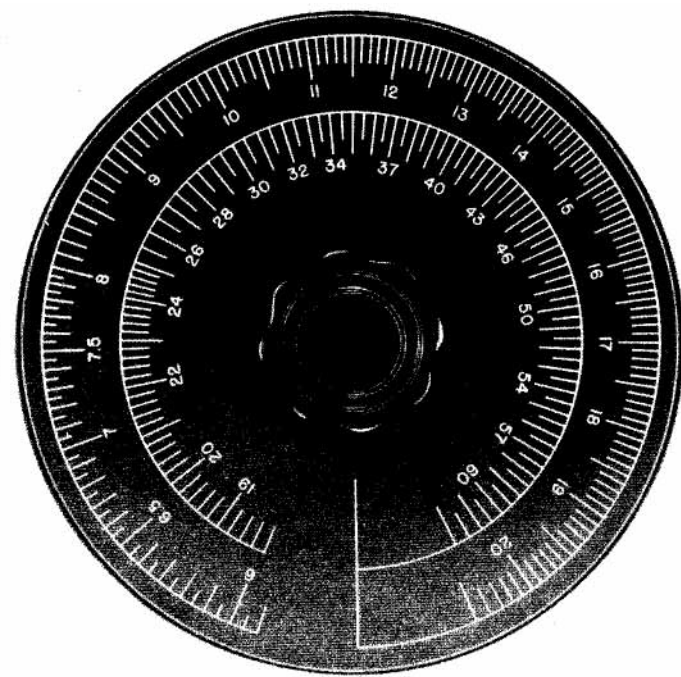

200I

Main tuning dial of the 200I, which is an oscillator of the band-spread type, intended for comparison work. The dial is calibrated over approximately 300° with effective scale length about 90" and range of 6 cps to 6 kc. Each Model 200I is carefully hand calibrated to insure maximum accuracy.



MODEL 201B

AUDIO OSCILLATOR

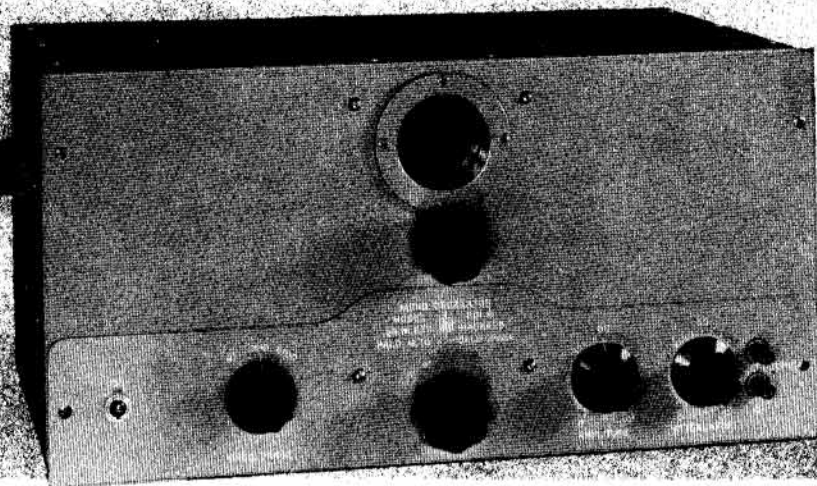
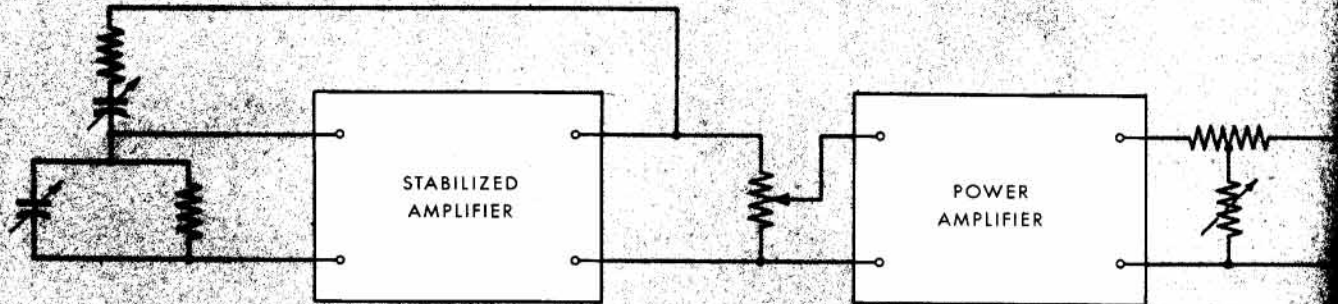

ADVANTAGES:

- 3 Watts Output
- Distortion Less Than 1/2%
- Low Hum Level
- New Dial with Ball Bearing Drive
- Accurate Expanded Frequency calibration
- Improved Control of Output Level

USE IT FOR:

- High Fidelity Amplifier Testing
- Transmission Line Measurement
- Loud Speaker Testing
- Frequency Comparison

CHECK THE ADVANTAGES OF THIS FINE, NEW OSCILLATOR

IN FM and other fields where high fidelity is important, this new *hp*- Model 201B Audio Frequency Oscillator will meet every requirement for speed, ease of operation, accuracy and purity of wave form. The product of 6 years of *hp*- oscillator development, this new oscillator has many brand new features, in addition to the revolutionary resistance-tuned circuit which has made *hp*- a by-word in engineering circles.

The 201B has an accurate, convenient method of frequency control. The 6" dial, with smooth ball-bearing action, may be tuned by a directly controlled knob, or for still greater accuracy, may be set by the vernier which has a ratio of 6 to 1 to the main dial. The illuminated main dial is designed so that parallax is eliminated. It is calibrated over 300 degrees with approximately 95 calibration points and has an effective scale length of about 47 inches. Frequency range is 20 cps to 20 kc.

Increased Power Output

The amplifier delivers up to 3 watts of power into a 600 ohm resistance load, with distortion held to 1%. Thus there is sufficient power available for driving almost any kind of laboratory or production equipment. Harmonic distortion may be kept to less than 1/2 of 1%, if the output of the amplifier is limited to 1 watt.

Another important feature of this oscillator is the provision which is made for standardizing each frequency range against a reliable standard, such as *bp's* Model 100B Secondary Frequency Standard. By standardizing the instrument regularly, frequencies can be depended upon to be better than 1% accurate.

Dual Control For Output Level

A new departure in oscillator design is the dual method for controlling output level. A volume control which is ahead of the amplifier controls the voltage at which the amplifier operates. An output attenuator is provided to attenuate the signal delivered by the amplifier. Attenuation is approximately linear from zero to 40 db. Both hum level and output voltage are thus attenuated together. As a result, hum level may be kept 60 db or more below the signal level, a special advantage in cases where small test signals are used.

The impedance looking back into the output circuit is about 50 ohms; thus the voltage regulation for varying loads is extremely good. For measurements where it is desirable to have impedance looking back into the instrument of 600 ohms, as in transmission measurements, the attenuator may be used to give about 6 db or more of attenuation, making the reflected impedance of the instrument about 600 ohms.

Important Details

Care has been taken to perfect every detail of this new oscillator. Improved chassis layout and placement of component parts minimizes thermal drift. The voltage on the oscillator is maintained constant with an electronic voltage regulator. The entire instrument is characterized by greater mechanical rigidity; the tuning assembly is mounted on a sturdy cast aluminum frame. The chassis itself is made of aluminum; the oscillator is light in weight and easy to handle.

SPECIFICATIONS MODEL 201B AF OSCILLATOR

Frequency Range: The frequency range is from 20 cps to 20,000 cps covered in three bands.

Band	Frequency Coverage
x1	20 - 200 cps
x10	200 - 2000 cps
x100	2,000 - 20,000 cps

Frequency Calibration: The calibration is direct in cycles per second for the lowest band. Approximately 95 calibration points are provided over a 300-degree arc. The dial is 6 inches in diameter, illuminated and driven by a vernier knob having 6:1 ratio. The effective scale length for the three bands is 47 inches.

Stability: Under normal temperature conditions the frequency stability is better than $\pm 2\%$, including the initial warm-up drift. Plus or minus 10% line voltage variations will result in no change in the output frequency. Adjustments are provided on each band to standardize the calibration against an accurately known frequency. With standardization the accuracy may be maintained better than $\pm 1\%$.

Output: The instrument is rated at a maximum of 3 watts or 42.5 volts into a 600 ohm resistive load. Maximum no load voltage is at least 60 volts. The impedance looking back into the output circuit (zero attenuator setting) is approximately 75 ohms. With attenuator set at a value of 10 db or more the impedance looking back into the output is 600 ohms.

Frequency Response: The output voltage is constant within ± 1 db over the frequency range of 20 cps to 20,000 cps.

Distortion: The total r.m.s. distortion of the output wave over the range of 20 cps to 20,000 cps is less than the following limits:

3 watts output	1% distortion
1 watt output	.5% distortion*

*Down to 50 cps, at 20 cps 1% distortion.

Volume Control: Two controls are provided for varying the output of the instrument:

1. An "Amplitude Control" adjusts the amount of oscillator voltage fed to the output amplifier.

2. An "Attenuator" attenuates the output of the amplifier. It is a variable T Pad having an attenuation range of 0 to infinity. Approximately linear in region 0 to 40 db.

Hum Voltage: The hum voltage is less 0.1% of maximum output voltage. If the output attenuator is used to control the output (with Amplitude control set for maximum rated power output) the hum level will be less than .1% below any signal level.

Power Supply: 115 volts $\pm 10\%$, 50/60 cycles. Power consumption: 75 watts. Plate supply voltage to oscillator section is electronically regulated.

Mounting: Cabinet Models are mounted in an aluminum cabinet finished in wrinkle grey. Size: 17 in. long x 8 1/2 in. high x 11 in. deep. Weight: 32 pounds. Shipping Weight: 46 pounds.



MODEL 400A

VACUUM TUBE VOLTMETER

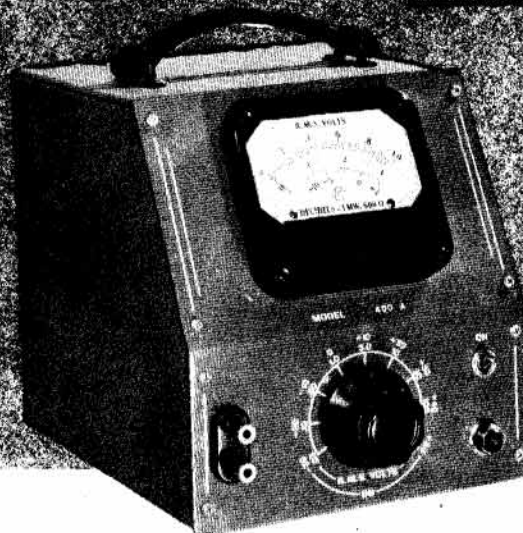
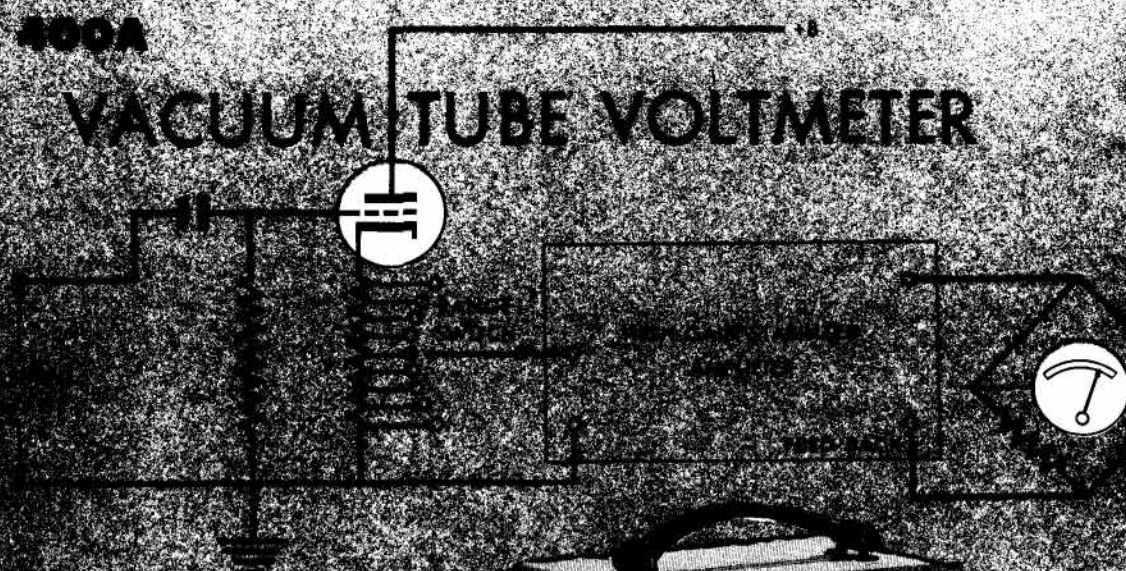

ADVANTAGES:

- Wide voltage range
- High sensitivity
- Hairline accuracy
- Time saving stability
- High input impedance
- Large overvoltage capacity
- Waveform errors minimized
- Measurements up to 1 mc.
- Small and light

USE IT TO MEASURE:

- Voltage in audio, supersonic, and lower RF region
- Amplifier gain
- Network response
- Output level
- Hum level
- Power circuit voltages
- High frequency voltages in transmitting equipment
- Video voltages
- Carrier current voltages
- Capacity
- Coil figure of merit

MEASUREMENTS UP TO 1 MC SIMPLY AND ACCURATELY MADE

FOR MANY YEARS the advantages of vacuum tube voltmeters have been recognized by electronic workers. The *hp* Model 400A Vacuum Tube Voltmeter is unusually flexible because of its wide frequency and voltage ranges. A-c voltages as small as .005 and as high as 300 volts can be simply and directly measured without any precautions over a frequency range of 10 cycles to 1,000,000 cycles. Accuracy of readings is assured because the high input impedance does not disturb the usual circuit under test. Furthermore, the calibration error of the instrument under all conditions is less than 3% to 100 kc and less than 5% to one megacycle.

BROAD BAND AMPLIFIER

This circuit consists of a high gain amplifier and a full wave rectifier. The cathode follower circuit, diagrammed above, provides an input impedance of 1 megohm, while also allowing a low impedance cathode circuit which is switched to change voltage ranges. The full wave rectifier actuates a one-mil meter. The amplifier is of the broad band type and

is substantially flat from 10 cps to one mc. Because the amplifier employs inverse feedback, it is extremely stable. Thus the accuracy of meter reading is virtually independent of line voltage changes and tube characteristics. See figure 1.

EASY TO OPERATE

The simplicity-of-operation characteristic of all *-hp-* instruments is exemplified by the Model 400A Vacuum Tube Voltmeter. Ordinarily, no precautions whatsoever are required. Turnover effect and waveform errors are minimized because this meter responds to the average value of the full wave. There are no adjustments to make during operation. Large overload voltages cause saturation of the amplifier which protects the meter from damage. Thus occasional overloads of 100 times normal will not damage the meter movement.

USES

The speed and accuracy of measurement of this meter make it invaluable for laboratory work in measuring amplifier gain, network response, and output level. The wide frequency range makes it suitable for video measurements as well as RF measurements. The sensitivity is sufficient to measure the hum level

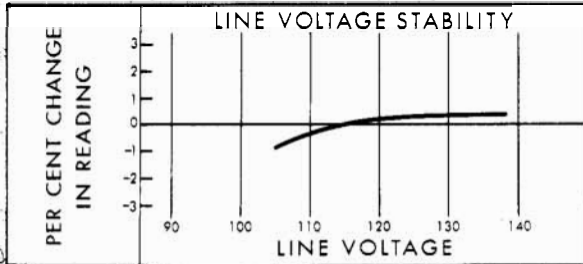

Figure 1

directly in many cases. The higher voltage ranges are useful for measuring power circuit voltages and high frequency voltages in broadcast equipment. It is also valuable as a VU meter, to measure coil Q, compare capacities and resistances, and as a null detector.

CONVENIENT TO USE

From the purely physical standpoint, the *-hp-* 400A is unusually convenient to use because of its small size and large, easily-read slanting scale. See figure 2. The power supply is completely contained. No adjustment to zero position is required, and the ranges are instantly available by means of a switch on the panel. The meter is calibrated in decibels as well as in volts and each voltage range is related to the next by 10 db steps. Thus any db level may be read directly. All in all, the *-hp-* Model 400A is probably one of the most useful instruments in the field of electronic laboratory equipment.

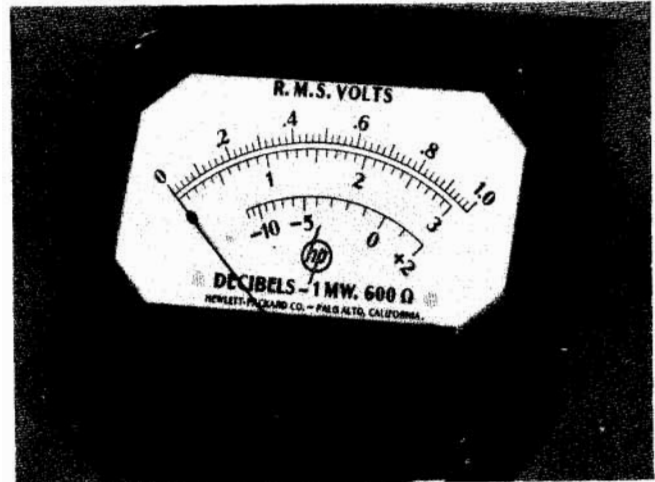

Figure 2 - Detail of Meter Face

SPECIFICATIONS

Voltage Range: A switch on the front panel selects nine voltage ranges having full scale sensitivities of .03 volts, 0.1 volts, 0.3 volts, 1.0 volts, 3.0 volts, 10.0 volts, 30.0 volts, 100 volts, 300 volts.

Calibration: The meter is calibrated to read the rms value of a sinusoidal wave. The voltage scale is linear and a decibel calibration based on 1 milliwatt in 600 ohms is provided. The indication is in proportion to the average value of the full wave; thus waveform errors and turnover are minimized.

Frequency Range: The frequency range is 10 cps to 1 mc.

Accuracy: The over-all accuracy of the meter is within $\pm 3\%$ below 100 kc and $\pm 5\%$ from 100 kc to 1 mc. Line voltage variations from 105 volts to 125 volts or changing tubes will affect the reading by less than 3% at all frequencies below 100 kc.

Input Impedance: The input impedance is equivalent to 1 megohm shunted by 16 uufd on the 30 volt range and below. On the 100 volt range: 3 megohms, and on the 300 volt range: 2.4 megohms.

Overvoltage Capacity: Occasional overloads of 100 times normal will not damage the meter movement. Continuous or frequent overloads should be avoided.

Power Supply: The instrument operates from 115 volts, 50/60 cycles, 40 watts.

Mounting: The meter is mounted in a steel cabinet finished in wrinkle gray. The front panel is finished in a satin gray baked enamel, with photo-etched designations. The cabinet is 7½ inches wide, 8 inches high, and 9 inches deep. A leather handle is provided at the top of the cabinet.

Net Weight: 15 pounds. Shipping Weight: 20 pounds.

Data subject to change without notice.



MODEL 205AG

AUDIO SIGNAL GENERATOR

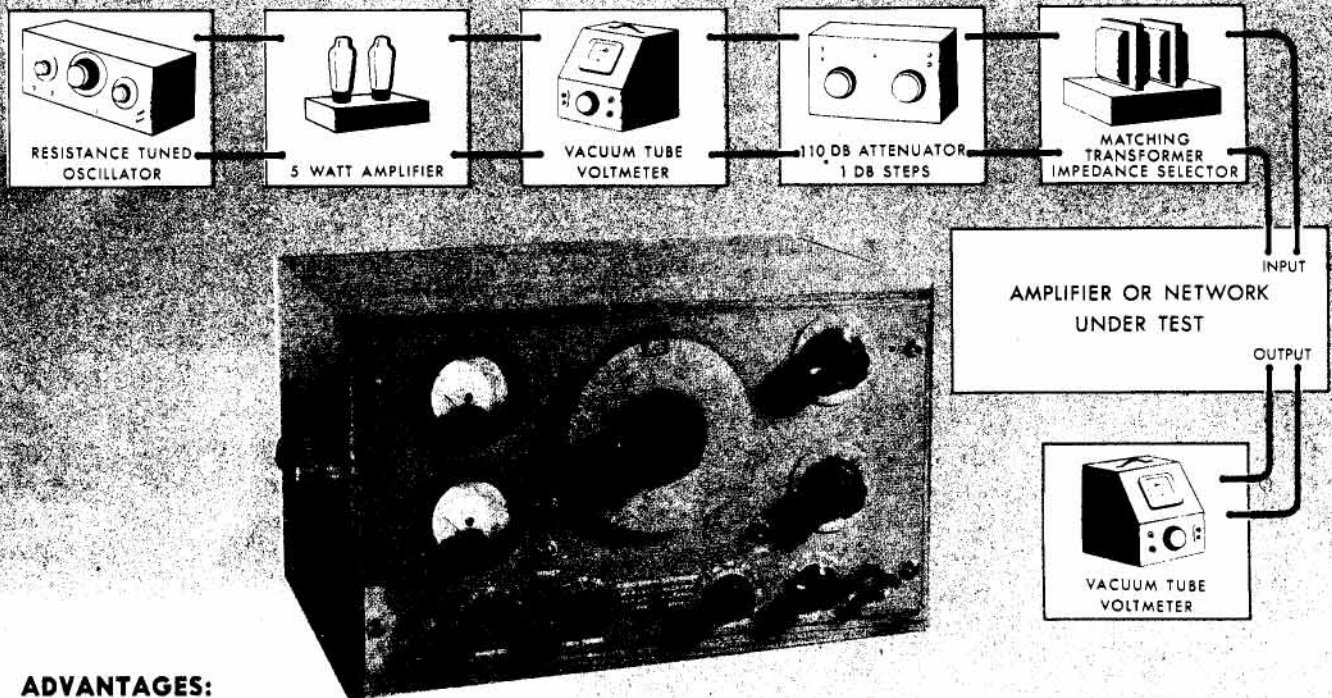

ADVANTAGES:

- No auxiliary equipment needed
- Range—20 to 20,000 cps
- 5 watts output, less than 1% distortion
- No zero setting
- Supplies known voltage
- Output meter calibrated in volts and decibels
- Standardized frequencies instantly available
- Separate input meter for gain measurements
- Wide range of output impedances

USE IT FOR:

- Amplifier gain measurements
- Network frequency response
- Source of voltage for distortion measurements
- Broadcast transmitter audio response
- Loudspeaker response
- General laboratory applications
- Production testing

SIX BASIC INSTRUMENTS COMBINED TO SPEED GAIN MEASUREMENTS

ALL THE necessary instruments for accurate gain or frequency response measurements have been assembled by *hp* engineers in one compact unit. (See block diagram.) No auxiliary equipment is required.

This Audio Signal Generator brings new speed and ease to testing jobs. Any desired frequency within the range of 20 to 20,000 cps is made available by the resistance-tuned audio oscillator. These frequencies are developed at any desired voltage between 150 volts and 50 micro-volts.

To make amplifier or network gain measurements with the *hp* Model 205AG Audio Signal Generator, the operator simply connects input and output leads to the binding posts.

Two vacuum tube voltmeters are provided, one to measure input and the second to measure output of the device under test. The input meter has a range of minus 5 db to plus 49 db, with an input impedance of 5,000 ohms. The attenuator sets the output voltage. The output impedance can be instantly changed by means of a selector switch (line matching transformer in the block diagram) to the commonly used impedances of 50, 200, 500, and 5,000 ohms, a convenience in

matching various types of networks. The Model 205AG will supply 5 watts output with less than 1% distortion, and thus is useful where sizeable amounts of power are required. Feedback is used for improved frequency response and lower distortion.

The *-hp-* Model 205AG is well adapted to measuring frequency response and gain or loss of any network. The frequency remains accurate, without the necessity of zero setting. *-hp-* Audio Signal Generators are built for heavy duty and long hard service.

AUDIO AND SUPERSONIC MODELS AVAILABLE

There are three models of signal generators. The *-hp-* Model 205AG provides all of the basic components to make a complete gain measurement in one unit. The *-hp-* Model 205A is similar to the 205AG except that the input vacuum tube voltmeter is eliminated. For supersonic measurements the *-hp-* Model 205AH signal generator is available. This instrument is similar to the *-hp-* Model 205A but covers a frequency range of 1 kc to 100 kc.

SPECIFICATIONS, MODEL 205AG AND 205A

Frequency Range: The frequency coverage is 20 cps to 20,000 cps, in three ranges.

Calibration: The dial is calibrated directly in cycles for the lowest range, 20 cps to 200 cps. A switch selects the desired range and indicates the proper multiplying factor. Each range covers approximately 270 degrees on the 6 $\frac{1}{2}$ " main dial. Range 1 covers 20 cps to 200 cps; Range 2 covers 200 cps to 2,000 cps; and Range 3 covers 2,000 cps to 20,000 cps.

Stability: Under normal temperature conditions the frequency will drift less than 2% over long periods of time. Each range is provided with an internal adjustment so that 1% accuracy may be maintained if required.

Output: Five watts output will be delivered to a matched resistance load.

Output Impedances: Output impedances of 50 ohms, 200 ohms, 500 ohms, and 5,000 ohms are available. All are center tapped, balanced and may be grounded if desired.

Frequency Response: The frequency response of the system beyond output meter is down 2.0 db at 20 cps and 1 db at 20,000 cps (at levels from +37 to -30 dbm). Drop in response exceeds these limits at levels lower than -30 dbm.

Distortion: The distortion is less than 1% at rated output at all frequencies above 30 cps.

Hum Level: The hum level is 60 db below the output voltage or 90 db below zero level, whichever is the larger.

Output Meter: The output meter is calibrated directly in volts at 500 ohms and in db above a 1 mw level (50 volts and plus 37 db full scale).

Input Meter:* The input meter has a range of minus 5 db to plus 49 db based on a 1 mw level in 500 ohms. The meter scale is calibrated from minus 5 db to plus 9 db and a multiplier switch adds from zero to 40 db to the reading in 5 db steps. The meter has an input impedance of 5,000 ohms.

*Not included in Model 205A.

Frequency Response: The input meter is compensated to have about 0.5 db rise at 20 kc so that gain measurements with the Model 205AG are accurate to 15 kc and only about 0.5 db in error at 20 kc.

Output Attenuator: The output attenuator provides 110 db in 1 db steps. It consists of a 100 db attenuator with 10 db steps and a 10 db attenuator with 1 db steps.

Mounting: Available in either relay rack or cabinet mounting. Panel size on either instrument, 19" x 10 $\frac{1}{2}$ ". Cabinet models are mounted in oak cabinets. Panels are finished in gray wrinkle enamel with machine engraved designations.

Net Weight: 73 pounds. Shipping Weight: 116 pounds.

MODEL 205AH SUPERSONIC SIGNAL GENERATOR

Frequency Range: 1 kc to 100 kc, in two ranges.

Power Output: 5 watts at 3% distortion, 3 watts at 1% distortion, 1 watt at $\frac{1}{2}$ % distortion.

Output Impedances: 50 ohms, 200 ohms, 500 ohms, and 5,000 ohms. All are center tapped (ungrounded).

Frequency Response: ± 1 db from 10 kc reference.

Hum Level: The hum level is at least 65 db below output voltage or 65 db below 1 milliwatt into 500 ohms, whichever is greater.

Output Attenuator: Range: 0 to 110 in 1 db steps. Accuracy: $\frac{1}{2}$ db in first 80 db, 3 db in last 30 db.

Power Supply: 115 volts, 50-60 cycles, 140 watts.

Accuracy of Frequency: $\pm 2\%$.

Stability of Frequency: $\pm \frac{1}{2}\%$ after $\frac{1}{2}$ hour warm up. Line voltage changes of 10% have no effect on frequency as power supply to oscillator is regulated.

Output Meter: The output meter is calibrated directly in volts at 500 ohms and in db above 1 milliwatt level (50 volts and +37 db, full scale).

Mounting: The instrument is available in either relay rack or cabinet mounting. The panel size on either instrument is 19" x 10 $\frac{1}{2}$ ". Cabinet models are mounted in oak cabinets.

Net Weight: 63 pounds. Shipping Weight: 110 pounds.

Data subject to change without notice.

NOISE AND DISTORTION ANALYZER

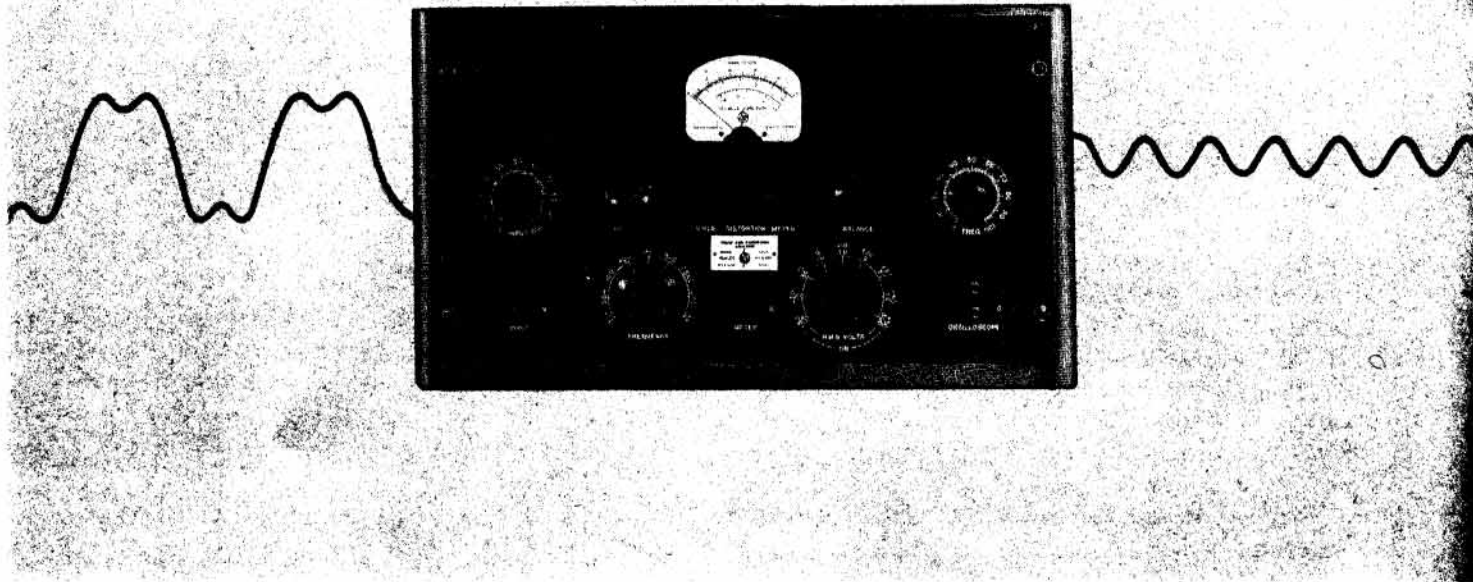

THREE BASIC INSTRUMENTS COMBINED TO SPEED DISTORTION MEASUREMENTS

ADVANTAGES:

- Measures total noise and distortion
- Measures distortion as low as 0.1%
- Measures voltage as low as .0005
- Will not load circuit being measured
- Available in standard FCC frequencies

USE IT TO MEASURE:

- Total noise • Frequency response
- Total distortion • Amplifier gain
- Hum level
- Voltage level, audio and supersonic

USE IT AS:

- A distortion analyser
- A broad band 20 or 75 db amplifier
- A pre-amplifier for an oscilloscope
- A 10 cps to 100 kc vacuum tube voltmeter
- A universal laboratory test instrument

ODEL 325B is a combination of three separate elements: a frequency elimination circuit; an input amplifier, stabilized at 20 db, and a vacuum tube voltmeter. Any of these may be used individually. Together they form a uniquely practical trio.

By eliminating the fundamental frequency of a wave, and measuring the residual voltage, the *hp*- Model 325B Noise and Distortion Analyzer makes possible accurate measurements of total noise and total distortion of any given wave.

ALMOST INFINITE ATTENUATION

At balance its filter circuit has almost infinite attenuation at a single frequency, while other frequencies pass with little or no attenuation. As shown in the chart, (*see figure 1*) the attenuation at the second harmonic (2F) is of the order of 1/2 db, while at the resonant frequency it is almost infinite—from 60 to 70 db in practical circuits. This makes it possible to measure distortion as low as 0.1%.

The amplifier employs inverse feedback, with the result that the accuracy is virtually independent of line voltage and tube characteristics and gives a constant gain of 20 db. The

amplifier is flat from 10 cps to 100 kc so that harmonics as high as the 6th of 15 kc are correctly indicated. Because the input impedance is high, the 325B will not load down the circuit being measured.

The sensitivity of the vacuum tube voltmeter is increased 10 times by the 20 db amplifier so that the hum may be measured directly, and voltage as low as .0005 can be measured.

The vacuum tube voltmeter is identical to the 400A except that the frequency range is limited to 100 kc. It is calibrated both in volts and in db. Terminals are provided at the output of the vacuum tube voltmeter amplifier for observation of the waveform on an oscilloscope. These terminals may also be used to employ the full system as a broad band amplifier of 75 db gain.

STANDARD FREQUENCIES

The *-hp-* Model 325B covers the audio frequency spectrum, with filters for frequencies of 30 cps, 50 cps, 100 cps, 400 cps, 1,000 cps, 5,000 cps, 7,500 cps, 10,000 cps and 15,000 cps, all set within $\pm 5\%$ of specified value. These are the frequencies recommended by the FCC for checking broadcast transmitters. On special orders, filters for other frequencies from 20 cps to 20 kc can be obtained. The meter scale is calibrated in volts and decibels.

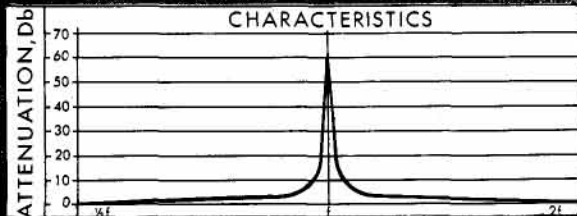

USES

The Model 325B, when used in conjunction with one of the *-hp-* 200 series Resistance-Tuned Audio Oscillators, provides equipment to make most laboratory AF measurements, including distortion, power gain, and frequency response. It will not load down the circuits under test since the input impedance is 200,000 ohms. The voltmeter section has an input impedance of 1,000,000 ohms and is very conveniently used independently to measure a-c voltages from .005 to 300 volts. When used with a simple diode detector the Model 325B will measure audio distortion in the r-f transmitted signal of a broadcast station. It is also useful in production testing of high fidelity receivers.

SPECIFICATIONS

Sensitivity: The Model 325B will give full scale indication on a distortion level which is .3% of the fundamental. Measurements to 0.1% may be made with good accuracy. The full scale sensitivity is 3.0 millivolts or 50 db below 1 mw in 600 ohms. Satisfactory readings to 70 db below zero can be made.

The over-all gain from the input terminals to the oscilloscope terminals is 75 db.

Voltmeter Range: Nine voltage ranges are provided with full scale sensitivities of .03, .10, .30, 1.0, 3.0, 10, 30, 100, 300. The ranges are also calibrated in db and the range multiplier changes the sensitivity in steps of exactly 10 db. Zero level is 1 mw in 600 ohms.

Voltmeter Accuracy: The over-all accuracy of the unit for voltage measurements is $\pm 3\%$. Line voltage variations from 105 volts to 125 volts or changing tubes affects the reading by less than 3%.

Voltmeter Frequency Response: The frequency response of the meter including the input amplifier is within 3% from 10 cps to 100 kc.

Filter Frequency: Filters are provided for the following frequencies: 30 cps, 50 cps, 100 cps, 400 cps, 1,000 cps, 5,000 cps, 7,500 cps, 10,000 cps and 15,000 cps. These frequencies are set to plus or minus 5% of specified value.

Distortion Measurement Accuracy: The filters are designed to eliminate the fundamental by more than 60 db and to attenuate the second and all higher harmonics by less than 5%. Distortion measurements in general will be accurate within $\pm 3\%$ for distortion levels above 0.5%. When the distortion is largely second harmonic the accuracy will be $\pm 5\%$ for frequencies above 7.5 kc.

Noise Measurement Accuracy: The accuracy of noise and hum measurements is essentially the same as the accuracy of voltage measurements. The measured value is the average value of the full wave.

Input Impedance: The impedance at the input amplifier terminals is approximately 200,000 ohms shunted by approximately 24 uufd. The input impedance at the meter terminals is 1 megohm shunted by approximately 32 uufd.

General: The Model 325B is complete with all necessary power supplies for operation from 115 volts 50/60 cycles. The various parts of the unit are arranged for maximum flexibility so they can be used separately if desired. Terminals are supplied to connect an oscilloscope across the metering circuit so that observations of the applied wave and residual distortion may be made if desired. The indicating meter is a 4-inch square type with a large scale for ease of reading. The meter and various range switches are calibrated in both volts and decibels.

Mounting: The unit is mounted in an attractive oak cabinet with the front panel 19" x 10 1/2". Complete shielding is provided against pickup from either 60 cycle or r-f fields of reasonable magnitude. The panel is finished in wrinkle gray with all controls and ranges clearly marked.

Net Weight: 56 pounds. Shipping Weight: 115 pounds.

Data subject to change without notice.



MODEL 330B

DISTORTION ANALYZER

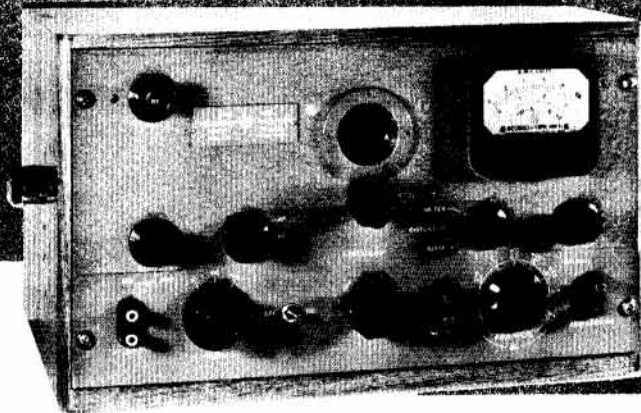
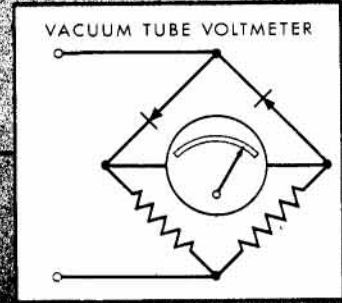
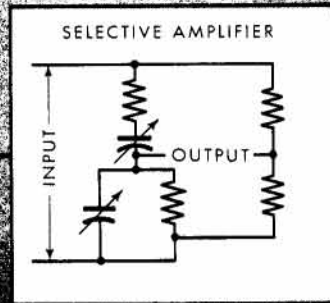
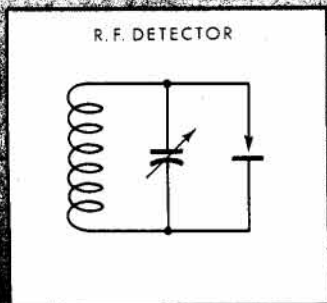

ADVANTAGES:

- Covers audio spectrum
- Measures noise as small as 100 microvolts
- Linear r-f detector
- Terminals for oscilloscope
- Ball bearing frequency control dial
- High order of accuracy and stability

USE IT FOR:

- Measuring total distortion of audio signal
- Measuring total distortion of audio-modulated r-f carrier
- Measuring voltage level, power output, amplifier gain
- Measuring noise and hum level of audio frequency equipment directly
- Determining frequency of unknown audio signal
- High-gain, wide-band, stabilized amplifier

THE Model 330B Distortion Analyzer is Hewlett-Packard's newest and finest distortion-measuring instrument. The Model 330B is capable of measuring distortion at any frequency between 20 cps and 20,000 cps. It will make noise measurements of voltages as small as 100 microvolts. A linear r-f detector makes it possible to measure these characteristics directly from a modulated r-f carrier. The convenience of operation, high sensitivity, accuracy, stability, and light weight of the 330B make it a uniquely valuable instrument for broadcast, laboratory, and production measurements.

The circuit of Model 330B consists of a linear r-f detector, a frequency-selective amplifier, a vacuum-tube voltmeter, and a regulated power supply.

The r-f detector includes a diode rectifier operating in conjunction with a resonant circuit which is tuned to the carrier frequency under measurement. The detector covers a range of 500 kc to 60 mc and is varied by means of a tuning condenser and range switch which selects one of six bands. The detector may be switched out of the circuit when audio frequencies are used.

The 20 db amplifier operates in conjunction with the *hp*-resistance-tuned circuit to provide infinite attenuation at one

frequency while allowing all other frequencies to be passed at the normal gain of the amplifier. See figure 1. Negative feedback is employed in the amplifier to minimize distortion, give a uniform response over a wide range of frequencies, and to provide a high order of stability. The frequency response is from 10 cps to 100,000 cps; thus even the fifth harmonic of 20 kc is passed through the amplifier without attenuation.

The voltmeter section of the instrument consists of a two-stage high-gain amplifier, a rectifier, and an indicating meter. A large amount of negative feedback is employed to insure stability and a uniform response from 10 cps to 100,000 cps.

Typical Applications

The flexibility of *hp's* Model 330B leads to a number of applications. It may be used to measure the total distortion at any frequency of an audio signal, or of an audio-modulated r-f carrier. It may also be used as a voltmeter for measuring voltage level, power output, amplifier gain, and for any other use which a high-impedance, wide frequency range, high sensitivity voltmeter is desirable. With the added gain of the amplifier the vacuum-tube voltmeter has sufficient sensitivity to measure directly noise and hum level in audio frequency equipment, such as studio amplifiers. With the linear detector the noise level in the carrier output of transmitting equipment can be readily measured. The frequency selective amplifier can be used as an audio frequency meter to determine the frequency of an unknown audio signal. The instrument may also be used as a high-gain, wide-band, stabilized amplifier, having a maximum gain of 75 db.

This new Model 330B Distortion Analyzer is particularly adapted for use as an all-around measurement device in the broadcast studio and broadcast transmitter rooms. Ruggedness, high stability, and the easy operation of the ball-bearing frequency control dial are features which add to its convenience and reliability for production test jobs.

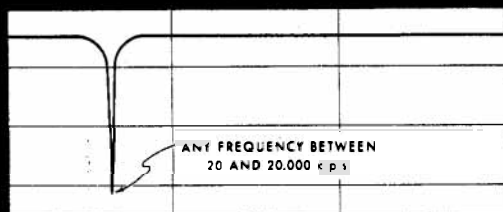

SPECIFICATIONS MODEL 330B DISTORTION ANALYZER

Range: The Model 330B will measure distortion at any frequency from 20 cps to 20,000 cps. The frequency of measurement is selected with a directly calibrated dial having its lowest range calibrated directly in cycles per second. A range switch selects the operating band.

Accuracy: The circuit will eliminate the fundamental by more than 60 db and will attenuate the second harmonic and higher harmonics by less than 10%. Distortion measurements accurate within $\pm 3\%$ for distortion levels as low as 0.5%.

Sensitivity: Distortion levels of 0.3% are measured with full scale, and levels of 0.1% can be read with good accuracy at approximately 25% scale reading.

Voltmeter Range: Nine ranges are provided with full scale sensitivities of .03, .1, .3, 1.0, 3.0, 10, 30, 100, 300. A calibration from +2 to -12 db is also provided, and the ranges are related to each other in 10 db steps. The range switch indicates db level as well as voltage range. Zero level is 1 milliwatt in 600 ohms.

Voltmeter Accuracy: The voltmeter accuracy is $\pm 3\%$. The accuracy is not affected by changing of tubes or by line voltage variations from 105 to 125 volts. The indicating meter is a 4-inch square type with large, easily read scales.

Voltmeter Frequency Response: The frequency response of the vacuum tube voltmeter including the analyzer circuits is flat within 3% over the range of 10 to 100,000 cps.

Noise Measurement: When used to measure hum or noise the meter will give a full scale deflection on a signal of 300 microvolts. Satisfactory readings may be made to 80 db below 1 milliwatt in 600 ohms.

R. F. Detector: A linear R. F. detector is provided to rectify the transmitted carrier. The input circuits of this rectifier are tunable from 500 kc to 60 mc, in 5 bands.

A. F. Input Impedance: The input impedance at the audio frequency input terminals is approximately 200,000 ohms shunted by 24 mmf. The input impedance at the vacuum tube voltmeter terminals is 1 megohm shunted by 32 mmf.

Oscilloscope Terminals: Terminals are provided for connection to an oscilloscope to observe the wave shapes of the original signal and the residual distortion components. The maximum gain from the A. F. input to the oscilloscope terminals is 75 db.

Power Supply: The instrument operates on 115 volt 50/60 cycles. The power consumption is 90 watts. An electronic voltage regulator maintains a constant plate supply.

Mounting: The instrument is mounted in an attractive oak cabinet. Front panel size: 19 inches x 10½ inches, depth 13 inches. The panel is finished in wrinkle grey. The Model 330B can be supplied for rack mounting and when so supplied is designated by the Model No. 330BR.

Net Weight 50 lbs. Shipping Weight 120 lbs.

Data subject to change without notice.

DISTORTION ANALYZERS

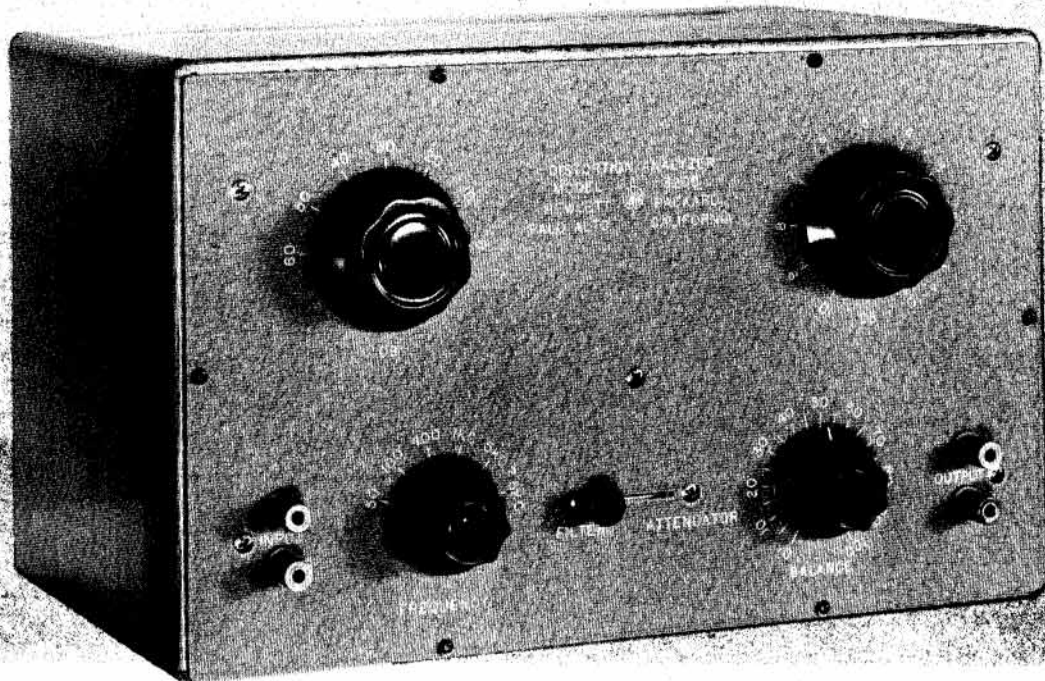

THIS CIRCUIT SHOWS TYPE AND AMOUNT OF DISTORTION

ADVANTAGES:

- Time-saving
- Available for any frequencies from 50 cps to 20 kc
- Measures harmonic distortion directly
- Accurate

USE IT TO:

- Compare distortion content of wave with fundamental voltage
- Observe type as well as amount of distortion (with oscilloscope)
- Speed production testing
- Attenuate voltages and signals—range zero to 70 db

THE *hp* Model 320 Distortion Analyzer is a simple and convenient device for studying and measuring the harmonic distortion in audio frequency apparatus. The instrument is particularly suitable for development work, inasmuch as the character and type of distortion can be determined at the same time that the distortion is being measured.

In addition, the instrument is excellent for production work because it is easy to operate and provides a rapid and accurate check for normal operation.

Essentially, the Model 320 is a comparison device; it is used to compare the distortion content of a wave with the applied wave itself.

When this comparison is made in conjunction with a cathode ray oscilloscope, the type of distortion can be observed readily. The various order harmonics will show up in the oscilloscope pattern together with hum and noise voltages, so that a great deal of information about the voltage being analyzed can be obtained. For this reason, the Model 320 is a valuable instrument, not only when used alone, but also

when used in combination with other equipment which measures the total rms distortion directly.

If more accurate measurements are desired than can be obtained with an oscilloscope, a sensitive voltmeter, such as the *-hp-* Model 400A, can be used as the detector. With such a meter the distortion measurements may be made with as good accuracy as can be obtained with the more expensive distortion meters.



The Model 320 Distortion Analyzer consists of fundamental elimination filters combined with a calibrated attenuator reading in decibels.

When the voltage to be analyzed is adjusted to the proper frequency, the fundamental is eliminated completely by the filters. The residual voltage containing the harmonics can then be observed with an oscilloscope or measured with a sensitive meter. When the level has been noted, a calibrated attenuator is substituted for the elimination filter. The attenuator is then adjusted until the same indication is obtained on the detector as with the filter in the circuit. When this condition is obtained, the distortion level is the number of decibels below the applied wave indicated by the setting of the attenuator.

MODELS

Two models of the *-hp-* Model 320 are available. The Model 320A is designed for measurement at frequencies of 400 and 5000 cps, while the Model 320B is designed for measurement at frequencies of 50, 100, 400, 1000, 5000, and 7500 cps. All filters are designed to provide more than 60 db of attenuation of the fundamental, so that distortion measurements may be made down to 0.1%.

SPECIFICATIONS

Frequency Range: The Model 320A is designed for measurements at 400 and 5000 cps. The Model 320B is designed for measurements at 50, 100, 400, 1,000, 5,000, and 7500

cps. Filters for other frequencies can be supplied on special order.

Input Impedance: The input impedance is at least 20,000 ohms. A bridging transformer may be used to increase the input impedance.

Attenuator: An attenuator is provided to compare the amplitude of the harmonic voltages with the fundamental. It consists of a 60 db unit adjustable in 10 db steps and a 10 db unit adjustable in 1 db steps. Individual resistors adjusted to $\pm 1/2\%$.

Distortion Range: The filter circuits will provide more than 60 db of attenuation of the fundamental. Distortion values as low as 0.1% of the fundamental may be measured with a detector of sufficient sensitivity.

Detector Sensitivity: The sensitivity of the instrument is determined by the detector. The detector should give a readable indication on 0.1% of the fundamental if harmonics of 0.1% are to be measured. The detector need not be calibrated because it is used for comparison only. The usual oscilloscope with a one stage amplifier is sufficiently sensitive to measure 0.3% of a 30 volt fundamental. For proper operation of the instrument the input impedance of the detector must be 100,000 ohms or greater. An amplifier may be used between the instrument and the detector to increase the sensitivity. The only requirements on such an amplifier are that it must pass the highest harmonic which is of interest, and that it have a high impedance input. It need not be free from distortion otherwise.

Mounting: The Model 320A and 320B are mounted in attractive oak cabinets with the panel finished in wrinkle gray. The Models 320AR and 320BR fit the standard 19" relay rack with $3/4$ " spacing. The panels are finished in wrinkle gray with machine engraved designations.

	Size	Net Weight	Shipping Weight
320A	13" x 9" x 8"	15 pounds	22 pounds
320B	13" x 9" x 8"	17 1/2 pounds	28 pounds
320AR	19" x 9" x 8"	17 pounds	32 pounds
320BR	19" x 9" x 8"	19 1/2 pounds	35 pounds

Data subject to change without notice.

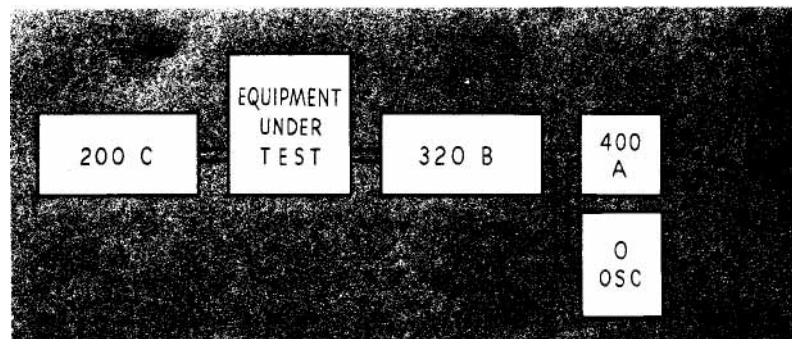



MODEL 300A

HARMONIC WAVE ANALYZER

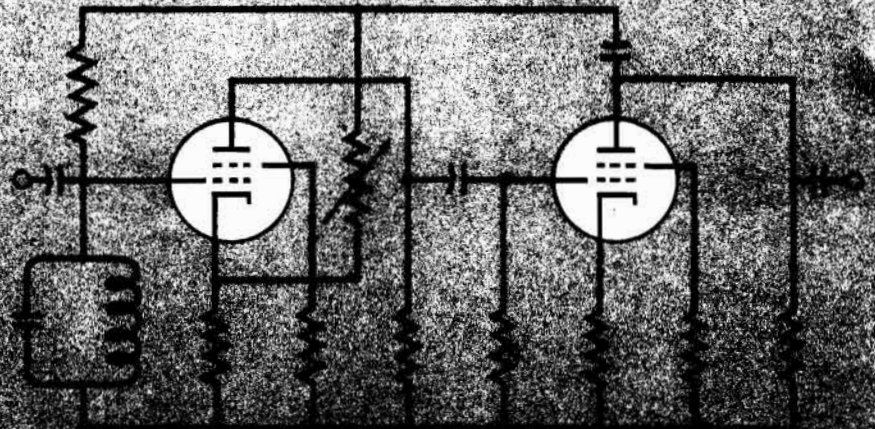
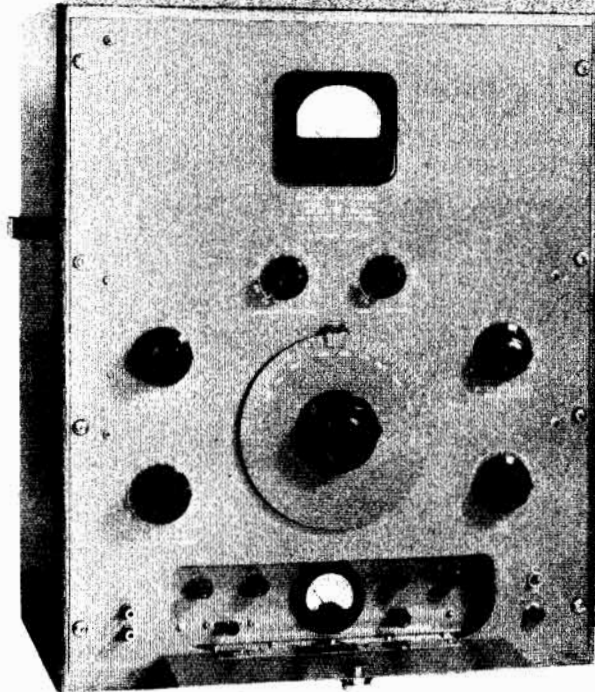

ADVANTAGES:

- Direct reading
- Simplified operation
- Variable selectivity
- Wide voltage range
- Linear meter scale

USE IT TO ANALYZE:

- Noise characteristics
- Broadcast amplifier characteristics
- Modulating amplifier distortion
- Recording devices
- Rotating machinery harmonic voltages
- Film sound track distortion
- Recording distortion
- Hum
- Network characteristics

VARIABLE SELECTIVITY PROVIDES RAPID, ACCURATE WAVE ANALYSIS

THIS *-hp-* Model 300A Harmonic Wave Analyzer is a selective voltmeter designed to measure the individual components of complex waves. The selectivity can be varied by means of a unique selective amplifier. Where the harmonics are close together the high selectivity easily separates the wave components. Yet, where the components are spaced far apart, the selectivity may be widened to increase the speed of operation without sacrificing essential accuracy. This feature is also valuable where it is necessary to measure distortion of waves containing a small amount of frequency modulation, such as in sound tracks, and may be used conveniently to integrate a small portion of the audio spectrum in noise measurements and the like. Maximum selectivity is sufficient to separate harmonic components spaced 30 cycles apart. See figure 1.

DIRECT READING

The *-hp-* Model 300A Harmonic Wave Analyzer covers the audio spectrum from 30 cps to 16,000 cps. The wide voltage range covers the values encountered in nearly every application. Full scale voltmeter readings may be obtained with inputs of .001 to 500 volts so that the instrument may be used with equal success with low output transducers and high

power modulating amplifiers. Other features which make it unexcelled for both laboratory and production testing are the linear meter scales fully protected against overloads, and the built-in calibrating system to standardize voltage measurements.

THEORY

The circuit of the Model 300A consists of a variable local oscillator, a balanced modulator, a selective amplifier, and an indicating meter. The variable local oscillator modulates the unknown frequency to produce a constant difference frequency. This difference frequency is applied to the selective amplifier, the output of which is then proportional to the magnitude of the unknown voltage. A meter in the output of the selective amplifier indicates the magnitude of the voltage.

The local oscillator is of the resistance-tuned type, providing a very stable, accurate voltage. A balanced modulator is used to eliminate the local oscillator frequency and to keep cross-modulation products very low. The selective amplifier consists of four tuned circuits in which the effective Q is controlled by positive feedback. Negative feedback is also used to stabilize the amplifier.

This amplifier has the unique characteristic that its selectivity may be varied over a wide range without appreciably affecting the gain of the amplifier.

SPECIFICATIONS

Frequency Range: The frequency range is from 30 to 16,000 cps and the frequency calibration is within 3%. The frequency is controlled by a 7" diameter dial located on the panel. The entire range is covered in approximately a 200° sweep of the dial.

Voltage Range: There are four input voltage ranges having maximum values of 0.5 volts, 5 volts, 50 volts, and 500 volts. In addition, a meter multiplier divides each voltage range into full scale meter readings of 500, 250, 100, 50, 25, 10, 5, 2.5, and 1. Thus full scale meter readings can be obtained on from 1 mv to 500 v. Two controls select the input range and meter multiplier. The linear meter is fully protected against overloads.

Selectivity: The selectivity can be varied by means of a control on the front panel. At the maximum selectivity setting, the response is down 3 db at 3 cycles, 10 db at 8 cycles, 40 db at 30 cycles, and 60 db at 53 cycles from maximum response. At minimum selectivity the response is down 3 db at 20 cycles, 10 db at 43 cycles, 40 db at 145 cycles, and 60 db at 280 cycles from maximum response. Selectivity may be varied continuously between these limits. The variable selectivity control is calibrated in the half band width at which the response is down 40 db.

Voltage Accuracy: The over-all voltage accuracy is $\pm 5\%$, provided adjacent harmonics are within limits determined by the selectivity. This accuracy can be maintained provided that unwanted voltages are attenuated by the selectivity of the instrument to less than $\frac{1}{3}$ of the voltage being measured. Thus, with maximum selectivity a 3% second harmonic of a 30 cycle voltage may be measured with 5% accuracy.

The residual modulation products are suppressed by at least 65 db. Hum is at least 75 db below maximum input voltage on any of the four input ranges.

Input Impedance: The input impedance is 200,000 ohms. The input circuit includes a potentiometer which is set to maximum for voltage measurements.

Power Supply: The instrument contains a voltage regulated power supply which operates from 115 volts, 50/60 cycles. Power required is 105 watts.

Mounting: The Model 300A is mounted in an attractive oak cabinet to harmonize with the panel which is finished in wrinkle gray with machine engraved designations. A relay rack model is also available and is designated as the Model 300AR.

Physical: Over-all dimensions of the Model 300A are 24" high, 21 $\frac{5}{8}$ " wide, and 14 $\frac{1}{8}$ " deep. Net weight is 78 pounds; shipping weight is 150 pounds.

Data subject to change without notice.

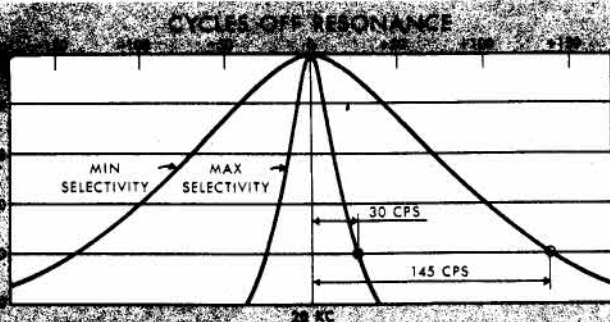

Figure 1

USES

The Model 300A is well adapted to the measurement of the harmonic distortion in audio frequency equipment of all kinds, broadcast receivers, transmitters; to determine the harmonic components in a-c machinery and power systems; to the study of induced voltages on telephone lines; to measurement of hum components in rectifier circuits.

Other uses include the study of noise by integrating portions of the spectrum with the selectivity control adjusted for a wide pass band and the checking of wave filter characteristics with maximum selectivity.

The Model 300A is also useful as a device to measure the amount of cross- or inter-modulation products generated by the simultaneous transmission of two frequencies by an audio system or to measure demodulation of a modulated wave applied through an audio system.

ELECTRONIC FREQUENCY METER

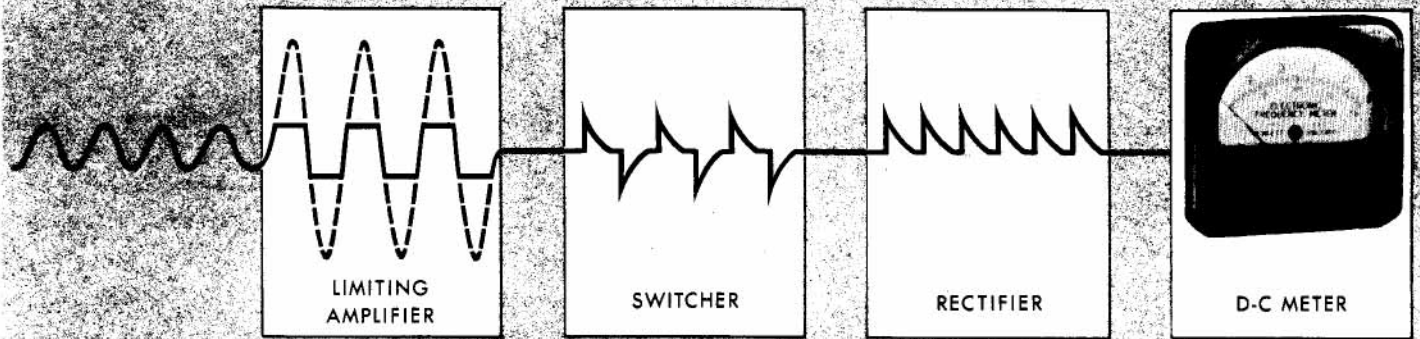

ADVANTAGES:

- Wide frequency range
- Accurate
- Good sensitivity
- Accuracy independent of line voltage changes and tube characteristics
- Ten convenient scale ranges

USE IT TO MEASURE:

- Beat frequency between two RF signals
- Crystal frequency deviation
- Audic frequencies
- Speed of rotating machinery
- Oscillator stability

MEASURES THE FREQUENCY OF A-C VOLTAGE AS HIGH AS 50 KC.

HE -hp- Model 500A directly measures the frequency of an alternating voltage from 5 cps to 50 kc. It is suitable for laboratory and production measurements of audio and supersonic frequencies.

The frequency meter consists of a wide band amplifier with a limiting circuit, and electronic switch, a constant current supply, a frequency discriminating circuit, and an output meter and rectifier. The input signal is amplified and used to switch the constant current source to alternate load resistors. The voltage developed across these resistors is applied to a condenser, and the output meter indicates the average value of the rectified charging current. (See diagram above.) The circuit is designed so that each pulse of charging current has the same average value, making the meter reading proportional to the number of pulses per second, and hence proportional to the frequency of the input signal.

INDEPENDENT OF SIGNAL VOLTAGE VARIATIONS

The reading is practically independent of the input voltage waveform, as normal waveform errors cannot affect the electronic switching operation. The regulated current source makes the reading independent of variations in input signal voltage, line voltage, and vacuum tube characteristics. A multiplier switch in the meter circuit provides ten convenient scale ranges. Provision is made for checking the calibration against power line frequency.

USES

The *-hp-* 500A will measure directly and without any precautions the frequency of any source in the audio and supersonic range. In frequency measurement work at higher frequencies, with the aid of a detector it can be used to measure the frequency difference between two radio frequency signals. It is particularly suited to crystal grinding work, where it can be used to measure the frequency deviation from the standard quickly and accurately. Similarly it may be used to measure oscillator and transmitter frequency stability. With the aid of a magnetic pickup it may be used to measure speed of machinery and rate of vibration. Provision is made to operate an Esterline-Angus 1 m.a. recorder with the Model 500A for a continuous record of frequency.

SPECIFICATIONS

Frequency Range: 5 cycles to 50 kc, in ten ranges having full scale values of 50, 100, 200, and 500 cycles, and 1, 2, 5, 10, 20, and 50 kc.

Input: An input voltage of at least 0.5 volts is required and the input impedance is 50,000 ohms. Variation of the input voltage from 0.5 volts to 200 volts will affect the reading of the meter by not more than plus or minus 1%.

Accuracy: The overall accuracy of the meter is plus or minus 2% of full scale value. A line voltage variation of from 105 volts to 125 volts will affect the meter reading by not more than plus or minus 1%.

Recorder Output: Jack provided on right-hand side of panel for use with 1 milliamperere, 1400 ohm Esterline-Angus Automatic Recorder.

Power Supply: 115 volts, 50/60 cycles, 65 watts.

Mounting: The instrument is available in either cabinet or relay rack mounting. The panel size is $8\frac{3}{4}$ " x 19" and the depth is 12".

Weight: Net weight, 28 pounds; shipping weight, 44 pounds.

Data subject to change without notice.

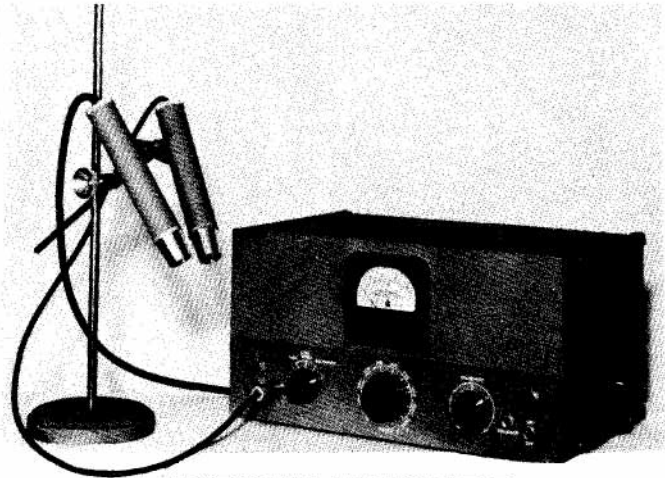

ELECTRONIC TACHOMETER

HOW TO COUNT RPM WITHOUT EXTERNAL LOADING

The Electronic Tachometer, new *-hp-* Model 505A and 505B, is a natural development from the 500A Electronic Frequency Meter. By connecting a photocell pickup in combination with a light source to this basic instrument, it becomes an electronic tachometer, capable of counting speeds or revolutions over a wide range, from about 300 rpm (5 cps) to 3,000,000 rpm (50,000 cps). The light illuminates the moving part to be measured, which is prepared with alternate reflecting and absorbing surfaces. The interrupted reflected light is picked up by the photocell; the electrical impulses generated thereby are transmitted to the frequency meter. The *-hp-* Electronic Tachometer is capable of measuring very high speeds of moving parts which have small energy or which for other mechanical reasons cannot be mechanically connected to any measuring device. The danger of fractional or multiple errors, inherent in other measuring methods, is eliminated.

SPECIFICATIONS

The Electronic Tachometer consists of a photo cell and a light source mounted on a stand and an electronic frequency counter which is similar to the *-hp-* Model 500A. Two tachometer models are supplied. The *-hp-* Model 505A is calibrated in rpm and the *-hp-* Model 505B is calibrated in rps.

Speed Range: Model 505A: 300 rpm to 3,000,000 rpm full scale reading, in ten ranges. Model 505B: 50 rps to 50,000 rps full scale reading in ten ranges.

Circuit and Construction: Similar to *-hp-* Model 500A except for calibration.

Photo Cell: Type 924 phototube. Mounted in shielded tube same size as light source and provided with condensing lens to focus reflected light on phototube. Three-foot cable connects photocell to frequency meter.

Light Source: 15 candle power, 6 volt automotive bulb, mounted in shielded tube. Condensing lens concentrates light. Net weight 38 pounds, shipping weight 50 pounds.

hp



SQUARE WAVES FOR RAPID TESTING

ADVANTAGES:

- Simplifies amplifier testing
- Wide frequency range
- Variable balance output
- Indicates phase shift and transient effects
- Indicates frequency response

USE IT TO:

- Test receivers, video amplifiers, networks, and transmitters
- Provide a time base
- Control an electronic switcher
- Adjust and check cathode ray sweep circuits
- Measure time constants
- Generate harmonics for frequency multiplication

HE *-hp-* Model 210A Square Wave Generator provides an excellent source of square waves for production test and experimental purposes. The fundamental frequency response is 20 cps to 10,000 cps and a reasonably square wave may be obtained at frequencies as high as 100 kc. The square wave frequency is synchronized from an external source of 2 or more volts. The output can be attenuated 70 db from a maximum voltage of 60 volts peak to peak. Output voltages are balanced to ground.

Square waves are formed in the Model 210A by amplifying and clipping the tops of a sine wave, and thus converting it into a wave which has vertical sides and a flat top. The square wave voltage is applied to the amplifier or network under test; the shape of the output wave immediately shows up any distortion present. Because a sharp wavefront contains a large number of frequencies, this wavefront is distorted when all of the frequencies originally present are not transmitted. The frequencies contained in a uniform square wave are shown in this equation:

$$F(t) = \frac{4}{\pi} (\sin wt + \frac{1}{3} \sin 3 wt + \frac{1}{5} \sin 5 wt + \dots)$$

In practice, a wave which appears to be perfectly square will contain 30 or more harmonics, and when the amplitude or phase relation of the harmonics is disturbed, the square

wave will be distorted. Thus the application of a square wave to a circuit shows up any irregularities in amplitude or phase transmission not only at the square wave frequency but also at frequencies far removed from the test point.

USES

When a square wave is applied to an amplifier, the top of the wave will show distortion if the frequency response of the amplifier does not extend to at least one tenth the frequency of the square wave applied. Likewise the sides of the wave will be distorted if the response of the amplifier does not extend to at least 10 times the frequency of the square wave applied. Thus one observation with a square wave applied to an amplifier will check a wide frequency range, a range of 100 to 1, or even more. This is an extremely important fact because once the proper criteria have been established a production test can be set up with one or at the most two observations with a square wave. A square wave may also be employed to study phase shift effects in an amplifier. An amplifier will not reproduce a square wave faithfully unless both the amplitude and phase shift characteristics are correct. Thus if the amplitude response is known to be good, phase shift effects can be determined with a square wave observation.

Peaks or deficiencies in amplification of an amplifier can readily be detected with a square wave generator. Tendency



to oscillate will appear as damped oscillations on top of the amplified square wave and these oscillations can be measured both in frequency and amplitude with a given observation. A square wave is also very useful in determining the transient response of networks. Time constants of R-C circuits can be easily observed, damped oscillations of resonant circuits can be checked, and the transient behavior of complicated networks can be studied by the application of a square wave to the network, making observations of the voltage or current with an oscilloscope.

Once proper criteria have been established it is possible with one or two observations with the *-hp-* Model 210A Square Wave Generator to check frequency response, phase shift characteristics, tendency to oscillate, time constants, etc. Thus the use of this instrument will save time and streamline production and laboratory testing.

SPECIFICATIONS

Frequency Range: The output of the generator is square within 1% over the frequency range from 20 cycles to 10,000 cycles. The time for the voltage to rise to 90% of maximum is approximately 1 microsecond; thus a reasonably square wave can be obtained even at 100 kilocycles.

Output Voltage: The output voltage is 60 volts peak to peak open circuit. The output impedance is 1000 ohms balanced to ground.

Output Attenuator: A 70 db attenuator is provided in the output with 5 db steps. The frequency response of the attenuator is sufficiently wide so that the output wave shape is not affected at the highest frequencies.

Driving Voltage: The generator is driven from any convenient external source of alternating voltage or it may be internally driven with the power line frequency. A driving voltage of two volts is required and the input impedance is 25,000 ohms.

Mounting: The Model 210A is mounted in an attractive steel cabinet 15" long, 7" high, and 9" deep, finished in wrinkle gray. The Model 210AR is mounted in a relay rack assembly with a 19" by 7" panel and is 8" deep. The dust cover is removable from the rear.

Power Supply: The generator is provided with a built-in power supply to operate from 115 volts 50/60 cycles. It requires approximately 50 watts.

Weight: Net weight, 30 pounds. Shipping weight, 39 pounds.

Data subject to change without notice.





MODEL 100B

SECONDARY FREQUENCY STANDARD

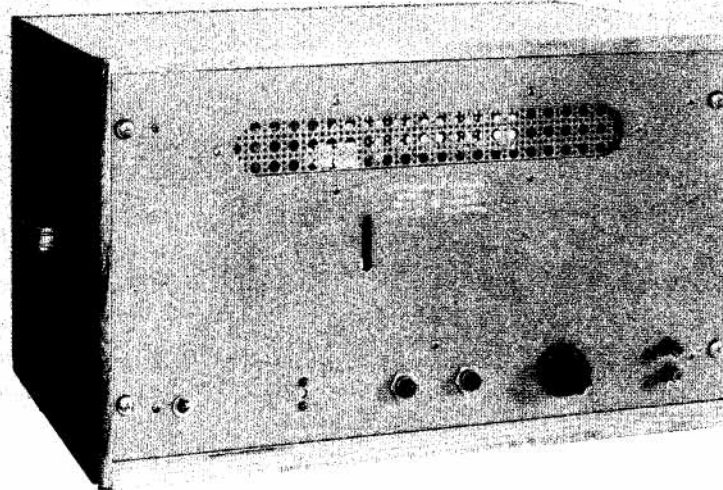
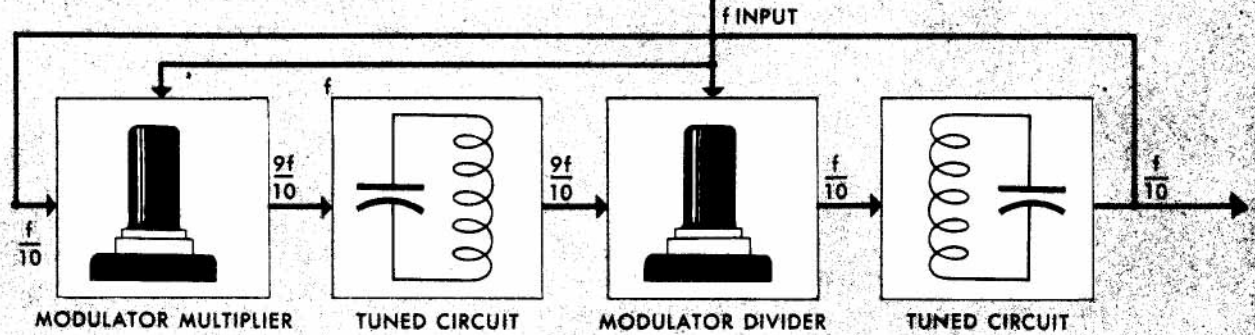

GENERATES FOUR STANDARD FREQUENCIES

ADVANTAGES:

- Supplies standard frequencies, 100 cps, 1 kc, 10 kc, and 100 kc
- Frequencies available simultaneously
- Stable operation
- Sinusoidal wave shape
- Separate terminals for each frequency
- Low output impedance

USE IT FOR:

- Calibrating audio oscillators
- Calibrating supersonic oscillators
- A time standard
- Checking oscillator stability

HE Model 100B Secondary Frequency Standard provides an extremely useful and convenient source of standard frequencies of 100 cps, 1 kc, 10 kc, and 100 kc. It is an accurate laboratory standard for calibration and comparison purposes.

The circuit of the Model 100B consists of a 100 kc crystal controlled oscillator and three frequency divider circuits which divide in a ratio of 10 to 1. The fundamental divider circuit consists of a modulator divider tube with a resonant circuit tuned to $f/10$ and a modulator multiplier tube with a resonant circuit of $9f/10$.

The operation of the circuit can be explained by assuming a small voltage in the resonant circuit of the modulator divider tube. This voltage is applied to the grid of the modulator multiplier tube, and the input control voltage is also applied to this tube. The two voltages mix to supply an output frequency of $9f/10$, which is fed to the grid of the modulator tube where it is mixed with the input control frequency (f), and results in a frequency of $f/10$ in the modulator divider

tuned circuit. The action is repeated and the voltage is built up until a stabilized condition is reached. Thus the output of the divider unit is controlled by the input frequency.

By cascading the 100 kc generated by the temperature-controlled oscillating quartz crystal down through three dividers, accurate fixed frequencies of 10 kc, 1 kc, and 100 cps are also made available. See figure 1.

USES

These frequencies are available through a selector switch (on front of panel) or individually from binding posts (rear of chassis). All four fixed frequencies can be utilized at separate test stations simultaneously, an economical feature.

The Model 100B provides four standard frequencies for accurate measurement purposes such as for calibrating oscillators, frequency meters and supplying test signals of high accuracy. The output wave shape is sinusoidal which will allow easy recognition of high fractional lissajous patterns such as 53/5 or 52/5. Thus exact measurements can be made of frequencies 1% or 2% apart in the audio spectrum, and up to 100 kc. With a distorting amplifier and a conventional mixer system harmonics may be obtained for frequency calibration to 20 megacycles or higher, even though the waveform of the standard is sinusoidal.

The output system is designed to isolate each frequency. The internal impedance of the output system is sufficiently low to permit the use of long lengths of low capacity shielded cable to distribute the standard frequencies in the laboratory or the test department.

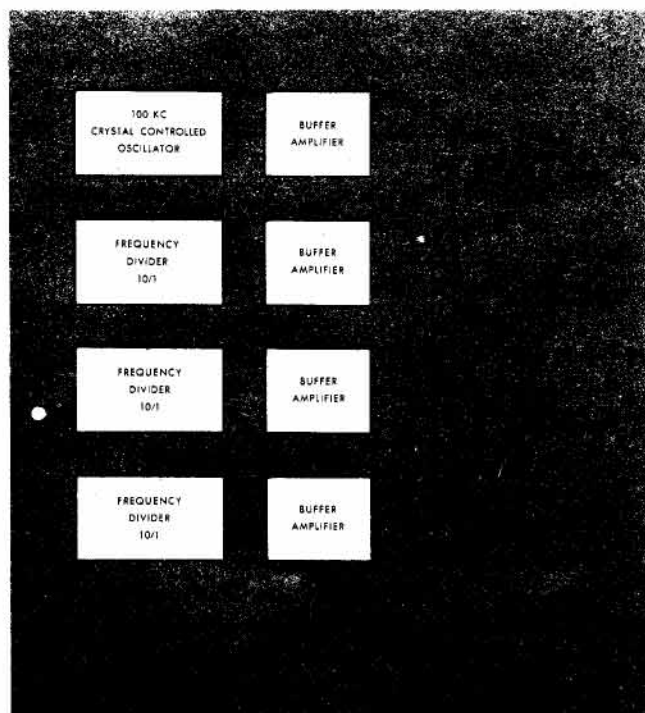

SPECIFICATIONS

Two models are available. The 100B which has a temperature controlled oscillating quartz crystal, and the Model 100A which is similar to the 100B but does not have temperature control.

Accuracy: The Model 100A is provided with a 100 kc crystal having a temperature coefficient of 3 cps per megacycle per degree centigrade. The crystal oscillator is arranged so that the frequency can be adjusted over a range of approximately ± 8 cps at 100 kc.

This feature allows the frequency to be set to a primary standard such as National Bureau of Standards Station WWV. The frequencies are correct within $\pm .01\%$ over a room temperature variation of ± 33 degrees Centigrade. The Model 100B is provided with a temperature controlled crystal which maintains the frequency within $\pm .001\%$ from minus 10 degrees Centigrade to plus 50 degrees Centigrade. It is also possible to adjust the frequency of the Model 100B approximately ± 8 cps at 100 kc.

Output: An output voltage of at least 5 volts is provided on all frequencies. The internal impedance of the output system is approximately 200 ohms and satisfactory wave shape can be obtained with a load impedance as low as 1000 ohms.

Wave Shape: The output wave shape is sinusoidal to a degree that will allow easy recognition of high fractional Lissajous patterns such as 53/4 or 52/5. Thus, exact measurements can be made at frequencies 1% or 2% apart in the audio spectrum, and up to 100 kc. With a suitable distorting amplifier and mixing system harmonics may be obtained for frequency calibration to 20 megacycles or higher.

Power Supply: The Standard operates from 115 volts 50/60 cycle power supply, and the power supply is regulated to minimize line voltage fluctuation effect. Power drawn is approximately 105 watts.

Mounting: The Model 100 is available in either cabinet or relay rack mounting. The panel size is 19" x 10 1/2", and the depth is 12".

Net weight, 53 pounds; shipping weight, 95 pounds.

Note: When ordering specify if temperature control of the crystal is desired; otherwise, specify ambient temperature at which crystal frequency should be set.

Data subject to change without notice.

SUPPLEMENTARY FREQUENCY DIVIDER

The Model 110 Frequency Divider Panel is for use in conjunction with Models 100A or 100B to supply frequencies not ordinarily generated by these instruments. The Model 110 can be supplied to generate frequencies between 10 and 100 cycles per second, or between 100 and 1 million cycles per second. The Model 110 Frequency Divider Panel is supplied only on special order to meet particular requirements.

ATTENUATORS AND VOLTAGE DIVIDERS

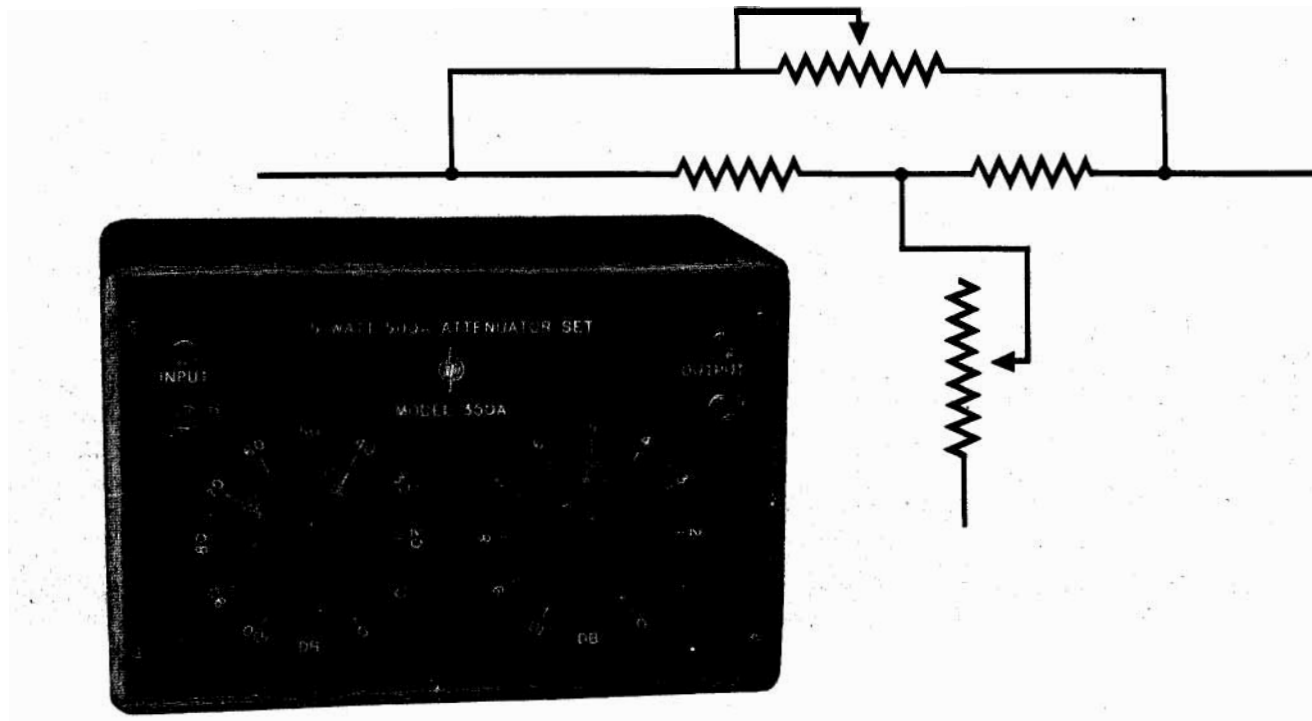

A SMALL INSTRUMENT WITH MANY USES

ADVANTAGES:

- Accurate
- Large Power Handling Capacity
- Wide Frequency Response
- Smooth Operation
- Convenient Controls

USE IT TO:

- Attenuate the output of supersonic and audio oscillators
- Measure gain and frequency response of amplifiers
- Measure transmission loss
- Increase usefulness of other laboratory instruments

OR measurement work where accuracy, wide frequency response, large power handling capacity, or other special features are desired, *-hp-* attenuators and voltage dividers are extremely valuable. Typical of these highly specialized instruments is the *-hp-* Model 350 Attenuator Set.

The schematic diagram above shows the basic bridged-T circuit, two of which make up the *-hp-* 350 Attenuator Set. One is a 100 db attenuator, calibrated in 10 db steps, and one is a 10 db attenuator, calibrated in 1 db steps.

A special design assures a response that is substantially flat to frequencies as high as 100 kc. See figure 1. Calibration is accurate because the individual resistors are adjusted to $\pm 1/2\%$.

USES

The *-hp-* Model 350 can be used wherever a decade attenuator is required.

In conjunction with an *-hp-* oscillator and one voltmeter, this *-hp-* Model 350 Attenuator may be used to make exact measurements of power gain. See figure 2.

The 350 may also be used to augment an *-hp-* audio oscillator and a vacuum tube voltmeter (*-hp-* 400A) to form a signal generator. See figure 3.

The 350 is built with a large power handling capacity—5 watts continuous duty. It is particularly adapted to work in the supersonic field, and for other work in measurements above the range of the conventional a-f attenuator. It may also be used for work down to zero frequency.

The 350, like all *-hp-* instruments, is held to a minimum size for convenience in use. Actual dimensions are 5" x 8" x 4½". Input and output binding posts are available on the front panel. The unit is completely shielded from moderate fields.

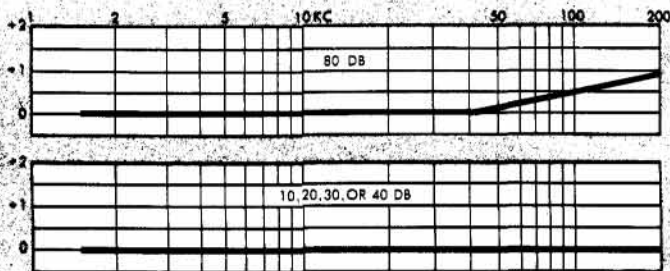

Figure 1

SPECIAL PROBLEMS

Attenuators, voltage dividers, matching networks, and precision resistors accurate for frequencies as high as one megacycle can be supplied. Inquiries pertaining to your particular measurement problem will be given prompt and careful attention.

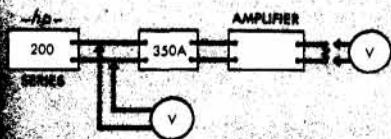

Figure 2

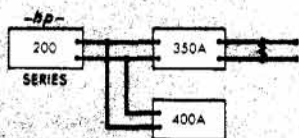

Figure 3

SPECIFICATIONS

Two models are available. The *-hp-* 350A matches a 500 ohm impedance and the *-hp-* 350B matches a 600 ohm impedance (one side grounded).

Attenuation: The attenuation is 110 db in 1 db steps.

Accuracy: Each individual resistor is adjusted to $\pm 1/2\%$.

Frequency Response: Accumulative error at 100 kc approximately 1 db in 50 db.

Power Capacity: The attenuator will handle 5 watts continuous duty.

Mounting: The attenuator is mounted in a small wooden cabinet 5" x 8" x 4½".

Net Weight: 4 pounds. Shipping Weight: 8 pounds.

Data subject to change without notice.

SPECIAL *-hp-* HARDWARE

Precision multi-tap switches and other hardware for use in equipment for measuring work are also available. Two typical examples of this special-purpose hardware are shown below.

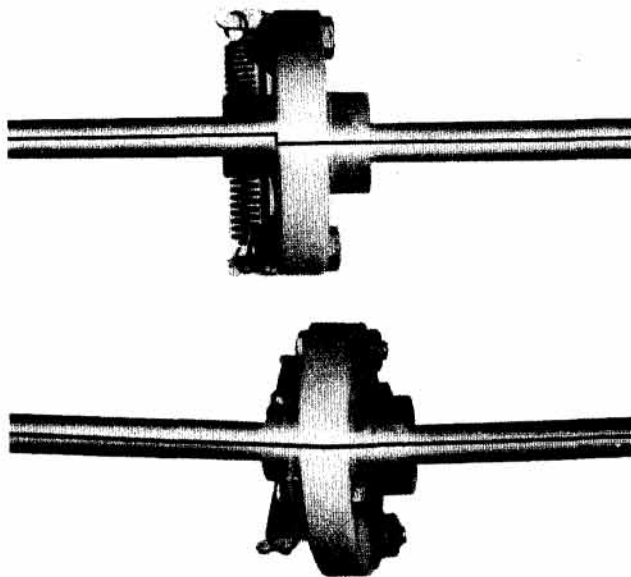

FLEXIBLE COUPLER

The *-hp-* flexible coupler permits the accurate, positive transmission of motion from one shaft to another when the two shafts are not accurately aligned. Misalignments of as much as 1/32" and/or 5° are permissible. At the same time, the two shafts are insulated from each other, each shaft being connected to a different point on the ceramic body of the coupler. The coupler is spring-loaded to prevent backlash.

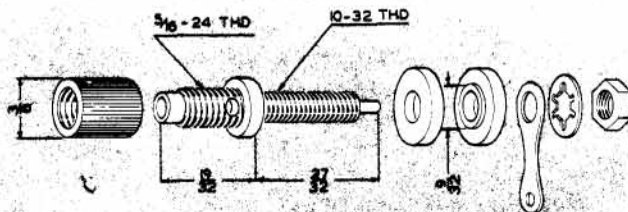

BINDING POSTS

The *-hp-* No. 10 binding posts shown, were designed to provide a positive connection that could be changed frequently. The recess for the "Banana" plug is in the main body of the post, a feature which eliminates excessive contact resistance. The cross-hole for permanent connection can be used even when the "Banana" plug is inserted. The screw thread is 10-32 and the tip is undercut so that a soldered connection will not damage the thread. The long, axially-knurled ferrule provides a wide surface for ease of handling and adds to the appearance.



MODEL 410A

HIGH FREQUENCY VACUUM TUBE VOLTMETER

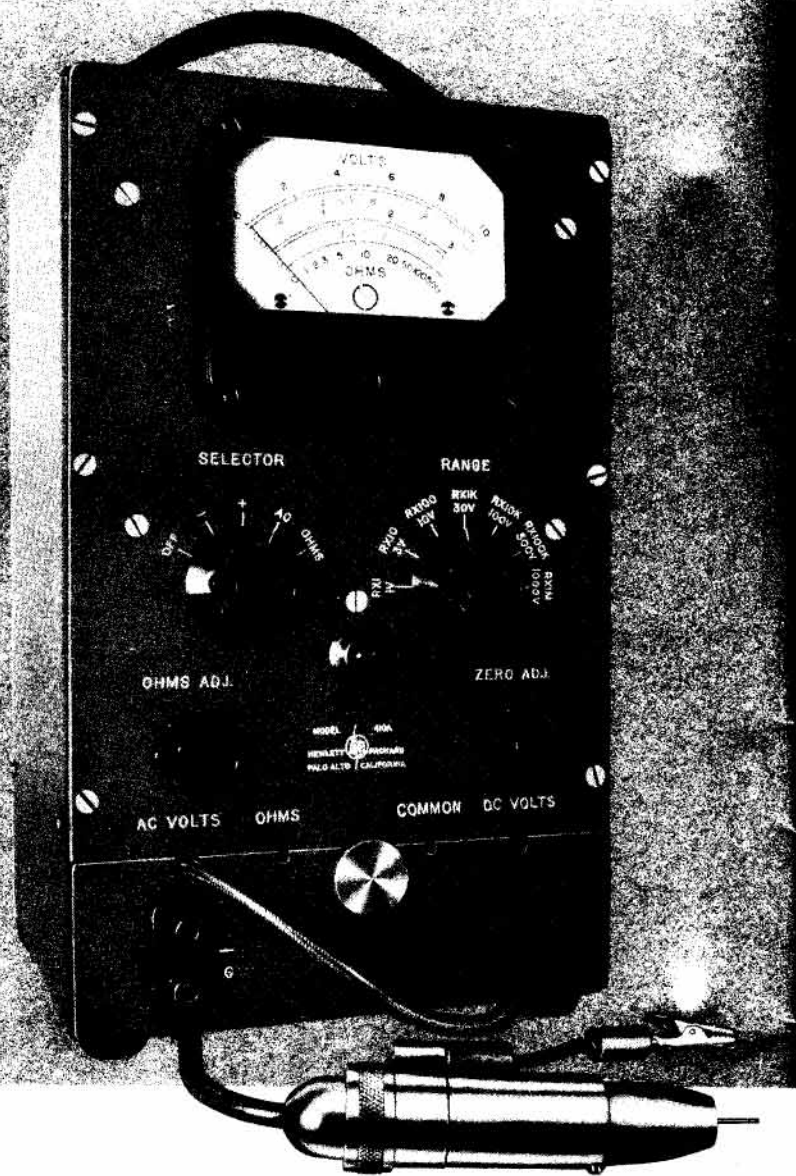

ADVANTAGES:

- Range: 20 cps to 700 mc
- Input Capacity 1.3 mmfd
- High Input Impedance
- Few Controls
- High Stability
- Rugged Meter Movement
- Excellent Overload Protection
- Small, Lightweight, Portable
- Built-in compartment for Probe and Test Leads

USE IT TO MEASURE:

- Audio Frequency, Supersonic R.F., and VHF Voltages
- Antenna Voltage, Current, and Power
- Transmission Line Characteristics
- Standing Waves
- Audio, Video, and VHF Amplifiers
- DC Voltage in High Impedance Circuits
- Resistance
- Insulation

ALL-PURPOSE TEST INSTRUMENT MEASURES TO 700 MC

BECAUSE of the tremendous number of tasks it will perform, the 410A High Frequency Vacuum Tube Voltmeter can play a uniquely valuable role in any laboratory, broadcast station, or production test department. It combines in one instrument an AC voltmeter covering the frequency range from audio to radar frequencies, a DC voltmeter with 100 megohms input impedance, and an ohmmeter capable of measuring resistance from 0.2 ohms to 500 megohms. In addition, it is easy to use, compact, portable, and light in weight.

A special probe, employing a new, radically different diode especially designed by Eimac for Hewlett-Packard, is used for making AC measurements. The resonant frequency of the diode is approximately 2000 Mc, and the shunt capacity is extremely low. Mounted in the probe, it places a capacity of only 1.3 mmfd across the circuit under test. Total input impedance for AC measurements is 6 megohms shunted by this capacity.

The 410A employs a high impedance DC voltmeter having a special circuit developed by *-b-p-* engineers. Its outstanding feature is low drift and maintenance of calibration over long periods of time. Only one zero adjustment is necessary for all voltage ranges, and once set it rarely needs readjustment. This circuit permits the use of a 1 ma meter movement which together with certain features of the circuit itself makes it im-

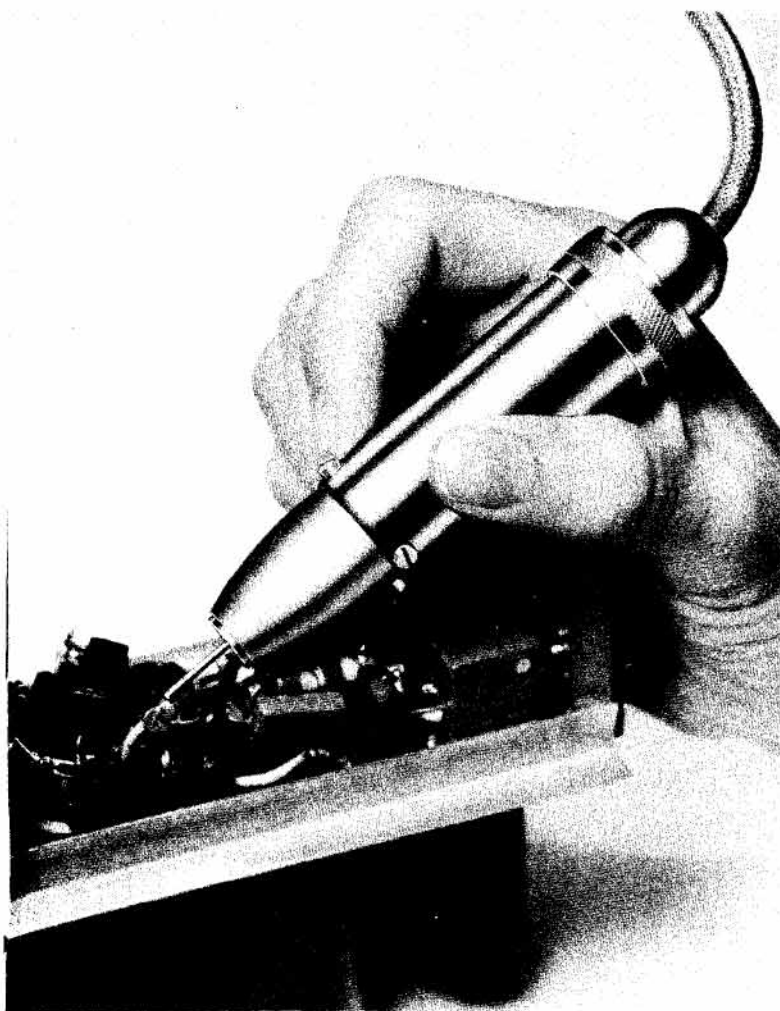

possible to damage the meter by overloads. Input impedance for DC measurements is 100 megohms for all ranges.

Frequency response of the instrument is flat within 1 decibel from 20 cps to 700 Mc, and due to the very high resonance frequency of the special diode, voltage indication can be obtained at a frequency of 3000 Mc. Overall accuracy of the instrument on sinusoidal voltages is $\pm 3\%$, and is the same for DC measurements.

USES

The versatility of the 410A is so great that the number of uses to which it may be put is almost endless. As an ohmmeter it will accurately measure resistance over a much wider range than is ever ordinarily encountered. As a DC voltmeter, its extremely high input impedance permits its use on almost any

equipment without any appreciable loading of the circuit under test.

As an AC voltmeter, its combination of high input impedance with great frequency range sets altogether new standards of performance. The probe can be inserted in almost any audio, supersonic, radio, or VHF amplifier without detectable loading of the circuit. It can be used to measure antenna and transmission-line voltage, current, and power with as much ease and convenience as if the circuits carried DC. Special adaptors can be supplied for use with the probe to connect to standard transmission lines.

Finally, the fact that all these functions are combined in one instrument means that where previously a whole battery of equipment might be required to test a given piece of apparatus, the 410A, in one small, convenient, and highly portable instrument, does the whole job. Leads are provided for all functions so that to change from one to another it is necessary only to throw a switch.

SPECIFICATIONS

Ranges: 1 to 300 volts in 6 ranges full scale: 1, 3, 10, 30, 100, and 300 volts AC or DC and 0-1000 volt range DC. Resistance 0.2 ohm to 500 megohms in seven ranges. Mid scale reading of 10, 100, 1000, 10,000, 100,000 ohms, 1 megohm, and 10 megohms.

Accuracy: $\pm 3\%$ of full scale on all ranges on sinusoidal AC voltages and on dc voltages. The ac portion of the instrument is essentially a peak-reading device and is calibrated in rms volts.

Frequency Response: Frequency response is flat within ± 1 db up to 700 mc and drops off less than 1 db at 20 cps. The resonant frequency of the probe input circuit is about 2000 mc, and an indication can be obtained up to 3000 mc.

Input Impedance: Input capacity is 1.3 mmfd; input resistance is 6 megohms at low frequencies. At high frequencies resistance drops off due to dielectric losses. DC input resistance is 100 megohms for all ranges.

Probe: The probe is approximately 1" diameter and $4\frac{3}{4}$ " long. It is equipped with a ground clip, and the connector may be soldered to the point under test. For operation at lower frequencies the probe can be mounted in the storage compartment and connections made to binding posts on the panel. Adapting connectors are available to measure voltages in coaxial transmission lines.

Power Supply: 115 volts, 50/60 cycles, 40 watts. Two $1\frac{1}{2}$ volt flashlight cells provide ohmmeter circuit voltage.

Mounting: Gray panel in a wrinkle gray finished metal case and provided with a carrying handle. May be operated vertically or lying flat on test bench. A compartment is provided to store the probe and leads. Size $12\frac{1}{16}$ " x $7\frac{5}{16}$ " x $6\frac{1}{4}$ ". Net weight 16 pounds, shipping weight 23 pounds.

POWER SUPPLY UNIT



REGULATED POWER SUPPLY

HE *-hp-* Model 710A Power Supply is an excellent source of DC power for every laboratory and production department use. It has been designed to give the ultimate in flexibility, compactness, portability, and economy. Output is continuously variable between 180 and 360 volts, and is practically independent of either line voltage or applied load for any setting. The noise and hum level is very low for any condition of operation. The output is stable over long periods of time. Its small size requires a minimum of bench space when in use, and little storage space when idle. Since many set-ups which call for a source of well-regulated DC also require an AC source for supplying filaments, a center-tapped, 6.3 volt source which will supply 5 amps AC has been included in addition. The low cost makes it practical and economical to employ many of them.

USES

Because of its stability and low noise level, the *-hp-* Model 710A Power Supply can be used in place of batteries in many applications. In such service its long life, dependability, and portability result in real savings, both in time and money. It may be used to power low-level amplifiers, constant-frequency oscillators, and any equipment requiring a voltage source of high stability. One of its outstanding uses is in supplying power for temporary set-ups, "breadboard" layouts, and the like, where its exceptional flexibility makes it applicable in countless ways.

ADVANTAGES:

- Compact
- Light weight
- Excellent regulation
- Low noise
- Variable output
- Low cost
- Flexible

USE IT FOR:

- Test set-ups
- "Breadboard" layouts
- Low-level amplifiers
- Stable oscillators

SPECIFICATIONS

Voltage Range: Output continuously variable from 180 to 360 volts. Either positive or negative output terminal may be grounded. 6.3 volts AC, center-tapped, also provided.

Regulation: Output constant to approximately 1% for loads of from 0 to 75 ma and line voltage variations of plus or minus 10%, for any setting. A maximum of 100 milliamperes can be drawn.

Noise and Hum: Total noise and hum is less than 0.005 volts for any condition of operation.

Input Power: 115 volts 50/60 cycles. 90 watts full load.

Mounting: Wrinkle gray finish. Panel size—7¼" x 8". Cabinet depth—11¾".

Weight: 18 lbs. Shipping weight—25 lbs.

Data subject to change without notice.

W A R R A N T Y

Hewlett-Packard Company warrants each instrument manufactured by them, to be free from defects in material and workmanship. Their obligation under this Warranty being limited to servicing or adjusting any instrument returned to their factory for that purpose, and to making good at their factory any part or parts thereof, which shall, within one year after making delivery to the original purchaser, be returned to them with transportation charges prepaid, and which on their examination shall disclose to their satisfaction to have been thus defective.

Hewlett-Packard reserves the right to make changes in design at any time without incurring any obligation to install same on units previously purchased.

This Warranty is expressly in lieu of all other obligations or liabilities on the part of Hewlett-Packard, and Hewlett-Packard neither assumes nor authorizes any other person to assume for them any liability in connection with the sales of Hewlett-Packard instruments.



HEWLETT-PACKARD COMPANY
395 Page Mill Road • Palo Alto, California

