

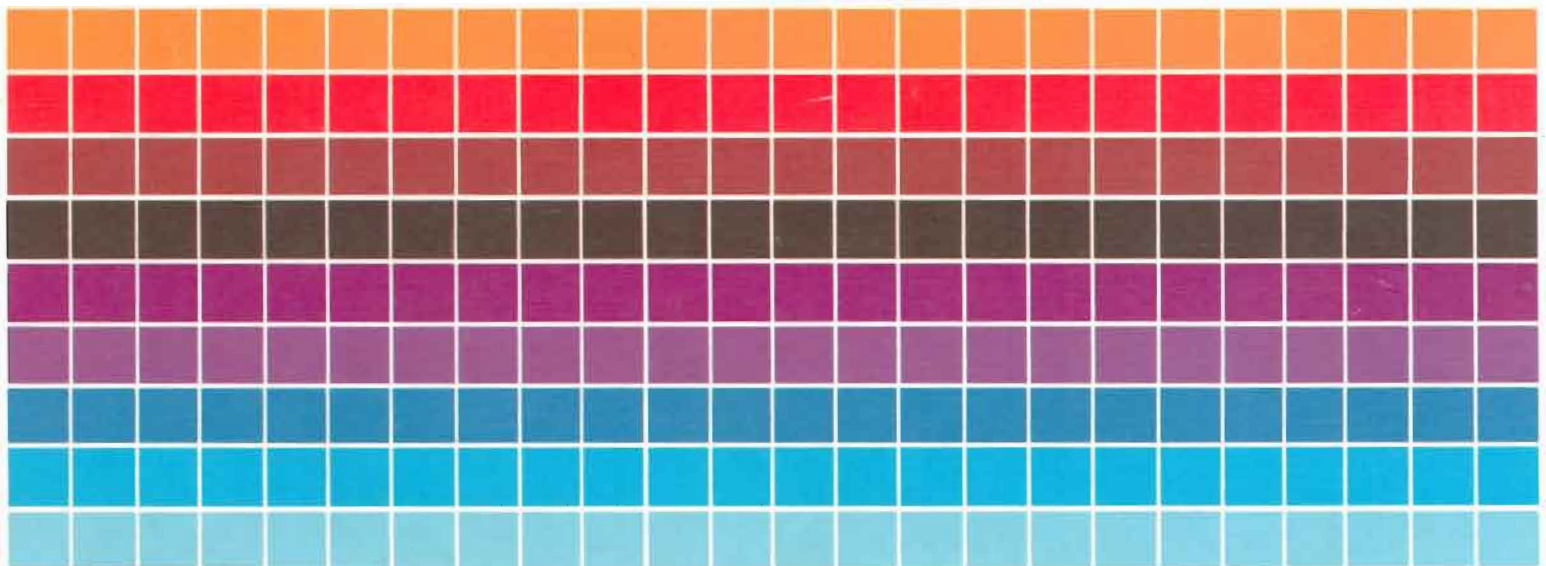

Measurement/Computation

ELECTRONIC INSTRUMENTS AND SYSTEMS

1981





**AT HEWLETT-PACKARD**

Our business is the practical application of high technologies. HP applies its scientific and engineering resources to two fundamental areas: Measurement and Computation. The company makes more than 4500 products with broad application in the fields of science, engineering, business, industry, medicine, and education.

HP has manufacturing facilities in more than 30 cities throughout the world and has more than 172 sales offices worldwide.

**Product Development**

Traditionally, HP invests from eight to ten percent of its sales revenue in research and development. The largest share of these dollars support product development programs within HP's manufacturing divisions. This level of commitment enables the company to employ the latest technologies in developing innovative products that can be reliably produced, delivered, and supported on a continuing basis.

*Many of the page numbers below refer to the beginning of a catalog section.*

**GENERAL PURPOSE  
ELECTRONIC INSTRUMENTS  
& SYSTEMS**

Accessories . . . . . p 75, 170, 207, 678, 682	Circuit Test Systems . . . p 120	Distortion Analyzers . . . p 548
Amplifiers . . . . . p 36	Component Testers . . . p 90	Electronic Counters . . . p 292
Calibrator . . . . . p 678	Digital Circuit Testers . . . . . p 124	Function Generators & Synthesizers . . . . . p 359

**RF & MICROWAVE  
MEASUREMENT**

Accessories . . . . . p 680	Microwave Counters . . . . . p 300
Amplifier . . . . . p 38	Microwave Link Analyzers . . . . . p 601
Electronic Counters . . . . . p 310	Microwave Semiconductors . . . . . p 696
Frequency Synthesizers . . . . . p 372	<b>Microwave Test Equipment . . . . . p 438</b>

**LOGIC & PROCESSOR-BASED  
CIRCUIT ANALYSIS**

Accessories . . . . . p 155, 343	IC Troubleshooters . . . . . p 124
Circuit Test Systems . . . . . p 120	<b>Logic Analyzers . . . . . p 138</b>
Digital Circuit Testers . . . . . p 124	Microprocessor Development System . . . . . p 144
Digital Test Systems . . . . . p 108	

**DIGITAL SIGNAL  
ANALYSIS (FOURIER)**

Digital Vibration Control System . . . . . p 546	Spectrum Analyzer . . . . . p 538, p 544
Fourier Analyzers . . . . . p 544	

**DATA ACQUISITION &  
CONTROL PRODUCTS**

Circuit Test Systems . . . . . p 120	<b>Data Acquisition Systems . . . . . p 78</b>
Computers, Peripherals & Calculators . . . . . p 610	Digital Voltmeters . . . . . p 49
	Electronic Counters . . . . . p 292

**TELECOMMUNICATIONS  
TEST EQUIPMENT**

Amplifier . . . . . p 38	Frequency Division Multiplexing (FDM) . . . . . p 588
Cable Maintenance & Construction Testers . . . . . p 585	Frequency Synthesizers . . . . . p 372
Data Communications Testers . . . . . p 570	Microwave Radio Testing . . . . . p 601

**HEWLETT-PACKARD  
INTERFACE BUS (HP-IB)  
SYSTEM PRODUCTS**

Component Testers . . . . . p 90	Electronic Counters . . . . . p 292
Computers & Peripherals . . . . . p 610	Function Generators & Frequency Synthesizers . . . . . p 359
Circuit Test Systems . . . . . p 120	<b>Hewlett-Packard Interface Bus . . . . . p 21</b>
Digital Voltmeters . . . . . p 49	

**COMPUTERS, PERIPHERALS  
& CALCULATORS**

Business Computers . . . . . p 631	Computer Graphics Displays . . . . . p 234
Calculators . . . . . p 612	CRT & Data Entry Terminals . . . . . p 632
<b>Computers, Peripherals &amp; Calculators . . . . . p 610</b>	Data Acquisition Systems . . . . . p 78
	Desktop Computers . . . . . p 620, 623

**OTHER PRODUCTS**

Analytical Instruments for Chemistry . . . . . p 698	Calibrator . . . . . p 678
Cabinets . . . . . p 682	Civil Engineering/Measuring Equipment . . . . . p 676
	CRT Displays . . . . . p 222

**HP Computer Museum**  
**[www.hpmuseum.net](http://www.hpmuseum.net)**

**For research and education purposes only.**

**Customer Experience**

Because HP products are functionally interrelated, the exchange of ideas throughout the company is continuous. A technological achievement in one product area often contributes to improved capabilities in other products and systems. Similarly, the wide range of customer needs improves HP's sensitivity and response. HP considers customer comments and suggestions essential to its continuing efforts to improve product quality and usefulness.



**Worldwide Support**

All HP products come with complete documentation, including instructions for their most effective and efficient operation. Wherever they are sold, worldwide, HP products are supported by customer training programs, by system analyst and customer engineer assistance where required, and by a worldwide network of parts and repair centers for maintenance and service. To locate the HP office nearest you, please see the listing on pages 715-720.

Contents overleaf

Multimeters, Digital . . . . . p 49	Power Supplies . . . . . p 236	Sweep Oscillators . . . . . p 403
Oscillators . . . . . p 353	Pulse & Data	Voltmeters, Analog . . . . . p 39
Oscilloscopes . . . . . p 176	Generators . . . . . p 336	Voltmeters, Digital . . . . . p 49
Plotters . . . . . p 653	Recorders & Printers . p 266	Wave Analyzer . . . . . p 492

Network Analyzers . . . . . p 460	RF Voltmeter . . . . . p 47	Transceiver Test Equipment . . . . . p 558
Oscilloscopes . . . . . p 176	Spectrum Analyzers . . . . . p 500	
Power & Noise Figure Meters . . . . . p 428	Signal Generators . . . . . p 373	
RF Impedance Meters . . . . . p 108	Sweep Oscillators . . . . . p 403	

Pulse & Data Generators . . . . . p 336		
Signature Analyzers . . . . . p 124, 536		

Frequency & Time	Logging Voltmeter . . . . . p 52	Multiprogrammers . . . . . p 665
Data Acquisition . . . . . p 303	Measurement & Control	Plotters . . . . . p 653
Hewlett-Packard Interface Bus . . . . . p 21	Processor . . . . . p 630	Recorders and Printers . . . . . p 266

Microwave Test Equipment . . . . . p 438	Pulse Code Modulation (PCM) . . . . . p 560	Sweep Oscillators . . . . . p 403
Network Analyzers . . . . . p 460	Signal Analyzers . . . . . p 492	<b>Telecommunications Test Equipment . p 560</b>
Power & Noise Figure Meters . . . . . p 428	Signal Generators . . . . . p 373	Transceiver Test Equipment . . . . . p 558
Pulse & Data Generators . . . . . p 336		

Logic Analyzers . . . . . p 138	Network Analyzers . . . . . p 460	Signal Generators . . . . . p 373
Measurement & Control	Power & Noise Figure Meters . . . . . p 428	Sweep Oscillators . . . . . p 403
Processor . . . . . p 630	Pulse & Data Generators . . . . . p 336	Telecommunications Test
Multiprogrammers . . . . . p 665	Signal Analyzers . . . . . p 492	Equipment . . . . . p 560

Discs/Drivers . . . . . p 647	Multiprogrammers . . . . . p 665	Technical Computers
Hard Copy Terminals . . . . . p 651	Plotters . . . . . p 653	& Systems . . . . . p 620, 623, 626
Hewlett-Packard Interface Bus . . . . . p 21	Recorders & Printers . . . . . p 266	
Line Printers . . . . . p 650		

Frequency & Time Standards . . . . . p 325	Physical & Optical Measurements . p 671	Training/Video Tapes . . . . . p 708
Laser Interferometer . . . . . p 672	Quartz Pressure Gauge . . . . . p 674	X-Ray Systems . . . . . p 702
Medical Instrumentation . . . . . p 700	Quartz Thermometer . . . . . p 673	
Optoelectronics Devices . . . . . p 694	Solid State Components . . . . . p 694	

## CONTENTS

<b>ALPHABETICAL INDEX</b> .....	<b>1</b>
<b>MODEL NUMBER INDEX</b> .....	<b>10</b>
Post-Sale Support Service .....	712
Application Notes .....	703
Information Request Card .....	back of catalog
Ordering Information .....	714
Sales/Service Offices .....	715
Warranty .....	712

### PRODUCT SECTIONS:

Analytical Instruments for Chemistry .....	698	Medical Instrumentation .....	700
Amplifiers .....	36	Microwave Test Equipment .....	438
Analog Voltmeters .....	39	Network Analyzers .....	460
Cabinets; Transit, Operating & Combining Cases .....	682	Oscillators .....	353
Cathode-Ray Tube Displays .....	222	Oscilloscopes .....	176
Circuit Test Systems .....	120	Personal Calculators .....	612
Civil Engineering/Measuring Equipment .....	676	Physical & Optical Measurements .....	671
Component Measurement .....	90	Power & Noise Figure Meters .....	428
Computers, Peripherals & Calculators .....	610	Power Supplies .....	236
Data Acquisition Systems .....	78	Pulse & Data Generators .....	336
DC Power Supplies .....	236	Recorders & Printers .....	266
Digital Circuit Testers .....	124	Signal Analyzers .....	492
Digital Voltmeters .....	49	Signal Generators .....	373
Electronic Counters .....	292	Sweep Oscillators .....	403
Function Generators & Frequency Synthesizers .....	359	Solid State Components .....	694
Frequency & Time Standards .....	325	Telecommunications Test Equipment .....	560
Hewlett-Packard Interface Bus (HP-IB) .....	21	Training/Video Tapes .....	708
Logic Analyzers .....	138	Transceiver Test Equipment .....	558
Measurement Accessories .....	678	X-Ray Systems, Scientific & Industrial .....	702



Identifies products having the Hewlett-Packard Interface Bus (HP-IB) capability. HP-IB is our implementation of the IEEE Standard 488 and the identical ANSI Standard MC1.1, "Digital interface for programmable instrumentation." For the complete story, see pages 21-35.



Identifies newly introduced products or capabilities. New products are also indicated by boldface listings in the Model Number Index.

**Specifications** describe the product's warranted performance.

Parameters that are described as **typical**, **nominal**, or **approximately** ( $\approx$ ) are non-warranted supplemental characteristics intended to provide information useful to applying the product.

- A**
- AC**
- Digital Voltmeter ..... 49-77, 554
  - Divider Probe ..... 75, 678
  - Probes ..... 75, 679
  - Resistance Meter ..... 43, 52-77, 92-3
  - True RMS Voltmeters ..... 46, 58, 66, 68, 70, 554
- Accessories**
- Cables/Connectors ..... 174, 680, 694
  - Camera ..... 216
  - Carrying Cases ..... 175, 218, 688-693
  - Connectors, Adapters ..... 681
  - Modular Enclosures (System II) ..... 681
  - Logic Analyzer ..... 170-175
  - Oscilloscope ..... 207
  - Overhead Transparency Kit ..... 660
  - Plotter/Printer ..... 660
  - Pulse & Data Generators ..... 349, 679
  - Signal Generator ..... 402
  - SLMS ..... 600
  - Spectrum Analyzer ..... 535
  - Transit Cases ..... 688
  - Voltmeter ..... 75, 678-680
- AC/DC Converter Preamplifier** ..... 286
- AC/DC Meter Calibrator** ..... 678
- Active Probes** ..... 212, 306, 481, 600
- Adapters**
- 50-75  $\Omega$  ..... 402, 477, 481, 535, 681
  - Cables/Connectors ..... 175, 680
  - Detector ..... 458
  - Noise Source ..... 437
  - Slotted Line Sweep ..... 448
- Air Line Extensions** ..... 453
- Alphanumeric LED Displays** ..... 694
- AM/FM Signal Generators** ..... 376, 378, 384, 387, 392
- AM/FM/ $\phi$ M Modulation Analyzer** ..... 551
- AM/FM/ $\phi$ M Signal Generator** ..... 380
- AM/FM Test Source** ..... 553
- Amplifiers**
- Broadband Preamp ..... 37
  - Distribution ..... 334
  - GaAs FETs ..... 697
  - General Purpose ..... 36
  - Logarithmic ..... 36
  - Low Noise ..... 36, 600
  - Plug-Ins for Oscillographic Recorder ..... 281-283, 285-287
  - Power ..... 38
  - Power Supply ..... 259
  - RF/Microwave ..... 38
- Analog Circuit Test System** ..... 123
- Analog-to-Digital Converter** ..... 29, 49-77, 665
- Cards, Multiprogrammer
    - High Speed ..... 665
    - Low Level ..... 665
- Analog Voltmeters** ..... 39-48
- Analyzers**
- Accuracy Enhancement Program for 8409B ..... 490
  - Audio ..... 554
  - Audio Spectrum ..... 526, 538, 546
  - Automatic Network ..... 465-467, 478, 490
  - Automatic Spectrum ..... 500, 514, 536, 538, 542, 544, 546
  - Baseband ..... 608
  - Correlation ..... 544, 546
  - Data Line ..... 573
  - Digital Signal ..... 120-123, 544, 546
  - Distortion ..... 546-549, 554
  - Fourier (FFT) ..... 538, 544, 546
  - Frequency Stability ..... 556
  - Gain-Phase ..... 465, 468, 546
  - HP-IB ..... 28, 173
  - Logic ..... 138-175
  - Low Frequency Impedance ..... 112
  - Low Frequency Spectrum ..... 526, 538, 544, 546
  - Mechanical Impedance ..... 544, 546
  - Microwave Link ..... 602, 604
  - Modal ..... 544
  - Modulation ..... 546, 549, 551
  - Network ..... 460-491
  - Power Spectrum ..... 544, 546
  - Primary Multiplex ..... 562
  - RF Impedance ..... 108
  - RF Signal Modulation ..... 551
  - Selective Level ..... 590, 596
  - Serial Data ..... 166-169
  - Spectrum ..... 500-543
  - Signature ..... 124, 132-135, 536-538, 546
  - Structural Dynamics ..... 544
  - Telephone Line ..... 572
  - Timing, Logic ..... 148-150
  - Transfer Function ..... 544, 546
  - Vibration ..... 536, 544, 546
  - Wave ..... 504, 544, 546, 550
- Applications Manual, Optoelectronics** ..... 695
- Application Notes** ..... 703-707
- APC-7<sup>®</sup> Series Adapters** ..... 681
- Atomic Clock/Frequency Standard** ..... 325
- Attenuators**
- 75-Ohm General Purpose ..... 602
  - 600-Ohm Balanced & Unbalanced ..... 115
  - Coaxial, Fixed ..... 440
  - Coaxial, Microwave, OEM ..... 439
  - High Power Microwave ..... 440
  - HP-IB Driver ..... 442
  - Coaxial Step ..... 439, 442
  - Waveguide ..... 439
- Automatic Calibration DMM** ..... 72
- Automatic Capacitance Bridge** ..... 94-105
- Automatic Data Acquisition Systems** ..... 78-89, 303
- Automatic LCR Meter** ..... 102
- Automatic Measurement & Control System** ..... 82
- Automatic Modulation Analyzer** ..... 551
- Automatic Pair Identifier** ..... 586
- Automatic Test Systems** ..... 78, 120, 478, 490, 514
- Automatic Network Analyzer** ..... 465, 478, 490
- Automatic Synthesizer** ..... 364-371
- Automatic Spectrum Analyzer** ..... 500, 514, 538, 546
- Automatic Sweep Oscillator** ..... 406
- Automatic Transceiver Test System** ..... 558
- B**
- Balanced 2/4 Wire Audio Channel Selector** ..... 564
- Baseband Analyzer** ..... 608
- Battery Operated**
- Counters ..... 314-322
  - DVM ..... 49-61, 64-67
  - Microwave Power Meter ..... 431, 434
  - Multifunction Meter ..... 52-61, 64-67
  - Strip Chart Recorder ..... 276
  - Voltmeter ..... 54



- Bit Error Rate Tester ..... 584  
 Board Tester, Analog ..... 123  
 Board Tester, Digital ..... 122  
 Breadboard Cards, Multiprogrammer ..... 665  
 Bridge, Directional ..... 456, 476, 481  
 Business Computers ..... 631  
 Broadband Sampling Voltmeter ..... 47
- C**
- C Meter ..... 95  
 Cabinet Identification ..... 682  
 Cabinet Accessories ..... 684-693  
 Cabinets, System II, 1/2-width Adapter ..... 342, 343  
 Cable Assemblies ..... 487, 680  
 Cables/Connectors ..... 174, 680  
 Cables, HP-IB ..... 30, 681
- Calculators, Personal  
   Alphanumeric Programmable ..... 614, 615  
   Financial ..... 614, 616, 617  
   Financial Programmable ..... 614, 616, 617  
   Fully Programmable ..... 614, 616  
   Printing ..... 614, 616  
   Scientific ..... 613, 614, 616  
   Scientific Programmable ..... 613, 614, 616  
 Calibration Data, Attenuators ..... 440
- Calibrators  
   AC/DC Meter Calibrator ..... 678  
   AM/FM (8901A) ..... 552  
   Power Meter Calibrator for 432 Series  
     Power Meters ..... 435  
   Range Calibrator for 435A Power Meter ..... 431  
   Peak Power ..... 435
- Camera  
   Adapters ..... 217  
   Oscilloscope ..... 216  
   Oscilloscope Camera Adapter Table ..... 218  
 Capacitance Bridges; Meters ..... 95-99  
 Capacitors, Decade ..... 115  
 Card Readers ..... 349, 645, 649  
 Card Reader for 1600A ..... 165  
 Carriage, Slotted Section ..... 448  
 Carrier Preamplifiers ..... 285  
 Carrier Testing ..... 588  
 Cart, Development Station ..... 175  
 Cartridge, Disc ..... 661  
 Cases, Combining ..... 692, 693  
 Cavity Frequency Meters ..... 447  
 Cesium Beam Frequency Standard ..... 328  
 Circuit Test Systems ..... 120-123  
 Civil Engineering Products ..... 676  
 Clips, Logic ..... 128  
 Clip, IC Test ..... 210  
 Clip-on, DC Milliammeter ..... 41  
 Clock, Atomic ..... 325
- Coaxial Instrumentation  
   Accessories ..... 680  
   Adapters ..... 452, 681  
   Air Lines ..... 452  
   Attenuators ..... 36, 439, 440, 442  
   Crystal Detectors ..... 446  
   Directional Bridge ..... 456, 476, 481  
   Directional Couplers ..... 444  
   Directional Detectors ..... 445, 607  
   Dual Directional Coupler ..... 444  
   Fixed Attenuators ..... 440  
   Filters ..... 450, 457  
   Frequency Meters ..... 447
- Harmonic Mixer ..... 450  
 High Pass Filter ..... 457  
 Low-Pass Filters ..... 450, 457  
 Noise Sources ..... 437  
 Pad Attenuators ..... 440  
 Power Sensors ..... 432, 435  
 Power Splitter ..... 456, 471, 482  
 Shorts ..... 449  
 Sliding Load ..... 449  
 Slotted Line Carriage ..... 448  
 Slotted Line ..... 448  
 Slotted Section ..... 448  
 Step Attenuators ..... 439, 442  
 Swept Slotted Line Systems ..... 448  
 Switches ..... 451  
 Terminations ..... 449  
 Thermistor Mounts ..... 435  
 Thermocouple Mounts ..... 432  
 Waveguide Adapters ..... 452
- Comb Generator ..... 535  
 Combining Cases ..... 692  
 Communications Test Equipment ..... 166-169, 560-609  
 Communications Test Set ..... 574  
 Comparator, Logic ..... 129  
 Component Measurement ..... 90-119  
 Components  
   Solid State ..... 694-696  
 Component Oscillators ..... 327  
 Component Testers  
   Digital IC Tester ..... 116  
   Digital IC Tester Interface Kit ..... 119  
   Digital IC Test System ..... 122, 110, 118
- Computers & Peripherals ..... 610, 621, 622, 653-659  
   Business Oriented Computer Systems ..... 620, 631  
   Desktop ..... 623  
   Disc Drives ..... 621, 622, 646, 647, 662, 664  
   Disc Media ..... 661  
   Display Terminals, CRT ..... 632  
   External Tape Memory ..... 649  
   Graphics Printer ..... 653, 659  
   Line Printer ..... 649, 650  
   Personal ..... 620  
   Plotters ..... 653-659  
   Plotter/Printers ..... 658  
   Printers, Printer Terminal ..... 651  
   Tape Drive ..... 652  
   Technical Computers ..... 623-628  
   Thermal Graphics Printers ..... 649, 659  
   Printing Terminals ..... 640, 641
- Computer-based Network Analyzer ..... 478, 490  
 Computer-based Spectrum Analyzer ..... 500-503, 502, 514, 546  
 Computer (Desktop) Controlled  
   Instrument Systems ..... 79-87  
 Computer System Test ..... 122, 152  
 Connector Adapters ..... 681  
 Connectors, Microwave Precision ..... 452, 681
- Converters  
   A-to-D ..... 28, 52-89, 665  
   D-to-A ..... 28, 665  
   DC to DC Converters ..... 261-263  
   Frequency ..... 391, 399, 401  
   Serial-to-Parallel Converters ..... 28, 165
- Counters, Electronic  
   Counter/Timer ..... 295  
   Counter/Tracking Generator ..... 528  
   Digital Multimeter/Counter ..... 321



DVM	307, 311	Modular, 110 W Switching	
F&T Data Acquisition System	303	Regulated	261–263
Heterodyne Converter Plug-Ins	324	Modular, Triple-Output Switching	261–263
Low Cost	317, 323	Options	260
Microwave	300–302	Precision Voltage Sources	256
Plug-In Adapters	298	Programmable	246, 252, 253, 264, 265, 665
Portable, Battery Operated	314–322	Specifications Definitions	237
Pulsed RF	299	Decade Capacitors and Attenuators	115
Reciprocal	295, 304, 307, 314	Degausser for 5061A Frequency Standard	329
Time Interval	295, 304, 307, 310, 314, 317, 321	Desktop Computers and Peripherals	34, 620–623, 647
Time Interval Probes	306	16-bit Parallel Interface	35
Universal	292–298, 304–322	BCD Input Interface	35, 622, 646
Counter/Totalizer Card	665	Card Reader	645, 649
Couplers, Directional (Coax and Waveguide)	444, 445	Cartridge Tape Unit	649
Cradle, Wall Mounting	644	Character Impact Printer	649
CRT Displays	222–235	Desktop Computers	34, 620, 623
CRT Terminals	632	Digitizer	648
Crystal Detectors	446, 447	Disc Interface	35
Crystal Oscillators	327	Flexible Disc Drive	647
Current Probe	41, 212	General Interface	35, 37, 622, 646, 656
Current Tracer, Digital	127	HP-IB Interface	34, 622, 646, 654–659
<b>D</b>		Incremental Plotter Interface	35
D/A Converter	28, 665	I/O Expander	649
D/A Converter Cards, Multiprogrammer	665	Interfacing Summary	646
Data		Multiprogrammer: I/O Expander & Converter	665
Acquisition Systems	78–89, 303	Plotters, Graphics	653–657
Capture Terminals	644	Plotter/Printers	653, 658
Communications	570	Printer, Graphics	653, 659
Generators	348–352, 566	Plotter (Incremental) Interface	35
Line Analyzers	573	Real Time Clock Interface	35
Logger	60, 78–89	Serial Interface	35, 622, 646, 656
Normalizer	475, 491	RS-232-C Serial Interface	35, 622, 654–659
Serial Analyzer	166–169	Tape Cartridge Unit	649
Transmission Test Set	574	Tape Degausser	289
Voice Channel Test Set	579	Tape Duplication Interface	35
<b>DC</b>		Tape Punch	649
Milliammeters	40–42, 62–74	Thermal Printers	291, 649, 659
Nullmeter	40	X-Y Plotters	266–275
Voltage Source	106	<b>Detectors</b>	
Voltmeters	49–77	Adapter	458
DC-to-DC Converters	261–263	Coaxial, Microwave, OEM	446
<b>DC Power Supplies</b>	236	Crystal, Coaxial and Waveguide	446, 447
Amplifier/Power Supply	259	Diodes	694
Autoranging	246, 253	Directional	445, 607
Condensed Listing	238	Error	566
Constant Current Sources	258	Error (Bell Compatible)	568
Digitally Controlled	252	Slotted Line	448
Dual Tracking	254	<b>Development Station</b>	144
General Information	236	<b>Development Systems, Logic</b>	144–147
General Purpose: 10-30W Output	240–243	<b>Diagnostic Kit</b>	600
General Purpose: 25–200 W Output	244	<b>Digital</b>	
General Purpose: 100–2000 W		AC Voltmeters	49–77
Output	248	Analyzer, Logic	138–175
General Purpose: 300–11,000 W		Analyzer, Signature	132–135, 536–543, 546
Output	250	Board Tester	120–123
High Voltage	255	Circuit Test	120–124
HP-IB Programmable	252, 264, 665	Current Tracer	127
Low Cost Lab	240–243	DC Voltmeters	49–77
Microprocessor	243, 261–263	IC Tester	116–119
Modular, DC-to-DC Converters	261–263	IC Tester, Interface Kit	119
Modular, Single Output, Series		IC Test System	118
Regulated	261–263	Impedance Meter	95–99, 101–105
Modular, Dual Output, Series		LCR Meter	96–99
Regulated	261–263	Microprocessor Troubleshooting	120, 123, 124
Modular, 200–600 W, Switching		Microprocessor Training	137
Regulated	261–263		



Multimeter .....	52-77	Event Sense Card, Multiprogrammer .....	665
Oscillator .....	358	Exerciser, Microprocessor .....	134
Output Card .....	665	Extenders, HP-IB .....	32, 33
PC Board Test System .....	122	<b>F</b>	
Power Meters .....	430, 434	Faxitron® X-Ray Systems .....	702
Pressure Gauge .....	668	FDM/Carrier Systems Testing .....	588
Programmable Power Supplies .....	246, 252, 253, 264, 265, 665	FDM Network Surveillance Systems .....	594
Signal Analyzers .....	492-557	Fiber Optic HP-IB Link .....	33
Signal Generators .....	376-390	Fiber Optics .....	694
Signature Analyzer .....	132-135, 536-543, 546	Fiber Optic Power Meter .....	434
Spectrum Analyzers .....	500-543	Fiber Optic Power Sensor .....	436
Stimuli .....	134, 336-352	Filters	
Storage Unit .....	475, 491	Bandpass .....	402
Test Sets, Digital Logic .....	130	Coaxial and Waveguide .....	402, 450, 457
Thermocouple Card, Multiprogrammer .....	665	High Pass .....	457
Thermometer .....	673	Low Pass .....	322, 450, 457, 522
To Analog Current Converter Card .....	665	Fixed Disc Drive .....	664
To Analog Voltage Converter Card .....	665	Four Color Plotters .....	654, 655
Training .....	136	Fourier Analyzer .....	544, 546
Troubleshooting .....	124	FM Modulation Analyzer .....	551
Troubleshooting (Video Tape) .....	708	FM Signal Generators .....	376, 378, 380, 384, 386, 387, 390, 392
Vibration Controller .....	546	Frame Alignment Monitor & Error Detector .....	565
Voltmeters .....	49-77	Frequency	
Digital Input/Analog Comparator Card .....	665	Converters .....	391, 399, 401
Digital Input Card, Multiprogrammer		Counters .....	292-324
Common Ground .....	665	Counter/Modulation Analyzer .....	551
Isolated Input .....	665	Counter/Signal Generator .....	387
Digital-to-Analog Converters .....	252, 665	Counter/Synchronizer .....	392
Digital Output Card, Multiprogrammer .....	665	Counter/Tracking Generator .....	528
Diode Tester .....	52, 60	Doublers .....	391, 399, 401
Diodes .....	696	Meters, Coaxial and Waveguide .....	447
Directional Bridge .....	456, 476, 481	Response Test Set .....	454
Directional Detectors .....	445, 607	Stability Analyzer .....	556
Disc Cartridge .....	661	Synthesizer, Microwave .....	386
Disc Drives .....	647, 662, 664	Frequency Reference Card, Multiprogrammer .....	665
Disc Media .....	661	Frequency Standards .....	325
Disc Pack .....	661	Cesium .....	328
Displays, Cathode-ray Tube .....	222-235	Distribution Amplifier .....	334
Computer Graphics .....	235, 653	General Information .....	325
Display System .....	27, 234	Quartz .....	327
Graphics Translator (HP-IB Interface) .....	27, 234	Rubidium .....	331
Imaging .....	226	Standby Power Supplies .....	335
Instrumentation .....	232	Frequency Doubler .....	391, 399, 401
Distortion Analyzers .....	547, 548	Frequency and Time Standards .....	325
Distance Meter .....	676	Frequency Selective Meter and	
Distribution Amplifier .....	334	Tracking Oscillator .....	596-599
Double Balanced Mixer .....	402, 697	Frequency Stability Analyzer .....	556
Doubblers, Frequency .....	391, 399, 401	Frequency Synthesizers .....	364-372, 374, 376, 378, 380, 384, 386
Down Converter .....	391	Function Generators .....	359-363
Down Converter (1.7-14.5 GHz to 70/140 MHz) .....	606	Functional Tester .....	123
Dual Tracking, Power Supply .....	254	Fuseholder, RF .....	402
Dynamics Analyzer, Structural .....	544		
<b>E</b>		<b>G</b>	
EIA Registered Visible Light		GaAs Field Effect Transistors .....	696
Emitters/Detectors .....	694	Gas Chromatographs .....	698
Optical Reflective Sensor .....	694	General Purpose Interface	
Electronic Counters .....	292-324	Bus Controllers .....	35
Electronic Total Station .....	676	Generators	
Emulator: Z80; 6800; 8080/8085 .....	144	Data .....	336, 566
Equalizers, Cable .....	600	Function .....	359-363
Error Measuring Set (1 kb/s-50 Mb/s) .....	567	HP-IB Timing .....	28
Error Measuring Set (1 kb/s-150 Mb/s) .....	566	Noise .....	437
Error Measuring Set (Bell Compatible) .....	568	Pattern .....	567
Error Rate Measurements .....	565-569		



Pattern (Bell Compatible) .....	568
Pulse .....	122, 361-364
Signal .....	373-399
Square Wave .....	348, 361, 364
Sweep .....	364, 372, 403-427, 607
Tracking .....	370, 516, 520, 526, 528, 530, 533
Graphics Plotters .....	653-654
Accessories & Supplies .....	660
Graphics Plotter/Printers .....	658
Graphics Printers .....	649, 659
High-Speed Desktop .....	659
Graphics Translator (HP-IB Interface for displays) .....	27, 234
Group Delay (Network Analyzer) .....	472
Guarded Digital Multimeter .....	72-77
<b>H</b>	
Harmonic Mixer (Coaxial and Waveguide) .....	450
Hewlett-Packard Interface Bus (HP-IB) .....	21-35
High Gain Preamplifier .....	285
High Power Attenuators .....	440
High Power Sensors .....	432
High Resistance Meter .....	93
High Speed A/D Converter Card, Multiprogrammer ..	665
High Speed Scanner .....	84
High Speed System Voltmeter .....	66, 68
How to Solder (Video Tape) .....	713
How to Use an Oscilloscope (Video Tape) .....	713
HP-IB	
Analyzers .....	28
Cables .....	30
Controlled Attenuator/Switch Driver .....	442
Controlled Channel Selector .....	564
Controllers .....	34
Extenders .....	32, 33
Extension .....	32, 33
General Information .....	21
Relay Actuator .....	28
<b>I</b>	
IC Tester, Digital .....	116, 120
IC Test System, Digital .....	116, 118
Impedance Analyzer .....	112
Impedance Meter .....	96-105, 114
Impedance Probe .....	481
Impedance Transformers (50-75 $\Omega$ ) .....	477, 481, 535
In-circuit Functional Tester .....	123
Industrial Distance Meter .....	677
Instrument Cart .....	175, 600
Insulation Resistance Meter .....	68, 93
Insulation Test .....	93
Integrators, Reporting .....	691
Interface Bus (HP-IB) .....	21
Interface Cards for Desktop Computers .....	34, 622
Interface Kits	
Logic Analyzer .....	172-173
Multiprogrammer .....	665
Interfacing Summary for Desktop Computers .....	646
Interrupt Card, Multiprogrammer .....	665
I/O Calculator .....	623, 646
Inverter Power Supply (1700 Series Oscilloscopes) .....	215
I/O Expander for Desktop Computers .....	649
<b>J</b>	
JAN & JANTX Products .....	696

<b>L</b>	
Laboratory Automation Systems .....	691
Laboratory Strip Chart Recorders .....	266, 276-280
Laboratory X-Y Recorders .....	266-275
Laser Measurement .....	672
LCR Meter .....	92, 96-105
Light Emitting Diodes .....	695
Limiter .....	535, 697
Liquid Chromatographs .....	699
Logarithmic Preamplifier .....	286
Logarithmic Voltmeter .....	48
Logging Multimeter .....	60
Logic	
Analyzer, Development System .....	144
Analyzers .....	138-175
Analyzer Accessories .....	170-175
Analyzer Interface Kits .....	172-173
Clip .....	128
Current Tracer .....	127
Comparator .....	129
Development System .....	144-147
Lab .....	136
Pattern Generator .....	350
Probes .....	125
Pulser .....	126
Signal Sources .....	336-352
Troubleshooting Kits .....	130
Low Distortion Generator .....	364
Low Distortion Measurement Set .....	548
Low Frequency Impedance Analyzer .....	112
Low Frequency Spectrum Analyzer .....	526, 536-538, 544, 546
Low Gain Bank Preamplifier (8-channel) .....	286
Low Gain Preamplifier .....	281-283, 285
Low Level A/D Converter Card, Multiprogrammer ..	665
Low Resistance Meter .....	68, 72, 92
<b>M</b>	
Machinery Analyzer .....	538, 544, 546
Magnetic Tape Recorders, Analog .....	288-290
Magnetic Tape Units .....	652
Mark Reader, Optical .....	645
Marker Generator .....	427
Mass Spectrometers .....	698
Measurement and Control System .....	79, 630
Mechanical Impedance Analyzer .....	544, 546
Media, Disc .....	661
Medical Instrumentation .....	700
Medium Gain Bank Preamplifier (8-channel) .....	286
Medium Gain Preamplifier .....	281-283
Medium Range Distance Meter .....	676
Memory Card, Multiprogrammer .....	665
Meters	
AC .....	42-77
AC Resistance .....	42, 43, 49-77
Capacitance .....	95-99, 101-105
Conductance .....	95-99, 101-105
Digital Multimeter .....	52-77
Frequency .....	447
Impedance .....	95-99, 101-105, 114
LCR .....	95-105
Logarithmic Voltmeter .....	48
Milliammeter, AC .....	54-77, 679
Milliammeter, DC .....	42, 54-77
Milliohmmeter .....	54-77, 92

Modulation .....	551	Null meter .....	40
Multifunction .....	43, 52-77	<b>O</b>	
Noise Figure .....	437	<b>OEM</b>	
Ohmmeter .....	52-77	Card Readers .....	649
Peak Power .....	435	Component Oscillators .....	327
Power (RF/Microwave) .....	430, 431, 434	Computers .....	620, 626-628
Reactance .....	92-105	Displays, CRT .....	231
Standing-Wave-Ratio (SWR) .....	549	Graphics Plotters .....	653-657
Susceptance .....	92-105	Graphics Plotter/Printers .....	653, 658
True RMS .....	46, 62, 72	Graphics Printers .....	653, 659
Vector Impedance .....	114	Instrumentation Tape Recorders .....	288-290
Microprocessor Exerciser .....	134	Microwave Attenuators .....	439
Microprocessor Power Supplies .....	242, 261	Microwave Components .....	696
Microprocessor Troubleshooting .....	124, 138-175	Microwave Crystal Detectors .....	446
Microprocessor Training .....	137	Microwave Switches .....	451
<b>Microwave</b>		Power Supplies .....	261
Catalog .....	438	Strip Chart Recorders .....	266, 276-280
Counters .....	299-302	X-Y Recorders .....	266-275
Diodes .....	696	Ohmmeters .....	43, 52-89, 92-93
GaAs FETs .....	696	Optical Mark Readers .....	645
Integrated Products .....	696	Optocouplers .....	695
Link Analyzers .....	602, 604	Optoelectronics .....	694
Network Analyzers .....	483-490	<b>Oscillators</b>	
Power Measuring Equipment .....	428-437	Audio .....	353
Radio Testing .....	601	Function .....	359-365
Signal Generators .....	373-399	General Information .....	353
Spectrum Analyzers .....	506, 511, 516, 522, 532	Low Distortion .....	355, 364
Sweep Oscillators .....	406-426	Low Frequency .....	364
Synthesizers .....	384-386	Pulse .....	361
Test Equipment .....	438-459	Quartz Component .....	327
Milliohmmeter .....	54-77, 92	Sinewave .....	356
Mixers, Double-balanced .....	402, 697	Squarewave .....	356, 361, 363, 364
Mixers, Coaxial and Waveguide .....	402, 450, 535	Sweep .....	364, 403-427, 607
Modal Analysis .....	544-546	Telephone Test .....	370
Modem .....	642	Test .....	357
Modem, Short Haul .....	643	Tracking .....	370
Modular Power Supplies .....	261	VHF .....	391
Modulation Analyzer .....	546, 551	Oscillographic Recorders .....	266, 281-287
Modulator/Demodulator .....	605	Oscilloscopes .....	176-221
Modulators, Absorptive .....	400	Accessories .....	207
Modulators, PIN .....	400	Camera .....	216
Modulation Test Source .....	553	Contrast Filters .....	214
Multi-frequency LCR Meter .....	102-105	100 MHz Third-channel Trigger View .....	180
Multimeter .....	43, 56-77	Crystal Delta Time .....	180
Multiple Span Plug-In Module .....		Delta Time .....	180
Multiplex (Primary) Analyzer .....	562	Fast Variable Persistence Storage .....	180
Multiplexer .....	84, 88	Variable Persistence Storage .....	180
Multiprogrammers .....	665	200 MHz Delta Time Measurements .....	190
Input and Output Cards .....	665	275 MHz Delta Time Measurements .....	190
Mainframes and Extenders .....	665	275 MHz Delta Time Measurements with Microprocessor .....	190
<b>N</b>		275 MHz Fast Variable Persistence Storage .....	192
Network Analysis, General Information .....	460-464	General Information .....	176
Network Analyzers .....	460-491	Inverter Power Supply for 1700 Series Oscilloscopes .....	215
Accuracy Enhancement Program for 8409B .....	487, 490	Large Screen Mainframe .....	197
Automatic .....	454, 478, 490	Light Shields .....	214
Scalar .....	454	Low Frequency .....	203
<b>Noise</b>		Plug-In, 180 series .....	196
Analyzer, Acoustic .....	538, 544, 546	Rack Mount Slides and Adapters .....	214
Analyzer/Modulation .....	551	Spectrum Analyzer Plug-In .....	518, 520, 522
Figure Meter .....	437	Testmobiles .....	219
Generator .....	437, 526, 534	Variable Persistence Storage .....	184, 198
Source (IF, UHF, VHF and Waveguide) .....	437	Viewing Hoods .....	214
Normalizer, Data .....	475, 491		

Outside Plant Cable Test Equipment ..... 585  
 Automatic Pair Identifiers ..... 586  
 Cable Fault Locator ..... 586  
 Conductor Fault Locators ..... 586  
 Open/Split Locators ..... 586  
 Pressurized Cable Leak Locators ..... 586  
 Overhead Transparency Kit ..... 660

**P**

pA Meter ..... 106  
 Pack, Disc ..... 661  
 Pad, Coaxial Attenuator ..... 440  
 Pattern Generator/Error Detector ..... 567, 568  
 PC Board Testers ..... 120-123  
 PCM Test Equipment ..... 560-569  
 PCM Test Systems ..... 563  
 Peak Power Calibrator ..... 435  
 Peak Power Meter, Analog ..... 435  
 Personal Calculators ..... 604  
 Personal Computers ..... 620  
 Personality Modules ..... 159-162, 656, 657  
 Phase Meters ..... 307, 470, 472, 480, 482, 483, 538  
 Phase Modulation Analyzer ..... 551  
 Phase Modulation, Signal Generator ..... 380  
 Phase Noise Measurement ..... 556  
 Phase Sensitive Demodulator .....  
 Physical & Optical Measurements ..... 666  
 PIN Modulators, Microwave ..... 400  
 PIN Photodiodes ..... 694  
 Plotter, Graphics ..... 653-657  
 Plotter/Printers ..... 658  
 Accessories and Supplies ..... 660  
 Plotters, X-Y ..... 266-275  
 Plug-In Oscilloscopes ..... 196  
 Portable  
 Counters ..... 314, 317, 318  
 Desktop Computers ..... 620, 623  
 Instrumentation Tape Recorders ..... 271-273  
 Signal Generators ..... 364, 392, 427  
 Strip Chart Recorders ..... 266, 276-280  
 Test Set ..... 574  
 Voltmeter ..... 52-54, 56-58  
 X-Ray Systems ..... 52-54, 56-58  
 Power Meters, RF & Microwave ..... 434, 440  
 Power Sensors  
 Fiber Optic ..... 436  
 RF & Microwave ..... 432, 435  
 Power Meter Calibrators ..... 431, 435  
 Power Meter/Modulation Analyzer ..... 551  
 Power Splitter ..... 456, 471, 482  
 Power Supplies  
 Amplifier/Power Supplies ..... 36, 259  
 Atomic Clock ..... 335  
 Condensed Listing ..... 238  
 Constant Current Sources ..... 258  
 Digitally Controlled ..... 252, 264, 665  
 Dual Tracking ..... 254  
 Frequency Standards ..... 335  
 HP-IB Programmable ..... 252, 264, 665  
 Low Cost Lab ..... 240-243  
 Microprocessor ..... 242, 261  
 Modular, DC to DC Converters ..... 261  
 Modular, Series Regulated ..... 261  
 Modular/Switching Regulated ..... 261  
 Precision Voltage Sources

Programmable ..... 252, 264, 665  
 Specifications Definitions ..... 237  
 Standby ..... 335  
 Transistor Bias Supply ..... 488  
 Power Supply/Amplifier ..... 36, 259  
 Practical Transistors ..... 712  
 Preamplifiers ..... 37, 280-283, 285-287  
 Precision Coaxial Connectors ..... 681  
 Precision Frequency Source ..... 328  
 Precision Oscillator ..... 327  
 Precision Voltage Sources ..... 256  
 Preselector ..... 532  
 Preset C Meter ..... 95  
 Pressure Gauge, Quartz ..... 674  
 Pressure Recording System ..... 675  
 Primary Multiplex Analyzer ..... 562  
 Primary Multiplex Analyzer Systems ..... 563  
 Printer, Line ..... 650  
 Printer/Printer Terminal ..... 651  
 Printers, Thermal Graphics ..... 649, 659  
 Printer, Thermal Instrumentation ..... 291

**Probes**  
 Accessories ..... 75, 210, 213, 214, 306, 679-681  
 Active ..... 212, 306, 481, 535, 600  
 Cable Assembly ..... 53, 210, 682  
 Current ..... 41, 118, 212, 685  
 Digital Multimeter ..... 53  
 High Frequency ..... 47, 53  
 Impedance ..... 80-96, 481  
 Logic ..... 124, 125  
 Miniature ..... 207  
 Passive ..... 600  
 Slotted Line ..... 448  
 Temperature ..... 209  
 Trigger, Digital ..... 155, 210  
 Time Interval ..... 306  
 Voltage Divider ..... 53, 207, 685

Programmable Audio Analyzer ..... 554  
 Programmable Modulation Analyzer ..... 551  
 Programmable Signal Source ..... 364-372, 376, 378,  
 380, 384-6

**PROM Programmer** ..... 144  
 Pulse Adder, Splitter, Invertor ..... 679  
 Pulse Counter Card ..... 665  
 Pulse and Data Generators ..... 336-352  
 Accessories ..... 349, 679  
 Pulse Generators ..... 116, 336-347  
 Pulse Modulator ..... 400  
 Pulsers, Logic ..... 126

**Q**

Q-Meter ..... 100  
 Quartz Component Oscillator ..... 327  
 Quartz Pressure Gauge ..... 674  
 Quartz Thermometer ..... 673

**R**

Rack Mount Kits ..... 686, 692  
 Range Calibrator (for 435A Power Meter) ..... 431  
 Readers, Card ..... 165, 349, 645, 649  
 Reader, Optical Mark ..... 645  
 Real Time Application Terminals ..... 644  
 Recorders  
 Oscillographic ..... 266, 281-287  
 Instrumentation Tape ..... 288-290  
 Strip Chart ..... 266, 276-280



- X-Y ..... 266, 276-275  
 Reflection/Transmission Test Sets ..... 456, 471, 476, 481, 487-489  
 Reflectometer Bridge ..... 456  
 Relay Actuator (HP-IB) ..... 28  
 Relay Driver (HP-IB) ..... 442  
 Relay Output Card, Multiprogrammer ..... 665  
 Remote Automatic Surveillance System ..... 594  
 Resistance Meter ..... 56-77, 93  
 Retrofit, Signature Analysis ..... 134  
 Return Loss Kit ..... 600  
 RF Impedance Analyzer ..... 108  
 RF Vector Impedance Meter ..... 114  
 RF Voltmeter ..... 47  
 RMS Voltmeter ..... 46, 58, 62, 72  
 Rotary Air Line, Coaxial ..... 453  
 Rotary Joint, Coaxial ..... 453  
 Rotary Vane Attenuators, Waveguide ..... 439  
 Rubidium Frequency Standard ..... 331
- S**  
 S-Parameter Test Sets ..... 459, 476, 487, 488  
 Scalar Network Analyzer ..... 454  
 Scanner ..... 84, 88  
 Selective Level Measuring Set ..... 590, 596  
 Selective Level Voltmeters ..... 504, 596  
 Selective Voltmeter ..... 578, 596  
 Self-Test Digital Multimeter ..... 72  
 Semiconductor/Component Test System ..... 110  
 Sensor, Fiber Optic Power ..... 436  
 Sensors, Microwave Power ..... 432, 435  
 Serial Data Analyzer ..... 166-169  
 Serial-to-parallel Converter ..... 165  
 Short Haul Modem ..... 643  
 Shorts, Coaxial ..... 449  
 Shorts, Waveguide ..... 449  
 Signal Analyzers ..... 492-557  
   Audio ..... 554  
   Automatic Spectrum ..... 514, 546  
   Digital ..... 544, 546  
   Distortion ..... 546  
   General Information ..... 492-499, 546  
   Modulation ..... 546, 551  
   Spectrum ..... 500-543, 544, 546  
 Signal Conditioners ..... 285-287  
 Signal Coupler Preamplifier ..... 286  
 Signal Generators  
   Accessories ..... 402  
   Avionics ..... 390  
   Down Converter, 0.5 to 500 kHz ..... 391  
   General Information ..... 374  
   HF, VHF, UHF, SHF ..... 387-399  
   Microwave ..... 384, 396-399  
   Programmable ..... 376-386  
   Pulse Modulator ..... 400  
   Synthesized ..... 376-385  
 Signal Sources ..... 353-358, 361-371, 376-399  
 Signal Sources, Programmable ..... 338, 350, 358, 361-372, 376-386  
 Signature Analysis ..... 124, 132-135, 536-542, 546  
 Signature Analysis Retrofit ..... 134  
 Signature Analyzer, Digital ..... 124, 132-135, 538-543, 546  
 Sinewave Oscillator ..... 356  
 Slotted Lines (Coaxial and Waveguide) ..... 448  
 Sliding Load (Coaxial and Waveguide) ..... 449  
 SLMS System Software ..... 594  
 Solid State  
   Displays/Lamps ..... 694  
   Diodes, Transistors, Integrated Products ..... 696  
   Source, AM/FM Test ..... 553  
   Source, Signal ..... 376-399  
   Spectrophotometer, UVI/VIS ..... 698  
   Spectrum Analyzers, General Information ..... 492-499, 546  
   Spectrum Analyzers ..... 500-543  
   Spectrum Analyzer Preselector ..... 532  
   Square Wave Generators ..... 356, 361-3, 364  
   Stability Analyzer, Frequency ..... 556  
   Standards: Frequency and Time ..... 325  
   Standing Wave Ratio (SWR) Meter ..... 549  
   Stepping Motor Control ..... 665  
   Step Attenuators, Coaxial ..... 439, 442  
   Storage-Normalizer ..... 475, 491  
   Strip Chart Recorders ..... 266, 276-280  
   Structural Dynamics ..... 544  
   Surveying Calculators & Products ..... 676  
   Sweep Oscillators, General Information ..... 359, 403-405  
   Sweep Oscillators ..... 356-365, 403-427, 607  
   Sweep Signal Generator ..... 378  
   Sweeper Synthesizer ..... 378  
   Swept Slotted Line ..... 448  
   Switch Controller ..... 442, 592  
 Switches  
   Access, Distribution and Bi-directional ..... 592  
   HP-IB Driver ..... 442  
   Coaxial, Microwave OEM ..... 451  
   SPST ..... 697  
   VHF Switch, HP-IB ..... 28  
 Swivel Adapter ..... 453  
 Synthesized Function Generator ..... 364  
 Synthesized Signal Generators ..... 376-384  
 Synthesized Signal Sources ..... 376-386, 546  
 Synthesizers, Automatic ..... 364-371, 376-386  
 Synthesizers, Frequency ..... 364-371, 376-386  
 System, Logic Development ..... 144-147  
 System Digital LCR Meter ..... 101  
 System Digital Voltmeter ..... 66-74, 554
- T**  
 Tape Cartridge Unit ..... 144, 649  
 Tape Degausser ..... 289-290  
 Tape Recorders, Analog Magnetic ..... 288-290  
 Technical Computers ..... 620, 623-628  
 Telecommunications Test Equipment ..... 560-609  
   Access Switch ..... 592  
   Amplifier, Error Detector Input ..... 567  
   Amplifier-IF ..... 602  
   Attenuator-75  $\Omega$  General Purpose ..... 602  
   Audio Channel Selector: HP-IB Controlled ..... 564  
   BB Sweeper ..... 602  
   Balanced 2/4-wire Audio Channel Selector ..... 564  
   Baseband Analyzer ..... 608  
   Bi-directional Switch ..... 592  
   Cable/Conductor Fault Locators ..... 586  
   Cable Maintenance and Construction  
   Test Equipment ..... 585  
   Carrier Testing ..... 588  
   Controller: Switch ..... 592  
   Converter, 75  $\Omega$  Unbal/110  $\Omega$  Bal ..... 567  
   Data Communications Test Set ..... 583  
   Data Communications Test Set, Analog ..... 580, 582  
   Data Error Analyzer ..... 583  
   Data Generator ..... 566  
   Data Line Analyzers ..... 573  
   DDS Test Set ..... 582  
   Detector, Error ..... 566, 568  
   Down Converter ..... 606

Error Measuring Set (1 kb/s-50 Mb/s)	567
Error Measuring Set (1 kb/s-150 Mb/s)	566
Error Measuring Set (Bell Compatible)	568
Error Rate Measurements	565-569
FDM Measurements	588-600
Frame Alignment Monitor & Error Detector	565
HP-IB Controlled Channel Selector	564
Isolator, PCM Test Equipment	567
Microwave Link Analyzers	602, 604
Microwave Radio Testing	601
Modulator Analyzer	551
Modulator/Demodulator	605
Pair Identifier	586
Pattern Generator/Error Detector	567, 568
PCM Test Systems	563
PCM Testing	560
Primary Multiplex Analyzer	562
Remote Automatic Surveillance Systems	594
Selective Level Measuring Set	590, 596-599, 608
Selective Level/Meter	590, 596-599
SLMS Accessories	600
Spectrum Analyzer	608
Switch: Access	592
Switch Controller	592
Telephone Line Analyzer	572
Transmission Impairment Measuring Set	580-582
Upconverter Simulator for Microwave Link Analyzer	607
Voice & Data Testing	570
White Noise Testing	608
Telephone Test Oscillators	577
Temperature Measurement	60, 673
Terminal, Data Capture	644
Termination Panel, Multiprogrammer	665
Terminations, Coaxial and Waveguide	214, 449
Testmobiles, Oscilloscope	219
Test Oscillators	357
Test Sets, Digital Logic	130
Test Sets, Transmission	574, 582
Thermal Plotter/Printers	658
Thermal Printers	291, 649, 659
Thermistor	
Sensors, Coaxial and Waveguide	435
Fiber Optic	436
Thermocouple Power Meters	430, 431
Thermocouple Power Sensors	432
Thermocouple Scanning Card, Multiprogrammer	665
Thermometer	68
Thermometer, Quartz	673
Time Base	269
Time Standard	325
Time Synthesizer	340
Timer/Pacer Card, Multiprogrammer	665
Timing Analyzer, Logic	148-150
Total Harmonic Distortion Measuring Set	546
Total Station	676
Touch-Hold Probe	53
Tracer, Current	127
Tracking Generators	368-371, 516, 520, 526, 528, 530, 533
Training/Logic	136
Training/Video Tapes	708
Transceiver Modulation Analyzer	551
Transceiver Test System	558
Transfer Function Analyzer	538
Transistors, GaAs FETs	696
Transmission Impairment Measuring Set	580
Transistor Bias Supply	488
Transistor Test Fixtures	487-489
True RMS Voltmeter	46, 58, 62, 72
Tuners, Microwave	450
Two-Channel Real Time Spectrum Analyzer	538, 531-546
TWT Amplifiers	38
Type N Short	449
<b>U</b>	
Ultrasonic Leak Detector	587
Understanding Microprocessors	137, 710
Universal Bridge	94
Universal Carriage (Slotted Section)	448
Upconverter Simulator for Microwave Link Analyzer	607
<b>V</b>	
Vector Impedance Meters	114
Vector Voltmeter	482
VHF Oscillator	391
Vibration Analyzer	538
Video Tapes	708
Voice/Data Testing	570
Voltmeters	
Analog	39-48
Digital	49-77, 307, 310
Logarithmic	48
RF	47
Vector	102, 482
<b>W</b>	
Wave Analyzer	492, 531-533, 542, 592
Waveform Analyzer, Fourier	538-550
Waveguide	
Attenuators	439
Coaxial Adapters	452
Crystal Detectors	447
Directional Couplers	445
Frequency Meters	447
Harmonic Mixer	450
Holder	452
Low-Pass Filters	450
Movable Shorts	449
Reflection/Transmission Test Sets	438, 487
Shorting Switch	449
Slide Screw Tuners	450
Sliding Loads	449
Sliding Shorts	449
Slotted Section	448
Stand	452
Terminations	449
Thermistor Mounts	435
Variable Attenuators	439
Waveguide-Waveguide Adapters	452
White Noise Test Set	608
Word Generators	348-352
<b>X</b>	
X-Ray Systems, Scientific & Industrial	702
X-Y CRT Displays	222-235
X-Y Plotters/Recorders	266-275



# MODEL NUMBER INDEX

New product listings are printed in bold face type

Dates in parentheses are references to recent HP Journal\* articles

HP-32E Scientific Calculator with Statistics	613
HP-33C Programmable Scientific Calculator	
with Continuous Memory	613
HP-34C Advanced Programmable Scientific Calculator	
with Continuous Memory (Dec. 1979, Aug. 1980)	613
HP-37E Business Calculator	617
HP-38C Advanced Financial Programmable Calculator	
with Continuous Memory	617
HP-41C Alphanumeric Full Performance Programmable	
Calculator with Continuous Memory (Mar. 1980)	614
HP-67 Handheld Fully Programmable Calculator	616
DTS-70 Digital Test Systems (Mar. 1979)	122
<b>HP-85A Personal Computer (July, Aug. 1980)</b>	<b>620</b>
HP-97 Fully Programmable Printing Calculator	616
HP-97S I/O Calculator	623
HFET-1000 series GaAs FETs	696
HFET-2201 GaAs FET	696
HFET-5001 GaAs FETs	696
HXMR-5001 Double Balanced Mixer	697
HXTR-2000 series Bipolar Transistors	696
HXTR-5000 series Bipolar Transistors	696
HXTR-6000 series Bipolar Transistors	696
<b>100</b>	
140T Spectrum Analyzer Mainframe	525
141T System Spectrum Analyzers	524
141T Spectrum Analyzer Mainframe	525
180 series Plug-in Oscilloscopes	196
180C, D High Writing Speed	
Oscilloscope Mainframes	197
180TR Rack-mount Display Mainframe	518, 520, 522
181A, AR, Variable Persistence Storage Mainframes	198
181T, TR Variable Persistence/Storage Display	
Mainframes	518, 520, 522
182C Large Screen Oscilloscope Mainframe	197
182T Large Screen Display Mainframe	518, 520, 522
184A High Speed Oscilloscope Mainframe	198
197B Oscilloscope Camera	216
<b>200</b>	
200CD Wide Range Oscillator	354
201C Audio Oscillator	354
204C Oscillator	356
204D Oscillator	356
209A Oscillator	356
214B Pulse Generator	341
236A Telephone Test Oscillator	577
239A Low Distortion Oscillator	355
HP 250 Business Computer System (Apr. 1979)	631
281 series Coaxial-Waveguide Adapters	452
292 series Waveguide-Waveguide Adapters	452
<b>300</b>	
HP 300 Business Computer System (Jun., Jul. 1979)	631
331A Distortion Analyzer	547
333A Distortion Analyzer	547
334A Distortion Analyzer	547
339A Distortion Measuring Set	548
340B Noise Figure Meter	437
342A Noise Figure Meter	437
343A VHF Noise Source	437
345B IF Noise Source	437
346B Noise Source	437
347A series Noise Sources	437
349A Noise Source	437
350D Attenuator Set	36

355 series Coaxial Step Attenuators	442
360 series Coaxial Low-pass Filters	450
362A series Waveguide Low-pass Filters	450
375 series Waveguide Variable Attenuators	439
382 series Waveguide Precision Variable Attenuators	439
393A Coaxial Variable Attenuator	439
394A Coaxial Variable Attenuator	439
<b>400</b>	
400E & EL AC Voltmeters	45
400F & FL AC Voltmeter	45
400 GL AC Voltmeter	45
403B AC Voltmeter	44
410C Voltmeter	43
415E SWR Meter	459
419A DC Null Voltmeter	40
420C Coaxial Crystal Detector	446
422A Series Waveguide Crystal Detectors	447
423A/B Coaxial Crystal Detectors	446
424A Series Waveguide Crystal Detectors	447
427A Voltmeter	42
428B Clip-on DC Milliammeter	41
432 Series Power Meters	434
<b>435B Power Meter</b>	<b>431</b>
436A Power Meter	430
440A Detector Mount	448
442B Slotted Line RF Probe	448
444A Slotted Line Untuned Probe	448
447B Slotted Line Detector Probe	448
448B Slotted Line Sweep Adapter Probes	448
461A Amplifier	36
467A Power Amplifier	36
478A Coaxial Thermistor Mount	435
486A Series Waveguide Thermistor Mounts	435
489A TWT Amplifier	38
491C TWT Amplifier	38
493A TWT Amplifier	38
495A TWT Amplifier	38
<b>500</b>	
532 Series Waveguide Frequency Meters	447
536A Coaxial Frequency Meter	447
537A Coaxial Frequency Meter	447
545A Logic Probe	125
546A Logic Pulser	126
547A Current Tracer	127
548A Logic Clip	128
<b>600</b>	
606B HF Signal Generator	394
608E VHF Signal Generator	395
612A UHF Signal Generator	396
618C SHF Signal Generator	398
620B SHF Signal Generator	398
626A SHF Signal Generator	399
628A SHF Signal Generator	399
651B Test Oscillator	357
652A Test Oscillator	357
654A Test Oscillator	357
680 Strip Chart Recorder	276
<b>700</b>	
752 series Waveguide Directional Couplers	445
774D Coaxial Dual Directional Coupler	444
775D Coaxial Dual Directional Coupler	444
776D Coaxial Dual Directional Coupler	444

\*A monthly publication of technical information from the HP Laboratories.

777D Coaxial Dual Directional Coupler	444	1321A 53.3 cm (21 in.) Display	224, 235
778D Coaxial Dual Directional Coupler	444	1332A Small Screen Display	224, 226
779D Coaxial Directional Coupler	444	1333A Small Screen Display	224, 226
786D Coaxial Directional Detector	445	1335A Small Screen Display	224, 226
787D Coaxial Directional Detector	445	1336S Small Screen Display	224, 226
788C Coaxial Directional Detector	445	1340A Display Module	224, 232, 233
789C Coaxial Directional Detector	445	1350S Computer Graphics Display System	27, 234
796D Coaxial Directional Coupler	444	1600A 16 Bit Logic State Analyzer	163-165
797D Coaxial Directional Coupler	444	1600S Logic State Analyzer	163-165
798C Coaxial Directional Coupler	444	1602A 16 Bit Logic State Analyzer	155-158
<b>800</b>			
805C Coaxial Slotted Line	448	1607A 16 Bit Logic State Analyzer	163-165
809C Slotted Line Carriage	448	1610A/B Logic State Analyzer (Oct. 1979, May 1980)	151-154
810B series Waveguide Slotted Sections	448	1611A Logic State Analyzer	159-162
816A Coaxial Slotted Section	448	1615A Logic Analyzer (Oct. 1979)	148-150
817B Coaxial Swept Slotted Line System	448	1640B Serial Data Analyzer	166-169
870A series Waveguide Slide Screw Tuners	450	1645A Data Error Analyzer	583
895A General Purpose Power Supply	248	1645S Data Transmission Test Set	584
<b>900</b>			
905A Coaxial Sliding Load	449	1700 series Oscilloscopes	180
907A Coaxial Sliding Load	449	1715A 200 MHz $\Delta$ Time Oscilloscope	190
908A Coaxial 50-Ohm Termination	449	1722B 275 MHz $\Delta$ Time Oscilloscope, with Microprocessor	190
909A Coaxial 50-Ohm Termination	449	1725A 275 MHz $\Delta$ Time Oscilloscope	190
910 series Waveguide Terminations	449	<b>1727A 275 MHz Oscilloscope</b>	<b>192</b>
911A/C Coaxial Sliding Loads	449	1740A 100 MHz Oscilloscope, Third-Channel Trigger View	180
914 series Waveguide Sliding Loads	449	1741A 100 MHz Oscilloscope, Variable Persistence Storage, Third-Channel Trigger View (Sep. 1979)	180
920 series Waveguide Moving Shorts	449	1742A 100 MHz $\Delta$ T Oscilloscope, Trigger View	180
923A Waveguide Sliding Short	449	1743A 100 MHz Crystal $\Delta$ Time Oscilloscope, Third Channel Trigger View	180
930A Waveguide Shorting Switch	449	1744A 100 MHz Oscilloscope, Fast Variable Persistence Storage, Trigger View	180
932A Waveguide Harmonic Mixer	450	1801A Dual Channel Vertical Amplifier, 50 MHz	199
934A Coaxial Harmonic Mixer	450	1804A Four Channel Vertical Amplifier, 150 MHz	200
938A Frequency Doubler Set	399	1805A Dual Channel Vertical Amplifier, 100 MHz	199
940A Frequency Doubler Set	399	1809A Four Channel Vertical Amplifier, 100 MHz	200
<b>1000</b>			
HP 1000 Computers and Systems	626	1820C Time Base	201
1006A Testmobile	219	1821A Time Base/Delay Generator	201
1007A Testmobile	219	1825A Time Base and Delay Generator	202
1008A Testmobile	219	<b>2000</b>	
1051A & 1052A Combining Cases	692	<b>2103L Computer</b>	<b>626-628</b>
1081B Liquid Chromatograph	699	2108M Computer	626-628
1084B Liquid Chromatograph	699	2109E Computer	626-628
1110A Current Probe	212	2111F Computer	626-628
1111A AC Current Amplifier	212	2112M Computer	626, 628
1112A Inverter Power Supply	215	2113E Computer	626, 628
1117B Testmobile, Oscilloscope	219	2117F Computer	626, 628
1120A 500 MHz Active Probe	213	2240A Measurement & Control Processor	630
1121A AC Probe	481	2608A Line Printer	650
1122A Probe Power Supply	212	2621A Interactive Display Terminal	632
1124A 100 MHz Active Probe	212	2621P Interactive Display Terminal	632
1200B Dual Channel Oscilloscope, 100 $\mu$ V/div	203	<b>2626A Display Station</b>	<b>633</b>
1201B Dual Channel Storage Oscilloscope, 100 $\mu$ V/div	203	2631B Printer	651
1205B Dual Channel Oscilloscope, 5 mV/div	203	2631G Graphics Printer	651
1220A Dual Channel Oscilloscope, 15 MHz	205	2635B Printer Terminal	651
1222A Dual Channel, Delay Line Oscilloscope, 15 MHz	205	2642A Display Station	635
1304A 32 cm. (13 in.) Display	224, 233	2645A Display Station	636
1310B 48.3 cm (19 in.) Display	224, 235	2647A Intelligent Graphics Terminal	637
1311B 35.6 cm (14 in.) Display	224, 235	2648A Graphics Terminal	638
1317A 43.2 cm (17 in.) Display	224, 235	2649A Microprogrammable Terminal	639
		<b>2649I Intelligent Alphanumeric Terminal</b>	<b>640</b>





# MODEL NUMBER INDEX

New product listings are printed in bold face type  
Dates in parentheses are references to recent HP Journal\* articles

2804A Quartz Thermometer .....	673	<b>3707A BB + Sweep Generator .....</b>	<b>604</b>
2811B Quartz Pressure Gauge .....	674	3710A IF/BB Transmitter (70 MHz IF) .....	602
2813B Quartz Pressure Probe .....	674	3711A IF/BB Transmitter (70/140 MHz IF) .....	602
2816A Pressure Signal Processor .....	674	3712A IF/BB Receiver (70/140 MHz IF) .....	602
2820A Pressure Recording System .....	675	<b>3717A 70 MHz Modulator/Demodulator .....</b>	<b>605</b>
		<b>3724A Baseband Analyzer .....</b>	<b>608</b>
		<b>3725A Display .....</b>	<b>608</b>
		<b>3726A Filter Mainframe .....</b>	<b>608</b>
<b>3000</b>		<b>3730B Down Converter: RF to IF .....</b>	<b>606</b>
HP 3000 Series III, Series 33 & Series 30 Business		<b>3736B RF Module (1.7 to 4.2 GHz) .....</b>	<b>606</b>
Computer Systems (Sep 1979) .....	631	<b>3737B RF Module (3.7 to 8.5 GHz) .....</b>	<b>606</b>
3040A Network Analyzer .....	465	<b>3738B RF Module (5.9 to 11.7 GHz) .....</b>	<b>606</b>
3042A Network Analyzer .....	466	<b>3739B RF Module (10.7 to 14.5 GHz) .....</b>	<b>606</b>
3044A/3045A Signal Analyzers .....	542	3743A IF Amplifier .....	602
3052A Automatic Data Acquisition System .....	82	3744A BB Sweeper Accessory .....	602
<b>3054A Automatic Data Acquisition/Control System .....</b>	<b>79</b>	3745A/B Selective Level Measuring Set (25 MHz) .....	590
3060A Circuit Test System (Mar. 1979) .....	123	3747A/B Selective Level Measuring Set (90 MHz) .....	590
3074A Data Link Adapter .....	644	3750A Attenuator: 75 $\Omega$ .....	602
3075A Desktop Data Capture Terminal .....	644	3754A Access Switch .....	592
3076A Wall-Mounted Data Capture Terminal .....	644	3755A Switch Controller .....	592
3077A Wall-Mounted Time Reporting Terminal .....	644	3756A 90 MHz Bi-directional Switch .....	592
3200B VHF Oscillator .....	394	3757A 8.5 MHz Access Switch .....	592
3310A Function Generator .....	361	3762A Data Generator .....	566
3310B Function Generator .....	361	3763A Error Detector .....	566
3311A Function Generator .....	362	3770B Telephone Line Analyzer .....	572
3312A Function Generator .....	363	3771A Data Line Analyzer (CCITT) .....	573
3320B Frequency Synthesizer .....	366	3771B Data Line Analyzer (BELL) .....	573
3325A Function Generator/Frequency		3777A HP-IB-controlled Channel Selector .....	564
Synthesizer/Sweeper (Jan. 1979) .....	364	<b>3779A Primary Multiplex Analyzer (CEPT)</b>	
3330B Automatic Synthesizer .....	367	(May 1980) .....	562
3335A Frequency Synthesizer .....	368	<b>3779B Primary Multiplex Analyzer (BELL)</b>	
3336A/B/C Synthesizer/Level Generator .....	370, 598	(May 1980) .....	562
3350 series Laboratory Automation Systems .....	698	3780A Pattern Generator/Error Detector .....	567
3380S Reporting Integrator .....	698	<b>3781B Pattern Generator (BELL Compatible) .....</b>	<b>568</b>
3388A Reporting Integrator .....	698	<b>3782B Error Detector (BELL Compatible) .....</b>	<b>568</b>
3400A RMS Voltmeter .....	46	3783A Frame Alignment Monitor & Error Detector .....	565
3403C True RMS Voltmeter .....	62	3808A Medium Range Distance Meter .....	676
3406A Broadband Sampling Voltmeter .....	47	3810A Total Station .....	676
3435A Digital Voltmeter .....	54	3820A Electronic Total Station .....	676
3437A High Speed Digital Voltmeter .....	66	<b>3850A Industrial Distance Meter (Jun. 1980) .....</b>	<b>677</b>
3438A 5-Function DMM;HP-IB .....	64	3964A Instrumentation Tape Recorder .....	289, 290
3455A 6½ Digit DMM .....	72	3968A Instrumentation Tape Recorder .....	289, 290
<b>3456A Systems DVM .....</b>	<b>68</b>		
3465A 4½ Digit DMM .....	56		
3465B Digital Multimeter .....	56		
3466A 4½ Digit Autoranging DMM .....	58		
3467A Logging DMM .....	60		
3476A/B 3½ Digit DMM .....	52		
3490A Multimeter .....	76		
3495A Scanner .....	88		
<b>3497A Data Acquisition/Control Unit .....</b>	<b>84</b>		
3529A Magnetometer Probe .....	41		
3550B Communications Test Set .....	579		
3551A Transmission Test Set .....	574		
3552A Transmission Test Set .....	574		
3555B Transmission & Noise Measuring Set .....	576		
3556A Psophometer .....	576		
3575A Gain/Phase Meter .....	468		
3580A Spectrum Analyzer .....	536		
3581A Wave Analyzer .....	550		
3581C Selective Voltmeter .....	578		
3582A Spectrum Analyzer .....	538		
3585A Spectrum Analyzer .....	500		
<b>3586A/B Selective Level Meter (May 1980) .....</b>	<b>596</b>		
<b>3586C Wave Analyzer (May 1980) .....</b>	<b>504</b>		
3702B IF/BB Receiver (70 MHz IF) .....	602		
		<b>4000</b>	
		<b>4061A Semiconductor/Component Test System .....</b>	<b>110</b>
		4140B pA Meter/DC Voltage Source (Dec. 1979) .....	106
		4191A RF Impedance Analyzer (Jan. 1980) .....	108
		<b>4192A LF Impedance Analyzer .....</b>	<b>112</b>
		4204A Oscillator .....	358
		4260A Universal Bridge .....	94
		4261A Digital LCR Meter .....	96
		4262A Digital LCR Meter .....	98
		4265B Universal Bridge .....	94
		4271B Component Test 1 MHz	
		Digital LCR Meter (Apr. 1979) .....	101
		4272A 1 MHz Preset .....	
		Capacitance Meter (Apr. 1979) .....	95
		4273A 1 kHz Preset C Meter .....	95
		4274A LCR Meter (Feb. 1979) .....	102
		4275A LCR Meter (Feb. 1979) .....	102
		4328A Milliohm meter .....	92
		4329A High Resistance Meter .....	93
		4332A LCR Meter .....	92
		4342A Q Meter .....	100
		4436A Attenuator .....	115



4437A Attenuator	115	5340A Microwave Frequency Counter	302
4440B Decade Capacitor	115	5342A Microwave Frequency Counter	300
4800A Vector Impedance Meter	114	5343A Microwave Frequency Converter	
4815A Vector Impedance Meter	114	(Mar. 1980)	300
4904A Cable Fault Locator	587	5345A Electronic Counter	295
4905A Ultrasonic Leak Detector	587	5353A Channel C: Plug-in for 5345A	298
4910G Open and Split Locator	586	5354A 4 GHz Frequency Converter	298
4930A Conductor Fault Locator	586	5355A Automatic Frequency Converter (Apr. 1980)	299
4935A Transmission Impairment Test Set	582	5356A & 5356B Frequency Converter	
4940A Transmission Impairment Measuring Set	580	Heads (Apr. 1980)	299
4943A Transmission Impairment Measuring Set	581	<b>5356C Frequency Converter Head</b>	<b>299</b>
4944A Transmission Impairment Measuring Set	581	5359A Time Synthesizer	340
4960/4961 Automatic Pair Identifier	586	5363B Time Interval Probes	306
		5370A Universal Counter	304
<b>5000</b>		5381A Frequency Counter	323
<b>5001A Microprocessor Exerciser</b>	<b>134</b>	5382A Frequency Counter	323
5004A Signature Analyzer	132	5383A Frequency Counter	323
5011T Logic Troubleshooting Kit	131	5390A Frequency Stability Analyzer	556
5015T Logic Troubleshooting Kit	131	5391A Frequency and Time Data	
5021A Logic Troubleshooting Kit	130	Acquisition System	303
5022A Logic Troubleshooting Kit	130	5420A Digital Signal Analyzer	544
5023A Logic Troubleshooting Kit	130	5423A Structural Dynamics Analyzer	544
5024A Logic Troubleshooting Kit	130	5427A Digital Vibration Control System	546
5035A Basic Logic Lab	136	5451C Fourier Analyzer	546
5035T Logic Lab	136	5501A Laser Transducer	672
5036A Microprocessor Lab (Oct. 1979)	137	5526A Laser Measurement	672
5045A Digital IC Tester	116	5700 series Gas Chromatographs	698-699
5046A Digital IC Test System	118	5840A Gas Chromatograph	698-699
5060 series Cooling Kits	693	5880A Gas Chromatograph	698-699
5060 series Control Panel Covers	693	5986A GC/Mass Spectrometer	698-699
5060 series Filler Panels	693	5992 series GC/Mass Spectrometers	698-699
5060 series Rack Adapter Frames	693	5993 series GC/Mass Spectrometers	698-699
5060 series Rack Mounting Kits	686, 692	5995A GC/Mass Spectrometer	698-699
K02-5060A Standby Power Supply	335		
5061A Cesium Beam Frequency Standard	328	<b>6000</b>	
5061A with Option 004 Tube	328	6002A Autoranging DC Power Supply	253
E21-5061A Flying Clock (Cesium)	329	6111A-6116A Precision DC Power Supplies	256
5062C Cesium Beam Frequency Reference	330	<b>6012A Autoranging Power Supply</b>	<b>246</b>
5065A Rubidium Frequency Standard	331	<b>6024A Autoranging DC Power Supply</b>	<b>246</b>
E21-5065A Portable Rubidium Time Standard	331	6129C-6131C Digitally Controlled Voltage	
5085A Standby Power Supply	335	Sources	264
5087A Distribution Amplifier	334	6140A Digital Current Source	264
5150A Thermal Printer	291	6177C Precision DC Current Source	258
5245L Electronic Counter	324	6181C Precision DC Current Source	258
5253B Frequency Converter Plug-in	324	6186C Precision DC Current Source	258
5255A Frequency Converter Plug-in	324	6200B-6209B DC Power Supplies	240
5257A Transfer Oscillator Plug-in	324	6212A-6218A Dual Range DC Power Supplies	240
5300A Counter Mainframe	319	6224B DC Power Supply	244
5300B Counter Mainframe	319	6226B DC Power Supply	244
5301A 10 MHz Counter Module	320	6227B Dual Tracking DC Power Supply	254
5302A 50 MHz Universal Counter Module	320	6228B Dual Tracking DC Power Supply	254
5303B 500 MHz Counter Module	320	6234A Dual Output Power Supply	241
5304A Timer/Counter Module	320	6235A Triple Output Power Supply	242
5305B 1300 MHz Counter Module	321	6236B Triple Output DC Power Supply	242
5306A Digital Multimeter/Counter	321	6237B Triple Output DC Power Supply	242
5307A Frequency Counter Module	321	6253A Dual Output DC Power Supply	244
5308A Timer Counter Module	321	6255A Dual Output DC Power Supply	244
5310A Battery Pack Module	322	6259B DC Power Supply	248
5311B Digital-to-Analog Converter	322	6260B DC Power Supply	248
5312A HP-IB Interface Module	322	6261B DC Power Supply	248
5314A Universal Counter (Jan. 1979)	317	6263B DC Power Supply	248
5315A & 5315B Universal Counters (Jan. 1979)	314	6264B DC Power Supply	248
<b>5316A Universal Counter (Sept. 1980)</b>	<b>314</b>	6265B DC Power Supply	248
5328A Universal Counter	310	6266B DC Power Supply	248
5335A Universal Counter (Sept. 1980)	307		

# MODEL NUMBER INDEX

New product listings are printed in bold face type  
Dates in parentheses are references to recent HP Journal\* articles

6267B DC Power Supply	248
6268B DC Power Supply	248
6269B DC Power Supply	248
6271B DC Power Supply	248
6274B DC Power Supply	248
6281A DC Power Supply	244
6282A DC Power Supply	244
6284A DC Power Supply	244
6286A DC Power Supply	244
6289A DC Power Supply	244
6291A DC Power Supply	244
6294A DC Power Supply	244
6296A DC Power Supply	244
6299A DC Power Supply	244
6384A DC Power Supply	241
6428B DC Power Supply	250
6433B DC Power Supply	250
6434B DC Power Supply	250
6438B DC Power Supply	250
6439B DC Power Supply	250
6443B DC Power Supply	250
6448B DC Power Supply	250
6453A DC Power Supply	250
6456B DC Power Supply	250
6459A DC Power Supply	250
6464C DC Power Supply	250
6466C DC Power Supply	250
6469C DC Power Supply	250
6472C DC Power Supply	250
6475C DC Power Supply	250
6477C DC Power Supply	250
6479C DC Power Supply	250
6483C DC Power Supply	250
6515A High Voltage DC Power Supply	255
6516A High Voltage DC Power Supply	255
6521A High Voltage DC Power Supply	255
6522A High Voltage DC Power Supply	255
6525A High Voltage DC Power Supply	255
6824A DC Power Supply/Amplifier	259
6825A DC Power Supply/Amplifier	259
6826A DC Power Supply/Amplifier	259
6827A DC Power Supply/Amplifier	259
6920B AC/DC Meter Calibrator	678
6940B Multiprogrammer	665
6941B Multiprogrammer Extender	665
6942A Multiprogrammer	668
6943A Multiprogrammer Extender	668
<b>7000</b>	
7004B X-Y Recorder	274
7010B X-Y Recorder	268
7015B X-Y Recorder	268
7034A X-Y Recorder	274
7035B X-Y Recorder	269
7044B X-Y Recorder	270-273
7045B X-Y Recorder	270-273
7046B X-Y Recorder	270-273
7047A X-Y Recorder	270-273
7100B Strip Chart Recorder, 2 Pen	280
7101B Strip Chart Recorder, 1 Pen	280
7130A Strip Chart Recorder, 2 Pen	278
7131A Strip Chart Recorder, 1 Pen	278
7132A Strip Chart Recorder, 2 Pen	279
7133A Strip Chart Recorder, 1 Pen	279
7155B Portable Strip Chart Recorder	277

7220A 4-Color Graphics Plotter	654
7220S 4-Color Plotter/Paper Advance (Dec. 1979)	654
7221B 4-Color Graphics Plotter	654
7221S 4-Color Plotter/Paper Advance (Dec. 1979)	654
7225A Graphics Plotter (Feb. 1979)	656
7240A Thermal Plotter/Printer	658
7245B Plotter/Printer	658
7260A Optical Mark Reader	645
7310A High-speed Graphics Printer	659
7402A 2-Channel Oscillographic Recorder	281-283
7404A 4-Channel Oscillographic Recorder	281-283
7414A 4-Channel Oscillographic Recorder	284
7418A 6 to 8 Channel Oscillographic Recorder	284
7562A Log Voltmeter/Converter	48
7563A Log Voltmeter/Amplifier	48
7906 Disc Drive	662
<b>7910 Fixed Disc Drive</b>	<b>664</b>
7920 Disc Drive	662
7925 Disc Drive	662
7970 B/E Tape Drive	652
<b>8000</b>	
8005B Pulse Generator	342
8007B Pulse Generator	345
8011A Pulse Generator	342
8012B Pulse Generator	343
8013B Pulse Generator	343
8015A Pulse Generator	344
8016A Word Generator	352
8018A Serial Data Generator	349
8080A Mainframe	347, 348
8081A Repetition Rate Generator, 300MHz	347, 348
8082A Pulse Generator	346
8083A Output Amplifier, 300 MHz	347, 348
8084A Word Generator, 300 MHz	347, 348
8091A Repetition Rate Generator, 1 GHz	347, 348
8092A Delay Generator/Freq. Divider	347, 348
8093A Output Amplifier, 1 GHz	347, 348
8160A Programmable Pulse Generator (May 1979)	338
8165A Programmable Signal Source	372
8170A Logic Pattern Generator (Aug. 1979)	350
8327A Test Set Selector	490
8350A Sweep Oscillator	408
8403A Modulator	400
8405A Vector Voltmeter	482
8406A Comb Generator	535
8407A Network Analyzer	480
<b>8409B Automatic Network Analyzer</b>	<b>490</b>
8410B Network Analyzer Mainframe	486
8410S series Network Analyzers	483
8411A Harmonic Frequency Converter	486
8412A Phase-Magnitude Display	480, 486
8413A Phase Gain Indicator	486
8414A Polar Display	480, 486
8418A Auxiliary Power Supply	486
8443A Tracking Generator-Counter	528
8444A Tracking Generator	530
8444A Option 059 Tracking Generator	516, 520, 533
8445B Automatic Preselector	532
8447 series Amplifiers	37
8450A UV/VIS Spectrophotometer (Feb. 1980)	698
8470A, B Coaxial Crystal Detectors	446
8471A Coaxial Crystal Detector	446
8472A Coaxial Crystal Detector	446
8473B/C Coaxial Crystal Detectors	446

\*A monthly publication of technical information from the HP Laboratories.

8477A Power Meter Calibrator	435	8745A S-Parameter Test Set	487
8478B Coaxial Thermistor Mount	435	8746B S-Parameter Test Set	488
8481A/H Power Sensors	432	8747A Waveguide series	
8481B Power Sensor	432	Reflection/Transmission Test Units	488
8482A/H Power Sensors	432	8748A S-Parameter Test Set	471
8482B Power Sensor	432	8750A Storage-Normalizer	491, 486
8483A Power Sensor	432	8754A Network Analyzer (Oct. 1979)	470
8484A Power Sensor	432	<b>8755C Frequency Response Test Set Plug-in</b>	<b>454, 458</b>
<b>8485A Power Sensor</b>	<b>433</b>	8755S Frequency Response Test Sets	454
8491A/B Coaxial Fixed Attenuators	440	8761A & B Coaxial Switches	451
8492A Coaxial Fixed Attenuator	440	8801A Low Gain Preamplifier	285
8493A/B series Coaxial Fixed Attenuators	440	8802A Medium Gain Preamplifier	285
8494A/B/G/H series Coaxial Step Attenuators	442	8803A High Gain Preamplifier	285
8495A/B/D/G/H/K series Coaxial		8805A Carrier Preamplifier	285
Step Attenuators	442	8805B Carrier Preamplifier	285
8496A/B/G/H series Coaxial		8806B Phase Sensitive Demodulator	286
Step Attenuators	442	8807A AC/DC Converter	286
8498A Coaxial Fixed Attenuator	440	8808A Logarithmic Preamplifier	286
8501A Storage-Normalizer	475	8809A Signal Coupler	286
8502A & B Reflection Transmission Bridges	471, 476	8820A DC Bank Amplifier	286
8503A & B S-Parameter Test Sets	476	8821A DC Bank Amplifier	286
8505A Network Analyzer	472	8900B Peak Power Calibrator	435
8507B/C Automatic Network Analyzers	478	8901A Modulation Analyzer (Nov. 1979)	551
8552A Spectrum Analyzer—IF Section	525	<b>8903A Audio Analyzer (Aug. 1980)</b>	<b>554</b>
8552B Spectrum Analyzer—IF Section	525	8950B Automatic Transceiver Test System	558
8553B Spectrum Analyzer, Tuning Section	528		
8554B Spectrum Analyzer, Tuning Section	530	<b>9000</b>	
8555A Spectrum Analyzer, Tuning Section	532	9030 Measurement and Control System	630
8556A Spectrum Analyzer, Tuning Section	526	9111A Graphics Tablet	648
8557A Spectrum Analyzer	518	9411A Switch Controller	629
8558B Spectrum Analyzer	520	9412A Modular Switch	629
8559A Spectrum Analyzer (Mar. 1980)	522	9413A VHF Switch	629
8565A Spectrum Analyzer	516	9414A Matrix Switch	629
8566A Spectrum Analyzer (Aug. 1979)	506, 511	9815S Desktop Computer	623
8568A Spectrum Analyzer	506, 508	9825B, T Desktop Computer	623
8581A Automatic Spectrum Analyzer	514	9835A, B Desktop Computer (May 1979)	624
8582A Automatic Spectrum Analyzer	514	9845B, C, T Desktop Computer	625
8600A Digital Marker	427	9866B Thermal Printer	649
8601A Generator/Sweeper	427	9871A Character Impact Printer	649
8614A Signal Generator	397	9872B 4-Color Graphics Plotter	654
8616A Signal Generator	397	9872S 4-Color Plotter/Paper Advance (Dec. 1979)	654
8620 system Sweep Oscillators	417, 607	9874A Digitizer	648
8620C Sweeper Mainframe	418	9875A Cartridge Tape Unit	649
8640A,B AM/FM Signal Generators	387	9876A Thermal Graphics Printer	649
8640B Option 004, Avionics Signal Generator	390	9878A I/O Expander	649
8654A Signal Generator	392	9884A Tape Punch Subsystem	649
8654B Signal Generator	392	9885M/S Flexible Disc Drive	647
8655A Synchronizer/Counter	393	9895A Flexible Disc Memory	647
<b>8656A Signal Generator</b>	<b>376</b>		
8660A Synthesized Signal Generator	380	<b>10000</b>	
8660C Synthesized Signal Generator	380	10001A 10:1 Divider Probe	211
8662A Synthesized Signal Generator	378	10001B 10:1 Divider Probe	211
8671A Microwave Frequency Synthesizer	386	10002A 50:1 Divider Probe	211
8672A Synthesized Signal Generator	386	10002B 50:1 Divider Probe	211
8690B Sweep Oscillator	424	10003A 10:1 Divider Probe	211
8691B-8695B RF Units (PIN leveled BWO)		10004D 10:1 Divider Probe	211
for 8690B	425	10005D 10:1 Divider Probe	211
8691A-8697A RF Units (Grid Leveled BWO)		10006D 10:1 Divider Probe	211
for 8690B	425	10007B 1:1 Probe	75, 211
8698B, 8699B Solid State RF Units for 8690B	425, 426	10008B 1:1 Probe	75, 211
8709A Phase-lock Synchronizer	425	10011B BNC Adapter Tip	214
8717B Transistor Bias Supply	488	10013A 10:1 Divider Probe	211
8721A Coaxial Directional Bridge	481	10014A 10:1 Divider Probe	211
8731-8735 series PIN Modulators	400	10016B 10:1 Divider Probe	211
8743A Reflection/Transmission Test Unit	487	10017A Miniature Divider Probe	207
		10018A Miniature Divider Probe	207

# MODEL NUMBER INDEX

New product listings are printed in bold face type

Dates in parentheses are references to recent HP Journal\* articles

10019A Cable Assembly .....	210	10285A HP 1000 L-Series Interface .....	172
10020A Resistance Divider .....	211	10281A HP-IB Interface (1640A) .....	169
10021A Miniature 1:1 Probe .....	207	10299A Rack Mount Adapter .....	175
10022A Miniature 1:1 Probe .....	207	10352B Graflok Back .....	217
<b>10023A Temperature Probe .....</b>	<b>209</b>	10353A Pack Film Back .....	217
10024A IC Test Clip .....	210	10358B Camera Carrying Case .....	217
10026A Miniature 1:1 Probe (50 Ω) .....	207	10361A Camera Bezel Adapter .....	217
10027A Miniature 1:1 Probe (50 Ω) .....	207	10362A Camera Bezel Adapter .....	217
10028A Jumper Cable .....	210	10363A Camera Bezel Adapter .....	217
10034A Probe Ground Lead Kit .....	213	10367A Camera Bezel Adapter .....	217
10035A Probe Tip Kit .....	213	10375A Camera Bezel Adapter .....	217
10036B Probe Tip Kit .....	213	10376A Camera Bezel Adapter .....	217
10037B Probe Tip Kit .....	213	10377A Camera Bezel Adapter .....	217
10040A 10:1 Miniature Divider Probe .....	207	10378A Camera Adapter .....	217
10041A 10:1 Miniature Divider Probe .....	207	10380A OEM Horizontal Frame for HP Small Screen Displays .....	231
10042A 10:1 Miniature Divider Probe .....	207	10382A Bench Hardware Kit for 10380A .....	231
10050A HP-IB Adapter (1602A) .....	158	10386A OEM Vertical Frame for HP Small Screen Displays .....	231
10051A Test Probe (1602A) .....	158	10387A Interface, Type 303 Modems (1645A) .....	584
10059A HP-IB Interface (1602A) .....	158	10388A Interface, CCITT V35 (1645A) .....	584
10066A HP-IB Probe Interface .....	172	10389A Interface, Breakout Box (RS-232C) (1645A) .....	584
10069A HP-IB Interface (1615A) .....	172	10407B Plug-in Extender (180 system) .....	214
10100C 50 ohm Feedthrough Termination .....	214	10475A 3 in. Drawer for 1117B .....	220
10100B 100 ohm Feedthrough Termination .....	214	10476A 8 in. Drawer for 1117B .....	220
10110B BNC Male to Dual Banana Plug .....	681	10491B Rack Mount Adapter, 1700 series, 1600A .....	175, 214
10111A Shielded Banana Plug to BNC Female .....	681	10494A HP-IB Interface (1610A) .....	154
10113A Triple Banana Plug to Dual BNC Female .....	681	10495A HP-IB Interface (1610A) .....	154
10116A Light Shield for 1220 Series Oscilloscopes .....	206, 214	10496A HP-IB Interface (1610B) .....	154
10117A Panel Cover for 1220 Series Oscilloscopes .....	206	10499A Field Retrofit Kit (1610A) .....	154
10119A Rack Mount Kit for 1220 Series Oscilloscopes .....	206	10501A Cable Assembly .....	680
10140A Viewing Hood for 1700 Series Oscilloscopes .....	214	10502A Cable Assembly .....	680
10166A Front Panel Cover (180A, 181A, 184A) .....	214	10503A Cable Assembly .....	680
10173A RFI Filter and Contrast Screen for 1700 Series Oscilloscopes .....	214	10511A Spectrum Generator .....	402
10176A Viewing Hood for 12.7 cm (5 in.) Rect. CRT .....	214	10514A Double-balanced Mixer .....	402
10178A Metal Mesh Contrast Screen for 181 and 184 series Oscilloscopes .....	214	10515A Frequency Doubler .....	401
10183A Light Shield HP for small screen displays .....	228	10519A Cable Assembly .....	680
10229A Retractable Hook Tip Adapter .....	214	10525T & 10525E Logic Probes .....	125
10230C Clock Probe, Logic Analyzer .....	170	10526T Logic Pulser .....	126
10231C Data Probe, Logic Analyzer .....	170	10528A Logic Clip .....	128
10233A Cable, 1645A to 5055A or 5150A .....	584	10529A Logic Comparator .....	129
10235A Interface Cover for 1645A .....	584	10533A BCD Interface Cable (5150A, 5300A) .....	319
10236A Trigger Bus Cable (1600S) .....	174	10534A Double-balanced Mixer .....	402
10237A Data Cable (1600S) .....	174	10541A Reference Boards .....	129
10247A Clock Probe .....	170	10541B Preprogrammed Reference Boards .....	129
10248C Data Probe .....	170	10548A Service Support Package .....	319
10250A TTL Trigger Probe .....	210	10631A, B, C, D HP-IB Cables .....	30
10253A Card Reader for 1600A .....	165	10638A Degausser .....	329
10254A Serial-to-Parallel Converter .....	165	10656A 5035A Texts & Lab Workbooks .....	136
10257B Personality Module for 1611A (6800 μP) .....	160	10657A 5035A Component & Wire Kit .....	136
10258B Personality Module for 1611A (8080 μP) .....	160	10811A/B Crystal Oscillators .....	327
10259A Personality Module for 1611A (0F8 μP) .....	161	10819A Leather Carrying Case (5300A/B) .....	319
10260A Personality Module for 1611A (Z80 μP) .....	161	10833 A/B/C/D HP-IB Cables .....	30
10261A Personality Module for 1611A (6502 μP) .....	161	10844A Programming Interface Kit (5045A) .....	119
10262A Personality Module for 1611A (1802 μP) .....	161	10845A Program Card (5045A) .....	119
10263A Personality Module for 1611A (8085 μP) .....	162	10846A Program Card Coupon Book .....	119
10264A GP Personality Module (1611A) .....	160	10847A 5045A Service Kit .....	119
10275A PDP-11 UNIBUS Interface .....	172	10851A/52A/53A/54A Rack Mount Kits (5300A/B) .....	319
10276A LSI-11 Interface .....	172	10855A Broadband Preamplifier .....	312
10277A,B,C General Purpose Interface .....	172	10856A Low Pass Filter Kit .....	322
10278A HP 1000 series Interface .....	172		
10279A NOVA 3 Interface .....	172	<b>11000</b>	
10280A microNOVA Interface .....	172	11000A Cable Assembly .....	680



11001A Cable Assembly	680	11675B Leveling Cable Assembly for 784B	607
11002A Test Leads	680	11678A Low Pass Filter Kit	457
11003A Test Leads	680	11679A/B Extension Cables for 8755	457
11035A Cable Assembly	680	11683A Range Calibrator	431
11036A AC Probe for 410C	43	11684/5/6/8/9A Low Pass Filters	457
11067A Test Lead Kit	75	11687A Adapter, 50 to 75 $\Omega$	402
11068A Soft Carrying Case	75	11690A Frequency Doubler	401
11075A & 11076A Instrument Cases	693	11691D Coaxial Directional Coupler	444
11096B High Frequency Probe	75	11692D Coaxial Dual Directional Coupler	444
11143A Cable Assembly	680	11693A Limiter	535
11170A/B/C Cable Assembly	680	11694A Matching Transformer, 50-75 $\Omega$	535
11310A Card Reader	649	11697A, B & C Bandpass Filters	402
11473A-11476A Balancing Transformers	679	11707A Test Plug-in	383
11500A/B Cable Assembly	680	11708A Attenuator (for Calibrating 8484A)	432
11501A Cable Assembly	680	11710B Down Converter	391
11507A Output Termination	402	11711A Noise Source Adapter	437
11508A Terminated Output Cable	402	11712A Service Support Kit (for 8671A, 8672A)	385
11509A Fuseholder	402	11713A Attenuator/Switch Driver	442
11511A Coaxial Short	449	11714A Service Support Kit (for 8662A)	379
11512A Coaxial Short	449	11715A AM/FM Test Source (Nov. 1979)	553
11515A Waveguide Adapter	452	11716A, B Interconnection Kits	442
11516A Waveguide Adapter	452	11720A Pulse Modulator	401
11517A Mixer	535	11721A Frequency Doubler	401
11518A-11520A Waveguide Taper Sections	535	11850A & B Power Splitters	471
11524A APC-7 to N (female) Adapter	681	11851A RF Cable Kit for 8505A	476
11525A APC-7 to N (male) Adapter	681	11852A 50-75 $\Omega$ Minimum Loss Pad	477
11533A APC-7 to SMA (male) Adapter	681	11853A 50 $\Omega$ Type N Accessory Kit	477
11534A APC-7 to SMA (female) Adapter	681	11854A 50 $\Omega$ BNC Accessory Kit	477
11536A Probe Tee for 8405A	482	11855A 75 $\Omega$ Type N Accessory Kit	477
11540A Waveguide Stand	453	11856A 75 $\Omega$ BNC Accessory Kit	477
11542A-11548A Waveguide Clamps	453	11857A/B Test Port Extension Cables for 8503A & B	477
11549A Power Splitter for 8405A	482	11858A Rigid Interconnect Adapter	477
11565A Coaxial Short	449	11863D Accuracy Enhancement Program for the 8409B	490
11566A Air Line Extension	453	11866A APC-7 Calibration Kit	477, 489
11567A Air Line Extension	453	<b>11867A RF Limiter</b>	<b>535</b>
11570A Accessory Kit for 8405A	482	11869A Adapter for 86200 Series Plug-ins	416
11581A Attenuator Set	440	<b>11870A Low Pass Filter</b>	<b>522</b>
11582A Attenuator Set	440	<b>12000</b>	
11583A Attenuator Set	440	12030A L-Series 10-slot card cage	628
11588A Swivel Adapter	453	12032A L-Series 5-slot card cage	628
11589A & 11590A Bias Networks	489	12035A L-Series Computer Power Module	628
11599A Quick-Connect Adapter for 8745A	489	12050A Fiber Optic HP-IB Link (Dec. 1979)	311
11600B Transistor Fixture	487	12897B Dual-Channel Interface	628
11602B Transistor Fixture	487	12940A 20 Mbyte Disc Cartridge	661
11604A Universal Extension for 8745A	487	12979B HP 1000 Computer I/O Extender	628
11605A Flexible Arm for 8743A	487	<b>13000</b>	
11606A Rotary Air Line	453	13064A Tape Degausser	289-290
11607A Small Signal Adapter for 8745A	489	13222C RS 232 Cable, Female	634
11608A Transistor Fixture	488	13222M European Modem Cable	634
11609A Cable Kit for 8410S	489	13222N U.S. Modem Cable	634
11610B Test Port Extension Cable	487	13222W HP 300 Cable	634
11650A Accessory Kit for 8410S	489	13222Y RS 232 EMP Protect Cable, male, 5m	634
11652A Reflection/Transmission Kit for 8407A	482	13231A Display Enhancements	641
11654A Passive Probe Kit for 8407A	482	13232R Multipoint Extension Cable, female, 100'	634
11655A Impedance Probe for 8407A	482	13238A Duplex Register	641
11658A Matching Resistor for 8407A	482	13242G RS 232 Cable, male/male, 5m	634
11661B Frequency Extension Module	383	13242H RS 232 Cable, male/female, 5m	634
11664A Detector for 8755	458	13242M European Modem Cable, male, 5m	634
11664B Detector for 8755	458	13242N US Modem Cable, male, 5m	634
<b>11664C Detector Adapter for 8755</b>	<b>458</b>	13242Y RS 232 EMP Protect Cable, male/male, 5m	634
11665B Modulator for 8755	456		
11666A Reflectometer Bridge for 8755	456		
11667A DC-18 GHz Power Splitter	456		
11668A 50 MHz High Pass Filter for 8755	457		
11672A Service Accessory Kit for 8660A, C	383		

# MODEL NUMBER INDEX

New product listings are printed in bold face type  
Dates in parentheses are references to recent HP Journal\* articles

13245A Character Set Generation Kit .....	641	15609A Remote Extender Cable .....	606
13250B Serial Printer Interface .....	641	<b>16000</b>	
13254A Video Output Interface .....	641	16008A Resistivity Cell .....	93
13265A 300 Baud Modem, originate only .....	641	16014A Series Loss Test Adapter .....	100
13266A Current Loop Interface .....	634	16029A Test Fixture .....	94
13267A Asynchronous Multipoint Interface Pod .....	634	16061A Test Fixture .....	91
13268A Asynchronous Multipoint Daisy-chain Interface Pod .....	634	16062A Test Lead .....	91
13290B Development Terminal .....	639	16063A Test Lead .....	91
13296A Shared Peripheral Interface .....	641	16380A Decade Capacitors .....	115
13356A 120 Mbyte Disc Pack .....	661	16470A/B/C Reference Inductors .....	100
13394A 50 Mbyte Disc Pack .....	661	<b>17000</b>	
13515A Frequency Doubler Probe .....	391	17012B Point Plotter .....	274-275
<b>14000</b>		17012C Point Plotter .....	274-275
14513A Rack Kit (for one unit, 3½"H) .....	260	17055A Overhead Transparency Kit .....	660
14515A Rack Kit (for one unit, 5¼"H) .....	260	17108A Time Base .....	269
14521A Rack Kit (for Bench Series) .....	260	17170A DC Coupler .....	274-275
14523A Rack Kit (for two units, 3½"H) .....	260	17171A DC Preamplifier .....	274-275
14525A Rack Kit (for two units, 5¼"H) .....	260	17172A Time Base .....	274-275
14533B Pocket Programmer .....	265, 665	17173A Null Detector .....	274-275
14534A Pocket Programmer Cable .....	265, 665	17174B DC Offset .....	274-275
14535A Interface Kit, DCPS-to-21 MX Computer .....	265	17175A Filter .....	274-275
14536A DCPS Chaining Cable .....	265	17176A Scanner .....	274-275
14539A Cable Assembly, DCPS to 21 MX Computers .....	265	17177A AC/DC Converter DC Preamplifier .....	274-275
14540 Cable Assembly, Multiprogrammer-to 21 MX Computer .....	665	17178A DC Attenuator .....	274-275
14541A Chaining Cable, 6940B or 6941B to 6941B .....	665	17400A High Gain Preamplifier .....	281-283
14550A Interface Kit, Multiprogrammer-to- 21 MX Computer .....	665	17401A Medium Gain Preamplifier .....	281-283
14551A Multiprogrammer Service Kit .....	665	17402A Low Gain Preamplifier .....	281-283
14555A Multiprogrammer Card Connector .....	665	17403A AC Carrier Preamplifier .....	281-283
14558A Termination Panel .....	665	17404A DC Bridge Amplifier .....	281-283
14560A Cable Assembly .....	665	17500A Medium Sensitivity .....	280
14561A Cable Assembly .....	665	17501A High Sensitivity .....	280
14562A Cable Assembly .....	665	17502A Temperature Module .....	280
14700A/14701A Extender Interface Kits .....	665	17505A Very High Sensitivity .....	280
14702A Chaining Cable .....	665	17600A General I/O Interface for 7225A .....	656-657
14703A Spare Card Connector .....	665	17601A HP-IB Interface for 7225A .....	656-657
<b>15000</b>		17602A 8, 12, 16-Bit Interface for 7225A .....	656-657
15104A Pulse Adder/Splitter .....	679	17603A RS-232-C Type Interface for 7225A .....	656-657
15115A Pulse Splitter/Inverter .....	679	17604A RS-232-C Interface for 7225A .....	656-657
15116A Pulse Inverter .....	679	<b>18000</b>	
15179A Rack Adapter Frame .....	342, 343	18062B MIL-STD-188C Interface (1645A) .....	584
15263A Card Reader .....	349	18107A External Oscillator (2804A) .....	673
15452A-15458A 8170A Accessories .....	351	18108A Line Amplifier (2804A) .....	673
15507A Isolator .....	567	18109A Diagnostic Kit (2804A) .....	673
15508B Impedance Converter .....	567	18110A Laboratory Probe and Cal Module, 26 mm (1") (2804A) .....	673
15509A Amplifier .....	567	18111A Laboratory Probe and Cal Module, 232 mm (9.1") (2804A) .....	673
15575A-H Equalizers .....	600	18112A Laboratory Probe and Cal Module, 486 mm (19.1") (2804A) .....	673
15580A 25 MHz High-Impedance Active Probe .....	600	18115A Heavy Duty Probe and Cal Module, 29 mm (1.1") (2804A) .....	673
15581B 25 MHz High-Impedance Passive Probe .....	600	18116A Heavy Duty Probe and Cal Module, 129 mm (5.1") (2804A) .....	673
15582A Return Loss Kit .....	600	18117A Heavy Duty Probe and Cal Module, 179 mm (7.1") (2804A) .....	673
15584A Transit Case .....	600	<b>20000</b>	
15585A Diagnostic Kit .....	600	22900A series Cards for 2240A .....	630
15587A 25 MHz Low-Noise Amplifier .....	600	<b>30000</b>	
15588A 90 MHz Low-Noise Amplifier .....	600	33300 series Coaxial Step Attenuators .....	439
15589A Instrument Cart .....	600	33311B/C Coaxial Switches .....	451
15600A Isolator (3.7 to 4.2 GHz) .....	606	33320 series Coaxial Step Attenuators .....	439
15601A Isolator (5.9 to 6.5 GHz) .....	606		
15602A Isolator (7.1 to 8.1 GHz) .....	606		
15603A Isolator (10.7 to 11.7 GHz) .....	606		

\*A monthly publication of technical information from the HP Laboratories.

33330B, C Coaxial Crystal Detectors ..... 446  
 34110A Carrying Case ..... 75  
 34111A High Voltage Probe ..... 75  
 34112A Touch-Hold Probe ..... 75  
 37013A System Software ..... 594  
 37014A System Software ..... 594  
 37201A HP-IB Extender (Aug. 1979) ..... 32  
**37203A HP-IB Extender ..... 33**  
 37210T 4800 Bits/s Modem ..... 642  
 37220T 9600 Bits/s Modem ..... 642  
**37264A Band Defining Filter (for 3726A) ..... 608**  
**37265A Band Stop Filter (for 3726A) ..... 608**  
**37266A Band Pass Filter (for 3726A) ..... 608**  
**37267A Adapter Case (for 3726A) ..... 608**  
**37268A Dummy Plug-in (for 3726A) ..... 608**  
**37269A Front Panel Input Connector (for 3726A) ..... 608**  
**37230A Short Haul Modem ..... 643**  
**40000**  
 43804 X-Ray System ..... 702  
 43805 X-Ray System ..... 702  
 43807 X-Ray System ..... 702  
**50000**  
 52126A Intel MULTIBUS Interface ..... 172  
 59301A ASCII-Parallel Converter ..... 28  
 59303A Digital-to-Analog Converter ..... 28  
 59306A HP-IB Relay Actuator ..... 28  
 59307A HP-IB VHF Switch ..... 28  
 59308A HP-IB Timing Generator ..... 28  
 59309A HP-IB Digital Clock ..... 28  
 59310B HP-IB Computer Interface ..... 35  
 59313A HP-IB Analog-to-Digital Converter ..... 28  
 59401A Bus System Analyzer ..... 30  
 59403A HP-IB Common Carrier Interface ..... 31  
 59500A Multiprogrammer HP-IB Interface ..... 29  
 59501A HP-IB Power Supply Programmer ..... 252  
 K70-59992 Rack Mount Adapter Kit (5342A) ..... 301  
**60000**  
 61000 Modular Power Supplies (OEM) ..... 261  
 61005C DC-to-DC Converter  
   (single output) ..... 261  
 61315D DC-to-DC Converter  
   (triple output) ..... 261  
 62000 & 63000 Modular Power Supplies (OEM) ..... 261  
 62005A-62048G Modular Power Supplies ..... 261  
 62212A-62215G Dual Output Modular Supplies ..... 261  
 62410A Modular Supply Rack Mounting Tray ..... 261  
 62411A Rack Tray Blank Front Panel ..... 261  
 62412A Rack Tray Blank Rear Panel ..... 261  
 62413A Rack Tray Cooling Unit (45 cfm) ..... 261  
 62414A Rack Slide Kit (for standard cabinets) ..... 261  
 62415A Rack Tray AC Distribution Panel ..... 261  
 62416A Rack Tray Cooling Unit (160 cfm) ..... 261  
 62605L, 62605M, 62615M 300-600 W Switching  
   Power Supplies ..... 261  
 63005C 110 W Switching Power Supply ..... 261  
 63312F Multiple Output DC Power Supply  
   (Jul. 1979) ..... 261  
 63315D Triple Output  
   Switching Power Supply ..... 261  
 64000 Logic Development System ..... 144-147  
 64001S Logic Development System ..... 144-147  
 64030A Development Station Cart ..... 175  
 64100A Development Station ..... 144  
 64200A Emulator, 8080/8085 ..... 144

64210A Emulator, 6800 ..... 144  
 64250A Emulator, Z80 ..... 144  
 64300A Logic Analyzer ..... 144  
 64500A PROM Programmer ..... 144  
 64940A Tape Cartridge Drive ..... 144  
**65105A-65612A 50 Watt Modular Switching  
 Power Supplies ..... 261**  
 69322A Quad D/A Voltage  
   Converter Card ..... 665  
 69330A Relay Output Card ..... 665  
 69331A Digital Output Card ..... 665  
 69332A Open Collector Output Card ..... 665  
 69335A Stepping Motor Control Card ..... 665  
**69336A Scanner Card ..... 665**  
 69351B Voltage Regulator Card ..... 665  
 69370A D/A Current Converter Card ..... 665  
 69380A Breadboard Output Card ..... 665  
 69422A High Speed A/D Converter Card ..... 665  
 69423A Low Level A/D Converter Card ..... 665  
 69430A Isolated Digital Input Card ..... 665  
 69431A Digital Input Card ..... 665  
 69433A Relay Output With Readback Card ..... 665  
 69434A Event Sense Card ..... 665  
 69435A Pulse Counter Card ..... 665  
 69436A Process Interrupt Card ..... 665  
 69480A Breadboard Input Card ..... 665  
 69500A Unloaded Resistance Output Card ..... 665  
 69501A-69513A Power Supply Control Cards ..... 665  
 69600B Programmable Timer Card ..... 665  
 69601B Frequency Reference Card ..... 665  
 69700A-69706A Resistance Output Card ..... 668  
 69720A Digital-to-Analog Voltage  
   Converter Card ..... 668  
 69721A Digital-to-Analog Current  
   Converter Card ..... 668  
 69730A Relay Output Card ..... 668  
 69731A Digital Output Card ..... 668  
 69735A Pulse Train Output/Stepping Motor  
   Control Card ..... 668  
 69736A Timer/Pacer Card ..... 668  
 69751A Analog-to-Digital Converter Card ..... 668  
 69770A Isolated Digital Input Card ..... 668  
 69771A Digital Input/Analog Comparator Card ..... 668  
 69775A Counter/Totalizer Card ..... 668  
 69776A Interrupt Card ..... 668  
 69790A Memory Card ..... 668  
 69793A Breadboard Card ..... 668  
**80000**  
 82104A Card Reader (41C) (Mar. 1980) ..... 615  
 82106A Memory Module (41C) (Mar. 1980) ..... 615  
 82143A Printer (41C) (Mar. 1980) ..... 615  
 82153A Optical Wand (41C) ..... 615  
 82901M/S Flexible Disc Drive ..... 621, 646  
 82902M/S Flexible Disc Drive ..... 621, 646  
 82903A 16 k Memory Module (85A) ..... 620  
 82937A HP-IB Interface Card ..... 34, 622, 646  
 82939A Serial Interface Card ..... 35, 622, 646  
 82940A GPIO Interface Card ..... 35, 622, 646  
 82941A BCD Interface Card ..... 35, 622, 646  
 83522A 0.01-2.4 GHz RF Plug-In for 8350A ..... 412  
 83525A 0.01-8.4 GHz RF Plug-In for 8350A ..... 412  
 83540A 2-8.4 GHz RF Plug-In for 8350A ..... 414  
 83545A 5.9-12.4 GHz RF Plug-In for 8350A ..... 414  
 83570A 18-26.5 GHz RF Plug-In for 8350A ..... 414



# MODEL NUMBER INDEX

New product listings are printed in bold face type  
Dates in parentheses are references to recent HP Journal\* articles

83592A 0.01-20 GHz RF Plug-In for 8350A .....	410	1250-1263 BNC Male to Single Banana Plug .....	681
84801A Fiber Optic Power Sensor .....	436	1250-1264 BNC Male to Dual Banana Plug .....	681
85010B Basic Measurement Program Pac for 8501A/8505A & 9825T .....	479	1250-1286 Right Angle BNC (female) .....	681
85030B Applications Pac for 8507B-9825T .....	479	1250-1287 BNC (female) to (female) .....	681
<b>85030C Applications Pac for 8507C-9845T</b> .....	<b>479</b>	1250-1288 BNC (male) to (male) .....	681
85031A APC-7 Calibration and Verification Kit for 8507B .....	479	1250-1454 BNC Adapter Tip for HP Miniature Probes	210
85032A 50 Ω Type-N Calibration Kit for 8507B .....	479	1250-1472 N (f) to N (f) Precision (50 Ω) .....	681
85033A SMA Calibration Kit for 8507B .....	479	1250-1473 N (m) to BNC (m) Precision (50 Ω) .....	681
85036A 75 Ω Type N Calibration Kit for 8507B .....	479	1250-1474 N (f) to BNC (f) Precision (50 Ω) .....	681
85426A Bias Insertion Network .....	481	1250-1475 N (m) to N (m) Precision (50 Ω) .....	681
85428B Minimum Loss Pad .....	481	1250-1476 N (m) to BNC (f) Precision (50 Ω) .....	681
<b>85860A Software Pac for</b> <b>8568A/9825/9866B Opt. 025/98034A</b> .....	<b>514</b>	1250-1477 N (f) to BNC (m) Precision (50 Ω) .....	681
<b>85861A Software Pac for</b> <b>8566A/9825/9866B Opt. 025/98034A</b> .....	<b>514</b>	1250-1528 N (male to male) (75 Ω) .....	681
86200 series Sweeper Plug-ins for 8620C .....	422, 607	1250-1529 N (f) to N (f) (75 Ω) .....	681
86222A & B Sweeper Plug-ins for 8620C .....	419	1250-1530 N-Male Short (50 Ω) .....	449
86240A/B/C Sweeper Plug-ins for 8620C .....	421	1250-1531 N-Female Short (75 Ω) .....	449
86290A, 86290B & 86290C Broadband Sweeper Plug-ins for 8620C .....	420	1250-1533 N (m) to BNC (m) (75 Ω) .....	681
86600 series RF Section Plug-ins for 8660A & C .....	382	1250-1534 N (f) to BNC (m) (75 Ω) .....	681
86630 series Modulation Section Plug-ins for 8660 A & C .....	383	1250-1535 N (m) to BNC (f) (75 Ω) .....	681
<b>90000</b>		1250-1536 N (f) to BNC (f) (75 Ω) .....	681
90100D Practical Transistor Series (Video Tape) .....	712	1251-2277 Dual Banana plug to BNC Female .....	681
90301RD Understanding Microprocessors .....	710	1251-2816 Dual Banana plug (for cable) .....	681
90420D Digital Troubleshooting (Video Tape) .....	711	1420-0259 4.2 V Mercuric Battery .....	634
92160A Blue Thermal paper, 8½"x100' .....	634	1490-0714 Fixed Slides (180, 181 rack style oscilloscopes) .....	171, 214
92160B Black Thermal paper, 8½"x100' .....	634	1490-0719 Pivoted Slides (180, 181 rack style oscilloscopes) .....	171, 214
92904A Wall Mounting Cradle .....		1490-0768 Slide Adapter for securing slides (180, 181 rack style oscilloscopes) .....	214
98032A 16-bit Parallel Interface .....	35	5020-0530 Amber Filter for 12.7 cm (5") rectangular CRT .....	214
98033A BCD Input Interface .....	35	5020-0567 Smoke Gray Filter for 12.7 cm (5") rectangular CRT .....	214
98034A HP-IB Interface .....	34	5040-0516 Front Panel Cover (1700 series oscilloscopes) .....	214
98035A Real Time Clock Interface .....	35	5060-0548 Blue Filter (1700 series oscilloscopes) .....	214
98036A Serial Interface .....	35	5060-0789 Cooling Kit .....	693
98040A Incremental Plotter Interface .....	35	5060-0796 Cooling Kit .....	693
98041A Disc Interface .....	35	5060-8739 to -8744 Rack Mounting Kits .....	692
98133A BCD Interface .....	35	5060-8756 Accessory Drawer .....	692
98134A General Interface .....	35	5060-8757 to -8761 Filler Panels .....	692
98135A HP-IB Interface .....	35	5060-8762 Rack Adapter Frame .....	692
98136A RS-232-C Serial Interface .....	35	5060-8764 Rack Adapter Frame .....	692
98137A Tape Duplication Interface .....	35	5060-8766 to -8771 Control Panel Covers .....	693
1250-0076 90° BNC Male-Female .....	681	5060-0074 to -0087 Rack Mount Kits .....	686
1250-0077 Type N Female to BNC Male .....	681	10004-69515 IC Probe Tip Adapter .....	214
1250-0080 BNC Female to Female .....	681	10017-67603 Adapter Cable, HP standard probe to 0.64 mm (0.025 in.) square pin .....	210
1250-0082 Type N Male to BNC Male .....	681	10017-67604 Adapter, converts HP miniature probes for use with standard probe accessories .....	210
1250-0176 Type N Male to Type N Female 90° .....	681	10024-69501 Interface Pin Kit for 10024A .....	210
1250-0216 BNC Male to Male .....	681		
1250-0559 Type N Tee, 1 Male, 2 Female .....	681		
1250-0777 Type N Female to Female .....	681		
1250-0778 Type N Male to Male .....	681		
1250-0780 Type N Male to BNC Female .....	681		
1250-0781 BNC Tee 1 Male, 2 Female .....	681		
1250-0831 SMC Male to BNC Male .....	681		
1250-0832 SMC Female to BNC Female .....	681		
1250-0846 Type N Tee, 3 Female .....	681		
1250-1158 SMA Female to Female .....	681		
1250-1159 SMA Male to Male .....	681		
1250-1236 SMB Female to BNC Female .....	681		
1250-1250 N Male to SMA Female .....	681		

\*A monthly publication of technical information from the HP Laboratories.

- An easy-to-use, high performance concept that links instruments, desktop computers, minicomputers, and peripheral devices into automated measurement systems
- Very broad selection of HP-IB compatible instruments and accessory devices
- Wide choice of computers for the reduction, analysis, storage and management of measurement systems and resulting data
- The hardware, documentation and support that delivers the shortest path to a measurement system

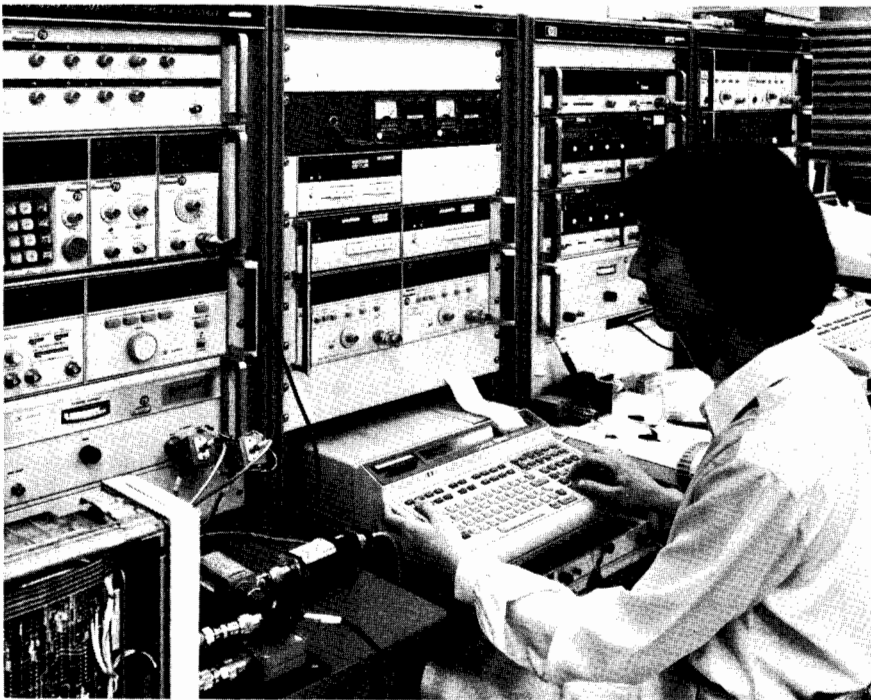

There are many applications where the measurement power of interactive instruments can be further enhanced by coupling them to desktop or minicomputer. Operating in a remote mode can provide more exact, error-corrected results as compared with conventional manual operation techniques.

Presently, three major parameters combine to reduce significantly the engineering development costs of configuring measurement systems:

- 1) The Hewlett-Packard Interface Bus, also known as "HP-IB";
- 2) Distributed computing through the growing number of "smart" instruments with internal microprocessors;
- 3) The broad choice of computers, ranging from "friendly" easy-to-program desktop computers to more sophisticated computer systems capable of managing multi-station instrument clusters and complex data bases.

### Relationship Between HP-IB and Other Interface Standards

Hewlett-Packard historically has been committed to the overall advancement of measurement technology, and has for some time been working on the problems of simplifying and standardizing means of instrumentation interfacing. An example of such an effort is the intimate involvement with the HP-IB from its conception at HP to its pre-

sent status as a world instrumentation interface standard (IEEE 488-1978).

In mid-1972, Hewlett-Packard began to participate in various international standardization bodies. The U.S. Advisory Committee, composed of diverse interests represented by both users and manufacturers, first established initial goals—and then adopted the interface concept utilized by the HP Interface Bus as an appropriate starting point. A draft document was subsequently written and evaluated by members of the Committee, and then submitted as the U.S. Proposal to the IEC (International Electrotechnical Commission) Working Group in the autumn of 1972. Since then, the interface definition has undergone a number of minor changes to accommodate various needs at the international level.

In September 1974, the parent technical committee IEC TC76, approved the main interface draft document for a formal ballot among the member nations of the IEC. Balloting took place in 1976, and IEC recommendation 625-1 was adopted. The IEC recommendation, using a different connector, is totally compatible with the present definition of the HP-IB.

Meanwhile, the IEEE Standards Board approved IEEE Standard 488-1975 "Digital Interface for Programmable Instrumentation", first published in 1975 and again pub-

lished in 1978 with minor editorial changes as IEEE Standard 488-1978. The IEEE standard is also fully compatible with the HP-IB. In January 1976, the American National Standards Institute adopted the IEEE Standard and published it as ANSI Standard MC 1.1.

The standardized interface concept is now well accepted, and more than 500 products utilizing the HP-IB concepts articulated in IEEE 488 are today available from more than 150 different manufacturers. As additional instrumentation interface standards evolve from the HP-IB, we will clearly indicate the relationship of the Hewlett-Packard Interface Bus to those standards—just as we have done with IEEE Standard 488, ANSI Standard MC 1.1 and IEC Publication 625.1.

### Why The HP Interface Bus Name?

As the list of HP products available with the "new digital interface" grew, our customers sought a convenient way to identify those products having the interface capability. In response, in 1974 we adopted the name "Hewlett-Packard Interface Bus" or simply "HP-IB". We will continue to use the identifying name and this symbol:



Both will be used with appropriate HP products so that their interface capabilities may be readily identified.

The Hewlett-Packard Interface Bus fully complies with IEEE Standard 488. As such, it incorporates the mechanical, electrical and functional specifications of the Standard. A fourth and vital element of any interface system is the operational aspect of a product at both the human-machine interface and machine-machine interface at the HP-IB port. HP-IB capability provides additional user benefits that are beyond the scope of IEEE Standard 488. Typical user conveniences such as underscored program codes on the front panel of the instruments for easy programming, convenient data output formats, designed-in "Learn Mode" capabilities, complete support documentation in the form of programming and interfacing guides, application notes and operation manuals illustrate the added benefits for users of products with HP-IB capability.

### Single Source Systems Approach

The decision to use a "system" instead of conventional manual methods must be based on an engineering evaluation of benefits versus costs. Among the many benefits associated with a systems approach:

- More consistent results in repeated measurements—a system is not subject to operator fatigue.
- Greater throughput because systems are generally faster.
- More thorough testing because system speed allows more parameters to be measured in a shorter time.
- Results expressed in engineering or scientific units, since many systems controllers are capable of on-line data manipulation.

# HEWLETT-PACKARD INTERFACE BUS

Versatile interconnect system for instruments and controllers



- Greater accuracy because system errors can be measured automatically, stored and accounted for in the results.
- "Adaptive" data acquisition wherein a system can be programmed to branch to other measurements to help pinpoint when it senses an abnormal condition.
- Measurement results can be stored in computer memory or on hard copy.

It is our objective to facilitate the integration of instrumentation systems by providing users with instruments and computers designed for systems applications. Computers are designed with HP-IB options that allow easy hook-up to the bus and incorporate easy-to-use bus commands in their software. HP's policy when designing HP-IB compatible instruments is to eliminate interfacing ambiguities associated with controllers and instruments operating per the IEEE, ANSI and IEC standards by adopting consistent interface design guidelines.

Proper training on system components is very important for efficient utilization of any interface system. Therefore, we offer training at sales and service offices worldwide on HP desktop computers, computer systems and instruments as they relate to the HP-IB. (Refer to HP-IB Training, Page 26). In the area of HP-IB support documentation, we offer Operating and Service Manuals with programming information, Instrument/Controller Introductory Operating Guides, Quick Reference Guides and Application Notes. Technical assistance during system development is available from resident systems engineers specialized in desktop computers, computer systems and instruments at most local sales and service offices.

### How The HP Interface Bus Operates

All active interface circuitry is contained within the various HP-IB devices, and the interconnecting cable (containing 16 signal lines) is entirely passive. The cable's role is limited to that of interconnecting all devices in parallel, whereby any one device may transfer data to one or more other participating devices.

Every participating device (instrument, controller, accessory module) must be able to perform at least one of the roles of TALKER, LISTENER or CONTROLLER. A TALKER can transmit data to other devices via the bus, and a LISTENER can receive data from other devices via the bus. Some devices can perform both roles (e.g., a programmable instrument can LISTEN to receive its control instructions and TALK to send its measurement).

A CONTROLLER manages the operation of the bus system primarily by designating which devices are to send and receive data, and it may also command specific actions within other devices.

A minimum HP-IB system configuration consists of one TALKER and LISTENER, without a CONTROLLER. In this configuration, data transfer is limited to direct transfer between one device manually set to "talk only" and one or more devices manually set to "listen only" (e.g., a measuring instrument talking to a printer, for semi-automatic data logging).

The full flexibility and power of the HP-IB become more apparent, however, when one device which can serve as CONTROLLER/TALKER/LISTENER (e.g., calculator or computer) is interconnected with other devices which may be either TALKERS or LISTENERS, or both (e.g., frequency synthesizers, counters, power meters, relay actuators, displays, printers, etc.), depending on the application. An HP-IB controller participates in the measurement by being programmed to schedule measurement tasks, set up individual devices so that they can perform these tasks, monitor the progress of the measurement as it proceeds, and interpret the results of the measurement. HP offers controllers which can be programmed in higher level languages such as BASIC, FORTRAN and HPL.

### HP-IB Connections and Structure

The HP-IB has a party line structure where all devices on the bus are connected in parallel. The 16 signal lines within the passive interconnecting HP-IB cable are grouped into three clusters according to their function as follows:

- 1) Data Bus (8 signal lines)
- 2) Data Byte Transfer Control Bus (3 signal lines)
- 3) General Interface Management Bus (5 signal lines)

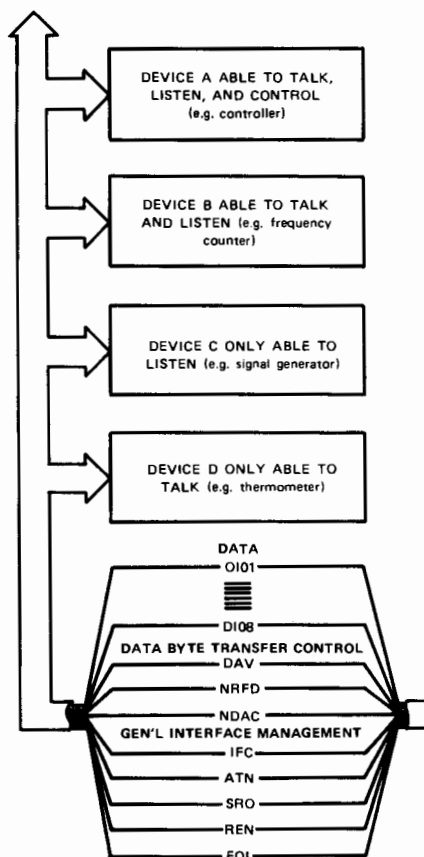

Interface connections and bus structure.



Rear panel switches are set so instrument will either be addressable by controller in a multi-device system, or will simply "talk only" to another device such as a printer.

The DATA BUS consists of eight signal lines which carry data in bit parallel, byte serial format across the interface. These signal lines carry addresses, program data, measurement data, universal commands and status bytes to and from devices interconnected in a system. Identification of the type of data present on the DIO signal lines is indicated by the ATN (attention) signal. When the ATN signal is true (asserted) either addresses or universal commands are present on the data bus and all connected devices are required to monitor the DIO lines. When the ATN message is false, then device dependent data (e.g., programming data) is carried between devices previously addresses to talk and listen.

Transfer of each byte on the Data Bus is accomplished via a set of three signal lines: DAV (data valid), NRFD (not ready for data), and NDAC (not data accepted). These signals operate in an interlocked handshake mode. Two signal lines, NRFD and NDAC, are each connected in a logical AND (wired OR) to all devices connected to the interface. The DAV signal is sent by the talker and received by potential listeners whereas the NRFD and NDAC signals are sent by potential listeners and received by the talker.

The General Interface Management Lines manage the bus to effect an orderly flow of messages. The IFC (interface clear) message places the interface system in a known quiescent state. SRQ (service request) is used by a device to indicate the need for attention or service and to request an interruption of the current sequence of events. REN (remote enable) is used to select between two alternate sources of device program data. EOI (end or identify) is used to indicate the end of a multiple byte transfer sequence or, in conjunction with ATN, to execute a polling sequence.

It is not possible in this limited space to go into detail on each signal line's role. But you should note that every HP-IB device need not be able to respond to all the lines. As a practical and cost-effective matter, each HP-IB device will usually be designed to respond only to those lines that are pertinent to its typical function on the bus. (Details appear in each device's operation manual.)



# HEWLETT-PACKARD INTERFACE BUS

Versatile interconnect system for instruments and controllers



## Products For "Do-It-Yourself" Unbundled HP-IB Systems

Hewlett-Packard has an extremely broad range of HP-IB instruments and controller capabilities, as indicated on the table below—capabilities you can use to solve a wide variety of measurement problems via HP-IB

tailored system solutions.

Each bench instrument is, by itself, an exceptional performer in terms of providing signals, making measurements, or recording results. Each has the additional capability which allows its use in HP-IB instrumentation systems—either in "do-it-yourself" sys-

tems configured and assembled by users themselves, or in some of the standard systems which are designed, preassembled and supported by HP. While the HP-IB Interface is optional in many instruments, it is increasingly becoming "standard" in new products.

Most principal functions on the instru-

## Individual Hewlett-Packard Products Available With HP-IB Capability

Products related to	Model	Product name/characteristics	See page
Design and Servicing	5004A Option H01	Signature analyzer: Order K17-59994A for complete HP-IB	132
	10050A	HP-IB Adaptor for 1602A Logic State Analyzer	158
	10051A	Test Probe for 1602A Logic State Analyzer	158
	10066A	Probe Interface for 1610A/B and 1615 A Logic State Analyzers	172
Stimulus	3320B Option 007	Frequency Synthesizer: 0.01 Hz to 13 MHz	366
	3325A	Synthesizer/Function generator/Sweeper: 1 μHz to 22 MHz	364
	3330B	Automatic Synthesizer/Sweeper: 0.1 Hz to 13 MHz	367
	3335A	Synthesizer/Level Generator: 200 Hz to 80 MHz	368
	3336A/B/C	Synthesizer/Level Generator: 10 Hz to 20.9 MHz	370
	4140 B	PA Meter/DC Voltage Source	106
	5359A	Time Synthesizer: 1 ns accuracy: 50 ps increments, 100 ps jitter	340
	6002A Option 001	DC Power Supply: 200 W autoranging. Listen only	253
	6129C Option J99	Digital Voltage Sources: ± 50 Vdc at 5 A (requires 59301A Converter)	264
	6130C Option J99	Digital Voltage Source: ± 50 Vdc at 1A (requires 59301A Converter)	264
	6131C Option J99	Digital Voltage Source: ± 100 Vdc at 0.5 A (requires 59301A Converter)	264
	6140A Option J99	Digital Current Source: ± 100 mA at 100 Vdc (requires 59301A Converter)	264
	6940B	Multiprogrammer (requires 59500A interface)	665
	6942A	Multiprogrammer	665
	8016A Option 001	Word Generator: 9 x 32 bit. Listen only	352
	8018A Option 001	Serial Data Generator: 50 MHz, 2048-bit memory. Listen only	349
	8160A	Programmable Pulse Generator: 20 ns to 999 ms period	338
	8165A	Programmable Signal Source: 0.001 Hz to 50 MHz	372
	8170A	Logic Pattern Generator: 8 x 1024/16 x 512 bit	350
	8350A	Sweep Oscillator: 10 MHz to 26.5 GHz	408
	8620C Option 011	Sweep Oscillator: 10 MHz to 22 GHz	406, 607
	8656A	Signal Generator: 0.1 to 990 MHz	376
	8660A Option 005	Synthesized Signal Generator: 10 kHz to 2.6 GHz. Listen only	380
	8660C Option 005	Synthesized Signal Generator: 10 kHz to 2.6 GHz. Listen only	380
	8662A	Synthesized Signal Generator: 10 kHz to 1280 MHz.	378
	8671A	Microwave Frequency Synthesizer: 2 to 6.2 GHz	386
	8672A	Synthesized Signal Generator: 2 to 18 GHz	384
Display	1350S	Graphics Display System	27, 234
	5150A Option 001	Alphanumeric Thermal Printer: 20 Columns. Listen only	291
	9871A Option 001	Character-Impact Printer: 132 columns	649
	7225A	Graphic Plotter: ISO A4 and 8½ x 11 inch chart size	656
	7245B	Thermal Plotter/Printer: Vector graphics, matrix printing	658
	7310A	Graphics Thermal Printer: Text, Graphics, and Forms	659
	9872B, 9872S	Graphics Plotter: multicolor (4 colors) programmable	654
	9876A	Thermal Graphics printer: 480 lines-per-minute	649
Switching Scanning Translation or Timing	2240A	Measurement and Control Subsystem	630
	3495A	Scanner: to 80 channels, low thermal; (up to 40 relay channels)	88
	3497A	Data Acquisition Control Unit	84
	3754A	25 MHz Access Switch (requires 3755A switch controller)	592
	3756A	90 MHz Switch (requires 3755A)	592
	3757A	8.5 MHz Access Switch (requires 3755A)	592
	3777A	Telecommunications Channel Selector: up to 30 channels; dc to 110 kHz	564
	6940B	Multiprogrammer (requires 59500A interface)	665
	6942A	MultiprogrammerII (no interface required)	665
	9411A	Switch Controller	629
	9412A	Modular Switch (requires 9411A switch controller)	629
	9413A	VHF Switch (requires 9411A)	629
	9414A	Matrix Switch (requires 9411A)	629
	11713A	Attenuator/Switch Driver (controls coax switches and step attenuators)	442
	12050A/B	Fiber Optic HP-IB Link	31
	37201A	HP-IB Extender Twisted-Pair or Modems	32
	37203A	HP-IB Extender: Coax and Fiber Optics	33
	59301A	ASCII-to-Parallel Converter: string to 16 characters	28
	59303A	Digital-to-Analog Converter	28
	59306A	Relay Actuator: for programmable switches, attenuators	28
	59307A	VHF Switch: two 50 Ohm, bidirectional, dc to 500 MHz	28
	59308A	Timing Generator	28, 29
	59309A	Digital Clock: month, day, hour, minute, second	28, 29
59313A	Analog-to-Digital Converter	28, 29	
59403A	HP-IB Common Carrier Interface: RS232C or CCITT V.24	31	
59501A	Power Supply Programmer: isolated D-to-A converter ± 10 V dc at 10 mA	29, 252	
Control and Computation	85A/F	Personal Computer (uses 82937A Interface)	34, 620
	9815A/S	Desktop Computer (uses 98135A Interface)	623
	9825B/T	Desktop Computer (uses 98034A Interface)	623
	9835A/B	Desktop Computer (uses 98034A Interface)	624
	9845B/T	Desktop Computer System 45 (uses 98034A Interface)	625
	HP1000 M-series	Computers (2108M & 2112M; use 59310B Interface)	628
	HP1000 E-series	Computers (2109E & 2113E; use 59310B Interface)	628
	HP 1000 F-series	High-performance computers (2111F and 2117F use 59310B Interface)	628
	HP1000 L-series	Low cost computer (2103, uses 12009A Interface)	628
	3075A	Desktop Data Capture Terminal	644
	3076A	Wall Mounted Data Capture Terminal	644

# HEWLETT-PACKARD INTERFACE BUS

Versatile interconnect system for instruments and controllers



ments are HP-IB programmable. New instruments incorporate conveniences for the programmer such as underscored program codes on front panels to enable quick refer-

ence programming and complete documentation to facilitate integration into a system. Just as with electronic instruments, HP controllers for use with HP-IB are all proven

performers. Regardless of the need for reducing, analyzing, storing or managing measurement systems data, HP has a controller that's right for your application.

## Individual Hewlett-Packard Products Available with HP-IB Capability (cont.)

Products related to:	Model	Product name/characteristics	See Page
Interface Cabling	10631A	HP-IB Interconnection Cable: 1 m (3.3 ft)	30
	10631B	HP-IB Interconnection Cable: 2 m (6.6 ft)	30
	10631C	HP-IB Interconnection Cable: 4 m (13.2 ft)	30
	10631D	HP-IB Interconnection Cable: 0.5 m (1.6 ft)	30
	10833A	HP-IB Interconnection Cable: 1 m (3.3 ft)	30
	10833B	HP-IB Interconnection Cable: 2 m (6.6 ft)	30
	10833C	HP-IB Interconnection Cable: 4 m (13.2 ft)	30
	10833D	HP-IB Interconnection Cable: 0.5 m (1.6 ft)	30
	10834A	HP-IB Interconnection Cable Adapter: 2.3 cm (.91 in)	30
	Measurement	436A Option 022	Power Meter: -70 dBm to +44 dBm, to 26.5 Ghz
1602A Option 001		Logic State Analyzer: 64 x 16 bit memory	155-158
1610A/B Option 003		Logic State Analyzer: 64 x 32 bit memory	151-154
1615A Option 001		Logic Analyzer: 256 x 24 bit memory	148-150
1640B Option 001		Serial Data Analyzer: 2048 bit memory	166-169
2240A		Measurement & Control Subsystem	630
2804A Option 010		Quartz Thermometer: 0.05°C accuracy	673
3437A		System Digital Voltmeter: high speed, 3½ digits	66
3438A		Digital Voltmeter: low-cost, 3½ digits	64
3455A		Digital Voltmeter: 5½ or 6½ digits, auto calibration	72
3456A		Digital Voltmeter: 3½ to 6½ digit voltmeter 1 nv. sensitivity	68
3490A Option 030		Digital Voltmeter: 5 digits, self test	76
3582A		2-channel Real Time (FFT) Spectrum Analyzer: 20 MHz to 25.6 kHz	538
3585A		Swept Spectrum Analyzer: 20 Hz to 40 MHz, 3 Hz BW, 0.5% amplitude accuracy	500
3586A/B/C		Selective Level Meter: 50 Hz to 32.5 MHz	504-596
3717A		Wideband 70 MHz modem	605
3724/25/26A		Baseband Analyzer	608
3745A		25 MHz Selective Level Measuring Set: CCITT FDM systems	590
3745B		25 MHz Selective Level Measuring Set: Bell FDM systems	590
3747A		90 MHz Selective Level Measuring Set: CCITT FDM systems	590
3747B		90 MHz Selective Level Measuring Set: Bell FDM systems	590
3771A Option 005		Data Line Analyzer: CCITT measurement standards	573
3771B Option 005		Data Line Analyzer: Bell measurement standards	573
3779A		Primary Multiplex Analyzer: CEPT 2 Mb/s PCM systems	562
3779B		Primary Multiplex Analyzer: Bell 1.5 Mb/s PCM systems	562
3781B		Pattern Generator	568
3782B		Error Detector	568
4140B Option 101		PA Meter / DC Voltage Source	106
4191A		RF Impedance Analyzer	108
4192A		LF Impedance Analyzer	112
4262A Option 101		Automatic LCR Meter	98
4271B Option 101		1 MHz Digital LCR Meter	101
4274A Option 101		Multifrequency LCR Meter: 10 Steps, 100 Hz to 100 KHz	102
4275A Option 101		Multifrequency LCR Meter: 10 steps, 10 kHz to 10 MHz	102
4943A Option 010		Transmission Impairment Measurement System (TIMS)	581
4944A Option 010		Transmission Impairment Measurement System (TIMS)	581
5312A		HP-IB interface (Talker) for 5300B Counter System	322
5316A		Universal Counter: 0-100 MHz	314
5328A Option 011		Universal Counter: to 512 MHz, 10 ns time interval	310
5335A		Automatic Universal Counter: 200 MHz/1.3 GHz, 2ns Time Interval	307
5340A Option 011		Automatic Microwave Counter: 10 Hz to 18 GHz	302
5342A Option 011		Automatic Microwave Counter: 10 Hz to 18 GHz	300
5343A Option 011		Microwave Frequency Counter: 10 Hz to 26.5 GHz	300
5345A Option 011.012		General Purpose Plug-In Counter	298
5353A		Channel C Plug-in for 5345A	298
5354A		4 GHz Frequency Converter for 5345A/5356A	298
5355A		Automatic Frequency Converter	299
5363B		Time Interval Probes	306
5370A		Time Interval Counter: ± 20 ps single-shot resolution	304
5420A		Digital Signal Analyzer	544
5423A		Structural Dynamics Analyzer	544
5427A		Digital Vibration Control Systems	546
5501A Option 251		Laser Transducer: for accurate positioning measurements	672
6940B		Multiprogrammer (requires 59500 interface)	665
6942A	Multiprogrammer II (no interface required)	668	
8501A	Storage Normalizer for 8505A RF network analyzer	475	
8503A & 8503B	S-Parameter Test Set: 50 or 75 Ohm, for 8505A	476	
8505A	RF Network Analyzer: 500 kHz to 1.3 GHz	472	
8566A	Spectrum Analyzer: 100 Hz to 22 GHz	506-511	
8568A	Spectrum Analyzer: 100 Hz to 1.5 GHz	506-508	
8901A	Modulation Analyzer: 150 kHz to 1.3 GHz	551	
8903A	Audio Analyzer: 20 Hz to 100 KHz	554	
		<i>Also see models 2240A, 6940B, 6942A, and 3497A.</i>	
Storage	3964A Option 007	Instrumentation Tape Recorder: 4 channel Listen only	289
	3968A Option 007	Instrumentation Tape Recorder: 8 channel Listen only	289
	9875A	Cartridge Tape Unit	649
HP-IB Extension	12050A/B	Fiber Optic HP-IB link	31
	37201A	HP-IB Extender: Twisted Pair or modems	32
	37203A	HP-IB Extender: Co-axial or Fiber Optic Cable	33
	59403A	HP-IB CommonCarrier Interface	31



# HEWLETT-PACKARD INTERFACE BUS

Versatile interconnect system for instruments and controllers



## Standard Bundled HP-IB Measurement Systems

Many application requirements can be satisfied with a standard HP-IB measurement system — already preassembled, tested, and

documented by Hewlett-Packard. Preconfigured systems save you design and setup time, and HP guarantees overall specified

system performance. Installation and service contracts are available from your local HP Sales and Service Office.

## Standard HP-IB Measurement Systems [HP Built]

Application	Model	Controller	System name/characteristic	See Page
Data Logging, Acquisition, and Control	3052A	9825/35/45	Automatic Data Acquisition: fast and precise low-level measurements, powerful computation.	82
	3054A	85/9825 9835/9845	Computer based Automatic Data Acquisition/Control System: fast, flexible, and precise data acquisition system with a wide choice of controllers	79
	5391A	9825	Frequency and Time Data Acquisition Systems: over 50,000 four-digit frequency and time interval measurements per second	303
	9030	9825/35/45	Measurement and Control System: Fully configured, self-contained, and easy to use portable laboratory or production system for computational measurement and control	630
	9875A	9825/35/45	Tape Cartridge Unit: Data logging applications	649
Network Analysis	3040A	9825	Network Analyzer: complete amplitude and phase characterization, 50 Hz to 13 MHz. Group delay optional.	465
	3042A	9825	Automatic Network analyzer: same as 3040A, and includes the faster 9825A as computing controller.	466
	8409A/B	9825/45	Automatic Microwave Network Analyzer: measures transmission and reflection parameters, 110 MHz to 18 GHz.	490
	8507B/C	9825/45	Automatic RF Network Analyzers: measures complex impedance, transfer functions, group delay; 500 kHz to 1.3 GHz.	478
Spectrum Analysis	3044A	9825	Spectrum Analyzer: precise amplitude and frequency measurements, 10 Hz to 13 MHz.	542
	3045A	9825	Automatic Spectrum Analyzer: same as 3044A, and includes the faster 9825A as computing controller.	542
	8581A	9825	Automatic Spectrum Analyzer: covers 100 Hz to 1.5 GHz; exceptional frequency tuning accuracy and resolution.	514
	8582A	9825	Automatic Spectrum Analyzer: covers 100 Hz to 22 GHz; exceptional frequency tuning accuracy and resolution.	514
Frequency Stability Analysis	5390A	9825	Frequency Stability Analyzer: short and long-term characterization of precision frequency sources, 500 kHz to 18 GHz.	556
Transceiver Testing	8950B	9825	Automatic Transceiver Test System: for AM and FM transceivers, to 1000 MHz, transmitters to 100 W.	558
Circuit Testing	DTS-70	1000	Digital Test System: fast, accurate fault location on loaded printed circuit boards.	122
	3060A	9825	Analog and Digital Test System: Fast, accurate fault location on loaded printed circuit boards	123
Digital IC Testing	5046A	9825	Digital IC Test System: Reduces production costs through the isolation of faulty components prior to printed circuit board loading.	118
FDM Network Surveillance	37013A	1000	Frequency Division Multiplex Network Surveillance System: remote capability based on HP 1000 Computer	594
	37014A	9835	Frequency Division Multiplex Network Surveillance System: remote capability based on 9835A Desktop Computer	594
Semiconductor/Component Testing	4061A	9835/45 1000	Semiconductor/Component Test System: evaluation of fundamental characteristics of semiconductor and electronic components (I-V, HF, C-V, + quasi static C-V)	110
Pressure Recording System	2820A	9825	Pressure recording system: displays, prints, and records pressure test data from oil and gas wells. Used with the 2813B Quartz Pressure Probe.	675
Graphics Display	1350S	9825	Graphics Display System with Digital Interface. High resolution display system for generation of bright, sharp vectors and alphanumerics at high writing speeds	27, 234



# HEWLETT PACKARD INTERFACE BUS

Versatile interconnect systems for instruments and controllers



## HP-IB Training and Support Available from Hewlett-Packard

Hewlett-Packard has field sales people trained in electronic instruments, desktop computers and computer systems to assist users configure HP-IB measurement systems. Also available for technical consultation are computing controller systems engineers and HP-IB instrumentation specialists.

Listed below are training courses on HP-IB computing controllers and instruments available on a regular basis.

### Computer Systems

Course Name	Duration
• Introduction to HP1000 Mini-computers	4 days
• Disc-Based RTE System Course	10 days
• Memory-Based RTE System Course	10 days
• HP-IB in a Minicomputer Environment	4 days
• Instrument Interface with HP-IB	4 days

### Desktop Computer Systems

Course Name	Duration
• 9825 Operating and Programming	5 days
• 9825 I/O Programming	4 days
• BASIC Language Programming for Desktop Computers	4 days
• 9845 Operating and Programming	5 days
• 9845 BASIC Language I/O Programming	4 days
• 9845 Image Data Base Management	5 days
• 9845 Color Graphics Operating and Programming	3 days
• 9835 Assembly Language Programming	5 days

### Electronic Instruments

Course Name	Duration
• HP-IB Seminar	2 days

## Service and Warranty Considerations

Hewlett-Packard has dedicated Measurement System Service people who perform onsite maintenance on both customer configured systems as well as HP configured systems, irrespective of whether an HP desktop or minicomputer is used. Service contract coverage is available to meet your specific measurement system service needs and can be tailored to include extended warranty, calibration and extended hours of coverage. Contact your local sales and service office for further information on HP-IB service contract information.

Every HP-IB device and HP configured system carries a standard Hewlett-Packard warranty appropriate to that product. The warranty period for each product will be provided on request at the time of sale and is specified in documentation supplied with the product. HP takes responsibility for standard HP-IB systems performing as specified. However, software or interfacing which has not been provided by Hewlett-Packard as part of a standard system delivered by HP is not covered by this warranty.

In all cases, overall operational responsibility for those HP-IB systems assembled by a customer from individual HP-IB devices shall rest with the customer.

## HP-IB Specifications Summary

### Interconnect Devices:

Up to 15 maximum on one contiguous bus.

### Interconnection Path:

Star or linear bus network; total transmission path length 2 metres times number of devices or 20 metres, whichever is

less (See HP-IB Extension Capabilities for extending operating distance.)

### Message Transfer Scheme:

Byte-serial, bit-parallel asynchronous data transfer using locked 3-wire handshake technique.

### Data Rate:

One megabyte per second maximum over limited distance; 250-500 kilobytes per second typical over full transmission path (actual data rate depends on individual device characteristics).

### Address Capability:

Primary addresses, 31 TALK and 31 LISTEN; secondary (2-byte) addresses, 961 TALK and 961 LISTEN. Maximum of 1 TALKER and up to 14 LISTENERS at a time.

### Control Shift:

In systems with more than one controller, only one can be active at a time. A currently active controller can pass control to another, but only designated system controller can assume control over others.

### Interface Circuits:

Driver and receiver circuits are TTL-compatible.

## Connector Lock Screw Compatibility

HP-IB products delivered now and in recent years are equipped with connectors having ISO metric-threaded lock screws, and stud mounts. (Very early HP-IB products have non-metric parts, but are readily distinguished from the metric by color: metric threaded parts are black and stamped with the letter "M" whereas non-metric parts have a shiny nickel finish). HP-IB Metric Conversion Kit (P/N 5060-0138) is available to convert these early instruments.

\*Classes are taught at selected sales offices and at Desktop Computer Division on a tuition basis.

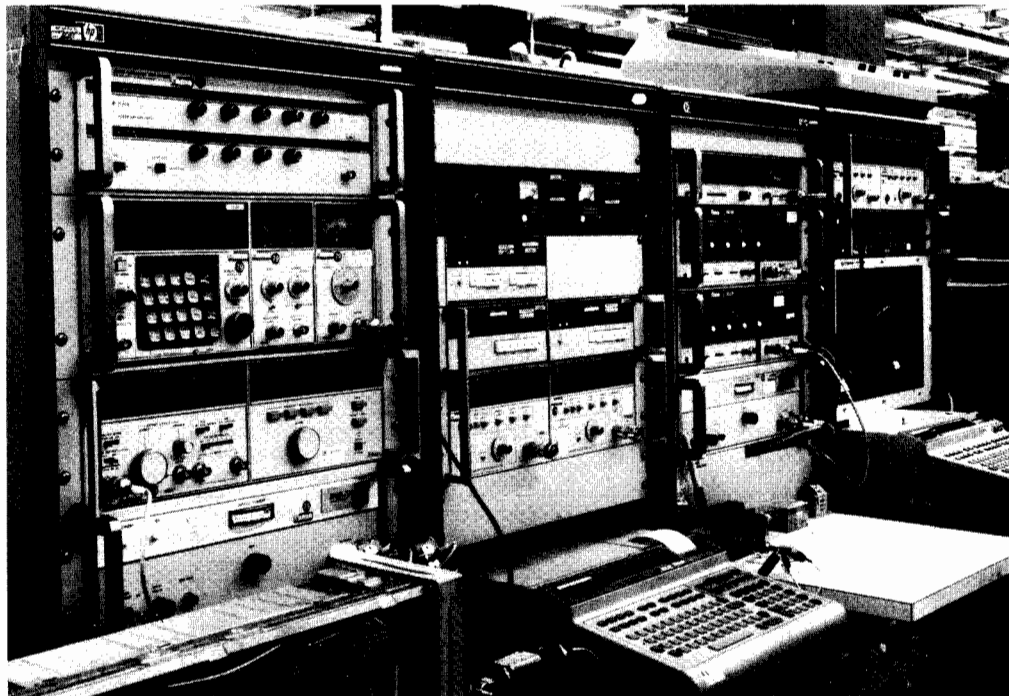

# COMPONENT MEASUREMENT

Multi-Frequency LCR Meters

Models 4274A & 4275A



- Test frequencies - 10 kHz to 10 MHz
- Test signal level - 1 mV to 1 Vrms
- 0.1% basic accuracy

- High Resolution - 5½ digit; D=0.00001
- Measure L/C - D/Q/ESR/G; IZI -  $\theta$ , R-X/B/L/C;  $\Delta$ LCRZ,  $\Delta\%$

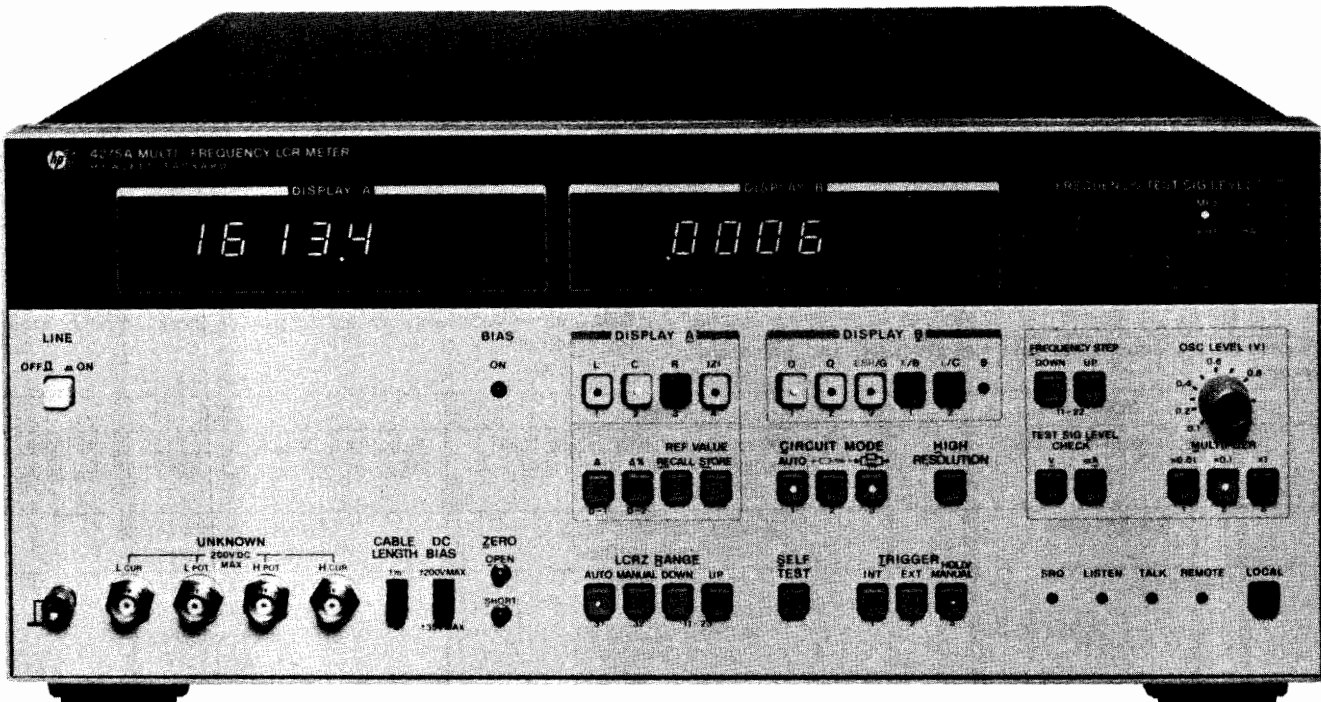

4275A



The fast measurement speed, high resolution, and high accuracy can make major contributions for the component manufacturer and user who is concerned about reducing his costs, improving quality, and throughput efficiency. In these areas, the 4274A and the 4275A are ideal for D-measurements of film capacitors or insulation material (with the high resolution of 0.00001), the C-G measurements of semiconductors (with maximum resolutions of 0.001 pF, 0.1 nS, respectively), and for the low impedance measurement of aluminum electrolytic capacitors (with a maximum resolution of 0.001 m $\Omega$ ).

## Automatic Semiconductor and Component Measurements With HP-IB

Integrating the 4274A and the 4275A into a system with the HP-IB option is an excellent method for improving efficiency and cost savings both in the laboratory and on the production line. These automatic measurement systems are assembled by connecting the HP-IB cables between the instruments to be utilized for a specific task.

A system built around the 4274A and/or 4275A allows the user to obtain useful data for many diverse applications. For example, the evaluation of semiconductors based on the frequency dependence of its C-V characteristics that requires a wide range and fast measurement speeds is easily accomplished with these instruments. The four-terminal pair input configuration and the automatic zero offset capability insures that the measured data is accurate, even in a systems environment.

## Sample Applications Semiconductor measurements

The evaluation of a semiconductor can be done with a C-V or G-V measurement with the multi-spot frequencies featured in the 4274A

and 4275A, (with C resolution of 0.001 pF and G resolution of 0.1 nS), their two programmable bias sources (maximum resolution 1 mV) and their continuously variable test signal levels (from 1 mVrms).

Of significant use is the evaluation of the doping process and the measurement of the characteristics of MOS or bipolar semiconductor materials which employ a C or G measurement with varying dc bias voltage.

A sample plot of a semiconductor measurement is shown in the figure below. Such measurements at high speed can offer high reliability and high throughput efficiency in the semiconductor manufacturing processes.

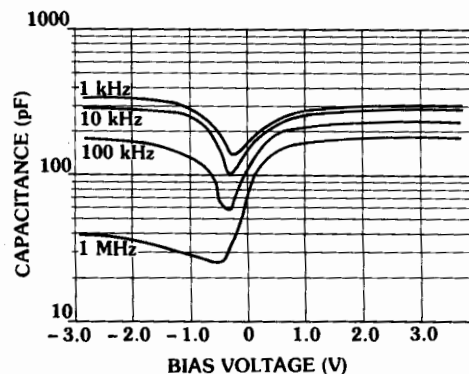



# COMPONENT MEASUREMENT

## Multi-Frequency LCR Meters



Models 4274A & 4275A (cont.)

### Common specifications (4274A & 4275A)

#### Parameters measured:

L: inductance	Q: =1/D	θ: phase angle
C: capacitance	ESR: equivalent series resistance	Δ: deviation for L, C, R, Z
R: resistance	G: conductance	Δ%: % of deviation
Z: impedance	X: reactance	Test frequency
D: dissipation factor	B: susceptance	Test signal level (voltage or current)

#### Parameter combinations:

Display A	Display B	
		
L	D / Q / ESR	D / Q / G
C		
R	X / L	B / C
Z	θ	

#### Measurement frequencies, test signal levels, and full scale range:

MODEL	4274A	4275A
Measurement frequencies	100Hz-100kHz, 11 spots (100Hz, 120Hz, 200Hz, 400Hz, 1kHz, 2kHz, 4kHz, 10kHz, 20kHz, 40kHz, 100kHz; ±0.01%)	10kHz-10MHz, 10 spots (10kHz, 20kHz, 40kHz, 100kHz, 200kHz, 400kHz, 1MHz, 2MHz, 4MHz, 10MHz; ±0.01%)
Test signal levels	4-ranges (1 mVrms-5 Vrms) continuously variable	3-ranges (1 mVrms-1 Vrms) continuously variable
Full scale range	L: 100.00nH - 1000.0H C: 1.0000pF - 1.00F R,  Z , ESR, & X: 100.00mΩ - 10.000MΩ D: 0.00001 - 9.9999 Q (1/D): 0.01 - 9900 G & B: 1.0000μS - 100.00S θ: 0 - ±180°	L: 100.00nH - 10.00H C: 1.0000pF - 100.00μF R,  Z , ESR, & X: 1.0000Ω - 10.000MΩ D: 0.00001 - 9.9999 Q (1/D): 0.01 - 9900 G & B: 1.0000μS - 10.00S θ: 0 - ±180°



**Accuracy (4274A only):** Typical C-D, L-D, R-X and |Z|-θ measurement accuracy values are given below.

**Range:** full scale range, accuracy: % of reading + counts (D: accuracy: % of reading + absolute D value + count)

FREQUENCY RANGE	C-D/Q	L-D/Q	R-X	Z -θ
	D-range: 0.00001-9.9999 Q-range: 0.01-9900 (=1/D) (C & D accuracies apply only when C: full scale and D: ≤ 0.1)	D-range: 0.00001-9.9999 Q-range: 0.01-9900 (=1/D) (L & D accuracies apply only when L: full scale and D: ≤ 0.1)	(R accuracies apply only when R: full scale) (X accuracies apply only when R: 1/10 of full scale and X: full scale)	θ-range: -180° - +180.00° ( Z  & θ accuracies apply only when  Z : full scale)
100Hz	C: 1000pF-1000mF, 0.1% + 3 D: 0.33% + 0.0008 + 1	L: 100μH-10kH, 0.1% + 3 D: 0.33% + 0.0013 + 1	R: 100mΩ-10MΩ, 0.1% + 3 X: 100mΩ-10MΩ, 0.1% + 13	Z : 100mΩ-10MΩ, 0.1% + 3 θ: ±0.1°
120Hz	C: 1000pF-1000mF, 0.1% + 2 D: 0.32% + 0.0007 + 1	L: 100μH-10kH, 0.1% + 3 D: 0.32% + 0.0012 + 1	R: 100mΩ-10MΩ, 0.1% + 3 X: 100mΩ-10MΩ, 0.1% + 13	Z : 100mΩ-10MΩ, 0.1% + 3 θ: ±0.1°
200Hz	C: 100pF-100mF, 0.14% + 1 D: 0.34% + 0.0013 + 1	L: 100μH-10kH, 0.1% + 3 D: 0.31% + 0.0011 + 1	R: 100mΩ-10MΩ, 0.1% + 3 X: 100mΩ-10MΩ, 0.1% + 13	Z : 100mΩ-10MΩ, 0.1% + 3 θ: ±0.1°
400Hz	C: 100pF-100mF, 0.1% + 3 D: 0.33% + 0.0008 + 1	L: 10μH-1000H, 0.1% + 3 D: 0.33% + 0.0013 + 1	R: 100mΩ-10MΩ, 0.1% + 3 X: 100mΩ-10MΩ, 0.1% + 13	Z : 100mΩ-10MΩ, 0.1% + 3 θ: ±0.1°
1kHz	C: 100pF-100mF, 0.1% + 2 D: 0.32% + 0.0007 + 1	L: 10μH-1000H, 0.1% + 3 D: 0.32% + 0.0012 + 1	R: 100mΩ-10MΩ, 0.1% + 3 X: 100mΩ-10MΩ, 0.1% + 13	Z : 100mΩ-10MΩ, 0.1% + 3 θ: ±0.1°
2kHz	C: 10pF-10mF, 0.14% + 1 D: 0.34% + 0.0013 + 1	L: 10μH-1000H, 0.1% + 3 D: 0.31% + 0.0011 + 1	R: 100mΩ-10MΩ, 0.1% + 3 X: 100mΩ-10MΩ, 0.1% + 13	Z : 100mΩ-10MΩ, 0.1% + 3 θ: ±0.1°
4kHz	C: 10pF-10mF, 0.1% + 3 D: 0.33% + 0.0008 + 1	L: 1μH-100H, 0.1% + 3 D: 0.33% + 0.0013 + 1	R: 100mΩ-10MΩ, 0.1% + 3 X: 100mΩ-10MΩ, 0.1% + 13	Z : 100mΩ-10MΩ, 0.1% + 3 θ: ±0.1°
10kHz	C: 10pF-10mF, 0.1% + 2 D: 0.32% + 0.0007 + 1	L: 1μH-100H, 0.1% + 3 D: 0.32% + 0.0012 + 1	R: 100mΩ-10MΩ, 0.1% + 3 X: 100mΩ-10MΩ, 0.1% + 13	Z : 100mΩ-10MΩ, 0.1% + 3 θ: ±0.1°
20kHz	C: 1pF-1000μF, 0.14% + 1 D: 0.34% + 0.0013 + 1	L: 1μH-100H, 0.1% + 3 D: 0.31% + 0.0011 + 1	R: 100mΩ-10MΩ, 0.1% + 3 X: 100mΩ-10MΩ, 0.1% + 13	Z : 100mΩ-10MΩ, 0.1% + 3 θ: ±0.1°
40kHz	C: 1pF-1000μF, 0.1% + 3 D: 0.33% + 0.0008 + 1	L: 100nH-10H, 0.1% + 3 D: 0.33% + 0.0013 + 1	R: 100mΩ-10MΩ, 0.1% + 3 X: 100mΩ-10MΩ, 0.1% + 13	Z : 100mΩ-10MΩ, 0.1% + 3 θ: ±0.1°

(Conditions: Warm-up time ≥ 30 minutes, environment temperature: 23°C ± 5°C) Refer to technical data sheet for accuracy details.

**Displays:** Dual 5½-digit and single 3-digit; maximum display 199999 (full scale and overrange in high resolution mode), and 4½-digit: maximum display 19999 in normal mode. (Number of digits depends on measurement frequency, test level, and range).

**Circuit modes:**  Series equivalent circuit and  parallel equivalent circuit. Automatic selection available in AUTO mode.

**Deviation measurement:** Difference between recallable stored reference and displayed is deviation value (count or percent).

Display range: -199999 to +199999 counts in AUTO range. -19999 to +19999 counts in MANUAL range (the sample should be measurable at the selected range). % Display range: -199.99% to +199.99%

**Ranging:** AUTO or MANUAL (UP/DOWN)

**Trigger:** Internal, External or Manual.

**Measurement terminals:** Four-terminal pair with guard.

**Auto zero adjustment:** Automatic normalization of the readout offset due to residuals of the test fixture by pushbutton operation.

**Normalization range:** C < 20 pF, L < 2000 nH, R < 0.5Ω, G < 5 μS.

**Self test:** Automatic operational verification check indicates pass or fail condition.

**Accuracy (4725A only):** Typical C-D, L-D, R-X and |Z|-θ measurement accuracy values are given below.

**Range:** full scale range, accuracy: % of reading + counts (D accuracy: % of reading + absolute D value + count)

Frequency Range	C-D/Q	L-D/Q	R-X	Z -θ
	D-range: 0.00001 - 9.9999 Q-range: 0.01-9900 (= 1/D) (C & D accuracies apply only when C: full scale and D: ≤0.1)	D-range: 0.00001 - 9.9999 Q-range: 0.01 = 9900 (= 1/D) (L & D accuracies apply only when L: full scale and D: ≤0.1)	(R accuracies apply only when R: full scale) (X accuracies apply only when R: 1/10 of full scale and X: full scale)	θ-range: -180.00° - +180.00°  (Z & θ accuracies apply only when Z: full scale)
10 kHz	C: 10 pF - 100 μF, 0.1% + 3 D: 0.33% + 0.008 + 1	L: 10 μH - 100H, 0.1% + 3 D: 0.33% + 0.0013 + 1	R: 1000 mΩ - 10 MΩ, 0.1% + 3 X: 1000 mΩ - 10 MΩ, 0.1% + 13	Z : 1000 MΩ - 10 mΩ, 0.1% + 3 θ: ± 0.1°
20 kHz	C: 10 pF - 100 μF, 0.1% + 2 D: 0.32% + 0.0007 + 1	L: 10 μH - 100 H, 0.1% + 3 D: 0.32% + 0.0012 + 1	R: 1000 mΩ - 10 MΩ, 0.1% + 3 X: 1000 mΩ - 10 MΩ, 0.1% + 13	Z : 1000 MΩ - 10 mΩ, 0.1% + 3 θ: ± 0.1°
40 kHz	C: 1 pF - 10 μF, 0.14% + 1 D: 0.34% + 0.0009 + 1	L: 10 μH - 100 H, 0.1% + 3 D: 0.31% + 0.0011 + 1	R: 1000 mΩ - 10 MΩ, 0.1% + 3 X: 1000 mΩ - 10 MΩ, 0.1% + 13	Z : 1000 MΩ - 10 mΩ, 0.1% + 3 θ: ± 0.1°
100 kHz	C: 1 pF - 10 μF, 0.1% + 3 D: 0.33% + 0.0008 + 1	L: 1 μH - 10 H, 0.1% + 3 D: 0.33% + 0.0013 + 1	R: 1000 mΩ - 10 MΩ, 0.1% + 3 X: 1000 mΩ - 10 MΩ, 0.1% + 13	Z : 1000 MΩ - 10 mΩ, 0.1% + 3 θ: ± 0.1°
200 kHz	C: 10 pF - 10 μF, 0.1% + 2 D: 0.32% + 0.0008 + 1	L: 1 μH - 1000 mH, 0.2% + 3 D: 0.53% + 0.0023 + 1	R: 1000 mΩ - 1 MΩ, 0.2% + 3 X: 1000 mΩ - 1 MΩ, 0.2% + 13	Z : 1000 MΩ - 1 mΩ, 0.2% + 3 θ: ± 0.1°
400 kHz	C: 1 pF - 1000 nF, 0.14% + 1 D: 0.34% + 0.0009 + 1	L: 1 μH - 1000 mH, 0.2% + 3 D: 0.51% + 0.0021 + 1	R: 1000 mΩ - 1 MΩ, 0.2% + 3 X: 1000 mΩ - 1 MΩ, 0.2% + 13	Z : 1000 MΩ - 1 mΩ, 0.2% + 3 θ: ± 0.1°
1 MHz	C: 1 pF - 1000 nF, 0.1% + 3 D: 0.33% + 0.0008 + 1	L: 100 nH - 100 mH, 0.2% + 3 D: 0.55% + 0.0025 + 1	R: 1000 mΩ - 1 MΩ, 0.2% + 3 X: 1000 mΩ - 1 MΩ, 0.2% + 13	Z : 1000 MΩ - 1 mΩ, 0.2% + 3 θ: ± 0.1°
2 MHz	C: 10 pF - 100 nF, 0.3% + 3 D: 0.55% + 0.0025 + 1	L: 1 μH - 10 mH, 0.5% + 5 D: 1.0% + 0.0033 + 1	R: 10 Ω - 100 kΩ, 0.5% + 5 X: 10 Ω - 100 kΩ, 0.5% + 15	Z : 10 Ω - 100 kΩ, 0.5% + 5 θ: ± 0.2°
4 MHz	C: 1 pF - 10 nF, 1% + 20 + 0.002 pF D: 3.3% + 0.01 + 1	L: 1 μH - 10 mH, 1% + 5 D: 2.0% + 0.0063 + 1	R: 10 Ω - 100 kΩ, 2% + 7 X: 10 Ω - 100 kΩ, 2% + 105	Z : 10 Ω - 100 kΩ, 2% + 7 θ: ± 0.8°
10 MHz	C: 1 pF - 10 nF, 2% + 20 + 0.002 pF D: 4% + 0.011 + 1	L: 100 nH - 1 mH, 2% + 7 D: 3.1% + 0.002 + 1	R: 10 Ω - 100 kΩ, 2% + 7 X: 10 Ω - 100 kΩ, 2% + 105	Z : 10 Ω - 100 kΩ, 2% + 7 θ: ± 0.8°

(Conditions: Warm-up time ≥ 30 minutes, environment temperature: 23°C ± 5°C) Refer to technical data sheet for accuracy details.

**General Information**

**Test signal level monitor:**

Model	Range		Accuracy
	Voltage	Current	
4274A	0.001 V - 5.00 Vrms	0.001 mA - 100 mArms	± (3% of reading + 1 count)
4275A	0.001 V - 1.00 Vrms	0.001 mA - 10.0 mArms	± (3% of reading + 1 count) at < 1 MHz ± (10% of reading + 2 counts) at ≥ 1 MHz

**Measurement time:** (typical) 140-180 ms (>1 kHz); 140-210 ms ≤ 1 kHz (Measurement time depends on range, sample value and offset adjustment value).

**Z - θ measurement time:** 170-210 ms > 1 kHz; 170-240 ms ≤ 1 kHz.

**High resolution mode:** Approximately 8 times the normal measurement time.

**Auto ranging time:** 100 ms - 300 ms per range change.

**Options**

**Opt 001:** 0 to ± 35 internal dc bias

Range	Steps	Accuracy
± (.000 - 999) V	1 mV	± (0.5% of reading + 1 mV)
± (1.00 - 9.99)	10 mV	± (0.5% of reading + 2 mV)
± (10.0 - 35.0)	0.1 V	± (0.5% of reading + 20 mV)

**Control:** 16023B DC Bias Controller or remote control with HP-IB (opt 101)

**Opt 002:** 0 - ± 99.9 V internal dc bias ( for C ≤ 0.1 μF)

**Range:** ± (00.0 - 99.9) V, 0.1 V steps

**Accuracy:** ± (2% of reading + 40 mV)

**Control:** Same as Opt 001

**External dc bias:** ± 200 V maximum.

**Bias monitor:** Rear panel BNC connector monitors internal or external input bias.

**Opt 003:** Memory Back-up for storing front panel key settings, reference data for deviation measurement and offset value of test fixture/cables. Contents of memory recallable upon command.

**Opt 004:** Frequency steps in 1-3-5 sequence.

**Opt 101:** HP-IB data output and remote control.

**Special options:** Up to two additional test frequencies can be added in the frequency range of the 4274A (100 Hz to 100 kHz) or 4275A (10 kHz to 10 MHz). The following special test frequencies are available and others are available on request:

Option number	Frequency	Option number	Frequency
F01	15.7 kHz	F14	25.2 kHz
F02	32.8 kHz	F15	79.6 kHz
F03	455 kHz	F16	252 kHz
F04	3.58 MHz	F17	796 kHz
F05	4.19 MHz	F18	2.52 MHz
F06	10.7 MHz	F19	7.96 MHz
F11	15.75 kHz	F21	15.625 kHz
F13	62.5 kHz	F25	63.18 kHz

**Accessories**

**16047A:** Direct coupled test fixture. Furnished accessory with the 4274A and 4275A.

**16023B:** DC Bias Controller, for control of dc bias Opt 001 or 002 Internal Bias Supply when HP-IB option is not installed. Control range 0 to ± 99.9 V by setting thumbwheel switch. \$300

**16034B:** Test Fixture for chip components \$315

**16047B:** Test Fixture with Safety Cover \$580

**16047C:** Test Fixture for high frequencies \$260

**16048A:** Test leads, BNC \$250

**16048B:** Test leads, RF miniature \$260

**16048C:** Test leads with Alligator Clips \$325

**16380A:** Standard Air Capacitor Set, includes 1 pF, 10 pF, 100 pF and 1000 pF standard capacitors usable to 10 MHz. \$2450

**Options**

**Opt 001:** 0 to ± 35 internal dc bias, max resolution; 1 mV steps \$745

**Opt 002:** 0 to ± 99.9 V internal dc bias, resolution: 100 mV steps. \$690

**Opt 003:** Memory backup. \$110

**Opt 004:** Frequency steps in 1-3-5 sequence N/C

**Opt 101:** HP-IB\* \$520

**Opt F01-F27:** Special test frequencies (each) \$460

**Ordering Information**

**4274A** 100 Hz - 100 kHz Multi-Frequency LCR Meter \$7930

**4275A** 10 kHz - 10 MHz Multi-Frequency LCR Meter \$8720

\*HP-IB cable not supplied. See page 30.



# COMPONENT MEASUREMENT

## pA Meter/DC Voltage Source

Model 4140B

- 3 basic semiconductor measurements:  
I, I-V and Quasi-Static C-V measurements
- Two programmable voltage sources
- Basic accuracy: 0.5%
- High resolution:  $1.000 \times 10^{-12}$
- HP-IB Standard

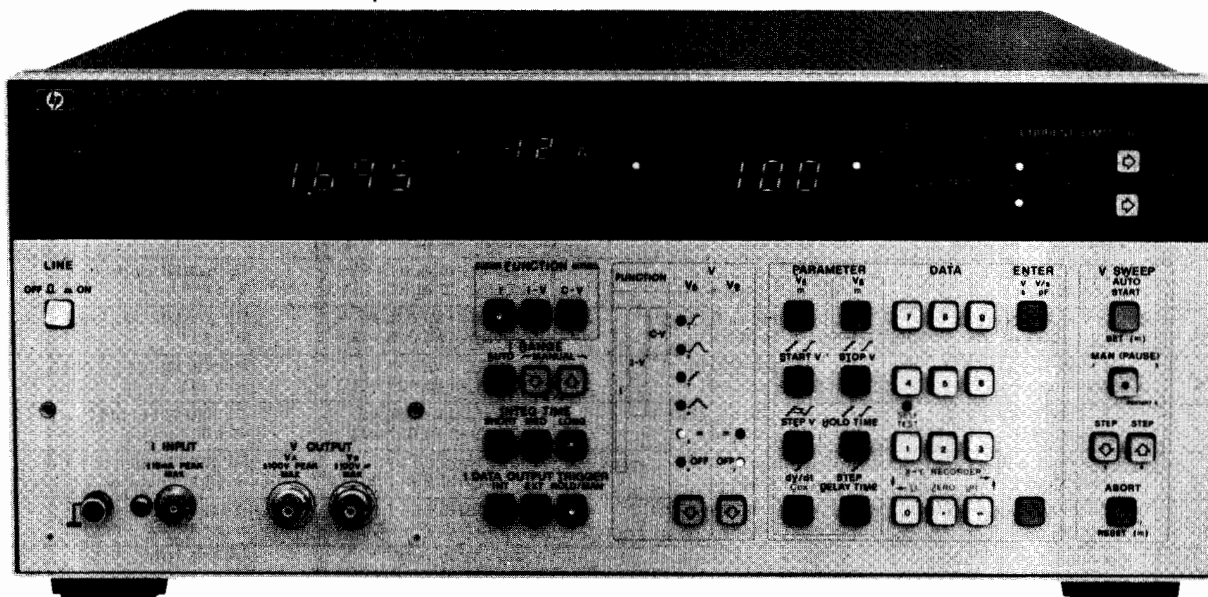

4140B



### Description

The 4140B pA Meter/DC Voltage Source is another in Hewlett-Packard's new generation of Component Measurement instrumentation. It consists of an extremely stable picoampere meter and two programmable dc voltage sources, one of which operates as a ramp and staircase generator as well as a dc source. These features make the 4140B ideal for making dc characteristic measurements such as leakage current, current-voltage characteristics and quasi-static C-V measurements required by the semiconductor industry for new product development and for improving production yields. It is equally useful in measurements of electronic components and materials to determine leakage currents or insulation resistances.

The 4140B can contribute to the development, production and quality control of semiconductor devices and to the improvement in the reliability of electronic components and equipment.

### Stable pA Measurements

Stable picoampere measurements can be made with the 4140B with a maximum resolution of  $10^{-15}$ A. This is made possible by a new measurement technique in conjunction with an offset current capability, low noise test leads, and an electrostatic and light shielded test fixture. These features provide both stable and fast picoampere measurements.

This measurement technique is very useful in making small leakage current measurements and determining dc parameters of semiconductor devices or measuring the insulation resistance and leakage current for dielectric absorption measurements necessary in the analysis of capacitors or insulation materials.

### Synchronized I-V Measurements

The 4140B makes automatic, synchronized current-voltage measurements that have required a large instrumentation system in the past.

The two voltage sources in the 4140B operate over a range of  $-100$  V to  $+100$  V with a maximum resolution of 10 mV. One operates only as a stable dc source while the other generates a staircase voltage, a precise ramp or a stable dc level.

By adding precise, programmable timing capability, we can now make fast, accurate I-V and C-V measurements. Device stabilization times, (time between the applied voltage and the subsequent current

measurement) can now be programmed from the front panel of the 4140B or via the HP-IB bus.

### Quasi-static C-V Measurements

Automatic quasi-static C-V measurements are easily accomplished by the ramp voltage capability of the 4140B. This measurement is highly significant in evaluating basic semiconductor characteristics.

The 4140B operates over a capacitance range of 0.1 pF to 1999 pF with a dc voltage ramp rate of 1 mV/s to 1 V/s in 1 mV/s increments. Capacitance, which is calculated from the measured current divided by the ramp rate, can also be provided as a percent of the capacitance of the oxide film ( $C_{ox}$ ) over a range of 0.0 to 199.9%. By providing the output voltage at each capacitance measurement point, we have the dc (quasi-static) C-V characteristics of the device under test.

### HP-IB Capability

Interfacing the 4140B to an HP-IB system improves measurement efficiency and takes advantage of its high speed (approx 5 ms) measurement rate. Such a system will minimize measurement time of dc parameters of semiconductors and the insulation resistance and leakage current of electric components and materials. This allows rapid feedback to production for fast evaluation of a new device in the development stage.

### Specifications

**Measurement functions:** I, I-V and C-V

**Voltage sources:** two separate sources ( $V_A$  and  $V_B$ )

$V_A$ :  $\pm 100$  V programmable source/function generator

$V_B$ :  $\pm 100$  V programmable DC voltage source

**Measurement Function/Source Selection:**

Function	$V_A$	$V_B$
I		DC
I-V		DC
C-V		DC



**Voltage sweep:** auto or manual (pause)

**Current measurements:**

**Displays:** current, 3½ digits with 2 digit annunciator. Voltage, 3½ digits.

**Measurement range:**  $\pm 1.000 \times 10^{-12} \text{A}$  to  $1.000 \times 10^{-2} \text{A}$  full scale in 11 ranges.

**Overrange capability:** 99.9% on all ranges.

**Range selection:** auto (lowest current range is selectable), and manual

**Measurement accuracy/Integration time:**

Range	Accuracy* ± (% of rdg. + counts)	Integration Time** (ms)		
		Short	Medium	Long
$10^{-2} - 10^{-3}$	0.5 + 2	20	80	320
$10^{-10}$	2 + 2			
$10^{-11}$	5 + 3	80	320	1280
$10^{-12}$	5 + 8	160	640	2560

\* Accuracy for long integration time. 23°C ± 5°C, humidity ≤ 70%. For short and medium integration time, see reference data section.

\*\* Integration times specified at 50 Hz. For 60 Hz operation, multiple time by %.

**Zero offset:** cancels leakage current of test leads or test fixtures.

**Offset range:** 0 to  $\pm 100 \times 10^{-15} \text{A}$ .

**Trigger:** INT, EXT and HOLD/MAN

**Input terminal:** triaxial

**Capacitance-voltage (C-V) measurement**

**Measurement ranges:** 0.0 pF – 100.0 pF and 200 pF – 1000 pF F.S. in two ranges; 99.9% overrange

**Ranging:** auto

**%C:** capacitance change of device under test is displayed as a percent of the set value of the oxide capacitance ( $C_{ox} = 100\%$ )

**%C range:** 0.0% – 199.9%

**Cox setting ranges (2 ranges):** 0.1 pF – 199.9 pF and 200 pF – 1999 pF

**Capacitance calculation accuracy:** accuracy is dependent on accuracy of both the current measurement and ramp voltage.

**Zero offset:** cancels stray capacitances of test fixtures and test leads.

**Offset range:** 0 to 100 pF

**High speed I data output:** available with HP-IB interface only. Outputs current measurement data at 5 ms intervals (max rate).

**DC voltage sources**

**Output modes,  $V_A$ :**

$V_B$ :

Function	$V_A$	$V_B$
I		--- (DC)
I-V		--- (DC)
C-V		--- (DC)

**Voltage ranges ( $V_A$  and  $V_B$ ):** 0 to  $\pm 10.00 \text{V}$  and 0 to  $\pm 100.0 \text{V}$  in 2 ranges, auto range only.

**Maximum current:** 10 mA, both sources.

**Voltage sweep:** auto and man (Pause), up/down step in manual (Pause) mode. Sweep abort standard

**Operating parameter setting ranges:**

**Start voltage and stop voltage:** 0 –  $\pm 10.00 \text{V}$ , 0.01 V steps; 0 –  $\pm 100.0 \text{V}$ , 0.1 V steps

**Step voltage:** 0 –  $\pm 10.00 \text{V}$ , 0.01 V steps; 0 –  $\pm 100.0 \text{V}$ , 0.1 V steps

**Hold time:** 0 – 199.9 seconds in 0.1s increments; 0 – 1999 seconds in 1.0s increments

**Step delay time:** 0 – 10.00 seconds in 0.01s increments; 0 – 100.0 seconds in 0.1s increments

**Ramp rate (dV/dt):** 0.001 V/s – 1.000 V/s in 0.001 V/s increments

**Accuracy (at 23°C ± 5°C):**

**Output voltage:**  $\pm 10 \text{V}$ ,  $\pm (0.07\% + 11 \text{mV})$ ;  $\pm 100 \text{V}$ ,  $\pm (0.09\% + 110 \text{mV})$

**Ramp rate:** typically 0.5%, 0 –  $\pm 10 \text{V}$ ;  $< 5\%$ ,  $> 10 \text{V}$ .

**Current limit:** 100  $\mu\text{A}$ , 1 mA and 10 mA,  $\pm 10\%$  ( $V_A$  and  $V_B$ )

**Output terminals:** BNC; L-GND

## Reference Data

### Current Measurement

#### Current measurement accuracy\*

Range	Integration Time	
	Short	Medium
$10^{-2} - 10^{-3}$	0.5 + 4	0.5 + 3
$10^{-10}$	2 + 4	2 + 3
$10^{-11}$	5 + 8	5 + 4
$10^{-12}$	5 + 13	5 + 10

\* ± (% of rdg. + counts), 23°C

**Current ranging times\*:** 21 ms to 3.8 sec. (longer ranging time needed for large changes in input signal level, especially on lowest current ranges).

\*When FILTER is on, current ranging time increases 60 ms (50 Hz power line) or 50 ms (60 Hz power line)

**Warm-up time:**  $\geq 1$  hour

**Common mode rejection ratio:**  $\geq 120 \text{ dB}$  ( $\leq 2$  counts)

### Analog Output I, C and $V_A$

**Accuracy:**  $\pm (0.5\% + 20 \text{mV})$

**Low pass filter:** 3 position: OFF, 0.22 s  $\pm 20\%$  and 1s  $\pm 20\%$  applied to both  $V_A$  and I/C data outputs

**Pen lift output:** TTL low level ( $\leq 0.8\text{V}$ ) during sweep period in I-V and C-V functions

**Recorder output scaling:** pushbutton scaling of lower left and upper right limits of X-Y recorder

### HP-IB Interface\*

**Remote controlled functions:** measurement function, current range, integration time, I data output trigger, voltage sweep controls, current limit,  $V_A$  and  $V_B$  voltages, zero (offset), self test and parameter settings (voltages, sweep/hold/delay times)

**Data output:**

Measured data (I, C and  $V_A$ ),

Voltage setting ( $V_A$  and  $V_B$ ),

Parameter settings

\*HP-IB cables not supplied; see page 30.

### General Information

**Power:** 100, 120, 220, V  $\pm 10\%$ , 240 V  $+5\% - 10\%$ ; 48-66 Hz, 135 VA max with any option

**Size:** 426 mm W x 177 mm H x 498 mm D (16.5" x 7" x 19.6")

**Weight:** 14.2 kg (31.2 lbs.)

### Accessories Furnished

**16053A test leads:** Consists of one triaxial cable, two each BNC-BNC cables and one connection plate with mating female panel-mount connectors. Cables are one meter in length.

**16055A test fixture:** for general device measurements. Provides electrostatic and light shielding for stable pA measurements.

### Accessories Available

**16054A connection selector:** provides a simple method to select appropriate connection of low lead for the pA meter section.

**16056A current divider (10:1):** for use only on the 10 mA range to extend the measurement capability to 100 mA.

### Ordering Information

#### Accessories

**16053A Test Leads (furnished)**

N/C

**16054A Connection Selector**

\$275

**16055A Test Fixture (furnished)**

N/C

**16056A Current Divider (10:1)**

\$140

#### Options

**Opt 907 Front Handle Kit (P/N 5061-0090)**

add \$40

**Opt 908 Rack Flange Kit (P/N 5061-0078)**

add \$30

**Opt 909 Rack & Handle Kit (P/N 5061-0084)**

add \$65

**Opt 910 Extra Manual**

add \$40

**4140B pA Meter/DC Voltage Source**

**\$7360**



# COMPONENT MEASUREMENT

## RF Impedance Analyzer

Model 4191A

- 1-1000 MHz variable test frequency with sweep capability
- Direct reading of  $|Z| - \theta$ ,  $|Y| - \theta$ ,  $|\Gamma| - \theta$ ;  
 $L \cdot C - R \cdot G \cdot D \cdot Q$   
 $R - X, G - B, \Gamma_x - \Gamma_y$
- High resolution—4½ digit max
- Wide measuring range—1 m $\Omega$  – 100 k $\Omega$  ( $|Z|$ )
- Versatile easy-to-use test fixtures

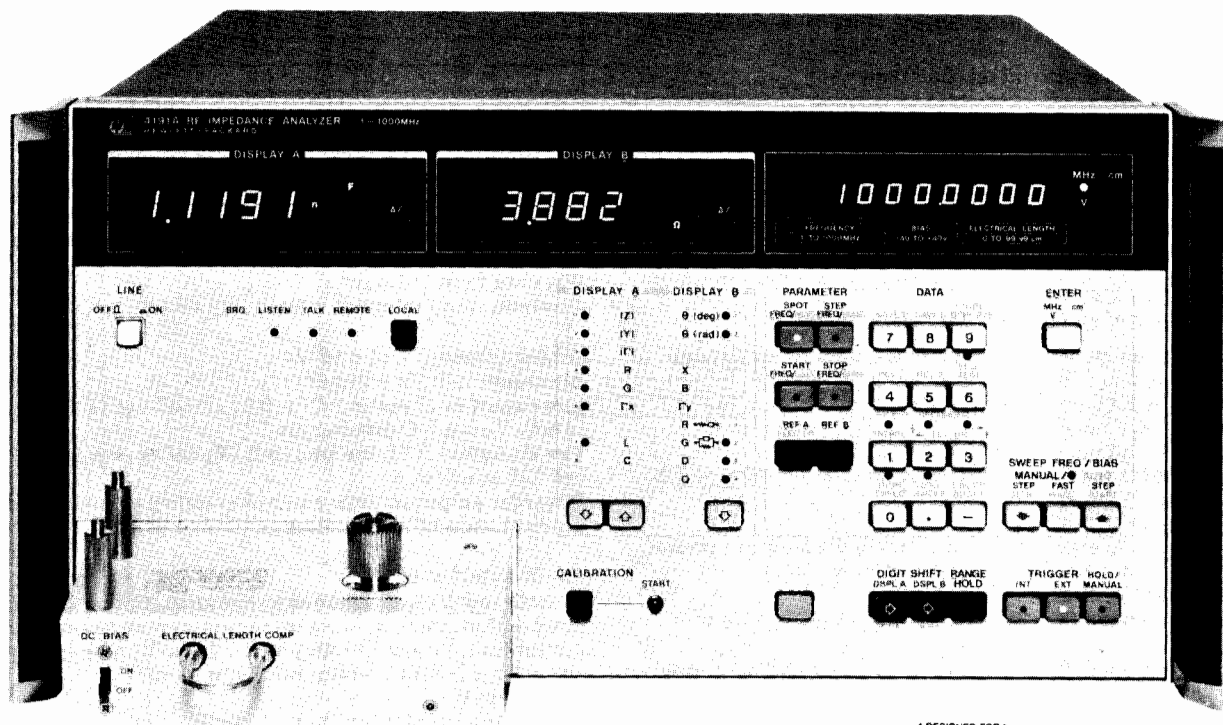

4191A (Shown with Opt 907A Handles)



### Description

The HP Model 4191A RF Impedance Analyzer measures 14 parameters with a maximum resolution of 4½ digits. The internal synthesizer provides variable frequencies from 1 MHz through 1000 MHz covering the UHF, VHF and video bands with automatic sweep capability. An internal dc bias supply with auto sweep function covers the voltage range of  $\pm 40$  V in 10 mV steps.

The 4191A permits reliable measurements over a wide measuring range. Its outstanding repeatability, frequency response and accuracy are made possible by unique error correction capability and specially designed test fixtures. These features allow the 4191A to be used in evaluation of electronic materials, components and circuitry.

The internal synthesizer provides a maximum resolution of 100 Hz (Opt 002) with an accuracy of 3 ppm, allowing small changes in the resonant frequency of the device under test to be easily detected. The swept frequency capability aids in the analysis of frequency characteristics of the device.

Two complete front panel settings (parameter selection and the sweep control) can be stored in a non-volatile memory and recalled at any time with a single key operation. This, together with the standard HP-IB interface, makes the 4191A extremely efficient either as a stand-alone or systems instrument.

These unique features permit very wide applications in: (1) semiconductor testing such as surface state evaluation at high frequencies (C-V/G-V and conductance ( $G/\omega$ )- $\omega$ ) characteristics), and the input/output impedance evaluation of diodes and transistors, (2) resonator, filter, and magnetic and dielectric materials testing, (3) evaluation of LCR components such as high frequency chip and leaded components, and (4) testing of communications related components such as cables, connectors, etc.

### Specifications

**Parameter measured:**  $|Z| - \theta$ ,  $|Y| - \theta$ ,  $|\Gamma| - \theta$   
 $R - X, G - B, \Gamma_x - \Gamma_y$   
 $L - R \cdot G \cdot D \cdot Q, C - R \cdot G \cdot D \cdot Q$

**Display:** 4½ digit, max display 19999 counts

**Deviation measurement** (deviation from stored reference):

$\Delta$ : -19999 to +19999 counts

$\Delta\%$ : -1999.9 to +1999.9%

**Measuring signal** ( $23 \pm 5^\circ\text{C}$ ):

**Frequency range:** 1 MHz to 1000 MHz

**Frequency step:** Standard: 100 kHz, 1-500 MHz  
 200 kHz, 500-1000 MHz

Opt 002: 100 Hz, 1-500 MHz

200 Hz, 500-1000 MHz

**Frequency accuracy:**  $\pm 3$  ppm

**Signal level (Into 50 $\Omega$ ):**  $-20 \pm 3$  dBm

**Frequency control:** spot and swept

**Measuring mode:**

**Spot measurement:** at specific frequency (or dc bias)

**Swept measurement:** manual or automatic sweep from start to stop frequency (or dc bias) at step frequency (or dc bias) rate in linear or logarithmic form.

**Auto calibration:**

Automatic error compensation referenced to connected terminations (0  $\Omega$ , 50  $\Omega$ , 0 S)

**Calibration frequency:** 51 frequencies between start and stop frequencies.

**Electrical length compensation:** automatic compensation for electrical length of test fixtures.

Compensating range: 0 to 99.99 cm.

**DC Bias:**

**Internal DC bias**

Voltage range: -40 to +40 V, 10 mV step

Setting accuracy: 0.1% of setting +10 mV

Bias control: spot and swept

**External DC bias**

Voltage range: -40 to +40 V

Max allowable current: 100 mA

**Key Status Memory:** 2 sets of measuring conditions can be stored and recalled at any time. These conditions are kept in storage even when LINE is turned off.

**Ranging:** Auto/Range hold

**Trigger:** Internal, External or Manual

**Self-Test:** Automatic internal program test

**HP-IB Data output and remote control:** Standard

**Measuring Range, Resolution and Accuracy:**

Specified at APC-7 UNKNOWN connector for reflect coefficient measurement at measuring frequency and ambient temperature (0 - 55°C) where calibration is performed after the warm-up time of 40 minutes. Refer to General Information for temperature coefficient and typical measuring range/resolution and accuracies of other measuring parameters (see data sheet for detailed specifications).

**$|\Gamma| - \theta/\Gamma_x - \Gamma_y$  Measurement**

**Measuring range:**

$|\Gamma|, \Gamma_x, \Gamma_y$ : 0.0001 to 1.0000

$\theta$ : 0° to ±180.00° (0 to ±π rad.)

$|\Gamma|, \Gamma_x, \Gamma_y$  resolution: 0.0001

$|\Gamma|, \Gamma_x, \Gamma_y$  Accuracy (see graph below):

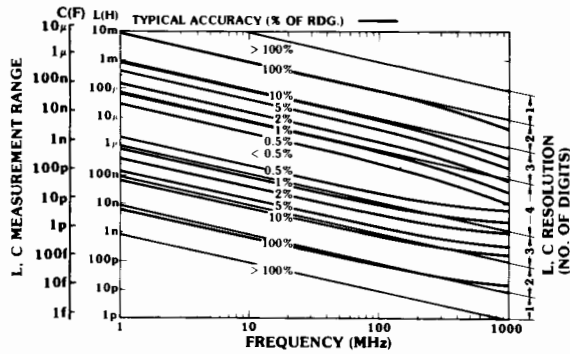
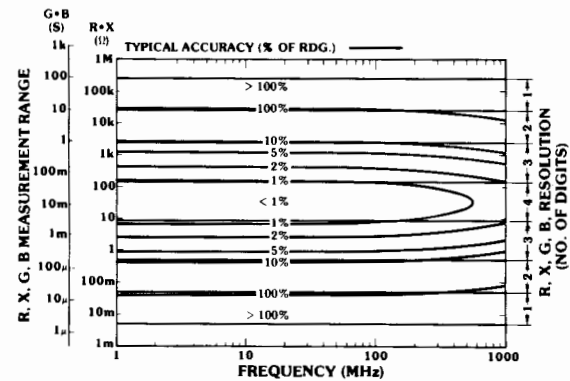
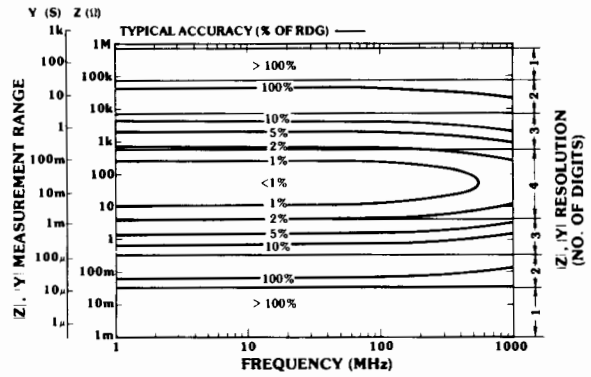
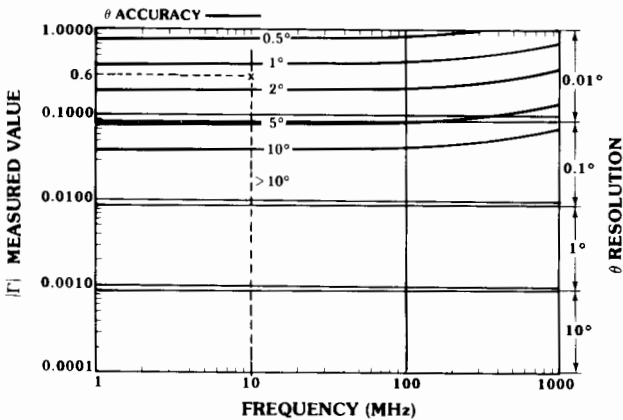
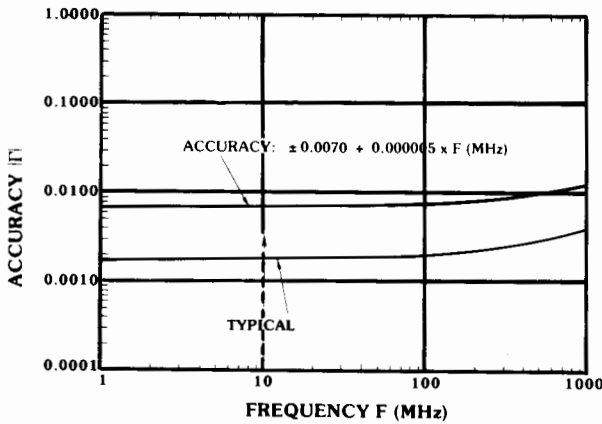

**General**

Temperature coefficient for  $|\Gamma|, \Gamma_x,$  and  $\Gamma_y$ : 0.0001/°C (23 + 5°C)

Measuring time: 800 ms or 250 ms (high speed mode)

Frequency switching time: ≤ 200 ms

Temperature: 0 - 55°C, < 95% RH

Power: 100, 120, 220 V ± 10%, 240 V + 10% - 5%, 48 - 66 Hz, 150 VA max.

Size: 425.5 mm (W) x 230 (H) x 574 (D) mm (16.75" x 9" x 22.6")

Weight: Approx. 24 Kg. (52.8 lbs.)

Accessories Furnished: accessory case (with reference terminations included).

**Accessories Available**

Accessories Available	Price
16091A Coaxial Fixture Set	\$460
16092A Spring Clip Fixture	\$450
16093A Binding Post Fixture	\$165
16093B Binding Post Fixture	\$170
16094A Probe Fixture	\$145

**Options**

002: 100 Hz/200 Hz resolution synthesizer	\$1,650
004: Recorder Outputs	\$445

**4191A RF Impedance Analyzer**

**\$14,260**

# COMPONENT MEASUREMENT

## Semiconductor/Component Test System

Model 4061A

- Ready to use—supplied with 7 turn-key application pacs
- Reliable impedance and current measurements with one probing
- Productivity improvement through accurate and fast measurement over wide range

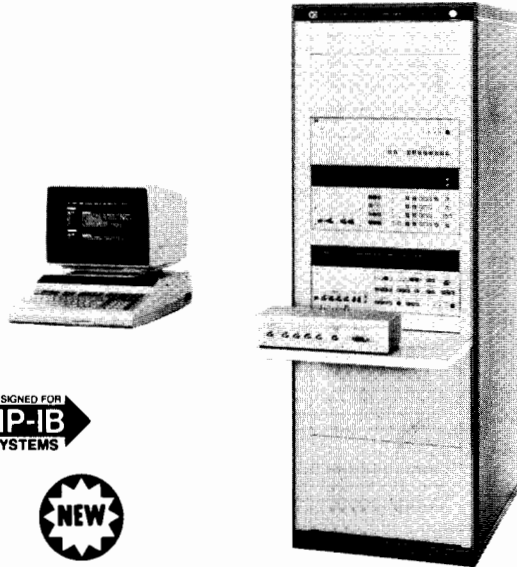

### Description

The 4061A Semiconductor/Component Test System is a dedicated system for making efficient, automatic evaluation of the fundamental characteristics of semiconductor and electronic components required in R & D and production areas. This system employs reliable, accurate measurements and high speed data processing to perform more reliable evaluations with speed and less manpower. The 4061A is supplied with 7 sophisticated applications programs and is flexible in both software and hardware. Thus, the system can output measurement results in nearly any required data format.

The switching subsystem, designed especially for use with the 4061A, allows both impedance and current measurement without changing DUT connection. Using this new switching subsystem, and by making impedance measurements, the 4061A performs evaluation of Doping profile, Oxide capacitance, Flat band condition, Threshold voltage, Surface charge, and Minority carrier life time/surface generation velocity. The 4061A also measures leakage current and reverse/forward current-voltage characteristics. Surface state density evaluation, using both high (e.g., 1 MHz) and low frequency (Quasi-static) C-V measurements and data processing are also possible by making modifications to system software.

The system offers significant improvement in both yield and quality in production through fast and reliable measurements and evaluations. It is also a valuable evaluation tool for the development of new materials and devices. The 4061A provides the flexibility to meet the future measurement requirements of the electronics industry.

### System Configuration

- The 4061A consists of the following:
- 4140B pA Meter/DC Voltage Source
- 4275A Multi-frequency LCR Meter
- Switching Subsystem
- 9835A System Controller
- 98034A HP-IB Card
- 98035A Real Time Clock
- 29402B 56-inch Rack Cabinet

### Impedance Measurement

The 4275A Multi-frequency LCR Meter offers excellent flexibility in measuring the impedance characteristics of semiconductors, LCR components and electronic materials. The 4275A's flexibility enables tests to be performed at test frequencies, test signal levels and DC bias voltage equivalent very near actual operating conditions.

The 4275A offers up to 5½ digit resolution, wide measurement range (0.01 fF to 199.999  $\mu$ F) basic accuracy of 0.1% over a 10 kHz to 10 MHz frequency range.

### Current Measurement

The 4140B pA Meter/DC Voltage Source offers stable current from 0.001 pA to 20 mA. Two programmable  $\pm 100$  VDC voltage sources are also built in. Fast, accurate I-V characterization of FETS and diodes are made easy using microprocessor timing control between the voltage sources and pico-ammeter. The 4140B also performs reliable quasi-static C-V measurement with high sensitivity and stability by using a highly linear ramp biasing technique.

### Switching Subsystem

The switching subsystem remotely changes DUT connection between the 4275A and 4140B. Thus, with one probing, the measurement cabling is automatically controlled and wide measurement range for both impedance measurements, up to 1 MHz, and current measurements, down to 0.001 pA are guaranteed.

This switching subsystem includes an 8 bit data I/O function with 2 bit interrupt input for interface versatility. Non-HP-IB products such as IC probers, temperature controls, or component handlers can be interfaced through this 8 bit I/O. Of course, other HP-IB compatible products can be interfaced, allowing greater flexibility in both measurement and data processing.

### Controller

The standard System controller is the HP 9835A with basic 64 k byte memory. The 9835A controls measurements and performs complex data manipulation. The derivation of the semiconductor characterization parameters and general data analysis such as statistical evaluation of the measurement result can be obtained immediately after measurement.

### System Software

System software consists of 7 turn-key application programs, 28 system subroutines, and 4 diagnostics. The application software is ready to use to perform basic semiconductor characterizations and component impedance evaluations. System subroutines are usable as major program subroutines to expand system measurement and data processing capabilities. The diagnostics isolate parts of the system not operating properly and can be used to verify system operation before making measurement.

### Furnished Application Software

Semiconductor high/low frequency C/V characteristics, I-V characteristics, C-t characteristics and Zerbst analysis, Impedance Frequency/Bias characteristics, Ideal C-V curve.

### Semiconductor Applications C-V/G-V Analysis

The 4061A measures the C-V characteristics of MIS structures. Both high frequency C-V (10 kHz to 1 MHz) and low frequency C-V (quasi-static) characteristics are easily measured.

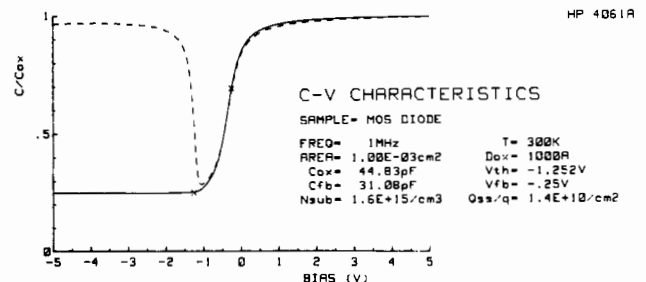

Conductance is simultaneously measured with capacitance so that the G-V characteristics are available for the Nicollian-Goetzberger surface state density analysis  $[(Gp/\omega) - \omega]$ .

### I-V and DC Characteristics

Total synchronization between the application of the voltage and the current measurement is automatically accomplished by the 4061A. This permits the accurate (0.5%) and high speed (35 ms on the 1 nA range) measurements necessary to measure small leakage currents in MOS structures, FET's, and diode static characteristics.

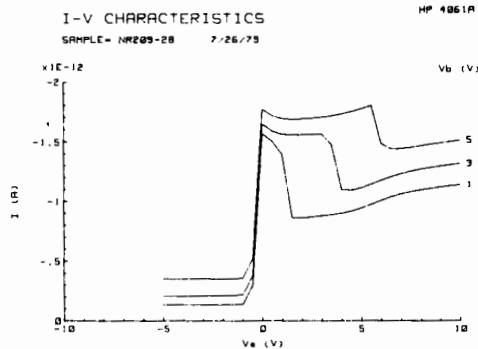

4061A System Library

### Specifications

For detailed specifications on each of the instruments used in the 4061A, refer to the individual data sheets.

#### Impedance Measuring Section (4275A)

These specifications are for the 4275A connected directly to the device-under-test (DUT).

**Display:** 4½ digits; 5½ digits in high resolution mode

**Frequency:** 10 kHz to 10 MHz; 10 spot frequencies in a 1-2-4 step sequence.

**Oscillator Level:** 1 mVrms continuously variable into open circuit. Output impedance approximately 100 ohms.

**Measurement Parameters:** C-D•Q•ESR•G, L-D•Q•ESR•G, R-X•B•L•C, |Z|—θ

#### Measurement Ranges:

**C:** 0.01 fF to 199.99 μF

**L:** 1 pH to 19.999 MΩ

**|Z|, R, X:** 0.01 mΩ to 19.999 MΩ

**G, B:** 0.01 nS to 19.999 S

**D:** 0.0001 to 9.9999

**Q:** 0.01 to 9900

**Basic Accuracy:** ±0.1%

**Measurement Time:** Approximately 140 ms to 210 ms

**DC Bias (4275A Option 001):** 0 to ±35 V, 1 mV maximum resolution.

#### Current Measurement Section

These specifications are for the 4140B connected directly to the device-under-test.

**Measurement Functions:** I, I-V, and C-V. Synchronized measurements of Current-Voltage (I-V) and Quasi-Static (C-V) are automatically performed.

#### Current Measurement:

**Display:** 3½ digit

**Range:** ±0.001 x 10<sup>-12</sup> A to 1.999 x 10<sup>-2</sup> A

**Basic Accuracy:** ±0.5%

**Measurement Time:** approximately 5 ms to 9 s

#### DC Voltage Sources: V<sub>A</sub> and V<sub>B</sub>

**Output mode:** V<sub>A</sub>:  V<sub>B</sub>: 

**Range:** Both sources, 0 to ±10 V in 10 mV steps; 0 to ±100 V in 100 mV steps; Ramp Rate, (V<sub>A</sub> only), 0.001 V/s to 1 V/s

#### Capacitance-Voltage (C-V Measurement)

**Measurement Ranges:** 0.0 pF to 199.9 pF and 200.0 pF to 1999 pF F.S. in two ranges; 99.9% overrange.

#### Switching Subsystem

The switching subsystem consists of a switch control module and switching module with interconnecting cables.

Function: Switches connection from DUT to either Multi-frequency LCR Meter or the pA Meter/DC Voltage source.

**System Measurement Range** (Only deviations from individual instrument specifications are listed.)

#### Impedance Measurements (4275A)

**Frequency Range:** 1 MHz

**Measurement Parameters:** C-G

**Capacitance:** ≤200 pF (With D≤0.1)

Accuracy: (Accuracy of 4275A) x 1.5 + ΔC (at 25°C + 5°C).

ΔC = 1.4 x 10<sup>-3</sup>Cxf<sup>2</sup> (pF) + 5 counts

**Conductance:** ≤12 mS (D≤0.1)

\*Accuracy: (Accuracy of 4275A) x 1.5 + ΔG (at 25°C + 5°C)

ΔG = 6 x 10<sup>-3</sup>Cxf(S) + 5 counts

\*After 1 hour warmup and at DUT terminal of switching module f: frequency in MHz

Cx: Measured capacitance value in pF

At 5°C to 40°C, ΔC and ΔG doubles (Example: Assume Cx = 1000 pF and f = 1 MHz). C = (1.4 x 10<sup>-3</sup>•10<sup>3</sup>•(1)<sup>2</sup>) pF + 5 counts = 1.4 pF + 5 counts

#### Current Measurements (4140B)

**Accuracy:** (Accuracy of 4140B) x 1.5 + 5 counts

After one-hour warmup and at DUT terminal of switching module

#### Controller (9835A)

**Internal Storage:** 64k bytes

**Dynamic Range:** 10<sup>99</sup> to 10<sup>-99</sup>, 0, -10<sup>-99</sup> to -10<sup>99</sup>

**Internal Calculation Range:** 10<sup>511</sup> to 10<sup>-511</sup>, 0, -10<sup>-511</sup> to -10<sup>511</sup>

**CRT Display:** 80 characters per line; 25 lines

**Data Cartridge Capacity:** 217k bytes

#### Available Options

**Option 001:** ±100 V internal dc bias; 4275A internal bias is changed to ±100 V with 0.1 V resolution

**Option 002:** 1-3-5 frequency step; 4275A frequency steps are in a 1-3-5 sequence

**Option 030:** European date format; 98035A output format is changed to (day, month, hour, minutes, seconds)

#### General Information

**Operating Temperature:** 5°C to 40°C

**Relative Humidity:** 70% at 40°C

**Power:** 100, 120, 220, and 240 V, +5% to 10%, 48 to 66 Hz, 690 VA Max (520 VA without the 9835A)

**Size:** Rack Cabinet, 535 mm (W) x 1635 mm (H) x 770 mm (D) (21" x 64.4" x 30.3"); 9835A: 384 mm (W) x 358 mm (H) x 496 mm (D) (15" x 14" x 19.5")

**Weight:** Rack Cabinet, approximately 125 kg (275 lbs.); 9835A, approximately 22.3 kg (49 lbs.); Standard System, approximately 190 kg (417 lbs.)

#### Ordering Information

**Option 001:** ±100 V dc Bias for 4275A

**Option 002:** 1-3-5 Frequency Steps for 4275A

**Option 030:** European Date Format

**4061A Semiconductor/Component Test System**

#### Price

N/C

N/C

N/C

**\$42,500**



# COMPONENT MEASUREMENT

## LF Impedance Analyzer (5 Hz to 13 MHz)

Model 4192A

- 5 Hz to 13 MHz Variable Measuring Frequency
- Gain-Phase Measurement: Amplitude, Phase and Delay
- Floating or Grounded Devices

- Impedance Measurement:  $|Z| \cdot |Y| \cdot \theta \cdot R \cdot X \cdot G \cdot B \cdot L \cdot C \cdot D \cdot Q \cdot \Delta \cdot \Delta\%$
- Standard HP-IB

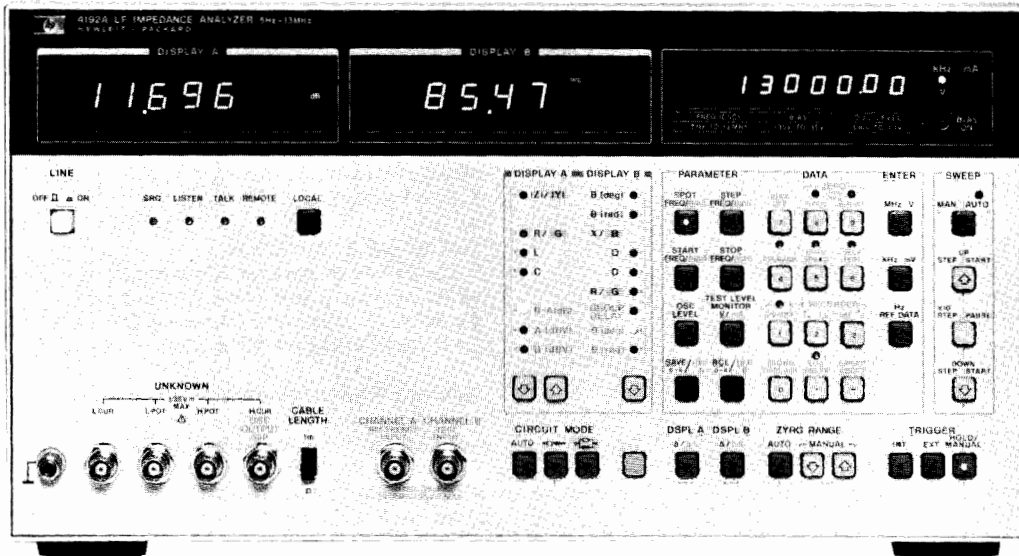

### Description

The 4192A LF Impedance Analyzer performs both network analysis and impedance analysis on devices such as telecommunication filters, audio/video electronic circuits, and basic electronic components. Both floating and L-grnd devices can be tested.

### Automatic Frequency Swept Measurement of All Impedance Parameters

The 4192A can measure 11 impedance parameters ( $|Z|$ ,  $|Y|$ ,  $\theta$ ,  $R$ ,  $X$ ,  $G$ ,  $B$ ,  $L$ ,  $C$ ,  $D$ ,  $Q$ ) over a wide range  $|Z|$ : 0.1 m $\Omega$  to 1 M $\Omega$ ;  $|Y|$ : 1 nS to 1 S.)

The built-in frequency synthesizer can be set from 5 Hz to 13 MHz with a maximum resolution of 1 mHz. This feature allows accurate characterization of high Q devices such as crystals. Test signal level is variable from 5 mV to 1.1 mV resolution. Also, an internal dc bias voltage source provides  $\pm 35$  V at 10 mV increments. Thus, the 4192A can evaluate components and entire circuits near actual operating conditions.

### Specifications (Complete specifications on data sheet)

#### Measuring Signal (23 $\pm$ 5°C)

**Frequency range:** 5 Hz to 13 MHz

**Frequency step:** 0.001 Hz (5 Hz to 10 kHz), 0.01 Hz (10 kHz to 100 kHz), 0.1 Hz (100 kHz to 1 MHz), 1 Hz (1 MHz to 13 MHz).

**Frequency accuracy:**  $\pm 50$  ppm

**OSC level:** 5 mV to 1.1 Vrms variable into 50 $\Omega$  (amplitude-phase measurement) or open circuit (impedance measurement).

**OSC level step:** 1 mV (5 mV to 100 mV), 5 mV (100 mV to 1.1 V)

**OCS level accuracy:** 5 Hz to 1 MHz:  $\pm(5 + 10/f)\%$  of setting  $\pm 2$  mV where f is in Hz. 1 MHz to 13 MHz:  $\pm(4 + 1.5 \times F)\%$  of setting  $\pm 2$  mV where F is in MHz.

**Level monitor** (impedance measurement): Current through or voltage across sample can be monitored

**Control:** spot and sweep via front panel or HP-IB

#### Measuring Mode

**Spot measurement:** at specific frequency (or dc bias)

**Sweep measurement:** manual or automatic sweep from START to STOP frequency (or dc bias) as STEP frequency (or dc bias) rate

**Sweep:** linear or logarithmic (frequency only)

**Recorder outputs:** output dc voltage proportional to each measured value, and frequency or dc bias.

**Maximum output voltage:**  $\pm 1$  V

**Output voltage accuracy:**  $\pm 0.5\%$  of voltage  $\pm 20$  mV

**Key status memory:** 5 sets of measuring conditions can be stored and recalled at any time.

**HP-IB data output and remote control:** standard  
**Self-test:** automatic instrument basic functional test  
**Trigger:** internal, external or manual

### Amplitude—Phase Measurement

**Parameter measured:** relative amplitude B-A (dB) and phase  $\theta$  (degrees or radians), B-A and group delay, absolute amplitude A (dBm or dBV) or B (dBm or dBV), and deviation ( $\Delta$ ,  $\Delta\%$ ) of all parameters

**Reference amplitude:** 0 dBV = 1 Vrms, 0 dBm = 1 mW (with 50 $\Omega$  termination)

**OSC output resistance:** 50 $\Omega$

**Channels A and B:** input impedance: 1 M $\Omega \pm 2\%$ , shunt capacitance: 30 pF  $\pm 5$  pF

### Measuring range and resolution:

**B-A:** 0 to  $\pm 100$  dB, 0.001 dB (0 to -20 dB), 0.01 dB (-20 to -100 dB)

$\theta$ : 0 to  $\pm 180^\circ$ , 0.01 $^\circ$

**Group delay:** 0.1 ns to 19 s, max. resolution 4 1/2 digits

**A or B:** +0.8 to -100 dBV, 0.001 dB ( $> -20$  dB), 0.01 dB ( $< -20$  dB), +13.8 to -86 dBm, 0.001 dB ( $> -7$  dBm), 0.01 dB ( $< -7$  dBm)

**Measuring accuracy (23  $\pm$  5°C):** Specified at BNC unknown terminal after 30 minute warmup (test speed: normal or average)

**B-A (Relative Amplitude) and  $\theta$  (Phase) Measurement:** Determined by sum of channel A and B accuracies given below (accuracy of each channel changes according to absolute input level)

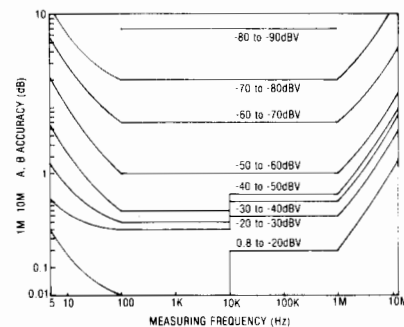

FIGURE 1: GAIN MEASUREMENT ACCURACY

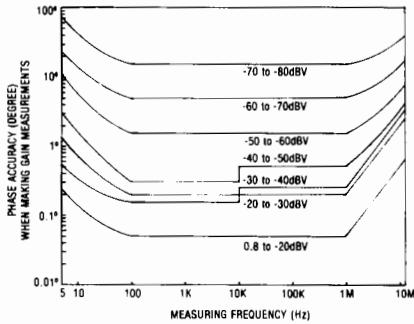

FIGURE 2: PHASE ACCURACY WHEN MAKING GAIN MEASUREMENTS

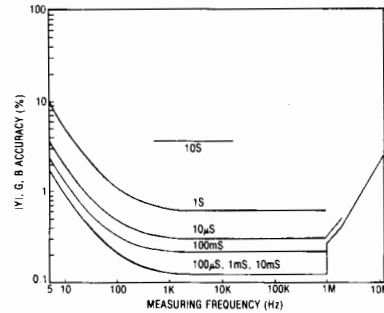

FIGURE 5: |Y|, G, B ACCURACY

**Impedance Measurement**

**Parameter measured:**  $|Z| - \theta, |Y| - \theta, R - X, G - B, L - D \cdot Q \cdot R \cdot G, C - D \cdot Q \cdot R \cdot G$  and deviation ( $\Delta, \Delta\%$ ) of all parameters

**Display:** 4½ digits, max. display 12999 counts

**Circuit mode:** Series equivalent circuit (  $\text{---}\square\text{---}$  ) and parallel equivalent circuit (  $\text{---}\square\text{---}$  ). Automatic selection available.

**Auto ZERO adjustment:** Automatic normalization of the readout offset due to residuals of the test fixture by pushbutton operation (at spot frequency)

**Measuring range and accuracy (23 ± 5°C):** Specified at BNC unknown connectors after 30 minute warmup when OSC level is more than 0.1 V and when auto ZERO adjust is performed (test speed: normal or average). Accuracy given below is only valid when the measured value is equal to full scale of each range.

**|Z| - θ, R - X Measurement:** Range:  $|Z|, R, X: 0.1 \text{ m}\Omega$  to 1.2999 M $\Omega$ ;  $\theta: -180.00^\circ$  to  $+180.00^\circ$ . Accuracy: R accuracy ( $D \geq 10$ ); X accuracy ( $D \leq 0.1$ )

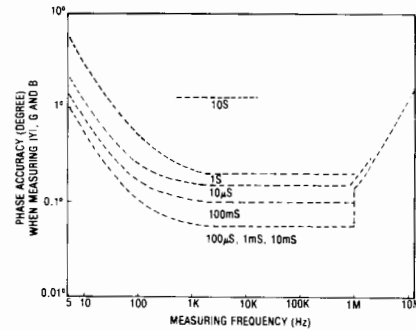

FIGURE 6: PHASE ACCURACY WHEN MEASURING |Y|, G, B

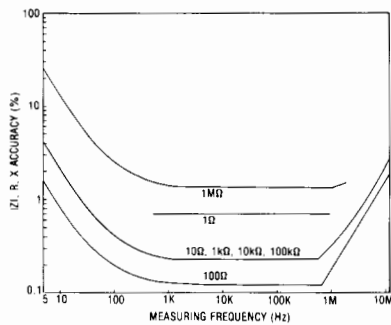

FIGURE 3: |Z|, R, X ACCURACY

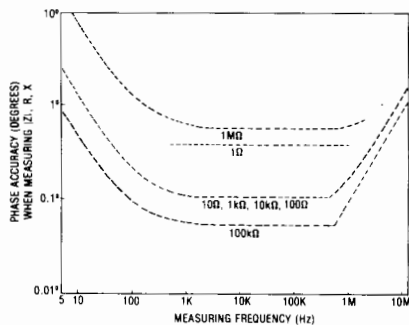

FIGURE 4: PHASE ACCURACY WHEN MEASURING |Z|, R, X

**L - D · Q, C - D · Q Measurement:** (automatically calculated from measured Z/Y values)

Parameter	Measuring Range*	Basic Accuracy
L	0.01 nH to 199 H	0.41%
C	0.1fF to 1999.9 mF	0.12%
D(1/Q)	0.0001 to 19.999	0.001 (C-measurement) 0.004 (L-measurement)

\*Varies with measuring frequency except for D(1/Q)

**Internal DC Bias:** Standard (Impedance Measurement only)

**Voltage range:** -35 V to +35 V, 10 mV step

**Setting accuracy (23 ± 5°C):** 0.5% of setting + 5 mV

**Bias control:** spot and swept, front panel keys and HP-IB

**General**

**Measuring time (high speed mode):**

**B-A and θ, A or B:** 170 to 190 ms ( $\geq 400 \text{ Hz}$ )

**Impedance parameters:** 90 to 170 ms ( $\geq 1 \text{ kHz}$ )

**Test level monitor range (impedance measurement):**

**Voltage:** 5 mV to 1.1 V

**Current:** 1 µA to 11 mA

**Operating Temperature:** 0 to 55°C,  $\leq 95\% \text{ RH}$  at 40°C

**Power:** 100, 120, 220 V ± 10%, 240 V + 5% to -10%, 48 to 66 Hz

**Size:** 425.5mm (W) x 230mm (H) x 574mm (D) (16.75" x 9" x 22.6")

**Weight:** Approx. 19 kg (41.9 lbs.)

**Furnished accessories and parts:** 16047A test fixture, 50Ω feed thru terminations (2 ea.), power splitter, BNC cables (2 ea.), BNC adapter

**Accessories available:**

16095A Probe Fixture	\$450
16096A 2-port Component Test Fixture	\$850
16097A Accessory Kit	\$1550
16047C 2-terminal Test Fixture	\$260
16048B Test Leads (miniature connector)	\$260
16048C Test Leads with alligator clip	\$325

4274A/4275A's test fixtures/leads are usable with 4192A

**4192A LF Impedance Analyzer**

**\$11,550**

**|Y| - θ, G - B Measurement:** Range:  $|Y|, G, B: 1 \text{ nS}$  to 12.999 S;  $\theta: -180.00^\circ$  to  $+180.00^\circ$ . Accuracy: G accuracy ( $D \geq 10$ ); B accuracy ( $D \leq 0.1$ ).



# COMPONENT MEASUREMENT

## Vector impedance meters

Models 4800A, 4815A

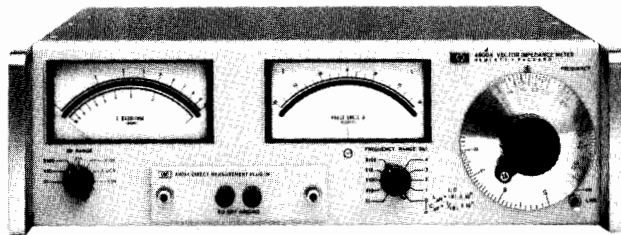

4800A

### Model 4800A

HP's 4800A measures the vector impedance of components, complex networks, and other two-terminal devices. Besides measuring vector impedance, the 4800A measures component values. At frequencies that are decade multiples of  $\frac{1}{2}\pi$ , as marked on the frequency dial, L and 1/C are read directly if the phase is approximately  $\pm 90^\circ$ , respectively. R is equal to the impedance magnitude at frequencies where the phase is approximately  $0^\circ$ . The vector impedance meter also yields Q and inductor values by using either  $f_0/\Delta$ ,  $R_p/wL$  or the  $wL/R_s$  technique.

The unit is equipped with analog outputs for three parameters: impedance magnitude, impedance phase, and frequency. The rear panel provision for an external oscillator input makes possible swept frequency characterization of "unknown." The impedance meter can be swept over any decade range of frequency and impedance within the range of the instrument.

### Specifications

#### Frequency Characteristics

**Range:** 5 Hz to 500 kHz in five bands: 5 to 50 Hz, 50 to 500 Hz, 0.5 to 5 kHz, 5 to 50 kHz, 50 to 500 kHz

**Accuracy:**  $\pm 2\%$ , 50 Hz to 500 kHz;  $\pm 4\%$ , 5 to 50 Hz;  $\pm 1\%$  at 15.92 on frequency dial from 159.2 Hz to 159.2 kHz;  $\pm 2\%$  at 15.92 Hz.

**Impedance measurement characteristics:** 1 ohm to 10 megohms in seven decade ranges from X1 to X10M. Accuracy is  $\pm 5\%$  of reading.

**Phase angle measurement characteristics:**  $0^\circ$  to  $\pm 90^\circ$  in  $5^\circ$  increments. Accuracy is  $\pm 6^\circ$ .

**Direct capacitance measurement capabilities:** 0.1 pF to 10,000 uF direct reading at decade multiples of 15.92 Hz. Accuracy  $\pm 7\%$  of reading for D less than 0.1 at 159.2 Hz to 159.2 kHz,  $\pm 8\%$  of reading for D less than 0.1 at 15.92 Hz.

**Direct inductance measurement capabilities:** 1 uH to 100,000 H direct reading at decade multiples of 15.92 Hz. Accuracy is  $\pm 7\%$  of reading for Q greater than 10 from 159.2 Hz to 159.2 kHz;  $\pm 8\%$  of reading for Q greater than 10 at 15.92 Hz.

**Measuring terminal characteristics:** both terminals above ground, ground terminals provided for shielding convenience; binding posts space  $\frac{3}{4}$ " at centers.

**Waveshape:** sinusoidal.

**External oscillator requirements:** 0.9 V  $\pm 20\%$  into 20 k $\Omega$

#### Recorder Outputs

**Frequency:** level: 0 to V nom.; source impedance: 0 to 1 k $\Omega$  nom.; proportional to frequency dial rotation.

**Impedance:** level: 0 to 1 V nom.; source impedance: 1 k $\Omega$  nom.

**Phase angle:** level: 0  $\pm 0.9$  V nom.; source impedance: 1 k $\Omega$  nom.

**Accessories furnished:** 13525A Calibration Resistor, 00610A Terminal Shield, Vector Impedance Calculator.

**Size:** 426 mm W x 133 mm H x 467 mm D (16 $\frac{3}{4}$ " x 5 $\frac{1}{4}$ " x 18 $\frac{3}{8}$ ").

**Weight:** net, 10.8 kg (24 lb); shipping, 13.5 kg (30 lb).

**Power:** 115 or 230 V  $\pm 10\%$ , 48 to 440 Hz, 29.7 VA.

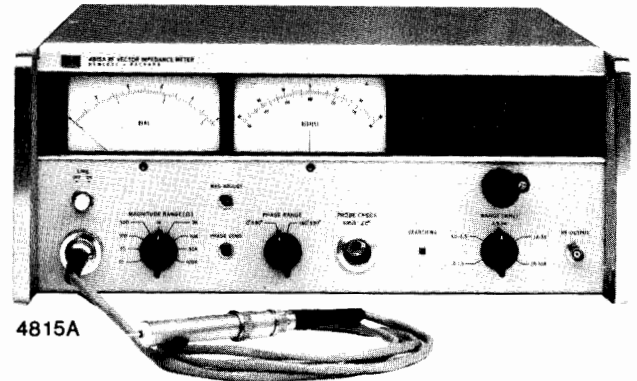

4815A

### Model 4815A

The RF Vector Impedance Meter offers these significant advantages:

- Direct reading of impedance and phase
- Convenient probe for in-circuit measurements
- Self calibration check provides measurement confidence
- Analog outputs for data recording
- Low-level test signal minimizes circuit disturbance

The HP 4815A RF Vector Impedance Meter provides all of the convenience of "probe and read" measurements. In use, the probe is connected directly into the circuit to be evaluated, frequency is selected, and complex impedance is read. This type measurement allows a straightforward adaptation to various jigs and fixtures for special measurements. Where only component values are to be determined, a quick-mount adapter is provided to allow rapid measurements. For critical component applications, the unit to be evaluated may be mounted directly in its working circuit and its value determined in its actual environment, at the frequency of interest.

### Specifications

#### Frequency

**Range:** 500 kHz to 108 MHz in five bands: 500 kHz to 1.5 MHz, 1.5 to 4.5 MHz, 4.5 to 14 MHz, 14 to 35 MHz, 35 to 108 MHz.

**Accuracy:**  $\pm 2\%$  of reading;  $\pm 1\%$  of reading at 1.592 and 15.92 MHz.

**RF monitor output:** 150 mV minimum into 50 ohms.

#### Impedance Magnitude Measurement

**Range:** 1 ohm to 100 k $\Omega$ ; full-scale ranges: 10, 30, 100, 300, 1 K, 3 K, 10 K, 30 K, 100 k $\Omega$ .

**Accuracy:**  $\pm 4\%$  of full scale  $\pm (f/30 \text{ MHz} + Z/25 \text{ k}\Omega)\%$  of reading, where f = frequency in MHz and Z is in ohms.

**Calibration:** linear meter scale with increments 2% of full scale.

#### Phase Angle Measurement

**Range:** 0 to  $360^\circ$  in two ranges:  $0 \pm 90^\circ$ ,  $180^\circ \pm 90^\circ$ .

**Accuracy:**  $\pm (3 + f/30 \text{ MHz} + Z/50 \text{ k}\Omega)$  degrees where f = frequency in MHz and Z is in ohms.

**Calibration:** increments of  $2^\circ$ .

**Adjustments:** screwdriver adj. for Magnitude and Phase Zero.

#### Recorder Outputs

**Frequency:** 0 to 1 V from 0 to 1 k $\Omega$  source, proportional to setting.

**Impedance magnitude:** 0 to 1 volt from 1 k $\Omega$  source.

**Phase angle:** 0  $\pm 0.9$  volt from 1 k $\Omega$  source.

**Size:** 426 mm W, 185 mm H, 476 mm D (16 $\frac{3}{4}$ " x 7 $\frac{1}{4}$ " x 18 $\frac{3}{8}$ ").

**Weight:** 17.6 kg (net 39 lb), shipping 24.8 kg (55 lb).

**Power:** 105 to 125 V or 210 to 250 V, 50 to 400 Hz, 50 W.

#### Accessories furnished:

00600A Probe Socket Accessory Kit: contains BNC Type "N" adapter. Probe Socket, 00601A Component Mounting Adapter, 2 probe center pins, probe ground assembly.

#### Options

**908:** Rack Flange Kit

**Price**  
Add \$22.50

#### Model Number and Name

**4815A** RF vector impedance meter

\$5500

**4800A** Vector impedance meter

\$3300

## Decade capacitors and attenuators

Models 4440B, 4436A, 4437A, 16380A

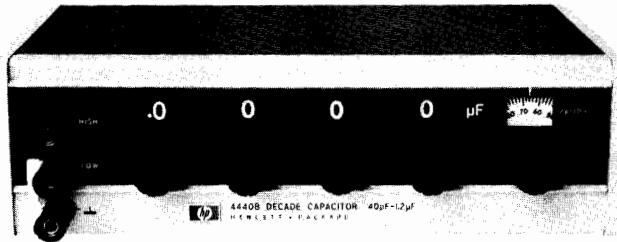

4440B

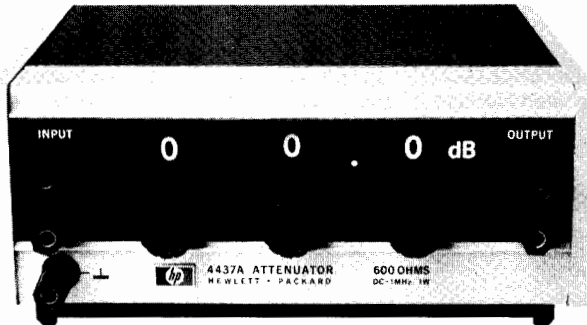

4437A

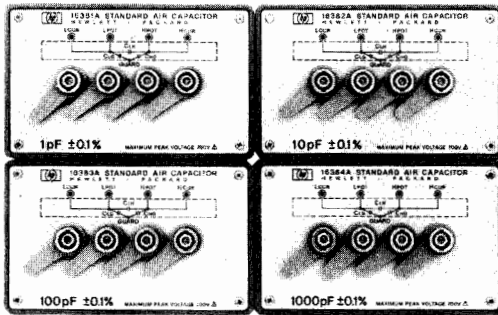

16380A

### 4440B Description

The Hewlett-Packard 4440B Decade Capacitor is a high accuracy instrument providing usable capacitances from 40 pF to 1.2 μF. Its 0.25% accuracy makes it an ideal aid for circuit design or as a working standard.

The use of silvered-mica capacitors in all four decades provides higher accuracy, lower dissipation factor and good temperature coefficient. An air capacitor vernier provides 100 pF (from 40 pF to 140 pF) with resolution of 1 pF. Capacitors are housed in a double shield in such a way that increased capacitance from two terminals to three terminals is held to 1 pF.

### 4440B Specifications

**Capacitance:** 40 pF to 1.2 μF in steps of 100 pF with a 40 pF to 140 pF variable air capacitor providing continuous adjustment to better than 2 pF between steps.

**Direct reading accuracy:** ±(0.25% + 3 pF) at 1 kHz for three-terminal connection.

**Resonant frequency:** typical values of the resonant frequency are 450 kHz at 1 μF, 4 MHz at 0.01 μF and 40 MHz at 100 pF

**Dissipation factor:** for C > 1040 pF, 0.001 MAX at 1 kHz.  
for C < 1040 pF, 0.005 MAX at 1 kHz.

**Temperature coefficient:** < +70 ppm/°C.

**Insulation resistance:** 5 GΩ minimum, after 5 minutes at 500 V dc.

**Maximum voltage:** 500 V peak.

**Weight:** net 2.5 kg (5½ lb); shipping 3.6 kg (8 lb).

**Size:** 76 mm H x 264 mm W x 152 mm D (3" x 11" x 6").

### 4436A/4437A Description

The Hewlett-Packard Models 4436A/4437A Attenuators provide accurate steps of attenuation with 0.1 dB resolution.

### 4436A Specifications

**Maximum attenuation:** 119.9 dB.

**Attenuation increments:** 0.1 dB.

**Input/output impedance:** 600Ω, balanced.

**Frequency range:** dc to 1.0 MHz, useable to 1.5 MHz; dc to 1.5 MHz (0 to 110 dB); dc to 1 MHz (0 to 119.9 dB).

**Accuracy:**

Attenuation	100 kHz	1 MHz	1.5MHz*
0 to 60 dB	±0.1 dB	±0.2 dB	±0.2 dB
60 to 90 dB	±0.1 dB	±0.3 dB	±0.3 dB
90 to 110 dB	±0.2 dB	±0.5 dB	±0.5 dB
110 to 119.9 dB	±0.3 dB	±1.0 dB	

\*Typical value

**Maximum input power:** +30 dBm (24.5 V max).

### 4437A Specifications

The Model 4437A is a 600 ohms unbalanced type, and its specifications are identical to the 4436A.

**DC Isolation:** signal ground may be ±300 V dc from external chassis.

**Size:** 76 mm H x 198 mm W x 177 mm D (3" x 7¾" x 6¾").

**Weight:** net, 1.7 kg (3½ lb). Shipping, 2.9 kg (6½ lbs).

### 16380A Description

The HP 16380A is a set of four air-dielectric four-terminal pair configuration capacitors with values of 1, 10, 100 and 1000 picofarads.

### 16380A Specifications (at 1 kHz, 23 ± 5°C)

	16381A	16382A	16383A	16384A
Capacitance	1 pF	10 pF	100 pF	1000 pF
Accuracy	±0.1%			
Dissipation Factor	≤0.0001			
Insulation Resistance (500V)	> 10 <sup>13</sup> Ω		> 5 x 10 <sup>13</sup> Ω	
Max. Allowable DC	700V peak			
Dimensions	112 mm (H) 142 mm (W) x 88 mm (D)			
Weight	1.4 kg each, Case: 8.6 kg			

### General

#### Frequency Characteristics

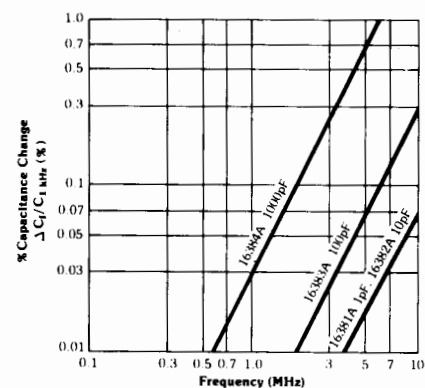

**Temperature coefficient (typ.):** +40 ppm/°C (1pF), +30 ppm/°C (10p, 100p, 1000pF)

**Calibration accuracy:** ±0.01% (certification at 1 kHz supplied).

**Stability:** 300 ppm/YR (at 1 kHz and 23 ± 5°C)

### Ordering Information

4440B Decade Capacitor	\$810
4436A Attenuator	\$1165
4437A Attenuator	\$785
16380A Standard Air Capacitor Set	\$2450



# COMPONENT MEASUREMENT

## Digital IC Tester

Models 5045A, 5046A

- Tests CMOS, ECL, TTL, DTL
- Printed record of IC failures
- Magnetic card programmable
- Tests IC's to 16 pins-24 pins optional

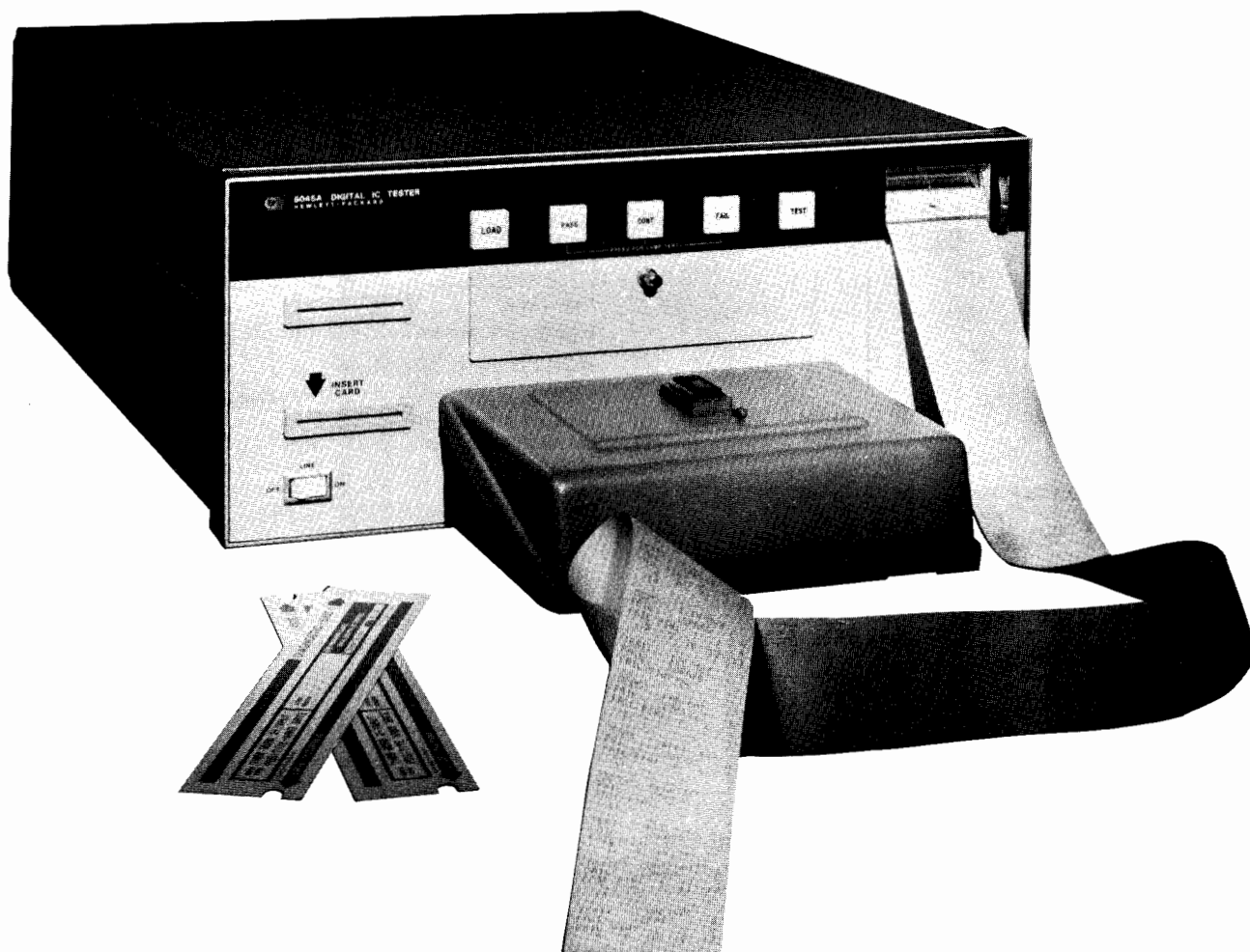

### 5045A Digital IC Tester

The HP Model 5045A is a processor controlled, microprogrammed digital IC Tester. Well suited for high volume incoming inspection as well as engineering evaluation and failure analysis, it's simple enough to be used by an unskilled operator yet it includes capabilities usually found only in large, computer-based test systems. To test a device, all that's required is a preprogrammed magnetic card. Insert the card into the front panel slot, and the tester is ready to provide complete DC parametric and functional verification of one of the many devices listed in our comprehensive program catalog.

To provide a permanent record of individual IC failures as the test is being made, the quiet HP thermal printer has been included in the 5045A to record detailed failure information for every bad IC. Your operator just keeps on testing—the record is automatically kept and can be reviewed later or returned with the bad IC's to the manufacturer.

#### Tests All These Families

ECL, CMOS, TTL, HTL, DTL

The universal pin electronics in the 5045A let each pin act as power supply, input, output, or open circuit. This provides the great flexibility and capability needed to test circuits all the way from basic gates to arithmetic logic units, and ROM's. Devices with power supply voltages up to 15 volts or both positive and negative voltages up to 7.5 volts may be tested. As your testing requirements expand to new devices, your 5045A can be easily and inexpensively updated by adding

new program cards. The nominal cost of these cards means that you don't have to be satisfied with testing a small fraction of your circuit types. You can keep your program library complete – and still stay within your budget.

#### DC Parametric and Functional Tests

The 5045A thoroughly tests devices both functionally and parametrically to ensure that those expensive failures don't get loaded into your PC boards. Functional tests check the ability of the device to correctly operate according to its truth table as the appropriate input stimulus is applied. DC parametric tests check the voltages and currents on device inputs and outputs under various conditions specified by the manufacturer. These tests eliminate almost all defective devices and avoid the expense of finding and replacing bad circuits once they have been soldered into PC boards and perhaps become part of a complex system.

#### Unique Test Technique

To provide the accuracy of direct comparison testing without expensive performance or reference boards, the 5045A uses a unique IC simulation technique. The correct functional operation of the device under test is simulated and this simulation is used as a reference. As both the device under test and simulator are driven with the same inputs, their outputs are compared on a step-by-step basis. If a failure occurs, the 5045A can indicate exactly where it happened by printed message or can stop on the failure so the fault can be investigated in more detail.

### Economical ROM Testing

To test the many different truth tables which may be programmed in ROM's of the same generic type, it is not necessary to buy a card for each one. A single card containing stimulus information for the generic ROM type is loaded into the 5045A and the unique truth table of a known good ROM is "memorized" by the 5045A. The complete program is then recorded on a blank card for future use. Duplicates of any card may be made from the original by programming the 5045A, pressing "write", and then inserting a blank card.

### Automatic IC Handlers

The 5045A was designed to work with automatic IC handlers needed for high volume testing. The special circuits which generate the fast rise and fall times for testing digital circuits are in a removable test deck which can be placed within inches of the IC being tested. Problems caused by long cables between handler and tester—ringing, oscillation, slow rise/fall times—are eliminated.

HP in cooperation with major automatic handler manufacturers, has designed custom interface kits for popular handlers. So, interfacing the 5045A and a handler requires nothing more than plugging the two together.

### Printer Gives Permanent Copy of Test Results

A built-in thermal printer provides useful test information: a) it tells whether a program is loaded correctly and what program it is, b) it records the number of failed and passed IC's, and c) it provides failure analysis information for each failed IC.

In its failure analysis modes, the printer can provide very detailed information; a special voltage/current printout, for example. This makes the printer a digital multimeter PLUS!

### Self Test Feature

In an incoming inspection or production environment it is important to know your equipment is operating as it should. The tester has self-test cards to automatically exercise all major circuitry (the drivers and receivers for all pins, the central processor, the memory, and associated circuits). This way, you know every day that the tester is functioning correctly and that none of those bad IC's are getting into your production run, and cutting into your company's profits. Also included are diagnostic cards.

### Ordering the Pre-programmed Magnetic Cards

The 5045A is programmed by pre-recorded magnetic cards available from HP. These cards, covering most common device types, are listed in our IC PROGRAM CATALOG. This catalog contains a wide variety of logic families and includes the majority of common device types. When additional programs are needed after the original purchase, they may be ordered through your local HP sales office or by mail with a prepaid coupon.

Each IC program ordered comes complete with both PASS/FAIL and DIAGNOSTIC test cards and includes duplicates of each. The PASS/FAIL test is used for the majority of testing since it is complete and fast (typical test time for MSI sequential devices is 300 ms). The DIAGNOSTIC test provides extra information by supplementing the PASS/FAIL card. Data sheets containing test descriptions and all parameters are included for both PASS/FAIL and DIAGNOSTIC cards.

## Condensed Specifications

### Test Set-up Method

Test conditions including parametric information, input stimuli and output data contained on magnetic card; program verified when loaded.

### Test Structure

**Functional test:** truth table verified by comparing device under test to software-generated IC simulator (or, stored truth table for some circuits).

**Parametric test:** DC parameters tested to IC device manufacturers data sheet specs, except where limited by 5045A capabilities. Test limits indicated on sheet sent with each program card.

**Continuity test:** verifies pin contact by checking current flow in or out of active pins; test failure shown by front panel indicator.

### Test Pattern Generation

Test patterns derived using algorithmic techniques or from stored truth tables; tests individually tailored to each IC.

### Universal Pin Drivers

Same circuit drives or monitors each pin whether an input, output, power supply, clock or open. Voltages and currents individually programmable for each pin. No external test fixtures required.

**Voltage applied to the device under test** (Supply Voltage, Input Voltage, and Output Voltage)

Range (15 Volts)	Accuracy
-7.5 V ≤ to < -1.875 V	± 25 mV
-1.875 V ≤ to ≤ +1.875 V	± 15 mV
+1.875 V < to ≤ +7.5 V	± 25 mV

**Current applied to the device under test** (Supply Current, Input Current, and Output Current)

Range	Accuracy*
-200 mA ≤ to < -2.5 mA	± 0.4 mA or ± 6%
-2.5 mA ≤ to ≤ 2.5 mA	± 10 μA or ± 6%
2.5 mA < to ≤ 200 mA	± 0.4 mA or ± 6%

\*whichever is greater

**Slow rate:** 30 ns/volt.

### Rear panel outputs

**Automatic handler interface:** 14 pin Amphenol connector provides +5 V @ < 100 mA, "End of Test", "Pass", "Fail", and "Fail Continuity" signals, accepts "Start Test". All signals are negative true TTL levels.

### General

**Power:** 100/120/200/240 V (+5%, -10%), 48-66 Hz, 240 VA.

**Size:** 19 H x 42.5 W x 58 cm D (7.5" x 16.7" x 22.8").

**Shipping weight:** 27.7 kg (61 lb.)

**Operating temperature:** 0°C to 50°C.

**Relative humidity:** 80%.

Prices

See page 119.

## 5046A Digital IC Test System

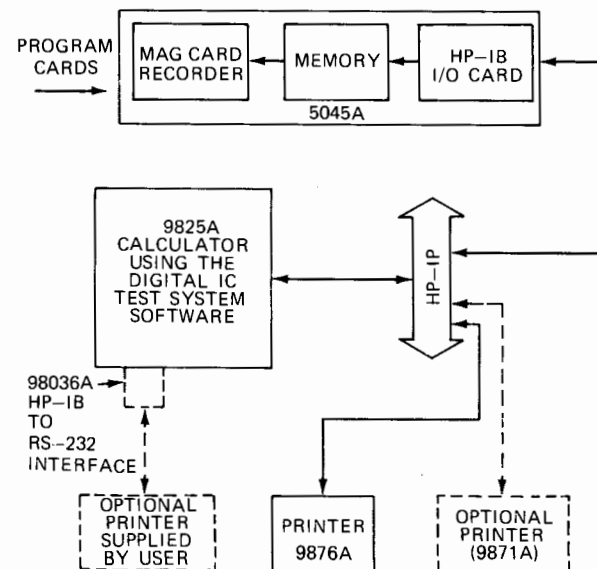

5046A Digital IC Test System Functional Block Diagram



# COMPONENT MEASUREMENT

## Digital IC Test System

Models 5045A, 5046A (cont)

- Modify existing device programs
- Generate one-of-a-kind device programs
- Change test parameters quickly, simply
- In-house programming—on your own schedule



### Description

The HP 5046A Digital IC Test System gives you capability previously available only at the factory: the ability to write or change IC test programs to meet your special needs. Also, the 5046A consists of the same equipment used at the factory to generate all of the standard device programs listed in our IC Program Catalog.

Built around the 5045A IC Tester, 9825B Desktop Computer and 9876A Printer, the system allows you to program proprietary devices, change parameters, write your own special programs, or modify existing device programs to meet special testing needs. This helps you to keep information about proprietary devices confidential, it saves time by allowing in-house programming capability, and it allows you to evaluate devices, all by use of an HP-IB based, fully programmable system.

In incoming QA inspection departments, quality control is a key concern. New IC's need to be tested to assure conformance to design requirements—bad or marginal IC's can generate great costs if installed in production equipment, and sometimes IC specifications can change overnight.

The 5046A provides flexibility in these areas because device programs can be changed quickly and simply by a few keystrokes. The user simply loads in the device program, using either a magnetic card or a tape cassette, lists the program, keys in the changes and generates a new program.

The 5046A system is a complete system consisting of hardware and software—it is fully integrated, specified, documented and tested as a

system prior to shipment. For easy on-site installation and verification, full hardware and software manuals are provided. The operating and programming manual, for example, is written to three different levels, each progressively deeper, to enable easy start-up and operation, quick comprehension of the operating system and its hardware, and complete self-instruction on the system software.

Each system requires a printer for operation; the 5046A includes a Model 9876A Thermal Printer as standard equipment, and the Model 9871A Impact Printer is also available as an option (Opt 001). Other RS-232 compatible printers, supplied by the user, can be interfaced to the system in lieu of the 9876A by ordering the HP-IB to RS-232 interface (opt 002).

### Software

The 5046A system software is stored on one standard 9825S tape cassette. The programs are accessible using the special function keys on the desktop computer. The software package consists of the following programs:

The **Editor** provides the capability to:

1. Enter IC test programs from the 9825B keyboard.
2. Read in source program from the 9825B cartridges.
3. Modify source programs.
4. Store source programs on 9825B cartridges.
5. Provide on-line editing.
6. Print-out listing of source programs.

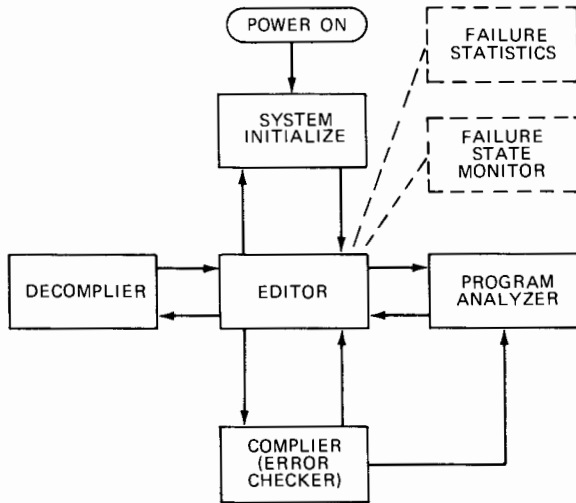

5046A Digital IC Test System Software Organization

The **Compiler** provides the capability to:

1. Do syntax checking on source program statement.
2. Convert the source program into an object (machine code) program.
3. Output the object program to the 5045A IC Tester.

The **Decompiler** provides the capability to:

1. Read an object program from the 5045A IC Tester.
2. Generate the corresponding source program.

The **Program Analyzer** is used for error checking and debugging source program. It interrogates the 5045A processor as it is run through a completed test program, then prints the following:

1. Listing of actual test sequence.
2. Programmed test parameters for each pin in each test.
3. The "1" and "0" logic state for each pin in each test.

The **Failure Statistics** program provides the following:

1. Printout of failure by pin for each specific test failed.
2. Summary of failure and failure percentage for each test in the program.

The **Failure State Monitor** program interacts with the 5045A while an IC is being tested. When a failure is encountered, it displays the state in which the IC failed.

The Operating and Programming Manual provides detailed information and modular program examples that enable the user to quickly and easily learn the 5046A programming language (it isn't necessary to learn the 9825B HPL language in order to generate IC test programs).

To generate an original IC test program, the user need only understand the IC technology of the device under test (DUT) and be able to design simple logic circuits using Boolean techniques.

The manual provides step-by-step instruction for programming. In addition, individual chapters in the manual cover the HP test philosophy and testing techniques used with the TTL, ECL, CMOS and DTL technologies.

#### Ordering Information

	Price
<b>5045A</b> Digital IC Tester: standard 16-pin version; includes self-check and diagnostic cards, 16 and 24 pin dummy IC's and socket adapter.	\$10,250
<b>5046A</b> Digital IC Tester System: basic system includes 5045A IC Tester, 9825B Desk Top computer, 98034A HP-IB Interface Model 9876A, Option 025 Thermal Printer, 10833B HP-IB Cable, a Programming Manual and 40 blank magnetic program cards.	\$24,950

Options and Accessories, 5045A/5046A	Price
<b>Opt 024:</b> expands 5045A capability to 24 pins	\$2,000
<b>Opt 025:</b> Flat-Pack adapter for 14, 16 and 24 pin IC	\$225
<b>05045-90003:</b> Card Holder, One Each	\$0.70
<b>05045-90027:</b> Card Holder 50 ea of 05045-90003	\$33
<b>5952-7546:</b> Program Catalog	N/C
<b>9164-0071:</b> blank magnetic PASS/FAIL program card	\$2.10
<b>9164-0072:</b> blank magnetic DIAGNOSTIC program card	\$2.10
<b>9281-0401:</b> 250 foot roll of thermal printer paper for 5045A (minimum order, six rolls)	\$2.50 ea.
<b>10845A:</b> preprogrammed magnetic card for any device listed in the <i>Program Catalog</i> (HP Publication Number 5952-7546)	1-9 \$40 ea. 10-500 \$35 ea.
<b>10846A:</b> book containing ten coupons, each redeemable for one IC program listed in the <i>IC Program Catalog</i> (HP Publication Number 5952-7546). Coupons are mailed to factory, programs sent by return mail. Coupons expire after two years	\$350
<b>10847A Service Kit:</b> allows fault isolation and rapid repair of the 5045A through board replacement thereby reducing downtime. The kit includes: all CPU boards, two pin-drivers, card reader and interface, printer interface and solenoid, front panel control, diagnostic program card kit and accessories, and carrying case.	\$3,500
Service agreements for the 5045A and 5046A as well as HP's rebuilt board exchange program are available. Contact your nearest HP office for details.	

#### Automatic Handler Options, 5045A/5046A

<b>Opt 004#:</b> interface package for IPT Model 806 automatic IC handler	\$1,100
<b>Opt 005#:</b> interface package for Sym-Tek model 7191ND automatic IC handler and other related models	
<b>Opt 006#:</b> interface package for Daymarc 952/3 automatic IC handler	\$1,100
<b>Opt 007#:</b> interface package for Micro Component Technology Model 2604/8 automatic IC handler	\$1,100
<b>Opt 008#:</b> interface package for Delta Model 8040 ambient naked DIP handler	\$1,100
<b>Opt 009#:</b> interface package for Control Model H310 automatic IC handler	\$1,100
<b>Opt 010#:</b> interface package for PAE Model 3033LP naked DIP handler	\$1,100
<b>Opt 013#:</b> interface package for TRIGON Model T2000 multi-size Ambient Test Handler	\$1,100

#: All interface packages include a test head extender cable, an interface board unique to the particular handler, and a cable to supply control signals to the handler.

#### Options and Accessories, 5045A Only

	Price
<b>10844A:</b> programming interface retrofit kit; contains all necessary parts, cables, interface board, and instructions to modify the 5045A for use in the 5046A Digital IC Test System. Programming manual and 40 blank magnetic program cards included.	\$2,475

#### Options and Accessories, 5046A Only

<b>Opt 001:</b> Substitute Model 9871 impact printer for 9876A and 10833B	+\$75
<b>Opt 002:</b> Substitute 98036 HP-IB to RS-232 interface for 9876A and 10833B	-\$3,325
<b>Opt 003:</b> Substitute 9866B with Option 025 Thermal Printer and 98226A Cradle for 9876A with Option 025 Thermal Printer and 10833B HP-IP Cable	+\$1,400
<b>Opt 125#:</b> Delete Model 9825 desk top computer, 98034A	-\$8,200
<b>Opt 145#:</b> Delete Model 5045A IC Tester from system	-\$10,250
<b>Opt 176:</b> Delete Model 9876A, Option 025, and 10833B HP-IB Cable	-\$4,025

# Only one of these options can be on any one order.



# CIRCUIT TEST SYSTEMS

## Production Testing of Electronic Printed Circuit Board Assemblies

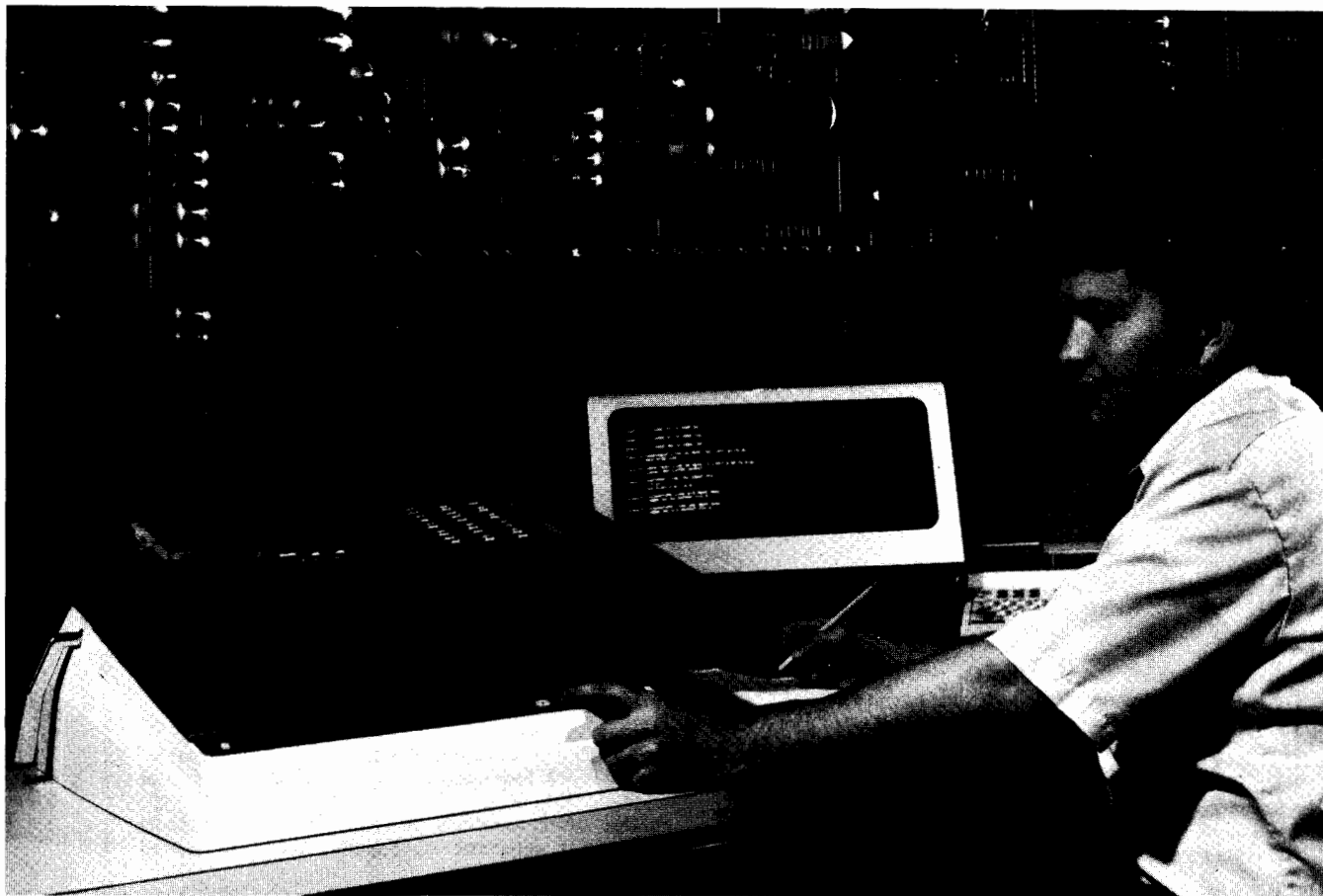

Is automatic testing a panacea? With today's PC volume and complexity, it's not so much a panacea as it is a necessity. But to implement a test solution requires a thorough understanding of the available test systems and your production environment.

### When to Test?

That's as important as how. The cost of fault identification increases dramatically with each production step. Thus, you want to catch faults as early in the production process as possible, but it doesn't necessarily follow that extensive incoming parts inspection is the answer. Your real goal is high turn-on rates in final test. That demands high-yield PC boards. And as the diagram below shows, several factors other than good parts go into high-yield PC boards.

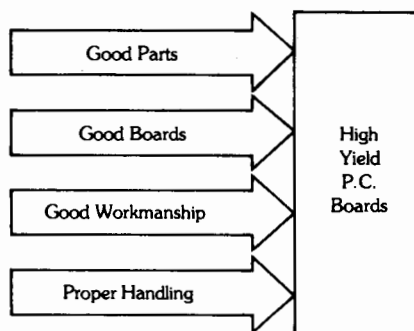

A new set of problems must be dealt with at the board assembly level and cannot be eliminated by 100% incoming inspection. Some of these typical problems are handling breakage, misloaded parts, incorrect parts loaded, soldering problems, PC board problems such as shorted traces, and heat damage to the parts as they are being assembled. It is mainly this factor that determines the amount of cost and manpower that should be devoted to incoming parts inspection.

The objective of these activities is to maximize the probability of system turn-on. Good parts and PC test reduce the problem level at final product test.

A PC board assembly process will produce anywhere from 20% to 80% good boards. A typical number is 60%. Of the faulty boards, a fault spectrum might look like this:

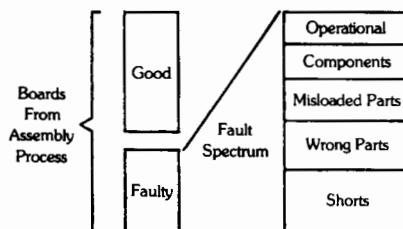

With a good board yield of 60% and no PC board testing, even a simple product with five boards would overload final test. Nine out of

ten units would fail. This makes board level a good place for thorough testing, for this is the first opportunity to locate faults across the entire fault spectrum. But which tester is for you?

### Choosing a Circuit Board Tester

There are no simple answers to selecting an automatic circuit test system. But, from our experience, we know that these are some of the factors involved: Production yield, test yield, fault spectrum, PC volume, board type, and anticipated new products.

Will the system test for the spectrum of faults that you will encounter? Will it generate component level diagnostic information? Will it test present and future board types and do it fast? Is it easy to expand and adapt to changing requirements?

What are the true costs? How much time and effort is involved in programming, debugging, fixturing and training? And will you get prompt, competent service if you need it?

### Over Two Million Boards Worth of Experience

HP's new Automatic Circuit Test Systems are the result of our extensive in-house experience with automatic circuit testing.

In fact, we were spending such large sums on dedicated equipment and manual test stations that back in 1970 we developed an automatic circuit test system called Optest I. This system, along with its more recent companion, Optest II, is still in operation today.

Optest I and Optest II are now testing over 100,000 printed circuit boards annually. Our new circuit test system is, in reality, a third-generation product, which originated from over eight years' experience in actual in-use operation. Today, HP is using 75 of these new automatic test systems within our own plants.

**Balanced Testing**

One hundred percent testing at all stages in the production process is expensive and inefficient. A balanced test strategy must be tailored to individual problems and requirements.

Thoughtful consideration of testing requirements will improve product yield and at the same time reduce costs. Other benefits are a smoother production line and lower test and troubleshooting times.

HP's electronic manufacturing experience has led to the development of two major automatic board test products, the HP 3060A and the DTS-70. Each system approaches the problem of PCB testing differently, focusing upon the different types of boards being manufactured. The HP 3060A is a combined in-circuit and functional analog/digital board test system, and the DTS-70 is a simulator based digital board test system.

**The Case for In-Circuit Plus Functional Testing**

The marketplace has many potential test solutions. You can choose from simple shorts testers to completely automated systems. From testers that measure components in-circuit to functional test systems that verify dynamic performance of complete circuits.

HP's new 3060A Board Test System is an advanced system that combines the latest in-circuit technology with functional testing. It includes a comprehensive software package for fast program development. It is a proven package, which combines ease of use with flexibility to handle tough test problems.

**Leverage Product Yield**

In-circuit testing is a powerful test approach. But today's complex products require more than in-circuit testing. Higher and higher PC board yields are required to maintain an acceptable product yield in final testing.

The addition of advanced in-circuit test techniques adds that extra increment to your PC board yield as shown below.

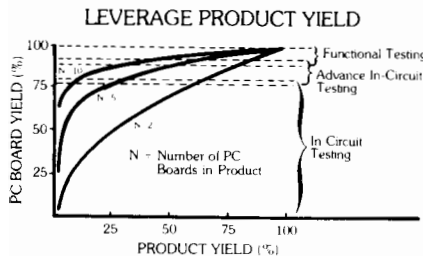

For example, in a five PC board product, increasing the PC board yield from 75% to 98% will leverage product yield from 23% to 90%. This can result in substantial savings,

since the cost of fault detection increases dramatically with each production step.

**What Is Advanced In-Circuit Testing?**

In-circuit testers contact each PC board node through a bed-of-nails fixture. The system switches from component to component and "inspects" for value, placement, etc. Today, the wide diversity of component values, tolerances, components, and interconnections, means that conventional in-circuit techniques often leave some parameters untested.

The 3060A utilizes advanced techniques that allow component isolation in commonly found but difficult circuit configurations. For example, a .01  $\mu$ F capacitor can be measured to an accuracy of 4% even when it is shunted by a 1000 Ohm resistor. The key to this measurement is a phase synchronous detector. This is a valuable tool for measuring components and circuits with significant real and reactive characteristics.

HP's ADVANCED IN-CIRCUIT TESTING

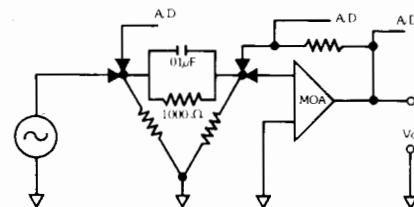

**Functional Testing Makes the Difference**

The standard HP 3060A also has a useful set of analog and digital testing tools. It incorporates board level stimulus/response testing in order that components such as operational amplifiers, DAC's and optoelectric devices can be tested. This functional testing permits circuit parameters, such as frequency and period, to be measured and circuit adjustments made. The 3060A's functional testing capability extends to digital pattern, analog and combined circuits. For example, the 3060A, can be used to test a D/A converter by applying digital patterns and then monitoring the analog output voltage.

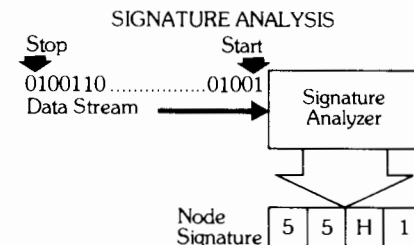

**At-Speed Testing of Microprocessor Boards**

The big news in PC board testing is the microprocessor. Conventional digital testers do not have the massive data storage required to test microprocessors. But the HP 3060A uses an HP-developed technique called Signature Analysis to test these microprocessor boards at operating speed. The 3060A collects length bit streams at circuit nodes and converts them to short, four-character hexadeci-

mal signatures. Under test, the bit stream signature at each circuit node is compared to the expected value, making it easy to locate nodes with faulty signatures. This data compression technique makes microprocessor-board testing manageable. HP's signature analysis technique is the right solution to testing microprocessor boards.

**Digital Test Effectiveness**

Some boards, such as large complex logic boards, will benefit from the use of HP's DTS-70 Digital PC Board Test System. This simulator-based tester tells you how effective your test programs are and identifies the portion of the circuit not completely tested. This is important feed-back permitting better program development. A useful tool in R&D, the DTS-70 can model your designs and help you produce better products. Your test engineer will appreciate its ability to model feed-back loops, find open traces and identify intermittent faults.

Just as important, the DTS-70's power and flexibility comes from its controller, the HP 1000 Computer System. Using a Real-Time Executive operating system, you can simultaneously test PC boards and develop new programs. As your testing needs expand, two more test stations and several programming terminals can be added without the expense of additional computer power. The operating system is compatible with data-base management software to keep track of your test data and help you better manage your production. The DTS-70 will easily fit into your long range computer network plans providing distributed processing and communication to your data processing center.

	3060A	DTS-70
In-Circuit	X	
Bed-of-Nails	X	
Edge Connector		X
Functional Analog	X	X
Functional Digital	X	X
Signature Analysis	X	
Board Simulator		X
HP-IB	X	X
Controller	HP 9825T	System 1000

**The Bottom Line**

Can automated PC board test equipment save you money? Again, there are no simple answers. But it has saved us money and chances are it will save you money, too, if any of these conditions exist in your plant: high PC volume, complex boards, production testing backlog, low turn-on rates of complete systems, high in-process inventory costs and high warranty costs.

Your production operation is unique, but we can help you characterize it by comparing the cost of testing, or not testing, at each level to arrive at your best test resource allocation. Let us help you answer these key test questions.

# CIRCUIT TEST SYSTEMS

## DIGITAL PC BOARD TEST SYSTEM

Model DTS-70

- High Speed, High Volume Digital Testing
- Isolate Faults Quickly and Easily
- Eliminate Production Bottlenecks

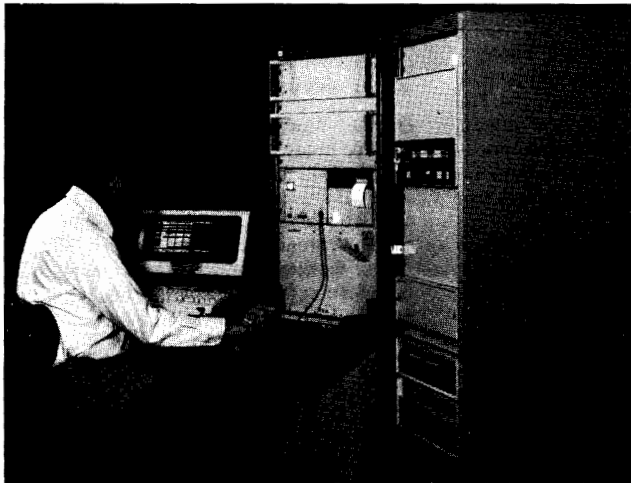

### Description

The DTS-70 Digital Printed Circuit Board Test System can solve your digital board testing needs. The DTS-70 can test your boards and isolate faulty components in seconds. Typical tests take only a few seconds and isolation of the failed component typically takes less than a minute. All this testing is performed to a known level of test effectiveness. The TESTAID board simulation software, provided with the system, enables you to model and test the largest and most complex of your digital printed circuit boards and to determine the overall effectiveness of your testing process, a benefit not possible on hardware comparison testers. The FASTRACE fault isolation software guides your test operator to probe for the faulty component quickly and easily, all but eliminating costly manual troubleshooting.

The DTS-70 System is a complete system consisting of the 9571A Test Station, the HP System 1000 computer and a complete software package. The 9571A Test Station comes complete with digital test unit, programmable power for your board under test, and fault isolation probe. The test station is expandable to do added analog testing that may be required. The field proven HP System 1000 includes the 21MX Series E computer and 7906A disc. The HP System 1000 provides both testing and software test generation expandability through the Real Time Executive operating system. The TESTAID simulator software and FASTRACE fault isolation software provide powerful test generation capability and advanced fault isolation which even enables you to isolate intermittent faults.

The DTS-70 is a test system with the capability, expandability, and reliability you expect from HP.

### No More Production Down-Time to Develop Test Programs

The multi-terminal capability of the DTS-70 allows you to generate test programs without shutting down testing on your production line. No longer do you have to choose between production shut downs and spending tens of thousands of dollars for off-line test generation capability. All you need is a relatively inexpensive terminal. Need more programming capability to keep up with new boards? Add up to six terminals to the DTS-70 for use as programming stations.

### High Speed, High Volume Digital Testing

Test complex boards in only seconds compared to the minutes or even hours necessary for manual test and fault isolation. The DTS-70 is capable of testing tens of thousands of PC assemblies a month for high through-put requirements.

### Isolate Faults Quickly and Easily

Troubleshooting and isolation of faulty components is done automatically. The computer instructs your test operator to isolate the fault in seconds using the guided probe. Avoid time-consuming manual fault diagnosis and reduce the need for highly skilled technicians.

### Eliminate Production Bottlenecks

The DTS-70 can test those complex boards that are so hard to troubleshoot at your final product test station and which hold up your shipments. The DTS-70 is capable of testing complex boards with over 200 MSI components.

### How Effective Is Your Test?

Only a simulator-based tester such as the DTS-70 can tell you how effective your tests are. Testing of complex digital assemblies is difficult and ordinarily does not provide this kind of feedback to the test programmer. As a result, the test programmer does not know when to stop test development. The DTS-70 not only tells you how effective your test is, but also which nodes on the board need further attention. This has improved test quality over manual test generation methods by factors of two or more.

### Worldwide Service

The DTS-70 Digital Test System is designed and manufactured by Hewlett-Packard and is backed up by HP worldwide support. HP recognizes that in a high volume production environment, each hour of operation affects a large portion of your profit dollars. When you take delivery of a DTS-70 system, the following support is available to you, worldwide, to keep your system working for you.

### Model Your Designs in R & D

Catch costly design and testability problems before they become designed-in problems. The DTS-70 TESTAID simulator software models the behavior of your designs, points out testing trouble spots, and predicts race and hazard conditions to your designers. Simulation at the design stage can prevent marginal designs and designed-in problems from reaching your end-users, preventing high warranty costs or costly on-site repairs.

### Installation

Installation services will be provided with each purchase of a DTS-70 Test System. These services consist of site preparation data in advance of system delivery and installation when your system arrives.

### Warranty

A complete warranty program covers the complete DTS-70 system for 90 days beyond the system installation date. This warranty provides complete repair service during the warranty period.

### Customer Assistance Agreements

For system support beyond the warranty period, Customer Assistance Agreements are offered for hardware support and software support. You may select these services together or you may tailor a service program to match your individual needs. With the exception of extremely remote areas, these support programs are available throughout HP's worldwide service organization.

### Training

A digital test programming course is included for customer personnel responsible for developing test programs. This 10-day course teaches system operation, FASTRACE fault isolation and emphasizes use of TESTAID to generate digital test programs. Two enrollments are provided with the purchase of a DTS-70 system.

### Documentation

Every DTS-70 System is delivered with a complete set of operating and service documentation. The documentation set includes system level manuals, instrument level manuals, software manuals and quick reference guides.

### Field Support Package

For those DTS-70 users who choose to do their own servicing, HP offers special field support packages in the form of service kits that contain replacements assemblies. These service kits are designed to allow a user to support his DTS-70 system. For more information on these field support packages, contact your local HP field engineer.

### Ordering Information

DTS-70

(Depends Upon Test Configuration)

### Price

Complete System Starts At \$90,000

- Tests Microprocessor Based Boards
- Increase PCB yields
- Advanced in-circuit testing

- Board level analog/digital functional testing
- Reduce production costs



3060A

## Description

The 3060A Board Best System combines powerful in-circuit fault isolation with wide range analog and digital functional test capability to maximize P.C. board yields. This system incorporates state-of-the-art measurement processing and interface technology combined with years of internal experience in board testing.

The 3060A combines advanced in-circuit component tests and board level functional stimulus/response tests. This new dimension in testing efficiency allows the testing of Printed Circuit Boards to a higher level of confidence than previously possible in a single operation. Not only is the board handling minimized, but the added expense of two test systems is eliminated. The 3060A provides broad functional testing in its standard configuration. For example, the 3060A can perform functional tests on a digital-to-analog converter using the standard analog and digital functions.

## Testing Power

Components and component configurations, which were previously not testable, can now be tested with HP's 3060A. The addition of extended guarding, phase-synchronous detection, and accuracy enhancement make this level of testing possible.

Functional testing is accomplished on the same fixture used to perform in-circuit component measurements. Increased productivity results since boards are handled only once for all tests. Flexibility in analog testing allows the use of standard sources and detectors in the HP 3060A or the addition of external instrumentation for special test requirements. A "bed-of-nails" interface provides direct hardware connection to each node of the board under test. This approach not only provides the necessary visibility for component in-circuit measurements, but simplifies digital testing as well. The response of the circuit to digital stimuli is available at these nodes.

## Board Test Sequence.

The HP 3060A follows a logical testing sequence which minimizes both stress on the board and testing time. Since the majority of board problems may be detected by shorts testing and in-circuit testing, these tests are performed first. By terminating the test sequence when

shorts or faulty components are found, redundant functional testing is avoided. This also eliminates catastrophic failures caused by applying power to a defective board.

## Digital Test & Signature Analysis

Two separate digital test capabilities are available on the 3060A: static pattern testing and an optional dynamic signature analysis (SA). Static pattern testing is ideally suited for testing combined digital and analog circuits, such as A to D and D to A converters. Signature analysis adds the capability to test LSI circuits, including microprocessor based boards at operating speeds. SA is a test method used to measure lengthy digital data streams at high speeds using data compression technique. This not only checks the data stream, but the timing as well. Each device will have a unique signature for a specific time interval. A fault can be traced to a particular device by checking the signature from point to point and comparing it with the correct signature stored in memory.

## Fast Programming

HP's 3060A reduces overall production test costs and programming time through a powerful, high level software called Board Test Language (BTL). As a further aid, the 3060A provides an In-Circuit Program Generator (IPG). IPG automatically generates the in-circuit portion of the program, prints out the finished program in BTL, and generates a fixturing map.

System programming and control is provided by the HP 9825T Desktop Computer for system programming and control. The 9825T provides easy programming with minimal training through its High Level Programming Language (HPL).

HPL is a highly versatile, easy to use language. Its programming statements consist of combinations of several common languages optimized for power and efficiency in controlling instruments, performing data manipulation, controlling input/output operations, and storing information. A set of over 40 high level PC board testing program statements (BTL) specifically designed for efficient 3060A application programming, complements the power of HPL.

## 3060A Board Test System

Standard system including 384 analog pins, 32 digital driver pins, and 32 digital receiver pins

**\$85,000**

# DIGITAL CIRCUIT TESTERS

Signature Analysis, IC Troubleshooters, Digital Education

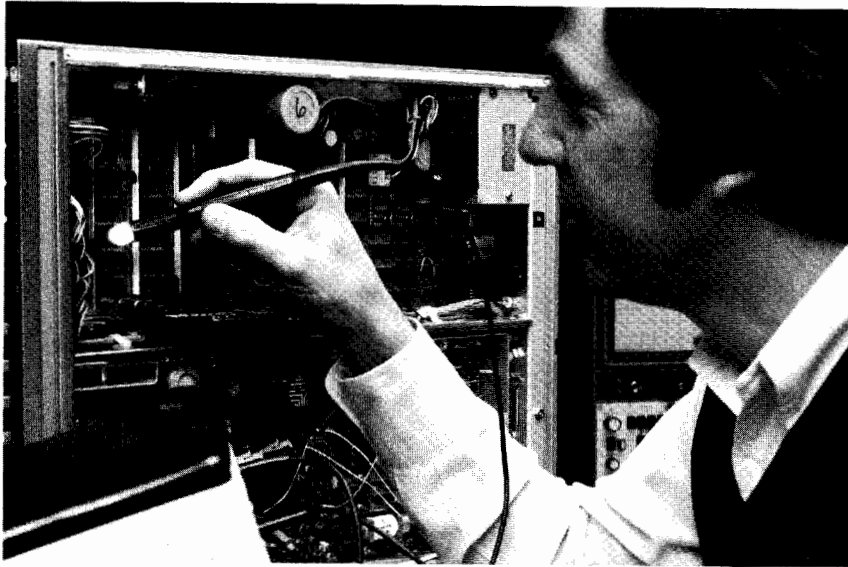

## Serviceability/Testability—A Growing Problem

Microprocessors have revolutionized many product lines. Products are now smarter, faster, friendlier and more competitive because they take advantage of microprocessor-based control and computation. They are also harder to build, test and troubleshoot. Complex bus structures and timing relationships have practically obsoleted the scope/voltmeter signal tracing techniques so effective on analog products. The need to enhance the testability and serviceability of digital products is acute.

Addressing this need, Hewlett-Packard has developed a line of digital circuit test instruments and training tools. Each product complements the other for complete troubleshooting, testing and training solutions. For example, by using Signature Analysis, simplified production test and field service procedures can be provided to isolate digital failures to the exact node. Then the IC Troubleshooters are used to pinpoint the component or process fault causing the problem, making repairs faster and easier. Finally, the Logic Lab and Microprocessor Lab are used to bring production and service personnel up to speed on the latest digital technologies.

## Signature Analysis—Finds the Faulty Node

Signature Analysis (SA) is a technique for component-level troubleshooting. A Signature Analyzer detects and displays the unique digital signatures associated with the data at nodes in a circuit under test. By comparing these actual signatures to the correct ones, a troubleshooter can quickly back-trace to a faulty node.

By adding SA capability to the digital portion of a product, a service support program can be set up for component-level repair, without an investment in board exchange or in special-purpose test equipment. Signature Analysis also speeds production line trouble-

shooting of individual PC boards, or assembled products containing many boards. Experience shows that Signature Analysis reduces the time spent in troubleshooting the digital portion of a product by at least 2:1. With this reduction in time comes a significant reduction in production and service labor costs. These savings usually far outweigh any time spent in setting up the product for SA troubleshooting.

## Signature Analysis Stimulus

There are two ways to provide Signature Analysis stimulus for a product. One way is to add some test features to the product so that it exercises itself. The other way is to provide some source of stimulus that is external to the product.

HP's 5001 series of Microprocessor Exercisers allow products not designed with SA self-stimulus in mind to economically take advantage of the SA technique. The 5001 series of Microprocessor Exercisers provide a source of external test stimuli for microprocessor-based products. To use them, the operator removes the microprocessor from its socket in the product under test, places it into the 5001, and plugs the 5001 into the vacant socket. The 5001 then runs pre-defined test programs from its own ROM.

## Signature Analysis Response

The 5004A Signature Analyzer is a compact instrument for troubleshooting microprocessor-based TTL logic systems with Signature Analysis, at speeds up to 10 MHz. Hundreds of companies have used the 5004A to reduce the costs of troubleshooting complex digital products.

## The IC Troubleshooters—Find the Faulty Component

The IC Troubleshooters have become the "digital screwdrivers" of today's laboratories, production lines, service facilities and electronic classrooms. They are low-cost, hand-held "instruments-on-a-chip", and have proven very effective in the functional testing and troubleshooting of digital cir-

cuits. HP Application Note 163-2, *Techniques of Digital Troubleshooting*, can help put the IC Troubleshooters to work for you.

**Logic comparator:** the Model 10529A Logic Comparator utilizes comparison techniques to identify faulty nodes in a digital circuit. It tests an IC dynamically, in-circuit, by comparing output responses to those of a known-good IC which is plugged into the Comparator. Having located bad nodes, use other IC Troubleshooters to isolate the defective component causing the fault.

**Logic probes:** detect logic levels at any circuit point and display them via a light at the probe tip. A logic high is indicated by a bright light. A logic low extinguishes the light. A bad level causes a dim light. Pulse activity is shown by a 10 Hz flashing light.

**Logic clips:** are multi-pin state indicators which clip directly onto ICs. The logic state of each pin is displayed by an individual LED, enabling the user to check the device's truth table.

**Logic pulser:** pulse stimulation is essential in checking digital logic circuits. Logic pulsers inject digital pulses between gates, without requiring unsoldering of components. They automatically drive low nodes high, or high nodes low, with substantial override current.

**Current tracer:** often a bad node is identified, but the specific device causing the fault can only be isolated by cutting traces, or replacing circuit elements. The 547A Current Tracer eliminates just such "shotgun" techniques by showing exactly where digital current pulses are flowing in the circuit. Use of current tracing techniques solves the most vexing troubleshooting problems: stuck data buses, solder-bridges, stuck nodes containing many circuit elements, and the wired-AND gate.

**Stimulus-response testing:** the Pulser/Probe or Pulser/Clip combination helps the user to identify the faulty circuits causing a system malfunction. These instruments permit signal injection and readout between gates.

**Troubleshooting kits:** a variety of kits is available, combining IC Troubleshooters for stimulus-response testing. Each kit includes a carrying case, and offers a price saving over the individual instruments.

**Education:** HP's 5035AT Logic Lab and 5036A Microprocessor Lab meet the need for thorough training in digital electronics. Both models are comprehensive hardware, software and hands-on troubleshooting courses. The 5035T deals with digital electronics and logic and the 5036A with microprocessor systems. Both are ideal for either self-study or use in industrial training, and include extensive use of HP's IC Troubleshooters.

# DIGITAL CIRCUIT TESTERS

125

Logic probes

Models 545A, 10525T, &amp; 10525E



- Dynamic multi-family logic indicators
- Pulse stretching for narrow pulses
- Bad level/open circuit detection

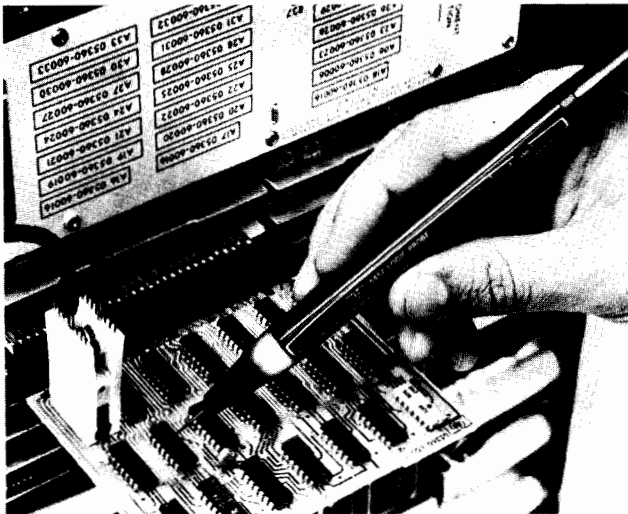

## Logic Probes

Logic Probes greatly simplify tracing logic levels and pulses in IC circuits to find nodes stuck HIGH or LOW, intermittent pulse activity, and normal pulse activity. That's because they instantly show whether the node probed is high, low, bad level, open circuited, or pulsing.

Logic probes require a simple connection to the circuit under test's power supply, and they're ready to use. The strain-relieved power cord, and line-voltage protected tip insure long life and durability. High input impedance protects against circuit loading, not just in the HIGH state, but for logic LOWs as well.

## 545A TTL/CMOS Logic Probe

The HP Model 545A Logic Probe contains all the features built into other HP probes, plus switch-selectable, multi-family operation and built-in pulse memory. Employing the same straightforward one-lamp display as our other probes, the 545A operates from 3 to 18 volts in CMOS applications or from 4.5 to 15 V dc supplies in the TTL mode while maintaining standard TTL thresholds.

The probe's independent, built-in pulse memory and LED display help you capture hard to see, intermittent pulses. Just connect the probe tip to a circuit point, reset the memory, and wait for the probe to catch those hard to find glitches. The memory captures and retains a pulse until reset.

The hand-held 545A is light, rugged, overload protected, and very fast: 80 MHz in TTL, 40 MHz in CMOS. It also employs handy power supply connectors that enable you to easily hook up to supply voltage almost anywhere in the unit under test.

## 545A Specifications

**Input current:**  $\leq 15 \mu\text{A}$  (source or sink).

**Input capacitance:**  $\leq 15 \text{ pF}$ .

### Logic thresholds

**TTL:** Logic one 2.0 + 0.4, -0.2 V dc. Logic zero 0.8 + 0.2, -0.4 V dc.

**CMOS:** 3-10 V dc supply

Logic one:  $0.7 \times V_{\text{supply}} \pm 0.5 \text{ V dc}$ .

Logic zero:  $0.3 \times V_{\text{supply}} \pm 0.5 \text{ V dc}$ .

**CMOS:**  $\geq 10-18 \text{ V dc supply}$ .

Logic ONE:  $0.7 \times V_{\text{supply}} \pm 1.0 \text{ V dc}$ .

Logic ZERO:  $0.3 \times V_{\text{supply}} \pm 1.0 \text{ V dc}$ .

**Input minimum pulse width:** 10 ns using ground lead (typically 20 ns without ground lead).

\* $\pm 5 \pm 10\%$  V dc power supply; unable to +15 V dc with slightly increased logic low threshold.

- One lamp, finger-tip display
- Pulse memory capability
- Overload protected

## Input maximum pulse repetition frequency:

TTL, 80 MHz. CMOS, 40 MHz.

**Input overload protection:**  $\pm 120 \text{ V}$  continuous (dc to 1 KHz);  $\pm 250$  for 15 seconds (dc to 1 kHz).

**Pulse memory:** indicates first entry into valid logic level; also indicates return to initial valid level from bad level for pulse  $\geq 1 \mu\text{s}$  wide.

## Power requirements

**TTL:** 4.5 to 15 V dc\*.

**CMOS:** 3 to 18 V dc.

**Maximum current:** 70 mA.

**Overload protection:**  $\pm 25 \text{ V dc}$  for one minute.

**Accessory included:** Ground Clip (HP Part No. 00545-60105).

## 10525T Logic Probe

The Model 10525T Logic Probe provides TTL/DTL trouble-shooting at low cost. Ideally suited to 5 volt logic applications, the 10525T has high input impedance, overload protection, and 50 MHz data rate capability.

## 10525T Specifications

**Input impedance:**  $> 25 \text{ k}\Omega$  in both the high and low state ( $< 1$  low power TTL load).

**Logic one threshold:** 2.0 V +0.4, -0.2 V.

**Logic zero threshold:** 0.8 V +0.2 V, -0.4 V

**Input minimum pulse width:** 10 ns.

**Input maximum pulse repetition frequency:**  $> 50 \text{ MHz}$ .

**Input overload protection:**  $\pm 70$  volts continuous,  $\pm 200$  volts intermittent, 120 V ac for 30 seconds, 240 V ac for 10 seconds.

**Power requirements:** 5 V  $\pm 10\%$  at 60 mA, internal overload protection for voltages from +7 to -15 volts. Includes power lead reversal protection.

**Accessories included:** BNC to alligator clips; ground clip.

## ECL Logic Probe

The HP Model 10525E Logic Probe extends time-proven, cost-saving logic probe troubleshooting techniques to high-speed ECL logic.

Operation of the ECL probe is analogous to that of the 10525T except the 10525E's high speed circuitry stretches single shot phenomena so that single pulses as narrow as 5 nanoseconds may be observed.

The 10525E may be powered directly from any -5.2 volt source and its high input impedance minimizes circuit loading.

## 10525E Specifications

**Input impedance:** 12 k $\Omega$  in both the high and low state.

**Logic one threshold:** -1.1 V  $\pm 0.1 \text{ V}$ .

**Logic zero threshold:** -1.5 V  $\pm 0.1 \text{ V}$ .

**Input minimum pulse width:** 5 ns.

**Input maximum pulse repetition frequency:** 50 MHz (typically 100 MHz at 50% duty cycle).

**Input overload protection:**  $\pm 70$  volts continuous, 200 volts intermittent, 120 V ac for 30 seconds.

**Power requirements:** -5.2 V  $\pm 10\%$  at 80 mA; supply overload protection for voltages from -7 to +400 volts.

**Accessories included:** BNC to alligator clips, ground clip.

## Accessories Available

	Price
00545-60104 Tip Kit for 545A Probe	\$33
10525-60012 Tip Kit for 10525T Probe, 10526T Pulser	\$47
10525-60015 Pulse Memory for 10525T Probe	\$100

## Ordering Information

545A Logic Probe	\$125
10525T Logic Probe	\$90
10525E Logic Probe	\$200



# DIGITAL CIRCUIT TESTERS

## Logic pulsers

Models 546A & 10526T

- In-circuit stimulation without unsoldering
- Greatly simplifies digital troubleshooting
- High current, low duty cycle output

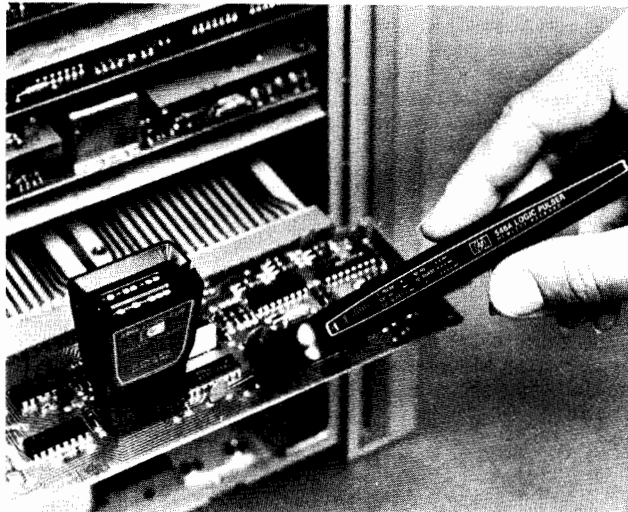

### Logic Pulser

The Logic Pulser solves the problem of how to pulse ICs in digital circuits for designers and troubleshooters. Merely touch the Pulser to the circuit under test, press the pulse button and all circuits connected to the node (outputs as well as inputs) are briefly driven to their opposite state. No unsoldering of IC outputs is required. Pulse injection is automatic so the user need not concern himself whether the test node is in the high or low state; high nodes are pulsed low and low nodes, high, each time the button is pressed.

The Pulser is essentially a pulse generator with high output current capability packed in a convenient, easy-to-use probe. Ability to source or sink up to 0.65 Amperes insures sufficient current to override IC outputs in either the high or low state. Output pulse width is limited so the amount of energy delivered to the device under test is never excessive. Additionally, the Pulser output is three-state so that the circuit under test is unaffected until the Pulser is activated.

Combining in-circuit pulse injection with the unique detection capabilities of Logic Probes, Logic Clips, and the 547A Current Tracer helps to focus new power on solving the problems of fault isolation. Pulser/Probe, Pulser/Clip, and Pulser/Tracer combinations enable the digital designer or troubleshooter to hold complete stimulus-response capability at his finger tips.

Gate operation is tested using the Pulser to drive the input while the probe monitors transmitted pulses at the output. When pulses are not received, place the Pulser and Probe on the same pin to detect if the failure is due to a short to ground or  $V_{cc}$ .

Testing sequential circuits is the domain of the Logic Clip and Logic Pulser. The Clip simultaneously monitors all output states while the Pulser applies clock and reset pulses to the device. Improper operation, if present is immediately obvious since the IC will not go through its prescribed truth table.

Finally, when Pulsers are used with the 547A Current Tracer, the Pulser acts as a current pulse source to find the exact location of faulty gates on a node, solder bridges, or stuck devices on bus structures.

### 546A Logic Pulser

Automatic polarity pulse output, pulse width, and amplitude make for easy multi-family operation when you use the 546A Logic Pulser. But, the real surprise comes when you code in one of its six ROM-programmable output patterns (single pulses; pulse streams of either 1, 10, or 100 Hz; or bursts of 10 or 100 pulses). This feature allows you to continually pulse a circuit when necessary, or it also provides an easy means to put an exact number of pulses into counters and shift registers. Used with our multi-family IC Troubleshooters, the 546A acts as both a voltage and current source in digital troubleshooting applications.

- Automatic pulse width
- Automatic pulse amplitude
- Automatic pulse polarity

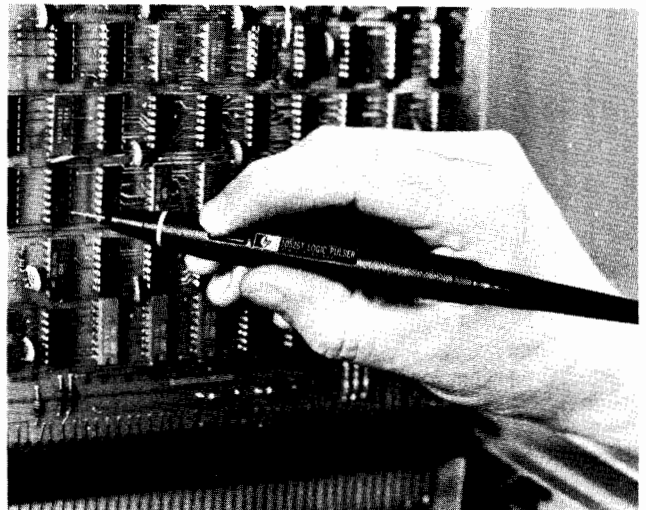

### 546A Specifications

#### Output

Family	Output Current	Pulse Width	Typical Output Voltage	
			HIGH	LOW
TTL/DTL	≤650 mA	≥0.5 μs	≥3 V dc	≤0.8 V dc
CMOS	≤100 mA	≥5.0 μs	V(supply) - 1 V dc	≤0.5 V dc

**Power supply requirements:** TTL; 4.5 to 5.5 V dc at 35 mA, CMOS; 3 to 18 V dc at 35 mA, protected to 25 V dc.

### 10526T Logic pulser

The economical 10526T provides dependable single-shot operation in TTL/DTL applications. Just press the pulse button, and the pulser delivers a single powerful pulse of the correct pulse width, polarity and amplitude.

### 10526T Specifications

**Output high pulse voltage:** >2 V at 0.65 A (1 A typical at  $V_{ps} = 5V, 25^{\circ}C$ ).

**Output low pulse voltage:** <0.8 V at 0.65 A (1 A typical at  $V_{ps} = 5V, 25^{\circ}C$ ).

**Output impedance, active state:** <2 ohms.

**Output impedance, off state:** >1 Megohm.

**Pulse width:** 0.3 μs nominal.

**Input overload protection:** ±50 volts continuous.

**Power supply input protection:** ±7 volts (includes power lead reversal protection).

**Power requirements:** 5V ±10% at 25 mA.

**Accessories included:** BNC to alligator clips, ground clip.

#### Accessories Available

00545-60104: Tip Kit for 546A Pulser

10525-60012: Tip Kit for 10526T Pulser

10526-60002: Multi-Pin Stimulus Kit

#### Price

\$33

\$47

\$30

#### Ordering Information

546A Logic Pulser

\$195

10526T Logic Pulser

\$115



- Troubleshoots three-state busses
- Solves the "Wired-AND" problem
- Displays in-circuit digital current flow

- Pinpoints supply-to-ground shorts
- All family: 1 mA to 1A
- Finger-tip indicator

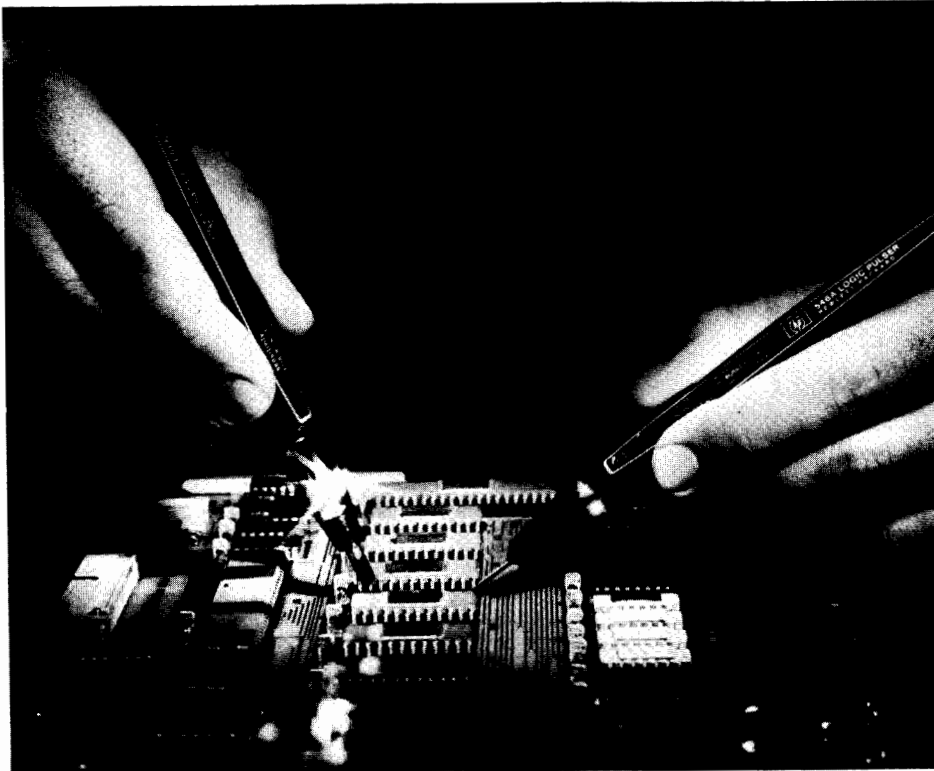

The 547A Current Tracer precisely locates low-impedance faults in digital circuits by locating current sources or sinks. On a shorted node, all points are stuck in one state by the short. Many similar troubleshooting problems such as shorted wired-AND/OR configurations, result in wasted time and excessive costs: several ICs have to be removed before finding the bad one, and in the process the circuit board may be damaged. Now, the 547A exactly pinpoints the one faulty point on a node, even on multilayer boards. In addition, the Tracer locates hairline solder bridges that manage to pass unnoticed until a circuit is operated for the first time.

Constructed as a hand-held probe, the Tracer is a sophisticated instrument designed to troubleshoot circuits carrying fast rise-time current pulses. The Tracer senses the magnetic field generated by these signals in the circuit (or, provided by a Logic Pulser), and displays transitions, single pulses, and pulse trains using a simple one-light indicator. Because it is not voltage sensitive, the Tracer operates on all logic families having current pulses exceeding 1 mA, and repetition rates less than 10 MHz, including CMOS, where even lightly loaded outputs can have up to 2 to 3 mA of instantaneous charging current.

Prior to introduction of the 547A, logic state indicators were limited to displaying voltage information. A node was HIGH, LOW, open, or pulsing. When a node is stuck, however, it may be trying to change state but isn't able to cross threshold levels. Use of the Current Tracer adds the final bit of information necessary to pinpoint just such logic faults on bad nodes. For example, on a bad node the Tracer can verify that the driver is functioning and also show where the problem is by

tracing current flow to the source or sink causing the node to be stuck.

To use the Tracer, simply align the dot on its tip at a reference point, usually the output of a node driver. Set the sensitivity control to indicate the presence of AC current activity. Then, trace the circuit to see where current is flowing. As you probe from point to point or follow traces, the lamp will change intensity, and when you find the fault the Tracer will indicate the same brightness found at the reference point.

## 547A Specifications

### Input

**Sensitivity:** 1 mA to 1 A.

**Frequency response:** light indicates single-step current transitions; single pulses  $\geq 50$  ns in width; pulse trains to 10 MHz (typically 20 MHz for current pulses  $\geq 10$  mA).

**Risetime:** light indicates current transitions with risetime  $\leq 200$  ns at 1 mA.

### Power supply requirements

**Voltage:** 4.5 to 18 V dc.

**Input current:**  $\leq 75$  mA.

**Maximum ripple:**  $\pm 500$  mV above 5 V dc.

**Overvoltage protection:**  $\pm 25$  Vdc for one minute.

547A Digital Current Tracer

\$375



# DIGITAL CIRCUIT TESTERS

## Logic clips

Models 548A & 10528A

- Displays IC logic states at a glance
- Self-powered, self-contained



- Sees up to 16 pins at a glance
- Easily verifies device truth table

### Logic Clips

The Logic Clip is an extremely handy service and design tool which clips onto dual-in-line-package (DIP) ICs, instantly displaying the states of up to 16 pins. Each of the clip's 16 LEDs independently follows level changes at its associated pin. Lit diodes are logic High, extinguished diodes are Low.

The Logic Clip's real value is in its ease of use. It has no controls to set, needs no power connections, and requires practically no explanation as to how it is used. The clip has its own gating logic for locating ground and  $V_{cc}$  pins and its buffered inputs reduce circuit loading.

The Logic Clip is much easier to use than either an oscilloscope or a voltmeter when you are interested in whether a circuit is in the high or low state, rather than its actual voltage. The Clip, in effect, is 16 binary voltmeters, and the user does not have to shift his eyes away from his circuit to make the readings.

The intuitive relationship of the input to the output—lighted diodes corresponding to high logic states—greatly simplifies the troubleshooting procedure. The user is free to concentrate his attention on his circuits, rather than on measurement techniques. Also, timing relationships become especially apparent when clock rates can be slowed to about 1 pulse per second.

When used in conjunction with the Logic Pulser, the Logic Clip offers unparalleled analysis capability for troubleshooting sequential circuits. The Clip attaches to the IC to be tested; the Pulser is then used to inject pulses between gates allowing it to supply signals to the IC under test absolutely independent of gates connected to the IC. All outputs may then be observed simultaneously on the Logic Clip. Deviations from expected results are immediately apparent as the Pulser steps the IC through its truth table.

### 548 Multi-family Logic Clip

Fully automatic, protected to 30 V dc, and employing bright individual LEDs in its display, the 548A brings multi-family operation to

the HP line of IC Troubleshooters. The Clip can be externally powered, if desired, using a simple power connector.

### 548A Specifications

**Input threshold:** ( $\geq 0.4 \times$  Supply Voltage) = Logic High.

**Input impedance:** 1 CMOS load per input.

**Input protection:** 30 V dc for 1 minute.

**Supply voltage:** 4-18 V dc across any two pins.

**Auxiliary supply input:** 4.5 to 18 V dc applied via connector. Supply must be  $\geq 1.5$  V dc more positive than any pin of IC under test.

**Supply current:** <50 mA.

### 10528A Logic Clip

Protection to +7 V dc, automatic operation, and low circuit loading in TTL/DTL applications helps make the 10528A a valuable replacement for more expensive test equipment like scopes and voltmeters. The clip is, in effect, like 16 binary voltmeters, allowing the user to look at the circuit rather than having to shift his attention toward test equipment.

### 10528A Specifications

**Input threshold:**  $1.4 \pm 0.6$  V; TTL or DTL compatible (except gates with expander inputs).

**Input impedance:** one TTL load ( $-1.2$  mA typical) per input.

**Input protection:** voltages  $< -1$  V or  $> 7$  V must be current limited to 10 mA.

**Supply voltage:**  $5$  V  $\pm 10\%$  across any two or more inputs.

**Maximum current consumption:** 120 mA.

### Ordering Information

548A Logic Clip  
10528A Logic Clip

**Price**  
\$165  
\$130

- Finds faulty nodes
- Dramatically cuts troubleshooting time
- Performs in-circuit IC testing with no unsoldering

- Easy-to-use comparison technique
- Versatile "socket board" included for seldom-tested IC's

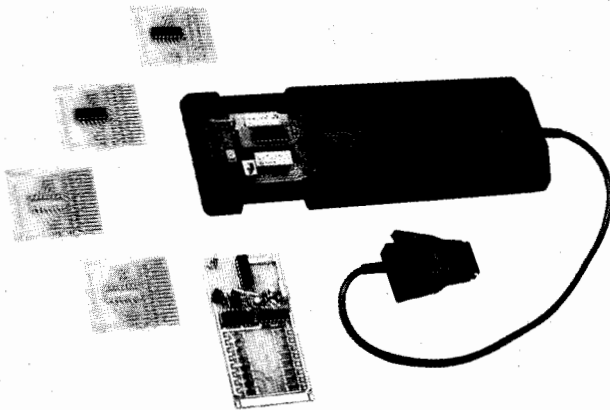

The Model 10529A Logic Comparator checks the operation of dozens of ICs in less than a minute per IC. The Comparator clips onto powered TTL or DTL ICs and detects functional failures by comparing the in-circuit test IC with a known good reference IC inserted in the Comparator. Any logic state difference between the test IC and reference IC is identified to the specific pin(s) on 14- or 16-pin dual in-line packages on the Comparator's display. A lighted LED corresponds to a logic difference. The Logic Comparator can save considerable time in locating a faulty IC. There are no controls to be set and no power connections.

The procedure is very simple. First the IC to be tested is identified. An IC of the same type is placed in the Comparator's IC socket, or a reference board with an IC of the same type is inserted in the Comparator. The Comparator is clipped onto the test IC, and an immediate indication is given if the test IC operates differently from the reference IC. Even very brief dynamic errors are detected, stretched, and displayed.

The 10529A operates by connecting the test and reference IC inputs in parallel; thus the reference IC is exercised by input signals identical to those of the test IC. The outputs of the two IC's are compared; any differences in outputs are detected, and LEDs corresponding to the particular pin are lit on the Comparator's display. Intermittent errors as short as 300 nanoseconds (using the socket board) are detected, and the error indication on the Comparator's display is stretched for a visual indication. A failure on an input pin, such as an internal short, will appear as a failure on the IC driving the failed IC; thus a failure indication actually pinpoints a malfunctioning node.

Programming for the specific IC is easily accomplished by two different methods. First, the socket board included with the Comparator is inserted in the Comparator drawer. Outputs of the particular IC to be tested are selected via 16 miniature switches which tell the Comparator which pins of the reference IC are inputs and which are outputs. The reference IC is then inserted into the socket and locked into place. An IC may be set up in seconds. Alternatively, if specific IC types are to be tested repeatedly, the reference IC may be soldered into one of the 10 reference boards provided with the Comparator. The reference board is programmed by opening the connections between the tests and reference ICs outputs and solder-bridging  $V_{cc}$  and ground.

When troubleshooting you want to know that the tester is operating properly. A test board is supplied with the Logic Comparator for this purpose. When inserted in the comparator the test board exercises all of the circuitry, test leads, and display elements to verify proper operation.

The Logic Comparator's ease of use and small size make it an invaluable addition to the troubleshooter's test gear either in the field or in the factory. With TTL and DTL failures that are functionally related, the Comparator can find bad nodes many times faster than conventional signal tracing techniques. At its low price, the Logic Comparator can pay for itself in days.

**10541A:** twenty additional blank reference boards; identical to the 10 boards provided with the Logic Comparator, they allow additional ICs to be programmed for Comparator testing.

**10541B:** twenty preprogrammed reference boards; 20 of the most common TTL ICs already programmed and ready for use with the Logic Comparator. The 10541B includes the following ICs: 7400 Quad 2-input NAND; 7402 Quad 2-input NOR; 7404 Hex inverter; 7408 Quad 2-input AND; 7410 Triple 3-input NAND; 7420 Dual 4-input NAND; 7430 8-input NAND; 7440 Dual 4-input NAND buffer; 7451 Dual 2-wide, 2-input AND-OR-INVERT; 7454 4-wide, 2-input AND-OR-INVERT; 7473 Dual J-K master-slave flip-flop; 7474 Dual D flip-flop; 7475 Quad bistable D latch; 7476 Dual J-K flip-flop with preset and clear; 7483 4-bit binary full adder; 7486 Quad 2-input exclusive-OR; 7490 Decade counter; 7493 4-bit binary counter; 74121 Monostable multivibrator; 9601 Monostable multivibrator, retriggerable.

## 10529A Specifications

**Input threshold:** 1.4 V nominal (1.8 V nominal with socket board), TTL or DTL compatible.

**Test IC loading:** outputs driving Test IC inputs are loaded by 5 low-power TTL loads plus input of Reference IC. Test IC outputs are loaded by 2 low-power TTL loads.

**Input protection:** voltages  $< -1$  V or  $> 7$  V must be current limited to 10 mA.

**Supply voltage:** 5 V  $\pm 10\%$ , at 300 mA.

**Supply protection:** supply voltage must be limited to 7 V.

**Maximum current consumption:** 300 mA.

### Sensitivity

**Error sensitivity:** 200 ns with reference board or 300 ns with socket board. Errors greater than this are detected and stretched to at least 0.1 seconds.

**Delayed variation immunity:** 50 ns. Errors shorter than this value are considered spurious and ignored.

**Frequency range:** maximum operational frequency varies with duty cycle. An error existing for a full clock cycle will be detected if the cycle rate is less than 3 MHz.

**Accessories included:** 1 test board; 10 blank reference boards; 1 programmable socket board; 1 carrying case.

### Accessories Available

Accessories Available	Price
<b>10541A:</b> Twenty Blank Reference Boards for the Logic Comparator	\$95
<b>10541B:</b> Twenty Pre-programmed Boards for the Logic Comparator	\$195

**10529A Logic Comparator**

**\$525**

# DIGITAL CIRCUIT TESTERS

## Logic Troubleshooting Kits

Models 5011T, 5015T, 5021A, 5022A, 5023A & 5024A

- Complete multi-family kits
- Stimulus-Response capability
- In-circuit fault finding

- In-circuit analysis
- Dynamic and static testing
- Multi-pin testing

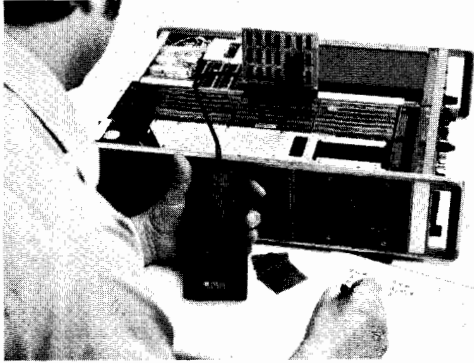

10529A

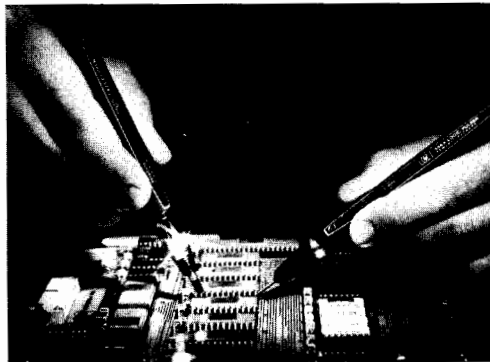

547A/546A

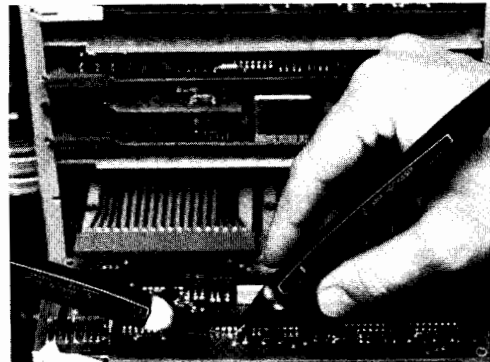

545A/546A

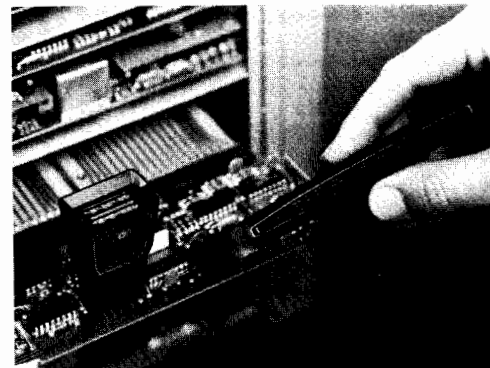

548A/546A

Used individually, each of HP's IC Troubleshooters provide their own unique and important troubleshooting function. Together they become invaluable stimulus-response testing partners that help pinpoint faults and ensure fast non-destructive repair of digital circuits.

To help you take advantage of the usefulness of the IC Troubleshooters, HP has packaged them into kits which offer both ordering convenience, and cost savings. Also, handy applications information is available, such as AN-163-1, "Techniques of Digital Troubleshooting", to help users derive maximum benefit from these instruments.

The table below shows a series of typical node and gate faults and the combination of tools used to troubleshoot the circuit. As with all sophisticated measuring instruments, operator skill and circuit knowledge are key factors once the various clues, or "bits" of information are obtained using the IC Troubleshooters.

To accomplish troubleshooting at the node and gate level, both stimulus (Pulser) and response (Probe, Tracer, Clip and Comparator) instruments are needed. Moreover, instruments with both voltage and current troubleshooting capability help isolate electrical faults where the precise physical location is hard to identify.

The 547A Current Tracer, the latest and most sophisticated of these troubleshooters, lets you "see" current flow on nodes and buses that otherwise appear stuck at one voltage level. Used with the 546A Pulser, stimulus-response testing is now also possible in the current domain.

FAULT	STIMULUS	RESPONSE	TEST METHOD
Shorted Node <sup>1</sup>	Pulser <sup>2</sup>	Current Tracer	<ul style="list-style-type: none"> <li>● Pulse shorted node</li> <li>● Follow current pulses to short</li> </ul>
Stuck Data Bus	Pulser <sup>2</sup>	Current Tracer	<ul style="list-style-type: none"> <li>● Pulse bus line(s)</li> <li>● Trace current to device holding the bus in a stuck condition</li> </ul>
Signal Line Short to Vcc or Ground	Pulser	Probe, Current Tracer	<ul style="list-style-type: none"> <li>● Pulse and probe test point simultaneously</li> <li>● Short to Vcc or Ground cannot be overridden by pulsing</li> <li>● Pulse test point, and follow current pulses to the short</li> </ul>
Supply to Ground Short	Pulser	Current Tracer	<ul style="list-style-type: none"> <li>● Remove power from circuit under test</li> <li>● Disconnect electrolytic bypass capacitors</li> <li>● Pulse across Vcc and ground using accessory connectors provided</li> <li>● Trace current to fault</li> </ul>
Internally Open IC	Pulser <sup>2</sup>	Probe	<ul style="list-style-type: none"> <li>● Pulse device input(s)</li> <li>● Probe output for response</li> </ul>
Solder Bridge	Pulser <sup>2</sup>	Current Tracer	<ul style="list-style-type: none"> <li>● Pulse suspect line(s)</li> <li>● Trace current pulses to the fault</li> <li>● Light goes out when solder bridge passed</li> </ul>
Sequential Logic Fault in Counter or Shift Register	Pulser	Clip	<ul style="list-style-type: none"> <li>● Circuit clock de-activated</li> <li>● Use Pulser to enter desired number of pulses</li> <li>● Place Clip on counter or shift register and verify device truth table</li> </ul>

1. A node is an interconnection between two or more IC's.

2. Use the Pulser to provide stimulus or use normal circuit signals, whichever is most convenient.



5011T

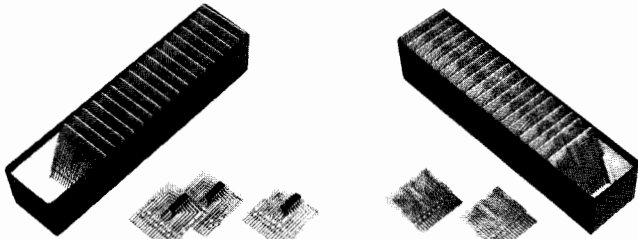

10541B

10541A

**Ordering Information**

**5021A TTL/CMOS Troubleshooting Kit**

Includes:

- 545A Logic Probe
- 546A Logic Pulser
- 548A Logic Clip

Size: 64 H x 146 W x 298 mm D (2.5" x 5.75" x 11.75").  
Weight: net, 0.6 kg (13 oz). Shipping, 0.72 kg (16 oz).

**Price**  
\$485

**5022A TTL/CMOS Troubleshooting Kit**

Includes:

- 545A Logic Probe
- 546A Logic Pulser
- 547A Current Tracer
- 548A Logic Clip

Size: 64 H x 146 W x 298 mm D (2.5" x 5.75" x 11.75").  
Weight: net, 0.43 kg (15 oz). Shipping 0.51 kg (1 lb 2 oz).

\$830

**5023A TTL/CMOS Troubleshooting Kit**

Includes:

- 545A Logic Probe
- 546A Logic Pulser
- 547A Current Tracer
- 548A Logic Clip
- 10529A Logic Comparator

Size: 225 H x 200 W x 337 mm D (8.875" x 7.875" x 13.25").  
Weight: net, 1.64 kg (3 lb 10 oz). Shipping, 2.12 kg (4 lb 12 oz).

\$1330

**5024A TTL/CMOS Troubleshooting Kit**

Includes:

- 545A Logic Probe
- 546A Logic Pulser
- 547A Current Tracer

Size: 64 H x 146 W x 298 mm D (2.5" x 5.75" x 11.75").  
Weight: net, 0.54 kg (12 oz). Shipping, 0.43 kg (15 oz).

\$670

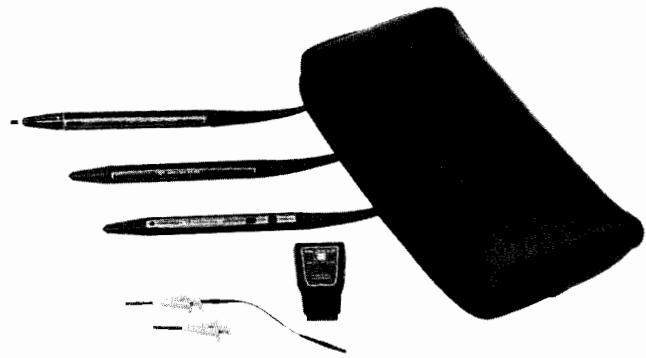

5022A

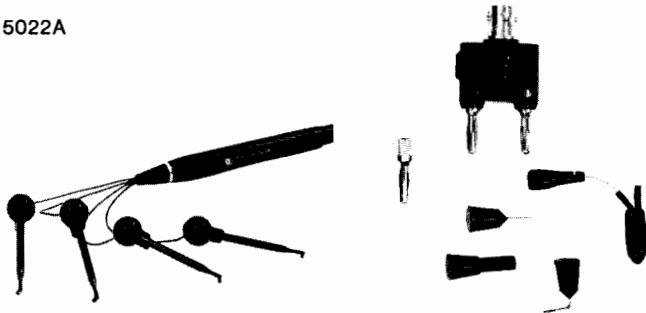

10526-60002

10525-60012

**IC Troubleshooter Kits Selection Guide**

	545A TTL/CMOS Probe	546A TTL/CMOS Pulser	547A TTL/CMOS Current Tracer	548A TTL/CMOS Clip	10525T TTL Probe	10526T TTL Pulser	10528A TTL Clip	10529A TTL Comparator
5011T Kit					X	X	X	X
5015T Kit					X	X	X	
5021A Kit	X	X		X				
5022A Kit	X	X	X	X				
5023A Kit	X	X	X	X				X
5024A Kit	X	X	X					

**5011T TTL Troubleshooting Kit**

\$790

Includes:

- 10525T Logic Probe
  - 10526T Logic Pulser
  - 10528A Logic Clip
  - 10529A Logic Comparator
- Size: 82.6 H x 203 W x 311.2 mm D (3.25" x 8" x 12.25").  
Weight: net, 1.36 kg (3 lb). Shipping, 2.27 kg (5 lb).

**5015T TTL Troubleshooting Kit**

\$315

Includes:

- Model 10525T Logic Probe
  - Model 10526T Logic Pulser
  - Model 10528A Logic Clip
- Size: 64 H x 133 W x 286 mm D (2.5" x 5.25" x 11.25").  
Weight: net, 0.63 kg (1 lb 6 oz). Shipping, 0.74 kg (1 lb 10 oz).

**Accessories Available**

Price

- 00545-60104:** Tip Kit for 545A Probe, and 546A Pulser \$33
- 10525-60012:** Tip Kit for 10525T Probe, 10526T Pulser \$47
- 10525-60015:** Pulse Memory for 10525T Probe \$100
- 10526-60002:** Multi-pin Stimulus Kit for Logic Pulsers \$30
- 10529-60006:** External Reference Kit for 10529A Comparator \$200
- 10541A:** Twenty blank reference boards for 10529A Comparator \$95
- 10541B:** Twenty pre-programmed reference boards for 10529A Comparator \$195

# DIGITAL CIRCUIT TESTERS

## Signature Analyzer, a $\mu$ P service solution

### Model 5004A

- Field troubleshoot microprocessor-based products to the component level
- Improve the confidence level of field service
- Reduce warranty and service support costs
- Reduce the end-user's cost of ownership



5004A

### The Product

The HP 5004A Signature Analyzer is a tool for field troubleshooting of complex logic circuits. It recognizes and displays unique digital signatures associated with data nodes in a circuit under test. By comparing these actual signatures to the correct ones, a service technician can back-trace to a faulty node. The technique is especially useful in checking operation of microprocessor-based products and high-speed state machines, where data streams are long and complex and where there are no conventional means to troubleshoot to the component level.

By designing or retrofitting the digital portion of a product with the Signature Analyzer in mind, a manufacturer can provide field troubleshooting procedures for component level repair, without having to invest in a board exchange program, or in expensive special-purpose equipment.

Signature Analysis is also attractive for production line troubleshooting. The 5004A can detect speed-related failures in assembled systems, which may not have been caught by subassembly testers.

### The Technique

HP's patented Signature Analysis technique enables the 5004A to display a compressed, four-digit "fingerprint" of the data stream present at a node. This signature is generated from a linear feedback shift register in the 5004A, and is unique for a specific good node. Any fault associated with a device on that node will force a change in the data stream and, therefore, result in an erroneous signature.

The 5004A utilizes a 16-bit shift register, with maximal-length feedback taps. The data stream being measured is summed, modulo

2, with the register feedback. The resulting probability of detecting an erroneous data stream is 99.998%. More importantly, the probability of detecting a single-bit error in a data stream is 100%. Signature Analysis detects time-related faults, such as mid-cycle displaced bits, which are not detectable by traditional transition and ones counting techniques.

The 5004A does not require programming, since the test stimulus is stored in the product under test. Gating and clock signals are also derived from the product under test.

### The Application

For a product which has been designed and documented for Signature Analysis, troubleshooting typically consists of:

- Switching the product to be tested into a test mode of operation.
- Attaching the 5004A's START, STOP, CLOCK, and GND leads to the test points of the product to be tested (no board or component removal required).
- Probing circuit nodes and observing the signatures displayed on the 5004A.
- Comparing them to correct signatures preprinted on a schematic or troubleshooting procedure in the service manual of the product under test.
- Isolating a faulty node by observing an erroneous signature.
- Tracing signatures back through gates and memory elements, until an element with correct inputs and faulty outputs is isolated.
- Replacing only the faulty component.

These steps can be performed quickly on-site, at a field service facility, or on a production line.



## 5004A Specifications

### Display

**Signature:** four-digit hexadecimal.

**Characters:** 0,1,2,3,4,5,6,7,8,9,A,C,F,H,P,U.

### GATE, UNSTABLE SIGNATURE indicators:

**Panel lights**

**Stretching:** 100 ms.

**Probe-tip indicator:** light indicates high, low, bad-level and pulsing states.

**Minimum pulse width:** 10 ns.

**Stretching:** 50 ms.

**Probability of classifying correct data stream as correct:** 100%.

**Probability of classifying faulty data stream as faulty:** 99.998%.

**Minimum gate length:** 1 clock cycle.

**Minimum timing between gates (from last STOP to next START):** 1 clock cycle.

### Data Probe

**Input impedance:** 50 k $\Omega$  to 1.4 V, nominal. Shunted by 7 pF, nominal.

### Threshold

**Logic one:** 2.0 V +0.1 -0.4

**Logic zero:** 0.8V +0.4 -0

**Setup Time:** 15 ns, with 0.2 V over-drive. (Data to be valid at least 15 ns before selected clock edge).

**Hold Time:** 0 ns (Data to be held until occurrence of selected clock edge).

## Designing for Signature Analysis

Use of the 5004A Signature Analyzer requires that some test features be designed or retrofitted into the product to be tested.

First, a short repetitive test stimulus should be stored in the product's ROM. The routine simulates circuit nodes, generating signatures detectable by the 5004A. It needs only to force a state change on each node, and does not have to create meaningful data. This stimulus can be merged with the product's self-check program, and enabled by a switch or jumper.

Second, data feedback paths should be opened, during part of the troubleshooting procedure, by switches, connectors, or disabling software. This prevents a fault from feeding back around, perturbing all data nodes.

Third, gating signals (START, STOP, CLOCK) should be brought out to test points for Signature Analyzer hookup.

HP Application Note 222, A Designer's Guide to Signature Analysis, provides examples and advice on designing products to be serviced by the 5004A.

## Operational Features

The active DATA PROBE is also a TTL Logic Probe, similar to the HP 545A, indicating high, low, bad-level, and pulsing states, for additional troubleshooting information.

The gating inputs (START, STOP, and CLOCK) are brought out to an active pod, for fast response and low circuit loading.

Front-panel controls allow selection of either rising or falling edges of start, stop, and clock waveforms.

The GATE light indicates proper start/stop gating operation.

The UNSTABLE SIGNATURE light indicates a difference between successive signatures, alerting the user to intermittent faults, which may not be observed from the display.

The HOLD/RESET controls allow observation of signatures associated with one-shot operations, such as power-on routines.

The front-panel SELF-TEST feature allows go/no-go checkout of the entire Signature Analyzer, including probe, pod, and cables, increasing confidence in on-site service.

MEASUREMENT GATING EXAMPLE, POSITIVE-EDGE START, STOP, AND CLOCK

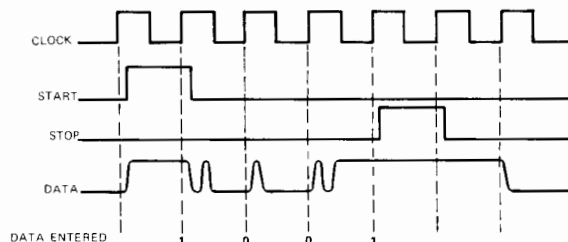

## Gating Input Lines

### START, STOP, CLOCK inputs

**Input impedance:** 50  $\Omega$  to 1.4 V, nominal. Shunted by 7 pF, nominal.

**Threshold:** 1.4 V  $\pm$  0.6 (0.1 V hysteresis, typical).

### START, STOP Inputs

**Setup time:** 25 ns. (START, STOP to be valid at least 25 ns before selected clock edge).

### CLOCK Input

**Maximum clock frequency:** 10 MHz

**Minimum clock time in high or low state:** 50 ns.

**Overload protection (all inputs):**  $\pm$  150 V continuous.  $\pm$  250 V intermittent. 250 V ac for 1 minute.

### Operating Environment

**Temperature:** 0°C–55°C.

**Humidity:** 95% RH at 40°C.

**Altitude:** 4,600 m.

**Power Requirements:** 25 VA max. See Options below for power line voltage and frequency.

**Weight:** net, 2.5 kg (5.5 lb.) Shipping 5 kg (11 lb.)

**Size:** 90 H x 215 W x 300 mm D (3.5" x 8.5" x 12"). Dimensions exclude bale, probe and pouch.

## 5004A Signature Analyzer

Opt 910. Extra manual

Orders must specify one of these power line options.

**Opt 100:** 100 V ac line, +5%, -10%, 48–440 Hz

**Opt 120:** 120 V ac line, +5%, -10%, 48–440 Hz

**Opt 220:** 220 V ac line, +5%, -10%, 48–66 Hz

**Opt 240:** 240 V ac line, +5%, -10%, 48–66 Hz

**\$1100**

add \$11.50



# DIGITAL CIRCUIT TESTERS

Microprocessor Exerciser, for S.A. Retrofit  
Model 5001A

- External Stimulus for Troubleshooting with Signature Analysis
- 51 Preprogrammed test stimuli

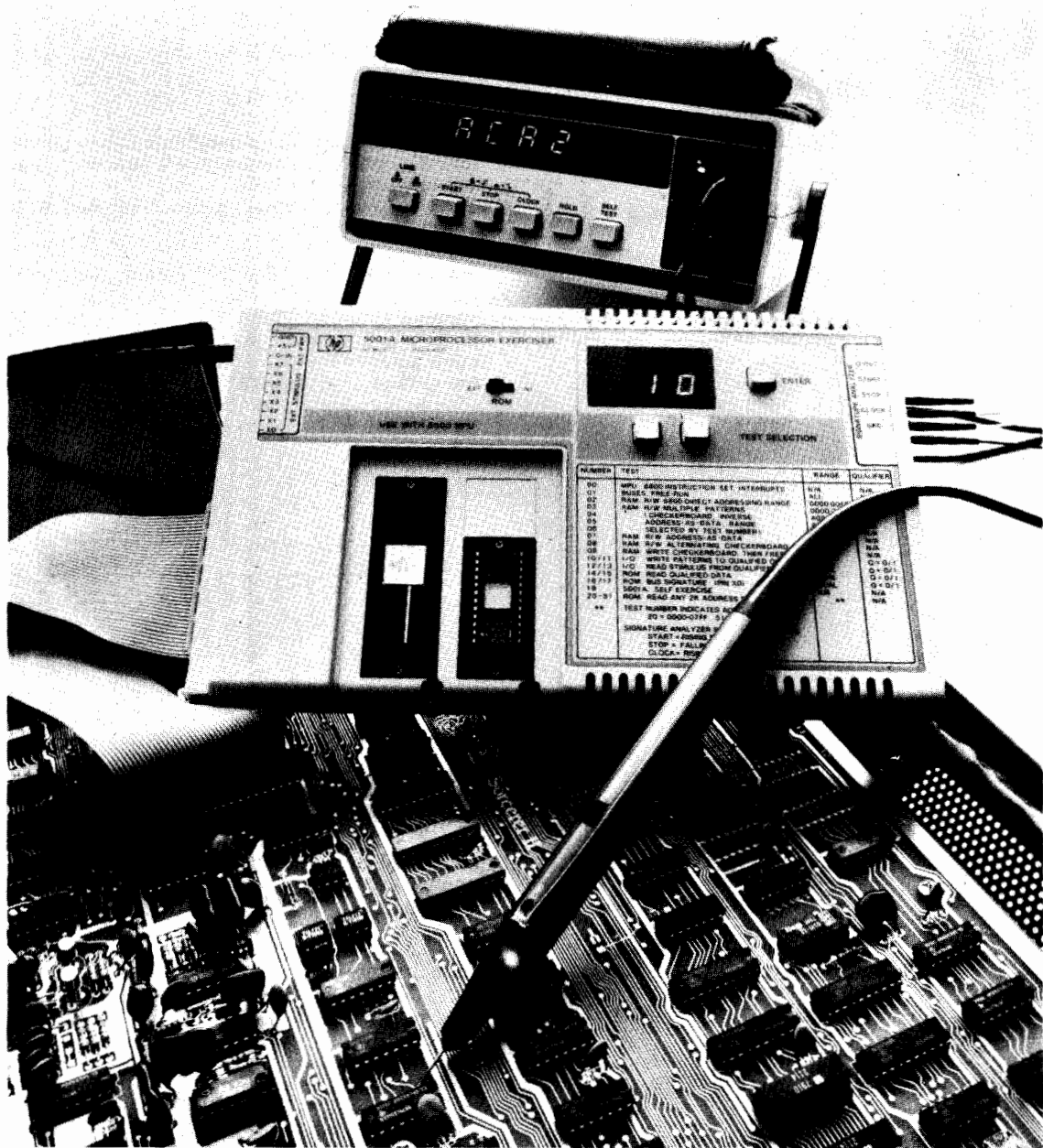

5001A with 5004A

## Description

The 5001 Microprocessor Exerciser series provides a source of external test stimulus for microprocessor-based products. The 5001A enables 6800-based products to be retrofitted for Signature Analysis, in both the free-run and stimulus modes. To use it, the operator removes the 6800 from its socket in the product under test, places it into the 5001A, and plugs the 5001A into the vacant socket. The 5001A then runs test stimulus programs from its own ROM after taking control of the buses of the product under test. The operator uses a Signature Analyzer to take signatures at designated circuit points for each selected stimulus.

## Preprogrammed Test Stimuli

Front panel switches on the 5001A allow selection of any of 51 preprogrammed tests which are stored in its ROM. These test stimuli include:

- A test of the 6800 instruction set and interrupts.
- A free-run test for address and data bus integrity.
- ROM read tests.
- RAM read-write tests.
- Output port pattern tests.
- Input port pattern tests.

Upon selection of a preprogrammed test stimulus, the 5001A uses the 6800 to execute the instructions on the product under test, repetitively. These tests have been designed to cover most of the stimuli required to test a microprocessor-based product with Signature Analysis.

NUMBER	TEST	RANGE	QUALIFIER
00	MPU 6800 INSTRUCTION SET, INTERRUPTS	N/A	N/A
01	BUSES - FREE-RUN	ALL	N/A
02	RAM R/W 6800 DIRECT ADDRESSING RANGE	0000-00FF	N/A
03	RAM R/W MULTIPLE PATTERNS	0000-3FFF	N/A
04	(CHECKERBOARD INVERSE ADDRESS-AS-DATA RANGE	4000-7FFF	N/A
05	SELECTED BY TEST NUMBER)	8000-BFFF	N/A
06	RAM R/W ADDRESS-AS-DATA	C000-FFFF	N/A
07	RAM R/W ALTERNATING CHECKERBOARD	ALL	N/A
08	RAM WRITE CHECKERBOARD THEN FREE-RUN	ALL	N/A
09	I/O WRITE PATTERNS TO QUALIFIED OUTPUTS	QUAL	Q=0/1
10/11	I/O READ STIMULUS FROM QUALIFIED INPUTS	QUAL	Q=0/1
12/13	ROM READ QUALIFIED DATA	DUAL	Q=0/1
14/15	ROM BUS SIGNATURE (PIN X0)	QUAL	Q=0/1
16/17	5001A SELF EXERCISE	N/A	N/A
18, 19	ROM READ ANY 2K ADDRESS RANGE	**	N/A
20-51	TEST NUMBER INDICATES ADDRESS RANGE 20=0000 07FF 51=F800 FFFF		
	SIGNATURE ANALYZER SETUP FOR ALL TESTS START = RISING EDGE / STOP = FALLING EDGE \ CLOCK = RISING EDGE /		

Front panel menu for the 5001A outlines the 51 preprogrammed test stimuli available for Signature Analysis testing on 6800-based systems.

### Custom Test Stimuli

For those portions of the product under test which require stimulus beyond that provided by the preprogrammed routines, the 5001A can be used to run custom programs. It has a socket which allows instructions to be executed from a custom programmed ROM. The user writes stimulus programs, generates a PROM containing 6800 code, and places it into the 5001A to execute up to 2K bytes of external stimulus. Typical custom tests would be:

- Configuration and stimulus for PIA's.
- Pattern stimuli for sequential logic which is outboard of output ports.
- Go/no go functional tests.

A unique address overlay scheme makes both internal and external ROM programs independent of the memory map of the product under test.

### Single-Signature Tests

Some preprogrammed stimuli are designed to provide pass/fail information on a particular part by means of a single signature. For example, RAM test number 02 requires taking only one signature to verify the RAM being tested. It does not require taking signatures on any RAM pins. Custom programs can also take advantage of this feature.

### Qualified Stimuli

Some stimuli utilize a "qualify" line to recognize the address of a particular part to be tested. For example, the output port tests call for the qualify line to be connected to the chip-enable pin of the port to be tested. The microprocessor searches its address field until that chip is enabled (and the qualify line asserted) then writes all possible patterns to that port, repetitively.

### Bus Signatures

The 5001A can read data from the product under test, as well as write patterns into it. Some stimuli utilize this feature to read bus data, serialize it, and output a single bit stream. The signature of this signal is a "bus signature", which saves taking eight separate data bus signatures. For example, one of the ROM tests causes the 6800 to read all data from a particular ROM chip, convert it to a serial bit stream, and present that signal to one of the 5001A output pins. The signature on that pin indicates whether the ROM chip is good or bad.

### Input Port Stimuli

The 5001A has eight output lines under microprocessor control. These can be used to stimulate input ports on the product under test. For example, the input port tests cause the 6800 to read from a qualified port, while externally stimulating that port with all possible 8-bit patterns. Data bus signatures then verify operation or failure of the port.

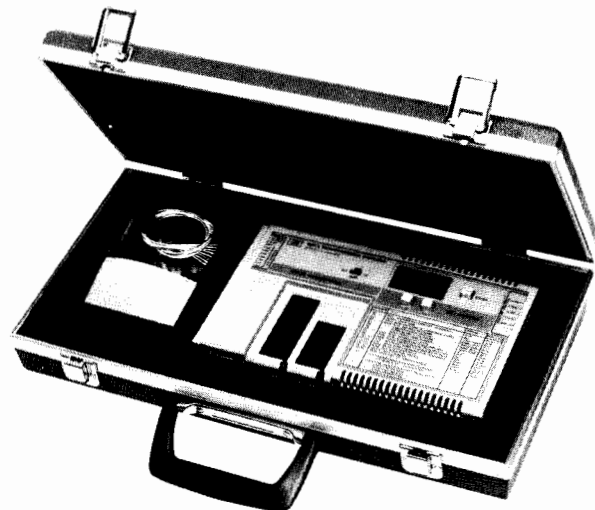

### 5001A Specifications

#### Main Interface to Product Under Test (Ribbon Cable)

##### Clock Input Frequency with ROM select switch set to:

- INT (internal preprogrammed ROM): 1.5 MHz maximum
- EXT (external custom ROM): Up to 2.0 MHz, depending upon type of ROM.

##### Output drive capability

- A<sub>0</sub>-A<sub>15</sub>, D<sub>0</sub>-D<sub>7</sub>, R/W, VMA: Drive 1 TTL load
- BA: Direct from microprocessor

##### Input loading

- D<sub>0</sub>-D<sub>7</sub>, DBE: 0.25 TTL load NOMINAL
- TSC: Direct to microprocessor
- HALT, IRQ, NMI, RES: No load

##### External Stimulus:

- X<sub>0</sub>-X<sub>7</sub> outputs: Drive 3 TTL loads

##### Qualifier Input:

- Q<sub>in</sub>: 0.5 TTL load NOMINAL

##### Signature Analyzer Interface:

- Start, Stop: Drive 3 TTL loads
- Clock: Drives 5 TTL loads
- Q<sub>out</sub>: Unbuffered Q<sub>in</sub>

##### General:

- Operating temperature: 0-55°C
- Power requirements: +5Vdc ±5%, 550 mA NOMINAL excluding the microprocessor and external (custom) ROM
- Shipping weight: 1.36kg (3 lbs)
- Size: 235 mm long x 140 mm wide x 26 mm high (9.25" x 9.5" x 1")

##### Furnished Accessories

- Ribbon cable to interface with the microprocessor socket of the product under test.
- Connector clips and leads for the external stimulus port, qualify input, and external power input.
- Plastic storage/carrying case.

**5001A Microprocessor Exerciser**  
Option 910: Additional Manual

**\$900**  
\$15



# DIGITAL CIRCUIT TESTERS

Digital Education Courses

Models 5035A, 5035T Logic Labs

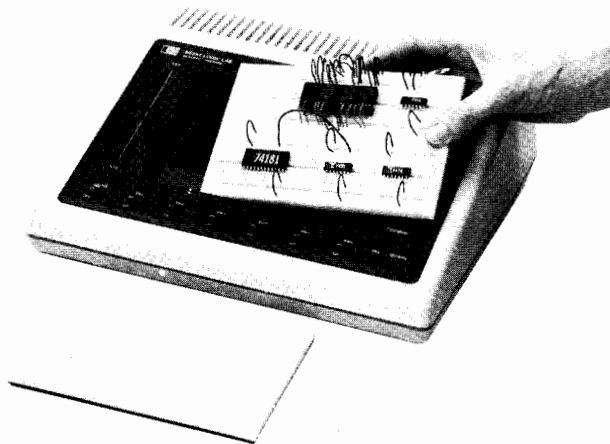

## 5035T Complete Logic Lab

Learn logic . . . the practical way. HP's Model 5035T Logic Lab combines theory and lab so you'll learn digital logic quickly, enjoyably, and memorably. Start by building simple circuits and work up to complete numerical readout clocks. Adopted by schools, industrial firms and individuals who want to keep up with the changing world of electronics, and enjoy doing it.

## 5035T Logic Lab Ordering Information

Includes

**5035A Mainframe** with removable breadboard (see below)  
**"Practical Digital Electronics"—An Introductory Course**

- Complete textbook
- 26 Experiment Workbook
- **TTL/DTL Test Instruments**
- 10525T Logic Probe
- 10526T Logic Pulser
- 10528A Logic Clip
- **Wire and Component Kit**
- 32 TTL, MSI, LSI ICs
- 285 Pre-stripped Wires
- 4 Large LED numerical displays
- IC Remover

### Accessories Available

	<b>Price</b>
<b>1258-0121:</b> Additional Breadboard Assembly	\$67.50
<b>10656A:</b> Set of 10 "Practical Digital Electronics" An Introductory Course—Texts and Lab Workbooks	\$150
<b>10657A:</b> Additional Component and Wire Kit	\$150
<b>5035T Logic Lab</b>	<b>\$900</b>

## 5035A Logic Lab Mainframe

The 5035A Logic Lab Mainframe brings convenience and flexibility to breadboarding by allowing solderless connection of new circuit ideas. Fully self-contained, the mainframe has a 5-volt 1-amp power supply, two clocks, four LED indicators, six data switches, two 5-volt BNC connectors, and a handy removable breadboard. To use it, just connect up circuits using standard 24-gauge wire, then power up either one or several breadboards to quickly and easily verify new circuit ideas before incurring expensive PC board layout and rework charges.

## 5035A Mainframe Ordering Information

**Power supply:** 5 volts  $\pm 5\%$ , over 0-1 Amp range; 10 mV rms ripple maximum. Continuous short circuit protection.

**Data switches:** 6 bounceless slide switches for TTL high/low outputs.

**LED indicators:** 4 high/low indicators.

**Clocks:** 2 independent; 1 Hz and 100 kHz.

**Breadboard assembly (HP part number 1258-0121):** removable.

**Interconnections:** all power supply, data switch, LED indicator, and component contact points may be interconnected by standard 24-gauge hook-up wire.

**Power requirements:** 100/120/220/240 V ac  $\pm 5\%$ ,  $-10\%$  50 or 60 Hz line frequency; 30 watts max;  $0^{\circ}\text{C}-55^{\circ}\text{C}$ .

**Size:** mainframe, 311 H x 89 W x 267 mm D ( $3\frac{1}{2}''$  x  $12\frac{1}{4}''$  x  $10\frac{1}{2}''$ ).

Breadboard assembly: 165 H x 114 W x 13 mm D ( $6\frac{1}{2}''$  x  $4\frac{1}{2}''$  x  $\frac{1}{2}''$ ).

**Weight:** net, 5.9 kg (13 lb). Shipping, 6.9 kg (15.13 lb).

### Accessories Available

	<b>Price</b>
<b>1258-0121:</b> Additional breadboard assembly	\$67.50
<b>1540-0258:</b> Heavy duty, padded vinyl carrying case	\$57.50
<b>05035-60006:</b> Wire interconnect kit (258 prestripped, assorted length and color, 24 gauge hook-up wires)	\$15

**5035A Logic Lab**

**\$475**

- Covers hardware, software and troubleshooting in one course.
- A practical, hands-on course for the general technical community.

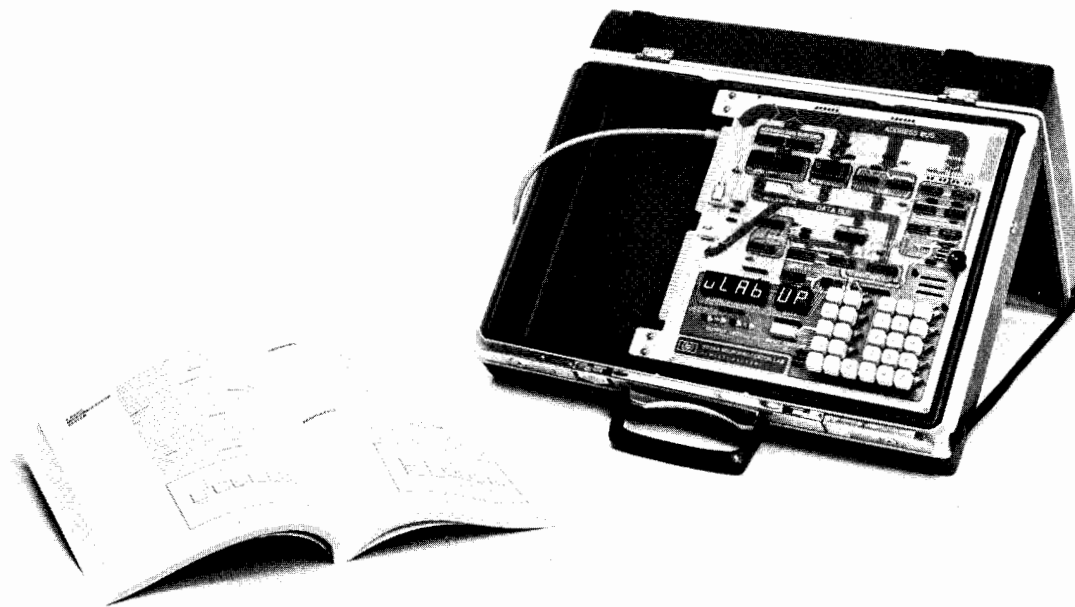

### Staying Current with Technology

The microprocessor represents an extension of electronics technology into areas previously dominated by mechanical devices, older electronic or electrical means, or even hydraulics. This means more versatile, less expensive electronic tools are rapidly replacing older less efficient equipment. However, repair of microprocessor-based systems by engineers, scientists and technicians trained on older equipment is a problem area ignored until now.

The microprocessor presents a repair problem due to its complexity, and because it is used in so many diverse products. Repair of these microprocessor products is currently a challenge to manufacturers. Little imagination is required to anticipate field repair problems with great quantities of microprocessor-based products like the following:

- Traffic Controller
- Typesetter
- POS Terminal
- Tire Balancer
- Photo Finisher
- Test Instruments
- Pipeline Control System
- Medical Instrumentation
- Telephone Exchange
- Taxi Meter
- Oceanographic Telemeter
- Elevator Control System

There are great numbers of scientists and engineers who can contribute to solving this problem by learning about both the hardware and software in microprocessor systems, and there is a virtual army of technicians who need to learn to troubleshoot them. The 5036A Microprocessor Lab provides both the hardware and software basics and vital troubleshooting information needed to solve the microprocessor puzzle.

To help fully understand how to repair faulty microcomputer systems, a user should understand both software and hardware. The 5036A course book, *Practical Microprocessors*, covers both areas in detail in separate chapters containing summaries, hands-on experiments and quizzes. Once these chapters are completed, the course builds up to a series of troubleshooting experiments employing recommended accessory troubleshooting instruments that challenge the user and reinforce major microprocessor operating concepts.

In addition to microcomputer basics, the book contains information on the use of oscilloscopes, signature analyzers, logic analyzers, logic probes and many other topics.

A practical hands-on course, *Practical Microprocessors*, removes the mystery from this exciting area and helps the user become current in a subject bound to be required knowledge in most engineering, scientific and technical disciplines for years to come.

### 5036A Major Features

- Multi-colored block diagram PC board graphics illustrate system organization to enhance learning.
- Multiple-experiment troubleshooting chapter highlights IC Troubleshooters such as 545A Probe, 546A Pulser, 547A Current Tracer and 5004A Signature Analyzer.
- Plug-in jumpers create real hardware faults that allow realistic troubleshooting practice.
- Complete resident software.
  - Easy program entry and modification.
  - Program debugging aids.
  - Interesting demonstration programs.
  - Built-in signature analysis and self-test routines.
  - 1K-Byte of user program space.
- Large, easy-to-read displays.
- Dual 5-Volt power supplies, plus edge connectors for expandability.
- Software-controlled speaker.
- LED monitors on all data, address, status and output lines.

### Ordering Information

**5036A** Microprocessor Lab and Power Supply mounted in briefcase, plus *Practical Microprocessors* text and lab book.

### Price

\$900

### Recommended Accessories for Troubleshooting Experiments:

**5024A** Logic Troubleshooting Kit; includes 545A Probe, 546A Pulser, 547A Current Tracer and vinyl case.

\$670

**5004A** Signature Analyzer

\$1,100

# LOGIC ANALYZERS

## Real-time analysis of digital systems



### Introduction

#### Continuing Evolution in the Data Domain

In a seemingly overnight conversion, electronics of the 70's switched primary allegiance from analog to digital design. Now there is an equally rapid adoption of processor-based designs for the majority of these digital implementations. New disciplines are appearing, which in turn require new tools. By necessity, the new tools lag behind the need, but the frequency of appearances of "the latest answer to your measurement needs" is so great that the task of "keeping up" is becoming a formidable task for electronics engineers and digital designers.

The evolutionary pressure which created the need for new answers is felt by the instrument designers as well as the users. Hewlett-Packard continues to be one of the leaders in developing new tools to meet the ever-changing needs of the electronics industry. In 1973, HP introduced a Logic State Analyzer to provide a growing population of digital designers with a window on the parallel flow of binary data. Today, HP has a family of logic analyzers and a universal logic development system which cover a wide spectrum of measurement capabilities to serve users engaged in design, production, and service of digital products.

#### The Electronic Bench

The many people who design, manufacture, and service HP products also use these same instruments in their day-to-day work. This situation creates a loop of constant and immediate feedbacks which results in innovative answers to measurement problems. Frequently, new measurement features are the end result of a designer at one work bench providing a solution for a problem of a designer at the next bench.

A basic understanding of measurements needed for logic systems is reflected in such functional analysis concepts as cross-bus analysis and glitch triggers. An awareness of how instruments are actually used led to the development of operator interfaces that meet the needs of the experts while still serving the novices. Menu-driven instrument control simplified the operation of second-generation logic analyzers in 1976.

Syntax-driven soft keys were introduced in 1979 with the logic development system, greatly simplifying both learning and use of a powerful operating system for software development. Major steps have been taken towards the "electronic bench" of the future, which will accommodate a wide variety of design, development, and troubleshooting tasks on a multistation configuration sharing a common data base with other electronic benches.

#### Analysis Tools for Logic Systems

Logic systems are built from two basic elements: hardware and software. If you were to design and build a logic-based unit "from the ground up", the sequence of steps you would take are likely to be those shown in figure 1. Ideally, you would complete each step in turn, but practically, you will have to return to an earlier process and retrace your steps many times. For instance, a malfunction at the point of integrating hardware and software could send you back to check the control lines or to verify that the data lines, the controlled circuits, are transmitting the state flow properly. Different analysis instruments are optimal for different phases in development of a logic system. Digital volt meters (DVMs) and oscilloscopes are useful in the initial steps of creating the hardware base, to assure that the circuits do indeed work, and within the limits you prescribe for timing and other electrical parameters.

As the system becomes more fully defined, you need analysis tools that give you a greater overview of system performance. You have verified that each separate line functions, but now you must concern yourself with many lines operating together. A logic timing analyzer is now the optimal tool, to view activity on circuits operating concurrently, asynchronously and synchronously.

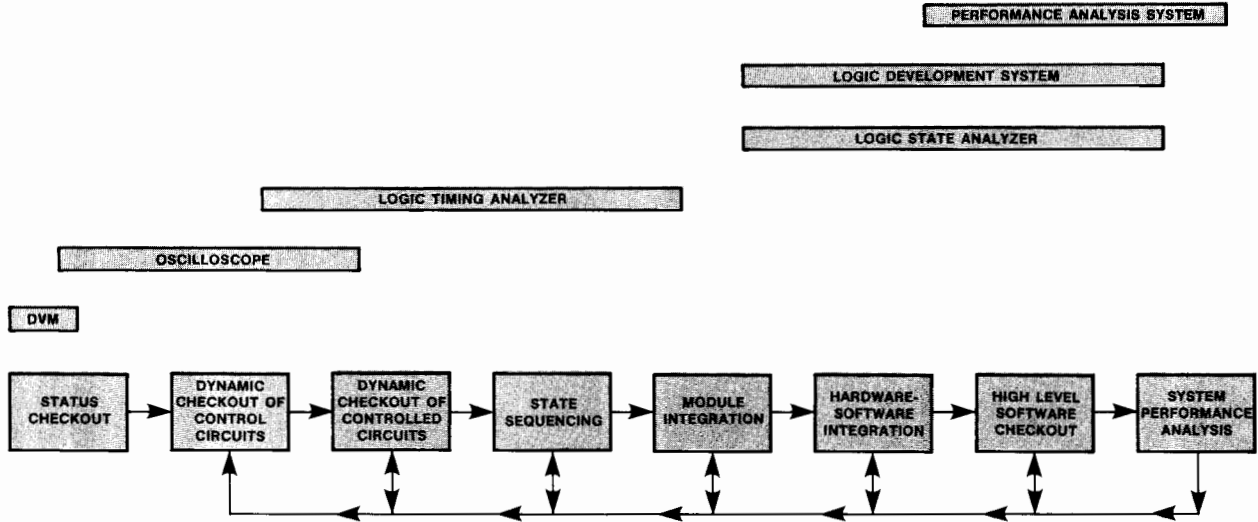

Figure 1. There are eight major functions in constructing a logic system. Different measurement instruments are appropriate for various stages, and no single instrument meets all measurement needs. Each function must be accomplished once, but, in most cases, it is necessary to return to an earlier step several times.

You now must generate code to be used with your hardware. The logic development system is the tool for software design; and, if your logic system employs a microprocessor, you can emulate your final logic system even when no hardware exists. With the initial software completed, the logic state analyzer is the optimal instrument for checking the state flow, the sequence of states on parallel, synchronous data and address lines. The logic state analyzer serves as a diagnostic tool, as any functional problem in a digital system is eventually reflected in an error in the state flow.

The job is not yet completed. Once hardware and software function adequately as a single unit, it is time to check out the high-level software performance, and to fine tune the system. Either the logic development system or a performance analysis system consisting of a logic analyzer with a Hewlett-Packard Interface Bus (HP-IB) capability, a computer or controller and a printer/plotter, enable you to make complex measurements on efficiency and effectiveness of your logic system.

As a final step, if your system is to be part of a larger logic system and the tie to that system is a serial transmission interface, such as the RS-232-C (V24) interface, then the serial data analyzer is the proper analysis instrument.

**Team Approach**

The one designer-one system approach to development of logic products is becoming less common. Competitive time pressures, complexity of the product, and the magnitude of the development process make it necessary to use teams of designers and developers.

Ordinarily, two teams are used, a hardware team and a software team. As shown in figure 2, logic analyzers and the logic development system have overlapping applications, but there are applications that are unique to

each of the two tools. Logic analyzers have an advantage of greater portability and a more sophisticated feature set focused on a specific measurement and analysis sphere: timing, state, or serial analysis. The logic development system becomes economically advantageous for larger scale logic system development projects, and greatly facilitates the team approach through a multistation configuration sharing a common data base.

Choosing the best analysis and development instruments for your needs is a function of your applications. Before selecting instruments, first determine what measurements and capabilities you need to accomplish your major functions. Then familiarize yourself with the measurements and capabilities available with each class of instrument. Compare the relative value of each to your applications, both today and tomorrow.

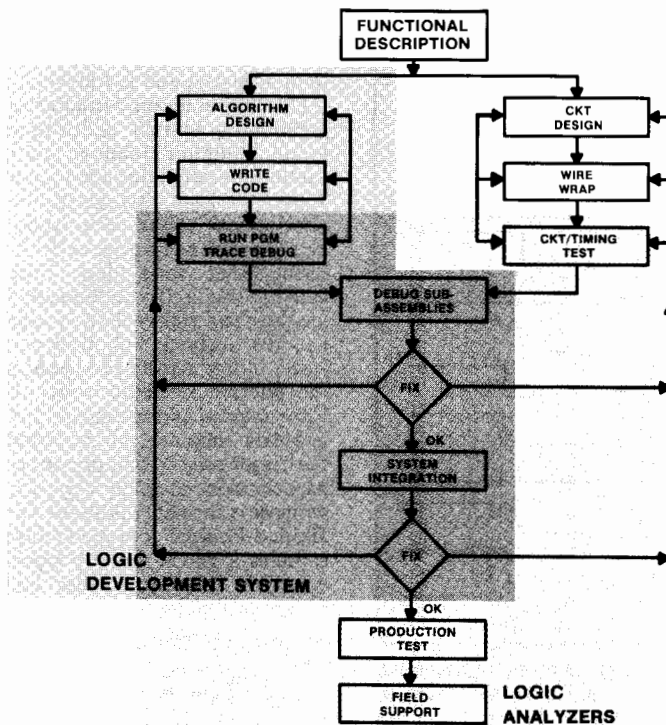

Figure 2. In the typical development cycle for digital systems, the Logic Development System is the proper tool for earlier design phases of creating and debugging software, while logic analyzers contribute sophisticated analysis capability to all phases of the development cycle beyond initial code generation and circuit building.

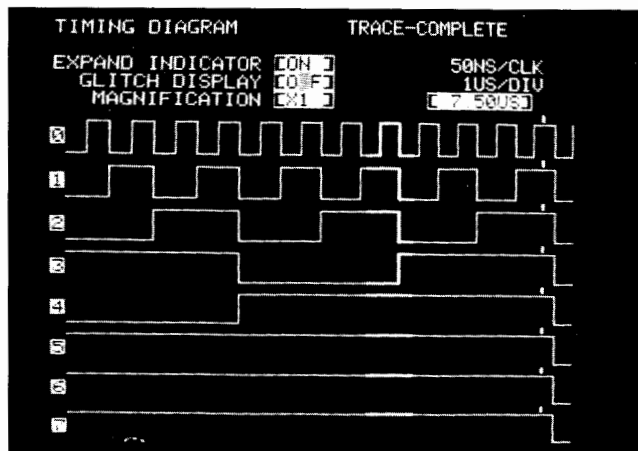

Figure 3. Timing display of a logic timing analyzer shows the state, high or low, of each of the eight lines monitored at each occurrence of an internal clock. Reference point for data collection, the trigger event, is indicated by the small tick mark.

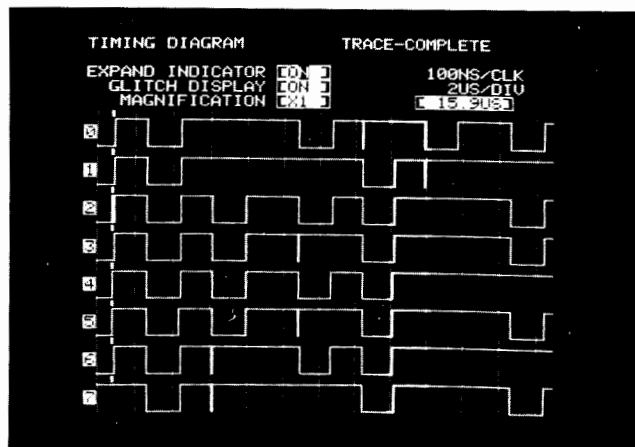

Figure 4. This timing analyzer display shows glitches as brightened vertical bars. Triggering data collection at the occurrence of a glitch on selected control lines and a Boolean pattern is a convenient feature for many troubleshooting applications.

### Timing Analysis

The logic timing analyzer is often called the hardware designer's tool. A primary function of the timing analyzer is providing a display of the functional timing relations between signals on the logic circuits.

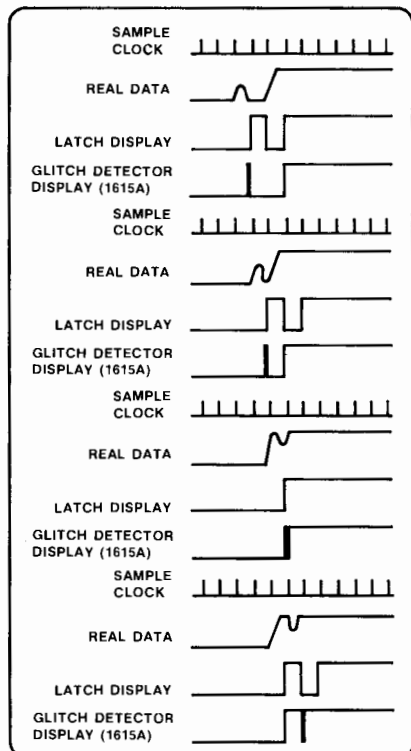

Figure 5. Two common forms of capturing glitches result in very different displays. The latch, or stretcher, circuit shows the same display whether the glitch occurs two clock periods ahead, one clock period ahead, or one clock period after the data transition. A glitch in the same clock period as the data transition is not registered by the latch circuit.

Timing analyzers do not replace DVMs and oscilloscopes; they provide a different measure. DVMs are used early in the design cycle (see figure 1) to check continuity and voltage levels, to assure that there will be no catastrophic failure when the system is turned on initially. Oscilloscopes are then used to check static and dynamic conditions of the control lines; e.g., is the reset in the correct state? Is the clock phasing proper? Once the initial design restraints are met, the hardware designer turns to the logic timing analyzer to check the control lines that are active, and subsequently, the controlled lines—the data and address lines.

Uniqueness of the measurement set of a logic timing analyzer is due to several features. A timing analyzer can trace the activity on multiple channels simultaneously. Unlike the logic state analyzer, the timing analyzer can collect information asynchronously as well as synchronously. A time filter distinguishes valid data from random activity. Unlike the oscilloscope, the timing analyzer can collect data in negative time; i.e., the analyzer will display the timing traces of line activity that occurred prior to the selected reference point, the trigger. Time interval measurements can be made, and data collection can be delayed beyond the trigger point by time or event counts. Perhaps the most valued feature to the hardware designer is the glitch detection circuit of the Hewlett-Packard Logic Analyzer, which captures a glitch, stores it separately, and displays it uniquely. Glitches can be used in trigger conditions.

### Functional Timing Measurements

Displays of timing information are in the idealized form which describes two states, high or low (figure 3). The search for glitches, inappropriate timing intervals, and signals occurring in the wrong sequence is a large part of the hardware engineer's work, in design, production, or maintenance.

Triggers are the reference points from which data is collected, either as an end point

or an initial point. Using a time filter, which uses the same identifying time interval as the system being observed, makes the trigger truly asynchronous. The timing analyzer will not trigger on events that are transient and would not cause a response in the target system, nor will the analyzer miss any set of signals that would be accepted as valid.

### Glitch Detection

Two forms of glitch detection are common. The latch method captures glitches and displays each glitch as a data bit, one sample-period wide. Glitch detection for Hewlett-Packard logic analyzers defines a glitch as more than one transition across the voltage threshold within a single clock period. Glitches are stored in a separate memory, and displayed uniquely on the timing diagram (figure 4).

The disadvantages of the glitch-latch approach can be seen in figure 5. Using a latch method to capture glitches results in the same display whether the glitch occurred two sample periods or one sample period before the data transition, or one sample period following the data transition. Glitches that occur in the same sample period as a data transition are not detected at all with the latch method; unfortunately, these can be some of the most troublesome of all glitches.

The Hewlett-Packard glitch-detection method uses twin, overlapping continuous monitors to identify glitches, and stores this information in a separate memory. Glitches on specified control lines can be used as part of trigger conditions, separately, or logically ANDed with synchronous or asynchronous triggers.

### Simultaneous State and Timing Analysis

Module integration and verification of the hardware/software interface are tasks usually best accomplished through state analysis. The hardware is operational and the sequence of states are defined, and errors or problems with either hardware or software will show up as disruptions in the state flow.



However, this is the phase at which the designer frequently finds it necessary to return to earlier work to find one more overlooked glitch or alter a timing relation that was reasonable when it was built into the hardware, but simply doesn't execute well with the software. A convenient tool at this time is a logic analyzer which will monitor state flow and timing conditions simultaneously. For example, a sequence of events on asynchronous logic circuits can be investigated at a particular point in program execution. By triggering on a glitch and collecting state flow in negative time, an analysis can be made of system performance preceding the glitch.

**State Analysis**

Logic state analyzers capture and display the flow of events occurring synchronously in a logic system. They present a real-time window on the operating system by transparently monitoring activity on address, data, and control buses. State flow is clocked (strobed) into the analyzer with the clock signal(s) that indicate data on the lines are valid. To collect accurate information, the logic state analyzer must meet the same criteria for selecting valid signals as the logic system observed. Set-up times for the analyzer must be minimal and a zero hold time is essential to avoid interpreting transitional states as valid status (figure 6).

The operator's view of system activity is the state list shown on the analyzer's display. Display formats vary. Simpler logic state analyzers offer 16 lines, sufficient to monitor only addresses, without the accompanying data. More sophisticated analyzers offer 24 to 36 parallel inputs (figure 7), which accommodate state flow from 16-bit microprocessors or additional control-line information. Format for the display also varies. The simplest logic state analyzer lists 1's and 0's grouped in three- or four-bit sets. Second-generation analyzers, which are themselves microprocessor-driven, offer more complex displays. Inputs can be selectively grouped under labels (e.g., A for address, D for data,

E for control lines) and translated to convenient numerical bases: binary, decimal, octal, hexadecimal. Analyzers dedicated to use with specific microprocessors can reassemble the machine language to the mnemonics used by programmers (figure 8), a convenience for comparing what did happen to what should have happened. Another specialized analyzer, the serial data analyzer, monitors serially transmitted data, translates the data into the code in use, and displays both transmitted and received data.

Logic state analyzers are an example of a "next-bench" solution. Less than a decade ago, the engineers working with electronic instruments found themselves increasingly involved in the data domain, and software designers began to appear. The oscilloscope, an analog tool, did not meet the needs of designers and troubleshooters who needed to see a number of timing lines simultaneously. In fact, it soon became apparent that even the timing lines were an inefficient form of information when the pertinent data was the state of each line at each successive clock signal. Consequently, the first logic state analyzers, and all subsequent logic analyzers, are optimized for the functions of troubleshooting logic systems. Triggering and selective tracing are key features for effective analysis of state flow.

**Triggering and Selective Tracing**

In most logic systems, many algorithmic tasks are performed repetitively, and much of the system actively is devoted to scanning routines. Collecting all of the state flow would be cumbersome and impractical, and would bury those key areas relating to a suspected problem under a mass of detail. Logic state analyzers allow the user to pinpoint the area to be observed with methods to define a starting point for data collection (triggers) and to select (qualify) the particular kind of data to be strobed into the analyzer memory.

The simplest trigger is a single state which is set to define the initial or final point of data collection. On more complex analyzers, two

or more points can be specified to occur in sequence before "making a trace" (data collection). If a count of trigger events is available, each sequence term can be specified to occur a given number of times. In systems with frequent use of nested loops, a convenient trigger feature is a sequence restart term. If the prescribed sequence is not found by the time the sequence restart term appears, the search for the entire sequence is begun again from the first term, avoiding a situation in which sequence terms are found in different passes through a loop. One analyzer permits a trace to be taken of states within a stated range of addresses. The serial data analyzer offers triggers suitable for serial transmission: pattern, protocol, parity, or time intervals. All logic state analyzers permit data collection in "negative time", i.e., before the trigger event; and permit a delay beyond the trigger point to allow a trace far removed from a convenient "landmark." Logic state analyzers also have an output signal which will trigger other instruments, such as an oscilloscope.

Triggers determine where to collect data; qualification determines what data is collected (figure 9). The result of qualification is a

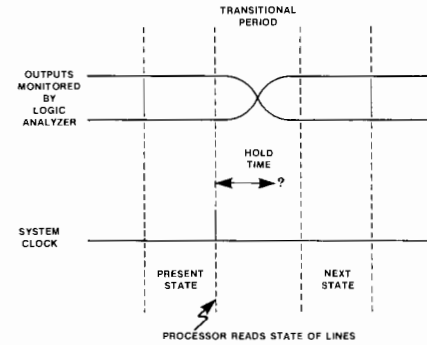

Figure 6. Data captured by a logic state analyzer may be ambiguous if the hold time is greater than zero. With a positive hold time, the analyzer may read the state of the lines in a transitional period.

TRACE LIST							TRACE-COMPLETE	
LABEL	A	B	C	D	E	F	TIME	
BASE	OCT	BIN	BIN	BIN	BIN	BIN	DEC	
SEQUENCE	00000	0	0	00	00	1	3	US
SEQUENCE	00000	1	0	00	00	1	6	US
SEQUENCE	00000	1	1	00	00	1	17	8 US
START	00000	0	0	00	00	1	6	540 US
+01	00030	0	0	00	00	1	1	US
+02	00030	0	0	00	00	1	1	US
+03	00030	1	0	00	00	1	1	US
+04	00030	1	0	00	00	1	1	US
+05	00030	1	0	00	00	1	1	US
+06	00030	1	0	00	00	1	1	US
+07	00030	1	0	00	00	1	1	US
+08	00030	1	0	00	00	1	1	US
+09	00030	1	0	00	00	1	1	US
+10	00030	1	0	00	00	1	1	US
+11	00030	1	0	00	00	1	1	US
+12	00030	1	0	00	00	1	1	US
+13	00030	1	0	00	00	1	1	US
+14	00030	1	0	00	00	1	1	US
+15	00030	1	0	00	00	1	1	US
+16	00030	1	0	00	00	1	1	US

Figure 7. A state list as displayed on a logic state analyzer is the sequence of events occurring at the clock signals of the system under test. Modern logic analyzers allow grouping 24-36 inputs under labels, with appropriate numerical bases for each group.

ADDRESS	DATA	EXTERNAL
TRIGGER	02A0	
TRIGR OCCUR=10	PRE-TRIGR=5	LINE 0
ADRS	OPCODE/DATA	EXTERNAL
029D	MOV A, M	0000 0000
029E	78 READ	0000 0000
029F	NOF	0000 0000
029F	STAX B	0000 0000
0BFD	70 WRITE	0000 0000
0BFD	NOP	0000 0000
02A1	POP D	0000 0000
0BBC	F3 READ	0000 0000
0BB0	0B READ	0000 0000
02A2	INR E	0000 0000
02A3	INR C	0000 0000
02A4	JNZ 029E	0000 0000
028E	LXI H, 02C0	0000 0000
0291	LDAX D	0000 0000
0BF4	10 READ	0000 0000
0292	NOP	0000 0000

Figure 8. Logic state analyzers dedicated to specific microprocessors can reassemble machine language into the programming mnemonics for easier comparison of the program as written to the program in execution on the user's system.

# LOGIC ANALYZERS

Real-time analysis for digital systems

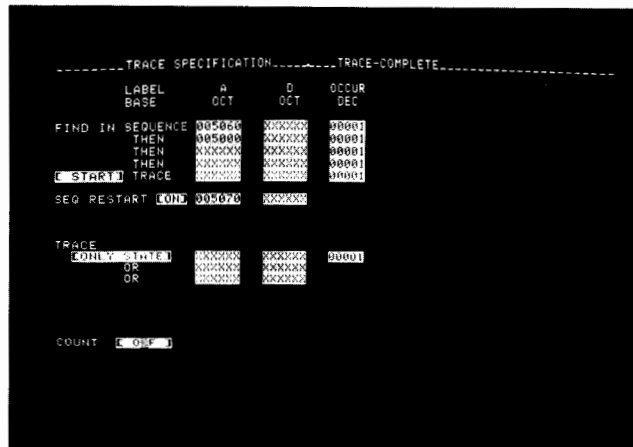

Figure 9. A Trace Specification menu for a modern logic state analyzer allows a user to set very complex conditions for initiating a state list trace and selecting specific classes of events for inclusion in the state list.

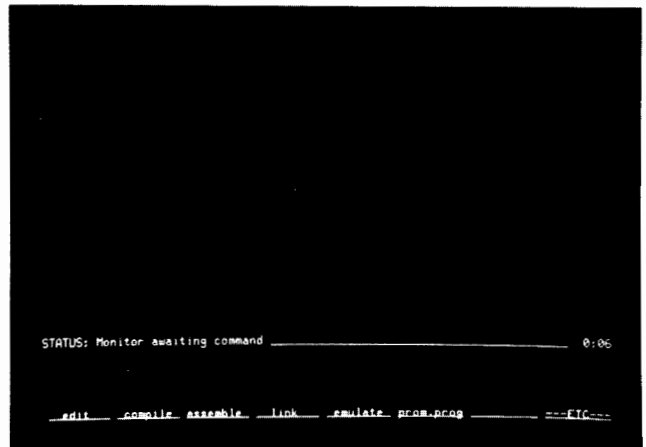

Figure 10. The eight syntax keys of the Logic Development Station are directly below the display, and the function of each key is shown on the display immediately above the key. These "soft" keys are syntax-driven. The choices shown are those on-screen at power up.

selective trace, a trace which contains only specified categories of states. There are four general ways to achieve the end of an "edited" trace: (1) tracing only trigger events; (2) tracing events independent of trigger events; (3) using clock qualifiers to collect data on the buses only when a combination of signals indicates the buses are carrying the target data type; or (4) using a dedicated or general purpose interface which is programmed to select data types. Triggering and qualification greatly reduce the amount of memory space required, and, more importantly, they save analysis time by eliminating extraneous information.

## Performance Measures and Displays

Simple measures, such as counting elapsed time or number of events between two critical points in program execution, are excellent diagnostic techniques for evaluating system performance. One or both measures are available on the second-generation logic analyzers, for use in fine-tuning and optimizing a logic system.

For a quick overview, a map or a graph describe system activity pictorially. A map plots the most significant half of each word against the least significant half, and operators learn quickly to distinguish atypical system behavior patterns. The graph plots word magnitude against sequence, and it offers the additional convenience of presenting a more global view by sampling every *n*th state rather than all states in the system operation.

## Connection to Target System

Connecting the logic analyzer to the system under test may be done directly with small pincer-type probes which come from each multinodal probe assembly. For repeated measurements, circuit-mounted ribbon cables simplify the connection. A general

purpose probe interface is available for easier connections and preprocessing of data flow on a wire-wrap board in the interface pod.

For some of the popular minicomputers, dedicated interfaces are available which further simplify connections, as well as providing access to the minicomputer buses. Each interface also provides further preprocessing and qualifiers.

## Serial Data Analysis

The serial data analyzer is a special type of logic state analyzer. While the information is passed one bit at a time, typically across an RS-232-C (V24) interface, many inputs are required for the control signals. The serial data analyzer is a transparent monitor in synchronous or asynchronous networks and decodes data in common character sets used with link-level protocols. As an aid to locating faulty network components, this analyzer can also simulate a CPU, a terminal, or a modem.

## Logic Development System

Hewlett-Packard Model 64000 Logic Development System is a universal system for designing and developing microprocessor-based logic systems. A multistation system which shares a common data base on hard disc, the 64000 meets the needs of today's design teams without compromising its adequacy for tomorrow's innovations. Software engineers compose, edit, assemble, and link their routines, and may use the optional Pascal compilers and logic analysis units for effective programming and debugging. Syntax-driven soft keys make the system easy to learn and use (figure 10). Simultaneously, for selected popular microprocessors, hardware engineers can use one of the emulator options to exercise their modules even when only part of the software and hardware exist.

## Minicomputer Performance

The host operating system has the processing power of a minicomputer. Each 64000 cluster has up to six development stations used with a single hard disc and printer. A 16-bit HP host processor with an independent 64k memory resides in each development station. Development stations may be configured to serve the purposes of the existing design program with a variety of options today, and reconfigured or upgraded tomorrow to match a new program in logic development. Options presently available include emulators for common microprocessors, logic analysis, PROM programmers, linkers and assemblers, and Pascal compilers.

Architecture of the Logic Development System reflects Hewlett-Packard's commitment to the concept of the "electronic bench." An open-ended design, the Logic Development System architecture provides a solid base for future compatible innovations.

## HP-IB Expanded Measurements

The sophisticated feature sets of standalone logic analyzers can be enhanced with an optional HP-IB Interface to provide automated operation, hard-copy records, or a performance analysis system. Refer to pages 21 to 35 for a complete list of HP-IB compatible instruments produced by Hewlett-Packard.

Combined with a printer or plotter/printer, permanent documentation and records can be made of logic analyzer traces, timing diagrams, and setups. Detailed analysis work can be done off-line in production and long-term evaluations. Field personnel can take the logic analyzer to remote sites and send hard copy back to a central facility for detailed statistical studies and trend analyses.



Adding a controller to a logic analyzer through the HP-IB creates a powerful test system for many settings. In production, operator prompts and automatic setups for analysis reduce training costs while assuring uniform test procedures. Repetitive tests, complicated measurement routines, and continuous system monitoring can be accomplished with little operator involvement. Preventative maintenance can be improved by using the automated logic analyzer to flag borderline system performance, before the entire system comes down. In the laboratory, the "intelligent" logic analyzer is an excellent instrument for performance analysis.

### Performance Analysis

The logic analyzer, controller, printer/plotter combination possible with HP-IB is an economical, effective system for a performance evaluation of a logic system. Data acquired by the logic analyzer can be processed by the controller to produce histograms, software execution profiles, matrices of branching probabilities, and other user-designed statistical tests and displays (figure 11). Performance analysis with the "intelligent" logic analyzer is valuable for optimizing software and dynamic monitoring to fine-tune logic systems.

### Focus on Quality

Hewlett-Packard takes the time and effort required to build in the extras that often make the difference in finding efficient solutions to logic design and development problems. The care and concern in building quality instruments is, in part, due to a company-wide charter to serve customers well, but it also follows naturally because HP people build instruments they themselves use by choice, in design, development, production, and service.

### Dependable Performance

Because HP engineers use the instruments they design and build, you are assured that the HP instrument you use has the dependability and careful design you need, too.

Consider the zero hold time feature of the logic state analyzers. This one feature requires additional design effort and accommodation, but it is included because HP engineers recognized the importance of obtaining a reliable signal from the system under test every time, not just "most of the time" or "with most systems." Since you use a logic analyzer with a variety of digital systems with varying specifications, the zero hold time feature completely eliminates a potential problem of acquiring transitional states which have the appearance of valid data.

A second example of the care taken to provide effective solutions is the emulator function of the Logic Development System. The designers chose to optimize "functional transparency" by constructing an emulator that makes a minimum intrusion into the target system. This decision was implemented by separating the host memory and buses from the emulator memory and buses. When you run your system with the emulator, you don't have to use processor memory space for emulation activity, and no interrupts are needed for the operating system activity. This results in fewer surprises when you replace the emulator with your processor.

### Reliability and Service

All Hewlett-Packard logic analyzers and logic development systems are thoroughly tested before shipment. Performance verification is imbedded in each instrument so you can check to make sure your instrument is performing properly each time you use it

(figure 12). Because serviceability is part of an HP instrument from the very first design concepts, downtime for servicing is held to a minimum.

### Friendly Interface

An instrument that is easy to use reduces training time and allows the user to focus on the design task rather than the intricacies of the design-aid tool. Logic analyzers were made simpler to operate by using an interactive menu for entering test parameters and setting up measurements. The Logic Development System introduced a new human interface concept: guided syntax and "soft" keys. Eight keys for operating the varied and complex functions of the 64000 are on the development station directly below the display. The function for each key is software-driven, and the function in current use is named on the display above the key. As a function is changed, the key functions change and new labels are shown on the display. Operators are able to begin using the Logic Development System immediately, not after extended study and repeated reference to a manual.

### Summary

Your first step in selecting measurement tools is a thorough understanding of your measurement applications and environments. There is a large variety of products available, but if you know what features and measures best suit your needs, the choice is narrowed quickly. Then apply the other rules and considerations for making a wise purchase.

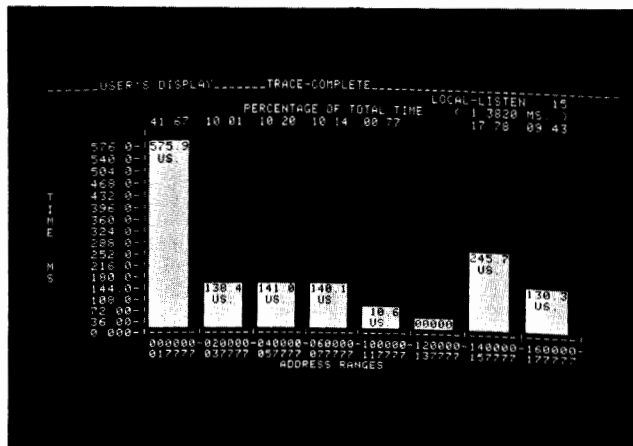

Figure 11. A logic analysis system composed of a logic analyzer, controller, and printer/plotter on HP-IB can be programmed for performance analysis. Histograms such as this are useful in evaluating program efficiency.

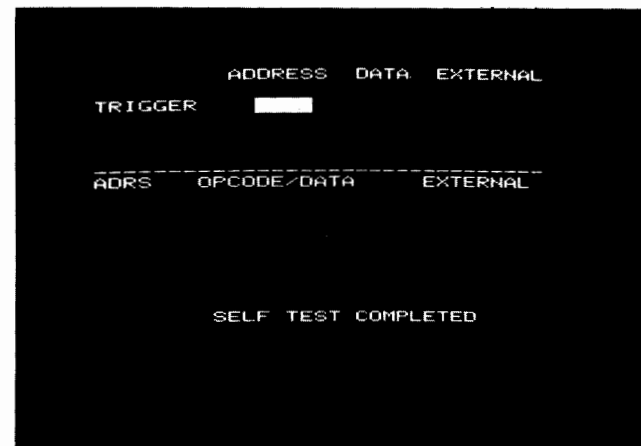

Figure 12. One form of performance verification is built into each analyzer, the self-test. At power-on, or with a rear-panel pushbutton, a series of self tests are performed by the logic analyzer to verify that the analyzer is operating correctly.



# LOGIC ANALYZERS

Logic Development System

Model 64000

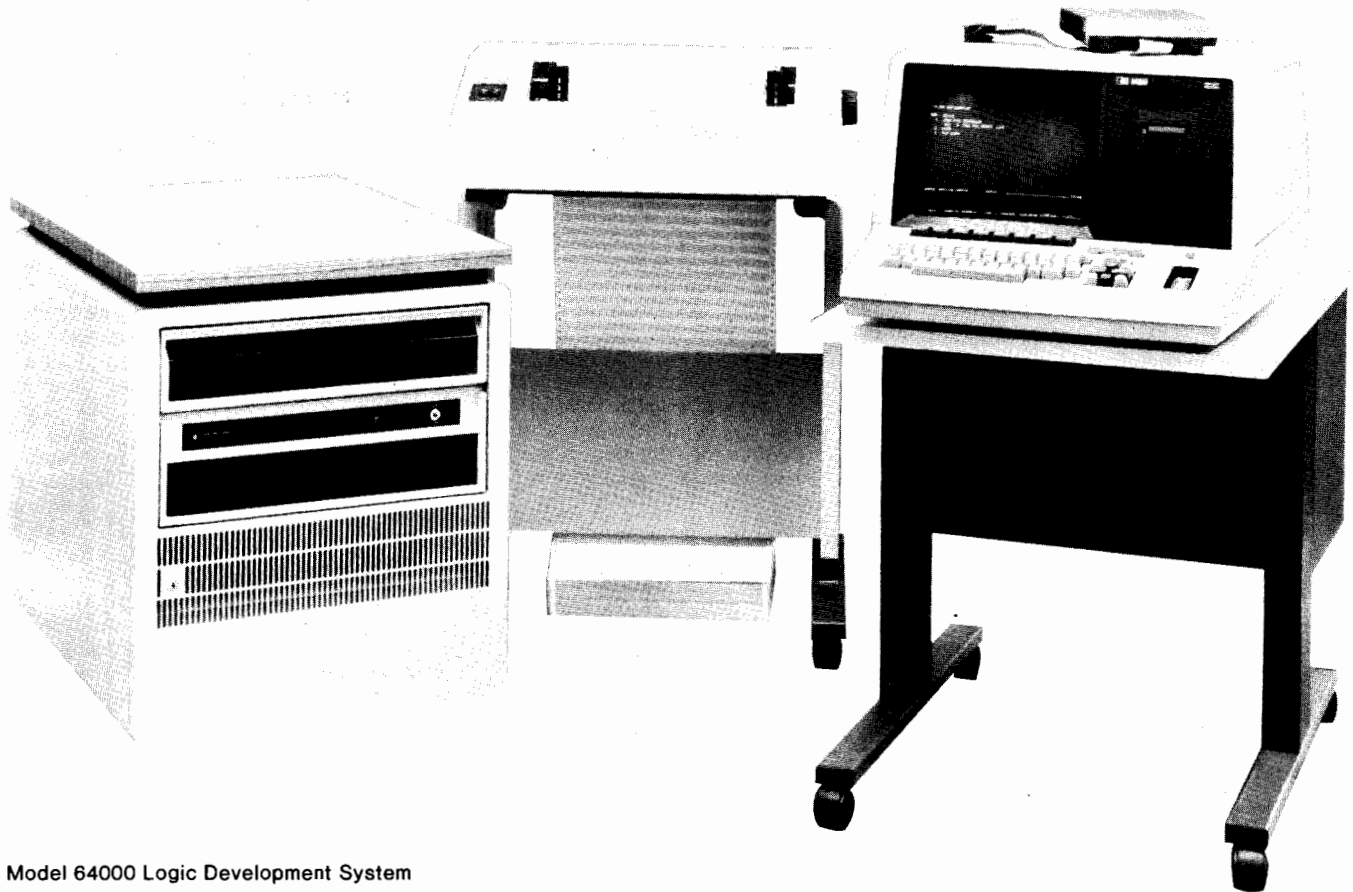

Model 64000 Logic Development System

## Introduction

The introduction of the microprocessor has created a revolution in the design lab. Hewlett-Packard Model 64000 Logic Development System meets the needs growing out of a new design philosophy. In today's design lab, most projects are developed by teams, and most of these teams divide the task into a hardware unit and a software unit, developed in parallel. The Logic Development System provides both hardware and software teams with effective design aid features, and fosters efficient teamwork and integration.

Model 64000 Logic Development System is a multistation, hard-disc based system which combines the hardware and software design aids necessary for developing microprocessor-based products. The operating system uses an HP-proprietary 16-bit microprocessor for minicomputer-like power. Emulators are available for the most commonly used microprocessors. An open-ended architecture provides maximal flexibility for configuration today and for future expansion. Directed syntax and soft keys give the 64000 a "friendly" system, easy to learn and comfortable to use.

A basic system consists of a Model 64100A Development Station with a Model 64940A tape cartridge drive installed and a compatible disc and printer. Expansion from this configuration can be made in several dimensions. Hard-disc memory can be altered by using a different compatible disc, with 12M, 20M, 50M or 120M byte capacities. One of two printers may be used, with speeds of 180 cps or 400 lpm. Development stations can be added, to a maximum of six development stations sharing a disc and printer. Each development station may have a tape cartridge drive and a full complement of optional functions: emulator, emulator memory, logic analysis, and PROM programmer.

The system bus connecting up to six development stations, disc, and printer has a maximum interconnection distance of 20 metres. Using a Model 37203A Extender, this distance can be as long as 250 metres. An RS-232-C (V24) or current loop interface in each development station provides asynchronous serial communication to serial-trans-

mission devices, such as a teletype for tape and punch operations. These serial interfaces are convenient means for downloading software from another system, transmitting ROM masters, and creating or reading a paper tape.

It is the unique combination of features and architecture that sets the Model 64000 apart. The Logic Development Station combines all of the components needed to support a product design from definition to production.

- Supports wide range of microprocessors
- Real-time emulation and analysis
- Exceptionally friendly user interface
- Integral universal PROM programmer
- Tape cartridge for file transfer and backup
- Multiuser
- Wide range of disc and printer options

## System Overview

Designing with microprocessors, especially for those systems using ROM, is best accomplished if the development team has available three key capabilities: software development tools, target system emulation, and logic analysis. Due to the favorable economics and competitive pressures, many new companies are entering into processor-based design. More software specialists are graduating from colleges today, but for many designers, software design represents a new discipline. These factors, together with inherent complexities of processor-based design, have sent the cost of software development spiraling up towards \$40 per line of code. Common sense dictates that these design teams have available the tools and performance aids that allow them to apply their efforts and skills effectively and efficiently. Model 64000 Logic Development System provides the tools these teams need for software development, emulation, and logic analysis (figure 1).

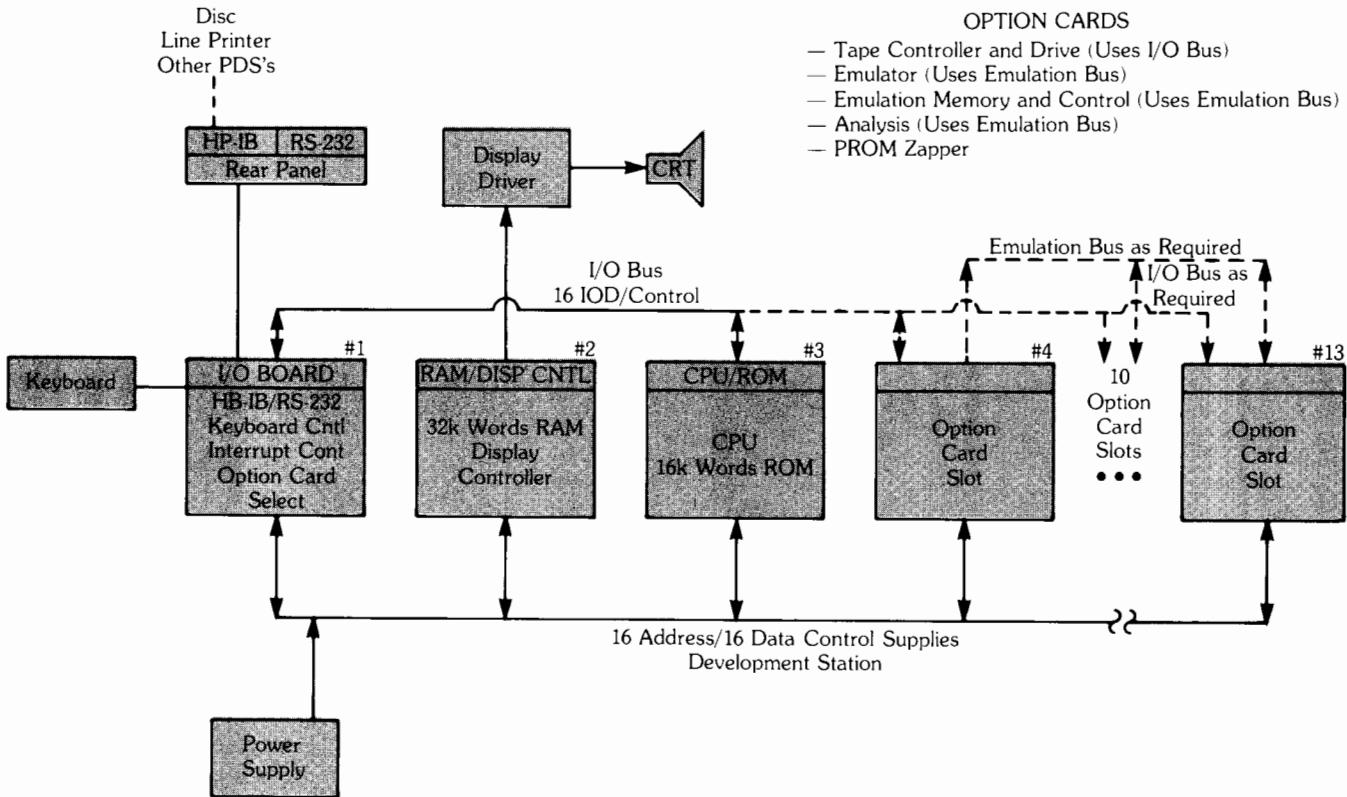

**Figure 1.** Model 64100A Development Station card cage reserves the first three slots for the host system, and the remaining ten slots are available for system options. If an emulation function is added, a separate, high-speed bus is used for the emulator control, emulator memory, and logic analyzer.

### Development Station

Model 64100A Development Station is the fundamental element of the Logic Development System (figure 1). It provides the interface between the user and the powerful operating system. Each development station contains:

- Host processor with 16 bytes of ROM, 64 bytes of RAM, and control for display and I/O
- Modular power supply
- Console with integral 12" CRT
- Full ASCII keyboard and cursor control field
- Eight "soft" keys that are labeled by the software
- Optional tape cartridge drive
- Card cage with ten slots available for option cards
- Optional PROM programmer
- RS-232-C (V24) interface

The development station is easy to use. The interactive display with "soft" keys and directed syntax lead the user through complex and powerful procedures without the need for memorizing long lists of commands and syntax or making frequent references to a manual. At each decision point, the "soft" key labels list all the choices available for the next step in creating a command structure. A flashing cursor identifies data entry or editing position, and it is moved with the cursor keys to change entry or control areas.

Each development station can be fully configured, or more generally, selected development stations in a cluster are optimized for specific design tasks. For example, a software designer may choose a basic station with an emulator function while a hardware designer is more likely to add logic analysis and PROM programming functions.

### Hard-Disc Drives

Hard discs give the 64000 System depth and speed. The depth allows a complex, powerful operating system while still keeping an abundance of memory space free for work space. The speed makes possible a smooth coordination of all active development stations in the cluster. Together with the host processor and host memory, the

fast mass storage of a hard disc facilitates good design discipline. A common, and troublesome, programming error occurs when a troubleshooter patches or fixes software in the object code, but fails to alter the source code to reflect the revision. But the 64000 system permits any keyboard command or entry to be automated directly into the command files. A change in a 2000-line program can be processed through edit, assembler, link as well as emulation, configuration and logic analysis in less than three minutes; and, the change is documented at the source code level.

Four compatible HP hard-disk drives are available: Model 7910H (12M byte), Model 7906M 20M byte Cartridge Disc, Model 7920M 50M byte Disc, and Model 7925M 120M byte Disc. Selecting the appropriate hard disc is a function of the project load planned for the cluster.

### Software Development

Software designers compose, revise and test code for the processor product. They need tools for language translation, source text revision, and a medium to check program execution (figure 2). Standard software for the Logic Development System includes a display-optimized editor, an "intelligent" file manager, and a linker to link relocatable code generated with optional assemblers and compilers. Command files can be created to reduce complex operations to a simple call. Test and analysis can be conducted with the addition of the emulation subsystem or logic analyzer.

Relocating macroassemblers and linkers are available for each emulator subsystem. Assemblers and linkers are also available for more than ten other common microprocessors, as well as an assembler which accommodates user-generated assembly programs. The relocating macroassembler is table-driven and accommodates new assemblers quickly and reliably.

Pascal/64000 is an implementation of the block-structured programming language, Pascal, for use with Model 64000 Logic Development System. There are Pascal compilers for the 8080, 8085, Z80, and 6809 microprocessors. Other Pascal compilers are in preparation; an HP Field Engineer or Logic Development System Specialist will have a current list of available compilers.

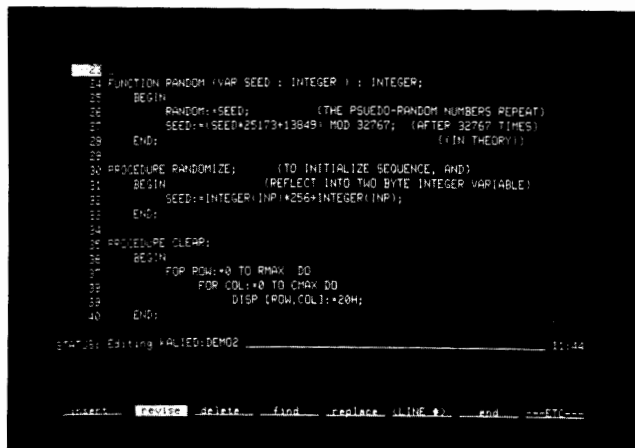

**Figure 2.** The 64000 Logic Development System has a powerful editor function for ease in preparing software for processor-based products. Labels for the eight "soft" syntax keys are shown at the bottom of the display.

**Emulation**

Emulation is an effective means to check how the software modules work with the target microprocessor and hardware. The emulation environment is valuable for debugging hardware and software at interim states, and provides download function, a RAM environment, and run controls with easy set-up.

Emulation in the Logic Development System is controlled by the host processor across a medium speed bus. The target microprocessor in the emulation pod and emulation control cards and emulation memory in the development stations card cage use a separate, high-frequency bus (figure 3). The high-speed emulation memory uses 8k, 16k, 32k, or 64k of static RAM.

Ideally, emulation would be functionally and electrically transparent to the target system. With functional transparency, the emulator would impose no demands on the target system, such as reserved address space, interrupt inputs, or direct memory access. An emulator with electrical transparency would not alter the electrical specifications of the target system, such as drive capability, capacitance, timing, clock speeds, and thresholds. Practically, one form of transparency is achieved at the expense of the other form, and trade-offs must be made. In Model 64000, functional transparency has been given primacy. The target system is isolated from the host system, and background operations, e.g., single-stepping, initialization, register interrogation, are transparent to the target system. However, placing the prototype target processor in the emulation pod introduces some electrical changes in the target system; processor drive, logic levels and loading are altered by the buffers, and the bus cables introduce some capacitance. Some electrical transparency was sacrificed to gain a better functional transparency.

A necessary condition to achieve functional transparency is the isolation of emulation buses and memory from the operating system buses and memory. A major benefit gained by functional transparency is real-time emulation. This means the target system and microprocessor will run at operational speeds without the insertion of wait states.

There are three possible modes of emulation. When all program memory is assigned to the target system, only the microprocessor activity is emulated. All execution may be performed from the emulation memory of the development system. A third mode combines these two modes, and program memory is mapped to both memories, and program execution is switched between host and emulation mem-

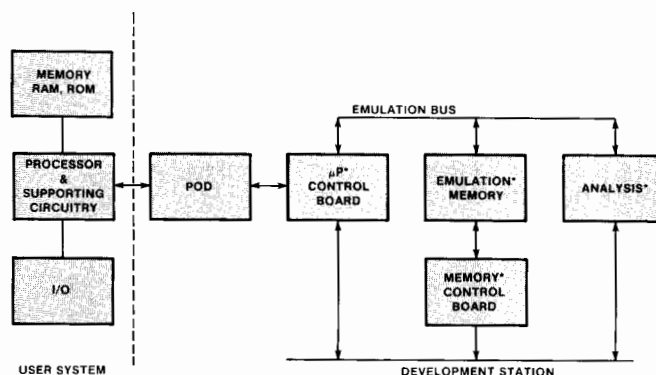

\*In Development Station Option Card Slots

**Figure 3.** The emulation function in Model 64000 uses a separate bus for emulation control and memory, logic analysis and inter-face to the target system. This enhances the functional transparency of the emulator.

ory as specified by the memory assignment map. Real-time operation is possible in all three modes. Fast-access memory chips are used to minimize memory board access time. Model 64000 Logic Development System allows the user to interleave host and target memories in noncontiguous 1k byte blocks.

The emulator is an important link between the development phase and the final product. As a rule, most of the program for a microprocessor-based product is stored in ROM. In the absence of any other tools, EROMs are used during development, but even simple changes can involve a long process. Downloading to the RAM of the emulator is automatic in the 64000 system, and a great time-saver in developing software which will finally reside on the processor ROM. Address space can be allocated to emulation RAM, emulation ROM, target RAM, target ROM, and an illegal address space. Error messages are displayed any time the target processor executes an illegal operation, such as a write to ROM or a reference to an illegal address. The emulator allows mapping in 1k byte segments, up to 64k bytes for 8-bit processors, and 128k bytes for 16-bit processors. Any disjoint grouping of 1k bytes can be mapped from target address space into available emulation memory. Even if all the program is transferred to the target ROM, and one more bug is found, the suspected area can be mapped back to the emulator, revised, and checked without removing the target ROM from the circuit.

**Programming Aids**

**Logic Analyzer**

The optional logic analyzer transparently monitors the emulator bus for a real-time view of activity on address, data, status and control lines of the target microprocessor. Logic analysis is a valuable tool for debugging and sorting out answers to the questions: "What happened?" "Why did that happen?" The logic analyzer occupies a slot in the development station card cage and requires no separate connections.

A major asset of a logic analyzer is a feature which allows the user to "window" a particular piece of system activity or a particular kind of information status. Triggers are used to locate the window. The logic analyzer of the 64000 system can be commanded to trigger (begin or end gathering data) upon the occurrence of one of two conditions, a range of addresses, the sequential occurrence of two conditions, or after the multiple occurrence of a given state. Once trigger conditions are met, the data can be qualified further by

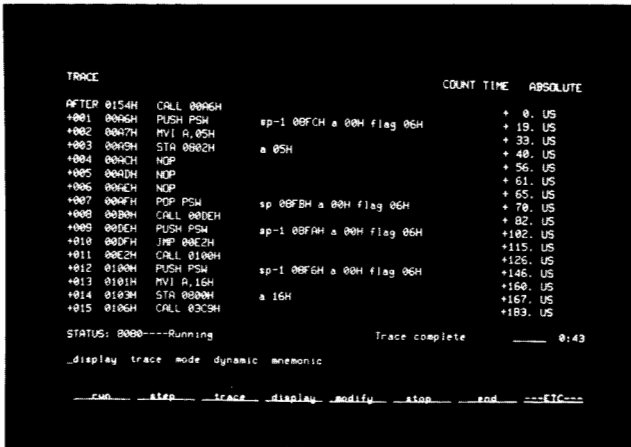

**Figure 4.** The logic analyzer function of Model 64000 transparently monitors the lines of the emulator bus. When state flow on the target system matches the trigger conditions, a trace is made of the system activity, which may be translated into programming mnemonics. The time elapsed after the trigger point is shown with each state in the right-hand column.

collecting only states that satisfy specified criteria, e.g., writes only, writes to a specified address range, etc. The same trigger parameters can be used to trigger external instruments, most commonly an oscilloscope, using the trigger output port.

As an aid to initial performance analysis, each state can be time-stamped by time measured from the trigger event or between traced states. This provides a bench-mark measure for comparing relative efficiency of alternate routines, checking execution time, or identifying a problem by finding anomalies in interevent time intervals.

A useful trigger condition is a sequential trigger with the "sequence restart" state specified. If the two sequential triggers are not found before the "sequence restart" term occurs, the search for the first trigger is begun again. This prevents ghost triggering in complex branching programs or in nested loops, where the first sequence term is found in one pass, and the second term occurs in a later pass, but dissociated from the first term.

Even more complex triggers are possible by programming a series of trigger conditions which are reset automatically by the operating system. Since the trigger conditions are "recognized" in hardware, execution speeds remain near real time. Displays may be translated into the microprocessor mnemonics for convenience in interpreting the state flow (figure 4).

### PROM Programmer

The PROM programming system combines hardware and software to provide simple and efficient programming for most PROMs in use today. The universal PROM programming control card is installed in the card cage of the development station, and the appropriate personality module is mounted in the front panel. Then, programming of the PROMs is automatic, and all conventions for the selected PROM family are observed.

Model 64502A (Model 64001S Option 502) PROM Programmer contains the personality module for 2716 PROMs and the performance verification routines for the control card. This module is included with all PROM programmer options to provide the self-test module.

### System Software

The appropriate software is included with system options. Operating system software is included with disc options; it must be ordered separately if no disc is ordered. Additional software packages can be ordered by model number or as an option to a system order.

Relocating macro assemblers and linkers are included with the ap-



**Figure 5.** Model 64100A Development Station is the basic unit of the 64000 System. The development station houses all the system options, and is the interface between the user and the Logic Development System. Up to six development stations can be used with a printer and one or more hard discs.

propriate emulator option. Assembler/linkers are also available for microprocessors not presently supported by an emulator option.

Pascal compilers are available currently for a limited number of microprocessors. These compilers use Pascal/64000, a modification of the "standard" Pascal language developed by Nicklaus Wirth, with extensions to facilitate separate compilation by modules and to better serve typical byte-oriented microprocessors. In two passes, source files are first translated into an intermediate data structure, and then to relocatable files which are, in turn, linked to form absolute files. The compilers give software designers the advantages of this modern, block-structured language.

### Reliability and Maintainability

Extensive performance verification software and signature analysis documentation provide component-level troubleshooting for the Logic Development System. Service contracts are available and supported by the worldwide HP service staff. All major units of the 64000 System are manufactured by Hewlett-Packard and adhere to a uniform set of quality standards (figure 5).

### Selecting a Logic Development System

Model 64000 Logic Development System is a complex system and, further, in most situations, it represents a major investment. It is recommended that you contact an HP Field Engineer or Logic Development System Specialist for suggested configuration for your design and development applications. Either one can give you a copy of the 64000 Configuration Guide (Publication Number 5953-2714) which gives you a more detailed description of the Logic Development system. Prices for some typical options are listed below.

Ordering Information	Price
64001S Logic Development System for configuration	\$22 865
	to \$127 000
Opt 010 7910H Disc Drive	\$8375
Opt 031 2631 Printer	\$4090
Opt 040 Cartridge Tape Drive	\$1800
Opt 100 Development Station	\$8600
Opt 153 16k Byte Emulation Memory	\$2300
Opt 2XX Emulation System	\$2800
Opt 300 Logic Analyzer	\$1600
Opt 502 PROM Programmer, 2716	\$700
Opt 81X Pascal Compiler	\$2000
Opt 8XX Assembler/Linker	\$550
64100A Development Station	\$8600

# LOGIC ANALYZERS

Simultaneous time, state & glitch information

Model 1615A

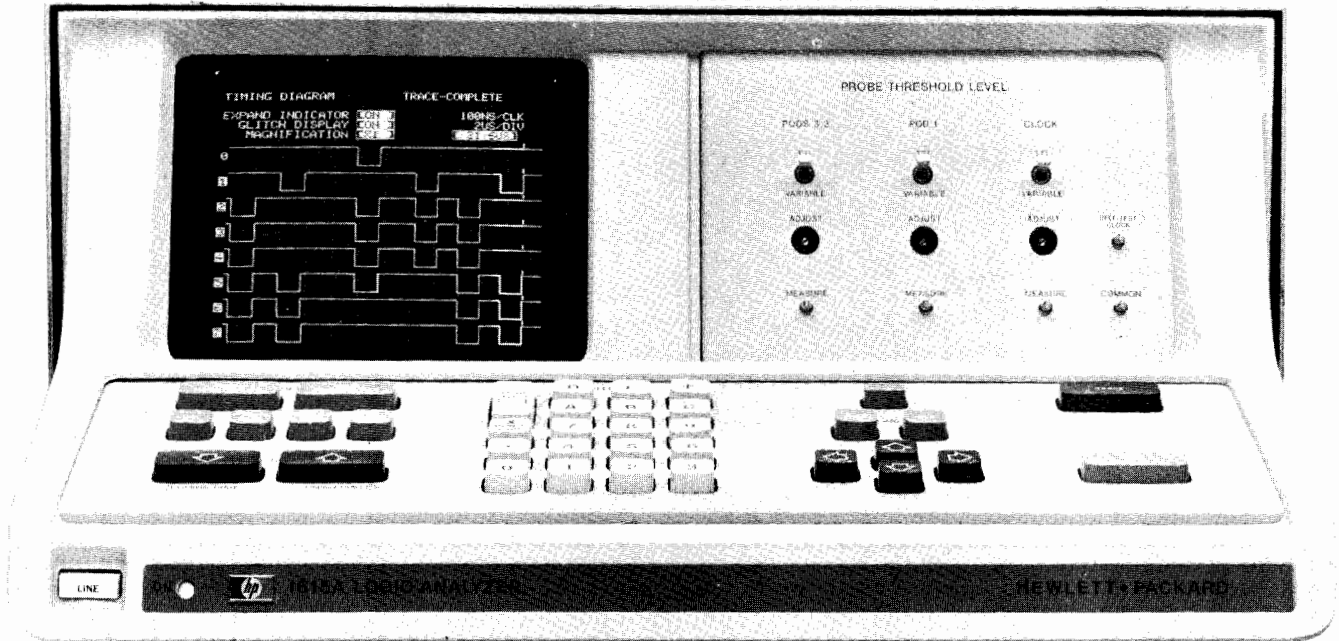

1615A



## 1615A Description

Hewlett-Packard's Model 1615A Logic Analyzer is two instruments in one, a timing analyzer and a state analyzer, for design and troubleshooting of digital systems. With Model 1615A, you can make timing measurements, state measurements, or both simultaneously. Using simple keyboard entries, the 1615A can be configured as an 8-bit timing analyzer, a combined 8-bit timing and 16-bit state analyzer, or 24-bit state analyzer, each with a memory 256 words deep. Powerful triggering capability, synchronous and asynchronous data capture modes, six clock qualifiers, and sophisticated delay functions assure that the timing and data information you need is collected.

The menu system simplifies measurement setups and eliminates the need for a complex, crowded keyboard. Mode of operation, state, time, or dual, is set with the Format Specification menu, and the test parameters are set with the Trace Specification menu. Each menu is an interactive display and parameters are either selected from a defined set or entered directly from the keyboard.

### Asynchronous Measurements

The 1615A makes asynchronous measurements in the time mode of operation, the 8-bit mode. This mode is selected on the Format Specification menu, and clock source, clock slope, labels, logic polarity, and numerical base are also defined on the same menu. Then the Trace Specification menu is used to enter trace parameters. The trace point (trigger) may be placed at the beginning or end of the trace list, so you can view activity either preceding or following the point you specify. Either an external or internal clock may be selected. Up to three ORed trigger states can be entered, or using ON NOT as a trigger condition, any condition other than the one named will act as a trace point. NOT triggering is convenient for monitoring a status word for change, or, with a "don't care" trigger state in end mode, and an external clock, a system crash results in capture of the 256 events preceding the crash. A time or clock delay can be added to trigger conditions.

The 8-bit mode is truly asynchronous in pattern recognition. The pattern duration may be set from 15 to 2000 ns, and when a specified pattern exists for the duration selected, it will be registered by the analyzer even if it was not true when the clock occurred. This feature always produces positive triggering, even with narrow patterns or



The Trace Specifications menu shows the label assigned to the timing lines (E) and the numerical base in which to enter data. This Trace Specification causes the 1615A to use a 100 ns internal clock and begin data collection when any one of the three ORed 8-bit patterns occurs AND a glitch appears on channel 4.

very slow clocks. Glitches are treated as separate parameters, stored in a separate memory, and displayed uniquely, even when they occur at data transitions. Glitches can be added to trigger conditions.

Tracing in the 8-bit mode produces an eight-line timing diagram. Short, vertical bars between the timing lines indicate the location of the trace point. A few quick keystrokes arrange the channels in any order you wish and channels not needed can be turned off. Glitches are recognized by the 1615A any time multiple transitions across threshold occur more than 5 ns apart between sampling pulses. When the glitch display is turned on, glitches are shown as bright vertical bars or as brightened edges if they occur at a data transition. Any part of the display may be selected to be magnified by a factor of ten for a better display resolution. The expand indicator serves a dual purpose as it is also used to display readout of the time between any two selected points of the display.

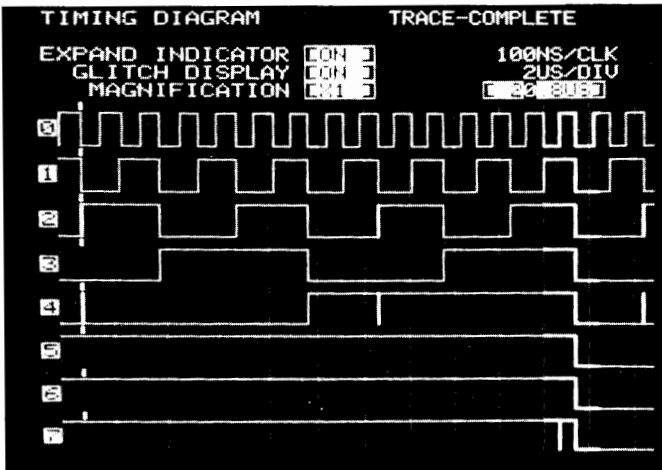

The 1615A displays timing information for up to eight lines and glitches which are displayed as vertical bars or brightened edges when they occur at a transition. A trigger point is indicated by a short vertical bar on each timing line, and is shown at the far left of this display. In addition, the sampling clock period and time per division are displayed.

#### Simultaneous Timing and State Measurements

Model 1615A captures asynchronous and synchronous activity simultaneously. Consequently, timing information can be traced relative to the occurrence of a specific state, or state flow can be monitored relative to a specific timing condition. Now you can monitor those critical "ripple through" paths and relate activity directly to program execution, or watch activity on both sides of an asynchronous I/O port. The 1615A dual mode of operation is the 16-bit and 8-bit mode, selected on the Format menu. Four interactive modes are offered on the Trace Specifications menu: 8-Bit Triggers/Arms 16-Bit and 16-Bit Triggers/Arms 8-Bit.

#### Timing Analyzer Registers Synchronous Data Collection

To observe state flow related to a timing event, either 8-Bit Triggers 16-Bit mode or 8-Bit Arms 16-Bit mode may be used. In trigger mode, the 1615A collects synchronous data as soon as the asynchronous trigger condition is met. Now you can observe state flow directly related to time events, such as activity on a data bus when an interrupt or glitch occurs. If you choose the arms mode, the 1615A will first find the asynchronous trigger, and only then search for specified point in the data flow. In this way you can view program activity, e.g., an output routine, only after a particular timing event occurs, such as a service request.

#### State Analyzer Registers Asynchronous Data Collection

Frequently it is necessary to check timing conditions preceding or following a specific point in program execution. In these situations, the 16-bit state analyzer portion of the 1615A sets conditions for displaying a timing diagram, using either the 16-Bit Triggers 8-Bit mode or 16-Bit Arms 8-Bit mode. A typical application is viewing activity on status or data lines to an input port shortly before reading data at that port. This is accomplished simply by monitoring state flow until the address of that port appears; then in End trace, 16-Bit Triggers 8-Bit, the display would be a timing diagram of activity on the control lines for the period just prior to addressing the port.

#### Synchronous Measurements

The quickest way to find faults in a state machine is monitoring program execution, because any malfunction in the machine is reflected by a corresponding deviation in program sequence. Model 1615A is a powerful state analyzer in the 24-bit mode of operation. The 24 lines may be grouped by up to three labels, and each label group is then treated as a separate variable. Logic polarity and numerical base (hexadecimal, decimal, octal, or binary) is assigned to each label set. The 24-bit trigger may be placed at the beginning or end of the 256-word trace list; any bits not required for the trigger word may be set to X for "don't care." Six clock qualifiers may be used and are set to 1, 0, or X from the keyboard in one or two ORed fields. Delays to 999 999 may be entered for number of states or number of trigger occurrences. The display is either a sequential list of

monitored states or only trigger words. Fifteen lines are visible on the display at any time, and the left column is the location of each line in the analyzer's memory. Other portions of the trace list are viewed by using the roll keys or entering the memory location number. The trigger word is shown in inverse video.

#### HP-IB Interface Bus for Measurement Systems Applications (Opt 001)

Hewlett-Packard Interface Bus (HP-IB) is HP's implementation of IEEE Standard 488-1975. An HP-IB configuration is available for Model 1615A on initial order as Option 001, or can be installed at a later date with Model 10069A HP-IB Interface Field Kit. With HP-IB, the 1615A can be configured for automatic functional testing of digital systems. Combined with a controller, such as HP Model 9825A, data captured by the logic analyzer can be transferred to the controller for automatic analysis. Hard copy of menus, data lists and timing diagrams can be produced by a variety of HP-IB compatible printers and plotters. In the laboratory, the speed and ease with which data is accumulated, summarized, and documented in hard copy lets you spend more time on analysis and design and less time in data collection. In production, automated testing reduces time and cost for making extensive tests on systems and subassemblies. Test programs with built-in operator instructions decrease testing costs even further by cutting training costs and providing uniform test procedures.

The primary advantage of computer control is the execution of complex, time-consuming measurement routines with minimal operator involvement. Trace parameters can be set and the data can be read, stored and compared. Branching decisions can be programmed which are based on the data collected by the 1615A. Data can be translated from assembler code to mnemonic code, or used for statistical computations. Operator prompts and computational results can be displayed on the 1615A CRT. Documentation can be collected directly with hard copy from a printer or plotter.

Many measurements not possible with stand-alone instruments become practical with the HP-IB interface. In the laboratory, a controller operated system can present statistical results graphically, as with a bar graph or cumulative curve of the number of calls to a subroutine or interrupt hits. Continuous monitoring routines can compare data acquired by the 1615A to stored data and then branch to restart a sequence or to collect other data. For better maintenance, particular control lines or subroutines can be monitored automatically and signals output when marginal operating conditions indicate a need for service (e.g., service a tape drive as a function of rewrite activity or parity check errors). In production, automated measurements are made more consistently and can be performed more quickly for better quality control and greater throughput.

TRACE LIST		TRACE-COMPLETE
LINE NO.	A HEX	C HEX
000	03E3	E1
001	03E4	03
002	03E1	10
003	03E2	C2
004	03E3	E1
005	03E4	03
006	03E1	10
007	03E2	C2
008	03E3	E1
009	03E4	03
010	03E1	10
011	03E2	C2
012	03E3	E1
013	03E4	03
014	03E1	10

A trace list of synchronous activity in the 24-bit mode of operation can be grouped under any of four labels, with a separate numerical base for each label group. In this trace two labels are used, both in hexadecimal base, and only addresses of the form 03EX<sub>16</sub> are captured for display.

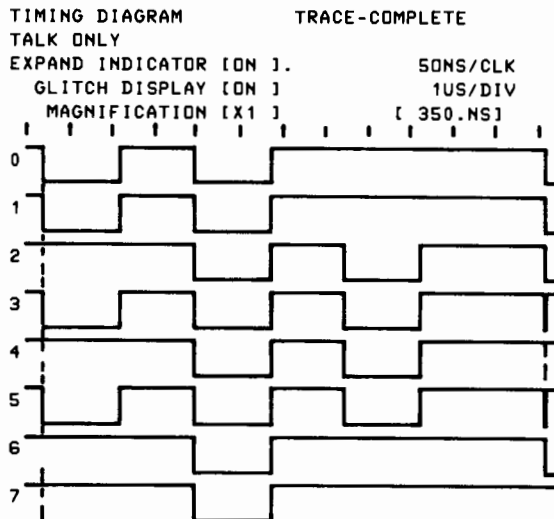

Model 1615A Option 001, the HP-IB option, can be used to link the 1615A to a printer or plotter, and in a Talk Only mode, the analyzer will output hard copy of menus, state trace lists, or timing diagrams without using a controller.

### Probes

Input data are sensed through 24 high impedance probes at rates to 20 MHz. The data probes are in three 8-bit pods for easier connection to the system under test. The fourth pod contains the clock probe, six qualifiers, and an external trigger. Threshold level is set on the front panel for TTL level, or adjusted in a range from  $-10\text{V}$  to  $+10\text{V}$ . It is possible to set one threshold for 16 data lines, a second threshold for the other eight data lines, and a third threshold for the clock pod, allowing you to make simultaneous measurements on systems comprised of several logic families, ECL, TTL, MOS, etc.

The front section of each probe may be disconnected from its pod, permitting individual leads to be wired into connectors for particular systems. Additional probe lead kits, probe tips, and interface kits are available to simplify set up and connection. Refer to the Logic Analyzer Accessories, page 170.

### Trigger Outputs

Once you have delineated a problem area with the 1615A Logic Analyzer you may want to use other measurement instruments for further investigation, e.g., an oscilloscope for more detailed timing analysis. The logic analyzer's state trigger output is stable with respect to the system clock, and provides a reliable reference point for triggering other instruments. The timing trigger output is based on the pattern recognition trigger at the probe, and can be used in the same manner as a state trigger point. A trace point output is also available to generate interrupt signals or "clock stopper" circuits in other parts of the system under test.

### Self Test

Self-test capability confirms the proper operation of the 1615A. During turn-on, a self-test to check ROM/RAM is performed automatically and a message on the analyzer display indicates completion of this test. Keyboard, data acquisition and two data stream analysis self-tests can be initiated from the keyboard if desired.

## 1615A Specifications

### Operating Modes

**24 Bit (State):** for asynchronous monitoring of one or more buses with combined width up to 24 bits.

**8 Bit (Time):** for asynchronous monitoring of control line activity or any asynchronous data lines.

### 16 Bit & 8 Bit (simultaneous State and Time)

**16 Bit Triggers 8 Bit:** 16-bit state trigger point is reference point for acquisition of 8-bit timing data.

**16 Bit Arms 8 Bit:** sequential trigger, 16-bit state trigger point initiates search for 8-bit timing trigger.

**8 Bit Triggers 16 Bit:** 8-bit timing trigger is reference point for acquisition of 16-bit state data.

**8 Bit Arms 16 Bit:** sequential trigger, 8-bit timing trigger point initiates search for 16-bit state trigger.

### Clock, Qualifier, and Data Inputs

**Repetition rate:** to 20 MHz.

**Input RC:** 100 k $\Omega$  shunted by  $\leq 5$  pF at probe body.

**Input threshold:** TTL, fixed,  $\approx +1.4$  V; variable  $\pm 10$  Vdc.

**Maximum input:**  $-40$  V to  $+40$  V.

**Dynamic range:**  $-15$  V to  $+15$  V.

**Minimum input**

**Swing:** 0.6 V

**Clock pulse width:** 20 ns at threshold level.

**Setup time:** time data must be present prior to clock transition, 20 ns.

**Hold time:** time data must be present after clock transition, zero.

### Synchronous Operation

**Trigger delay:** to 999 999 clocks.

**Trigger occurrence:** to 999 999.

### Asynchronous Operation

**Sample rate:** 2 Hz to 20 MHz.

**Data skew:** 9 ns max.

**Minimum detectable glitch:** 5 ns with 30% peak overdrive or 250 mV, whichever is greater.

**Glitch trigger:** on any selected channel(s), if a glitch is captured, the glitch is ANDed with the asynchronous pattern trigger.

**External trigger pulse width:** 5 ns min with 30% peak overdrive or 250 mV, whichever is greater.

**Pattern trigger:** any 8-bit pattern. Trigger duration required is selectable 15, 50, 100, 200, 500, 1000, or 2000 ns  $\pm 15$  ns or 15%, whichever is greater.

**Delay time:** to 1 048 575 x sample period.

### Trigger Outputs (Rear Panel)

#### 16/24 Bit trigger output

**Level:** high,  $\geq 2$  V into 50 $\Omega$ ; low,  $\leq 0.4$  V into 50 $\Omega$ .

**Pulse duration:**  $\approx 25$  ns.

**Delay from input clock:**  $\approx 85$  ns.

#### 16/24 Bit trace point output

**Level:** high,  $\geq 2$  V into 50 $\Omega$ ; low,  $\leq 0.4$  V into 50 $\Omega$ .

**Pulse duration:** starts at beginning of trace and ends at trigger point (pattern trigger plus delay).

**Delay from input clock:**  $\approx 85$  ns.

#### 8 Bit pattern output

**Level:** high  $\geq 2$  V into 50 $\Omega$ ; low  $\leq 0.4$  V into 50 $\Omega$ .

**Pulse duration:** pattern duration minus asynchronous trigger duration width.

**Delay from pattern at probe:**  $\approx 75$  ns plus synchronous trigger duration width.

### General

**Memory depth:** 256 data transactions (in timing display mode, 249 samples are displayed).

**Power:** 100, 120, 220, 240 Vac;  $-10\%$  to  $+5\%$ ; 48 to 66 Hz; 230 VA max.

**Size:** 189 H x 426 W x 664 cm D (7  $\frac{1}{16}$ " x 16  $\frac{3}{4}$ " x 26  $\frac{1}{8}$ ").

### Operating environment

**Temperature:**  $0^\circ\text{C}$  to  $+55^\circ\text{C}$ .

**Humidity:** up to 95% relative humidity at  $+40^\circ\text{C}$ .

**Altitude:** to 4600 m (15 000 ft).

**Vibration:** vibrated in three planes for 15 min. each with 0.3 mm (0.015 in.) excursions, 10 to 55 Hz.

**Weight:** net, 19.1 kg (42 lb); shipping, 23.6 kg (52 lb).

**Accessories supplied:** three 8-bit Model 10248C data probes and one Model 10248C clock probe with probe leads and tips (three probes for data and one probe for clock, qualifiers, and external trigger), one 2.3 m (7.5 ft) power cord, and one Operating and Service Manual.

### Ordering Information

**1615A Logic Analyzer**

**Opt 001: HP-IB Interface**

**Price**

**\$6800**

add \$400

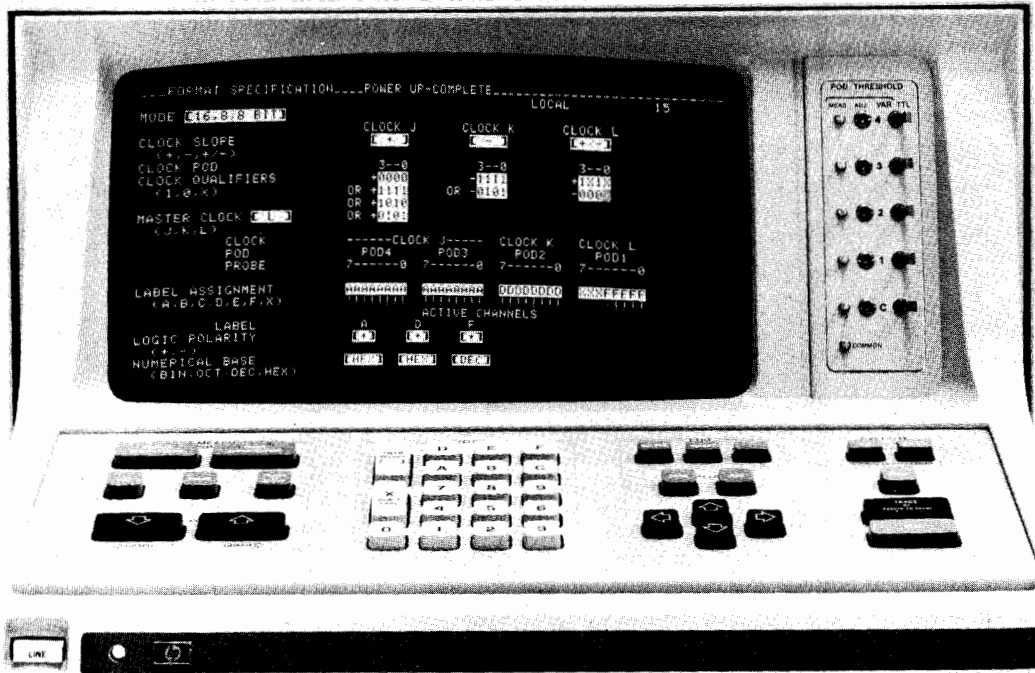

1610B



### 1610A and 1610B Description

Hewlett-Packard Models 1610A and 1610B Logic State Analyzers offer general purpose measurements in microprocessor-based systems, minicomputers, or virtually any digital circuits. Model 1610B includes the feature set of Model 1610A, and other features, most notably the addition of multiple clocks and clock qualifiers for direct monitoring of multiplexed data flows. The 1610 performs synchronous real-time traces at speeds to 10 MHz with an extensive triggering capability on as many as seven sequential words, each as wide as 32 bits. A simple, functionally organized keyboard together with the interactive display are combined in the menu concept, allowing you to focus your analysis work, capturing only pertinent data.

Measurements of system activity are displayed on the analyzer's CRT screen in selectable hexadecimal, octal, binary, or decimal codes. Setup for a measurement is aided with the Format and Trace specification menus which indicate the test parameters you are to enter. Data is strobed into Model 1610A with the selected edge of the analyzer clock, while Model 1610B uses a combination of edges and qualifiers of three clocks. The events and activity that are captured and displayed from the system are gathered at clock transitions after the 1610 locates the specified trace position and then captures 64 words of data. The displayed trace may be a simple breakpoint with the trace position at the beginning, end, or center of the captured data; or, in a state sequence where one to seven words must be found in a specified order before data is captured. This state sequence permits you to directly locate sections of branched, looped, or nested loops of state flow. A selective trace of from one to seven words may be OR specified which allows only the words of interest to be captured and eliminates data that is not necessary for your measurement.

A count measurement capability allows you to perform a time or state count on all 64 traced states in either absolute or relative modes. With the count measurement you can determine how much time a program spends in loops, servicing interrupts, as well as the time between program steps. This measurement is performed simultaneously with the trace and all 64 words traced are assigned a count record which is displayed as positive or negative time in relation to the loca-

tion of the trace position (absolute mode), or in relation to the previously acquired state (relative mode).

One complete measurement, including Format and Trace Specifications, may be internally stored to be recalled at a later time or for use in a trace compare mode. When a trace compare mode is called, the display presents an exclusive OR tabular listing of the differences between the current and stored measurements. The trace compare mode may be also used to direct the Analyzer to continuously rerun a measurement until the current and stored measurements are equal, or not equal, and the 1610 automatically halts and retains the current measurement.

The 1610 includes a Trace Graph to provide a display of data magnitude versus time sequence for all 64 words in memory. Each dot representing a word is given a vertical displacement corresponding to its magnitude and is positioned horizontally in the order of its occurrence. The result is a graph that offers a quick overview of program operation.

For increased confidence of the instrument's operation, there are self-tests for the keyboard, ROM/RAM, display, a trace test which includes all probe pods, an interrupt test, and a printer test.

Hard copy of both the Format and Trace specifications as well as the Trace List and Trace Compare can be obtained by adding a Hewlett-Packard printer (Model 9866B or 9876A). Rear panel printer outputs are included in the 1610 for direct interfacing.

With Option 003 or a field installation kit, both models can be used with any of the family of HP-IB instruments. HP-IB is Hewlett-Packard's implementation of IEEE Standard 488-1978 interface bus. With the HP-IB capability, a controller such as HP Model 9825A Desktop Computer can be added for automated analysis, data reduction, and test procedures.

### Data Entry

Entries are made in inverse video fields with the entry location indicated by a blinking cursor. Entry fields (enclosed with brackets) are multiple choice with the desired test parameter selected by using the Field Select key (e.g. positive or negative edge of clock transition).





## Models 1610A and 1610B (cont.)

Trace specifications are entered through the keyboard directly in octal, hexadecimal, binary, or decimal notation which permits working in a familiar format without worrying about base conversions.

### Menu

The displays which are called up by keyboard commands are referred to as menus because they include the selections for setting up test parameters and labeling of test results. These menus include Format Specification, Trace Specification, Trace List, Trace Compare, and Trace Graph.

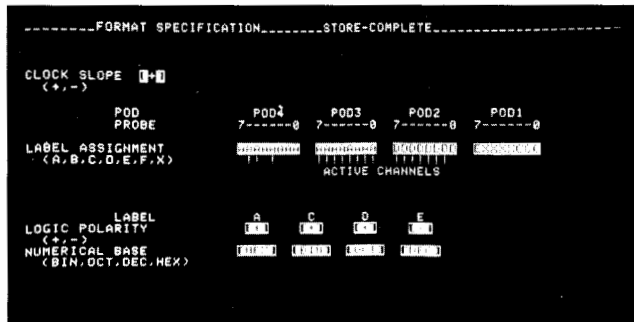

Format specification menu of Model 1610A lets you define which group of bits will act as a unit by assigning labels which may be separately defined as to numerical base and polarity. The allowed selections are defined on-screen to minimize front panel controls.

### Format Specification

The formatting capabilities allow you to separate the 32 input data channels into the desired test parameters. This allows those data bits which act as a unit to be assigned to one of six labels (e.g. 16 bits of address bus assigned as "A" and 8 bits of data bus assigned as "D"). This labeling capability then permits all trace specifications to be assigned as a unit rather than on individual lines. Each assigned label may be independently defined in positive or negative logic as well as different bases of binary, octal, decimal, or hexadecimal. Another feature of this menu is that active channels are shown as exclamation marks (!) for a quick overview of system activity.

Model 1610B offers multiphased, qualified clocking. The three clocks can be set in three modes: 32-bit, 16-16 bit or 16-8-8 bit. In the 32-bit mode, all data present on the four data pods are clocked into the logic analyzer simultaneously on all selected active edges of the ORed combination of clocks J, K, and L. For each clock there are four choices for the active edge: positive edge (+), negative edge (-), both edges (+/-), or off. For each clock used, there are up to four qualifier minterms. A minterm bit may be set to 1, 0, or X (don't care). In the 16-16 bit mode, data from pods 4 and 3 are strobed into the logic analyzer with clock J, and data from pods 2 and 1 are

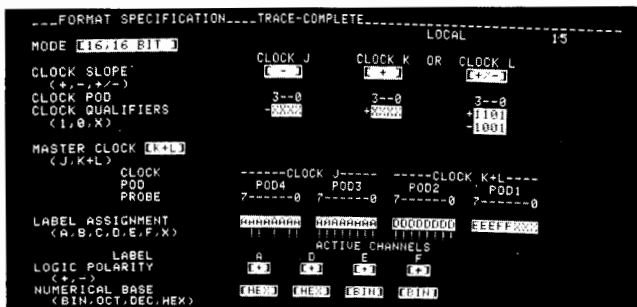

Model 1610B offers up to three clocks, used independently or in ORed combinations. For active clocks, either or both edges can be used to strobe data into holding registers on the current list, and each clock can be qualified with up to four minterms.

strobed in with the ORed combination of clocks K and L. The master clock, J or K+L, is set on the menu, and is the last to occur in the sequence of events monitored. Data from the other clock(s) are put in a holding register and transferred to the trace list with the edge of the master clock. In the 16-8-8 bit mode, all three clocks are used independently with data on pods 4 and 3 strobed in by clock J, data from pod 2 strobed in by clock K, and data on pod 1 strobed in by clock L.

### Trace Specification

After the Format Specifications have been defined, the Trace Specification menu is called up and the measurement parameters are entered. The Trace measurement may be defined as a single word or may be in a sequence of from one to seven words which must be found in the specified order. The ability to select a sequence of words allows

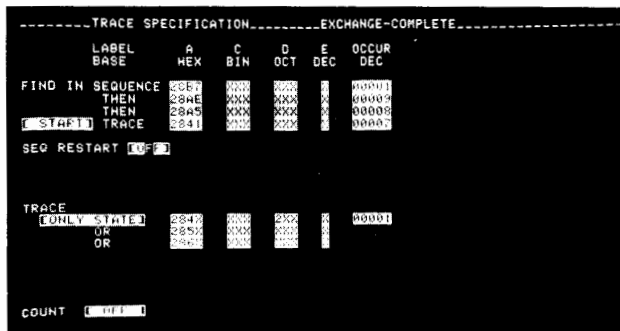

Typical trace specification for defining a test sequence that will capture a nested loop as well as only selected states in the loop.

you to locate sections of branched, looped, or nested loops during machine operation. To further qualify the sequence, each word in a sequence may be specified to occur from 1 to 65 536 times so you can capture the nth pass of a loop beginning at a given word.

A Sequence Protect function is included with Model 1610B. When Sequence Protect function is ON, data acquisition is accomplished in the same manner as with Model 1610A. No data but the sequence terms are stored until after the last sequence term is found. When the Sequence Protect function is OFF, data is stored immediately after the beginning of the trace and is displayed relative to the trace point position. Rather than listing the sequence terms, the display shows only SEQUENCE FOUND. When the trace is centered or placed in end trace mode, the sequence terms which are a part of the trace are not labeled as sequence terms.

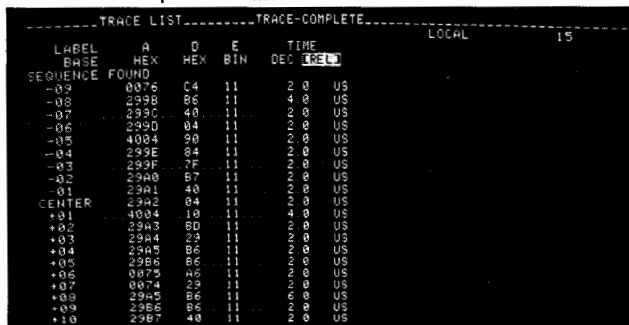

When the Sequence Protect function of Model 1610B is off, the logic analyzer begins data storage immediately at the beginning of the trace. Rather than showing the sequence words separately, the remarks SEQUENCE FOUND is displayed. Sequence terms are not labeled.

### Trace List

When the Trace key is pressed, the 1610 searches for the word sequence defined in the Trace Specification. As the data is captured it is displayed on the CRT along with a line number and alphabetically formatted into the assigned labels and in their numerical base. The display contains 20 words, and Roll keys permit you to view the entire 64 word listing. To make it easier to locate the Trace position, which may be selected to start, be in the center, or end a trace, Start is spelled out on the display. Any count information is also presented adjacent to each word.

The count measurement may be specified to be either Time or State (word) count for all 64 words in memory and may be in either absolute mode or relative mode. The absolute mode gives you the time or count between the trace position and a selected word, while the relative mode presents the time or count between each consecutively acquired state. This allows you to directly determine the time spent in loops, interrupts, or program time between steps.

```

-----TRACE LIST-----EXCHANGE-COMPLETE-----
 LABEL   A   C   D   E   TIME
 BASE   HEX  BIN  OCT DEC  DEC
SEQUENCE 28B7 000 206 1 1 009 S
SEQUENCE 28A5 000 206 1 80 00 MS
SEQUENCE 28A1 000 000 1 6 049 MS
START    2842 000 232 1 4 0 US
+01     2843 000 000 1 2 0 US
+02     2844 000 232 1 4 0 US
+03     2845 000 002 1 2 0 US
+04     2846 000 200 1 4 0 US
+05     2847 000 002 1 2 0 US
+06     2848 000 046 1 2 0 US
+07     2849 000 004 1 2 0 US
+08     284A 000 212 1 6 0 US
+09     284B 000 000 1 2 0 US
+10     284C 000 204 1 2 0 US
+11     284D 000 002 1 2 0 US
+12     284E 000 316 1 4 0 US
+13     284F 000 050 1 2 0 US
+14     2850 000 344 1 2 0 US
+15     2851 000 010 1 2 0 US
+16

```

Trace list displays the label and numerical bases, as well as the sequence requirements and resulting state flow. This example also shows time in the relative mode which is the elapsed real time between each state and the previously acquired state.

Model 1610B offers two additional features for ease of operation. Pressing the Default key after rolling the display returns the listing to the initial trace point. A memory retrieval function has been added and is entered by holding down the Stop key for two or three seconds. This is useful when a clock has failed or trigger conditions were not met. The trace is aborted and up to 63 states of the most recent transaction in memory are displayed with a remark, either HISTORY AT STOP or NO HISTORY AVAILABLE.

**Trace Graph**

Trace Graph is a presentation of data magnitude versus time sequence which provides a display of all 64 words in memory. This graph allows you to see at a glance in which part of a program the machine under test is operating. Each word is displaced vertically according to its magnitude and positioned horizontally in order of its occurrence. The data to be graphed is selected by label with its base displayed on screen.

The trace graph mode is the same for both models with the exception that the graph display of Model 1610B indicates whether the graph is generated from current trace or a stored trace.

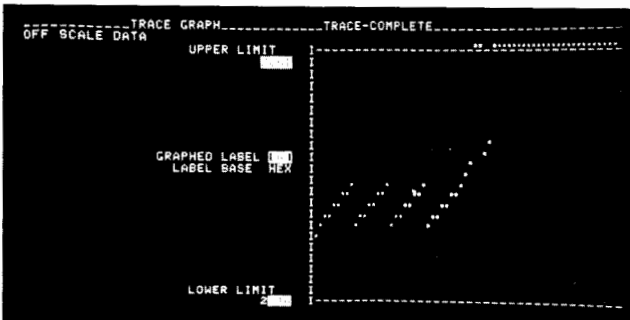

A trace graph may be selected to give you a view of all 64 states in the analyzer's memory. Each dot's vertical position is determined by its numerical value and its horizontal position is determined by its time sequence of occurrence.

**Trace Compare**

One complete trace measurement including format and specification may be stored internally which allows comparison between a current and stored measurement. The current and stored measurement may also be interchanged which allows you to quickly review the stored measurement as well as its specifications.

Trace Compare presents an exclusive OR tabular listing of the differences between the current and stored measurements. The listing is formatted and rolled as a trace list with identical bits displayed as zeros and different bits displayed as nonzeros. For example, in the octal base, 03 is equivalent to a binary 000 011 which means that the least significant bits are different in the two measurements. A compared Trace mode is also available which directs the 1610 to continuously rerun a measurement until the current and stored measurements are either equal or not equal which makes it much easier to capture intermittent problems.

**HP-IB Interface**

HP-IB Interface may be added initially with Model 1610A or 1610B as Option 003 or installed later with a field kit. With the HP-IB interface, you can combine the 1610 with any instrument that is HP-IB compatible, such as printers, plotters, external memories, and computing controllers.

The most common configuration is the addition of a computing controller, such as 9825A Desktop Computer, and a printer and/or plotter for automatic operating modes. In the laboratory, data can be accumulated, summarized, and documented quickly. Statistical computations can be completed automatically, with results displayed on the logic analyzer and hard copy. Making your analyzer "programmable" drastically reduces time and cost of making production tests by reducing, and sometimes eliminating, the need for constant surveillance by highly skilled operators. Testing becomes standardized, and operator prompts can be built-in, simplifying training and decreasing the number of operator errors. Babysitting (continuous, long-term monitoring) can be done unattended, with branching instructions and resetting done by the controller. Maintenance of a digital system is streamlined and focused on prevention rather than repair by using the analyzer/controller combination to flag marginal operation in subunits of software and hardware.

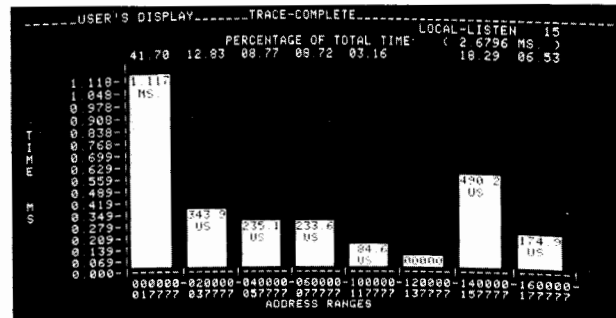

When the HP-IB interface is used with a controller, data collected by the analyzer and user-defined menus are transferred to the controller. In this example, the controller counts the events occurring in each address range, and displays the results, with percentages, as a histogram on the 1610 CRT.

**Probes**

Input data is sensed through 32 high impedance probes at rates to 10 MHz. Data probes are separated into four 8-bit pods for easier connection to a system, with a fifth probe pod for connecting to a clock source. To make it easier for connecting to different systems, the front section of each probe may be disconnected from its pod. This allows the individual probe leads for each probe pod to be wired to connectors for specific systems. Additional probe lead kits as well as probe tips are available separately as accessories.

```

-----TRACE COMPARE-----COMPARED TRACE-COMPLETE-----
 LABEL   A   C   D   E   COMPARED
 BASE   HEX  BIN  BIN  DEC  TRACE MODE
START    0000 000 00000000 0 0
+01     0000 000 00000000 0 0
+02     0000 000 00000000 0 0
+03     0000 000 00000000 0 0
+04     0000 000 00000000 0 0
+05     0000 000 00000000 0 0
+06     0000 000 00001100 0 0
+07     0000 000 00000000 0 0
+08     0000 000 00000000 0 0
+09     0000 000 00000000 0 0
+10     0000 000 00000000 0 0
+11     0000 000 00000000 0 0
+12     0000 000 00000000 0 0
+13     0000 000 00000000 0 0
+14     0000 000 00000000 0 0
+15     0000 000 00000000 0 0
+16     0000 000 00000000 0 0
+17     0000 000 00000000 0 0
+18     0000 000 00000000 0 0
+19     0000 000 00000000 0 0

```

The trace compare mode offers an exclusive OR comparison of stored versus active data. In this example, the 1610 stopped data acquisition when the active data was not equal to the stored data at state +06.

# LOGIC ANALYZERS

Models 1610A and 1610B (cont.)

## Trigger Outputs

Once a fault is found, another type of analysis instrument, usually an oscilloscope, is often required to pinpoint the problem. The analyzer's Trigger Output is stable with respect to the system clock so an oscilloscope can be used for critical timing measurements. The Measurement Enable output is useful for gating clocks or interrupting the device under test or for added "clock stopper" circuits in other parts of the system.

## 1610A and 1610B Specifications

### Clock and Data Inputs

**Repetition rate:** to 10 MHz.  
**Input RC:** 100 kΩ shunted by approx 5 pF at probe body.  
**Input threshold:** TTL, fixed at  $\approx +1.5$  V; variable,  $\pm 10$  Vdc.  
**Max input:** -40 V to +40 V.  
**Dynamic range:** -15 V to +15 V.

### Min input

**Swing:** 0.6 V.  
**Clock pulse width:** 20 ns at threshold level.  
**Edge-to-edge timing:** (1610B) master active edge to master active edge, 100 ns; master active edge to next slave active edge, 20 ns; slave active edge to slave active edge, zero.  
**Data setup time:** time data must be present prior to clock transition, 20 ns.  
**Hold time:** time data must be present after clock transition, zero.

### Trigger and Meas Enable Outputs

**Trigger output (rear panel):** a 50 ns  $\pm 10$  ns positive TTL level trigger pulse is generated each time the trace position is recognized. If the trace position includes a word sequence, the pulse occurs when the last word is found. Trigger outputs continue until a new specification is traced or the Stop key is pressed. Pulse rep-rate is 0 to 10 MHz depending on input data rates. In continuous or compared trace modes, the internal display process blanks out pulses for 100  $\mu$ s at rep-rates of <20 Hz.

**Measurement enable output (rear panel):** (1610A, serial number prefix 1812 or below) the positive TTL level measurement enable output goes high and remains high when the 1610A is looking for a trace position and goes low when a trace position is recognized or if the Stop key is pressed. In continuous or compared trace modes the transitions repeat each time the 1610A makes a new measurement. (1610A, serial number prefix 1822 or above, and 1610B) two BNC rear panel outputs for TTL-level measurement enable. One BNC outputs a signal which goes high and remains high when the analyzer is

looking for a trace position and goes low when a trace position is recognized or Stop key is pressed. Other BNC goes low and remains low when the analyzer is looking for a trace position and goes high when a trace position is recognized or Stop key is pressed.

**Delay from input clock:**  $\leq 150$  ns.

### General

**Memory depth:** 64 data transactions; 20 transactions are displayed on screen, roll keys permit viewing all 64 data transactions.  
**Time interval:** resolution, 100 ns; accuracy, 0.01%. Maximum time, 429.4 seconds.

**Events count:** 0 to  $2^{32} - 1$  events.

**Power:** 100, 120, 220, 240 Vac; -10% to +5%; 48 to 63 Hz; 260 VA max.

**Rear panel BNC output:** 5 V, 100 mA output for logic probe or other accessories.

**Size:** 230 H x 425 W x 752 mm D (9 $\frac{1}{16}$ " x 16 $\frac{3}{4}$ " x 29 $\frac{5}{8}$ ").

### Operating environment

**Temperature:** 0°C to +55°C (+32°F to +132°F).

**Humidity:** up to 95% relative humidity at +40°C (+104°F).

**Altitude:** to 4600 m (15 000 ft).

**Vibration:** vibrated in three planes for 15 min. each with 0.25 mm (0.010 in.) excursions for 1610A and 0.38 mm (0.015 in.) excursions for 1610B, 10 to 55 Hz.

**Weight:** (1610A) net, 26.5 kg (58.5 lb) shipping, 32.2 kg (71 lb). (1610B) net, 23.8 kg (52.5 lb); shipping, 29.4 kg (65 lb).

**Accessories supplied:** four 10248C data probes and one 10247A clock probe for 1610A; five 10248C data probes for 1610B; one 2.3 m (7.5 ft) power cord, one Operating manual, and one Service manual.

### Ordering Information

	<b>Price</b>
<b>1610A</b> Logic State Analyzer	\$11000
<b>1610B</b> Logic State Analyzer	\$12500
<b>Opt 002:</b> adds 9866B Thermal Printer	add \$4100
<b>Opt 003:</b> (1610A) HP-IB Interface (factory installed)	add \$800
<b>Opt 003:</b> (1610B) HP-IB Interface (factory installed)	add \$700
<b>Opt 004:</b> adds 9876A Thermal Printer	add \$3950
<b>10494A</b> HP-IB Interface Kit for 1610A Serial Number Prefix 1812A and below	\$1200
<b>10495A</b> HP-IB Interface Kit for 1610A Serial Number Prefix 1822A and above	\$900
<b>10496A</b> HP-IB Interface Kit for 1610B	\$800
<b>10499A</b> Field Retrofit Kit to upgrade 1610A (Serial Number Prefix 1940A and above) to 1610B	\$1800

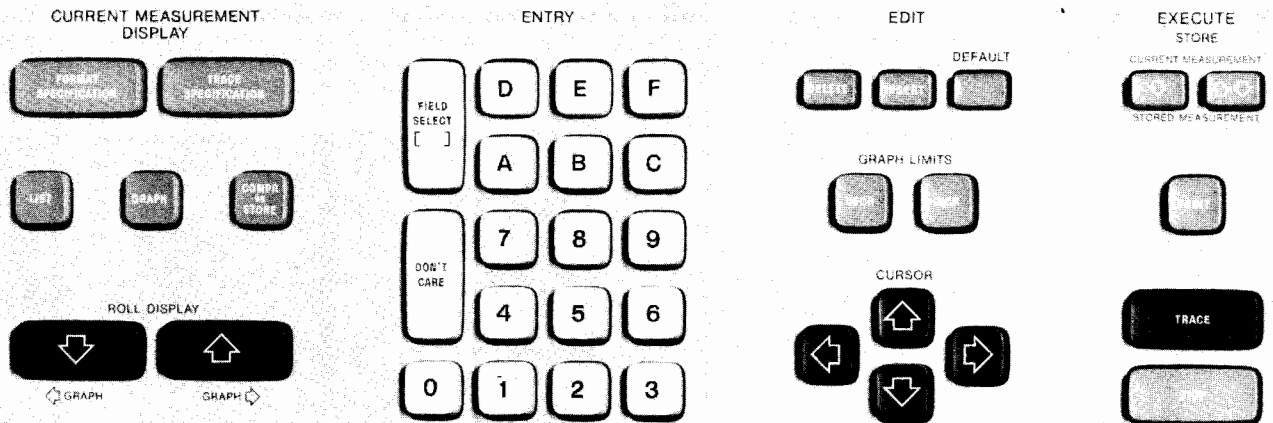

Logically arranged Logic State Analyzer keyboard, divided into functional blocks, and an interactive display, allow entry of complex measurements with a minimum of controls.

General purpose logic analysis, automated testing, HP-IB debugging  
Model 1602A

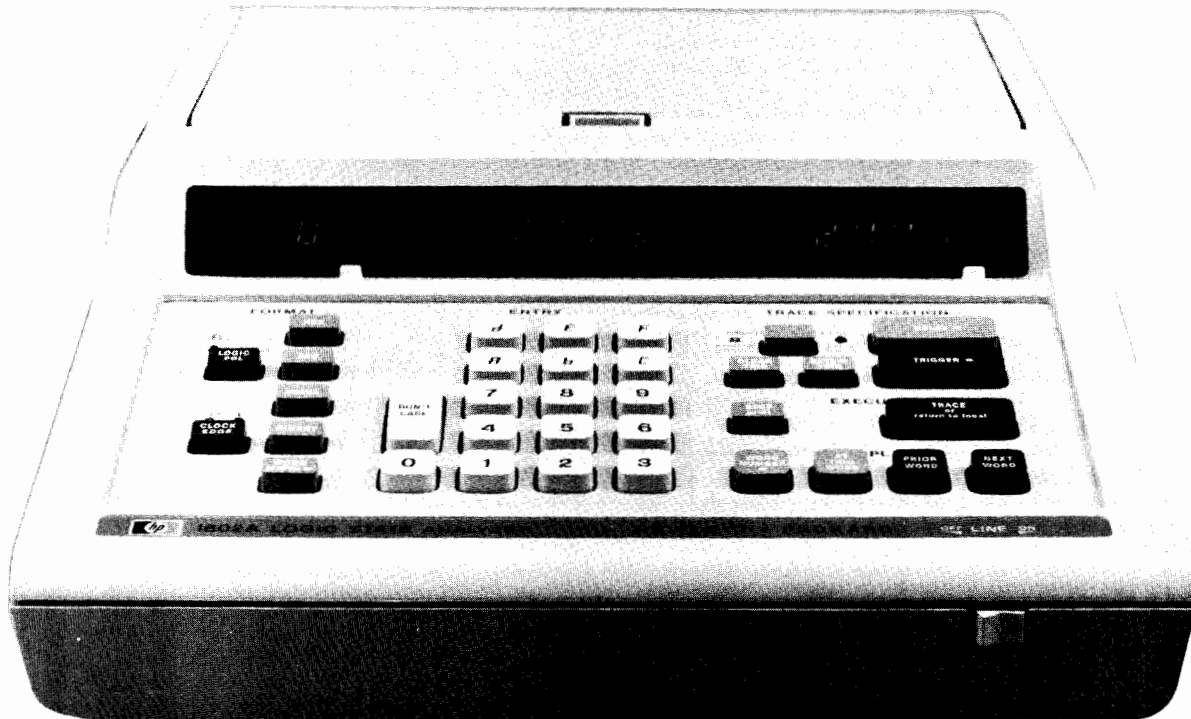

1602A



## 1602A Description

Hewlett-Packard's easy-to-use low-cost Model 1602A keyboard controlled Logic State Analyzer is for use in the design and troubleshooting of digital systems. The 16-bit wide and 64-word deep memory operates at clock speeds to 10 MHz allowing the instrument to capture virtually any 64-word sequence in a system. The data may be registered with versatile pattern recognition trigger and digital delay. Measurements of system activity are displayed on the Analyzer's LED readout in hexadecimal, octal, or binary format, which eliminates the need for base conversions by the operator. Keyboard entry of the desired trigger is in the same base as selected for the display.

A Hewlett-Packard Interface Bus option (HP's implementation of IEEE Standard 488) allows you to make automated functional tests of digital systems. This means more consistent and repeatable measurements as well as more thorough testing because the test speed of the automated system allows more measurements in a shorter time in both production and service environments.

## Ease of Use

The 1602's keyboard with its key-per-function layout is basically self-teaching. Entry of triggering and display conditions is a series of self-explanatory keystrokes with all entries displayed as they are entered enabling you to check their accuracy every step of the way.

## Data Probe

The simplicity of the Analyzer starts with the probe which is a single pod containing all 16 data lines, clock, qualifier, and ground. At the front of the pod is a standard edge connector which allows you to quickly move the test connection from an address bus to the data bus, control lines, or I/O structures. You need only incorporate a few simple mating printed circuit board connectors in your system.

## Tracing Data Flow

Capturing data flow is also easy and only requires a logical sequence of key strokes. The first item to define is the Logic Polarity of your system by pressing the Logic Polarity key. The panel LED's indicate your selection, positive for high true and negative for low true. Next select the clock edge on which you want to gather data which is also indicated by panel LED's.

Now select the display format that you want to use for the test. If you are running tests on an address or data bus, you would most likely select either hexadecimal or octal display format. However, if the test is on an I/O bus with numerical data, decimal may be preferred. For activity on control lines, binary is a meaningful base. In all cases the display indicates the selected format with a base (b) notation on the right. Many times all of the input lines are not used and if you want to blank the more significant bits, just press the Word Width key and enter the number of bits to be displayed from 2 to 16.

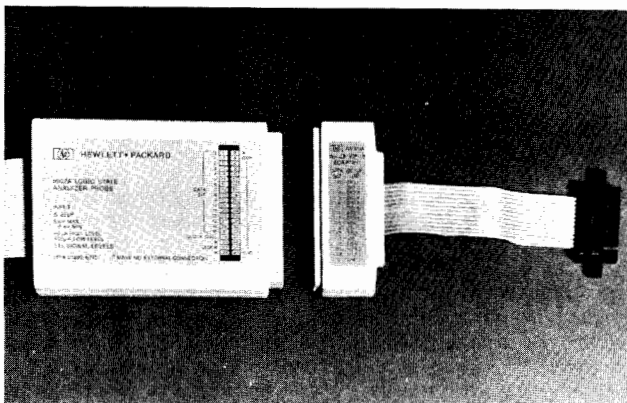

# LOGIC ANALYZERS

## Model 1602A (cont.)

The desired data window is entered from the Trace Specification section of the keyboard. If you want to view data after the desired trigger point, press Trigger Plus Delay Starts Trace which directs the 1602A to start collecting data as soon as the Trace Specification is satisfied. If you are more interested in data preceding the trigger point, select Trigger Plus Delay Ends Trace. For either mode, Start or End, an LED indicates the selected mode.

To define a trigger point, press the Trigger = key and enter the desired trigger point, e.g. 2805, in the same format previously selected for the display. The trigger word is displayed for verification.



To enter a delay that will position the start or stop of data collection a specific number of clock pulses from the trigger word, press the Delay = key and enter the number of desired clock pulses. The delay count is entered and displayed in decimal format. Delays of up to 65 535 clock pulses after the trigger point may be entered and used to either start or end data collection.

The trace specification is now complete and the 1602A is ready to capture data. Pressing the Trace key instructs the Analyzer to start looking for the trigger word. Once the trigger word is recognized, the Analyzer captures and stores 64 words in memory as defined by the preset trace specifications.



Two words are normally displayed in the viewing window. The number at the far left (0 in this example) is the memory location of the word 2805<sub>16</sub>. The word on the far right is in the next higher location of the Analyzer's memory.

The data in the Analyzer's memory may be viewed on the display using the four keys in the display block. The Prior Word and Next Word keys permit you to view the memory contents one word at a time, or if you hold a key, the memory contents will sequence rapidly through the display. The Word Number = key allows you to quickly address any memory location and the At Trigger Word key automatically restores the display to the trigger point.

### Measurement Flexibility

This Analyzer, with all its operating simplicity, has the power required to capture more than basic data lists. For example, to determine if a data line is stuck in one state, a Trace Continuous mode permits the suspected line to be monitored for activity. The mode is entered by pressing TRACE followed by C and may be used with any number base.

To capture data on the n<sup>th</sup> pass of a loop, a Delay By Events mode is available. Delay By Events is entered by pressing in sequence Delay =, E, and then entering in decimal format the desired number of events to 65 535. The display then shows that the Analyzer is set to Delay By Events with an E, and also the selected number of events, 352. When Trace is pressed the 1602A will count the selected number of Events (trigger points) before capturing data.

For viewing consecutive occurrences at specific points, such as data being sent to a peripheral, a Trace Events Mode is provided. This mode is entered by pressing Trace followed by E which directs the 1602A to capture only the data that is described by the current trace specification trigger word plus delay.

When additional qualification is needed for data collection, such as restricting the data to only reads, writes, or outputs, the rear panel trigger and clock qualifiers are available. These inputs are compatible with the HP Model 10250A TTL trigger probe allowing expansion to four qualifier inputs.

Once a functional fault is located in execution of the program, another form of analysis instrument, usually an oscilloscope, is frequently desired to pinpoint the problem. The Analyzer's trigger output is stable with the system clock which allows an oscilloscope to be used for critical timing measurements.

A Trace Point Output is available for generating interrupt signals or for added "clock stopper" circuits in other parts of the system un-

der test. The rear panel outputs can also be used to cascade 1602A's or other analyzers.

And, for those occasions where the data being gathered are mixtures of information from buses and control lines, a mixed mode of binary and either hex, decimal, or octal bases can be easily entered with a few keystrokes. Pressing Word Width = 16 and Hex 8 gives the display shown.



The resulting trace then displays the captured data in the format most convenient for analysis.



The Analyzer also interacts with message codes which assist the operator in gathering and sorting data. The definitions of these message codes are included inside the storage compartment top cover for easy reference.

For increased confidence of the Analyzer's operation, it performs a self-test during turn-on and indicates the results on the display. In addition, there is a multilevel diagnostic software which allows the Analyzer to identify virtually any internal fault.

### Automatic Testing

In addition to stand-alone operation the Analyzer can be configured for use with the Hewlett-Packard Interface Bus (IEEE 488) family of interactive instruments. An optional HP-IB interface is available which when combined with a computing controller and suitable stimulus allows the data captured by the programmable 1602A to be transferred to the controller for analysis, providing fast, easily repeatable checkout and troubleshooting in production and service environments. Now, the engineer who designs a system can establish proper vs improper operating characteristics and provide an automatic test sequence which will functionally check the system. By developing the tests in an HP-IB configuration, he can print out a complete data record for each test, greatly simplifying documentation of test procedures.

The greatest benefit of automated testing is that each instrument is tested identically; a QA inspector can functionally test the system with the same parameters used in final test. System failures that occur during testing can be readily defined and documented, and since they are stored in an automated test routine, the failure test conditions can be duplicated at will. Libraries of faults can be rapidly generated using these automated test procedures, with each fault documented and stored in a data cartridge file for use in automated debugging in production or field service.

### Programming

A learn mode feature provides an easy way for a designer to program the Analyzer with an HP Model 9825A Computing Controller without using the formal HPL language. A few special function keys are all that is needed for most test programs, and the procedure for using them is also easy. Just make the measurement once manually using the 1602A and then press LEARN on the Computing Controller. The system will then become conversational and ask for the test number, number of words of 1602A memory to be compared, desired measurement time limit, and which test to go to if the present test passes or fails. The Computing Controller then automatically reads the Analyzer's keyboard and memory and transfers this data to its cassette. The first test of the "test procedure" is now completed and documented. A complete test procedure can be rapidly generated and documented by using this method. To use the test procedure, simply connect to the system or device under test and press the special function "Run" key on the Computing Controller. Your "Automated" test system then sets up the first test in the procedure, compares the data collected to the reference data stored on the cassette, and automatically branches (based on the data comparison) to either a new test or a comment. This means that all your devices can be functionally tested in minutes, automatically, with identical procedures eliminating variations due to differences between operators.

## Debugging HP-IB (IEEE 488) Systems

Hewlett-Packard's Models 10050A and 10051A HP-IB Adapter and Test Probe offer a convenient method of Monitoring HP-IB (IEEE 488) lines with a 1602A Logic State Analyzer. These accessories connect directly to the interface bus, do not interfere with normal system operation, and are capable of monitoring activity at full operating speeds. The 1602A's mixed display mode allows decoding of bus information to match the bus format of eight data, and eight control and handshake lines. With a few keystrokes, the display may be configured with eight lines in binary and the remaining eight in either hexadecimal, octal, or decimal format.



### HP-IB Adapter

For basic monitoring of an HP-IB system, the Model 10050A Adapter is quickly connected to the 1602A probe and HP-IB piggy-back connector. There are no time consuming problems of connecting individual probe leads to an HP-IB connector.

### HP-IB Test Probe

More complete tests of an HP-IB system can be performed using Model 10051A Test Probe in conjunction with the 10050A Adapter. Connection to the system under test is accomplished by plugging in the test probe, adapter, and connecting to the HP-IB connector.

With the 10051A, you automatically check for protocol violations on three handshake wires. If any of the six legal states occur out of sequence or one of the two illegal states is accessed, the LED on the probe flashes to indicate a possible problem and also supplies a pulse for triggering the 1602A or external instrumentation so that a problem can be quickly located. The timing diagram shows the normal sequence on the three handshake lines.

### SEQUENTIAL REQUIREMENTS OF THE THREE WIRE TRANSFER

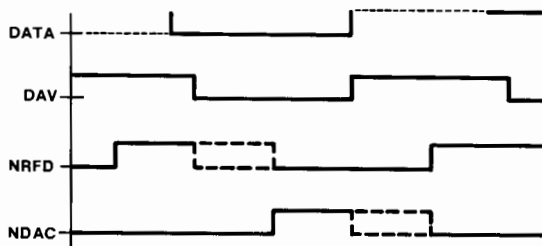

A Clock Qualifier switch allows selection of Commands, Data, or Both to control the type of bus activity that is loaded into the 1602A's memory. A Clock Source switch allows you to strobe data into the 1602A on the positive edge of NDAC, negative edge of DAV, completion of a parallel poll, or with a manual pushbutton. By selecting Parallel Poll as a clock the 1602A monitors DIO lines to check device status when a parallel poll is conducted. If there are no handshake operations being conducted, the Manual pushbutton allows you to clock the current bus state into the 1602A.

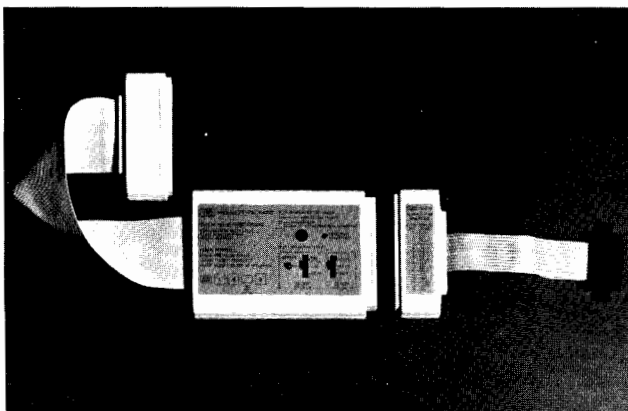

## 1602A Specifications

### Probe Inputs

**Repetition rates:** to 10 MHz.

**Input load:** one low power Schottky gate (<400  $\mu$ A source).

**Input threshold:** TTL, fixed at  $\approx 1.5$  V.

**Max input:** <+5.5 V.

### Min input

**Level:** >-0.5 V.

**Swing:** from  $\leq +0.4$  V (low) to  $\geq +2.4$  V (high).

**Clock pulse width:**  $\geq 25$  ns at threshold.

**Data setup time:** time data must be present prior to a clock transition, 35 ns at threshold.

**Hold time:** time data must be present after a clock transition, zero.

### Trigger and Clock Qualifier Inputs (Rear Panel)

**Input load:** 8 mA max source.

**Max input:** <+5.5 V.

### Min input

**Level:** >-0.5 V.

**Swing:** from  $\leq +0.4$  V (low) to  $\geq +2.5$  V (high).

**Setup time:** time data must be present prior to a clock transition, 40 ns with 10250A probe, 10 ns without probe.

**Hold time:** time data must be present after a clock transition, 15 ns with 10250A probe, 30 ns without probe.

### Trigger and Trace Point Outputs

**High:**  $\geq 2$  V into 50 $\Omega$ .

**Low:**  $\leq 0.4$  V into 50 $\Omega$ .

### Pulse duration (width)

**Trigger:** high for  $\approx$  one clock period.

**Trace point:** sets low when Trace key is pressed, returns high when the Trace Specification is met.

**Delay from input clock:** <150 ns.

### General

**Power:** 100, 120, 220, and 240 Vac; -10% +5%; 48 to 66 Hz; 50 VA max.

**Size:** 197 H x 275 W x 421 mm D (4 $\frac{7}{32}$ " x 10 $\frac{3}{16}$ " x 16 $\frac{1}{16}$ ").

### Operating environment

**Temperature:** 0°C to +55°C (+32°F to +132°F).

**Humidity:** up to 95% relative humidity at +40°C (+104°F).

**Altitude:** to 4600 m (15 000 ft).

**Vibration:** vibrated in three planes for 15 min. each with 0.38 mm (0.015 in.) excursions, 10 to 55 Hz.

**Weight:** net, 4.5 kg (10 lb); shipping, 5.9 kg (13 lb).

**Accessories supplied:** one external probe pod, one connector with individual clock, ground, and data probe leads with tips, three display labels (HP P/N 01602-94302), one 2.3 m (7.5 ft) power cord, one Operating and Service Manual.

**Probe interface:** the probe interface is a standard, two row, edge connector which may be easily added to instruments during development, providing easily accessed test points for production and field service requirements.

### Options

#### 001: HP-IB Interface

Operating instruction labels are available in five additional languages. On initial order of a 1602A, one special language label may be ordered as an option. Additional labels must be ordered by part number.

**400:** French (HP P/N 7120-6467)

**401:** Spanish (HP P/N 7120-6468)

**402:** Italian (HP P/N 7120-6469)

**403:** German (HP P/N 7120-6960)

**404:** Japanese (HP P/N 7120-6697)

### Accessories

**10250A TTL trigger probe:** Model 10250A Trigger Probe offers a convenient method of expanding the qualification capabilities of the 1602A. With the 10250A connected to the 1602A rear panel Trigger or Clock Qualifier inputs, you have an additional four bits of qualification. The four inputs may be switched to HI, LO, or OFF (don't care) for selection of the desired qualification pattern. Power for the trigger probe is obtained from the circuit under test.

# LOGIC ANALYZERS

Model 1602A (cont.)

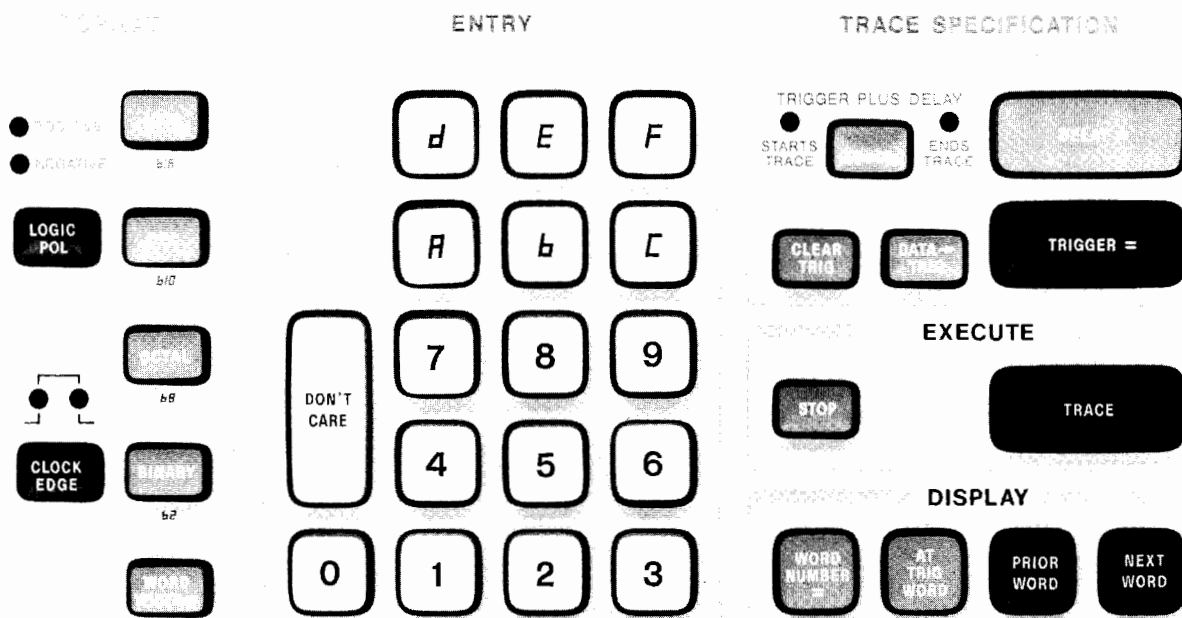

The keyboard of the Model 1602A Logic State Analyzer is easy to use with its key-per-function layout. Entry of triggering and display conditions is a series of self-explanatory keystrokes with entries displayed as they are entered, for a quick check of input accuracy.

### Probe Interfacing

**01602-68701:** connector with leads (without slip-on probe tips).

**01602-68702:** connector kit (without leads).

**10230-68702:** package of ten slip-on probe tips.

The probe interface is a standard two row, edge connector which may be easily added to instruments during development, for easily accessed test points in production and field service requirements.

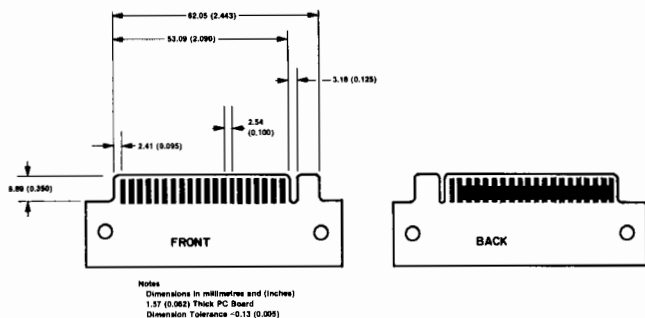

### HP-IB Controllers and Accessories

The following computing controller and accessories combined with a 1602A Option 001 provide a complete HP-IB Test System.

**Model 9825A Computing Controller:** Opt 002 with a 23 000 byte memory is recommended for maximum flexibility. Accessories required are Model 98210A String and Advanced Program ROM, Model 98213A General and Extended I/O ROM, and a Model 98034A HP-IB Interface Card.

**Software:** the Model 10060A Automatic Logic State Analysis Application Program for the 9825A controller is available and virtually eliminates the need to learn controller or HP-IB language.

### 10050A/10051A Specifications

Specifications apply with the 10050A/10051A connected to the 1602A.

**Adapter, 10050A:** when used as passive connection to the 1602A, loads each HP-IB signal line with one Schottky TTL gate (<400  $\mu$ A source) except DAV which is loaded with two low power Schottky TTL gates (<800  $\mu$ A source).

#### Test probe, 10051A

**Input Load:** one low power Schottky TTL gate (<400  $\mu$ A source) on each HP-IB signal line.

**Input threshold:** TTL fixed at  $\approx 1.5$  V except DAV, NRFD, NDAC, ATN, EOI which are buffered with low power Schottky TTL hysteresis gates (positive going threshold  $\approx 1.7$  V, negative going threshold  $\approx 0.9$  V).

**Max input:** <  $\pm 5.5$  V.

**Min input:** > -0.5 V.

**Differential signal delay:** signals on the ATN and EOI lines are delayed approx 30 ns more than DIO 1-8, SRQ, IFC, REN which are applied to the 1602A data inputs without buffering.

**Setup time:** data must be present 35 ns prior to a clock transition.

**Hold time:** data must remain stable 50 ns after a clock transition.

### Ordering Information

	Price
1602A Logic State Analyzer	\$1800
Opt 001: HP-IB Interface	add \$300
10250A TTL Trigger Probe	\$125
10050A HP-IB Adapter	\$35
10051A HP-IB Test Probe (includes 10050A)	\$185
10060A Automatic Logic State Analysis Applications Program for 9825A	\$58
01602-68701 Connector with leads (without slip-on probe tips)	\$80
01602-68702 Connector Kit (without leads)	\$25
10230-68702 Slip-on probe tips (10)	\$22.50

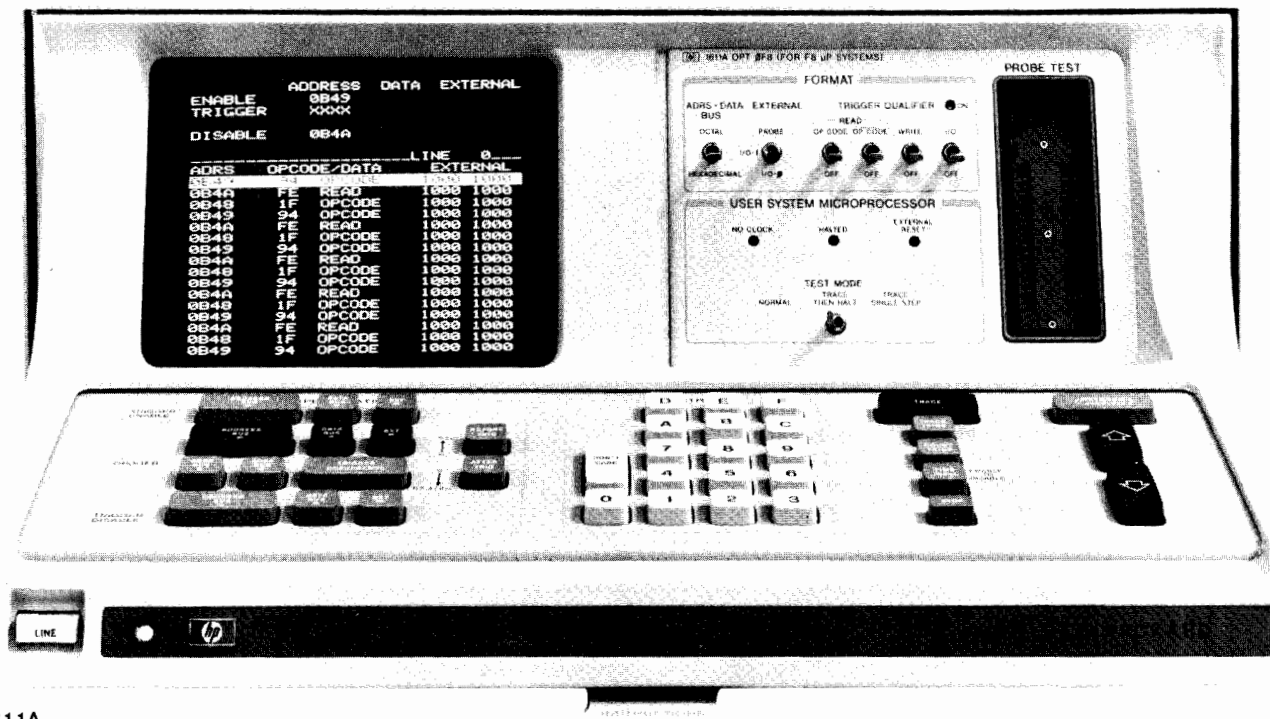

1611A

## 1611A Description

Hewlett-Packard's Model 1611A Logic State Analyzer quickly locates those elusive software and hardware problems in microprocessor systems. This stand-alone logic state analyzer saves time in design and troubleshooting for earlier operation, shorter down time for maintenance, and lower development and production costs. There are now eight personality modules available for the 1611A; seven of the personality modules can perform a complete inverse assembly of code from buses of seven major processor families, while the eighth personality module is a general purpose module. Programs are debugged on operating hardware with real-time viewing of the system's actual operation for analysis. Extensive triggering capability allows you to capture 64 pertinent transactions on data and address buses as well as external lines. Model 1611A is passive to the system under test, adding small capacitance and drawing only a small amount of current. Data entry may be hexadecimal or octal base, with binary base for control lines.

The keyboard is divided into four functional areas, data registration, entry, execute, and display. Specific events in program execution can be pinpointed with the ability to trigger on address, data, external signals, or any combination of the three. A direct readout of elapsed time or number of events between specified states, as well as minimum and maximum times or counts, can be obtained. Selective triggering is further refined by range triggering, selective store, sequential triggering and trace triggers. In effect, you "edit" the data, collecting only the transactions needed for analysis. Model 1611A performs a self-test during turn-on and displays the results.

## Dedicated Personality Modules

The seven dedicated personality modules reduce setup time as input parameters are already matched to proper trigger levels and clock slopes of the microprocessor. Connection to the system is quick and easy with a "clothespin" clip, or the 40-pin connectors for address and data and eight auxiliary leads with individual miniature probes for related control lines. You can view microprocessor transactions in mnemonic language or absolute code on the 32-bit wide display. Halting or single-stepping the microprocessor is possible with any of the dedicated personality modules.

## General Purpose Personality Module

Using the general purpose personality module makes the 1611A a conventional logic state analyzer for microprocessors. All but the device-specific capabilities of the dedicated modules are retained, and you can monitor virtually any microprocessor which has accessible test points. With a display up to 36 bits wide you can observe activity on several buses simultaneously on 8-bit or 16-bit microprocessors. Seven clocks allow multiplexed information to be latched into the 1611A at the appropriate time for display. The listing is displayed in absolute code in hexadecimal or octal for address and data buses, and in same base or binary for the external and auxiliary lines. Connection to the system under test is universal, with two pods, individual leads, and miniature probes for all inputs.

ADDRESS DATA EXTERNAL			
TRIGGER		000F	
PRE-TRIGR=7			
LINE 0			
ADRS	OPCODE/DATA	EXTERNAL	EXTERNAL
0009	LD C, B	0000	0000
000A	LD L, 00	0000	0000
000C	LD H, D	0000	0000
000D	LD A, <HL>	0000	0000
0400	00 READ	0000	0000
000E	LD H, B	0000	0000
000F	LD <HL>, A	0000	0000
3400	00 WRITE	0000	0000
0010	INC L	0000	0000
0011	JP NZ, 000C	0000	0000
000C	LD H, D	0000	0000
000D	LD A, <HL>	0000	0000
0401	31 READ	0000	0000
000E	LD H, B	0000	0000
000F	LD <HL>, A	0000	0000
3401	31 WRITE	0000	0000

Inverse assembly of the data on the data buses is possible with the seven dedicated personality modules. This mnemonic display is in the familiar assembler format for easy interpretation.



# LOGIC ANALYZERS

Model 1611A (cont.)

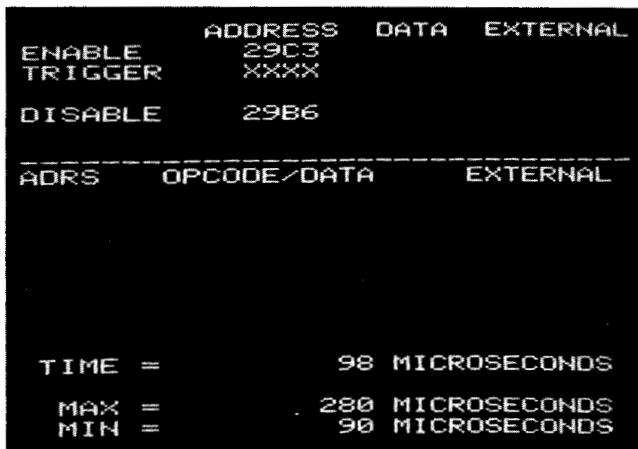

The time interval mode and the ability to select enable and disable trigger conditions allows direct measurements of execution time in loops, subroutines, and responses to interrupts. The 1611A can record the time for one measurement or provide the minimum and maximum values along with the last measurement from repeated measurements.

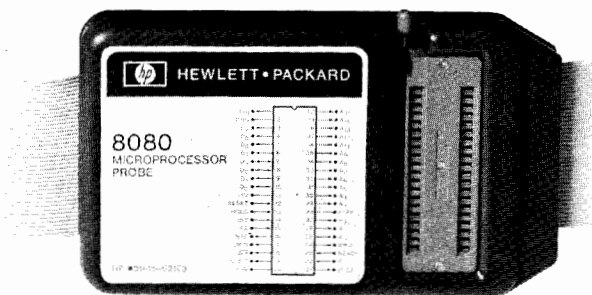

Connection with dedicated personality probes is with a 40-pin dual in-line package clip or the microprocessor may be relocated to the probe body and the probe connected to the system with a 40-pin connector.

### Configuration

The flexibility and convenience of Model 1611A are a function of the eight personality modules. On initial order, the 1611A is fitted with the module of your choice. Subsequently, to change the configuration, a new personality module can be installed on site in about 15 minutes. Each module consists of two or three printed circuit boards, an insert for the front panel, and the accompanying microprocessor probe. Dedicated personality modules are available for seven microprocessor types: 6800, 8080, F8, Z80, 6502, 1802, and 8085. The general purpose personality module features flexibility, and can be used to troubleshoot most microprocessors manufactured now or in the foreseeable future.

### Option 001 (General Purpose Personality Module)

**Note:** Model 10264A personality module may be ordered separately for installation in a 1611A to provide Option 001 capability.

#### Inputs

**Input current:** 200  $\mu$ A, logic 0 (low);  $\approx$  20  $\mu$ A logic 1 (high).  
**Threshold:** 2 V min, logic 1 (high); 0.7 V max, logic 0 (low). All inputs have hysteresis.  
**Input capacitance:**  $\approx$  20 pF.

#### Clock

**Clock rate:** dc to 2.8 MHz max (2.2 MHz max if installed in a 1611A with serial number prefix of 1723A or below). Min pulse width is 30 ns. No clock should occur until at least 100 ns after the master clock. The NO CLOCK indicator lights if the period between clocks exceeds 4 ms.

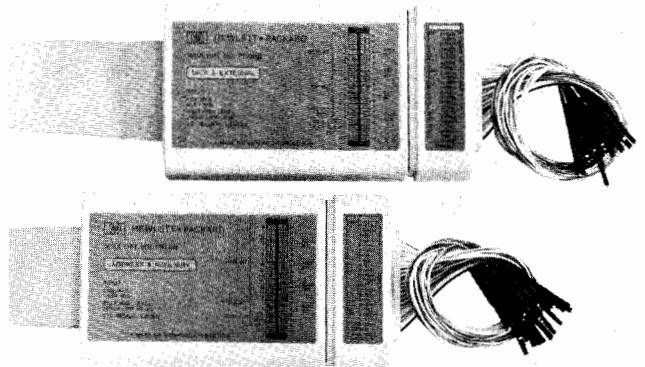

External probes used with the general purpose personality module can obtain signals from up to 36 test points, whether the lines are dedicated or multiplexed.

### Setup and Hold Times

**Setup time:** 80 ns relative to specified clock edge.  
**Hold time:** zero.

### Option A68 (6800 Microprocessors)

**Note:** Model 10257B personality module may be ordered separately for installation in a 1611A to provide Opt A68 capability.

### Microprocessor Compatibility

**Motorola:** 6800, 68A00, 68B00, 6802.  
**AMI:** 6800.

**Note:** The 1611A Opt A68 is compatible with any microprocessor that meets specifications of the Motorola 6800.

### Clock and Data Inputs

**Clock rate:** 70 kHz to 2.0 MHz; (70 kHz to 1.66 MHz with 10257B installed in 1611A with serial number prefix below 1723A).

#### Input loading

**A<sub>0</sub>-A<sub>15</sub>, R/W, VMA:**  $\approx$  1 M $\Omega$  shunted by  $\approx$  40 pF, including capacitance of 30.4 cm (12") cable;  $\approx$  30 pF with 7.6 cm (3") cable.  
**D<sub>0</sub>-D<sub>7</sub>, BA:** 20  $\mu$ A max with V<sub>in</sub> = 2.7 V; -0.2 mA max with V<sub>in</sub> = 0.4 V.  
**HALT:** 120  $\mu$ A max with V<sub>in</sub> = 2.7 V; -0.2 mA max with V<sub>in</sub> = 0.4 V.  
 $\Phi$ 2: 0.2 mA max with V<sub>in</sub> = 5 V; -0.4 mA max with V<sub>in</sub> = 0.4 V.  
**Threshold:** 2.4 V to 5.5 V, logic 1 (high); -0.8 V to 0.8 V, logic 0 (low).  
**Halt output:** TTL open-collector compatible output capable of sinking at least 8 mA when active.

### Option A80 (8080 Microprocessors)

**Note:** Model 10258B personality module may be ordered separately for installation in a 1611A to provide Opt A80 capability.

### Microprocessor Compatibility

**Intel:** 8080, 8080A, 8080A-1, 8080A-2.  
**AMD:** 9080A, 9080A-1, 9080A-2, 9080A-4.  
**NEC:**  $\mu$ PD8080,  $\mu$ PD8080A-E.  
**TI:** TMS8080, TMS8080A.  
**National:** INS8080A.

**Note:** The 1611A Opt A80 is compatible with any microprocessor that meets specifications of the Intel 8080A.



### Clock ( $\Phi 2$ only)

**Repetition rate:** 300 kHz to 4 MHz.

**Width:** 75 ns min for either high or low state.

**Input resistance:**  $\approx 12$  k $\Omega$ .

**Input capacitance:**  $\approx 25$  pF, includes capacitance of 30.5 cm (12") cable,  $\approx 15$  pF with 7.6 cm (3") cable.

**Threshold:** 9 to 13 V, logic 1 (high); -1 to 0.8 V, logic 0 (low).

### Data, Address, Wait, Ready, HLDA, INTE, SYNC

**Input resistance:**  $\approx 1$  M $\Omega$ .

**Input capacitance:**  $\approx 25$  pF, includes capacitance of 30.5 cm (12") cable,  $\approx 15$  pF with 7.6 cm (3") cable.

**Threshold:** 3 V to 6 V, logic 1 (high); -1 to 0.8 V, logic 0 (low).

**Ready output:** TTL open-collector compatible output capable of sinking at least 8 mA when active.

### Option 0F8 (F8 Microprocessors)

**Note:** Model 10259A personality module may be ordered separately for installation in a 1611A to provide Option 0F8 capability.

#### Microprocessor Compatibility

**Fairchild:** F8 (3850).

**Mostek:** F8 (3850).

**Note:** The 1611A Opt 0F8 is compatible with any microprocessor that meets specifications of the Fairchild F8.

#### Clock and Write

**Clock rate:** 100 kHz to 2 MHz.

**Width:** 180 ns min for either high or low state.

**Input current:**  $\approx 50$   $\mu$ A, logic 0 (low) and logic 1 (high).

**Input capacitance:**  $\approx 25$  pF, includes capacitance of 30.4 cm (12") cable;  $\approx 15$  pF with 7.6 cm (3") cable.

**Threshold:** 2.4 V to 5.5 V, logic 1 (high); -0.8 to 0.8 V, logic 0 (low).

**Write period:** either 4 or 6 times the clock period.

**Write pulse width:** max = clock period, min = clock period - 100 ns.

#### ROMC

**Input current:**  $\approx 22$   $\mu$ A, logic 0 (low);  $\approx 40$   $\mu$ A, logic 1 (high).

**Input capacitance:**  $\approx 25$  pF, includes capacitance of 30.4 cm (12") cable;  $\approx 15$  pF with 7.6 cm (3") cable.

**Threshold:** 2 V min, logic 1 (high); 0.7 V max, logic 0 (low).

#### Data, $\overline{I/O0}$ , $\overline{I/O1}$ , EXT RES

**Input current:**  $\approx 200$   $\mu$ A, logic 0 (low);  $\approx 20$   $\mu$ A, logic 1 (high).

**Input capacitance:**  $\approx 25$  pF, includes capacitance of 30.4 cm (12") cable;  $\approx 15$  pF with 7.6 cm (3") cable.

**Threshold:** 2 V min, logic 1 (high); 0.7 V max, logic 0 (low).

#### Halting

The F8 CPU must be placed in the 1611A Probe socket to halt or single-step the F8 microprocessor.

### Option Z80 (Z80 Microprocessors)

**Note:** Model 10260A personality module may be ordered separately for installation in a 1611A to provide Option Z80 capability.

#### Microprocessor Compatibility

**Zilog:** Z80, Z80A.

**Mostek:** 3880 (Z80), 3880N-4 (Z80A).

**Note:** The 1611A Opt Z80 is compatible with any microprocessor that meets specifications of the Zilog Z80.

#### Clock, Data, Address, and Control Inputs

**Clock rate:** 500 kHz to 4 MHz.

**Input current:**  $\approx 200$   $\mu$ A, logic 0 (low);  $\approx 20$   $\mu$ A, logic 1 (high).

**Input capacitance:**  $\approx 25$  pF, includes capacitance of 30.4 cm (12") cable;  $\approx 15$  pF with 7.6 cm (3") cable.

**Threshold:** 2 V min, logic 1 (high); 0.7 V max, logic 0 (low).

**Wait output:** TTL open-collector compatible output capable of sinking at least 8 mA when active.

1611A OPT 001 (FOR 8 OR 16 BIT PROCESSOR SYSTEMS)

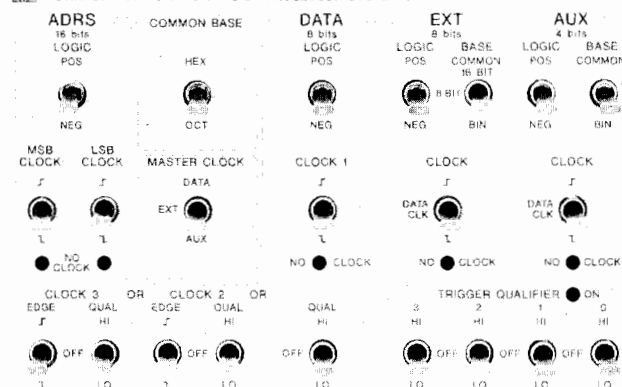

#### Opt 001

### Option A65 (6502 Microprocessors)

**Note:** Model 10261A personality module may be ordered separately for installation in a 1611A to provide Option A65 capability.

#### Microprocessor Compatibility

**MOS Technology:** MCS6502, MCS6502A.

**Rockwell:** R6502, R6502A, R6512, R6512A.

**Synertek:** SY6502.

**Note:** The 1611A Opt A65 is compatible with any microprocessor that meets specifications of the MOS Technology MCS6502.

#### Clock and Data Inputs

**Clock rate:** 70 kHz to 2 MHz.

#### Input loading

**A0-A15, R/W, Sync:**  $\approx 1$  M $\Omega$  shunted by  $\approx 40$  pF, including capacitance of 30.4 cm (12") connecting cable,  $\approx 30$  pF with 2.6 cm (3") cable.

**DO - D7:** 20  $\mu$ A max with  $V_{in} = 2.7$  V; -0.2 mA max with  $V_{in} = 0.4$  V.

**Rdy:** 120  $\mu$ A max with  $V_{in} = 2.7$  V; -0.2 mA max with  $V_{in} = -0.4$  V.

$\Phi 2$ : 0.2 mA max with  $V_{in} = 5$  V; -0.4 mA max with  $V_{in} = 0.4$  V.

**Threshold:** 2.4 to 5.5 V, logic 1 (high); -0.8 V to 0.8 V logic 0 (low).

**RDY output:** TTL compatible open collector output capable of sinking at least 8 mA when active.

### Option A18 (1802 Microprocessors)

**Note:** Model 10262A personality module may be ordered separately for installation in a 1611A to provide Option A18 capability.

#### Microprocessor Compatibility

**RCA®:** CDP1802D, CDP1802CD. Example of RCA acceptable operating conditions at +25°C with a shunt capacitance of 50 pF are:

$V_{cc}$	$V_{dd}$	CLOCK SPEED
5	5	2 MHz
5	10	4 MHz
10	10	5 MHz

**Note:** The 1611A Opt A18 is compatible with any microprocessor that is functionally identical to the RCA 1802. Microprocessor operating conditions (clock rate, supply voltages and signal timing) must be compatible with the 10262A setup and hold specifications.

®Registered Trade Mark RCA Corp.

#### Clock and Data Inputs

**Input loading, MA 0—MA 7, Bus 0—Bus 7, TPA, TPB, XTAL, SC0, SC1, MRD, MWR, NO, N1, N2, WAIT, CLEAR:**  $\approx 32$  k $\Omega$  shunted by  $\approx 25$  pF including the capacitance of a 30.5 cm (12") cable or  $\approx 15$  pF with a 7.6 cm (3") cable.

**Threshold:** automatically adjusted internally to  $\approx V_{DD}/2$ .

**Wait output:** series current limit. Open collector output series with current limited to 10 mA.

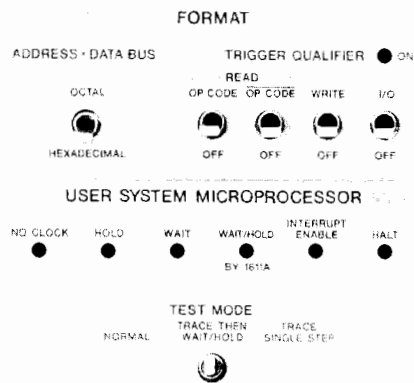
1611A OPT A80 (FOR 8080  $\mu$ P SYSTEMS)

Opt A80

**Warning:** with the Test Mode Switch in TRACE THEN WAIT or TRACE SINGLE STEP with the CPU in the 1611A probe socket, the 1611A will cause the CPU to wait. If the CPU is not in the probe socket, waiting cannot be guaranteed.

### Option A85 (8085 Microprocessors)

**Note:** Model 10263A personality module may be ordered separately for installation in a 1611A to provide Option A85 capability.

#### Microprocessor Compatibility

**Intel:** 8085, 8085A, 8085A-2.

**AMD:** AM9085.

**Siemens:** 8085.

**NEC:**  $\mu$ PD8085.

**Note:** The 1611A Opt A85 is compatible with any microprocessor that meets specifications of the Intel 8085.

#### Clock, Data, Address, Status, and Control Inputs

**Clock rate:** 300 kHz to 5 MHz.

**Threshold:** 2 V to 5.5 V, logic 1 (high); -0.5 V to 0.8 V logic 0 (low).

#### Input current

**Clock and Control:**  $\approx 50 \mu\text{A}$  max with  $V_{in} = 2.7 \text{ V}$ ; -0.4 mA max with  $V_{in} = 0.5 \text{ V}$ .

**Data, Address, and Status:**  $\approx 20 \mu\text{A}$  max with  $V_{in} = 2.7 \text{ V}$ ; -0.2 mA max with  $V_{in} = 0.4 \text{ V}$ .

**Input capacitance:**  $\approx 25 \text{ pF}$  including capacitance of 30.5 cm (12") cable;  $\approx 15 \text{ pF}$  with 7.6 cm (3") cable.

**Ready output:** TTL compatible open-collector output capable of sinking at least 8 mA when active.

## 1611A Specifications

### General

#### External probe inputs

**Current:**  $\approx 50 \mu\text{A}$  logic 0 or logic 1

**Capacitance:**  $\approx 25 \text{ pF}$  at probe tip.

**Threshold:** 2.4 V to 5.5 V logic 1 (high); -0.8 to 0.8 V logic 0 (low).

**Hold time:** zero, relative to appropriate strobe edge.

#### Outputs

**Low:**  $< 0.4 \text{ V}$  into 50 $\Omega$ .

**High:**  $> 2.0 \text{ V}$  into 50 $\Omega$  (nominally 3.9 V into an open circuit).

**Trigger:** duration  $\approx 75 \text{ ns}$  in RZ format; delay  $\approx 350$  to 400 ns after the appropriate strobe edge during the cycle that defines a valid trigger.

**Trace Point ( ):** provides a positive edge  $\approx 350$  to 400 ns after the appropriate strobe edge during the cycle that defines the specific

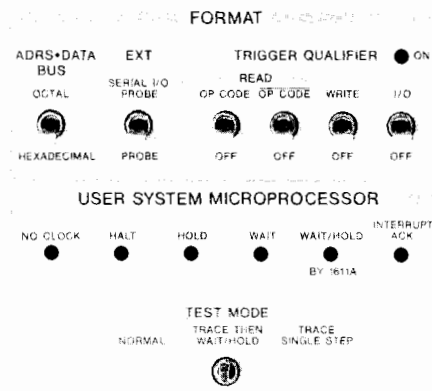
1611A OPT A85 (FOR 8085  $\mu$ P SYSTEMS)

Opt A85

valid trigger to be displayed on the 1611A. If the 1611A Delay is set so that the trigger word is not displayed, Trace Point output occurs for the cycle that defines the valid word immediately preceding the first displayed word.

**Trace Point ( ):** complement of Trace Point ( ).

**Memory depth:** 64 data transactions; 16 transactions are displayed at one time, roll keys permit viewing of all 64 transactions.

**Time interval:** accuracy, 0.1%  $\pm 1 \mu\text{s}$ . Max time,  $(2^{24}-1) \mu\text{s}$  (16.7 s).

**Events count:**  $2^{24}-1$  events (16.7 million) max.

**Logic probe output power:** 5 V dc at 0.1 A max.

**Power:** 100, 120, 220, 240 V ac; -10% +5%; 48 to 440 Hz; 120 VA max.

**Size:** 189 H x 426 W x 572 mm D (7  $\frac{7}{16}$ " x 16  $\frac{3}{16}$ " x 22  $\frac{1}{2}$ ").

**Operating environment:** temperature, 0°C to +55°C (+32°F to 132°F); humidity, to 95% relative humidity at +40°C (+104°F); altitude to 4600 m (15 000 ft); vibrated in three planes for 15 min. each with 0.38 mm (0.015 in.) excursions, 10 to 55 Hz.

**Weight:** net, 15 kg (33 lb); shipping, 19.5 kg (43 lb).

### Accessories Supplied

**With 1611A:** external 8-bit probe; one 2.3 m (7.5 ft) power cord; and one Operating and Service Manual.

**With Dedicated Module:** one 40-pin clip with 30.5 cm (12") cable; one 40-pin male socket with 30.5 cm (12") cable; and one 40-pin male socket with 7.6 cm (3") cable.

**With General Purpose Module:** two universal probes with individual leads, and miniature probe tips for each input.

### Ordering Information

	Price
1611A Opt 001 Logic State Analyzer, General Purpose	\$6000
1611A Opt A68 Logic State Analyzer for 6800 $\mu$ P	\$5200
1611A Opt A80 Logic State Analyzer for 8080 $\mu$ P	\$5200
1611A Opt 0F8 Logic State Analyzer for F8 $\mu$ P	\$5200
1611A Opt Z80 Logic State Analyzer for Z80 $\mu$ P	\$5200
1611A Opt A65 Logic State Analyzer for 6502 $\mu$ P	\$5200
1611A Opt A18 Logic State Analyzer for 1802 $\mu$ P	\$5200
1611A Opt A85 Logic State Analyzer for 8085 $\mu$ P	\$5200

### Personality Modules for Field Installation

10257B for 6800 $\mu$ P	\$1250
10258B for 8080 $\mu$ P	\$1250
10259A for F8 $\mu$ P	\$1250
10260A for Z80 $\mu$ P	\$1250
10261A for 6502 $\mu$ P	\$1250
10262A for 1802 $\mu$ P	\$1250
10263A for 8085 $\mu$ P	\$1250
10264A General Purpose	\$2000

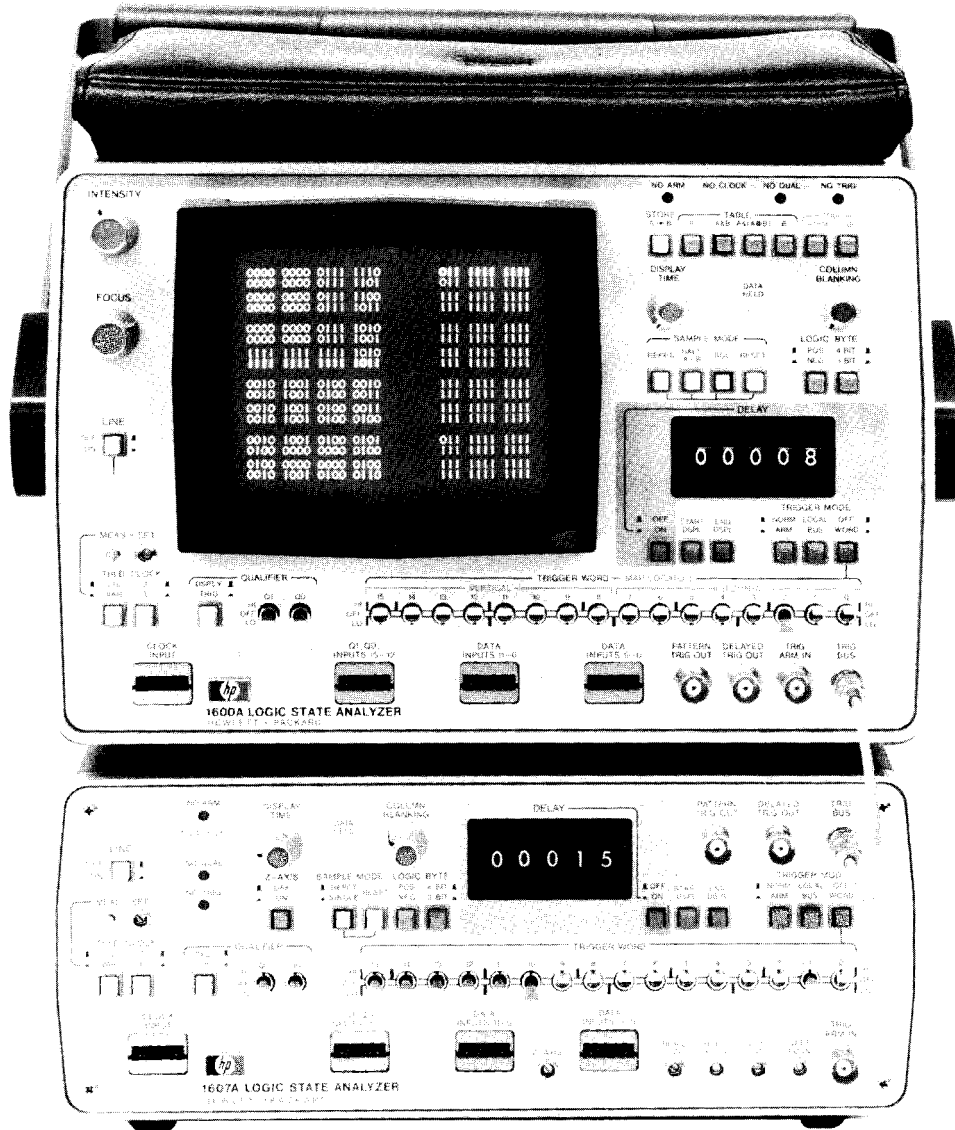

1600S

## 1600S Description

The 1600S Logic State Analyzer is a versatile, general purpose data domain instrument for use in design and troubleshooting of minicomputer and microprocessor based systems as well as other digital systems. Parallel data is captured at clock speeds to 20 MHz and presented in an easy-to-read one's and zero's display format for fast functional analysis of digital data flow. The ability to capture and display words up to 32-bits wide lets you observe, in real time, microcodes or addresses with resulting data, saving time in system design and development, hardware troubleshooting, software evaluation, and service and maintenance. Convenient and flexible functional analysis is provided by features such as sequential triggering, dual clock, separately configured data tables, display qualification, exclusive OR comparison of Tables A and B, dynamic mapping, and halt when A is not equal to B.

The 1600S consists of a 1600A Logic State Analyzer, a 1607A Logic State Analyzer, a 10236A Trigger Bus Cable, and a 10237A Data Cable. The Trigger Bus Cable logically AND's the trigger registers of both the 1600A and 1607A for a trigger word up to 36 bits wide (four qualifiers not displayed). The Data Cable connects the 1600A Table B memory to the 1607A to enable the display of words up to 32 bits wide, to display two 16-bit data sequences at the same time—such as addresses and instructions, to display 32 consecutive

16-bit words, or for dual clock application. When the full system capabilities are not needed, the 1600A or 1607A may be used separately. The 1600A by itself is a complete logic state analyzer with 16-bit triggering plus two qualifiers, and a 32-bit wide table display as well as dynamic mapping. The 1607A needs only the proper oscilloscope or X-Y display for another complete analyzer, also with 16-bit triggering plus two qualifiers. Both the 1600A and 1607A have a pattern trigger output to trigger an oscilloscope for electrical analysis.

## Display Modes

The Map display provides a dynamic overview of a system's operation—a pattern of dots interconnected with vectors that are unique for each area of program implementation. Each dot represents a specific word; its location indicates binary magnitude and its brightness indicates relative frequency of occurrence. The vectors between each dot allow you to observe the sequence of data transactions. The vector gets brighter as it moves toward a new point to show the direction of data flow. With the map you can identify program loops, improper data flow, as well as lost portions of a program. You can also map single-shot events such as those in turn-on sequences.

In the Table display mode you can display up to sixteen 32-bit words which allow you to view address and resultant data flow at the same time. You can look at events leading up to, surrounding, or following the trigger word; and delay up to 99 999 clock cycles beyond

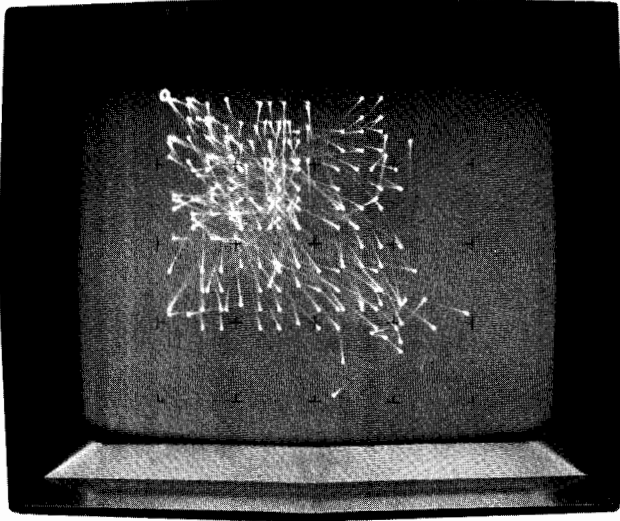

The map display offers an overall view of machine operation, with each dot representing one input word. The real time display allows you to identify program loops, improper data flow, as well as lost portions of a program.

the trigger point to view events anywhere in a program. Two 16-bit by 16-bit table displays, A and B, can be used separately or in various combinations to satisfy a wide variety of applications.

An Exclusive OR mode, A & (A ⊕ B), makes comparison of Table A and Table B data easy by displaying any differences as intensified one's on Table B. This display mode allows you to quickly compare active data to known stored data, or to compare data from two active systems simultaneously. Comparison data for Table B can be entered from an HP Model 10253A Card Reader. Model 10253A plugs directly into the 1600A Logic State Analyzer and provides a convenient method for performing repetitive tests for incoming inspection, production testing, or any situation requiring frequent comparisons to predetermined data sets.

Another useful mode is the halt when A does not equal B mode (A ≠ B), which automatically halts and stores the data in the A memory when it does not equal the data in the B memory. Used in conjunction with the A & (A ⊕ B) mode, this mode frees you from the tedious waiting and watching for intermittent malfunctions.

#### Display Qualification and Triggering

The 1600S has a total of four qualifier channels which allow only selected data to be captured, greatly expanding the effectiveness of the memory since irrelevant or extraneous data is not strobed into memory. The 1607A pattern trigger output (PTO) can be used as a qualifier input to the 1600A for analysis of multiplexed buses.

You can define two events which must occur in sequence to trigger a data acquisition cycle. The trigger output of the 1607A can be used to arm the 1600A on a selected event, enabling it to look for the second event. Sequential triggering is useful for analyzing branch operations.

Both the 1607A and the 1600A may be operated in the Start Display or End Display modes. In Start Display, the Analyzer triggers on a unique word established by the trigger word switches and displays that trigger word and the fifteen following words as they are clocked in. This is a valuable mode for paging through a system while following an algorithm to trace data flow. End Display triggering captures events leading up to and including the trigger word, providing a "negative time" display. This is extremely helpful for troubleshooting, since you can trigger on an unallowed state or a fault and see where the machine malfunctioned rather than the end results of the error. In addition, delay may be combined with the End Display trigger to capture both positive and negative time data, allowing you to see events before and after the trigger event and reduce analysis time.

When the data you want to see does not immediately follow the de-

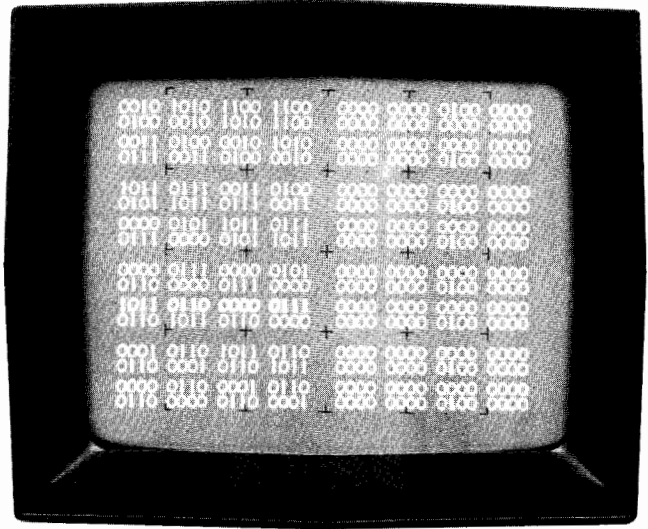

In the Exclusive OR mode, A & (A ⊕ B), A memory data is displayed on the left while the table on the right displays logic differences between A and B memories. This provides very fast "at-a-glance" comparisons.

sired trigger word, delay can be used to position the sixteen word "window" an exact number of clock pulses from the trigger word. The 1600A and the 1607A each permit selection of up to 99 999 clock cycles of delay.

The 1600A and 1607A have trigger outputs that extend troubleshooting capabilities in digital circuit analysis by windowing oscilloscopes to the proper digital point in time for electrical analysis of circuit operation.

#### Dual Clock

The 1600A and 1607A may be clocked at different rates which permits you to examine simultaneously up to 16 bits on both sides of an I/O port even though state flow is from two different sources running at different speeds. You can also easily relate bus activity to events occurring elsewhere at different clock rates, such as system peripherals. Dual clock capability can be particularly useful in determining design incompatibilities between hardware and software in micro-computer-controlled systems.

#### Serial Data Analysis

Model 10254A Serial-to-parallel Converter extends the analytical capabilities of the 1600S to include monitoring serially transmitted data. Data is collected serially at rates to 10 MHz into bidirectional registers and transmitted in parallel to the 1600S by bytes up to 16 bits wide. Sync mode may be a Pattern sync, initiating data collection with the pattern triggers of the analyzer, or Edge sync, using the appropriate edge of the clock for the system under test. You can use the Converter with either Model 1600A or Model 1607A and a display, or two Converters for a display of serial data 32 bits wide. Operating parameters are matched to those of the 1600S, including a zero hold time and adjustable threshold levels. With the 1600S and 10254A in combination, you can observe data transfers at I/O ports, and monitor communication networks, serial processors, and digital filters.

#### Versatile Miniature Probes

The 1600S acquires data through six, 6-channel high impedance probes. Two separate clock probes allow connection to the desired strobe source. The miniature probe tips are small enough to connect to adjacent pins or can be slipped off the probe wire for direct connection to 0.6 mm (0.025 in.) square pins, IC test clips, Model 10024A IC clip, and wire wrap pins.

Individual probes are connected to each data or clock pod through a quick disconnect ganging-bar which permits hardwired or semipermanent connections to system nodes that do not need to be disturbed when the Logic State Analyzer and its probe pods are removed.

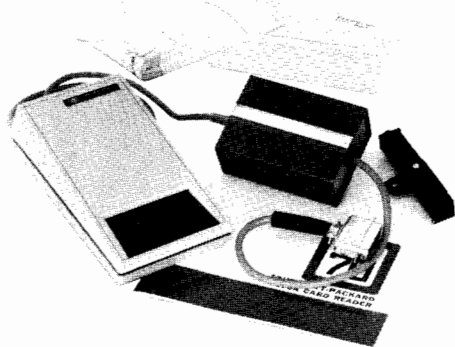

10253A Card Reader

### 1600S Specifications

#### Clock and Data Inputs

**Repetition rate:** 0 to 20 MHz.

**Input RC:** 40 k $\Omega$   $\pm$  3 k $\Omega$  shunted by  $\leq$ 14 pF (at the probe tip).

**Input bias current:**  $\leq$ 30  $\mu$ A.

**Input threshold:** TTL, fixed at  $\approx$  +1.5 V; variable  $\pm$  10 Vdc.

**Max input:** level, -15 to +15 Vdc; swing, 15 V peak from threshold.

**Min input:** swing, 0.5 V +5% of p-p threshold voltage; clock pulse width, 20 ns at threshold; data pulse width, 25 ns at threshold; data setup time, 20 ns; hold time, zero.

#### Pattern and Delayed Trigger Outputs

**High:**  $\geq$  2 V into 50 $\Omega$  (line driver interface).

**Low:**  $<$ 0.4 V into 50 $\Omega$  (line driver interface).

#### Pulse duration

**Delayed trigger:**  $\approx$  25 ns (RZ format) at 1 V level.

**Pattern trigger:**  $\approx$  25 ns in RZ format at 1 V level, delay zero or off. With delay on and not zero, pattern trigger output starts on receipt of a pattern trigger signal and ends when delay ends.

#### Trigger Arm Input

**Impedance:** 50 $\Omega$ .

**Level:** low state, 0 V to  $<$ 0.4 V; high state, 2 V to  $<$ 5 V.

**Pulse width:** 15 ns min at 1.5 V level.

**Arming conditions:** if the arming pulse positive edge occurs  $<$ 45 ns after a clock, triggering occurs on the same clock cycle that it is armed. If the arming pulse positive edge occurs  $>$ 75 ns after a clock, triggering occurs on the next clock cycle.

#### 1607A X-, Y- and Z-axis Outputs

**X-axis:**  $<$ 0.6 V to  $>$ 6 V p-p,  $\pm$ 8 V max into  $\geq$ 100 k $\Omega$

**Y-axis:**  $<$ 0.6 V to  $>$ 6 V p-p,  $\pm$ 8 V max into  $\geq$ 100 k $\Omega$ .

**Z-axis:** 0 to 10 V p-p into  $\geq$ 1 k $\Omega$ .

**Display interface requirements:** the 1607A interfaces with oscilloscope or display with the following input parameters (Not recommended for storage oscilloscopes or displays other than HP Model 1741 Opt 001 Storage Oscilloscope).

**X and Y inputs:** 0.1 to 1 V/div deflection factors; dc coupled input; and  $>$ 500 kHz bandwidth.

**Z-axis input:** dc coupled with positive blanking; full blanking must occur with 10 V input at 10 mA.

#### General

**Display rate:** variable from  $<$ 200 ms to  $>$ 5 s (1600A),  $<$ 50 ms to  $>$ 5 s (1607A).

**Power:** 100, 120, 220, 240 Vac; -10%, +5%; 48 to 440 Hz; 120 VA max.

**Logic probe power:** rear panel BNC connector, +5V, 100 mA.

#### Size

**1600A:** 197 H x 335 W x 540 mm L with handle (7<sup>3</sup>/<sub>4</sub>" x 13<sup>3</sup>/<sub>16</sub>" x 21<sup>1</sup>/<sub>4</sub>"); 460 mm (18<sup>1</sup>/<sub>8</sub>") L without handle.

**1607A:** 121 H x 284 W x 460 mm D (4<sup>3</sup>/<sub>4</sub>" x 11<sup>3</sup>/<sub>16</sub>" x 18<sup>1</sup>/<sub>8</sub>").

**Operating environment:** temperature, 0 to +55°C (+32°F to +130°F); humidity to 95% relative humidity at +40°C (+104°F); altitude to 4600 m (15 000 ft); vibrated in three planes for 15 minutes each with 0.254 mm (0.010 in.) excursion, 10 to 55 Hz.

#### Weight

**1600S:** net, 19.1 kg (42 lb); shipping, 22.7 kg (50 lb).

**1600A:** net, 12.7 kg (28 lb); shipping, 15.9 kg (35 lb).

**1607A:** net, 6.4 kg (14 lb); shipping, 8.2 kg (18 lb).

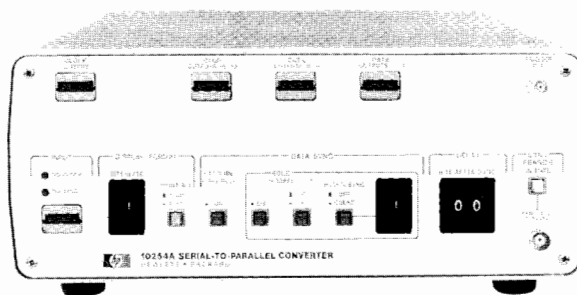

10254A

#### Accessories supplied

**1600S:** six 10231C data probes, two 10230C clock probes, one 10236A Trigger Bus Cable, one 10237A Data Cable, two 2.3. m (7.5 ft) power cords, one accessory case for each analyzer, one 1600A and one 1607A Operating and Service Manual.

**1600A or 1607A:** three 10231C data probes, one 10230C clock probe, one accessory case, one Operating and Service Manual.

### 10253A Specifications

**Cards:** printed cards in format required for 1600A Logic State Analyzer Table B memory; 187 mm (7<sup>3</sup>/<sub>8</sub>") long.

**Power:** supplied by 1600A.

**Weight:** net, 1 kg (2.1 lb); shipping, 1.8 kg (4 lb).

**Operating environment:** same as 1600A except: temperature, +10°C to +40°C (+50°F to +104°F); humidity, to 80% relative humidity at +40°C (+104°F).

**Accessories supplied:** one drum card, HP P/N 10253-90001; one exerciser card, HP P/N 10253-90002; 100 data cards, HP P/N 9320-3324; one interface box mounting bracket, HP P/N 01120-64701; and one Operating Note.

### 10254A Specifications

#### Probe Inputs

**Rep rate:**  $\leq$ 10 MHz in Edge Sync,  $\leq$ 7MHz in Pattern Sync.

**Input RC:** 40 k $\Omega$   $\pm$  3k $\Omega$  shunted by  $\leq$ 14 pF (at the probe tip).

**Input threshold:** TTL, fixed at 1.5 Vdc; variable  $\pm$  10 Vdc selected at the logic state analyzer.

**Max Input:** level,  $\pm$  15 Vdc; swing, 15 V peak from threshold.

**Min input:** pulse width, 40 ns min at threshold; setup time, 50 ns min; hold time, zero.

#### Operating Modes

##### Display format

**Bits/byte:** 1 to 16 bits (a byte is one line on the display).

**First bit, left/right:** displays most significant bit left or right.

##### Data sync

**Pattern:** sync on selected unique pattern in the serial data stream.

**Edge:** sync on input signal on selected edge.

**Bytes/sync:** select from 1 to 16 bytes of data following each sync.

**Delay:** 1 to 99 clock pulses after sync signal before data acquisition begins.

**Sync search:** Initiate pushbutton or a positive-going input pulse starts a new search cycle.

#### General

**Weight:** net, 3.2 kg (7 lb.). Shipping, 5 kg (11 lb).

**Power:** supplied by the 1600A or 1607A.

**Size:** 12.1 H x 28.4 W x 41.4 cm D (4<sup>3</sup>/<sub>4</sub> x 11<sup>3</sup>/<sub>16</sub> x 16<sup>5</sup>/<sub>16</sub>").

**Accessories supplied:** one Model 10236A Trigger Bus Cable, four interface cables (HP P/N 10254-61601), and one Operating Note.

#### Ordering Information

**1600S** 32-channel Logic State Analyzer, includes a 1600A and 1607A

**Opt 910:** extra set of manuals add \$37

**1600A** 16-channel Logic State Analyzer \$4800

**Opt 910:** extra Operating and Service Manual add \$20

**1607A** 16-channel Logic State Analyzer \$3300

**Opt 910:** extra Operating and Service Manual add \$17

**10253A** Card Reader \$800

**10254A** Serial-to-parallel Converter \$1275

# LOGIC ANALYZERS

Troubleshooting computer communications networks

Model 1640B



1640B



## 1640B Description

Selective transparent monitoring and interactive simulation make Hewlett-Packard's 1640B Serial Data Analyzer a valuable tool for quickly locating faulty components in computer networks and most RS-232-C (V24) interfaces. Regardless of network size, system downtime is minimized when the problem source can be isolated rapidly. Model 1640B combines the convenience of programmed operation in real time with the versatility of a variety of triggering modes: character sequences, time intervals, transmission errors, and external. Whether in design, systems integration, preventative maintenance, or on-line debugging, the 1640B aids you in moving efficiently from the symptom to the cause.

As a passive monitor, the Serial Data Analyzer collects status information and serial data on the RS-232-C (V24) interface and records up to 2048 characters in memory. You can monitor all data flow, or restrict your data window to specific data types by suppressing the collection of nonpertinent information. Once connected, the 1640B does not interrupt the communication links, permitting you to troubleshoot the system at operating speeds.

In the interactive mode, Model 1640B can simulate the output of a DTE (data terminal equipment) unit or the output of a modem, effectively exercising the entire system for analysis and troubleshooting. Configurations for simulation modes of operation is set quickly on the patch panel matrix which defines the RS-232-C (V24) interface. A separate 1024-character transmission memory contains messages you construct from the 1640B keyboard, enter using a ROM or the HP-IB option with a computer-controller, or "copy" from the 1640B monitor memory. Messages may be transmitted directly or separated for sequential transmission. Branch modes are used to simulate a CPU polling sequence, with one of two simulated replies sent conditional on the stimulus message.

Any character displayed on-screen can be selected with the display cursor for decoding in the code in use, hexadecimal, octal, and binary. The entire contents of memory are accessible by using the up/down cursor keys. This feature was added for the convenience of the operator in entering the code from the 1640B keyboard or checking for skipped bits.

## Easy-to-Use

Operating Model 1640B Serial Data Analyzer is simple and easy to learn because the 1640B uses interactive menus to set up the analysis modes. Each menu presents the appropriate variables, and specific parameters are chosen from a fixed set with the display cursor and Field Select key, or set directly from the keyboard. The four menu keys across the top of the keyboard are FORMAT, MODE (Monitor or Simulate), TX ENTRY, and LIST. Once the menu is selected and the parameters set, the actual operation of the 1640B is automatic, freeing you from learning extensive instruction sets and writing programs for specific tests and simulations.

When the HP-IB interface is added, Option 001, you can further simplify set up and operation of the Serial Data Analyzer with Model 10291B PROMs. Each PROM holds two instrument setups for Format, Mode, and TX Entry menus. Up to five PROMs, ten setups, can be installed in the HP-IB board and loaded into the 1640B by setting rear panel switches and pushing the Load pushbutton. This reduces the opportunity for operator error and is particularly convenient for field applications.



The matrix of the 1640B Serial Data Analyzer provides a versatile interface to configure the analyzer for various applications. When configured as shown here, the analyzer is set for most RS-232-C (V24) applications.

## Computer Network Troubleshooting

As a monitor, Model 1640B Serial Data Analyzer has analysis features which facilitate identifying and pinpointing network problems. Most network problems belong to one of three categories: (1) software problems, most commonly protocol violations; (2) data errors; or (3) interface problems such as incorrect timing relations. Three internal trigger modes and an external trigger identify these common problems readily. The character sequence trigger lets you select up to eight characters in sequence on transmit or receive leads to trigger data collection; this trigger locates protocol errors. For data errors, parity or optional LRC/CRC checks can be used as triggers. Time interval violations can be used as trigger points, and detect interface problems. Examples of an external trigger are the RS-232-C (V24) handshake ON conditions and a computer halt flag output.

Monitoring alone is sufficient to identify most network problems. When you select the Monitor mode on the Mode menu, you will also select Trigger Source and Suppression conditions. There are three choices for the Run Mode: Continuous, Trigger Starts Display, or Trigger Ends Display. In the Continuous mode, the 1640B collects data until halted manually; then the last 2048 characters are retained in memory. With the Trigger Starts Display mode, data collection begins at the trigger event and stops automatically after the next 2048 characters are collected. Trigger Ends Display mode collects data continuously and stops after 64 characters beyond the trigger event are collected, giving you an overview of events preceding the trigger event and an indication of system activity immediately following the trigger. Following completion of any of the three Run modes, the display also shows the most recent time interval measurement and the total count of trigger occurrences during the run.

### Network Component Simulation

Because some network problems cannot be located without interactive testing, the 1640B can simulate both Data Terminal Equipment (DTE) and Data Communications Equipment (DCE) at the RS-232-C (V24) interface. Simulation allows loop-back testing so that the precise location of a problem can be found after it is isolated to a particular link. Also, system components can be checked at the site to determine if they are operating properly. A simple matrix setup establishes the proper hardware interface, and the TX ENTRY and Simulate MODE menus provide the software interface.

The TX ENTRY menu allows up to 1024 characters to be sent in up to eleven separate blocks. Transmit data can be entered through the keyboard, a "copy" or "learn" feature, or remote entry.

Messages can be composed directly from the 1640B's hexadecimal keyboard with the characters displayed in any code set during composition. A cursor shows the position of the next character to be entered. Only information bits have to be entered because parity or optional CRC characters are automatically added during transmission. Edit keys allow the composer to insert or delete characters during any phase of the composition.

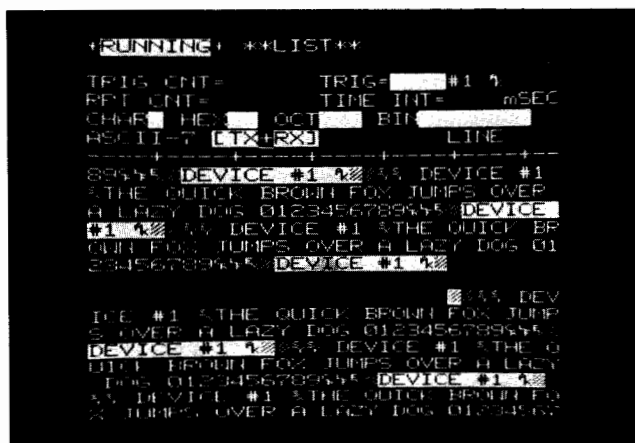

As a monitor, 1640B Serial Data Analyzer captures 2048 bytes on a real-time basis, with 416 characters displayed. Two lines of old data are erased to make room for incoming information. Transmitted characters are displayed in video and received characters are shown in inverse video.



Most network problems can be isolated using the Monitor mode. Parameters for the Monitor menu set the trigger type, manner of data collection, trigger, and specify characters to be suppressed.

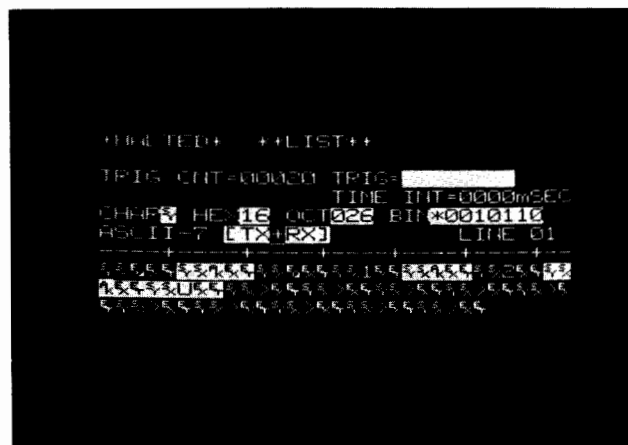

Complicated protocol sequences can be entered in the 1640B Serial Data Analyzer using the copy capability. This sequence is a conversation between a CPU (video) and a terminal (inverse video). The code for a sync character is shown above the line in hexadecimal, octal, and binary codes.

Protocol sequences are often too long and complicated for convenient manual entry. If the 1640B's monitor mode is used to record the actual network protocol, its "Copy Transmit Monitor" or "Copy Receive Monitor" feature will automatically transfer appropriate data to the transmit message buffer. After transfer, the message can be edited, broken into blocks, syncs added, address changed, idles deleted, etc., through the keyboard.

Messages may be entered remotely using a teletype through the current loop interface (HP Model 10284A) or with the optional HP-IB interface (IEEE-488-1978) and a controller such as an HP Model 9825A Computing Controller. Model 10292A Application Software package for a 1640B with HP-IB interface (Option 001) and an HP Model 9825A Desktop Computer allows you to enter messages in the TX ENTRY buffer from the 9825A's alphanumeric keyboard.

PROMs (10291B) containing user-definable "canned" messages can be installed on the HP-IB board and automatically loaded into the TX ENTRY buffer with a rear panel pushbutton. This allows fast and error-free message entry without an accompanying Computing Controller—a feature especially useful in field service applications.

The 1640B's Simulate Mode menu allows selection of HDX/FDX operation, the choice of Transmit First or Receive First, the Reply condition and five different preprogrammed RUN (execute) modes. In addition, you can specify any of the three internal trigger sources and a suppression condition if desired.





## Model 1640B

**Simulation RUN Modes:** Five run modes for component simulation by the 1640B allow you to duplicate most common forms of serial communication in computer networks. Single and Count Trigger mode directs the 1640B to send an entire message once. After a total of 2048 TX and RX characters has been captured the run stops automatically. The Repeat and Count Triggers mode causes the message to be sent each time the reply condition occurs. The run must be manually halted. The Repeat and End on Trigger mode causes the message to be sent after each occurrence of the reply condition until the specified trigger condition occurs. This allows repetitive testing with a permanent display of the data at a suspected fault. Branch and End on Trigger mode transmits the first of three message blocks repetitively until a reply is received. Then Block 2 or Block 3 is used, based on the response. The run terminates immediately when trigger conditions are met. Branch and Repeat mode functions in the same manner except that the three block sequence is repeated after transmission of Block 2 or Block 3. At the end of any test, the number of trigger events, number of transmit message repetitions, and results of the last time interval measurement are displayed.

#### Programmable Operation

The 1640B solves most network problems in a passive sense, or when necessary, as an interactive simulator. For more complex network interaction the HP-IB option, along with a suitable controller, adds such capabilities as remote control, sophisticated programming, mass storage, data manipulation, and hard copy.

#### 1640B Operating Characteristics

Specifications describe Model 1640B's warranted performance. The Operating Characteristics provide extra information for instrument use by describing the nonwarranted operating parameters.

**Patch Panel Matrix:** permits configuration of 1640B for a variety of configurations. Pin assignments for RS-232-C (V24) pin assignments are:

TX (transmit data)	Pin 2
RX (receive data)	Pin 3
RTS (request to send)	Pin 4
CTS (clear to send)	Pin 5
DSR (data set ready)	Pin 6
CAR DET (carrier detect)	Pin 8
SCT (synchronous clock transmitter)	Pin 15 or 24
SCR (synchronous clock receiver)	Pin 17
DTR (data terminal ready)	Pin 20

For modem simulation applications, the matrix would be reconfigured. Mylar overlays are provided with prepared pin configurations for common applications to facilitate matrix setup. Any pin, 2 through 25, can be monitored with an auxiliary tristate LED. Other functions configured on the matrix are time interval counter, external trigger input, trigger output, clock output, and buffered power supplies ( $\pm 12V$ , ground).

**Test results:** after data acquisition any of the run modes (monitor and simulate) is stopped, the following test results are displayed:

1. Last time interval measured, or time interval trigger event, between user-defined start and stop events on the patch panel matrix.
2. Number of trigger events counted during the run.
3. Number of messages transmitted by the 1640B (simulate only).

**Default:** returns the displayed menu to its wakeup condition.

**Display hold:** pressing and holding the FIELD SELECT key while the 1640B is collecting data causes the display to "freeze". Data is still collected, but the display will not be updated until the key is released. Full memory contents are displayed when the run is halted.

**Suppression:** allows capturing only information of interest for efficient use of memory, easier data analysis. Synchronizing characters, idles (all logic one's), nulls (all logic zero's), or everything but trigger and next n characters (with n from 0 to 99) may be suppressed.

#### Monitor Mode

##### Run (execute) modes

**Continous:** continuously monitors and records data and counts trigger occurrences; record stopped manually.

**Trigger Starts Display:** trigger starts a single record of 2048 characters (any combination of transmit and receive data).

**Trigger Ends Display:** trigger stops a continuous record. Built-in delay of 64 characters captures 64 characters after trigger event.

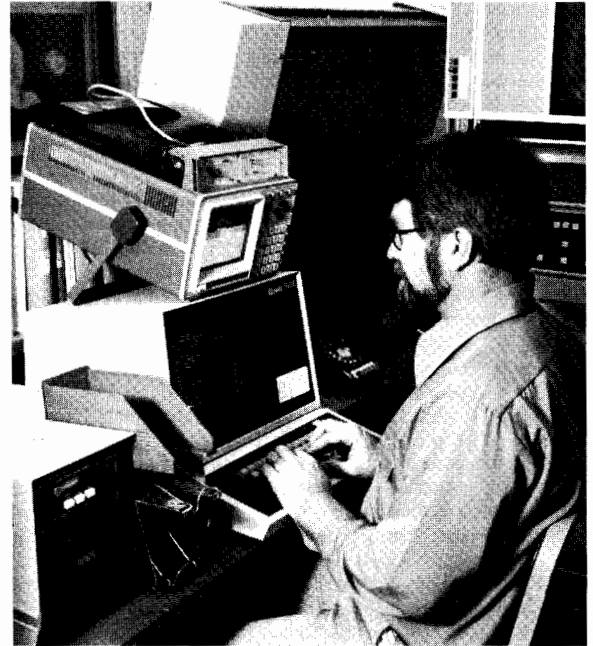

Model 1640B Serial Data Analyzer monitors or simulates serial data transmissions in computer networks which use the RS-232-C (V24) interface.

#### Simulate Mode

The 1640B can simulate a CPU, terminal, or modem (digital side).

**Output:**  $\geq 3 V$  into  $3 k\Omega$  load. Output rows on the patch panel matrix are TX (Transmit Data), RTS (Request To Send), and DTR (Data Terminal Ready).

**Interface control signaling:** automatic with additional control available through the matrix.

**State:** ON is  $> +3 V$ ; OFF is  $< -3 V$ . Nominal values of driven leads are  $\pm 8 V$  to  $\pm 12 V$ .

**HDX:** Request To Send is on only during transmission. Data Terminal Ready is always on.

**FDX:** Data Terminal Ready is always on; Request To Send is programmable via the matrix, either always on or on only during transmission. Idle condition between transmissions is a steady mark.

**Reply on:** similar to, but separate from, trigger. A Reply On sequence of from 1 to 8 characters, including DON'T CARE and NOT characters, immediately followed by an internally generated time delay from 0 to 6553 ms may be entered which enables a message block to be sent only when these two events occur.

#### Run (execute) modes

**Single and Count Triggers:** a message block is transmitted after each occurrence of the REPLY ON condition until all message blocks have been sent once. The run automatically stops when a total of 2048 characters (including the transmitted message) have been recorded in the monitor buffer.

**Report and Count Triggers:** a message block is transmitted after each occurrence of the REPLY ON condition until all message blocks have been sent. The process repeats until manually stopped with the last 2048 characters retained in memory.

**Repeat and End on Trigger:** a message block is transmitted after each occurrence of the REPLY ON condition until all message blocks have been sent. The process repeats and automatically stops when the trigger event occurs with the last 2048 characters prior to the trigger event retained in memory.

**Branch and End on Trigger:** a three-block message is loaded in the TX ENTRY memory. Block 1 is transmitted. If no reply is received on the RX lead in the time allotted in the REPLY ON time-field, Block 1 is retransmitted. When a reply is received, Block 2 is transmitted if the response satisfies the REPLY ON character sequences; otherwise Block 3 is transmitted. The 1640B halts automatically when the trigger condition is found.

**Branch and Count Triggers:** same as Branch and End on Trigger mode, except that the sequence is repeated until the 1640B is halted manually.

**Transmit modes**

**Transmit First:** the first message block is sent by pressing RUN. Succeeding blocks are sent following each occurrence of the REPLY ON condition.

**Receive First:** a message block is sent after each occurrence of the REPLY ON condition.

**Transmit message entry:** a total of 1024 characters including block delimiter continue symbols (I>) and the end symbol (|-), may be entered. The transmit memory may be loaded by transferring contents of monitor memory to the transmit memory with a single key-stroke, or, with Option 001 (HP-IB), through a remote ASCII keyboard or user-definable PROMs (10291B).

**Message Editing Keys**

**CONTINUE:** Places a I> symbol in the message as a block delimiter. Up to 10 continue symbols may be entered. The continue symbol is recognized only by the 1640B and is not sent as part of data.

**END:** places a |- symbol as a message terminator. Additional messages may be added after end symbol as user instructions but will not be transmitted. The end symbol is not sent as part of data.

**INSERT:** inserts a space for an additional character at the point indicated by a moveable cursor by automatically shifting all following characters one cell to the right.

**DELETE:** deletes character immediately above a moveable cursor. All following characters are automatically shifted one space left.

**1640B Specifications**

**Inputs**

**Impedance:** >30 kΩ on all interface connections except ground.

**Connector:** mates with RS-232-C (V24) interfaces.

**Format**

**Framing:** 5, 6, 7, or 8 information bits with or without a parity bit.

**Data codes:** ASCII, Hex, or EBCDIC. Other optional code sets in addition to or in lieu of EBCDIC are available.

**Data modes**

**Asynchronous:** 1 or 2 stop bits in addition to information and parity bits.

**Synchronous:** 1 or 2 user-entered synchronizing characters. Sync search may be initiated on a user-entered character immediately followed by a user-entered number of idle characters from 0 to 99. Idle is defined as a steady mark (logic 1's) in all bit positions.

**Speed**

**(Monitor Modes)**

CHARACTER SIZE INCLUDING PARITY (bits)	NORMAL OPERATION		HIGH SPEED MODE*	
	Max Bits Per Second		Max Bits Per Second	
	HDX	FDX	HDX	FDX
9	19200	9600	19200	9600
8	14400	7200	19200	9600
7	14400	7200	19200	9600
6	9600	6400	14400	7200
5	9600	4800	9600	7200

\*Memory data is not displayed while a run is in progress. High speed switch located on rear of Patch Panel Matrix.

**Simulate mode:** Max 9600 bps in branching run modes.

**Internal Clock (Asynchronous):** 50, 75, 110, 134.5, 150, 200, 300, 400, 600, 900, 1200, 1800, 2400, 4800, and 9600 bps. Also, any external X1 clock to a maximum of 9600 bps may be used for asynchronous operation.

**Note:** asynchronous operation follows the same speed vs character specification as synchronous operation.

**ERROR CHECK:** odd, even, or no parity; optional (003) BCC generation and checking based on LRC-8, CRC-16, or CRC-CCITT from a user-entered beginning to a user-entered ending character. Optional (002) SDLC frame check sum (FCS) generation and error checking for SDLC frames.

**Triggering (Trap) Modes**

**Character sequence:** up to 8 sequential characters including NOT and DON'T CARE may be used as a trigger and may be specified on either the send or receive data lead.

**Note:** DON'T CARE is the set of all possible bit patterns of any given character framing length. The NOT character is the set of all characters except the one specified. For example, NOT C (C) is set of all non-C (A, B, D, etc.).

**Time interval:** time intervals between two RS-232-C events may be used as a trigger. Max or min times to 6553 ms with 1 ms resolution may be specified.

**Error:** data errors, as defined in the FORMAT menu under ERROR CHECK, may be used as a trigger.

**External:** trigger supplied from user hardware or RS-232-C ON conditions (>+3 V).

**General**

**Memory:** 2048 characters of monitor buffer and 1024 characters of transmit message buffer.

**Display:** 10 cm by 13 cm CRT which displays up to 480 characters. All characters in memory can be viewed via the ↓ Cursor keys.

**Power:** 100, 120, 220, 240 Vac; -10% to +5%; 48 to 440 Hz; 150 VA max.

**Size:** 251 H x 335 W x 546 mm D with handle (9 7/8" x 13 3/16" x 21 1/2"); 445 mm D without handle (17 1/2").

**Operating environment:** temperature, 0°C to +55°C; humidity, to 95% relative humidity at +40°C; altitude, to 4600 m (15 000 ft); vibration, vibrated in three planes for 15 min. each with 0.3 mm (0.015 in.) excursions, 10 to 55 Hz.

**Weight:** net 11.4 kg (25 lb); shipping, 15.9 kg (35 lb).

**Accessories supplied:** one 3 m (10 ft) RS-232-C interface cable; Model 10289A Mylar overlay kit, shorting pins and Mylar punch; front panel cover; one 2.3 m (7.5 ft) power cord; one operator's guide; and one service manual.

**Ordering Information**

**Price**

**Factory Installed Options**

- 001: HP-IB Interface add \$475
- 002: SDLC (Synchronous Data Link Control)/HDLC (High Level Data Control) Interface add \$200
- 003: LRC, CRC-16, CRC-CCITT Check/Generation add \$150  
NOTE: Options 002 and 003 cannot be installed simultaneously
- 005: Code ROM, messages in ASCII and EBCDIC add \$110
- 007: Code Set Board with ASCII, EBCDIC, HEX and space for five other codes add \$325
- 008: Dataspeed 40/4, ten tests for teletype add \$1050
- 105: IPARS Code ROM for Opt 007 add \$35
- 201: Baudot Code ROM for Opt 007 add \$35
- 202: EBCD Code ROM for Opt 007 add \$35
- 203: Selectric Code ROM for Opt 007 add \$35

**User Installed Kits**

- 10281A HP-IB Field Kits \$475
- 10282A SDLC/HDLC Check Field Kit \$200
- 10283A LRC/CRC Check Field Kit \$150  
NOTE: Models 10282A and 10283A cannot be installed simultaneously
- 10284A 20/60 Current Loop Interface \$300
- 10286A NRZI Interface \$325
- 10287A MIL-STD 188C Interface \$325
- 10288A Code Set Board Field Kit \$325
- 10289A Mylar Overlays, three prepunched, 20 blanks \$40
- 10290A Special Code Set ROM \$35
- 10290B Code ROM (Option 007) \$35
- 10291B Menu PROM (Option 001 required) \$110
- 10292A Firmware Package for 9825A Desktop Computer \$150
- 1640B Serial Data Analyzer \$5800

# LOGIC ANALYZER

## ACCESSORIES

### Probes and Probe leads

Hewlett-Packard offers a large line of accessories to give you optimal flexibility in integrating the logic analyzers into your digital design and troubleshooting applications.

	Page		Page
Data/Clock Probes	170	Interfaces	172
Microprocessor Probes	170	Cables	174
Trigger Probes	170	Connectors	174
Miniature Probes	170	Testmobiles, Accessories	175
Probe Leads	171		

### Logic Analyzer Probes

Most of the probes in this section are supplied with the appropriate logic analyzers. Be sure to check the list of accessories supplied with the logic analyzers you have or will have purchased. The descriptions of these probes are included for your convenience in selecting replacement parts.

Probe Model Number	Logic Analyzer											
	1600S	1600A	1607A	1601A*	1602A	1610A	1610B	1611A	1615A	1620A*	1640B	10254A Converter
10231C Data Probe	6	3	3	2								
10230C Clock Probe	2	1	1	1						3		1
10248C Data Probe						4	5		4			
10247A Clock Probe						1						
10250A (TTL) Trigger Probe					1							

\*No longer in production

#### Models 10231C Data Probe and 10230C Clock Probe

These probes are generally used with Model 1600S Logic Analyzer system, which is comprised of Models 1600A and 1607A Logic Analyzers. Each analyzer requires three data probes and one clock probe. These probes are also used with Model 10254A Serial-to-parallel Converter, Model 1620A Pattern Analyzer, and Model 1601A Logic Analyzer. Individual probes are connected to each data or clock pod through a quick-disconnect ganging bar for flexibility in connecting to a system.

#### Models 10248C Data Probe and 10247A Clock Probe

Models 10248C Data Probes are used with Models 1610A/B and 1615A Logic Analyzers. Each data probe is an 8-bit probe, Model 10247A Clock Probe is a one-bit probe used with the 1610A Logic State Analyzer.

#### Probe Clip Set (HP P/N 5061-3611)

For convenience in using Model 10248 probes, the Probe Clip Set (HP P/N 5061-3611) permits you to stack the probes without damage. This set is provided on initial order with Models 1610A/B and 1615A Logic Analyzers. The set includes four holders for probes.

#### Model 1611A Microprocessor Probes

Use the following chart to order replacement microprocessor probes for the various personality modules for Model 1611A Logic State Analyzer; remember that the appropriate microprocessor probe is provided on initial order of personality modules, whether the modules are ordered as options or separate modules.

Micro-Processor Family	1611A Option Number	Personality Modules: Model No.	Module Model Price	Probe Part No.	Probe Price
MOTOROLA 6800	A68	10257B	\$1250	01611-62106	\$330
INTEL 8080A	A80	10258B	\$1250	01611-62107	\$330
FAIRCHILD F8	0F8	10259A	\$1250	01611-62104	\$330
ZILOG Z80	Z80	10260A	\$1250	01611-62105	\$330
ROCKWELL 6502	A65	10261A	\$1250	01611-62108	\$330
RCA 1802	A18	10262A	\$1250	01611-62109	\$330
INTEL 8085	A85	10263A	\$1250	01611-62112	\$330
GENERAL PURPOSE	001	10264A	\$2000	01611-62110	\$675

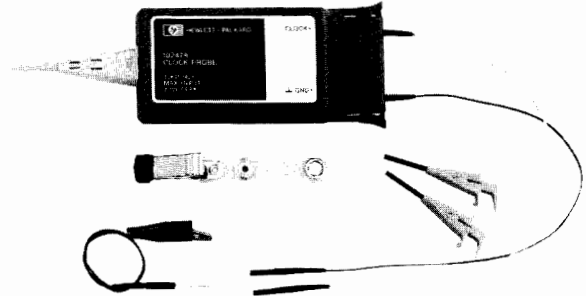

10247A Clock Probe

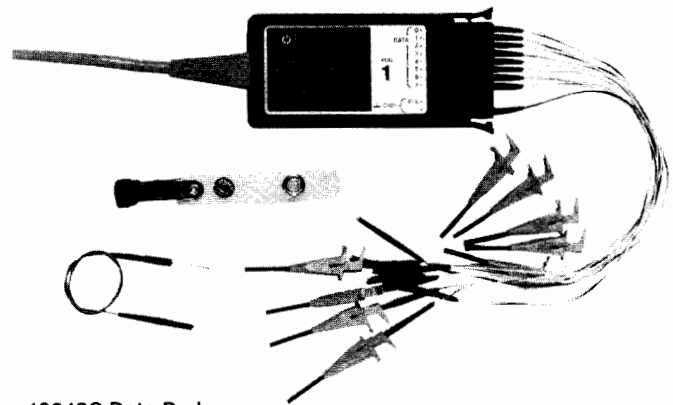

10248C Data Probe

### Trigger Probes

#### Eight-bit External Probe (HP P/N 01611-62101)

The 8-bit external probe (HP P/N 01611-62101) permits connections in a system external to the microprocessor bus for tracing related events or for additional trigger qualifications on Model 1611A Logic Analyzer.

**Resistance:** 1 MΩ.

**Capacitance:** 25 pF at probe tip.

**Threshold:** +2.4 V to +5.5 V, logic 1 (high); -0.8 V to +0.8 V at logic 0 (low).

**Setup time:** 250 ns prior to falling edge of appropriate strobe.

**Hold time:** zero (after falling edge of strobe).

**Accessories supplied:** one ganging bar, eight data leads, one ground lead, and nine probe tips.

### Miniature Probes

The Hewlett-Packard series of miniature probes give you easy access to test points in densely populated digital circuits. The basic probe, a small (2.4 mm diameter, 25 mm long) cylinder with a needle-like tip, provides access to test points while reducing the possibility of shorting to adjacent leads. This series of probes consists of 10:1 high impedance divider probes, 1:1 probes for instruments with high impedance inputs, and 1:1 probes for 50 ohm inputs.

For a more complete description of the miniature easy IC probes and accessories, refer to page 207, Oscilloscope Probes and Other Accessories.

### Ordering Information

	Price
10230C Clock Probe	\$175
10231C Data Probe	\$250
10247A Clock Probe	\$175
10248C Data Probe	\$395
01611-62101 8-bit External Probe	\$220
5061-3611 Probe Clip Kit	\$6

### Probe Leads and Probe Lead Kits

Probe leads are provided with every logic analyzer probe. For replacement or special applications, available leads are listed in the next three tables. The last table lists the quick disconnect probe lead kits which are available.

#### Quick Disconnect Probe Pod Leads

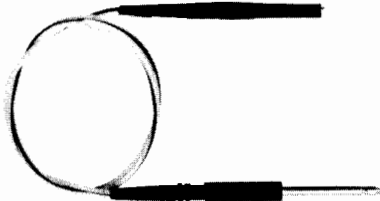

PART NUMBER	LEAD END	LENGTH mm (in.)	COLOR	PRICE
5061-1215	PIN	305 (12)	BLACK	\$3.50
5061-1251	PIN	152 (6)	BLACK	7.00
10231-61624	PIN	610 (24)	BLACK	7.00
10231-61625	ALLIGATOR	305 (12)	BLACK	3.50
5061-1227	PIN	305 (12)	RED	3.50
5061-1216	PIN	305 (12)	YELLOW	3.50
5061-1217	PIN	305 (12)	WHITE/BLACK	3.50
5061-1218	PIN	305 (12)	WHITE/BROWN	3.50
5061-1219	PIN	305 (12)	WHITE/RED	3.50
5061-1220	PIN	305 (12)	WHITE/ORANGE	3.50
5061-1221	PIN	305 (12)	WHITE/YELLOW	3.50
5061-1222	PIN	305 (12)	WHITE/GREEN	3.50
5061-1223	PIN	305 (12)	WHITE/BLUE	3.50
5061-1224	PIN	305 (12)	WHITE/VIOLET	3.50

#### Threaded Probe Pod Leads

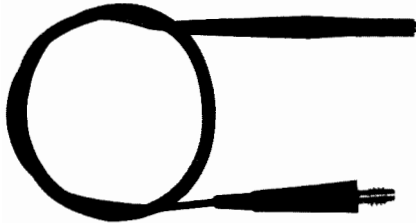

PART NUMBER	LEAD END	LENGTH mm (in.)	COLOR	PRICE
10231-61606	PIN	305 (12)	BLACK	\$3.50
10231-61611	ALLIGATOR	305 (12)	BLACK	3.50
10231-61602	PIN	305 (12)	RED	3.50
10231-61605	PIN	305 (12)	YELLOW	3.50
10231-61604	PIN	305 (12)	GREEN	3.50
10231-61608	PIN	305 (12)	WHITE/BLACK	3.50
10231-61612	PIN	305 (12)	WHITE/BROWN	3.50
10231-61613	PIN	305 (12)	WHITE/RED	3.50
10231-61614	PIN	305 (12)	WHITE/ORANGE	3.50
10231-61615	PIN	305 (12)	WHITE/YELLOW	3.50
10231-61616	PIN	305 (12)	WHITE/GREEN	3.50

#### "Single-ended" Probe Pod Leads (Prepared for soldering)

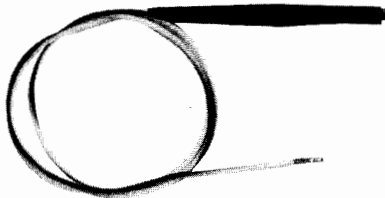

PART NUMBER	LEAD END	LENGTH mm (in.)	COLOR	PRICE
5061-1231	PIN	305 (12)	BLACK	\$3.50
5061-1232	PIN	305 (12)	YELLOW	3.50
5061-1233	PIN	305 (12)	WHITE/BLACK	3.50
5061-1234	PIN	305 (12)	WHITE/BROWN	3.50
5061-1235	PIN	305 (12)	WHITE/RED	3.50
5061-1236	PIN	305 (12)	WHITE/ORANGE	3.50
5061-1237	PIN	305 (12)	WHITE/YELLOW	3.50
5061-1238	PIN	305 (12)	WHITE/GREEN	3.50
5061-1239	PIN	305 (12)	WHITE/BLUE	3.50
5061-1240	PIN	305 (12)	WHITE/VIOLET	3.50
5061-1241	PIN	305 (12)	GRAY/BLACK	3.50
5061-1242	PIN	305 (12)	GRAY/BROWN	3.50
5061-1243	PIN	305 (12)	GRAY/RED	3.50
5061-1244	PIN	305 (12)	GRAY/ORANGE	3.50
5061-1245	PIN	305 (12)	GRAY/YELLOW	3.50
5061-1246	PIN	305 (12)	GRAY/GREEN	3.50
5061-1247	PIN	305 (12)	GRAY/BLUE	3.50
5061-1248	PIN	305 (12)	GRAY/VIOLET	3.50

	NUMBER OF KITS REQUIRED BY LOGIC ANALYZER MODELS									KIT PRICE
	ANALYZER MODEL NUMBER									
	1600A	1607A	1601A*	1602A	1610A/B	1611A	1615A	1620A*	10254A	
Quick Disconnect Kits										
10231-68703 Data	3	3	2			1		3	1	\$30
10247-68701 Clock					1					\$10
10248-69501 Data					4		3			\$37.50
Threaded Probe Leads 10230-68701 Clock	1	1	1					1		\$12
Threaded Probe Leads 10231-68702 Data	3	3	2					3	1	\$30
Kit of 10 Miniature Probe Tips 10230-68702	3	3	2	2	4	1	4	3	1	\$22.50
(Order single tips as HP P/N 10230-62101).										\$ 2.50

\*No longer in production.

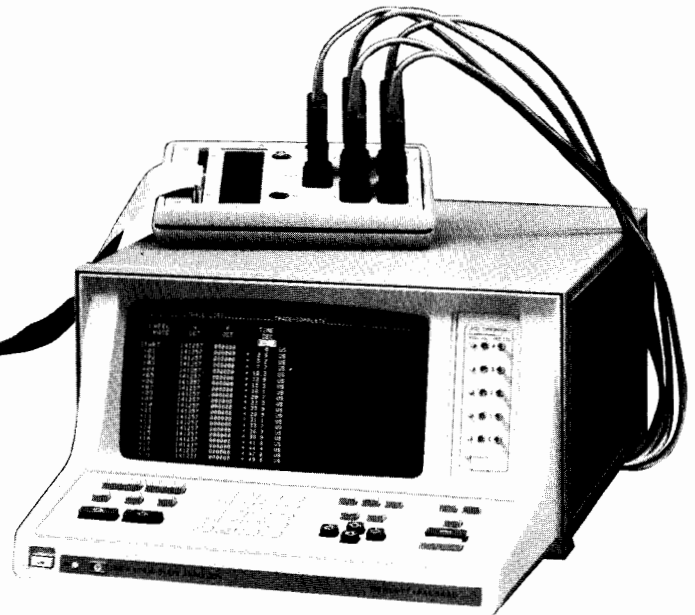
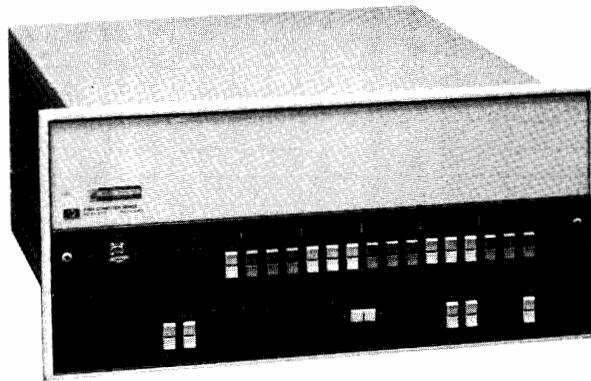

1610A with Interfaces

### Interfaces

Three categories of interfaces are available for Hewlett-Packard logic analyzers: (1) general purpose, (2) minicomputer, and (3) HP-IB. The general purpose interfaces simplify the mechanical connections between the logic analyzer and the system under test, and provide some preprocessing capabilities to adapt and qualify signals from the system. Seven minicomputer interfaces give you access to address, data, and control line signals from specific minicomputers. Because these are dedicated interfaces, minicomputer interfaces have even more flexibility for preprocessing and selecting the signals you want

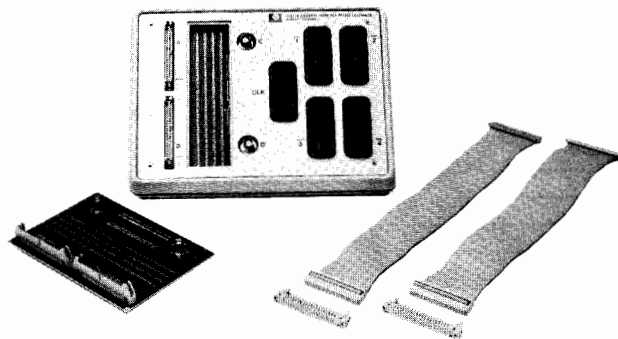

10277A General Purpose Probe Interface

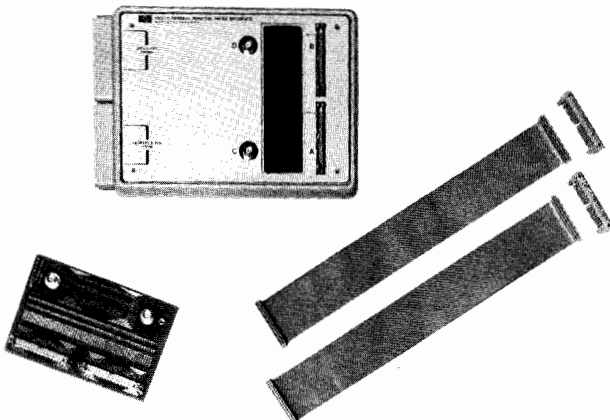

10277D General Purpose Probe Interface

to monitor of the many active lines in the typical minicomputer. An HP-IB interface may be a monitor only or an active interface that adds the logic analyzer to a larger measurement system.

### 10277A/B/C/D General Purpose Probe Interface

For convenient connections between your analyzer and a digital system, Model 10277A/B/C/D has dedicated sockets for the analyzer probe pods, and cables with 40-pin connectors for the system under test. Wire-wrap boards in the interface carry active circuits to preprocess the system signals for the logic analyzer. These interchangeable boards can be set up for a variety of analysis modes, such as serial-to-parallel conversion, sorting out signals on multiplexed buses, generating ORed clocks from multiclock systems, etc. Analysis modes can be changed quickly by simply swapping boards. Option 001 for Models 10277A/B replaces one wire-wrap board with a prewired board that directly accesses address and data lines. The appropriate 10277 interface can be used with Models 1600S, 1610A/B, 1611A, and 1615A logic analyzers.

### 10277A/B/C/D Interface Specifications

**Input connectors:** two 40-pin connectors to interface with a system. Two BNC connectors on the wire-wrap boards allow external signals or power to user-constructed circuits on the board.

**Output connectors:** four data connectors for HP logic analyzers with Model 10248 or 10231 data probes. One clock connector for Models 10247, 10230, or 10248B Opt. 001 clock probes. Model 10277D has two plugs for the two 40-pin connectors of the HP 1611A Logic State Analyzer.

**Weight:** net, 0.75 kg (1.7 lb); shipping, 2 kg (4.4 lb).

**Accessories supplied:** two removable interconnection wire-wrap boards (HP P/N 10277-66501 for Models 10277A/B/C, HP P/N 10277-66507 for Model 10277D), two 36 mm (1.4 in.) ribbon cables with 40-pin female connectors on each end (HP P/N 10277-61601), and two 40-pin male connectors (HP P/N 1251-3004).

### Ordering Information

	<b>Price</b>
10277A Interface for 1610A	\$400
10277B Interface for 1610B or 1615A	\$400
Opt 001 (10277A/B only) replaces one wire-wrap board (HP P/N 10277-66501) with a prewired board for connection to minicomputer interfaces; replaces 35.5 (14 in.) cable (HP P/N 10277-61601) with a 91.5 cm (3 ft) cable (HP P/N 10277-61602)	N/C
10277C Interface for 1600A or 1607A	\$400
10277D Interface for 1611A	\$475
10277-66501 Wire-wrap Board with Connectors (two supplied with Model 10277 Interface)	\$100



## Minicomputer Interfaces

Interfaces for HP logic analyzers are available for seven minicomputer families. Minicomputer interfaces provide a simple, rapid connection between logic analyzers and the system under test, and preprocess system activity to produce signals suitable for the analyzers. The one or two printed circuit boards of each interface connect directly to the minicomputer mainframe or system bus to transparently monitor address and data buses and control lines. Interface boards have switches to qualify signals so that only particular activities can be monitored, as, for example, only reads, or only DMA outputs. Active circuits on the board assure transparent monitoring with buffering as required, and also generate a clock signal for the logic analyzer.

### Minicomputer/Logic Analyzers Interfaces

INTERFACE MODEL	COMPUTER	NET WEIGHT kg (lb)	SHIPPING WEIGHT kg (lb)
10275A	PDP-11 (Digital Corp)	0.28 (0.6)	0.60 (1.3)
10276A	LSI-11 (Digital Corp)	0.2 (0.4)	0.32 (0.7)
10278A	HP 1000 M/E/F Series	0.8 (1.8)	1.40 (3)
10279A	NOVA 3 (Data General)	0.23 (0.5)	0.45 (1)
10280A	microNOVA (Data General)	0.23 (0.5)	0.45 (1)
10285A	HP 1000 L-Series	0.23 (0.5)	0.45 (1)
52126A	Intel MULTIBUS	0.23 (0.5)	0.45 (1)

### HP-IB Interface Kits

Logic analyzer HP-IB interfaces allow you to add the measurement set of the analyzers to a system with other HP-IB compatible instruments for automated monitoring, higher-level analysis, and documentation. Refer to pages 21-35 for an overview of instruments available with HP-IB capability. HP-IB interfaces may be ordered as options on initial order for factory installation, or you may buy a field kit and install the interface at your site.

### Logic Analyzers/HP-IB Interfaces

LOGIC ANALYZER MODEL NUMBER	FACTORY-INSTALLED OPTION NUMBER	USER-INSTALLED KITS MODEL NUMBER
1602A Logic State Analyzer	001	10059A
1610A Logic State Analyzer, serial number prefix 1812A and below	003	10494A
1610A Logic State Analyzer, serial number prefix 1822A and above	003	10495A
1610B Logic State Analyzer	003	10496A
1615A Logic Analyzer	001	10069A
1640B Serial Data Analyzer	001	10281A

### Performance Analysis

Using the second-generation logic analyzers with HP-IB capability and a smart controller creates a measurement system for higher-level evaluations of system performance. Model 1610A/B Logic State Analyzer or Model 1615A Logic Analyzer may be used to acquire data and provide front end storage. Data is sent across the HP-IB to an intelligent controller for post-processing. Model 9825A/35A/45A Desktop Computers or any HP-IB compatible computer can be programmed for user-defined tests and routines. The post processing results can then be displayed on a graphics terminal, printer/plotter, or the logic analyzer display. Typical analysis formats include histograms of system activity by frequency or time, software execution time profiles, or matrices of branching probabilities.

### HP-IB Monitors

Two interfaces are available for directly monitoring activity on HP-IB lines. Model 10050A and 10051A HP-IB Adapter and Test Probe are used with Model 1602A Logic State Analyzer; refer to pages 157-158 for a description and specifications.

Model 10066A HP-IB Probe Interface is used with the 1610A/B Logic State Analyzer or 1615A Logic Analyzer to transparently monitor the 16 HP-IB lines. The interface connects directly to the bus and has pod sockets for the analyzer probes. Protocol violations in the handshake sequences set a flag for the analyzer and flash an LED on the interface. A clock source switch gives you a choice of acquiring

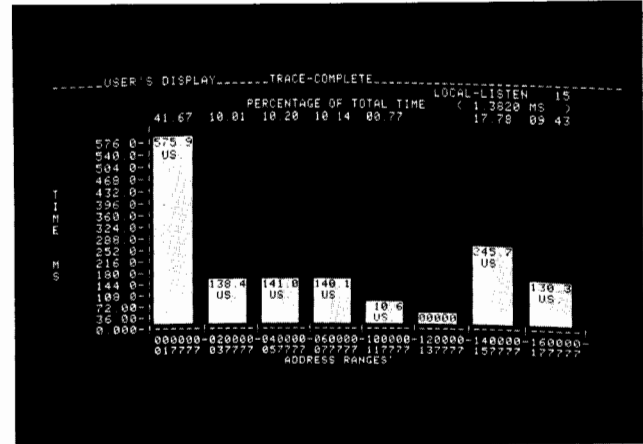

A logic analyzer with HP-IB interface and an intelligent controller are used for higher-level performance analysis. This histogram of occurrence counts is displayed on a 1610 Logic State Analyzer.

talker asserted data (DAV), listener accepted data (NDAC), or parallel poll sequences. A pushbutton on the interface displays on the analyzer the state of quiescent lines on a quiet or stalled HP-IB bus.

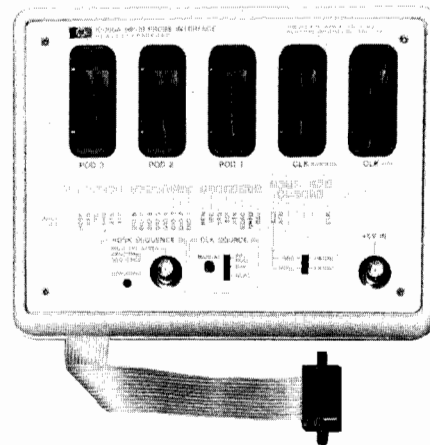

### 10066A HP-IB Probe Interface

#### 10066A HP-IB Probe Interface Specifications

**Input load:** <math>400 \mu\text{A}</math> source or logic analyzer probe load.

**Input Threshold:** TTL fixed at approx 1.5V.

**Maximum input:**  $\leq 5.5\text{V}$  or logic analyzer spec.

#### Minimum input

**Voltage:**  $\geq 0.5\text{V}$  or logic analyzer spec.

**Setup time:** time data stable prior to clock edge, 20ns.

**Hold time:** time data stable following clock edge, 50 ns.

**Power:** +5V, 100 mA max.

#### Ordering Information

10059A HP-IB Interface Kit for 1602A	\$ 300
10066A HP-IB Probe Interface, 1610A/B and 1615A	\$ 300
10069A HP-IB Interface Kit for 1615A	\$ 400
10275A PDP-11 UNIBUS Interface	\$ 300
10276A LSI-11 Q-Bus Interface	\$ 375
10278A HP 1000 M/E/F Series Interface	\$ 650
10279A NOVA 3 Interface	\$ 500
10280A microNOVA Interface	\$ 500
10281A HP-IB Interface Kit for 1640B	\$ 475
10285A HP-1000 L-Series Interface	\$ 350
10494A HP-IB Interface Kit for 1610A with Serial Number Prefix 1812A and below	\$1200
10495A HP-IB Interface Kit for 1610A with Serial Number Prefix 1822A and above	\$ 900
10496A HP-IB Interface Kit for 1610B	\$ 800

# LOGIC ANALYZERS

## Accessories

**Analyzer/Converter Cables**  
10254-61601



**Test Cable, Clip**  
01611-61609

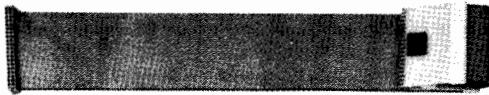

**Test Cable, Plug**  
01611-61610

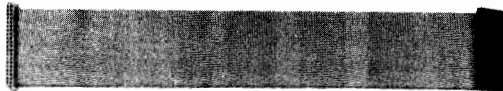

**Trigger Bus Cable**  
10236A



**Test Cable**  
01611-61612



**RS-232-C Cable**  
01640-61604

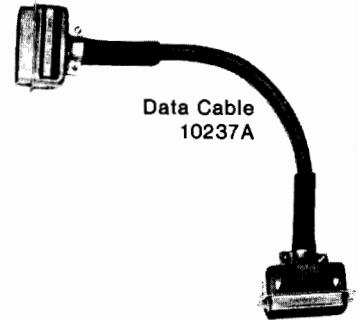

**Data Cable**  
10237A

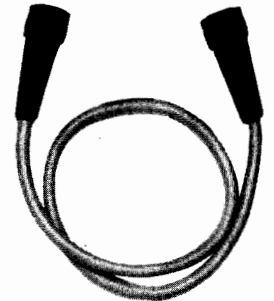

**Analyzer/Printer Cable**  
09866-61630

### Cables

The following cables are supplied with the respective instruments and options on initial order. They are included for convenience in ordering replacement parts.

#### Models 10236A Trigger Bus Cable and 10237A Data Cable

These cables connect the 1600A and 1607A Logic Analyzers to double the 16-bit word capacity to 32-bit word width. Model 10236A Trigger Bus cable also provides the connection of Model 10254A Serial-to-parallel Converter to the 1600A or 1607A Analyzers. The appropriate number of cables are supplied with the 1600S and 10254A.

#### Models 1600S Logic Analyzer/10254A Serial-to-parallel Converter Interconnecting Cable (HP P/N 10254-61601)

These interconnecting cables transmit the clock and data output of the 10254A Serial-to-parallel Converter to 1600A or 1607A Logic Analyzer. Four cables are needed and are supplied with Model 10254A.

#### Models 1610A/B Logic Analyzers and 9866A/B Printer Cable

A cable is available to connect the 1610A/B Logic Analyzer to either Model 9876A or 9866B Thermal Printer. This cable, HP P/N 09866-61630, is provided with Options 002 or 004 for the 1610A/B. The two end connectors can be ordered alone, vendor Burndy, P/N BTO 6B ( ) 14-19PAA143.

#### Model 1611A Logic Analyzer Cables

Three test cables are supplied with Model 1611A Logic Analyzer, and provide the connections between the Analyzer's microprocessor probe and the microprocessor under test. Any of these three cables can be used to connect the microprocessor to the 1611A input.

#### Model 1640A Serial Data Analyzer RS-232C (V24) Interface Cable

A 3 m (10 ft) RS-232C (V24) cable is supplied with Model 1640A Serial Data Analyzer. To replace this cable, order HP P/N 01640-61604.

### Connectors

#### Model 1602A Analyzer Probe Connectors

Several kits and units are available to make more convenient connectors for Model 1602A Logic Analyzer. HP P/N 01602-68701 is an assembly of quick disconnect pod with a printed circuit board and 30.5 cm (12 in.) leads; no slip-on probe tips are included. HP P/N 01602-68702 includes the quick disconnect plastic pod halves and a printed circuit board, but no leads are included. An unloaded printed circuit board, HP P/N 01602-26506, is available for use with the quick disconnect plastic pods. This probe/system interface is a standard two row, edge connector which is easily added to your instrument during development.

#### Model 1640A Connectors

If you wish to custom wire your 1640A Serial Data Analyzer in your system, a male cannon connector (HP P/N 1251-0063) and a female cannon connector (HP P/N 1251-0064) are available and are recommended for RS-232C (V24). An RS-232C (V24) T-connector cable (HP P/N 8120-2755) is also available.

#### Ordering Information

Ordering Information	Price
10236A Trigger Bus Cable	\$20
10237A Data Cable	\$60
1251-0063 Cannon Connector, Male	\$13
1251-0064 Cannon Connector, Female	\$15.50
8120-2755 T-Connector Cable	\$43
01602-68701 Probe Connector with Leads	\$80
01602-68702 Quick Disconnect Kit	\$25
01602-26506 Unloaded PC Board	\$4
01611-61609 30.5 cm (12 in.) Test Cable with a 40-pin female connector and 40-pin clip	\$95
01611-61610 30.5 cm (12 in.) Test Cable with a 40-pin female connector and 40-pin plug	\$30
01611-61612 10.2 cm (4 in.) Test Cable with a 40-pin female connector and a 40-pin plug	\$29
01640-61604 RS-232C (V24) Interface Cable	\$250
09866-61630 Printer Cable	\$185
10254-61601 Cable, each	\$75

### Probe/System Connector Kit

The Hewlett-Packard probe/system connector kit (HP P/N 5061-1263) includes five plastic connector bodies (HP P/N 01610-87601) and fifty connector pins (HP P/N 01610-06101). By incorporating these connectors into your system during initial design, you have easy access to signals necessary for testing with an HP Logic Analyzer. Alternatively, these connectors can be installed on an interface board which can then be connected to a system with a ribbon cable.

Connectors can be mounted on an exterior surface of an internal circuit board with only a portion of the body extending through an external panel. Two notches in the connector body mate with the feet of the Analyzer probes to assure proper alignment.

If you want to solder wires directly to probe connector pins, order hollow pins, HP P/N 1251-4305. When soldering pins to the printed circuit board, a dummy fixture or other probe should be used to keep the pins parallel. A dummy probe can be fabricated using a pod cover (HP P/N 5040-8125), four screws (HP P/N 0624-0306), and the pod housing for a logic probe. For probe models 10230C, 10231C, and 10247A use pod housing HP P/N 5040-8010; for probe models 10248A/B/C, 10248B Opt 001, and HP P/N 01611-62101 use pod housing HP P/N 5040-8011.



64030A Development Station Cart and  
1610B Logic State Analyzer

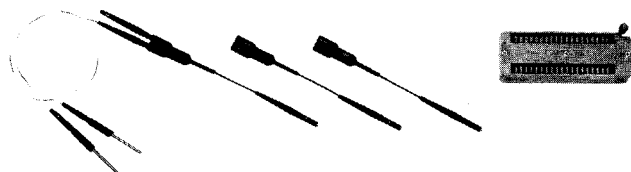

1200-0623 40-pin Socket  
5061-3613 Demultiplexing Adapter

### Special Connectors

HP P/N 5061-3613 Demultiplexing Adapter is a 95 mm (3.7 in.) 2-for-1 adapter which can route a system signal to two monitoring lines. In combination with clock qualifiers, these leads allow you to monitor multiplexed pins on microprocessors and display the two signals in parallel on the logic analyzer display.

HP P/N 1200-0623 is a 40-pin, zero insertion force socket for use in a circuit board for damage-free insertion and removal of microprocessors and 40-pin DIPs. HP P/N 1200-0682 is a socket for Model 1611A Logic Analyzer microprocessor probe cable, and prevents header breakage. This socket also protects the pins for any 40-pin DIP that is removed or replaced frequently.

### Accessories and Testmobiles

#### Testmobiles

Four styles of testmobiles can be used with your logic analyzer: Models 1006A, 1007A, 1008A, and 1117B. A variety of options are available for add-on drawers and shelves. Refer to page 219.

For the 64100A Development Station and logic analyzers with horizontal keyboards, Model 64030A Development Station Cart is a convenient, 690 mm (27 in.) high table-level working surface which rolls easily on ball casters. A large recessed shelf under the table top provides convenient storage space for manuals and parts. The wheel base matches the 600 mm x 760 mm (24 in. x 30 in.) for stability.

#### Adapter Plate

An adapter plate, HP P/N 5061-1213, can be used to fasten Model 1740 and 1720 Series Oscilloscopes to the Model 1607A Logic Analyzer, the 1600A Logic Analyzer to the 1607A Logic Analyzer, or either of these two analyzers to Model 10254A Serial-to-Parallel Converter. This part consists of an aluminum plate and a strap for the top unit.

#### Rack Mount Slides and Adapter

Hardware is available to install some logic analyzers in standard 483 mm (19 in.) racks. Model 10491B Rack Mount Adapter can be used with Model 1600A Logic Analyzer. Fixed slides (HP P/N 1490-0714) and pivot slides (HP P/N 1490-0719) can be used in conjunction with this rack adapter. Model 1640A can be placed in a standard rack with Model 10299A Rack Mount Adapter.

### Transit Cases

Transit cases are available for some of the logic analyzers. A standard transit case (HP P/N 9211-2459) can be used for Model 1600A Logic Analyzer, and it is also suitable for the 1700 Series Oscilloscopes. For Model 1602A Logic Analyzer, use Model 10058A Transit Case. The transit case for Model 9866A/B Printer is HP P/N 9211-0839. To add wheels to these cases, order Field Kit HP P/N 1490-0913.

For all other analyzers, have your Field Engineer contact the HP Corporate Parts Center where a specialist is available to advise the best solution for transporting your analyzer.

### Pouches

Three pouches are available for use with logic analyzers: HP P/N 1540-0325 is a large pouch which will hold all of the accessories for Model 1610A, 1611A, or 1615A Logic Analyzer. HP P/N 1540-0320 is a small pouch for the 10230/10248 probes. HP P/N 1540-0440 is a medium pouch for Model 1611A Logic Analyzer probe.

### Keyboard Covers

A hard, protective keyboard cover (HP P/N 5040-0588) is available to fit the keyboards of Models 1611A and 1615A Logic Analyzers.

### Ordering Information

	Price
1006A Testmobile	\$200
1007A Testmobile	\$350
1008A Testmobile	\$390
1117B Testmobile	\$575
10058A Transit Case (1602A)	\$50
10299A Rack Mount Adapter	\$225
10491B Rack Mount Adapter	\$150
64030A Development Station Cart	\$300
0624-0306 Screw, each	\$0.06
1200-0623 40-Pin Socket	\$18.50
1200-0682 Socket for 1611A	\$10.50
1251-4305 Hollow Connector Pin, each	\$0.05
1490-0714 Fixed Slides	\$97.50
1490-0719 Pivot Slides	\$150
1490-0913 Field Kit, Wheels	\$160
1540-0320 Small Pouch	\$4.70
1540-0325 Large Pouch	\$26
1540-0440 Medium Pouch	\$9.75
5040-0588 Keyboard Cover	\$27
5040-8010 Pod Housing	\$1.95
5040-8011 Pod Housing	\$1.95
5040-8125 Pod Cover	\$1.50
5061-1213 Adapter Plate	\$36
5061-1263 Probe-System Connector Kit	\$20
5061-3613 Demultiplexing Adapter	\$8.50
9211-2459 Transit Case (1600A)	\$525
01610-87601 Connector Body	\$2.90
01610-06101 Connector Pin, each	\$0.15



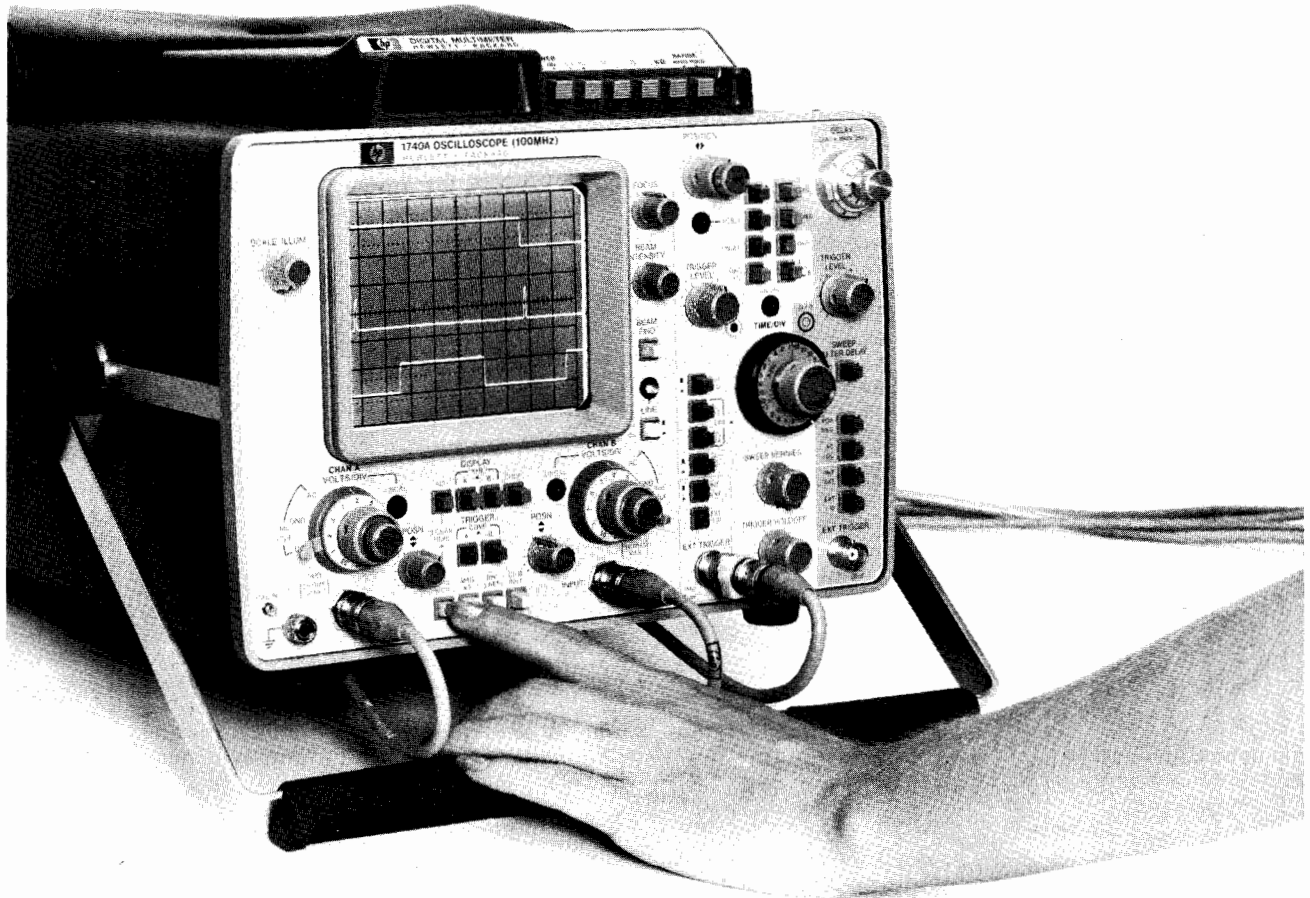

The oscilloscope—the most general purpose and basic tool of the electronic industry—has evolved into a very accurate and versatile measurement tool. With the rapid growth, in the past few years, of technology in integrated circuits, the measuring capabilities have increased tremendously. New capabilities include the Hewlett-Packard developed delta time measurements, the crystal referenced time base of the 1743A, and the faster-writing expansion storage CRTs of the 1727A and 1744A. In general, the most versatile test instrument has become even more accurate and more flexible.

Hewlett-Packard pioneered many of the measurement capabilities that are now taken for granted in oscilloscopes. A few of these are internal graticule CRT, beam finder, expansion mesh CRT, trigger holdoff, mixed sweep, and rugged variable persistence storage.

### Selecting an Oscilloscope

When selecting an oscilloscope you will need to match your present and future measurement needs with the oscilloscope feature set. Price is always a consideration and incremental cost must be weighed against incremental measurement capability. In many cases ease-of-use should be considered along with measurement accuracy and the overall feature set. Some of the major feature decisions include:

- Bandwidth
- Number of channels
- Rack or cabinet configuration
- Portability
- Plug-in versatility
- Vertical and horizontal accuracy
- Ease-of-use
- Price
- Time interval capability
- Variable persistence storage
- Various combinations of the above.

Hewlett-Packard manufactures several oscilloscope families. Each family optimizes a different combination of the considerations previously listed. Refer to the Oscilloscope Selection Chart on page 179 for feature sets and page references.

### The 180 System for Versatility

The 180 series of oscilloscopes provides up to 100 MHz real-time bandwidth in seven different mainframes. Plug-ins for measurement versatility include:

- General purpose dual channel verticals, 50 MHz—100 MHz
- General purpose time base systems
- Four channel verticals (50 MHz—100 MHz)

In addition, the 180 family is available in cabinet or rack mount (5¼ in.) versions with 8 x 10 cm CRT display or in a large screen cabinet version with a 16.5 cm diagonal CRT (8 x 10 div, 1.29 cm/div).

The 180 family also provides variable persistence storage mainframes for bright flicker-free viewing of low duty cycle waveforms and for capture of single-shot transients and glitches in digital systems.

The plug-in system, 5¼ in. rack or cabinet configuration, plus variable persistence storage versions, permits the 180 system to be configured to satisfy a broad range of measurement needs for R & D, production, and general bench applications.

### The 1700 Family for General Purpose Applications

The 1700 family of oscilloscopes provides a wide selection of dedicated instruments. It is further divided into the 1740 series (dc to 100 MHz), and the 1715 and 1720 series which are dc to 200 MHz and dc to 275 MHz respectively.

### The 1740 series

The 1740 100 MHz series offers both general purpose and specialized versions. The series consists of the 1740A (HP Journal, December 1975) for general purpose work;



The 275 MHz 1727A provides variable persistence storage and delta time measurements.

the 1742A and 1743A (HP Journal, December 1977) for applications requiring easier, more consistent and more accurate time interval measurements; and the 1741A (HP Journal, September 1976) and 1744A for applications where variable persistence storage is required.

All of the 1740 series are dual channel 100 MHz oscilloscopes with a third channel trigger view. The trigger-view channel allows simultaneous display of the timing relationships between the trigger signal and the two vertical channels. The series has 5 mV/div deflection factors and a times 5 vertical magnifier that increases sensitivity to 1 mV on both channels to 40 MHz\* without the need to cascade channels. Also featured are a main and delayed sweep time base with a 5 ns/div maximum sweep speed, and vertical inputs that provide a switchable input impedance of 1 M $\Omega$  or 50 $\Omega$  for convenience and optimum matching of oscilloscope input to source impedance.

\*The 1741A and 1744A have 30 MHz bandwidth in this mode.

#### Variable persistence storage in the 1740 family

The 1741A and 1744A provide all of the oscilloscope features of the 1740A with the addition of a variable persistence storage CRT. Automatic storage modes add to the measurement capabilities and greatly increase operating ease. For general purpose work with digital circuits the 1741A provides an excellent solution. Its 200 cm/ $\mu$ s writing speed permits easy viewing of low repetition rate signals and with its light integrating capability can display transitions as fast as 3.5 ns over the full screen height after only 10 occurrences of the sweep. The 200 cm/ $\mu$ s writing speed of the 1741A also permits single-shot capture of 10 MHz events with full

screen amplitude. Proportionately higher frequency transients may be captured and displayed at lesser amplitudes. An auto-camera option and a triggered A vs. B option add even more flexibility to the general purpose 1741A.

The 1744A variable persistence storage oscilloscope offers a writing speed of 1800 cm/ $\mu$ s which permits the 1744A to capture and display single-shot events from dc to 100 MHz and display them over a 6  $\times$  8 division quality area.

The Hewlett-Packard developed system of expansion storage used in the 1744A has a writing speed consistent with the 100 MHz oscilloscope bandwidth while providing sharp trace quality. This technology provides a larger display area of the stored 100 MHz transients than any other 100 MHz storage oscilloscope available today. State-of-the-art features and performance make the 1744A ideal for today's digital design and troubleshooting applications.

#### High speed, high bandwidth variable persistence storage with 1727A

The 1727A oscilloscope is the solution for those difficult measurement applications that require both high bandwidth signal fidelity and fast writing speed to capture single-shot or very low duty cycle events. The 1727A's stored writing speed of 2000 cm/ $\mu$ s allows capture of single-shot rise times as fast as 1.27 ns, 4 div high with 1 ns/div sweep speed. This fast writing speed is obtained by using Hewlett-Packard's expansion storage technology. With this technology, the full 2000 cm/ $\mu$ s writing speed is available while in the variable persistence mode—thus providing the maximum light integrating capability to produce bright, crisp displays of low

repetition rate signals. Also, with the 1727A, there is no need to use a reduced scan display mode in order to obtain fast writing speeds. Conveniently grouped variable persistence storage controls, automatic selection of operating conditions, and front panel color coding make the 1727A one of the easiest-to-use high speed storage oscilloscopes available today.

The 1727A also provides 275 MHz bandwidth, dual marker time interval measurement and other 1725A operating features.

#### Delta time means ease-of-use and accuracy

Many of the 1700 series oscilloscopes provide time interval measurement capability known as DELTA TIME ( $\Delta T$ ). This capability is presently provided on the 1742A, 1743A, 1715A, 1722B, 1725A and 1727A. The demand for precise and consistent time interval measurements has expanded with the growth of digital systems. System timing is an all important consideration in the design, manufacture, and troubleshooting of digital circuits. The Hewlett-Packard DELTA TIME system uses a two marker method with the markers defining the start and stop events. The interval contained by the two markers can be read directly on an LED display. This technique eliminates the error prone procedures required when using conventional delayed sweep where careful readings of a 10-turn helical must be taken for both the START and STOP events, and the difference multiplied by the MAIN TIME base setting. These steps are eliminated using the Hewlett-Packard introduced DELTA TIME system. In addition to speed and ease-of-use, the DELTA TIME system is more accurate since it eliminates the mechanical non-linearities of a 10-turn potentiometer. The DELTA TIME system also permits the operator to view two events which are separated in time on alternate sweeps with the high resolution of the delayed sweep. This allows the operator to measure pulse width and period jitter, or compare events separated in time, with higher resolution and accuracy than is possible without DELTA TIME.

#### Precision timing

Oscilloscopes which rely on a Miller Integrator ramp for their timing reference can approach accuracies of  $\pm 1\%$  using delayed sweep methods. The 1743A has a crystal referenced time base with timing accuracy of  $\pm 0.002\%$  of reading  $\pm 1$  count. It has a built in 5-digit LED readout for time interval with resolution up to 100 ps. The 1743A has the two marker delta time system and in addition offers unprecedented time interval accuracy. Sweep speeds can be continuously calibrated so that the CRT graticule lines can be calibrated to your system's units. Triggered delta time measurements mean that the time interval readout automatically tracks changes in the input signal without operator intervention; and delay goes all the way to zero to allow the delayed sweep precision to be used on low duty cycle and non periodic events. The 1743A also provides a precise on-screen indication of the trigger level at which the start and stop events are being measured without any hysteresis error.

# OSCILLOSCOPES

General information (cont.)

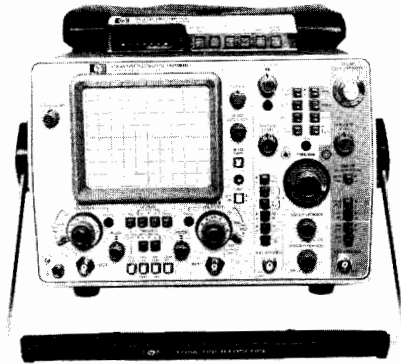

1740A Opt 034, 100 MHz general purpose.



1741A Opt 034 and 1744A, 100 MHz for measurements requiring variable persistence storage and transient capture.

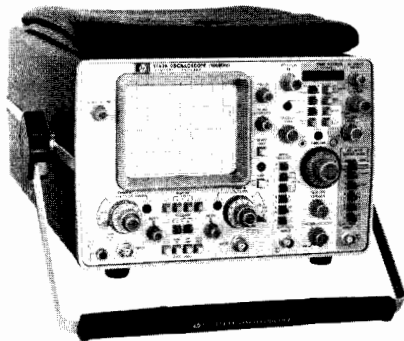
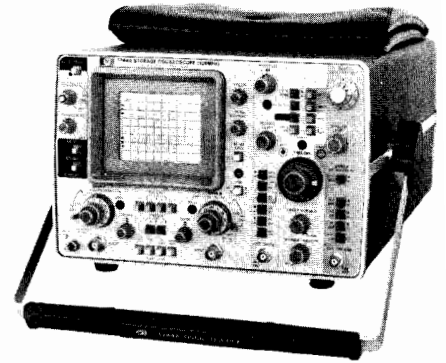

1743A and 1742A Opt 034, 100 MHz delta time measurements.

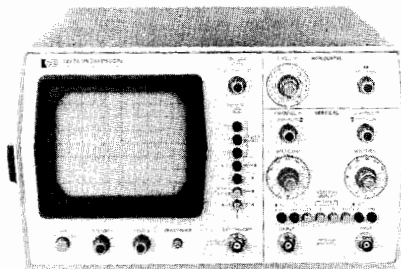
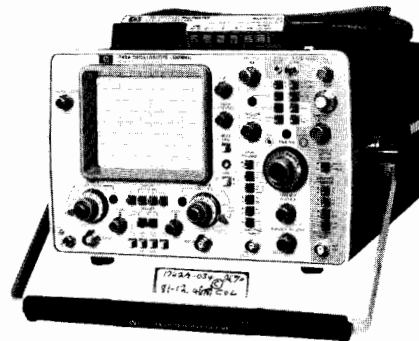

1222A, 15 MHz for industrial and educational use.

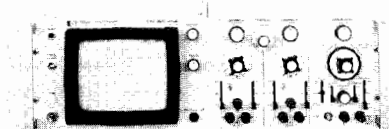

1205B, a 500 kHz "workhorse" of industry.

### The high frequency 1700 series

Hewlett-Packard offers three high speed delta time oscilloscopes in addition to the 1727A that are ideal for use in the design, manufacturing, and testing of high speed computers and peripherals, with fast interface logic, high speed digital communications, and high frequency RF and analog applications.

The 275 MHz Model 1722B ("A" version described in HP Journal, December, 1974) with its microprocessor and LED display provides a measurement set which provides ease-of-use and increased accuracy on both the voltage and time axes.

The 1722B incorporates the two marker Delta Time System. In addition, a  $\Delta V$  system is provided to make voltage measurements between any two points on a displayed waveform. The 1722B also has a vertical mode which scales measurements in percentages so that measurements such as percent overshoot can be easily made. Another vertical mode on the 1722B allows dc voltages to be measured through the oscilloscope probe. The microprocessor can provide the reciprocal of delta time readings for a direct frequency readout. The vertical and horizontal measurement capabilities of the 1722B make it a remarkably versatile test instrument which economizes on bench space while providing a high quality 275 MHz laboratory oscilloscope with a greatly expanded measurement set.

Models 1725A and 1715A offer 275 MHz and 200 MHz bandwidths respectively and both have the delta time system advantages. These oscilloscopes are available with an optional built-in DMM for direct readout of time interval and the DMM measurement set. The 1725A and 1715A have a selectable input impedance on both vertical channels (1 M $\Omega$ , 11 pF or 50 $\Omega$ ). The 11 pF shunt capacitance of these units is the lowest input capacitance presently available on a high impedance input oscilloscope. The specified bandwidth of the 1725A in the high impedance input mode is also the highest presently available.

### Low Frequency

#### 500 kHz

Low frequency oscilloscopes which have 500 kHz bandwidth are used in education, medicine, system monitors, engineering, production, and in some cases field service. These could be classified as the "workhorses" of the electronics industry since they are most commonly found in system applications. The 1200 series oscilloscopes easily fill these requirements with their 100  $\mu$ V and 5 mV sensitivity, differential inputs, solid-state and lightweight construction, and reliable and stable operation. Also available are storage and variable persistence models which eliminate annoying flicker from low rep rate signals and retain single-shot traces that are common in biomedical or electromechanical applications.

#### 15 MHz

In the dc to 15 MHz range the 1220A and 1222A dual channel oscilloscopes are designed for industrial and educational applications, and production line testing. Logical front panel layout, large 8  $\times$  10 division internal graticule, and automatic triggering reduce familiarization time and assure maximum efficiency in production and student environments. The 1220A and 1222A have a TV Sync for triggering on video frames.

Model 1222A has all of the features of the 1220A plus a delay line that allows viewing of the leading edge of the sweep trigger signal. Applications include design and check-out of logic systems such as calculators and appliance controllers.

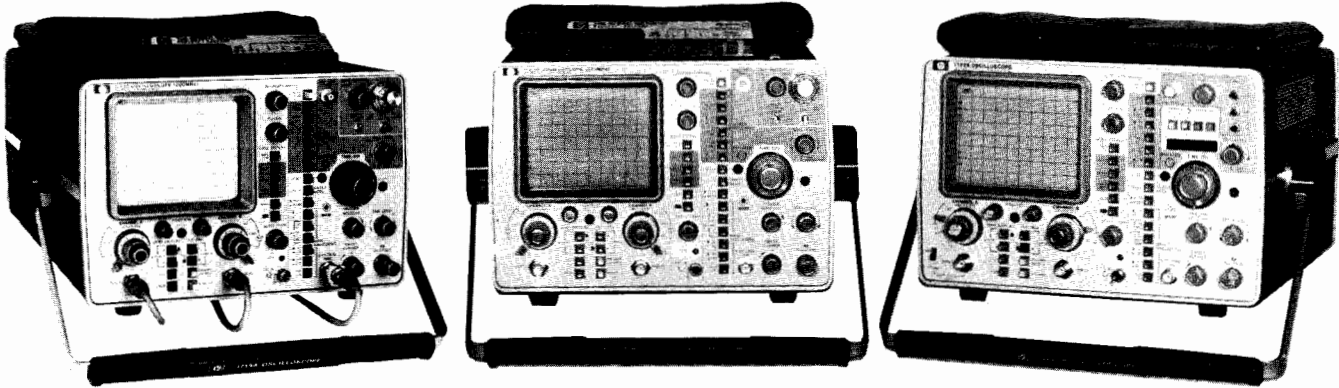

1715A Opt 034 (200 MHz), 1725A Opt 034 and 1722B (275 MHz) provide high frequency measurements and 1% delta time accuracy.

### Additional Measurement Features Time and state displays

The 1700 series option 101 permits one-button switching between time domain waveforms and data domain state displays. The State display is obtained from the 1607A, a 16-channel logic analyzer with pattern trigger recognition, digital delay, variable threshold selection, data qualifier lines, and pretrigger display. The outputs of the 1607A are displayed on the 1700 series oscilloscope via rear panel inputs. The front panel inputs of the oscilloscope remain free for waveform inputs. The 1607A triggers the oscilloscope when a specified word occurs and by switching from the State to the waveform display it is possible to vector the oscilloscope with its high resolution directly to the vicinity of errors located on the State display.

### DMM option for delta time oscilloscopes

Hewlett-Packard models 1742A, 1715A, 1725A and 1727A have Delta Time as a standard feature. The DMM option provides a 3½ digit DMM built into the top cover of the oscilloscope with an internal connection which allows the DMM to read out time intervals on its display. The DMM can be used for time interval readouts or as a DMM with separate inputs for measuring ac and dc volts and amps, and ohms. A delta time oscillo-

scope with the optional DMM provides a multi-measurement test station, yet offers easy portability.

The DMM option, without time interval readout, is also available on the 1740A and 1741A oscilloscopes.

### Oscilloscope Accessories

Cameras and adapters, testmobiles, active and passive probes, and adapters to meet most any need are available to help you get the most out of your oscilloscope investment. See page 207.

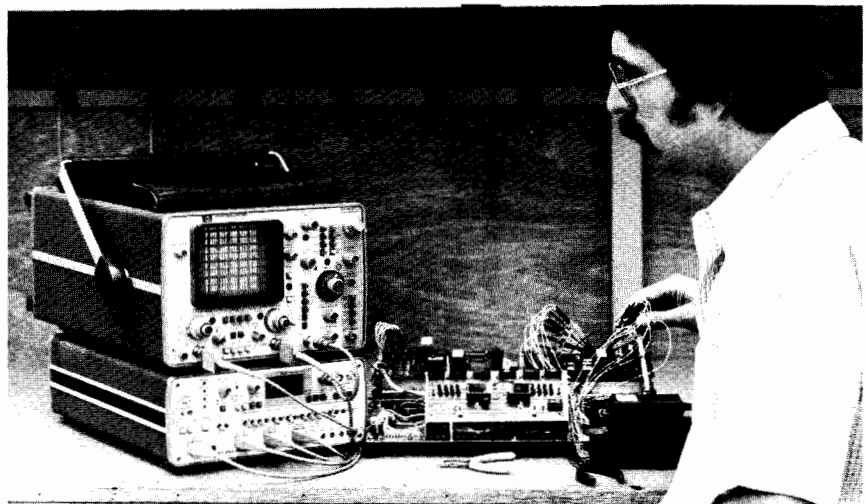

Option 101 to 1740A offers one button switching between Logic State Analysis and volts vs. time measurements.

## Oscilloscope Selection Chart

Characteristics	1700 Series										180 Series	1220A 1222A	1200 Series		
	1715A	1722B	1725A	1727A	1740A	1741A	1742A	1743A	1744A	1200B			1201B	1205B	
Bandwidth	200 MHz	275 MHz	275 MHz	275 MHz	100 MHz	100 MHz	100 MHz	100 MHz	100 MHz	50 MHz, 100 MHz	15 MHz	500 kHz	500 kHz	500 kHz	
Deflection Factors/Div.	5 mV to 5 V	10 mV to 5 V	10 mV to 5 V	10 mV to 5 V	1 mV* to 20 V	1 mV* to 20 V	1 mV* to 20 V	1 mV* to 20 V	1 mV* to 20 V	500 $\mu$ V Min.	2 mV to 10 V	0.1 mV to 20 V	0.1 mV to 20 V	5 mV to 20 V	
Sweep Speeds/Div.	1 ns to 0.5 s	1 ns to 0.5 s	1 ns to 0.5 s	1 ns to 0.5 s	5 ns to 2 s	5 ns to 2 s	5 ns to 2 s	5 ns to 2 s	5 ns to 2 s	5 ns to 1 s	10 ns to 0.5 s	0.1 $\mu$ s to 5 s	0.1 $\mu$ s to 5 s	0.1 $\mu$ s to 5 s	
Channels	2	2	2	2	2	2	2	2	2	2,4	2	2	2	2	
Time Measurements	•	•	•	•			•	•							
Variable Persistence Storage				•		•			•	•			•		
3rd Channel Trigger View					•	•	•	•	•						
TV sync					Optional	Optional					•				
Differential Inputs										•		•	•		
Optional Logic State Switch	•	•	•		•	•	•	•							
LED Readout/DMM	Optional	•	Optional	Optional	Optional	Optional	Optional	•							
Page	190	190	190	190	180	180	180	180	180	196	205	203	203	203	

\*With X5 vertical magnification at reduced bandwidth.

# OSCILLOSCOPES

100 MHz crystal delta time, storage

Models 1740A, 1741A, 1742A, 1743A & 1744A

- Optional built-in DMM for expanded measurement convenience
- Dual channel, 5 mV/div to 100 MHz
- 3rd Channel trigger view and selectable input impedance



1740A, Opt 034/035

## 1740A, 1741A, 1742A, 1743A, 1744A Description

Hewlett-Packard's 1740 series of 100 MHz, dual-channel oscilloscopes offer the high performance necessary to meet the demanding requirements of both laboratory and field applications. These oscilloscopes have the performance and features to make accurate measurements with ease. The front panel includes a large, high-resolution CRT with color-coded controls which reduce operator learning time and make repetitious measurements easier. Several features that add to the versatility of these 100 MHz portable oscilloscopes include a third channel trigger view for viewing the external signal along with both vertical channels; a X5 vertical magnifier for 1 mV/div deflection factors on both channels; selectable input impedance (1 M $\Omega$ /50 $\Omega$ ) for general purpose probing and precise rise time measurements; a Logic State Display option (except for the 1744A) for convenient switching between logic state and electrical analysis; and for the 1740A, 1741A, and 1742A, an optional built-in DMM for expanded measurement convenience.

## 8 X 10 cm Display

### 1740A, 1742A, 1743A Conventional CRT

The CRT has a crisp, bright trace over the fully specified 8 x 10 cm display area. An accelerating potential of 15 kV makes the display compatible with the 5 ns/cm sweep speeds for easier viewing of low rep rate, fast transition time signals. The small spot size of the lab quality CRT along with the no parallax internal graticule makes critical and difficult timing measurements easier to perform. An internal floodgun uniformly illuminates the CRT phosphor for high quality trace photos with a sharp well defined internal graticule.

## 3rd Channel Trigger View

In many measurements, especially in digital applications, it is desirable to externally trigger the main sweep using a signal synchronous with the displayed waveforms. The third channel trigger view offers several measurement conveniences in dual channel timing applications.

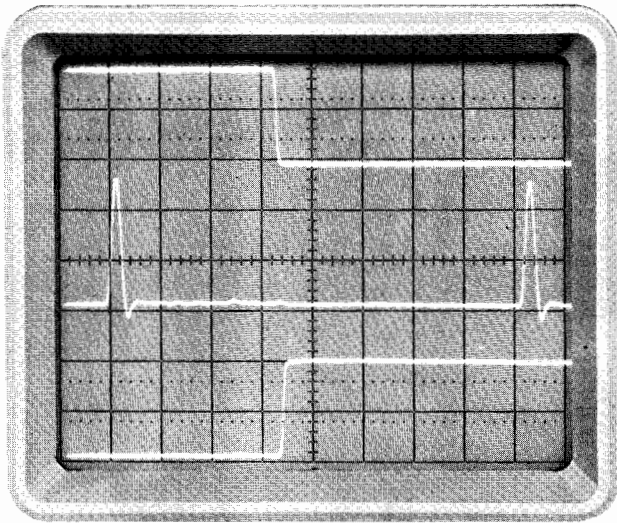

Third channel trigger view of external trigger signal adds measurement convenience. Center screen trigger threshold allows you to see which portion of the signal is triggering the display. Specified delay of  $\leq 3.5$  ns between external trigger input and either vertical channel offers valid timing measurements.

- The external trigger signal can be displayed without the need to physically connect it to one of the vertical input channels.
- Trigger threshold can be viewed for either an internal or external trigger source. Trigger threshold is the center horizontal graticule line and the trigger point is selected by positioning the trigger waveform vertically using the Sweep Trigger Level control.
- With the trigger view mode, the shape of the trigger waveform can be viewed to verify that the correct signal is used as the trigger source. Trigger view also allows you to verify that the trigger threshold is not set to portions of a waveform containing irregularities and reflections.
- With trigger view, three channels of information are displayed so that timing analysis can be accomplished. The trigger channel is displayed with a specified delay of  $\leq 3.5$  ns relative to the two vertical channels.

### Stable Flexible Triggering

Stable internal triggering to greater than 100 MHz requires only 1 cm of vertical deflection. The internal trigger sync take-off is immediately after the attenuator which maintains a stable display regardless of changes in position, vernier, or polarity controls. The desired trigger signal conditioning for your measurement application is quickly achieved with easy-to-use push-button controls. In the external trigger mode, signals of only 100 mV trigger the oscilloscope to 100 MHz (only 50 mV to 50 MHz).

In the composite trigger mode these oscilloscopes internally trigger on asynchronous signals without the need to vertically overlap the traces or use additional trigger conditioning controls. This is useful when looking at signals across an I/O port where clock rates are asynchronous.

### Vertical Amplifiers

To meet many measurement requirements, vertical deflection factors from 5 mV/div to 20 V/div are provided with 3% accuracy. For low level, dual channel measurements, a times five vertical magnifier provides 1 mV/div and 2 mV/div capability which allows you to analyze both input and output signals such as those on tape and disc heads or power supply ripple and its influence on other waveforms.

### Selectable Input Impedance

For maximum measurement flexibility, switchable 50 $\Omega$  and 1 M $\Omega$  inputs are provided. The internal 50 $\Omega$  input with low reflections is useful for measurements requiring a 50 $\Omega$  termination for accurate pulse reproduction.

### Serviceability

Innovations in circuit design along with custom integrated hybrid circuits reduce calibration time because of a minimum of adjustments. Wire harnesses and interconnection cables between boards are reduced with an interface board which connects the main boards together. This interface board helps to reduce service time and reassembly errors normally encountered with instruments containing many cables. These oscilloscopes, with the exception of the high writing speed 1744A, do not require a fan or ventilating holes for convection cooling which reduces the amount of dust and dirt that can accumulate internally.

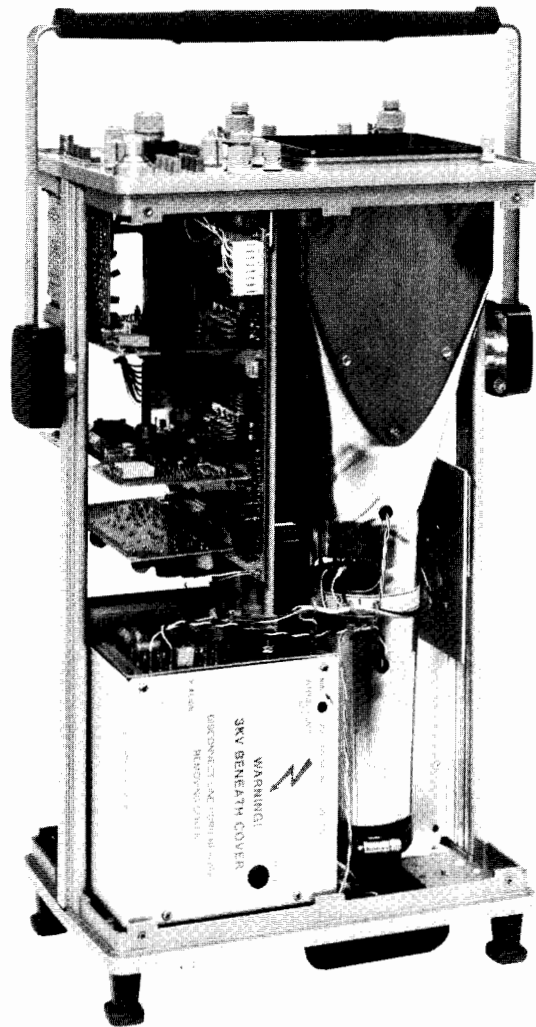

Service and calibration time is reduced with the low number of adjustments (approximately 44) and an interface board reduces interconnecting cables (1740A shown).

### General Purpose 1740A

The Model 1740A contains all of the standard 1740 series features described, such as third channel trigger view, flexible triggering, 1 mV/div deflection factor in the X 5 mode, large 8 X 10 cm CRT, and selectable input impedance. The versatility of this 100 MHz oscilloscope simplifies both real-time and data domain measurements.



Models 1740A, 1741A, 1742A, 1743A & 1744A (cont.)

- Delta time measurements
- Dual channel, 5 mV/div to 100 MHz
- 3rd Channel trigger view and selectable input impedance
- Optional built-in DMM for increased accuracy, flexibility



1742A, Opt 034

### Delta Time Measurements

#### 1742A Time Interval Measurements

Model 1742A provides two methods for making time interval measurements. One is the familiar single marker delayed sweep using the helidial delay control for differential time relationship measurements or for convenient expansion of selected areas of waveforms. The second method is the Hewlett-Packard developed system of dual intensified markers, known as delta time, which greatly simplifies time interval measurements while improving the accuracy and resolution. In delta time mode, Start and Stop markers are alternately displayed on the Main Intensified sweep and the time interval between the markers are read directly on the optional DMM or on the calibrated ten turn dial, or available as a rear panel scaled voltage output compatible with most DVM's. When the delayed sweep mode is selected, the region of the intensified markers is expanded and alternately displayed with the increased resolution of the faster delayed sweep. Now, when the waveforms are overlapped, the maximum precision of delta time interval measurement is obtained. The delta time measurement system with Option 034 improves the percent of full scale error

by a factor of two over the single marker delayed sweep method.

For added convenience, a switch allows the Start marker to be displayed on either channel when making dual channel delta time measurements. The ability to switch starting channels allows you to make dual channel delta time measurements with respect to either channel without having to switch probe test points.

When operating the 1742A in the three channel trigger view mode, the start marker is displayed on the trigger channel and time coincident stop markers on each of the other two channels. This allows you to directly read time intervals between events on either channel and the external trigger input signal.

Production environments often require system timing to be set up by making circuit adjustments. The delta time system with Option 034 or an external DVM permits the desired time interval to be preset on the LED display and the circuit adjusted until the Start and Stop events are overlapped on the CRT. The ability to preset time intervals and adjust the circuit offers speed, and accuracy, with reduced human error in setting up time intervals.

- Precise delta time measurements with crystal reference
- Dual channel, 5 mV/div to 100 MHz
- 3rd Channel trigger view and selectable input impedance
- Semiautomatic triggered delta time measurements

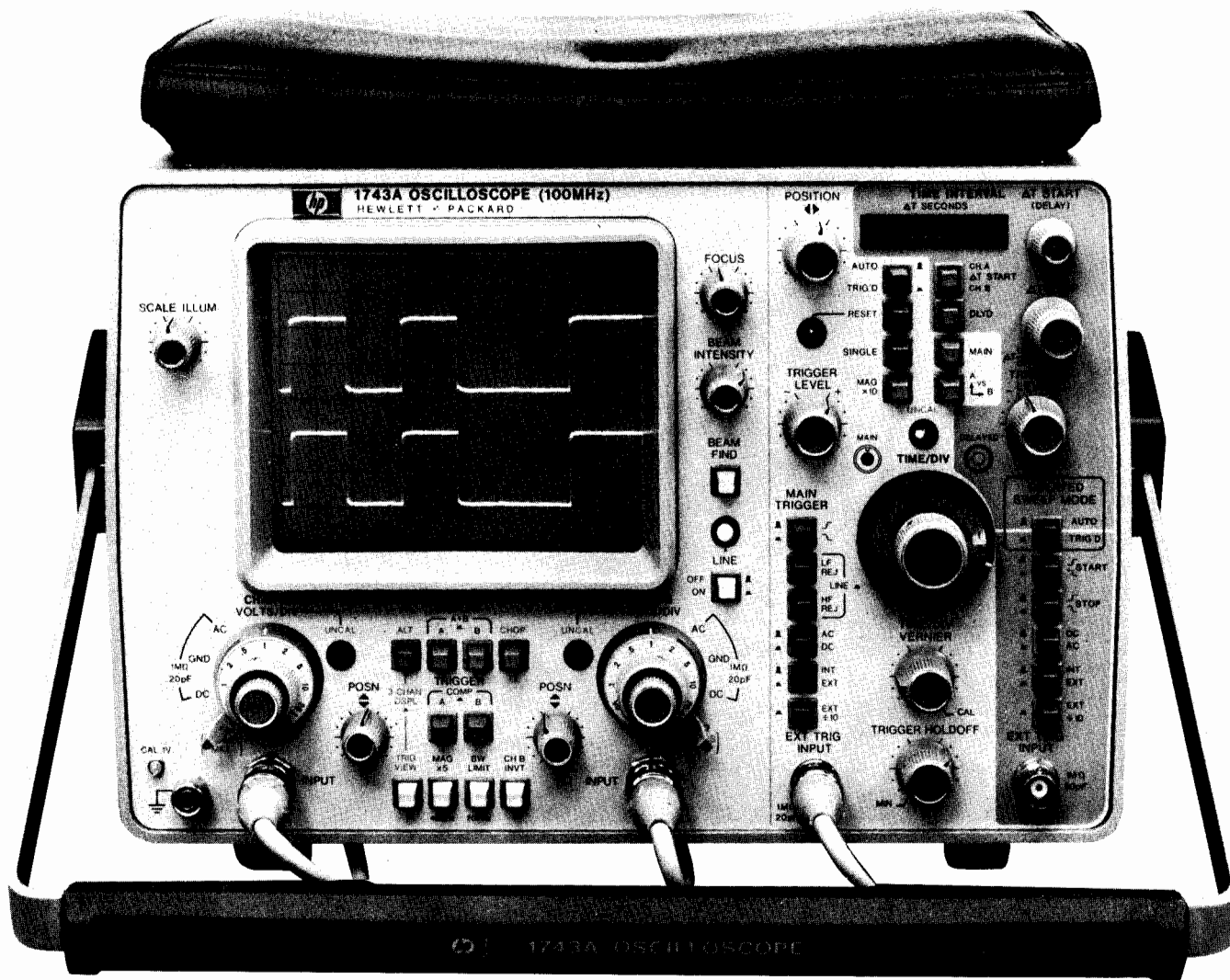

1743A

### 1743A Crystal Accurate Timing

The 1743A incorporates a second generation delta time system based on a 100 MHz crystal timing reference rather than the traditional analog ramp reference. This internal crystal reference offers additional measurement capability and increased accuracy. The time between the two intensified marks is displayed on a five digit LED readout with an accuracy of 0.002% plus or minus one count. For main sweep speeds of five microseconds or less, the one count corresponds to plus or minus 100 ps.

**First pulse measurements:** The 1743A, by using a crystal reference, allows you to measure time intervals relative to the leading edge of the first pulse in the main sweep display. The first pulse measurement capability makes high resolution measurements possible on asynchronous pulses that are common in digital system interfaces.

**Triggered measurements:** The triggered delta time mode of the 1743A offers a major improvement in measurement ease, as well as increased capability. Simply select the proper trigger level and slopes for the Start and Stop markers and the 1743A will perform the measurement with minimum operator involvement. The oscilloscope will track changes in the signal, making this mode well suited for production test applications.

There is no need to operate the 1743A in the delayed sweep mode when the triggered delta time mode is used. This mode expands the measurement window to that of the main sweep.

**Sweep vernier:** Crystal timing now allows you to use the sweep vernier out of its detent position to calibrate the CRT divisions for various measurements without uncalibrating the LED time readout. For example, you can set up the graticule lines to represent clock periods and then make two channel measurements of other signals related to the pre-calibrated "clock" signal.

The sweep vernier also increases the display resolution by up to three times. With the vernier in detent, the resolution of a full screen display is a maximum of one part in 50 000 and with the vernier full ccw, full screen resolution is a maximum of one part in 150 000.

This increased resolution is obtained by using a faster main sweep speed. For example, by switching from a 1  $\mu\text{s}/\text{div}$  range to a 0.5  $\mu\text{s}/\text{div}$  range the last digit of the five digit display becomes hundreds of picoseconds instead of nanoseconds. The same display of the 1  $\mu\text{s}/\text{div}$  sweep can now be obtained on the 0.5  $\mu\text{s}/\text{div}$  sweep by adjusting the sweep vernier.





# OSCILLOSCOPES

Models 1740A, 1741A, 1742A, 1743A & 1744A (cont.)

- Variable persistence storage, auto-store, auto-erase, 200 cm/ $\mu$ s writing speed; auto-intensity circuit
- Optional built-in DMM
- Dual channel, 5 mV/div to 100 MHz
- 3rd Channel trigger view and selectable input impedance

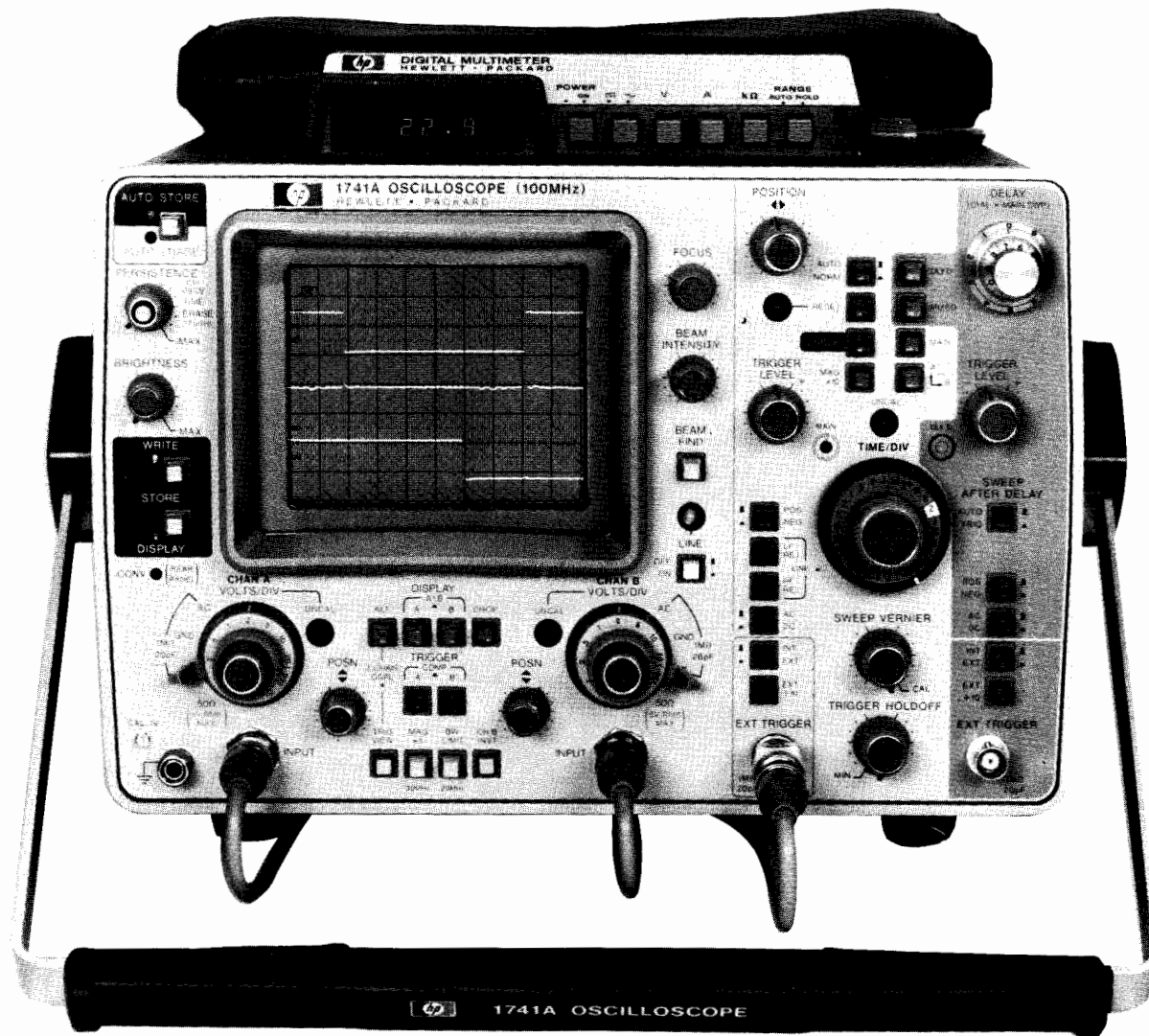

1741A Opt 034

## 1741A, 1744A, Variable Persistence Storage

The Hewlett-Packard variable persistence CRT extends the oscilloscope's usefulness into areas beyond the capabilities of conventional CRT technology. The 1741A and 1744A provide well-defined, easily viewed traces in applications that otherwise require a camera or produce annoying flicker. Applications that require sweep speeds slower than 2 ms/div produce a flickering display on a conventional CRT and as the sweep speed is reduced further the display decays to a moving dot. The variable persistence CRT solves these problems by allowing adjustment of the persistence control to obtain an easily viewed display.

Low repetition rate signals at fast sweep speeds produce very low light output from conventional CRT's, requiring use of a viewing hood or CRT photography to obtain a viewable display. In these applications the variable persistence CRT becomes a light amplifier

by integrating several sweeps to produce bright sharp traces.

The variable persistence storage oscilloscope allows convenient analysis of single-shot events without use of a camera. The 200 cm/ $\mu$ s writing rate of the 1741A is somewhat better than that of ASA 3000 film. The 1800 cm/ $\mu$ s writing rate of the 1744A is higher than can be obtained with ASA 10 000 film without special techniques such as post fogging.

The cathode-ray tube technology used in both the 1741A and 1744A results in full variable persistence performance in all storage operating modes. Neither of these CRT's requires reduced scan display modes or unusually long erase cycle times. With minimum erase cycle time, these oscilloscopes are not "blind" to transients that might be present in the system under test.

Model 1741A's CRT has a writing rate greater than 200 cm/ $\mu$ s and a highly burn resistant storage surface which results in an oscilloscope that is ideally suited to the majority of applications.

- Variable persistence storage with auto-store, auto-erase; auto-intensity circuit
- Expansion storage CRT for 1800 cm/ $\mu$ s writing speed
- Dual channel, 5 mV/div to 100 MHz
- 3rd Channel trigger view and selectable input impedance

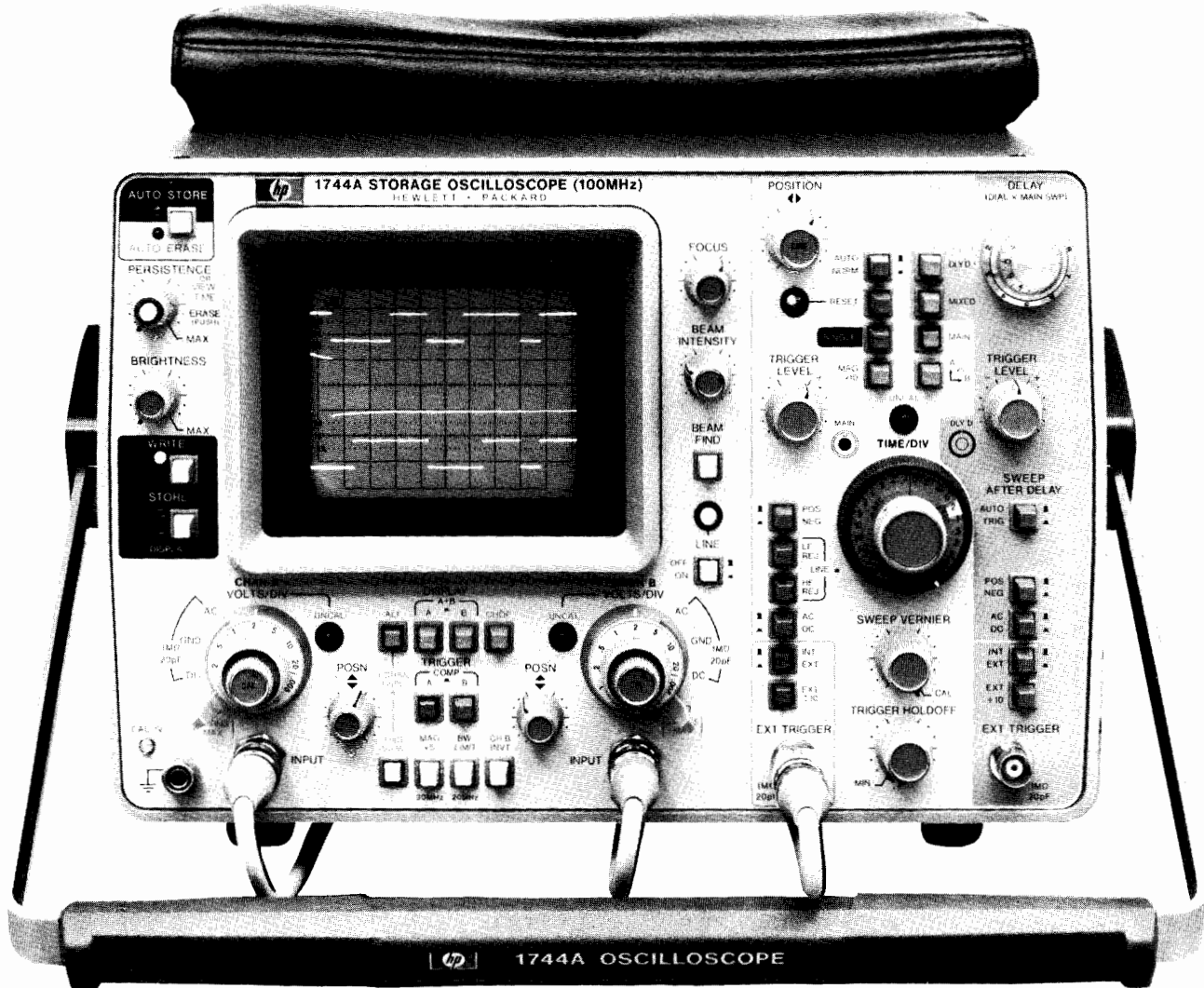

1744A

For high writing rate performance, the 1744A provides a writing rate of 1800 cm/ $\mu$ s. This writing rate allows capture of a 100 MHz sine wave with an amplitude of 8 divisions. Any signal within the bandwidth of the 1744A's 100 MHz vertical amplifier system can be captured and displayed in one sweep.

Capture of transients at the full bandwidth of the 1744A vertical deflection system is achieved with a new CRT technology called Expansion Storage. The waveform to be captured is written on a storage mesh positioned close to the deflection plates. The storage mesh is about the size of a postage stamp and is capable of storing very sharp waveform images. A flood gun electron cloud projects the image through a lens system onto the CRT phosphor for viewing. This combination of a small storage surface and an expansion lens system provides a storage CRT capable of capturing transients at or beyond the slew rate of the 100 MHz deflection systems. Now you can capture fast voltage and current spikes, high energy X-ray impulses, laser pulses, and other transients consistent with 100 MHz bandwidths.

The Auto-Erase mode provides a rapidly updated display of transient events such as switch bounce in keyboard systems.

Another capability of the fast variable persistence design is the ability to repetitively write traces at the rate of either the input signal repetition rate or the time base duty cycle. This allows you to scan data streams for random events such as glitches, noise, coupling and other spurious signals without having to wait for lengthy erase cycles between sweeps. This fast resetting capability makes the 1744A a valuable troubleshooting instrument for locating random glitches and improves the ability to capture aperiodic events.

When noise is on a displayed waveform it is often necessary to determine its frequency so the source can be located. The fast writing speed and fine spot size of the 1744A allows a single sweep capture of a pulse which can then be analyzed to determine the period of the noise component.

Other applications ideally suited to the 1744A include the capture of glitches generated by switching loads on power supplies, printed circuit board trace coupling, and race conditions in digital circuits.



Models 1740A, 1741A, 1742A, 1743A & 1744A (cont.)

### 1741A, 1744A Operation

An automatic intensity circuit simplifies operation of these oscilloscopes. A bloom-free trace is displayed over a wide range of beam intensity and sweep speed settings, greatly reducing the possibility of accidental storage surface burns. The brightness control allows the display to be adjusted for optimum contrast at various writing speeds and scan rates.

The storage control mode LED indicators provide positive indication of the oscilloscope's operational condition. Two automatic operating modes further simplify operation of these oscilloscopes.

The auto-erase mode provides a series of individual "snapshots" of a waveform automatically, freeing the operator to simply probe a circuit at desired points and observe the display. The auto-erase mode also provides a convenient method of setting the focus and intensity for single-shot events. If you are displaying traces on two or more channels, the 1741A or 1744A will wait for the required number of sweeps to be displayed before automatically erasing the display.

For maximum convenience in single-shot applications, an auto-store mode, which operates in single-shot mode, makes it easy to capture random events. To prevent the possibility of recording the wrong event, the 1741A and 1744A automatically switch from Write mode to Store mode at the end of the sweep. This is shown by the

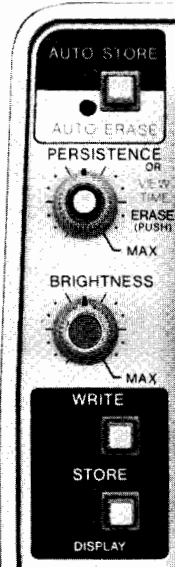

mode indicators. To view the signal, a press of the Store/Display pushbutton displays the trace. For convenience, a push of the Erase pushbutton erases the CRT and resets the time base.

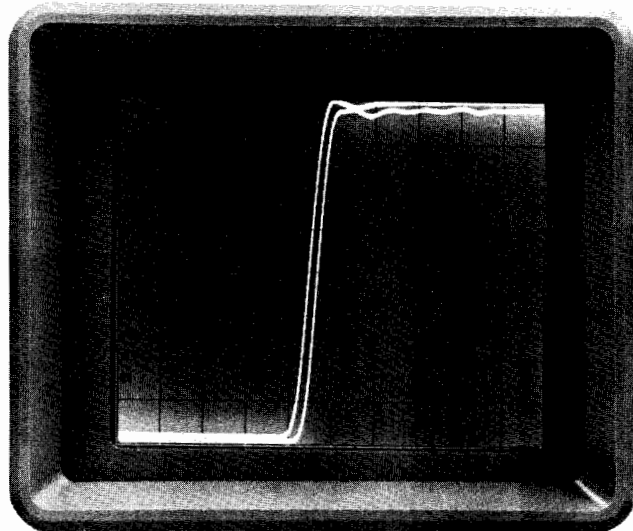

Exceptionally fine trace in the variable persistence mode permits high resolution timing measurements as shown with this dual trace, alternate sweep display at a sweep speed of 5 ns/div.

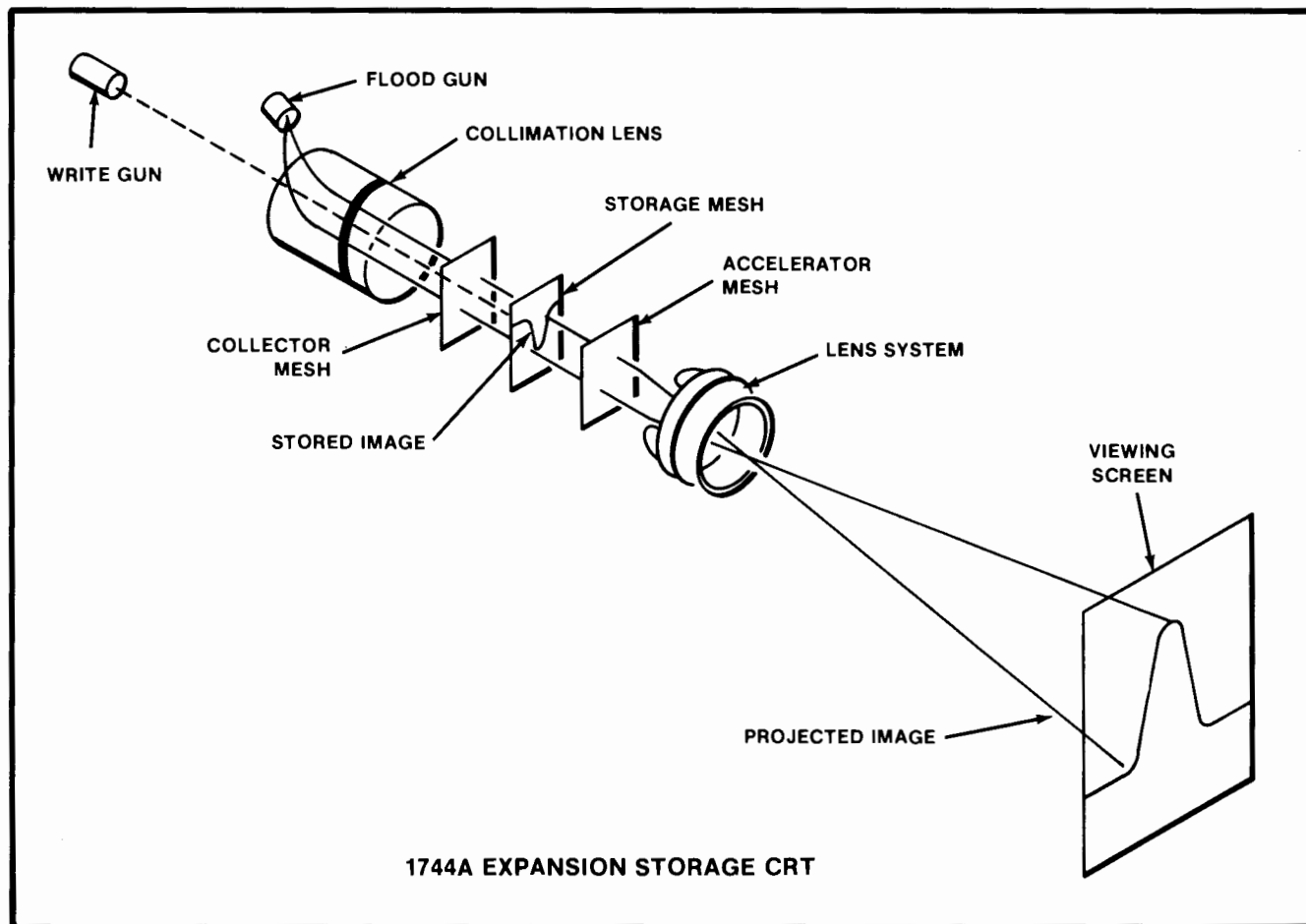

### 1741A Auto-camera Option

Model 1741A Auto-camera Option 003 produces automatic photographic records of a stored display. This mode is particularly valuable for applications which require the long term monitoring of circuits. Setup involves simply mounting a Model 197B Camera on the 1741A and selecting the auto-store mode. When the trigger signal is received, the oscilloscope switches automatically to store mode. Camera control circuits then command a display of the stored trace, and the camera shutter is actuated. After the first exposure of the waveform, the 1741A executes an erase cycle, and the camera takes a second exposure to superimpose the graticule of the photograph. The combination of a 1741A and 197B can save hours of "baby-sitting" time. For example, the 1741A can be set up to monitor a signal node over a long weekend to see if plant start-up power transients are the cause of a problem.

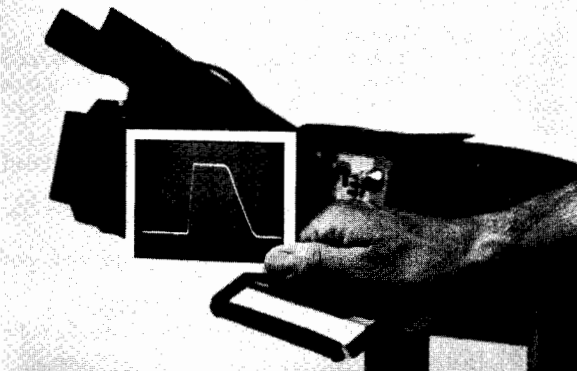

Long term monitoring of circuits to capture random events is simplified with the 1741A Auto-camera Option 003. You can set up the oscilloscope / camera, leave them unattended, and automatically capture single-shot events.

### 1741A Optional Parametric Measurements

A new dimension of measurement capability is added to the 1741A with Option 002, Triggered A vs B mode. This option allows you to generate many non-time related displays commonly found in engineering problems, such as the familiar Lissajous pattern. Other common non-time related displays include transducer linearization and power transistor safe-area testing.

#### Phase corrected display

Modern, high bandwidth oscilloscopes incorporate a delay line in the vertical axis to permit viewing of the leading edge of internally triggered signals. This delay line introduces a significant phase error in A vs B plots for signals above 20 kHz. Option 002, Triggered A vs B, adds a variable delay line in the horizontal axis which eliminates phase error and enables the 1741A to produce matched phase response up to the 5 MHz bandwidth of the horizontal deflection system. Additionally, linear phase errors due to differential delay in the probing system can be corrected. With this option, the 1741A produces phase corrected displays, even when using probes with unequal propagation delays, across the full horizontal system bandwidth.

#### Display windows

Main and delayed sweeps are useful tools to window a waveform of interest in normal oscilloscope modes. Usually this facility is lost when the oscilloscope operates in A vs B mode because the CRT beam is always "on," which results in a confusing display. In this mode, the display is not qualified and all cycles of the system under test are shown. Periods of inactivity produce a bright dot that can mask the information display.

Model 1741A Option 002 overcomes these problems by allowing the main and delayed sweeps to window the A vs B display. The A vs B display mode button becomes a display format control. In the "out" position, the display is the normal time-related oscilloscope display. When A vs B is selected, the plot of A channel input is displayed as a function of B channel input. However, the display is qualified by the main and/or delayed sweeps. The normal main and delayed sweep modes are active in the A vs B mode, with the A vs B mode "on" for the length of the selected sweep. This allows you to use the main sweep to window several cycles of an event, and then select the delayed sweep A vs B mode to examine each cycle. Bright spots can be eliminated by using the delayed sweep to remove periods of inactivity from the display. The 1741A Option 002 can switch from normal time-related displays to a parametric phase corrected display at the push of a button.

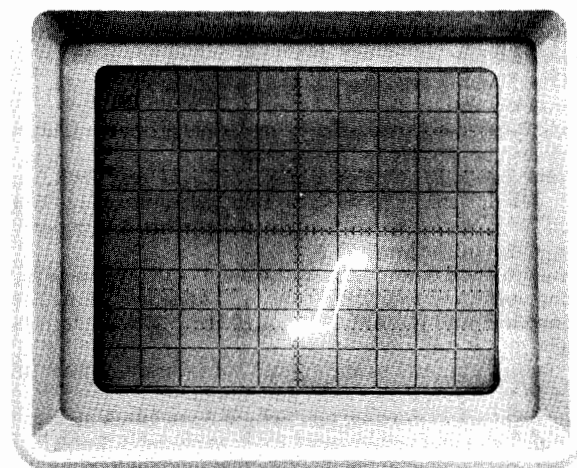

without triggered X, Y

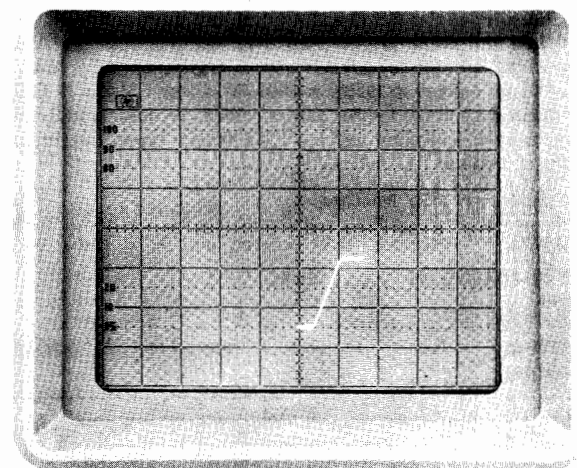

with triggered X, Y

### Logic State Display Option

As digital circuits are used more extensively, and become more complex, there is a corresponding growth in the need for troubleshooting and debugging tools in digital systems. The "Gold Button," Option 101, combines the real time data analysis of a Model 1607A Logic Analyzer with the measurement sets of the 1740A, 1741A, 1742A, 1743A, 1715A, 1722B, or 1725A Oscilloscopes. The 1607A pattern trigger output allows you to window the oscilloscope volts vs time display to a point in program execution determined by a 16-bit parallel trigger point. Option 101 for the 1740 series oscilloscopes removes the A vs B mode and replaces it with a state display pushbutton and associated control circuits.

1741A Triggered A vs B Option 002. The display of signals (top trace) in main sweep, A vs B mode shows total signal parameters. With delayed sweep A vs B, the display can be qualified (lower trace) to show only changing parameters which eliminates the bright dots caused by stationary values and confusion caused by unnecessary information.



# OSCILLOSCOPES

Models 1740A, 1741A, 1742A, 1743A & 1744A (cont.)

## 1740A, 1741A, 1742A, 1743A, 1744A

### Specifications

#### Vertical Display Modes

Channel A; channel B; A and B displayed alternately on successive sweeps (ALT); A and B displayed by switching between channels at  $\approx 250$  kHz rate with blanking during switching (CHOP); A plus B (Algebraic addition); and trigger view.

**Vertical Amplifiers (2)** Bandwidth and Rise Time at all deflection factors from 0°C to +55°C.

**Bandwidth:** 3 dB down from 8 div reference signal; 3 dB down from 6 div reference signal for 1741A, 1744A.

**DC-coupled:** dc to 100 MHz in both 50Ω and 1 MΩ input modes.

**AC-coupled:**  $\approx 10$  Hz to 100 MHz.

**Bandwidth limit:** limits upper bandwidth to  $\approx 20$  MHz.

**Rise Time:**  $\leq 3.5$  ns measured from 10% to 90% points of a 6 div (5 div, 1744A) input step.

#### Deflection factor

**Ranges:** 5 mV/div to 20 V/div (12 calibrated positions) in 1, 2, 5 sequence, attenuator accuracy  $\pm 3\%$ .

**Vernier:** extends deflection factor to  $\geq 50$  V/div.

**Polarity:** channel B may be inverted.

**Input coupling:** selectable AC or DC, 50Ω (dc), or ground.

**Input RC (selectable):** AC or DC, 1 MΩ  $\pm 2\%$  shunted by  $\approx 20$  pF; 50Ω, 50Ω  $\pm 3\%$ , SWR  $\leq 1.4$  at 100 MHz.

**Maximum input:** AC or DC, 250 V (dc + peak ac) or 500 V p-p at  $\leq 1$  kHz; 50Ω, 5 V rms.

#### A + B operation

**Amplifier:** bandwidth and deflection factors are unchanged; channel B may be inverted for A-B operation.

**Differential (A-B) common mode:** CMR is at least 20 dB from dc to 20 MHz. Common mode signal amplitude equivalent to 8 div (6 div, 1744A) with one vernier adjusted for optimum rejection.

#### Vertical Magnification (X5)

**Bandwidth:** 3 dB down from 8 div (6 div, 1744A) reference signal.

**DC-coupled:** dc to  $\approx 40$  MHz; dc to  $\approx 30$  MHz for 1741A, 1744A.

**AC-coupled:**  $\approx 10$  Hz to 40 MHz;  $\approx 10$  Hz to 30 MHz for 1741A, 1744A.

**Rise time:**  $\leq 9$  ns,  $\leq 12$  ns for 1741A, 1744A (measured from 10% to 90% points of 8 div, 5 div 1744A, input step).

**Deflection factor:** increases sensitivity of 5 and 10 mV settings by a factor of 5 with max sensitivity of 1 mV on channels A and B.

#### Trigger Source

Selectable from channel A, channel B, composite, or line frequency.

#### Trigger View

Displays internal or external trigger signal. In Alternate or Chop mode, channel A, channel B, and the trigger signals are displayed. In channel A or B mode, trigger view overrides that channel. Internal trigger signal amplitude approximates vertical signal amplitude. Ext trigger signal deflection factor is 100 mV/div or 1 V/div in EXT  $\div 10$ . Triggering point is approx center screen. With identically timed signals to a vertical input and the EXT trigger input, trigger signal delay is  $\leq 3.5$  ns.

#### Horizontal Display Modes

Main,  $\Delta$ time with channel A or B start (1742A, 1743A), main intensified, mixed (except 1743A), delayed, mag X 10, and A vs. B.

#### Main and Delayed Time Bases

**Main:** 50 ns/div to 2 s/div (24 ranges) in 1, 2, 5 sequence.

**Delayed:** 50 ns/div to 20 ms/div (18 ranges) in 1, 2, 5 sequence.

#### Accuracy

Sweep Time/Div	*Accuracy		Temp Range
	X1	X10	
50 ns to 20 ms	$\pm 3\%$	$\pm 4\%$	0°C to +15°C
	$\pm 2\%$	$\pm 3\%$	+15°C to +35°C
	$\pm 3\%$	$\pm 4\%$	+35°C to +55°C

\*Add 1% for 50 ms to 2 s ranges

**Main sweep vernier:** extends slowest sweep to at least 5 s/div.

**Magnifier (X10):** extends fastest sweep to 5 ns/div.

#### Calibrated Sweep Delay (except 1743A)

**Delay time range:** 0.5 to 10 X Main Time/Div settings of 100 ns to 2 s (min delay 150 ns).

#### Differential time measurement accuracy

(Using one intensified marker and helical control)

Main Time Base Setting	Accuracy* (+15°C to +35°C)
100 ns/div to 20 ms/div	$\pm (0.5\%$ of reading $+0.1\%$ of fs)
50 ms/div to 2 s/div	$\pm (1\%$ of reading $+0.1\%$ of fs)

\*Add 1% for temperature from 0°C to +15°C and +35°C to +55°C.

**Delay jitter:**  $< 0.002\%$  (1 part in 50 000) of max delay in each step from +15°C to +35°C;  $< 0.005\%$  (1 part in 20 000) from 0°C to +15°C and +35°C to +50°C.

#### Differential Time Measurement Accuracy (1742A)

(Using  $\Delta$ time dual intensified markers)

Main Time Base Setting	Accuracy* (+15°C to +35°C)		
	Opt 034/035	External DVM***	Helical
100 ns** to 20 ms/div	$\pm (0.5\%$ of reading $+0.05\%$ of fs)	$\pm (0.5\%$ of reading $+0.05\%$ of fs)	$\pm (0.5\%$ of reading $+0.1\%$ of fs)
50 ms to 2 s/div	$\pm (1\%$ of reading $+0.1\%$ of fs)	$\pm (1\%$ of reading $+0.1\%$ of fs)	$\pm (1\%$ of reading $+0.1\%$ of fs)

\*Add 1% for temperatures from 0°C to +15°C and +35°C to +55°C.

\*\*On 100 ns/div range, specification applies after first cm of main sweep.

\*\*\*Add DVM accuracy.

#### Time Interval ( $\Delta$ Time) 1742A

**Function:** measures time interval between two events on channel A (A display); two events on channel B (B display); or two events starting from an event on either channel A or B and ending with an event on either channel A or B (alternate display).

**Time interval output voltage:** varies from 50 V to 100 mV full scale. Full scale output voltage can be determined by multiplying the number on the Time/Div dial by 10 V (e.g. 0.05 s, 0.05 ms, or 0.05  $\mu$ s per div gives 0.5 V output full-scale).

**Stability (0°C to +55°C):** short-term 0.005%. Temperature,  $\pm 0.03\%/^{\circ}\text{C}$  deviation from calibration temperature range.

#### Crystal Referenced $\Delta$ Time (1743A)

**Delay time range:** 0 to 10 X Main Time/Div settings of 100 ns to 2 s.

#### Differential time measurement accuracy

**Accuracy:**  $\pm 0.002\%$  of reading  $\pm 1$  count from +15°C to +35°C;  $\pm 0.005\%$  of reading  $\pm 1$  count from 0°C to +15°C and +35°C to +55°C.

#### Time resolution of $\pm 1$ count

Sweep Ranges/div	$\pm 1$ Count	Averages
0.1 $\mu$ s, 0.2 $\mu$ s, 0.5 $\mu$ s	$\pm 100$ ps	10 000
1 $\mu$ s, 2 $\mu$ s, 5 $\mu$ s	$\pm 1$ ns	1 000
10 $\mu$ s, 20 $\mu$ s, 50 $\mu$ s	$\pm 10$ ns	100
0.1 ms, 0.2 ms, 0.5 ms	$\pm 100$ ns	direct

**Readout:** 5 digit LED plus exponent.

**Crystal Aging:** 0.0005% per year.

**Delay jitter:** same as other 1740 series oscilloscopes.

#### Triggering

##### Main sweep

**Normal:** sweep is triggered by internal or external signal.

**Automatic:** baseline displayed in absence of input signal. Above  $\approx 40$  Hz, triggering is same as normal.

**Single:** sweep occurs once with same triggering as Normal. Reset arms sweep and lights indicator. (1741A, 1744A) Single sweep is also initiated with Erase, sweep is armed after the erase cycle.

**Internal:** dc to 25 MHz on signals  $\geq 0.3$  div vertical deflection, increasing to 1 div vertical deflection at 100 MHz in all display modes (required signal level is increased by 2 when in Chop mode and by 5 when X5 vertical magnifier is used).

**External:** dc to 50 MHz on signals of 50 mV p-p or more, increasing to 100 mV p-p at 100 MHz (required signal level is increased by 2 when in Chop mode).

##### Delayed sweep (sweep after delay)

**Auto:** delayed sweep starts at end of delay period.

**Trig:** delayed sweep armed and triggerable at end of delay period.

**Internal:** same as Main Sweep except 1743A is dc to 25 MHz on signals causing 1 div or more vertical deflection, increasing to 2 div of vertical deflection at 100 MHz.

**External:** same as Main sweep except 1743A is dc to 50 MHz on signals 100 mV p-p increasing to 200 mV p-p at 100 MHz.



**External input RC:**  $\approx 1 \text{ M}\Omega$  shunted by  $\approx 20 \text{ pF}$ ; max external input, 250 V (dc + peak ac) or 500 V p-p at  $\leq 1 \text{ kHz}$ .

**Level and slope:** internal, at any point on positive or negative slope of displayed waveform; external, continuously variable from +1 V to -1 V on either slope of trigger signal, +10 V to -10 V in  $\div 10$ .

**Coupling:** AC, DC, LF REJ, or HF REJ.

**Trigger holdoff (main sweep):** increases sweep holdoff, all ranges.

#### Calibrated Mixed Time Base (except 1743A)

Dual time base in which the main time base drives the first portion of sweep and the delayed time base completes the sweep at the faster delayed sweep. Also operates in single sweep mode. Accuracy, add 2% to main time base accuracy.

#### A vs B Operation (deleted with Opt 101)

**Bandwidth:** channel A (Y-axis), same as channel A; channel B (X-axis), dc to 5 MHz.

**Deflection factor:** 5 mV/div to 20 V/div (12 cal positions) in 1, 2, 5 sequence; phase difference between channels,  $< 3^\circ$ , dc to 100 kHz (75 kHz, 1743A).

#### Cathode-ray Tube and Controls (1740A, 1742A, 1743A)

**Type:** 12.7 cm (5 in.) rectangular CRT, post accelerator,  $\approx 15 \text{ kV}$  accelerating potential, aluminized P31 phosphor.

**Graticule:** 8 x 10 div (1 div = 1 cm) internal non-parallax graticule, 0.2 subdivision markings on major horizontal and vertical axes and markings for transition time measurements. Internal floodgun graticule illumination.

**Beam finder:** returns trace to CRT screen.

**Z-axis input (intensity modulation):** +4 V,  $\geq 50 \text{ ns}$  wide pulse blanks trace of any intensity, usable to  $\leq 10 \text{ MHz}$  for normal intensity. Input R, 1 k $\Omega$   $\pm 10\%$ . Max input  $\pm 20 \text{ V}$  (dc + peak ac).

**Rear panel controls:** astigmatism and trace align.

#### Cathode-ray Tube and Controls (1741A)

**Type:** 12.7 cm (5 in.) rectangular CRT, post accelerator,  $\approx 7.5 \text{ kV}$  accelerating potential, aluminized P31 phosphor.

**Graticule:** 8 x 10 div (1 div = 0.85 cm) internal, non-parallax graticule, 0.2 subdivision markings on major horizontal and vertical axes, with markings for transition time measurements. Graticule illumination is achieved with Persistence control set to min.

**Beam finder:** returns trace to CRT screen.

**Z-axis input (intensity modulation):** same as 1740A.

**Operating modes:** write, store, display, auto-store, auto-erase, and conventional (rear panel control).

**Persistence:** variable,  $\approx 100 \text{ ms}$  to 1 min; conventional,  $\approx 40 \mu\text{s}$ .

**Storage writing speed:**  $\geq 200 \text{ cm}/\mu\text{s}$  (235 div/ $\mu\text{s}$ ) over center 7 x 9 div (with viewing hood).

**Storage time:** display mode, at least 10 s at 22°C; store mode, at least 30 s at 22°C.

**Brightness:**  $\approx 170 \text{ cd}/\text{m}^2$  (50 f) increasing to  $\approx 340 \text{ cd}/\text{m}^2$  (100 f) depending on brightness control setting.

**Erase time:**  $\approx 300 \text{ ms}$ .

**Rear panel controls:** astigmatism, trace align, conventional push-button, and view time.

#### Cathode-ray Tube and Controls (1744A)

**Type:** 12.7 cm (5 in.) rectangular CRT, post accelerator,  $\approx 10 \text{ kV}$  accelerating potential, aluminized P31 phosphor.

**Graticule:** 8 x 10 div (1 div = 0.72 cm) internal graticule, 0.2 subdivision markings on major horizontal and vertical axes, with markings for transition time measurements. Graticule illumination is achieved with Persistence control set to min.

**Beam finder, Z-axis input (intensity modulation):** See 1741A.

**Operating modes:** write, store, display, auto-store, and auto-erase.

**Storage writing speed:**  $\geq 1800 \text{ cm}/\mu\text{s}$  (2500 div/ $\mu\text{s}$ ) over center 6 x 8 div (with viewing hood).

**Storage time:** store mode, at least 30 s; view mode, at least 10 s; wait time, at least 60 s, at 22°C.

**Persistence:** variable (100 ms min).

**Erase time:**  $\approx 300 \text{ ms}$ .

**Rear panel controls:** astigmatism and trace align.

#### General

**Rear Panel outputs:** main and delayed gates, 0.8 V to  $\geq +2.5 \text{ V}$  capable of supplying  $\approx 5 \text{ mA}$ .

#### Amplitude Calibrator (0°C to +55°C)

Output voltage	1 V p-p into $\geq 1 \text{ M}\Omega$ 0.1 V p-p into 50 $\Omega$	$\pm 1\%$
Rise time	$\approx 0.1 \mu\text{s}$	
Frequency	$\approx 1.4 \text{ kHz}$	

**Power:** 100, 120, 220, 240 V ac  $\pm 10\%$ ; 48 to 440 Hz; 100 VA max.

**Weight:** (1740, 1742) net, 13 kg (28.6 lb); shipping 15.7 kg (34.6 lb). (1741, 1743, 1744) net 13.8 kg (30.5 lb); shipping 17.7 kg (39 lb).

**Operating environment:** temperature 0°C to +55°C; humidity to 95% relative humidity at +40°C; altitude, to 4600 m (15 000 ft); vibration, vibrated in three planes for 15 min. each with 0.254 mm (0.010 in.) excursion, 10 to 55 Hz.

**Size:** (1740A) 197 H x 335 W x 597 mm D (7.8" x 13.2" x 23.5") with handle, 492 mm D (19.4") without; (1741A) 616 mm D (24.3") with handle, 552 mm D (21.7") without; (1742A) 570 mm D (22.4") with handle, 502 mm D (19.8") without; (1743A) 613 mm D (24.1") with handle, 549 mm D (21.6") without; (1744A) 635 mm D (25") with handle; 511 mm D (20.1") without.

**Accessories furnished:** one blue light filter HP P/N 01740-02701, one front panel cover, one 2.3 m (7.5 ft) power cord, one vinyl accessory storage pouch, one Operators Guide and one Service Manual, two Model 10041A 10:1 divider probes  $\approx 2 \text{ m}$  (6.6 ft) long. The 1741A and 1744A also include one Model 10173A RFI filter and contrast screen, and one Model 10140A viewing hood.

#### Options and Accessories

**001:** fixed power cord (U.S. only). add \$15

**002 (1741A):** Triggered A vs B Mode; phase shift  $\leq 1^\circ$ , dc to 5 MHz; internal triggering on channel B. add \$225

**003:** Auto Camera (1741A) add \$75

**005 (1740A or 1741A):** TV sync add \$215

**034 (except 1743A, 1744A):** built-in DMM (60 Hz) add \$325

**035 (except 1743A, 1744A):** built-in DMM (50 Hz) add \$325

**091:** two 3 m (9.8 ft) 10042A 10:1 probes in lieu of 10041A probes N/C

**096:** two 1.8 m (6 ft) 10006D 10:1 probes in lieu of 10041A probes. N/C

**101 (except 1744A):** state display (deletes A vs B mode) single switch interface for use with 1607A Logic State Analyzer. add \$150

**112:** includes 1112A Inverter Power Supply, a portable power source for 1700 series oscilloscopes. add \$1000

**910:** extra set of product manuals.

**1740A, 1742A, or 1743A Opt 910** add \$15

**1741A Opt 910** add \$12

**Time interval multimeter kit:** HP P/N 01742-69501 \$375

(1742A), 01741-69502 (1741A), or 01740-69503 (1740A) adapts standard oscilloscope to an Option 034/035 with built-in LED readout. Kit includes a multimeter, top oscilloscope cover, vinyl storage pouch, and mounting hardware.

**Opt 101 Field Instl Kit:** converts std 1740 series oscilloscopes (except 1744A) to Opt 101. Order HP P/N \$200

01740-69501 for 1740A, 1742A, 1743A; order HP P/N 01741-69501 for 1741A.

#### Logic State Analysis Equipment Required for Option 101

**1607A:** 16-Bit Logic State Analyzer including three data probes and one clock probe. \$3300

**Four 10121A:** 20 cm (8") cables. Three for X, Y, and Z and one for pattern trigger connections. \$20 ea.

**Adapter plate and strap:** (HP P/N 5061-1213) for mounting the oscilloscope on top of the 1607A. \$24

#### Ordering Information

**1740A** 100 MHz Oscilloscope \$2675

**1741A** 100 MHz Storage Oscilloscope \$4750

**1742A** 100 MHz  $\Delta$ Time Oscilloscope \$2925

**1743A** 100 MHz  $\Delta$ Time Oscilloscope \$3700

**1744A** 100 MHz Storage Oscilloscope \$5500

# OSCILLOSCOPES

200/275 MHz delta time, 275 MHz storage

Models 1715A, 1722B, 1725A, & 1727A

- 200 MHz (1715A) and 275 MHz (1725A) bandwidths
- Delta time and delayed sweep
- Optional DMM
- Easy-to-use color-coded controls



1725A Opt 034

## 1715A, 1725A Description

Hewlett-Packard's Models 1725A, 275 MHz, and 1715A, 200 MHz oscilloscopes offer delta time measurements with an optional DMM for direct delta time readout and current, voltage, or resistance measurements. The large 8 × 10 cm display provides easy viewing of dual trace signals on which timing measurements can be made conveniently and accurately using the Hewlett-Packard developed delta time technique. For easier percentage measurements, reference lines of 0% and 100% amplitude are 5 divisions apart and markings for 10% and 90% and 20% and 80% are also provided for easier transition time measurements. Vertical deflection factors of 10 mV/div to 5 V/div over the full bandwidth (5 mV/div to 150 MHz in the 1715A) and a selectable 50 ohm or 1 megohm input offer the high performance required for both laboratory and field applications.

## Delta Time Measurements

These oscilloscopes offer two methods for making timing measurements; one is the familiar single marker delayed sweep, using the calibrated delay control to accurately measure time relationships; the second is a system of dual intensified markers which significantly improves accuracy while conveniently reducing the time necessary to make a measurement. The latter, better known as the Delta Time measurement method, incorporates a system of two intensified markers which are two delayed sweeps displayed alternately.

The Delta Time measurement technique is to select the Main Intensified mode and position the first marker at  $t_1$  with the Time Interval Start control and position the second marker at  $t_2$  with the Time Interval Stop control. The difference between the two selected points is then read directly on the optional DMM or on the calibrated delay time control, or is available as a rear panel scaled voltage output compatible with most DVM's. Units of seconds, milliseconds, or microseconds are read on the Main Time/Div control.

For increased precision, Delayed Sweep mode is selected where the two intensified portions are displayed alternately. Maximum accuracy is achieved by superimposing the start and stop points using the

Time Interval Stop control. Even without an external voltmeter and using only the Time Interval Stop control, this optical nulling technique reduces the chance of error in time interval measurements.

The Delta Time technique makes timing measurements such as transition times, propagation delay, clock phasing, and other high speed digital timing measurements faster and with more repeatability than with standard delayed sweep oscilloscopes. Time interval measurements can be made between two events on channel A, two events on channel B, or between two events on alternate channels.

For added convenience, the Delta Time capability can be selected with the time interval start marker on channel A or channel B.



1715A Opt 034

- 275 MHz bandwidth
- Direct LED readout with 20 ps resolution
- Microprocessor calculated delta time measurements

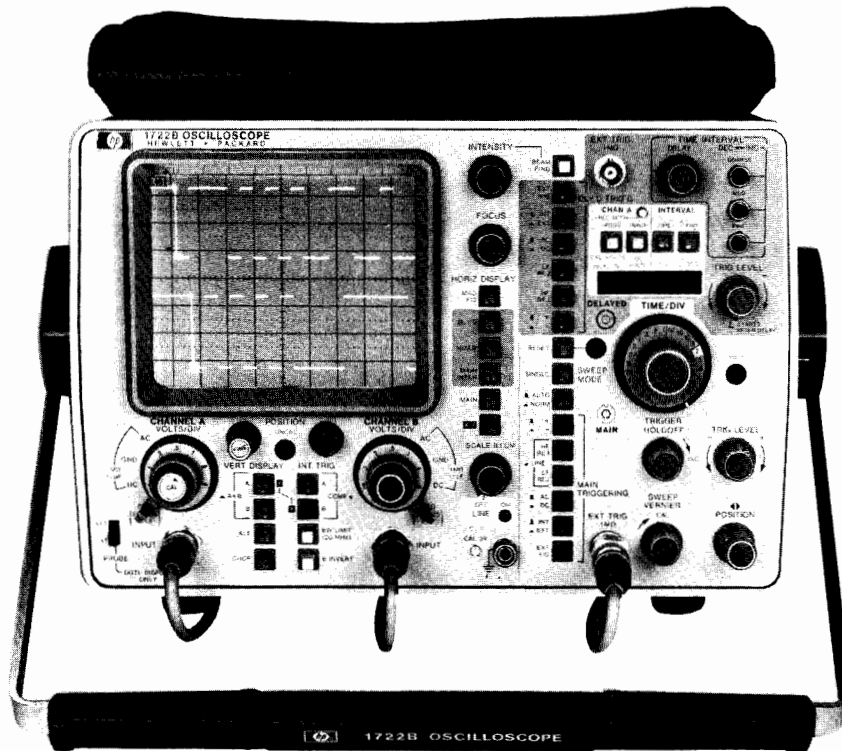

1722B

### 1722B Description

Model 1722B is a 275 MHz bandwidth, 1 ns/div sweep speed, dual channel oscilloscope with a built-in microprocessor and five function LED display for precise real time measurements. In addition to the conventional volts versus time CRT display, the microprocessor gives you direct readout of delta time, frequency, dc voltage, instantaneous waveform voltage, and percent amplitude. The 1722B's outstanding repeatability and 20 ps resolution make it ideally suited for making clock phasing measurements in large computer timing applications.

### Delta Time Measurements

Delta time measurement, developed by Hewlett-Packard, is used in the Time Interval mode for making accurate time interval measurements including transition time, pulse duration (width), period, and propagation delay. Time interval measurements can be made between two events on Channel A, two events on Channel B, or between an event beginning on Channel A and ending on Channel B.

The delta time measurement technique is to select Main Intensified mode and set the first intensified marker to  $t_1$ . The second intensified marker is positioned by using the DEC → INC controls (coarse, medium, or fine) which causes the microprocessor to develop the voltage to position the second marker. While developing the voltage ( $t_2 - t_1$ ) to separate the two markers, the microprocessor drives and updates the 3 1/2 digit LED display. Time interval measurements are automatically scaled for the proper sweep speed and displayed in units of seconds (exponent 0), milliseconds (exponent -3), microseconds (exponent -6), or nanoseconds (exponent -9).

Additional precision is obtained by switching to the Delayed Sweep mode where the two intensified markers are expanded and displayed alternately. Maximum accuracy is quickly obtained by overlapping the two expanded sweeps using the DEC → INC controls. Superimposing the start and stop points of the measured time interval provides a more accurate digital readout by nulling any amplifier or CRT nonlinearities. Separate portions of a sweep can be magnified and examined simultaneously, enabling you to view two events separated in time while maintaining their relative time relationship.

The microprocessor not only keeps track of the distance between the two markers but automatically expands the measurement resolution by a factor of 10 whenever the two markers are within 1 div of each other. The microprocessor also interrogates the function switches to help prevent inaccurate measurements.

### 1/Time (Frequency) Measurements

The 1722B gives an automatic 3 or 4 digit display of the reciprocal of time, eliminating the need for calculations when setting up clock frequencies and measuring the frequency or repetition rate of a waveform.

### DC voltage measurements

The Input (dc volts) mode provides a direct digital display of the average value of a waveform at the input to channel A. The built-in DVM measurement is made using a successive approximation algorithm controlled by the microprocessor which allows you to establish a reference level with respect to any voltage and enables differential dc measurements.

### Instantaneous Voltage Measurements

In the Position mode you can measure the voltage at any point on a waveform in channel A without the need to count divisions from a base line and multiply by the attenuator setting. The measurement mode is useful for measuring peak voltages, crossover, and threshold points in logic circuits, or any time you need to know a precise voltage at a particular point on a waveform.

### Percentage Measurements

Percentage measurements are made in the Position mode with the channel A vernier out of the Cal position to establish 5 div separation between the 0% and 100% points. By positioning the desired 0% point on a convenient graticule line, zeroing the LED display, and then positioning the waveform to the 100% point, percent amplitude of any point on the waveform with respect to the 100% point is measured by positioning that point at the reference graticule and reading the LED display. Relative amplitude measurements such as pulse overshoot, ringing, preshoot, and percent amplitude modulation on an rf carrier are easily measured using this measurement mode.





Models 1715A, 1722B, 1725A & 1727A (cont'd.)

- Variable persistence storage with auto-store, auto-erase, auto-intensity circuits
- Expansion storage CRT for 2000 cm/ $\mu$ s writing speed
- 275 MHz bandwidth, 10 mV/div with 1 M $\Omega$  input Z
- Single-shot rise times as fast as 1.27 ns (4 div)
- Delta time and delayed sweep
- Optional DMM



1727A

### 1727A Description

Hewlett-Packard's 275 MHz, Model 1727A Variable Persistence Storage Oscilloscope, offers 2000 cm/ $\mu$ s single-shot writing speed for the capture and display of fast transient signals. The fast writing speed and large display area make the 1727A ideal for viewing and analysis of narrow pulses in the physical sciences as well as glitches and noise pulses in digital environments. Conveniently grouped variable persistence storage controls, front panel color coding, and automatic operating modes make the 1727A one of the easiest-to-use high speed storage oscilloscopes available today.

Additional features which provide exceptional versatility and ease-of-use include dual marker delta time measurements; auto-erase and auto-store operating modes; auto-intensity circuitry to greatly simplify the setup of a crisp, nonblooming trace; and selectable input impedance (1 M $\Omega$ /50  $\Omega$ ) for both general purpose probing and high fidelity, high frequency signal capture with the built-in 50  $\Omega$  impedance matching.

#### Variable Persistence Storage

The Hewlett-Packard variable persistence storage CRT offers a well defined trace at the high writing speed of 2000 cm/ $\mu$ s for capture of transients to 275 MHz. The fast CRT writing speed is derived from a field expansion element in the CRT which permits high writing speeds over the full display quality area. An automatic focus circuit maintains a crisp display with changes in intensity, and for increased operator convenience an auto-intensity circuit helps maintain a constant beam current to the storage surface over a wide range of sweep speeds.

The variable persistence mode permits the display of waveforms over a broad range of sweep speeds and input repetition rates. In re-

petitive sweep applications, the persistence is continuously variable to match the sweep or input signal repetition rate. The integrating capability of the variable persistence mode offers "light amplification" by integrating several sweeps to provide bright, sharp traces over the entire quality area. For capturing fast transients with minimum operator intervention, maximum persistence is automatically selected when in either auto-store or auto-erase modes.

Another capability of this fast writing rate, variable persistence design is the ability to repetitively write traces at the rate of either the input signal repetition rate or the time base duty cycle. This allows the user to scan data streams for random events such as glitches, noise, coupling, and other spurious signals without having to wait for lengthy erase cycles between sweeps. This fast resetting capability makes the 1727A a valuable troubleshooting instrument for locating random glitches and improves the ability to capture a periodic event.

#### Auto-Erase

The short erase cycle time in combination with the auto-erase capability offers many operating conveniences. In auto-erase, the 1727A operates in a repetitive single-shot mode. This offers a convenient, rapid method for setting focus, intensity, and horizontal and vertical positioning in preparation for single-shot events. The view time control allows continuous selection of view time between erase cycles for approximately 1 second to 13 seconds. When in the auto-erase mode, maximum persistence is automatically selected for maximum trace retention between erasures and operator convenience. Once the auto-erase mode is set up, a continuous sequence of updated displays is captured at a user selectable repetition rate. Because there is no need to reset the oscilloscope, you can concentrate on adjusting



circuits or check out test procedures. If a dual channel display mode is selected using alternate sweep, the auto-erase circuits wait until both sweeps are completed before initiating the erase cycle.

### Storage Modes

The 1727A provides two modes of waveform storage: auto-store and store. The auto-store mode is useful for single shot events. This mode is selected by pressing both auto-store and single pushbuttons. Auto-store mode automatically sets the persistence control to maximum for the fastest viewable writing speed. As a convenience feature, the normal triggering mode is also automatically selected. After an event triggers the sweep, and the signal is captured, the 1727A automatically switches to store mode for maximum storage time. A front panel LED indicates when the transient has occurred and the 1727A is in the storage mode. The stored waveform is displayed by pressing the display pushbutton.

Auto-store mode also provides the maximum wait time for a transient. This is the time between setting up the 1727A in the auto-store mode and the occurrence of the transient. Wait time is important consideration when complex experiments are being performed, and the occurrence of the transient cannot be carefully controlled.

Any time an operator would like to store waveforms displayed on screen, he may press the store pushbutton. This mode provides a convenient method for retaining and examining events that are displayed during repetitive scan or single sweep operation.

### Minimum Reset Time

All oscilloscopes have a reset time during sweep retrace with storage oscilloscopes generally requiring additional time for erase cycles. When operating in the variable persistence mode, the 1727A reset time is the same as that for a conventional nonstorage oscilloscope, such as the 1725A. In auto-erase, reset is held to a minimum because the erase cycle time is exceptionally short ( $\approx 300$  ms).

### Expansion Storage CRT

The ability to capture transients up to 275 MHz or up to 1.27 ns rise time is achieved with a Hewlett-Packard CRT technology called expansion storage. With expansion storage, the waveform to be captured is written on a storage mesh positioned close to the deflection plates. This storage mesh is about the size of a postage stamp and is capable of storing very sharp waveform images. A flood gun electron cloud projects the image through an electronic lens system onto the CRT phosphor for viewing. This combination of a small storage surface and the expansion lens system provides a storage CRT capable of capturing transients at a 2000 cm/ $\mu$ s stored writing rate.

### Writing Speed

Writing speed is a specification defining what maximum CRT beam velocity can be captured and displayed on a single-shot basis. In order to simplify comparisons between various oscilloscopes, it is convenient to express writing speed in cm/ $\mu$ s not div/ $\mu$ s, which eliminates the need to know the CRT division size. Also, to avoid ambiguity, all writing speed measurements are made using a viewing hood, not in ambient light. Therefore, in order to determine if a storage oscilloscope can capture a specific single-shot waveform, calculate the maximum spot velocity required and compare this with the writing rate specification. The table identifies the single-shot signals that can be captured with a 2000 cm/ $\mu$ s writing speed.

Amplitude (pk-pk)	Sine Wave Frequency	Pulse Rise Time	Sweep Speed	Required Writing Speed
4 div		1.27 ns	1 ns/div	1952 cm/ $\mu$ s
4 div		1.27 ns	10 ns/div	1816 cm/ $\mu$ s
3 div	275 MHz		1 ns/div	2000 cm/ $\mu$ s
3 div	275 MHz		10 ns/div	1867 cm/ $\mu$ s
4 div	200 MHz		1 ns/div	1948 cm/ $\mu$ s
4 div	200 MHz		10 ns/div	1811 cm/ $\mu$ s

### Stable Flexible Triggering

Stable internal triggering to 300 MHz requires only 1 div of vertical deflection. The internal trigger sync takeoff is immediately after the attenuator which maintains a stable display regardless of changes in position, vernier, or polarity controls. The desired trigger signal conditioning for your measurement application is quickly achieved with easy-to-use pushbutton controls. In the external trigger mode, signals of only 100 mV pk-pk trigger the oscilloscope to 300 MHz (only 50 mV to 100 MHz).

In the internal, composite trigger mode, the oscilloscope solidly triggers on asynchronous signals without the need to vertically overlap the traces. This is useful, for example, when comparing waveforms produced by asynchronous clocks.

### Delta Time Measurements

The 1727A has a system of two intensified markers to conveniently and accurately measure time relationships. An optional DMM is available for direct delta time readout and current, voltage, or resistance measurements. The 1727A delta time system is identical to that offered on the 1725A.

### 1715A, 1722B, 1725A, 1727A Specifications

#### Vertical Display Modes

Channel A; channel B; A and B displayed alternately on successive sweeps (ALT); A and B displayed by switching between channels at  $\approx 1$  MHz rate with blanking during switching (CHOP); A plus B (algebraic addition); X-Y (A vs. B).

#### Vertical Amplifiers (2)

**Bandwidth:** (3 dB down from 6 div reference signal).

**DC-coupled:** (1722B, 1725A, 1727A) dc to 275 MHz, (1715A) dc to 200 MHz 10 mV/div to 5 V/div (to 150 MHz at 5 mV/div, 1715A), in both 50  $\Omega$  and high Z input modes.

**AC-coupled:** lower limit  $\approx 10$  Hz.

**Bandwidth limit:** limits upper bandwidth to  $\approx 20$  MHz.

**Rise time:** (1722B, 1725A, 1727A)  $< 1.3$  ns; (1715A)  $< 1.75$  ns 10 mV/div to 5 V/div,  $< 2.3$  ns at 5 mV/div.

#### Deflection factor

**Ranges:** 10 mV/div to 5 V/div (9 calibrated positions) in 1, 2, 5 sequence,  $\pm 2\%$  attenuator accuracy; 5 mV/div to 5 V/div (10 calibrated positions) in 1715A.

**Vernier:** extends max deflection factor to  $\geq 12.5$  V/div.

**Polarity:** channel B may be inverted.

**Input coupling:** selectable, AC or DC, 50  $\Omega$  (dc) or ground.

**Input RC (selectable):** AC and DC, 1 M $\Omega$   $\pm 2\%$  shunted by  $\approx 11$  pF; 50  $\Omega$ , 50  $\Omega$   $\pm 2\%$ ; SWR (1722B, 1725A, 1727A)  $\leq 1.3$  on 10, 20, and 50 mV ranges,  $< 1.15$  on all other ranges; SWR (1715A)  $\leq 1.3$  on 5, 10, 20, and 50 mV ranges and  $< 1.15$  on all other ranges.

**Max input:** AC and DC,  $\pm 250$  V (dc + peak ac) at  $\leq 1$  kHz; 50  $\Omega$ , 5 V rms.

#### A+B operation

**Amplifier:** bandwidth and deflection factors are unchanged; channel B may be inverted for A-B operation.

**Differential (A-B) Common Mode:** CMR is  $\geq 40$  dB from dc to 5 MHz decreasing to 26 dB at 50 MHz. Common mode signal amplitude equivalent to 12 div with one vernier adjusted for optimum rejection.

#### Trigger Source

Selectable from channel A, channel B, Composite, or line frequency.

#### Channel A Input-dc Volts (1722B)

**Display:** 3 $\frac{1}{2}$  digits (LED's).

**Display units:** 0 exponent, volts; -3 exponent, millivolts.

**X1 range:** 95 mV to 47 V full scale vertical deflection (10 mV/div to 5 V/div).

**X10 range:** 0.95 V to 470 V full scale vertical deflection (100 mV/div to 50 V/div with X10 probe).



## Models 1715A, 1722B, 1725A & 1727A (cont.)

**Accuracy:**  $\pm 0.5\%$  reading  $\pm 0.5\%$  full scale (f.s. = 10 cm),  $+20^\circ\text{C}$  to  $+30^\circ\text{C}$ .

**Stability:** temperature coefficient,  $< \pm 0.02\%/^\circ\text{C}$ .

**Input impedance:** X1 range, 1 M $\Omega$  shunted by  $\approx 11$  pF; X10 range (with X10 probe) 10 M $\Omega$  shunted by  $\approx 10$  pF.

**Sample rate:**  $\approx 2/\text{s}$ , response time  $\leq 1$  s.

**Reference set:** meter may be zeroed permitting dc voltage measurements with respect to any voltage within selected range. Drift may be eliminated by the REF SET control.

**Overrange:** flashing display indicates overrange condition.

### Channel A Position - Volts (1722B)

(Channel A vernier in CAL detent.) With the following exceptions, specifications are the same as Channel A input - dc Volts.

**Measurement:** dc substitution method using channel A position control to determine voltage of any point on displayed waveform using any graticule line as reference.

**Bandwidth:** dc to 275 MHz ( $\leq 3$  dB down from 6 div ref signal).

**Dynamic range:**  $\pm 6$  cm from ground referenced to center screen.

**Reference set:** meter may be zeroed, permits instantaneous voltage measurements with respect to any voltage within selected range.

**Accuracy:**  $\pm 1\%$  reading  $\pm 0.5\%$  of full scale (10X the volts/div range) measured at dc.

### Channel A Position - % (1722B)

(Channel A vernier out of CAL detent.)

**Measurement:** dc substitution method using channel A position control to determine percent of any waveform point with respect to user defined 0 and 100% points.

**Range:** 0 to  $\pm 140\%$  (set with vernier so that 100% equals 5 div).

**Accuracy:**  $\pm 1\%$ .

**Zero reference:** meter may be zeroed to permit percent measurements with respect to any waveform point.

### Vertical Output (Rear Panel)

**Amplitude:** one div of vertical deflection produces  $\approx 100$  mV output, dc to 50 MHz in 1722B, 1725A, 1727A, dc to 25 MHz in 1715A.

**Cascaded deflection factor:** 1 mV/div with both vert channels set to 10 mV/div. Bandwidth, dc to 5 MHz (with bandwidth limit). Source resistance,  $\approx 100\Omega$ ; selection, trig source set to A selects channel A output, to B selects channel B output.

### Horizontal Display Modes

Main, main intensified (1715A, 1722B, 1725A), delayed, mixed, X-Y, and mag X10. The 1727A main intensified mode is automatically selected whenever the delayed time base is turned on. In main intensified, mixed, and delayed modes, 1715A, 1725A, and 1727A have selectable channel A or B start time interval measurements.

### Main Time Base

#### Sweep

**Ranges:** 10 ns/div to 0.5 s/div (24 ranges) 1, 2, 5 sequence.

#### Accuracy

Main Sweep Time/Div	Accuracy ( $0^\circ\text{C}$ to $+55^\circ\text{C}$ )	
	X1	X10
10 ns to 50 ns	$\pm 3\%$	$\pm 5\%$
100 ns to 20 ms	$\pm 2\%$	$\pm 3\%$
50 ms to 0.5s	$\pm 3\%$	$\pm 3\%$

**Vernier:** extends slowest sweep to at least 1.25 s/div.

**Magnifier:** extends fastest sweep to 1 ns/div.

#### Sweep mode

**Normal:** sweep is triggered by internal or external signal.

**Automatic:** baseline displayed in absence of input signal. Triggering is same as normal above  $\approx 40$  Hz.

**Single (1715A, 1722B, 1725A):** in Normal, sweep occurs once with same triggering as Normal, reset arms sweep and lights indicators; in Auto, sweep occurs once each time Reset is pressed.

**Single (1727A):** automatically switches triggering to Normal and the sweep occurs once with same triggering as Normal, Reset pushbutton arms sweep and lights indicator. The Erase pushbutton arms sweep and lights indicator. The Erase pushbutton also performs the Reset function immediately following the erase cycle.

### Triggering

**Internal:** dc to 100 MHz on signals causing  $\geq 0.5$  div vertical deflection, increasing to 1 div of vert deflection at 300 MHz (200 MHz, 1715A) in all display modes. Line frequency triggering selectable.

**External:** dc to 100 MHz on signals  $\geq 50$  mV p-p increasing to 100 mV p-p at 300 MHz (200 MHz, 1715A). Max input,  $\pm 250$  V (dc + peak ac) at  $\leq 1$  kHz. External input RC  $\approx 1$  M $\Omega$  shunted by  $\approx 15$  pF.

### Trigger level and slope

**Internal:** at any point on the vertical waveform displayed.

**External:** continuously variable from +1.0 V to -1.0 V (+10 V to -10 V in  $\div 10$  mode).

**Coupling:** AC, DC, LF REJ, or HF REJ.

**Trigger holdoff:** variable, to  $> 1$  sweep from 10 ns/div to 50 ms/div.

### Main Intensified

Delta time intensifies two parts of main time base to be expanded to full screen in delayed time base mode.

**Delayed Sweep except 1722B:** intensifies that part of main time base to be expanded to full screen in delayed time base mode.

### Delayed Time Base

#### Sweep

**Ranges:** 10 ns/div to 20 ms/div (20 ranges) in 1, 2, 5 sequence.

**Accuracy:** same as main time base.

#### Triggering

**Internal:** same as main time base except there is no Line Frequency triggering.

**Starts after delay:** delayed sweep automatically starts at end of delay period.

**Trigger:** with delayed trigger level control out of detent (starts after delay) delayed sweep is triggerable at end of delay period.

**Delay time range:** 0.5 to 10X Main Time/Div settings of 20 ns to 0.5 s (min delay 50 ns).

External triggering, external input RC, max external input, trigger level and slope, and coupling are same as main time base.

### Differential time measurement accuracy (1715A, 1725A, 1727A)

Main Time Base Setting	Accuracy ( $+15^\circ\text{C}$ to $+35^\circ\text{C}$ )
50 ns/div to 20 ms/div	$\pm 0.5\%$ of reading $+0.1\%$ of full scale
20 ns/div	$\pm 1\%$ of reading $+0.2\%$ of full scale
50 ms/div to 0.5 s/div	$\pm 3\%$

**Delay jitter:**  $< 0.005\%$  of max delay in each step.

**Stability ( $0^\circ\text{C}$  to  $+55^\circ\text{C}$ ):** short term 0.005%. Temperature,  $\pm 0.03\%/^\circ\text{C}$  deviation from calibration temperature range.

### Time Interval ( $\Delta$ Time Mode— 1715A, 1725A, 1727A)

**Function:** measures time interval between two events on channel A (A display), on channel B (B display), or starting from an event on either A or B and ending with an event on either A or B (alt display).

**Time interval output voltage:** from 50 V to 100 mV full scale.

**Accuracy:** measurement accuracy is the Time Interval Accuracy plus the external DVM accuracy.

Main Time Base Setting	Accuracy ( $+20^\circ\text{C}$ to $+30^\circ\text{C}$ )
100 ns/div to 20 ms/div	$\pm 0.5\%$ of reading $\pm 0.05\%$ of fs
50 ns/div*	$\pm 0.5\%$ of reading $\pm 0.1\%$ of fs
20 ns/div*	$\pm 0.5\%$ of reading $\pm 0.2\%$ of fs
50 ms/div to 0.5 s/div	$\pm 3\%$

\*Starting after 80 ns of sweep

**Stability ( $0^\circ\text{C}$  to  $+55^\circ\text{C}$ ):** short term 0.005%. Temperature,  $\pm 0.03\%/^\circ\text{C}$  deviation from calibration temperature range.



### Time Interval Measurements (1722B)

**Time interval delay:** continuously variable from 10 ns to 5 s.

**Delay jitter:** refer to Time Interval Measurements, Stability.

#### Time interval measurement (time)

**Function:** measures time interval between two events on channel A (A display), on channel B (B display), or between two events starting from an event on A and ending with an event on channel B (alt display).

**Display units:** 0 (s), -3 (ms), -6 ( $\mu$ s), or -9 (ns).

#### Time interval accuracy

Main Time Base Setting	Accuracy (+20°C to +30°C)
100 ns/div to 20 ms/div	$\pm 0.5\%$ of measurement $\pm 0.02\%$ of full scale (for measurements < 1 cm). For measurements > 1 cm, $\pm 0.5\%$ of measurement $\pm 0.05\%$ of full scale.
50 ns/div*	$\pm 0.5\%$ of measurement $\pm 0.06\%$ of full scale.
20 ns/div*	$\pm 0.5\%$ of measurement $\pm 0.15\%$ of full scale.
50 ms/div to 0.5 s/div.	$\pm 3\%$

\*Starting after 60 ns of sweep.

**Resolution:** intervals < 1 cm, > 0.01% of full scale; intervals > 1 cm, 0.1% of full scale; max display resolution, 20 ps.

**Stability (0 to +55°C):** short term, < 0.01%. Temperature,  $\pm 0.03\%/^{\circ}\text{C}$  deviation from calibration temperature range.

#### Reciprocal of time interval measurement (1/time)

**Display units:** 0 (Hz); 3 (kHz); 6 (MHz).

**Accuracy, resolution, stability:** same as time interval measurements.

### Mixed Time Base

Dual time base in which the main time base drives the first portion of sweep and the delayed time base completes the sweep at the faster delayed sweep. Also operates in single sweep mode.

### X-Y Operation

#### Bandwidth

**Y-axis (channel A):** same as channel A.

**X-axis (channel B):** dc to > 1 MHz.

**Deflection factor:** 10 mV/div to 5 V/div, 9 cal positions (5 mV/div to 5 V/div, 10 cal positions, 1715A) in 1, 2, 5 sequence.

**Phase difference between channels:** < 3°, dc to 1 MHz (3 MHz, 1722B).

### Cathode-ray Tube and Controls (1715A, 1722B, 1725A)

**Type:** post accelerator,  $\approx 20.5$  kV, aluminized P31 phosphor.

**Graticule:** 8 x 10 div internal graticule, 0.2 subdiv markings on major horiz and vert axes, 1 div = 1 cm. Internal floodgun illum.

**Beam finder:** returns trace to CRT screen.

**Intensity modulation (Z-axis):** +8 V,  $\geq 50$  ns width pulse blanks trace of any intensity, usable to 20 MHz for normal intensities. Input R, 1 k $\Omega$   $\pm 10\%$ . Max input,  $\pm 10$  V (dc + peak ac).

**Auto-focus:** maintains beam focus with variations of intensity.

**Intensity limit:** limits beam current to decrease possibility of CRT damage. Circuit response time ensures full writing speed for viewing low duty cycle, fast transition time pulses.

### Cathode-ray Tube and Controls (1727A)

**Type:** post accelerator,  $\approx 9.5$  kV, aluminized P31 phosphor.

**Graticule:** 8 x 10 div internal graticule, 0.2 subdivision markings on major horiz and vert axes, 1 div = 0.72 cm.

**Beam finder:** returns trace to CRT screen.

**Intensity modulation (Z-axis):** +4V,  $\geq 50$  ns width pulse blanks trace of any intensity, usable to 20 MHz for normal intensities. Input R, 1 k $\Omega$   $\pm 10\%$ . Max input,  $\pm 20$  V (dc + peak ac).

**Operating modes:** write, store, display, auto-store, and auto-erase.

**Storage writing speed:**  $\geq 2000\text{cm}/\mu\text{s}$  (2775 div/ $\mu\text{s}$ ) over center 6 x 8 div (with viewing hood).

**Storage time (at 22°C):** display mode, at least 10s; store mode, at least 30s; wait time, at least 60s.

**Persistence:** variable,  $\geq 100$  ms.

**Erase time:**  $\approx 300$  ms.

**Intensity limit:** automatically limits beam current to simplify operation and decrease possibility of CRT damage. Circuit response time ensures full writing speed for viewing low duty cycle, fast rise time pulses.

**Auto-focus:** automatically maintains beam focus with variations of intensity.

**Rear panel controls:** astigmatism and trace align (both X and Y).

### General

**Rear panel outputs:** main and delayed gates, -0.7 V to +1.3 V capable of supplying  $\approx 3$  mA; and vertical output.

**Calibrator:** type, 1 kHz  $\pm 15\%$  ( $\pm 10\%$ , 1722B) square wave; 3 V p-p  $\pm 1\%$ , < 0.1  $\mu\text{s}$  transition time.

**Power:** 100, 120, 220, and 240 Vac, -10% + 5%; 48 to 440 Hz; 110 VA max.

### Weight

**1715A, 1725A:** net, 12.9 kg (28.5 lb); shipping, 17.9 kg (39.5 lb).

**1722B:** net 13.6 kg (30 lb); shipping, 19.5 kg (43 lb).

**1727A:** net, 15.9 kg (35 lb); shipping, 20 kg (44 lb).

**Operating environment:** temp, 0°C to +55°C; humidity, to 95% rel humidity at +40°C; altitude, to 4600 m (15 000 ft); vibration, in three planes for 15 min. each with 0.254 mm excursion, 10 to 55 Hz.

**Size:** (1715A, 1725A, 1722B) 197 H x 335 W 570 mm D (7.75" x 13.8" x 22.4") with handle; (1715A, 1725A) 502 mm D (18.88" without handle; (1722B) 510 mm (20.06") without handle; (1727A) 197 H x 335 W x 652 mm D (7.75" x 13.8" x 25.69") with handle; 595 mm (23.38") without handle.

**Accessories furnished:** one blue light filter; one panel cover; two 10017A 10:1 divider probes with 1722B, 1725A, 1727A; two 10018A 10:1 divider probes with 1715A; one 2.3 m (7.5 ft) power cord; one vinyl storage pouch; one Operating and Service Manual. The 1727A includes one Model 10173A RFI filter and contrast screen, and one Model 10140A viewing hood.

### Options and Accessories

**001:** U.S. fixed line cord

**Price**

add \$15

**003:** probe power supply with two rear panel jacks for use with HP active probes. Provides power to operate two 1120A, or 1124A active probes.

add \$50

**034 (except 1722B):** built-in DMM (60 Hz)

add \$325

**035 (except 1722B):** built-in DMM (50 Hz)

add \$325

**091 (except 1715A):** two 2 m (6.6 ft) 10018A, 10:1 probes substituted for two 10017A miniature probes

N/C

**091 (1715A):** two 1 m (3.3 ft) 10017A, 10:1 probes substituted for two 10018A miniature probes

N/C

**092:** two 1.8 m (6 ft) 10016B, 10:1 probes substituted for two miniature probes

N/C

**101 (except 1727A):** state display-single switch interface for operation with 1607A Logic State Analyzer

add \$150

**112:** includes 1112A Inverter Power Supply, a portable power source for 1700 series oscilloscopes

add \$1000

**910 (except 1727A):** additional set of manuals

add \$15

**910 (1727A):**

add \$20

**Time interval multimeter kit:** (HP P/N 01715-69501 for 1715A or 1725A, HPP/N 01727-69501 for 1727A) adapts a standard Model 1715A, 1725A, or 1727A to an Opt 034/035, built-in, LED readout, delta time oscilloscope. The kit includes a multimeter, a new top oscilloscope cover, a vinyl storage pouch, and mounting hardware.

\$375

### Logic State Analysis Equip Required for Opt 101

**1607A:** 16-bit Logic State Analyzer including three data probes and one clock probe

\$3300

**10121A:** 20 cm (8") cable for trigger connection

\$20 ea

**11170A:** 3, 60 cm (24") cables for X, Y, Z connection

\$17 ea

**5061-1213:** Adapter plate and strap for mounting the oscilloscope on top of the 1607A

\$36

### Ordering Information

**1715A** 200 MHz Oscilloscope

\$3650

**1722B** 275 MHz Oscilloscope with Microprocessor

\$5200

**1725A** 275 MHz Oscilloscope

\$4000

**1727A** 275 MHz Storage Oscilloscope

\$7200

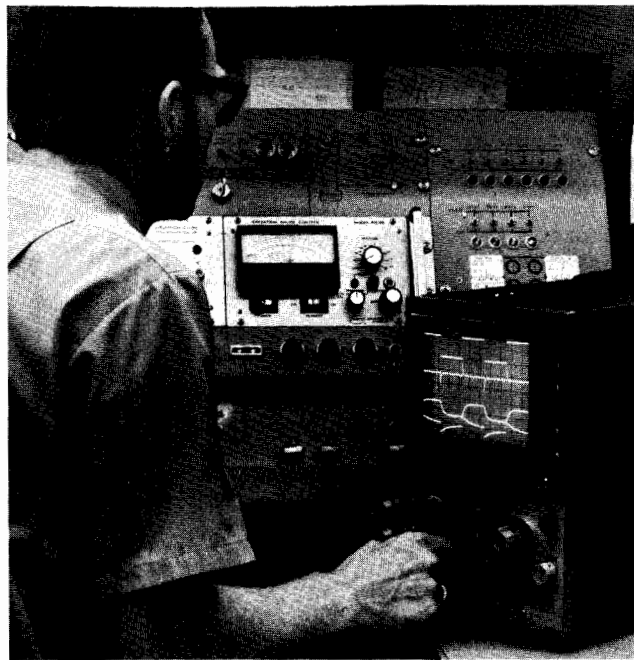
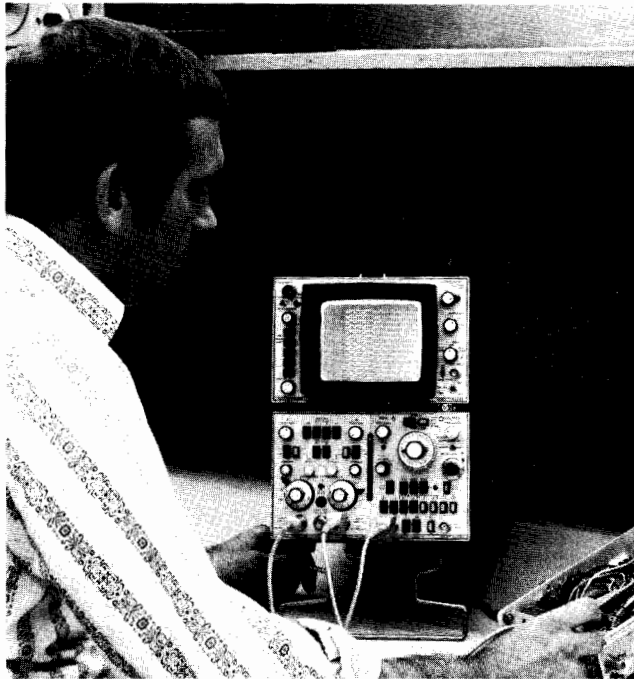

## Introduction

The 180 plug-in oscilloscopes combine high performance, plug-in versatility, and operating ease to give you a flexible operating system with laboratory quality throughout. These versatile plug-in oscilloscopes provide two or four channel measurements to 100 MHz in mainframes that offer a choice of performance characteristics and screen sizes plus variable persistence and storage.

The focal point for performance is the mainframe with a high quality CRT for accurate measurements. Four mainframes, including one with a large screen, and a selection of plug-ins allow you to configure an oscilloscope for your particular application. You can meet your present measurement needs, selecting only those plug-ins to meet present requirements at minimum cost, yet keep the full capability of the mainframe for future requirements.

Models 180C, 180D, and 182C mainframes have bright, easy-to-see displays for maximum resolution and measurement accuracy. Models 180C and 180D each have a CRT display with a full 8 x 10 cm internal graticule and a writing speed of 1500 cm/ $\mu$ s. For multi-trace viewing and easy-to-see displays the 182C CRT display has a large 8 x 10 division (one division equals 1.29 cm) internal graticule.

## Variable persistence storage

Variable persistence storage mainframes give you the widest selection of general purpose and high speed storage applications. Advances in processing and target material have resulted in a very rugged storage surface as well as extremely high writing speeds. This storage surface is so burn resistant that special operating procedures are not required, extending the versatility of storage measurements to general purpose applications.

Storage writing speeds of 100 cm/ $\mu$ s and 400 cm/ $\mu$ s are available in the 184A and 184A Option 005 respectively, which allows you to capture those elusive transients. With these fast writing speeds you can easily make pulse timing adjustments, locate noise pulses and missing bits from low duty-cycle digital signals. Low duty-cycle pulse trains from disc, tape, or drum peripheral units can also be viewed through repetitive sweeps by using variable persistence to build up the intensity of dim traces.

For medium speed storage and variable persistence applications, Models 181A/AR mainframes are available. Variable persistence mode, in both models, allows you to adjust display retention time to match the speed of slowly changing signals for maximum viewing ease. This allows direct viewing of complete waveforms without clutter in electromechanical, biomedical, chemical, geological, oceanographical, and many other areas with slowly changing signals. The light amplification capability of the 181A/AR permits easy viewing of low rep rate, fast pulses.

## Real time measurements

A selection of high performance, vertical real time plug-ins assures the right plug-in for most measurement applications. Real time, dual channel plug-ins are available in 50 MHz and 100 MHz bandwidths with a 5 mV/div minimum deflection factor. Additional measurement capability is provided by four channel 100 MHz, and 50 MHz plug-ins.

A selection of time base plug-ins gives you a choice of single or main and delayed sweeps with magnified sweep speeds to 5 ns/div in 180 mainframes. Models 1820C and 1825A have triggering capabilities to 150 MHz and the 1821A triggers in excess of 50 MHz. Models 1821A and 1825A have calibrated delayed and mixed sweeps for accurate timing measurements and detailed examination of selected portions of waveforms.

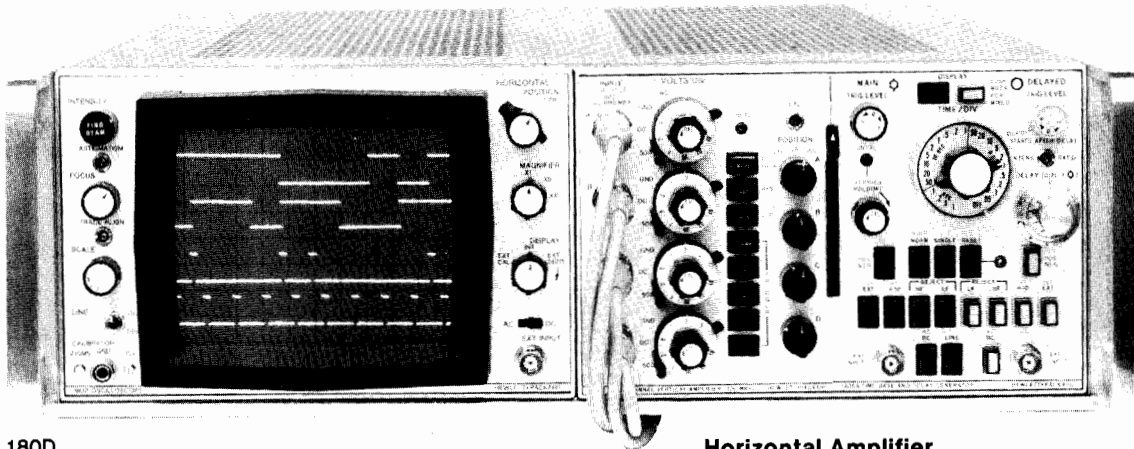

180D

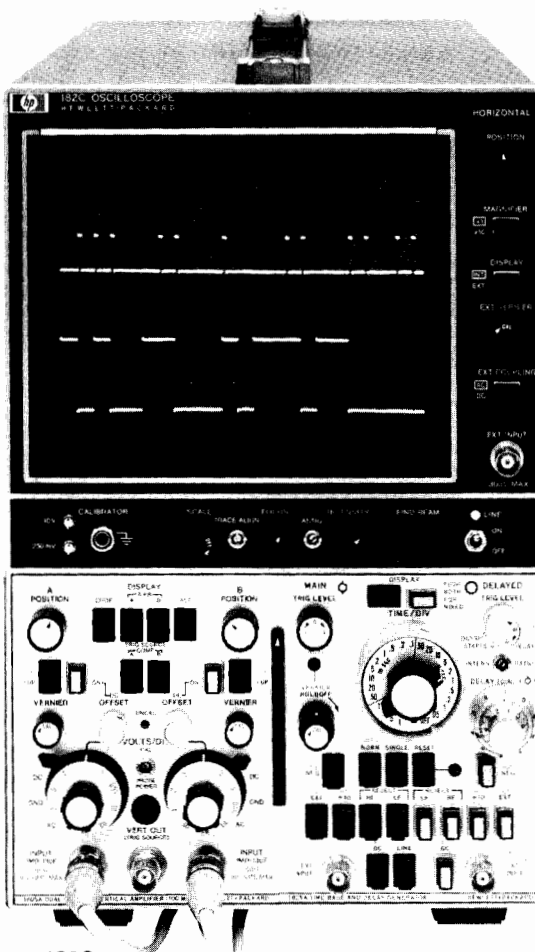

182C

## 180 C/D, 182C Specifications

### Cathode-ray Tube and Controls

**Type:** post accelerator, 15 kV (180 C/D), 21 kV (182C); aluminized P31 phosphor.

**Graticule:** 8 x 10 div internal graticule, 0.2 div subdivisions on major axes; (180 C/D) 1 div=1 cm, (182C) 1 div=1.29 cm. Scale control illuminates CRT phosphor for viewing with hood or taking photos.

**Beam finder:** returns trace to CRT screen.

**Intensity modulation (external input):** input,  $\approx +2$  V,  $\geq 50$  ns pulse width blanks trace of normal intensity; input R  $\approx 50$  k $\Omega$ ; Max input,  $\pm 20$  V (dc + peak ac) at  $\leq 1$  kHz.

### Horizontal Amplifier

#### External input

**Bandwidth:** dc-coupled, dc to 5 MHz; ac-coupled, 5 Hz to 5 MHz.  
**Deflection factor:** 1 V/div, X1; 0.2 V/div, X5 (180C/D); 0.1 V/div, X10; accuracy,  $\pm 5\%$ .

**Dynamic range:**  $\pm 20$  V.

**Max input:** (180C/D) 600 V dc (ac-coupled input); (182C)  $\pm 300$  V (dc + peak ac) at  $\leq 1$  kHz.

**Input RC:**  $\approx 1$  M $\Omega$  shunted by  $\approx 30$  pF.

**Sweep magnifier:** X10, X5 (180 C/D); accuracy,  $\pm 5\%$  (with 3% accuracy time base).

**Calibrator:**  $\approx 1$  kHz square wave,  $< 3\mu$ s rise time; 250 mV p-p and 10 V p-p into 1 M $\Omega$ ,  $\pm 1\%$ .

#### Outputs

Four rear panel emitter follower outputs for main and delayed gates, main and delayed sweeps, or vertical and horizontal outputs when used with TDR/Sampling plug-ins. Max current available,  $\pm 3$  mA. Will drive impedances  $\geq 1000$  ohms without distortion.

#### General

**Operating environment:** temperature, 0 to 55°C (+32°F to +130°F); humidity, to 95% relative humidity at 40°C (104°F); altitude, to 4600 m (15 000 ft); vibration, vibrated in three planes for 15 min. each with 0.254 mm (0.010 in.) excursion, 10 to 55 Hz.

#### Size

**180C (cabinet):** 289 H x 200 W x 540 mm D behind panel (11.4" x 7.9" x 21.3").

**180D (rack):** 133 H x 425 W x 543 mm D overall (5.2" x 16.7" x 21.4") 493 mm (19.4") D behind rack mount tabs.

**182C (cabinet):** 338.1 H x 201.6 W x 498.5 mm D overall (13.3" x 7.9" x 19.6").

#### Weight (without plug-ins)

**180C (cabinet):** net, 10.4 kg (23 lb); shipping, 15.4 kg (34 lb).

**180D (rack):** net, 11.8 kg (26 lb); shipping, 17.2 kg (38 lb).

**182C (cabinet):** net, 12.2 kg (27 lb); shipping, 15.4 kg (34 lb).

**Power:** 115 or 230 V,  $\pm 10\%$ , 48 to 440 Hz; normally  $< 110$  watts with plug-ins at normal line. Max mainframe power, 200 VA.

#### Accessories supplied

**180C/D:** 2.3 m (7.5 ft) power cord, blue plastic light filter (HP P/N 5060-0548), one Operating and Service Manual. A rack mount kit (HP P/N 5060-0552) and 2 clip-on probe holders (HP P/N 5040-0464) are supplied with the 180D rack model.

**182C:** 2.3 m (7.5 ft) power cord, blue plastic light filter (HP P/N 5060-0547), one Operating and Service Manual.

#### Ordering Information

Model	Price
180C Cabinet Style Mainframe	\$2200
Opt 010: deletes rear panel outputs for main and delayed gates and main and delayed sweeps.	N/C
Opt 910: additional Operating and Service Manual	add \$12
180D Rack Style Mainframe	\$2400
Opt 010: (see 180C Option 010)	N/C
Opt 910: additional Operating and Service Manual	add \$12
182C Cabinet Style Mainframe	\$2500
Opt 010: (see 180C Opt 010)	N/C
Opt 910: additional Operating and Service Manual	add \$12

# OSCILLOSCOPES

180 Mainframes: storage

Models 181A/AR & 184A

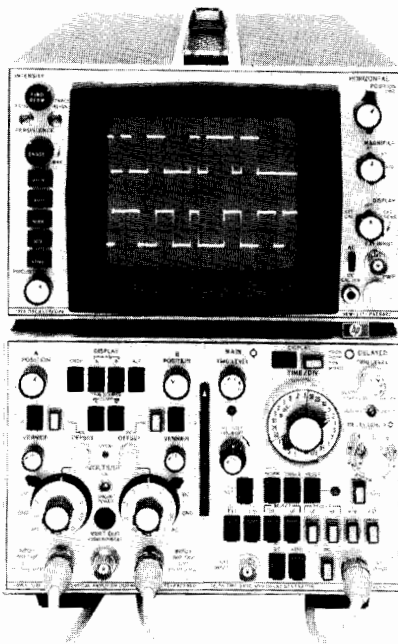

181A

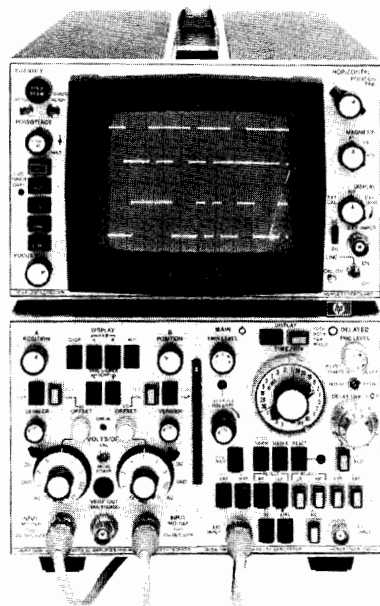

184A

## 181A/AR, 184A Specifications

### Cathode-ray Tube and Controls

**Type:** post-accelerator storage tube, 8.5 kV (181A/AR); aluminized P31 phosphor.

**Graticule:** 8 x 10 div internal graticule, 0.2 div subdivisions on major axes; 1 div = 0.95 cm. (184A) 8 x 10 div internal graticule superimposed in center of normal scope graticule (for fast writing speed mode); 1 div = 0.475 cm.

**Beam flinder:** returns trace to CRT screen.

### Intensity modulation (external input)

**Input:**  $\approx +2V$ ,  $\geq 50$  ns pulse width blanks normal intensity trace. Input R  $\approx 5$  k $\Omega$ . Max input,  $\pm 20$  V (dc + peak ac).

### Persistence, Storage, 181A/AR

**Persistence:** normal,  $\approx 40$   $\mu$ s; variable,  $< 0.2$  to  $> 1$  min.

**Storage writing speed:** write mode,  $> 20$  cm/ms; max write mode,  $> 5$  cm/ $\mu$ s.

**Brightness:**  $> 342.6$  cd/m<sup>2</sup> (100 f).

**Storage time:** from Write to Store, trace may be stored at reduced intensity for  $> 1$  hr; to View, traces may be viewed at normal intensity for  $> 1$  min. From max Write to Store, traces may be stored at reduced intensity for  $> 5$  min.; to View, traces may be viewed at normal intensity for  $> 15$  s.

**Erase:** manual, pushbutton erasure takes  $\approx 300$  ms.

### Persistence, Storage, 184A

**Writing modes:** conventional (non-storage), standard, and fast (variable persistence and storage). Pressing STORE and either STD or FAST provides max persistence with floodguns off for a ready-to-write state. CRT will remain primed for the storage time of  $> 10$  min. in STD/STORE and  $> 30$  s in FAST/STORE.

**Persistence:** conventional,  $\approx 40$   $\mu$ s; variable,  $< 50$  ms to  $> 1$  min.

### Storage writing speed

Model No.	Standard*	Fast**
184A	$> 0.2$ cm/ $\mu$ s	$> 100$ cm/ $\mu$ s
184A Opt 005	$> 0.2$ cm/ $\mu$ s	$> 400$ cm/ $\mu$ s

\*Adjustable writing speeds to  $\approx 10$  cm/ $\mu$ s are available with rear panel controls.

\*\*Calibrated 3.8 x 4.75 cm reduced scan area.

**Brightness:** standard, 342.6 cd/m<sup>2</sup> (100 f); fast,  $> 173.3$  cd/m<sup>2</sup> (50 f).

### Storage time

**Standard writing speed:** variable from  $> 1$  min. at normal intensity to  $> 10$  min. at reduced brightness.

**Fast writing speed:** at 22°C variable from  $> 10$  s (8s for Opt 005) at normal intensity to  $> 30$  s at reduced brightness.

**Erase:** manual, pushbutton erasure takes  $\approx 300$  ms.

### Horizontal Amplifier

#### External input

**Bandwidth:** dc-coupled, dc to 5 MHz, ac-coupled,  $\approx 5$  Hz to 5 MHz.

**Deflection factor:** 1 V/div in X1; 0.2 V/div in X5; 0.1 V/div in X10.

**Dynamic range:**  $\pm 20$  V.

**Max input:** 600 V dc (ac-coupled input).

**Input RC:**  $\approx 1$  M $\Omega$  shunted by  $\approx 30$  pF.

**Sweep magnifier:** X5, X10; accuracy,  $\pm 5\%$  (with 3% time base).

### General

#### Outputs

Four rear panel emitter follower outputs for main and delayed gates, main and delayed sweeps, or vertical and horizontal outputs when used with TDR/Sampling plug-ins. Max current available,  $\pm 3$  mA. Will drive impedances  $\geq 1000\Omega$  without distortion.

**Calibrator:**  $\approx 1$  kHz square wave, 3  $\mu$ s rise time; 10 V p-p into  $\geq 1$  M $\Omega$ ; accuracy,  $\pm 1\%$ .

**Operating environment:** same as 180 C/D.

#### Dimensions

**181A, 184A (cabinet):** 289 H x 200 W x 540 mm D behind panel (11.4" x 7.9" x 21.3").

**181AR (rack):** 133 H x 425 W x 543 mm D overall (5.2" x 16.7" x 21.4"); 493 mm (19.4") D behind rack mount tabs.

#### Weight (without plug-ins)

**181A, 184A (cabinet):** net, 10.9 kg (24 lb); shipping, 15.4 kg (34 lb).

**181AR (rack):** net, 11.8 kg (26 lb); shipping, 17.2 kg (38 lb).

**Power:** 115 or 230 V  $\pm 10\%$ , 48 to 440 Hz; 115 watts at normal line with plug-ins; max mainframe power, 225 VA.

**Accessories supplied:** 2.3 m (7.5 ft) power cord, Model 10178A mesh contrast filter, blue plastic light filter (HP P/N 5060-0548) and 2 clip-on probe holders (HP P/N 5040-0464) are supplied with the 181AR rack model.

### Ordering Information

<b>181A Storage Mainframe, Cabinet Style</b>	\$3300
<b>Opt 910:</b> additional Operating and Service Manual	add \$12
<b>181AR Storage Mainframe, Rack Style</b>	\$3500
<b>Opt 910:</b> additional Operating and Service Manual	add \$12
<b>184A Storage Mainframe, Cabinet Style</b>	\$4000
<b>Opt 005:</b> Fast Storage CRT	add \$1200
<b>Opt 910:</b> additional Operating and Service Manual	add \$15

### Price

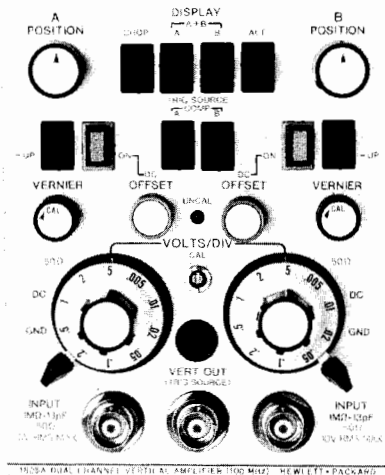

1805A

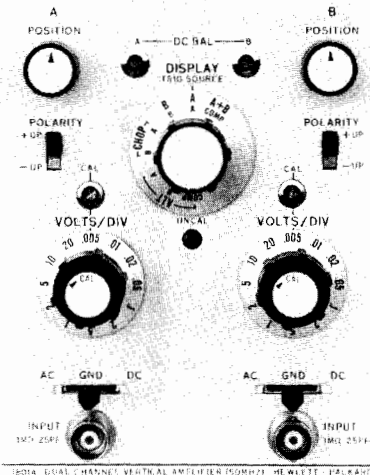

1801A

### 1805A, 1801A Specifications

#### Modes of Operation

Channel A; Channel B; A and B displayed alternately on successive sweeps (ALT); A and B displayed by switching between channels at approx 400 kHz rate (CHOP) with blanking during switching; A plus B (algebraic addition).

#### Each Channel (2)

**Bandwidth:** (measured with or without 10014A probe (1805A), 10004D probe (1801A), 3 dB down from 8 div ref signal from a terminated 50Ω source.)

**DC-coupled:** (1805A) dc to 100 MHz, (1801A) dc to 50 MHz.

**AC-coupled:** (1805A) ≈10 Hz to 100 MHz, (1801A) ≈8 Hz to 50 MHz.

**Rise time:** (1805A) <3.5 ns (measured with or without 10014A probes, 10% to 90% points of 6 div input step from a terminated 50Ω source); (1801A) <7 ns (measured with or without 10004D probe, 10% to 90% points of 8 div input step from a terminated 50Ω source).

#### Deflection factor

**Ranges:** (1805A) 5 mV/div to 5 V/div (10 cal positions) in 1, 2, 5 sequence; ±2% attenuator accuracy. (1801A) 5 mV/div to 20 V/div (12 positions) in 1, 2, 5 sequence; ±3% attenuator accuracy.

**Vernier:** extends max deflection factor ≥12.5 V/div (1805A), ≥50 V/div (1801A).

**Polarity:** + up or - up selectable.

**Input coupling:** (1805A) AC, DC, 50Ω (dc), or ground; (1801A) AC, DC, or ground.

**Input RC:** (1805A) AC and DC, 1 MΩ ±1% shunted by ≈13 pF; 50Ω, 50Ω ±2%; SWR <1.2 at 100 MHz on all ranges. (1801A) ≈1 MΩ shunted by ≈25 pF.

**Max input:** (1805A) AC and DC, ±300 V (dc + peak ac) at ≤1 kHz; ±150 V (dc + peak ac) on 5 mV/div range at ≤1 kHz; 50Ω, 10 V rms, DC-coupled. (1801A) DC-coupled ±350 V (dc + peak ac) at ≤10 kHz; ±150 V (dc + peak ac) on 5 mV/div range at ≤1 kHz; AC-coupled, ±600 V dc.

**Dynamic range (1805A):** 6 div at 100 MHz to 16 div at ≤15 MHz.

**Positioning range (1805A):** 16 div.

**A + B operation:** amplifier bandwidth and deflection factors unchanged; either channel may be inverted for ±A ±B operation. Differential input (A-B) common mode, (1805A) CMR ≥ 40 dB dc to 1 MHz for common mode signals ≤16 div, ≥20 dB at 50 MHz for signals ≤6 div; (1801A) CMR ≥ 40 dB at 5 mV/div and ≥20 dB on other ranges, dc to 1 MHz, for common mode signals ≤24 div.

**Offset (1805A):** ±200 div of offset.

#### Triggering (1805A)

**Source:** selectable from channel A, channel B, or a composite (Comp) signal from A and B in any display mode. Composite is A and B signals switched for Alt and Chop modes and added for A and B mode. Vernier and position controls do not affect A, B, or composite trigger signals. A and B signals are independent of polarity selection.

#### Frequency

Time Base Plug-in	Trigger Frequency*	Required Vertical Deflection
1820C, 1825A	dc-50 MHz	½ div
	dc-100 MHz	1 div
1821A	dc-50 MHz	1 div

\*all display modes except Chop, dc to 100 kHz in Chop.

#### Triggering (1801A)

**Source:** for channel A or B, on signal displayed; Chop selectable from A or B; Alt selectable from A, B, or Comp (A and B switched).

**Frequency:** dc to >50 MHz on signals causing ≥0.5 div vert deflection in all display modes except Chop which is dc to 100 kHz.

#### Vertical Signal Output (1805A)

**Bandwidth:** >50 MHz into 50Ω.

**Amplitude:** >50 mV for each div of display into 50Ω with useable amplitudes up to 500 mV p-p.

**Source Impedance:** ≈50 ohms.

#### General

**Operating environment:** same as 180 C/D mainframes.

#### Weight

**1805A:** net 2.3 kg (5 lb); shipping, 3.6 kg (8 lb).

**1801A:** net 1.8 kg (4 lb); shipping, 3.6 kg (8 lb).

**Accessories supplied:** (1805A) two 10014A 10:1 divider probes ≈1.1 m (3.5 ft), one Operating and Service Manual. (1801A) two 10004D, 10:1 divider probes, ≈1.1 m (3.5 ft), one Operating and Service Manual.

**Recommended probes:** (1805A) full performance maintained by 10014A, 10016B passive probes, 10017A, 10018A miniature passive probes, 10026A, 10027A miniature 50 Ω probes, 10020A resistive divider probe kit, and the 1120A active probe; (1801A) full performance maintained by 10004D, 10005D, and 10006D passive probes and 10041A, 10042A miniature passive probes.

#### Ordering Information

	Price
<b>1805A</b> 100 MHz Dual Channel Vertical Amplifier	\$2050
<b>Opt 910:</b> additional Operating and Service Manual	add \$10
<b>1801A</b> 50 MHz Dual Channel Vertical Amplifier	\$1450
<b>Opt 001:</b> channel B output and X5 magnifier	add \$155
<b>Opt 090:</b> 1.8 m (6 ft) 10006D probes in lieu of 10004D	N/C
<b>Opt 091:</b> 3 m (10 ft) 10005D probes in lieu of 10004D	N/C
<b>Opt 910:</b> additional Operating and Service Manual	add \$10



# OSCILLOSCOPES

180 Verticals: 4 channel, 100 MHz and 50 MHz

Models 1809A & 1804A

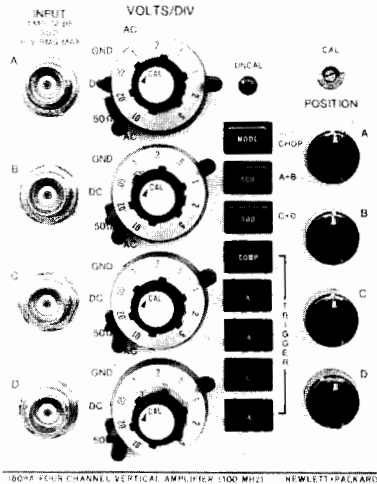

1809A, 100 MHz 4 channel

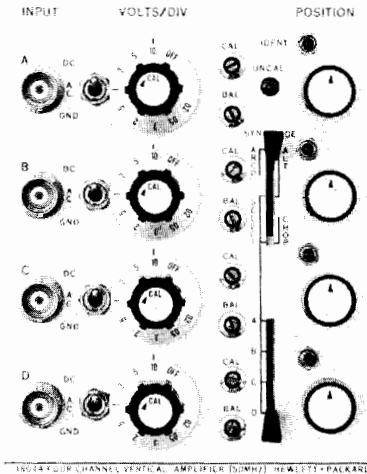

1804A

## 1809A Specifications

### Modes of Operation

Channels A, B, C, or D or any combination displayed alternately on successive sweeps (ALT) or chopped (CHOP) with blanking during switching; either A and B or C and D may be algebraically added ( $\pm A \pm B$ ) or ( $\pm C \pm D$ ). Approx chop rate for two channels displayed is 1 MHz, 3 channels is 667 kHz, 4 channels is 500 kHz.

### Each Channel (4)

**Bandwidth:** (measured with or without 10014A probe, 3 dB down from a terminated 50Ω source.)

**DC-coupled:** dc to 100 MHz.

**AC-coupled:**  $\approx 10$  Hz to 100 MHz.

**Rise time:**  $< 3.5$  ns. Measured with or without 10014A probe, 10% to 90% of 6 div input step from a terminated 50Ω source.

### Deflection factor

**Ranges:** from 0.01 V/div to 5 V/div (9 cal positions) in 1, 2, 5 sequence. Attenuator accuracy,  $\pm 2\%$ .

**Vernier:** extends max deflection factor to  $\geq 12.5$  V/div.

**Input coupling:** ac, dc, 50Ω (dc), or ground.

**Input RC (selectable):** AC or DC, 1 MΩ,  $\pm 1\%$  shunted by  $\approx 12$  pF; 50Ω, 50Ω  $\pm 2\%$ . SWR, 1.3 at 100 MHz on all ranges.

**Max input:** AC and DC,  $\pm 300$  V (dc + peak ac) at  $\leq 1$  kHz,  $\pm 150$  V (dc + peak ac) on 10 mV/div range at  $\leq 1$  kHz; 50Ω, 10 V rms (dc-coupled input).

**Polarity:** any channel may be inverted ( $\pm A$ ,  $\pm B$ ,  $\pm C$ ,  $\pm D$ ).

### Algebraic Addition (A + B), (C + D)

**Amplifier:** bandwidth and deflection factors are unchanged, any channel may be inverted for ( $\pm A \pm B$ ) or ( $\pm C \pm D$ ) operation.

**Differential Input (A - B) or (C - D) common mode:** CMR is  $\geq 20$  dB from dc to 80 MHz on all ranges.

### Triggering

**Source:** selectable from channel A, B, C, D, or composite (on displayed signals) in all display modes.

### Frequency

Time Base Plug-in	Trigger Frequency*	Required Vertical Deflection
1820C, 1825A	dc-50 MHz dc-100 MHz	$\frac{1}{2}$ div 1 div
1821A	dc-50 MHz	1 div

\*All display modes except Chop, dc to 100 kHz in Chop.

### General

**Operating environment:** same as 180C/D mainframes.

**Weight:** net, 3.2 kg (7 lb); shipping, 4.5 kg (10 lb).

**Accessories supplied:** one Operating and Service Manual.

## Recommended Probes

Models 10014A, 10016B, 10017A, and 10018A will maintain 1809A bandwidth and rise time in the high impedance (ac or dc) mode. Models 10020A, 10026A, and 10027A will maintain bandwidth and rise time in the 50Ω input mode.

## 1804A Specifications

### Modes of operation

Channels A, B, C, or D or any combination displayed alternately on successive sweeps (ALT) or chopped (CHOP) with blanking during switching. Approx chop rate for two channels displayed is 500 kHz, 3 channels is 333 kHz, and 4 channels is 250 kHz.

### Each channel (4)

**Bandwidth:** (measured with or without 10004D probe, 3 dB down from 8 div ref signal from a terminated 50Ω source.)

**DC-coupled:** dc to 50 MHz.

**AC-coupled:**  $\approx 10$  Hz to 50 MHz.

**Rise time:**  $< 7$  ns (measured with or without 10004D probe, 10% to 90% of 8 div input step from a terminated 50Ω source).

### Deflection factor:

**Ranges:** 0.02 V/div to 10 V/div (9 cal positions) in 1, 2, 5 sequence, attenuator accuracy,  $\pm 3\%$ .

**Vernier:** extends max deflection factor to  $\geq 25$  V/div.

**Input coupling:** AC, DC, and Ground.

**Input RC:**  $\approx 1$  MΩ shunted by  $\approx 25$  pF.

**Max input:** DC-coupled,  $\pm 350$  V (dc + peak ac),  $\pm 150$  V (dc + peak ac) on 20 mV/div at 10 kHz or less; AC-coupled,  $\pm 400$  V dc.

**Trace identification:** pushbutton displaces respective trace  $\approx 0.5$  div.

### Triggering

**Source:** selectable on signal from any channel in Chop or Alt mode, or successively from displayed signal on each channel in Alt mode.

**Frequency:** dc to 50 MHz on signals causing  $\geq 0.5$  div vert deflection in all display modes except Chop, dc to 200 kHz in Chop.

### General

**Operating environment:** same as 180C/D mainframe.

**Weight:** net, 2.3 kg (5 lb); shipping, 3.6 kg (8 lb).

**Accessories supplied:** one Operating and Service Manual.

### Recommended Probes

10004D, 10005D, 10006D passive probes and, 10040A, 10041A, 10042A miniature passive probes, maintain full performance of the 1804A.

### Ordering Information

1809A 100 MHz 4 Channel Vertical Amplifier

Opt 910: additional Operating and Service Manual

1804A 50 MHz 4 Channel Vertical Amplifier

Opt 910: additional Operating and Service Manual

### Price

\$3200

add \$15

\$2600

add \$10

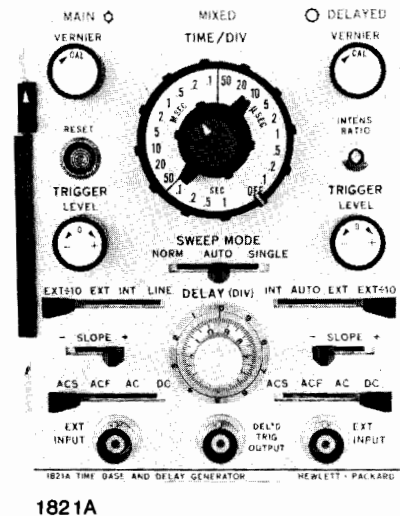
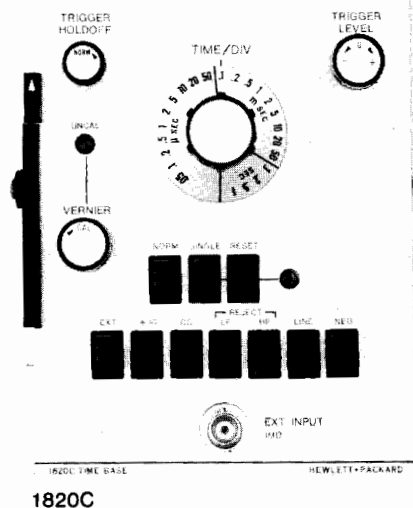

## 1820C Specifications

### Time Base

#### Sweep

**Ranges:** 0.05  $\mu$ s/div to 1 s/div (23 positions) in 1,2,5 sequence;  $\pm 3\%$  accuracy with vernier in CAL position.

**Vernier:** extends slowest sweep to at least 2.5 s/div.

**Magnifier:** (mainframe) expands fastest sweep to 5 ns/div.

#### Sweep mode

**Normal:** triggered by an int, ext, or power line signal.

**Automatic:** baseline displayed in absence of trigger signal. Triggering is same as Normal except low frequency limit is 40 Hz.

**Single:** in Normal, sweep occurs once with the same triggering as Normal (reset pushbutton arms sweep and lights indicator); in Auto, sweep occurs once each time reset is pressed.

### Triggering

**Internal:** refer to vertical plug-in specifications.

**External:** dc to 50 MHz on signals 50 mV p-p or more increasing to 100 mV at 100 MHz and 150 mV at 150 MHz.

**Line:** power line frequency signal.

#### Level

**Internal:** at any point on the vertical waveform displayed.

**External:** continuously variable from +2V to -2V on either slope of trigger signal, from +20V to -20V in  $\div 10$  setting.

**Slope:** pushbutton selection of + or - slope of trigger signal.

**Coupling:** AC, DC, HF Reject or LF Reject.

**Trigger holdoff:** time between sweeps continuously variable, exceeding one full sweep on all ranges.

### General

**Operating environment:** same as 180C/D mainframe.

**Weight:** net, 1.4 kg (3 lb); shipping, 3.2 kg (7 lb).

## 1821A Specifications

### Main Time Base

#### Sweep

**Ranges:** from 0.1  $\mu$ s/div to 1 s/div (22 positions) in 1, 2, 5 sequence;  $\pm 3\%$  accuracy with vernier in CAL position.

**Vernier:** extends slowest sweep to at least 2.5 s/div.

**Magnifier:** (mainframe expands fastest sweep to 10 ns/div (main or delayed).

#### Sweep mode

**Normal:** triggered by an int, ext, or power line signal.

**Automatic:** baseline displayed in absence of input signal. Triggering same as normal except low frequency limit is 40 Hz for internal or external modes.

**Single:** sweep occurs once with same triggering as normal; reset pushbutton with indicator light.

### Trace Intensification

In Main sweep mode, intensifies that part of Main time base to be expanded to full screen on Delayed time base. Rotating Delayed time base sweep switch from Off position activates intensified mode. Front panel screwdriver adjustment sets relative intensity of brightened segment.

### Delayed Time Base

Delayed time base sweeps after a time delay set by Main time base and Delay controls.

#### Sweep

**Ranges:** from 0.1  $\mu$ s/div to 50 ms/div (18 positions) in 1, 2, 5 sequence;  $\pm 3\%$  accuracy with Vernier in CAL position.

**Vernier:** continuously variable between all ranges; extends slowest sweep to at least 125 ms/div.

### Triggering

(Main and Delayed time base)

**Internal:** refer to vertical plug-in specifications.

**External:** dc to 50 MHz on signals 0.5 V p-p or more, increasing to 100 MHz on signals 1 V p-p or more.

**Line:** power line frequency signal (main only).

**Level and slope:** internal, at any point on the vertical waveform displayed; external, continuously variable from +3 V to -3 V on either slope of the sync signal, from +30 V to -30 V in  $\div 10$ .

**Automatic (delayed only):** triggered at end of set time delay.

**Coupling:** AC, DC, ACF (ac-fast), or ACS (ac-slow).

#### Delay (before start of Delayed sweep)

**Time:** continuously variable from 0.1  $\mu$ s to 10 s.

**Accuracy:**  $\pm 1\%$  of differential delay  $\pm 2$  minor divisions of delay dial. Time jitter is 0.005% of max delay of each step.

**Trigger output:** (at end of Delay time)  $\approx 1.5$  V with  $> 50$  ns rise time from 1000 $\Omega$  source resistance.

### Mixed Time Base

Dual time base in which Main time base drives first portion of sweep and delayed time base completes sweep at up to 1000 times faster. Also operates in single sweep mode.

### General

**Operating environment:** same as 180 C/D mainframes

**Weight:** net, 1.8 kg (4 lb); shipping, 3.6 kg (8 lb)

### Ordering Information

**1821A Time Base and Delay Generator** \$1700

**Opt 910:** additional Operating and Service Manual add \$10

**1820C Time Base** \$1000

**Opt 910:** additional Operating and Service Manual add \$10

# OSCILLOSCOPES

180 Time base: delayed

Model 1825A

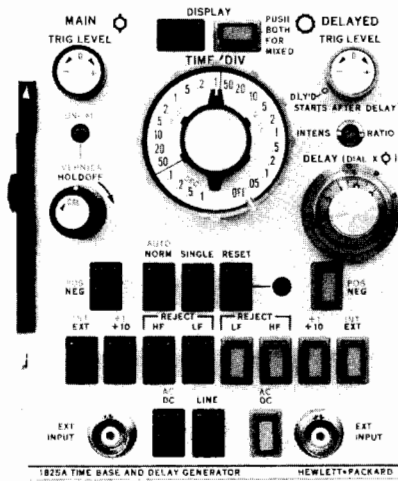

1825A

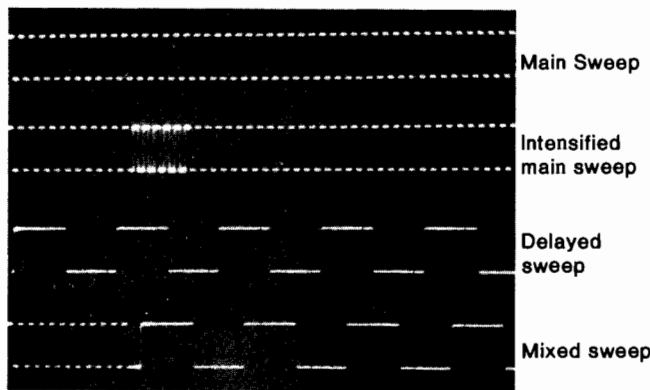

Multiple exposure shows four modes of operation for 1825A, with time relationship maintained in all modes.

## 1825A Description

Model 1825A time base and delay generator provides sweep speeds ranging from 0.05  $\mu\text{s}/\text{div}$  to 1 s/div in 23 positions. Delay times are continuously variable from 50 ns to 10 s and are accurate to 0.75% with extremely low jitter of 1 part in 50 000. Also, a calibrated mixed sweep mode is provided. A mainframe X10 magnifier increases sweep-speed capability to 5 ns/div with 5% accuracy.

One knob control makes triggering easy in main, delayed, and mixed modes. Stable, accurate time displays are provided in main, delayed, and mixed modes with the highly sensitive 50 mV external trigger capability at 50 MHz which increases to only 150 mV at 150 MHz. Trigger synchronization is maintained when switching between main, delayed, and mixed modes, further simplifying use.

Front panel controls are logically arranged for quick familiarization and easy use. Pushbuttons eliminate front panel clutter and reduce the possibility of errors. Easy-to-operate pushbuttons establish main, delayed, and mixed modes of operation.

Trigger level controls on main and delayed sweeps allow selection of the triggering point on the desired portion of the signal for almost every measurement application. Also, the  $\times 10$  function provides a wide dynamic range of triggering in both external and internal modes of operation.

External trigger sensitivity of 50 mV on both main and delayed sweeps allows a 10:1 divider probe to be used to reduce circuit loading at trigger pick-off points and reduces the possibility of circuit malfunction caused by the measuring instrument.

## 1825A Specifications

### Main Time Base

#### Sweep

**Ranges:** 0.05  $\mu\text{s}/\text{div}$  to 1 s/div (23 positions) in 1, 2, 5 sequence;  $\pm 3\%$  accuracy with vernier in CAL position.

**Vernier:** extends slowest sweep to at least 2.5 s/div.

**Magnifier:** (on mainframe) expands fastest sweep to 5 ns/div, accuracy  $\pm 5\%$  (main or delayed).

#### Sweep mode

**Normal:** sweep is triggered by an internal, external, or power line signal.

**Automatic:** baseline displayed in absence of trigger signal. Triggering is same as normal except low frequency limit is 40 Hz.

**Single:** in Normal, sweep occurs once with same triggering as Normal (reset pushbutton arms sweep and lights indicator); in Auto, sweep occurs once each time reset pushbutton is pressed.

### Trace Intensification

In Main sweep mode, intensifies that part of main time base to be expanded to full screen in delayed time base mode. Rotating time base switch from OFF position activates intensified mode.

### Delayed Time Base

Delayed time base sweeps after a time delay set by Main time base and Delay controls. Delayed time base is triggered on first trigger pulse after set delay or automatically triggers after set delay when delayed level control is in detent position.

**Sweep Ranges:** 0.05  $\mu\text{s}/\text{div}$  to 20 ms/div (18 positions) in 1, 2, 5 sequence;  $\pm 3\%$  accuracy.

### Triggering

(Main and Delayed time base)

**Internal:** refer to vertical amplifier plug-in specifications.

**External:** dc to 50 MHz on signals 50 mV p-p or more increasing to 100 mV p-p at 100 MHz and 150 mV p-p at 150 MHz.

**Line:** power line frequency signal (Main only).

### Level

**Internal:** at any point on the vertical waveform displayed.

**External:** continuously variable from +2 V to -2 V on either slope of trigger signal, from +20 V to -20 V in  $\times 10$  setting.

**Slope:** pushbutton selects either positive or negative slope of trigger signal.

**Coupling:** AC, DC, HF Reject, or LF Reject. AC, attenuates signals below  $\approx 20$  Hz; LF reject, attenuates signals below  $\approx 15$  kHz; HF reject, attenuates signals above 15 kHz.

**Trigger holdoff:** time between sweeps continuously variable, exceeding one full sweep on all ranges (Main only).

**Delay** (before start of delayed sweep)

**Time:** continuously variable from 50 ns to 10 s.

**Accuracy:**  $\pm 0.75\%$  of differential delay  $\pm 2$  minor divisions of delay dial.

**Time jitter:**  $\pm 0.002\%$  of max delay on each range.

### Calibrated Mixed Sweep

Combines Main and Delayed Sweeps into one display. Sweep is started by the Main time base and is completed by the faster Delayed time base.

### General

**Operating environment:** same as 180C/D mainframes.

**Weight:** net, 1.8 kg (4 lb); shipping 2.7 kg (6 lb).

**Accessories supplied:** one Operating and Service Manual.

### Ordering Information

**1825A Time Base and Delay Generator**

Opt 910: additional Operating and Service Manual

**Price**

**\$1300**

add \$10

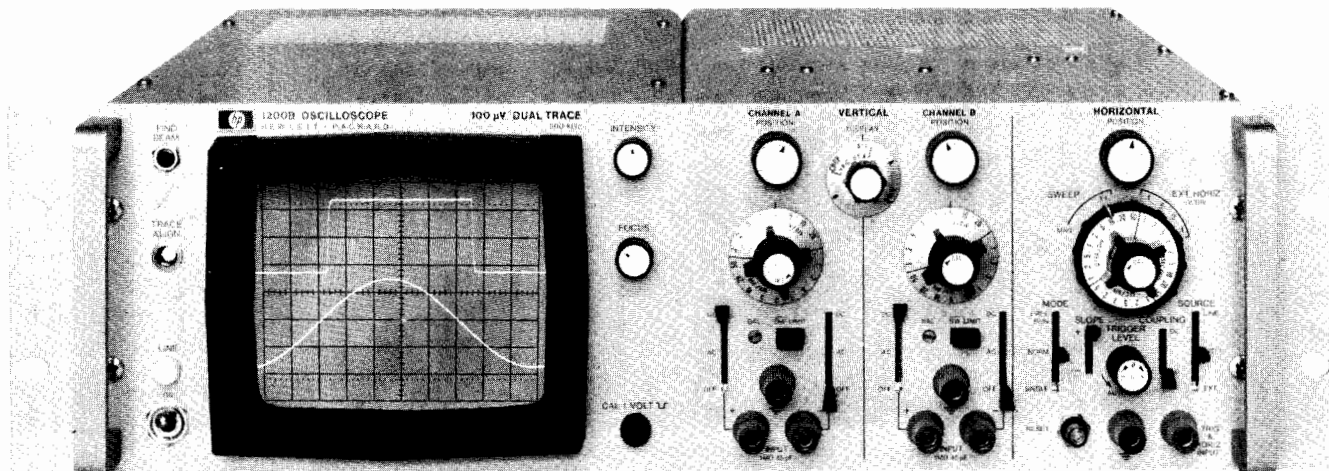

1200B

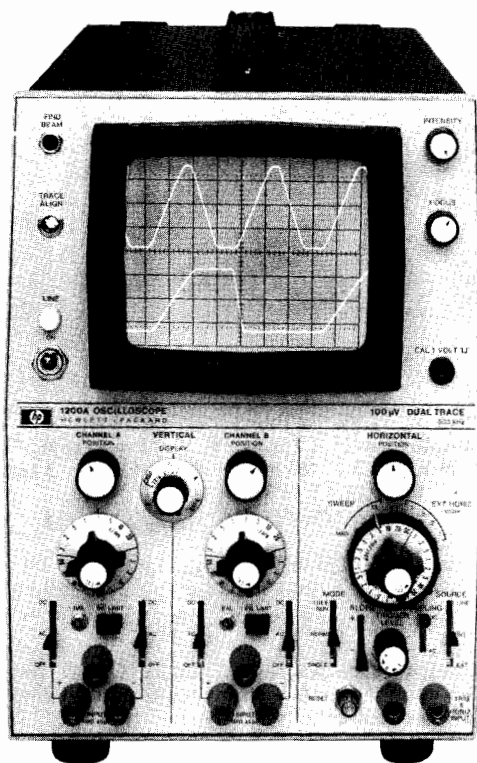

1200A

### 1200A/B, 1201B, 1205B Specifications

#### Vertical Amplifiers

**Modes of operation:** channel A; channel B; channels A and B (either Chop or Alternate triggered by channel A), Chop frequency is  $\approx 100$  kHz; channel A vs B (A-vertical, B-horizontal).

**Bandwidth:** dc-coupled, dc to 500 kHz; ac-coupled, 2 Hz to 500 kHz. Bandwidth limit switch (1200 and 1201) selects upper bandwidth to  $\approx 50$  kHz or 500 kHz.

**Rise time:** 0.7  $\mu$ s max.

#### Deflection factor

**Ranges (1200 and 1201):** from 0.1 mV/div to 20 V/div (17 positions) in 1, 2, 5 sequence.

**Ranges (1205):** from 5 mV/div to 20 V/div (12 positions) in 1, 2, 5 sequence.

**Attenuator accuracy:**  $\pm 3\%$  with vernier in Cal.

**Vernier:** extends max deflection factor to at least 50 V/div.

**Noise (1200 and 1201):**  $< 20 \mu$ V measured tangentially at full bandwidth.

**Input:** differential or single-ended on all ranges.

#### Common mode

**Frequency:** dc to 10 kHz.

#### Rejection ratio

**1200 and 1201:** 100 dB (100 000 to 1) with dc-coupled input on 0.1 mV/div range, decreasing by  $< 20$  dB per decade of deflection factor to at least 40 dB on the 0.2 V/div range; CMR is at least 30 dB on 0.5 V/div to 20 V/div ranges. Max signal is  $\pm 10$  V (dc + peak ac) on 0.1 mV/div to 0.2 V/div ranges;  $\pm 400$  V (dc + peak ac) on all other ranges.

**1205:** 50 dB with dc-coupled input on 5 mV/div to 0.2 V/div ranges; CMR  $\geq 30$  dB on the 0.5 V/div to 20 V/div ranges. Max signal is  $\pm 3$  V (dc + peak ac) on 5 mV/div to 0.2 V/div ranges;  $\pm 300$  V (dc + peak ac) on all other ranges.

**Input coupling:** selectable AC, DC, or OFF for + and - inputs.

**Input RC:**  $\approx 1$  M $\Omega$  shunted by  $\approx 45$  pF.

**Max input:** refer to Common Mode Rejection Ratio.

**Internal trigger source:** on channel A signal for A, Chop, and Alternate displays, on channel B signal for B display.

**Isolation:**  $> 80$  dB between channels at 500 kHz, with shielded input connectors.

**Phase shift:** A vs B mode,  $< 1^\circ$  to 100 kHz with verniers in Cal.

#### Time Base

##### Sweep

**Ranges:** from 1  $\mu$ s/div to 5 s/div (21 positions) in 1, 2, 5 sequence;  $\pm 3\%$  accuracy with vernier in Cal.

**Vernier:** extends slowest sweep to at least 12.5 s/div.

**Magnifier:** direct reading X10 magnifier expands fastest sweep to 100 ns/div with  $\pm 5\%$  accuracy.

##### Automatic triggering

Baseline is displayed in absence of an input signal.

**Internal:** 50 Hz to  $> 500$  kHz on most signals causing 0.5 div or more vert. deflection. Triggering on line frequency also selectable.

**External:** 50 Hz to above 1 MHz on most signals  $\geq 0.2$  V p-p.

**Trigger slope:** positive or negative slope on internal, external or line trigger signals.

##### Amplitude selection triggering

**Internal:** dc to 500 kHz on signals causing  $\geq 0.5$  div vert. deflection.

**External:** dc to 1 MHz on signals  $\geq 0.2$  V p-p. Input impedance  $\approx 1$  M $\Omega$  shunted by  $\approx 20$  pF.

**Trigger level and slope:** internal, at any point on vertical waveform displayed; or continuously variable from +100 V to -100 V on either slope of the external trigger signal.

**Trigger coupling:** dc or ac for external, line, or internal triggering. Lower ac cutoff is 2 Hz for external; 5 Hz for internal.

**Single sweep:** selectable by front panel switch. Reset switch with armed indicator light.

**Free run:** selectable by front panel switch.

**Max input:**  $\pm 350$  V (dc + peak ac).



Models 1200A/B, 1201B &amp; 1205B (cont.)

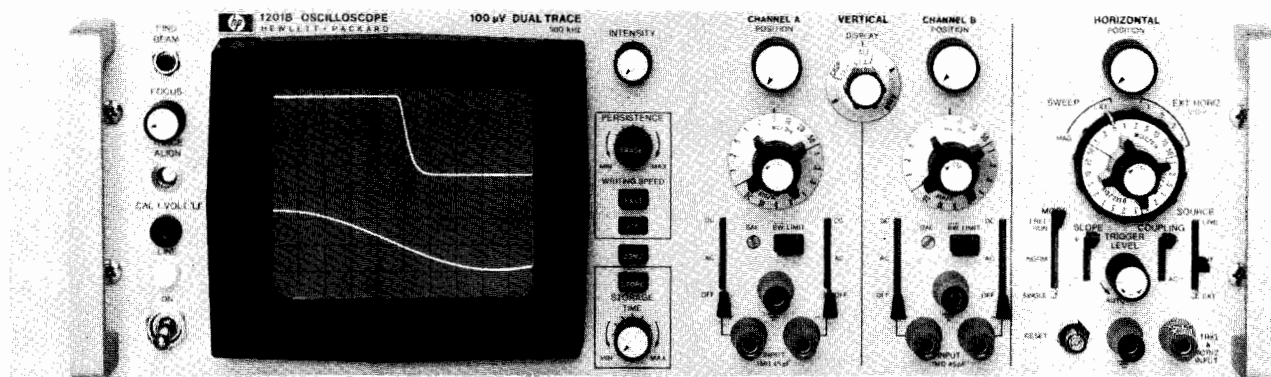

1201B

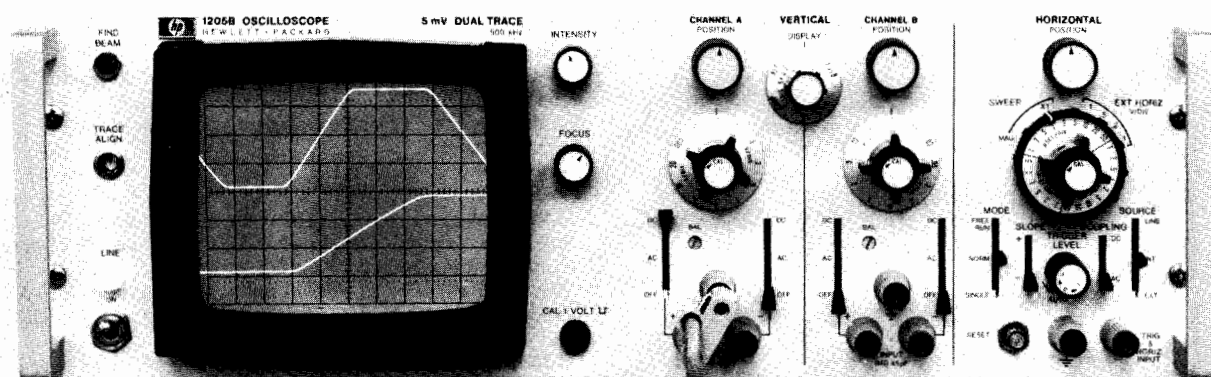

1205B

### Horizontal Amplifier

**Bandwidth:** dc-coupled, dc to 300 kHz; ac-coupled, 2 Hz to 300 kHz.

**Deflection factor:** ranges, 0.1 V/div, 0.2 V/div, 0.5 V/div, and 1 V/div. Vernier, extends max deflection to at least 2.5 V/div.

**Max input:**  $\pm 350$  V (dc + peak ac).

**Input RC:**  $\approx 1$  M $\Omega$  shunted by  $\approx 20$  pF.

**Input:** single-ended on all ranges.

### Cathode-ray Tube and Controls

**Beam finder:** returns trace to CRT screen.

**Intensity modulation:** +2 V signal blanks trace of normal intensity, +8V signal blanks any intensity trace. DC-coupled rear panel input; amplifier rise time,  $\approx 200$  ns; input R  $\approx 5$  k $\Omega$ .

### Standard CRT, 1200, 1205

**Type:** mono-accelerator,  $\approx 3000$  V accelerating potential, P-31 phosphor standard.

**Graticule:** 8 x 10 div internal graticule, 0.2 subdivision markings on horizontal and vertical major axes; 1 div = 1 cm.

### Variable Persistence Storage CRT, 1201

**Type:** post-accelerator, variable persistence storage tube;  $\approx 10.5$  kV accelerating potential; aluminized P-31 phosphor.

**Graticule:** 8 x 10 div internal graticule, 0.2 subdivision markings on major axes; 1 div = 0.95 cm.

### Persistence storage characteristics

(Referenced to a centered 7 x 9 div area in STD mode and to a centered 6 x 8 div area in FAST mode.)

**Persistence:** conventional,  $\approx 40$   $\mu$ s; variable, continuously variable from 0.2 s to  $> 1$  min., STD mode; from 0.2 s to 15 s, FAST mode.

**Storage writing Speed:** STD, 20 div/ms; FAST, 0.5 div/ $\mu$ s.

**Brightness:** 343 cd/m<sup>2</sup> (100 fl) in write mode.

**Storage time:** STD writing speed variable from  $\approx 1$  min. to  $> 1$  hr. FAST writing speed, variable from  $\approx 15$  s to  $> 15$  min.

**Erase:** pushbutton erasure takes  $\approx 1.2$  s. Write gun is blanked and sweep is reset until erasure is completed.

### General

**Calibrator:** 1 V  $\pm 1.5\%$  line frequency square wave.

**Size:** 1200A, 298 mm H x 211 mm W x 475 mm D (11.7" x 8.3" x 18.7") 133 H x 483 W x 466 mm D overall, 423 mm D behind front panel (5.2" x 19" x 18.4"; 16.7").

**Power:** 115/230 V  $\pm 10\%$ , 48 to 440 Hz, 150 VA max.

### Weight

1200A: net, 11.3 kg (25 lb); shipping, 15.6 kg (34.5 lb).

1200B, 1205B: net, 10.2 kg (22.5 lb); shipping, 15.9 kg (35 lb).

1201B: net, 12.5 kg (27.5 lb); shipping, 18.1 kg (40 lb).

### Vertical output signal specifications (Opt 015)

**Output:** 0.3 V/div  $\pm 10\%$ , 0 V offset unaffected by position setting.

**Bandwidth:** dc to 500 kHz.

**Dynamic range:**  $\pm 3.5$  V.

**Max slewing rate:** 12 V/ $\mu$ s with 300 pF load.

**Min load RC:** 10 k $\Omega$  shunted by  $\approx 300$  pF.

**Source impedance:**  $\approx 300$   $\Omega$ .

### Options

**006:** rear input terminals wired in parallel with front panel vertical and horizontal input terminals. Vertical

input shunt capacitance is increased to  $\approx 100$  pF. Horizontal input shunt capacitance is increased to  $\approx 75$  pF.

**009:** storage model only, remote erase through rear panel banana jack, shorting to ground provides erasure (not compatible with Opt 006).

**015:** vertical channel signal outputs through rear panel connectors.

**910:** additional Operating and Service Manual

1200A/B or 1201B

1205B

**Price**  
add \$60

add \$25

add \$125

add \$12

add \$13

### Ordering Information

1200A or 1200B Dual Channel, 100  $\mu$ V Oscilloscope \$1950

1201B Dual Channel, 100  $\mu$ V Storage Oscilloscope \$2990

1205B Dual Channel, 5 mV Oscilloscope \$1840

- X-Y Operation
- TV Sync
- Auto or Normal trigger selection
- A ± B Operation (1222A)
- Delay line (1222A)

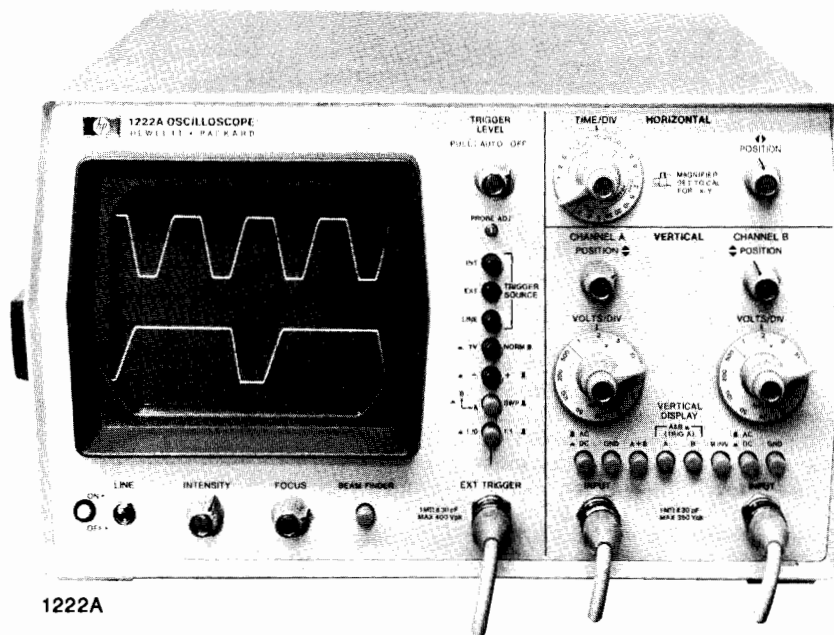

### 1220A, 1222A Description

Hewlett-Packard Models 1220A and 1222A dual channel 15 MHz oscilloscopes are high quality instruments with the performance necessary for a wide variety of applications. Features include a large 8 x 10 cm internal graticule for no-parallax measurements, 3% vertical attenuator accuracy, 4% horizontal accuracy, calibrated sweep times from 0.5 s/div to 0.1  $\mu$ s/div, dc coupling, automatic triggering, a sweep magnifier to expand the display up to ten times for detailed analysis, a pushbutton beam finder, X-Y display capability and TV Sync separator.

The ability to measure and compare input and output signals makes these oscilloscopes an excellent choice for basic electronic laboratories, service, production, and educational purposes. Both Models 1220A and 1222A provide selection of automatic or normal triggering. Model 1222A includes a delay line that allows viewing of the leading edge of the pulse that triggered a sweep. Measurements in the design and checkout of logic systems such as calculators and appliance controllers are easily made with the 1222A.

### Easy Operation

The human engineered front panel with functionally grouped controls and color-coded pushbuttons makes measurements easier and faster. Inputs are protected to 350 V, reducing chances of accidental electrical damage. Automatic triggering assures that a base-line is present even in the absence of a signal or if the trigger level control is set beyond the range of the trigger signal. And, although the oscilloscopes operate in either a chopped or alternate mode, with automatic triggering the operator need not concern himself with making a choice since the Time/Div switch automatically selects the best display mode.

The basic stability of the solid-state circuits and components used throughout is such that internal adjustments have been reduced to a minimum. This decreases calibration requirements and provides real savings over the oscilloscope's lifetime. Recalibration, when necessary is simple and straightforward.

### Triggering

Even though the instruments are easy to operate, these oscilloscopes have the flexibility for multi-purpose use. The operator can select the source of sweep trigger (internal, external, ac line, TV) and he can select the trigger slope, adding to the oscilloscope's versatility by allowing triggering on either the positive or negative going transitions

of the signal. Further flexibility is added by the ability to preset the signal amplitude required to trigger the sweep, assuring that perturbations below the desired amplitude will not trigger the oscilloscope.

With automatically triggered sweep, displays are stable because the observed signal itself determines when a sweep should start. Automatic triggering produces a free running trace in the absence of a signal for fast setup. It locks onto any input signal of the proper polarity and amplitude.

### CRT

The internal 8 x 10 cm CRT graticule eliminates parallax errors that occur when the graticule is external to the CRT. The 3% vertical accuracy combined with the no-parallax graticule enables the oscilloscope to be used as a voltmeter as well as for waveform display. CRT beam intensity can be modulated through a rear panel Z-axis input.

### X-Y Inputs

Phase shift measurements through the vertical amplifiers in the 1222A permit maximum measurement flexibility with the wide selection of deflection factors. In the 1220A, external signals can be applied to the horizontal deflection amplifiers. This X-Y capability permits X-Y plots for Lissajous figures with a phase shift of less than 3° to 100 kHz.

### TV Sync

The built-in TV sync separator assures stable, automatic triggering on frame or line for convenient TV troubleshooting. With the instrument's times-ten magnifier, signals can be pulled out easily. The calibrated time base makes it easy to identify timing problems in vertical or horizontal TV circuits. The external horizontal input allows vector presentations of color CRT drive signals. Dual channels make it easy to set color demodulator circuits.

### Rugged Lightweight Design

These oscilloscopes are, except for the CRT, entirely of solid-state design, resulting in low power consumption. The consequent low heat has made possible a rugged, lightweight cabinet with a vinyl-clad aluminum cover that is resistant to shock and moisture. A convenient side-panel handle and stabilizing feet on the opposite side make handling easy. This allows these oscilloscopes to be used in areas where ruggedness is a necessity. These areas include production lines, numerically controlled machinery, process control equipment, automotive, aircraft and marine electronics, and communications.

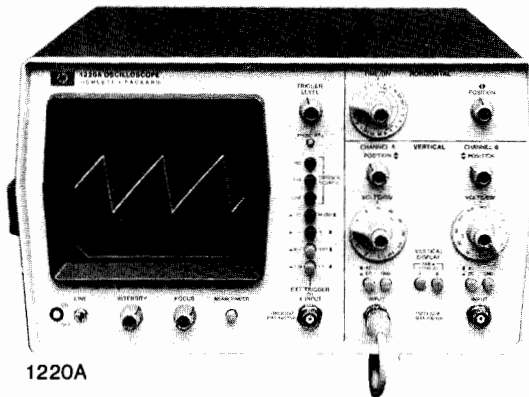

1220A

### Optional Accessories

General purpose probing is provided with the Model 10013A 10:1 divider probe with an input impedance of 10 megohms shunted by only 13 pF. It extends input range to 100 V/div and multiplies input impedance without degrading frequency response. An optional front panel cover, Model 10117A, is available for protection during transportation and to provide storage space for probes and other accessories. With a rack mount kit, Model 10119A, the oscilloscopes can be mounted in only 22.2 cm (8.75 in.) of vertical space. Model 10116A light shield is available for viewing in brightly lighted areas.

### 1220A, 1222A Specifications

#### Modes of Operation

Channel A; channel B; channel B inverted (1222A); channel A  $\pm$  B (1222A); channels A and B displayed alternately on successive sweeps (Alt); triggering by A channel; channels A and B displayed by switching between channels at approx 200 kHz rate with blanking during switching (Chop). Automatic selection of alternate or chop mode—chop, at speeds from 0.5 s/div to 1 ms/div, alternate, 0.5 ms/div to 0.1  $\mu$ s/div.

#### Vertical Amplifiers (2)

**Bandwidth** (3 dB down from 50 kHz, 6 div reference signal from a terminated 50 $\Omega$  source.)

**DC-coupled:** dc to 15 MHz.

**AC-coupled:** lower limit is  $\approx$  2 Hz.

**Rise time:**  $\approx$  23 ns (measured from 10% to 90% points of 6 div input step from a terminated 50 $\Omega$  source).

#### Deflection factor

**Ranges:** from 2 mV/div to 10 V/div (12 calibrated positions) in 1, 2, 5 sequence.  $\pm$  3% Accuracy with vernier in cal position on 20 mV/div to 10 mV/div ranges,  $\pm$  5% on 2 mV/div, 5 mV/div, and 10 mV/div ranges.

**Vernier:** extends max deflection factor to at least 25 V/div.

**Polarity (1222A):** Channel B may be inverted.

**Signal delay (1222A):** input signals are delayed sufficiently to view leading edge of input signal without advanced external trigger.

**Input RC:** AC or DC,  $\approx$  1 M $\Omega$  shunted by  $\approx$  30 pF.

**Input coupling:** AC, DC, or GND.

**Maximum input:**  $\pm$  350 V (dc + peak ac) at  $\leq$  1 kHz.

**A + B operation (1222A):** bandwidth and deflection factors are unchanged; channel B may be inverted for A - B operation.

**Differential (A - B) common mode (1222A):** CMR is at least 30 dB from dc to 1 MHz.

#### Time Base

**Sweep Ranges:** from 0.1  $\mu$ s/div to 0.5 s/div (21 ranges) in 1, 2, 5 sequence;  $\pm$  4% accuracy over full scale with Magnifier/Expander in calibrated position.

**Sweep trigger mode:** normal, sweep is triggered by internal or external signal; automatic, bright baseline displayed in absence of input signal, above  $\approx$  10 Hz, triggering same as normal.

#### Triggering

**Internal:**  $\approx$  2 Hz to 15 MHz on signals with  $\geq$  1 div vertical deflection.

**External:**  $\approx$  2 Hz to 15 MHz on signals of 0.1 V p-p or more.

**External input RC:**  $\approx$  1 M $\Omega$  shunted by  $\approx$  30 pF.

**Line:** triggers on line frequency.

**TV sync:** separator for + or - video, requires 1 div of video signal to trigger, automatic frame (0.5 s/div to 100  $\mu$ s/div) and line select (50  $\mu$ s/div to 0.1  $\mu$ s/div). Usable also as a low pass filter.

#### Level and Slope

**Internal:** at any point on the positive or negative slope of the displayed waveform.

**External:** continuously variable from +0.5 V to -0.5 V on either slope of the trigger waveform; +10 extends trigger range to +5 V to -5 V.

#### Calibrated X-Y Operation (1222A)

Operation is via channel A (X-axis) and channel B (Y-axis).

**Bandwidth:** X-axis dc to 1 MHz, otherwise see Vertical Amplifiers Bandwidth specifications.

**Accuracy:** see Vertical Amplifiers Deflection Factor specifications. X-Y phase shift  $<$  3 $^\circ$  at 100 kHz.

#### Cathode-ray Tube and Controls

**Type:** mono-accelerator,  $\approx$  2 kV accelerating potential, P31 phosphor.

**Graticule:** 8 x 10 cm internal graticule; 0.2 cm subdivisions on major horizontal and vertical axes.

**Beam finder:** returns trace to CRT screen.

**Intensity modulation:** +5 V (TTL compatible) 2 Hz to 1 MHz blanks trace of any intensity. Input R  $\approx$  1 k $\Omega$ . Max input, 7 V rms, ac-coupled.

#### External Horizontal Input (1220A)

**Bandwidth:** dc to 1 MHz.

**Coupling:** dc

EXPANDER	X MODE ATTENUATOR	DEFLECTION FACTOR
Cal.	1:1	1 V/div
Cal.	1:10	10 V/div
cw	1:1	100 mV/div

Continuous adjustment between ranges by Expander.

**Input RC:**  $\approx$  1 M $\Omega$  shunted by  $\approx$  30 pF.

**X-Y Phase shift:**  $<$  3 $^\circ$  at 100 kHz.

#### General

**Probe adjust:**  $\approx$  0.5 V p-p, 1 kHz square wave for adjusting probe compensation.

**Power:** 100, 120, 220, 240 V,  $\pm$  10%, 60 VA max.

#### Weight

**1220A:** net, 7.3 kg (16 lb); shipping 10 kg (22 lb).

**1222A:** net, 7.3 kg (16 lb); shipping 10 kg (22 lb).

**Size:** 181 H x 311.2 W x 412.8 mm D (7.13" x 12.25" x 16.25").

**Accessories furnished:** one blue light filter, one power cord, one fuse for 100 V, 120 V, 220 V or 240 V operation, and one Operating and Service Manual.

#### Environment

**Operating temperature:** 0 $^\circ$ C to +45 $^\circ$ C (+32 $^\circ$ F to 113 $^\circ$ F).

**Non-operating temperature:** -40 $^\circ$ C to +75 $^\circ$ C (-40 $^\circ$ F to +167 $^\circ$ F).

**Relative humidity:** to 95% at +40 $^\circ$ C (+104 $^\circ$ F).

**Altitude:** to 4600 m (15 000 ft).

**Vibration:** vibrated in three planes for 15 minutes each with 0.254 mm (0.01 in.) excursion, 10 to 55 Hz.

#### Accessories Available

**10116A:** Light Shield.

**10117A:** Front Panel Cover

**10119A:** Rack Mount Kit

**Note:** Probes are not supplied

**10013A:** 10:1 Divider Probe recommended

#### Price

\$13

\$28

\$100

\$50

#### Ordering Information

**1220A Dual Channel Oscilloscope**

**Opt 910:** extra Operating and Service Manual

add \$7

**1222A Dual Channel Oscilloscope**

**Opt 910:** extra Operating and Service Manual

\$975

add \$7

### Miniature Oscilloscope Probes

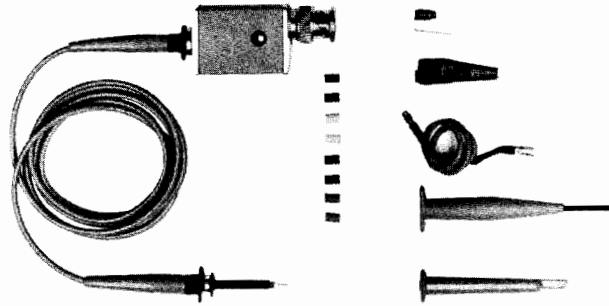

10017A, 10018A, 10040A, 10041A, 10042A

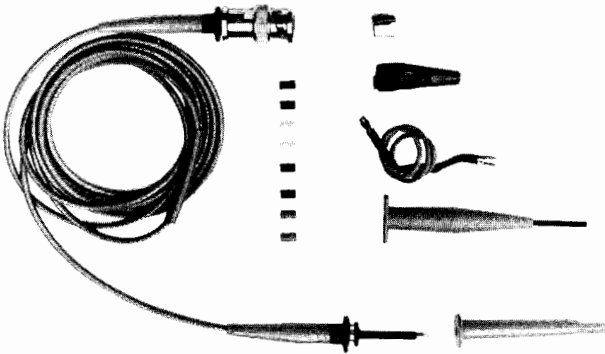

10021A, 10022A

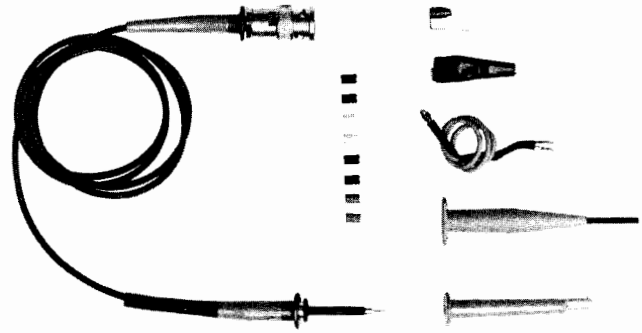

10026A, 10027A

*OSCILLOSCOPE/MINIATURE PROBE COMPATIBILITY AND PROBE CHARACTERISTICS								
HP Oscilloscope/ Plug-in Model No. and Bandwidth	Probe Model No.	Approx Overall Length in Metres (ft)	Division Ratio	Input R	Shunt Capacitance	Compensates Oscilloscope Input	Max DC Volts	Price
1725A/275 MHz 1722B/275 MHz 1727A/275 MHz	10017A	1 m (3.3)	10:1	1 MΩ	8 pF	9 to 14 pF	300	\$90
1715A/200 MHz 1809A/100 MHz 1805A/100 MHz	10018A	2 m (6.6)	10:1	1 MΩ	10 pF	9 to 14 pF	300	\$90
1740A, 1741A, 1742A, 1743A, 1744A/ 100 MHz	10040A	1 m (3.3)	10:1	1 MΩ	9 pF	20 to 30 pF	300	\$90
	10041A	2 m (6.6)	10:1	1 MΩ	12 pF	20 to 26 pF	300	\$90
	10042A	3 m (9.8)	10:1	1 MΩ	15 pF	20 to 24 pF	300	\$90
All Scopes with high Z inputs (may reduce bandwidth)	10021A	1 m (3.3)	1:1		36 pF		300	\$55
	10022A	2 m (6.6)	1:1		62 pF		300	\$55
All Scopes with 50 Ω inputs and with a 50 Ω source impedance	10026A	1 m (3.3)	1:1	50 Ω			2 Amps	\$55
	10027A	2 m (6.6)	1:1	50 Ω			2 Amps	\$55

**Accessories supplied with each probe:** one retractable hook tip, one IC probe tip adapter, one alligator clip, one 20 cm (8") ground lead, eight color-coded indicator sleeves, one grounding spring, and one Operating Note.  
 \*These miniature probes may be used with other oscilloscopes and test instruments with the proper input capacitance with no noticeable bandwidth degradation. However, due to variations of input characteristics, the probes may require recalibration for optimum performance.



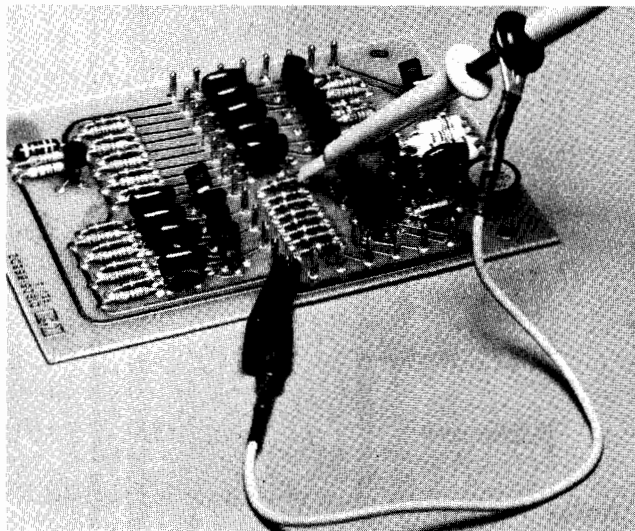

Figure 1. With the slip-on hook tip and flexible ground lead in place, the miniature probe can be used like a conventional probe for attachment to test points or component leads.

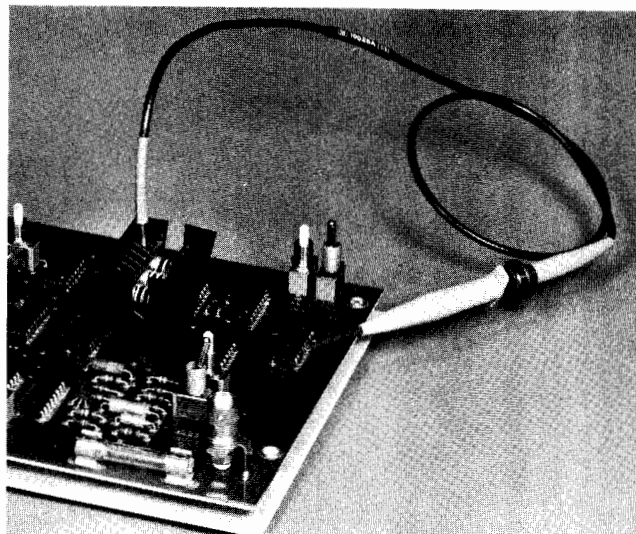

Figure 4. The 10028A Jumper Cable with the supplied slip-on IC probe tip adapter provides easy patching of signals from other IC's into the 10024A IC Test Clip.

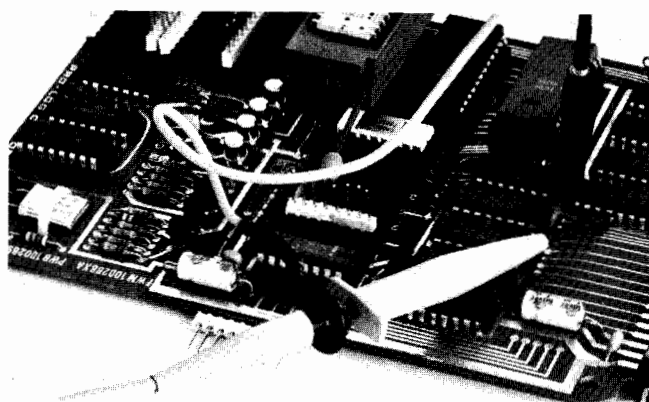

Figure 2. The slip-on IC probe tip adapter provides convenient connection to closely spaced leads on DIP's without shorting.

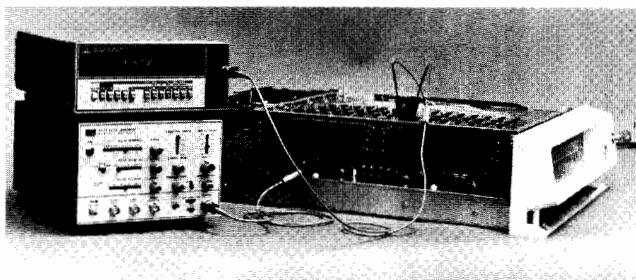

Figure 5. The 10019A cable assembly has many uses such as applying power to a DIP through the 10024A or interfacing wire wrap pins with a pulse generator.

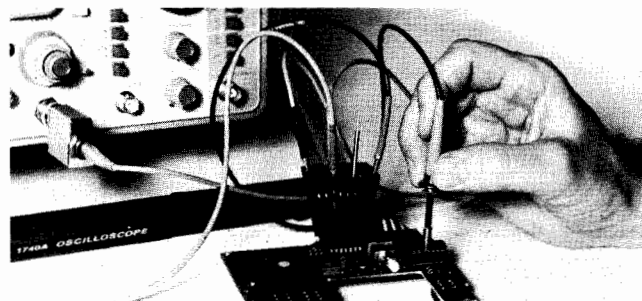

Figure 3. Miniature probes with insulating sleeves removed are held in place on an IC lead by the optional IC clip. The circuit interface pin in the right hand corner of the clip can be inserted at any lead position to ground reference planes that contact the barrel of the probe(s). Rise times as short as 1.3 ns are preserved by this arrangement. The hand held probe's insulating tip has been retracted to allow the spring ground tip to establish a ground-reference point at the end of the barrel for measurements of high speed signals.

### Miniature Oscilloscope Probes

#### Small, Lightweight

Hewlett-Packard's series of miniature, oscilloscope probes easily access test points in densely populated circuits. These small, lightweight probes, which fit in the hand much like a pencil, simplify previously difficult measurements. The basic probe is a small (2.4 mm diameter, 25 mm long) cylinder with a needle-like tip which is used with a variety of interfacing/insulating accessories to meet a variety of testing situations. The narrow body provides easier access to test points in congested areas without worrying about accidental shorts to adjacent leads.

#### Conventional Probing

An insulating sleeve added to the basic probe provides a miniature version of the traditional oscilloscope probe. In this configuration, the probe looks and handles like a small-scale version of the traditional oscilloscope probe except that the forward barrel insulator is retractable which makes the traditional slip-on insulators for protection against shorts unnecessary. With the barrel insulator retracted, the ground spring configures the probe with a very short ground lead for high-frequency point-to-point probing.

With the barrel insulator in the forward position, the probe is used with the 20 cm flexible ground lead for probing where this type of grounding allows adequate response fidelity. The probe tip makes positive metallic contact to narrow conductors and penetrates commonly-used protective coatings while the extended insulating sleeve prevents shorts to closely-spaced adjacent leads.

With the barrel insulator retracted and using the flexible ground lead, the probe may be used with the slip-on hook tip (figure 1) for attaching to various component leads. For monitoring signals on dual in-line packages, a slip-on IC probe tip adapter allows connection to closely spaced leads without shorting (figure 2).

### DIP Probing

By removing the probe's insulating sleeve and using the accessory clip (10024A), you can monitor points on 14- and 16-pin DIP's with improved pulse fidelity (figure 3) and without worrying about shorting adjacent pins.

In this application, the clip is installed on the DIP, a circuit interface pin is inserted into the appropriate position, and one or more probes are inserted to contact the desired package leads. The circuit interface pin contacts reference planes in the clip to provide a ground reference for any probe inserted in the clip. This grounding arrangement is extremely effective; high-speed pulse fidelity achieves a level previously associated only with probe-to-BNC adapters or high frequency, point-to-point probing. In addition, the clip makes it extremely easy to monitor two channel signals while using a third probe to provide an external trigger signal.

The circuit interface pins for the 10024A have a section of insulation which allows them to be inverted from the grounding position for using other types of probes to couple signals into or out of an IC. When the circuit interface pins are used in this position they are isolated from the ground bus in the IC clip.

The tips of the circuit interface pins are compatible with slip-on probes such as those used with HP Logic Analyzers and 0.64 mm (0.025 in.) back plane adapters.

### Stimulus-Response Testing

The 10024A can be expanded to a stimulus-response test system with the use of 1:1 miniprobes and some accessories. The 10019A cable assembly can be used for applying power to a circuit under test with the 10026A or 10027A 50 ohm 1:1 probe used to insert signals. And, completing the system, the 10028A Jumper Cable allows signals from other IC's to be patched into the 10024A (figure 4).

### 0.64 mm (0.025 in) Square Pin or Wire Wrap Pins

HP miniature probes are ideal for applications where the signals are available on 0.64 mm (0.025 in.) square pins or wire wrap pins. Their small size and light weight reduce the possibility of damage to these fragile pins. For coaxial measurement, slip-on coaxial cable adapter HP P/N 10017-67603 provides a coaxial interface between the pins and a standard probe; or with the addition of adapter 10017-67604, between the pins and a miniature-probe. The 10019A cable assembly provides a convenient interface between these pins and other instruments, e.g., counters, DMM's, or power supplies (figure 5).

## 10023A Temperature Probe

The Model 10023A Temperature Probe provides the fast, accurate temperature measurements needed in a wide variety of thermal design, diagnostic, and testing applications. Surface temperature measurements are read directly in degrees Celsius on any general purpose digital multimeter (DMM) having an input impedance of  $\geq 10$  megohms. A pencil-like probe tip easily accesses small components and a press-to-read switch make measurements easy; just press the button, touch the surface to be measured, and read its temperature directly on the DMM.

The probe is a self-contained temperature-to-voltage transducer with a forward-biased diode chip bonded to a small ceramic substrate in the probe tip. A calibrated, linear output of 1 mV/ $^{\circ}$ C is assured by individually characterizing each diode in a precision thermal reference bath. An integrated circuit resistor network is then laser trimmed to match each diode to its electronic compensation circuit.

The use of Hewlett-Packard integrated circuits permits the entire electronics assembly, including the battery, to be packaged in the probe barrel. A standard dual banana plug output connector provides universal readout through most digital voltmeters including the built-in DMMs on Hewlett-Packard's Option 034/035, 1700 Series oscilloscopes.

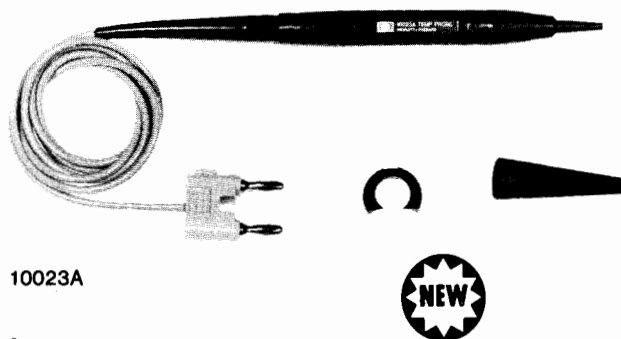

10023A

### Accuracy

Measurement accuracy of the temperature probe is  $\pm 2^{\circ}$ C from  $0^{\circ}$ C to  $+100^{\circ}$ C decreasing linearly to  $+2^{\circ}$ C,  $-4^{\circ}$ C at  $-55^{\circ}$ C and to  $+4^{\circ}$ C,  $-2^{\circ}$ C at  $+150^{\circ}$ C. For applications requiring relative rather than absolute measurement of similar temperatures, the probe has a short term repeatability of  $\pm 0.3^{\circ}$ C.

### Applications

The small-size, thermal performance, and ease-of-use makes the probe suitable for a wide range of thermal measurements of both surfaces and noncorrosive liquids. Some of the electronic applications include:

- Evaluation of power semiconductor heat-sink performance.
- Isolation of defective IC's in large PC boards.
- Thermal sensitivity studies
- Experimental verification of thermal designs.
- Estimation of transistor junction temperatures.

### 10023A Specifications

#### Electrical

**Measurement Range:**  $-55^{\circ}$ C to  $+150^{\circ}$ C.

**Output:** 1 mV/ $^{\circ}$ C.

**Short Term Repeatability:**  $\pm 0.3^{\circ}$ C (minimum of 48 hrs).

**Accuracy:**  $\pm 2^{\circ}$ C from  $0^{\circ}$ C to  $100^{\circ}$ C, decreasing linearly to  $+2^{\circ}$ C,  $-4^{\circ}$ C at  $-55^{\circ}$ C and  $+4^{\circ}$ C,  $-2^{\circ}$ C at  $+150^{\circ}$ C.

**Maximum Voltage at Tip:** 600 V (dc + peak ac).

**Tip Capacitance to Ground:** approx 0.5 pF.

**Thermal Response:**  $< 3$ s to settle within  $2^{\circ}$ C of final reading (liquid measurement) for a  $100^{\circ}$ C temperature change.

**DMM Input R:**  $\geq 10$  M $\Omega$ .

#### General

**Operating Environment (probe tip to approx 13 mm (0.5 in.) from probe tip):** temperature,  $-55^{\circ}$ C to  $+150^{\circ}$ C; altitude, to 4600 m (15 000 ft); vibration, vibrated in three planes for 15 min. each with 0.38 mm (0.015 in.) excursion, 10 to 55 Hz.

**Operating Environment (probe body):** temperature,  $0^{\circ}$ C to  $60^{\circ}$ C (battery limitation); humidity (non-condensing), to 95% relative humidity at  $+40^{\circ}$ C, altitude and vibration same as those for probe tip.

**Overall Length:** approx 1.4 m (53 in.).

**Weight:** net, 85 g (3 oz); shipping, 312 g (11 oz).

**Battery Life:** approx 50 hr (varies with ambient temperature).

**Low Battery Indication:** probe output indicates approx  $-70^{\circ}$ C on DMM. First indication of a low battery condition is a decreasing indication of  $1^{\circ}$  to  $2^{\circ}$ C/minute with probe tip at a constant temperature.

**Accessories Supplied:** one replacement battery (1420-0256), one sliding lock collar (10023-23201), and one probe tip cover (00547-40005).

**Replacement Batteries:** batteries may be purchased locally using the following part numbers, RAY-O-VAC<sup>®</sup>, RS 312-G or T-312-G; DURACELL<sup>®</sup> 10L125; or batteries with similar specifications.

<sup>®</sup>RAY-O-VAC is registered trademark of ESB, Inc.

<sup>®</sup>DURACELL is a registered trademark of P. R. Mallory & Co.

### Ordering Information

10023A Temperature Probe

10023-60001 Replacement Tip, includes pre-calibrated tip and matching compensation network

### Price

\$150

\$75

# OSCILLOSCOPES

Probes and other accessories (cont.)

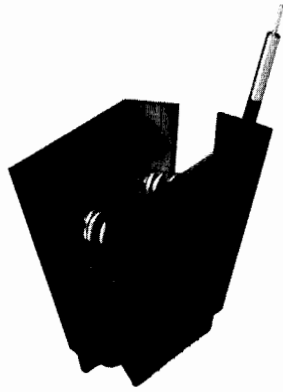

10024A IC Test Clip

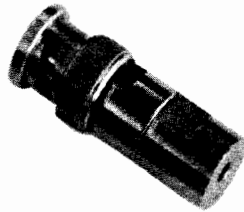

BNC to Probe Adapter  
1250-1454

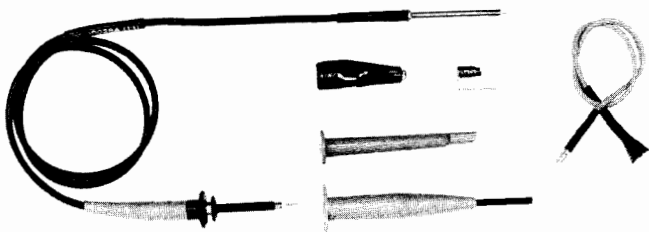

10028A Jumper Cable is supplied with a slip-on IC probe tip adapter for easy access to IC leads.

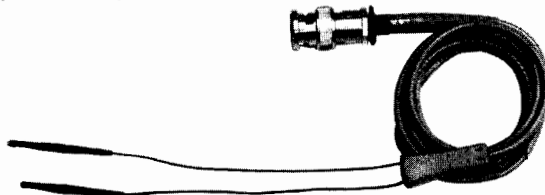

10019A Cable Assembly



10017-67603 Coaxial Adapter Cable



10017-67604 Mini to Standard Probe Adapter

## Miniature Probe Accessories

### 10024A IC Test Clip

Model 10024A IC Test Clip provides easy probing of dual in-line packages and includes four insulated circuit interface pins. Additional circuit interface pins are available (see Ordering Information) in packages of twelve pins. Each pin has a tip on each end so that probes such as those on HP Logic Analyzers can be connected for fast, functional checks of circuit operation.

### 10036B and 10037B Probe Tip Kits

Models 10036B and 10037B probe tip kits increase probing versatility with an assortment of 6/32 screw-on tips. Slip-on to 6/32 adapters are included for compatibility with the miniature probes.

### 10028A Jumper Cable

Model 10028A 50 ohm 610 mm (24 in.) miniature probe/jumper cable is designed primarily for bypassing suspected faulty circuits in densely populated IC circuits. The basic tip on either end of the cable inserts directly into a 10024A IC Test Clip, allowing easy temporary connections between IC's without the danger of shorting between pins. The cable can also be used as a 50 ohm 1:1 probe to insert signals from an external source or as an input source to an external measuring device. For the latter uses, Probe Tip to BNC Adapter (HP P/N 1250-1454) is available.

### 10019A BNC to Square Pin Cable Assembly

Model 10019A cable assembly is designed for connecting test equipment to 0.64 mm–0.76 mm (0.025 in.–0.030 in.) square pin signal nodes or to integrated circuits through the 10024A IC Test Clip. This adaptable cable assembly is primarily used as:

a. A signal pick-off device for applying circuit signals to the input of test equipment such as oscilloscopes, voltmeters, etc. An application is the checking of voltages on computer back plane pins.

b. A signal insertion cable for inserting signals into suspected faulty circuits from power supplies, pulse generators, etc. Used in conjunction with Model 10024A IC Test Clip, signals are easily inserted into the proper IC leads.

For applications requiring greater separation between the circuit nodes and the instrumentation, the 10019A may be extended by using a BNC to BNC adapter (HP P/N 1250-0080) and a 50 ohm test cable such as the 122 cm (48 in.) Model 11170C. And when the test equipment hookup requires a dual banana plug, BNC to Dual Banana Plug Adapter (HP P/N 1251-2277) is available.

### 10017-67603 Coaxial Adapter Cable

HP P/N 10017-67603 is a 230 mm (9 in.) 50 ohm slip-on adapter cable for miniature and standard HP probes that provides a coaxial interface to 0.64 mm (0.025 in.) square pin circuit nodes. The cable is ideal for probing computer back planes as well as wire wrap terminals. HP P/N 10017-67604 mini to standard probe adapter allows the cable to slip directly onto the HP Easy IC Miniature Probe tip with the insulating barrel removed.

### 10017-67604 Mini to Standard Probe Adapter

HP P/N 10017-67604 allows standard size slip-on probe tip accessories to be used with HP miniature probes. With the retractable insulating barrel removed from the miniature probe and replaced with the 10017-67604 adapter, the probe slides directly into the standard size probe tip accessories.

### Digital Trigger Probes

Model 10250A (TTL) 4 bit Trigger Probe is a useful service, production, and design troubleshooting tool that offers digital pattern triggering to enhance the use of oscilloscopes, logic analyzers, and other test equipment. The four inputs maybe switched to HI, LO, or OFF (don't care) for convenient selection of the trigger point. No separate power supply is needed because probe power is obtained from the circuit under test.

### Ordering Information

	Price
10024A IC Test Clip for easy probing of dual in-line packages; includes 4 insulated circuit interface pins	\$15
10024-69501 Interface Pin Kit for 10024A; includes 12 interface pins	\$19.50
1250-1454 BNC to probe adapter permits the miniature probes to be connected to BNC connectors to maintain fast pulse response.	\$9.25
10036B Probe Tip Kit	\$50
10037B Probe Tip Kit	\$50
10028A Jumper Cable	\$50
10019A Cable Assembly	\$35
10017-67603 Coaxial Adapter Cable	\$20
10017-67604 Mini to Standard Probe Adapter	\$5
10250A Trigger Probe (TTL)	\$125

### Standard probes

For measurements in standard circuits where miniature probes are not a requirement, Hewlett-Packard offers a wide selection of standard size probes.

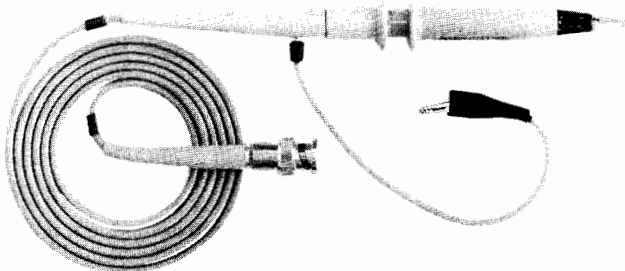

10001-10003A

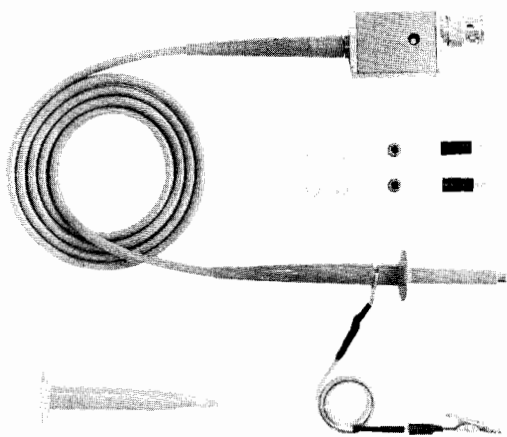

10004D-10006D, 10014A, 10016B

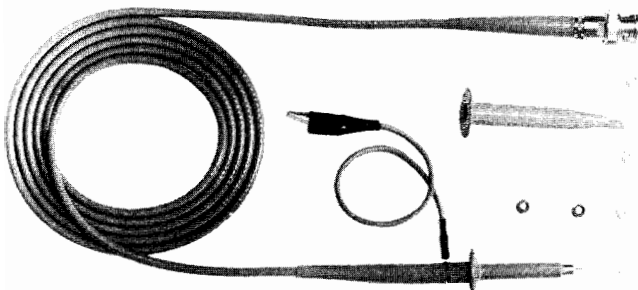

10007B, 10008B

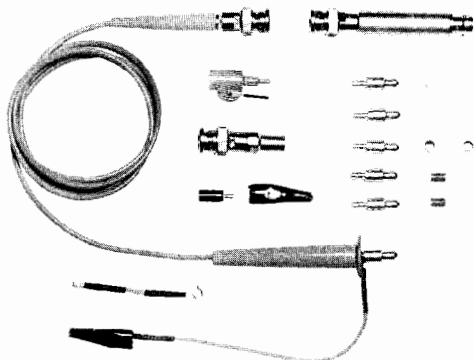

10020A

### Standard Probe Instrument Compatibility

Scope/ Plug-in	1200 Series	1220 Series	1715A 1725A 1722B 1727A	1740A thru 1744A	1801A 1804A	1805A 1809A
Probe						
10001A	X	X		L	L	
10001B	X	X		L	L	
10002A	X	X		L	L	
10002B	X	X		L	L	
10003A	X	X		L	L	
10004D		X		X	X	
10005D		X		L	X	
10006D		X		X	X	
10007B	X	X	L	L	L	L
10008B	X	L	L	L	L	L
10013A	X	X			L	
10014A			X			X
10016B			X			X
10020A			X	X		X
1120A			X	X		X
1124A			L	L		L

**Notes:**

X Indicates that probe will maintain the bandwidth of the instrument.  
L Indicates that probe may limit the bandwidth of the instrument.

### Standard Divider Probe Characteristics

Model No.	Division Ratio	Resistance (M Ω)	Shunt Capacitance (pF)	Compensates Scope Input C (pF)	Max DC Volts	Overall Length m (ft)	Price
10001A	10:1	10	10	15-55	600	1.5 (5)	\$90
10001B	10:1	10	20	15-45	600	3 (10)	\$90
10002A	50:1	9	2.5	15-55	1000	1.5 (5)	\$105
10002B	50:1	9	5	15-55	1000	3 (10)	\$105
10003A	10:1	10	10	15-55	600	1.3 (4)	\$90
10004D	10:1	10	10	20-30	500	1.1 (3.5)	\$80
10005D	10:1	10	17	20-30	500	3 (10)	\$80
10006D	10:1	10	14	20-30	500	1.8 (6)	\$80
10007B	1:1	—	40	—	600	1.1 (3.5)	\$45
10008B	1:1	—	60	—	600	1.8 (6)	\$45
10013A	10:1	10	13	24-45	500	1.8 (6)	\$50
10014A	10:1	10	10	9-13	500	1.1 (3.5)	\$75
10016B	10:1	10	14	9-13	500	1.8 (6)	\$85

### 10020A Resistive Dividers

Division Ratio	Input R* (ohms)	Division Accuracy	Max V** (rms)	Input C (pF)
1:1	50	—	6	—
5:1	250	±3%	9	<0.7
10:1	500	±3%	12	<0.7
20:1	1000	±3%	15	<0.7
50:1	2500	±3%	25	<0.7
100:1	5000	±3%	35	<0.7

\*When terminated in 50 ohms.

\*\*Limited by power dissipation of resistive element.

**Probe length (overall):** ≈ 1.2 m (4 ft).

**Weight:** net, 0.45 kg (1 lb); shipping, 1.4 kg (3 lb).

**Accessories supplied:** blocking capacitor, BNC adapter tip, 6-32 adapter tip, alligator tip, probe handle, cable assy's 5.1 cm (2 in.) & 15.2 cm (6 in.) ground, spanner tip, insulating caps, colored sleeves.

**10020A Resistive Divider Probe Kit**

**\$210**

# OSCILLOSCOPES

## Probes and other accessories (cont.)

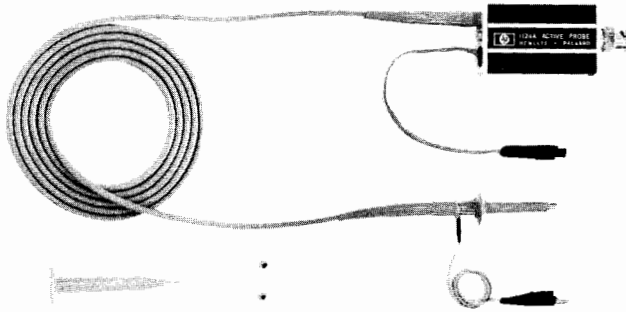

1124A

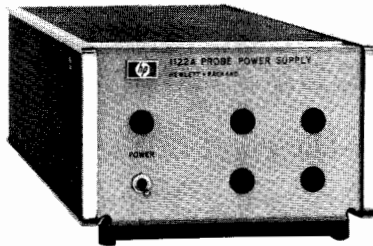

1122A

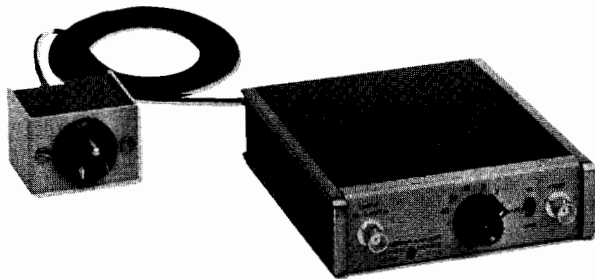

1111A

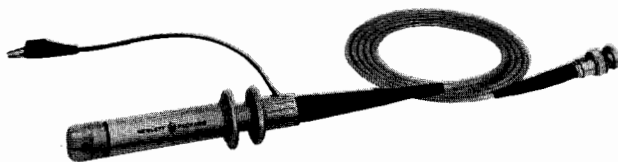

1110A

### 1124A 100 MHz Active Probe

Model 1124A Active Divider Probe provides high voltage, general purpose probing capabilities for instruments having 50 ohm inputs without selectable high impedance inputs. This 10 megohm 10 pF probe allows direct measurements of 100 volts, in the 100:1 division ratio mode, from dc to 100 MHz. In the 10:1 division ratio mode, input voltage range is  $\pm 10$  volts. Power is supplied by instruments with probe power jacks or the 1122A probe power supply.

#### 1124A Specifications

(Measured when connected to a 50 $\Omega$  load.)

**Bandwidth:** (measured from a terminated 50 $\Omega$  source) dc-coupled,

dc to 100 MHz; ac-coupled, 2 Hz to 100 MHz.

**Pulse response:** (measured from a terminated 50 $\Omega$  source) transition time, <3.5 ns; perturbations, 5% p-p. Measured with pulse transition time of >2.5 ns.

**Attenuation ratio:** 10:1  $\pm 5\%$ ; 100:1  $\pm 5\%$ .

**Dynamic range:** X10,  $\pm 10$  V; X100,  $\pm 100$  V.

**Input RC:** 10 M $\Omega$  shunted by  $\approx 10$  pF.

#### Maximum safe input

**DC-coupled:** X10,  $\pm 300$  V (dc + peak ac)  $\leq 100$  MHz; X100,  $\pm 500$  V (dc + peak ac)  $\leq 100$  MHz.

**AC-coupled:** X10,  $\pm 300$  V (dc + peak ac)  $\leq 100$  MHz. DC component must not exceed  $\pm 200$  V; X100,  $\pm 500$  V (dc + peak ac)  $\leq 100$  MHz. DC component must not exceed  $\pm 200$  V.

**Accessories supplied:** one 20.3 cm (8 in.) ground lead, one retractable hook tip, and two probe tip insulating caps.

**Power:** supplied by instruments with probe power jacks or Model 1122A probe power supply.

**Weight:** net, 0.2 kg (5 oz.); shipping, 0.91 kg (2 lb).

**Length:**  $\approx 1.5$  m (5 ft) overall.

**Available accessory:** 10131B 91.4 cm (36 in.) extender cable (refer to 1122A Probe Power Supply). Required for use with 1700 oscilloscopes with probe power option.

### 1122A Probe Power Supply

Model 1122A is a regulated power supply that provides all power requirements for simultaneous operation of up to four active probes.

#### 1122A Specifications

**Probe driving capability:** up to four HP active probes.

**Power output:** -12.6 V and +15 V,  $\pm 3\%$ .

**Power input:** 115 V or 230 V  $\pm 10\%$ , 48 to 440 Hz, 40 W (with four probes).

**Weight:** net, 2.7 kg (6 lb); shipping, 3.6 kg (8 lb).

**Accessories supplied:** four Model 10131B 91.4 cm (36 in.) extender cables.

### 1111A AC Current Amplifier

**Deflection factor:** (with a 50 mV/div oscilloscope deflection factor) in X1, 1 mA/div to 50 mA/div; in X100, 100 mA/div to 5 A/div; 1, 2, 5 sequence in X1 or X100.

**Accuracy:** in X1,  $\pm 3\%$ ; in X100,  $\pm 4\%$ .

**Rise time:** 18 ns.

**Noise:** <100  $\mu$ A p-p, referenced to input signal.

**Maximum ac current:** above 700 Hz, 50 A p-p; below 700 Hz, decreases at 1.4 A/20 Hz.

**Output impedance:** 50  $\Omega$ .

**Size:** 38.1 H  $\times$  130.2 W  $\times$  152.4 mm D (1 $\frac{1}{2}$ "  $\times$  5 $\frac{1}{8}$ "  $\times$  6").

**Weight:** net,  $\approx 0.9$  kg (2 lb); shipping, 1.4 kg (3 lb).

**Power:** 115 or 230 V  $\pm 10\%$ , 50 to 440 Hz, 1.5 watts.

### 1110A Current Probe

**Sensitivity:** without 100 $\Omega$  termination, 1 mV/mA; with 100 $\Omega$  termination, 0.5 mV/mA.

**Accuracy:**  $\pm 3\%$ .

#### Bandwidth

**Lower -3 dB point:** without 100 $\Omega$  termination,  $\approx 1700$  Hz; with 100  $\Omega$  termination,  $\approx 850$  Hz.

**Upper -3 dB point:** with 4 pF capacitive load,  $\approx 45$  MHz; with 30 pF capacitive load  $\approx 35$  MHz.

**Rise time:** with 4 pF capacitive load,  $\approx 7$  ns; with 30 pF capacitive load,  $\approx 9$  ns.

**Insertion impedance:**  $\approx 0.01\Omega$  shunted by 1  $\mu$ H; capacitance to ground <3 pF.

**Maximum dc current:** 0.5 A.

**Maximum ac current:** 15 A p-p above 4 kHz; decreasing below 4 kHz at 3.8 A/kHz rate.

**Weight:** net, 0.5 kg (1 lb); shipping, 0.9 kg (2 lb).

**Dimensions:** probe aperture, 3.9 mm ( $\frac{5}{32}$ " diameter; overall length, 1.5 m (5 ft).

#### Ordering information

1122A Probe Power Supply

1124A 100 MHz Active Probe

1111A Current Amplifier

1110A Current Probe

**Price**

\$600

\$225

\$650

\$300

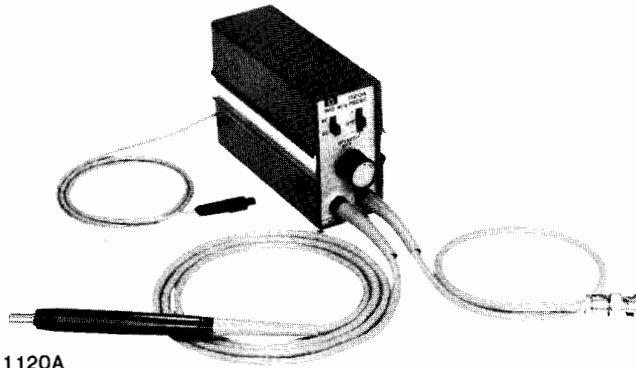

1120A

### 1120A 500 MHz Active Probe

For probing high source impedances at high frequencies, the Model 1120A 1:1 active probe provides a probe tip impedance of 100 k $\Omega$  shunted by approx 3 pF at 100 MHz. When used with the 10:1 or 100:1 divider tips, the shunt capacitance is <1 pF at 100 MHz. The 50 ohm output provides the optimum impedance match and measurement accuracy for oscilloscopes, spectrum analyzers, counters, and network analyzers with 50 ohm inputs. Power is supplied by instruments with probe power jacks or the 1122A probe power supply. A probe power output jack on the 1120A permits a second active probe to be powered by instruments with only a single probe power jack.

### 1120A Specifications

(Measured with output connected to a 50 $\Omega$  load.)

**Bandwidth:** (measured from a terminated 50 $\Omega$  source) dc-coupled, dc to >500 MHz; ac-coupled, <1.5 kHz to >500 MHz.

**Pulse response:** (measured from a terminated 50 $\Omega$  source) transition time, <0.75 ns; perturbations, < $\pm$ 6% measured with 1 GHz sampler.

**Dynamic range:**  $\pm$ 0.5 V with  $\pm$ 5 V dc offset.

**Noise:**  $\approx$  2.5 mV (measured tangentially).

**Input RC:** 100 k $\Omega$ , shunt capacitance  $\approx$  3 pF at 100 MHz; with 10:1 or 100:1 dividers, shunt capacitance is <1 pF at 100 MHz.

**Maximum input:**  $\pm$ 80 V.

**Weight:** net, 1.8 kg (4 lb); shipping, 3.2 kg (7 lb).

**Power:** supplied by oscilloscopes with probe power jacks or a Model 1122A probe power supply.

**Length:** 1.2 m (4 ft) overall; with Option 001, 1.8 m (6 ft).

### Accessories Furnished

**Model 10241A 10:1 divider:** increases input R to  $\approx$  1 M $\Omega$  shunted by <1 pF at 100 MHz.

**Model 10243A 100:1 divider:** increases input R to  $\approx$  1 M $\Omega$  shunted by <1 pF at 100 MHz.

**Model 10242A bandwidth limiter:** reduces bandwidth to  $\approx$  27 MHz shunted by  $\approx$  6 pF and reduces gain <2%.

**Also included:** slip-on hook tip, 6.4 cm (2.5 in.) ground lead, spare probe tips, a slip-on BNC probe adapter, and a probe divider adjustment tool (PN 5020-0570).

### Ordering Information

1120A 500 MHz Active Probe

1120A Opt 001, 1.8 m (6 ft) length

### Price

\$750

add \$35

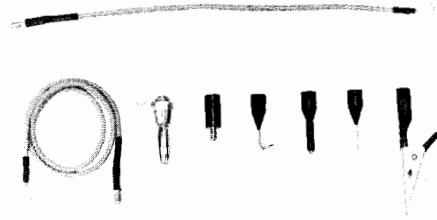

10034A

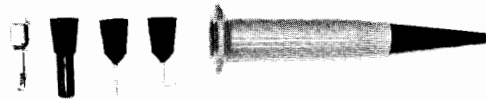

10035A

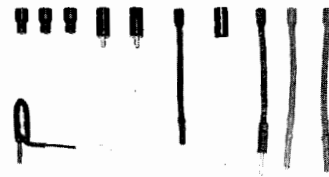

10036B

### 10034A Ground Lead Kit

Model 10034A probe adapter kit consists of an assortment of 6-32 screw-on tips, and two ground lead cables which allow many methods of connecting the ground leads in a circuit. A 6-32 to slip-on adapter allows these tips to be used on 10004D-10006D, 10007B, 10008B, 10013A, 10014A, 10016B, and 1124A probes. The kit consists of one 15.2 cm (6 in.) and one 30.5 cm (12 in.) ground lead, one hook tip, one alligator tip, one pin tip, one tip for 0.6 mm (0.025 in.) square pins, one banana tip, and one slip-on to 6-32 adapter.

### 10035A Probe Tip Kit

The tips in this kit are designed to be used with probes that accept a No. 6-32 screw-on tip which include: Models 10001A/B, 10002A/B, and 10003A. A slip on to 6-32 adapter allows these tips to be used with other probes with pin tips. The adapter is supplied with 10004D through 10006D, 10014A, 10016B, 10020A Probes, and 10034A Ground Lead Kit. Model 10035A Probe Tip Kit contains a pincer jaw, banana tip, pin tip, and spring tip.

### 10036B Probe Tip Kit

The tips in this kit extend the usefulness of standard probes that accept slip-on tips, and the Easy IC Miniature Probes. Included in the kit are two slip-on to 6-32 adapters and three bushing adapters that provide the flexibility to use the supplied tips with both types of probes. The adapters also allow use of other 6-32 probe tips with the probes. Model 10036B includes an assortment of tips for the following: 2.0 mm (0.08 in.) jack; 0.6 mm (0.025 in.) and 1.14 (0.045 in.) square pin; 1.0 mm-1.6 mm (0.040-0.062 in.) dia pin.

### 10037B Probe Tip Kit

Model 10037B Probe Tip Kit contains six 0.64 mm (0.025 in.) square female (white) tips for standard probes that accept slip-on tips, and the Easy IC Miniature Probes. Also included are six bushings that adapt HP miniature probes to the supplied tips.

### Ordering Information

10034A Ground Lead Kit

10035A Probe Tip Kit

10036B Probe Tip Kit

10037B Probe Tip Kit

### Price

\$35

\$15

\$50

\$50

# OSCILLOSCOPES

## Probes and other accessories (cont.)

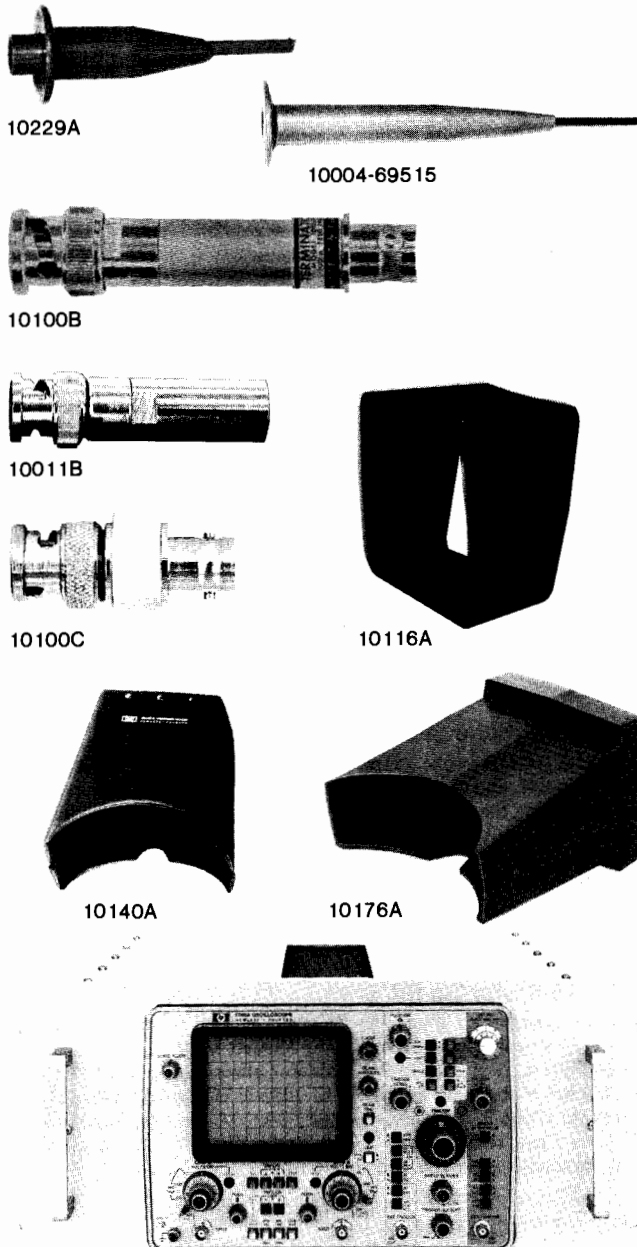

10491B

### Probe Accessories

#### Terminations

**10100C:** 50 Ω ± 1% BNC male to BNC female feedthrough termination.

**10100B:** 100 Ω ± 2 Ω BNC male to BNC female feedthrough termination.

#### Standard Probe Tip Adapters

**10011B slip-on to BNC probe tip adapter:** for probes 10004D-10006D, 10007B, 10008B, 10013A, 10014A, 10016B, and 1124A.

**10229A hook tip adapter:** retractable pincer tip provides firm connection to circuit nodes. Supplied with 1120A probe. Recommended accessory for 10020A Resistive Divider Kit.

**HP P/N 10004-69515 IC probe tip adapter:** retractable pincers provide convenient connection to dual in-line packages for probes 10004D-10006D, 10007B, 10008B, 10013A, 10014A, 10016B, and 1124A. Supplied with 10004D, 10005D, 10006D, 10014A, and 10016B.

### Servicing and Viewing Accessories

#### Plug-in Extender

**Model 10407B:** 180 system extender (metal frame extends both plug-ins). Allows calibration while a unit is operating.

#### Viewing Hoods

**10116A:** collapsible light shield for 1220 series oscilloscopes.

**10140A:** collapsible viewing hood for 1700 series oscilloscopes.

**10176A:** viewing hood for 12.7 cm (5 in.) rectangular CRT bezels.

#### Light Filters

**10173A:** RFI filter and contrast screen for 1700 series oscilloscopes.

**10178A:** metal mesh contrast screen for 181, 184 oscilloscopes.

**Amber plastic filter:** HP P/N 5020-0530, for 12.7 cm (5 in.) rectangular CRT (180 style).

**Smoke gray plastic filter:** HP P/N 5020-0567, for 12.7 cm (5 in.) rectangular CRT (180 style).

**Blue plastic filter:** HP P/N 5060-0548, for 12.7 cm (5 in.) rectangular CRT (180 style).

**Blue light filter:** HP P/N 01740-02701 for 1700 series oscilloscopes.

#### Rack Mount Slides and Adapters

##### 1700 series oscilloscopes, 1600A Logic State Analyzer

**10491B rack mount adapter:** adapts 1700 series oscilloscopes and 1600A Logic State Analyzer to standard 483 mm (19") rack; 222 mm (8 3/4") high, 540 mm (21 1/4") deep. Requires fixed slides (HP P/N 1490-0714) or pivoted slides (HP P/N 1490-0719) for slide mounting.

##### 180 and 181 rack style oscilloscopes

A slide adapter is required to secure an oscilloscope to the slides.

**Fixed slides:** HP P/N 1490-0714, 55.9 cm (22").

**Pivot slides:** HP P/N 1490-0719, 55.9 cm (22").

**Slide adapter:** HP P/N 1490-0768 (required for all slides).

#### Front Panel Covers

**10166A:** provides front panel protection for 180A, 181A, 184A oscilloscopes.

**HP P/N 5040-0516:** provides front panel protection for 1700 series oscilloscopes, 1600A Logic State Analyzer.

#### Ordering Information

	Price
<b>10229A</b> Retractable Hook Tip Adapter	\$10
<b>10004-69515</b> IC Probe Tip Adapter	\$10
<b>10011B</b> BNC Probe Tip Adapter	\$12
<b>10100C</b> 50 Ω Feedthrough Termination	\$25
<b>10100B</b> 100 Ω (± 2 Ω) Feedthrough Termination	\$35
<b>10407B</b> Plug-in Extender	\$225
<b>10116A</b> Light Shield for 1220 series oscilloscopes	\$13
<b>10140A</b> Viewing Hood for 1700 series (8 x 10 div. CRT)	\$25
<b>10166A</b> Front Panel Cover for 180A, 181A, 184A oscilloscopes	\$160
<b>10176A</b> Viewing Hood for 12.7 cm (5 in.) rect. CRT	\$25
<b>10173A</b> RFI Filter and Contrast Screen for 1700 series oscilloscopes (8 x 10 div. CRT)	\$20
<b>10178A</b> Metal Mesh Contrast Screen for 181, 184 oscilloscopes	\$20
<b>5020-0530</b> Amber Plastic Filter for 12.7 cm (5 in.) rectangular CRT	\$10.50
<b>5020-0567</b> Smoke Gray Plastic Filter for 12.7 cm (5 in.) rectangular CRT.	\$18.50
<b>5060-0548</b> Blue Plastic Filter for 12.7 cm (5 in.) rectangular CRT	\$8.25
<b>01740-02701</b> Blue Light Filter for 1700 series oscilloscopes (8 x 10 div. CRT)	\$7
<b>10491B</b> Rack Adapter for 1700 series oscilloscopes, 1600A Logic State Analyzer	\$150
<b>1490-0714</b> Fixed Slides for 180, 181 rack style oscilloscopes and 10491B	\$97.50
<b>1490-0719</b> Pivoted Slides for 180, 181 rack style oscilloscopes and 10491B	\$150
<b>1490-0768</b> Slide Adapter, required for securing slides to 180, 181 rack style oscilloscopes	\$195
<b>5040-0516</b> Front Panel Cover for 1700 series oscilloscopes, 1600A Logic State Analyzer	\$10.50

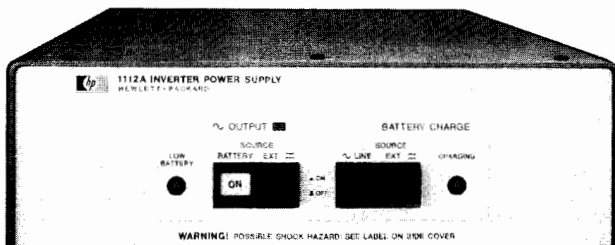

## 1112A Inverter Power Supply

Model 1112A Inverter Power Supply provides a portable power source for HP 1700 series oscilloscopes. The regulated 400 Hz, 120 V or 240 V power output can be derived from either an internal nickel cadmium battery pack or from an external 11.5 V to 50 V dc source.

No modifications are required to 1700 series oscilloscopes when using the 1112A; simply set the power supply line voltage to match your normal line voltage and you are ready to make measurements. A mounting bracket kit is supplied so that the 1112A can be mounted on the top or bottom of the oscilloscope for a unified package. With a fully charged internal battery pack, the 1112A is capable of operating a Model 1740A oscilloscope for approximately two hours. Operating time is dependent on battery condition (full or partial charge) and the oscilloscope power requirements which vary with operating modes. For example, oscilloscope power requirements increase when using a high intensity trace, delayed sweep, and/or the verniers which turn on the Uncal indicators.

The inverter allows the full measurement capabilities of your oscilloscope to be used in areas where adequate line power is not available.

**Note:** The Model 1112A Inverter Power Supply is *not* intended for use in floating (non-grounded) measurements. Hewlett-Packard 1700 series oscilloscopes are constructed with their chassis common to the low side of the BNC input terminals. Therefore, if the oscilloscope chassis is not grounded and the probe ground lead is connected to a potential other than ground, a serious shock hazard could be present.

### Grounding

When operating the Inverter on its internal battery pack or from an external dc source (with its ac line disconnected), inverter/oscilloscope combination grounding is provided by the 2.1 m (7 ft) ground lead supplied with each inverter. When the inverter ac power cord is connected to an approved three-contact electrical outlet, both the oscilloscope and inverter chassis are automatically grounded.

### Battery Operation

The inverter can be powered from either an external dc source, such as a marine battery\* or from its supplied internal battery pack. When operating from the internal battery pack, excessive discharging is prevented by a built-in protection circuit which flashes a front panel LED for about 10 minutes when the battery power is low and then disables the inverter output. Charging of the internal battery can be accomplished from either an ac or dc source. When using an ac charging source, line power is also applied to the inverter output which allows oscilloscope operation while the battery is charging. Temperature sensors inside the battery pack prevent cell damage during a charging cycle. These sensors also prevent battery damage if the charging source remains connected beyond the full charging time.

\*Automobile batteries, when used as a stand-alone power source, will not provide satisfactory life due to their poor recovery from deep discharge.

### Output Power

The 400 Hz Inverter output waveform is a complex wave shape with the same ratio of peak to rms values of sine waves (1:0.707) that matches the oscilloscope input requirements. The use of a complex waveform output, rather than a square wave output with a peak to rms value of 1:1, assures that there is no additional stress in your oscilloscope's power supply circuits and CRT filament when using the 1112A as a power source.

## 1112A Specifications

### Output

**Voltage:** 120 or 240 V ac, peak-to-peak output is fixed at 285 V; rms value changes with load; minimum usable load, 20 W.

Load	120 V Range		240 V Range	
	400 Hz	60 Hz*	400 Hz	60 Hz*
65 W	≥ 96 V rms	≥ 99 V rms	≥ 192 V rms	≥ 198 V rms
20 W	≤ 126 V rms	≤ 126 V rms	≤ 250 V rms	≤ 250 V rms

\*With Option 060

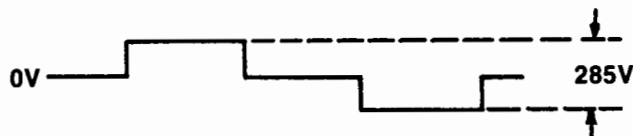

**Waveform:** duty cycle is 50% for loads of 40 W, increasing to 65 as the load decreases to 20 W.

**Frequency:** 400 Hz ± 10% (Opt 060, 60Hz ± 0.5Hz).

**Max power:** 65 W nominal, compatible with line voltage and 60 to 70 VA load requirements of HP 1700 series oscilloscopes.

**Operating time:** ≈ 140 watt hours with a fully charged battery pack at 25°C.

### Input power

**External dc source:** 11.5 V to 50 V (Opt 060, 12V to 50V), at least 90 watts.

**External ac source:** 100 V to 120 V or 220 V to 240 V, +5%, -10%; 48 to 66 Hz; 250 VA max.

**AC feedthrough operation:** output voltage and frequency is the same as the input; output power, 120 VA max.

### Battery charging

**AC input:** full charge in 14 hrs at +25°C with 120 V rms input (80% in 8 hrs).

**DC input:** full charge in 24 hrs at +25°C with 18 watts input.

### General

**Size:** 92 H x 273 W x 403 mm D (3 3/8" x 10 3/4" x 15 7/8").

**Weight:** net, 9.1 kg (20 lb) with battery pack, 4.5 kg (10 lb) without battery pack; shipping, 10. kg (22 lb) with battery pack, 5.4 kg (12 lb) without battery pack.

**Oscilloscope compatibility:** HP Models 1740A, 1741A, 1742A, 1743A, 1744A, 1715A, 1725A, 1727A, 1722B. For compatibility with other instruments call your Hewlett-Packard Field Engineer.

**Operating environment:** temperature, 0 to +55°C (+32°F to +130°F), non-operating -40°C to +55°C (-40°F to +130°F); humidity, to 95% relative humidity at +40°C (+104°F); altitude, to 4600 m (15 000 ft); vibration, vibrated in three planes for 15 min. each with 0.38 mm (0.015 in.) excursion, 10 to 55 Hz.

**Accessories supplied:** one Model 10421A battery pack, one mounting bracket kit, one 2.3 m (7.5 ft) power cord, one 2.1 m (7 ft) grounding cable, and one operating and service manual.

### 1112A Accessories

**10421A Battery pack:** the battery pack consists of 30 size "D" nickel cadmium cells and includes temperature sensors to reduce the possibility of cell damage during charging (supplied with 1112A).

**Weight:** net, 4.4 kg (10 3/4 lb); shipping, 5.3 kg (11 3/4 lb).

**01112-61605 Grounding cable:** grounds inverter and oscilloscope chassis (supplied with 1112A).

**01112-69501 Mounting bracket kit:** for mounting the 1112A on top or bottom of 1700 series oscilloscopes (supplied with 1112A).

### Ordering Information

1112A Inverter power supply (400 Hz)

**Price**

Opt 001: without battery pack \$1000

Opt 002: without mounting bracket kit less \$275

Opt 060: 60 Hz output frequency, internal battery less \$15

operation reduced to 120 watt hours add \$50

10421A Battery pack \$350

01112-61605 Grounding cable \$7.75

01112-69501 Mounting bracket kit \$65



# OSCILLOSCOPES

## Camera for display recording

### Model 197B

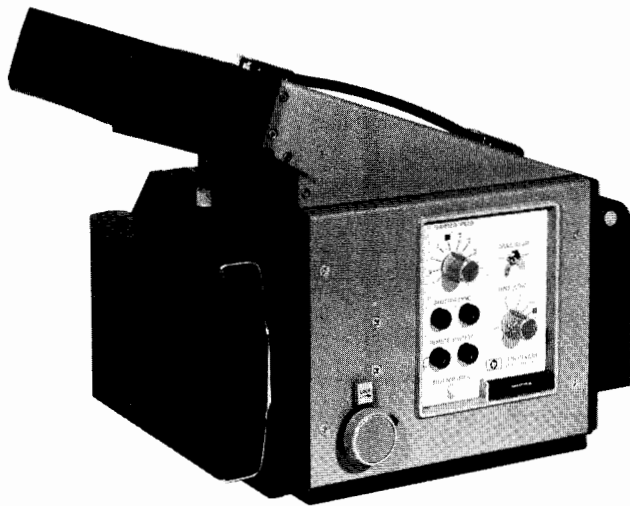

### Introduction

Model 197B is a versatile, general purpose instrument for cathode-ray tube photographic recording. The standard camera includes the 10376A Adapter which directly fits HP 1700 Series Oscilloscopes with 8 x 10 div CRTs. 197B Option 002 replaces the standard adapter with the 10378A which directly fits most HP oscilloscopes with 127 mm (5 in.) round or rectangular CRT's (e.g., 180C/D, 181A/AR). Option 006 replaces the standard adapter with the 10375A which directly fits many HP and Tektronix small screen cathode-ray tube displays. With all adapters, the camera features lift-off mounting and swing-away hinging. Interchangeable film backs enable capture of CRT display information on a complete spectrum of Polaroid® or conventional sheet, pack, or roll film.

All controls are located outside of the camera for easy reading and fast adjustment during setup. The camera is hinged to swing away from the CRT display by pressing a single latch release button. A low angle viewing port provides a direct view of the display through a flexible facemask while the camera is in the photographic position.

A combination split-image focusing plate and image reduction ratio scale is included with the 197B and is stored in a convenient pocket underneath the camera. The reduction ratio scale provides 1:1, 1:0.9, and 1:0.7 reference settings for displays with one centimetre graticule spacing. Corner marks on the focusing plate allow you to accurately identify the usable film area. The optional Graflok® back is equipped with a ground glass focusing plate and a snap-out viewing hood.

Another feature is the shutter-open light. By continually indicating whether the shutter is open or closed, the indicator helps you avoid actions which might ruin a photograph.

### Performance Features

Model 197B camera incorporates an electronically controlled shutter with all solid state circuits for reliable operation. There are eight exposure times from 1/30 to 4 seconds. Time (T) and bulb (B) control settings are also provided.

Remote shutter and shutter synchronization features are included so that the 197B camera can be incorporated into an automatic photographic recording system, such as the 1741A Oscilloscope Auto-Camera Option. In the remote shutter mode, the 197B shutter is opened by a contact closure or a TTL logic "0" level of at least 12 milliseconds duration. When multiple exposure operation is used, shutter operation can be initiated once every ten seconds.

The 197B camera lens opening is continuously adjustable from f/1.9 to f/16. The 75 mm, high transmission lens provides high resolution, low distortion photographs for a wide range of CRT display images.

### Ultraviolet Illumination

The standard 197B camera is equipped with both a UV light source and a UV lens filter to provide graticule illumination. Ultraviolet

light excites the CRT phosphor causing it to fluoresce at the phosphor's characteristic wavelength. The UV filter blocks the ultraviolet light causing the film to record only the display fluorescence. The UV illumination performs a function similar to the flood-gun graticule illumination feature available on most HP oscilloscopes.

### Applications

In the laboratory, the 197B couples with an oscilloscope or a signal analyzer to permanently capture experimental data for later reference or comparison. When investigating single shot or low repetition rate phenomena, the 197B camera and a conventional oscilloscope can be used in applications which would otherwise require a storage oscilloscope.

In production environments, the 197B camera provides a cost effective method of documenting product operating parameters for statistical analysis by production and quality engineers.

The 197B camera is performance-matched to the critical photographic recording requirements in ultrasonic, thermographic, X-ray, and computerized axial scanner applications. The basic design features of the 197B camera have been field-proven in thousands of applications worldwide.

The 197B camera is safety engineered for medical and dental applications. Option 007 provides a hospital grade power cord and a label stating that the instrument meets the requirements of UL 544 for medical and dental equipment.

### 197B Characteristics

**Reduction ratio:** continuously adjustable from 1:1 to 1:0.7. Reference scale provided on focus plate.

**Lens:** 75 mm, f/1.9 high transmission lens; aperture, f/1.9 to f/16.

**Shutter speeds:** 1/30, 1/15, 1/8, 1/4, 1/2, 1, 2, 4 seconds, Time and Bulb; shutter has a sync contact closure output for triggering external equipment and an input jack for remote operation.

**Camera back:** 83 mm x 108 mm (3.25" x 4.25") Polaroid pack back (another back is available, see Options); backs may be interchanged without refocusing.

**Mounting:** lift on/off mounting with positive lock, swing-away hinging to left. Standard 10376A adapter mounts directly on HP 1700 Series oscilloscopes with 8 x 10 div CRTs. Adapters are available to fit other instruments and displays; see Instrument/Camera Adapter Compatibility Table, page 218. To order the 197B with alternative adapters, see 197B Options, or Camera Accessories.

**Viewing:** low-angle, direct viewing through a flexible facemask.

**Shutter open indicator:** illuminated whenever shutter is open.

**Ultraviolet illumination:** light source and lens filter provide graticule illumination and photographic speed enhancement. Controlled by on/off toggle switch.

**Focus:** adjustable focusing with lock; split image focusing plate provided.

**Size:** 267 H x 194 W x 356 mm D (10.5" x 7.6" x 14").

**Weight:** net, 4.5 kg (10 lb); shipping, 7.3 kg (16 lb).

**Power:** switch selectable 115 Vac ± 10% or 230 Vac ± 10%, 48 to 66 Hz\*, 10 VA max.

\*The camera will operate from 48 to 440 Hz, but does not meet the ac line to chassis leakage requirements of UL 544 (medical and dental) listing above 66 Hz.

**Accessories furnished:** comb. split image focusing plate reduction ratio scale, 2.3 m (7.5 ft) power cord, and instruction manual.

### 197B Options & UV Kit

	<b>Price</b>
<b>001:</b> deletes ultraviolet illumination feature	less \$50
<b>002:</b> replaces standard 197B adapter with 10378A adapter to directly fit most HP oscilloscopes with 127 mm (5 in.) round or rectangular CRT's	N/C
<b>003:</b> Graflok back in place of pack back	add \$200
<b>006:</b> replaces standard 197B adapter with 10375A adapter to fit many HP and Tektronix small screen CRT displays	N/C
<b>007:</b> meets UL listing requirements for medical and dental electronic equipment	add \$15
<b>Ultraviolet Light Kit</b> (P/N 00197-69507) for field installation of ultraviolet illumination feature on 197B Opt 001 cameras	\$150
<b>197B Camera</b>	<b>\$1250</b>
<b>Opt 910:</b> additional manual	add \$6

\*Registered Trademark of Polaroid, Inc.  
\*Registered Trademark of Graftek, Inc.



### Film Backs for 197B Camera

Model 197B has the Polaroid Film Back as standard equipment. The Graflok Back may be ordered initially in place of the Polaroid pack film back as Option 003.

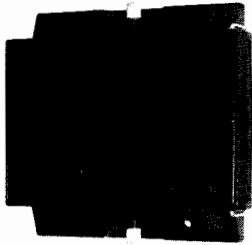

**10353B Pack Film Back:** uses Polaroid Land Film, 83 mm x 108 mm (3.25" x 4.25"), with eight exposures.

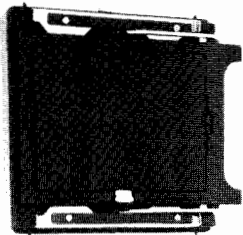

**10352B Graflok Back:** requires a film holder. For Polaroid 102 mm x 127 mm (4" x 5") packet film use Polaroid 545 Land film holder. Standard cut film holders are available from Graflex Inc., 210 Brant Road, Lake Park, Florida 33403.

### Camera Adapters for 197B, 197A, and 195A

The following HP adapters permit the 197B, 197A, and 195A cameras to be mounted on a wide variety of instruments. Refer to the table on page 218 to cross-reference these adapter/camera/instrument combinations.

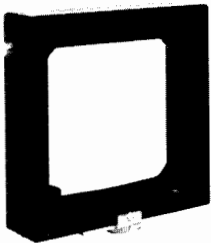

**10375A:** supplied with 197B Option 006. Provides direct mounting of 197B, 197B Opt 002, 197A, 195A cameras to most HP small screen displays, some HP analyzers, Tektronix 600, 5100, & 7000 series oscilloscopes.

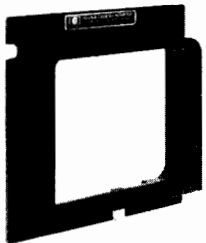

**10376A:** supplied with standard 197B Camera. Provides direct mounting of 197B Opt 002, 197B Opt 006, 197A, 195A cameras to HP 1700 series oscilloscopes with 8 x 10 div CRTs.

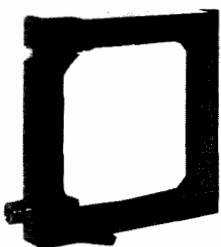

**10378A:** supplied with 197B Option 002. Provides direct mounting of 197B, 197B Opt 006, 197A, 195A cameras to HP 127 mm (5") rectangular CRT (180C style), HP 127 mm (5") round CRT, & some HP analyzers.

### Camera Bezel Adapters

The following HP adapters provide mounting of HP, Tektronix, and Dumont cameras to HP as well as Tektronix and Dumont oscilloscopes. Refer to the table on page 218, to cross-reference these adapter/camera/instrument combinations.

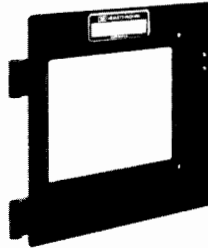

**10361A:** adapts Tektronix C12 camera to HP 127 mm (5") rectangular CRT (180C style bezels).



**10362A:** adapts Tektronix C27 and C50\* cameras to HP 127 mm (5") rectangular CRT (180C style bezels); C50, C51, C52, C53 require Tektronix battery pack.

\*C50 camera without a flange on the lower front casting.

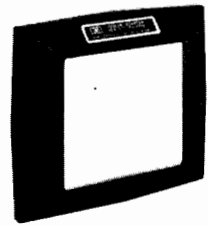

**10363A:** adapts Tektronix C30A, C31, C32, or C40 cameras to HP 127 mm (5") rectangular CRT (180C style bezels).

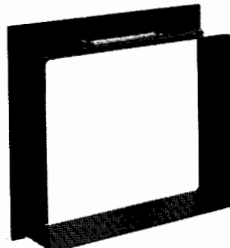

**10367A:** adapts 197B Option 002, 197A, and 195A to HP 182 oscilloscope.

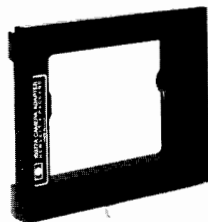

**10377A:** adapts Tektronix C30A, C31, C32, or C40 cameras to HP 1700 series oscilloscopes with 8x10 div CRTs.

### Ordering Information

	Price
<b>10353B</b> Pack Film Back	\$60
<b>10352B</b> Graflok Back	\$250
<b>10375A</b> Camera Adapter	\$120
<b>10376A</b> Camera Adapter	\$125
<b>10378A</b> Camera Adapter	\$120
<b>10361A</b> Camera Adapter	\$40
<b>10362A</b> Camera Adapter	\$55
<b>10363A</b> Camera Adapter	\$70
<b>10367A</b> Camera Adapter	\$80
<b>10377A</b> Camera Adapter	\$140

### Supplemental Camera/Adapter Information

The following information will assist you in interfacing various cameras, both obsolete and current, to a variety of instruments. Included are obsolete adapters which may be in your inventory. Only HP adapters presently in production are pictured on the previous page. Cameras and adapters listed in the table should permit the cameras to physically fit on the listed instruments. Other variables such as type of phosphor, graticule illumination, focusing and depth of field must be checked for each instrument and camera combination. Unless otherwise noted, the listed cameras are considered in their standard configuration without options.

Cameras from Dumont Corporation are not listed in the cross reference table. However, Dumont 450A-1, 453A-1, 450A-7B, and 321A cameras directly fit HP instruments with a 5-inch round CRT and with the addition of an HP Adapter Model 10360A (which is no longer in production) will fit HP 5-inch rectangular CRTs (180 style).

### Camera Carrying Case

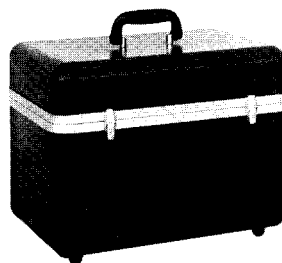

**10358B:** Constructed of fiberglass and aluminum with padding for protection during transit. The carrying case will accommodate the 195A, 197A, 197B, & 198A cameras.

10358B Camera Carrying Case

\$300

CAMERA/BEZEL ADAPTER TABLE												
INSTRUMENT	CAMERA											
	HEWLETT-PACKARD								TEKTRONIX INC.			
HEWLETT-PACKARD	123A <sup>1</sup>	195A <sup>1</sup>	196A/B <sup>1</sup>	197A <sup>1</sup>	197B	197B Opt 002	197B Opt 006	198A <sup>1</sup>	C12	C27, C28 and C50 Series	C30 Series and C40	C5B and C5B Opt 01
HP 5-in. Round CRTs: 120, 130, 132, 140A, 140S, 141A, 141S, 150, 175, 3702A, 8414A, 851B, 852A	10369A <sup>1</sup>	Direct	Direct	Direct	10378A	Direct	10378A	Direct				
HP 5-in. Rectangular CRT's: 1200 Series (not 1220 Series), 140B, 140T, 141B, 141T, 1600A, 180, 181, 183, 191A, 193A, 3580A, 3710A, 3720A, 3721A, 3790A, 8412A	10369A <sup>1</sup>	Direct	10360A <sup>1</sup>	Direct	10378A	Direct	10378A	Direct	10361A	10362A <sup>3</sup>	10363A <sup>4</sup>	
182A/C/T	10370A <sup>1,5</sup>	10367A		10367A	10378A and 10367A	10367A	10367A and 10378A					
1332A, 1333A, 1335A, 1336A, 1340A, 3582A, 3585A, 5420A, 5423A, 8505A, 8565A, 8568A		10375A		10375A <sup>6</sup>	10375A	10375A	Direct					Direct
1700 Series with 6 x 10 div CRT's	Direct										10106A <sup>1</sup>	
1700 Series with 8 x 10 div CRT's)	16491A <sup>1</sup>	10376A		10376A <sup>7</sup>	Direct	10376A	10376A				10377A	
<b>TEKTRONIX INC</b>												
TEK 5 in. Round 549	10369A <sup>1</sup> and 10355A <sup>1</sup>	10355A <sup>1</sup>	10355A <sup>1</sup>	10355A <sup>1</sup>	10378A and 10355A <sup>1</sup>	10355A <sup>1</sup>	10378A and 10355A <sup>1</sup>	10355A <sup>1</sup>				
TEK 5 in. Rectangular and 560 Series		10356A <sup>1</sup>		10356A <sup>1</sup>	10378A and 10356A <sup>1</sup>	10356A <sup>1</sup>	10378A and 10356A <sup>1</sup>	10356A <sup>1</sup>				
529 Series	10369A <sup>1</sup> and 10356A <sup>1</sup>	10356A <sup>1</sup>		10356A <sup>1</sup>	10378A and 10356A <sup>1</sup>	10356A <sup>1</sup>	10378A and 10356A <sup>1</sup>	10356A <sup>1</sup>				
455,464,465,466,475	10372A <sup>1</sup>											
422,453,454,485	10371A <sup>1</sup>											
600, 5100, 7000 Series		10375A		10375A <sup>6</sup>	10375A	10375A	Direct					
<b>DUMONT</b>												
5-in. Round CRT	10369A <sup>1</sup> and 10355A <sup>1</sup>	10355A <sup>1</sup>	Direct	10355A <sup>1</sup>	10378A and 10355A <sup>1</sup>	10355A <sup>1</sup>	10378A and 10355A <sup>1</sup>	10355A <sup>1</sup>				
<b>PHILIPS</b>												
PM 3211, 3212, 3214, 3240 Series, 3260 Series	10369A <sup>1</sup> and Note 2	Note 2	10360A <sup>1</sup>	Note 2	10378A and Note 2	Note 2	10378A and Note 2	Note 2				

**Notes**

- All HP cameras and adapters with note 1 are no longer in production and may or may not be in your inventory.
- Requires an HP bezel P/N 5020-0476 and 5040-0444 to replace the Philips bezel. Call your HP Field Engineer for ordering information.
- HP Model 10362A Adapter mates with Tektronix C50 Cameras without a flange on the lower front casting.
- Requires a Tektronix adapter with C40 cameras.
- A combination of adapters 10369A<sup>1</sup> and 10367A may be used instead of a 10370A<sup>1</sup>.
- A Model 197A<sup>1</sup> Opt 006 includes a 10375A camera adapter.
- A Model 197A<sup>1</sup> Opt 008 includes a 10376A camera adapter.

Testmobiles: save bench space, easily moved

Models 1006A, 1007A, 1008A & 1117B

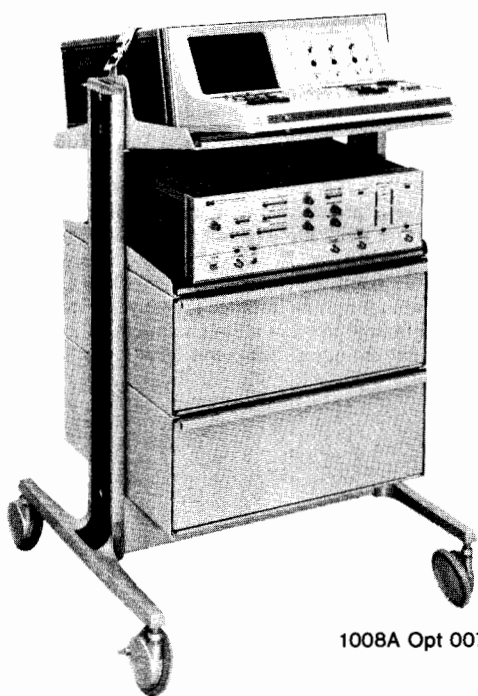

1008A Opt 007

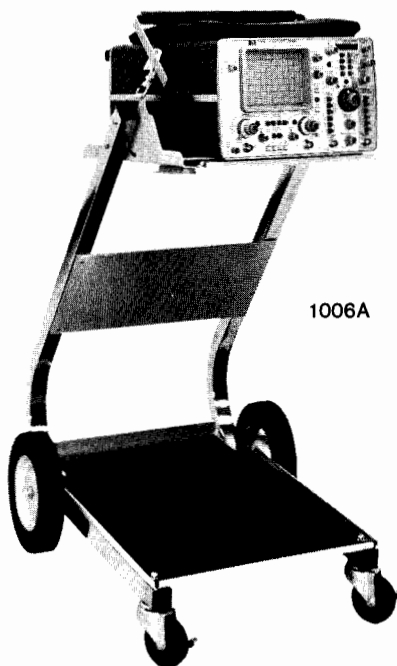

1006A

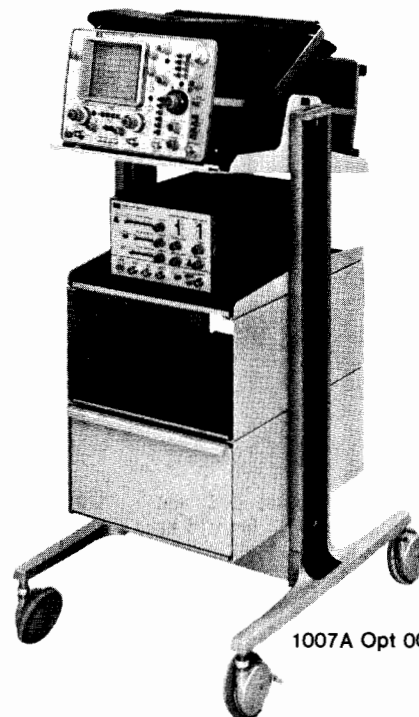

1007A Opt 006

### Introduction

Hewlett-Packard Testmobiles offer convenient portability for your oscilloscopes or instrumentation systems. The top tray on these testmobiles may be tilted to position your instrument for easy operation. The selection of testmobiles range from a basic model such as the 1006A, designed to hold a single oscilloscope or other instrument, to a testmobile such as the 1008A or 1117B that can be adapted to provide a complete mobile test system. Refer to the testmobile/instrument compatibility chart for assistance in selecting the testmobile that will best fit your requirements.

### Testmobile/instrument compatibility\*

Testmobile Model Number	Instrument
1006A 1007A	All Hewlett-Packard 180, 1200, 1220, and 1700 Series cabinet style oscilloscopes, or other instruments that meet the height and weight requirements.
1008A	All Hewlett-Packard instruments that are configured to be mounted in a standard 48.3 cm (19 in.) rack and meet the testmobile height and weight requirements.
1117B	All instruments listed above.

\*Refer to page 175 for Logic Analyzer/Testmobile compatibility.

### 1007A, 1008A Description

These versatile testmobiles provide a sturdy, lightweight, stable platform for your oscilloscope or instrumentation system (see compatibility chart). Large angled wheels with a wide track move quietly and smoothly over most surfaces. The top trays are table-top height and can be tilted to a convenient viewing angle between 30° above and 30° below the horizontal position with a total of seven detent positions in 10° increments. The caps on each side rail are designed to conveniently hold three probes to reduce the possibility of damaging probes not in use.

### 1007A, 1008A Options

Many options are available so that the 1007A or 1008A can be easily tailored to your specific requirements. Refer to the option photographs with description to select the testmobile best suited to your requirements. Options apply to either the 1007A or 1008A. Option 008, U.S. only five outlet power strip option, is also available for convenient instrument operation.



1006A

### 1006A Description

This is a sturdy general purpose testmobile for cabinet style oscilloscopes and other instruments (see compatibility chart). The tilt tray adjusts  $\pm 30^\circ$  in 10° increments. A base tray and an accessory rack add space for other instruments and accessories; and a convenient bracket holds three HP probes. Large rear wheels allow easy movement and locking front casters hold the testmobile in position. A five outlet power strip accessory is available for mounting under the tilt tray or beneath the accessory rack.

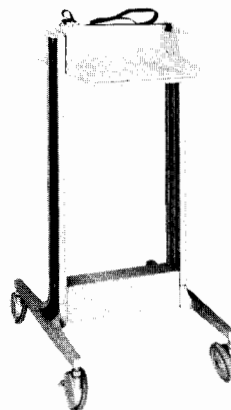

Basic Testmobile

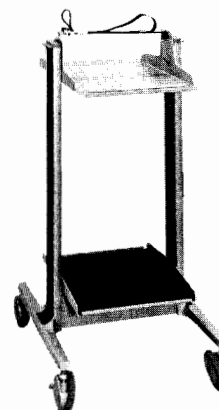

Opt 001: storage shelf  
load limit: 18 kg (40 lb).

# OSCILLOSCOPES

Testmobiles: save bench space, easily moved

Models 1006A, 1007A, 1008A & 1117B (cont.)

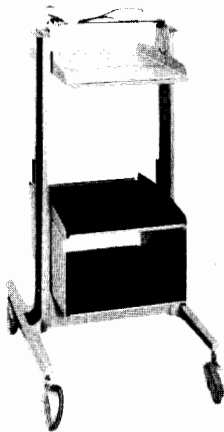

**Opt 002:** storage shelf and lower cabinet; load limit 18 kg (40 lb) ea.

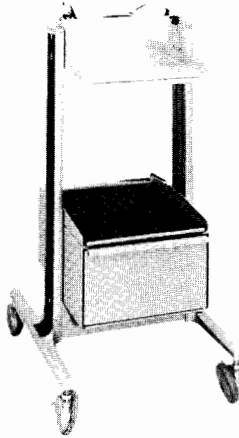

**Opt 003:** 15 cm (6 in.) lockable drawer with shelf on top; load limit 11 kg (25 lb) in drawer and 18 kg (40 lb) on shelf.

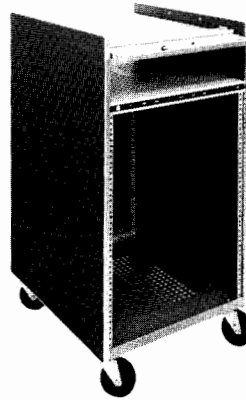

1117B

## 1117B Description

Model 1117B provides a mobile test station for cabinet and rack model instruments, with tilt tray angles from  $-15^{\circ}$  to  $+30^{\circ}$  in  $7\frac{1}{2}^{\circ}$  increments for easy viewing. In addition, other instruments can be mounted in the standard EIA racks of the lower compartment. Rack mounting height is 62.2 cm (24½ in.), depth is 58.4 cm (23 in.), and power distribution is provided with a built-in four outlet power strip. Optional accessory drawers 7.6 cm (3 in.) and 20.3 cm (8 in.) deep are available to provide convenient storage space. The drawers may be installed in many vertical positions of the lower compartment, allowing room for other rack mounted equipment.

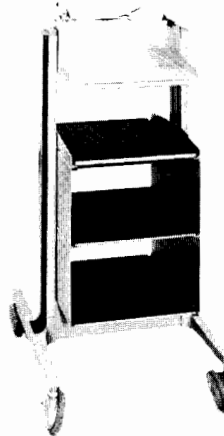

**Opt 004:** two storage cabinets with shelf on top; combined load limit, cabinets and shelf, 45 kg (100 lb).

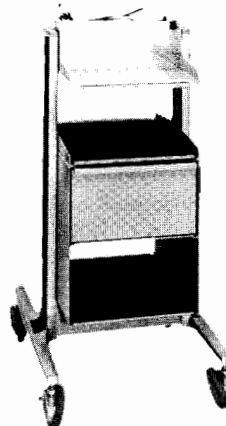

**Opt 005:** storage cabinet and drawer in upper position with shelf on top; load limit 18 kg (40 lb) ea on shelf and in cabinet, 11 kg (25 lb) in drawer.

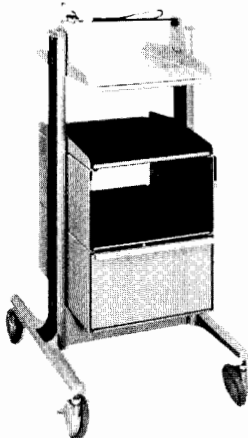

**Opt 006:** storage cabinet with shelf on top and drawer in lower position; load limit 18 kg (40 lb) ea on shelf and in cabinet, 11 kg (25 lb) in drawer.

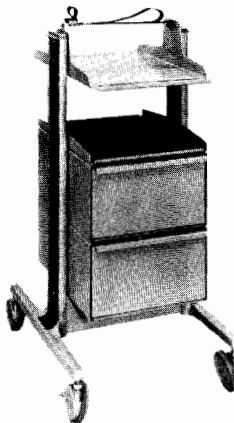

**Opt 007:** two lockable drawers with shelf on top; load limit 18 kg (40 lb) on shelf, 11 kg (25 lb) ea drawer.

## Specifications

(see Testmobile data sheet for complete specifications)

	1006A	1007A	1008A	1117B
Height	841mm (33½")	930mm (36½")	930mm (36½")	1003mm (39½")
Overall width	502mm (19¾")	584mm (23")	759mm (29¾")	511mm (20½")
Width of tray	322mm (12¾")	321mm (12¾")	473mm (18¾")	
Tilt tray angle	$\pm 30^{\circ}$	$\pm 30^{\circ}$	$\pm 30^{\circ}$	$-15^{\circ}$ to $+30^{\circ}$
Weight	net	11.8 kg (26 lb)	11 kg (25 lb)	13 kg (28 lb)
	shipping	14.5 kg (32 lb)	19 kg (41 lb)	22 kg (48 lb)
Max load on tilt tray	23 kg (50 lb)	34 kg (75 lb)	45 kg (100 lb)	45 kg (100 lb)
Max load below tilt tray	23 kg (50 lb)	see Option descriptions	see Option descriptions	56.7 kg (125 lb)

## Optional Accessories

## Price

<b>10475A</b> 7.6 cm (3") drawer for 1117B testmobile	\$90
Weight: net, 4.1 kg (9 lb); shipping, 5.9 kg (13 lb).	
<b>10476A:</b> 20.3 cm (8") drawer for 1117B testmobile	\$135
Weight: net, 5.4 kg (11 lb); shipping, 8.2 kg (18 lb).	
<b>01008-61201</b> Probe Pod Holder holds three small Logic Analyzer probe pods such as 10230 and 10248	\$15
<b>01008-61202</b> Probe Pod Holder holds one small and one large Logic Analyzer probe for 1611A	\$15
<b>01008-68701</b> Rack Mount Kit for 1008A, 13.3 cm (5¼") high for mounting under the tilt tray	\$75
<b>01008-68702</b> Rack Mount Kit for 1008A, 19 cm (7½") high for mounting under the tilt tray	\$82.50
<b>01007-60008</b> Power Strip kit adds Opt 008 power strip to all versions of 1006A, 1007A, 1008A testmobiles	\$75

## Ordering Information

<b>1006A Testmobile</b>	\$200	
Opt 008 Power Strip	add \$45	
<b>1007A, 1008A Testmobiles</b>		
(see 1007A, 1008A Options for option descriptions)	(1007A) \$350	(1008A) \$390
<b>Opt 001:</b> storage shelf	add \$40	add \$45
<b>Opt 002:</b> storage shelf, lower cabinet	add \$100	add \$115
<b>Opt 003:</b> storage shelf, locking drawer	add \$175	add \$195
<b>Opt 004:</b> two storage cabinets, shelf	add \$170	add \$180
<b>Opt 005:</b> upper drawer, lower storage	add \$215	add \$260
<b>Opt 006:</b> lower drawer, upper storage	add \$215	add \$260
<b>Opt 007:</b> two locking drawers	add \$285	add \$345
<b>Opt 008:</b> power strip (5 outlet)	add \$45	add \$45

**1117B Testmobile (includes power strip)**

\$575

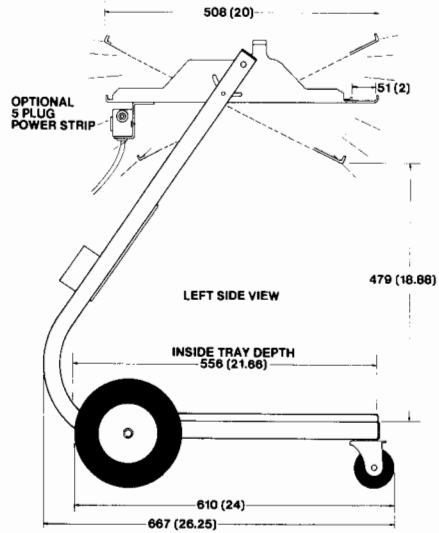
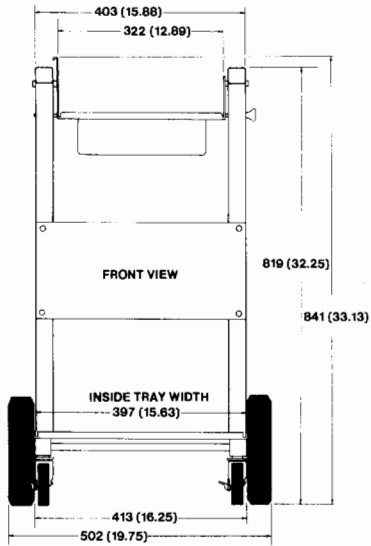

1006A

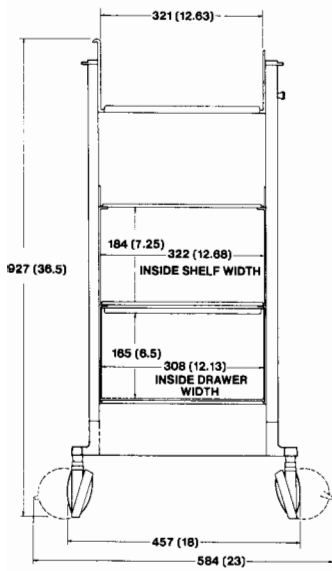

1007A

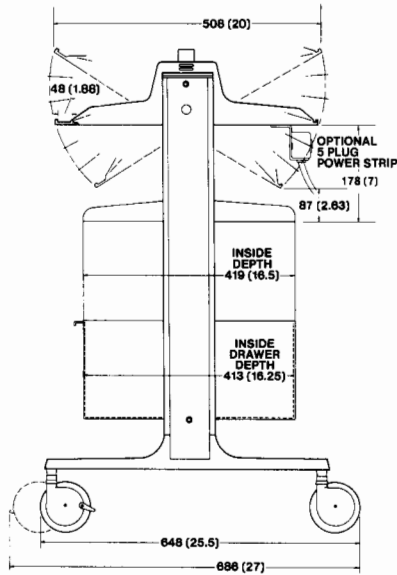

1007A / 1008A

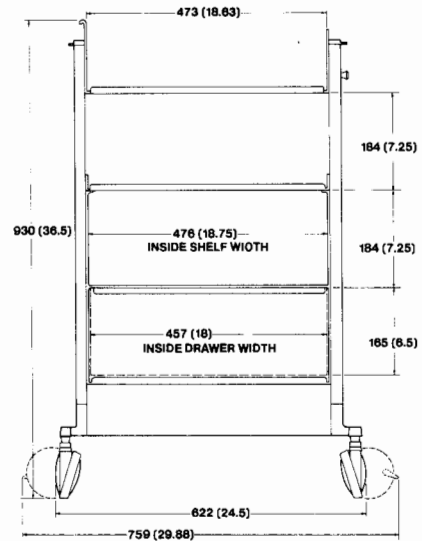

1008A

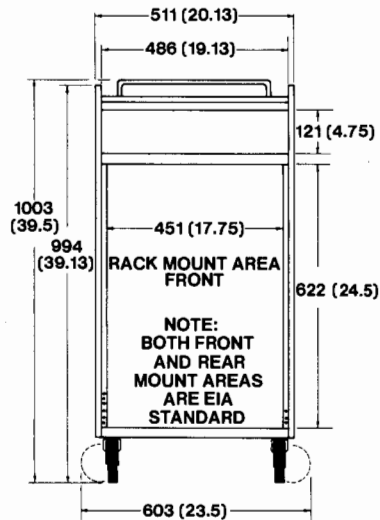
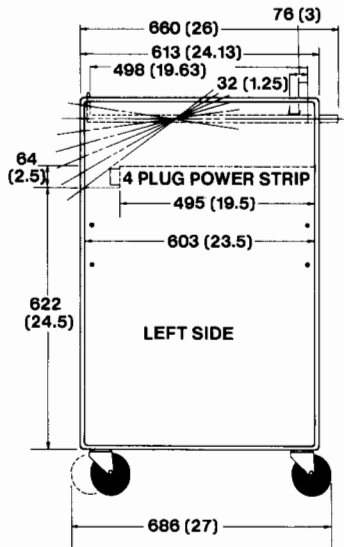

1117B

# CATHODE-RAY TUBE DISPLAYS

Imaging, instrumentation & computer graphics applications

1300 Series

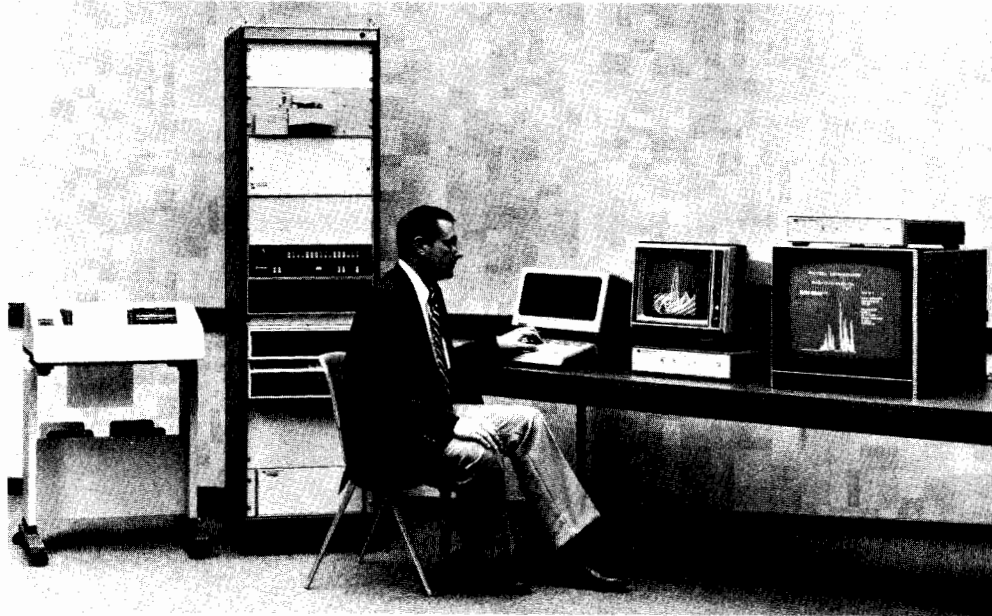

## Introduction

Selecting an X-Y display is no longer a simple choice between an electrostatic or an electromagnetic cathode-ray tube (CRT). The trend to microcomputer and minicomputer control of instruments and systems is generating needs to display more complex pictures. Reduced memory costs are making it possible to design a greater variety of digital displays using either electrostatic or electromagnetic CRTs.

Consequently, the choice of a CRT display can involve both a complex set of picture needs and a separate set of requirements for interfacing the display. Picture needs include writing speed, data density, brightness, resolution, and CRT size. For example, a spectrum analyzer display needs high writing speed, has low data density, medium brightness, high resolution, and typically uses a 7 in. CRT. A terminal for a computer may require medium to high data density, low writing speed, high brightness, low resolution, and a 12 in. CRT.

Interface needs include the type of digital interface, amount of memory, data rate, local data entry provision, picture manipulation, pan control, and hard copy provisions. The designer of a measurement instrument may satisfy all of his interface requirements either within his instrument or through the front panel. The display would only have to satisfy the picture needs. Conversely, the graphic display or terminal for a computer controlled measurement system would have to meet digital interface and memory criteria as well as other needs for a keyboard, light pen, digitizer, etc.

## Electrostatic CRT

The heart of HP X-Y displays is an electrostatic CRT. Also included are X- and Y-axis deflection amplifiers, a Z-axis (video) amplifier, and both high and low voltage power

supplies. HP small screen displays are available with or without cabinets. In addition, several rack and bench type cabinet configurations are available, giving your designer a high degree of flexibility in incorporating HP displays into your instrument or system.

The primary attributes of the electrostatic CRT are high writing speed and low power requirements. The deflection plates are voltage driven whereas electromagnetic CRTs are current driven, through a yoke and tuned circuit in raster-scan displays. Vector writing speeds of electrostatic CRT displays are typically ten times faster than high-performance electromagnetic CRT displays.

Power requirements become a significant consideration with large screen displays. All HP large screen displays meet environmental specifications without a fan. The maximum power of any HP display is 110 watts. This can be a benefit in reducing system cooling requirements.

## HP Technology

Recent advances in technology have expanded the range of applications for which electrostatic CRTs provide the optimum solution for picture drawing needs. Most of these advances have occurred in small screen (5 to 7 in. diagonal) CRTs.

- High resolution
- Increased brightness
- Beam-penetration color
- Improved light-output uniformity

The first three listed improvements in HP CRTs provide viable design alternatives to electromagnetic CRTs. The high resolution HP display offers picture drawing performance similar to an electromagnetic display, at a lower cost. Similarly, the tri-color beam penetration display has a significant price advantage over comparable electromagnetic

displays. It provides faster writing speed as an added benefit.

Increased brightness is a very significant breakthrough in electrostatic CRTs. It virtually eliminates the primary argument for using electromagnetic CRTs instead of electrostatic. With comparable brightness, the instrument designer is free to focus on other picture and access criteria.

HP electrostatic CRT displays offer several benefits in applications where raster scan picture drawing is required. In real time medical ultrasound systems the scan rate may be varied to match transducer determined scanning frequencies. This presents no problem with an electrostatic display. Conversely, the tuned circuit of an electromagnetic display has a limited frequency range for raster operation.

In some instruments or systems it is desirable to rotate the picture 90 degrees, to change its size or aspect ratio, or to offset a series of reduced size images for multiple image presentations. These operations are easy to perform with electrostatic CRT displays.

Good light output uniformity is an extremely important performance attribute for medical diagnostic applications. For a given Z-axis drive voltage, the intensity of the dot or picture element should be the same anywhere in the viewing area. HP Models 1333A and 1336S represent a significant improvement in light output uniformity over previous displays.

## Digital Interfaces

Since all HP X-Y displays have analog X-Y-Z inputs, the Model 1350A Graphics Translator was developed to provide a digital interface to computers and controllers. The standard model has an HP-IB interface, digital memory that can store up to 2048 vectors or characters, and an internal refresh controller. The Model 1350A has analog X-Y-Z

and TTL blanking outputs for versatile data presentations on one or more displays.

The combination of digital memory and display (Model 1350S) provides high writing speed and 1000 x 1000 addressable picture resolution. It is an ideal display system for minicomputers which are used in real-time measurement systems, radar and sonar systems, fire control training and simulation systems, and medical or physiological research systems.

The 1350S digital memory provides the added benefit of fast picture updating. It is possible to change a segment of the picture without rewriting the entire picture.

An optional RS-232-C interface allows the 1350S to operate as a remote display for a computer. It also provides a convenient method of using the 1350S with microprocessor-controlled systems. Standard baud rates up to 9600 can be selected. A second mode of operation permits use of the 1350S clock to drive the computer RS-232-C interface board at rates up to 57 000 baud.

A high speed 16-bit parallel interface option is also available with a data transfer rate of 500K 16-bit bytes/s and a vector transfer rate of up to 250K vectors/s.

The Model 1350S Display System is the combination of a Model 1350A Graphics Translator and a Model 1311B X-Y Display (14 in. CRT). Three other large screen X-Y displays are options to the system: Models 1310B (19 in. CRT), 1317A (17 in. CRT), and 1321A (21 in. CRT).

### Information Displays

The types of pictures produced for information displays fall in two major categories: continuous-tone imaging, and line drawing. Continuous-tone imaging is best exemplified by television pictures. Line drawings may be bar charts, instrument displays, or pictures from computer-aided drafting or design systems.

### Imaging Applications

HP CRT displays have been used to present continuous-tone images both for direct viewing and photographic recording for many years. One of the first applications was to produce high-speed, random dot images from gamma cameras used in nuclear medicine. HP's advanced technology now makes it possible to manufacture CRTs with highly uniform light output. This is essential in assuring the diagnostic accuracy of gamma camera pictures.

Many imaging pictures are produced in a raster scan format, for which electromagnetic CRTs might be assumed to be the logical choice. An example are those produced by medical ultrasound diagnostic systems. However, the performance of real-time imaging systems can be enhanced by electrostatic CRT displays. One primary benefit is that the display can be operated at variable raster frequencies as dictated by system parameters. Displays using electromagnetic CRTs which are driven through a tuned-circuit and deflection yoke are limited to a narrow range of raster scan rates.

Model 1332A, 1333A, 1335A and 1336S displays are widely used in imaging systems. More detailed information is provided on the following pages to help you decide which display is best suited to your imaging system.



Continuous-tone image of a human fetus produced by a real-time medical ultrasound diagnostic system using an HP 1332A display. (Photo courtesy of Advanced Diagnostic Research, Inc.)

### Measurement Instruments

Most measurement instruments that produce line drawing pictures operate in real-time. Because of the need for high writing speed they usually include an electrostatic CRT display. The HP Model 1340A was designed specifically to meet the needs of measurement instrument designers. The modular package makes the 1340A physically easy to incorporate into an instrument or system. Integrated circuit amplifiers provide flexibility when electrically integrating the 1340A with an instrument. DC voltage levels control X and Y amplifier gain and position as well as intensity. Either controls supplied with the 1340A or circuits in your instrument can be used to control the display. CRT performance meets the picture drawing needs of both analog and digitally controlled instruments.

### Computer Graphics

Large screen displays are used in measurement systems where the operator is more

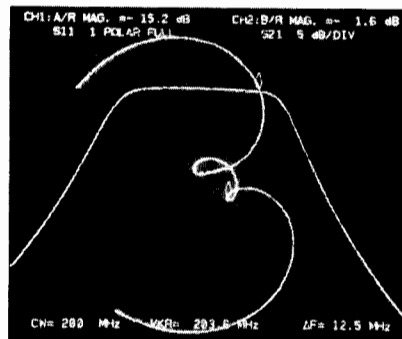

Both polar impedance and amplitude response of a filter are plotted on a network analyzer. Models 1332A, 1335A, and 1340A can be used in many types of measurement instruments.

than an "arm's-length" from the picture. Again, the benefits of HP displays—picture writing speed and quality—are essential in real-time measurement systems.

The capability of the 1350S to update a portion of the picture without redrawing the entire display is extremely useful in measurement systems.

Radar and sonar system designers can benefit from the speed and versatility of HP graphics display systems. Most of these systems display continually changing pictures which the operator uses to make tactical decisions. He cannot afford to wait a significant length of time for pictures to be updated; the 1350A can draw complex pictures in less than 80 milliseconds. Again, selective update of the picture is valuable in reducing the time required to service the display system. For radar and sonar systems HP digital display systems represent an excellent price-performance comparison with high resolution electrostatic CRT display systems.

Analytical chemistry systems need large screen, high resolution pictures to display various spectra. The 1350S 1000 x 1000 addressable resolution is a good match to most analytical instrument specifications. Its memory versatility enables the system operator to store several spectra and quickly display various sequences of data for comparative analysis. All this can be done at ambient light levels because of the brightness of the 1350S Display System.

Some medical research and data acquisition system applications require simultaneous display of several traces. It is possible to continuously update 1350S displays (1311B, 1310B, 1317A, and 1321A) to simulate a multiple-trace chart recorder. In this application, the high data transfer rate from the minicomputer to the 1350S Display System is a benefit.

Simulation systems usually operate in a real-time mode and require fast picture writing speeds. The 1350S is being used in several simulation systems because it can display changes in the picture at rates faster than operator response times. Other benefits for simulation systems are the capability to operate multiple displays and to use a variety of CRT sizes.

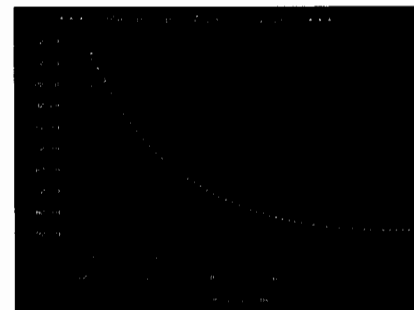

The 1350A may be used to generate displays for a computer-controlled test system. File capability of the 1350A allows rapid changing of waveforms without erasing and rewriting the entire display.





# CATHODE-RAY TUBE DISPLAYS

## Performance specifications

1300 Series

CATHODE-RAY TUBE	1332A	1333A	1335A		1336S	1340A
			Conventional	Storage		
Viewing Area	≈9.6 x 11.9 cm (3.8 x 4.7 in.)	≈8 x 10 cm (3.1 x 3.9 in.)	≈7.1 x 9 cm (2.8 x 3.6 in.)		≈8 x 10 cm (3.2 x 3.9 in.)	≈9.6 x 11.9 cm (3.8 x 4.7 in.)
Quality Area	≈8.4 x 10.8 cm (3.3 x 4.3 in.)	≈8 x 10 cm (3.1 x 3.9 in.)	≈7.1 x 8.9 cm (2.8 x 3.5 in.)		≈6.4 x 8 cm (2.5 x 3.2 in.)	≈9.6 x 11.9 cm (3.8 x 4.7 in.)
Graticule	8 x 10 div 1 div = 1.2 cm	Opt. 8 x 10 div 1 div = 1 cm	8 x 10 div 1 div = 0.89 cm		None	8 x 10 div 1 div = 1.2 cm
Spot Size (within quality area)	≤0.30 mm	≤0.20 mm	≤0.25 mm	See "Resolution"	See "Resolution"	≤0.46 mm
Resolution	31.5 lines/cm (80 lines/in.)	49 lines/cm (124 lines/in.)	39 lines/cm (99 lines/in.)	20 lines/cm (51 lines/in.)	140 lines/cm (356 lines/in.) (center screen); 80 lines/cm (203 lines/in.) (quality area)	≈22 lines/cm (55 lines/in.)
Light Output (at 0.25 cm/μs, 60 Hz refresh, unless otherwise noted)	170 cd/m <sup>2</sup> (50 fl)	34 cd/m <sup>2</sup> (10 fl)	68 cd/m <sup>2</sup> (20 fl)	680 cd/m <sup>2</sup> (200 fl)	2 μW/cm <sup>2</sup> steradian (4 x 4 cm raster)	Not Specified
Light Output Uniformity	Not Specified	≤16% overall ≤6%/cm	Not Specified	Not Specified	≤16% overall ≤6%/cm	Not Specified
Light Output Stability	<10%/hr	<10%/hr	<10%/hr	Not Specified	<5%/hr	Not Specified
Writing Speed (Storage)	N/A	N/A	N/A	≥50 cm/ms	N/A	N/A
Dot Writing Time (Storage)	N/A	N/A	N/A	≤1 μs	N/A	N/A
Storage Time	N/A	N/A	N/A	<1 minute (Write Mode)	N/A	N/A
<b>X &amp; Y AXES AMPLIFIERS</b>						
	<b>1332A</b>	<b>1333A</b>	<b>1335A</b>		<b>1336S</b>	<b>1340A</b>
Deflection Factor Range	80–200 mV/div	80–200 mV/cm	80–200 mV/div		100–200 mV/cm 0.5–2.0 V/cm	80–200 mV/div, 0.4–1.0 V/div
Settling Time	≤300 ns	≤300 ns	≤300 ns		≤500 ns	≤300 ns
Linear Writing Speed	>25 cm/μs (10 in./μs)	>25 cm/μs (10 in./μs)	>25 cm/μs (10 in./μs)		Not Specified	>25 cm/μs (10 in./μs)
Linearity	≤3%	≤3%	≤3%		≤3%	≤5%
Dynamic Range	Up to ½ screen diameter off screen in any direction.					
Drift	≤1 mm in 24 hours.					
<b>Z-AXIS AMPLIFIER</b>						
	<b>1332A</b>	<b>1333A</b>	<b>1335A</b>		<b>1336S</b>	<b>1340A</b>
Blanking Range (Internal Adjust.)	1 V–2.5 V p-p	1 V–2.5 V p-p	1 V–2.5 V p-p		1 V–2.5 V p-p, 5 V–25 V p-p	1 V–2 V p-p
Rise Time	≤25 ns	≤25 ns	≤25 ns		≤25 ns	≤25 ns
X, Y, Z INPUTS	Single-ended BNC	Single-ended BNC	Single-ended BNC		Differential, Separate BNC's	Single-ended BNC
Input RC	≈1 MΩ, ≤60 pF (50 Ω Optional)	≈1 MΩ, ≤60 pF (50 Ω Optional)	≈1 MΩ, ≤60 pF (50 Ω Optional)		≥10 kΩ, <70 pF (50 Ω selectable)	≥1 MΩ, <40 pF (50 Ω selectable)
Maximum Input	±50 V	±50 V	±50 V		±50 V	±50 V
Line Power at 60 Hz, 120 VRMS	≈24 W	≈40 W	≈35 W		≈100 W	≈30 W
UL Medical & Dental Listing	Optional	Optional	Optional		Standard	Optional
UL Medical & Dental Component Recog.	Standard	Standard	Standard		N/A	Optional

**Note:** These are condensed specifications; refer to applicable data sheet for complete specifications, including options and accessories.

### Common Specifications

#### Operating environment

**Temperature:** 0°C to +55°C (+32°F to +131°F), operating; –40°C to +70°C (–40°F to +158°F), non-operating.

**Humidity:** to 95% RH at +40°C (+104°F).

**Altitude:** to 4600 m (15 000 ft), operating; to 6300 m (20 669 ft), non-operating.

**Shock:** 30 g peak, ½ sine wave, 11 ms duration.

**Vibration:** 15 min. in each plane at 0.38 (0.015 in.) mm p-p excursion, 5–55 Hz, 1 min./octave, 10 min. at each resonant frequency

(except 1332A, 1333A, 1335A: 15 min. in each plane, 0.25 mm (0.010 in.) p-p excursion, 10–55 Hz).

**Primary line voltage:** 100, 120, 220, or 240 Vac, +5%, –10% (1333A, 1336S: +5%, –20%).

#### Ordering Information

**1332A** Small Screen Display

**1333A** Small Screen Display

**1335A** Small Screen Display

**1336A** Display Module

**1336P** Power Supply Module

**1336S** Display System (includes 1336A, 1336P)

**1340A** Display Module (with control panel)

OEM and quantity discounts available.

#### Price

\$1875

\$2100

\$2500

\$2950

\$950

\$3900

\$1200

CATHODE-RAY TUBE	1338A (Color)	1304A	1310B	1311B	1317A	1321A
Viewing Area	≈9.6 x 11.9 cm (3.8 x 4.7 in.)	≈20 x 25 cm (7.9 x 9.8 in.)	≈28 x 38 cm (11 x 15 in.)	≈20.3 x 25.4 cm (8 x 10 in.)	≈26 x 34 cm (10.2 x 13.5 in.)	≈30.5 x 35 cm (12 x 14 in.)
Quality Area	≈8 x 10 cm (3.2 x 3.9)	≈20 x 25 cm (7.9 x 9.8 in.)	≈28 x 38 cm (11 x 15 in.)	≈20.3 x 25.4 cm (8 x 10 in.)	≈25.4 x 25.4 cm (10 x 10 in.)	≈30.5 x 30.5 cm (12 x 12 in.)
Spot Size (center screen) (corners)	≤0.36 mm (0.014 in.)	≤0.5 mm (0.02 in.)	≤0.51 mm (0.02 in.) ≤0.76 (0.03 in.)	≤0.43 mm (0.017 in.) ≤0.51 (0.02 in.)	≤0.51 mm (0.02 in.)	≤0.51 mm (0.02 in.)
Resolution	28 lines/cm (70 lines/in.)	20 lines/cm (50 lines/in.)	19.7 lines/cm (50 lines/in.)	24 lines/cm (61 lines/in.)	19.7 lines/cm (50 lines/in.)	19.7 lines/cm (50 lines/in.)
Light Output (at 0.25 cm/μs, 60 Hz refresh)	Color Dependent	19.2 cd/m <sup>2</sup> (5.6 fl)	84 cd/m <sup>2</sup> (24.5 fl)	84 cd/m <sup>2</sup> (24.5 fl)	82.4 cd/m <sup>2</sup> (24 fl)	82.4 cd/m <sup>2</sup> (24 fl)

X & Y-AXES AMPLIFIERS	1338A	1304A	1310B	1311B	1317A	1321A
Deflection Factor Range (approx.)	Internally Adjustable, ≈0.9 V to 2.5 V for full deflection	80-120 mV/div, 1 div = 20 mm (0.8 in.)	(Vertical) 35, 80-60.9 mV/cm, 90-153 mV/in. (Horizontal) 26.2-45.9 mV/cm, 67-117 mV/in.	(Vertical) 46, 3-81 mV/cm, 118-207 mV/in. (Horizontal) 35.8-60.9 mV/cm, 90-153 mV/in.	39-69 mV/cm, 100-175 mV/in.	33-58 mV/cm, 83-147 mV/in.
Settling Time	≤300 ns	≤300 ns	≤500 ns	≤500 ns	≤1 μs	≤500 ns
Linear Writing Speed	≥25 cm/μs (≥10 in./μs)	≥25 cm/μs (≥10 in./μs)	≥25 cm/μs (≥10 in./μs)	≥25 cm/μs (≥10 in./μs)	≥25 cm/μs (≥10 in./μs)	≥25 cm/μs (≥10 in./μs)
Repeatability error	Not Specified	<0.15%	<0.15%	<0.15%	<0.15%	<0.15%
Linearity	≤2%	≤3%	≤1%	≤1%	≤3%	≤1%
Dynamic Range	Up to ½ screen diameter offscreen in any direction					
Drift	≤2.5 mm in 24 hours					

Z-AXIS AMPLIFIER	1338A	1304A	1310B	1311B	1317A	1321A
Blanking Range	Internally adjustable from 1 V to 2.5 V p-p.					
Rise Time	≤30 ns	≤25 ns	≤25 ns	≤25 ns	≤20 ns	≤20 ns
X, Y, Z INPUTS	Differential, separate BNC's	Differential, separate BNC's	Single-ended BNC	Single-ended BNC	Single-ended BNC	Single-ended BNC
Input RC	≈100 Ω, ≈70 pF or 50 Ω	≥100 kΩ, ≤65 pF (50 Ω selectable)	(X, Y inputs) 50Ω or ≈10 kΩ/ ≈40 pF (Z input) 50Ω or ≈10 kΩ/ ≈60 pF	(X, Y inputs) 50Ω or ≈10 kΩ/ ≈40 pF (Z input) 50Ω or ≈10 kΩ/ ≈60 pF	(X, Y inputs) 50Ω or ≈10 kΩ/ ≈40 pF (Z input) 50Ω or ≈10 kΩ/ ≈60 pF	(X, Y inputs) 50Ω or ≈10 kΩ/ ≈40 pF (Z input) 50Ω or ≈10 kΩ/ ≈60 pF
Maximum Input	(High Z) ±50 V (50 Ω) ±2.5 V	(High Z) ±50 V (50 Ω) ±2.5 V	(High Z) ±50 V (50 Ω) ±5 V	(High Z) ±50 V (50 Ω) ±5 V	(High Z) ±50 V (50 Ω) ±5 V	(High Z) ±50 V (50 Ω) ±5 V
TTL Blanking Input (rear panel BNC)	Standard	Optional	Standard	Standard	Standard	Standard
Primary Line Voltage	100, 120, 220, or 240 Vac +5%, -10%	100, 120, 220 or 240 Vac +5%, -20%	100, 120, 220 or 240 Vac +5%, -20%	100, 120, 220 or 240 Vac +5%, -20%	100, 120, 220 or 240 Vac +5%, -10%	100, 120, 220 or 240 Vac +5%, -10%
Maximum Power	≈100 W	≈85 W	≈125 W	≈125 W	≈100 W	≈110 W
UL Medical and Dental Listing	Not Available	Optional	Optional	Optional	Optional	Optional

Note: These are condensed specifications; refer to applicable data sheet for complete specifications, including options and accessories.

(0.38 mm, 0.015 in. for 1304A, 1338A), 5 to 55 Hz; 1 min./octave, 10 min. at each resonant frequency.

### Common Specifications

#### Operating environment

**Temperature:** 0°C to 55°C (+32°F to +131°F), operating; -40°C to +70°C (-40°F to +158°F), non-operating.

**Humidity:** to 95% RH at +40°C (+104°F).

**Altitude:** to 4600 m (15 000 ft), operating; to 7600 m (25 000 ft), non-operating (15 300 m, 50 197 ft for 1304A).

**Vibration:** 15 min. in each plane, 0.25 mm (0.010 in.) p-p excursions

#### Ordering Information

**1304A** 32 cm (13 in.) Display

**1310B** 48 cm (19 in.) Display

**1311B** 36 cm (14 in.) Display

**1317A** 43 cm (17 in.) Display

**1321A** 53 cm (21 in.) Display

**1338A** Tri-color Display

#### Price

\$2750

\$5900

\$5300

\$4650

\$4750

\$4750



## Imaging

Models 1332A, 1333A, 1335A &amp; 1336S

## Introduction

Models 1332A, 1333A, 1335A, and 1336S can best be classified as continuous tone imaging displays. The other major classification used in this discussion is line drawing displays which are exemplified by HP large screen displays. A definition of both types of applications will help you in deciding whether a continuous tone display will best meet your requirements.

## Continuous Tone, Line Drawing Defined

A continuous tone image has all of the space in the X-Y plane utilized with shades ranging from black to white (see figure 1). This is in contrast to line drawing displays in which portions of the picture contribute no meaning, i.e., are unused space (see figure 2). Line drawing displays transmit information by the orientation and relationship of the lines with respect to one another.

A continuous tone image is also continuous in the third dimension, the Z-axis, which is usually used to represent some parameter in the physical world which is translated to brightness (or gray shades) in the image. The parameter can be radar return, or reflectivity of the tissues of the body in ultrasound—any parameter that has some varying magnitude distributed in space. Continuous tone implies that the brightness can be varied continuously from zero to maximum, in contrast to a binary or bistable display which contains only black or white.

## Vector vs. Raster

Either type of image, continuous tone or line drawing, can be generated using either a raster technique or a vector technique. However, it is easier to draw continuous tone images with a raster that scans the entire screen. On the other hand, line drawings are better suited to the vector technique. Just those lines that are needed can be drawn without sweeping the beam over the entire screen. Of course, continuous tone images can be drawn in random fashion also.



Figure 1. Ultrasonically generated view of a human liver and kidney is representative of continuous-tone images (photo courtesy of Rohé Scientific).

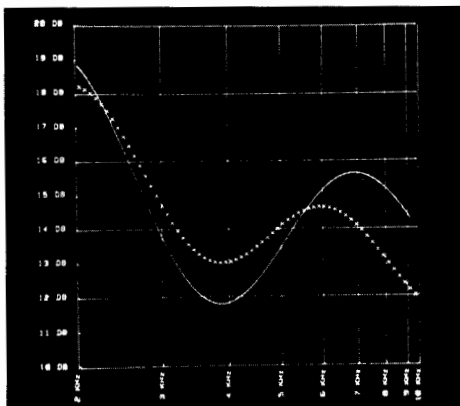

Figure 2. A line-drawing presentation of an electronic test system output.

## Applications, General

Many display applications clearly dictate whether a continuous tone or a line drawing technique should be used. Continuous tone images contain many orders of magnitude more data than line drawings. Computerized Axial Tomography (CAT), nuclear medicine, ultrasound, or weather radar images can only be continuous tone. Computer graphic drawings of a part, on the other hand, are obviously line drawings.

## Displays Suited to Continuous Tone vs. Line Drawing

All HP displays can be used to generate continuous tone images or line drawings. The displays designed to be most compatible with continuous tone imaging are the 1332A, 1333A, 1335A, and 1336A. However, the 1340A can be and is used for continuous tone images. HP large screen displays are not recommended for viewing continuous tone images in room light because spreading the beam power over their relatively large screen area reduces brightness.

## Parameters Optimized for Continuous Tone

Some of the parameters that are optimized for continuous tone displays are deflection defocussing, drive defocussing, Z-axis stability, and light output uniformity. Deflection defocussing is important in a continuous tone image because a variation in spot size from center screen to the screen edge is much more obvious than in a line drawing. This spot defocussing is significantly reduced in HP continuous tone imaging displays by electronic correction circuits and/or CRT design parameters.

Drive defocussing is also important, i.e., how well the electron beam maintains sharp focus as the Z-axis level changes. Drive defocussing can become critical in continuous tone applications since the full range of Z-axis brightness levels are used.

Stability in the Z-axis is important because if the window of brightness/information shifts up or down, you can lose information. Z-axis stability is designed into HP's continuous tone imaging displays with fully differential, fully power-matched Z-axis amplifiers for minimum drift.

Light output uniformity is a critical parameter in film recordings of continuous tone images that are used for diagnostic purposes. This is because light or dark areas introduced by the phosphor may be interpreted as a true representation of the input data and cause incorrect diagnosis.

## Viewing vs. Photography

When selecting a continuous tone imaging display, one of the first questions to ask is "Am I going to look at the screen or photograph it?" In viewing, you need more brightness; in photography parameters such as stability and resolution become more important. For viewing at refresh rates down to 15–20 Hz, the 1332A is the best choice, producing a bright, sharply defined image that can be viewed in normal ambient light. For a very slow refresh rate, e.g., nuclear medicine or M-mode ultrasound, the 1335A variable persistence display retains an image on the screen long enough for the eye to comprehend it. In the storage mode the 1335A has a limited number of gray shades because of the storage mesh transfer function (see figure 3). When the display is for photographing only, either the 1333A or 1336S can be used, depending on the resolution requirements.

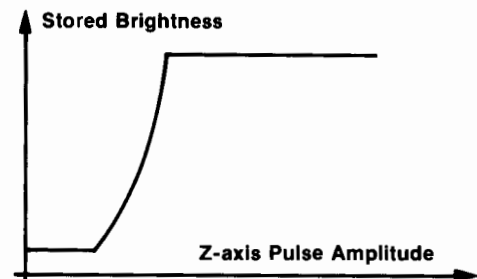

Figure 3. Composite storage electron gun and mesh transfer characteristics of the 1335A.

**Resolution**

Resolution of the display should be matched as closely as possible to the system resolution. If the display has a much higher resolution than the system, a raster image will have an obvious, distracting line structure which might interfere with comprehension. Ideally the raster line spacing should equal 50% of the beam width (50% of spot size). If the display and system cannot be matched exactly, you should select the display with a higher resolution, and defocus until the resolution of the display matches the resolution of your image. The display resolution should be as close to system resolution as possible for several reasons. When the display resolution is higher than system resolution and the spot is defocused, brightness decreases. Another reason for not using a display with higher resolution than necessary is that you don't have to be as critical in reducing system noise.

**Resolution and Brightness Requirements for Photography**

When selecting a display with the proper resolution for photography, it is important to relate it to film and print size. For Polaroid® 7.4 x 9.4 cm film, the 1333A Display is the logical choice. If the CRT image is to be photographed for a 20 x 25 cm enlargement the higher resolution of the 1336S is needed. For film size in between, e.g., 12.7 x 17.8 cm, either display can be used, the choice depending on the system resolution desired.

The 1333A display resolution matches ultrasound applications, which use mostly Polaroid film. It is also best suited for single images in nuclear medicine on small size film for up to 12.7 x 17.8 cm photographs. For larger photographs and multiple image nuclear medicine photos on larger film formats, the 1336S should be used.

In photography, brightness isn't as critical as in viewing, but there must be sufficient light to expose the film. For raster formats where the entire screen area is illuminated, the 1333A easily exposes Polaroid film, or X-ray film, or most of the currently popular films for CRT recording with one full raster frame at normal refresh rates. If four standard TV raster type images are to be photographed for a 20 x 25 cm final print size, it may be necessary to refresh each raster more than once to obtain sufficient light from the 1336S to expose the film. Alternately, the raster writing rate may be reduced to obtain an increase in beam current density.

**Phosphor Selection**

The choice of phosphor is also heavily influenced by whether you are going to view the picture or photograph it. For viewing, you need to consider the refresh rate of the image and choose a phosphor whose persistence matches the refresh rate to eliminate flicker (refer to Phosphor Selection Guide, page 230).

Orange phosphors, such as P7, P28, and P33 tire the eye easily—a problem for radar operators who must look at a screen for long periods. A green phosphor is more pleasing to the eye and doesn't create as much eye fatigue. The choice of phosphor, providing that you can choose any color that you want, is almost entirely dictated by the refresh rate of the picture. P31 green phosphor is probably the best overall choice down to 50 Hz. P4 phosphor allows viewing without objectionable flicker down to 30 to 40 Hz. Below these refresh rates, a longer persistence phosphor such as P39 with a green emission, or P7 with a combined yellow and blue emission, is needed. For even lower refresh rates, you can select a variable persistence display such as the 1335A, however, there may be some smearing.

**Smearing**

There is a trade off in persistence just as there is in resolution. The phosphor persistence should be such that the image doesn't flicker. You need enough persistence to retain light from one frame to the next. However, if there is movement within the image such as heart valve motion in ultrasound, you must be careful that the persistence isn't long enough to cause smearing of the image. Refer to the persistence curves in HP Application Note 115 and compare the persistence times with the speed of the moving portions of your image. P31 is the first choice for imaging requirements with refresh rates of 50 Hz or above. It is the brightest phosphor, i.e., has the greatest energy conversion efficiency. Its peak emission wavelength corresponds to the eye's peak spectral response for maximum coupling effi-

ciency between the eye and the phosphor. Also, P31 is the most burn resistant phosphor known, and is commonly available. In real time ultrasound systems with refresh rates from 20 to 40 Hz, P4 phosphor is a good choice with its longer persistence and black and white appearance. For M-mode ultrasound, P39 phosphor is recommended. There is no phosphor with long enough persistence to be useful for direct viewing in nuclear medicine. In this case the 1335A variable persistence display is required.

**Contrast Filters**

Contrast filters can be very helpful for obtaining greater picture contrast. The choice of a filter depends on the phosphor used and room lighting conditions and selection is difficult without trying different filters under actual operating conditions. In general, with P31 the blue filter provides a more pleasing color and gives good contrast enhancement. With P4, the neutral gray filter retains the white color. With P7, an amber filter is generally used since it matches the yellow emission from the phosphor for the greatest contrast enhancement, and filters out the annoying blue flash from the short-persistence blue component of P7.

For photography, a clear implosion shield should be used. A contrast filter provides no contrast enhancement since ambient light does not reach the phosphor. All filters block ultraviolet light, so it may be necessary to remove the filter while photographing the display if a UV-sensitive film and UV-emitting phosphor such as P11 or P16 is used. A filter must be in place whenever the user is exposed to the CRT, for implosion protection.

**Gamma**

Gamma is also an important factor in continuous tone imaging requirements. It's not only important to get the maximum range of brightness from minimum to maximum, but the distribution of levels in between is also important.

Gamma is simply the transfer function that defines the relationship between the physical variable and the corresponding brightness in the image. It is not the magnitude or absolute slope of the function, but the shape of the function (see figure 4).

For visual observation gamma should typically be approximately exponential, usually with a gamma (or base) of about 2.2. For photographic recording with X-ray and other negative film, gamma should typically be approximately linear.

In general, for direct viewing you would use a display that does not have the gamma correction option. For photographic recording, you generally want to have the gamma correction option. For Polaroid recording you may want to design in some special compensating networks in the system that will give a non-linear gain characteristic to compensate for the non-linear response curve of Polaroid (see published Polaroid Gamma Curves) in order to realize the maximum gray shades.

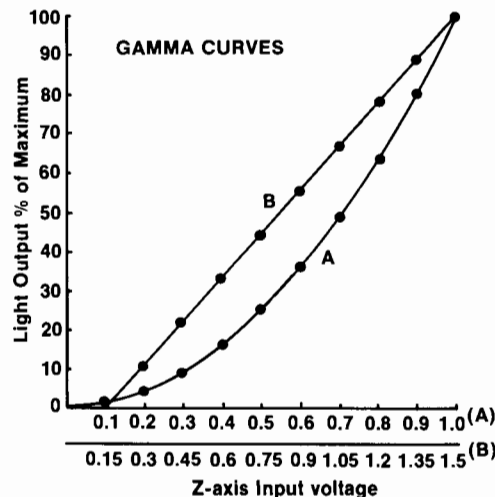
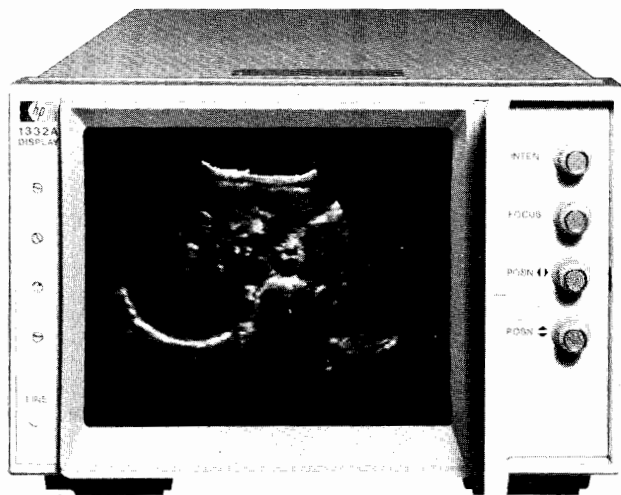
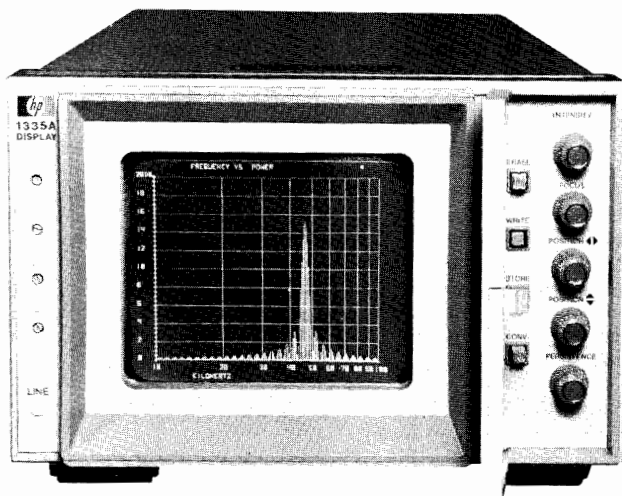

Figure 4. Typical CRT light output vs. Z-axis input voltage without Gamma correction (curve A), with Gamma correction (curve B).  
\*Registered Trademark of Polaroid, Inc.



1332A



1335A

### 1332A, 1333A, 1335A, and 1336S Description

Models 1332A, 1333A, 1335A, and 1336S are high-quality cathode-ray tube displays designed to satisfy a wide range of OEM medical and electronic instrument display needs. The major differences between these displays are their CRT's.

Model 1332A has a large 9.6 × 11.9 cm display area with the resolution and picture quality required for medical diagnosis systems plus a bright display for differentiating between many gray shades, or for viewing in brightly lighted areas. Option 530 provides even greater brightness with up to 500 cd/m<sup>2</sup> line brightness.

Model 1333A has a high resolution CRT with an 8 × 10 cm viewing area specifically optimized for photographic applications such as gamma camera systems. The 1333A's combination of high resolution, excellent uniformity, and speed permits crisp easy-to-read, diagnostic-quality photographs to be obtained from state-of-the-art nuclear, ultrasonic, thermographic, and X-ray scanning systems.

Model 1335A's high resolution 8 × 10 cm storage display offers medical and instrumentation OEM users a variable persistence, storage, and non-storage CRT display with excellent performance. Outstanding picture quality and amplifier performance combine to make the 1335A a significant advancement in storage displays.

Model 1336S consists of an 8 × 10 cm display module (1336A) and a separate power supply module (1336P) for mounting flexibility. With up to 140 lines/cm resolution the 1336S is ideal for all high resolution imaging requirements.

The 1332A, 1333A, and 1335A have post deflection accelerator CRT's to assure a bright, crisp trace. The 1336S display uses a mono-accelerator CRT design to achieve 140 lines/cm resolution at center screen with low power consumption. An opaque aluminum layer behind the phosphor (except in model 1336S, which is non-aluminized) enhances trace brightness.

Regulated, low power write gun and flood gun filaments assure a constant light output under varying line voltage conditions. More importantly, the low power filament operation significantly extends CRT life and eliminates grid and other stray emissions common to older, less efficient designs.

Models 1332A, 1333A, 1335A (Opt 330), and 1336S are listed with Underwriters Laboratories in accordance with the UL 544 Medical Safety Standard which defines detailed patient protection requirements. Regular inspection of our production facility by UL assures you that this patient protection is built into the display that you purchase.

Models 1332A, 1333A, and 1335A are 13.3 cm (5¼ in.) high, half rack width, 49.5 cm (19½ in.) long packages that can be combined with identical empty modules to form an attractive full width horizontal or vertically stacked OEM instrument. The 1336A Display Module has the same dimensions and the 1336P Power Supply Module has the same height and width but is 33.5 cm (13 ⅜ in.) deep. If the 1336A/P are to be mounted together, 1336P Option 018 may be

ordered to provide the same cabinet depth as the 1336A, with locking hardware to form a standard EIA rack width unit.

### Picture clarity

**Model 1332A:** spot size is only 0.305 mm (0.012 in.) diameter at high intensity levels and remains focused over the entire range of intensity levels. This resolution makes the 1332A well suited for applications requiring sharp focusing on multiple gray shades or varying writing speeds with frequent video drive level changes. Spot size is 0.3 mm over the entire quality area, making the display especially useful in applications where sharp focus is required. An example of this is where alphanumeric characters are mixed with traces, curves, or graphs.

The large 9.6 cm x 11.9 cm viewing area and bright display make the 1332A ideal for the OEM with both visual and some photographic requirements. Display brightness lets you view the display in high ambient light conditions while maintaining resolution and gray shades for photographic work. Whenever uniform photographic recording of the display becomes critical, the 1333A or 1336S should be used.

**Model 1333A:** is specifically designed for photographic recording where display uniformity and high image quality are essential. Spot size is a crisp 0.20 mm (0.008 in.) diameter everywhere on its 8 x 10 cm display, which allows resolution of 193 354 picture elements. The spot remains round and sharply focused in all areas of the screen and at varying intensity levels, eliminating the need to readjust focus or astigmatism controls. No compromises are needed for optimizing overall image sharpness in applications where all areas of the screen contain critical information and the Z-axis drive level varies widely. For displays that do not require the entire screen, sharply focused alphanumeric messages such as patient identification or operator instructions can be inserted along the extreme edges and corners for maximum use of the display area.

Light output uniformity is fully specified, both overall and for small increments, which assures you that the information content of the display is an accurate representation of the input signals. Additionally, light output drift is specified, including all effects of the Z-axis amplifier, high voltage supply, and CRT. A regulated dc CRT filament voltage is also used to assure constant light output independent of line voltage fluctuations. The regulated dc filament voltage also reduces the possibility of interference patterns resulting from correlation between input signal frequencies and the high voltage oscillator or power line frequencies.

**Model 1335A:** The CRT can be operated in non-storage, storage, or variable persistence modes. In the non-storage mode (called CONVENTIONAL), the CRT operates similar to a mono-accelerator conventional CRT with an exceptionally small spot that focuses uniformly over the entire quality area. Resolution is approximately 40 lines per cm (100 lines per in.). In addition, spot size is relatively independent of intensity settings or Z-axis input signals, eliminating the need to refocus at each intensity setting. This characteristic enhances

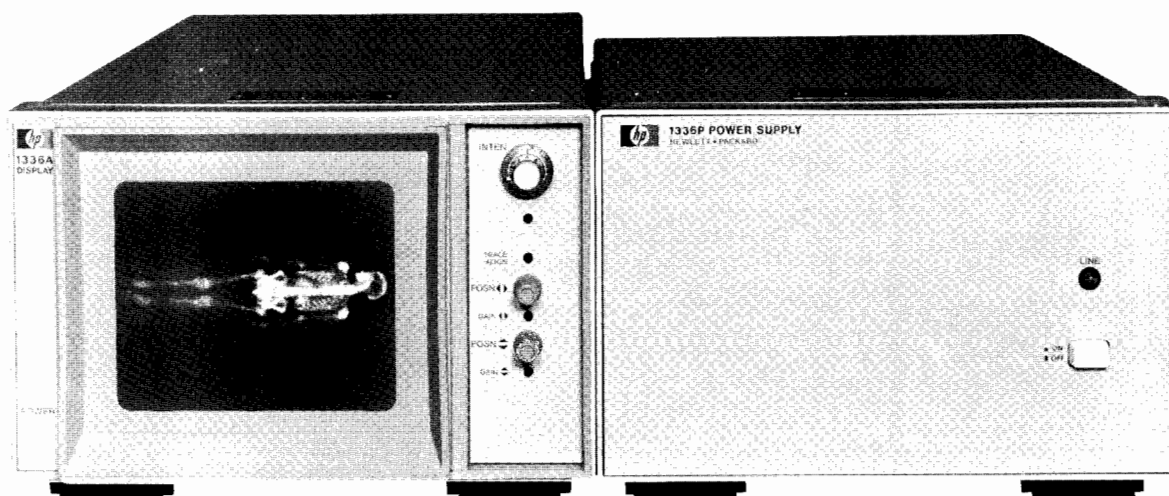

## 1336S

the CRT image in applications requiring the CRT to focus on a wide range of intensity levels. Applications include those where markers intensify areas of interest, where characters or vectors are written, and anywhere that the writing speed or drive levels of the beam vary. The light output remains stable through use of regulated CRT filament voltage and stable Z-axis amplifier design.

The same excellent CRT performance is maintained in the Variable Persistence operating mode. Persistence is continuously adjustable with a front panel control, from approximately 0.20s to > 1 minute. This mode allows you to eliminate flicker on some presentations by increasing the persistence to match the refresh rate. The variable persistence mode is selected by pressing the WRITE pushbutton.

The storage CRT is preset to store dots having a Z-axis width of 1  $\mu$ s or greater for up to 30 minutes. The STORE mode offers the greatest contrast because the background is completely dark. An internal adjustment allows an increase of writing speed to capture faster signals with reduced storage time and trace-to-background contrast. Another adjustment may be used to enhance either the storage time of the trace or the stored brightness of the stored images. Stored resolution is over 20 lines per cm (50 lines per in.) and stored traces retain sharp details for the specified storage time (1 minute in WRITE mode, 30 minutes in STORE mode).

**Model 1336S:** offers a choice of 140 lines/cm or 90 lines/cm (Option 005) resolution for all high-resolution imaging requirements such as multi-imaging for nuclear or ultrasound medical diagnostic systems, scanning electron microscopes, and scanning auger microprobes. The display uses a mono-accelerator CRT with an accelerating potential of approximately 5 kV to produce a small, high intensity spot. HP contributions in electron gun and circuit design make it possible to provide this high resolution with only 100 watts power consumption.

The CRT is designed to prevent spurious light from reaching photographic film during long time exposures. Light output uniformity is tested to assure that the information content of the displayed image is an accurate representation of the input signals.

### Programmability (1335A)

The Model 1335A offers users great flexibility in selecting ERASE, STORE, WRITE, CONVENTIONAL, and VARIABLE PERSISTENCE modes. These modes can be selected with the manual front panel controls, remote program inputs, or a combination of both.

In manual operation, the front panel controls select the operational mode. In program mode, a single program line inhibits the manual controls and prevents operator intervention. Additional control lines can be used to selectively enable the front panel ERASE and VARIABLE PERSISTENCE controls during remote operation to provide interactive capability. Provisions have been made so that certain programmable functions can be hard wired to operate through the front panel controls during remote operation.

### Electronics

#### Models 1332A, 1333A, and 1335A

The X and Y amplifiers have 70 ns rise time (bandwidth is 5 MHz) and the Z-axis blanking amplifier has a 25 ns rise time. When faster X and Y amplifier response is required, Model 1332A has an Option available to obtain 25 ns rise times. All amplifiers are fully differential and operate at low power levels for stable, drift-free performance over wide ranges of operating temperatures.

The time required to make any size movement on the CRT, including the response time for the amplifiers to settle within one spot diameter of final position, is less than 300 ns. This means that many thousands of vectors and characters can be written on the display without flicker or annoying distortions.

#### Model 1336S (1336A and 1336P)

The 1336A's deflection amplifiers settle to within one spot diameter in <500 ns after receiving an input step command. All amplifiers are fully differential and operate at low power levels for stable operation and minimum warm-up time. Dynamic focus circuits automatically correct for spot position to assure optimum resolution over the entire CRT face. A regulated dc CRT filament supply assures a stable light output.

Interfacing flexibility is provided by internal switches which allow selection of X, Y, and Z amplifier input characteristics. An optional TTL blanking input unconditionally overrides any analog Z-axis input and the intensity control, and can be used to provide CRT protection in the event of CRT failure.

### Options and accessories

A wide range of options is available for tailoring the display to specific requirements; refer to data sheets for complete listing. Accessories available include rack mounting kits, OEM half module frames and rack slides, a light shield (Model 10183A), and BNC shorting caps for use with certain options. For convenient system interconnection, Model 10488A 3.6 m (12 ft) Display Cable is available as an accessory. Model 197B Option 006 camera is adapted for direct recording of 1332A, 1333A, 1335A, and 1336S displays. Refer to individual display data sheets for complete description of accessories.

### Ordering information

	<b>Price</b>
1332A Small Screen Display	\$1875
1333A Small Screen Display	\$2100
1335A Small Screen Display	\$2500
1336A Display Module	\$2950
1336P Power Supply Module	\$950
1336S Display System (includes 1336A, 1336P)	\$3900
1336A or 1336S Opt 005	less \$300
10183A Light Shield for 1332A, 1333A, 1335A, 1340A, 1338A	\$15
OEM and quantity discounts available.	



# CATHODE-RAY TUBE DISPLAYS

## Phosphor selection guide

Film Type	Phosphor		
	P31	P11	P4
<b>Kodak*</b>			
NMB (formerly SO-179)	Recommended	Usable	Usable
NMC (formerly SO-241)	Recommended	Usable	Usable
X-OMAT G	Not Usable	Recommended	Not Recommended
X-OMAT L	Not Usable	Recommended	Not Recommended
X-OMAT M	Not Usable	Recommended	Not Recommended
CFA	Recommended	Usable	Usable
PF	Recommended	Usable	Usable
PFC	Recommended	Usable	Usable
Shellburst 2476	Not Recommended	Recommended	Not Recommended
<b>Du Pont® MRF 31, MRF 32</b>	Recommended	Usable	Usable
<b>Polaroid*</b>			
611	Recommended	Usable	Usable
811	Recommended	Usable	Usable
084	Recommended	Usable	Usable
667	Recommended	Usable	Usable

Note: Cameras with a UV light, e.g., 197B, work well with P31, P11, and P7 phosphors, not as well with P4, and do not work with P39.

\*Registered Trademark of Eastman Kodak Company.

\*Registered Trademark of E. I. Du Pont De Nemours.

Application	Recommended Model(s)	Recommended Phosphor	Recommended Contrast Filter
<b>Medical Diagnostic Ultrasound</b>			
Real-time Linear Array	1332A	P4	Neutral Gray
Real-time Phased Array	1332A	P31	Blue
M-Mode	1332A	P39	Blue
A-Mode	1340A	P31	Blue
<b>Nuclear Medicine</b>			
Single-image Photographic Recording	1333A	See Film/ Phosphor table	Clear
Multiformat Photographic Recording	1336S		Clear
Patient Positioning	1335A	P31	Blue
<b>Scanning Auger Microprobe, Scanning Electron Microscope</b>	1336S	P11 or P31	Clear

Note: Filters and implosion shields are made of a polycarbonate material which does not transmit UV light. For photographing with UV sensitive film and UV emitting phosphors such as P11 or P16, the implosion shield or filter should be removed. Provision must be made to insure that the camera is locked in place and provides adequate implosion protection to the display operator.

Phosphor	P31	P4	P39	P11	P7
<b>Color</b>					
Fluorescence	Green	Blue	Green	Blue-Violet	Blue-Violet
Phosphorescence (decay)	Green	Yellow	Green	Blue-Violet	Yellow-Orange
<b>Efficiency</b> (relative to P31)	100%	50%	50%	100% (note 1)	40%
<b>Flicker Frequency</b>	50 Hz	30 Hz	20 Hz	N/A (note 2)	10 Hz
<b>Smear Velocity</b>	*	10"/s	0.1"/s	*	0.01"/s
<b>Burn Resistance</b>	Highest	Good	Good	Poor	Poor
<b>Recommended Contrast Filter</b>	Neutral Gray or Blue	Neutral Gray	Neutral Gray or Blue	None (note 2)	Amber

\* Persistence is short enough that no amearing is visible in rapidly changing pictures.

Note 1: P11 efficiency is given relative to radiometric measurement; all others are as measured photometrically.

Note 2: P11 is not recommended for direct viewing applications. Its primary use is in photography.

# HEWLETT-PACKARD INTERFACE BUS

Versatile interconnect system for instruments, computers, and controllers

Model 1350S

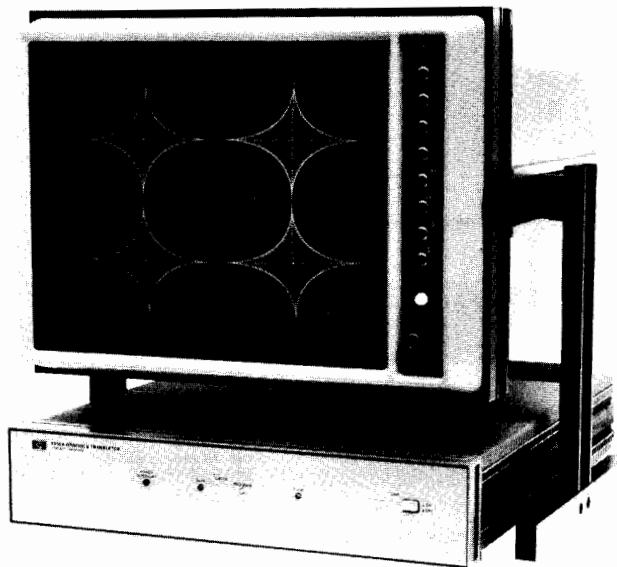

The 1350S Display System includes a 1311B X-Y Display, a 1350A Graphics Translator, rack mounting parts, a tilt stand with space below the display for a translator, an interconnecting cable, and a binder for instruction manuals.

## 1350S Display System

- High speed CRT display for HP-IB systems
- Operates with HP 85, 9825, 9835 or 9845
- System 1000 graphics accessory
- Remote display using RS-232-C (Option 001)
- 16-Bit parallel interface (Option 002)

Model 1350S is a high resolution display system that generates bright, sharp vectors and alphanumerics at high writing speeds. The system includes a graphics translator with the high speed HP-IB (IEEE 488-1975) interface that accepts digital data from desktop computers and minicomputers or microprocessor controlled systems. Data is stored in a digital memory which continually refreshes the display, without placing a load on the controller or computers.

## High Speed Graphics

The digital memory of the 1350S can be addressed in random fashion. Thus, any number of vectors or characters can be entered without erasing or rewriting all 2048 memory locations. For example, one curve on a graph can be updated while other picture elements remain unchanged. Random-access memory also increases the speed at which the graphics portion of a system can be operated. The 1350S is ideally suited for real time applications.

## Versatile Operation

Up to 32 files are available for storing text, graticules, or other segments of the picture. A file can be repetitively flashed to alert an operator to abnormal system operation such as an out-of-tolerance measurement. File Management capability allows the 1350S to display different information on up to three additional CRT's.

## Binary Tape Option

A 10184B Binary Tape option simplifies programming the 1350S when it is used with the 9825 Desktop Computer. It uses most of the same program commands as the 9872 or 9862 plotters. Additional commands are provided to blank and view individual files as well as flash segments of the picture. The 10184B binary program resides in 9825B memory, occupying 3806 bytes.

## RS-232C Interface Option

An RS-232-C interface option (001) can be substituted for the standard HP-IB interface. Option 001 is a teletypewriter interface (standard EIA RS-232-C/CCITT V-24).

Option 001 operates in an asynchronous, receive only mode. It provides a system clock at standard baud rates from 110 to 9600 that can be used to clock the teletypewriter interface in the controller or computer.

## 16-Bit Parallel Interface Option

A 16-bit parallel binary interface option (002) is also available in lieu of the standard HP-IB interface. This option allows the 1350A to receive data from a 16-bit computer or controller configured to output 16-bit bytes at very high data rate. The data transfer rate is 500k 16-bit bytes/sec, or up to approximately 250k vectors/sec.

## NOTES

For complete description and specifications, request technical data sheets for the 1350S Display System, the 1311B Display, and the 1350A Graphics Translator. An HP-IB cable is not supplied with the 1350S, and must be ordered separately.

## System Options

System Options	Price
001: RS-232-C interface instead of standard HP-IB	add \$100
002: 16-Bit parallel interface instead of std HP-IB	N/C
184: 10184B binary tape	add \$150
510: 1310B 19 in. X-Y display instead of 1311B	add \$600
517: 1317A 17 in. X-Y display (rack mounting configuration) instead of 1311B	less \$650
521: 1321A 21 in. X-Y display instead of 1311B	less \$550
604: P-4 phosphor display, without graticule	add \$30
639: P-39 phosphor display, without graticule	add \$30

## Ordering Information

1350S Display System (includes 1311B display)	\$9300
1350A Graphics Translator (supplied with 1350S)	\$3850
1008A Option C01 Testmobile	\$550

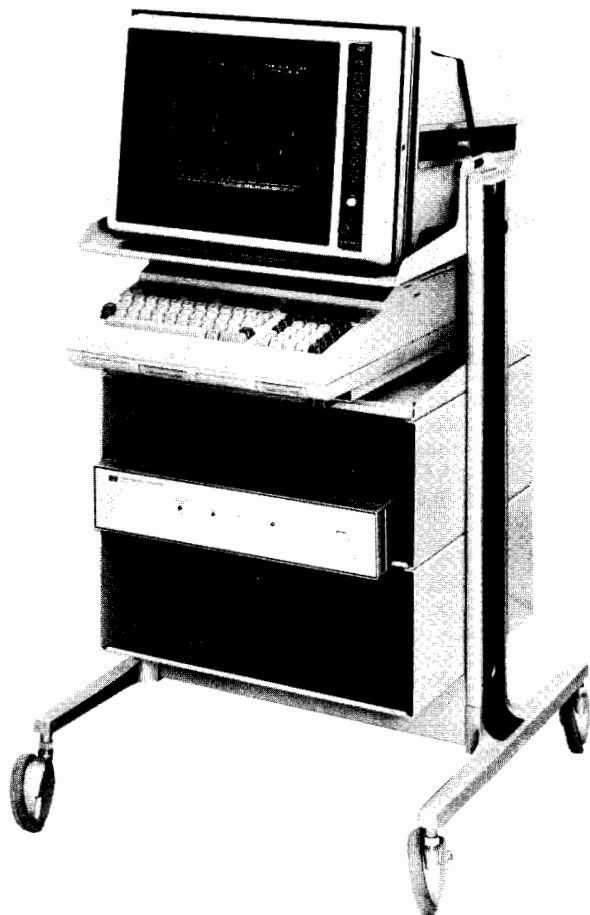

A complete, mobile softcopy graphics test station can be assembled using HP's Model 1008A C01 Testmobile with the options required to fit your application. With the configuration shown, HP small screen displays or the 1311B Large Screen Display may be used, and a slide-out tray is provided for the 9825 Computing Controller.





# HEWLETT-PACKARD INTERFACE BUS

Versatile interconnect system for instruments and controllers

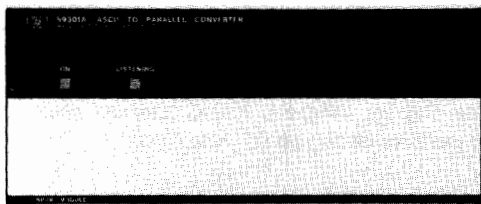

59301A

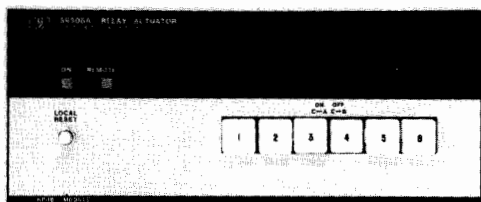

59306A

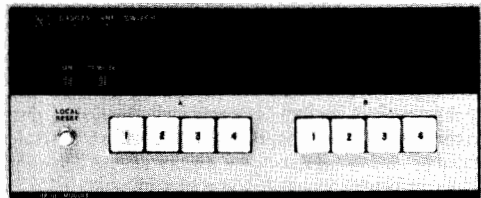

59307A

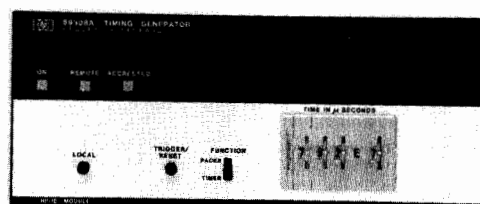

59308A

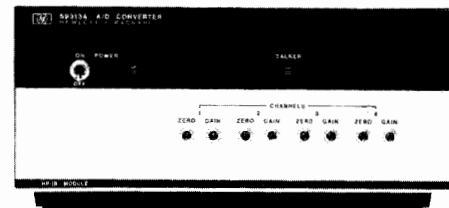

59313A

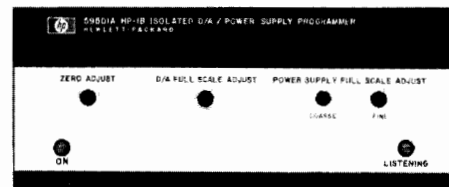

59501A

## HP-IB Accessory Modules

Modules in the HP 59300, 59400 and 59500-series are ideal building blocks for use with instruments to extend measurement capabilities. Modules listed here can be interconnected via the HP-IB to HP measuring instruments, signal sources and recording devices capable of operating directly on the HP-IB. In addition, these modules frequently serve as useful ways to interconnect with devices which are not themselves capable of direct HP-IB operation.

Instrument requirements differ. Some only output or accept data on the HP-IB. Others can be remotely programmed by ASCII characters sent along the HP-IB. These modules can work with instruments on any of these levels with or without a controller. Each module having controls can be operated stand-alone from its front panel, or it can be placed in automatic operation under program control.

Module provision for stand-alone, local operation also has important system benefits. The operator can set up and check out the system under manual control, avoiding otherwise complex and time consuming error tracing. Each module has status indicator lights that make it easy to monitor operation.

### 59301A ASCII-to-parallel Converter

Accepts byte-serial ASCII characters from the HP-IB and converts them to parallel output. A string of up to 16 characters terminated by linefeed is converted to 1-2-4-8 BCD and placed on the output lines; the ASCII linefeed character causes a print command (strobe) to be output by the 59301A.

With the 59301A, instruments with the HP-IB interface can be operated with HP 5050B/5055A Printers (requires two output cables, HP 562-16C, not furnished). Or, the 59301A can be used with HP 6129C thru 6131C and 6140A (Option J99) digitally-controlled power supplies for HP-IB programmable voltage and current. The 59301A can additionally be used to control other functions using its hexadecimal format.

#### General

**Size:** 101.6 mm H<sup>1</sup> x 212.9 mm W x 294.6 mm D (4" x 8.38" x 11.6")  
**Weight:** Net 1.70 kg (3.78 lb), Shipping 2.33 kg (5.16 lb)

**59301A ASCII-To-Parallel Converter** **\$575**

### 59303A Digital-to-analog Converter

Accepts an ASCII string and converts any three consecutive digits to a dc voltage accurate to 0.1% in 30  $\mu$ s. Fully programmable via the HP-IB. Height includes feet. With feet removed height is 88.1 mm (3.45")



59309A

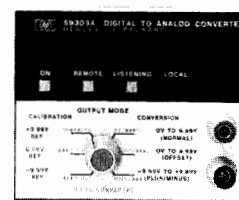

59303A

HP-IB or operates stand-alone from the front panel. Offers three output modes for conversion: normal, offset, or plus-minus (9.99 volts to -9.99 volts) to make it convenient for operating strip chart recorders.

A primary application for the HP 59303A is to present on a logging device the data points being taken during a measurement, such as with the HP 5345A Counter. No controller is required for operation. Compatible logging devices include strip chart recorders, X-Y plotters, and displays.

#### General

**Size:** 101.6 mm H<sup>1</sup> x 105.9 mm W x 294.6 mm D (4" x 4.17" x 11.6")

**Weight:** Net 2.61 kg (5.80 lb), Shipping 3.17 kg (7.04 lb)

**59303A Digital-To-Analog Converter** **\$1025**

### 59306A Relay Actuator

Has six Form-C relays that provide for control of external devices either manually from front panel pushbuttons or remotely from the HP-IB. Relay contacts are specified to switch 24 V dc or 115 V ac @ 0.5 A. Use the 59306A with HP 8761A/B SPDT switches for HP-IB programmable microwave switching dc-18 GHz; use it with HP 8494 thru 8496G/H attenuators for HP-IB programmable attenuation dc-18 GHz (external power supply required).

#### General

**Size:** 101.6 mm H<sup>1</sup> x 212.9 mm W x 294.6 mm D (4" x 8.38" x 11.6")

**Weight:** Net 2.64 kg (5.87 lb), Shipping 3.23 kg (7.18 lb)

**59306A Relay Actuator** **\$750**

### 59307A Dual VHF Switch

This module offers a pair of single throw 4-pole switches (dc to 500 MHz, 50 ohm) optimized for fast risetime (1 ns) pulse waveforms. Switches are independent and bidirectional, and can be operated either from front panel pushbuttons or remotely from the HP-IB.



# HEWLETT-PACKARD INTERFACE BUS

Versatile interconnect system for instruments and controllers

### General

**Size:** 101.6 mm H<sup>1</sup> x 212.9 mm W x 294.6 mm D (4" x 8.38" x 11.6")  
**Weight:** Net 2.64 kg (5.87 lb), Shipping 3.23 kg (7.18 lb)  
**59307A VHF Switch** **\$750**

### 59308A Timing Generator

Has two modes of operation—a pacing function which provides output at a specified rate, and a timing function which provides a delay with respect to a trigger for a specified period of time. Timed intervals can be selected by thumbwheel switches on the front panel, or can be programmed remotely from the HP-IB. Times from 1 μs to more than a day are available. Trigger inputs are available via HP-IB commands and rear panel connector. Timing outputs are available for both TTL and ECL levels, with switch selection of a squarewave or pulse output positive or negative-going edge. Output pulses are 500 ns ± 100 ns wide, and rise time is < 50 ns (into 50 Ω).

### General

**Size:** 101.6 mm H<sup>1</sup> x 212.9 mm W x 294.6 mm D (4" x 8.38" x 11.6")  
**Weight:** Net 2.10 kg (4.67 lb), Shipping 3.83 kg (8.51 lb)  
**59308A Timing Generator** **\$1150**

### 59309A Digital Clock

Displays month, day, hour, minute and seconds, and upon command will output time via the interface bus. Time can be set into the clock by local control, or by remote commands received from the HP-IB. The clock accepts a small internal battery which can provide more than a day's standby during short power interruptions. Alternately, an external source such as the K10-59992 can sustain the clock for up to one year.

### General

**Size:** 101.6 mm H<sup>1</sup> x 105.9 mm W x 294.6 mm D (4" x 4.17" x 11.6")  
**Weight:** Net 1.70 kg (3.78 lb), Shipping 2.84 kg (6.31 lb)  
**59309A HP-IB Digital Clock** **\$1025**

### 59313A Analog-to-Digital Converter

This medium-speed 4-channel unit can accept a full scale input of ± 10 V dc on each channel, individually selectable in four ranges. It also has a program-controlled reverse channel for driving small signal lamps, relays, or TTL circuits. An HP-IB controller can command this unit to perform a single conversion, or initiate a series of internally-paced conversions at one of six selectable rates (up to 200/s on one channel; up to 50/s on each of four channels). Sampling can also be initiated externally by TTL transition or contact closure to ground.

### General

**Size:** 101.6 mm H<sup>1</sup> x 212.9 mm W x 345.4 mm D (4" x 8.38" x 13.6")  
**Weight:** Net 5.45 kg (12.0 lb), Shipping 6.36 kg (14.0 lb)  
**59313A Analog-To-Digital Converter** **\$1900**

### 59501A Power Supply Programmer (Isolated DAC)

This single-channel digital-to-analog converter can control a wide range of power supplies (output voltage, or current), as well as other analog programmable devices. It may also be used as a low level signal source, depending on the speed of the controller. It has two output ranges (0-1 and 0-10V dc in unipolar mode; -1 to +1 and -10 to +10 V dc in bipolar mode), as well as photo-isolators which electrically separate HP-IB control and data lines from power supply circuitry by up to 600 V dc. (Additional details on page 252.)

### General

**Size:** 101.6 mm H<sup>1</sup> x 212.9 mm W x 194.6 mm D (4" x 8.38" x 11.6")  
**Weight:** Net 2.61 kg (5.80 lb), Shipping 3.17 kg (7.04 lb)  
**59501A Power Supply Programmer** **\$625**

<sup>1</sup>Height includes feet. With feet removed height is 88.1 mm (3.47").

### With a Multiprogrammer

Your HP Desktop or Minicomputer Becomes a Reliable Easy-to-use Automatic Test or Control System



### MULTIPROGRAMMER

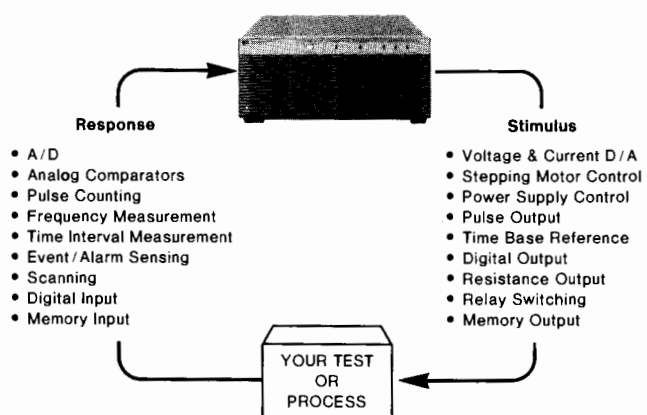

### Benefit from the Multiprogrammer Functional Card System

You can quickly design and implement a control system using the HP-IB and one of the HP Multiprogrammers. Choose from the wide selection of functional plug-in cards and assemble them into a Multiprogrammer mainframe to economically interface your analog and digital input/output signals. The Multiprogrammer provides the interface between your HP-IB controller and the physical world. Thousands of Multiprogrammers are in everyday use as the nucleus of user defined and assembled systems for production testing and control, data acquisition, process monitoring, laboratory experiment control, life testing, quality control, and component evaluation.

Start building your system with one of the HP Multiprogrammers combined via the HP-IB with a computing controller. To help you, HP offers a variety of proven design aids. These include the *Multiprogrammer Technical Brochures* complete with capabilities, typical system layouts, specifications, and more; . . . A *User's Guide* that gives you sample programs, test routines, and I/O interface data for all 38 Multiprogrammer plug-in cards . . . There is also a *Utility Cartridge* with a recorded program ready to use in the HP 9825A, 9835A and 9845A computing controllers, to aid in writing your own application . . . and a *System Throughput Analysis* that allows you to accurately determine the measurement and control speed you can expect before you build your system.

Refer to pages 665 and 668 for more details on the HP 6940B and 6942A Multiprogrammers and how they are used with the HP-IB.

Model	Description	Dimensions—max. height x width x depth mm (inches)	Net Weight kg (lb)	Shipping Weight kg (lb)	Price
59301A	ASCII-to-parallel Converter	101.6 x 212.9 x 294.6 (4 x 8.38 x 11.6)	1.70 (3.78)	2.32 (5.16)	\$ 575
59303A	Digital-to-analog Converter	101.6 x 105.9 x 294.6 (4 x 4.17 x 11.6)	2.61 (5.80)	3.17 (7.04)	\$ 1025
59306A	Relay Actuator	101.6 x 212.9 x 294.6 (4 x 8.38 x 11.6)	2.64 (5.87)	3.23 (7.18)	\$ 750
59307A	VHF Switch	101.6 x 212.9 x 294.6 (4 x 8.38 x 11.6)	2.64 (5.87)	3.23 (7.18)	\$ 750
59308A	Timing Generator	101.6 x 212.9 x 294.6 (4 x 8.38 x 11.6)	2.10 (4.67)	3.83 (8.51)	\$1150
59309A	HP-IB Digital Clock	101.6 x 105.9 x 294.6 (4 x 4.17 x 11.6)	1.70 (3.78)	2.84 (6.31)	\$1025
59313A	Analog-to-digital Converter	101.6 x 212.9 x 345.4 (4 x 8.38 x 13.6)	5.45 (12.0)	6.36 (14.0)	\$1900
59401A	Bus System Analyzer	145.5 x 205.1 x 495.3 (5.73 x 8.08 x 19.5)	5.64 (12.44)	9.1 (20)	\$2900
59403A	HP-IB/Common Carrier Interface	101.6 x 212.9 x 430.0 (4 x 8.38 x 16.9)	4.50 (10.0)	6.10 (13.5)	\$1900
59501A	Power Supply Programmer	101.6 x 212.9 x 194.6 (4 x 8.38 x 11.6)	2.61 (5.80)	3.17 (7.04)	\$ 625

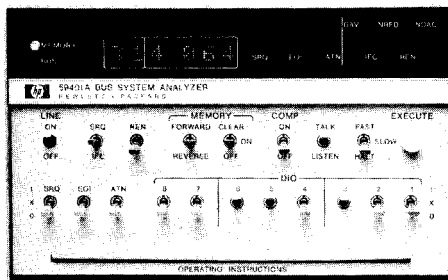

59401A

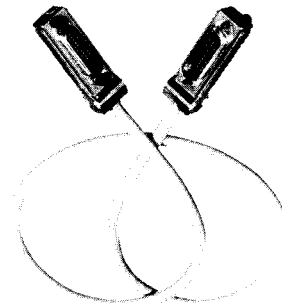

10833A/B/C/D

## 59401A Bus System Analyzer

The HP-IB (IEEE 488) concept has greatly simplified many of those things which have in the past made instrument interfacing a burdensome task. Even so, software errors can occur if the system designer does not completely understand the bus system or the capabilities of the instruments and other devices being interfaced. Hardware problems can occur if the instruments/devices are not functioning properly, or if they are not completely compatible with the bus standard.

The 59401 Bus System Analyzer is especially useful in design and service work. It simplifies and speeds up the diagnosis of software and hardware problems by allowing the user to see the status of all bus lines, including the actual characters on the bus data lines. Because the 59401A can also drive all bus lines, it can completely exercise another Talker, Listener or Controller—which is especially useful in verifying compatibility of new or user-designed products with the HP-IB.

There are several choices of analyzer operating speed. It may be operated at one character at a time (useful for software debugging), at 2 characters per second, or at regular bus speed. It may also be operated at a variable rate as determined by the external clock input.

The analyzer's 32 character memory can be used to store bus characters in the Listen mode, or to output characters to the bus in the Talk mode. When the analyzer is in the Compare mode, a stream of bus traffic may be stopped on a pre-selected character—and at that time, a trigger pulse is available, which is very useful when analyzing transient or timing problems related to the bus.

## 59401A Specifications

**Display:** monitors all bus lines. Represents data lines, any memory location, or DIO front panel switch settings; in octal code and ASCII character.

**Listen mode:** stores up to 32 characters of bus traffic in memory for real time and repetitive testing. In compare mode, halts bus traffic when a selected character is present, and user can display any one of the previous 31 characters stored in memory.

**Timing:** accept <750 ns; ready <750 ns.

**Talk mode:** bus lines can be driven directly from front panel switches; memory can be loaded from front panel switches for driving bus with a 32 character sequence.

**Timing:** (1) data changed >500 ns before DAV pulled low; (2) ATN driven low > 1 μs before DAV pulled low; (3) DAV driven high <700 ns after NDAC is false; (4) DAV driven low <700 ns after NRFD is false, if conditions 1 and 2 are met.

**Operating speeds:** one character at a time, 2 characters per second, regular bus speed, or variable rate determined by external clock input; in either Listen or Talk mode.

**External clock input:** 1 standard power TTL gate input; ≤10 MHz repetition rate.

**Compare output:** provides 1 standard power TTL gate output (LOW TRUE) sync pulse when bus character is same as front panel switches.

**HP-IB load:** 1 bus load (capable of driving 14 other bus devices).

### General

**Temperature ranges:** operating, 0 to 50°C; storage, -40 to +75°C.

**Humidity:** 95% relative, 0 to 40°C.

**Power requirements:** 100, 120, 220 or 240 V +5%, -10%; 48 to 66 Hz; ≤42 VA.

**Size:** 145.5 H, 205.1 W, 495.3 mm D (5.730" x 8.075" x 19.500")

**Weight:** net, 5.64 kg (12.44 lb).

### Options and Accessories

**5061-0089** front handle kit

**10631B** 2 m (6.6 ft) bus cable, furnished

### Price

\$32

N/C

### 59401A Bus System Analyzer

\$2900

## HP-IB Interconnection Cables

Cables for interconnecting HP-IB devices are available in four different lengths. The connector block at both ends of each HP-IB cable (photo above) has a plug on one side and a matching receptacle on the other, so that several cables may be conveniently connected in parallel, thus simplifying system interconnection. Lock screws provide for secure mounting of each connector block to an HP-IB instrument, or to another cable connector block.

**SPECIAL NOTE:** HP-IB cables are not always included with individual HP-IB devices, particularly those that normally connect directly to an HP computing controller. (The HP-IB interface for HP computing controllers contains the necessary cable and connector). Product listings in this catalog should be checked to see if HP-IB cables are furnished.

The new 10833 series of cables features an improved shielding design which can help to improve overall RFI levels in many systems. These new cables are completely compatible with the 10631 cable series.

The 10834A adapter was designed to help in cases where rear panel space has resulted in difficult cabling situations. The adapter provides clearance by extending the first cable connection 2.3 cm away from the rear panel of the instrument.

### Ordering Information

**10631A** HP-IB Cable, 1 m (3.3 ft)

**10631B** HP-IB Cable, 2 m (6.6 ft)

**10631C** HP-IB Cable, 4 m (13.2 ft)

**10631D** HP-IB Cable, 0.5 m (1.6 ft)

**10833A** HP-IB Cable, 1m (3.3 ft)

**10833B** HP-IB Cable, 2m (6.6 ft)

**10833C** HP-IB Cable, 4m (13.2 ft)

**10833D** HP-IB Cable, 0.5m (1.6 ft)

**10834A** Adapter

### Price

\$70

\$75

\$85

\$70

\$70

\$75

\$85

\$70

\$20



# HEWLETT-PACKARD INTERFACE BUS

Versatile interconnect system for instruments and controllers

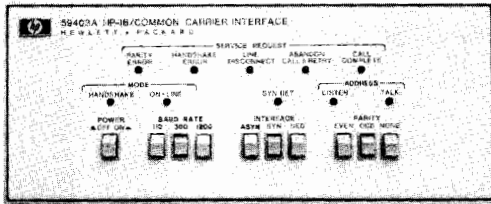

59403A

12050A

12050A

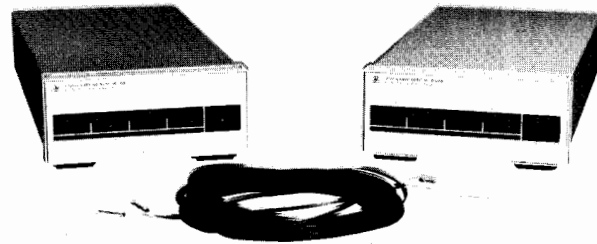

39200 series Fiber Optic Cable

## HP-IB Operating Range

A fundamental limitation which applies to all devices designed to comply with IEEE Standard 488 is that the maximum cumulative length of HP-IB cable in any system should not exceed 2 metres of cable per device, or 20 metres, whichever is less.

However, for many applications, there is a requirement to interconnect HP-IB devices at sites separated by several hundred metres or even thousands of miles. Hewlett-Packard has developed several products which allow the HP-IB operating range to be extended, using twisted pair cable, coaxial cable, fiber optics or the telephone network.

## HP 12050A Fiber Optic HP-IB Link With 39200 Series Cable

- Extends HP-IB length up to 100 metres via Fiber Optic Cable
- 20 kbytes/s data rate
- Excellent electromagnetic noise immunity
- Electrical isolation between distant sites
- Built-in self test and error correction

A single point-to-point Fiber Optic HP-IB Link consists of two HP 12050A Fiber Optic HP-IB Link units, one at the local controller site and the other at the remote instrumentation site. The 12050A units are connected using a single length of 39200 Series Fiber Optic Duplex Cable or two Simplex Cables. Data transfer rate is up to 20 KBytes/s regardless of cable length. If a remote device requests service, the service request (SRQ) will be asserted at the local end of the Link typically within 100  $\mu$ s of its occurrence. Thus for many HP-IB applications, no system performance degradation will be observed when extending the bus length with the Fiber Optic HP-IB link. HP-IB devices communicate programmatically via the 12050A units just as they would in local operation. Since information is transmitted using light pulses rather than electrical signals, it is impossible for large electromagnetic fields to interfere with data being sent over the Fiber Optic Cable.

## Specifications

### HP 12050A Fiber Optic HP-IB Link

**Power Requirements:** 86 to 127 V ac; 172 to 254 V ac. 48 to 66 Hz. 15 W.

**Operating Temperature/Humidity:** 0 to 55°C. 10 to 95% RH; non-condensing at 40°C

**Size:** 9 H x 21 W x 44 cm D (3.5" x 8.4" x 17.4")

**Weight:** 2.75 kg (6 lb. 1 oz.)

### 39200 Series Fiber Optic Cables

**Operating temperature:** 0 to 70°C.

**Storage temperature:** -40 to 85°C.

**Relative Humidity:** 95% at 70°C.

**Max. tensile force on Cable:** 60 kg (132 lbs.).

**Max. tensile force on Connector/Cable:** 5 kg (11 lbs.).

**Min bend radius:** 7 mm (0.3 in.)

**Flexing:** 50000 cycles (180° bending at minimum bend radius).

**Crush load:** 20 kg (44 lbs.)

## Ordering Information

### 39200 Series Fiber Optic Cables<sup>1</sup>

Length	Simplex		Duplex	
	(2 req'd/system)	Price	(1 req'd/system)	Price
10 m	39201A	\$110	39201B	\$225.00
25 m	39202A	\$140	29302B	\$292.50
50 m	39203A	\$190	39203B	\$405.00
75 m	39204A	\$240	39204B	\$517.50
100 m	39205A	\$290	39205B	\$630.00

### 12050A Fiber Optic HP-IB Link<sup>2</sup>

**\$1950 ea**

<sup>1</sup>Quantity discounts available.

<sup>2</sup>(Two required per system)

Product	59403A Common Carrier Interface	37201A HP-IB Extender	12050A Fiber Optic Link	37203A HP-IB Extender
Application	General purpose; inter/intra facility	General purpose; inter/intra facility	Fast; intra facility	Fast; intra facility
Transmission Medium	Dual twisted pair or modem link	Dual twisted pair or modem link	Dual fiber optic cable	Single coax or dual fiber optic cable
Operating Range	Twisted pair: 1000 metres; Modem link: unlimited	Twisted pair: 1000 metres; Modem link: unlimited	100 metres	1000 metres
Modem Data Rates	Asynchronous: 110/300/1200 bits/s	Asynchronous: 150/300/600/1200 bits/s Synchronous: up to 19200 bits/s	—	—
Hardwired Speed	1760 bytes/s	775 bytes/s	20k bytes/s	Up to 50k bytes/s
Error Checking	Parity only, no retransmission	Block check with auto retransmission	Checksum byte with auto retransmission	Cyclic redundancy check
Electrical Noise Isolation	—	Balanced coupling on hardwired links	Optical	Fiber optic or opto-isolated coax
Programming Transparency	No	Yes, except Parallel Poll and Pass Control	Yes, except Parallel Poll and Pass Control	Yes, including Parallel Poll and Pass Control

## 59403A HP-IB/Common Carrier Interface

Provides a way to extend the separation of component parts in an HP-IB system by more than the 20-metre maximum transmission path length specified in various interface standards, and it is especially useful for production or remote site applications. Distances up to 1000 metres are possible by using two 59403A modules (one at each location) interconnected by a dedicated and shielded two-twisted-pair cable. And even longer distances can be achieved by using a telephone line (with appropriate modems) instead of the dedicated cable.

The recommended dedicated cable is available from HP as Part Number 8120-1197 (Belden type 8723). The 59403A is designed to operate with 110, 300, and 1200 baud asynchronous or synchronous full duplex modems which are EIA RS 232C or CCITT V.24 compatible. In the U.S., Bell 103A modems with "soft carrier turn-off" are recommended for the direct dial (DDD) network. (Check your local telephone authorities regarding data communication regulations.)

59403A HP-IB/Common Carrier Interface

**\$1900**

# HEWLETT-PACKARD INTERFACE BUS

Versatile interconnect system for instruments and controllers  
Model 37201A



- Transparent extension of HP-IB systems
- Operation over twin-pair cable or modems
- Automatic error detection and correction
- High immunity to electrical interference
- Multi-point (multi-drop) capability
- Auto-dialler interface

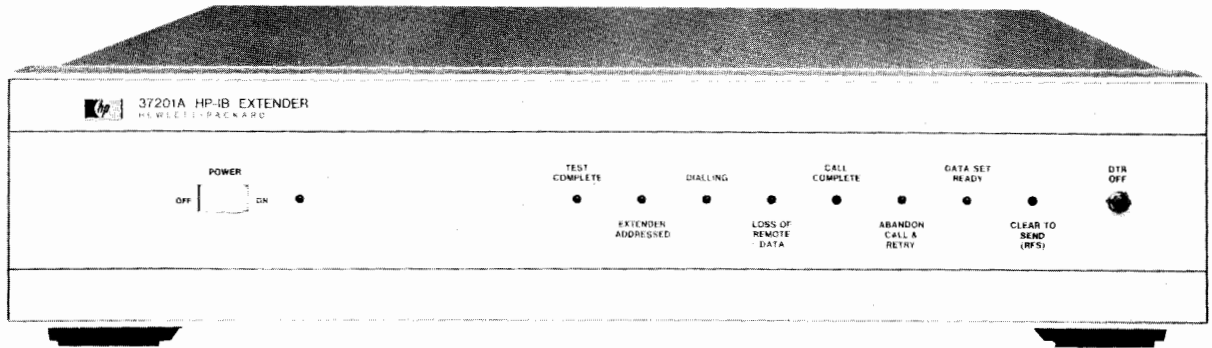

The 37201A HP-IB Extender overcomes the limited range available with direct HP-IB cable interconnections. Each 37201A converts parallel data from the interface bus into a serial bit stream, suitable for transmission to a remote site, and reconverts incoming serial data to bit-parallel HP-IB format. An HP-IB system can therefore be split into two or more discrete parts separated by HP-IB Extenders and a serial data link. A range of 1000 metres is obtainable if twin-pair cable is used for the transmission path, and virtually unlimited range is available if a modem link is used. Communication between Extenders is full duplex, allowing information to flow in both directions simultaneously.

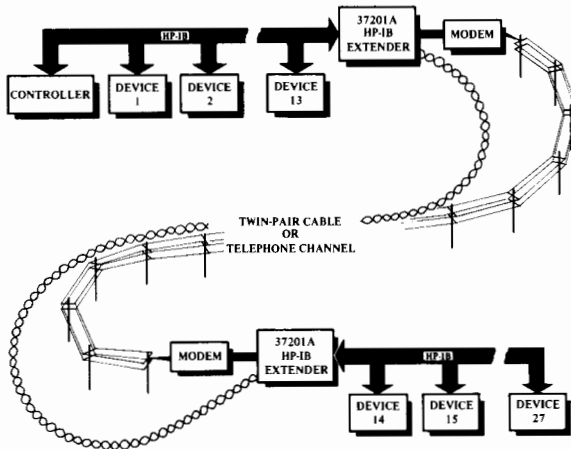

Point-to-point connection using twin twisted pair cable or full duplex modem link.

A pair of HP-IB Extenders provides a transparent interface between local and remote HP-IB devices. Program control of the 37201A is seldom necessary. Consequently, HP-IB Extenders can be added to an HP-IB system usually without any modification of software and without writing special routines to control the Extenders. The 37201A supports the full range of HP-IB functions with the exception of Parallel Poll and Pass Control.

Integrity of HP-IB data and control signals is assured by an automatic error-checking protocol, which retransmits any data corrupted in transmission. The 37201A is in general compliance with each of the following standards and supports their major capabilities:

- IEEE Standard 488-1978
- ANSI Standard MC1.1
- IEC Standard 625-1

### Twin-Pair Cable Operation

Twin twisted-pair cable provides a simple inexpensive transmission medium for distances up to 1000 metres. The serial data rate is nominally 20 kbit/s. Suitable cable is available as an accessory (HP Part Number 8120-1187). Transformer coupling within the 37201A gives a high degree of immunity from the effects of common mode signals. This, combined with the automatic error correction capability, makes the 37201A suitable for use in an electrically hostile environment.

### Modem Link Operation

The 37201A is designed to operate with a wide range of synchronous and asynchronous modems over private lines, leased lines, or the public switched (dial-up) telephone network. The data interface is compatible with EIA RS-232C and CCITT V.24 and V.28 standards. Asynchronous data rates provided are: 150, 300, 600, and 1200 bit/s. For synchronous modems, operation at any bit rate up to 19.2 kbit/s is possible. Besides operating in point-to-point mode, the 37201A can be used with modems in a multi-point (multi-drop) leased line configuration involving up to 31 remote sites. When operating over the public switched telephone network, connections may be dialled manually. Alternatively, an external auto-dialler may be used to make connections under program control. The 37201A has an RS-366/V.25 interface to permit operation with an auto-dialler.

The error checking/correcting communications protocol used in the 37201A protects against errors introduced by poor quality data circuits. It even provides immunity to major interruptions in the data link, such as dropouts, line breaks and modem sync loss, and recovers automatically without loss of data.

The following HP modems are suitable for use with the 37201A: Models 37210T, 37220T, and 37230A.

**37201A HP-IB Extender**

**\$2115**

# HEWLETT-PACKARD INTERFACE BUS

Versatile interconnect system for instruments and controllers

Model 37203A



- Transparent HP-IB extension up to 1000 metres
- HP-IB transfer rate up to 50k bytes/s
- Supports all HP-IB functions including Pass Control and Parallel Poll

- Transmission over single low-cost coaxial cable or, with Option 001, dual optical fiber
- Electrical isolation plus error detection and correction protect HP-IB from transmission errors

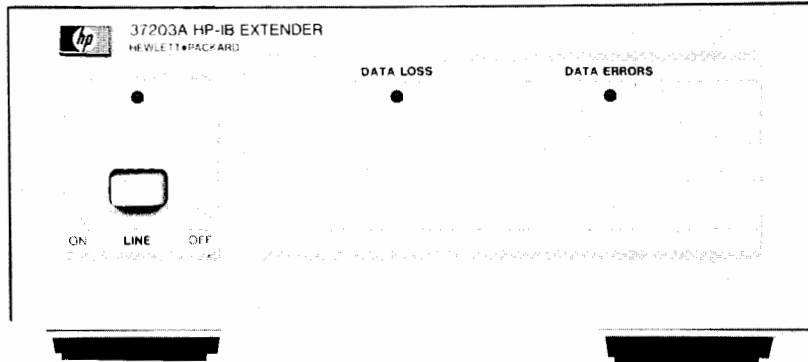

37203A

The 37203A HP-IB Extender overcomes the limited range available with direct HP-IB cable interconnections, providing a high-speed, low-cost means of extension up to 1000 metres.

37203A's are used in pairs: each Extender serialises the normally parallel HP-IB information and transmits it in serial format over a single coaxial cable, used for both directions of transmission, to another Extender located up to 1000 m distant. This second 37203A converts the serial data back into normal HP-IB format. In addition to transmission over a single coaxial cable, Option 001 of the 37203A allows transmission of the serial data over dual optical fiber.

The 37203A is in general compliance with each of the following standards and supports their major capabilities:

- IEEE Standard 488-1978
- ANSI Standard MC1.1
- IEC Standard 625-1

### Speed

The maximum HP-IB byte transfer rate between a pair of 37203A's is determined by several factors including serial transmission rate, link propagation delay and the source and acceptor handshake rates of the slowest device connected to the bus at either end of the link.

The serial transmission rate between 37203A's has been chosen to give the best compromise between transfer rate and transmission range that can be achieved over the recommended coaxial cable. This rate can be reduced to achieve greater range, as explained below.

Nominal HP-IB Transfer Rates (k bytes/s)

Coaxial Cable				Optical Fiber (Opt 001)		
Short* (At normal speed)	250m (max range at normal speed)	500m (max range at 1/4 speed)	1000m (max range at 1/16 speed)	Short*	250m	1000m
50	40	14.2	2.75	50	39	25

\* For distances < 250m, interpolate between Short and 250m columns.

### Range

When using coaxial cable, the operating range of the 37203A is limited by the signal attenuation of the cable. This increases approximately with the square root of the signal frequency. Using the recommended cable type (or equivalent), transmission range is up to 250 m at the normal serial transmission rate. At 1/4 of the normal rate, the range is increased to 500 m. A further increase in range up to 1000 m can be achieved by reducing the transmission rate to 1/16 of the normal rate.

With the optical fiber option (001) fitted, the 37203A operates over distances up to 1000 m at the normal serial transmission rate.

### Parallel Poll Operation

The 37203A supports the Parallel Poll function but because of the absolute transmission delay, a guaranteed response cannot be delivered within 200 ns, as required by IEEE 488. Instead, the response from distance devices is returned as rapidly as possible to the polling controller.

### Pass Control

Some HP-IB systems include more than one device which can be Active Controller. Control of the bus can be passed between capable devices using the Take Control (TCT) command. With the 37203A, there is no restriction on the use of Pass Control.

### Transmission Over Coaxial Cable

The standard serial link between 37203A's is a single coaxial cable which is used for transmission in both directions. Coaxial cable was chosen for this link because it is relatively inexpensive, easy to handle, and easy to obtain. The use of Belden type 9248 cable (or equivalent) is recommended.

### Transmission Over Optical Fiber

Option 001 of the 37203A provides the capability of operation over duplex optical fiber as a user selectable alternative to coaxial cable. The use of optical fiber removes the metallic path between the Extenders and, therefore, eliminates all risk of electromagnetic pick-up on the link. Option 001 is recommended for use in severe electrical environments or where the use of electrical signalling is not acceptable. A further advantage of optical fiber is that it enables a higher byte transfer rate to be attained for transmission distances greater than 250 m than is possible with coaxial cable (see table).

### Error Detection and Correction

Data is transmitted across the link in frames. Each frame includes a cyclic redundancy check code which is rechecked when the frame is received. Any transmission errors which are detected cause the frame to be rejected. Data integrity is maintained by automatic retransmission of the rejected data frame. The presence of errors in the received data causes the DATA ERRORS indicator on the 37203A front panel to be illuminated.

### Options

- 001: Fiber Optic Interface
- 301: Rack Mount Adaptor
- 302: Dual Rack Mount Adaptor

### Prices

- \$600
- \$30
- \$50

**37203A HP-IB Extender**

**\$1080**

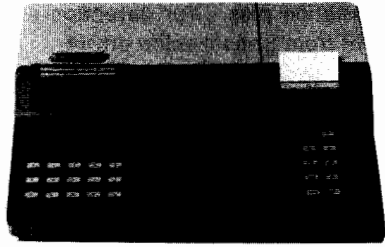

HP 9815 Desktop Computer (HP 98135A Interface)

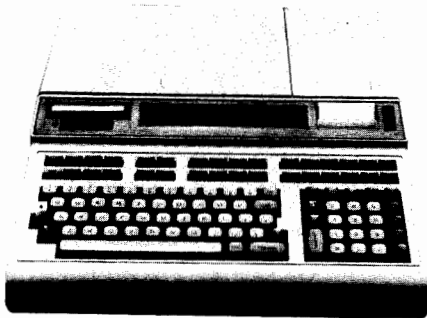

HP 9825 Desktop Computer (HP 98034A Interface)



System 35 Desktop Computer (HP 98034A Interface)

## Role of a Controller

In addition to managing the flow of information over the bus, the controller in a measurement system schedules measurement tasks, sets up individual devices so they can perform the tasks, monitors measurement progress and interprets results.

An HP controller can provide access to display, input/output and data storage peripherals such as plotters, line printers, floppy discs and tape cartridges. A controller can also provide the tools for program development. These normally include an editor for generating source programs, debug aids used in analyzing and modifying program flow, and a means of storing and recalling programs and/or results.

## Controllers Working Together

Individually, a controller such as either the HP 9825 or the HP 1000 can handle program development and data collection, processing and storage. However, establishing cooperation between two such computers merges the relative strengths of both machines to form a system with more efficiency and versatility than is possible using either computer alone. For example, passing HPL programs from the HP 9825 to the HP 1000 and back again avoids wear and tear on the HP 9825 tape drive, and allows the use of the HP 1000 text-editing feature to modify or create HPL programs for the HP 9825.

## HP Controller and Interface Selection

Hewlett-Packard offers a wide selection of HP-IB (IEEE-488) controllers. For engineering design or other single-user applications, a desktop unit such as the HP 85, 9815, 9825, System 35 or System 45 may be preferred. But for high-volume production testing at multiple locations involving multiple users, your choice could be one of the solutions offered by the HP 1000 Computer.

Using an HP-IB interface allows any of these HP computers to control as many as 14 HP-IB compatible devices.

HP controllers, their HP-IB and other interfaces are described briefly below. For detailed information on the controllers, please consult pages 620-628.

## HP-85A and 82937A HP-IB Interface

The HP-85A is a complete BASIC language computer with 16K of read/write memory, expandable to 32K and 32K of read-only memory, expandable to 80 K; a built-in CRT display that provides 16 lines (scrolls 64 lines) of 32 alphanumeric characters each, and a quiet, built-in, bidirectional thermal printer.

Configured with the I/O ROM and the 82937A HP-IB Interface, the HP-85A is an economical HP-IB controller.

## 9815 and 98135A HP-IB Interface

The 9815 desktop unit, another cost-effective HP controller, is used to perform the less complex tasks associated with small systems. It provides a 16-character numeric display, a thermal printer, and a high-speed tape cartridge system.

The 98135A HP-IB Interface allows the 9815 to function as a controller, but without interrupt capability.

## 9825, System 35 or System 45 and 98034A HP-IB Interface

The 9825, HP's fastest desktop controller, uses HPL, a high-level programming language that provides for subroutine nesting and flags. It includes a two-level interrupt capability. The 9825 has a 32-character alphanumeric display, a 16-character printer and a high-performance data cartridge system. Three slots are available for interfaces.

The Series 9800 System 35 (Models 9835A and B) offers user read/write memory from 64K to 256K bytes, built-in tape cartridge drive, optional thermal printer and a range of interfacing capabilities, plus 15 levels of priority interrupt. System 35A has a 12-inch CRT display, while System 35B has a 32-character single-line display. The standard programming language is BASIC, with Assembly Language available to experienced programmers for speed enhancement in specialized applications.

The Series 9800 System 45 is an integrated desktop computer that excels in such applications as mathematical modeling, design analysis, text processing and linear programming. It provides 15 levels of priority interrupt, and includes a CRT display, an optional 80-character thermal line printer, enhanced BASIC language and tape cartridge drive (one standard, the second optional). The System 45 optionally offers color graphics capability with a CRT capable of displaying up to 4913 distinguishable colors to enhance presentation of data and interpretation of results.

The HP 98034A Interface is required for operating the 9825, System 35 or System 45 in HP-IB applications. I/O ROMs are built into the 9825 for complete HP-IB control, whereas the 9835A/B requires an optional General I/O ROM. System 45 has complete HP-IB capability when combined with the Opt. 312 I/O ROM. Several interfaces can be plugged into the 9825, the System 35 or System 45, and additional interfaces can be connected using the 9878A I/O expander.

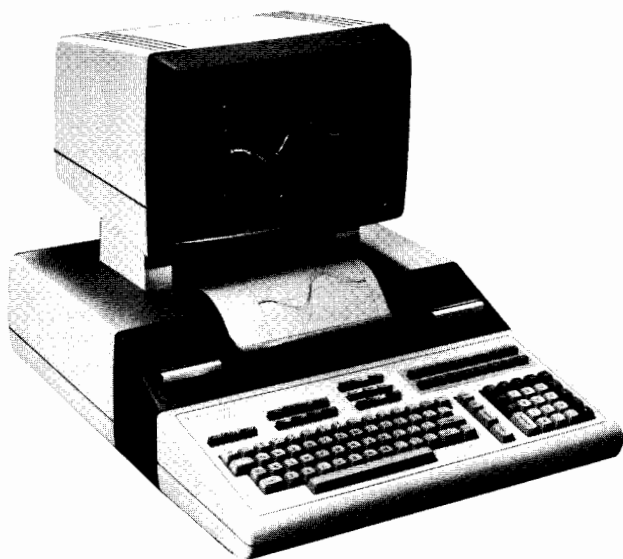

System 45 Desktop Computer (HP 98034A interface)

### HP 1000 and 59310B HP-IB Interface

The HP 1000 computer system is well suited for broad measurement and data management requirements. Combining an E-series or F-series computer and Real Time Executive Software, the HP 1000 can concurrently control multiple clusters of HP-IB test and measuring equipment, which may be organized into separate physical or functional groupings. Each grouping may have up to 14 HP-IB devices per cluster.

Each separate bus cluster connected to the HP 1000 requires one 59310B Interface. The 59310B is supported by a driver, utility software and a manual supporting operation in HP's memory-based RTE-M and disc RTE-II and RTE-IV Real Time Executive systems. A diagnostic routine for quickly confirming correct operation is included with the interface. Compatibilities between various HP computer systems, computers and operating systems are shown below. The E-series and F-series computers include the HP 2170A, 2171A, 2172A, 2174A/B, 2175A, 2176A/B and 2177A/B. Note that the 59310B interface may also be used with HP 2100A/S computers.

	HP 1000	HP 2105A	HP 2176A/B 2177A/B	HP 2100A/S
RTE-M:	Yes	Yes	Yes	No
RTE-II:	Yes	No	Yes	Yes
RTE-IV:	Yes	No	Yes	No

### Other Interfaces

HP offers all the above HP-IB interface cards, plus others designed for customers who want to build custom, computer-controlled instrumentation systems.

### HP-85 Interface Cards

- 82939A Serial Interface — provides RS-232-C compatible I/O for communication with devices such as printers and terminals.
- 82940A GPIO Interface — general purpose 16-bit interface for connection to TTL-type signal levels.
- 82941A BCD Interface — 11 digit input or output capability for binary coded decimal instruments.

### 9815 Interface Cards

- 98133A BCD Interface — provides 9-digit BCD input with high-speed mode, 8-bit parallel output.



HP 1000 Computer System (HP 59310B interface)

- 98134A General Interface — bidirectional 8-bit parallel interface.
- 98136A RS-232-C Serial Interface — conforms to EIA RS-232-C recommended specifications.
- 98137A Tape Duplication Interface — allows duplicating tapes using two 9815s.

### 9825 and Systems 35 and 45 Interface Cards

- 98032A 16-bit Parallel Interface — latched 16-bit input/output for bidirectional transfer of information.
- 98033A BCD Input Interface — connects the 9825 with bit-parallel, digit-parallel BCD devices.
- 98035A Real Time Clock — adds real time reference and time-related control capabilities to the 9825, 9835 and 9845.
- 98036A Serial Interface — provides bit serial communication between the desktop computers and asynchronous EIA RS-232-C devices such as data terminals and modems.
- 98040A Incremental Plotter Interface — allows the System 45 to access large flatbed and drum incremental plotters.
- 98041A Disc Interface — provides the System 45 access to large capacity, high-speed disc peripherals.

### Ordering Information

	Price
<b>59310B</b> Interface, RTE-II/IV for HP 1000	\$ 600
<b>82937A</b> HP-IB (IEEE-488-1978) Interface	395
<b>82939A</b> Serial Interface	395
<b>82940A</b> GPIO Interface	495
<b>82941A</b> BCD Interface	495
<b>98032A</b> 16-bit Parallel Interface	500
<b>98033A</b> BCD Input Interface	500
<b>98034A</b> HP-IB (IEEE-488-1978) Interface	500
<b>98035A</b> Real Time Clock Interface	600
<b>98036A</b> Serial Interface	700
<b>98040A</b> Incremental Plotter Interface	600
<b>98041A</b> Disc Interface	2100
<b>98133A</b> BCD Interface	600
<b>98134A</b> General 8-bit Parallel Interface	400
<b>98135A</b> HP-IB (IEEE-488-1978) Interface	700
<b>98136A</b> RS-232-C Serial Interface	600
<b>98137A</b> Tape Duplication Interface	600



# AMPLIFIERS

General purpose amplifier & attenuator  
Models 461A, 465A, 467A, & 350D



461A

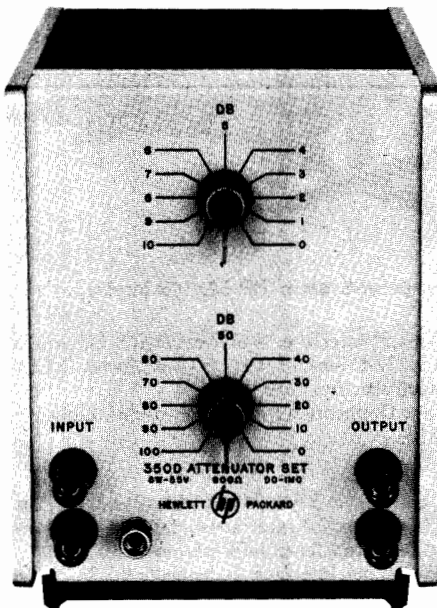

350D

## 461A Description

This general purpose amplifier can be used as a preamplifier to raise the level of a signal or as a buffer.

The solid-state HP amplifier Model 461A provides stable 20 and 40 dB gain over a wide frequency range with fast rise time.

### 461A Specifications

**Frequency response:**  $\pm 1$  dB, 1 kHz to 150 MHz when operating into a 50  $\Omega$  resistive load (500 kHz reference).

**Gain at 500 kHz:** 40 dB  $\pm 0.5$  dB or 20 dB  $\pm 1.0$  dB, selected by front panel switch (inverting).

**Input impedance:** nominal 50  $\Omega$ .

**Maximum input:** 1 V rms or 2 V p-p pulse.

**Maximum dc input:**  $\pm 2$  V.

**Maximum output:** 0.5 V rms into 50  $\Omega$  resistive load.

**Equivalent wide-band input noise level:**  $< 40$   $\mu$ V in 40 dB position when loaded with 50  $\Omega$ .

**Distortion:**  $< 5\%$  at maximum output and rated load.

**Overload recovery:**  $< 1$   $\mu$ s for 10 times overload.

**Size:** 76 mm H x 130 mm W x 279 mm D (3" x 5 1/8" x 11").

**Weight:** net, 1.8 kg (4 lb). Shipping, 2.7 kg (6 lb).

## 465A Description

HP's 465A amplifier provides 20 dB or 40 dB gain ( $\times 10$  or  $\times 100$ ) with flat frequency response from 5 Hz to 1 MHz with floating inputs.

## 465A Specifications

**Voltage gain:** 20 dB ( $\times 10$ ) or 40 dB ( $\times 100$ ), open circuit.

**Gain accuracy:**  $\pm 0.1$  dB, ( $\pm 1\%$ ) at 1 kHz.

**Frequency response:**  $\pm 0.1$  dB, 100 Hz to 50 kHz;  $< 2$  dB down at 5 Hz and 1 MHz.

**Output:**  $> 10$  V rms open circuit;  $> 5$  V rms into 50  $\Omega$  (0.5 W).

**Distortion:**  $< 1\%$ , 10 Hz to 100 kHz;  $< 2\%$ , 5 Hz to 10 Hz and 100 kHz to 1 MHz.

**Input impedance:** 10 M $\Omega$  shunted by  $< 20$  pF.

**Output impedance:** 50  $\Omega$ .

**Noise:**  $< 25$   $\mu$ V rms referred to input (with 1 M $\Omega$  source resistance).

**Size:** 76 mm H x 130 mm W x 279 mm D (3" x 5 1/8" x 11").

**Weight:** net, 1.8 kg (4 lb). Shipping, 3.2 kg (7 lb).

## 467A Description

HP's 467A Power Amplifier/Supply is a 10 watt peak power amplifier and  $-20$  V (to  $+20$  V) dc power supply. The wide bandwidth of dc to 1 MHz offers low dc drift and 0.3% gain accuracy. With continuously variable gain and floating inputs, HP's 467A can also be used as a power supply.

## 467A Specifications

### Power amplifier

**Voltage gain (non-inverting):** fixed steps: X1, X2, X5, X10. Variable: 0-10, resolution is better than 0.1% of full output.

**Accuracy:**  $\pm 0.3\%$  from dc to 10 kHz  $\pm 1.0\%$  from 10 kHz to 100 kHz,  $\pm 10\%$  from 100 kHz to 1 MHz with load of  $> 40\Omega$ .

**Output:**  $\pm 20$  V p at 0.5 Ap.

**Distortion:**  $< 0.01\%$  at 1 kHz;  $< 1\%$  at 100 kHz;  $< 3\%$  at 1 MHz.

**Input impedance:** 50 k $\Omega$  shunted by 100 pF.

### DC Power Supply

**Voltage range:**  $> \pm 20$  V,  $\pm 10$  V,  $\pm 4$  V,  $\pm 2$  V,  $\pm 1$  V with adjustable vernier. Resolution: better than 0.1% of full output.

**Current:**  $\pm 0.5$  A.

**Load regulation:**  $< 10$  mV, no load to full load.

**Line regulation:**  $< 10$  mV for a  $\pm 10\%$  change in line voltage.

### General

**Output impedance:** 5 m $\Omega$  in series with 1  $\mu$ H.

**Current limit:**  $< 800$  mA.

**Size:** 159 mm H x 130 mm W x 279 mm D (6 1/4" x 5 1/8" x 11").

**Weight:** net, 4.5 kg (10 lb.). Shipping 6.8 kg (15 lbs.).

## 350D Description

Two 600  $\Omega$  unbalanced attenuator sections make up the Hewlett-Packard 350D Attenuator. One section is a 100 dB attenuator, adjustable in 10 dB steps. The other is a 10 dB attenuator, adjustable in 1 dB step.

## 350D Specifications

**Attenuation:** 0 to 110 dB, 1 dB and 10 dB steps.

**Power capacity:** 5 W (55 Vdc or rms) max, continuous duty.

**DC isolation:** signal ground may be  $\pm 500$  Vdc from chassis.

**Accuracy:** dB at any step listed below.

	10 dB Section		100 dB Section	
	0 dB	10 dB	70 dB	100 dB
dc to 100 kHz	$< \pm 0.125$	$< \pm 0.25$	$< \pm 0.5$	$< \pm 0.5$
100 kHz to 1 MHz	$< \pm 0.25$	$< \pm 0.5$	$< \pm 0.5$	$< \pm 0.75$

**Size:** standard HP 1/2 module (system I) 159 mm H x 130 mm W x 203 mm D (6 1/4" x 5 1/8" x 8").

**Weight:** net, 1.8 kg (4 lb.). Shipping, 2.7 kg (6 lb.).

## Ordering Information

461A Amplifier  
465A Amplifier  
467A Power Amplifier/Supply  
350D Attenuator

**Price**  
\$525  
\$450  
\$1200  
\$350

- Wide band
- Flat response
- Low noise

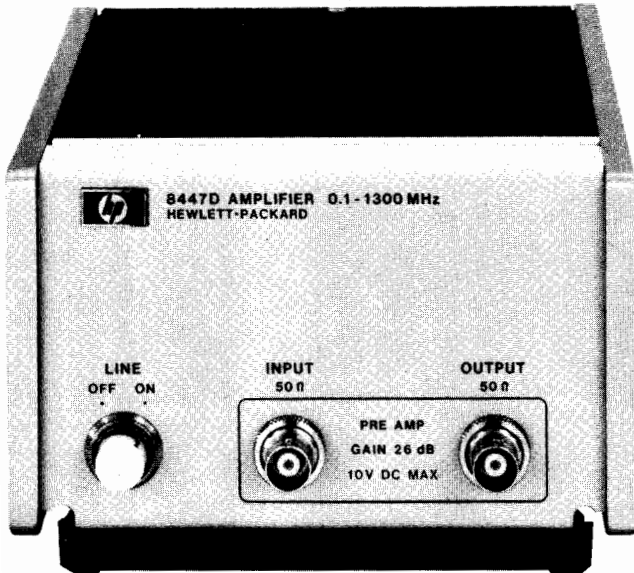

8447D

The HP 8447 series of general purpose amplifiers combines high reliability and convenience.

### High Performance

The performance of these amplifiers qualifies them for a number of uses: to improve the sensitivity of counters, spectrum analyzers, RF voltmeters, EMI meters, power meters and other devices without distortion or degradation of amplitude accuracy; to increase the maximum power available from a signal generator or sweeper.

### Specifications

	8447A Preamp	8447C Power Amp	8447D Preamp	8447E Power Amp	8447F Preamp-Power Amp
Frequency Range	0.1-400 MHz	30-300 MHz	100 kHz-1.3 GHz	100 kHz-1.3 GHz	100 kHz-1.3 GHz
Typical 3 dB Bandwidth	50 kHz-700 MHz	10-400 MHz	50 kHz-1.4 GHz	50 kHz-1.4 GHz	50 kHz-1.4 GHz
Gain (Mean)	20 dB ± 0.5 dB at 10 MHz	30 dB ± 1 dB	26 dB ± 1.5 dB (20°C-30°C)	22 dB ± 1.5 dB (20°C-30°C)	
Gain Flatness Across Full Frequency Range	±0.5 dB	±1 dB	±1.5 dB	±1.5 dB	
Noise Figure	<5 dB	<11 dB	<8.5 dB	<11 dB typical	
Output Power for 1 dB Gain Compression	>+6 dBm	>+17 dBm	>+7 dBm typical	>+15 dBm	
Harmonic Distortion	-32 dB for 0 dBm output	-35 dB for +10 dBm output	-30 dB for 0 dBm output (typical)	-30 dB for +10 dBm output	
Typical Output for <-60 dB Harmonic Distortion	-25 dBm	-15 dBm	-30 dBm	-20 dBm	
VSWR	<1.7	<2.0	<2.0 input <2.2 output 1-1300 MHz	<2.2 1-1300 MHz	
Impedance	50Ω	50Ω	50Ω	50Ω	
Reverse Isolation	>30 dB	>35 dB	>40 dB	>40 dB	
Maximum DC Voltage Input	±10 V	±10 V	±10 V	±10 V	
Options Available	001	002	001, 010, 011	010	010
Option Prices	add \$415	add \$10	add \$515, \$35, \$570	add \$35	add \$70

-8447D AND 8447E COMBINED IN A SINGLE PACKAGE-

### Broadband Frequency Coverage

The 8447 series offers an amplifier for nearly every application in the 100 kHz to 1.3 GHz frequency range. The wide bandwidths are compatible with other wideband instruments and accommodate wide-band spectra.

### Options

A variety of options are available: a 75Ω impedance model (Option 002) for applications such as television/FM broadcasting and CATV; Option 001 and Option 011 dual channel versions with BNC and Type N connectors respectively for operation with dual channel systems such as oscilloscopes or network analyzers (or the channels may be cascaded for increased gain); Type N connectors rather than the standard BNC connectors (Option 010).

### General

**Weight:** net, 1.56 kg (3.4 lb). Shipping, 2.30 kg (5.1 lb).

**Size:** 85.8 H x 130 W x 216 mm D (3.4" x 5.1" x 8.5").

**Power requirements:** 110 or 230 V ac ± 10%, 48-440 Hz, 15 watts.

### Ordering Information

8447A Preamp	\$700
8447C Power Amp	\$625
8447D Preamp	\$765
8447E Power Amp	\$815
8447F Preamp-Power Amp	\$1365

### Price

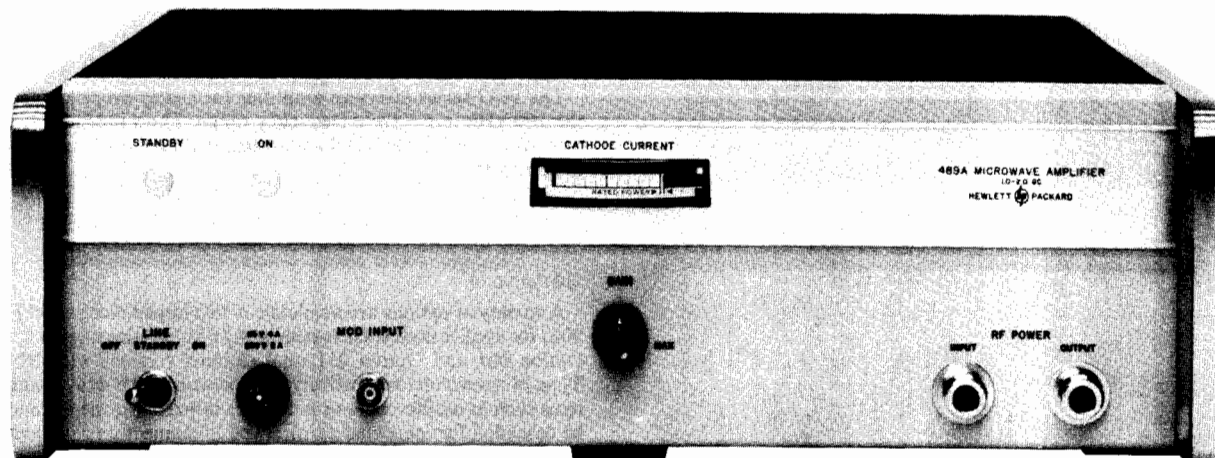

489A

### Microwave TWT Amplifiers

Amplification of frequencies from 1 to 12.4 GHz is accomplished in four ranges by the Hewlett-Packard medium-power, microwave amplifiers. Each delivers at least 1 watt for a 1-milliwatt input—a gain of at least 30 dB.

All four TWT amplifiers have provision for amplitude modulation, and since the internal modulation amplifier is dc-coupled, remote programming and power leveling are possible. Sensitivity is high for large output power changes from relatively small modulation signals, obviating the need for an external modulation amplifier.

The dc amplifier has a gain of 20 dB and exhibits a passband from dc to 500 kHz when the modulation index is in the neighborhood of 1 dB, as might be encountered in RF leveling. When the modulating levels are high, in the region of 20 volts, the passband will be a minimum of 100 kHz: a 20-volt change at the MOD INPUT produces a minimum of 20 dB on/off ratio.

Cathode current in the TWT is monitored by a front panel meter and can be conveniently controlled by the GAIN adjustment for rated power output, or for reducing tube current to extend tube life when full output power is not required. The helix, collector, and anode current can be measured at an easily accessible test point board. Combined with the 8350, 8620 or 8690 Sweep Oscillator they make an excellent high power swept source.

#### Advantages

DC coupled modulation circuitry allows power leveling and remote programming.

Periodic-permanent-magnet focusing means fewer alignment problems.

#### Applications

Antenna efficiency and pattern measurements.

Extends attenuation measuring systems capability by at least 30 dB.

RFI susceptibility tests.

### 489A-495A Specifications

**Output power:** 1 watt for an input of  $\leq 1$  mW.

**Gain:** 30 dB at rated output.

**Input/output:** impedance, 50 $\Omega$ ; connectors, type N female.

**Noise figure:**  $\leq 30$  dB.

**Amplitude modulation:**

**Sensitivity:** modulation input of  $> -20$  V peak reduces RF output by  $\leq 20$  dB from dc to 50 kHz.

**Frequency response:** dc to 500 kHz (3 dB).

**Pulse response:**  $< 1$   $\mu$ s rise and fall times.

**Size:** 140 H  $\times$  426 W  $\times$  467 mm, (5.5"  $\times$  16.75"  $\times$  18.38").

**Weight:** net, 14.9 kg (33 lb). Shipping, 18.0 kg (40 lb).

	489A	491C	493A	495A
Frequency range (GHz)	1-2	2-4	4-8	7-12.4
Gain variation with freq. at rated output:	$\leq 6$ dB	$\leq 6$ dB	$\leq 6$ dB	$\leq 6$ dB
small signal: across any 10% of band	$\leq 5$ dB	$\leq 5$ dB	$\leq 5$ dB	$\leq 5$ dB for 300 MHz
across full band	$\leq 10$ dB	$\leq 10$ dB	$\leq 10$ dB	$\leq 10$ dB

#### Ordering Information

489A 1 to 2 GHz TWT Amplifier

491C 2 to 4 GHz TWT Amplifier

493A 4 to 8 GHz TWT Amplifier

495A 7 to 12.4 GHz TWT Amplifier

Opt 908: Rack Flange Kit (for all models)

#### Price

\$4650

\$4650

\$5050

\$5050

add \$22



### Analog Voltmeter Considerations

**Accuracy**—Before we can discuss meter accuracy, we must have a familiarity with the various meter scales available. Many instruments have meter scales marked in both volts and decibel (dB) units. It should be noted that dB and voltage are complements of each other. That is, if a voltage scale is made linear, the dB scale on the same meter face will be logarithmic or nonlinear. Likewise, if the dB scale is made linear, the voltage scale becomes nonlinear. The term “linear-log scale” is applied to an instrument that has a linear dB scale and, therefore, a nonlinear voltage scale. Several different types of meter faces are illustrated in Figure 1.

Analog meters usually have nonlinearities and/or offsets present in the attenuators and amplifiers. The meter movement itself can have nonlinearities even with individually calibrated meter scales. Nonlinearities cause percent of reading errors, and offsets cause percent of full scale errors.

Looking at instrument specification sheets, accuracy specifications are usually expressed in one of three ways: 1. percent of the full-scale value, 2. percent of the reading, 3. (percent of reading + percent of full-scale). The first is probably the most commonly used accuracy specification. The second (percent of reading) is more commonly applied to meters having a logarithmic scale. The last method has been used more recently to obtain a tighter accuracy specification on a linear-scale instrument.

Hewlett-Packard uses the two-part accuracy specification to take advantage of the upper-scale accuracy and yet maintain a reasonable specification for the lower portion of the scale.

### Selecting an Analog Voltmeter

1. For measurements involving dc applications, select the instrument with the broadest capability meeting your requirements.
2. For ac measurements involving sine waves with only modest amounts of distortion (<10%), the average-responding voltmeter can perform over a bandwidth extending to several megahertz.
3. For high-frequency measurements (>10 MHz), the peak-responding voltmeter with the diode-probe input is the most economical choice. Peak-responding circuits are acceptable if inaccuracies caused by distortion in the input waveform can be tolerated.
4. For measurements where it is important to determine the effective power of waveforms that depart from a true sinusoidal form, the true rms-responding voltmeter is the appropriate choice.

For applications requiring monitoring signals with large excursions and in applications requiring log values to be plotted on a graphic recorder, the HP 7562A and HP 7563A log voltmeters provide a large dynamic range (110 dB) and display the input on a single meter range while providing an output voltage that is the log of the input.

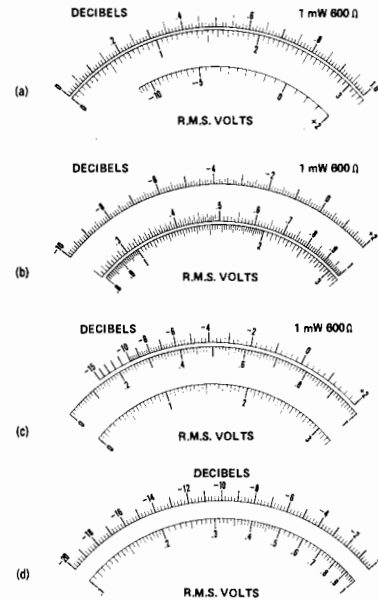

Figure 1. Four different types of meter scales available. (a) Linear 0-3 V and 0-10 V scales plus a dB scale. (b) Linear dB scale plus non-linear (logarithmic) voltage scales. (c) dB scale placed on larger arc for greater resolution. (d) Linear -20 to 0 dB scale useful for acoustical and communications applications.

### Analog Voltmeter Selection Chart

Model	DC VOLTMETERS	Voltage Range	Frequency Range; Accuracy at FS*	Page
419A	DC NULL VOLTMETER	± 3 μV to ± 1 kV end scale 0.1 μV resolution (18 ranges)	dc ±(2% + 0.1 μV)	40
Model	AC VOLTMETERS	Voltage Range	Frequency Range; Typical Accuracy	Page
403B	RECHARGEABLE BATTERY AC VOLTMETER	1 mV to 300V (12 ranges)	5 Hz to 2MHz; ± 2% to ± 5%	44
400F 400 FL	FAST-RESPONSE AC VOLTMETER 100 kHz low-pass filter ac amplifier	100 μV to 300 V; -90 dB to +52 dB	20 Hz to 4 MHz; ± 1% to ± 4%	45
400GL	HIGH ACCURACY dB VOLTMETER 20 dB log scale (0 dB = 1 V)	-100 dB to +60 dB (8 ranges)	20 Hz to 4 MHz; ± 0.2 dB to 0.4 dB	45
400E 400 EL	HIGH ACCURACY AC VOLTMETER has dc output (± 0.5%) for driving recorder	1 mV to 300 V; -70 dB to +52 dB	10 Hz to 10 MHz ± 1% ± 5%	45
3400A	RMS VOLTMETER provides rms readings of complex signals. Has dc output for driving DVM's or recorders	1 mV to 300 V (12 ranges)	10 Hz to 10 MHz ± 1% to ± 5%	46
3406A	SAMPLING RF VOLTMETER provides true rms measurements when used with 3400A. Many accessories	1 mV to 3 V (8 ranges)	10 kHz to >1.2 GHz ± 3% to ± 13%	47
Model	MULTI-FUNCTION METERS	Voltage Range (Accuracy)	Resistance Range (Accuracy)	Page
427A	BATTERY-OPERATED MULTI-FUNCTION METER has 10 MΩ dc input impedance and 10MΩ/20 pF ac input impedance	DC: ± 100 mV to 1000 V (± 2%) 9 ranges AC: 10 mV to 300 V 10 Hz to 1 MHz (± 2%) 10 ranges	100 to 10 MΩ mid-scale ± 5%; from 0.3 to 3 on the meter scale (7 ranges)	42
410C	VERSATILE VOLTMETER has 100 MΩ dc input impedance and 10 MΩ/1.5 pF ac impedance	DC: ± 15 mV to ± 1500 V (± 2%) 11 ranges AC: 0.5 V to 300 V 20 Hz to >700 MHz (± 3% at 400 Hz) 7 ranges	100 to 10 MΩ (center scale) 0 to mid-scale: ± 5% or ± 2% of midscale (whichever is greater) 7 ranges current: DC: ± 1.5 μA to ± 150 mA (± 3%)	43
Model	CURRENT METERS	Current Range	Frequency Range	Page
428B	DC MILLIAMMETER with clip-on probe eliminates direct connection	1 mA to 10 A FS (9 ranges)	dc to 400 Hz	41
Model	LOG VOLTMETER	Voltage Range	Accuracy; Frequency Response	Page
7562A	LOGARITHMIC VOLTMETER/CONVERTER true RMS responding	80 dB (2 ranges); 1 mV to 10 V or 10 mV to 100 V	0.5 Hz to 100 kHz ± 0.5 dB to -3, +1 dB dc = ± 0.25 dB	48
7563A	LOGARITHMIC VOLTMETER/AMPLIFIER	110 dB (1 range); 316 μV to 100 V dc	dc = ± 0.25 dB to ± 1.5 dB	48

\*For exact accuracy refer to page designated.

# ANALOG VOLTMETERS

DC null volt-ammeter

Model 419A

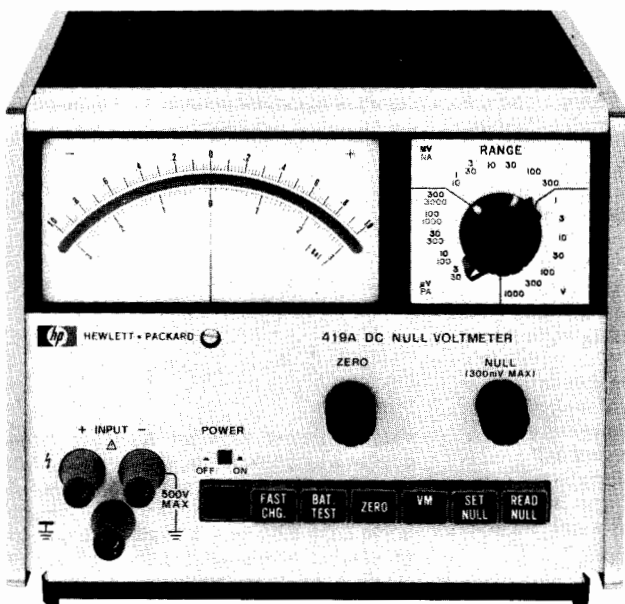

## Description

Eighteen voltage ranges with 0.1  $\mu\text{V}$  resolution on the lowest range. Accuracy of this rechargeable battery-operated instrument is  $\pm 2\%$  of end scale  $\pm 0.1 \mu\text{V}$  on all ranges. Noise is less than 0.3  $\mu\text{V}$  p-p, and drift is less than 0.5  $\mu\text{V}/\text{day}$ .

An internal nulling voltage allows input voltages up to 300 mV to be nulled giving an infinite input impedance. Input impedance above 300 mV range is 100 megohms.

Seven pushbuttons allow rapid function selection. This dc null volt-meter operates from an ac line or from internal rechargeable batteries. During operation from ac line, batteries are trickle-charged. A fast-charge pushbutton is provided to increase the charging rate, recharging batteries in approximately 16 hours. Battery voltage may be checked with the battery-test pushbutton. The zero pushbutton allows compensation for any internal offsets before measurement. When this pushbutton is depressed, the positive leg of the voltmeter is disconnected from the positive input terminal.

When the voltmeter pushbutton is depressed, HP 419A functions as a zero-center scale 3  $\mu\text{V}$  to 1000 V dc voltmeter.

When the AM pushbutton is depressed, HP 419A functions as a zero-center scale 30 pA to 30 nA ammeter.

## Specifications

### DC Null Voltmeter

**Ranges:**  $\pm 3 \mu\text{V}$  to  $\pm 1000 \text{ V}$  dc in 18 zero-center ranges.

**Accuracy:**  $\pm (2\%$  of range  $+0.1 \mu\text{V})$ .

**Zero control range:**  $> \pm 15 \mu\text{V}$ .

**Zero drift:**  $< 0.5 \mu\text{V}/\text{day}$  after 30 min warm-up.

**Zero temperature coefficient:**  $< 0.05 \mu\text{V}/^\circ\text{C}$ .

**Response time:** 3 s to within 95% of final reading on 3  $\mu\text{V}$  range; 1 s to within 95% of final reading on 10  $\mu\text{V}$  to 1000 V ranges.

**Noise:**  $< 0.3 \mu\text{V}$  p-p, input shorted. Noise amplitude approximates Gaussian distribution. RMS value (standard deviation) is  $< 0.075 \mu\text{V}$ , p-p noise value is  $< 0.3 \mu\text{V}$  95% of the time.

### Input Characteristics

**At null:** infinite resistance on 3  $\mu\text{V}$  through 300 mV ranges in set null mode. Negative input terminal can be floated to  $\pm 500 \text{ V}$  dc from power line ground.

**Off null**

Voltage range	Input resistance
3 $\mu\text{V}$ - 3mV	100 k $\Omega$
10 mV - 30 mV	1 M $\Omega$
100 mV - 300 mV	10 M $\Omega$
1 V - 1000 V	100 M $\Omega$

Negative input terminal can be floated up to  $\pm 500 \text{ V}$  dc from power-line ground.

**AC normal mode rejection:** ac voltages 50 Hz and above and 80 dB greater than end scale affect reading  $< 2\%$ . Peak ac voltage not to exceed maximum overload voltage.

### DC Ammeter

**Ranges:**  $\pm 30 \text{ pA}$  to  $\pm 30 \text{ nA}$  in 7 zero-center ranges.

**Accuracy:**  $\pm (3\%$  of range  $+ 1 \text{ pA})$ .

**Zero control range:**  $> \pm 150 \text{ pA}$ .

**Zero drift:**  $< 5 \text{ pA}/\text{day}$  after 30 min warm-up.

**Zero temperature coefficient:**  $< 0.5 \text{ pA}/^\circ\text{C}$ .

**Noise:**  $< 3 \text{ pA}$  p-p, input shorted.

**Input resistance:** 100 k $\Omega$  on all ranges.

### Amplifier

**Gain:** 110 dB on 3  $\mu\text{V}$  range, decreases 10 dB per range.

**Output:** 0 to  $\pm 1 \text{ V}$  at 1 mA maximum for end-scale reading. Output level adjustable for convenience when used with recorders.

**Output resistance:** depends on setting of output level control.  $< 35\Omega$  when output control is set to maximum.

**Noise:** 0.01 Hz to 5 Hz: same as voltmeter (referred to input).  $> 5 \text{ Hz}$ :  $< 10 \text{ mV rms}$  (referred to output).

### General

**Overload protection:** the following voltages can be applied without damage to instrument.

**1 V to 1000 V range:** 1200 V dc.

**10 mV to 300 mV range:** 500 V dc.

**3  $\mu\text{V}$  to 300 mV range:** 50 V dc.

**Operating temperature:** instrument will operate within specifications from  $0^\circ\text{C}$  to  $50^\circ\text{C}$ .

**Operating humidity:**  $< 70\%$  R.H.

**Storage temperature:**  $-20^\circ\text{C}$  to  $+50^\circ\text{C}$ .

**Power:** 115 V or 230 V  $\pm 10\%$ , 48 Hz to 440 Hz, 2 VA max. or 4 internal rechargeable batteries (furnished). 30-hr operation per recharge. Operation from ac line permissible during recharge.

**Size:** 156 mm H (without removable feet), 197 mm W, 203 mm D (6.1" x 7.75" x 8").

**Weight:** net, 3.7 kg (8.3 lb). Shipping, 5.4 kg (12 lb).

419A DC Null Volt-Ammeter

\$1225

# ANALOG VOLTMETERS

1 mA to 10 A clip-on dc milliammeter

Model 428B

41



- No circuit interruption
- No circuit loading



428B



3529A

## Description

Direct current from 1 milliampere to 10 amperes full scale can be measured without interrupting your measured circuit or producing loading errors. With the HP Model 428B Clip-on Milliammeter, cutting wires for insertion of current meters and calculating current from voltage and resistance readings are eliminated. All that is required for fast, accurate readings is to clip around the wire and select the proper current range.

The 428B measures current by utilizing a clip-on transducer that converts the magnetic field around the conductor to an ac voltage proportional to dc current. This voltage is detected and displayed as direct current on the 428B's meter. Since there is no direct contact with the circuit being measured, complete dc isolation is assured.

The meter responds to dc current only and is therefore not susceptible to common mode currents. However, low frequency currents up to 400 Hz can be measured by connecting an oscilloscope or voltmeter to the convenient front panel output; or this output can be used to drive a strip chart recorder for permanent long term records.

For even greater sensitivity, several loops of the measured conductor can be put through the probe, increasing sensitivity by the same factor as the number of turns used.

## Specifications

**DC current range:** 1 mA to 10 A full scale, nine ranges.  
**Accuracy:**  $\pm 3\%$  of full scale  $\pm 0.15$  mA, from  $0^\circ\text{C}$  to  $55^\circ\text{C}$  (when instrument is calibrated to probe).  
**Probe inductance:**  $< 0.5 \mu\text{H}$ .  
**Probe induced voltage:**  $< 15$  mV p (worst case at 20 kHz and harmonics).  
**Output:** variable linear output level with switch position for calibrated 1 V into open circuit (corresponds to full scale deflection). 1.5 V

max. into open circuit in uncalibrated position.  $0.73 \pm .01$  V into  $1 \text{ k}\Omega$  in calibrated position.

**Noise:** 1 mA range,  $< 15$  mV rms across  $1 \text{ k}\Omega$ ; 3 mA range,  $< 5$  mV rms across  $1 \text{ k}\Omega$ ; 10 mA through 10 A ranges,  $< 2$  mV rms across  $1 \text{ k}\Omega$ .

**Frequency range:** dc to 400 Hz (3 dB point).

**AC rejection:** signals  $> 5$  Hz with pk value  $<$  full scale affect meter accuracy  $< 2\%$  (except at 40 kHz carrier frequency and its harmonics). On the 10 A range, ac pk value is limited to 4 A.

**Power:** 115 or 230 V  $\pm 10\%$ , 50 to 60 Hz, approx. 75 V A max.

**Operating temperature range:**  $-20^\circ\text{C}$  to  $+55^\circ\text{C}$ .

**Storage temperature:**  $-40^\circ\text{C}$  to  $+65^\circ\text{C}$ .

**Probe insulation:** 300 V maximum.

**Probe tip size:**  $\approx 0.5"$  (12.7 mm) by  $0.66"$  (16.67 mm) aperture diameter  $0.16"$  (3.97 mm).

**Size:** cabinet: 292 H x 191 W x 368 mm D (11.5" x 7.5" x 14.5").

**Weight:** net, 8.6 kg (19 lb). Shipping, 10.9 kg (24 lb).

## Accessories Available

**3529A Magnetometer Probe:** this probe measures magnetic field strength and direction. The component of magnetic field sensed is parallel to the cylindrical axis of the probe. Applications include the testing of magnetic materials for air shipment.

**Range:** 1 mG to 10 G full scale, nine ranges.

1 mG = 1 mA conversion factor.

**Accuracy:**  $\pm 3\%$  of full scale ( $0^\circ\text{C}$  to  $+55^\circ\text{C}$ ) after calibration.

**Frequency range:** dc to 80 Hz (3 dB point).

**Weight:** net 0.45 kg (1 lb). Shipping 0.91 kg (2 lb).

## Ordering Information

3529A Magnetometer Probe

428B Analog Milliammeter (cabinet)

## Price

\$125

\$1350



# ANALOG VOLTMETERS

Low-cost multi-function meter

Model 427A

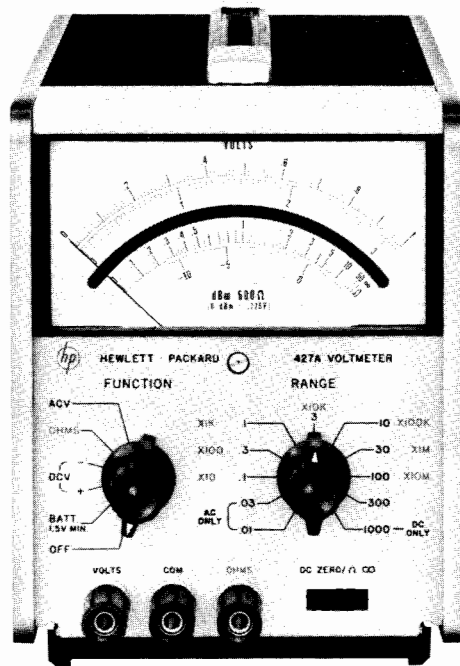

427A

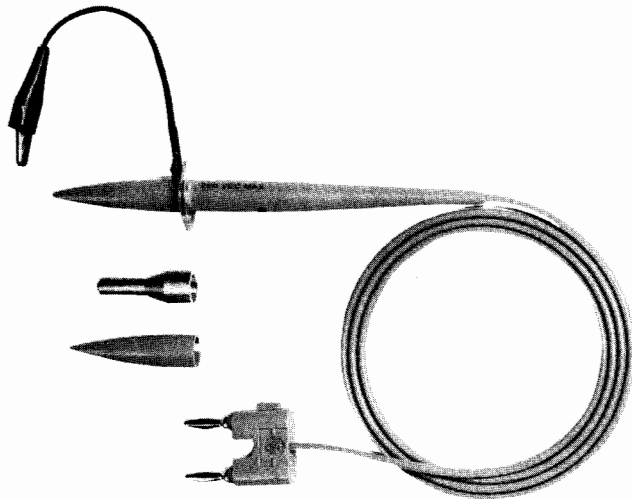

11096B

## Description

Hewlett-Packard's Model 427A is a portable, versatile, low cost multi-function meter which is valuable in any laboratory, production line, service department, or in the field. It is capable of measuring dc voltages from 100 mV to 1 kV full scale; ac voltage from 10 mV to 300 V full scale at frequencies up to 1 MHz (>500 MHz with the 11096B High Frequency Probe); and resistance from 10 $\Omega$  to 10 M $\Omega$  center scale.

The 427A will operate continuously for more than 300 hours on its internal 22.5 V dry cell battery. AC line and battery operation is available with option 001.

## Specifications

### DC Voltmeter

**Ranges:**  $\pm 100$  mV to  $\pm 1000$  V in 9 ranges in 10 dB steps.

**Accuracy:**  $\pm 2\%$  of range.

**Input resistance:** 10 M $\Omega$ .

**AC normal mode rejection (ACNMR):** ACNMR is the ratio of the normal mode signal to the resultant error in readout. 50 Hz and above: >80 dB.

**Overload protection:** 1200 V dc.

### AC Voltmeter

**Ranges:** 10 mV to 300 V in 10 ranges in 10 dB steps.

**Frequency range:** 10 Hz to 1 MHz.

**Response:** responds to average value, calibrated in rms.

**Accuracy:**

Frequency	Range	
	0.01 V to 30 V	100 V to 300 V
10 Hz to 100 kHz	2% of range	2% of range
100 kHz to 1 MHz		

**Input impedance:** 10 mV to 1 V range, 10 M $\Omega$  shunted by <40 pF; 3 V to 300 V range, 10 M $\Omega$  shunted by <20 pF.

**Overload protection:** 300 V rms momentarily, 1 V range and below; 425 V rms max above 1 V range.

### Ohmmeter

**Ranges:** 10 $\Omega$  to 10 M $\Omega$  center scale in 7 decade ranges.

**Accuracy:**  $\pm 5\%$  of reading (from 0.3 to 3 on scale)

**Source current** (ohms terminal positive)

Range	Open circuit Voltage	Short circuit Current
X 10	0.1 V	10 mA
X 100	0.1 V	1 mA
X 1 k	1 V	1 mA
X 10 k	1 V	100 $\mu$ A
X 100 K	1 V	10 $\mu$ A
X 1 M	1 V	1 $\mu$ A
X 10 M	1 V	0.1 $\mu$ A

## General

**Input:** may be floated up to  $\pm 500$  V dc above chassis ground. Ohms input open in any function except ohms. Volts input open when instrument is off.

**Operating temperature:** 0°C to 50°C.

**Power:** > 300 hr operation per battery.

**HP 427A.** 22.5 V dry cell battery, Eveready No. 763 or RCA VS102. HP 427A Option 001: battery operation or ac line operation, selectable on rear panel. 115 V or 230 V  $\pm 20\%$ , 48 Hz to 440 Hz, 2 VA max. **Size:** (standard  $\frac{1}{2}$  module): 159 mm H (without removable feet), 130 mm W, 203 mm D (6.25" x 5.13" x 8").

**Weight:** net, 2.4 kg (5.3 lb). Shipping, 3.6 kg (8 lb).

## Accessories Available

HP 11096B High Frequency AC Probe extends range to >500 MHz. With the 11096B, you can measure 0.25 to 30 V rms signals out to 500 MHz with better than  $\pm 1$  dB accuracy. Usable relative measurements can be made up to 1 GHz (3 dB point at 700 MHz). The 11096B is a peak-responding detector calibrated to produce a dc output proportional to the rms value of a sine wave input. Input impedance is 4 M $\Omega$  shunted by 2 pF.

## Options and Accessories

	Price
<b>11075A</b> High Impact Case. A rugged case for carrying, storing and operating the 427A	\$165
<b>11096B</b> High Frequency AC probe	\$100
<b>11001A</b> 45" test lead, dual banana plug to male BNC	\$17
<b>11002A</b> 60" test lead, dual banana plug to alligator clips	\$15
<b>11003A</b> 60" test lead, dual banana plug to pencil probe and alligator clip.	\$12
<b>10111A</b> BNC female to dual banana adapter	\$20
<b>11067A</b> Test lead kit	\$5

## Ordering Information

427A Multi-function Meter (includes batteries)	\$775
427A Option 001 AC power supply & battery	add \$30

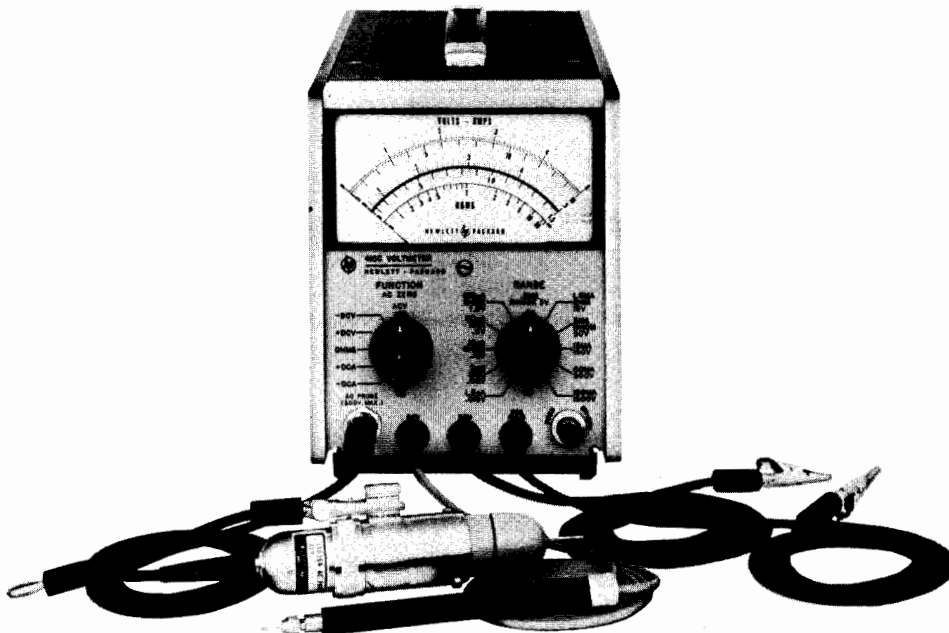

410C with 11036A

## Description

HP's Model 410C is a versatile general purpose instrument for use anywhere electrical measurements are made. This instrument measures dc voltages from 15 mV to 1500 V, dc current from 1.5  $\mu$ A to 150 mA, and resistance from 0.2 $\Omega$  to 500 M $\Omega$ . With a standard plug-in probe, ac voltages at 20 Hz to 700 MHz from 50 mV to 300 V and comparative indications to 3 GHz are attainable.

## Specifications

### DC Voltmeter

**Voltage ranges:**  $\pm 15$  mV to  $\pm 1500$  V full scale in 15, 50 sequence (11 ranges).

**Accuracy:**  $\pm 2\%$  of full scale on any range.

**Input resistance:** 100 M $\Omega$   $\pm 1\%$  on 500 mV range and above, 10 M $\Omega$   $\pm 3\%$  on 150 mV range and below.

### AC Voltmeter

**Voltage ranges:** 0.5 V to 300 V full scale in 0.5, 1.5, 5 sequence (7 ranges)

**Frequency range:** 20 Hz to 700 MHz.

**Accuracy:**  $\pm 3\%$  of full scale at 400 Hz for sinusoidal voltages from 0.5 V–300 V rms. The ac probe responds to the positive peak-above-average value of the applied signal. The meter is calibrated in rms.

**Frequency response:**  $\pm 2\%$  from 100 Hz to 50 MHz (400 Hz ref.); 0 to  $-4\%$  from 50 MHz to 100 MHz;  $\pm 10\%$  from 20 Hz to 100 Hz and  $\pm 1.5$  dB from 100 MHz to 700 MHz.

**Input impedance:** input capacitance 1.5 pF, input resistance  $> 10$  M $\Omega$  at low frequencies. At high frequencies, impedance drops off due to dielectric loss.

**Safety:** the probe body is grounded to chassis at all times for safety. All ac measurements are referenced to chassis ground.

### DC Ammeter

**Current ranges:**  $\pm 1.5$   $\mu$ A to  $\pm 150$  mA full scale in 1.5, 5 sequence (11 ranges).

**Accuracy:**  $\pm 3\%$  of full scale on any range.

**Input resistance:** decreasing from 9 k $\Omega$  on 1.5  $\mu$ A range to approximately 0.3 $\Omega$  on the 150 mA range.

**Special current ranges:**  $\pm 1.5$ ,  $\pm 5$  and  $\pm 15$  nA may be measured on the 15, 50 and 150 mV ranges using the dc voltmeter probe, with  $\pm 5\%$  accuracy and 10 M $\Omega$  input resistance.

### Ohmmeter

**Resistance range:** resistance from 10 $\Omega$  to 10 M $\Omega$  center scale (7 ranges).

**Accuracy:** zero to midscale:  $\pm 5\%$  of reading or  $\pm 2\%$  of midscale, whichever is greater;  $\pm 7\%$  from midscale to scale value of 2;  $\pm 8\%$  from scale value of 2 to 3;  $\pm 9\%$  from scale value of 3 to 5;  $\pm 10\%$  from scale value of 5 to 10.

### Amplifier

**Voltage gain:** 100 maximum.

**AC rejection:** 3 dB at 0.5 Hz; approximately 66 dB at 50 Hz and higher frequencies for signals  $< 1600$  V p or 30 times full scale, whichever is smaller.

**Isolation:** impedance between common and chassis is  $> 10$  M $\Omega$  in parallel with 0.1  $\mu$ F. Common may be floated up to 400 V dc above chassis for dc and resistance measurements.

**Output:** proportional to meter indications; 1.5 V dc at full scale, maximum current, 1 mA.

**Output impedance:**  $< 3\Omega$  at DC.

**Noise:**  $< 0.5\%$  of full scale/on any range (p-p).

**DC drift:**  $< 0.5\%$  of full scale/yr at constant temperature.  $< 0.02\%$  of full scale/ $^{\circ}$ C.

**Overload recovery:** recovers from 100:1 overload in  $< 3$  s.

### General

**Maximum input:** (see overload recovery). DC: 100 V on 15, 50 and 150 mV ranges, 500 V on 0.5 to 15 V ranges, 1600 V on higher ranges. AC: 100 times full scale or 450 V p whichever is less.

**Power:** 115 V or 230 V  $\pm 10\%$ , 48 Hz to 440 Hz, 13 VA (20 VA with 11036A ac probe).

**Size:** 165 mm H (without removable feet), x 130.2 mm W x 280 mm D (6 $\frac{1}{2}$ " x 5 $\frac{1}{8}$ " x 11") behind panel.

**Weight:** net, 4 kg (8 lb). Shipping, 5.44 kg (12 lb).

**Accessories furnished:** detachable power cord, 11036A AC probe.

**Accessories available:** see page 75.

### Ordering Information

410C with HP 11036A Detachable AC probe  
410C Option 002 (less ac probe)

### Price

\$175  
less \$44



# ANALOG VOLTMETERS

## 5 Hz to 2 MHz AC solid-state voltmeters

### Model 403B

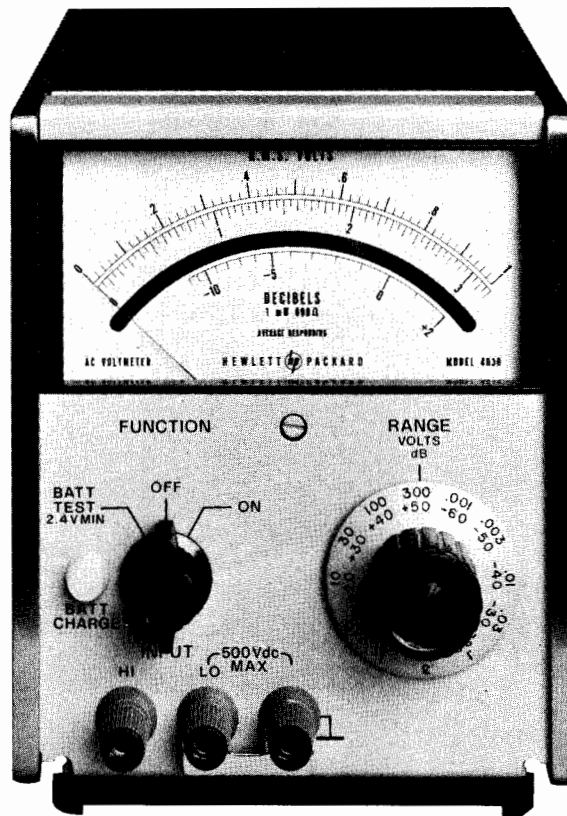

### Description

The Hewlett-Packard 403B AC Voltmeter is a versatile, general purpose instrument for laboratory and production work, yet is ideal for use in the field since it is solid-state, battery operated, and portable.

It measures from 100 microvolts to 300 volts, covering 5 Hz to 2 MHz. It operates from internal batteries and thus may be completely isolated from the power line and external grounds, permitting accurate measurements at power line frequency and its harmonics without concern for beat effects. Isolation from external ground also permits use where ground loops are troublesome. Turnover effect and waveform errors are minimized because the meter responds to the average

value of the input signal.

The 403B operates from an AC line as well as from the internal battery pack, and batteries recharge during AC operation. Battery charge may be easily checked with a front-panel switch to assure reliable measurements. Normally, about 60 hours of AC operation recharges the batteries; but an internal adjustment is provided which nearly doubles the charging rate. The Model 403B can be used while its batteries charge. A sturdy taut-band meter eliminates friction and provides greater precision and repeatability.

For improved resolution in dB measurements, the 403B Option 001 is available. This version spreads out the dB scale by making it the top scale of the meter.

### Specifications

Range	0.001 to 300 V rms full scale, 12 ranges, in a 1, 3, 10 sequence. -60 dB to +50 dB in 12 ranges with 10 dB steps.
Meter	Responds to average value of input waveform, calibrated in the rms value of a sine wave.
Frequency Range	5 Hz to 2 MHz
Accuracy	Within $\pm 2\%$ ( $\pm 0.2$ dB) of full scale from 10 Hz to 1 MHz; within $\pm 5\%$ ( $\pm 0.4$ dB) of full scale from 5 to 10 Hz and from 1 to 2 MHz, except $\pm 10\%$ ( $\pm 0.8$ dB) from 1 to 2 MHz on the 300 V range (0 to 50°C).*
Input Impedance	2 M $\Omega$ ; shunted by <60 pF, 0.001 to 0.03 V ranges; <30 pF, 0.1 to 300 V ranges.
Maximum Input	Fuse protected (signal ground can be $\pm 500$ V DC from chassis).
Power	4 rechargeable batteries, 40 hr. operation per recharge, up to 500 recharging cycles; self-contained recharging circuit functions during operation from AC line.
Size	159 mm H (without removable feet) x 130 mm W x 203 mm D (6.25" x 5.13" x 8").
Weight	net, 2.9 kg (6.5 lb). Shipping, 3.6 kg (8 lb).
Price	403B: \$675 Opt 001: add \$30

\*Use 10001A 10:1 Divider and 10111A Adapter to retain  $\pm 5\%$  ( $\pm 0.4$  dB) accuracy while measuring up to 425 V rms from 1 to 2 MHz.

# ANALOG VOLTMETERS

AC voltmeter, 10 Hz to 10 MHz

Models 400E, EL, F, FL, GL

45

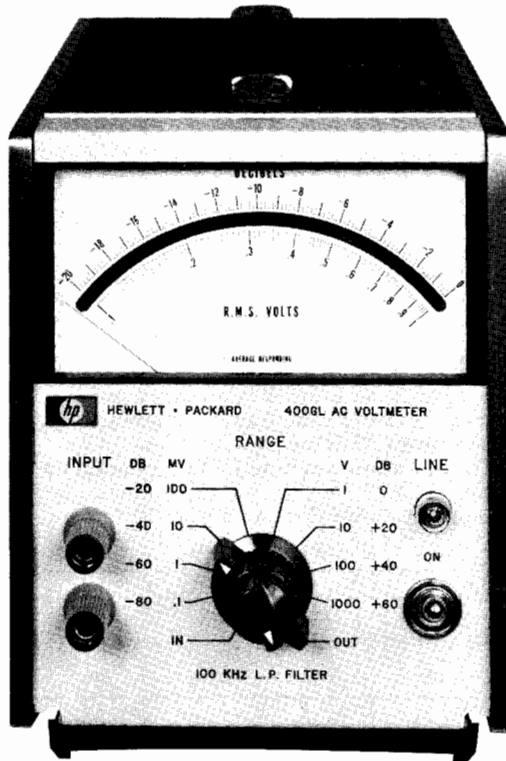

400GL

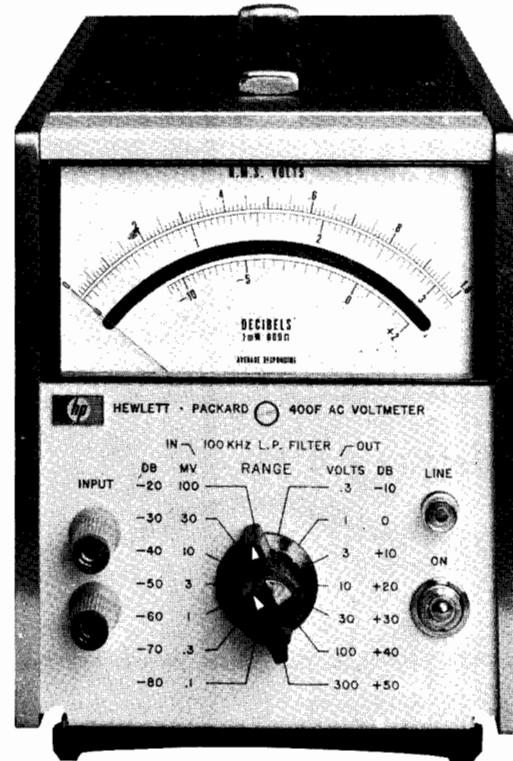

400F

## Specifications

	400E/EL*	400F/FL*	400 GL
Voltage range	1 mV to 300 V F.S. 12 ranges	100 $\mu$ V to 300 V F.S. 14 ranges	-80 dB to +60 dB F. S. 8 ranges
Frequency range	10 Hz-10 MHz	20 Hz-4MHz	20 Hz-4 MHz
Input impedance	10 M $\Omega$ on all ranges <25 pF to <12 pF depending on ranges	10 M $\Omega$ on all ranges <30 pF to <15 pF depending on ranges	10 M $\Omega$ on all ranges <30 pF to <15 pF depending on ranges
Accuracy*	$\pm$ (% reading + % range) <b>3 mV-300 V ranges</b> 10 Hz-40 Hz: $\pm(2.5 + 2.5)$ 40 Hz-2 MHz: $\pm(1 + 0)$ 2 MHz-4 MHz: $\pm(1.5 + 1.5)$ <b>4 MHz-10 MHz</b> 3 mV range: $\pm(2.5 + 2.5)$ 10 mV-3V range: $\pm(3.0 + 2.0)$ for 4 MHz to 6 MHz $\pm(3.75 + 3.75)$ for 6 MHz to 10 MHz 10 V-30 V: $\pm(3.5 + 3.5)$ <b>1 mV range</b> 10 Hz-40 Hz: $\pm(2.5 + 2.5)$ 40 Hz-500 kHz: $\pm(1 + 0)$ 500 kHz-4 MHz: $\pm(2.5 + 2.5)$	(% reading + % range) <b>300 <math>\mu</math>V-300 V ranges</b> 20 Hz-40 Hz: $\pm(2 + 2)$ 40 Hz-100 Hz: $\pm(1 + 1)$ 100 Hz-1 MHz: $\pm(\frac{1}{2} + \frac{1}{2})$ 1 MHz-2 MHz: $\pm(1 + 1)$ 2 MHz-4 MHz: $\pm(2 + 2)$ <b>100 <math>\mu</math>V range</b> 30 Hz-60 Hz: $\pm(2 + 2)$ 60 Hz-100 kHz: $\pm(1 + 1)$ 100 kHz-500 kHz: $\pm(1 + (+0, -7))$	<b>+60 dB range</b> 20 Hz-40 kHz: $\pm 0.4$ dB 40 kHz-100 kHz: $\pm 0.2$ dB <b>-60 dB thru +40 dB ranges</b> 20 Hz-40 kHz: $\pm 0.4$ dB 40 Hz-500 kHz: $\pm 0.2$ dB 500 kHz-2 MHz: $\pm 0.4$ dB 2 MHz-4 MHz: $+0.2, -0.8$ dB <b>-80 dB range</b> 30 Hz-60 Hz: $\pm 0.4$ dB 60 Hz-100 kHz: $\pm 0.2$ dB 100 kHz-500 kHz: $+0.2, -0.8$ dB
Recovery		<2 s for 80 dB overload	
Overload		**500 V rms ac, 300 V dc	**1200 V rms max. input; 1000 V dc max. input
Calibration		Scale -10 to +2 dB between ranges, 100 divisions on 0 to 1 scale. The dB scale reads -10 to +2 dB; 10 dB between ranges.	Linear dB scale, 100 divisions from -20 to 0 dB. Long voltage scale 0 dB = 1V.
Weight		Net, 2.7 kg (6 lb). Shipping, 4.1 kg (9 lb)	
Size		159 mm H (without removable feet) x 130 mm W x 279 mm D (6.25" x 5.13" x 11")	
Power		AC: 115 or 230 V +10%, 48 to 440 Hz, 6 VA max. DC: External batteries: + and - voltages between 35 V and 55 V	
Price:	400E, \$675; 400 EL \$700	400F, \$675; 400 FL, \$600	400 GL, \$725

\* NOTE: 400 EL same as 400E, and 400FL same as 400F, except for calibration. Linear dB scale -10 dB to +2 dB, 10 dB between ranges. Log voltage scales 0.3 to 1 and 0.8 to 3, 120 divisions from -10 dB +2 dB. 400 FL accuracy is % of reading in dB only.

\*\* AC overload voltage decreases with increasing frequency

# ANALOG VOLTMETERS

## 10 Hz to 10 MHz true RMS voltmeter

### Model 3400A



- 10 MHz bandwidth
- High crest factor for accurate pulse measurements
- Stable, linear DC output

- 1 mV full-scale sensitivity
- 10 MΩ input impedance
- Taut-band individually calibrated meter

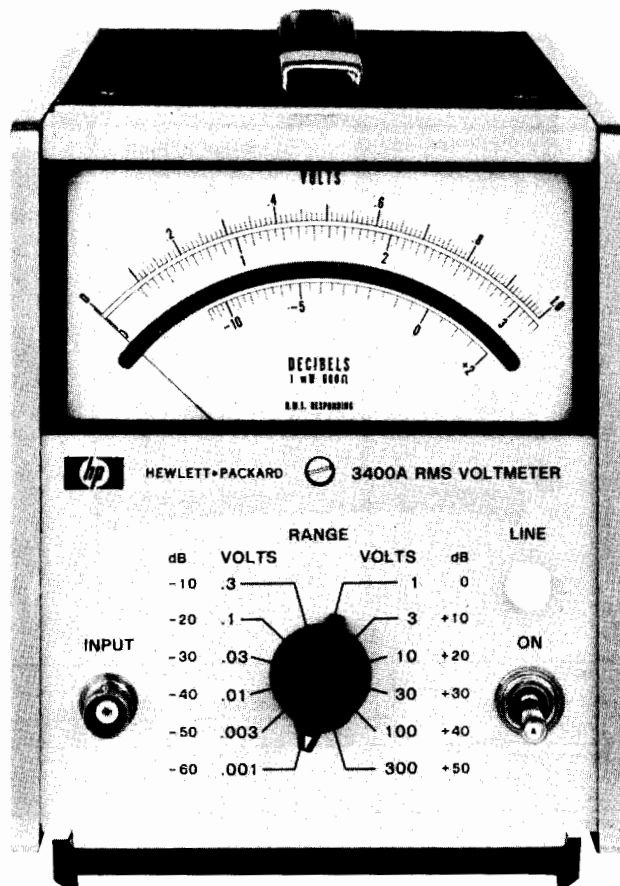

### Description

The Hewlett-Packard Model 3400A is a true root-mean-square (rms) voltmeter, providing a meter indication proportional to the dc heating power of the input waveform.

Six-decade frequency coverage makes the 3400A extremely flexible for all audio and most RF measurements and permits the measurement of broadband noise and fast-rise pulses.

Pulses or other non-sinusoids with crest factors (ratio of peak to rms) up to 10:1 can be measured full scale. Crest factor is inversely proportional to meter deflection, permitting up to 100:1 crest factor at 10% of full scale.

Permanent plots of measured data and higher resolution measurements can be obtained by connecting an X-Y plotter, strip chart recorder or digital voltmeter to the convenient rear-panel dc output. The dc output provides a linear 0 to 1 volt drive proportional to meter deflection.

### RMS Current

True rms current measurements can be made conveniently by using the HP Model 456A Current Probe with the Mode 3400A. See page 33.17.

### Specifications

**Voltage range:** 1 mV to 300 V full scale, 12 ranges.

**DB range:** -72 to +52 dBm (0 dBm = 1 mW into 600Ω).

**Frequency range:** 10 Hz to 10 MHz.

**Response:** responds to rms value (heating value) of the input signal for all waveforms.

**Meter accuracy:** % of full scale (20°C to 30°C)\*

10Hz	50Hz	1MHz	2MHz	3MHz	10MHz
±5%	±1%	±2%	±3%	±3%	±5%

**AC-to-DC converter accuracy:** % of full scale (20°C to 30°C)\*

10Hz	50Hz	1MHz	2MHz	3MHz	10MHz
±5%	±0.75%	±2%	±3%	±3%	±5%

\* TC: ±0.1% from 0°C to 20°C and 30°C to 55°C.

**Crest factor:** (ratio of peak to rms amplitude of input signal): 10 to 1 at full scale (except where limited by maximum input) inversely proportional to meter deflection (e.g., 20 to 1 at half-scale, 100 to 1 at tenth scale).

**Maximum continuous input voltage:** 500 V ac peak at 1 kHz on all ranges; 600 V dc on all ranges.

**Input impedance:** from 0.001 V to 0.3 V range: 10 MΩ shunted by <50 pF. From 1.0 V to 300 V range: 10 MΩ shunted by <20 pF. AC coupled input.

**Response time:** for a step function, <5 s to final value.

**AC overload:** 30 dB above full scale or 800 V p, whichever is less, on each range.

**Output:** negative 1 V dc into open circuit at full-scale deflection, proportional to meter deflection from 10–100% of full scale. 1 mA maximum; nominal source impedance is 1000Ω. Output noise <1 mV rms.

**Power:** 115 or 230 V ±10%, 48 to 66 Hz, 15 VA max.

**Size:** 159 H (without removable feet) x 130 W x 279 mm D (6.25" x 5.1" x 11"); ½ module.

**Weight:** net, 3.3 kg (7.3 lb). Shipping, 4.5 kg (10 lb).

**Accessories furnished:** 10110A Adapter, BNC to dual banana jack.

### Accessories Available

Accessories Available	Price
11001A Cable, 45 in. long, male BNC to dual banana plug	\$17
11170A Cable, 12 in., male BNC connectors	\$17
11170B Cable, 24 in., male BNC connectors	\$17
11170C Cable, 48 in., male BNC connectors	\$20
11002A Test lead, dual banana plug to alligator clips	\$15
11003A Test Leads, dual banana plug to probe and alligator clip	\$12
11076A Carrying Case	\$155

### Ordering Information

3400A Opt 001 spreads out the dB scale by making it the top scale of the meter. add \$30

Rear terminals in parallel with front panel terminals and linear log scale uppermost on the meter face are available on special order.

**3400A RMS Voltmeter**

**\$1125**

# ANALOG VOLTMETERS

10 kHz to 1.2 GHz RF Voltmeter

Model 3406A

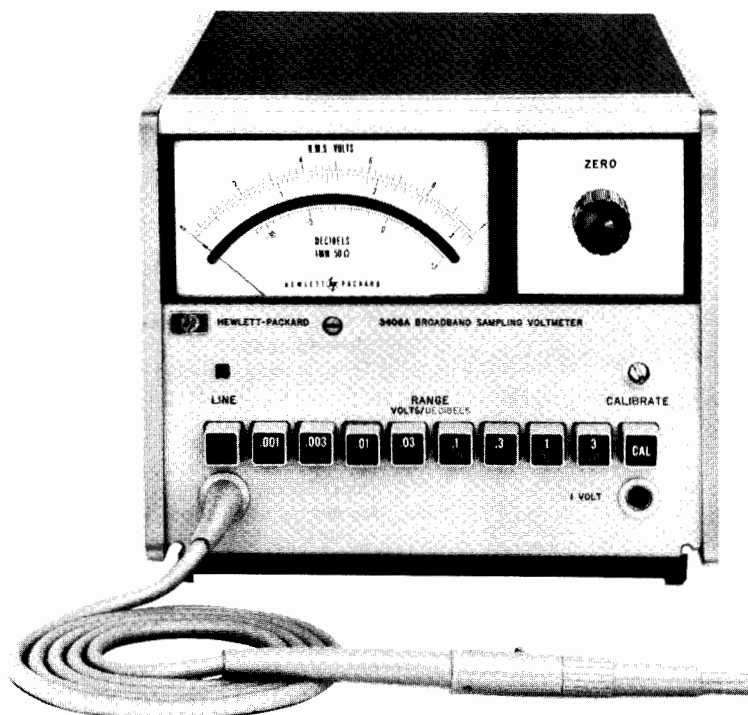

## Description

High frequency voltages can be measured easily with HP's 3406A Sampling Voltmeter. Employing sampling techniques, the HP 3406A has extremely wide bandwidth (10kHz to 1.2 GHz) with high input impedance. Signals as small as 50  $\mu$ V can be resolved. Full scale sensitivity from 1 mV to 3 V is selected in eight 10 dB steps and may be read directly from -62 dBm to +23 dBm. Accessory probe tips convert the HP 3406A for voltage measurements in applications such as receivers, amplifiers and coaxial transmission lines.

Measurement can be retained on the 3406A meter by depressing a pushbutton located on the pen-type probe. This is useful when measurements are made in awkward positions where the operator cannot observe the meter indication and probe placement at the same time.

## Specifications

**Voltage range:** 1 mV to 3 V full scale in 8 ranges; decibels from -50 to +20 dBm (0 dBm = 1 mW into 50 $\Omega$ ); average-responding instrument calibrated to rms value of sine wave.

**Frequency range:** 10 kHz to 1.2 GHz; useful sensitivity from 1 kHz to beyond 2 GHz.

**Full-scale accuracy (%) with appropriate accessory** (after probe is properly calibrated)

10 kHz	20 kHz	25 kHz	100 kHz	100 MHz	700 MHz	1 GHz	1.2 GHz
±13	±8	±5	±3	±5	±8	±13	±13

**Input impedance:** input capacity and resistance will depend upon accessory tip used. 100,000 $\Omega$  shunted by <2.1 pF at 100 kHz with bare probe; <10 pF with 11072A isolator tip supplied.

### Sample Hold Output

Provides ac signal whose unclamped portion has statistics that are narrowly distributed about the statistics of the input, inverted in sign

(operating into >200 k $\Omega$  load with <1000 pF). Output is 0.316 V at f.s. on any range.

**Noise:** <175  $\mu$ V rms referred to input.

**Accuracy (after calibration):** 0.01 V range and above: same as full scale accuracy of instrument. 0.001 V to 0.003 V range: value of input signal can be computed by taking into account the residual noise of the instrument. Jitter: meter indicates within  $\pm 2\%$  pk of reading 95% of time (as measured with HP 3400A True RMS Voltmeter).

**RMS crest factor:** 0.001 V to 0.3 V, 20 dB; 1 V, 13 dB; 3 V, 3 dB.

### Meter

**Meter scales:** linear voltage, 0 to 1 and 0 to 3; decibel, -12 to +3. Individually calibrated taut-band meter.

**Response time:** Indicates within specified accuracy in <3 s.

**Jitter:**  $\pm 1\%$  peak (of reading).

### General

**DC recorder output:** adjustable from 0 to 1.2 mA into 1000 ohms at full scale, proportional to meter deflection.

**Overload recovery time:** meter indicates within specified accuracy in <5 s (30 V p-p max.).

**Maximum input:**  $\pm 100$  V dc, 30 V p-p.

**RFI:** conducted and radiated leakage limits are below those specified in MIL-6181D and MIL-1-16910C except for pulses emitted from probe. Spectral intensity of these pulses is nominally 50 nV/ $\sqrt{\text{Hz}}$ ; spectrum, extends beyond 2 GHz.

**Temperature range:** Instrument, 0°C to +55°C; probe, +10°C to +40°C.

**Power:** 115 or 230 V  $\pm 10\%$ , 48 Hz to 66 Hz, 25 VA max.

**Size:** 159 mm H (without removable feet), x 197 mm W x 279 mm D (6.25" x 7.75" x 11"); 1/2 module.

**Weight:** net, 5.4 kg (12 lb). Shipping, 6.8 kg (15 lb).

**Accessories:** refer to data sheet.

**3406A RF Voltmeter**

**\$2050**

# ANALOG VOLTMETERS

Single channel analog voltmeters

Models 7562A and 7563A

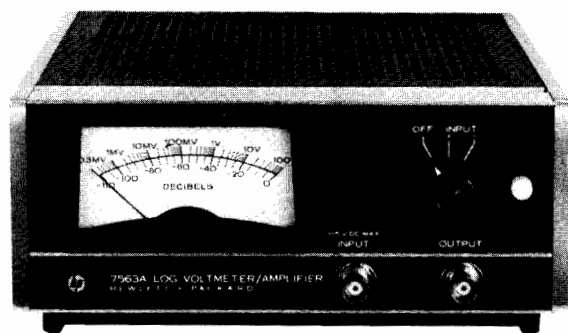
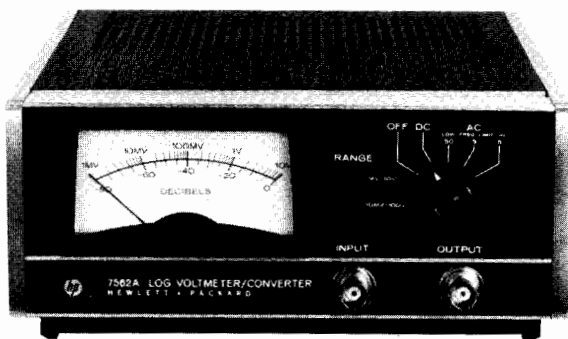

7563A

## Description

The Model 7562A is a wide range (80 dB), single channel logarithmic voltmeter/converter designed to produce dc output voltages in a logarithmic relationship to dc input voltages or the true RMS value of an ac input voltage. It contains a true RMS detector which is not dependent on pure sinusoidal signals to achieve measurement accuracy. A self-contained meter calibrated in volts and dB results in an accurate voltmeter. A constant amplitude oscilloscope output makes the converter compatible with a variety of oscilloscope readout and phase meter applications.

The Model 7563A Logarithmic Voltmeter/Amplifier is a low cost, single channel, dc logarithmic amplifier with a very high dynamic range (110 dB) designed to produce a logarithmic-related dc output voltage for a very wide range of dc input voltages. A single input range of 316  $\mu$ V to 100 V is coupled with an input polarity switch for ease and versatility of operation. A high input impedance (100 k $\Omega$ ) and a low output impedance (less than 5 $\Omega$ ) allows the 7563A to be used in systems or on the bench. A front panel meter calibrated in dB and mV provides instantaneous visual indication of operating levels. Applications include log scaling of recorder axes, pulse height analyzers, scope displays, and almost any circumstances where log compression of dc voltage ranges is required. Dual or single mounting capability is afforded by a field installable rack mounting adapter, utilizing minimum rack space.

## 7562A Specifications

### Performance specifications

#### AC and DC Modes

##### Input

**Dynamic range:** 80 dB.

**Voltage range:** 1 mV to 10 V or 10 mV to 100 V selectable by front panel switch. Accepts either ac or positive signals.

##### Output

**Voltage:** 0 to 800 mV dc corresponding to 10 mV/dB.

**Output impedance:** 100 ohms.

#### DC Mode

**Accuracy:**  $\pm 0.25$  dB at 25°C.

**Input impedance:** 100 k $\Omega$ , shunted by less than 100 pF; single ended.

**Temperature coefficient:**  $\pm 0.02$  dB/°C maximum.

**Zero stability:**  $\pm 0.25$  dB.

#### AC Mode

**Input impedance:** 1 M $\Omega$ , shunted by less than 100 pF; single ended.

**Accuracy and frequency response:** (at 25°C).

Range Setting	0.5 Hz	2	5	20	50	200 Hz	50 kHz	100 kHz
							(<10 V)	(>10 V)
0.5 Hz	$\pm 1$ dB					$\pm 0.5$ dB	$\pm 1$ dB	+1 -3 dB
5 Hz			$\pm 1$ dB			$\pm 0.5$ dB	$\pm 1$ dB	+1 -3 dB
50 Hz					$\pm 1$ dB	$\pm 0.5$ dB	$\pm 1$ dB	+1 -3 dB

**Temperature coefficient:**  $\pm 0.04$  dB/°C maximum.

#### Slewing speed:

Range setting	Minimum slewing speed
0.5 Hz	1 dB/s
5 Hz	10 dB/s
50 Hz	60 dB/s

**Oscilloscope output:** approx. 0.5 V rms regardless of input.

**Crest factor:** 5:1 unless limited by max. input voltage.

**Maximum peak input voltage:**  $\pm 25$  V on 1 mV to 10 V range;  $\pm 250$  V on 10 mV to 100 range.

## General Specifications

**Operating temperature:** 10°C to 40°C.

**Warm-up time:** 20 minutes nominal.

**Connectors:** front and rear input and output BNC connectors.

**Power requirements:** 115/230 Vac, 50 to 400 Hz, 40 VA.

**Size:** 88 mm H x 197 mm W x 292 mm D (3 $\frac{1}{16}$ " x 7 $\frac{3}{4}$ " x 11 $\frac{1}{2}$ ").

**Weight:** net, 3.6 kg (8 lb). Shipping 5.4 (12 lb).

## 7563A Specifications

### Performance Specifications

#### Input

**Dynamic range:** 110 dB.

**Voltage range:** 316  $\mu$ V to 100 V. Accepts either positive or negative signals, selectable by front panel switch.

#### Output

**Voltage:** 0 to 1.1 V dc corresponding to 10 mV/dB. Rear terminals; adjustable to 1 to 10 mV/dB.

**Output impedance:** less than 5 $\Omega$  front panel, 300 $\Omega$  rear.

**Meter accuracy:** reading accurate to  $\pm 1.5$  dB, referred to output.

**Input impedance:** 100 k $\Omega$ , shunted by less than 100 pF, single ended.

**Accuracy:** (at 25°C).

316 $\mu$ V	1 mV	10 V	31.6 V	100 V
$\pm 0.5$ dB	$\pm 0.25$ dB	$\pm 1.0$ dB	$\pm 1.5$ dB	

**Temperature coefficient:**  $\pm 0.02$  dB/°C maximum and  $\pm 3$   $\mu$ V/°C referred to input.

**Zero stability:**  $\pm 0.25$  dB at constant temperature.

#### Rise Time

Signal Level	Maximum Rise Time	
	1 mV-10 V Range	
316 $\mu$ V-1 mV	2000 $\mu$ s	
1 mV-10 mV	400 $\mu$ s	
10 mV-100 mV	40 $\mu$ s	
100 mV-1 V	4 $\mu$ s	
1 V-100 V	2 $\mu$ s	

## General Specifications

**Operating temperature:** 10°C to 40°C.

**Warm-up time:** 20 minutes nominal.

**Connectors:** front and rear input and output BNC connectors.

**Power requirements:** 115/230 V ac, 50 to 400 Hz, 40 VA.

**Size:** 88.1 mm H x 197 mm W x 292 mm D (3 $\frac{1}{16}$ " x 7 $\frac{3}{4}$ " x 11 $\frac{1}{2}$ ").

**Weight:** net, 3.6 kg (8 lb). Shipping, 5.4 kg (12 lb).

## Ordering Information

7562A Logarithmic Voltmeter/Converter

7563A Logarithmic Voltmeter/Amplifier

## Price

\$2150

\$1650

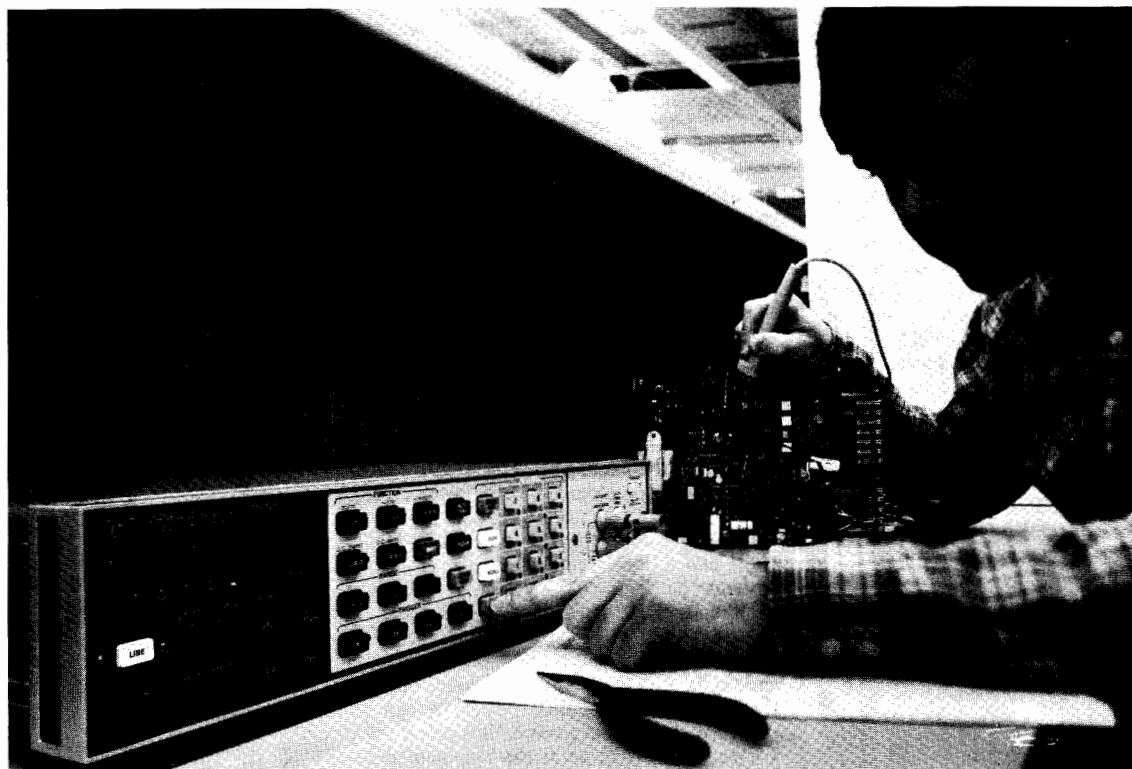

Digital voltmeters (DVM's) offer many advantages such as greater speed, increased accuracy and resolution, reduction of operator errors and the ability to make automatic measurements.

DVM's have historically been optimized for either a systems environment where speed is important or for bench applications where users want high accuracy, high resolution and low noise. HP's new 3456A Digital Voltmeter is able to function equally well in both application areas (see page 68) using a new multi-slope A/D conversion technique. There is the classical trade-off between speed and resolution. For quiet, stable readings with high normal mode noise rejection an integrating technique is the best approach. The speed of most integration techniques is limited by certain constraints. If a final reading can be developed during the measurement cycle, measurement speed can be increased. This explains why the successive approximation A/D technique is fast because the final reading is developed one digit at a time so that no final tally of counts is necessary at the end of the measurement. The trade-off, using the successive approximation technique, is to sacrifice noise rejection for speed.

### New HP Multi-slope A/D Conversion Technique

A second speed limitation lies in the fact that microprocessors add and subtract a lot faster than they multiply. In HP's new multi-slope A/D technique, timing errors and leakage errors become offset errors which are removed quickly by microprocessor addition or subtraction.

The easiest way to understand HP's new A/D conversion technique is to look at the

classical dual slope integration in Fig. 1. The input is applied to an integrator during run-up for a period related to the power line frequency. Measurement of the input is made by applying a reference voltage of opposite polarity to the integrator. The time required for run-down until its zero crossing is proportional to the input voltage. Not until this final zero crossing is made is the magnitude of the input known.

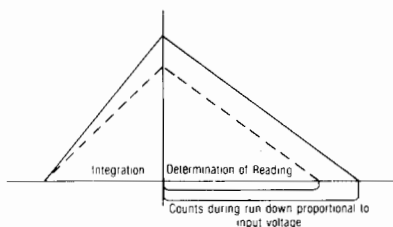

Figure 1 The classical dual-slope integration technique is limited in speed to how fast the zero crossing can be detected accurately. In addition, the final reading is not known until rundown has been completed. Note that the voltage remaining on the integrator's capacitor is proportional to input level.

The voltage left on the integrator's capacitor at the end of the integration period varies directly as a function of input level. For small inputs, noise becomes a problem and for large inputs, the dielectric absorption of the capacitor becomes a problem. The run-down speed could be improved by application of a steeper slope (reference voltage of larger magnitude, incorporating high speed logic).

The basic design contributions of HP's new multi-slope A/D technique are: 1) speed, 2) elimination of high speed logic in the zero comparator, 3) keeping the run-up slopes steep to effectively extend the range of the comparator, 4) completion of A/D conversion during the measurement and 5) conversion of gain errors and timing errors into

offset errors where they can be subtracted out.

The run-down portion of HP's Multi-slope II technique is illustrated in Fig. 2. A steep

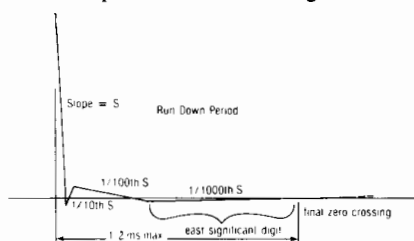

Figure 2 The Multi-slope II technique used in the 3456A Digital Voltmeter employs a four-slope rundown to successively establish the value of the four least significant digits in the final reading. Note that the final zero crossing which determines the least significant digits is done with the shallowest slope.

run-down is applied initially and a finite amount of overshoot is allowed intentionally. The next slope applied is exactly a decade less in steepness and opposite in polarity. After its zero crossing (with a finite amount of overshoot), a third slope a decade again less in steepness is applied. Then after its zero crossing, a fourth slope is applied which turns out to be one one-thousandth as steep as the initial slope.

The residual charge remaining on the integrator's capacitor after the conclusion of each slope represents what is left to digitize. At the beginning of each slope, a clock is started, then stopped at the zero crossing for that slope. The mathematics of the technique are such that the four least significant digits are developed sequentially during run-down from the stored counts for each of the four slopes.

Note that the steepest slope and the most poorly defined zero crossing is the least

critical in terms of the final reading. The usable sensitivity of the DVM is to a large degree determined by the final zero crossing for the least significant digit. This is determined by using the shallowest zero crossing having the greatest precision. Thus, HP's Multi-slope II technique develops the final reading during run-down rather than after run-down.

Looking next at run-up where integration is accomplished, Multi-slope II also makes its contribution. When the operator selects 100, 10 or 1 power line cycles of integration from the front panel of HP's 3456A DVM, the instrument is able to resolve six full digits with the first two established during run-up. If 0.1 power line cycles is selected, only five digit resolution is practical with the first (most significant) digit established during run-up and the remaining four determined during run-down. At 330 readings per second and 0.01 line cycles of integration, the HP 3456A has 4½ digit resolution. At this speed, the integration period looks similar to dual slope as illustrated in Fig. 1.

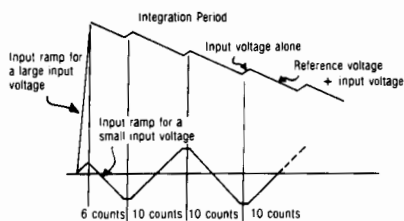

Figure 3. In multi-slope integration, the final voltage across the integrator capacitor was left at a fairly high level at the end of the integration period. In addition, the number of switch transitions varied greatly as a function of the input level.

Dual slope uses linear run-up where the input voltage is applied and allowed to ramp. Dual slope does not fully exploit the dynamic range of the integrator. In a multi-slope technique a sawtooth approach is used to keep the integrator charging at a fast rate. This was achieved by periodically switching in a reference of opposite polarity to ramp down as shown in Fig. 3. In this technique, the larger the input voltage, the larger the average voltage on the integrator capacitor and the more sensitive accuracy is to dielectric absorption. HP's Multi-slope II keeps the average voltage after run-up as low as practical. It, however, uses the sawtooth approach to maintain a high charging rate.

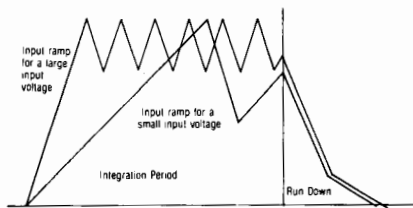
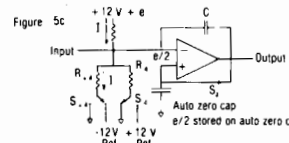
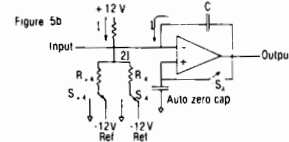
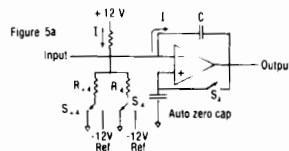

Figure 4. Multi-slope II as applied to HP's 3456A Digital Voltmeter uses a runup broken into fixed periods which do not vary no matter what the input level is. In addition, the average voltage on the integrator capacitor tends to be lower than with previous techniques, thus reducing the errors created by dielectric absorption. When resolving six full digits, the first two digits are established during this runup period.

One source of errors is variations in switching time, and if there is a lot of switching of the input and reference voltages, these errors can be considerable. In Fig. 4 the number of switching points during run-up using the multi-slope technique varies as a function of the magnitude of the input voltage. Full scale inputs produce the maximum number of switching points. With Multi-slope II these errors are removed because the number of transitions is held constant irrespective of the magnitude of the input voltage. Potential timing errors are then converted into offset errors which are removed. Fig. 4 illustrates how Multi-slope II handles a full scale input and a tenth of full scale input.

### Easy Calibration

Another contribution of HP's multi-slope technique is the use of a single reference voltage to simplify calibration and lower cost. Due to the auto zero technique, both positive and negative ramps can be generated. Fig. 5a, b, and c show a simplified schematic to illustrate how this works. As shown in Fig. 5a, when both S<sub>+4</sub> and S<sub>-4</sub> are switched to ground, the current (I) flowing from the +12V supply will pass through the summing node and out to the integrator capacitor (C). Due to operational amplifier action, the summing node is a virtual ground. This generates a negative going ramp at the output of the integrator.



This abbreviated schematic of the integrator is shown for three different conditions: 5a) the generation of a negative-going ramp, 5b) the generation of a positive-going ramp and 5c) the conditions during analog auto zero.

When both S<sub>+4</sub> and S<sub>-4</sub> are closed to the -12V reference as illustrated in Fig. 5b, current is sucked away from the summing node at twice that supplied by the +12V supply. The balance of current required to achieve equilibrium in the node is removed from the integrator capacitor, generating a positive ramp on the output of the integrator.

Between measurement cycles, there is an analog auto zero performed. The cycle is shown in Fig. 5c, where S<sub>+4</sub> is closed to the -12V reference but S<sub>-4</sub> is switched to ground. Since the resistors (R) are of approximately equal value, any error in voltage from the +12V supply (e) will appear as e/2 at the summing node. With S<sub>a</sub> closed, e/2 is stored on the auto zero capacitor.

During ramp generation, the auto zero

switch (S<sub>a</sub>) is opened and the voltage (e/2) held on the auto zero capacitor elevates the positive input to the operational amplifier. Any error in absolute magnitude of the +12V supply is removed and the supply need only have good short term stability. Any error in the +12V supply is converted to an offset and subtracted during the measurement.

Small differences in R<sub>+4</sub> and R<sub>-4</sub> can be averaged out by alternating between the two during auto zero cycles. This, in effect, converts a potential gain error into an offset error removable during the auto zero cycle. Resistors R<sub>+4</sub> and R<sub>-4</sub> have a tolerance of 0.01%, but due to this technique, are effectively matched to within 1 ppm.

Zero comparators have some hysteresis. Not only are the switch transistors kept constant during run-down, but also the ramping is arranged so that the final and most critical zero crossing is made from the same direction. The application of both the S<sub>-4</sub> and S<sub>+4</sub> slopes are made for both the rundown of a positive voltage as well as a negative voltage on the integrator capacitor. This is illustrated in Fig. 6. Note also that the number of ramps which are required is limited to S<sub>-4</sub>, S<sub>+4</sub>, S<sub>-3</sub>, S<sub>+2</sub> and S<sub>-1</sub>.

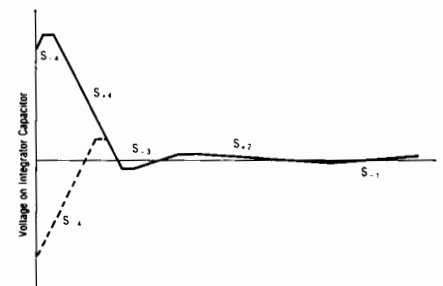

Figure 6. The artificial introduction of an extra S<sub>-4</sub> slope during rundown keeps the switch transitions balanced between negative and positive inputs and also makes the final zero crossing from the same direction.

### Offset Compensated Ohms

The ohms converter incorporated in HP's 3456A DVM uses a new technique called Offset Compensated Ohms. Thermal offsets generated by bimetallic junctions are a source of error in ohms measurements. When the ohms function is selected in HP's 3456A, the instrument first makes a normal ohms measurement and stores the result in memory. The constant current source is switched off next and a conventional voltage reading is made. Offsets detected during the voltage reading are subtracted from the voltage measured with the constant current source applied. The result is an offset compensated ohms measurement. The ohms converter capitalizes on the low noise, high accuracy, multi-slope A/D converter in the 3456A.

In summary, the design emphasis of HP's 3456A DVM provides the operator with a smart DMM to allow the operator to choose the performance level required, whether it is high resolution, high accuracy bench application or high speed systems use. The DMM Selection Chart on the next page can help you to select a DVM for your bench or systems application.

## DVM SELECTION GUIDE

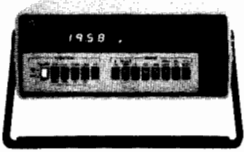

3435A

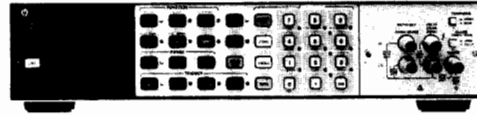

3456A

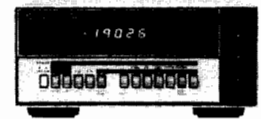

3465A/B



3476A/B



3437A

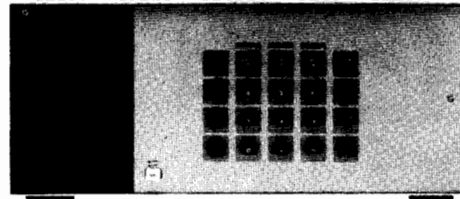

3497A

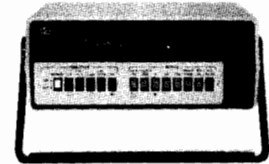

3466A

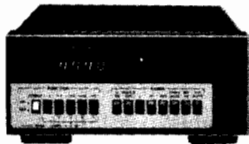

3438A

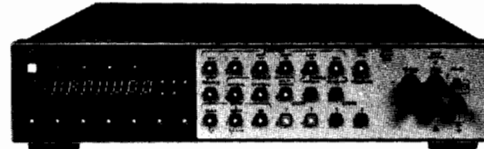

3455A

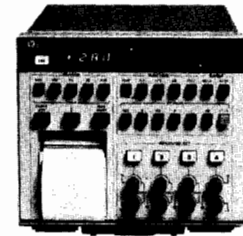

3467A

### BENCH DVM'S

### SYSTEM DVM'S

DVM'S	3476A/B • 3 1/2 Digit	3435A • 3 1/2 Digit	3465A/B • 4 1/2 Digit	3466A • 4 1/2 Digit	3467A • 4 1/2 Digit	3438A • 3 1/2 Digit	3437A • 3 1/2 Digit	3455A • 5 1/2/6 1/2 Digit	3456A • 3 1/2, 4 1/2, 5 1/2, 6 1/2 Digit	3497A 3 1/2, 4 1/2, 5 1/2, Digit
OPEN CRT. VOLT	• Low Cost • Autorange	• Accuracy • 10 Milli Ω	• 1 μV Sensitivity • Bench/Field	• Autorange • True RMS • 1 μV Sensitivity	• Temperature • True RMS • 4 Channels • Math	• HP-IB • Low Cost	• High Speed • HP-IB	• High Performance • Auto Cal	• Very high performance • Selectable integration time • Built-in memory	• Selectable number of digits • Built-in memory
MAX INPUT	1000V	1200V	1000V	1200V	350V	1200V	20V	1000V	1000V	120V
MAX RDGS/SEC	3	4.7	2.5	4.7	4.5	4.7	5700	24	330 (48 WITH 6 1/2 DIGITS)	300 (50 WITH 5 1/2 DIGITS)
DC VOLTS	RANGES 100mV TO 1000V	100mV TO 1200V	10mV TO 1000V	10mV TO 1200V	20mV TO 350V	200mV TO 1200V	100mV TO 10V	100mV TO 1000V	100μV TO 1000V	1V TO 100V
	SENSITIVITY 100μV	100μV	1μV	1μV	1μV	100μV	100μV	1μV	100nV	1μV
	BASIC ACCURACY ±0.3% RDG. ±1 DIGIT	±0.1% RDG. ±1 DIGIT	±0.02% RDG. ±1 DIGIT	±0.03% RDG. ±1 DIGIT	±0.03% RDG. ±1 DIGIT	±0.1% RDG. ±1 DIGIT	±0.03% RDG. ±2 DIGITS	±0.02% RDG. ±1 DIGIT	±(0.008% + 2 COUNTS)	±(0.02% + 1)
AC VOLTS	BANDWIDTH 10kHz	100kHz	20kHz	100kHz TRUE RMS	100kHz TRUE RMS	100kHz	1 MHz TRUE RMS	250kHz TRUE RMS		
	RANGES 1kΩ TO 10MΩ	100 TO 10MΩ	1000 TO 10MΩ	100 TO 10MΩ	2000 TO 20MΩ	100 TO 10MΩ	1000 TO 10MΩ	1000 TO 10MΩ	1000 TO 10Ω	PROGRAMMABLE CURRENT SOURCE FOR OHMS
RESISTANCE	SENSITIVITY 1Ω	10 milli Ω	10 milli Ω	1 milli Ω	20 milli Ω	10 milli Ω	1 milli Ω	100μΩ		
	OPEN CRT. VOLT <4V	<5V	<5V	<5V	<5V	<5V	<5V	<5V	<9.5V	
CURRENT	AC YES	YES	YES	TRUE RMS		YES				
	DC YES	YES	YES	YES		YES				
	RANGING AUTO/HOLD	AUTO/MANUAL	MANUAL	AUTO/MANUAL	AUTO/HOLD	AUTO/MANUAL	MANUAL	AUTO/MANUAL	AUTO/MANUAL	AUTO/MANUAL
	OVERRANGE 10%	100%	100%	100%	100%	100%	100%	50%	20%	20%
GENERAL	OTHER BATTERY POWER-3476B	BATTERY POWER OPT 002	BATTERY POWER 3465B	BATTERY POWER TRMS EITHER AC OR DC DIODE TEST	TOTAL MEASUREMENT STATION	FIVE FUNCTION	HP-IB GUARDED INTERNAL TIMER	HP-IB GUARDED 4 TERMINAL Ω	HP-IB, GUARDED, BUILT-IN MEMORY, STATISTICS, PASS/FAIL, dBm, dBV, SCALE AND OFFSET, % ERROR	HP-IB, FLOATING PROGRAMMABLE CURRENT SOURCE, BUILT-IN MEMORY, GUARDED
	PAGE 52	54	56	58	60	64	SAMPLE-HOLD	MATH		84
	PRICE \$225—\$275	\$335—\$400	\$450—\$550	\$575—\$650	\$2300	\$875	\$2300	\$3600—\$3800	\$3500	3497A OPTION 001 \$1500



# DIGITAL VOLTMETERS

Low-cost autoranging 3½ digit DMM

Model 3476A/B

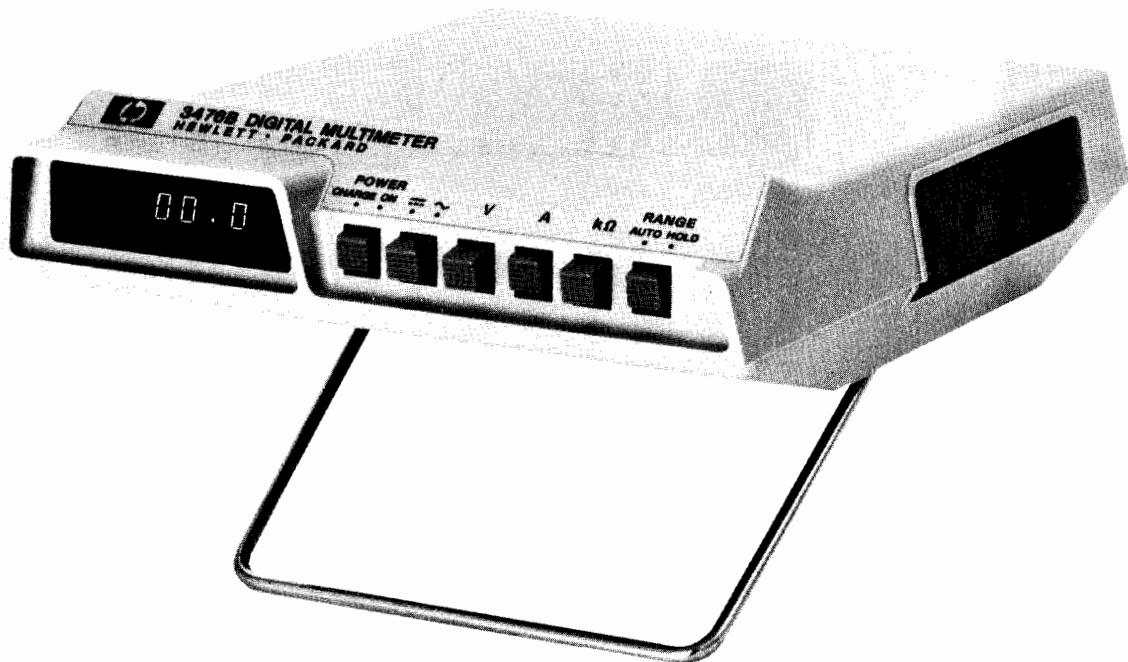

## Description

If you measure current, voltage or resistance, you can use the 3476A/B to make these measurements faster and with fewer reading errors. This versatile instrument incorporates autorange to let you concentrate on your measurement, not the range or range multiplier. With autorange, readings always have the same multiplier: voltage always in volts, current in amps, and resistance in kilohms. In addition to autorange the 3476A/B has auto-zero and auto-polarity. Auto-zero eliminates the need to zero the instrument prior to a test, and auto-polarity lets you measure both positive and negative voltages without the inconvenience of reversing test leads.

The 3476A/B saves you time by combining the five most common measurements in one instrument. It measures AC voltage, DC voltage, AC current, DC current and resistance. In addition to these five basic measurements, the 3476A/B has additional features to save you time and effort. For example, there are two units to choose from. The lower cost 3476A operates on AC for your bench measurements. The 3476B will operate on either AC or nickel-cadmium batteries. Under battery operation you can break ground loops resulting in quieter readings or make measurements in remote locations. The 3476B will give you eight hours of continuous service before a recharge is required. Keep it plugged in and it will charge overnight and be ready for your next trip.

## Convenience

An instrument designed to make your most common measurements should be convenient to use. The 3476A/B was designed to be convenient. An example is the replacement of the input protection fuses. Replacement is easy—no disassembly or re-calibration is necessary—simply slide back the input terminal cover plate to expose the defective fuse. Convenience means attention to design detail. A multiposition bail allows convenient positioning. There is even a vertical detent for viewing from above. Another convenient detail is the shape of the case. Small instruments with pushbuttons have trouble staying put when the buttons are pressed. The 3476A/B solves this problem with a finger grip ridge allowing one-handed operation.

## 3476A/B specifications

### DC Voltmeter

<b>Ranges:</b>	0.1100V	<b>Maximum display:</b>	± 0.1098 V
	1.100 V		± 1.098V
	11.00 V		± 10.98 V
	110.0 V		± 109.8 V
	1100 V		± 1000 V

**Maximum input:** 1000 V (DC + Peak AC).

**Accuracy:** (20°C to 30°C)\*

Range	Accuracy
0.1100 V	±(0.3% of reading + 2 digits)
1.100 V 11.00 V	±(0.3% of reading + 1 digit)
110.0 V 1100 V	±(0.4% of reading + 1 digit)

\*90 day cal. cycle. Add (0.2% of reading) for one year cal. cycle.

**Common mode rejection:** (1 kΩ unbalance) > 100 dB @ 50 Hz, 60 Hz.

**Input resistance:** 10 MΩ ± 5%.

**Input protection:** < 1100 V peak.

**Temperature coefficient:** ± (0.05% of reading + 0.2 digit)/°C.

### AC Voltmeter

<b>Ranges:</b>	0.1100 V	<b>Maximum Display:</b>	0.1098 V
	1.100 V		1.098 V
	11.00 V		10.98 V
	110.0 V		109.8 V
	1100 V		700 V

**Maximum input:** 700 V rms.

**Accuracy:** converter is average responding calibrated in rms (20°C to 30°C)\*

Ranges**	45 Hz to 2 kHz	2 kHz to 5 kHz	5 kHz to 10 kHz
1.100 V to 1100 V	±(1.5% of reading + 4 digits)	±(3% of reading + 6 digits)	±(8% of reading + 10 digits)
0.1100 V	±(2% of reading + 6 digits)	±(5% of reading + 6 digits)	±(18% of reading + 10 digits)

\*90 day cal. cycle. Add (0.2% of reading + 1 digit) for one year cal. cycle

\*\*Ranges usable from 3% of range to full scale.

**Common mode rejection:** (1 kΩ unbalance) > 80 dB @ 50 Hz, 60 Hz.

**Input resistance:** 10 MΩ ± 5%.

**Input capacitance:** < 30 pf.

**Input protection:** < 1100 V peak.

**Temperature coefficient:** ±(0.05% of reading + 0.5 digit)/°C.

**DC Ammeter**

**Ranges:** 0.110 A                      **Max. display:** ±0.109 A  
1.100 A                                      ±1.098 A

**Accuracy:** (20°C to 30°C) ±(0.8% of reading + 2 digits).\*

**Impedance:** 1–1.5 ohm constant.

**Current protected:** 1.5 A fuse.

**Temperature coefficient:** ±(0.05% of reading + 0.2 digit)/°C.

\*90 day cal. cycle. Add (0.2% of reading) for one year cal. cycle.

**AC Ammeter**

**Ranges:** 0.110 A                      **Max. display:** 0.109 A  
1.100 A                                      1.098 A

**Accuracy:** (20°C to 30°C)\*

Ranges**	45 Hz to 2 kHz	2 kHz to 5 kHz
1.100 A	±(2% of reading + 4 digits)	±(3.5% of reading + 6 digits)
0.110 A	±(2.5% of reading + 6 digits)	±(5.5% of reading + 6 digits)

\*90 day cal. cycle. Add (0.2% of reading + 1 digit) for one year cal. cycle.

\*\*Ranges usable from 3% of range to full range

**Impedance:** 1–1.5 ohm constant.

**Current protected:** 1.5 A fuse.

**Temperature coefficient:** ±(0.05% of reading + 0.5 digit)/°C.

**Ohmmeter**

**Ranges:** 1.100 kΩ                      **Max. display:** 1.098 kΩ  
11.00 kΩ                                      10.98 kΩ  
110.0 kΩ                                      109.8 kΩ  
1100 kΩ                                      1098 kΩ  
11000 kΩ                                      10980 kΩ

**Accuracy:** (20°C to 30°C)\*

Ranges	Accuracy
110.0 kΩ, 1100 kΩ	±(0.3% of reading + 1 digit)
11000 kΩ, 1.100 kΩ 11 kΩ	±(0.5% of reading + 1 digit)

\*90 day cal. cycle. Add (0.2% of reading) for one year cal. cycle.

**Open circuit voltage:** < 4 V.

**Input voltage protection:** < 30 V rms continuous, fuse protected from 30 V to 250 V rms.

**Temperature coefficient:** ±(0.05% of reading + 0.2 digit)/°C.

**General**

**Ranging:** Automatic, Range Hold.

**Common to ground:** < 500 V (peak).

**Sample rate:** ≈ 3/second.

**Overload indication:** horizontal bars.

**Operating environmental conditions**

**Temperature range:** 0°C to 40°C.

**Humidity:** < 95% RH.

**Power:** 3476A AC line, 3476B AC line and batteries, < 6 VA

Standard, 104–127 V ac; 54–66 Hz

Option 001, 86–106 V ac; 54–66 Hz

Option 002, 86–106 V ac; 48–54 Hz

Option 003, 190–230 V ac; 48–54 Hz

Option 004, 208–250 V ac; 48–54 Hz.

Option 006, 208–250 V ac; 54–66 Hz

Note: No charge for options 001 through 004. Power options may be changed in field by re-arranging jumpers. See manual for details.

**Batteries:** 4 rechargeable Nickel Cadmium Sub C size. Typical continuous operating time using fully charged batteries: 8 hours at 25°C. Typical battery charging time: 14 hours at 25°C with instrument turned off. Trickle charge with instrument on.

**Weight:** 3476A — net, 0.77 kg (1.7 lb); shipping, 1.68 kg (3.7 lb)  
3476B — net, 0.97 kg (2.13 lb); shipping, 1.88 kg (4.13 lb).

**Size:** 3476A/B: 58 H x 168 W x 206 mm D (2.3" x 6.6" x 8.1").

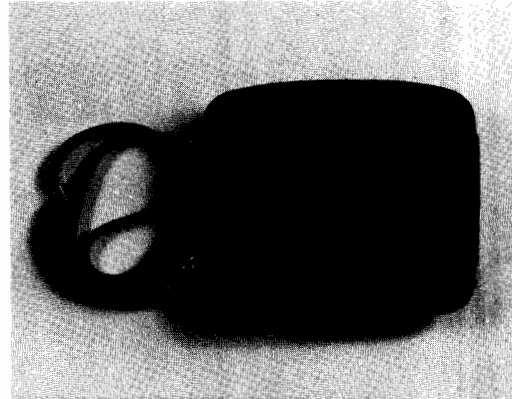

11068 A

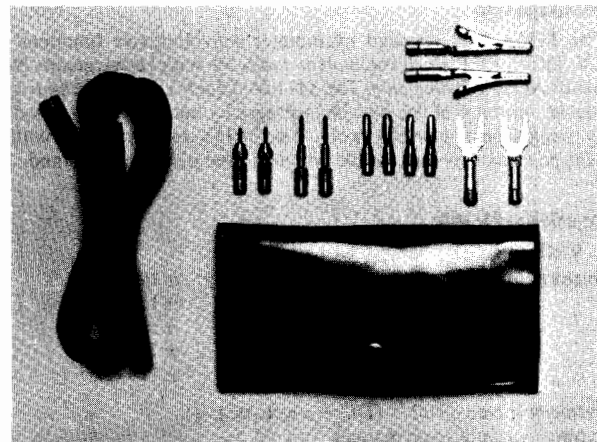

11067 A

**Accessories**

<b>11096B</b> RF probe 10 kHz to 700 MHz (with adaptors)	<b>Price</b> \$100
<b>11067A</b> Test Lead Kit	\$5
<b>11068A</b> Soft Carrying Case	\$20
<b>34111A</b> High Voltage Probe 40Kvdc	\$75

**Ordering Information**

<b>Opt 005</b> 3476A/B, Test Lead Kit, and Soft Carrying Case	add \$25
<b>3476A</b> Digital Voltmeter (includes pair of test leads)	\$225
<b>3476B</b> Digital Voltmeter (includes pair of test leads)	\$275



## Description

The 3435A is a 3 1/2 digit multimeter providing five functions of ACV, DCV, ACI, DCI and  $\Omega$ . It is available with rechargeable batteries or AC line power only. The 34112A Touch-Hold probe provides "eyes-on" probing of AC and DC voltages by holding the 3435A display using a button on the probe. The 3435A case is rugged with a detent position carrying handle which is used also as a tilt stand.

## Specifications

### DC Voltmeter

<b>Ranges:</b> 200 mV	<b>Maximum display:</b> $\pm 199.9$ mV
2 V	$\pm 1.999$ V
20 V	$\pm 19.99$ V
200 V	$\pm 199.9$ V
1200 V	$\pm 1199$ V

**Maximum input:** 1200 V (DC + Peak AC).

**Ranging:** automatic or manual.

**Sensitivity:** 100  $\mu$ V on 200 mV range.

**Polarity:** automatically sensed and displayed.

**Accuracy:** 1 year, 15 to 30°C.

Range	Specifications
200 mV	$\pm(0.1\%$ of reading + 2 digits)
2 V to 1200 V	$\pm(0.1\%$ of reading + 1 digit).

**Temperature coefficient:** (0 to 15°C and 30 to 55°C)  $\pm(0.015\%$  of reading + 0.1 digit)/°C.

**Input resistance:** 10 M $\Omega$   $\pm 1\%$ .

**Input type:** floating, 500 V maximum com. to ground.

**Normal mode rejection:** >40 dB at 50 Hz/60 Hz  $\pm 0.1\%$ .

**Response time:** <0.7 second to within 1 digit of final value on one range. Add 1 second for each range change.

**Effective common mode rejection:** (1 k $\Omega$  unbalance) >120 dB at 50/60 Hz  $\pm 0.1\%$ .

### DC Current

<b>Ranges:</b> 200 $\mu$ A	<b>Maximum display:</b> $\pm 199.9$ $\mu$ A
2 mA	$\pm 1.999$ mA
20 mA	$\pm 19.99$ mA
200 mA	$\pm 199.9$ mA
2000 mA	$\pm 1999$ mA

**Maximum input:** current: 2 amp (fuse protected). Voltage: 250 V.

**Ranging:** manual only.

**Sensitivity:** 100 nA on 200  $\mu$ A range.

**Polarity:** automatically sensed and displayed.

**Accuracy:** 1 year, 15 to 30°C.

Range	Specifications
200 $\mu$ A to 200 mA	$\pm(0.3\%$ of reading + 2 digits)
2000 mA	$\pm(0.6\%$ of reading + 2 digits)

**Temperature coefficient:** (0 to 15°C and 30 to 55°C)  $\pm(0.028\%$  of reading + 0.1 digit)/°C.

### Voltage burden

Range	Maximum Burden at Full Scale
200 $\mu$ A to 20 mA	<220 mV
200 mA	<240 mV
2000 mA	<400 mV

**Response time:** <0.7 second on any range to within 1 digit of final value.

### AC Voltmeter

**AC converter:** avg. responding rms calibrated.

<b>Ranges:</b> 200 mV	<b>Maximum display:</b> 199.9 mV
2 V	1.999 V
20 V	19.99 V
200 V	199.9 V
1200 V	1199 V



**Maximum input:** 1700 V (DC + Peak AC),  $10^7$  volt-Hz max.

**Ranging:** automatic or manual.

**Sensitivity:** 100  $\mu$ V on 200 mV range.

**Accuracy:** (with display of  $\geq 20$  digits) 1 year, 15 to 30°C.

Range	Specification
30 Hz-50 Hz	$\pm(1.5\%$ of reading +3 digits)
50 Hz-20 kHz	$\pm(0.3\%$ of reading +3 digits)
20 kHz-100 kHz	$\pm(1.5\%$ of reading +10 digits)

**Temperature coefficient:** (0 to 15°C and 30 to 55°C)  $\pm(0.04\%$  of reading +0.2 digit)/°C.

**Input impedance:** resistance: 5 M $\Omega$ . Shunt capacitance: <50 pF.

**Response time:** <1.6 seconds to within 3 digits of final value on one range. Add 1.2 seconds for each range change.

**Input type:** floating, 500 V maximum com. to ground.

#### AC Current

<b>Ranges:</b> 200 $\mu$ A	<b>Maximum display:</b> 199.9 $\mu$ A
2 mA	1.999 mA
20 mA	19.99 mA
200 mA	199.9 mA
2000 mA	1999 mA

**Maximum input:** current: 2 amp (fuse protected). Voltage: 250 V.

**Ranging:** manual only.

**Sensitivity:** 100 nA on 200  $\mu$ A range.

**Accuracy:** (with display of  $\geq 20$  digits)—1 year, 15 to 30°C.

Current Range	30 Hz	50 Hz	10 kHz
2000 mA	$\pm(2\%$ of reading +5 digits)	$\pm(1.2\%$ of reading +5 digits)	$\pm(1.2\%$ of reading +5 digits)
200 mA To 200 $\mu$ A	$\pm(1.7\%$ of reading +5 digits)	$\pm(0.9\%$ of reading +5 digits)	$\pm(0.9\%$ of reading +5 digits)

Frequency of Input Signal

**Temperature coefficient:** (0 to 15°C and 30 to 55°C)  $\pm(0.05\%$  of reading +0.2 digit)/°C

#### Voltage burden

Range	Maximum Burden at Full Scale
200 $\mu$ A to 20 mA	<220 mV rms
200 mA range	<240 mV rms
2000 mA range	<400 mV rms

**Response time:** <1.6 seconds on any range to within 3 digits of final value.

**Input type:** floating, 500 V maximum com. to ground.

#### Ohmmeter

<b>Ranges:</b> 20 $\Omega$	<b>Maximum display:</b> 19.99 $\Omega$
200 $\Omega$	199.9 $\Omega$
2 k $\Omega$	1.999 k $\Omega$
20 k $\Omega$	19.99 k $\Omega$
200 k $\Omega$	199.9 k $\Omega$
2000 k $\Omega$	1999 k $\Omega$
20 M $\Omega$	19.99 M $\Omega$

**Input protection:** 250 V rms.

**Ranging:** automatic or manual.

**Sensitivity:** 10 milliohm on 20 $\Omega$  range.

**Accuracy:** 1 year, 15 to 30°C.

Range	Specifications
20 $\Omega$	$\pm(0.5\%$ of reading +12 digits)
200 $\Omega$ -2000 k $\Omega$	$\pm(0.2\%$ of reading + 2 digits)
20 M $\Omega$	$\pm(0.8\%$ of reading + 2 digits)

**Temperature coefficient:** (0 to 15°C and 30 to 55°C)

Range	Specifications
20 $\Omega$ -2000 k $\Omega$	$\pm(0.04\%$ of reading +0.2 digit)/°C
20 M $\Omega$	$\pm(0.18\%$ of reading +0.2 digit)/°C

**Configuration:** 2 wire.

**Open circuit voltage:** <5 V.

**Current through unknown**

Range	20 $\Omega$	200 $\Omega$	2 k $\Omega$	20 k $\Omega$	200 k $\Omega$	2000 k $\Omega$	20 M $\Omega$
Current	5 mA	5 mA	500 $\mu$ A	50 $\mu$ A	5 $\mu$ A	500 nA	50 nA

**Response time:** <0.8 second to within 1 digit. Add 0.8 second for each range change.

#### General

**Calibration:** data sheet specifications guaranteed for 1 year.

**Display:** 7 segment red 0.3 inch high LED's. Function and range announcement.

**Reading rate:** 2.4 - 4.7/s depending on input level.

**A-D conversion:** dual slope.

**Integration time:** 100 ms.

**Ranging:** automatic or manual on ACV, DCV and ohms. Manual only on AC & DC current.

**Storage temperature:** AC line power only, -40 to +75°C; with batteries, -40 to +65°C.

**Operating temperature:** 0 to 55°C.

**Humidity:** 95% RH, +15 to +40°C.

**Power:** AC line: 48-440 Hz; 86-250 V (see Ordering Information). Battery: rechargeable lead-acid 10 hours minimum continuous operation with full charge. Recharge time: 16 hours operating, 12 hours nonoperating. Batteries and charger available separately; consult operating manual. Total instrument power dissipated: AC only; 3 watts; with charger; 8 watts.

#### Size:

	3435A	3435A Option 002
	23.81 cm (9.4") wide	20.96 cm (8.25") wide
	9.84 cm (3.9") high	8.57 cm (3.4") high
	27.62 cm (10.9") long	26.67 cm (10.5") long

**Weights:** 3435A 2.41 kg (5.3 lb.)

3435A Opt. 001 1.84 kg (4.1 lb)

3435A Opt. 002 1.81 kg (4 lb)

**Accessories Furnished:** 2 test probes

#### Accessories

11000A Test leads, dual banana both ends.	Price \$17
11002A Test leads, dual banana to dual alligator.	\$15
11003A Test leads, dual banana to probe and alligator.	\$12
11096B RF Probe, 10 kHz to 700 MHz.	\$100
34110A Soft vinyl carrying/operating case.	\$25
34111A High-voltage probe 40 kV DC.	\$75
34112A Touch-Hold Probe.	\$40
11067A Test lead kit.	\$5
5061-0072 1/2 Module rack mount kit. (Available on Opt 002 only).	\$35

#### Ordering Information

3435A streamlined portable case with handle, AC line power. Batteries and charger included. \$400

3435A Opt. 001, streamlined portable case, AC line power only. less \$65

3435A Opt. 002, Rack and Stack case, AC line power only. (Rack mount kit not included.) less \$35

All orders must include one of the power options: 86-106 V Opt. 100; 190-233 V Opt. 210; 104-127 V Opt. 115; 208-250 V Opt. 230. N/C

# DIGITAL VOLTMETERS

1  $\mu\text{V}$  Sensitivity, 4½-digit, 5-function multimeter

Models 3465A/B Digital Multimeters



3465A



3465B

## Description

The 3465A and B are 4½ digit multimeters providing five functions of ACV, DCV, ACI, DCI and  $\Omega$ . They feature both portability and bench applications by offering a choice of line and battery power options. The 3465A is offered in the half-module rack and stack case. The 3465B is offered in the rugged streamlined synthetic case with a carrying handle. Both units accept the 34112A touch-hold probe for "eyes-on" measurements of AC and DC voltage.

## Specifications

### DC Voltmeter

<b>Ranges:</b> 20.000 mV	<b>Maximum display:</b> $\pm 19.999$
200.00 mV	$\pm 199.99$
2.0000 V	$\pm 1.9999$
20.000 V	$\pm 19.999$
200.00 V	$\pm 199.99$
1000.0 V	$\pm 1000.0$

**Maximum input:** 1000 VDC and peak AC.

**Sensitivity:** 1 microvolt on lowest range.

**Polarity:** automatically sensed and displayed.

**Accuracy:** (1 year, 23°C  $\pm 5^\circ\text{C}$ )

Range	Specifications
20 mV	$\pm(0.03$ of reading + 2 digits)
200 mV thru 200 V	$\pm(0.02\%$ of reading + 1 digit)
1000 V	$\pm(0.025\%$ of reading + 1 digit)

**Temperature coefficient:** (0°C to 50°C)  $\pm 0.003\%$  of reading/ $^\circ\text{C}$ .

**Input resistance:**

Range	Specifications
20 mV thru 2 V	$\geq 10^9\Omega$
20V thru 1000 V	10 M $\Omega$ $\pm 1\%$

**Normal mode rejection:**  $>60$  dB at 50/60 Hz  $\pm 0.1\%$ .

**Effective common mode rejection:** (1 k $\Omega$  unbalanced) AC:  $>120$  dB at 50/60 Hz  $\pm 0.1\%$ .

### DC Current

<b>Ranges:</b> 200.00 $\mu\text{A}$	<b>Maximum display:</b> $\pm 199.99$
2.0000 mA	$\pm 1.9999$
20.000 mA	$\pm 19.999$
200.00 mA	$\pm 199.99$
200.00 mA	$\pm 199.99$
2000.0 mA	$\pm 1999.9$

**Maximum input:** 2A from  $<250$  V source (fuse protected).

**Sensitivity:** 10 nA on lowest range.

**Polarity:** automatically sensed and displayed.

**Accuracy:** (1 year, 23°C  $\pm 5^\circ\text{C}$ )

Range	Specifications
200 $\mu\text{A}$ , 2 mA	$\pm(0.07\%$ of reading + 1 digit)
20 mA	$\pm(0.11\%$ of reading + 1 digit)
200 mA, 2000 mA	$\pm(0.6\%$ of reading + 1 digit)

**Temperature coefficient:** (0°C to 50°C)

Range	Specifications
200 $\mu\text{A}$	$\pm 0.006\%$ of reading/ $^\circ\text{C}$
2 mA, 20 mA	$\pm 0.004\%$ of reading/ $^\circ\text{C}$
200 mA, 2000 mA	$\pm 0.01\%$ of reading/ $^\circ\text{C}$

### Voltage burden

**2000mA range:**  $<700$  mV at full scale.

**All other ranges:**  $<250$  mV at full scale.

### Ohmmeter

<b>Ranges:</b> 200.00 $\Omega$	<b>Maximum Display:</b> 19.999
2.0000 k $\Omega$	1.9999
20.000 k $\Omega$	19.999
200.00 k $\Omega$	199.99
2000.0 k $\Omega$	1999.9
20.000 M $\Omega$	19.999

**Protection:** 350 V (DC + peak AC); 250 V rms.

**Sensitivity:** 10 milliohm on lowest range.

**Accuracy:** (1 year, 23°C  $\pm 5^\circ\text{C}$ )

Range	Specifications
200 $\Omega$	$\pm(0.02$ of reading + 2 digits)
2 k $\Omega$ thru 2 M $\Omega$	$\pm(0.02\%$ of reading + 1 digit)
20 M $\Omega$	$\pm(0.1\%$ of reading + 1 digit)

**Temperature coefficient:** (0°C to 50°C)

Range	Specifications
200 $\Omega$ thru 2 M $\Omega$	$\pm 0.0015\%$ of reading/ $^\circ\text{C}$
20 M $\Omega$	$\pm 0.004\%$ of reading/ $^\circ\text{C}$

**Configuration:** 2 wire.

**Open circuit voltage:** <5 V max.  
**Current through unknown**

Range	1
200Ω	1 mA
2 kΩ	1 mA
20 kΩ	10 μA
200 kΩ	10 μA
2000 kΩ	1 μA
20 MΩ	0.1 μA

**AC Voltmeter**

**Ranges:** 200.00 mV    **Maximum Display:** 199.99  
 2.0000 V                    1.9999  
 20.000 V                    19.999  
 200.00 V                    199.99  
 500 V                        500.00

**Maximum Input:** full scale to 10 kHz decreasing linearly to 50% of full scale at 20 kHz; except on 500 V range, 2 kHz.

**Overload protection:** 600 V DC max.  
 500 V AC rms  
 800 V peak.

**Sensitivity:** 10 μV on lowest range.

**Accuracy:** converter is average responding calibrated to rms (1 year, + 23°C ± 5°C)

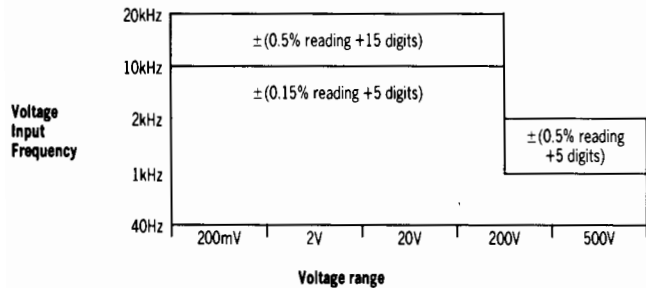

**Temperature coefficient:** (0°C to 50°C) ± (0.005% of reading + 0.2 digit)°C.

**Input impedance:** resistance: 1 MΩ, <100 pF shunt.

**AC Current**

**Ranges:** 200.00 μA    **Maximum Display:** 199.99  
 2.0000 mA                    1.9999  
 20.000 mA                    19.999  
 200.00 mA                    199.99  
 2000.0 mA                    1999.9

**Maximum input:** 2 A from < 250 V source (fuse protected). Full scale to 10 kHz decreasing linearly to 50% of full scale at 20 kHz on lowest 4 ranges; 1 kHz max on 2000 mA range.

**Sensitivity:** 10 nA on lowest range.

**Accuracy:** (1 year, + 23°C ± 5°C)

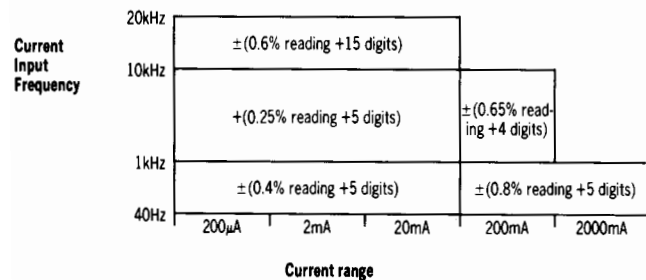

**Temperature coefficient:** (0°C to 50°C): ± 0.01% of reading /°C.

**Voltage burden:**

**200 mA range:** <700 mV FS.  
**All other ranges:** <250 mV FS.

**General**

**Integration time:** 100 ms.  
**Reading rate:** 2½ readings per second.  
**Display:** light-emitting diodes.

**Overload indication:** display blanks, except for overrange "1" and decimal point.

**Humidity range:** 95% RH at 40°C.

**Operating temperature:** 0°C to +55°C. (Nickel Cadmium Batteries 0°C to +40°C).

**Storage temperature:** -40°C to +75°C. (Nickel Cadmium-Batteries -40°C to +40°C).

**Size:**

**3465A** 85.7 H × 209.6 W × 266.7 mm D (3.4" × 8.25" × 10.5")

**3465B** 98.4 H × 238.1 W × 276.2 mm D (3.9" × 9.4" × 10.9")

**Weights:** net, 2 kg (4.5 lbs). Shipping, 4.5 kg (10 lbs).

**Accessories:**

- |  |              |
|--|--------------|
| <b>34112A</b> Touch-hold Probe   | <b>Price</b> |
| <b>34111A</b> High Voltage Probe   | \$40.00      |
| The 34111A, 100 to 1 DC High Voltage Divider Probe, lets you measure up to 40,000 volts. |              |
| <b>11096B</b> RF Probe   | \$75.00      |
| The 11096B RF Probe detects AC voltage up to 700 MHz.                                    |              |
| <b>11067A</b> Test Lead Kit  | \$5.00       |
| <b>11000A</b> Test Leads, dual banana both ends  | \$17.00      |
| <b>11002A</b> Test Leads, dual banana to dual alligator                                  | \$15.00      |
| <b>11003A</b> Test Leads, dual banana to probe and alligator                             | \$12.00      |
| <b>34110A</b> Soft Vinyl Carrying/operating case   | \$25.00      |

**For 3465A only:**

- |   |             |
|---|-------------|
| <b>5061-0072</b> Rack Mount Kit   | \$35.00     |
| <b>82001A</b> Nickel Cadmium battery pack (2 required)                                | ea. \$10.00 |
| <b>82002A</b> Battery Eliminator (hand-held calculator charger)                       | \$20.00     |
| <b>1420-0024</b> Type "D" Alkaline cell in U.S.A. equal to U-2 in Europe (4 required) | ea. \$3.30  |

**For 3465B only**

- |   |         |
|---|---------|
| <b>82033A:</b> Nickel Cadmium battery pack (1 required) | \$18.00 |
|---|---------|

**Options:**

**Standard 3465A DVM** \$550.00

Includes test leads, AC line power, batteries, and battery charger.

**AC line:** 87-127 V; 48-440 Hz or 176-250 V; 48-440 Hz (switch selectable)

**Batteries:** 2 rechargeable Nickel Cadmium packs (model 82001A) 6 hours continuous operation.

**Opt 001:** AC line power only. Batteries not included; battery charger is provided. AC line: 87-127 V; 48-440 Hz or 176-250 V; 48-440 Hz (switch selectable) less \$20.00

**Opt 002:** 4 type D Alkaline dry cells (U-2 cells in Europe). These non-rechargeable batteries provide 60 hours continuous use at 23°C. Includes receptacle to use 82002A battery eliminator which provides power from AC line (82002A not included) less \$100.00

**Standard 3465B DMM**

\$525.00

Includes test leads, AC line power, batteries, and battery charger.

**AC line:** One of the following no-charge power options must be specified for the 3465A:

- |   |     |
|---|-----|
| <b>Opt 100:</b> 86-106 V AC; 48-440 Hz  | N/C |
| <b>Opt 115:</b> 104-127 V AC; 48-440 Hz | N/C |
| <b>Opt 210:</b> 190-230 V AC; 48-440 Hz | N/C |
| <b>Opt 230:</b> 208-250 V AC; 48-440 Hz | N/C |

**Batteries:** One rechargeable Nickel Cadmium battery pack (model 82033A) provides 6 hours continuous operation. Recharge time is 8 hours with instrument off. Trickle charge with instrument on.

**Ordering Information** (including test leads)

- |  |          |
|--|----------|
| <b>3465A</b> DMM with 2 82001A's, AC line, batteries & charger | \$550.00 |
| <b>3465B</b> DMM with battery, AC line, and charger            | \$525.00 |

# DIGITAL VOLTMETERS

4½ digit autoranging DMM

Model 3466A

- 1 μV dc sensitivity
- 1 milliohm sensitivity

- True-Rms (DC + AC)
- Diode Test

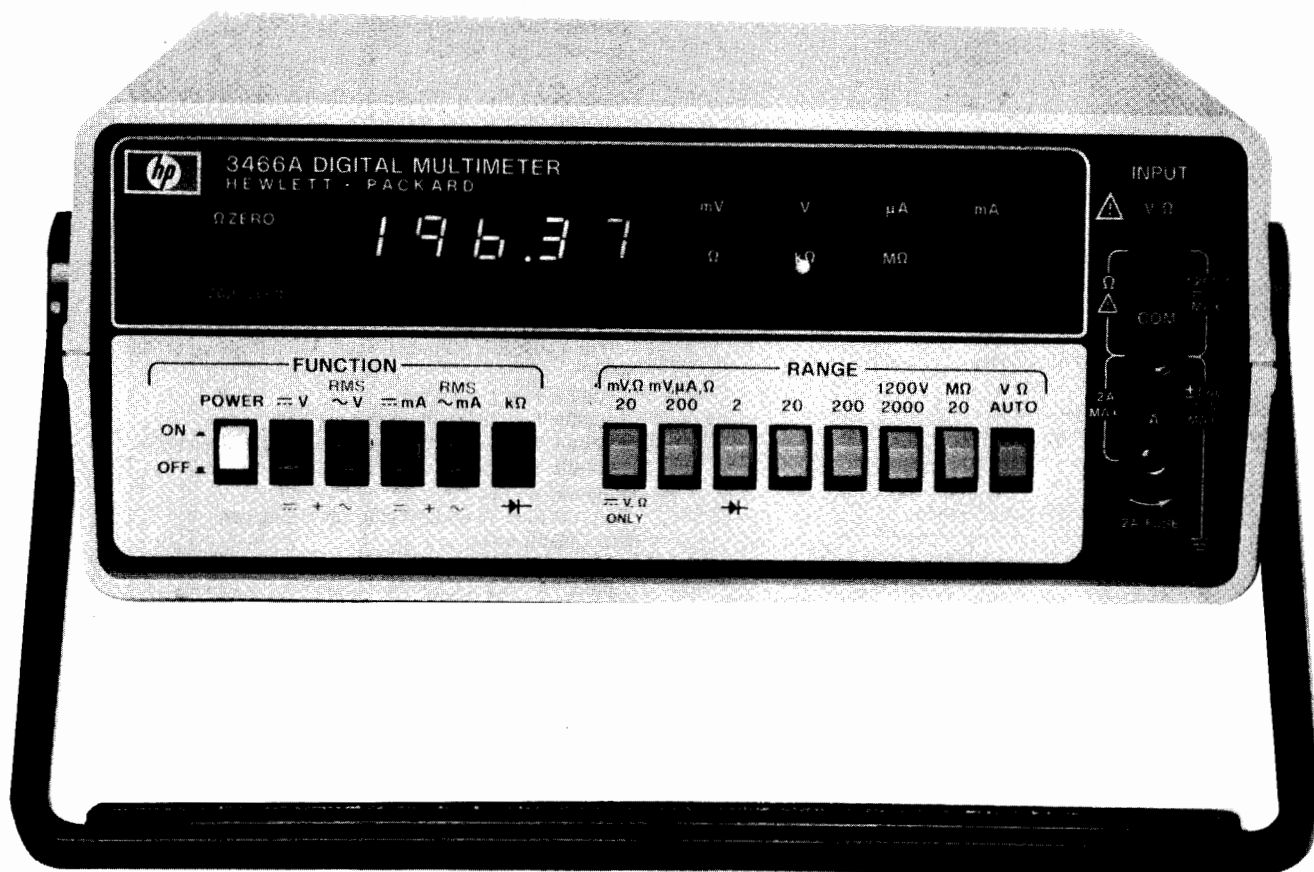

## Description

The 3466A is a 4½ digit Multimeter with autoranging volts and ohms. Functional capability includes ACV, DCV, (AC + DC) V, ACI, DCI, (AC + DC) I, Ω, and diode test. AC measurements are true-rms with selectable AC or DC coupling. Available with rechargeable batteries or AC power only, it has 1 μV DC and 1 mΩ sensitivity with zero adjustment on lowest ranges to compensate for external offsets.

**Input resistance:** 10 meg Ω ± 0.5% all ranges.  
**Normal mode rejection:** ≥ 60 dB @ 50/60 Hz ± 0.1%.  
**Effective common mode rejection (1 KΩ unbalance):** ≥ 120 dB @ 50/60 Hz ± 0.1%; ≥ 140 dB @ DC  
**Input type:** floating, 500 V maximum common to ground.

## Specifications

### DC Voltmeter

Voltage Range	Maximum Display
20 mV	± 19.999 mV
200 mV	± 199.99 mV
2 V	± 1.9999 V
20 V	± 19.999 V
200 V	± 199.99 V
1200 V	± 1199.9 V

### DC Current

Current Range	Maximum Display
200 μA	± 199.99 μA
2 mA	± 1.9999 mA
20 mA	± 19.999 mA
200 mA	± 199.99 mA
2000 mA	± 1999.9 mA

**Maximum Input:** ± 1200 V maximum DC and peak AC.

**Ranging:** automatic or manual.

**Sensitivity:** 1 μV on 20 mV range.

**Accuracy:** (1 yr., 18 to 28°C assuming rear panel zero adjustment on lowest two ranges)

**Maximum Input:** 2 amp from < 250 V source (fuse protected).

**Ranging:** manual only.

**Sensitivity:** 10 nA on 200 μA range.

**Accuracy (1 yr., 18 to 28°C):**

Range	Specification ± (% of reading + # digits)
20 mV	(.05 + 3)
200 mV	(.04 + 2)
2 V → 200 V	(.03 + 1)
1200 V	(.035 + 1)

Range	Specification ± (% reading + # digits)
200 μA through 20 mA	(.07 + 2)
200 mA	(0.15 + 2)
2000 mA	(0.5 + 2)

**Input type:** floating 500 V maximum Common to ground.



## AC Voltmeter

**AC Converter:** True-rms Responding True-rms Calibrated

Range	Maximum Display
200 mV	199.99 mV
2 V	1.9999 V
20 V	19.999 V
200 V	199.99 V
1200 V	1199.9 V

**Maximum input:** (AC + DC):  $\pm 1200$  V DC;  $\pm 1700$  V (DC + Peak AC),  $10^7$  V  $\cdot$  Hz, AC:  $\pm 600$  V DC; 1700 V (Peak AC + DC),  $10^7$  V  $\cdot$  Hz.

**Ranging:** automatic or manual.

**Sensitivity:** 10  $\mu$ V on 200 mV range.

**Crest factor:** 4:1 at Full Scale.

**Accuracy** (with display of  $\geq 10\%$  of range): 1 yr., 18 to 28°C sinusoid waveform.

**AC TRMS: (20 Hz to 100 kHz)**

Frequency Range	Specification $\pm$ (% of reading + # digits)
20 Hz to 30 Hz	(2 + 50)
30 Hz to 50 Hz	(1 + 30)
50 Hz to 10 kHz	(0.3 + 20)
10 kHz to 20 kHz	(1 + 40)
20 kHz to 100 kHz	(2 + 150)

**DC + AC TRMS:** DC + (20 Hz to 100 kHz).

(Accuracy applies after 10 minute warmup)

DC + Frequency Range	Specification $\pm$ (% of reading + # digits)
DC, 20 Hz to 50 kHz	(1 + 80)
50 kHz to 100 kHz	(2 + 200)

**Input impedance:** resistance 2 M $\Omega$ ,  $\pm 1.5\%$ .

Shunt capacitance <75 pF.

**Input type:** Floating, 500 V Maximum common to ground.

## AC Current

Current Range	Maximum Display
200 $\mu$ A	199.99 $\mu$ A
2 mA	1.9999 mA
20 mA	19.999 mA
200 mA	199.99 mA
2000 mA	1999.9 mA

**Detector:** true RMS.

**Crest factor:** 4:1 at Full Scale

**Maximum input:** 2 Amp RMS from <250 V source (fuse protected).

**Ranging:** manual only.

**Sensitivity:** 10 nA on 200  $\mu$ A range.

**Accuracy:** (with display  $\geq 10\%$  of range) 1 yr., 18°C to 28°C, sinusoid waveform.

**AC TRMS:** 20 Hz to 10 kHz.

Range	Frequency	Specification $\pm$ (% of reading + # digits)
200 $\mu$ A–200 mA	20 Hz–30 Hz	2 + 50
	30 Hz–10 kHz	0.9 + 35
2000 mA	20 Hz–30 Hz	2 + 50
	30 Hz–10 kHz	1.2 + 20

**(DC + AC) TRMS:** DC + (20 Hz to 10 kHz).

(Accuracy applies after 10 minute warmup)

**All ranges:** 20 Hz to 10 kHz,  $\pm$  (1.5% of reading + 80 digits).

**Input type:** floating, 500 V maximum common to ground.

## Ohms

Range	Maximum Display
20 $\Omega$	19.999 $\Omega$
200 $\Omega$	199.99 $\Omega$
2 k $\Omega$	1.9999 k $\Omega$
20 k $\Omega$	19.999 k $\Omega$
200 k $\Omega$	199.99 k $\Omega$
2000 k $\Omega$	1999.9 k $\Omega$
20 M $\Omega$	19.999 M $\Omega$

**Accuracy:** 1 yr., 18 to 28°C (assuming use of front panel zero on lowest two ranges).

Range	Specification $\pm$ (% of reading + # digits)
20 $\Omega$ –200 $\Omega$	.08 + 2
2 k $\Omega$ –200 k $\Omega$	.03 + 1
2000 k $\Omega$	.04 + 1
20 M $\Omega$	.15 + 1

**Input protection:** 250 V RMS or 350 V (DC + peak AC).

**Ranging:** automatic or manual.

**Sensitivity:** 1 milliohm on 20 ohm range.

**Configuration:** 2 wire.

**Zero adjustment:** range of 700 m $\Omega$ . Use on 20 $\Omega$ , and 200 $\Omega$  ranges.

**Open circuit voltage:** <5 V maximum.

**Current through unknown:**

Range:	20 $\Omega$ ,	200 $\Omega$ ,	2 k $\Omega$ ,	20 k $\Omega$ ,	200 k $\Omega$ ,	2000 k $\Omega$ ,	20 M $\Omega$
Current:	5 mA,	5 mA,	1 mA,	100 $\mu$ A	10 $\mu$ A	1 $\mu$ A	100 nA

## Diode Test

**Function:**  $\rightarrow \leftarrow$  (k $\Omega$ ).

**Range:**  $\rightarrow \leftarrow$  (2k $\Omega$ ).

**Current source:** 1 mA  $\pm 1.5\%$ .

**Diode voltage drop displayed in volts:** 1.9999 volts maximum.

**Open circuit voltage:** <5 volts maximum.

**Overload protection:** 350 V (DC + peak AC).

## General

**Display:** 7 segments red 0.3 in high LED. Function and range annunciated.

**Reading rate:** 2.4 to 4.7/sec. depending on input level.

**Remote trigger:** shorting COM to A stops sampling in Volts functions.

**Storage temperature:** AC only,  $-55^\circ\text{C}$  to  $+75^\circ\text{C}$ ; with batteries,  $-55^\circ\text{C}$  to  $+65^\circ\text{C}$ .

**Operating temperature:** (0 to 55) $^\circ\text{C}$ .

**Humidity:** 95% RH at  $+40^\circ\text{C}$ .

**Power:** AC line; 48–440 Hz; 86–250 V.

**Battery:** rechargeable lead-acid 8 hours maximum continuous operation with full charge. Recharge time: 16 hours operating, 12 hours non-operating. Batteries and charger available separately, consult operating manual. Total power dissipated: AC only, 4 watts; with charger, 9 watts.

**Size:** 3466A: 98.4 mm H x 238.1 mm W x 276.2 mm D (3.88" x 9.38" x 10.88"). 3466A Opt. 002: 81 mm H x 215 mm W x 279 mm D (3.13" x 8.38" x 10.88")

**Weight:** 3466A: 2.9 kg (6.31 lb).

3466A Opt 001: 2 kg (4.41 lb).

3466A Opt. 002: 2.6 kg (5.73 lb).

## Ordering Information

**Configuration:** 3466A streamlined portable case with handle, AC line power, batteries and charger included; 3466A Opt 001, eliminate battery and charger, AC line power only. Opt 002 Rack and Stack case, AC line-power only (rack mount kit not included). All orders must include one of these line power options: Opt 100, 86–106 V; Opt 115, 104–127 V; Opt 210, 190–233 V; Opt 230, 208–250 V.

## Options

Opt 001

less \$75

Opt 002

less 35

Opt 100, 115, 210, 230

N/C

**3466A Digital Multimeter**

**\$650**





# DIGITAL VOLTMETERS

## 4½ digit logging multimeter

### Model 3467A

- DC voltmeter, true-rms voltmeter, ohmmeter
- Digital thermometer
- Four channel scanner
- Math functions
- Printer & timer
- Diode test

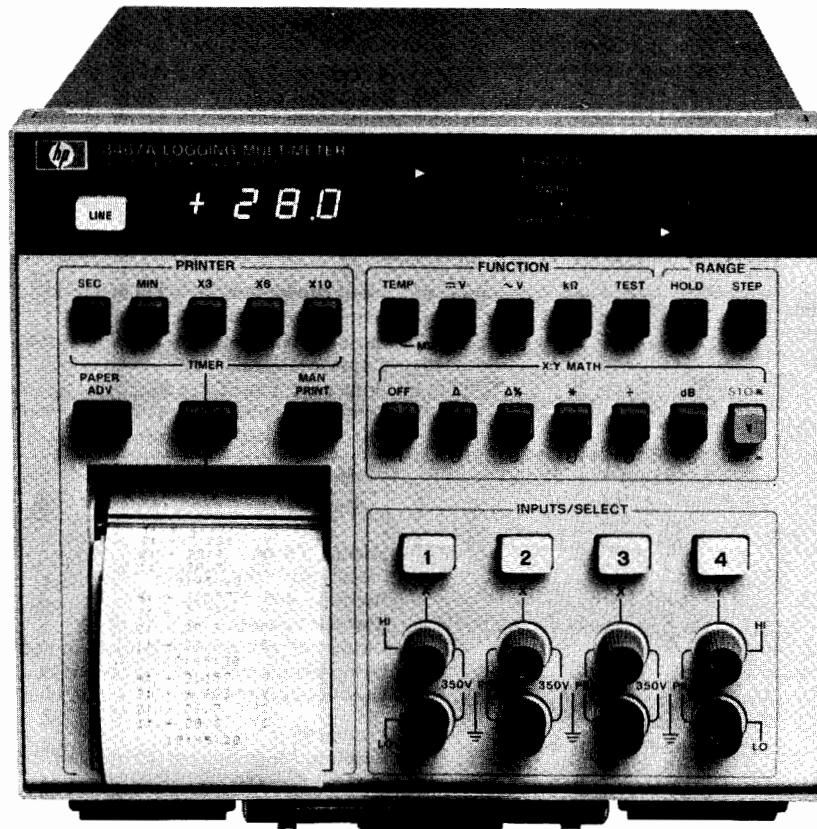

3467A

### Description

Hewlett-Packard's 3467A Logging DMM is a total measurement station, doing jobs that used to require several instruments. The HP 3467A combines a high performance 4½ digit DMM, four channel scanner, digital thermometer, math functions, and printer with timer in a single instrument. It simplifies setups and measurements and gives you a record of data in the units you need (°C, dB, etc.) . . . unattended or manually.

The 3467A can be used to measure DC volts, resistance, true-rms AC volts, or temperature. Temperature can be measured simultaneously with voltage or resistance to allow convenient analysis of temperature dependent parameters. Using thermistors, the temperature measurements can be made directly in °C or °F. Other built-in math functions can be performed on the first three channels with respect to a measured input on the fourth channel or a manually entered constant.

### Specifications

#### DC Voltmeter

Range	Maximum Reading
20mV	± 19.999mV
200mV	± 199.99mV
2V	± 1.9999V
20V	± 19.999V
200V	± 199.99V
350V	± 349.9V

**Maximum input:** ± 350 V from any terminal to ground and between any two terminals

**Ranging:** Automatic or Hold/Step

**Sensitivity:** 1 µV on 20 mV range

**Polarity:** Automatically sensed and displayed

**Zero adjustment:** Front panel pushbutton compensated for up to ± 2 mV offset for each channel

**Accuracy:** 6 months, 18°C to 28°C (Assuming 30 minute warmup and use of zero adjustment):

Range	± (% of Reading + Number of Counts)
20mV	0.05 + 10
200mV	0.04 + 2
2V - 200V, 350V	0.03 + 1

**Temperature coefficient:** (0° to 18°C, 28° to 50°C): ± (.003% of reading + 0.15 counts)/°C

**Input resistance:** 10 MΩ ± 5% on all ranges

**Normal mode rejection:** > 60 dB at 50/60 Hz ± 0.1%

**Effective common mode rejection (1 KΩ unbalance):** > 120 dB at 50/60 Hz ± 0.1%

**Single channel response time (no print):** < 0.7 seconds to within 1 count of final value on one range. Add 0.8 seconds for each range change.

**Ohmmeter**

Range	Maximum Reading	Current Through Unknown
200Ω	199.99Ω	5 mA
2KΩ	1.9999Ω	1 mA
20KΩ	19.999KΩ	100 μA
200KΩ	199.99KΩ	10 μA
2MΩ	1.9999MΩ	1 μA
20MΩ	19.999MΩ	100 nA

**Input Protection:** 250 V RMS or 350 V (DC + peak AC)

**Ranging:** Automatic or Hold/Step

**Sensitivity:** 10 mΩ on 200Ω range

**Configuration:** 2 wire with front panel pushbutton zero adjustment.

Lead resistance of up to 20Ω can be nulled out for each channel

**Accuracy:** 6 months, 18°C to 28°C (Assuming use of zero adjustment on 200Ω range):

Range	± (% of Reading + Number of Counts)
200Ω	0.08 + 10
2KΩ	0.03 + 3
20KΩ-200KΩ	0.03 + 1
2MΩ	0.04 + 1
20MΩ	0.15 + 1

**Temperature coefficient:** (0°C to 18°C, 28°C to 50°C)

Range	± (% of Reading + Number of Counts)/°C
200Ω	±(0.002% of reading + 1 count)/°C
2KΩ-2MΩ	±(0.002% of reading + 0.1 count)/°C
20MΩ	±(0.01% of reading + 0.1 count)/°C

**Open circuit voltage:** <5V

**Single channel response time (no print):** <1.1 seconds to within 1 count of final value on one range. Add 0.8 seconds for each range change.

**Diode test**

**Function:** (kΩ) ←

**Range:** 2KΩ

**Current source:** 1mA ±4%

**Diode voltage drop displayed in volts:** 1.9999 volts maximum measurable voltage

**AC Voltmeter**

**AC converter:** True RMS Responding and calibrated in true RMS; AC coupled

Range	Maximum Reading
200mV	199.99mV
2V	1.9999V
20V	19.999V
200V	199.99V
250V	249.9V

**Maximum input:** ±350V (DC + peak AC), 10<sup>7</sup> V•Hz from any terminal to ground and between any two terminals

**Ranging:** Automatic or Hold/Step

**Sensitivity:** 10 μV on 200 mV range

**Crest factor:** 4:1 at full scale

**Accuracy:** Accuracy applies with readings of ≥9% of full scale (≥1800 counts on 250 V range): 6 months, 18°C to 28°C; sinusoidal waveform

Frequency	± (% of Reading + Number of Counts)
45 Hz-100 Hz	1 + 40
100 Hz -10 kHz	0.2 + 40
10 kHz-20 kHz	1 + 40
20 kHz-100 kHz	2 + 200

**Temperature coefficient:** (0°C to 18°C, 28°C to 50°C)

Frequency	± (% of Reading + Number of Counts)/°C
45 Hz-100 Hz	±(0.05% of reading + 2 counts)/°C
100 Hz-10 kHz	±(0.03% of reading + 2 counts)/°C
10 kHz-20 kHz	±(0.05% of reading + 2 counts)/°C
20 kHz-100 kHz	±(0.05% of reading + 15 counts)/°C

**Input impedance:** 2MΩ ± 5% in parallel with <100 pF

**Single channel response time (no print):** <2 seconds to within 4 counts of final value on one range. Add 1.2 seconds for each range change.

**Temperature Measurement**

**Technique:** Temperature measurements using thermistors can be made directly in °C or °F, selectable by an internal switch.

**Thermistor linearization is included for the following thermistors:** YSI 44007, OMEGA 44007, FENWAL UUA 35J1 or equivalent. (One thermistor is furnished with each 3467A).

**Accuracy:** The accuracy specification includes ohmmeter accuracy, thermistor curve fit accuracy, and thermistor self-heating:

-80°C to + 80°C:	±0.3°C
+80°C to +110°C:	±0.5°C
+110°C to +150°C:	±1.3°C

**Four-Channel Scanner**

**Type:** One 2-pole low thermal dry reed relay per channel.

**Inputs:** Floating inputs. Any combination of four channels may be selected to measure one of these functions: DC volts, true-rms AC volts, resistance or temperature. Measurements of temperature on channels 1 and 2, and either DC volts, AC volts, or resistance on channels 3 and 4 can also be made.

**Channel-to-Channel Isolation:**

Source Impedance	Up to 1 kHz	Up to 100 kHz
600 Ω	>100 dB	>60 dB
10 KΩ	> 80 dB	>40 dB

**Printer and Timer**

**Type:** Thermal Printer

**Print modes:** Manual: Initiates a printout of selected input channels; Automatic: Scans, measures and prints selected input channels at preset time intervals

**Time Interval\*:** 1, 3, 6, 10, 18, 30, 60, or 180 seconds/minutes interval selectable via front panel pushbuttons

**Timer:** Internal 24-hour crystal controlled interval timer. Timer starts at 00:00:00 (HH:MM:SS). A time offset can be manually entered to synchronize the timer with the time of day.

**Timer accuracy:** Within 1 minute in 24 hours

**Power failure protection:** Should a momentary power failure occur (up to 5 seconds), the 3467A will retain the math constant, elapsed time, zero offsets, and ranges.

\*Time intervals ≤10 seconds may be shorter than the actual time required to completely measure and print the selected channels.

**General**

**Reading rate:** Depends on input signal level. 2 to 4½ readings/second.

**Operating temperature:** 0°C to +50°C

**Storage temperature:** -40°C to +55°C without thermal paper

**Thermal paper storage temperature:** -40°C to +30°C

**Humidity:** 95% R.H., +40°C without thermal paper  
60% R.H., +30°C with thermal paper

**Power:** 100/120/220/240 +5%, -10%  
48 to 440 Hz line operation, <25 VA

**Size:** 190.5mm H × 212.9mm W × 304.8mm D (7.5" × 8.4" × 12")

**Weight: Net:** 4.77 kg (10.5 lbs.); **Shipping:** 5.44 kg (12 lbs.)

**Accessories**

Accessories	Price
5061-2003 Carrying Handle Kit (44416A is also required with this accessory)	\$30
44416A Rear Panel Support and Cord Wrap Kit	\$25
44414A Four Thermistor Pack	\$20
82045A Six Rolls of Thermal Paper	\$6

**3467A Logging Multimeter** (includes 1 roll of thermal paper and a thermistor) **\$2300**

# DIGITAL VOLTMETERS

True RMS voltmeter  
Model 3403C

- DC and 2 Hz to 100 MHz
- 3½ digit

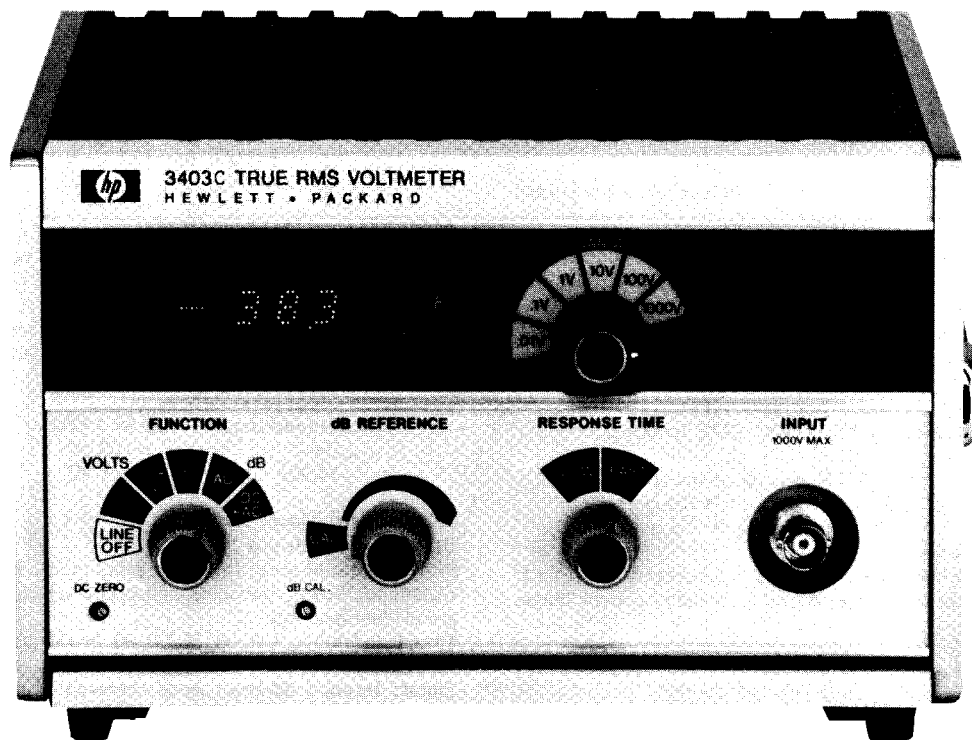

## Description

The Model 3403C is usable from dc to 100 MHz. True rms is especially valuable for measurements of noise, multiplexed signals, modulated waves and signals with high harmonic content.

### dB Display

The dB display option provides readings directly in dB, a major convenience to ac users. The dB reference to which the measurement is made is conveniently adjustable from the front panel to provide referenced dB measurements, or to provide a convenient means to offset the reading by as much as 13 dB for unreferenced measurements.

## Specifications

### Ranges

**Full range display:** 10.00 mV (ac only); 100.0 mV; 1.000 V; 10.00 V; 100.0 V; 1000 V.

**Overrange:** >90% on all ranges except as limited by max input voltage.

**Ranging Information:** front panel annunciators indicate overrange (approximately 190% of full range), or underrange (approximately 17% of full range) conditions.

### Performance

#### AC frequency range

**Slow response:** 2 Hz to 100 MHz.

**Fast response:** 25 Hz to 100 MHz.

### Response time

**Fast response:** 1 s.

**Slow response:** 10 s.

Instrument reads final reading  $\pm 0.1\%$  of input change in stated response time.

### Display rate

**Fast response:** 4 readings per s.

**Slow response:** 2 readings per s.

READING ACCURACY =  $\pm$  (% OF RANGE + % OF READING)\*\*

RANGE	% OF RANGE (VOLTS)			% OF READING (VOLTS)						
	DC	DC + AC	AC	DC	2 Hz	25 Hz	100 KHz	1 MHz	10 MHz	100 MHz
1000V	.3	.3	.3	.2	.4*	.2	[Cross-hatched area]			
100V	.2	.2	.2	.2	.4*	.2				
10V	.2	.2	.2	.2	.4*	.2	.5	1	[Cross-hatched area]	
1V	.2	.2	.2	.2	.4*	.2	.5	1		
100mV	.6	.6	$\frac{2}{4}$ 40mV	.2	.4*	.2	.5	2	2.5	10
10mV			$\frac{2}{4}$ 4mV			.3	1.2	3	FROM 50V	

[Cross-hatched area] CAUTION: frequencies and ranges in this area may result in invalid readings without ranging indication.

\* DC + AC function and slow response time only

\*\* % of reading specification is representative of typical flatness.



### Functions

**DC:** responds to dc component of input signal.

**AC:** responds to true rms value of ac coupled input signal.

**AC+ DC:** responds to true rms value of dc and ac input signal; reading is  $\sqrt{(dc)^2 + (ac \text{ rms})^2}$

**Temperature coefficient:**  $\pm(0.1 \times \text{reading accuracy}^*/^\circ\text{C})$  outside the  $25^\circ\text{C} \pm 5^\circ\text{C}$  temperature range.

\*Data from accuracy charts.

**Accuracy:** 90 days ( $25^\circ\text{C} + 5^\circ\text{C}$ , <95% RH, 17% of range to 190% of range).

### Input characteristics

**Input impedance:** (< 10 MHz):

**1 V to 1000 V range:**  $10 \text{ M}\Omega \pm 10\%$  shunted by  $24 \text{ pF} \pm 10\%$ .

**10 mV and 100 mV range:**  $20 \text{ M}\Omega \pm 10\%$  shunted by  $20 \text{ pF} \pm 10\%$ .

**10 MHz to 100 MHz:** the following table gives maximum loading due to input shunt impedance across a terminated source.

System impedance (source and load)	Frequency	
	10 MHz	100 MHz
50 $\Omega$	1%	10%
75 $\Omega$	2%	20%

### Crest factor

2 Hz to 25 Hz	2:1 at full range input.
>25 Hz	10:1 at full range input.

### Maximum input voltage

**High to low:** 1000 V rms, 1500 peak or  $10^8$  V-Hz on any range. Maximum dc voltage in ac mode: 500 V dc.

**Low to chassis:**  $\pm 500$  V dc, when floated with special banana to BNC adapter.

### Options:

#### Autoranging (3403C option 001)

**Automatic ranging:** uprange at approximately 190% of full range; downranges at approximately 17% of full range.

**Autorange time:** fast response: 1 s per range change. Slow response: 10 s per range change.

**Remote control + digital output + autoranging (3403C option 003):** Provides remote control of all front panel functions, ranges, digital output and autoranging.

#### dB display (3403C option 006)

**Measurement range:** 108 dB ( $-48$  dBV to  $+60$  dBV).

**Calibrated dB reference:** 0 dB = 1.000 V; reference level may be set for 0 dBm (600 $\Omega$ ) by adjusting front panel dB calibration adjustment.

**Variable dB reference:** reference level may be shifted downward from calibrated position  $> 13$  dB.

**dB recorder output:** output voltage: 200 mV for 20 dB. Output resistance:  $1 \text{ k}\Omega \pm 500 \Omega$ .

**Accuracy:** 90 days ( $25^\circ\text{C} + 5^\circ\text{C}$ , <95% RH).

READING  
ACCURACY =  $\pm(\text{dB} + \pm \text{dB})^{**}$

RANGE	dB		dB										
	AC	DC+AC	DC	2 Hz	25 Hz	100 KHz	1 MHz	10 MHz	100 MHz				
1000V	.15	.15	.02	.04*	.02								
100V	.15	.15	.02	.04*	.02					.1			
10V	.15	.15	.02	.04*	.02					.05	.1		
1V	.15	.15	.02	.04*	.02					.05	.1	2.5	1
100mV	.15	.15	.02	.04*	.02					.05	.2	2.5	1
10mV	.15				.03					.12	.3	2M	

CAUTION: frequencies and ranges in this area may result in invalid readings without ranging indication.

\* DC + AC function and slow response time only

\*\* specification is representative of typical flatness.

### General

#### Operating conditions

**Temperature range:**  $0^\circ\text{C}$  to  $50^\circ\text{C}$ .

**Humidity:** <95% RH.

#### Recorder output

**Output voltage:** 1 V dc open circuit for full range input.

**Output resistance:**  $1 \text{ k}\Omega \pm 10\%$ .

**Power:** 115 V or 230 V  $\pm 10\%$ , 48 Hz to 440 Hz, 35 VA max. (including all options).

**Input terminals:** BNC front panel connector standard for low to high terminals; rear panel connector available by internally reversing position of ac converter module.

**Weight:** including all options: net, 5 kg (11 lb). Shipping, including all options: Net, 7.2 kg (16 lb).

**Size:** 127 H x 234.9 W x 196.8 mm D ( $5'' \times 9.25'' \times 7.75''$ ).

**Accessories furnished:** floating adapter-banana to BNC.

#### 3403C True RMS Voltmeter

**Opt 001** autoranging

\***Opt 003** remote control + digital output + autoranging

\***Opt 006** dB display

\*Options 003 and 006 are available only as factory installed options.

**\$3250**

add \$170

add \$370

add \$330

# DIGITAL VOLTMETER

## HP-IB 5 Function DMM

Model 3438A



### Description

The 3438A is an autoranging 3½ digit Multimeter with 5 functions of ACV, DCV, ACI, DCI, and Ω. It interfaces to the HP-IB providing both addressable and talk-only modes.

The addressable mode allows triggering either from the Calculating Controller (remote) or internally (local). Function and range are selected manually on the front panel with autoranging of volts and ohms.

### Specifications

#### DC Voltmeter

Ranges:	Maximum display:
200 mV	±199.9 mV
2 V	±1.999 V
20 V	±19.99 V
200 V	±199.9V
1200 V	±1199 V

**Maximum input:** 1200 V (DC + peak AC).

**Ranging:** Automatic or manual.

**Sensitivity:** 100μV on 200 mV range.

**Polarity:** Automatically sensed and displayed.

**Accuracy:** (1 year, 15 to 30°C)

Range	Specifications
200 mV	±(0.1% of reading + 2 digits)
2 V to 1200 V	±(0.1% of reading + 1 digit)

**Temperature coefficient:** (0 to 15°C and 30 to 55°C) ± (.015% reading + 0.1 digit)/°C.

**Input resistance:** 10 meg Ω ± 1%.

**Input Type:** floating, 500 V maximum com. to ground.

**Normal Mode Rejection:** >40 dB at 50 Hz and 60 Hz ± 0.1%

**Response time:** <0.7 seconds to within 1 digit of final value on one range. Add 1 second for each range change.

**Effective common mode rejection:** (1 kΩ unbalance) > 120 dB at 50/60 Hz ± 0.1%.

#### DC Current

Ranges:	Maximum display:
200 μA	±199.9 μA
2 mA	±1.999 mA
20 mA	±19.99 mA
200 mA	±199.9 mA
2000 mA	±1999 mA

**Maximum input:** current: 2 amp (fuse protected); voltage: 250 V

**Ranging:** manual only.

**Sensitivity:** 100 nA on 200 μA range.

**Polarity:** automatically sensed and displayed.

**Accuracy:** (1 year, 15 to 30°C)

Range	Specifications
200 μA to 200 mA	±(0.3% of reading + 2 digits)
2000 mA	±(0.6% of reading + 2 digits)

**Temperature coefficient:** (0 to 15°C and 30 to 55°C) ± (.028% of reading + 0.1 digits)/°C.

**Voltage burden:**

Range	Maximum Burden at Full Scale
200 μA to 20 mA	< 220 mV
200 mA	< 240 mV
2000 mA	< 400 mV

**Response time:** <0.7 seconds on any range to within 1 digit of final value.

#### AC Voltmeter

**AC Converter:** (average responding RMS calibrated)

Ranges:	Maximum Display:
200 mV	199.9 mV
2 V	1.999 V
20 V	19.99 V
200 V	199.9 V
1200 V	1199 V



**Maximum Input:** 1700 V (DC + Peak AC), 10<sup>7</sup> Volt-Hz max.

**Ranging:** Automatic or manual.

**Sensitivity:** 100  $\mu$ V on 200 mV range.

**Accuracy (with display of  $\geq 20$  digits)** 1 year, 15 to 30°C

Frequency	Specifications
30 Hz-50 Hz	$\pm (1.5\% \text{ of reading} + 3 \text{ digits})$
50 Hz-20 kHz	$\pm (0.3\% \text{ of reading} + 3 \text{ digits})$
20 kHz-100 kHz	$\pm (1.5\% \text{ of reading} + 10 \text{ digits})$

**Temperature coefficient:** (0 to 15°C and 30 to 55°C)  $\pm (0.04\% \text{ of reading} + 0.2 \text{ digit})/^\circ\text{C}$ .

**Input impedance:** resistance: 5 meg  $\Omega$   $\pm 5\%$ ; shunt capacitance: <100 pf.

**Response time:** < 1.6 seconds to within 3 digits of final value on one range. Add 1.2 seconds for each range change.

**Input type:** floating, 500 V maximum com. to ground.

#### AC Current

Ranges:	Maximum display:
200 $\mu$ A	199.9 $\mu$ A
2 mA	1.999 mA
20 mA	19.99 mA
200 mA	199.9 mA
2000 mA	1999 mA

**Maximum Input:** current: 2 amp (fuse protected) voltage: 250 V.

**Ranging:** Manual only.

**Sensitivity:** 100 nA on 200  $\mu$ A range.

**Accuracy (With display of  $\geq 20$  digits)** 1 year, 15 to 30°C

Current Range	2000 mA	$\pm (2\% \text{ of reading} + 5 \text{ digits})$	$\pm (1.2\% \text{ of reading} + 5 \text{ digits})$
	200 mA to 200 $\mu$ A	$\pm (1.7\% \text{ of reading} + 5 \text{ digits})$	$\pm (0.9\% \text{ of reading} + 5 \text{ digits})$

30 Hz                      50 Hz                      10 kHz  
Frequency of Input Signal

**Temperature coefficient:** (0 to 15°C and 30 to 55°C)  $\pm (0.05\% \text{ of reading} + 0.2 \text{ digits})/^\circ\text{C}$ .

**Voltage burden**

Range	Maximum Burden at Full Scale
200 $\mu$ A to 20 mA	<220 mV RMS
200 mA range	<240 mV RMS
2000 mA range	<400 mV RMS

**Response time:** 1.6 seconds on any range to within 3 digits of final value.

**Input type:** floating, 500 V maximum com. to ground.

#### Ohmmeter

Ranges:	Maximum display
20 $\Omega$	19.99 $\Omega$
200 $\Omega$	199.9 $\Omega$
2 k $\Omega$	1.999 k $\Omega$
20 k $\Omega$	19.99 k $\Omega$
200 k $\Omega$	199.9 k $\Omega$
2000 k $\Omega$	1999 k $\Omega$
20 M $\Omega$	19.99 M $\Omega$

**Input protection:** 250 V RMS.

**Ranging:** automatic or manual.

**Sensitivity:** 10 milliohm on 20 $\Omega$  range.

**Accuracy** (1 year, 15 to 30°C)

Range	Specifications
20 $\Omega$	$\pm (0.5\% \text{ of reading} + 12 \text{ digits})$
200 $\Omega$ to 2 M $\Omega$	$\pm (0.2\% \text{ of reading} + 2 \text{ digits})$
20 M $\Omega$	$\pm (0.8\% \text{ of reading} + 2 \text{ digits})$

**Temperature coefficient** (0 to 15°C and 30 to 55°C)

Range	Specifications
20 $\Omega$ -2 M $\Omega$	$\pm (0.04\% \text{ of reading} + 0.2 \text{ digits})/^\circ\text{C}$
20 M $\Omega$	$\pm (.18\% \text{ of reading} + 0.2 \text{ digits})/^\circ\text{C}$

**Configuration:** 2 wire.

**Open circuit voltage:** <5 V.

**Current through unknown**

Range	20 $\Omega$	200 $\Omega$	2 k $\Omega$	20 k $\Omega$	200 k $\Omega$	2 M $\Omega$	20 M $\Omega$
Current	5 mA	5 mA	500 $\mu$ A	50 $\mu$ A	5 $\mu$ A	500 nA	50 nA

**Response time:** <0.8 seconds to within 1 digit. Add 0.8 seconds for each range change.

#### HP-IB

**Data output format:**

$\pm X.XXX$   $E \pm X$ ,  $F_n$  CR LF (13 byte, fixed)

DISPLAY EXPONENT FUNCTION

**Function Code:** DCV, 1; ACV, 2; DCI, 3; ACI, 4;  $\Omega$ , 5

**Overload indication:**  $\pm 1.XXX E + 9$

**Talk Modes (Selected by internal switch)**

**Addressed to talk**

**Local:** continuously sampling input; outputs on Bus when addressed to talk.

**Remote:** samples input only on command from controller.

**Talk only (used without controller)**

**Input:** switch selectable, front or rear.

**Reading rate:** is function of input level and ranging (2.5 to 4.7/sec. if in proper range).

**With Range change**

**ACV, ACI:** add 1.2 seconds for each range change. After arrival on proper range, the first six readings are always discarded. The seventh reading is output on Bus. Allow 1.6 seconds additional for first reading on Bus.

**DCV, DCI, k $\Omega$ :** Add 1 second for each range change. After arrival on proper range, the first reading is always discarded. Allow 310 ms additional for first reading on Bus.

#### General

**Calibration:** data sheet specifications guaranteed for 1 year.

**Display:** 7 segment red 0.3 inch high LED's. Function, range, HB-IB status and annunciation.

**Reading rate:** 2.4-4.7/sec. depending on input level.

**A-D Conversion:** dual slope.

**Integration time:** 100 msec.

**Ranging:** automatic or manual on ACV, DCV, and ohms. Manual only on AC & DC current.

**Storage temperature:** -40 to +75°C.

**Operating temperature:** (0 to 55)°C.

**Humidity:** 95% RH at +40°C.

**Power:** 48-440 Hz, 12 watts; 86-106 V Opt 100; 104-127 V Opt 115; 190-233 V Opt 210; 208-250 V Opt 230.

**Size:** 85.7 mm H x 209.6 mm W x 282.2 mm D (3.4" x 8.25" x 11.5").

**Weight:** 2.8 kg (6.2 lb).

#### Ordering Information

Ordering Information	Price
11000A Test leads, dual banana both ends	\$17
11002A Test leads, dual banana to dual alligator	\$15
11003A Test leads, dual banana to probe and alligator	\$12
11096B RF Probe 10 kHz to 700 MHz	\$100
34110A Soft vinyl carrying/operating case	\$25
34111A High-voltage Probe 40 kV DC	\$75
34112A Touch-Hold Probe	\$40
11067A Test lead kit	\$5
5061-0072 1/2 module rackmount kit	\$35
10631A HP-IB Cable 1 m (39.4")	\$70
10631B HP-IB Cable 2 m (78.7")	\$75
10631C HP-IB Cable 4 m (157.5")	\$85
10631D HP-IB Cable 1/2 m (19.7")	\$70

**3438A Digital Multimeter**  
Opt 100, 115, 210, or 230 (specify one)

**\$875**  
N/C

# DIGITAL VOLTMETERS

High speed 3½ digit system voltmeter

Model 3437A

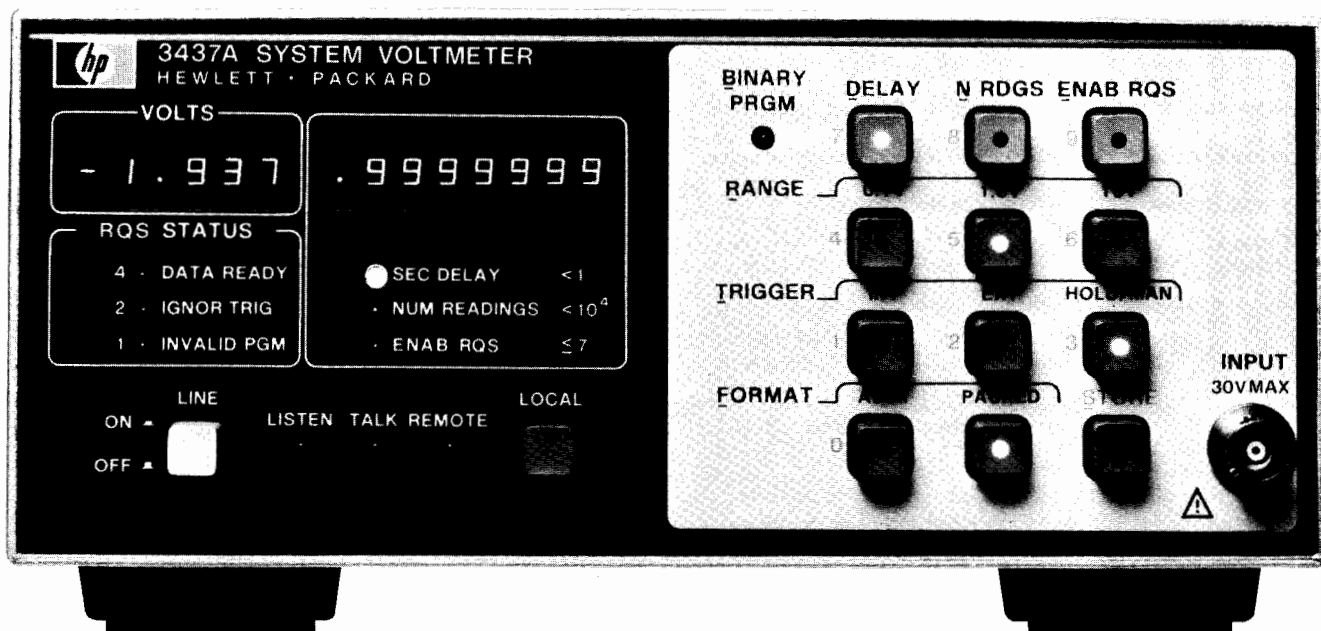

## Description

The Hewlett-Packard 3437A System Voltmeter has been designed to be used in systems. It is a 3½ digit high speed dc voltmeter with sample and hold. The standard unit measures DC volts, provides trigger delay, burst reading capability and Hewlett-Packard Interface Bus (HP-IB).

There are three DC floating input ranges: 0.1V, 1.0V and 10.0V full scale with a maximum display of "1999." Sample and Hold allows the 3437A to be an instantaneous reading voltmeter. The trigger delay can be set from 0.1μs to 1.0 second and the number of readings can be set from 0 to 9999 readings.

## Typical Operation

**Example:** set Delay to 1 ms and Number of Readings is set to 1000. The 3437A will now take 1000 readings spaced 1 ms apart upon receiving one trigger.

## Data Output

All front panel switches are programmable from the HP-IB. Two data output formats are available: (1) ASCII output (Serial ASCII characters) and (2) Packed output (two 8-bit bytes on the HP-IB to send the complete reading).

## High Speed

The Packed output mode allows more data to be stored in the calculator or computer as well as increasing the maximum reading rate from 3000 readings/second to greater than 5000 readings/second.

## Systems Capability

The user may select the mode for which the voltmeter requests service from the controller. Request Service can be programmed manually or automatically to request service for: (1) Data Ready, (2) Trigger Ignore, or (3) Invalid Program. Any combination of these three can be selected.

## Applications

**Waveform analysis**—The 3437A can be used to analyze a wide variety of waveforms. The delay and burst reading capability allows frequency, positive or negative peak values, RMS value and harmonic distortion to be measured. The accuracy of these measurements is comparable to more traditional measurement techniques.

**Transient signal analysis**—The 3437A is capable of measuring transient signals because of the wide bandwidth input (>1 MHz), high measuring speed and sample-and-hold.

**Fast AC measurements**—Sinusoidal signals of known frequency can be measured in less than one cycle of the signal. Very low frequency measurements can be made more quickly than with conventional techniques.

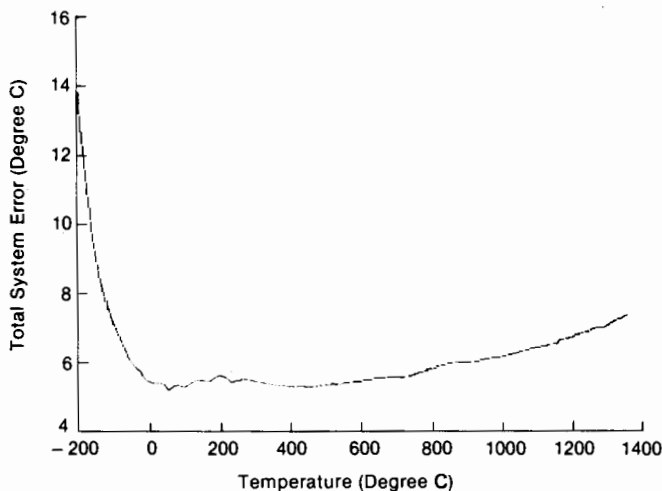

Figure 1 shows the performance of a 3437A when used to measure J type thermocouples. The 3437A can be used to measure multiple thermocouples at up to 4800 channels per second. Thermocouple linearization routines are provided in the 3054A Data Acquisition and Control System software.

**High speed scanning:** multiple input measurement applications can be satisfied with the 3437A and the HP 3497A Data Acquisition/Control Unit. Reading rates of up to 4800 channels/second can be attained.

**Bench measurements:** in addition to systems applications, the 3437A can be used to improve oscilloscope amplitude and measurement accuracy.

### Data-Sheeted Systems

The 3437A is a component of the 3054A Automatic Data Acquisition and Control System. The 3054A includes the 3437A for high speed measurements, the 3456A Digital Voltmeter for high accuracy measurements and the 3497A Data Acquisition/Control Unit for multiplexing and control outputs. The 3054A includes an extensive software package to support the 3437A when used for thermocouple measurements, high speed scanning, and waveform digitization. The 3437A is also a component of the 3052A Data Acquisition System.

## Specifications

### DC Volts

Ranges	Max. Display	Overload Reading
10 V	±19.98	±99.99
1 V	±1.998	±9.999
0.1 V	±.1998	±.9999

**Ranging:** Manual or Remote.

### Performance

#### Static accuracy (90 days, 23°C ±5°C)

**10 V range:** ±(0.05% of reading +1.6 counts.)

**1 V range:** ±(0.03% of reading +1.6 counts.)

**0.1 V range:** ±(0.06% of reading +1.8 counts.)

#### Static accuracy (1 year, 23°C +5°C)

**10 V range:** ±(0.05% of reading +2 counts.)

**1 V range:** ±(0.03% of reading +2 counts.)

**0.1 V range:** ±(0.06% of reading +2.2 counts.)

**Static accuracy temperature coefficient (0°C–50°C):** ±(0.002% reading +0.05 counts) / °C.

### Input Characteristics

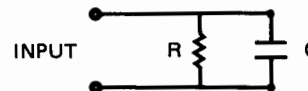

**10 V range:**  $R = 1 \text{ M}\Omega \pm 20\%$ ;  $C < 75 \text{ pF}$ .

**1 V range:**  $R > 10^6 \Omega$ ;  $C < 75 \text{ pF}$ .

**0.1 V range:**  $R > 10^6 \Omega$ ;  $C < 75 \text{ pF}$ .

**Maximum input voltage high to low on all ranges:**  $< \pm 30 \text{ V peak}$ .

**Maximum voltage low to chassis:**  $\pm 42 \text{ V peak}$ .

**Number of Readings (N Readings):** 0 to 9,999.

Readings are not internally stored.

For  $N = 0$  the 3437 operates in delay mode only.

**Maximum reading rate (Remote, N Rdgs. > 1, and a zero delay listener\*)**

**ASCII:** 3600 Readings/s.

**PACKED:** 5700 Readings/s.

Actual Reading Rate is given by  
 $\frac{3600}{3600 + \text{listen rate}}$

**ASCII:** —

$\frac{3600 + \text{listen rate}}$

Listen rate is the maximum speed at which the listener can accept 7 data bytes.

$\frac{5700}{5700 + \text{listen rate}}$

**PACKED:** —

$\frac{5700 + \text{listen rate}}$

Listen rate is the maximum speed at which the listener can accept 2 data bytes.

### Delay

**N Rdgs. = 0 or 1**

**DELAY (setting):** 0 to 0.999 999 9 sec. in 0.1  $\mu\text{s}$  steps.

**N Rdgs. > 1 (Remote and a zero delay listener)**

**ASCII:**  $0.0002778 \text{ s} \leq \text{DELAY} \leq 0.9999999 \text{ s}$ .

**PACKED:**  $0.0001754 \text{ s} \leq \text{DELAY} \leq 0.9999999 \text{ s}$ .

Minimum delay is a function of listener delay related by:

**ASCII:**  $277.8 \mu\text{s} + \text{listener delay}$ .

**PACKED:**  $175.4 \mu\text{s} + \text{listener delay}$ .

**Accuracy (EXT. TRIG to DELAY OUT, 0°C to 50°C)**

**Delay offset:**  $100 \text{ ns} \pm 25 \text{ ns}$  (with  $< 150 \text{ pF}$  cable capacitance)

**Delay accuracy:**  $\pm 0.008\% \text{ DELAY Setting} + \text{Delay offset}$ .

**Delay repeatability (Jitter) for N Rdgs = 0 or 1**

DELAY of 0 or 0.1  $\mu\text{s}$ : 2 ns

DELAY of 0.2  $\mu\text{s}$  to 50 ms:  $10 \text{ ns} + 0.0002\% \text{ DELAY setting}$ .

DELAY of  $> 50 \text{ ms}$ :  $\pm 110 \text{ ns}$ .

### Input bandwidth (3 dB)

**10 V range:** 1.0 MHz.

**1 V range:** 1.1 MHz.

**0.1 V range:** 40 kHz.

### Settling Time:

**10 V range:** 10 V Range with 10 V step input:

Reading settles to within 30 mV of final value in 7.5  $\mu\text{s}$  or to within 200 mV of final value in 700 ns.

**1 V range:** 1 V Range with 1 V step input:

Reading settles to within 3 mV of final value in 1.5  $\mu\text{s}$  or to within 20 mV of final value in 700 ns.

**0.1 V range:** 0.1 V Range with .1 V step input

Reading settles to within 200  $\mu\text{V}$  of final value in 25  $\mu\text{s}$ .

### General

**Operating temperature:** 0 to 55°C.

**Storage temperature:**  $-40^\circ\text{C}$  to  $75^\circ\text{C}$ .

**Humidity range:**  $< 95\% \text{ R.H.}$ ,  $0^\circ\text{C}$  to  $40^\circ\text{C}$ .

**Power:** 100 V, 120 V, 220 V, 240 V +5%,  $-10\%$ , 48 Hz to 440 Hz line operation,  $< 42 \text{ VA}$  with all options.

**Size:** 88.9 mm H x 212.7 mm W x 527.1 mm D ( $3\frac{1}{2}'' \times 8\frac{3}{8}'' \times 20\frac{3}{4}''$ ).

**Weight:** net, 5.6 kg (12 lb 4 oz). Shipping, 7.6 kg (16 lb 12 oz).

**3437A System Voltmeter**

**\$2300**



# DIGITAL VOLTMETERS

## 3½ to 6½ Digit DVM for Bench/System Applications

Model 3456A

- Up to 330 rdgs/sec
- 100 nanovolt resolution
- Transfer standard performance

- 100 micro-ohm to 1.0 gigaohm measurement capability
- Offset Compensated Ohms (OC)
- Fast AC

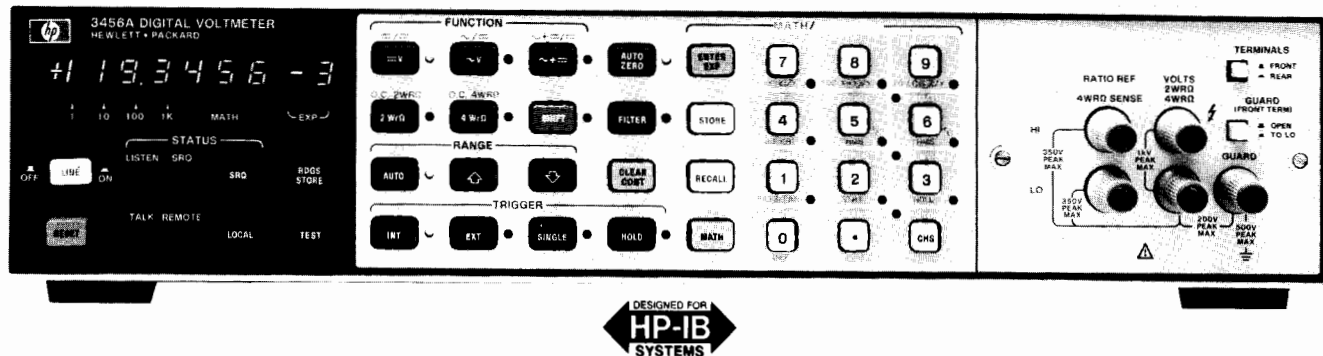

### Description

This new microprocessor-based, fully guarded, integrating Digital Multimeter is designed for bench or systems use. Called the HP Model 3456A, the instrument measures dc, true RMS ac voltage and resistance.

Five full scale dc ranges from 0.1 volt to 1000 volts are provided. Measurement speed and accuracy can be enhanced for a specific application, using the HP 3456A's selectable integration time (up to 100 power line cycles) and settling time. An operator can select up to 330 readings/second for high speed bursts or one reading every fifteen minutes for periodic measurements. Resolution of 100 nanovolts at 48 readings/second (6½ digits) to 10 microvolt resolution at 330 readings per second (3½ or 4½ digits) can be selected.

Because the HP 3456A uses an integration technique with new features such as "Program Memory" and "Reading Store", the operator can obtain the fastest possible reading rate with the most noise rejection. The first reading is correct, every time. The HP 3456A built-in memory is divided into two parts (Program and Reading Store). This feature lets the operator choose the length of program and the number of readings to be stored. For example, one could store an instrument command string 8 bytes long in program memory with room for 348 stored readings. The size of the HP 3456A memory is 1400 bytes long.

Transfer standard performance is assured with the HP 3456A. With good repeatability and 100 nanovolt sensitivity, accuracy on the ten volt range is  $\pm 0.0008\% + 2$  counts over a 24-hour period at  $23^\circ\text{C} \pm 1^\circ\text{C}$ .

Four full-scale, true TRMS ac voltage ranges are provided, with reading speeds up to 12 per second speed over a 20 Hz to 250 kHz frequency range with 1 microvolt resolution (6 digits). Best accuracy is 0.05%. Crest factor is greater than seven at full scale.

### New Ohms Technique

A technique called Offset Compensated Ohms is incorporated in the 3456A. The DMM compensates for any resistance inaccuracies that may be caused from thermally produced offset voltages in the circuit under test. In the ohms function, the instrument first measures the voltage drop across the circuit under test. The voltage measured is stored in the DMM. Simultaneously, the DMM supplies a fixed current through the circuit under test and measures the voltage drop. Since the thermal error first stored in the DMM's memory, it is automatically eliminated from the measurement.

The measurement range is from 1 mΩ to 1.2 GΩ, using either 2 or 4 wire connections.

### System DMM

Standard on the 3456A is an isolated HP-IB (IEEE-488) I/O for the systems operation. The front panel indicators on the 3456A display range, function and HP-IB status during remote operation. Also on the front panel is a SRQ (Service Request) button which can be

used to flag or interrupt a computer. With the 3456A's program memory and reading storage capability, system programmers and operators can use only one desktop or minicomputer to control numerous test stations, each containing a 3456A. By depressing the 3456A numerical entry keys and SRQ, the computer can be instructed to transfer a measurement sequence to the 3456A. The 3456A can take measurements and store them while a computer continues its operation as before the SRQ interrupt.

Another system feature of the 3456A is its hardware scanner advance capability for scanned or multiplexed system applications. As soon as the 3456A's measurement cycle is complete, a TTL signal is available to trigger an HP 3495A Scanner or 3497A Acquisition/Control Unit to advance to their next channel. Up to 330 channels can be scanned per second without computer interaction.

### Bench DMM

With a 2 ppm stability, the HP 3456A is a true transfer standard offering either 100 nanovolt sensitivity or 0.001% accuracy. Other standard features include fast autorange and easy-to-use math functions. The user can scale, limit test, null and make measurements in percent error, dB and dBm, as well as the themistor compensation in degrees F and C. A statistics function key (STAT) enables the operator to improve the 3456A's sensitivity, resolution and accuracy by averaging. Averaging reduces random noise fluctuations and improves sensitivity by a factor of the square root of the number of measurements. For example, for low level signals after 100 measurements, the actual sensitivity of the 3456A is approximately 10 nanovolts instead of 100 nanovolts. In addition, STAT enables the operator to recall the maximum (upper), minimum (lower), and variance.

Calibration of the HP 3456A is fast and convenient since all routine adjustments are accessible from a concealed door in the front panel. Should service be necessary, built-in diagnostics and PC Board modules make the HP 3456A easy to service.

### Specifications

#### DC Voltage

#### Input characteristics:

RANGE	MAXIMUM READING (5½ digit)	6½ digit	RESOLUTION 5½ digit	4½ digit	INPUT IMPEDANCE	MAXIMUM INPUT VOLTAGE
0.1 V	.119999 V	100 nV	1 μV	10 μV	>10 <sup>9</sup> Ω	±1000 V peak
1.0 V	1.19999 V	1 μV	10 μV	100 μV	>10 <sup>9</sup> Ω	
10.0 V	11.9999 V	10 μV	100 μV	1 mV	>10 <sup>9</sup> Ω	
100.0 V	119.999 V	100 μV	1 mV	10 mV	10 MΩ ± 5%	
1000.0 V	1000.00 V	1 mV	10 mV	100 mV	10 MΩ ± 5%	

Guard to chassis: ±400 V peak

Guard to low: ±200 V peak

**Measurement Accuracy:**  $\pm$  (% of Reading + Number of Counts).  
Auto-zero on and filter off.

**24 hour: 23°C  $\pm$  1°C**

RANGE	6½ digit ( $\geq 10$ PLC) <sup>2</sup>	6½ digit (1 PLC)	5½ digit (.1 PLC)	4½ digit (.01 PLC)
0.1 V	.0022 + 24	0.0024 + 32	0.007 + 14	0.06 + 3
1.0 V	0.0009 + 4	0.0012 + 5	0.007 + 3	0.06 + 2
10.0 V	0.0008 + 2	0.0011 + 3	0.007 + 2	0.06 + 2
100.0 V	0.0011 + 3	0.0014 + 4	0.007 + 2	0.06 + 2
1000.0 V <sup>1</sup>	0.0011 + 2	0.0013 + 3	0.007 + 2	0.06 + 2

<sup>1</sup>Add .02  $\frac{\text{Input Voltage}^2}{1000}$  % to % of reading.

**>90 days: 23°C  $\pm$  5°C**

Add  $\pm$  .0006% of Reading/month to 90 day accuracy.

**Temperature coefficient:**  $\pm$  (% of Reading + Number of Counts/°C)

RANGE	5½ Digit Display				
	0.1V	1.0V	10.0V	100.0V	1000.0V
Temp Coef.	0.0002 +0.2	0.0002 +0.02	.0002 +.002	0.0002 +0.02	0.0002 +0.02

For 6½ digits, multiply counts by 10. For 4½ digits, multiply counts by .1

**Auto-zero OFF:** (5½ digit). For a stable environment  $\pm$  1°C, add 10 counts for 0.1 V range, 1 count for 1 V and 100 ranges, and .1 count for 10 V and 1000 V ranges. For 6½ digits, multiply counts by 10. For 4½ digits, multiply counts for .1.

**Filter ON:** Rejection is  $>60$  dB at 50 Hz. Add 2  $\mu$ V for .1 V, 1.0 V and 10 V range and 200  $\mu$ V for 100 V and 1000 V range.

**Response time:**

**Filter off:** for preprogrammed settling times (0.0 seconds), error is  $<.005\%$  of input voltage step.

**Filter On:** for preprogrammed settling times (.65 seconds), error is  $<.01\%$  of input voltage step.

**NOISE REJECTION (dB) (1 k $\Omega$  unbalance in Lo)**

	AC <sup>3</sup>		DC
	NMR	ECMR	ECMR
.01 PLC or .1 PLC	0	90	140
$\geq 1$ PLC	60	150	140
$\geq 1$ PLC with filter	120	160	140

<sup>3</sup>For 50, 60 Hz (depending on option)  $\pm$  .09%

**Measurement Accuracy:**  $\pm$  (% of Reading + Number of Counts).  
Auto-zero on,  $>1\%$  of scale, and DC component  $<10\%$  of AC component.

**24 hour: 23°C  $\pm$  1°C**

Filter OFF Filter ON	FREQUENCY IN HZ				
	20 to 30	400-20k 30-20k	20k to 50k 20k to 50k	50k to 100k 50k to 100k	'100k to 250k '100k to 250k
6½ digit ( $\geq 1$ PLC) <sup>2</sup>	.33 + 300	.05 + 440	.15 + 1500	.53 + 2700	5.0 + 6300
5½ digit (.1 PLC)	.34 + 33	.06 + 44	.16 + 150	.54 + 270	5.0 + 630
4½ digit (.01 PLC)	.39 + 5	.11 + 6	.21 + 17	.59 + 29	5.1 + 65

<sup>2</sup>Frequencies  $> 100$  kHz are specified for 1.0 V and 10 V ranges only.

**>90 days: 23°C  $\pm$  5°C (5½ digit)**

Add  $\pm$  (.004% of Reading + 12 counts)/month to 90 day accuracy. For 6½ digit, multiply counts by 10. For 4½ digit, multiply counts by .1.

**90 day: 23°C  $\pm$  5°C**

RANGE	6½ digit ( $\geq 10$ PLC) <sup>2</sup>	6½ digit (1 PLC) <sup>2</sup>	5½ digit (.1 PLC)	4½ digit (.01 PLC)
0.1 V	0.0034 + 24	0.0035 + 32	0.008 + 14	0.06 + 3
1.0 V	0.0024 + 4	0.0025 + 5	0.007 + 3	0.06 + 2
10.0 V	0.0023 + 2	0.0024 + 3	0.007 + 2	0.06 + 2
100.0 V	0.0026 + 3	0.0027 + 4	0.007 + 2	0.06 + 2
1000.0 V <sup>1</sup>	0.0024 + 2	0.0025 + 3	0.007 + 2	0.06 + 2

<sup>2</sup>Integration Time in Power Line Cycles (PLC). For 5½ digits, multiply counts by 0.1. For 4½ digits, multiply counts by 0.01.

**MAXIMUM READING RATES (RDGS/S)**

	Remote		Bench	
	60 Hz	50 Hz	60 Hz	50 Hz
4½ digit	330	290	200	167
5½ digit	210	180	150	125
6½ digit	48	40	46	38

For more detail, see "Reading Rates"

**AC RMS Voltage (ac, ac + dc)  
Input characteristics**

RANGE	MAXIMUM READING (5½ digit)	6½ digit	RESOLUTION 5½ digit	4½ digit	INPUT IMPEDANCE	MAXIMUM INPUT VOLTAGE
1.0 V	1.19999 V	1 $\mu$ V	10 $\mu$ V	100 $\mu$ V	1 M $\Omega$ $\pm$ 5% shunted by <90 pF	$\pm$ 1000 V peak (700 V rms) 10 <sup>6</sup> VHZ
10.0 V	11.9999 V	10 $\mu$ V	100 $\mu$ V	1 mV		
100.00 V	119.999 V	100 $\mu$ V	1 mV	10 mV		
1000.0 V	700.00 V	1 mV	10 mV	100 mV		

**Guard to Chassis:**  $\pm$  500 V peak

**Guard to Low:**  $\pm$  200 V peak

**Temperature coefficient:**  $\pm$  (% of Reading + Number of Counts)/°C. (5½ digit)  $\pm$  (.008 + 6)/°C for DC component  $<10\%$  AC component. Otherwise add  $\pm$  (.008 + 12)/°C. For 6½ digit, multiply counts by 10. For 4½ digit, multiply counts by .1.

**DC Component  $>10\%$  of AC Component:** (5½ digit) Add  $\pm$  (.05% of Reading + 50 counts) to accuracy. For 6½ digit, multiply counts by 10. For 4½ digit, multiply counts by .1. For signals with no ac component, use the 1 kHz ac spec.

**Crest factor:**  $>7:1$  at full scale.

**Common mode rejection (1 k $\Omega$  unbalance in Lo):**  $>90$ dB dc to 60 Hz.

**Auto-zero OFF:** For stable environment  $\pm$  1°C no accuracy change.  
**Response time:** for preprogrammed settling times, error is  $<.1\%$  of input voltage step.

**Filter OFF:** 0.06 seconds

**Filter ON:** .80 seconds

**90 day: 23°C  $\pm$  5°C<sup>2</sup>**

Filter OFF Filter ON	FREQUENCY IN HZ				
	20 to 30	400-20k 30-20k	20k to 50k 20k to 50k	50k to 100k 50k to 100k	'100k to 250k '100k to 250k
6½ digit ( $\geq 1$ PLC) <sup>2</sup>	.35 + 500	.07 + 700	.17 + 1700	.55 + 2900	5.0 + 6500
5½ digit (.1 PLC)	.36 + 53	.08 + 73	.18 + 173	.56 + 293	5.0 + 653
4½ digit (.01 PLC)	.41 + 7	.13 + 9	.23 + 19	.61 + 31	5.1 + 67

<sup>2</sup>Integration Time in Power Line Cycles (PLC). For 5½ digits, multiply counts by 0.1. For 4½ digits, multiply counts by 0.01.



# DIGITAL VOLTMETERS

## 3½ to 6½ Digit DVM for Bench/System Applications

Model 3456A

**Resistance** (2 WrΩ, 4 WrOCΩ, 4 WrOCΩ)

**Input characteristics:**

RANGE	MAXIMUM READING (5½ digit)	6½ digit	RESOLUTION 5½ digit	4½ digit	CURRENT THROUGH UNKNOWN	MAXIMUM VALID READING VOLTAGE	MAXIMUM OPEN CIRCUIT VOLTAGE
100 Ω	119.999 Ω	100 μΩ	1 mΩ	10 mΩ	1 mA	.12 V	5.5 V
1 kΩ	1199.99 Ω	1 mΩ	10 mΩ	100 mΩ	1 mA	1.2 V	5.5 V
10 kΩ	11.9999 kΩ	10 mΩ	100 mΩ	1 Ω	100 μA	1.2 V	5.5 V
100 kΩ	119.999 kΩ	100 mΩ	1 Ω	10 Ω	50 μA	6 V	9.5 V
1 MΩ	1199.99 kΩ	1 Ω	10 Ω	100 Ω	5 μA	6 V	9.5 V
10 MΩ	11.9999 MΩ	10 Ω	100 Ω	1 kΩ	500 nA	6 V	9.5 V
100 MΩ	119.999 MΩ	100 Ω	1 kΩ	10 kΩ	≤500 nA <sup>1</sup>	5 V	5.5 V
1 GΩ	1000.00 MΩ	1 kΩ	10 kΩ	100 kΩ	≤500 nA <sup>1</sup>	5 V	5.5 V

<sup>1</sup>Ohms source is a 500 nA current source in parallel with a 10 MΩ resistance.

**Non-destructive overload:** 350 V peak

**Measurement accuracy:** ± (% of Reading + Number of Counts).

Auto-zero on, filter off, and 4-wire ohms.

**24 hour: 23°C ±1°C**

RANGE	6½ digit (≥10 PLC) <sup>a</sup>	6½ digit (1 PLC)	5½ digit (.1 PLC)	4½ digit (.01 PLC)
100 Ω	0.003 + 24	0.003 + 32	0.009 + 14	0.07 + 3
1 kΩ	0.002 + 4	0.003 + 5	0.008 + 3	0.07 + 2
10 kΩ	0.002 + 4	0.003 + 5	0.008 + 3	0.07 + 2
100 kΩ	0.002 + 2	0.003 + 3	0.008 + 2	0.07 + 2
1 MΩ	0.006 + 2	0.006 + 3	0.012 + 2	0.07 + 2
10 MΩ	0.041 + 2	0.041 + 3	0.07 + 2	0.12 + 2
100 MΩ	1.3 + 1	1.3 + 1	1.5 + 1	1.5 + 1
1 GΩ	11 + 1	11 + 1	13 + 1	13 + 1

**>90 days: 23°C ±5°C**

Add ±.0004% of Reading/month to 90 day accuracy.

**2-Wire Ohms Accuracy:** Same as 4-wire ohms except add a maximum of .2 ohm offset.

**Auto-Zero OFF Accuracy:** (5½ digit). For a stable environment ±1°C, add 10 counts for 100 Ω range, 1 count for 1 kΩ and 10 kΩ range, and .2 counts for ≥100 kΩ range. Changes in lead resistance are not corrected in 4-wire ohms. For 4½ digit, multiply counts by .1. For 6½ digit, multiply counts by 10.

RANGE	MAXIMUM LEAD RESISTANCE FOR 4-WIRE OHMS	MAXIMUM OFFSET VOLTAGE FOR OFFSET COMPENSATED OHMS	PREPROGRAMMED SETTling TIME IN SECONDS
100 Ω	10 Ω	.01 V	0
1 kΩ	100 Ω	.1 V	0
10 kΩ	1000 Ω	.1 V	0
100 kΩ	1000 Ω	.5 V	.0008
1 MΩ	1000 Ω		.008
10 MΩ	1000 Ω		.08
100 MΩ	1000 Ω		.08
1 GΩ	1000 Ω		.08

**Offset compensated ohms accuracy:** same as 2-wire and 4-wire except maximum reading may be reduced by 9% for large offset voltages.

**Response time:** with preprogrammed settling time and <200 pF of capacitance, first reading is in specification.

**Filter is not operational in ohms.**

**Temperature coefficient:** (5½ digits) ± (% of Reading + Number of Counts)/°C

RANGE	100Ω	1 kΩ 10 kΩ	1 MΩ	10 MΩ	100 MΩ	1 GΩ
Temp Coef.	.0004 +2	.0004 +02	.0004 +004	.0010 +004	.16 +0	1.6 +0

4½ digit: multiply counts by .1; 6½ digit: multiply counts by 10.

**90 day: 23°C ±5°C**

RANGE	6½ digit (≥10 PLC) <sup>a</sup>	6½ digit (1 PLC) <sup>a</sup>	5½ digit (.1 PLC)	4½ digit (.01 PLC)
100 Ω	0.004 + 24	0.004 + 32	0.01 + 14	0.07 + 3
1 kΩ	0.003 + 4	0.004 + 5	0.009 + 3	0.07 + 2
10 kΩ	0.003 + 4	0.004 + 5	0.009 + 3	0.07 + 2
100 kΩ	0.003 + 2	0.004 + 3	0.009 + 2	0.07 + 2
1 MΩ	0.007 + 2	0.007 + 3	0.013 + 2	0.07 + 2
10 MΩ	0.042 + 2	0.042 + 3	0.07 + 2	0.12 + 2
100 MΩ	1.8 + 1	1.8 + 1	2.0 + 1	2.0 + 1
1 GΩ	16 + 1	16 + 1	18 + 1	18 + 1

<sup>a</sup>Integration Time in Power Line Cycles (PLC). For 5½ digits multiply counts by 0.1. For 4½ digits multiply counts by 0.01.

### MAXIMUM READING RATES (RDGS/S) (100 TO 10 kΩ RANGES)

	Remote		Bench	
	60 Hz	50 Hz	60 Hz	50 Hz
4½ digit	330	290	200	167
5½ digit	210	180	150	125
6½ digit	48	40	46	38

For more detail, see "Reading Rates"

### Ratio

**Type:** DC/DC, AC/DC, or (AC + DC)/DC  
**Method:** 4-wire with Volts Lo input common

$$\text{Ratio} = \frac{\text{Signal Voltage}}{\text{Ref. Hi Voltage} - \text{Ref. Lo Voltage}}$$

**Signal Measurement:** Same as DC Volts, AC Volts, or AC + DC Volts

**Reference Measurement:** Automatically selects .1 V, 1 V, or 10 V DC. Volts range and a 0.0 msec. settling time. Filter is off.

**Maximum reference voltages:**

- Ref. Hi: ±12 V
- Ref. Lo: ±9% of Ref. Hi
- Ref. Hi-Ref. Lo: ±11.9999 V
- Protection: ±350 V peak

**Accuracy:** Total % signal error + total % reference error (same as .1 V, 1 V, or 10 V DC volts)

### Reading Rate

Reading rates are with autorange, math, display and filter off. Output is to internal memory using internal trigger and packed mode. Packed output in place of internal memory adds .35 ms; ASCII output adds 2.3 ms.

**Rates vs. integration time and Auto-Zero:** DC volts and 100 Ω thru 10 kΩ ranges with preprogrammed settling times (-0.0 sec.). Also, AC or AC + DC Volts and 100 kΩ thru 10 kΩ ranges with 0.0 sec. delay.



**RATES**

INTEGRATION TIME IN POWER LINE CYCLES (PLC)	Auto Zero OFF		Auto Zero ON	
	60 Hz	50 Hz	60 Hz	50 Hz
0.01 (4½ digit)	330	290	210	180
0.10 (5½ digit)	210	180	120	100
1.00 (6½ digit)	48	40	25	20
10.00 (6½ digit)	5.8	4.0	2.9	2.4
100.00 (6½ digit)	.57	.47	.29	.24

**Memory**

**Reading Store:** Can store up to 350 readings.

Can be recalled from HP-IB interface or front panel

**Program memory:** Can execute an internal program which controls instrument configuration and measurement sequence. Program is input from the HP-IB interface with up to 1400 ASCII characters.

**Memory size:** Total size is 1400 bytes. Memory used is 1 byte per ASCII character + 4 bytes per reading stored.

**Math Function Specifications**

**General:** Math function specifications do not include error in X (instrument reading) or in entered values (R, L, U, Y, Z). Range of values input or output is 0.000000 x 10<sup>-9</sup> to ±1999999 + 10<sup>9</sup>. Out of range values send "OL" to display and +1999999 x 10<sup>9</sup> to HP-IB.

**Pass/Fail:** Displays "HI" for values upper limit (U), "LO" for values lower limit (L), and X for values between the limits, with no introduced error. SRQ mask can be programmed to respond to out-of-limit conditions.

**Maximum execution time:** 20 ms

**Statistics:**

$$\text{Mean (M)} = X_1 + \frac{1}{C} \sum_{i=1}^C (X_i - X_1)$$

$$\text{Variance (V)} = \frac{\sum_{i=1}^C (X_i - X_1)^2 - \frac{1}{C} \left[ \sum_{i=1}^C (X_i - X_1) \right]^2}{C - 1}$$

Maximum (U) and Minimum (L) are the most positive and negative instrument readings, respectively. X is displayed during calculation of statistics.

X<sub>1</sub> is the first reading taken after enabling statistics and is stored in the Z register. The number of readings taken (C) is stored in the count register.

$$\text{Accuracy of Mean: } < \pm \frac{C(U-L)}{10^{11}} + 1 \text{ LSD}$$

$$\text{Accuracy of Variance: } < \pm \frac{C(U-L)^2}{10^8} + 1 \text{ LSD}$$

**Maximum execution time:** 50 ms

**Null:** X - X<sub>1</sub> (X<sub>1</sub> is the first valid reading taken after enabling null and is stored in the Z register).

**Maximum execution time:** 15 ms

**dBm(R):** 10 log  $\left| \frac{x^2/R}{1mW} \right|$  R is the user-entered impedance.

**Output range:** -280 to +340 dBm

**Accuracy:** ±.001 dBm

**Maximum execution time:** 150 ms

**Thermistor (F):** Converts resistance of thermistor HP0837-0164, YSI 44007, Omega UUA35J3, and Fenwal UUA35J1 to temperature in °F.

**Output range:** -112 to 302°F

**Accuracy:** -103 ≤ T ≤ +266°F: ±.11°F max.

-112 ≤ T ≤ +302°F: ±.27°F max.

Accuracy specification does not include any inaccuracies in the actual thermistor used.

**Maximum execution time:** 100 ms

**Scale:** (X-Z)/Y

**Accuracy:** ±1 LSD

**Maximum execution time:** 60 ms

**dB:** 20 log  $\frac{X}{Y}$

**Output Range:** -620 to +620 dB

**Accuracy:** .001 dB

**Maximum execution time:** 100 ms

**% Error:** 100 x (X-Y)/Y

**Accuracy:** ±1 LSD

**Maximum execution time:** 60 ms

**General**

**Operating Temperature:** 0 to 50°C

**Warmup time:** one hour to meet all specifications

**Humidity range:** 95% R.H., 0 to 40°C

**Storage temperature:** -40 to +75°C

**Power:** 100/120/240 V +5%, -10%, 48 Hz to 66 Hz line operation, 60 VA; 220 V ±10%, 48 Hz to 66 Hz line operation, 60 VA.

**Size:** 88.9 mm H x 425.5 mm W x 527.1 mm D (3½" x 16¾" x 20¾")

**Weight:** Net, 10.49 kg (23.13 lbs.); Shipping, 13.35 kg (29.38 lbs.)

**Ordering Information**

	<b>Price</b>
<b>10631A:</b> 1 Meter (39.37 in.) HP-IB Cable	\$60
<b>10631B:</b> 2 Meter (78.74 in.) HP-IB Cable	\$65
<b>10631C:</b> 4 Meter (157.48 in.) HP-IB Cable	\$75
<b>10631D:</b> 0.5 Meter (19.69 in.) HP-IB Cable	\$60
<b>03456-90001:</b> Operating information supplement (one furnished with 3456A)	\$2.50
<b>11000A:</b> Test Leads, dual banana both ends	\$17
<b>11002A:</b> Test Leads, dual banana to probe and alligator	\$12
<b>34111A:</b> High Voltage Probe, 40 kV	\$75
<b>Opt 050:</b> Noise rejection for 50 Hz	N/C
<b>Opt 060:</b> Noise rejection for 60 Hz	N/C
<b>Front Handle Kit</b> (Opt 907) Pt. #5061-0088	+\$28
<b>Rack Mount Kit</b> (Opt 908) Pt. #5061-0074	+\$15
<b>Rack Mount Kit</b> (Opt 909) Pt. #5061-0075	\$41
<b>Extra Operating and Service Manual</b> (Opt 910)	+\$21.50

**Model 3456A Digital Voltmeter** **\$3500**

# DIGITAL VOLTMETERS

5½ / 6½-digit DVM with Auto Cal  
Model 3455A

- AutoCal
- Self test
- Bench/system
- AC/DC/OHMS
- High speed
- Removable reference

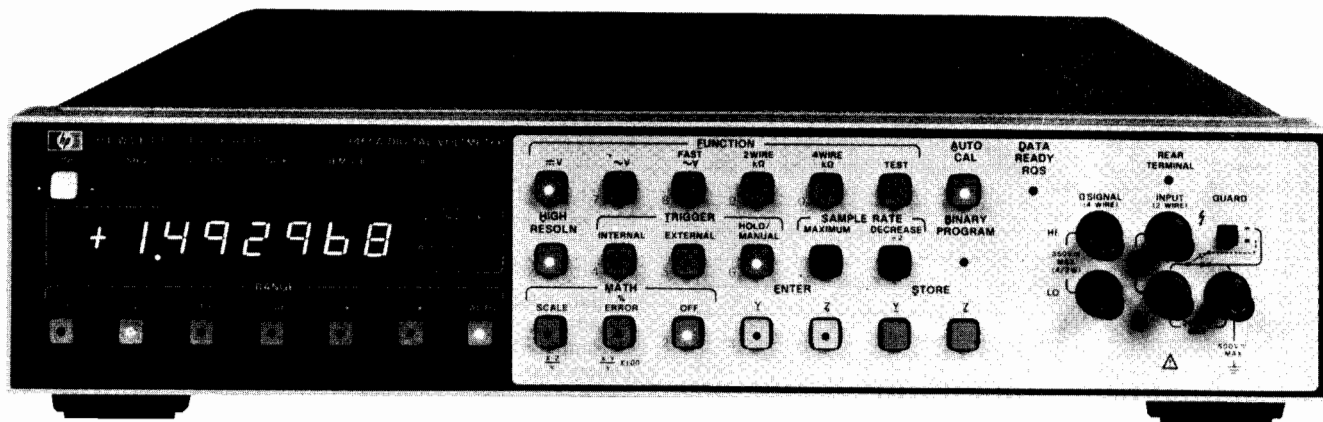

3455A



## Description

Hewlett-Packard's 3455A Digital Voltmeter is a microprocessor controlled 5½- or 6½-digit integrating voltmeter for bench or systems applications. The standard instrument measures DC volts, AC volts, and resistance. HP-IB I/O for systems applications is also standard.

## Measuring Speed

The 3455A is fully guarded and has greater than 60 dB normal mode noise rejection at reading rates of up to 24 readings per second on all DC ranges. Ohms reading rates are up to 12 readings/second and an AC fast mode gives reading rates of up to 13 readings/second at frequencies above 300 Hz. (Readings/seconds given for 60 Hz operation and high resolution off.)

## Performance

DC measurements can be made with up to 1 μV sensitivity. Ohms measurements are made with either a 2-wire and 4-wire mode. The High Resolution (6½-digit) mode gives DC and Ohms measurements with greater than 1 part per million resolution. AC voltage measurements can be made from 30 Hz to 250 kHz with the optional average responding converter.

## True rms

The standard true rms converter gives AC measurements from 30 Hz to 1 MHz. Complex signals with crest factors of up to 7:1 at full scale can be measured.

## Math

The math functions provide the user with unique computational capability. The Scale mode ( $\frac{X}{Y}$ ) allows the user to offset, take ratios, or scale readings to give readouts in physical units. The % Error mode ( $\frac{X}{Y} \times 100\%$ ) converts readings into percentage change from Y which is entered as a reference. For the math functions X is the present reading. Y and Z are previously entered readings or numbers entered from the front panel or by remote program.

## Auto Cal

The auto cal feature gives the user accurate DC volts and ohms measurements and simplifies calibration of these functions. The DC and ohms operating circuits are checked against internal references

and any errors are corrected digitally. All dc and ohms adjustments are in a removable reference assembly.

## Serviceability

The self-test feature is used to aid in troubleshooting as well as verifying operation of the 3455A. Test verifies proper operation of the DC measuring circuits by comparing their parameters against predetermined limits. If a problem is found, the display is used to assist in finding the problem area by indicating which parameter is in error. Detailed troubleshooting can then be used to quickly isolate the problem.

Routine maintenance and calibration has been simplified with the removable reference assembly. Calibration of DC and ohms functions can be done by replacing the reference assembly with a recently calibrated one. Extra reference assemblies are available as HP accessory number 11177A. A spare assembly is ideal for one or more 3455A's. Calibrate DC and ohms in a 3455A without removing it from the bench or system. Just return the extra reference assembly to the cal lab or HP for calibration and have it back in time to calibrate the 3455A next time.

## HP Technology

HP has developed an instrument oriented microprocessor to provide the high performance of the 3455A. The microprocessor has a parallel architecture to give the high speed necessary to control the measurement processes of a bench/systems voltmeter. Two microprocessors are used: one for control of the measurement and the second for interface to the HP-IB and computation of the math functions.

The HP-developed fineline tantalum nitride resistor technology used in several HP digital voltmeters is also used in the 3455A. This technology provides accurate temperature tracking resistors that result in excellent long term DC accuracy.

## Data-sheet Systems

The 3455A is included as part of the 3052A standard system. The 3052A is fully integrated, tested, verified and specified as a system and comes with complete systems software and documentation. This system provides complete solutions to many of your measurement problems.



## Specifications

### DC Voltage

Ranges		Maximum Display	
0.1	—	±0.149999 V	—
1	1	±1.499999 V	±1.499999 V
10	10	±14.9999 V	±14.99999 V
100	100	±149.999 V	±149.9999 V
1000	1000	±1000.00 V	±1000.000 V

### Performance

#### (High Resolution Off)

#### Accuracy ± (% of reading + counts)

24 hrs: 23°C ± 1°C		
Range	High Resolution Off	High Resolution On
0.1 V	0.004 + 4	—
1 V	0.003 + 1	0.003 + 4
10 V	0.002 + 1	0.002 + 3
100 & 1000 V	0.004 + 1	0.004 + 3
90 days: 23°C ± 5°C		
Range	High Resolution Off	High Resolution On
0.1 V	0.007 + 4	—
1 V	0.006 + 1	0.006 + 4
10 V	0.005 + 1	0.005 + 3
100 & 1000 V	0.007 + 1	0.007 + 3
6 months: 23°C ± 5°C		
Range	High Resolution Off	High Resolution On
0.1 V	0.010 + 5	—
1 V	0.009 + 1	0.009 + 5
10 V	0.008 + 1	0.008 + 3
100 & 1000 V	0.010 + 1	0.010 + 3
1 year: 23°C ± 5°C		
Range	High Resolution Off	High Resolution On
0.1 V	0.015 + 6	—
1 V	0.014 + 1	0.014 + 6
10 V	0.013 + 1	0.013 + 3
100 & 1000 V	0.015 + 1	0.015 + 3

### Input characteristics

**Input resistance:** 0.1 V through 10 V range: > 10<sup>10</sup> ohms. 100 V and 1000 V range: 10 megohm ± 0.1% with Auto Cal. "off."

#### Maximum input voltage

**High to low input terminals:** ± 1000 V peak.

**Guard to chassis:** ± 500 V peak.

**Guard to low terminal:** ± 200 V peak.

**Normal mode rejection (NMR):** NMR is the ratio of the peak normal-mode voltage to the peak error voltage in the reading.

**NMR at 50 or 60 Hz ± 0.1%:** > 60 dB.

**Effective common mode rejection (ECMR):** ECMR is the ratio of the peak common-mode voltage to the resultant peak error voltage in the reading.

**ECMR with 1 kΩ unbalance in low lead at**

**DC:** > 140 dB.

**50 Hz or 60 Hz ± 0.1%:** > 160 dB.

#### Maximum reading rate

	60 Hz Gate Length		50 Hz Gate Length	
	High Resolution Off	High Resolution On	High Resolution Off	High Resolution On
Local	5 rdg/s	3 rdg/s	3.5 rdg/s	2.5 rdg/s
Remote	24 rdg/s	6 rdg/s	22 rdg/s	5 rdg/s

### AC Voltage (rms converter)

#### (High Resolution On or Off)

**Ranges:** 1.00000 V      **Maximum Display:** 1.49999 V  
 10.0000 V              14.9999 V  
 100.000 V              149.999 V  
 1000.00 V              1000.00 V

**Range selection:** Manual, Automatic or Remote.

**Function selection:** ACV or Fast ACV.

### Input characteristics

#### Input impedance

**Front terminals:** 2 MΩ ± 1% shunted by less than 100 pf.

**Rear terminals:** 2 MΩ ± 1% shunted by less than 75 pf.

#### Maximum input voltage

**High to low terminals:** ± 1000 volts peak.

Subject to a 10<sup>7</sup> volts—Hz limitation.

**Guard to chassis:** ± 500 V peak.

**Guard to low terminal:** ± 200 V peak.

#### Maximum reading rate

	60 Hz Gate Length		50 Hz Gate Length	
	ACV	FAST ACV	ACV	FAST ACV
Local	1.3 rdg/s	4.5 rdg/s	1.1 rdg/s	3.5 rdg/s
Remote	1.3 rdg/s	13 rdg/s	1.1 rdg/s	12 rdg/s

### Response time

#### ACV and FAST ACV

First reading to < 0.1% of step size when triggered coincident with step change when on correct range (for AC signals with no DC component).

### Performance (rms converter)

#### Accuracy: ± [% of reading + counts]<sup>1</sup> (AC Coupled)<sup>2</sup>

Frequency		24 hours 23°C ± 1°C	90 days 23°C ± 5°C	6 months 23°C ± 5°C	1 year 23°C ± 5°C
<b>Fast ACV</b>	<b>AVC</b>				
300 Hz to 20 kHz	30 Hz to 20 kHz	0.04 + 40	0.05 + 50	0.06 + 60	0.07 + 70
20 kHz to 100 kHz	20 kHz to 100 kHz	0.40 + 80	0.50 + 100	0.60 + 130	0.70 + 160
100 kHz to 250 kHz	100 kHz to 250 kHz	1.80 + 200	2.00 + 250	2.10 + 300	2.20 + 350
250 Hz to 500 Hz	250 Hz to 500 Hz	4.0 + 400	5.0 + 500	5.1 + 600	5.3 + 700
500 kHz to 1 MHz	500 kHz to 1 MHz	5.0 + 2600	6.0 + 3100	6.3 + 3500	6.6 + 3900

<sup>1</sup>Guard must be connected to low. Specifications are only for input levels above 1% of range.

For AC coupled inputs < 1% of full scale: add 20 counts to above accuracy table, except for AC coupled inputs above 50 kHz and < 5% of full scale: add 170 counts to above accuracy table. See footnote 2 for AC/DC coupled inputs.

<sup>2</sup>For any AC/DC coupled input: add (0.05% of reading + 20 counts) to above accuracy table, except for an AC/DC coupled input above 50 kHz and < 5% of full scale: add 170 counts to above accuracy table.

<sup>3</sup>Frequencies of greater than 100 kHz are specified for the 1 V and 10 V ranges only.

<sup>4</sup>Accuracy is not specified if the volt-hz product exceeds 10<sup>7</sup>. For inputs > 500 V, multiply the above table accuracy by  $\frac{1500 + V_{in}}{1000}$ .

### AC voltage (average converter) Opt 001

#### (High Resolution On or Off)

**Ranges:** 1 V      **Maximum Display:** 1.49999 V  
 10 V              14.9999 V  
 100 V             149.999 V  
 1000 V            1000.00 V

**Range selection:** Manual, Automatic or Remote.

**Function selection:** ACV or Fast ACV.

### Input characteristics

**Front Terminals:** 2 MΩ ± 1% shunted by less than 100 pf.

**Rear Terminals:** 2 MΩ ± 1% shunted by less than 75 pf.

#### Maximum input voltage

**High to low terminals:** ± 1000 volts peak.

Subject to a 10<sup>7</sup> volts—Hz limitation.

**Guard to chassis:** ± 500 V peak.

**Guard to low terminal:** ± 200 V peak.

#### Maximum reading rate

	60 Hz Gate Length		50 Hz Gate Length	
	ACV	FAST ACV	ACV	FAST ACV
Local	1.3 rdg/s	4.5 rdg/s	1.1 rdg/s	3.5 rdg/s
Remote	1.3 rdg/s	13 rdg/s	1.1 rdg/s	12 rdg/s

# DIGITAL VOLTMETERS

5½ / 6½-digit DVM with AutoCal

Model 3455A (cont.)

## Performance (average converter)

Accuracy: ± [% of reading + counts]<sup>1</sup>

Frequency		24 hours 23°C ± 1°C	90 days 23°C ± 5°C	6 months 23°C ± 5°C	1 year 23°C ± 5°C
<b>Fast ACV</b> 300 Hz to 500 Hz	<b>ACV</b> 30 Hz to 50 Hz	0.47 + 70	0.50 + 70	0.50 + 70	0.50 + 70
500 Hz to 1 kHz	50 Hz to 100 Hz	0.32 + 50	0.35 + 50	0.40 + 60	0.40 + 70
1 kHz to 100 kHz	100 Hz to 100 kHz	0.09 + 25	0.10 + 25	0.1 + 30	0.12 + 35
100 kHz to 250 kHz	100 kHz to 250 kHz	0.70 + 60	0.75 + 60	0.75 + 70	0.75 + 80

<sup>1</sup>Guard must be connected to Low.

<sup>2</sup>Frequencies greater than 100 kHz specified on 1 and 10 V ranges only.

<sup>3</sup>Accuracy is not specified if the volt-Hz product exceeds 10<sup>7</sup>.

## Ohms

Ranges		Maximum Display	
High Resolution Off	High Resolution On	High Resolution Off	High Resolution On
0.100000 kΩ	—	0.149999 kΩ	—
1.00000 kΩ	1.000000 kΩ	1.49999 kΩ	1.499999 kΩ
10.0000 kΩ	10.00000 kΩ	14.9999 kΩ	14.99999 kΩ
100.000 kΩ	100.00000 kΩ	149.999 kΩ	149.9999 kΩ
1000.00 kΩ	1000.0000 kΩ	1499.99 kΩ	1499.999 kΩ
10000.0 kΩ	10000.000 kΩ	14999.9 kΩ	14999.99 kΩ

Range selection: Manual, Automatic, or Remote.

## Performance

Function selection: 2-wire kΩ or 4-wire kΩ.

Accuracy ± (% of reading + counts) 4-wire kΩ

24 hours: 23°C ± 1°C		
Range	*High Resolution Off	*High Resolution On
0.1 kΩ	0.003 + 4	—
1 kΩ	0.003 + 1	0.0025 + 4
10 kΩ	0.005 + 2	0.0045 + 4
100 kΩ	0.002 + 2	0.0020 + 5
1000 kΩ	0.012 + 5	0.0120 + 4
10,000 kΩ	0.10 + 5	0.1000 + 4
90 days: 23°C ± 5°C		
Range	High Resolution Off	High Resolution On
0.1 kΩ	0.005 + 5	—
1 kΩ	0.005 + 1	0.0035 + 5
10 kΩ	0.007 + 2	0.0060 + 5
100 kΩ	0.004 + 2	0.0035 + 6
1000 kΩ	0.014 + 5	0.0135 + 5
10,000 kΩ	0.100 + 5	0.1000 + 5
6 months: 23°C ± 5°C		
Range	High Resolution Off	High Resolution On
0.1 kΩ	0.005 + 6	—
1 kΩ	0.005 + 1	0.0040 + 6
10 kΩ	0.007 + 2	0.0065 + 6
100 kΩ	0.004 + 3	0.0040 + 7
1000 kΩ	0.014 + 5	0.0140 + 6
10,000 kΩ	0.100 + 5	0.1000 + 6
1 year: 23°C ± 5°C		
Range	High Resolution Off	High Resolution On
0.1 kΩ	0.006 + 7	—
1 kΩ	0.006 + 2	0.0045 + 7
10 kΩ	0.008 + 3	0.0070 + 7
100 kΩ	0.005 + 4	0.0045 + 8
1000 kΩ	0.015 + 6	0.0145 + 7
10,000 kΩ	0.100 + 6	0.1000 + 7

\*High Resolution Off: 1 count = 0.001% of Range

\*High Resolution On: 1 count = 0.001% of Range

2-wire kΩ: all accuracy specifications are the same as 4-wire kΩ except add 0.0004 kΩ to all readings.

## Input Characteristics

Maximum voltage generated across unknown: <5 volts for open circuit; <4.7 volts for valid reading.

Signal source driving unknown (nominal): 0.1 kΩ, 1 kΩ & 10 kΩ ranges.

## Overload Protection

Non-destruction: ± 350 V peak.

## Equivalent Ohmmeter Circuits:

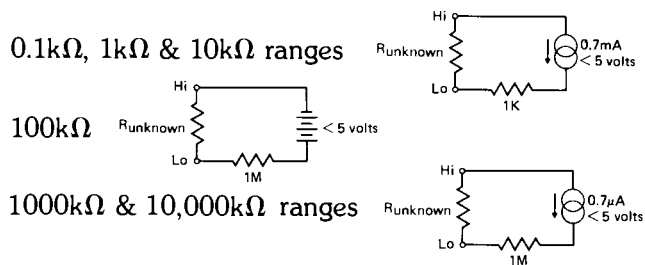

## Maximum reading rate

	60 Hz Gate Length		50 Hz Gate Length	
	High Resolution Off	High Resolution On	High Resolution Off	High Resolution On
Local	4.5 rdg/s	2 rdg/s	4 rdg/s	1.8 rdg/s
Remote	12rdg/s	3 rdg/s	11 rdg/s	2.5 rdg/s

## Math

Scale ( $\frac{X-Z}{Y}$ ): X is present reading. Y and Z are previously entered readings, or numbers entered from the front panel or by external program.

Maximum number (entered or displayed): ± 199,999.9.

Accuracy: ± (Accuracy of X reading ± 1 digit of displayed answer). This assumes no "Y" or "Z" error.

%Error ( $\frac{X-Z}{Y} \times 100\%$ ): X is present reading. Y is a previously entered reading, or number entered from the front panel or by external program.

Maximum number (entered or displayed): ± 199,999.9.

Accuracy: ± (Accuracy of X reading ± 1 digit of displayed answer). This assumes no "Y" error.

## How to enter numbers in "Y" or "Z"

From a current displayed reading: press STORE "Y" or "Z".

From front panel: Press ENTER "Y" or "Z". The front panel is now set for numerical entry. These numbers are in blue next to the keys. Enter number and press STORE "Y" or "Z".

By remote program: send program codes for equivalent front panel operations.

## General

Power: 100 V, 120 V, 240 V +5% -10%, 48 Hz to 400 Hz line operation; <60 VA with all options.

Size: 88.9 H x 425.5 W x 527.1 mm D (3.5" x 16.75" x 20.75").

Weight: net, 9.38 kg (20.7 lb). Shipping, 11.8 kg (26 lb).

## Options

001: Average converter

Price

less \$200

3455A Digital Voltmeter

\$3800

# DIGITAL VOLTMETERS



Voltmeter accessories  
Probes, dividers, carrying cases

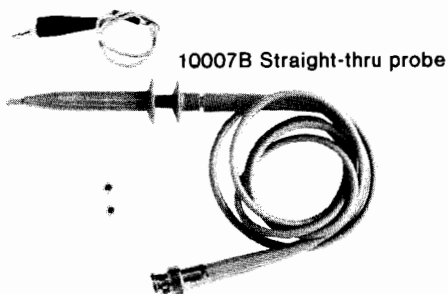

10007B Straight-thru probe

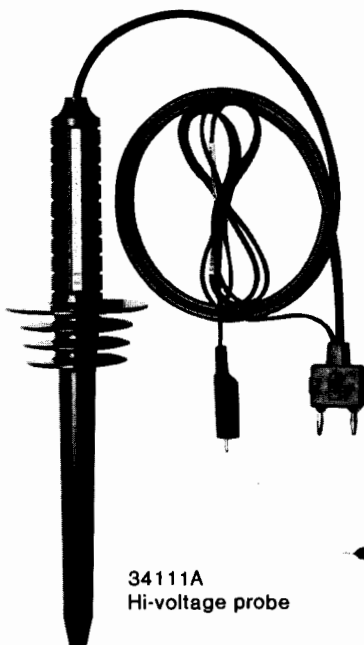

34111A  
Hi-voltage probe

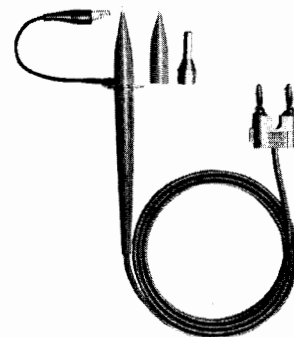

11096B  
High frequency probe

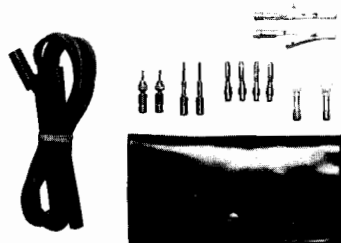

11067A Test lead kit

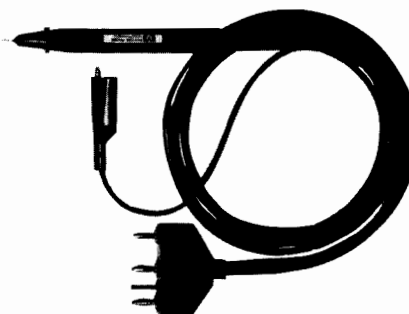

34112A  
Touch-hold probe



34110A Soft vinyl carrying case

## 10007B, 10008B Probe

The 10007B and 10008B are straight-thru BNC probes with a retractable hook tip and 20 cm (8 in.) ground lead with alligator tip.

	Peak Voltage	Shunt Capacitance	Length
10007B	600 V	40 pF	1.1 m (3.5 ft.)
10008B	600 V	60 pF	1.8 m (6 ft.)

## 11067A Test Lead Kit

Includes two leads with many interchangeable tips to accommodate various applications.

## 11068A

Soft carrying case for 3476A and B DMM. Has shoulder strap and zippered opening for instrument and accessory pouch.

## 11096B High Frequency Probe

Converts dc voltmeter with 10 M $\Omega$  input to high-frequency ac voltmeter. Works with any dc voltmeter with 10 M $\Omega$  input impedance.

## 11096B Specifications

**Voltage range:** 0.25 to 30 V rms.

**Transfer accuracy (when used with 10 M $\Omega$   $\pm$  10% dc voltmeter)**

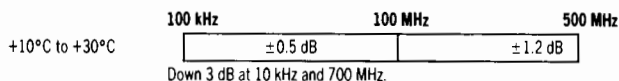

**Response:** peak responding. Calibrated to read rms value of sine wave.

**Input impedance:** 4 M $\Omega$  shunted by 2 pF.

**Maximum input:** 30 V rms ac; 200 V dc.

**Cable length:** 4' long (1219 mm).

**Accessories furnished:** High-Frequency Adapter; Straight tip; Hook Tip; Ground Lead.

**Accessories available:** HP 10218A BNC Adapter; HP 10219A Type 874 Adapter; HP 11063A 50 $\Omega$  Tee.

## 34110A

Carrying case for 1/2 rack size instruments. Inside dimensions of 25.4 cm x 22.9 cm x 10.2 cm or 10" deep x 9" wide x 4" thick. Zipper flip top lid and zippered accessory pouch. Has shoulder carrying strap.

## 34111A DC Hi-Voltage Probe

1000:1 divider will accept up to 40 kV. Input Z = 10 $^9\Omega$ . Divider accuracy meets specifications when connected to 10 M $\Omega$  input resistance instrument.

### Division ratio accuracy:

0-20 kV	<4%	Divider has interchangeable hook and pointed tip.
30-40 kV		
20-30 kV	<2%	

## 34112A Touch-Hold Probe

Allows user to hold DMM display by depressing button on probe body. Both AC and DC voltage up to 1200 V max. DC or AC RMS may be measured and held. Usable on the 3435A, 3438A, 3465A/B, and 3466A.

## Ordering Information

10007B Probe	\$40
10008B Probe	\$40
11067A Test Lead Kit	\$5
11068A Soft Carrying Case for 3476A and B DMM	\$20
11096B High Frequency Probe	\$90
34110A Carrying Case for 1/2 Rack Size Instruments	\$25
34111A DC Hi-Voltage Probe	\$75
34112A Touch-Hold Probe	\$40



# DIGITAL VOLTMETERS

## Five-digit digital multimeter with self test

### Model 3490A

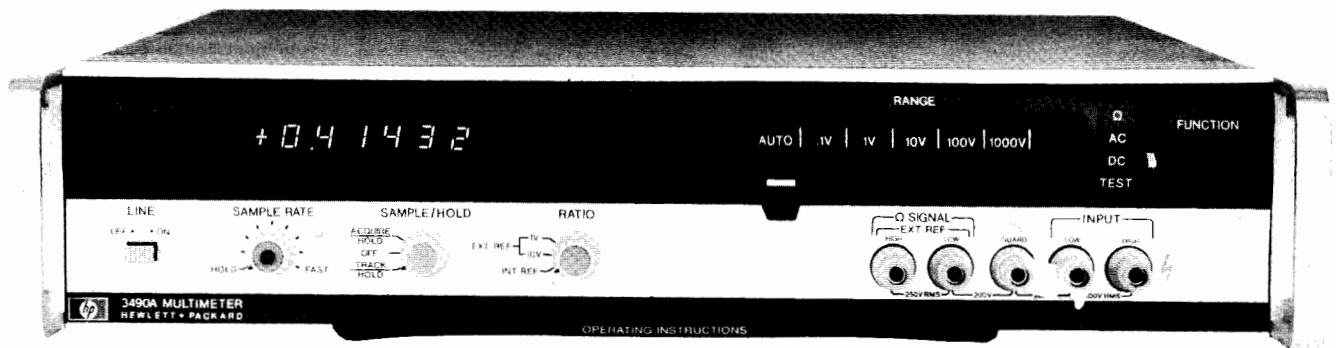

### Description

Hewlett-Packard's Model 3490A Multimeter is a five-digit integrating digital voltmeter. The basic instrument measures dc voltages, ac voltages, and resistances. Additional measurement capability is achieved by the addition of low cost options.

HP's 3490A uses a dual slope integrating technique and is fully guarded, providing excellent noise immunity at five readings per second on all dc ranges. Ranging is automatic over all ranges on all functions. DC measurements can be made with 1 $\mu$ V resolution on the 100 mV range. AC voltage measurements can be made from 20 Hz to 250 kHz in four ranges. The 1 V range provides 10 $\mu$ V of ac voltage resolution. Resistance measurements are made with the 4-wire conversion technique, eliminating errors caused by test lead resistances. Six ranges, including the 100 $\Omega$  range, are provided in the ohms functions.

### Self-Test

At the flip of a switch, Hewlett-Packard's 3490A Digital Multimeter sequences itself through 10 tests that check timing signals and autoranging circuits, validate the performance of most logic-circuit IC's and check the six-digit LED display. These tests, and six others provided by six additional front-panel switches, cut calibration costs and ensure the DMM is ready to make accurate measurements.

### DC Functions

The standard 3490A includes five ranges of dc measurement capability from 100 mV to 1000 V. Measurements are made from the front panel at precise five readings/s, and at slower rates, using digitally controlled sampled rate selector. High input resistance, >10<sup>10</sup> $\Omega$  on 100 mV, 1 V, and 10 V range, assures accurate measurement of high impedance sources.

### AC Functions

Four ranges of ac measurements are provided. The average ac value is accurately detected, and the rms value is displayed with five digits of resolution. Full autoranging, wide frequency response, and 20% overranging are designed-in features to permit easy operation.

### Ohms

Six ohms ranges are standard, and all ranges provide true four-wire ohms measurement capability. Maximum current through the unknown is approximately 1 mA. Over-voltage protection for ohms sensing terminals insures maximum protection against inadvertent application of a high voltage to ohms terminals. Over-voltage protection is provided to 250 V and fuse protection to 1000 V.

### Serviceability

HP's 3490A has been "designed for serviceability." Inside, the 3490's low parts density provides easy access for servicing. Test points

and jumpers are keyed to detailed diagnostics.

Additional diagnostic and service aids are:

Service Video Tape	11128A
IC Reference Boards for use with the HP 10529A Logic Comparator	11126A
Spare Parts Set	11127A

### Specifications

#### DC Voltage Ranges

**Full range display:**  $\pm 1.00000$  V,  $\pm 1.00000$  V,  $\pm 10.0000$  V,  $\pm 100.000$  V,  $\pm 1000.00$  V.

**Overrange:** 20% on all ranges except 1000 V range.

**Range selection:** manual, automatic, or remote (optional).

#### DC Voltage Performance

**Accuracy**  $\pm$ (% of reading + % of range)

		0.1 V Range		1 V to 1000 V Range	
		% rdg.	% rng.	% rdg.	% rng.
24 hrs	(23°C $\pm$ 1°C)	$\pm(0.005 + 0.001)$		$\pm(0.004 + 0.001)$	
30 days	(23°C $\pm$ 5°C)	$\pm(0.01 + 0.005)$		$\pm(0.008 + 0.002)$	
90 days	(23°C $\pm$ 5°C)	$\pm(0.01 + 0.005)$		$\pm(0.01 + 0.002)$	
6 months	(23°C $\pm$ 5°C)	$\pm(0.013 + 0.005)$		$\pm(0.013 + 0.002)$	
1 year	(23°C $\pm$ 5°C)	$\pm(0.015 + 0.005)$		$\pm(0.015 + 0.002)$	

#### Notes:

1. On the 1000 V range, add 0.04 ppm/volt to the % of reading specification.
2. Thermal EMF's generated external to the DVM may be compensated to achieve the % of range accuracy specified by utilizing the rear panel zero adjust provided in the 3490A.

**DC voltage input characteristics:** fully guarded with 140 dB ECMR at dc and 60 Hz  $\pm$  0.1% with 1 k $\Omega$  imbalance between guard and low.

#### Maximum input voltage

**0.1 V to 1000 V ranges:**  $\pm 1500$  V peak.

**Guard to chassis:**  $\pm 500$  V peak.

**Guard to low:**  $\pm 200$  V peak.

#### Input resistance

**0.1 V to 10 V ranges:**  $> 2 \times 10^{10}$  $\Omega$ . (<70% R.H.).

**100 V and 1000 V ranges:** 10 M $\Omega$   $\pm$  0.15%.

**Maximum reading rate:** 5 readings/s.

**Normal mode rejection ratio:** 50 Hz  $\pm$  0.1%; 60 Hz  $\pm$  0.1%; >50 dB.

#### AC Voltage Ranges

**Full range display:** 1.00000 V, 10.0000 V, 100.000 V, 1000.00 V.

**Overrange:** 20% on all ranges except 1000 V range.

**Range selection:** manual, automatic, or remote (optional).

# DIGITAL VOLTMETERS

Five-digit digital multimeter with self-test

Model 3490A (cont).



## AC Voltage Performance

Accuracy  $\pm$  (% of reading + % of range)

		20 Hz–50 Hz	50 Hz–100 kHz	100 kHz–250 kHz
24 hrs	(23°C $\pm$ 1°C)	$\pm$ (0.32 + 0.05)	$\pm$ (0.09 + 0.025)	$\pm$ (0.7 + 0.06)
30 days	(23°C $\pm$ 5°C)	$\pm$ (0.35 + 0.05)	$\pm$ (0.1 + 0.025)	$\pm$ (0.75 + 0.06)
90 days	(23°C $\pm$ 5°C)	$\pm$ (0.35 + 0.05)	$\pm$ (0.1 + 0.025)	$\pm$ (0.75 + 0.06)
6 months	(23°C $\pm$ 5°C)	$\pm$ (0.40 + 0.06)	$\pm$ (0.1 + 0.03)	$\pm$ (0.75 + 0.07)
1 year	(23°C $\pm$ 5°C)	$\pm$ (0.45 + 0.07)	$\pm$ (0.12 + 0.035)	$\pm$ (0.75 + 0.08)

### Notes:

- Guard must be connected to low.
- On the 1000 V range, add 0.01 ppm/(volt-kHz).
- Frequencies > 100 kHz specified on 1 V and 10 V ranges only.
- Specifications are for input levels above 1/100th of full scale.

## AC Voltage Input Impedance

Without rear terminals: 2 M $\Omega$   $\pm$  1% shunted by < 65 pF.

With rear terminals: 2 M $\Omega$   $\pm$  1% shunted by < 90% pF.

AC voltage maximum reading rate: 1 reading/s.

AC voltage response time: < 1 s to within rated accuracy for a step input applied coincident with encoder trigger.

AC maximum input voltage: 1000 V rms;  $\pm$  1500 V peak.

## Ohms Ranges

Full range display: .100000 k $\Omega$ , 1.00000 k $\Omega$ , 10.0000 k $\Omega$ , 100.000 k $\Omega$ , 1000.00 k $\Omega$ , 10000.0 k $\Omega$ .

Overrange: 20% on all ranges.

Range selection: manual, automatic, or remote (optional).

## Ohms Performance

Accuracy:  $\pm$  (% of reading + % of range)

Note: Thermal EMF's generated external to the DVM may be compensated to achieve the % of range accuracy specified by utilizing the rear panel zero adjust provided in HP's 3490A.

		0.1 k $\Omega$		1 k $\Omega$ –100 k $\Omega$		1000 k $\Omega$		10,000 k $\Omega$	
		% rdg.	% rng.	% rdg.	% rng.	% rdg.	% rng.	% rdg.	% rng.
24 hrs	(23°C $\pm$ 1°C)	$\pm$ (0.006 + 0.001)		$\pm$ (0.005 + 0.001)		$\pm$ (0.007 + 0.001)		$\pm$ (0.025 + 0.001)	
30 days	(23°C $\pm$ 5°C)	$\pm$ (0.012 + 0.005)		$\pm$ (0.010 + 0.002)		$\pm$ (0.012 + 0.002)		$\pm$ (0.035 + 0.002)	
90 days	(23°C $\pm$ 5°C)	$\pm$ (0.012 + 0.005)		$\pm$ (0.012 + 0.002)		$\pm$ (0.015 + 0.002)		$\pm$ (0.035 + 0.002)	
6 months	(23°C $\pm$ 5°C)	$\pm$ (0.015 + 0.005)		$\pm$ (0.015 + 0.002)		$\pm$ (0.020 + 0.002)		$\pm$ (0.040 + 0.002)	
1 year	(23°C $\pm$ 5°C)	$\pm$ (0.018 + 0.005)		$\pm$ (0.018 + 0.002)		$\pm$ (0.025 + 0.002)		$\pm$ (0.050 + 0.002)	

## Ohms Terminal Characteristics

Maximum voltage generated across unknown: 20 V for overload; 13 V for valid reading.

Ohms current thru unknown

0.1 k $\Omega$  to 10 k $\Omega$  range: 1 mA.

100 k $\Omega$  to 1000 k $\Omega$  range: 10  $\mu$ A.

10,000 k $\Omega$  range: 1  $\mu$ A.

Ohms overload protection

Nondestructive: 250 V rms.

Fuse destructive:  $\pm$  1000 V peak.

Ohms maximum reading rate

0.1 k $\Omega$  to 100 k $\Omega$  range: 5 reading/s.

1000 k $\Omega$  range: 4 reading/s.

10,000 k $\Omega$  range: 2 reading/s.

## General

### Data Output (BCD), Option 021

Data output is 1-2-4-8 TTL output which is compatible with HP 5050B, and 5055A Digital Recorders. Either high true or low true logic code can be selected with an internal switch.

Storage temperature:  $-40^{\circ}\text{C}$  to  $+75^{\circ}\text{C}$ .

## Remote Control, Option 022

The remote control option uses a low true logic (BCD type) code. Required voltage levels for input signal and output signal levels are listed below.

## BCD and Remote Terminals

	High Level	Low Level
DVM Inputs	+3.9 V $\pm$ 1.5 V, 100 $\mu$ A max	+0.3 $\pm$ 0.3 V, 2 mA max
DVM Outputs	+3.9 V $\pm$ 1.5 V, 400 $\mu$ A max	+0.3 V $\pm$ 0.3 V, 15 mA max

Operating temperature:  $0^{\circ}\text{C}$  to  $50^{\circ}\text{C}$ .

Warm-up time: one hour warm-up required to meet all specifications on the 0.1 V range and the 0.1 k $\Omega$  range. Thirty minutes warm-up required to meet all other specifications.

Humidity range: < 95% R.H.,  $0^{\circ}\text{C}$  to  $40^{\circ}\text{C}$ .

Power: 100 V, 120 V, 220 V, 240 V  $\pm$  5%,  $-10\%$ , 48 Hz to 400 Hz line operation  $\leq$  60 VA with all options.

Size: 85.7 mm H x 425.4 mm W x 466.7 mm D (3.4" x 16.75" x 18.4").

Weight: net, 9.38 kg (20.7 lb). Shipping, 11.79 kg (26 lb).

## Options

020: BCD/remote expand, includes rear terminals in parallel \$325

021: BCD\*—full parallel, 1-2-4-8 code \$315

022: Remote\*—full parallel, 1-2-4-8 code \$275

030: HP-IB remote control and data output. For cables see page 3.10. \$1100

040: Sample-and-hold\* \$570

045: Sample-and-hold (without Opt 020 or 030) \$700

050 or 060: 50 Hz or 60 Hz operation N/C

080: Three-wire ratio \$245

908: Rack mounting kit \$25

**3490A Digital Multimeter** (includes ac, dc, & ohms) **\$3100**

Opt 050: Noise Rejection for 50 Hz N/C

Opt 060: Noise Rejection for 60 Hz N/C

\*These options require BCD/Remote Expand Option 020 or HP-IB Opt 030.

Note: Rack mounting requires support in rear of instrument.



### Introduction

Hewlett-Packard offers many opportunities to incorporate automatic data acquisition and control. With a growing number of products incorporating microprocessors and the Hewlett-Packard Interface Bus (HP-IB), instruments are more capable and easier to implement in a system. The controller capabilities of automatic systems continue to increase with new minicomputers and desktop computers.

Many measurements that were made manually are now being automated. For example, performance testing of devices is a procedure that can easily be automated. Besides making measurements, most automatic data acquisition involves some control. More products are becoming available that can control a variety of processes. With a large selection of measurement, control, and computer capabilities, how could you decide?

One approach to making data acquisition and control choices is to first categorize the applications. Then, select instruments and computers to best satisfy the needs.

Data acquisition and control needs can be organized into three major types of automated measurements. These are: *Test*, *Measurement*, and *Control*.

#### Test

The approach to automation described as *TEST* represents a situation where a product or device is being checked for completeness and compared to its design standards. The variables to be measured and the requirements for accuracy and precision are well known. As an example of the *TEST* philosophy, consider battery testing. A definite set of variables are measured (output voltage, voltage under load, output current, charge capacity, etc.). Specified values and allowable tolerances for all these parameters are very well known. Since the test model is known, a 3½ digit (instead of a 5½ digit) measurement of voltage, could be sufficient. A 5½ digit measurement does not necessarily make a better test. Another consideration is test time. The more batteries that can be tested to specifications in a given amount of time the more productive the system is. The resultant system for a test approach is often a permanent installation with software that is configured to be insensitive to changes in operators.

#### Measurement

A *Measurement* approach to automation includes applications that evaluate or re-

search something. Unlike the *TEST* approach, the model is not necessarily known. In fact, the quantities to be measured may not be understood. In a research application, the data acquisition system developed should be as accurate, flexible, and general purpose as possible. For example, scientists who would research optimum watering methods for food crops might consider the *MEASUREMENT* philosophy. A number of researchers believe that a plant's leaf temperature rises slightly as the plant develops a critical need for water. By using this temperature rise as an indicator, farmers could automatically water crops as plants need water. Besides characterizing the relationships of leaf temperatures vs. water need, researchers need to evaluate the effectiveness of various water schemes.

Since a *Measurement* application involves considerable learning — precision, stability, and accuracy are very important considerations. For example, precise temperature measurements over long distances might be required. If the temperature changes are very small, the system must have very little drift and uncertainty. HP's 3456A Digital Voltmeter in the 3054A system can provide these precise and stable measurements. If different cause and effect relationships are to be studied, the data acquisition system should be easy to reconfigure. The computer should be available and easy to program in a high level language, like HPL or BASIC. The system should also have the ability to control external devices with a scanner/multiplexer.

#### Control

A *Control* type of application is similar to a *TEST* application in that the model or process is well understood. A system would make a series of events take place and make measurements that are necessary to guarantee the desired sequence of events. For example, consider the sequence of events in a bottling operation. First, the control system fills each bottle with the same amount of liquid, while making sure that the bottle is in place before the liquid is turned on. The amount of liquid needs to be as exact as possible without sacrificing the throughput speed. It may be more important to ship more full bottles to consumers than to spend the time measuring each bottle precisely. Next, the system could count bottles, package every six bottles, count these 6-packs, and package 6-packs in cases. If a problem should develop in the se-

quence of events, such as a bottle sticking on a conveyor, the system must sound an alarm and stop the process. Also, the system could be capable of keeping data on the process and periodically reporting to a central data base.

Once a control-oriented system is installed and operating, the user has little need to interact. The computer is rarely programmed by the operator so it doesn't necessarily have to be easy to use as in the *MEASUREMENT* application. But, this computer should be fast and capable of simultaneous operations.

#### Summary

Although systems in all three application groups each contain measuring instruments, computational devices and devices to control process or measurements, the approach taken in each case is different. Also, the equipment used in each application has different characteristics. The researcher making leaf temperature measurements would use a high resolution digital voltmeter, like the 3456A, and would consider 20 readings per second very fast. The battery manufacturer could use a 12-bit A to D converter and he would be concerned about achieving a 30 microsecond digitizing time. To determine the amount of liquid in each bottle, the bottler may use a simple balance mechanism that could trigger a switch when the bottle is full.

Since measurement conditions change, the researcher needs a computer that is easy to use and a system that is easy to reconfigure. In contrast, the battery manufacturer and the bottler need a computer that completes the test or the bottling operation as fast as possible and they may want the computer hidden from the operators.

Hewlett-Packard offers a wide selection of measurement and computational products. The products mentioned below can be used for all three applications—*Test*, *Measurement*, or *Control*. Consult with your HP Sales Representative for the best solution for your data acquisition application.

HP Model	Primary Application	Refer to Page
3052A	Measurement	82
3054A		79
6940A	Test	665
6942A		668
2240A	Control	630
9030A		79

# DATA ACQUISITION SYSTEMS

Automatic Data Acquisition/Control System

Model 3054A

79

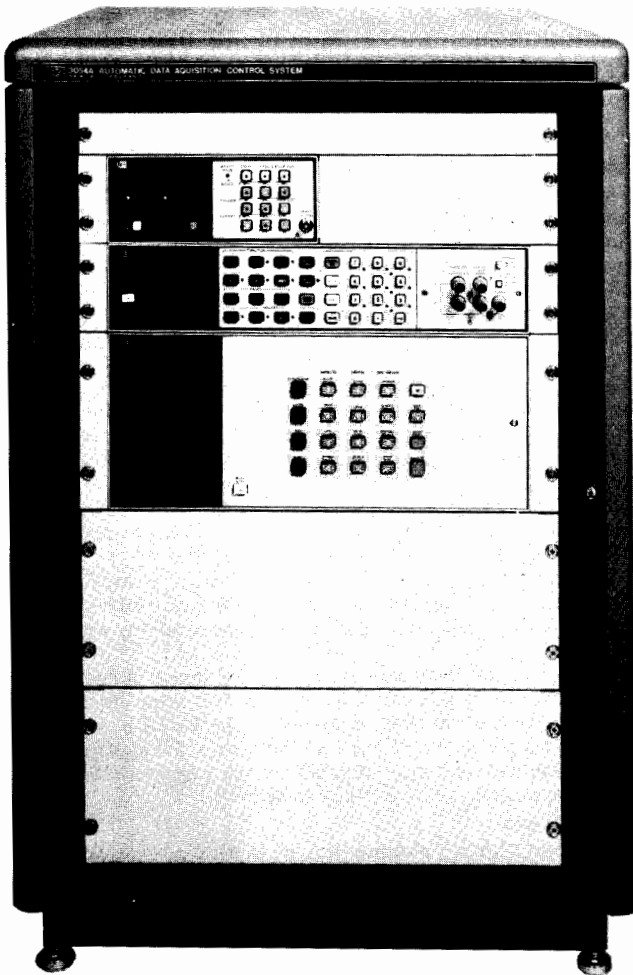

## Description

The 3054A is a computer-based automatic data acquisition and control system. The 3054A combines speed, precision and a variety of control functions with full computation and analysis capabilities. The 3054A offers flexibility, convenience, and performance to solve many data acquisition applications.

The system has the flexibility to make a wide variety of measurements, including outputs of thermocouples, strain gauges, RTD's, flow meters, and other transducers. The 3054A also has digital inputs and outputs, voltage and current D/A converters for precision closed-loop control.

The 3054A offers the convenience of using instrumentation that is designed as a system. To help the user get started fast, the measuring system is rack-mounted and pre-tested. System specifications represent the summation of all instrument errors. An Introductory User's Guide is part of the system documentation package which enables the user to quickly learn how to use the system for his or her application.

The 3054A system performs by combining speed, accuracy and computational power. Measurement rates from 4500 channels/second to 48 channels/second are possible with resolutions from 3½ digits to 6½ digits. DC measurements of low level transducers can be made with 100 nanovolt resolution with greater than 150 dB of noise rejection. An HP desktop computer or mini-computer will automate the system, store data, linearize transducers, and provide computational and analysis tool.

- Low cost data acquisition
- Precision transducer measurements and analysis
- Improve productivity in research and manufacturing
- 1000 analog channels and 1360 digital points
- Control functions for closed-loop applications



The 3054A system provides a very powerful, yet economical solution for transducer measurements and production control development.

## System Configuration

The 3054A System includes:

**3497A Data Acquisition/Control Unit** with a front panel display and keyboard, real time clock and HP-IB keyboard, real time clock and HP-IB programming. Optional assemblies and 3498A Extenders may be added as needed to solve your application.

**3456A Digital Voltmeter** with DC volts, True RMS AC volts, ohms, and ratio measurement capability with HP-IB programming.

**3437A System Voltmeter** with HP-IB programming

**30" Cabinet** with filler panels, fan and power outlets

**System Documentation and Software** includes Introductory Guide, System Operating and Programming Manual, pre-recorded system programming routines, operational verification programs for instruments, application programs and service manuals.

**One of four computer configurations** are needed to complete the system. You should choose one of the following configurations depending upon the specific requirements of your application.

- (1) **85A Computer**  
82937A HP-IB Interface  
00086-15003 I/O ROM  
82936A ROM Drawer  
82903A Memory Expansion Module
- (2) **9825T Computer**  
98034A HP-IB Interface
- (3) **9835A Computer**  
98034A HP-IB Interface  
98332A I/O ROM
- (4) **9845T Computer**  
98034A HP-IB Interface  
98412A I/O ROM



85A  
Desktop Computer



9825T  
Desktop Computer



9835A  
Desktop Computer



9845T  
Desktop Computer

### Measurement and Control

The 3497A Data Acquisition/Control Unit is the instrument that provides the analog multiplexing, digital monitoring, and control functions using plug-in assemblies. The 20 Channel Reed Relay Assembly provides low level guarded switching with  $<2 \mu\text{V}$  of thermal offset. An isothermal connector is provided as an option to this assembly for thermocouple compensation. High speed scanning to greater than 4500 channels/second is accomplished with the FET Assemblies\*. Digital input and output assemblies are available for monitoring and control. And you get specialized measurement and control using the Reciprocal Counter Assembly\* and the programmable D/A Converter Assemblies\*. Up to five of these optional plug-in assemblies can be contained in the 3497A mainframe. Expanding to more than five assemblies is provided by the 3498A Extender. Each 3498A can hold ten more assemblies. A total of thirteen extenders can be supported by one 3497A mainframe, giving a maximum of 1000 analog channels and 1360 digital channels.

System timing is accomplished through the non-volatile real time clock in the 3497A. Besides providing calendar and time of day information, this quartz-based clock has interrupt capability and elapsed time.

The two digital voltmeters in the 3054A System provide a very flexible measurement solution for various data acquisition applications, but the optional DVM assembly for the 3497A is an alternate choice. This plug-in DVM has  $1 \mu\text{V}$  sensitivity,  $5\frac{1}{2}$  digit resolution, integration, and guarding—capability previously available only on stand-alone system DVMs. (Refer to page 84.)

\* Available 3rd quarter

The 3456A Digital Voltmeter is a  $3\frac{1}{2}$  to  $6\frac{1}{2}$  digit integrating voltmeter with high accuracy, 100 nanovolt sensitivity, and speed to 330 readings/second. Its DC and True RMS DC voltage and resistance measurement capability reduce the amount of signal conditioning necessary. The 3456A can detect 100 nanovolt changes in 100 mV signals at speeds of 48 readings/second. This capability is necessary for measuring thermocouples with the 3054A system to better than  $0.01^\circ\text{C}$  resolution.

The 3456A has selectable integration times from 0.01 up to 100 power line cycles. At 0.01 power line cycles of integration, the reading rate of the 3456A is 330 readings/second with  $4\frac{1}{2}$  digits of resolution. With 100 power line cycles of integration plus guarding, the 3456A has greater than 140 dB of effective common mode rejection. The excellent noise rejection and stability make the 3054A system particularly suited for repeatable low level measurements in the presence of noise.

The analog input filter and digital averaging are two more ways the 3456A can eliminate the effects of noise.

The built-in memory of the 3456A can store both readings and sequences of measurement commands. The 3456A can store internally up to 350 readings or up to 1400 ASCII programming characters or combinations of both readings and programming characters.

A scanner advance signal and a voltmeter reading complete signal provide the necessary synchronization between the 3456A and 3497A to achieve analog scanning rates to 300 channels/second. (Refer to page 68.)

The 3437A System Voltmeter is a high speed  $3\frac{1}{2}$  digit DV voltmeter which provides precisely timed sample and hold readings. It can perform a variety of tasks from scanning DC inputs at rates greater than 4500 channels/second to AC waveform analysis. The high speed scanning is provided by a hardware synchronization between the 3437A and 3497A with a FET assembly. Repetitive signals with frequency components up to 1 MHz and low frequency transients longer than 1 ms can be rapidly digitized and analyzed. Parameters like RMS value, residual DC, harmonic content, and peak values can be automatically determined in only a fraction of the time required by conventional methods. (Refer to page 66.)

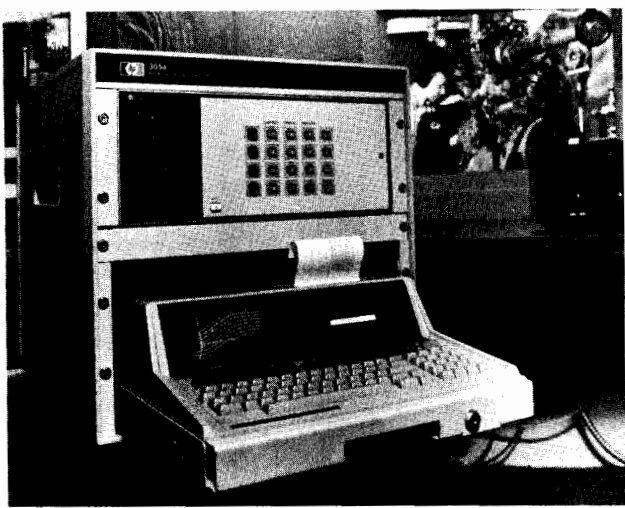

The variety of cabinet options with the 3054A can be configured to fit a wide range of applications. With the 16" combining case and locking system drawer, you could have a portable data logging and analysis system.

**Power and Performance in Desktop Computers**

The choice of four computers with the 3054A provides a wide range of capability and performance for automating data acquisition applications. The desktop computers supported with the 3054A are the HP 85A, 9825T, 9835A and 9845T. The computers automate the system by controlling the instruments and gathering the data over HP-IB. All four computers offer easy interaction to greatly simplify the writing and editing of programs. The friendly languages of the computers and the 3054A software package make it easy to get started. The presentation of data is very versatile when using a computer and external peripherals. The transducer data can be converted to engineering units, statistical analyses of the data can be performed and graphical representations of the data can be outputted. The individual capabilities of each computer such as speed, memory size, and output devices should be considered for the different data acquisition applications.

**Software and Documentation**

The system software is an integral part of the 3054A Automatic Data Acquisition/Control System. Specially written software and documentation packages are supplied for each of the four computers. This complete software package greatly simplifies programming and enables the user to get started fast.

The complete software and documentation package supplied with the 3054A includes:

- operational verification programs
- system sub-programming routines
- typical application programs

The system verification/diagnostic programs can be used to verify that the system is in operating condition at the time of installation. The programming of the 3054A is most effectively accomplished by combining the system sub-program with other system operations. Sample application programs are also provided for assistance in developing functional software.

**Racks and Cabinets**

Other cabinets may be chosen besides the standard 30" rack for the 3054A. A 16" case is offered as a compact and portable package for the 3054A. A desk provides rack space for the instrument and a table top for software development. The 56" cabinet provides space for additional equipment and future expansion.

For more information on the 3054A, contact the local HP Field Engineer or nearest HP Sales Office.

**System Options Price**

**Analog Input Assemblies for the 3497A**

- 010:** 20 Channel, Low Thermal Relay Multiplexer Assembly \$500
- 020:** Relay Multiplexer Assembly with Thermocouple Compensation \$600

**Digital Input Assemblies for the 3497A**

- 050:** 16 Channel, Isolated, Digital Input/Interrupt Assembly \$450

**Output Assemblies for the 3497A**

- 110:** 16 Channel Actuator/Digital Output Assembly Configuration Options \$550
- 230:** U.S. Clock Format for the 3497A (Month:Day:Hours:Min:Sec) N/C
- 231:** European Clock Format for the 3497A (Day:Month:Hours:Min:Sec) N/C
- 260:** Delete Keyboard and Display on 3497A less \$350
- 261:** Delete 3437A SVM and HP-IB cable less \$2,460
- 262:** Delete 3456A DVM and HP-IB cable less \$3,560
- 280:** Add 5½ digit DVM and current source for the 3497A. NOTE: Only one DVM may be deleted from system, unless optional 3497A DVM assembly is added. \$1,500
- 298:** Add 3498A Extender and connecting cables \$1,700

**Cabinet Options**

- 400:** Delete 30" cabinet; rack-mounting hardware supplied less \$1,000
- 416:** Add 16" combining case with power strip; delete 30" cabinet less \$650
- 456:** Add 56" cabinet with fan and power strip; delete 30" cabinet \$200
- 490:** Add 44530A systems desk with fan, power strip, and 23" rack space; delete 30" cabinet \$400
- 496:** Add locking drawer, 8" high, for 85A or 9825T \$200
- 498:** Add locking drawer, 18" high, for 9835A \$250

**Software and Documentation Options**

- 841:** Complete 3054A System Documentation—85A N/C
- 842:** Complete 3054A System Documentation—9825T N/C
- 843:** Complete 3054A System Documentation—9835A N/C
- 844:** Complete 3054A System Documentation—9845T N/C

**Basic 3054A System \$10,300**



# DATA ACQUISITION SYSTEM

## Automatic data acquisition system

### Model 3052A

- Improve productivity in research and manufacturing
- Increase throughput and lower the cost in Q.A. testing
- Conserve plant energy through electric load monitoring/control

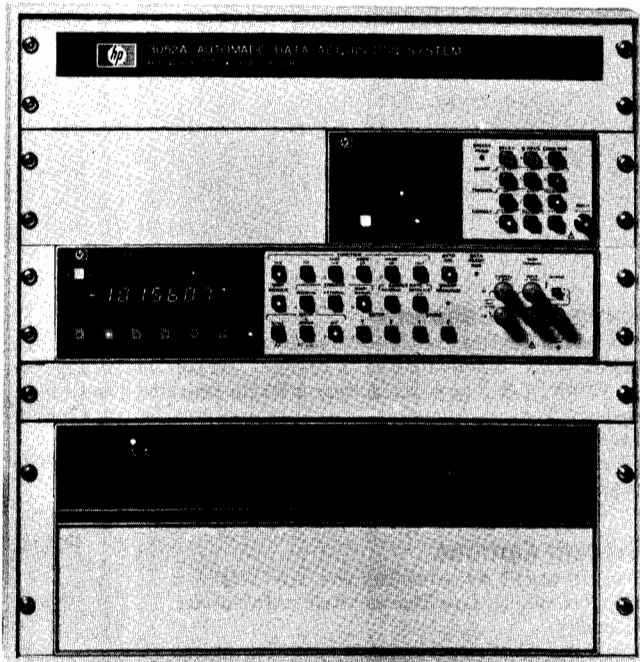

3052A

### Description

The 3052A Automatic Data Acquisition System combines speed, precision and repeatability in low level measurements with full computation and analysis capabilities. This system provides a highly capable, yet economical solution to process control development, transducer measurements, production testing, and signal analysis applications. Powerful system software for instrument driver routines, data analysis and presentation programs, instrument verification routines and application programs are provided with the standard system.

### System Configuration

The 3052A consists of the following:

- 3455A High Accuracy/High Resolution DVM
  - 3437A High Speed Sampling DVM
  - 3495A Scanner (See 3495A Multiplexer/Scanner for details)
  - 19" Combining Case
  - System Documentation and Software
- One of 4 computers must be ordered to complete the system.

### Measurement and Control

DC measurement rates up to 19 channels/second are possible with 1  $\mu$ V resolution on the 100 mV range. This sensitivity and dynamic range are required, for example, in thermocouple measurements with a 0.5°C or better resolution.

Excellent noise rejection and very low thermal uncertainty make the 3052A particularly suited for accurate, repeatable, low-level measurements even in the presence of noise. The > 120 dB effective common-mode rejection of the 3455A/3495A effectively cancels out unwanted offsets or superimposed noise signals.

AC measurements can be made up to 1 MHz with the standard AC True RMS converter or up to 250 kHz with the optional average converter. A programmable Fast AC mode provides an AC measurement rate of up to 10 channels/second for inputs above 300 Hz.

Repetitive waveforms up to 1 MHz or low frequency transients (below 1 kHz) can be digitized by the 3437A High Speed Sampling DVM. With this DVM and 9845T Desktop Computer, more than

- Monitor pilot and production processes
- Perform on-line data analysis and processing
- Measure DC, AC, and Ohms



9845T

4500 readings/second on a single high speed channel can be stored for further analysis.

By multiplexing the 3437A input with the scanner, up to 1000 channels/second can be measured with 100  $\mu$ V resolution and 3 1/2 digits. Use of the 20 Channel Low Thermal Relay Assemblies or the 19 Channel Reference Assemblies with Thermocouple Compensation are required to attain this speed. The sample-and-hold measuring technique of the 3437A makes it more suited for high quality inputs with minimum noise and common mode signals.

Resistance measurements can be made with either an easy-to-connect 2-wire technique or the more accurate 4-wire method. Multiplexed high resistance measurements up to 15 megohms can be made with the full accuracy of the 3455A.

The system can assume an active role in application processes by performing control, alarm, and multiple switching functions with the relay actuator cards in the 3495A. Each of these cards provides ten double-pole single-throw contact closures for connection to external devices.

### Power and Performance in Desktop Computers

Offering four desktop computers provide you with choices of languages, displays, memory options and printouts (see the chart below). These choices provide the flexibility, simplicity and ease for resolving simple or complex applications. All four desktop computers offer easy interaction to greatly simplify your tasks of writing and editing programs. And during system programming or operation, interaction with the operator is greatly enhanced with the immediate feedback from the controllers. When the system is on line, you will notice the efficiency and effectiveness which each calculator provides in controlling instruments, performing data manipulation, controlling input/output operations and storing data. This is possible because of the Hewlett-Packard Interface Bus (HP-IB).

The HP-IB (Hewlett-Packard's implementation of IEEE Std. 488-1975 and ANSI Standard MC1.1) not only allows simple interfacing with the system voltmeters and scanner, but other HP-IB compatible instrumentation may easily be added to the system for stimulus-response testing applications. Plus a large variety of computer peripherals are readily available as your requirements change. Producing finished test reports, completely documenting problem solutions or other desired system outputs are handled by such devices as HP's plotters, printers, or floppy disks.

**System Software**

Usually application software is expensive and time consuming to develop. Programming the 3052A, however, is greatly simplified. When using the supplied software, you can have the system fully operational in a short time. The easy-to-use programming languages of the computers, the supplied and well-documented instrument control routines, and the data analysis programs allow you to conveniently and rapidly develop your own software. Examples of the data analysis routines would be transient analysis, harmonic distortion and thermocouple linearization.

The various subroutine packages are arranged in order by the user

to suit his particular application. An "auto-loader" routine configures the subroutines automatically into a single program and stores the program on tape for use at any time. Thus, the major emphasis of the software is to enable fast system start-up and easy operation.

The 3052A System is fully integrated, tested, verified and specified as a system with complete software and documentation supplied. Once you receive this system, you will note that installation and verification, as well as detailed operating instructions and application programs, are explained in step-by-step instructions.

For more information, contact your local HP Sales Representative or nearest HP Sales Office.

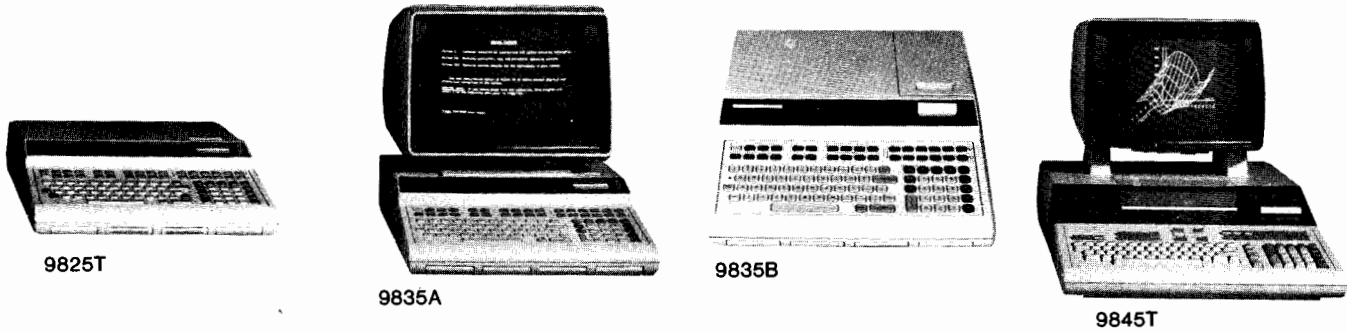

**Standard Features With Each Computer**

FEATURE	9825T	9835A	9835B	9845T
Language	HPL	BASIC	BASIC	BASIC
Display	32 Character Alpha-Numeric	CRT w/Printing and Character Plotting	32 Character Alpha-Numeric	CRT w/Printing and Full Graphics
Printout	16 Character Thermal Strip Printer	16 Character Thermal Strip Printer	16 Character Thermal Strip Printer	80 Character Thermal Line Printer
Memory (Std.)*	62K	49K	56K	187K
Additional Memory Options	Smaller memory available	115K 180K 246K	122K 187K 253K	318K 449K
Standard ROMS	String-Advanced Programming 9872A Plotter-General I/O, Extended I/O System Programming	98332A I/O	98332A I/O 98412A I/O	98411A Graphics
Tape Cartridge Storage	250K bytes	217K bytes	217K bytes	217K bytes**

\*Memory given as user read write memory in 8-bit bytes.

\*\*9845T has dual tape cartridge drives, therefore, total storage on tape is 434K bytes.

**Scanner Mainframe**

<b>102:</b> Ten Channel Low Thermal Assembly	<b>Price</b>	\$650
<b>104:</b> Twenty Channel Low Thermal Assembly		\$725
<b>106:</b> Nine Channel Reference Assembly with Thermocouple Compensation		\$725
<b>108:</b> Nineteen Channel Reference Assembly with Thermocouple Compensation		\$825
<b>110:</b> Ten Channel Relay Actuator Assembly		\$450
<b>120:</b> Additional 3495A Scanner Mainframe with 10631A HP-IB Cable		\$1,810

**Cabinets**

<b>350:</b> 50 Hz, 230 V single-phase for 3052A	N/C
<b>360:</b> 60 Hz, 120 V single-phase for 3052A (120/240 V split-phase; 120 V/208 V three-phase)	N/C
<b>363:</b> Delete standard 19" combining case; add 29402B 56" rack with fan, power strip	\$1,700
<b>365:</b> Delete standard 19" combining case (rack mounting hardware supplied)	-\$350

**Documentation Options**

<b>401:</b> 9825T Documentation for complete system	<b>Price</b>	N/C
<b>501:</b> 9835A Documentation for complete system		N/C
<b>601:</b> 9835B Documentation for complete system		N/C
<b>801:</b> 9845T Documentation for complete system		N/C
<b>914, 915, 916 and 918:</b> Extra sets of Documentation		\$400

**Ordering Information**

**3052A Automatic Data Acquisition System** from **\$8,705**



# DATA ACQUISITION SYSTEMS

Data Acquisition/Control Unit  
Model 3497A

- Relay and FET Multiplexing
- DVM
- Real Time Clock

- Digital Inputs/Outputs
- Counter
- Programmable D/A's

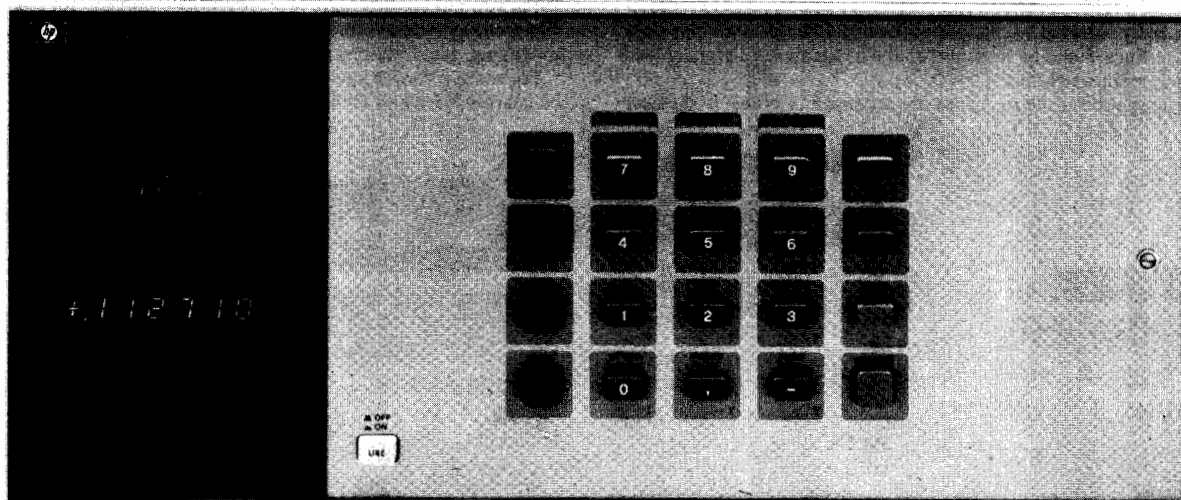

3497A

## Description

The 3497A Data Acquisition/Control Unit combines the capabilities of several instruments and is a basic building block of an automatic data acquisition and control system. The 3497A will be used in an HP-IB automated system and can be viewed as a precision measurement and control computer peripheral.

The 3497A has been designed to be a very versatile and very powerful instrument. A basic 3497A consists of a mainframe that includes a front panel keyboard and display, a non-volatile real time clock, and an HP-IB interface. Available as an option is a 5½ digit integrating digital voltmeter and current source that occupies a dedicated slot in the 3497A chassis. Capability is added to the 3497A by using any combination of plug-in assemblies. Available plug-in assemblies are:

- Relay or FET Multiplexers with or without thermocouple compensation
- Digital Input/Interrupt
- Counters
- Actuators
- Programmable voltage and current D/A's

Up to 5 assemblies can be added to a 3497A and the 3498A Extender chassis can hold up to 10 more plug-in assemblies.

## High Performance

The 3497A DVM can resolve 1 microvolt signals and is ideal for the precise measurement of the outputs of thermocouples, strain gauges and other transducers. Included on the DVM is a programmable current source that allows four terminal resistance measurements. The multiplexer assemblies switch 3 wires (Hi, Lo, and Guard) and add less than 2 microvolts of thermal offset to the measured signal.

## Flexible Hardware Configuration

The 3497A card cage can hold 5 of any combination of the plug-in assemblies. This allows the multiplexing of up to 100 3-wire inputs to the DVM in a single 3497A or a single 3497A might contain 60 multiplexer channels, 16 digital inputs, 16 actuator outputs, and a DVM. By using the 3498A Extender, up to 1000 analog channels and 1360 digital channels can be controlled, all at a single bus address.

## Ease of Use

The 3497A keyboard and display make the 3497A very easy to use and makes debugging of a 3497A-based system easy. The calibration adjustments for the 3497A DVM are located behind a hinged front panel; this allows complete calibration of the 3497A without remov-

ing it from the test rack. Connections to all of the 3497A assemblies are made using screw terminals, therefore eliminating the need for soldering.

## Automatic Data Acquisition and Control Systems

The 3497A is an integral part of the 3054A Automatic Data Acquisition and Control System. The 3054A consists of a 3456A Digital Voltmeter for high accuracy measurements, a 3437A Systems Voltmeter for high speed measurements and a 3497A for multiplexing, digital I/O and control. Included with the 3054A is a sophisticated software package compatible with the HP 85, 9825T, 9835A or 9845T computers. See the 3054A description for more information.

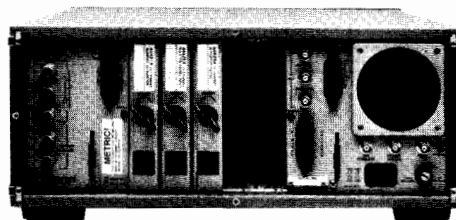

## Real Time Clock

The 3497A mainframe includes a quartz referenced non-volatile real time clock. In addition to providing timing data, the clock can measure elapsed time, interrupt at a pre-settable time, and output a programmable pulse train.

### Clock Format:

Month:Day:Hours:Minutes:Seconds (U.S. Format)

Day:Month:Hours:Minutes:Seconds (European Format)

Modes	Max. Time	Resolution	Accuracy
Real Time Mode:	1 year	1 second	±(.005% of time + .1 s)
Elapsed Time Mode:	10 <sup>6</sup> seconds	1 second	±(.005% of time + .1 s)
Time Alarm Mode:	24 hours	1 second	±(.005% of time + .1 s)
Time Interval Mode:	24 hours	1 second	±(.005% of time + .1 s)
Timer Output Mode:	1 second	100 μs	±.02% of time



**Power failure protection:** Battery back-up for >24 hours for all functions except timer output mode.

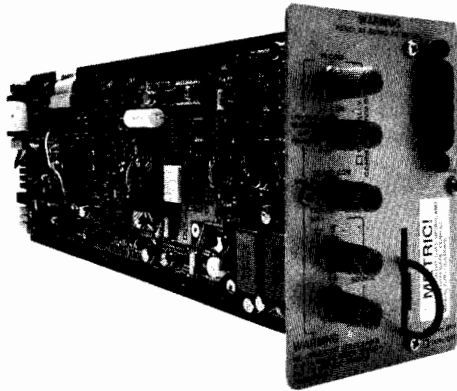

**Option 001—5½ Digit DVM and Current Source**

The 3497A DVM assembly is a systems quality, 5½ digit, 1 micro-volt sensitive DC Voltmeter. The DVM is fully guarded and uses an integrating A/D conversion technique; this yields excellent common and normal mode noise rejection.

Included on the DVM assembly is a three level programmable current source. The current source, when used simultaneously with the DVM, can be used to make high accuracy four terminal resistance measurements with 1 milliohm resolution.

The 3497A DVM assembly is fully programmable and can be configured to meet almost any measurement configuration. The 3497A DVM can be programmed for increased reading rates, obtaining a maximum of 50 readings per second in 5½ digit mode and 300 readings in 3½ digit mode. The number of readings per trigger and the delay between readings are programmable. Included on the DVM assembly is memory storage of up to sixty 5½ digit readings.

**Voltmeter Ranges/Resolution**

Range	Max. Display	5½ Digit Resolution	4½ Digit Resolution	3½ Digit Resolution	Max. Input Voltage
.10 V	±.119999	1 μV	10 μV	100 μV	120 V peak
1.0 V	±1.19999	10 μV	100 μV	1 mV	
10.0 V	±11.9999	100 μV	1 mV	10 mV	
100.0 V	±119.999	1 mV	10 mV	100 mV	

**Voltmeter Measurement Accuracy**

± (% of reading + Number of Counts)

**Auto Zero On:**

**90 Days: 23°C ± 5°C**

Digits Displayed

Range	5½ Digits	4½ Digits	3½ Digits
.10 V	.007 + 3	.01 + 1	.1 + 1
1.00 V	.006 + 1	.01 + 1	.1 + 1
10.00 V	.006 + 1	.01 + 1	.1 + 1
100.00 V	.006 + 1	.01 + 1	.1 + 1

**Auto Zero Off!:** Additional error if Auto Zero is turned off in a thermally stable environment (temperature deviations less than ±1°C, up to 24 hours).

Range	Additional Error
.10 V	10 counts
1.00 V	1 count
10.00 V	.1 count
100.00 V	1 count

**Temperature Coefficient!:** ± (% Reading + Number of Counts)/°C, 28-55°C

Range	Additional Error
.10 V	.00025 + .15
1.00 V	.00020 + .02
10.00 V	.00020 + .01
100.00 V	.00025 + .03

\*Valid for 5½ digit operation. Multiply counts by .1 for 4½ digit operation. Multiply counts by .01 for 3½ digits operation.

**Input Impedance**

High to Low (in parallel with 120 pF at 1 MHz)    25 °C, <85% R.H.    40 °C, <60% R.H.    40 °C, <95% R.H.

.1 V to 10 V Range	>10 <sup>9</sup>	>10 <sup>8</sup>
100 V Range	10 MΩ ± .5%	10 MΩ ± .5%

**Maximum Input Voltage**

**High to Low:** 120 V peak  
**Low to Guard:** 170 V peak  
**Guard to Chassis:** 170 V peak  
**Current Source Accuracy:** 90 days

Range	23°C ± 5°C
10 μA	2.5 nA
100 μA	25.0 nA
1 mA	250 nA

**Compliance:** > +15 volts  
**Isolation voltage:** 170 volts peak  
**Output resistance:** > 10<sup>10</sup> Ω

**General Information**

**Maximum Reading Rate:** (readings/second)

Auto Zero	60 Hz Operation Digits Displayed			50 Hz Operation Digits Displayed		
	5½	4½	3½	5½	4½	3½
ON	25	100	150	20	83	125
OFF	50	200	300	40	166	250

**Delay:** 0 to 99.9999 sec. in 100 μsec. steps

**Delay Accuracy:** 5% ± 200 μseconds

**Buffer size:** packed format: 100 readings; ASCII format: 60 readings

**Number of readings per trigger:** 1 to 999

**Measurement speeds**

For the 3497A DVM and the relay or FET multiplexer, speeds are given for measurements on random channels (using software channel selection) and sequential channels (using external hardware increment). Speeds include I/O times to the indicated computers.

**60 Hz operation**

	Voltmeter Digits Displayed	85A	9825T	9835A	9845T
Sequential Channels	5½	39	40	40	40
	4½	97	100	100	100
	3½	116	120	120	120
Random Channels	5½	16	31	20	20
	4½	22	58	30	30
	3½	23	65	31	31

# DATA ACQUISITION SYSTEM

Data Acquisition/Control Unit  
Model 3497A

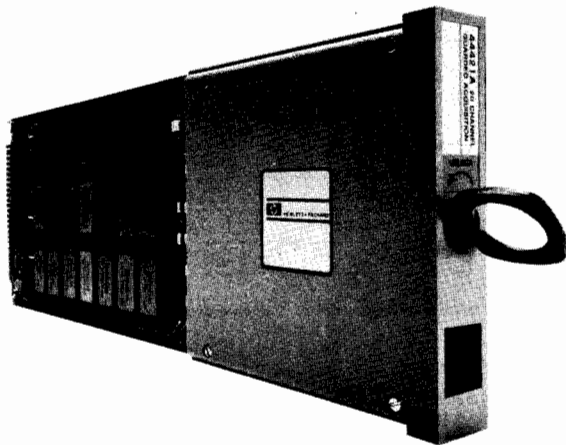

### Option 010—20 Channel Relay Multiplexer

This assembly uses reed relays to multiplex signals to the DVM or other instruments. Each assembly switches 20 channels, each channel consists of HI, Lo, and Guard lines. Two channels may be closed per assembly and relays may be closed in a random sequence or incremented between programmable limits. The low thermal offset of the relays make it suitable for measuring the outputs of strain gauges and other transducers.

#### Input Characteristics

- Maximum Input Voltage:** <170 V peak between any two input terminals
- Maximum current:** 50 mA per channel non-inductive
- Maximum power:** 1 VA per channel
- Thermal offset:** Direct Switched: <1  $\mu$ V Differential, Tree Switched: <2  $\mu$ V Differential
- Closed channel resistance:**
  - In series:** 100  $\Omega$   $\pm$  10% in High, Lo and Guard
  - Relays contacts only:** <1  $\Omega$
- Open channel isolation:** >10<sup>10</sup>  $\Omega$  (Hi to Lo, 40°C, <60% R.H.)

#### Operating Characteristics

- Maximum switch rate:** Random Channels: 38/second (using 9835A Computer); 475/second (using hardware increment)
- Rated switch life at 1 VA:** 10<sup>7</sup> operations
- All relays are break-before-make**

### Option 020—Relay Multiplexer with Thermocouple Compensation

The option 020 assembly uses the same relay multiplexer as option 010 but incorporates a special isothermal connector block to allow thermocouple compensation. Two types of compensation (selectable by the user) are available. A temperature-dependent voltage is generated for software compensation; this voltage is then used in a computer program to compensate the thermocouple voltage. Hardware compensation involves inserting a voltage in the measurement circuit that automatically compensates the thermocouple voltage.

#### Reference Junction Compensation Comparison

	Compensation Type	
	Software	Hardware
Compatible Thermocouples	Any mixture	One of the following types: B,E,J,K,R,S,T
Measurement channels available per assembly	19	20
Reference junction compensation accuracy (23° C $\pm$ 5° C)	.1°C	

	Compensation Type	
	Software	Hardware
Temperature coefficient (0°C–18°C, 28°C–55°C)	.009°C/°C	
Stability	.075°C/1000 hours	
Temperature difference across isothermal block	<.2°C	
Software compensation output (Channel B9)	100mV/°C 2.5 V @ 25°C	
Additional in-series resistance (hardware compensation only)	10 $\Omega$	

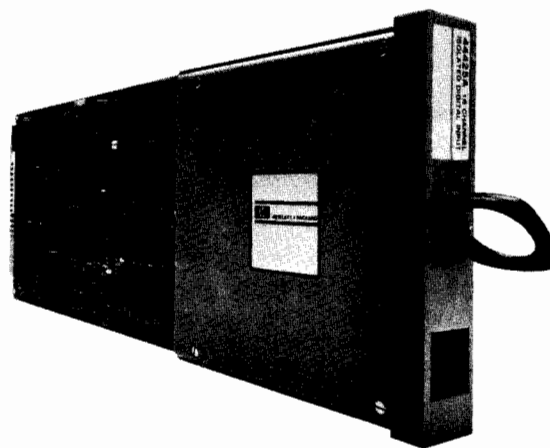

### Option 050—16 Channel Isolated Digital Input/Interrupt

The option 050 assembly can sense up to 16 channels of digital data. The first 8 channels can also be used as interrupt lines to detect transient signals. The assembly can accept a wide range of input levels and all functions and masks are fully programmable. A five volt supply is provided for driving external contact closures and open collector outputs.

#### Input signal characteristics:

Input Level	Low Voltage Maximum	High Voltage Minimum	Maximum Input Voltage Between High & Low Terminals	Minimum Input Current
5 V	0.8 V	2.4 V	30 V	400 $\mu$ A
12 V	3.0 V	7.0 V	42 V	1 mA
24 V	6.0 V	13.0 V	42 V	2 mA

**Maximum voltage between any terminal and chassis:**  $\pm$  170 V peak

**Logic polarity:** Positive True (Negative True is Jumper Selectable)

#### Handshake:

- Gate handshake line is isolated, open collector output.
- Flag handshake line is isolated, 5 V, 12 V, or 24 V input

#### Interrupt mode (Bits 0-7)

- Minimum Pulse Width:** 100 microseconds
- Triggering:** Each interrupt line is individually programmable for positive or negative edge triggering.
- Masking:** Each interrupt line may be enabled or disabled using a programmable mask.

### Option 110—Actuator/Digital Output Assembly

Option 110 consists of 16 mercury wetted form C (single pole-double throw) relays. Each relay can be individually closed and can switch one amp at 100 volts. The actuator assembly can be used to switch test fixture power or to actuate alarm bells. This flexibility of this assembly allows it to be used as a digital output or matrix switch.



### Input Characteristics

**Contact ratings:** Voltage:  $\pm 100$  V peak; Current: 1 ampere/channel. **CAUTION:** For use only in circuits fused at 1 ampere or less and less than 100 VA.

**Thermal Offset:**  $< 20 \mu\text{V}$

**Contact Resistance:**  $< 400$  milliohms

**Isolation:**  $> 10^6 \Omega$  common to open

**Isolation voltage:** 170 V peak any terminal to chassis

### General Information

**Single channel closure rate:**  $> 27/\text{second}$  (Using 9835A)

**Switch life:**  $> 10^{10}$  with contact protection

**+5 V Supply:** source up to 50 mA per assembly

**Operating Consideration:** should not be used in a position greater than  $30^\circ$  above horizontal

**Handshake lines:** optically isolated TTL

### Other Plug-ins Available

#### Option 030—20 channel FET Multiplexer

Similar to the Option 010 Relay Multiplexer, this assembly uses FET switches to multiplex signals to the 3497A DVM or other devices. The FET's have a longer switch life than relays and can scan sequential channels at greater than 4800 channels per second.

#### Option 040—FET Multiplexer with Thermocouple Compensation

This option expands the capability of the FET multiplexer assembly to include thermocouple compensation. Compensational performance is identical to Option 020.

#### Option 060—100 kHz Reciprocal Counter

This programmable counter assembly can measure period and pulse width on signals up to 100 kHz. The counter can also count up (totalize) or count down from a programmable start point. All functions, ranges and trigger modes are fully programmable.

#### Option 120—Dual Output 0 to $\pm 10$ V D/A Converter Assembly

This assembly contains 2 independently programmable 0 to  $\pm 10$  V D/A converters. Each converter is isolated from the 3497A and each other and has 13 bit resolution (including polarity).

#### Option 130—Dual Output 0 to 20 or 4 to 20 mA D/A Converter Assembly

This assembly contains 2 independently programmable current sources. Each source can be configured to operate in a 0 to 20 or 4 to 20 mA range and has 12 bit resolution. Each source is isolated from the 3497A and each other.

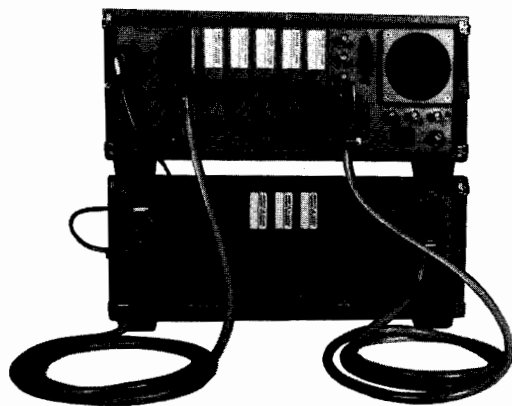

#### Option 298—3498A Extender

The 3498A Extender chassis allows low cost expansion of 3497A-based systems. Each 3498A can hold up to ten 3497A plug-in assemblies. Use of one or more 3498A's requires a 3497A (for control); all required connecting cables are supplied with the 3498A.

**Number of slots per 3498A:** 10

**Maximum number of added analog multiplexer channels** (options 010, 020, 030, 040): 900 channels (45 assemblies)

**Maximum number of added non-analog acquisition assemblies** (options 050, 060, 110, 120, 130): 85 assemblies

**Maximum number of 3498A's per 3497A:** 13

### System Noise Rejection

**Normal Mode Rejection (NMR):** 50 or 60 Hz,  $\pm .09\%$

DVM Digits Displayed	Rejection
5½	60 db
4½	0 db
3½	0 db

NMR is a function of the 3497A DVM configuration only and is not affected by the number of channels in the system.

**Effective common mode rejection (ECMR):** The ECMR of a 3497A based system is a combination of the ECMR of the 3497A DVM and the effects of adding multiplexer assemblies and 3498A extenders.

**ECMR:** (1 k $\Omega$  imbalance in low lead, using tree switching, ac at 50 or 60 Hz, 25°C  $< 85\%$  R.H.).

### Voltmeter configuration

No. of Acquisition Channels (Opt 10, 20)	5½ Digits	4½ Digits	3½ Digits
0 AC	150 dB	90 dB	90 dB
DC	120 dB	120 dB	120 dB
<100 AC	150 dB	90 dB	90 dB
DC	104 dB	104 dB	104 dB
<400 AC	140 dB	80 dB	80 dB
DC	92 dB	92 dB	92 dB
<1000 AC	130 dB	70 dB	70 dB
DC	85 dB	85 dB	85 dB

### General

**Size** (3497A or 3498A): 190.5 mm H x 428.6 mm W x 520.7 mm D ( $7\frac{1}{2}$ " x  $16\frac{7}{8}$ " x  $20\frac{1}{2}$ "). Additional 2" in depth should be allowed for wiring.

**Net Weight:** 3497A, 20.4 kg (45 lbs.) and 3498A, 20.4 kg (45 lbs.) with assemblies in all slots.

**Shipping Weight:** 3497A and 3498A maximum with assemblies in all slots are 26.3 kg (26.3 lbs.).

#### Environmental (3497A or 3498A):

Operating temperature: 0°C to 55°C

Non-operating temperature:  $-40^\circ\text{C}$  to  $75^\circ\text{C}$

Humidity: to 95% at  $40^\circ\text{C}$  except as noted

Operating power: switch selection of 110, 120, 220 and 240 volts  $\pm 10\%$ , 48-66 Hz, 150 VA 3497A and 3498A.

### Ordering Information

Ordering Information	Price
<b>Opt 001</b> 5½ digit DVM and Current Source	\$1500
To field install, order 44420A kit	
<b>Opt 010</b> 20 channel Relay Multiplexer Assembly	\$500
To field install, order 44421A kit	
<b>Opt 020</b> Relay Multiplexer Assembly with thermocouple compensation; to field install, order 44422A kit	\$600
<b>Opt 050</b> 16 channel isolated Digital Input/Interrupt Assembly; to field install, order 44425A kit	\$450
<b>Opt 110</b> 16 channel Actuator/Digital Output Assembly; to field install, order 44425A kit	\$550
<b>Opt 230</b> Clock Format (Month:Day:Hours:Min:Sec)	N/C
<b>Opt 231</b> Clock Format (Day:Month:Hours:Min:Sec)	N/C
<b>Opt 260</b> Delete Keyboard and Display	less \$350
<b>Opt 298</b> Add 3498A Extender & connecting cables; to field install, order as a 3498A, not as a 3497A Opt 298	\$1700
<b>Opt 315-346</b> Power and Frequency Options:	N/C
<b>Opt 907</b> Front Handle Kit (5061-0090)	\$40
<b>Opt 908</b> Rack Flange Kit (5061-0078)	\$30
<b>Opt 909</b> Rack Flange & Front Handle Kit (5061-0084)	\$65
<b>Opt 910</b> Extra Set of 3497A/3498A Documentation	\$60
<b>3497A Data Acquisition/Control Unit</b>	\$2450

# DIGITAL VOLTMETERS

## Multiplexer Scanner

Model 3495A

- Low level switching
- Multichannel closure
- Switched guard
- Relay actuation

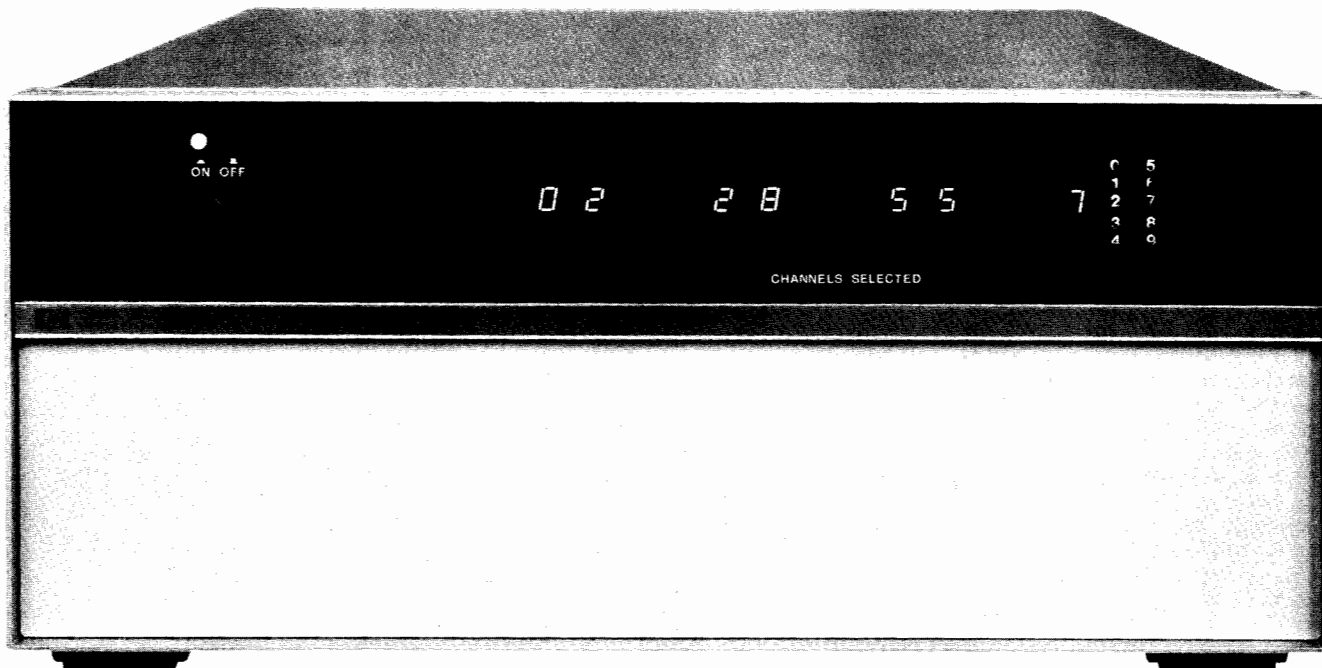

3495A



### Description

#### General

The 3495A Scanner switches analog input signals to an appropriate measuring device (voltmeter). It can also control external devices with relay actuator closures. Ideal for many data logging and data acquisition applications, the scanner can be used for sequential or random scanning. Any Hewlett-Packard Interface Bus (HP-IB) compatible controller can be used to operate the Scanner. Any combination of four relay assemblies (discussed below) can be used per scanner mainframe. More than four assemblies requires additional scanner mainframes.

Five optional relay assemblies are available with the scanner, four low thermal assemblies and one actuator assembly.

to 230V peak. A separate guard relay for each channel minimizes the effects of common mode voltage on low level measurements. A break-before-make feature ensures that only one channel at a time is closed, which prevents connecting two inputs simultaneously.

**Maximum contact ratings:** Voltage: 200V peak; Current: 200 mA (non-inductive); Maximum input voltage: 230V peak; Thermal Offset:  $< 2\mu\text{V}$  differential EMF; Isolation:  $> 10^{10}\Omega$ ; Switching Time: 10 ms max.

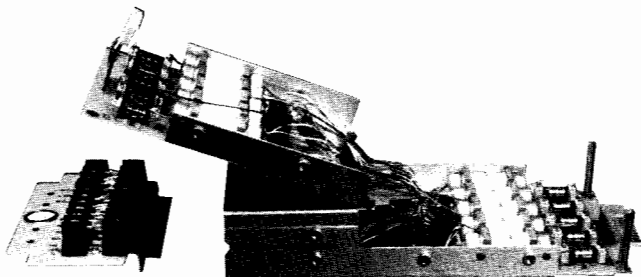

OPTION 001

#### Low thermal relay assemblies

Applications: low level dc measurements; dc volts and resistance scanning.

Transducer sensing: thermocouples, thermistors, strain gauges, pH meters.

**1. Ten Channel Low Thermal Relay Assembly (Opt. 001):** This assembly provides ten 3-wire input channels for switching voltages up

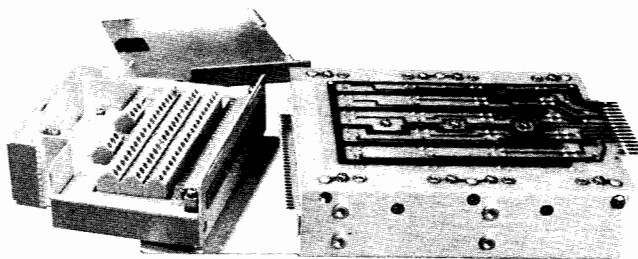

OPTION 004

**2. Twenty Channel Low Thermal Relay Assembly (Opt. 004):** Designed for switching voltages below 42V peak, this assembly contains twenty 3-pole input channels. Very low thermal offset voltages are maintained in the assembly for low level switching. When used in conjunction with the High Speed Controller Board (Opt. 100) and the 3437A System Voltmeter, switching speeds of up to 1000 channels/s with  $100\mu\text{V}$  resolution can be obtained.

**Maximum contact ratings:** Voltage: 42V peak; Current: 40mA (non-inductive); Maximum input voltage: 42V peak; Thermal Offset:  $< 1\mu\text{V}$  differential EMF; Isolation:  $> 10^9\Omega$ ; Switching Time: 1 ms max.

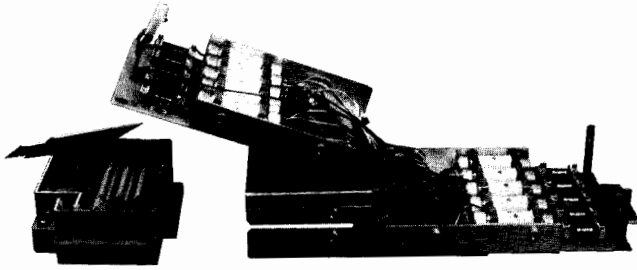

Option 003

**3. Nine Channel Reference Assembly with Thermocouple Compensation (Opt. 003):** An isothermal block, which replaces the standard terminal connector, acts as a reference junction for up to nine thermocouples. The remaining channel measures the temperature of the reference junction with a built-in thermistor. This temperature information is used for thermocouple reference junction compensation.

**Maximum contact ratings:** Voltage: 42V peak; Current: 200mA (non-inductive); Maximum input voltage: 42V peak; Thermal offset:  $<2\mu\text{V}$  differential EMF; Isolation:  $>10^9\Omega$ ; Switching Time: 10 ms max.

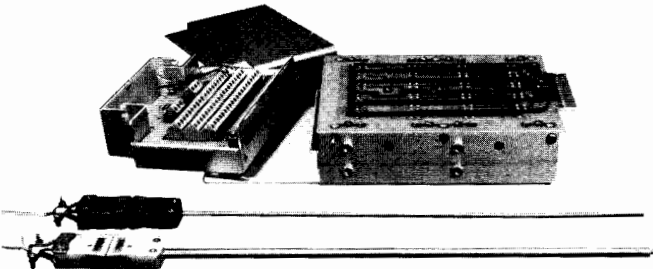

Option 005

**4. Nineteen Channel Reference Assembly with Thermocouple Compensation (Opt. 005):** similar in operation to Option 003 except there are nineteen low thermal channels instead of nine channels. When used in conjunction with Option 100 and the 3437A SVM, switching speeds of up to 1000 channels/s with  $100\mu\text{V}$  resolution can be achieved.

**Maximum contact ratings:** Voltage: 42V peak; Current: 40 mA (non-inductive); Maximum input voltage: 42V peak; Thermal offset  $<1\mu\text{V}$  differential EMF; Isolation:  $>10^9\Omega$ ; Switching time: 1 ms max.

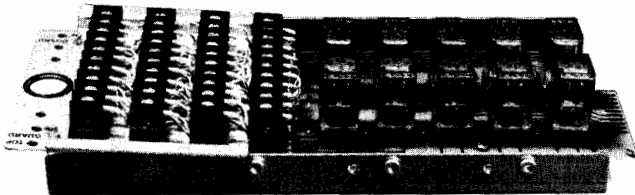

Option 002

#### Relay Actuator Assembly

**Applications:** process control, actuate visual or audio indicators, control high current relays, up to  $2 \times 5 \times 2$  Matrix switching.

**Ten Channel Relay Actuator Assembly:** This relay actuator assembly provides ten independently programmable 2-wire closures for controlling high current relays, distributing low current dc or ac voltages, or external control function. Each two-pole relay can switch currents up to 2 A rms. Any combination of channels on this assembly may be closed or opened simultaneously.

**Maximum contact ratings:** voltage: 100V rms; Current: 2 A rms; Maximum input voltage: 230V peak; Thermal offset:  $<30\mu\text{V}$  differential EMF; Switching time: 40 ms max. (Caution: For use in cir-



Option 100

uits fused at 2 amperes or less and less than 200 VA).

**High Speed Control Board (Opt. 100):** Replacing the standard control board with the High Speed Control Board adds high speed capability to the 3495A Scanner. When Opt. 004 or Opt. 005 low thermal assemblies are used in conjunction with an external triggering device, such as a 3437A System Voltmeter, speeds of up to 1000 channels/s with  $100\mu\text{V}$  resolution can be obtained. The High Speed Control Board is compatible with other relay assemblies, but no speed improvements are achieved.

#### General

**Operating temperature:**  $0^\circ\text{C}$  to  $+55^\circ\text{C}$

**Humidity range:** 95% R.H.,  $0^\circ\text{C}$  to  $+40^\circ\text{C}$

**Power:** 100/120/220/240 +5%, -10%

48 to 66 Hz line operation,  $<100\text{VA}$

**Size:** 190.5 H x 428.6 W x 520.7 mm D (7.5" x 16.87" x 20.5")

**Weight:** Depends on options. Net: 18 kg (39.6 lbs.) maximum with four relay assemblies. Shipping: 22 kg (48.4 lbs.) maximum.

#### Options, accessories and field installation kits

Order one or more optional relay assemblies to obtain desired number of channels. Up to a total of four assemblies may be used in any combination in each scanner mainframe.

#### Option

Option	Price
<b>001:</b> Ten Channel Low Thermal Relay Assembly	+\$650
<b>002:</b> Ten Channel Relay Actuator Assembly	+\$450
<b>003:</b> Nine Channel Reference Assembly With Thermocouple Compensation	+\$725
<b>004:</b> Twenty Channel Low Thermal Relay Assembly	+\$725
<b>005:</b> Nineteen Channel Reference Assembly With Thermocouple Compensation	+\$825
<b>100:</b> High Speed Control Board	+\$250

#### Field installation kits

<b>44401A</b> Ten Channel Low Thermal Relay Assembly	+\$650
<b>44402A</b> Ten Channel Relay Actuator Assembly	+\$450
<b>44403A</b> Nine Channel Reference Assembly With Thermocouple Compensation	+\$725
<b>44404A</b> Twenty Channel Low Thermal Relay Assembly	+\$725
<b>44405A</b> Nineteen Channel Reference Assembly With Thermocouple Compensation	+\$825
<b>44413A</b> High Speed Control Board	+\$350

In addition, options 001 or 004 can be field modified to include thermocouple compensation by ordering the appropriate terminal connectors.

#### Additional terminal connectors for:

Ten Channel Low Thermal Relay Assembly 03495-64101	+\$140
Ten Channel Relay Actuator Assembly 03495-64104	+\$120
Nine Channel Thermocouple Reference Assembly 03495-64103	+\$235
Twenty Channel Low Thermal Relay Assembly 03495A-64114	+\$132.50
Nineteen Channel Thermocouple Reference Assembly 03495-64115	+\$170

**3495A Scanner**

**\$1400**

# COMPONENT MEASUREMENT

## General information

C, R, L, D, Q, Z,  $\theta$  and IC's

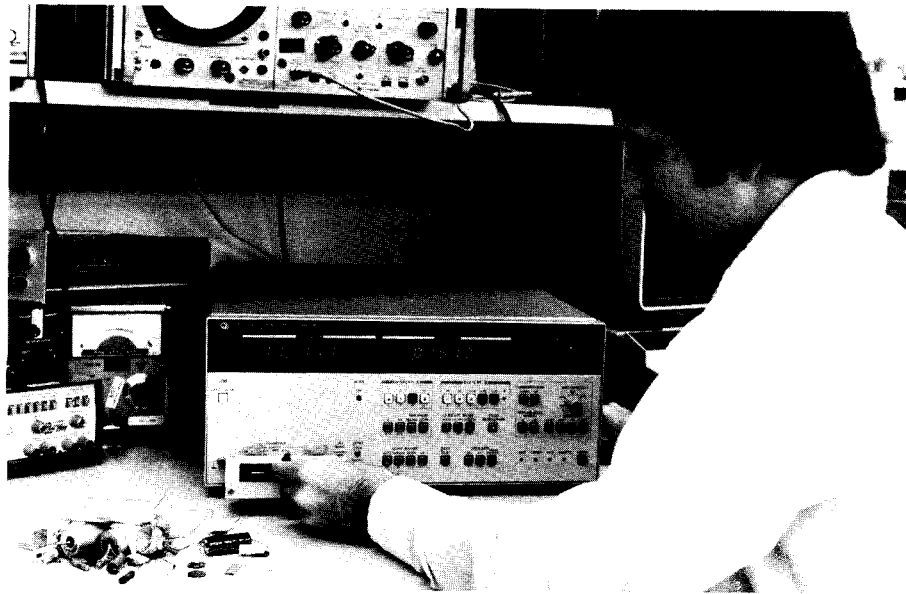

Instrument	Frequency				Q or $\frac{1}{D}$	C in farads, L in henries or R in ohms								Basic Accuracy			Page			
	DC	1 Hz	1 kHz	1 MHz		1 GHz	$10^0$	$10^3$	$10^{-15}$	$10^{-12}$	$10^{-9}$	$10^{-6}$	$10^{-3}$	$10^0$	$10^3$	0.1%		1%	10%	
Milliohm Meter 4328A													R							92
LCR Meter 4332A									C			L		R	$10^6$					92
High Resistance Meter 4329A	.									$10^6$			R	$10^{16}$						93
Universal Bridge 4260A	.								C			L		R	$10^7$		.			94
Universal Bridge 4265B						$10^{-3}$			C			L		R	$10^6$		.			94
1 MHz Preset C Meter 4272A									C											95
1 kHz Preset C Meter 4273A									C											95
Digital LCR Meter 4261A									C			L		R	$10^7$					96
Digital LCR Meter 4262A									C			L		R	$10^7$					98
Q Meter 4342A									C			L								100
1 MHz LCR Meter 4271B									C			L		R						101
Multi-frequency LCR Meter 4274A									C			L		R	$10^7$					102
Multi-frequency LCR Meter 4275A									C			L		R	$10^7$					104
pA Meter /DC Voltage Source 4140B*	.								C			I		V						106
RF Impedance Analyzer 4191A						$10^{-3}$			C			L		R, Z	$10^5$					108
Semiconductor/ Component Test System 4061A	.								C			I		V						110
LF Impedance Analyzer 4192A									C			L		Z, R	$10^6$					112
Vector /Z/Meter 4800A									C			L		Z	$10^7$					114
RF Vector/Z/Meter 4815A													L	Z	$10^5$					114
Digital IC Tester 5045A	Functional and DC Parameter measurements on TTL, CMOS, ECL, HTL, and DTL logic families.																		116	

\*I in amperes, V in volts; (V is test voltage).



## Impedance $|Z|$ , $\theta$ , C, R, L, D & Q

Hewlett Packard's family of component measurement instruments covers the impedance range from less than one milliohm to greater than  $10^{18}$  ohms. Instruments range from the traditional manual null measurement technique to the completely automatic, microprocessor controlled, systems oriented type.

The basic characteristics of each instrument are summarized in the selection guide on the preceding page. This guide is convenient for selecting the most suitable instrument for a particular application or for considering trade-offs of key characteristics.

### Impedance Considerations

Impedance measuring instruments can be categorized, according to the technique used, into the bridge, voltage/current and Q methods. In the bridge technique, circuit conditioning required to achieve a balance or null condition is detected and processed to indicate the measured value. The voltage/current method essentially uses Ohm's Law in that a constant voltage or current is applied to the unknown and the converse current or voltage is indicative of the unknown value. The Q method utilizes unique characteristics of the series resonant circuit to determine Q, and indirectly L, C and R.

Traditionally, the bridge has been the most accurate measurement technique. It required operator skill to manually null the bridge and determine the value of the unknown. Today's technology yields automatic, digital readout bridges with accuracy exceeding the less sophisticated manual bridges.

The manual HP 4265B Universal Bridge is a traditional laboratory oriented bridge with excellent accuracy at low cost.

The semi-automatic HP 4260A Universal Bridge required only one adjustment without a tedious balancing operation, yielding speed and convenience at nominal cost.

Several fully automatic digital bridges are available from Hewlett-Packard, each with special features. The HP 4271B 1 MHz LCR Meter uses a state-of-the-art four terminal pair arrangement to eliminate the mutual inductance of the test leads—a principle consideration at 1 MHz. The HP 4272A 1 MHz Preset C Meter has an internal comparator for automatic sorting.

In the past, the voltage/current technique utilized analog meter readouts for speed and convenience, but offered less accuracy than the bridge method. With recent advances in technology, this is no longer the case. The new fully automatic digital instruments using the voltage/current method offer accuracy exceeding all but the most sophisticated manual bridges.

The first of these instruments introduced by Hewlett-Packard was the 4261A. It offers fully automatic L, C, R and D measurements at two test frequencies with excellent accuracy. The HP 4262A is the first of a new generation of microprocessor-based instruments, featuring three test frequencies and automatic self-test capability.

## New Generation Component Measurements

Many of these measurements have been either not practical, very difficult, or very costly to make with earlier instruments that were designed to make measurements only under relatively limited test conditions. However, Hewlett-Packard now offers a new generation of instruments to change the measuring concept of evaluating electronic components, devices and circuits—that is, "testing and evaluating under actual working conditions."

The addition of the HP 4274A and 4275A will allow the user to test components under actual operating conditions. Both instruments feature variable test signal levels, ten spot frequencies, self test capability, digital offset to compensate for test leads and fixtures, and vector/phase angle measurements.

Impedance analysis and network analysis can be performed accurately and efficiently using the HP Model 4191A RF Impedance Analyzer and the new HP Model 4192A LF Impedance Analyzer.

In the frequency range of 1 MHz to 1000 MHz, the 4191A measures 14 parameters including  $|Z|$ ,  $|Y|$ ,  $\theta$ , R, X, G, B, L, C, D, and Q, reflection coefficient  $|\Gamma|$ ,  $|\Gamma_x|$ , and  $|\Gamma_y|$  plus deviation  $\Delta$  and  $\Delta\%$  for all parameters. The 4192A measures all the preceding parameters plus Group Delay in the frequency range from 5 Hz to 13 MHz.

Both 4191A and 4192A have built-in frequency synthesizers and dc bias sources, including internal sweep of both frequency and bias voltage. Basic measuring accuracy for the 4191A (1 MHz to 1000 MHz) is 1%. Basic accuracy for the 4192A (5 Hz to 13 MHz) is 0.3%.

## Semiconductor Measurements

The 4140B pA Meter/DC Voltage Source is the latest addition to the new generation of component measuring instruments for doing basic DC characteristics measurements such as leakage current, current-voltage characteristics, quasi-static C-V measurements and those others especially required by the semiconductor industry for new device development and for improvement of production yields.

The 4140B is also usable for making measurements on electric components and equipment such as for measuring leakage current or insulation resistance to improve product reliability.

Generally, in low current measurements, there have been many problems—noise, drift, measuring speed and accuracy which have been preventing reliable results.

The 4140B consists of a very stable picoampere meter with a synchronized, dual programmable DC voltage supply— $V_A$  and  $V_B$  ( $V_A$  includes staircase capability and ramp voltage generation). The instrument is designed to solve the measurement problems described above and specifically to facilitate making them more easily.

## Integration into HP-IB System

Adding the HP-IB option to a component measuring instrument enables the instrument to be incorporated into an HP-IB system. This permits high speed measurement of many components along with arithmetic processing of the data and allows a remarkable efficiency increase to be realized in the production line testing of discrete components, in quality assurance tests, or in laboratory evaluations.

For more comprehensive semiconductor measurement, Hewlett-Packard has recently introduced the Model 4061A Semiconductor/Component Test System. The 4061A is a dedicated HP-IB system that performs efficient, automatic evaluation of the fundamental characteristics of semiconductor and electronic components. The 4061A is especially useful for new component/material development, quality control, and in the early stages of semiconductor manufacture, for monitoring and controlling the wafer process.

A wide range of characteristics measurements can be done, including doping profile, surface charge, density, minority carrier lifetime and threshold voltage. The 4061A can also perform analysis of more conventional impedance characteristics of electronic components. Software for seven typical applications are provided with the system.

The 4061A employs a unique switching sub-system that controls DUT connection between the LCR meter and pA Meter. This insures that both impedance and current characteristics can be measured without changing the system set-up. The 4061A is flexible enough in both hardware and software to allow expansion and increased data processing capabilities.

## Summary

To assist in the selection of an impedance meter suitable for your needs, the following guidelines may be used:

- (1) Choose an instrument which measures the device under test (DUT) under the identical conditions (frequency, signal level, bias, . . .) as its intended use.
- (2) Consider the environmental parameters (lead resistance and inductance, stray capacitance, temperature variations, . . .) that will affect your measurement and choose a measurement technique that will tend to counteract them.
- (3) Then select the instrument with the broadest measurement capability within accuracy and cost constraints.

Hewlett-Packard's impedance measuring instruments have been used in numerous diverse applications. If you have an unusual application or need assistance, contact your nearest Hewlett-Packard sales office for information.



# COMPONENT MEASUREMENT

## Milliohmmeter / LCR Meter

Model 4328A/4332A

- 20  $\mu\Omega$  resolution on 1 m $\Omega$  range
- Four terminal measurement
- Low test voltage

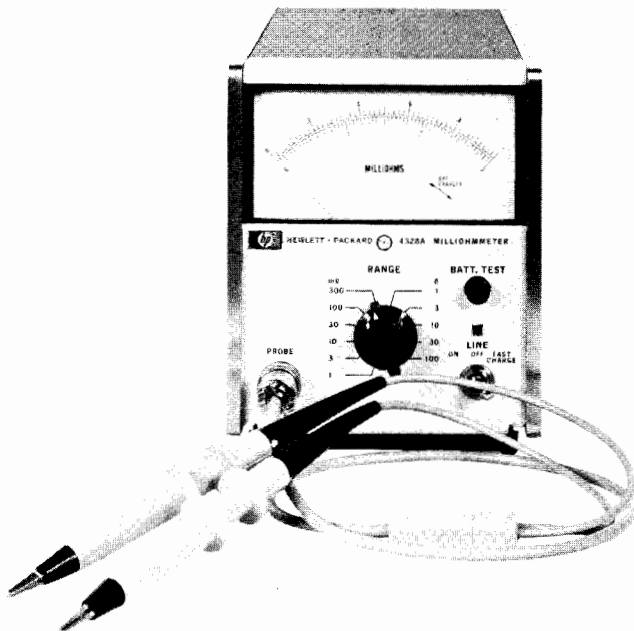

4328A

### Description

HP's 4328A Milliohmmeter is a high sensitivity portable instrument for measurement of low resistances. The 1 m $\Omega$  to 100  $\Omega$  measuring range and 20  $\mu\Omega$  resolution make the 4328A ideal for measuring the contact resistance of switches, relays, and connectors and the resistivity of conductors and semiconductors. Series reactances of up to twice the full scale resistance will not affect the accuracy. The maximum voltage across a sample, with the instrument at the proper range, is less than 200  $\mu\text{V}$  peak. Even at incorrect range settings, the voltage across the sample will not exceed 20 mV peak.

The special probes that allow four-terminal measurement in two probes are furnished with the 4328A.

The basic 4328A is line operated but Opt 001 permits operation from rechargeable batteries for 15 continuous hours.

### Specifications

- Range:** 0.001 to 100 ohms full scale in a 1, 3 sequence.  
**Accuracy:**  $\pm 2\%$  of full scale. No additional error is caused by series reactance of samples up to two times full scale.  
**Measuring frequency:** 1000 Hz  $\pm 100$  Hz.  
**Voltage across sample:** 200  $\mu\text{V}$  peak at full scale.  
**Maximum voltage across sample:** 20 mV peak.  
**Superimposed dc:** 150 V dc maximum (external source).  
**Recorder output:** 0.1 V dc output at full scale, output resistance approx. 1k $\Omega$ .  
**Applied current (mA):** Constant by range, 150/(full scale value in milliohms).

### General

- Power requirements:** 115/230 V  $\pm 10\%$ , 50 to 60 Hz, 1.5 VA.  
**Weight:** 3.2 kg (7 lb).  
**Size:** 155mm H x 130 mm W x 279 mm D (6 $\frac{3}{32}$ " x 5 $\frac{1}{8}$ " x 11").  
**Accessories furnished:** Model 16005A Probe, 16006A Probe and 16007A/B Test Leads. 16143A Probe Cable.

### Ordering Information

- 4328A Milliohmmeter** \$1405  
**Opt 001:** Rechargeable battery operation \$90  
**Opt 910:** extra manual \$12.50

- Touch and read operation
- Low test voltage
- Guarded measurement

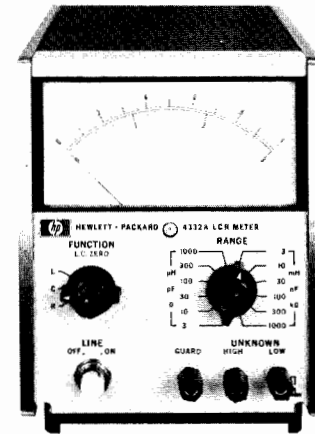

4332A

### Description

Hewlett-Packard's Model 4332A LCR Meter measures inductance, capacitance, and resistance with speed and accuracy. The instrument provides direct-readings of L, C, and R with linear meter scales. The 4332A is extremely useful for measurements of both linear and non-linear components such as semiconductor capacitor values and inductance of coils with ferrite core.

### Specifications

Function	Full Scale Range	Test Signal	Accuracy (meter reading) at 25°C
Inductance (series)	3 $\mu$ to 1000 $\mu\text{H}$	100kHz $\pm 5\%$ <1.5mVrms	+ [1% reading + (1.5 + 3/Q)% full scale + 0.03 $\mu\text{H}$ ]
	3m to 1000mH	1kHz $\pm 5\%$ <1.5mVrms	
Capacitance (parallel)	3p to 1000pf	100kHz $\pm 5\%$ $\approx 70\text{mVrms}$	$\pm$ [1% reading + (1.5 + 3/Q)% full scale + 0.03pF]
	3n to 1000nF	1kHz $\pm 5\%$ $\approx 70\text{mVrms}$	
Resistance	3 $\Omega$ to 1M $\Omega$	1kHz $\pm 5\%$ <1mVrms	$\pm$ [0.5% reading + 2% full scale + 0.03 $\Omega$ ]*

\*Add 0.5% reading in 100 k $\Omega$  and 1 M $\Omega$  ranges.

- Analog output:** 1.0 V dc or 0.3 V dc full scale.  
**Output impedance:** approximately 500 $\Omega$ .  
**Accuracy:** better than meter reading accuracy by 0.5% full scale.

### General

- Response time:** typically 0.25 s for analog outputs. Typically 1.0 s for meter.  
**Operating temperature:** 0°C to 50°C.  
**DC bias:** 100 V dc maximum can be applied from external source.  
**Power:** 115 V/230 V  $\pm 10\%$ , 48 Hz to 66 Hz, 8VA.  
**Size:** 130 mm W x 155 mm H x 279 mm D (5 $\frac{1}{8}$ " x 6 $\frac{3}{32}$ " x 11").  
**Weight:** net, 3.5 kg (7 lb 11 oz).  
**Accessories furnished:** 16138A Test Leads, Power Cord 8120-1348.

### Ordering Information

- Accessories available:** 16019A Test Fixture \$130  
**4332A LCR Meter** \$1750  
**Opt 910:** extra manual \$9.00



- Wide range: 500 kΩ to 2 × 10<sup>16</sup>Ω

- Selectable test voltages: 10 V to 1000 V

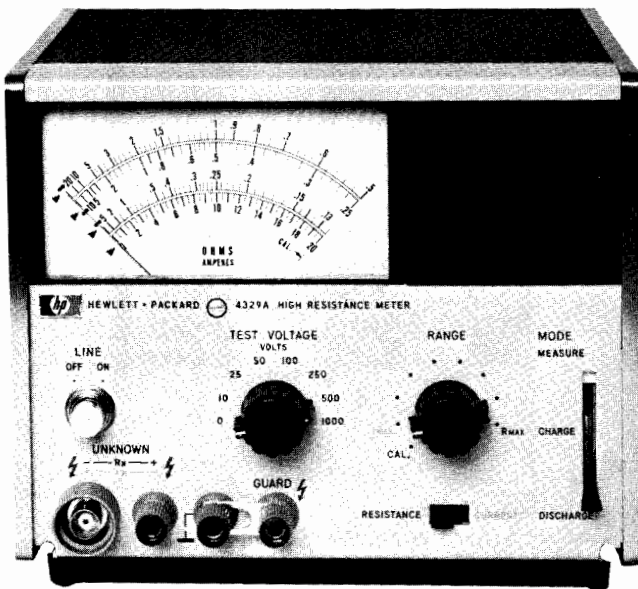

### Current Measurement

**Range:** 5 × 10<sup>-14</sup> to 2 × 10<sup>-5</sup> A in 8 ranges.

**Meter scale:** 0 to 20 in 40 linear divisions.

**Input resistance:** 10<sup>4</sup> to 10<sup>11</sup>Ω ± 1%, depending on range.

**Accuracy:** ± 5% of full scale deflection (there can be an additional ± 3% error at the top decade).

### General

**Recorder output:** 0 to 100 mV dc, proportional to meter deflection; 1kΩ output resistance.

**Power:** 115/230 V ± 10%, 50-60 Hz, approximately 3 VA.

**Size:** 166 mm H, 198 mm W, 224 mm D (6½" × 7<sup>25</sup>/<sub>32</sub>" × 8<sup>25</sup>/<sub>32</sub>").

**Weight:** 3.5 kg (7.7 lb).

**Accessory furnished:** HP 16117A Low Noise Test Leads.

**Accessory available:** Model 16008A Resistivity Cell.

### Description

The HP 4329A is a solid-state insulation resistance meter designed for easy, accurate and direct readings of the very high resistance values typically found in synthetic resins, porcelain, insulating oils and similar materials. It is also useful for measurements in electrical components like capacitors, transformers, switches and cables. Seven fully regulated dc test voltages (between 10 and 1000 V) are provided as test sources.

Selected scales are identified by illuminated indicators on the meter face. Selected resistance or current multiplying factors are also illuminated for rapid, error-free measurement. Three resistance scales and one current scale are provided. The HP 4329A is instantly convertible from ungrounded-to-grounded-sample operation via a simple relocation of the front panel ground strap from "guard" to "+" position. The instrument cabinet itself is always at ground potential. Test voltage shorts or sample breakdown currents will not damage instrument circuitry.

The HP 4329A also has a current measurement capability. Minute currents as low as 0.05 pA can be readily measured. The standard instrument package includes HP 16117A Low Noise Test Leads; these are used in most types of measurement.

Use of the HP 16008A Resistivity cell alters the HP 4329A's measurement accuracy. However, the measurement error is consistent and repeatable. This is true as long as the measurement set-up is not changed.

### 4329A Specifications

#### Resistance Measurement

**Range:** 500 kΩ to 2 × 10<sup>16</sup>Ω.

**Accuracy:** total accuracy is determined by test voltage and range used. At low resistance end of each scale, accuracy is ± 3%, near center scale ± 5%, and near the specified upper limit on the meter scale (see table below), accuracy is ± 10%. Accuracy is not specified above these limits. On all voltage ranges, if multiplier is set to Rmax., an additional ± 3% is included.



### 16008A Description

The HP 16008A can safely, rapidly and conveniently measure the volume and surface resistivity of sheet insulation materials. Conversion from volume to surface resistivity measurement requires operation of one switch only; no lead interchange or disconnection is necessary. Designed for use with the HP 4329A Resistance Meter (other voltage supplies and picoammeters may be used), the complete system allows direct measurement of volume resistivity up to approximately 4 × 10<sup>18</sup>Ω-c-m (on samples 0.1 cm thick)—and surface resistivity up to approximately 4 × 10<sup>17</sup>Ω. Test voltages up to 1000 V may be used.

### 16008A Specifications

**Inner electrode:** 50 mm diam.

**Guard electrode:** 70 mm diam.

**Auxiliary electrode:** 100 mm × 120 mm.

**Maximum sample size:** 125 mm × 125 mm × 7 mm.

**Maximum test voltage:** 1000 V dc.

**Size:** 49 mm H, 198 mm W, 152 mm D (2" × 7<sup>13</sup>/<sub>16</sub>" × 6<sup>1</sup>/<sub>8</sub>").

**Weight:** 1.8 kg (4 lb).

### Ordering Information

**16008A** Resistivity cell

**4329A** High resistance meter

**Opt 910:** extra manual

### Price

\$660

\$1910

add \$12.50

Test voltage	10 V	25 V	50 V	100 V	250 V	500 V	1000 V
Available resistance readings	5 × 10 <sup>5</sup> Ω to 2 × 10 <sup>14</sup> Ω	1.25 × 10 <sup>6</sup> Ω to 5 × 10 <sup>14</sup> Ω	2.5 × 10 <sup>6</sup> Ω to 1 × 10 <sup>15</sup> Ω	5 × 10 <sup>6</sup> Ω to 2 × 10 <sup>15</sup> Ω	1.25 × 10 <sup>7</sup> Ω to 5 × 10 <sup>15</sup> Ω	2.5 × 10 <sup>7</sup> Ω to 1 × 10 <sup>16</sup> Ω	5 × 10 <sup>7</sup> Ω to 2 × 10 <sup>16</sup> Ω
Meter scale	.5 to 20	.125 to 5	.25 to 10	.5 to 20	.125 to 5	.25 to 10	.5 to 20
Upper limit	5	1.25	2.5	5	1.25	2.5	5

\*Accuracy of test voltage is < ± 3%

# COMPONENT MEASUREMENT

Universal Bridge  
Models 4260A, 4265B



4260A

## 4260A Description

Measurements of C, R, L, D and Q are easily made with Hewlett-Packard's Model 4260A Universal Semi-Automatic Impedance Bridge.

Nulling is easily accomplished with a unique auto-balance circuit. Illuminated pointers (<CRL>) automatically indicate whether a null is up- or down-scale. Both range and CRL controls can be set watching these pointers.

Components may be biased by connecting a battery to rear terminals. An external oscillator and detector can be used for measurements in the 20 Hz-20 kHz range.

## Specifications

Model	4260A			4265B		
Full scale ranges	C	1000 pF to 1000 μF, 7 ranges			1000.0 pF to 1000.0 μF, 7 ranges	
	L	1000 μH to 1000 H, 7 ranges			1000.0 μH to 1000.0 H, 7 ranges	
	R	10 Ω to 10 MΩ, 7 ranges			1000.0 mΩ to 1.0000 MΩ, 7 ranges	
Range	C	1 pF to 1 nF	1 nF to 100 μF	100 μF to 1000 μF	all ranges except →	1000.0 μF range only
	L	1 μH to 1 mH	1 mH to 100 H	100 H to 1000 H	all ranges except →	1000.0 μH range only
	R	10 mΩ to 10 Ω	10 Ω to 1 MΩ	1 MΩ to 10 MΩ	all ranges except →	1000.0 mΩ range only
Accuracy (% of reading)		±(2% + 1 digit)	±(1% + 1 digit)	±(2% + 1 digit)	±(0.2% of reading + 0.01% of F.S.)	±(0.4% of reading + 0.01% of F.S.)
D	Range	LOW D (series C) 0.001 to 0.12	HIGH D (parallel C) 0.05 to 20		series C 0.001 to 1	parallel C 0.1 to 1000
	Accuracy	$\pm \frac{2}{\sqrt{D}}$ %	+(10 D of reading + 4)% -(10√D of reading + 2)%		±(5% of reading + 2 minor divisions)	±(5% of rdg + 2 minor divisions) for 1/D
Q	Range	LOW Q (series L) 0.05 to 20	HIGH Q (parallel L) 8 to 1000		series L 0.001 to 10	parallel L 1 to 1000
	Accuracy	+(10/Q of reading + 4)% -(10/√Q of reading + 2)%	±2√Q of reading %		±(5% of reading + 2 minor divisions)	±(5% of rdg + 2 minor divisions) for 1/Q
Oscillator	Internal: 1 kHz ± 2%, 100 mV rms ± 20% external: 20 Hz to 20 kHz, ≤ 2 V rms.			Internal: 1 kHz ± 15 Hz, ≤ 0.4 V rms external: 50 Hz to 10 kHz or dc for R-measurement; ≤ 4 V rms		
DC bias	Voltage ≤ 6 V, current ≤ 10 mA			Voltage ≤ 250 V, current ≤ 10 mA		

## General (4260A)

**Power:** 115 or 230 volts ± 10%, 50-60 Hz, approx. 7 VA.  
**Size:** 166 mm H x 198 mm W x 279 mm D (6.5" x 7.8" x 11").  
**Weight:** Net, 5 kg (11 lb). Shipping, 6.8 kg (15 lb).

## Options

Opt 910: Extra Manual

4260A Universal Bridge

## Price

add \$9

\$1710

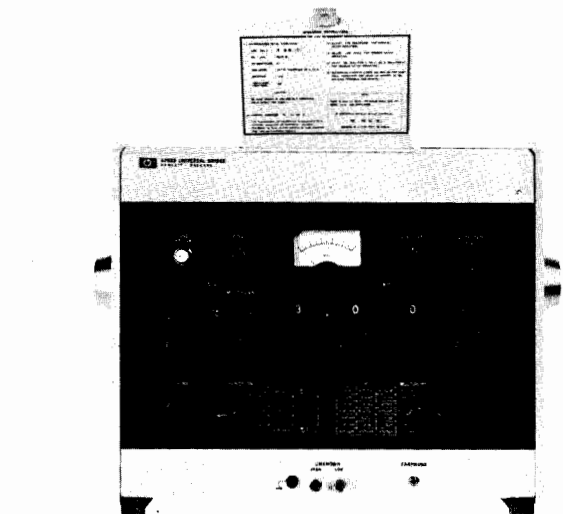

4265B

## 4265B Description

Hewlett-Packard's Model 4265B Universal Bridge provides an economical way to make precision measurements of L, C, or R and D or Q. Components can be measured in ranges of 0.1 μH to 1111 H in inductance, 0.1 pF to 1111 μF in capacitance and 0.1 mΩ to 1.111 MΩ in resistance with a basic measurement accuracy of 0.2% of reading for L, C, and R.

Measurement frequency range is 50 Hz to 10 kHz with an external oscillator, and 1 kHz with internal oscillator.

## General (4265B)

**Power:** 100/120/200/240 V ± 10%; 48 to 440 Hz, 5 VA.  
**Size:** 376 mm H x 393 mm W x 115 mm D (14.8" x 15.5" x 4.5").  
**Weight:** Net, 5.5 kg (12.1 lb). Shipping, 7.1 kg (15.7 lb).

## Ordering Information

16029A Test Fixture

Opt 910: Extra Manual

4265B Universal Bridge

## Price

\$140

add \$9

\$1655

# COMPONENT MEASUREMENT

Preset C Meter

Model 4272A (1 MHz), Model 4273A (1 kHz)

95



- Simultaneous go / no go check on production line

- High speed measurements

**4272A**  
1 MHz  
PRESET  
C METER

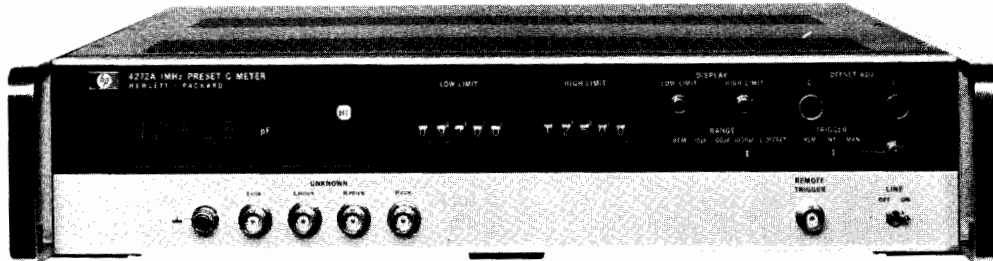

**4273A**  
1 kHz  
PRESET  
C METER

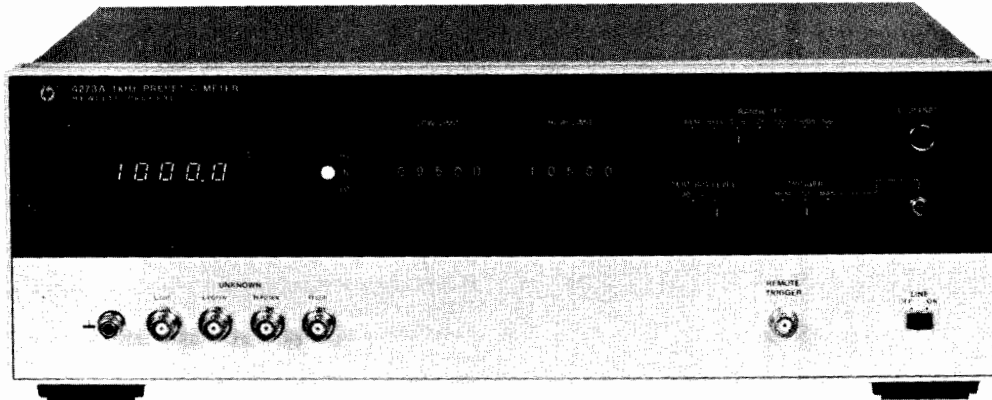

## Description

Hewlett-Packard's 4272A and 4273A are Preset C Meters which measure capacitance at 1 MHz and at 1 kHz, respectively, and which, combined with a 5 digit "in-house" comparator, provide GO/NO GO information for high speed measurements up to 8 per second (4272A) or 6 per second (4273A) with high reliability and accuracy. A basic accuracy of 0.1% is achieved by the four-terminal-pair method and an offset adjustment to reduce measurement error due to test fixture configuration. This provides high efficiency for production line testing or incoming inspection.

The 4272A measures capacitance from 10 pF full scale (0.001 pF

resolution) to 1000 pF full scale (maximum display 1900 pF), and the 4273A measures capacitance from 100.0 pF full scale (0.01 pF resolution) to 10  $\mu$ F full scale.

With their comparator capabilities, the instruments can be set to high and low limits with the built-in thumbwheel switches. Limit indications include panel lamp display, relay contact and TTL outputs for HI, IN and LO comparisons. TTL outputs are provided on the rear panel connector for use with an automatic sorter and BCD output of measurement data is also provided. For higher sorting speeds, a high speed version Opt HO1 is available.

## Specifications

Model		4272A			4273A
Parameter measured		Capacitance—equivalent parallel circuit by four terminal pair method			
Test signal frequency & level		1 MHz; 1 Vrms			1 kHz; 1 Vrms and 300 mVrms
Range & accuracy	Range	10.000 pF	100.00 pF	1000.0 pF	100.00 pF - 10.000 $\mu$ F
	Digit & overrange	4 digit, overrange 90%			4 digit, overrange 20%
	Accuracy*	0.1 + 7	0.1 + 3	0.1 + 2	0.1 + 3
	Conditions	23°C $\pm$ 5°C at D < 0.1, * $\pm$ (% of reading + counts)			
Comparator function		Compares measured value with HI and LO LIMIT settings and provides HI, IN and LO comparison outputs.			
HI and LOW LIMIT setting ranges		00000 - 19999 at each limit switch			00000 - 11999 at each limit switch
Comparison output		Lamp, relay contacts and TTL outputs			
Digital output		BCD 1-2-4-8 data parallel (option)			BCD 1-2-4-8 data parallel (furnished)
Remote programming		TTL and contact closure			
Measuring time		<120 ms, (high speed option; <50 ms 4 digit display, 0.2% accuracy)			<150 ms, (high speed option; <75 ms 3 digit display, 0.2% accuracy)
General	Power	100/120/220/240 V $\pm$ 10% 48-66Hz $\leq$ 60 VA			100/120/220/240 V $\pm$ 10% 48-66 Hz $\leq$ 25 VA
	Size	88 mm H x 426 mm W x 467 mm D (3 $\frac{1}{2}$ " x 16 $\frac{3}{4}$ " x 19 $\frac{1}{16}$ " )			147 mm H x 426 mm W x 349 mm D (5 $\frac{1}{4}$ " x 16 $\frac{3}{4}$ " x 13 $\frac{3}{4}$ " )
	Weight	Approximately 10 kg (22 lbs)			Approximately 8 kg (17.5 lbs)

### Options Available

**002:** BCD and Decision Outputs

add \$105

**006:** BCD Remote Control

add \$155

**H03:** High Speed Version (4 Digit Display, < 50 ms)

**Opt 908:** Rack Flange Kit

add \$25

**4272A 1 MHz Preset C Meter**

**\$5635**

### Options Available (4273A)

**Opt 006:** BCD Remote Control

\$70

**Opt H01:** Hi Speed Version (3 digit display, < 75 ms)

**4273A 1 kHz Preset C Meter**

**\$3420**

# COMPONENT MEASUREMENT

## Digital LCR Meter

Model 4261A

- Fully automatic—autoranging
- Wide range C = 0.1 pF to 19 mF, L = 0.1 μH to 1900 H, R = 1 mΩ to 19 MΩ
- Low cost with high performance
- Versatile accessories/options
- High reliability



### Description

The Model 4261A Digital LCR Meter is a new, fully automatic instrument that satisfies many of today's user requirements in the LCR measurement field.

The 4261A features high speed, accurate measurements. The devices under test need only be connected and the function L, C, or R selected. The instrument automatically displays the desired parameter. Tedious balancing operations typically used in conventional manual bridges are completely eliminated. Measurement circuit mode (series or parallel) is also automatically selected.

Complementing its wide LCR measurement range, HP's 4261A has other features such as high accuracy (basically 0.2% of reading), high speed measurement (typically 4 per second), 120 Hz or 1 kHz measurement frequencies, 1 V or 50 mV test signal levels, internal bias sources and parallel or series equivalent circuit modes.

Measurements are taken using the five-terminal method, which easily converts to four, three or two terminals to meet most LCR measurement applications. For example, the four-terminal input could be

used to measure the capacitance of an electrolytic capacitor, the inductance of transformer or the internal resistance of a dry cell. The three-terminal input is appropriate for semiconductor junction capacitance or cable capacitance measurements. To fit these needs, three kinds of optional test leads and fixtures are available. The 4261A can easily measure parameters of pulse transformers, filter coils and electrolytes in addition to ordinary LCR components.

Expanded use features of this highly reliable instrument include optionally available digital output and remote control which enable a wide range of applications from the research laboratory to the production line.

### Specifications

**Parameter measured:** C-D (Capacitance & Dissipation Factor), L-D (Inductance & Dissipation Factor), and R (Resistance).

**Display:** 3½ digits, max. display 1900.

**Circuit mode:** Auto, Parallel and Series.

**Measuring circuit:** 5-terminal method.

**Range mode:** Auto or Range Hold.

**Measurement frequencies:** 120 Hz ± 3% and 1 kHz ± 3%.

**Trigger:** Internal, Manual or External.

**Measurement ranges, measurement accuracies & test signal levels:** see tables on next page for C-D, L-D, and R measurements. Accuracy applies over a temperature range of 23°C ± 5°C (at 0°C to 55°C, error doubles).

#### DC Bias

**Internal source:** 1.5 V, 2.2 V, 6 V (selectable on front panel).

**Accuracy:** ± 5%.

**External source:** provision for external DC bias voltage of +30 V maximum at binding posts on rear panel.

#### General

**Measuring time:** typical for approx. 1000 counts on fixed range for low loss measurements. Specific data follows:

**1 kHz:** C/L 220-260 ms, R 120-160 ms.

**120 Hz:** C/L 900 ms, R 700 ms.

When auto range is selected, a range selection time of 180 ms at 1 kHz and a range step time 670 ms at 120 Hz is added to the above typical times.

**Reading rate:** internal trigger—approx. 30 ms between end of measurement and start of next cycle; External trigger—measurement cycle is initiated by remote trigger input.

**Data format:** + 1-2-4-8 BCD, TTL logic level, "1" (high level).

**Operating temperature:** 0°C to 55°C.

**Humidity:** to 95% RH at 40°C.

**Voltage requirements:** 100/120/220/240 V ± 10%, 48 to 66 Hz.

**Power consumption:** ≤ 25 VA with any option.

**Altitude:** 15,240 m (50,000 ft.).

**Size:** 132.6 H x 213 W x 422 mm D (5¼" x 8¾" x 16¾").

**Weight:** approx. 7.5 kg (16.5 lb).

### R Measurement

RANGE	120 Hz or 1 kHz	1000 mΩ	10.00Ω	100.0Ω	1000Ω	10.00 kΩ	100.0 kΩ	1000 kΩ	10.00 MΩ
Test Signal		1 V							
		70 mA	10 mA	1 mA	100 μA	10 μA			
Level Note 1	AUTO	Same as  Mode				Same as  Mode			
		0.3% + 2 counts							
R Accuracy Note 2		0.2% + 2 counts							
	AUTO	Same as  Mode				Same as  Mode			

1. Typical data, varies with number of counts.

2. ± (% of reading + counts).

**C-D Measurement**

RANGE	C	120 Hz 1 kHz	1000 pF 100.0 pF	10.00 nF 1000 pF	100.0 nF 10.00 nF	1000 nF 100.0 nF	10.00 μF 1000 nF	100.0 μF 10.00 μF	1000 μF 100.0 μF	10.00 mF 1000 μF		
	D	0.001 to 1.900, common to all C ranges.										
Test Signal Level Note 1		1 V or 50 mV										
		10 μA					100 μA		1 mA		10 mA	
	AUTO	Same as  Mode					Same as  Mode					
C Accuracy Note 2		0.2% + 1 count + 0.2 pF						(Test signal level; 1 V)				
		0.5% + 3 counts	0.3% + 2 counts						(Test signal level; 50 mV)			
	AUTO	Same as  Mode					Same as  Mode					
D Accuracy Note 2		0.2% + (2 + 200/Cx) counts						(Test signal level; 1 V)				
		0.3% + (2 + 1000/CX) counts						(Test signal level; 50 mV)				
	AUTO	Same as  Mode					Same as  Mode					

- 1. Typical data, varies with value of D and number of counts.
- 2. ±(% of reading + counts + a). Cx is capacitance readout in counts.
- ‡ (5% + 2 counts) at 1 kHz.

**L-D Measurement**

RANGE	L	120 Hz 1 kHz	1000 μH 100.0 μH	10.00 mH 1000 μH	100.0 mH 10.00 mH	1000 mH 100.0 mH	10.00 H 1000 mH	100.0 H 10.00 H	1000 H 100.0 H	
	D	0.001 to 1.900, common to all L ranges.								
Test Signal Level Note 1		1 V								
		70 mA	10 mA	1 mA	100 μA	10 μA				
	AUTO	Same as  Mode					Same as  Mode			
L Accuracy Note 2		0.3% + 2 counts						1% + 2 counts		
		0.2% + 2 counts + 0.2 μH								
	AUTO	Same as  Mode					Same as  Mode			
D Accuracy Note 2		0.3% + (3 + Lx/500) counts						11% + (3 + Lx/500) counts		
		0.2% + (3 + 200/Lx) counts								
	AUTO	Same as  Mode					Same as  Mode			

- 1. Typical data, varies with value of D and number of counts.
- 2. ±(% of reading + counts + a). Lx is inductance readout in counts.

**Accessories Available**

- 16061A:** Test Fixture (direct coupled type), 5-terminal
- 16062A:** Test Leads with alligator clips, 4-terminal (for low impedance measurements)
- 16063A:** Test Leads with alligator clips, 3-terminal (for high impedance measurements)

**Options Available**

- Opt 001:** BCD Output of C/L/R and D (simultaneous)
- Opt 002:** BCD Output of C/D, L/D and R (alternately)

**Opt 003:** BCD Remote Control (except for DC bias function)

**Ordering Information**

<b>16061A</b> Test Fixture	<b>Price</b> \$140
<b>16062A</b> Test Leads	\$70
<b>16063A</b> Test Leads	\$70
<b>Opt 001:</b> BCD Output (Simultaneous)	add \$185
<b>Opt 002:</b> BCD Output (Alternately)	add \$160
<b>Opt 003:</b> BCD Remote Control	add \$80
<b>Opt 910:</b> Extra Manual	add \$10
<b>4261A Digital LCR Meter</b>	<b>\$2330</b>



# COMPONENT MEASUREMENT

## Digital LCR Meter

Model 4262A

- Automatic balancing, ranging & circuit mode selection
- Test frequencies of 120 (100) Hz, 1 kHz and 10 kHz

- HP-IB, BCD and Comparator options available
- Microprocessor control features self test and deviation measurement capabilities

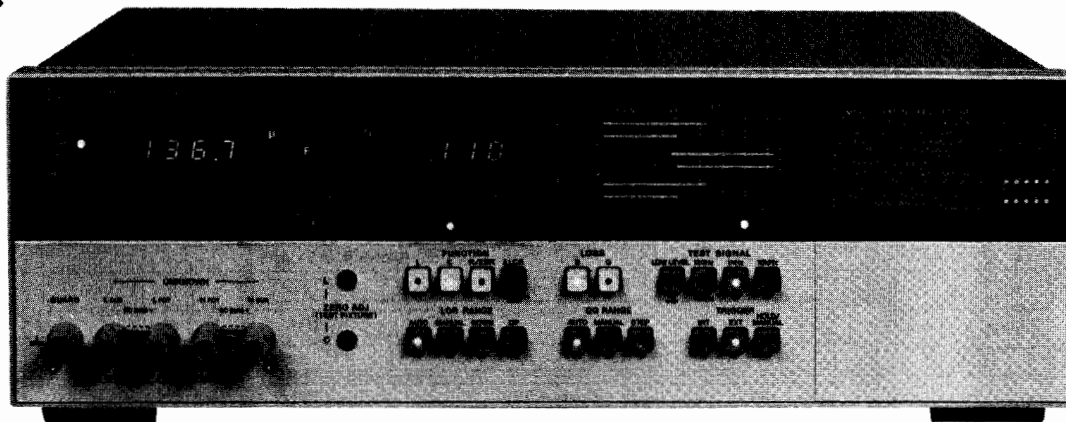

The HP 4262A is a 3½ digit microprocessor based Digital LCR Meter that meets today's requirements for component measurements in the lab, on the production line, and in the QA inspection area. The 4262A features fully automatic operation over a wide range of measurements. Simply select the function and loss parameters, one of three test frequencies, and insert the device to be measured. The instrument does the rest—automatically selecting the proper measurement range and equivalent circuit mode.

In addition to automatic measurements and wide range, the 4262A features high accuracy (typically 0.2% of reading), 120 (100) Hz, 1 kHz, and 10 kHz measurement frequencies, 1 V test signal level (1 V or 50 mV in Cp mode), three internal DC bias levels (plus external) and series and parallel equivalent circuit modes. The microprocessor control allows other features such as an automatic self test capability and deviation measurements. These features make the 4262A capable of meeting the measurement needs of the diversified electronics

industry by measuring such things as the parameters of semiconductors, pulse transformers, filter coils, electrolytic and film capacitors, or determining the internal resistance of a dry cell.

The arrangement of the front panel keyboard switches insure maximum operating convenience and error-free operation. When the instrument is turned on, the microprocessor automatically selects capacitance, dissipation factor, 1 kHz test signal, autorange, auto circuit mode selection, internal trigger and normal test voltage mode of operation. Individually LED lighted keys allow the user to easily determine the selected functions at a glance.

Several options are available for the user that needs systems capability. A BCD output of LCR and DQ data is available for use with a printer or calculator. If both data output and remote control are required, HP-IB compatibility is available. A comparator option (for both LCR and DQ data) is also available.

### Specifications

**Accuracy:** All accuracies apply over a temperature range of 23°C ± 5°C (at 0°C to 55°C, error doubles)

#### C-D and C-Q Measurement

Range	C	120 (100) Hz 1 kHz 10 kHz	1000 pF 100.0 pF 10.00 pF	10.00 nF 1000 pF 100.0 pF	100.0 nF 10.00 nF 1000 pF	1000 nF 100.0 nF 10.00 nF	10.00 μF 1000 nF 100.0 nF	100.0 μF 10.00 μF 1000 nF	1000 μF 100.0 μF 10.00 μF	10.00 mF 1000 μF 100.0 μF				
	D	.001-19.9 (2 Ranges)												
Q	*1 .050-1000 (4 Ranges)													
Test Signal Level *2		1 V or 50 mV								10 μA	100 μA	1 mA	10 mA	40 mA
	AUTO	Same as  Mode				Same as  Mode				Same as  Mode				
C Accuracy *3		0.2% + 1 count				(Test signal level: 1 V)								
		0.5% + 3 Counts	0.3% + 2 counts				(Test signal level: 50 mV)							
		At 120 (100) Hz, 1 kHz				0.3% + 2 counts				0.5% + 2 counts	1% + 2 counts *4			
		At 10 kHz								1% + 2 counts	5% + 2 counts			
AUTO	Same as  Mode				Same as  Mode									
D (1/Q) Accuracy *3		0.2% + (2 + 200/Cx) counts				At 120 (100) Hz, 1 kHz (Test signal level: 1 V)								
		0.5% + (2 + 200/Cx) counts				At 10 kHz								
		0.3% + (2 + 1000/Cx) counts				At 120 (100) Hz, 1 kHz (Test signal level: 50 mV)								
		1.0% + (2 + 1000/Cx) counts				At 10 kHz								
	At 120 (100) Hz, 1 kHz				0.3% + (2 + Cx/500) counts				1% + (5+ Cx/500) counts					
	At 10 kHz				0.5% + (2 + Cx/500) counts				1% + (5+ Cx/500) counts					
AUTO	Same as  Mode				Same as  Mode									

\*1. Calculated from D value as a reciprocal number.  
\*2. Typical data, varies with value of D and number of counts.

\*3. ± (% of reading + counts) Cx is capacitance readout in counts. Accuracies in this table apply when D < 1.999.  
\*4. 5% + 2 counts at 1 kHz.



### L-D and L-Q Measurement

Range	C	120 (100) Hz 1 kHz 10 kHz	1000 $\mu$ H 100.0 $\mu$ H 10.00 $\mu$ H	10.00 mH 1000 $\mu$ H 100.0 $\mu$ H	100.0 mH 10.00 mH 1000 $\mu$ H	1000 mH 100.0 mH 10.00 mH	10.00 H 1000 mH 100.0 mH	100.0 H 10.00 H 1000 mH	1000 H 100.0 H 10.00 H	
	D	.001-19.9 (2 Ranges)								
	Q	.050-1000 (4 Ranges)								
Test Signal Level *2		1 V								
		40 mA	10 mA	1 mA	100 $\mu$ A	10 $\mu$ A				
	AUTO	Same as  Mode					Same as  Mode			
L Accuracy *3		At 120 (100) Hz, 1 kHz			0.3% + 2 counts			1% + 2 counts		
		At 10 kHz						1% + 2 counts	5% + 2 counts	
		0.2% + 2 counts								
	AUTO	0.3% + 2 counts			0.2% + 2 counts			At 120 (100) Hz, 1 kHz		
		Same as  Mode					Same as  Mode			
D (1/Q) Accuracy *3		At 120 (100) Hz, 1 kHz			0.3% + (3 + Lx/500) counts			1% + (3 + Lx/500) counts		
		At 10 kHz			0.5% + (3 + Lx/500) counts			1% + (3 + Lx/500) counts	5% + (5 + Lx/500) counts	
		0.2% + (3 + 200/Lx) counts								
	AUTO	0.5% + (3 + 200/Lx) counts						At 120 (100) Hz, 1 kHz		
		Same as  Mode					Same as  Mode			

\*1 Calculated from D value as a reciprocal number

\*3  $\pm$  (% of reading + counts) Lx is inductance readout in counts. Accuracies in this table apply when D < 1.999.

\*2 Typical data varies with value of D and number of counts

### R/ESR\*\* Measurement

Range	120 (100) Hz 1 kHz 10 kHz	1000 m $\Omega$	10.00 $\Omega$	100.0 $\Omega$	1000 $\Omega$	10.00 k $\Omega$	100.0 k $\Omega$	1000 k $\Omega$	10.00 M $\Omega$	
Test Signal Level *1		1 V								
		40 mA	10 mA	1 mA	100 $\mu$ A	10 $\mu$ A				
	AUTO	Same as  Mode					Same as  Mode			
Accuracy *2		0.3% + 2 counts *3								
		0.2% + 1 counts								
	AUTO	Same as  Mode					Same as  Mode			

\*1 Typical data, varies with number of counts

\*2  $\pm$  (% of reading + counts)

\*3  $\pm$  (5% + 2 counts) on 10.00 M $\Omega$  range at 10 kHz test frequency.

\*\* The measurement range for ESR is from 1 m $\Omega$  to 19 k $\Omega$  (typical). These values vary depending on the series capacitance or inductance value of the device under test.

**Parameters measured:** C-D or C-Q (1/D), L-D or L-Q (1/D), R (ESR).

**Display:** dual 3½ digit, maximum display of 1999. For D value greater than 10, maximum D display is 199.

**Measurement terminals:** 5-terminal configuration.

**Measurement circuit modes:** auto, parallel and series.

**Test frequencies:** 120 (100) Hz, 1 kHz and 10 kHz  $\pm$  3%.

**Range mode:** LCR—Auto and manual (up-down), D/Q Auto and manual (step).

**Trigger:** internal, external or manual.

**Deviation measurement:** when the  $\Delta$ LCR switch is depressed, the measurement value is stored in memory as a reference value. At the same time, the range is set to "Manual" and the display is offset to zero. Deviation is displayed as the difference between a stored value and subsequent measurement data. Deviation is in counts from -999 to 999.

**Offset adjustments:** front panel adjustments to compensate for stray capacitance and residual inductance of the test fixtures.

**C:** 0 to 10 pF. **L:** 0 to 1  $\mu$ H.

**Self test indicators:** when the SELF TEST function is selected, the results of the test are displayed in the LCR and DQ window. Results are indicated by PASS, FAIL 1, FAIL 2 or FAIL 3.

**DC bias:** internal: 1.5 V, 2.2 V and 6 V (selectable on front panel). Accuracy  $\pm$  5%; external: Provision for external DC bias (0 to +40V).

### General

**Measurement time (typical)** for a 1000 count measurement on a low loss component on a fixed range;

1 kHz, 10 kHz: C/L 220-260 ms, R 120-160 ms

120 (100) Hz: C/L 900 ms, R 700 ms

When autorange is selected, the following times per range step must be added to the above time:

1 kHz, 10 kHz: 45 ms/180 ms per range step

120 (100) Hz: 150 ms/670 ms per range step

When the uncal lamp is lit, the faster ranging time is selected.

**Reading rate:** INT (Internal Trigger) approximately 30 ms between the end of a measurement cycle and the start of the next cycle. EXT (External Trigger) measurement cycle is initiated by a remote trigger input.

**Operating temperature and humidity:** 0°C to 55°C; to 40°C at 95% RH.

**Power requirements:** 100/120/220 VAC  $\pm$  10%, 240 Vac +5% - 10%; 48-66 Hz.

**Power consumption:**  $\leq$  55 VA with any option.

**Size:** 147 mm H x 426 mm W x 345 mm D (5¾" x 16¾" x 13¾").

**Weight:** Approximately 8 kg (17.5 lbs).

**Accessories available:** 16061A: test fixture, direct coupled, 5-terminal; 16062A: test leads with alligator clips, 4-terminal (for low impedance measurements); 16063A: test leads with alligator clips, 3-terminal (for high impedance measurements).

**Options available:** Opt 001: BCD data output of LCR and DQ data. Opt 004: Digital comparator for LCR and DQ data. Comparison output (HIGH, IN, LOW): visual, relay contact closure and TTL level. Not compatible with Opt 101. Opt 101: HP-IB Data Output and Remote Control. Not compatible with Opt 001 and 004.

### Options and Accessories

<b>001:</b> BCD Output	<b>Price</b>
<b>004:</b> Digital Comparator	\$340
<b>010:</b> 100 Hz Test Frequency	\$810
<b>101:</b> HP-IB Interface	nc
<b>908:</b> Rack Flange Kit	\$545
<b>910:</b> Extra Manual	\$25
<b>16061A</b> Test Fixture	\$15
<b>16062A</b> Test Cables	\$140
<b>16063A</b> Test Cables	\$70
	\$70

### 4262A Digital LCR Meter

**\$3035**



# COMPONENT MEASUREMENT

## Q Meter

Model 4342A

- Frequency range: 22 kHz to 70 MHz
- Q range: 5 to 1000

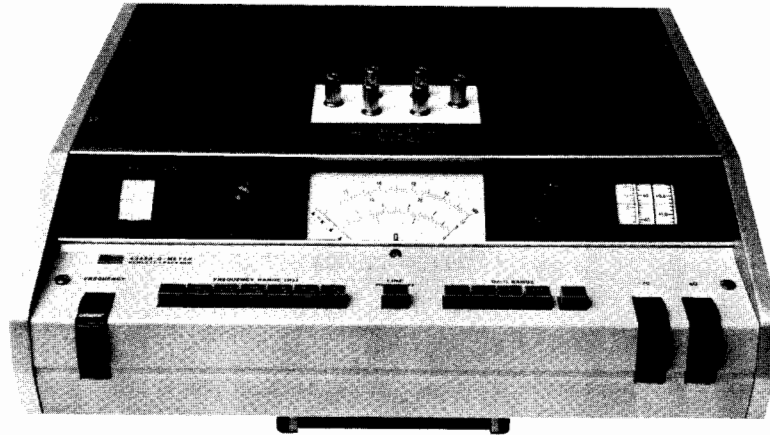

### Description

The direct-reading expanded scale of the 4342A permits measurement of Q from 5 to 1000 and readings of very small changes in Q resulting from variation in test parameters. The 4342A is solid state with the elimination of specially matched, fragile thermocouple components.

The 4342A will measure dissipation factor and dielectric constant of insulating materials. The Q meter can measure coefficient of coupling, mutual inductance, and frequency response of transformers. RF resistance, reactance, and Q of resistors and capacitors can also be determined.

Push button operation of frequency range and Q/ $\Delta$ Q range selection provides straightforward measurement. Automatic indication of meter scales, frequency dials and frequency multipliers are featured, adding to simplicity and reading speed.

### Specifications

#### RF Characteristics

**RF range:** 22 kHz to 70 MHz in 7 bands: 22 to 70 kHz, 70 to 220 kHz, 220 to 700 kHz, 700 to 2200 kHz, 2.2 to 7 MHz, 7 to 22 MHz, 22 to 70 MHz.

**4342A Opt 001:** 10 kHz to 32 MHz in 7 bands: 10 to 32 kHz, 32 to 100 kHz, 100 to 320 kHz, 320 to 1000 kHz, 1 to 3.2 MHz, 3.2 to 10 MHz, 10 to 32 MHz.

**RF accuracy:**  $\pm 1.5\%$  from 22 kHz to 22 MHz;  $\pm 2\%$  from 22 MHz to 70 MHz;  $\pm 1\%$  at "L" point on frequency dial.

**4342A Opt 001:**  $\pm 1.5\%$  from 10 kHz to 10 MHz;  $\pm 2\%$  from 10 MHz to 32 MHz;  $\pm 1\%$  at "L" point on frequency dial.

**RF increments:** approximately 1% resolution.

#### Q Measurement Characteristics

**Q range:** 5 to 1000 in 4 ranges: 5 to 30, 20 to 100, 50 to 300, 200 to 1000.

**Q accuracy:** % of indicated value: (at 25°C)

Q	4342A & 4342A Opt. 001		4342A
	22 kHz-30MHz		30 MHz-70 MHz
5-300	$\pm 7$		$\pm 10$
300-600	$\pm 10$		$\pm 15$
600-1000	$\pm 15$		$\pm 20$

**Q increments:** upper scale: 1 from 20 to 100; lower scale: 0.5 from 5 to 30.

**$\Delta$ Q range:** 0 to 100 in 4 ranges: 0 to 3, 0 to 10, 0 to 30, 0 to 100.

**$\Delta$ Q accuracy:**  $\pm 10\%$  of full scale.

**$\Delta$ Q increments:** upper scale: 0.1 from 0 to 10; lower scale: 0.05 from 0 to 3.

#### Inductance Measurement Characteristics

**L range:** 0.09  $\mu$ H to 1.2 H, direct reading at 7 specific frequencies.

**L accuracy:**  $\pm 3\%$  after substitution of residuals (approx. 10 nH).

#### Resonating Capacitor Characteristics

**Capacitor range:** main dial: 25 to 470 pF; vernier dial  $-5$  to  $+5$  pF.

**Capacitor accuracy:** main dial:  $\pm 1\%$  or 1 pF, whichever is greater; vernier dial  $\pm 0.1$  pF.

**Capacitor increments:** main dial: 1 pF from 25 to 30 pF; 2 pF from 30 to 200 pF; 5 pF from 200 to 470 pF; vernier dial: 0.1 pF.

#### General

##### Rear panel outputs

**Frequency monitor:** 170 mV rms min. into 50 $\Omega$ .

**Q analog output:** 0 to 1 V  $\pm 50$  mV dc after 15 minutes warmup, proportional to meter deflection. Output impedance approximately 1 k $\Omega$ .

**Over limit signal output:** contact closure at the rear panel. Relay contact capacity 0.5 A/15 VA.

**Over limit display time:** selectable, 1 s or continuously on, after limit exceeded.

**Temperature range:** 0°C to 50°C.

**Power:** 115 or 230 V  $\pm 10\%$ , 50-400 Hz, 25 VA max.

**Size:** 129 mm H x 425 mm W x 414 mm D (5 $\frac{1}{16}$ " x 16 $\frac{3}{4}$ " x 16 $\frac{3}{16}$ " )

**Weight:** net, 14 kg (31 lb). Shipping, 18.45 kg (41 lb).

##### Accessories available:

HP 16014A: Series Loss Test Adaptor is designed for measuring low-value inductors and resistors and high-value capacitors.

HP 16462A: Auxiliary Capacitor is designed to extend the Q and L measurement capability of the 4342A Q Meter. It is especially useful for measuring small inductors at low frequencies.

HP 16470A Reference Inductors: A range or 20 inductors (any of which can be supplied separately) which can be used with the 4342A Q Meter when measuring the RF characteristics of capacitors, resistors, or insulating materials.

HP 16470B Stable Inductors: A set of 4 inductors (any of which are separately available) which can be used to compensate indicated Q values and/or instrumental variation in the maintenance of the 4342A Q Meter. They are useable over a range of 800 kHz to 50 MHz with excellent long-term temperature stability.

#### Options and Accessories

**Opt 001:** Frequency Range

**Opt 910:** Extra Manual

**16014A** Series Loss Test Adaptor

**16462A** Auxiliary Capacitor

**16470A** Reference Inductors, set of 20

**16470B** Stable Inductors, set of 4

**16470C** Complete set of 24 Inductors (16470A + 16470B)

#### Price

add \$240

add \$17.50

\$80

\$385

\$1050

\$730

\$1780

**4342A Q Meter**

**\$3720**



### Description

The HP 4271B 1 MHz LCR Meter meets the requirements of the lab, manufacturing and where automatic high speed and accuracy measurements are essential. The four-pair measurement technique

has the advantage of reducing errors due to residual inductance, stray capacitance, and electromagnetic coupling of leads. Offset adjustments are provided to cancel the residuals of the test fixtures.

Typical applications include microcircuit measurements, C-V characteristics of semiconductor devices and passive component tests.

### Specifications

**Full scale ranges and Accuracy:** (When conductance reading is less than 100 counts and resistance reading is less than 1000 counts.) Accuracy listed in the following table applies over a temperature range of 23°C ± 5°C.

**Capacitance and conductance/dissipation factor: using parallel equivalent circuit.**

Range	Test Sig Level	Capacitance: (Overrange 90%)		Conductance: (Overrange 90%)		Dissipation Factor*: (Overrange 60%)	
		Full Scale Display	Accuracy**	Full Scale Display	Accuracy**	Full Scale Display	Accuracy**
1	HIGH		0.1 + 7		0.2 + (7 + Nc/1000)	1.0000	1.0 + (10 + 20000/Nc)
	LOW	10.000 pF	0.2 + 8	100.00 μS	0.3 + (7 + 2 Nc/1000)		1.0 + (15 + 30000/Nc)
2	HIGH		0.1 + 3		0.2 + (3 + 2 Nc/1000)	1.0000	1.0 + (10 + 10000/Nc)
	LOW	100.00 pF	0.2 + 4	1000.0 μS	0.3 + (3 + 2 Nc/1000)		1.0 + (15 + 20000/Nc)
3	HIGH		0.1 + 3		1.2 + (2 + 2 Nc/1000)	1.0000	10 + (10 + 10000/Nc)
	LOW	1000.0 pF	0.2 + 3	10.000 mS	1.2 + (2 + 2 Nc/1000)		1.0 + (15 + 20000/Nc)
4***	LOW	10.000 nF	0.4 + 3	100.00 mS	1.2 + (2 + 2 Nc/1000)	1.0000	1.0 + (15 + 30000/Nc)

**Inductance and resistance/dissipation factor: using series equivalent circuit.**

Range	Test Sig Level	Inductance: (Overrange 90%)		Resistance: (Overrange 90%)		Dissipation Factor*: (Overrange 90%)	
		Full Scale Display	Accuracy**	Full Scale Display	Accuracy**	Full Scale Display	Accuracy**
1***	LOW	1000.0 nH	1.0 + 15	10.000 Ω	1.2 + (8 + 2 N <sub>L</sub> /1000)	1.0000	1.0 + (20 + 30000/N <sub>L</sub> )
	HIGH		0.6 + 4		1.2 + (2 + 2 N <sub>L</sub> /1000)		1.0 + (15 + 10000/N <sub>L</sub> )
2	LOW	10.000 μH	0.6 + 6	100.00 Ω	1.2 + (2 + 2 N <sub>L</sub> /1000)	1.0000	1.0 + (20 + 20000/N <sub>L</sub> )
	HIGH		0.2 + 4		0.3 + (2 + 2 N <sub>L</sub> /1000)		1.0 + (15 + 10000/N <sub>L</sub> )
3	LOW	100.00 μH	0.3 + 6	1000.0 Ω	0.5 + (2 + 2 N <sub>L</sub> /1000)	1.0000	1.0 + (20 + 20000/N <sub>L</sub> )
	HIGH		0.2 + 4		0.3 + (2 + 2 N <sub>L</sub> /1000)		1.0 + (15 + 20000/N <sub>L</sub> )
4	LOW	1000.0 μH	0.3 + 6	10.000 kΩ	0.5 + (2 + 2 N <sub>L</sub> /1000)	1.0000	1.0 + (20 + 30000/N <sub>L</sub> )
	HIGH		0.2 + 4		0.3 + (2 + 2 N <sub>L</sub> /1000)		1.0 + (15 + 20000/N <sub>L</sub> )

\*When reading of L or C is more than 1500 counts.

\*\* ± (% of reading + counts), Nc and N<sub>L</sub> are capacitance and inductance readouts in count.

\*\*\*Test Level is low on range 4 for C and range 1 for L measurements.

**Test frequency:** 1 MHz ± 0.01%

**Test signal level:**

RANGE	C measurement		L measurement	
	HIGH	LOW	HIGH	LOW
1			2 mA rms ± 20%	2 mA rms ± 20%
2	0.5 V rms ± 10%	20 mV rms ± 10%	5 mA rms ± 10%	200 μA rms ± 10%
3			500 μA rms ± 10%	20 μA rms ± 10%
4	20 mV rms ± 20%	20 mV rms ± 20%	50 μA rms ± 10%	2 μA rms ± 10%

**Display:** dual 4½ digit LED displays.

**Ranging:** automatic and manual. Remote control with Opt 101.

**Measurement terminals:** four-terminal pair construction.

**Offset adjustment ranges:** capacitance ≤ 1 pF, conductance ≤ 1 μS, inductance ≤ 100 nH, resistance ≤ 100 mΩ.

**DC bias (optional)**

**Internal source:** available; Opt 001, 00.0 V to 39.9 V, 0.1 V steps.

**External source:** ± 200 V max to BNC connector.

**General**

**Measuring Speed**

**Fixed range:** 100 ms to 250 ms for C-G and L-R measurement.

160 ms to 400 ms for C-D and L-D measurements.

**Autorange:** 100 ms/range step added to above values.

**Power:** 100/120/220 V ± 10%, 240 V + 5% - 10%, 48-66 Hz, 80 VA max.

**Size:** 88 mm H x 425 mm W x 496 mm D (3 1/2" x 16 3/4" x 19 9/16").

**Weight:** 10 kg (22 lb).

**Accessory furnished:** 16038A Test Fixture for radial and axial lead components.

**Ordering Information\***

**16021A** Calibration Test Fixture (GR900 connector) \$690

**16022A** General Purpose Test Fixture \$575

**16023A** DC Bias Voltage Controller (used with Opt 001) \$600

**16032A** Test Leads (BNC) \$245

**16033A** Test Leads with miniature coaxial connectors \$275

**16034A** Test Fixture for chip capacitor measurement \$500

**16039A** Test Fixture with "D" offset. \$360

**Opt 001:** DC Bias supply; 0.0 V to 39.9 V add \$330

**Opt 002:** C/L BCD output; may be used with Opt 003 add \$165

for simultaneous outputs +8421 Code

**Opt 003:** G/R/D BCD output. +8421 Code (see Opt 002) add \$165

**Opt 004:** Parameter Serial BCD output add \$300

**Opt 101:** HP-IB Data Output and Remote Control add \$945

**Opt 908:** Rack Flange Kit add \$25.00

**4271B 1 MHz Digital LCR Meter \$6485**

\*HP-IB cable not supplied. See page 30.



# COMPONENT MEASUREMENT

## Multi-Frequency LCR Meters

Models 4274A & 4275A

- Test frequencies - 100 Hz to 100 kHz
- Test signal level - 1 mV to 5 Vrms
- High Resolution - 5½ digit: D=0.00001
- Measure L/C - D/Q/ESR/G;  $|Z| - \theta$ , R-X/B/L/C;  $\Delta$ LCRZ,  $\Delta\%$
- 0.1% basic accuracy

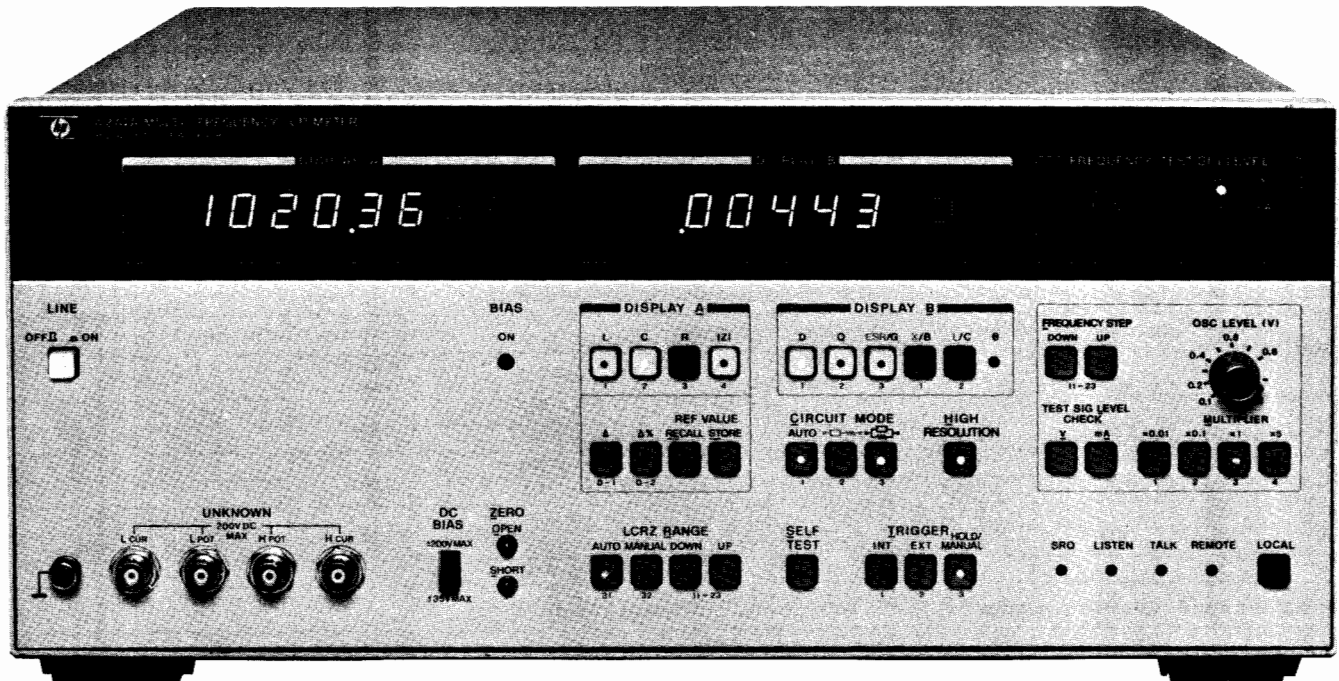

4274A



### Description

The 4274A and 4275A Multi-frequency LCR Meters are the most recent additions to Hewlett-Packard's new generation of micro-processor-based impedance measuring instrumentation. Both instruments offer a new measuring concept for the evaluation of LCR components, complex components, electronic circuits "tested under actual working conditions", and semiconductor materials. A measurement under conditions similar to the intended use contributes to the improvements in quality and reliability of electronic components, devices and circuits.

### Multi-Frequency Capability

To insure the high reliability in circuits and devices, it is most important that they be tested and evaluated at test signals similar to those of actual operating conditions.

The 4274A covers the wide frequency range of 100 Hz to 100 kHz in 11 spot frequencies and the 4275A has 10 spot frequencies from 10 kHz to 10 MHz, in 1-2-4 step sequence with 1-3-5 as an option. This feature produces the frequency characteristics of components or devices. In addition, two optional special frequencies (for example: 455 kHz and 10.7 MHz) are available within the frequency range of each instrument. This wide frequency range selection offers evaluation of circuit design with a continuously variable test signal over the range of 1 mV to 5 Vrms (to 1 Vrm for the 4275A), and with internal dc bias optionally available with 1 mV maximum resolution. The test voltage or current values can be monitored on the 3-digit display for accurately setting the actual conditions under which the device-under-test will operate.

### Multi-Parameter Measurements

The 4274A and 4275A measure equivalent series resistance (ESR), impedance ( $|Z|$ ), phase angle ( $\theta$ ), reactance (X), susceptance (B), and conductance (G), in addition to the conventional L,C,R,D and Q parameters in certain combinations with a dual 5½ digit display, and an HP-IB option for systems integration.

This wide selection of 11 parameters provides for more accurate evaluation of electronic materials or components with high measurement speed for most needed combined parameters; for example, the C-G measurement of semiconductors, an R-X measurement in circuit design, or the C-ESR or  $|Z|-\theta$  measurement of tantalum capacitors.

In addition, a deviation measurement capability ( $\Delta\Delta\%$ ) for the L,C,R. and  $|Z|$  functions displays the difference between the actual value and a stored reference, either as a difference value or in percent. Deviation applications include, for example, a temperature dependence measurement of devices in environmental tests.

### Reliable Measurements With 5½ Digit Resolution

The 4274A and 4275A measure only the value of the component and/or device under test, with 5½ resolution and 0.1% basic accuracy by reducing the possibility of errors due to self or mutual inductance, stray capacitance and/or residual inductance in the test leads or test fixture used. This measurement is obtained by a state-of-the-art four terminal pair configuration and a built-in automatic ZERO-offset capability to compensate for these errors.

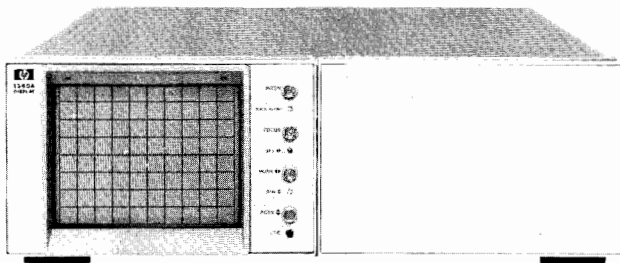

1340A Option 316 assembled in a 10380A OEM cabinet

All HP small-screen displays—the 1332A, 1333A, 1335A, 1336S, and 1340A—use the HP System II cabinet and frame structure, which affords the OEM an extremely flexible choice of attractive, rugged, electrically and thermally optimized building blocks with which to assemble a complete instrument or system around the display. The standard versions illustrated, Model 10380A Horizontal OEM Package and Model 10386A Vertical OEM Package, provide approximately 660 cubic inches of useable space for your circuitry, with combining covers to provide a unitized appearance. Power dissipation in added circuits should be limited to 50 watts. All necessary combining hardware, frame castings, trim, etc., are included. Rack mounting kits, slide mounting kits, and handles are available for the Model 10380A Horizontal OEM Package. Detailed drawings are available on request to aid in mechanical design and documentation. Special configurations can be quoted on request. The display and OEM packages shown can be painted in any desired color or silk-screened with customer-specified logos or other artwork.

**Note:** Model 1340A display requires Option 316 for use with the 10380A or 10386A. Refer to the 1340A data sheet for a description of Option 316 in addition to Options 315 (1340A display module with half-rack width cabinet) and 317 (1340A display module with full rack width cabinet).

### OEM Cabinets and Accessories

For complete listing of display options, see individual data sheets.

#### 10380A OEM Horizontal Frame

Model 10380A Frame Kit provides an empty 13.4 cm (5.25 in.) high half-module frame for mounting on the left or right of a display. The kit includes locking hardware for side-by-side mounting; combining covers (covers supplied with Option 315 or 330 are not required with this kit); side covers with strap handles for both sides; and blank panels for the empty module.

#### 10382A Bench Hardware Kit for 10380A

Model 10382A Bench Hardware Kit provides hardware for finishing the 10380A for bench use. The kit includes plastic trim for the front handles, plastic feet, tilt stands, and front rack handles.

#### Rack Mounting for OEM Frame or Two Displays

Rack mounting the Model 10380A OEM frame requires either a Rack Flange Kit HP P/N 5061-0077 or a Rack Flange and Front Handle Combination Kit HP P/N 5061-0083. To rack mount two displays, a Cabinet Lock-together Kit HP P/N 5061-0094 is required in addition to one of the rack flange kits. Two displays may also be combined and rack mounted.

**Cabinet lock-together kit P/N 5061-0094:** the Cabinet Lock-together Kit joins equal length instruments and contains enough hardware and screws for joining instruments in several configurations. The kit includes enough horizontal links (12 front, 6 rear) to form three side-by-side joints and enough vertical links (4 front, 4 rear) to form two over-under joints.

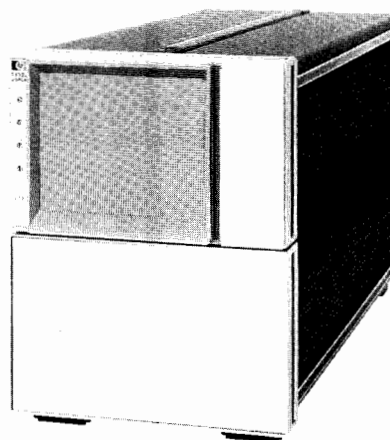

1332A Display with the 10386A vertical OEM cabinet

**Rack flange kit P/N 5061-0077:** the Rack Flange Kit provides rack mounting for the Model 10380A OEM Horizontal Frame or two side-by-side displays. The kit includes two flush rack ears without handles that fit on each side of the 13.3 cm (5.25 in.) high front panel frame and attaching hardware.

**Rack flange, front handle combination kit P/N 5061-0083:** the Rack Flange and Front Handle Combination Kit provides rack mounting for the Model 10380A OEM Horizontal Frame or two side-by-side displays. The kit includes two rack flanges and front handle combinations that fit on each side of the 13.3 cm (5.25 in.) high front panel frame and attaching hardware.

**Rack Mounting Adapter Kit P/N 5061-0057** The Rack Mounting Adapter Kit allows mounting one display in a standard 48.3 cm (19 in.) EIA rack when not using the Model 10380A OEM Horizontal Frame. This kit includes a 13.3 cm (5¼ in.) high half rack adapter plate with an integral rack ear, one rack flange for the display, and attaching hardware.

#### 10386A OEM Vertical Frame

Model 10386A Frame Kit provides an empty half-module for mounting above or below a display. The kit includes locking hardware for mounting above or below the display; top and bottom covers (covers supplied with Option 315, 330, 332, or 333, are not required with this kit); combining side covers; blank panels for the empty module; and cabinet trim.

#### Rack Slide Kits

When mounting two displays on slides, they must be fastened together using the cabinet lock-together kit HP P/N 5061-0094 and one rack flange kit HP P/N 5061-0077 or, one rack flange/front handle combination kit HP P/N 5061-0083. With either slide kit, bracket kit HP P/N 1494-0023 is required for mounting in racks other than HP racks.

**Non-pivoting slide kit P/N 1494-0017:** includes two slides and accessory hardware for attaching to a Model 10380A or two displays

**Pivoting slide kit P/N 1494-0026:** includes two pivoting slides and accessory hardware for attaching to a Model 10380A or two displays.

**Slide adapter bracket kit P/N 1494-0023:** includes brackets for mounting either pivoting or non-pivoting slides in non-HP rack system enclosures.

**197B Option 006 Camera** For HP small screen displays (see page 216)

### Price

\$200

\$30

\$42

\$25

\$55

\$45

\$200

\$72.50

\$160

\$43

\$1250

# CATHODE-RAY TUBE DISPLAYS

Instrumentation display module

Model 1340A

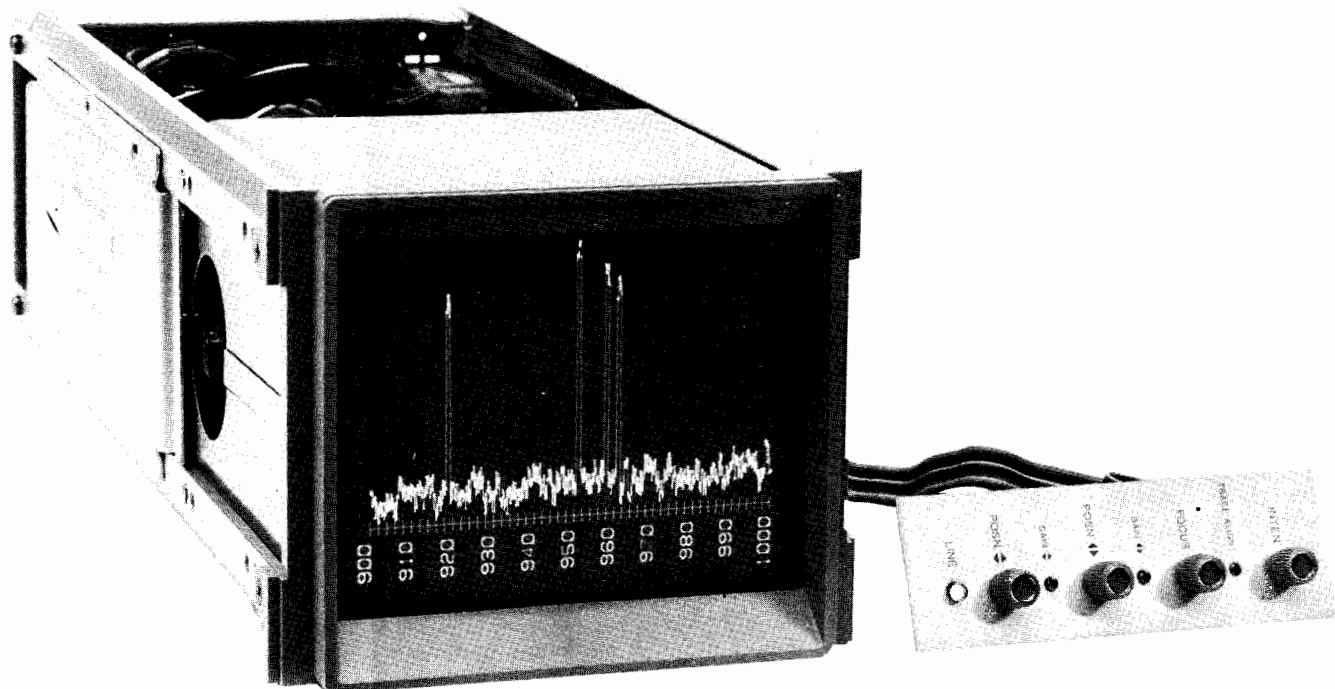

1340A Option 631

## 1340 Description

Model 1340A modular 15.3 cm display offers flexibility, convenience, and cost-effectiveness for OEM system designers with a basic display module that is rugged and easy to integrate into an instrument or system console.

Functional controls for intensity, focus, X and Y position, X and Y gain, and trace alignment can be located to suit design criteria. The standard display module includes a control panel that can be located to the right of the module or in a remote position. An option is available which omits the control panel so that you can use your own controls. Since the control functions are dc inputs to the integrated-circuit amplifiers, you can provide them from an appropriate part of your system.

## Electronics

Integrated circuits contain most of the X, Y and Z amplifier components, improving reliability as well as reducing cost. X and Y attenuators, input impedance, polarity, and bandwidth limiting are internally switch selectable. This provides flexibility to designers and inventory convenience when you use the 1340A in more than one instrument or system.

A dc supply option deletes the power transformer, rectifiers, and power line cable, allowing power to be supplied from your own instrument or system. Two voltages are required: regulated +20 Vdc and regulated -15 Vdc.

## Mechanical Construction

The 1340A module is a unitized structure, which is independently rugged without a cabinet. The display integrates easily into almost any instrument or system console design. If you wish to simplify the cabinet design for your system, there are several OEM cabinets for the 1340A. These are attractively styled and accommodate circuitry for a variety of instrument applications.

## Serviceability

Ease of service is designed into the 1340A, beginning with the mechanical construction which provides easy accessibility and continuing with an electrical design that incorporates IC's which reduce the number of components that can fail.

The power supply and amplifier boards are easily removed, giving you several service options: remove the entire module for service off-site, substitute pc boards and repair removed boards at a central location, or on-site component level repair. Your HP Field Engineer can arrange a service support plan to meet your needs.

## Applications

The price-performance ratio of the 1340A makes it ideal for almost every instrumentation system. Resolution, viewing area, and brightness are suitable for spectrum, network, vibration, transient, pulse height, and digital logic analyzers. The CRT writes a clear, crisp trace.

The 1340A can be used in a number of non-destructive test systems or instruments. The dc gain adjustment is helpful in remotely programming changes of the parameters being displayed. This capability is particularly useful in programmed test systems where operator interaction is impossible or undesirable.

The 1340A is adaptable to geophysical measurement systems, particularly the dc power option. This option simplifies integration into a system and reduces weight, a benefit with portable equipment or other systems that require minimum size and weight.

The 1340A may also be used as a basic display for communication system analyzers, chemical and scientific analysis systems, and some medical diagnostic systems. And it provides an economical operator interface in special production test systems. With the optional full rack module cabinets you have space to mount your own test system circuitry.

## Ordering Information

For a complete listing of options, refer to the 1340A data sheet.

	<b>Price</b>
<b>1340A</b> Display Module (with control panel)	\$1200
<b>Opt 001:</b> display module without control panel	less \$25
<b>Opt 002:</b> display module and control panel without internal power supply (requires +20 Vdc regulated $\pm 5\%$ including ripple, 1.5 A; and -15 Vdc regulated $\pm 5\%$ including ripple, 0.25 A; each supply floating with its own ground return.)	less \$25

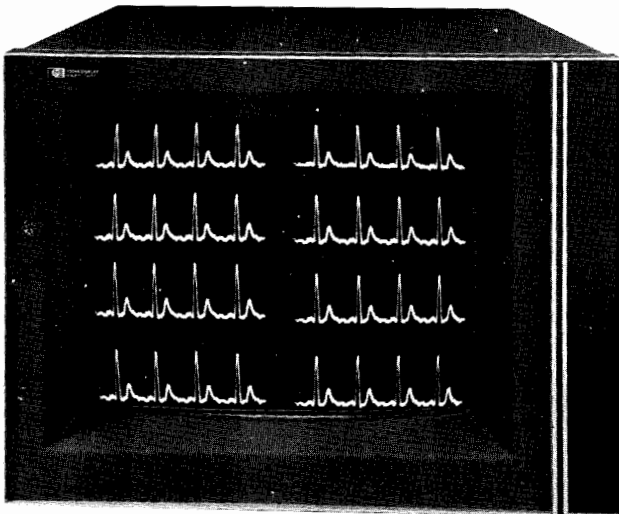

1304A

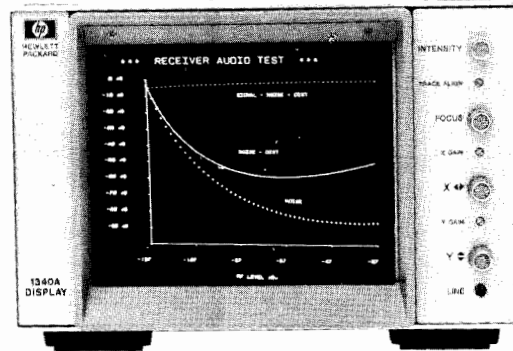

1340A Option 315 includes half rack width cabinet

Models 1304A and 1340A provide the electrical performance and picture quality required for most measurement instruments. In addition, the cabinet designs provide convenience in the mechanical integration of the displays into a variety of instrument or system configurations. Both units are well suited for engineers or scientists who need good display performance at a reasonable cost.

### 1304A Description

The 1304A is a moderately-priced, large screen display that has high writing speed and fast settling time. Both X and Y amplifiers have full differential input. In addition, there are internal switches that enable the user to select one, five, or ten volt full scale input at either 50Ω or 100Ω impedance. This makes the 1304A well suited for general purpose use or as a component in production test systems.

A wide variety of measurement systems and analytical instruments often require an auxiliary display. The 1304A provides an excellent price-performance ratio in these applications. If optimum picture resolution is desired, the Model 1311B with the same 14-inch CRT size as the 1304A is recommended.

High writing speed means that the 1304A can be used in system applications where electromagnetic CRT displays are too slow. An example of this is multiple-bed patient monitoring systems, where four to eight heart rates are shown on the CRT.

### 1340A Description

High writing speed and input voltage range selection are also available in the Model 1340A. A variety of cabinet configurations offer benefits to engineers and scientists who either want to add a display to an instrument or who are designing an instrument around the display. Option 315, shown above, makes the 1340A a free standing display for use with instruments such as logic analyzers, network analyzers, vibration analyzers, swept receivers, or other instrument analyzers or systems that do not have a built-in display.

Other cabinet options allow room for the instrument designer to package his circuits and power supply with the display in one unit. These are valuable whether you are building a research tool or production quantities of a product. The relatively short length (approx. 17 in.) of the 1340A appeals to designers of systems for airborne operations and other applications where space is at a premium.

**1340A Accessories:** Model 10380A Cabinet and Frame Kit provides an empty 13.4 cm (5.25") high half-rack module for mounting

beside the 1340A. The kit includes the half-rack module, connecting hardware for the 1340A, and full rack width top and bottom covers. Model 10386A Cabinet and Frame Kit provides the same features for mounting an empty module above or below the 1340A.

### Options

For a complete listing of options, refer to the 1304A or 1340A data sheets.

#### Digital Input (1304A)

**216:** TTL blanking level. High state (+2.5 to +5 V) blanks any Z-axis analog input signal. Low state (0.0 V to 0.8 V) returns blanking to analog Z-axis input. Input through rear panel BNC connector. add \$50

**217:** same as 216, except polarity reversed add \$50

**218:** 4-bit binary input allows binary selection of 16 levels of gray shades, TTL levels. Settling time  $\leq 300$  ns. Levels linear within  $\pm 20\%$ . Includes 25 pin program connector mounted to rear panel. When Option 218 is ordered with Option 216 or 217, TTL blanking input is provided through both a BNC connector and the 25 pin remote connector. add \$100

**Cabinets (1340A)**

**315:** Display module with HP System II 133 mm (5.25") high, half-rack width cabinet, 381 mm (15") long and with control panel (Model 1340A is supplied without cabinet and with control panel.) add \$100

**316:** Display Module with rear bracket for mounting in 10380A (side-by-side cabinet) or 10386A (vertically stacked cabinet) with 457 mm (18") side struts. Front casting, rear casting, two 457 mm (18") struts, no covers, rear cover panel. add \$50

**317:** Display module with HP system II 133 mm (5.25") high, full-rack width cabinet with 381 mm (15") long struts, 488 mm (17.63") overall length. Painted blank front panel and rear filler panel included. add \$150

### Ordering Information

<b>1304A</b> Large Screen Display	\$2750
<b>1340A</b> Display Module (with control panel)	\$1200
<b>10380A</b> Cabinet and Frame Kit (side by side) for 1340A	\$200
<b>10386A</b> Cabinet and Frame Kit (vertically stacked) for 1340A	\$200

# CATHODE-RAY TUBE DISPLAYS

## Graphics display systems with digital interfaces

### Model 1350S

- Computer/Calculator Compatible Digital Interfaces
- Fast Display Updating
- High Resolution Graphics



The 1350S Display System includes a 1311B X-Y Display, a 1350A Graphics Translator, rack mounting parts, a tilt stand which provides space below the display for a translator, an interconnecting cable, and a binder for instruction manuals.

Model 1350S Display System provides a high resolution, real-time, cost-effective solution for generating bright line vectors and alphanumeric characters. This system includes a high quality HP electrostatic CRT display (with gain controlled Z-axis) and the 1350A Graphics Translator.

The 1350A Graphics Translator accepts digital instructions and data from a computer or calculator and stores it in digital memory. Contents of memory are then used to generate X, Y, and Z analog voltages capable of driving a display. Continuous refreshing of the display by the 1350A removes the load on the controller or computer.

The 1350A provides bright, high-resolution graphics in minicomputer or desk-top computer systems on either large or small screen CRT displays. The Graphics Translator can address and selectively display 1000 x 1000 points on a CRT display. This can be a mix of text and vector presentations.

The Graphics Translator has a significant advantage in system applications with its ability to drive up to four CRT displays, each with different information. Presenting different information to multiple displays is accomplished with 32 independent files.

The 32 files also provide selective erase to change some or all of the data on any display without altering the information on all the displays. For added operating flexibility, the 32 files are selectable in size, separately addressable and erasable, and can be directed to flash information to highlight areas of interest on any display.

Each digital word in the 1350A can be a vector coordinate or an upper or lower case ASCII character. A character ROM generates each ASCII character, using only one word of RAM, making more words of RAM available for other display information. Each character can be programmed to be displayed in four different sizes with two degrees of rotation (0 and 90°).

#### RS-232-C or 16-Bit Parallel Optional Interface

The 1350A has an extremely flexible interface structure. As a result, a specific type of interface is implemented as a simple plug-in circuit card or module. The 1350A has HP-IB as the standard interface and RS-232-C or 16-Bit parallel binary as an optional replacement.

Features of the 1350A RS-232-C option are:

- Software compatibility with most teletypewriter system handlers,
- Increased transmission distances,
- Selectable clock rates from 110 to 9600 baud, and a
- Special high speed transmission rate of 57k baud.

Features of the 16-Bit parallel interface are:

- High speed data transfer rate of 500k 16-bit bytes/sec, and a
- Vector transfer rate of up to 250k vectors/sec.

#### Applications

The 1350S is ideally suited for minicomputer and calculator applications which require high speed and/or high resolution displays. Typical applications are:

- Radar and Sonar
- Fire Control
- Integrated Circuit Layout
- Instrumentation Displays
- Production Testing and Calibration
- Process Control
- Flight Instrument Simulation
- Structural Design
- Computer Aided Design
- Interactive Graphics
- Analytical Chemistry Scans
- Spectrum Analysis

#### Options and Accessories

	Price
001: RS-232-C interface instead of standard HP-IB	add \$175
002: 16-Bit parallel interface instead of std HP-IB	N/C
510: 1310B, 19 in. X-Y display instead of 1311B	add \$600
517: 1317A, 17 in X-Y display (rack mounting configuration) instead of 1311B	less \$650
521: 1321A, 21 in. X-Y display instead of 1311B	less \$550
604: P-4 phosphor display, without graticule	add \$30
639: P-39 phosphor display, without graticule	add \$30

#### Ordering Information\*

1350S Display System (includes 1311B display)	\$9300
1350A Graphics Translator (supplied with 1350S)	\$3850

\*An HP-IB cable is not supplied and must be ordered separately (see pg. 30).

- Fast writing speed and bright, high-contrast screen

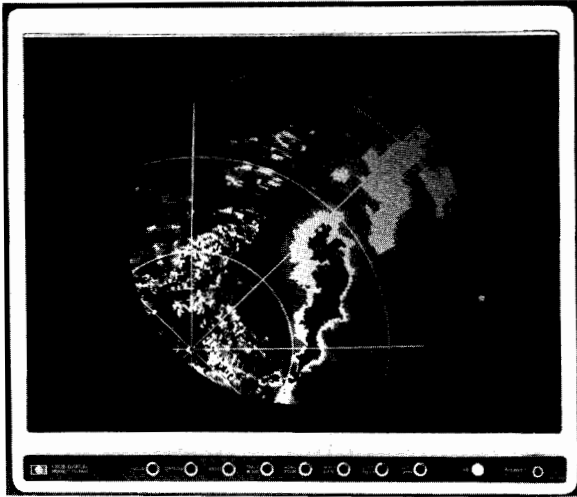

The yokeless electrostatic deflection system used in the 1310B results in low power consumption and increased reliability, important factors in remote locations such as this round-the-clock weather radar. (Radar photo courtesy of Bendix Avionics, Inc.)

- Computer peripheral softcopy

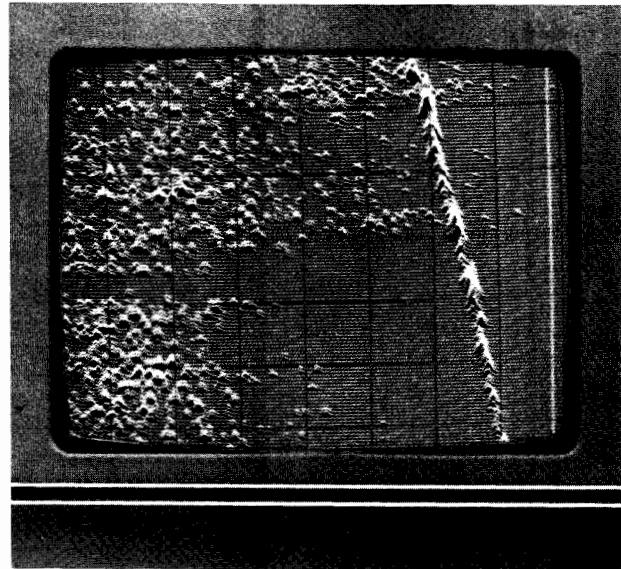

1321A large screen display is ideal for high density information such as this waterfall display, showing machine vibration frequency and amplitude versus time. (Photo courtesy of Spectral Dynamics, Inc.)

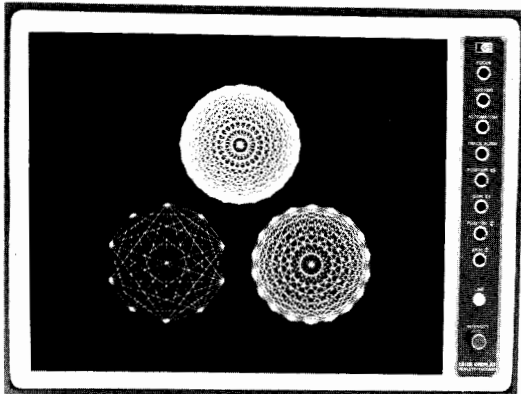

The 1311B provides high resolution computer graphics.

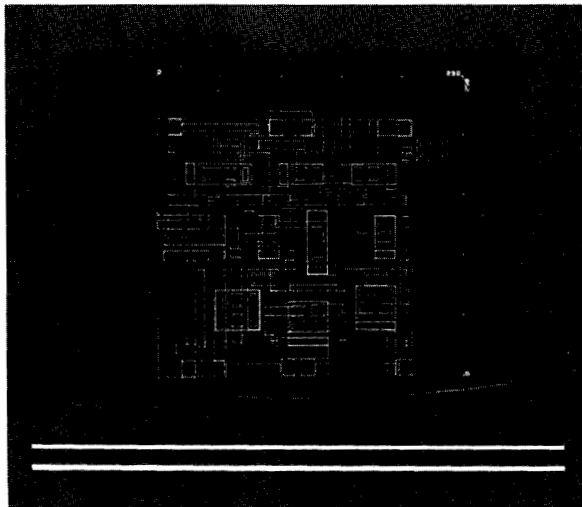

IC layout is developed on a 1317A large screen display.

## 1310B, 1311B, 1317A, 1321A

### Description

Hewlett-Packard's Models 1310B, 1311B, 1317A, and 1321A Large Screen Displays offer the high writing speed and fast settling time needed in high density information systems such as computer graphics, analytical research, and radar. The advanced electrostatic deflection systems used in these displays provide writing speeds of 25 cm/ $\mu$ s (10 in./ $\mu$ s), and settling times of 1  $\mu$ s or less. The yokeless electrostatic deflection also simplifies operation, eliminates geometric correction circuits and unnecessary delay lines, and reduces power requirements and weight. High CRT accelerating potentials of 27 or 28.5 kV assure bright, easy-to-read displays, and a small spot size gives a crisp, clear image over the large quality area.

The 1310B, 1311B, 1317A, and 1321A are electrically almost identical but offer a wide variety of display sizes and configurations to fit almost any high-speed, large screen OEM display requirements.

The 1321A has the highest overall resolution (screen area divided by spot size) of any HP CRT display, making it the choice for computer graphics or other applications where maximum information density is the main consideration. The 1317A is ideal for standard 48.3 cm (19 in.) rack-mount applications requiring the largest possible screen area in the minimum vertical rack space. For table-top applications such as remote graphics, Models 1310B and 1311B offer an attractive modern styled stand-alone package. Both of these displays may be ordered without top and bottom protective covers (Opt 001) and mounted in standard 48.3 cm (19 in.) racks or in your own customer designed enclosures. Reliability of these displays, an important criterion for OEM system components, is enhanced with solid-state electronics, low component count, low power consumption, and improved CRT design.

### Ordering Information

### Price

For information on options and accessories, refer to the Large Screen Displays data sheet.

<b>1310B</b> 48 cm (19 in.) Display	\$5900
<b>1311B</b> 36 cm (14 in.) Display	\$5300
<b>1317A</b> 43 cm (17 in.) Display	\$4650
<b>1321A</b> 53 cm (21 in.) Display	\$4750

OEM discounts available



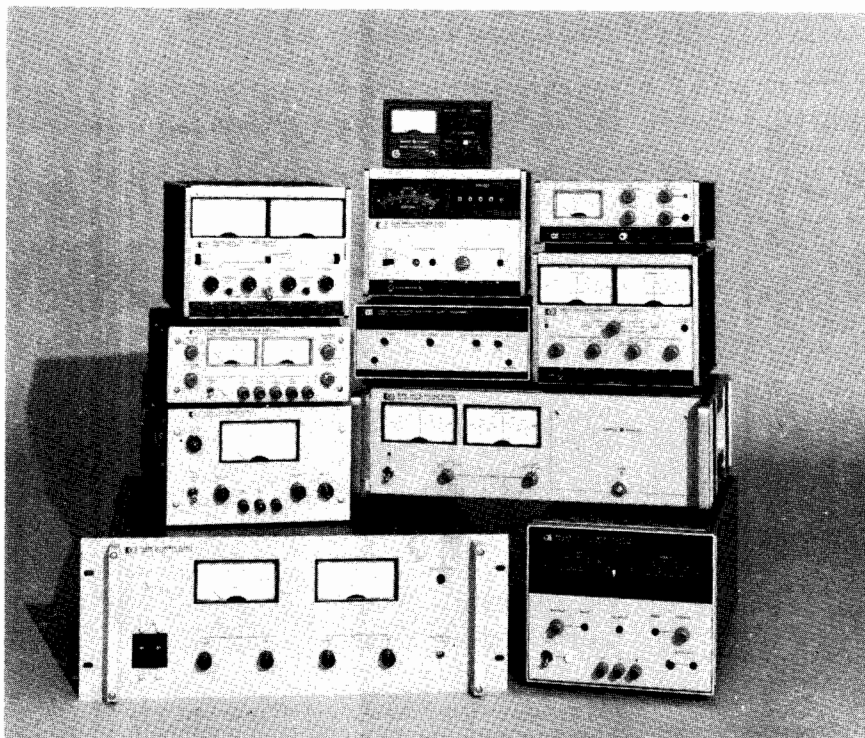

### Introduction

Hewlett-Packard power supplies are available in many types, sizes, and ratings. There are laboratory supplies used in circuit development, modular supplies to power systems, high-power supplies for industrial processes, and many special purpose supplies ranging from constant-current sources to bipolar power supply amplifiers.

### The True Value of a Power Supply

The best power supply for the job must first satisfy all the physical criteria: voltage and current ratings, performance specifications, size, and features. But equally important are the less tangible aspects that affect the real cost of ownership. Such factors as the experience and expertise of the manufacturer's engineering staff should be considered. Are his designs conservative—does he use quality components, does he have established QA procedures?

If you have a problem or need application assistance, are the manufacturers' reps accessible, responsive, and knowledgeable? Are spare parts and service available on a worldwide scale?

These factors do not show up on a spec sheet, but are closely related to a company's capability and responsibility towards its customers. When you purchase a power supply from Hewlett-Packard, you receive guaranteed product performance plus the intangibles that add up to long-term value—and it usually costs no more.

### Regulation Techniques

HP power supplies are designed using one of four proven stabilization techniques: series, switching, SCR, and SCR preregulator/series regulator.

**Series Regulation:** this technique uses a

feedback loop to control the voltage drop across a series-pass transistor located between the rectified dc input and the output terminals of the power supply. The feedback network senses changes in the output voltage and develops an error signal which adjusts the drop across the series transistor such that it maintains the output terminal voltage at the desired level. Good regulation (0.001% to 0.05%), low ripple and noise (50  $\mu$ V to 1 mV), and fast transient response (<50  $\mu$ s) characterize this type of regulator.

With all its attributes of excellent performance and circuit simplicity, the series regulator has one drawback; it is relatively inefficient (typically 30 to 40%). Heat sinks are employed to dissipate the heat generated by the series transistors and this necessarily increases the size and weight of the supply.

All linear OEM modular and low power lab supplies use this technique.

**Autoranging series regulation:** this technique uses a pair of triac switches with appropriate control logic to automatically select different transformer secondary taps depending on the output voltage and current demand placed on the supply, and the AC input voltage and frequency. Several voltage-current combinations can thereby be supplied from the input rectifier to the following series regulator. This extends the range of voltage (or current) output available within the power rating of the supply beyond that obtained from a simple series regulator. Model 6002A uses this technique.

**Switching regulation:** this technique regulates the output voltage by essentially switching a series transistor on and off at a rapid rate (about 20 kHz) and delivering this "chopped" current to an output filter. A feed-

back network senses changes in the output and feeds back a correction signal which adjusts the transistors on-off duty cycle to maintain a constant output voltage. Since a transistor dissipates very little power when it's fully on or off, the regulator has excellent efficiency (typically 65-80%).

Besides low power dissipation, another advantage of this technique is that the high pulse repetition rates make possible the use of transformers, inductors, and filter capacitors that are much smaller than those required for operation at power line frequencies.

Stabilization performance of the switching regulator is somewhat lower than the series regulator (typically 0.2% regulation; 20 mV rms, 40 mV p-p ripple and noise) but well suited for the majority of OEM system applications.

**Autoranging Switching Regulation:** This technique utilizes pulse-width modulation in conjunction with the principle of inductance-flyback voltage generation. Unlike a conventional power supply which can provide maximum power at only one combination of output voltage and current, the autoranging supply provides maximum power over a wide range of output voltages and currents.

**SCR regulation:** In many high power applications, the tight regulation and low ripple and noise characteristics of the series regulator can be beneficially traded for economy, efficiency, and compact size. This is where the SCR regulator is most valuable. Typical performance specifications for SCR supplies are 0.05 to 1% regulation, 50 mV rms, 500 mV p-p ripple and noise, 50-200 ms transient response, and 70% efficiency. Regulation is accomplished by sensing both the AC input and DC output of the supply and generating a firing pulse for SCR's located in two legs of a bridge rectifier. If the output voltage tries to decrease, the control circuit generates the firing pulse earlier in the input half cycle. More voltage is then passed through the SCR to the output filter to raise the output voltage to the correct level.

**SCR Pre-regulator / Series Regulator:** this technique incorporates the best of both worlds, and is used in most medium to high power, high performance power supplies. In these supplies, the SCR pre-regulator changes the rectifier output in coordination with the output voltage of the supply so that only a small voltage drop is maintained across the series pass transistor. This reduces the power dissipation in the series elements and greatly improves the efficiency (up to 70%). Typical performance specifications are similar to series regulated supplies except for slower transient response.

### Selecting Power Supplies

**By model number:** if you know the model number, you can find the power supply description page from the numerical index in the front of this catalog.

**By voltage rating:** the condensed listing on the following two pages lists power supplies in order of output voltage rating. The referenced catalog page covers detailed specifications.



### Specification Definitions

**Ambient temperature:** the temperature of the air immediately surrounding the power supply.

**Auto-parallel operation:** a master-slave connection of the outputs of two or more supplies used for obtaining a current output greater than can be obtained from one supply.

**Auto-series operation:** a master-slave connection of the outputs of two or more supplies used for obtaining a voltage greater than can be obtained from one supply.

**Auto-tracking operation:** a master-slave connection of two or more supplies each of which has one of its output terminals in common with one of the output terminals of all of the other supplies.

**Complementary tracking:** a master-slave interconnection of two supplies in which the voltage of the slave is equal to or proportional to that of the master and of opposite polarity with respect to a common point.

**Compliance voltage:** the output voltage of a power supply operating in the constant-current mode.

**Constant-current (CC) power supply:** a power supply that stabilizes output current with respect to changes in influence quantities. Thus, for a change in load resistance, the output current remains constant while the output voltage changes by whatever amount necessary to accomplish this.

**Constant-voltage (CV) power supply:** a power supply that stabilizes output voltage with respect to changes in influence quantities. Thus, for a change in load resistance, the output voltage remains constant while the output current changes by whatever amount necessary to accomplish this.

**Constant-voltage/constant-current (CV/CC) power supply:** a power supply that operates as a constant voltage power supply or a constant-current power supply depending on load conditions. It acts as a constant-voltage source for comparatively large values of load resistance and as a constant-current source for comparatively small values of load resistance.

**Constant-voltage/current-limiting (CV/CL) power supply:** a power supply similar to a constant-voltage/constant current supply except that at comparatively small values of load resistance, its output current is limited instead of being stabilized.

**Crowbar:** see overvoltage protection.

**Current limiting:** the action of limiting the output current of a constant-voltage supply to some predetermined maximum value (fixed or adjustable) and automatically restoring the output voltage to its normal value when the overload or short circuit is removed. There are three types of current limiting: 1) by constant-voltage/constant-current crossover, 2) by decreasing the output voltage as the current increases, 3) by decreasing both voltage and current as the load resistance decreases (referred to as foldback or cutback current limiting).

**Drift:** the maximum change of an output voltage or current during an 8-hour period following a 30-minute warmup, with all influence and control quantities maintained constant during the warm-up time and the period of drift measurement. Drift includes both periodic and random deviations over the bandwidth from zero frequency (dc) to a specified upper frequency limit (usually 20 Hz).

**Load effect:** formerly known as load regulation, load effect is the change in the steady-state value of the stabilized output voltage or current resulting from a full-load change in the load current of a constant-voltage supply or the load voltage of a constant-current supply, with all other influence quantities maintained constant.

**Load effect transient recovery time:** the time interval between a specified step change in the load current of a constant-voltage supply (usually a full-load or 5-amp change, whichever is smaller) or in the load voltage of a constant-current supply and the instant when the stabilized output quantity returns to and stays within the specified transient recovery band.

**Master-slave operation:** a method of interconnecting two or more supplies such that one of them (the master) serves to control the others (the slaves). The outputs of the slave supplies always remain equal to or proportional to the output of the master. The outputs of the

master supply and of one or more slaves may be connected in series, in parallel, or with just their negative or positive output terminals in common. (See also complementary tracking.)

**Nominal value:** the value that exists "in name only," not the actual value. For example, in the case of a power supply with a calibrated output control, the nominal value is the value indicated by the control setting. For a supply with a fixed output, the nominal output is the output indicated on the nameplate. The nominal value of a 120-volt  $\pm 10\%$  line voltage is 120 volts.

**Output impedance:** the complex ratio of a sinusoidal voltage and sinusoidal current at the output terminals, the one being caused by the other and being of external origin.

**Overcurrent protection:** protection of the power supply and/or connected equipment against excessive output current.

**Overtemperature protection:** protection of the power supply or parts of it against temperatures exceeding specified values.

**Overvoltage protection:** protection of the power supply and/or connected equipment against excessive output voltage. Overvoltage protection is usually by means of a crowbar protection circuit, which rapidly places a low resistance shunt across the supply's output terminals to reduce output voltage to a low value if a predetermined voltage is exceeded. A supply equipped with an overvoltage crowbar must also be protected by a means of limiting or interrupting output current.

**PARD (acronym for periodic and random deviation):** the term PARD replaces the former term ripple and noise. PARD is the periodic and random deviation of a dc output voltage or current from its average value, over a specified bandwidth (20 Hz to 20 MHz, except Models 6515A-6525A: 1 Hz to 20 MHz) and with all influence and control quantities maintained constant).

**Programming speed:** the maximum time required for the programmed output voltage or current to change from a specified initial value (usually zero or maximum output) to a value within a specified tolerance band of a specified newly programmed value (for most models 99.9% or 0.1% of maximum output, respectively; 99% and 1% for the 6111A-6116A, 6177C-6186C, and 6428B-6483C) following the onset of a step change in the programming input signal.

**Remote control:** also referred to as remote programming, remote control is the setting of the power supply voltage, current, or other function by means of an external control quantity such as a variable resistance, voltage, or current, or a digital signal.

**Remote sensing:** remote sensing, or remote error sensing, is a means by which a power supply monitors the stabilized voltage directly at the load using extra sensing leads. The resulting circuit action compensates for voltage drops in the load leads (up to a specified limit).

**Resolution:** the smallest change in output voltage or current that can be obtained using the front panel controls.

**Reverse voltage protection:** protection of the power supply against reverse voltage applied at the output terminals.

**Slave operation:** see master-slave operation.

**Source effect:** formerly known as line regulation, source effect is the change in the steady-state value of the stabilized output voltage on current resulting from any change in the source voltage within its specified range, with all other influence quantities maintained constant. Source effect may be measured at any output voltage and current within rating.

**Temperature effect coefficient:** the maximum steady-state change in a power supply's output voltage or current per degree Celsius following a change in the ambient temperature within specified limits, with all other influence quantities maintained constant.

**Voltage limiting:** the action of limiting the output voltage of a constant-current supply to some predetermined maximum value (fixed or adjustable) and automatically restoring the output current to its normal value when the load conditions are restored to normal. There are two types of voltage limiting: 1) by constant-voltage/constant-current crossover, 2) by decreasing the output current as the voltage increases.

**Warm-up time:** the time interval after switching on a power supply until it complies with all performance specifications.

# POWER SUPPLIES

## Condensed Listing

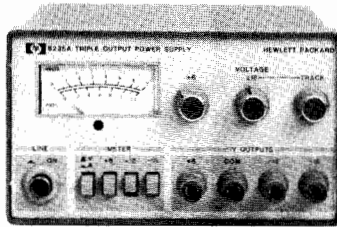

6235A—page 242

DC Volts	DC Amps (Max)	Type	Model	Page
4-5.5	8	Low Cost Lab	6384A†	240
0 ± 5 & ± 20 Dual Range	1	BPSA*	6825A†	259
0 ± 5 & ± 50 Dual Range	1	BPSA*	6826A†	259
5 ± 0.50	2	Modular	62005A†	262
5 ± 0.50	8	Modular	62005E†	262
5	10	Modular	65105A	262
5 & ± 12 Triple Output	10 & 1.5	Modular	65321A	262
5 & ± 15 Triple Output	10 & 1.0	Modular	65315A	262
5 & ± 18 Triple Output	10 & 1.0	Modular	65317A	262
5	10	Modular	65512A	262
± 16	1.0			
5 to 12	0.3-1.0			
-5 to -12	0.3-1.0			
Five Outputs	50 W total			
5	10	Modular	65612A	262
± 16	1.0			
5 to 12	0.3-1.0			
-5 to -12	0.3-1.0			
-5 to 12	0.1-0.3	0.3		
Six Outputs	50 W total			
5 ± 0.50	16	Modular	62005G†	262
5, ± 12 to 15, ± 0.25 Triple	18 & 2A max	Modular	63315D†	262
4.75 to 5.25	50	Modular	63312F†	262
+11.4 to +15.75	10			
-11.4 to -15.75	10			
Multi-output Microprocessor System				
5 ± 0.25	22	DC-to-DC	61005C†	262
5 ± 0.25	22	Modular	63005C†	262
5 & 12 to 15, ± 0.25 Triple	18 & 2A max	DC-to-DC	61315D†	262
5 ± 0.25	40 & 10A	Modular	62605L†	262
5 ± 0.25	100	Modular	62605M†	262
0-6, 0 ± 18 Triple	1 & 0.2	Low Cost Lab	6235A†	242
0-6, 0 ± 20, Triple	2.5 & 0.5	Low Cost Lab	6236B†*	242
0-7.5	3	Low Cost Lab	6203B†♦	242
0-7.5	5	Gen. Purpose	6281A†♦♦	244
0-8	1000	High Pwr.	6464C†♦♦	250
0-10	1	Low Cost Lab	6214A†	240
0-10	2	Prec. Volt	6113A†♦♦	256
0-10	10	Gen. Purpose	6282A†♦♦	244
0-10	50	Gen. Purpose	6259B†♦♦	248
0-10	100	Gen. Purpose	6260B†♦♦	248
0 ± 10 & 0 ± 10 Dual Range	0.5	BPSA*	6827A†	259
12 ± 0.60	1.5	Modular	62012A†	262
12	4.2	Modular	65112A	262
12 ± 0.60	6	Modular	62012E†	262

†Available on GSA Contract Number GS-OOS-85288.

♦May be used with the 59501A HP-IB Isolated D/A Converter/Power Supply Programmer.

♦♦Requires Option J30 for use with the 59501A Power Supply Programmer.

★May be used with the 8940B or 8942A Multiprogrammer when the power supply is equipped with Option 040.

\*BPSA = Bipolar Power Supply/Amplifier.

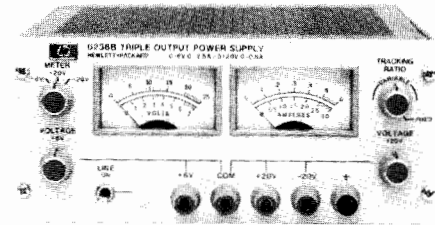

6236B—page 242

DC Volts	DC Amps (Max)	Type	Model	Page
12 ± 0.60	12	Modular	62012G†	262
± 12 ± 0.60 Dual	1.4	Modular	62212A†	262
± 12 to ± 15 Dual	17.5, 17.5	Modular	62615D	262
± 12 to ± 15 & 5 ± 0.25 Triple max	2 & 18A	Modular	63315D†	262
+11.4 to +15.75	10	Modular	63312F†	262
-11.4 to -15.75	10			
4.75 to 5.25	50			
Multi-output Microprocessor System				
± 12 ± 0.60 Dual	3.3	Modular	62212E†	262
± 12 ± 0.60 Dual	6	Modular	62212G†	262
0-15	200	High Pwr.	6453A†♦	250
15 ± 0.75	1.25	Modular	62015A†	262
15 ± 0.75	5	Modular	62015E†	262
15 ± 0.75	10	Modular	62015G†	262
± 15 ± 0.75 Dual	1.25	Modular	62215A†	262
± 15 & 5 ± 0.25	2 & 18 max	Modular	63315D†	262
± 15 ± 0.75 Dual	3	Modular	62215E†	262
± 15	3.5	Modular	65115A	262
± 15 ± 0.75 Dual	5.2	Modular	62215G†	262
± 15 to ± 12 Dual	17.5, 17.5	Modular	62615D	262
0-16 or 0-18	600 or 500	High Pwr.	6466C†♦♦♦	250
0-18 & 0-± 20 Dual Tracking	1 & 0.5	Low Cost Lab	6237B†	242
0 ± 18, 0-6 Triple	0.2 & 1	Low Cost Lab	6235A†	242
0 ± 20, 0-6 Triple	0.5 & 2.5	Low Cost Lab	6236B†	242
0 ± 20, 0-18 Triple	0.5 & 1	Low Cost Lab	6237B†	242
0-20 & 0-40 Two Dual Range	0.6 & 0.3	Low Cost Lab	6205B†♦♦	240
0-20	1			
0-20 & 0-40 Dual Range	1.5 & 0.75	Prec. Volt. Low Cost Lab	6111A†♦♦	256
0-20 & 20-40 Dual Range	2 & 1	Prec. Volt.	6114A†♦♦	256
0-20	3	Gen. Purpose	6284A†♦♦	244
0-20 & 0-20 Two Outputs	3 & 3	Gen. Purpose	6253A†♦♦	244
0-20	10	Gen. Purpose	6263B†♦♦	248
0-20	10	Gen. Purpose	6286A♦	244
0-20	20	Gen. Purpose	6264B†♦♦	248
0-20	45	High Pwr.	6428B†♦♦	250
0-20	50	Gen. Purpose	6261B†♦♦	248
20-40 & 0-20 Dual Range	1 & 2	Prec. Volt.	6114A†♦♦	256
0-24	3	Gen. Purpose	6224B†♦♦	244
24 ± 1.20	3.75	Modular	62024E†	262
24 ± 1.20	7.5	Modular	62024G†	262
0 ± 25 Dual Output	0.2 ea	Low Cost Lab	6234A†	241
0-25	0.4	Low Cost Lab	6216A†	240
0-25 & 0-25 Two-Tracking	2	Gen. Purpose	6227B†♦♦	254
28 ± 1.40	0.7	Modular	62028A†	262

†Available on GSA Contract Number GS-OOS-85288.

♦May be used with the 59501A HP-IB Isolated D/A Converter/Power Supply Programmer.

♦♦Requires Option J30 for use with the 59501A Power Supply Programmer.

★May be used with the 8940B or 8942A Multiprogrammer when the power supply is equipped with Option 040.

\*BPSA = Bipolar Power Supply/Amplifier.

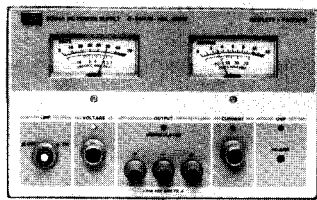

6024A—page 246

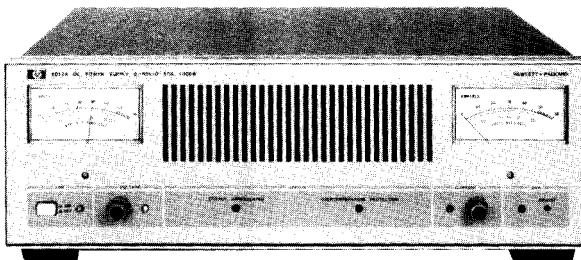

6012A—page 246

DC Volts	DC Amps (Max.)	Type	Model	Page
28 ±1.40	3.25	Modular	62028E†	262
28 ±1.40	6.5	Modular	62028G†	262
0-30 & 0-60	1 & 0.5	Low Cost	6206B†♦	240
Dual Range		Lab		
0-36	10	High Pwr.	6433B†♦♦	250
0-36	100	High Pwr.	6456B†♦	250
0-36	300	High Pwr.	6469C†♦♦★	250
0-40 & 0-20	0.3 & 0.6	Low Cost	6205B†♦	240
Dual Range		Lab		
0-40	0.5	Prec. Volt	6112A†♦★	256
0-40 & 0-20	0.75 &	Low Cost		
Dual Range	1.5	Lab	6200B†♦	240
0-40 & 0-40				
Two Outputs	1.5 & 1.5	Gen. Purpose	6255A†♦	244
0-40	1.5	Gen. Purpose	6289A†♦★	244
0-40	3	Gen. Purpose	6265B†♦★	248
0-40	5	Gen. Purpose	6266B†♦★	248
0-40	5	Gen. Purpose	6291A†♦	244
0-40	10	Gen. Purpose	6267B†♦★	248
0-40	25	High Pwr.	6434B†♦♦	250
0-40	30	Gen. Purpose	6268B†♦★	244
0-40	50	Gen. Purpose	6269B†♦★	244
0-40	0.45	Modular	62048A†	262
48 ±2.40	2	Modular	62048E†	262
48 ±2.40	4	Modular	62048G†	262
0-50	0.2	Low Cost	6218A†	240
0-50 (Compliance)	0-0.5	Prec. Cur.	6177C†♦	258
0-50 & 50-100				
Dual Range	0.8 & 0.4	Prec. Volt.	6115A†♦★	256
0-50 & 0-50				
Two-Tracking	1	Gen. Purpose	6228B†♦★	254
0-50	1.5	Gen. Purpose	6226B†♦★	244
50-100 & 0-50				
Dual Range	0.4 & 0.8	Prec. Volt.	6115A†♦★	256
0-50	10-4	HP-IB	6002A†	253
0 ± 50	5	Dig. Prog. Volt.	6129C†	264
0 ± 50	1	Dig. Prog. Volt.	6130C†	264
0 ± 50	1	BPSA*	6824A†♦	259
0-60 & 0-30	0.5 & 1	Low Cost	6206B†♦	240
Dual Range		Lab		
0-60	1	Gen. Purpose	6294A†♦★	244
0-60	3	Gen. Purpose	6296A†♦	244
0-60	3	Gen. Purpose	6271B†♦★	248
0-60 Autoranging	10 (200 W)	Autoranging	6024A	246
0-60 Autoranging	50 (1000 W)	Autoranging	6012A	246
0-60	5	High Pwr.	6438B†♦♦	250
0-60	15	Gen. Purpose	6274B†♦★	244
0-60	15	High Pwr.	6439B†♦♦	250
0-64	50	High Pwr.	6459A†♦	250
0-64	150	High Pwr.	6472C†♦♦★	250
0-100 (Compliance)	±0.016	Dig. Prog. Cur.	6140A†	264
0-100	0.1	Low Cost	6212A†	240
0-100	0.2	Prec. Volt.	6116A†♦	256
0-100(Compliance)	0.25	Prec. Cur.	6181C†♦	258
0-100	0.75	Gen. Purpose	6299A†♦★	244
0 ± 100	0.5	Dig. Prog. Volt.	6131C†	264
0-110	100	High Pwr.	6475C†♦♦	250
0-120	2.5	High Pwr.	6443B†♦♦	250

†Available on GSA Contract Number GS-005-85286.

♦May be used with the 59501A HP-IB Isolated D/A Converter/Power Supply Programmer.

♦♦Requires Option J30 for use with the 59501A Power Supply Programmer.

★May be used with the 6940B or 6942A Multiprogrammer when the power supply is equipped with Option 040.

\*BPSA = Bipolar Power Supply/Amplifier.

DC Volts	DC Amps (Max.)	Type	Model	Page
0-160	0.2	Low Cost	6207B†♦	240
		Lab		
0-220	50	High Pwr.	6477C†♦♦	250
0-300 (Compliance)	0.1	Prec. Cur.	6186C†♦	258
0-300	35	High Pwr.	6479C†♦	250
0-320	0.1	Low Cost	6209B†♦	240
		Lab		
0-320	1.5	Gen. Purpose	895A†	248
0-440 or 0-500	25 or 20			
or 0-600	or 15	High Pwr.	6483C†♦♦	250
1-600	1.5	High Pwr.	6448B†	250
0-1000	0.2	High Volt.	6521A†	255
0-1600	0.005	High Volt.	6515A†	255
0-2000	0.1	High Volt.	6522A†	255
0-3000	0.006	High Volt.	6516A†	255
0-4000	0.05	High Volt.	6525A†	255

†Available on GSA Contract Number GS-005-85286.

♦May be used with the 59501A HP-IB Isolated D/A Converter/Power Supply Programmer.

♦♦Requires Option J30 for use with the 59501A Power Supply Programmer.

★May be used with the 6940B or 6942A Multiprogrammer when the power supply is equipped with Option 040.

\*BPSA = Bipolar Power Supply/Amplifier.

### Power Supply Digital Programming Interfaces

Description	Model	Page
<b>HP-IB Isolated D/A Converter/Power Supply Programmer:</b> one channel, two programmable ranges. Provides HP-IB interface for programming either output voltage, or current (where current programming is available as described in specifications for individual power supply model) of power supplies designated with a ♦ or ♦♦ symbol in the above condensed list "model" column. Interfacing details are covered in publication 5952-3990.	59501A	252
<b>Multiprogrammer:</b> Two models of highly versatile I/O expanders and converters that can control up to 240 power supplies from one HP-IB port or one 16-bit duplex I/O channel (model 6940B). They will control output voltage and current of power supplies designated with a ★ symbol in the above condensed listing "model" column when the supplies are equipped with Option 040. Additional Multiprogrammer capabilities include digital I/O for monitoring crowbars, relays for output switching, A/D converters for measuring power supply output, timers for automatic power supply sequencing, etc. See pages 665-670 for more extensive descriptions of the individual Multiprogrammer capabilities and information on how to obtain complete technical data on the 6940B and 6942A Multiprogrammers.	6940B 6942A	665 668

## POWER SUPPLIES

Low cost lab: Single output 10W-30W

Models 6200B-6218A and 6384A

- 10 Watts output...Low ripple and noise
- Compact, Impact-resistant stackable case
- Short-circuit proof

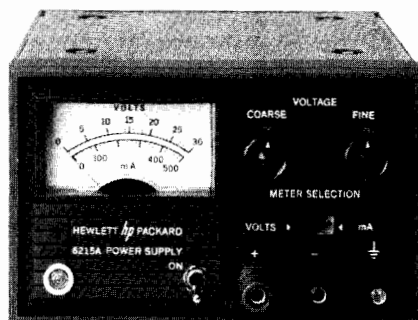

6212A-6218A

- 30 watts output
- Multi-function meter
- Remote sensing

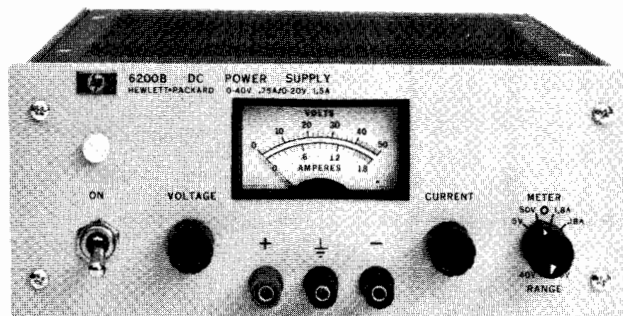

6200B-6203B, 6207B, 6209B



6206B and 6384A

### Description

#### Models 6212A-6218A

These popular low-cost bench supplies are designed for general laboratory use and are equipped with front-panel mounted voltage controls, a combination volt/ammeter, and output binding posts. Output voltage is continuously variable, via coarse and fine controls from 0V to 15% above the maximum rated output. A switch selects either output voltage or current for display on the panel meter.

Load connections are made via three binding posts. Either the + or the - post may be grounded through an adjacent GND terminal or the supply may be operated floating at up to 300 volts above ground.

These Constant Voltage/Constant Current supplies have concentric coarse and fine current controls which allow setting the current-limit point to any value within the current rating. Using these controls the supplies can also be operated as constant current sources with 500  $\mu$ A load regulation. All CV/CC models can be connected in series or parallel.

The molded, impact-resistant case includes an interlocking feature for stacking several units vertically, thus minimizing bench space required for multiple supplies. Alternatively, up to three units can be mounted side by side in a 19" rack using Rack Mounting Kit 14521A. These supplies measure 86H x 133W x 368mm D (3.40" x 5.25" x 8") and weigh 2kg (4.4 lb).

### Specifications

See page 243 for ratings, performance specifications and ordering information on SINGLE OUTPUT — 10 WATT power supplies.

### Description

#### Models 6200-6209B

This series of low-cost bench supplies includes eight models covering an output voltage range from 0-7.5 V to 0-320 V. All models

equipped with coarse and fine output voltage controls (except Models 6207B and 6209B, which have 10-turn voltage controls), volt/ampere meter, meter function/range switch, and front and rear output terminals. In addition, on the dual-range models (6200B and 6206B), an output range switch permits the selection of either a high or a low output voltage range.

The Constant-Voltage/Current-Limiting supplies are short-circuit protected by a fixed current limiting circuit which is activated at approximately 110% of rated load current. The current-limit point can be reduced by changing the value of a single internal resistor. For the Constant-Voltage/Constant-Current supplies, concentric coarse and fine current controls allow the current-limit point to be set to any value within the current rating. Using these controls the CV/CC supplies can also be operated as constant-current sources.

Units may be bench operated or rack mounted individually or in pairs using accessory rack mounting hardware.

### Model 6384A

This low-cost bench supply is designed specifically for use with digital logic integrated circuits. Its output ratings and superior performance, combined with the protection of built-in overvoltage crowbar and current limiting circuits, make it an excellent IC supply for both laboratory and systems use.

All models in this group of supplies measure 89H x 216W x 317mm D (3.50" x 8.50" x 12.50") and weigh 4.5kg (10 lb).

### Specifications

See page 243 for ratings, performance specifications and ordering information on SINGLE OUTPUT — 30 WATT power supplies.

- 10 watts output, Model 6234A
- Short-circuit proof
- Independent voltage controls

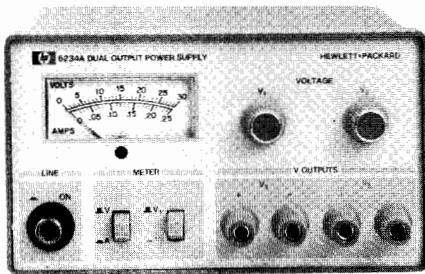

6234A

- 24 watts output, Model 6205A
- Multi-function meter

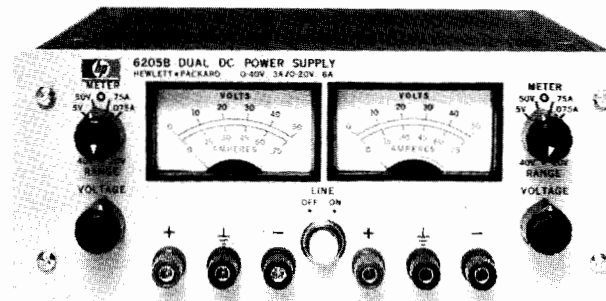

6205B

### Description Model 6234A

Model 6234A is a low-cost, dual-output bench power supply with two independently adjustable and isolated power sources in one compact unit. Both of the dc power sources are of the constant voltage/current limit type with each output voltage being adjustable continuously over a 0 to 25V range. The maximum current available per output is 0.2A and is limited automatically to prevent over-load.

The HP 6234A offers considerable flexibility to the user with output voltages that can be arranged to provide identical or different voltages in any polarity combination with respect to 0 or other common positive or negative voltage points. The outputs can also be connected in series to provide up to 50V at 0.2A. Both sources are fully isolated to permit either of the output terminals to be grounded.

With pushbutton switches, users can select either voltage or current for each output to be monitored on the unit's meter. Other features include two multiple-turn controls for precise voltage setting, regulation to 0.01% and ripple and noise of less than 200 microvolts rms.

With dimensions of only 93 mm high, 157 mm wide and 210 mm deep (3.64" x 6.17" x 8.25"), the HP 6234A supply takes up a minimum amount of bench space. Its weight is 2.3 kg (5 lbs.). The unit can be powered from a 115V or an optional 230V, 47-63Hz ac input, (Option 028).

### Specifications

See page 243, under listing for DUAL OUTPUT - 10 WATT power supplies for detailed performance specifications and ordering information for model 6234A.

### Description Model 6205B

This low-cost bench supply is equipped with coarse and fine output voltage controls, volt/ampere meter, meter function/range switch, and front and rear output terminals. In addition, an output range switch permits the selection of either a high or a low output voltage range.

Model 6205B combines the versatility of a dual power supply with the flexibility of auto-parallel and auto-series operation to extend the output ratings of this supply to 20 V/1.2 A, 40 V/0.6 A, and 80 V/0.3 A. In addition, using the supply's auto-tracking capability, opposite polarity voltages ( $\pm 20$  V,  $\pm 40$  V) can conveniently be obtained from this one supply.

This Constant-Voltage/Current-Limiting supply is short-circuit protected by a fixed current limiting circuit which is activated at approximately 110% of rated load current. The current-limit point can be reduced by changing the value of a single internal resistor. Units may be bench operated or rack mounted individually or in pairs using accessory rack mounting hardware.

### Specifications

See page 243, under listing for DUAL OUTPUT-30 WATT power supplies, for detailed performance specifications and ordering information for model 6205B.



## POWER SUPPLIES

Low cost lab: triple outputs 10W-30W

Models 6235A, 6236B & 6237B

- 10 watts output
- 0 to 6 V & 0 to  $\pm 18$  V, Model 6235A

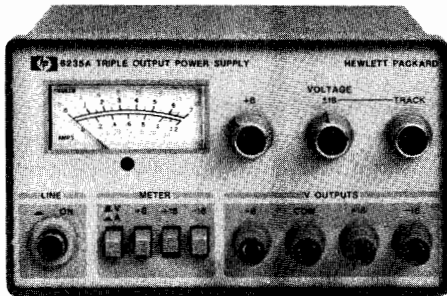

6235A

- Up to 30 watts output
- 0 to 6 V & 0 to  $\pm 20$  V, Model 6236B
- 0 to 18 V & 0 to  $\pm 20$  V, Model 6237B

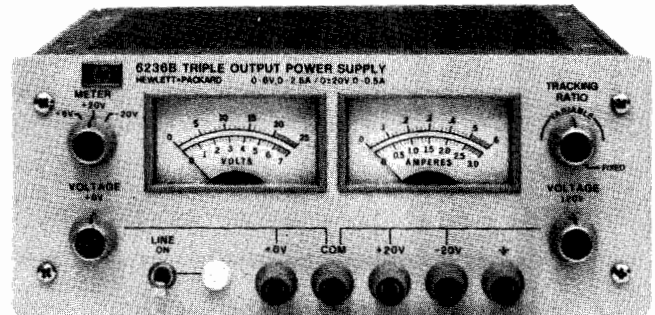

6236B, 6237B

### Description

#### 6235A

This compact, low-cost, three-in-one power supply is a handy addition to the lab bench where single or multiple voltages are needed for designing and testing breadboards and prototypes. The Hewlett-Packard Model 6235A delivers three adjustable dc output voltages: 0 to +6 V at 1 A, 0 to +18 V at 0.2 A, and 0 to -18 V at 0.2 A. A single 0 to 36 volt output at 0.2 A can also be obtained by connecting across the +18 V and -18 V terminals.

The controls, meter, and binding posts are conveniently arranged on the front panel. One voltage control simultaneously adjusts the +18 V and -18 V outputs, which track one another and can be used to power operational amplifiers and other circuits requiring balanced positive and negative voltages. The supply's dual outputs have added versatility with an adjustable tracking ratio control (TRACK) that can set the negative output to a lower voltage than the positive output. Once the tracking ratio control has established a voltage ratio between the positive and negative outputs, the ratio remains constant as the +18 V voltage control is adjusted. A third control sets the 0 to +6 V output voltage.

The supply is a constant voltage/current limit type with each output voltage continuously adjustable over its range, while the maximum current available is automatically limited to prevent overloading. The power supply's outputs share a common terminal and are isolated from chassis ground so that any output terminal can be grounded if desired. Each output voltage or current can be quickly selected and monitored with the push-button meter switches.

Model 6235A measures 89 H x 157 W x 210 mm D (3.5" x 6.17" x 8.25") and weighs 2.3 kg (5 lb).

#### Specifications

See next page for performance specifications and ordering information under TRIPLE OUTPUT—10 WATTS.

#### 6236B and 6237B

Microprocessors, digital and linear integrated circuits, and displays used in lab development frequently require triple output power supplies for operating prototypes. The 6236B and 6237B are valued addi-

tions to the design bench due to their multiple output voltages, small size, ease of operation and application-related performance.

These compact constant-voltage/current-limiting supplies combine 0 to  $\pm 20$  V tracking outputs rated at 0.5 amps with a single output rated at 0 to +6 volts at up to 2.5 amps in the 6236B, and 0 to +18 volts at 1 amp in the 6237B.

Controls, meters, and binding posts are logically arranged on a neatly laid out front panel. One voltage control simultaneously adjusts the 20 V and -20 V outputs, which track within 1% to power operational amplifiers and circuits requiring balanced voltages. A tracking ratio control can disable the 1:1 tracking feature and set the negative output to a lower voltage than that of the positive output. Once the tracking ratio control has established a voltage ratio between the positive and negative outputs, the ratio remains constant as the  $\pm 20$  V voltage control varies both outputs. Another voltage control sets the 0 to +6 V (6236B) or 0 to +18 V (6237B) output.

All outputs are protected against overload and short-circuit damage by fixed current limiting circuits. For any overload condition, the +20 V and -20 V outputs in both models are limited to 0.55 amps and the +18 V output in the 6237B is limited to 1.1 amps. The overload protection circuit for the +6 V output in the 6236B has a current foldback characteristic that reduces the maximum available current from about 2.75 amps at a 6 V terminal voltage to 1 amp at zero volts (or short circuited). This foldback limiting characteristic maximizes the available current in the important 5 to 6-volt range while minimizing semiconductor dissipation during overloads.

Another protective feature safeguards sensitive load circuitry by preventing an output voltage overshoot when the supply is turned on or off.

Separate dual-range panel meters allow both the voltage and current of any output to be monitored simultaneously. A three-position switch selects the supply output and the proper meter ranges.

Both models measure only 89 H x 216 W x 319 mm D (3.5" x 8.5" x 12.5") and weigh 4.3 kg (9.5 lb).

#### Specifications

See next page for performance specifications and ordering information under TRIPLE OUTPUT — UP TO 30 WATTS.



## Specifications

RATINGS		PERFORMANCE							GENERAL	
DC Output		Model	Load Effect	Source Effect	PAR D rms/p-p	Control Mode and Resolution	Remote Control Coefficients	Power* 115 V ac ± 10%	Options*	Price
Volts	Amps									
<b>SINGLE OUTPUT—10 WATTS</b>										
0-10	0-1	6214A	4 mV	4 mV	200 μV/1 mV	CV/CC	NA	48-440 Hz 0.3 A, 28 W	28	\$240
0-25	0-0.4	6216A	4 mV	4 mV	200 μV/1 mV	CV/CC	NA	48-440 Hz 0.3 A, 28 W	28	\$240
0-50	0-0.2	6218A	4 mV	4 mV	200 μV/1 mV	CV/CC	NA	48-440 Hz 0.3 A, 28 W	28	\$240
0-100	0-0.1	6212A	8 mV	4 mV	200 μV/1 mV	CV/CC	NA	48-440 Hz 0.3 A, 28 W	28	\$240
<b>SINGLE OUTPUT—UP TO 30 WATTS</b>										
4.4-5.5	0-8	6384A	2 mV	2 mV	1 mV/5 mV	CV/CL 15 mV/NA	NA	48-63 Hz 1.4 A, 120 W	28	\$450
0-7.5	0-3	6203B	5 mV	3 mV	200 μV/1 mV	CV/CC 5 mV/2 mA	200Ω/V ± 1% 500Ω/A ± 10%	48-440 Hz 0.9 A, 70 W	9, 11, 15, 28	\$395
Dual range 0-20 or 0-40	0-1.5 0-0.75	6200B	0.01% + 4 mV	0.01% + 4 mV	200 μV/1 mV	CV/CC 10 mV/2 mA	200Ω/V ± 1% 0.5 kΩ/A ± 10% or 1 kΩ/A ± 10%	48-440 Hz 0.9 A, 70 W	9, 11, 15, 28	\$400
Dual range 0-30 or 0-60	0-1 0-0.5	6206B	0.01% + 4 mV	0.01% + 4 mV	200 μV/1 mV	CV/CL 10 mV/NA	300Ω/V ± 1% N/A	48-440 Hz 1 A, 66 W	9, 11, 15, 28	\$375
0-160	0.2	6207B	0.02% + 2 mV	0.02% + 2 mV	500 μV/40 mV	CV/CC 25 mV/500 μA	300Ω/V ± 1% 75 kΩ/A ± 10%	48-63 Hz 1 A, 60 W	9, 15, 28	\$475
0-320	0-0.1	6209B	0.02% + 2 mV	0.02% + 2 mV	1 mV/40 mV	CV/CC 40 mV/200 μA	300Ω/V ± 1% 150 kΩ/A ± 10%	48-63 Hz 1 A, 60 W	9, 15, 28	\$475
<b>DUAL OUTPUT—10 WATTS</b>										
Dual output 0-25 and 0-25	0.2 0.2	6234A	0.01% + 1 mV	0.01% + 1 mV	200 μV/1 mV	CV/CL	NA	104-127 Vac 47-63 Hz 0.26A, 35 W	28	\$250
<b>DUAL OUTPUT—UP TO 30 WATTS</b>										
Two dual ranges 0-20/0-40 and 0-20/0-40	0-0.6/0.3 0-0.6/0.3	6205B	0.01% + 4 mV	0.01% + 4 mV	200 μV/1 mV	CV/CL 10 mV/NA	200Ω/V ± 1% N/A	48-440 Hz 0.5 A, 50 W	9, 11, 15, 28 40	\$495
<b>TRIPLE OUTPUT—10 WATTS</b>										
Triple output 0 to 6 and 0 to 18 and 0 to -18	0-1	6235A	8 mV	8 mV	1 mV/5 mV	CV/CL	NA	47-63 Hz 0.26 A, 35 W	28	\$270
	0-0.2		10 mV	15 mV	1 mV/5 mV	CV/CL	NA			
	0-0.2		10 mV	15 mV	1 mV/5 mV	CV/CL	NA			
<b>TRIPLE OUTPUT—UP TO 30 WATTS</b>										
Triple output 0 to +6 and 0 to +20 and 0 to -20	1-2.5	6236B	0.01% + 2 mV	0.01% + 2 mV	350 μV/1.5 mV	CV/CL 70 mV/NA	NA	104-127 Vac 47-63 Hz 1.2 A, 112 W	100:100 Vac	\$495
	0.5								220:220 Vac	
	0.5								240:240 Vac	
Triple Output 0 to +18 and 0 to +20 and 0 to -20	1	6237B	0.01% + 2 mV	0.01% + 2 mV	350 μV/1.5 mV	CV/CL 70 mV/NA	NA	104-127 Vac 47-63 Hz 1.2 A, 112 W	100:100 Vac	\$495
	0.5								220:220 Vac	
	0.5								240:240 Vac	

\*For 230 V ac ± 10% operation, order Opt 028 See page 260 for complete option descriptions.



# POWER SUPPLIES

General purpose: 25–200 W output

Models 6224B–6299A

- Constant voltage/constant current operation
- Remote sensing and programming
- Auto-series, -parallel, & -tracking operation

- Front and rear output terminals
- Floating output—use as positive or negative source
- Bench or rack mounting

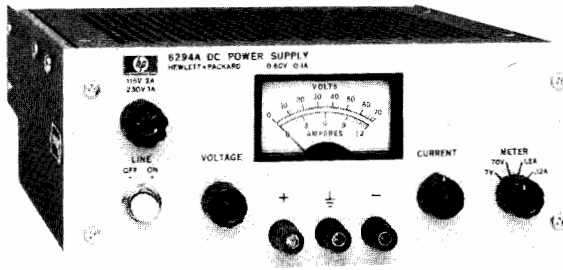

6281A, 6284A, 6289A,  
6294A, 6299A

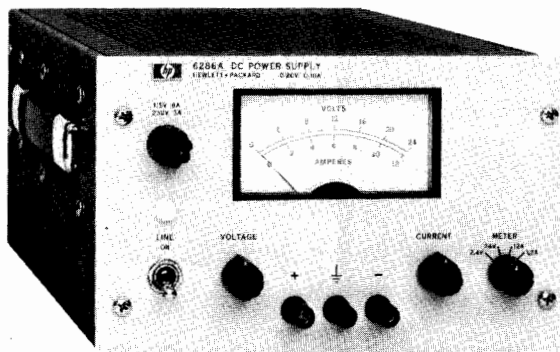

6282A, 6286A,  
6291A, 6296A

## Description

### 6281A–6299A

This series of medium-power Constant-Voltage/Constant-Current power supplies is available in two power ranges: 37–75 watts (packaged in 3½-inch high half-rack cases), and 100–200 watts (packaged in 5¼-inch high half-rack cases). All models except 6294A and 6299A have separate coarse and fine voltage and current controls that allow the voltage and current outputs to be varied from zero to the maximum rated values. The latter two models have ten-turn voltage controls. Crossover from constant-voltage to constant-current operation occurs automatically when the load current exceeds the value established by the current control settings. A four-position meter function switch selects either of two output voltage or output current ranges (X1, X0.01) for display on the panel meter.

The 37–75 watt models are of the series-regulated type. They have excellent regulation and ripple characteristics and include a special output-capacitor discharge circuit for improved programming speed. The 100–200 watt models employ a series-regulator/SCR-preregulator configuration to achieve the high efficiency necessary for a convection-cooled package of this size. They also have excellent regulation, low ripple and noise, and moderate programming speeds.

### 6253A and 6255A

These versatile dual-output models each contain two identical, independently-adjustable 60-watt power supplies in a full-rack width case. The regulator, voltage and current control, and metering circuits of each section of the supply are electrically identical to those of the individual 37–75 watt models described above.

## Specifications

RATINGS			PERFORMANCE							
DC Output		Model	Load Effect		Source Effect		PARD (rms/p-p)		Drift (stability)	
Volts	Amps		Voltage	Current	Voltage	Current	Voltage	Current	Voltage	Current
0–7.5	0–5	6281A	5 mV	0.01% + 250 µA	0.01% + 2 mV	0.01% + 250 µA	200 µV/1 mV	4 mA rms	0.1% + 2.5 mV	0.1% + 12.5 mA
0–10	0–10	6282A	0.01% + 1 mV	0.05% + 1 mA	0.01% + 1 mV	0.05% + 1 mA	500 µV/25 mV	5 mA rms	0.1% + 2.5 mV	0.1% + 25 mA
0–20	0–3	6253A*	0.01% + 4 mV	0.01% + 250 µA	0.02% + 2 mV	0.01% + 250 µA	200 µV/1 mV	2 mA rms	0.1% + 2.5 mV	0.1% + 7.5 mA
0–20	0–3	6284A	0.01% + 4 mV	0.01% + 250 µA	0.01% + 2 mV	0.01% + 250 µA	200 µV/1 mV	2 mA rms	0.1% + 2.5 mV	0.1% + 7.5 mA
0–20	0–10	6286A	0.01% + 1 mV	0.05% + 1 mA	0.01% + 1 mV	0.05% + 1 mA	500 µV/25 mV	5 mA rms	0.1% + 2.5 mV	0.1% + 25 mA
0–24	0–3	6224B	0.01% + 4 mV	0.01% + 250 µA	0.01% + 2 mV	0.01% + 250 µA	200 µV/1 mV	200 µA/1 mA	0.1% + 2.5 mV	0.1% + 7.5 mA
0–40	0–1.5	6255A*	0.01% + 2 mV	0.01% + 250 µA	0.01% + 2 mV	0.01% + 250 µA	200 µV/1 mV	500 µA rms	0.1% + 2.5 mV	0.1% + 4 mA
0–40	0–1.5	6289A	0.01% + 2 mV	0.01% + 250 µA	0.01% + 2 mV	0.01% + 250 µA	200 µV/1 mV	500 µA rms	0.1% + 2.5 mV	0.1% + 4 mA
0–40	0–5	6291A	0.01% + 1 mV	0.05% + 1 mA	0.01% + 1 mV	0.5% + 1 mA	500 µV/25 mV	3 mA rms	0.1% + 2.5 mV	0.1% + 12.5 mA
0–50	0–1.5	6226B	0.01% + 2 mV	0.1% + 250 µA	0.1% + 2 mV	0.01% + 250 µA	200 µV/1 mV	200 µA/1 mA	0.1% + 2.5 mV	0.1% + 4 mA
0–60	0–1	6294A	0.01% + 2 mV	0.01% + 250 µA	0.01% + 2 mV	0.01% + 250 µA	200 µV/1 mV	500 µA rms	0.1% + 2.5 mV	0.1% + 2.5 mA
0–60	0–3	6296A	0.01% + 1 mV	0.5% + 1 mA	0.01% + 1 mV	0.05% + 1 mA	500 µV/25 mV	3 mA rms	0.1% + 2.5 mV	0.1% + 7.5 mA
0–100	0–0.75	6299A	0.01% + 2 mV	0.01% + 250 µA	0.01% + 2 mV	0.01% + 250 µA	200 µV/1 mV	500 µA rms	0.1% + 2.5 mV	0.1% + 2 mA

\*Models 6253A and 6255A contain two identical, independently-adjustable power supplies.

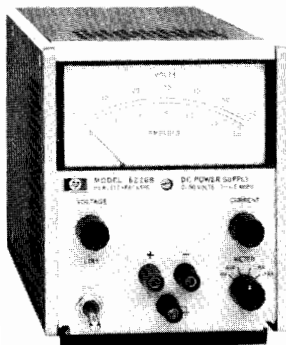

6224B, 6226B

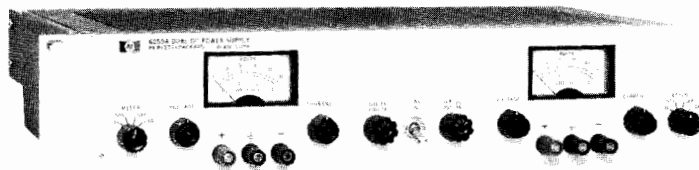

6253A, 6255A

By combining the versatility of a dual power supply with the flexibility of auto-series and auto-parallel operation, twice the maximum rated output voltage or current of each section can be obtained from the one supply. In addition, using the supply's auto-tracking capability, opposite-polarity voltages ( $\pm 20$  V for Model 6253A or  $\pm 40$  V for Model 6255A) are possible.

**6224B and 6226B**

These Constant-Voltage/Constant-Current supplies are designed for general laboratory use. Both have excellent regulation, low ripple and noise, and high speed programming characteristics. Large easy-to-read meter scales, 10-turn voltage and current controls, and front and rear output terminals enhance ease of operation. Models 6224B and 6226B have single outputs of 0–24 V at 0–3 A and 0–50 V at 0–1.5 A, respectively.

**Accessories and options**

The accessories and options available for use with Models 6224B–6299A are listed on page 260.

**Specifications—General**

**Load effect transient recovery:** Time, 50  $\mu$ s. Level, 15 mV.

**Meter accuracy:** 3% of full scale.

**Power:** standard input voltage is 115 V ac  $\pm 10\%$ . Order option 028 for 230 V ac  $\pm 10\%$  operation. Input power frequency, maximum input current, maximum power consumption are:

6224B, 48–63 Hz, 1.8 A, 164 W 6226B, 48–63 Hz, 1.8 A, 164 W;  
6253A, 48–440 Hz, 2.6 A, 235 W 6255A, 48–440 Hz, 2.6 A, 235 W;  
6281A, 48–440 Hz, 1.3 A, 118 W 6282A, 57–63 Hz, 3.5 A, 200 W;  
6284A, 48–440 Hz, 1.5 A, 128 W 6286A, 57–63 Hz, 5.5 A, 320 W;  
6289A, 48–440 Hz, 1.3 A, 110 W 6291A, 57–63 Hz, 5.5 A, 280 W;  
6294A, 48–440 Hz, 1.3 A, 114 W 6296A, 57–63 Hz, 4.5 A, 250 W;  
6299A, 48–440 Hz, 1.5 A, 135 W.

**Size:** 6224B, & 6226B: 166 H x 130 W x 294 mm D ( $6\frac{1}{2}$ " x  $5\frac{1}{8}$ " x  $11\frac{1}{16}$ "). 6253A, 6255A: 87 H x 483 W x 403 mm D ( $3\frac{7}{16}$ " x  $19$ " x  $15\frac{5}{16}$ "). 6281A, 6284A, 6289A, 6294A, 6299A: 87 H x 209 W x 398 mm D ( $3\frac{7}{16}$ " x  $8\frac{7}{32}$ " x  $15\frac{5}{16}$ "). 6282A, 6286A, 6291A, 6296A: 131 H x 210 W x 435 mm D ( $5\frac{1}{32}$ " x  $8\frac{1}{4}$ " x  $17\frac{1}{16}$ ").

**Temperature:** operating, 0 to 55°C; storage, –40 to 75°C.

**Specifications, continued**

REMOTE CONTROL FEATURES								GENERAL					
Resistance Coefficient		Voltage Coefficient		Speed, UP*		Speed, DOWN*		Overvoltage		Weight		Options <sup>a</sup>	Price
Voltage	Current	Voltage	Current	NL	FL	NL	FL	Range	Margin	Net	Shipping		
200 $\Omega$ /V $\pm 1\%$	200 $\Omega$ /A $\pm 10\%$	1 V/V $\pm 1\%$	0.2 V/A $\pm 10\%$	1 ms	2 ms	10 ms	6 ms	2.5–10 V	4% + 2 V	6.4 kg/14 lb	7.2 kg/16 lb	9, 11, 15, 28, 40	\$525
200 $\Omega$ /V $\pm 1\%$	100 $\Omega$ /A $\pm 10\%$	1 V/V $\pm 1\%$	100 mV/A $\pm 10\%$	70 ms	200 ms	9 s	40 ms	1–13 V	7% + 1 V	11.3 kg/25 lb	13.6 kg/30 lb	5, 9, 11, 15, 28, 40	\$675
200 $\Omega$ /V $\pm 1\%$	500 $\Omega$ /A $\pm 10\%$	1 V/V $\pm 1\%$	0.33 V/A $\pm 10\%$	30 ms	80 ms	400 ms	100 ms	2.5–23 V	4% + 2V	12.7 kg/28 lb	17.7 kg/39 lb	9, 10, 11, 15, 28, 40	\$850
200 $\Omega$ /V $\pm 1\%$	500 $\Omega$ /A $\pm 10\%$	1 V/V $\pm 1\%$	0.33 V/A $\pm 10\%$	30 ms	80 ms	400 ms	100 ms	2.5–23 V	4% + 2 V	6.4 kg/14 lb	7.2 kg/16 lb	9, 11, 15, 28, 40	\$450
200 $\Omega$ /V $\pm 1\%$	100 $\Omega$ /A $\pm 10\%$	1 V/V $\pm 1\%$	100 mV/A $\pm 10\%$	150 ms	150 ms	9 s	70 ms	2–22 V	7% + 1 V	10.8 kg/26 lb	13.1 kg/29 lb	5, 9, 11, 15, 28	\$675
200 $\Omega$ /V $\pm 1\%$	500 $\Omega$ /A $\pm 10\%$	1 V/V $\pm 1\%$	0.33 V/A $\pm 10\%$	4 ms	10 ms	50 ms	15 ms	NA	NA	7.3 kg/16 lb	9.5 kg/21 lb	15, 28, 40	\$650
200 $\Omega$ /V $\pm 1\%$	500 $\Omega$ /A $\pm 10\%$	1 V/V $\pm 1\%$	0.66 V/A $\pm 10\%$	15 ms	45 ms	200 ms	40 ms	2.5–44 V	4% + 2 V	12.7 kg/28 lb	17.7 kg/39 lb	9, 10, 11, 15, 28, 40	\$850
200 $\Omega$ /V $\pm 1\%$	500 $\Omega$ /A $\pm 10\%$	1 V/V $\pm 1\%$	0.66 V/A $\pm 10\%$	15 ms	45 ms	200 ms	40 ms	2.5–44 V	4% + 2 V	6.4 kg/14 lb	7.2 kg/16 lb	9, 11, 15, 28, 40	\$450
200 $\Omega$ /V $\pm 1\%$	200 $\Omega$ /A $\pm 10\%$	1V/V $\pm 1\%$	200 mV/A $\pm 10\%$	275 ms	275 ms	13 s	275 ms	6–43 V	7% + 1V	11.3 kg/25 lb	12.7 kg/28 lb	5, 9, 11, 15, 28	\$675
200 $\Omega$ /V $\pm 1\%$	500 $\Omega$ /A $\pm 10\%$	1V/V	1 V/A	20 ms	65 ms	200 ms	50 ms	NA	NA	7.3 kg/16 lb	8.2 kg/18 lb	15, 28, 40	\$650
300 $\Omega$ /V $\pm 1\%$	1 k $\Omega$ /A $\pm 10\%$	1 V/V $\pm 1\%$	1 V/A $\pm 10\%$	25 ms	80 ms	2 s	175 ms	5–65 V	4% + 2 V	5.9 kg/13 lb	6.8 kg/15 lb	9, 11, 15, 28, 40	\$475
300 $\Omega$ /V $\pm 1\%$	500 $\Omega$ /A $\pm 10\%$	1V/V $\pm 1\%$	333 mV/A $\pm 10\%$	600 ms	600 ms	5 s	200 ms	9–66 V	7% + 1 V	11.3 kg/25 lb	12.7 kg/28 lb	5, 9, 11, 15, 28	\$675
300 $\Omega$ /V $\pm 1\%$	1 k $\Omega$ /A $\pm 10\%$	1 V/V $\pm 1\%$	1.3 V/A $\pm 10\%$	25 ms	200 ms	1.5 s	200 ms	20–106 V	4% + 2 V	5.9 kg/13 lb	6.8 kg/15 lb	11, 15, 28, 40	\$495

<sup>a</sup>See page 260 for complete option and accessory descriptions.

\*Up = increasing output voltage. NL = No output load current. FL = Full rated output load current.



## POWER SUPPLIES

General Purpose: Autoranging—200 & 1000 W output

Models 6012A and 6024A

- Autoranging output
- Ten-turn voltage and current controls
- Fast remote programming speed

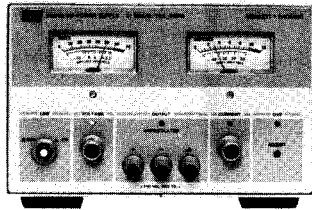

6024A—200 watts

### Autoranging Power Supply Description

The model 6012A and 6024A set a new technological standard for laboratory and system dc power supplies. They are the first in a new generation of power supplies from Hewlett-Packard, combining state of the art advances in both components and circuit design. The result is increased performance and flexibility, and friendlier operation both on the bench and in automated test and control systems.

The basic difference between an autoranging power supply and conventional Constant Voltage/Constant Current (CV/CC) power supplies can be seen by comparing the output characteristics of each. A conventional CV/CC power supply can provide maximum output power at only one combination of output voltage and current. Autoranging power supplies provide maximum output power over a wide and continuous range of voltage and current combinations, without the operator having to manually select the proper output range.

Using the model 6024A as an example, you would have to combine a 20-volt 10-amp supply, a 40-volt 5-amp supply, and a 60-volt 3-amp supply in order to approximate the same capability as the 6024A. (See output curves on next page.) The extended range feature of these power supplies makes them a convenient and cost-effective unit capable of satisfying many different dc requirements.

### In the Lab . . . .

Both models have many features that make them versatile. Mode indicators, adjustable overvoltage protection, 10-turn pots, amplified current monitor terminals, and voltage and current meters are some of the features. A barrier strip at the rear of the supply provides the necessary terminals for current monitoring, remote programming, and remote sensing. Auto-Parallel—Up to eight units of the same model may be connected in parallel to increase total output current capability while maintaining control from one master power supply. Auto-Series—Up to four units may be connected in series to increase total output voltage to 240V while maintaining control from one master power supply.

Several LEDs on the front panel indicate the operating status. Two of them are green and indicate whether the supply is in constant-voltage or constant-current operation. Red LEDs signal an unregulated output condition whenever the power supply exceeds its output power rating, or an overtemperature condition or ac brownout occurs. Another red LED indicates when the overvoltage protection (OVP) circuit is enabled. These indicators provide the power supply operating status without any further measurements or control changes.

Two 10-turn potentiometers on the front panel provide high resolution control of output voltage and current. Therefore the user does not have to compromise resolution at low voltages. A secondary scale on the voltmeter indicates maximum "Amperes Available". Likewise, the ammeter has a secondary scale to indicate the "Volts Available". The secondary scales are calibrated to follow the maximum output power curve and let the user know approximately how much power margin is available at any operating point.

Because of the delicate nature of many loads several types of protection have been included. When operating in constant-voltage mode, a maximum current limit can be set. Similarly, when operating in constant-current mode, a maximum compliance voltage can be set.

- Designed for system applications
- Operating mode status indicators
- High efficiency, compact and lightweight

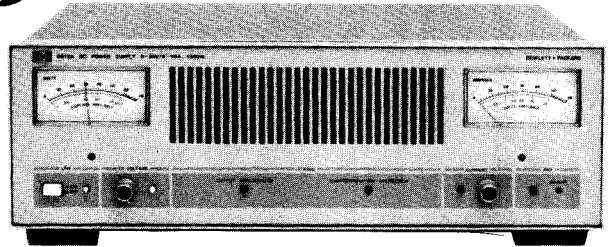

6012A—1000 watts

These supplies also feature an adjustable overvoltage protection circuit.

### In the System . . . .

System designers frequently need a variety of fixed and programmable power supplies. In general, the power supply is selected by taking into consideration the existing and anticipated applications of the system. Since it is difficult to fully identify all of the system lifetime requirements, a high performance, wide voltage/current range, system compatible supply has high merit. Furthermore, by standardizing on autoranging power supplies the system designer can reduce the number of different models needed along with their consequent documentation and support requirements.

Two programming techniques are available—voltage and resistance. Either of these techniques can be used to program the output voltage or current. Both models offer fast programming speed. In a no-load, down-programming condition this active down-programming speed gives an improvement of up to 15-to-1 over a conventional power supply of similar output rating. Sensing terminals are located at the rear of the power supply for applications where the load may be some distance from the supply. When using remote sensing, the power supply maintains regulation at the load rather than at the rear terminals of the supply. The amplified current monitor feature provides a voltage referenced to the negative output terminal that is proportional to the output current.

Some of the most important benefits of using these supplies in systems results from the switching technology employed. A switching frequency of 20 kHz is used which allows most power handling components, as well as the filter capacitors, to be substantially reduced in size. This contributes to the reduced size and weight of the supply. Typical operating efficiency is 75%, which reduces the amount of cooling necessary for the overall system and enables the system to use less power.

The optional interface (Option 002) provides a convenient low-cost means of integrating the supply into a system. The interface features are available through a 37-pin connector on the back of the power supply, and include:

**Remote Programming:** Both the output voltage and current can be remotely programmed. In addition to external voltage and resistance programming, the interface allows current programming.

**Status Readback:** Six optically isolated status lines provide a digital output to indicate the following states: constant-voltage, constant current, unregulated output, ac line fault, overtemperature, and over-voltage.

**Remote Shutdown:** There are two methods to remotely disable the output. The first method, utilizing two inputs, allows one input to be pulse "set" and the other to be pulse "reset." The second method uses one input whose level determines the output condition. These input lines are TTL compatible and optically isolated to prevent ground loops.

**Output Bias Supplies:** Three bias supplies are available with +5V, +15V, and -15V to power DAC's and other user supplied circuitry.

**Voltage & Current Readback:** For convenience, both are brought through the option connector.



### Specifications for model 6024A—200 watts

**DC Output:** Voltage and current output can be adjusted over the ranges indicated by using front panel controls, analog programming, or optional system interface.

**Voltage:** 0–60 V **Current:** 0–10 A  
Maximum available output power from 20V to 60V is indicated below.

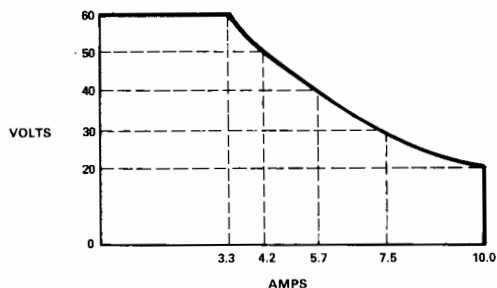

**Load Effect:** (Load Regulation):

**Voltage:** 0.01% + 3 mV **Current:** 0.01% + 3 mA

**Source Effect:**

**Voltage:** 0.01% + 2 mV **Current:** 0.01% + 2 mA

**Pard:** (Ripple and Noise) RMS/p-p, 20Hz to 20 MHz:

**Voltage:** 3 mV/30 mV **Current:** 5 mA RMS

**Temperature Coefficient:**  $\Delta/^\circ\text{C}$  after 30 minute warmup:

**Voltage:** 0.01% + 1 mV **Current:** 0.03% + 1 mA

**Drift:** (Stability) change in output over an 8 hour interval.

**Voltage:** 0.03% + 3 mV **Current:** 0.03% + 3 mA

**Load Transient Recovery Time:** Less than 1 ms for output voltage recovery to within 75 mV of the nominal output following a change in output current from 90% to 100% or 100% to 90% of maximum current.

**Resolution:** (Minimum adjustment of front panel controls):

**Voltage:** 20 mV **Current:** 5.0 mA

**Output Impedance:** Typical value is  $1\text{m}\Omega$  in series with  $30\ \mu\text{H}$ .

**Remote Control (Analog Programming):**

Resistance necessary for full scale output of:

**Voltage:** 2500 $\Omega$  **Current:** 2500 $\Omega$

**Accuracy:** 0.8% + 1 mV **Accuracy:** 2.4% + 1 mA

Voltage necessary for full scale output of:

**Voltage:** 5 volts **Current:** 5 volts

**Accuracy:** 0.2% + 1 mV **Accuracy:** 0.9% + 1 mA

**Programming Response Time:** Maximum time for output voltage to change from 0V to 60V or 60V to 2V and settle within 60 mV.

**Up:** Full Load (18 $\Omega$ ) 200ms **Down:** Full Load (18 $\Omega$ ) 300ms

No Load 200ms No Load 600ms

**Overvoltage Protection:** Trip voltage adjustable from 2 to 64 volts.

**Amplified Current Monitor:** 0-5V monitor output for 0-10 A output.

**Accuracy:** 0.9% + 7 mV **Output Impedance:** 10 k $\Omega$  nom.

**EMI Specifications:** Meets VDE 0871/6.78 Level A.

**Safety Specifications:** Complies with IEC 348, VDE 0411, CSA 556B, CSA C22.2 #0-1975

**Meter Accuracy:**  $\pm 3\%$  of full scale

**DC Output Isolation:**  $\pm 240$  Vdc from ground

**Temperature Rating:** Operating: 0 to 55 $^\circ\text{C}$ .

Storage: -40 to +75 $^\circ\text{C}$ . Fan Cooled

**AC Input:** 104–127 Vac 48–63 Hz, 5.3 A RMS maximum.

#### System interface option specifications

**Remote Control (Analog Programming):**

Sink current necessary for full scale of:

**Voltage:** 2 mA **Current:** 2 mA

**Accuracy:** 0.3% + 7 mV **Accuracy:** 1% + 2 mA

**Isolation:** Status and control lines; 600Vdc max from equipment ground, from the power supply output or from each other.

**Weight:** Net 5.4 kg (12 lbs.). Shipping 7.3 kg (16 lbs.).

#### Ordering Information

Model	Price
6024A Power Supply	\$875
Option 002: System Interface	\$300
Option 220: 191–233 VAC, 48–63 Hz	N/C
Option 240: 208–250 VAC, 48–63 Hz	N/C
Option 910: Extra Operating & Service Manual	\$10

### Specifications for model 6012A—1000 watts

**DC Output:** Voltage and current output can be adjusted over the ranges indicated by using front panel controls, analog programming, or optional system interfaces.

**Voltage:** 0–60 V **Current:** 0–50 A  
Maximum available output power from 20V to 60V is indicated below.

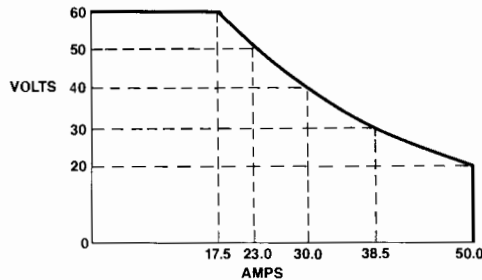

**Load Effect:** (Load Regulation):

**Voltage:** 0.01% + 5 mV **Current:** 0.01% + 5 mA

**Source Effect:**

**Voltage:** 0.01% + 3 mV **Current:** 0.01% + 5 mA

**Pard:** (Ripple and Noise) RMS/p-p, 20Hz to 20MHz:

**Voltage:** 5 mV/50 mV **Current:** 25 mA RMS

**Temperature Coefficient:**  $\Delta/^\circ\text{C}$  after 30 minute warmup:

**Voltage:** 0.01% + 2 mV **Current:** 0.01% + 3 mA

**Drift:** (Stability) change in output over an 8 hour interval.

**Voltage:** 0.03% + 5 mV **Current:** 0.03% + 5 mA

**Load Transient Recovery Time:** Less than 2 ms for output voltage recovery to within 100 mV of the nominal output following a change in output current from 90% to 100% or 100% to 90% of maximum current.

**Resolution:** (Minimum adjustment of front panel controls):

**Voltage:** 20 mV **Current:** 20 mA

**Output Impedance:** Typical value is  $0.2\text{m}\Omega$  in series with  $15\ \mu\text{H}$ .

**Remote Control (Analog Programming):**

Resistance necessary for full scale output of:

**Voltage:** 2500 $\Omega$  **Current:** 2500 $\Omega$

**Accuracy:** 1% + 3 mV **Accuracy:** 2.5% + 10 mA

Voltage necessary for full scale output of:

**Voltage:** 5 volts **Current:** 5 volts

**Accuracy:** 0.3% + 3 mV **Accuracy:** 1% + 10 mA

**Programming Response Time:** Maximum time for output voltage to change from 0V to 60V or 60V to 2V and settle within 200 mV.

**Up:** Full Load (3.4 $\Omega$ ) 120ms **Down:** Full Load (3.4 $\Omega$ ) 400ms

No Load 120ms No Load 1.2s

**Overvoltage Protection:** Trip voltage adjustable from 2 to 60 volts.

**Amplified Current Monitor:** 0-5V monitor output for 0-50 A output.

**Accuracy:** 1% + 10 mV **Output Impedance:** 10 k $\Omega$  nom.

**EMI Specifications:** Meets VDE 0871/6.78 Level A.

**Safety Specifications:** Complies with IEC 348, VDE 0411, CSA 556B, CSA C22.2 #0-1975

**Meter Accuracy:**  $\pm 3\%$  of full scale

**DC Output Isolation:**  $\pm 240$  Vdc from ground

**Temperature Rating:** Operating: 0 to 50 $^\circ\text{C}$ .

Storage: -40 to +75 $^\circ\text{C}$ . Fan Cooled

**AC Input:** 104–127 Vac 48–63 Hz, 24 A RMS maximum.

#### System interface option specifications

**Remote Control (Analog Programming):**

Sink current necessary for full scale of:

**Voltage:** 2 mA **Current:** 2 mA

**Accuracy:** 0.4% + 9 mV **Accuracy:** 1.1% + 15 mA

**Isolation:** Status and control lines; 600 Vdc max from equipment ground, from the power supply output or from each other.

**Weight:** Net 15 kg (33 lbs.). Shipping 16 kg (35 lbs.).

#### Ordering Information

Model	Price
6012A Power Supply	\$1550
Option 002: System Interface	\$300
Option 220: 191–233 VAC, 48–63 Hz	N/C
Option 240: 208–250 VAC, 48–63 Hz	N/C
Option 910: Extra Operating & Service Manual	\$10

# POWER SUPPLIES

General purpose: 120–2000 W output  
Models 6259B-6274B & 895A

- Built-in overvoltage protection\*
- Constant voltage/constant current operation
- Remote programming and sensing

- Remote sensing
- Auto-series, -parallel, and -tracking operation
- $\leq 50 \mu\text{sec}$  load transient recovery

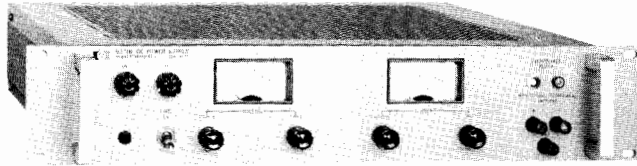

6263B, 6265B, 6266B, 6271B

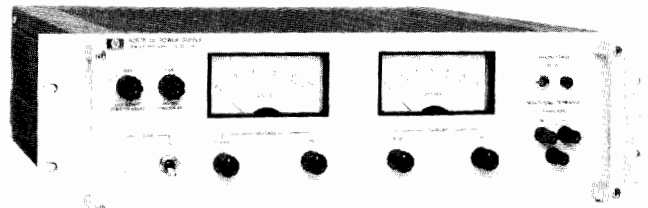

6264B, 6267B

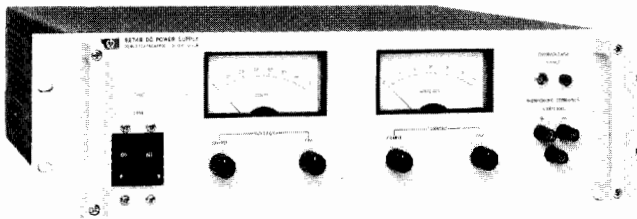

6274B

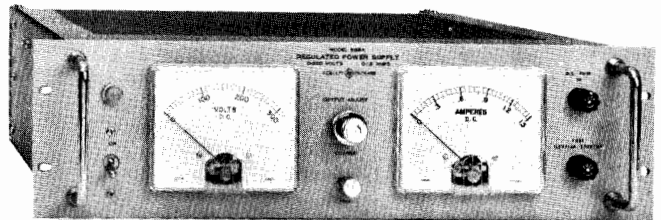

895A

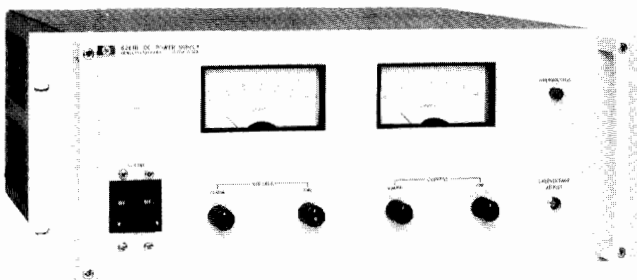

6259B, 6260B, 6261B, 6268B, 6269B

## Models 6259B-6274B

The series of high-performance Constant Voltage/Constant Current supplies includes twelve models with output rating from 10 to 60 V. All models employ a transistor series-regulator/triac-preregulator circuit to achieve high efficiency, excellent regulation, low ripple and noise, and moderate programming speeds in a compact full-rack width package.

Separate coarse and fine voltage and current controls allow the voltage and current outputs to be varied from zero to the maximum rated value, crossover from constant voltage to constant current operation occurs automatically when the load current exceeds the value established by the current control settings.

\*These six features apply to models 6259B-6274B, but not to model 895A.

## Specifications†

RATINGS		PERFORMANCE								
DC Output		Model	Load Effect		Source Effect		PAR (rms/p-p)		Drift (stability)	
Volts	Amps		Voltage	Current	Voltage	Current	Voltage	Current	Voltage	Current
0-10	0-50	6259B	0.01% + 200 $\mu\text{V}$	0.02% + 1 mA	0.01% + 200 $\mu\text{V}$	0.02% + 1 mA	500 $\mu\text{V}/5 \text{ mV}$	25 mA rms	0.03% + 2 mV	0.03% + 10 mA
0-10	0-100	6260B	0.01% + 200 $\mu\text{V}$	0.02% + 2 mA	0.01% + 200 $\mu\text{V}$	0.02% + 2 mA	500 $\mu\text{V}/5 \text{ mV}$	50 mA rms	0.03% + 2 mV	0.03% + 20 mA
0-20	0-10	6263B	0.01% + 200 $\mu\text{V}$	0.02% + 500 $\mu\text{A}$	0.01% + 200 $\mu\text{V}$	0.02% + 500 $\mu\text{A}$	200 $\mu\text{V}/10 \text{ mV}$	3 mA rms	0.03% + 500 $\mu\text{V}$	0.03% + 6 mA
0-20	0-20	6264B	0.01% + 200 $\mu\text{V}$	0.02% + 500 $\mu\text{A}$	0.01% + 200 $\mu\text{V}$	0.02% + 500 $\mu\text{A}$	200 $\mu\text{V}/10 \text{ mV}$	5 mA rms	0.03% + 500 $\mu\text{V}$	0.03% + 6 mA
0-20	0-50	6261B	0.01% + 200 $\mu\text{V}$	0.02% + 1 mA	0.01% + 200 $\mu\text{V}$	0.02% + 1 mA	500 $\mu\text{V}/5 \text{ mV}$	25 mA rms	0.03% + 2 mV	0.03% + 10 mA
0-40	0-3	6265B	0.01% + 200 $\mu\text{V}$	0.02% + 500 $\mu\text{A}$	0.01% + 200 $\mu\text{V}$	0.02% + 500 $\mu\text{A}$	200 $\mu\text{V}/10 \text{ mV}$	3 mA rms	0.03% + 500 $\mu\text{V}$	0.03% + 3 mA
0-40	0-5	6266B	0.01% + 200 $\mu\text{V}$	0.02% + 500 $\mu\text{A}$	0.01% + 200 $\mu\text{V}$	0.02% + 500 $\mu\text{A}$	200 $\mu\text{V}/10 \text{ mV}$	3 mA rms	0.03% + 500 $\mu\text{V}$	0.03% + 3 mA
0-40	0-10	6267B	0.01% + 200 $\mu\text{V}$	0.02% + 500 $\mu\text{A}$	0.01% + 200 $\mu\text{V}$	0.02% + 500 $\mu\text{A}$	200 $\mu\text{V}/10 \text{ mV}$	3 mA rms	0.03% + 2 mV	0.03% + 3 mA
0-40	0-30	6268B	0.01% + 200 $\mu\text{V}$	0.02% + 2 mA	0.01% + 200 $\mu\text{V}$	0.02% + 2 mA	1 mV/5 mV	20 mA rms	0.03% + 2 mV	0.03% + 5 mA
0-40	0-50	6269B	0.01% + 200 $\mu\text{V}$	0.02% + 2 mA	0.01% + 200 $\mu\text{V}$	0.02% + 2 mA	1 mV/5 mV	25 mA rms	0.03% + 2 mV	0.03% + 10 mA
0-60	0-3	6271B	0.01% + 200 $\mu\text{V}$	0.02% + 500 $\mu\text{A}$	0.01% + 200 $\mu\text{V}$	0.02% + 500 $\mu\text{A}$	200 $\mu\text{V}/10 \text{ mV}$	3 mA rms	0.03% + 500 $\mu\text{V}$	0.03% + 3 mA
0-60	0-15	6274B	0.01% + 200 $\mu\text{V}$	0.02% + 500 $\mu\text{A}$	0.01% + 200 $\mu\text{V}$	0.02% + 500 $\mu\text{A}$	200 $\mu\text{V}/20 \text{ mV}$	5 mA rms	0.03% + 2 mV	0.03% + 5 mA
0-320	0-1.5	895A	0.007% or 20 mV	—	0.007% or 20 mV	—	1 mV rms	—	0.1% + 5 mV	—

†Refer to page 237 for complete specification definitions.



Additional features include built-in overvoltage crowbar protection; remote error sensing; and auto-series, auto-parallel, and auto-tracking operation. The crowbar trip point adjustment and associated overvoltage indicator are conveniently located on the front panel.

Auto-series, auto-parallel, and auto-tracking connections should ordinarily include no more than three supplies. If a specific application requires the use of more than three supplies in any of the three connections, consult your local HP Field Engineer for additional information.

All dc output, ac input, sensing, control, and programming connections are made to rear-panel terminals. Either the positive or negative output terminal may be grounded or the supplies may be operated floating at up to 300 volts above ground. Models 6263B, 6264B, 6265B, 6266B, 6267B, and 6271B are convection cooled. All other models in this series employ cooling fans.

## Model 895A

Model 895A is a general purpose Constant-Voltage/Current-Limit supply. Output voltage is adjustable from 0-320 V via a front panel 10-turn potentiometer with concentric lock and a single-turn fine control. Separate voltage and current meters provide continuous indication of power supply outputs. High performance specifications include 0.007% line and load regulation and 1 mV rms ripple and noise. Remote sensing and programming are standard features.

### Accessories and options

The accessories and options available for use with Models 6259B-6274B, 895A are listed on page 260. Special option J10 provides 220V/50 Hz operation of the model 895A only.

## Specifications—General

**Load effect transient recovery:** time—50  $\mu$ s. Level—10 mV

**Resolution:** voltage control—less than 0.02%. Current control—less than 0.15%.

**Temperature coefficient per °C:** 0.01% of output plus 200  $\mu$ V (895A—0.03% + 1.5 mV).

**Temperature ratings:** operating, 0 to 55°C; Storage, -40 to 75°C.

**Remote control programming:** these power supplies are capable of being programmed in constant voltage and constant current operation by using an external resistance or DC voltage with coefficients as shown in the table below.

Rear terminal wiring configurations for remote control operation are specified in the operation and service manual supplied with the power supply. For remote control programming procedures and timing considerations, contact your local HP field engineer.

**Power:** input voltage is 115V ac or 230 V ac  $\pm$  10%, 57-63 Hz. For other input voltage and frequency options available, see option listing below and page 260. Standard input voltage, maximum input current, and maximum power are:

6259B, 230 V ac, 6 A, 850 W†; 6260B, 230 V ac, 12 A, 1600 W†; 6261B, 230 V ac, 12 A 1500 W†; 6263B, 115 V ac, 4.5 A, 350 W\*; 6264B, 115 V ac, 8 A, 600 W†; 6265B, 115 V ac, 3 A, 180 W\*; 6266B, 115 V ac, 4 A, 325 W\*; 6267B, 115 V ac, 8 A, 550 W†; 6268B, 230V ac, 12 A, 1600 W†; 6269B, 230 V ac, 18 A, 2500 W†; 6271B, 115 V ac, 4 A, 300 W\*; 6274B, 115 V ac, 15 A, 1200 W†; 895A, 115 V ac, 8.7 A, 585 W†.

\*Three-wire, five-foot AC power cord included with power supply.

†Three-terminal barrier strip provided on power supply for AC power connections.

### Size:

6263B, 6265B, 6266B, 6271B: 83.7 H x 483 W x 479.4 mm D (3.296" x 19" x 18.875").

6264B, 6267B, 6274B: 127 H x 483 W x 479.4 mm D (5.00" x 19" x 18.875").

6259B, 6260B, 6261B, 6268B, 6269B: 173 H x 483 W x 479.4 mm D; (6.812" x 19" x 18.875").

895A: 128.6 H x 483 W x 463.6 mm D (5.062" x 19" x 18.25").

**Typical output impedance:** approximated by a resistance in series with an inductance:

6259B, 50  $\mu$  $\Omega$ , 1  $\mu$ H;

6260B, 20  $\mu$  $\Omega$ , 1  $\mu$ H;

6263B, 500  $\mu$  $\Omega$ , 1  $\mu$ H;

6265B, 2 m $\Omega$ , 1  $\mu$ H;

6267B, 500  $\mu$  $\Omega$ , 1  $\mu$ H;

6269B, 100  $\mu$  $\Omega$ , 1  $\mu$ H;

6274B, 1 m $\Omega$ , 1  $\mu$ H;

6261B, 100  $\mu$  $\Omega$ , 1  $\mu$ H;

6264B, 200  $\mu$  $\Omega$ , 1  $\mu$ H;

6266B, 1 m $\Omega$ , 1  $\mu$ H;

6268B, 200  $\mu$  $\Omega$ , 1  $\mu$ H;

6271B, 5 m $\Omega$ , 1  $\mu$ H;

895A, 40 m $\Omega$ , 16  $\mu$ H.

## Specifications, continued

REMOTE CONTROL FEATURES								GENERAL					
Resistance Coeff.		Voltage Coeff.		Speed Up*		Speed Down*		Overvoltage		Weight		Options <sup>▲</sup>	Price
Voltage	Current	Voltage	Current	NL	FL	NL	FL	Range	Margin	Net	Shipping		
200 $\Omega$ /V $\pm$ 1%	4 $\Omega$ /A $\pm$ 10%	1 V/V $\pm$ 1%	10 mV/A $\pm$ 10%	70 ms	70 ms	200 ms	100 ms	2-12 V	5% + 2V	31.3 kg/69 lb	35.3 kg/78 lb	5, 9, 10, 15, 22, 26, 27, 40	\$1275
200 $\Omega$ /V $\pm$ 1%	2 $\Omega$ /A $\pm$ 10%	1 V/V $\pm$ 1%	5 mV/A $\pm$ 10%	70 ms	70 ms	200 ms	75 ms	2-12 V	5% + 2V	43.9 kg/97 lb	48 kg/106 lb	5, 9, 10, 15, 16, 22, 27, 40	\$1475
200 $\Omega$ /V $\pm$ 1%	100 $\Omega$ /A $\pm$ 10%	1 V/V $\pm$ 1%	50 mV/A $\pm$ 10%	150 ms	150 ms	7 s	350 ms	2-23 V	5% + 1V	15.4 kg/34 lb	18.6 kg/41 lb	5, 9, 10, 15, 22, 27, 28, 40	\$900
200 $\Omega$ /V $\pm$ 1%	10 $\Omega$ /A $\pm$ 10%	1 V/V $\pm$ 1%	25 mV/A $\pm$ 10%	140 ms	140 ms	10 s	150 ms	2.5-23V	5% + 1V	21.3 kg/47 lb	24.5 kg/54 lb	5, 9, 10, 15, 22, 27, 28, 40	\$995
200 $\Omega$ /V $\pm$ 1%	4 $\Omega$ /A $\pm$ 10%	1 V/V $\pm$ 1%	10 mV/A $\pm$ 10%	150 ms	150 ms	250 ms	250 ms	2-23 V	5% + 2V	35.3 kg/78 lb	39.4 kg/87 lb	5, 9, 10, 15, 22, 26, 27, 40	\$1375
200 $\Omega$ /V $\pm$ 1%	300 $\Omega$ /A $\pm$ 10%	1 V/V $\pm$ 1%	167 mV/A $\pm$ 10%	275 ms	275 ms	12 s	1.5 s	2.5-45 V	5% + 1V	15.4 kg/34 lb	18.6 kg/41 lb	5, 9, 10, 15, 22, 27, 28, 40	\$825
200 $\Omega$ /V $\pm$ 1%	200 $\Omega$ /A $\pm$ 10%	1 V/V $\pm$ 1%	100 mV/A $\pm$ 10%	275 ms	275 ms	13 s	1.5 s	2.5-45 V	5% + 1V	15.4 kg/34 lb	18.6 kg/41 lb	5, 9, 10, 15, 22, 27, 28, 40	\$875
200 $\Omega$ /V $\pm$ 1%	100 $\Omega$ /A $\pm$ 10%	1 V/V $\pm$ 1%	50 mV/A $\pm$ 10%	275 ms	275 ms	13 s	750 ms	2.5-45 V	5% + 1V	17.7 kg/39 lb	20.8 kg/46 lb	5, 9, 10, 15, 22, 27, 28, 40	\$975
200 $\Omega$ /V $\pm$ 1%	6 $\Omega$ /A $\pm$ 10%	1 V/V $\pm$ 1%	16.7 mV/A $\pm$ 10%	300 ms	300 ms	1 s	650 ms	4-45 V	5% + 1V	34.4 kg/76 lb	38.1 kg/84 lb	5, 9, 10, 15, 22, 26, 27, 40	\$1325
200 $\Omega$ /V $\pm$ 1%	4 $\Omega$ /A $\pm$ 10%	1 V/V $\pm$ 1%	10 mV/A $\pm$ 10%	350 ms	350 ms	1 s	600 ms	4-45 V	5% + 1V	40.3 kg/89 lb	44 kg/98 lb	5, 9, 10, 15, 22, 27, 40	\$1400
300 $\Omega$ /V $\pm$ 1%	300 $\Omega$ /A $\pm$ 10%	1 V/V $\pm$ 1%	167 mV/A $\pm$ 10%	600 ms	600 ms	7 s	2 s	6-66 V	5% + 1V	15.4 kg/34 lb	18.6 kg/41 lb	5, 9, 10, 15, 22, 27, 28, 40	\$850
300 $\Omega$ /V $\pm$ 1%	67 $\Omega$ /A $\pm$ 10%	1 V/V $\pm$ 1%	33.3 mV/A $\pm$ 10%	600 ms	600 ms	40 s	800 ms	6-66 V	5% + 1V	21.7 kg/48 lb	24.5 kg/54 lb	5, 9, 10, 15, 22, 27, 28, 40	\$1150
300 $\Omega$ /V	—	—	—	—	—	—	—	NA	NA	22.6 kg/50 lb	29.4 kg/65 lb	J10	\$1250

\*Up = increasing output voltage. NL = No output load current. FL = Full rated output load current

▲See page 260 for complete option and accessory descriptions. 895A-J10 is a special option for 220V/50Hz operation

# POWER SUPPLIES

General purpose: 300—11,000 W output

Models 6428B—6483C

- Outstanding value—low cost/watt
- Up to 75% efficiency at full output
- Constant voltage/current operation

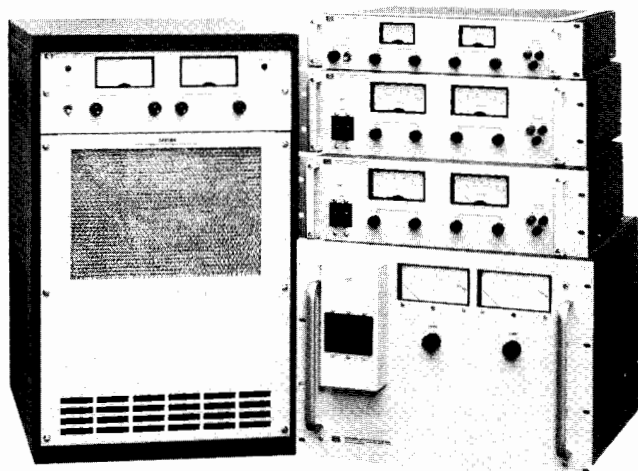

6428B—6483C

## Description

This series of SCR-regulated power supplies is designed for high-power applications requiring a fixed or variable DC source with moderate regulation and ripple. For supplies with better regulation, faster response time, and lower ripple, see models 6259B—6274B and 895A, on page 248.

## Operating Features

All supplies in this series are of the Constant-Voltage/Constant-Current type. Large easy-to-read panel meters continuously monitor output voltage current.

## Specifications†

RATINGS			PERFORMANCE						
DC Output		Model	Load Effect		Source Effect		PAR Δ rms/p-p	Temperature Coefficient	Drift
Volts§	Amps§		Voltage	Current	Voltage	Current			
0-8	0-1000	6464C	0.05% + 5 mV	0.1% + 1 A	0.05% + 5 mV	0.1% + 1 A	80 mV/1V	0.03% + 100 μV	0.03% + 1 mV
0-15	0-200	6453A	0.2% + 10 mV††	1% or 2A††	0.2% + 10 mV††	1% or 2A††	150 mV rms	0.05% + 2 mV	0.25% + 10 mV
0-16 or 18	0-600 or 500*	6466C	0.05% + 5mV	0.1% + 0.6 A	0.05% + 5 mV	0.1% + 0.6 A	180 mV/1V	0.03% + 200 μV	0.2% + 1 mV
0-20	0-45	6428B	40 mV	450 mA	20 mV	450 mA	40 mV/500 mV	0.05% + 5 mV	0.15% + 15 mV
0-36	0-10	6433B	36 mV	100 mA	18 mV	100 mA	36 mV/400 mV	0.03% + 5 mV	0.1% + 15 mV
0-36	0-100	6456B	0.2% + 10 mV††	1% or 1 A††	0.2% + 10 mV††	1% or 1 A††	180 mV rms	0.05% + 2 mV	0.25% + 10 mV
0-36	0-300	6469C	0.05% + 5 mV	0.1% + 0.3 A	0.05% + 5 mV	0.1% + 0.3A	180 mV/1 V	0.03% + 400 μV	0.15% + 1 mV
0-40	0-25	6434B	40 mV	200 mA	18 mV	200 mA	40 mV/500 mV	0.03% + 5 mV	0.1% + 20 mV
0-60	0-5	6438B	60 mV	50 mA	30 mV	50 mA	120 mV/400 mV	0.03% + 10 mV	0.1% + 30 mV
0-60	0-15	6439B	120 mV	150 mA	60 mV	150 mA	60 mV/500 mV	0.03% + 10 mV	0.1% + 30 mV
0-64	0-50	6459A	0.2% + 10 mV††	1% or 0.5 A††	0.2% + 10 mV††	1% or 0.5 A††	160 mV rms	0.05% + 2 mV	0.25% + 10 mV
0-64	0-150	6472C	0.05% + 100 mV	0.1% + 0.15 A	0.05% + 100 mV	0.1% + 0.15 A	160 mV/2V	0.03% + 4 mV	0.15% + 16 mV
0-110	0-100	6475C	0.05% + 100 mV	0.1% + 0.1 A	0.05% + 100 mV	0.1% + 0.1 A	200 mV/2 V	0.03% + 5 mV	0.15% + 20 mV
0-120	0-2.5	6443B	120 mV	25 mA	60 mV	25 mA	240 mV/400 mV	0.03% + 20 mV	0.1% + 60 mV
0-220	0-50	6477C	0.05% + 100 mV	0.1% + 50 mA	0.05% + 100 mV	0.1% + 50 mA	330 mV/2 V	0.03% + 8 mV	0.15% + 35 mV
0-300	0-35	6479C	0.05% + 100 mV	0.1% + 35 mA	0.05% + 100 mV	0.1% + 35 mA	330 mV/3 V	0.03% + 11 mV	0.15% + 45 mV
0-440, 500 or 600	0-25, 20, 15*	6483C	0.05% + 100 mV	0.1% + 35 mA	0.5% + 100 mV	0.1% + 35 mA	600 mV/5 V	0.03% + 20 mV	0.15% + 80 mV
1-600	5 mA-1.5 A	6448B	1 V	40 mA	600 mV	15 mA	600 mV/2 V	0.03% + 100 mV	0.1% + 300 mV

†Refer to page 237 for complete specification definitions.

††Specified for combined line and load regulation.

Δ For operation with a 50 Hz input (possible only with Option 005), the rms ripple and transient response specifications are increased by 50%.

\* The output current rating is given in the same order corresponding with the voltage rating.

Input and output power, remote sensing, remote programming, and auto-series, -parallel, and -tracking connections are made to bus bars and terminal blocks on the rear panel.

## Protective Features

In addition to the overload protection inherent in Constant voltage/Constant Current operation, there are many other built-in protective features included in these supplies. The features vary within the three model classifications as follows:

**6428B—6448B:** (1) Reverse voltage protection. (2) Fused AC input.

**6453A, 6456B, 6459A:** (1) AC line loss protection circuit monitors 3-phase input and cuts off SCR's and opens output bus if a phase drops out; operation resumes when AC input returns to normal. (2) 3-phase input circuit breaker. (3) Optional internal crowbar (Option 006) protects load from overvoltage condition.

**6464C—6483C:** (1) High-temperature protection thermostat opens input to power transformer and lights front panel indicator if supply overheats. (2) Prolonged overload protection circuit is activated and lights front panel indicator if output current exceeds approximately 115% of maximum rating. (3) Optional internal crowbar (except on 6464C) protects load from overvoltage condition. (4) Turn-on circuit limits peak line current during start-up into low impedance loads. (5) Phase-balance circuit permits operation with line-to-line input voltage imbalance up to 8%. (6) Overcurrent and overvoltage circuits of master slave supplies used in auto-series, -parallel, or -tracking operation can be interlocked.

## Auto-Series, -Parallel, -Tracking Operation

Supplies may be connected in auto-series, or auto-tracking. (Except 6448B and 6483C, which cannot be connected in auto-series.)

Up to three lower power models (6428B—6448B) may be connected in any of the above configurations. Higher-power model (6453A/6483C) interconnection should ordinarily include no more than two supplies.

## Remote Sensing

Remote sensing permits regulation at the load connection, rather than at the output terminals of the power supply. In all cases, there are limits to the permissible load-lead voltage drops, as follows:

Models 6428B—6448B: 2 volts in negative output lead.

Models 6453A, 6456B, 6459A: 1 volt in negative output lead.

Models 6464C—6483C: 3 volts in negative output lead.

§ Under light loading conditions, power supply may not meet all published specifications. The graph on the next page defines the permissible operating regions for CV and CC modes of operation.

For operation with a 50 Hz input (possible only with Option 05), output current is linearly derated from 100% at 40°C to 80% at 50°C.

POWER SUPPLY OUTPUT RESTRICTIONS AS A FUNCTION OF LOADING

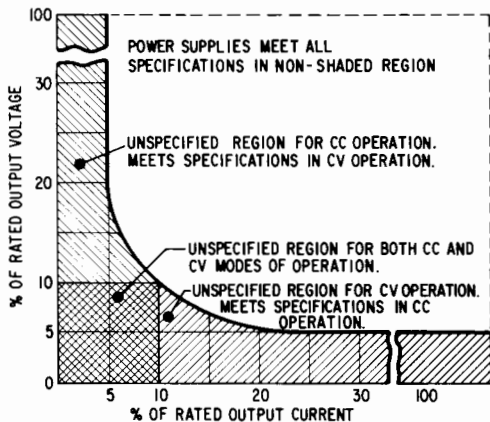

**Remote programming**

The voltage and current outputs of the supplies can be programmed by a remote resistance, or, for most models, a remote voltage source. Programming speeds and coefficients are detailed in the specifications table.

**AC power requirements**

The AC power requirements vary with the three model classifications (see option listings). When powered from a 50 Hz source (possible with Option 005), the rms ripple and transient response specifications increase by 50%. The p-p ripple specification is unchanged by line frequency.

**Size**

**Models 6433B, 6438B and 6443B:** 89 H x 483 W x 445 mm D (3.5" x 19" x 17.5").

**Specifications, continued**

REMOTE CONTROL								GENERAL						
Resolution		Load Transient Recovery $\Delta$	Resistance Coefficient		Voltage Coefficient		Up		Down		Net Weight		Options $\Delta$	Price
			Voltage	Current	Voltage	Current	NL	FL	NL	FL	Kg	lb		
8 mV	1 A	100 ms, 500 mV	200 $\Omega$ /V $\pm$ 2%	1 $\Omega$ /A $\pm$ 2%	1 V/V $\pm$ 1%	6.2 mV/A $\pm$ 7%	1.6 s	0.6 s	6 s	0.1 s	235	518	1, 2, 3, 5, 23, 31, 32, 40	\$6500
65 mV	1 A	50 ms, 150 mV	200 $\Omega$ /V $\pm$ 2%	1 $\Omega$ /A	0.4 V/V	30 mV/A	1 s	0.5 s	20 s	0.2 s	108	238	1, 2, 3, 5, 6, 10, 31, 32	\$2850
18 mV	0.5 A	100 ms, 500 mV	200 $\Omega$ /V $\pm$ 2%	1.66 $\Omega$ /A $\pm$ 2%	1 V/V $\pm$ 1%	10.3 mV/A $\pm$ 7%	1.6 s	0.6 s	15 s	0.2 s	226	500	1, 2, 3, 5, 6, 23, 31, 32, 40	\$5600
10 mV	22.5 mA	200 ms, 200 mV	200 $\Omega$ /V $\pm$ 2%	6 $\Omega$ /A	1 V/V	**	0.2 s	0.7 s	65 s	0.7 s	30.4	67	5, 10, 27, 28	\$1195
9 mV	5 mA	200 ms, 200 mV	200 $\Omega$ /V $\pm$ 2%	30 $\Omega$ /A	1 V/V	**	0.3 s	1.4 s	110 s	1.4 s	14.9	33	5, 10, 27, 28	\$850
90 mV	0.5 A	50 ms, 300 mV	200 $\Omega$ /V $\pm$ 2%	2 $\Omega$ /A	166 mV/V	60 mV/A	1 s	0.5 s	60 s	0.5 s	108	238	1, 2, 3, 5, 6, 10, 31, 32	\$2650
36 mV	0.3 A	100 ms, 500 mV	200 $\Omega$ /V $\pm$ 2%	3.33 $\Omega$ /A $\pm$ 2%	1 V/V	20.6 mV/A $\pm$ 7%	1.6 s	3 s	20 s	0.5 s	226	500	1, 2, 3, 5, 6, 23, 31, 32, 40	\$5600
10 mV	12.5 mA	200 ms, 200 mV	200 $\Omega$ /V $\pm$ 2%	12 $\Omega$ /A	1 V/V	**	0.3 s	1.2 s	75 s	1.2 s	30.4	67	5, 10, 27, 28	\$1150
9 mV	2.5 mA	200 ms, 300 mV	300 $\Omega$ /V $\pm$ 2%	60 $\Omega$ /A	1 V/V	**	0.5 s	2.5 s	200 s	2.5 s	14	31	5, 10, 27, 28	\$825
9 mV	7.5 mA	200 ms, 600 mV	300 $\Omega$ /V $\pm$ 2%	20 $\Omega$ /A	1 V/V	**	0.3 s	1.3 s	75 s	1.3 s	27.6	61	5, 10, 27, 28	\$1100
100 mV	0.25 A	50 ms, 600 mV	300 $\Omega$ /V $\pm$ 2%	4 $\Omega$ /A	94 mV/V	120 mV/A	1 s	0.5 s	45 s	0.7 s	108	238	1, 2, 3, 5, 6, 10, 31, 32	\$2650
64 mV	0.15 mA	100 ms, 750 mV	300 $\Omega$ /V $\pm$ 2%	6.7 $\Omega$ /A $\pm$ 2%	1 V/V $\pm$ 3%	41.2 mV/A $\pm$ 7%	1.4 s	2.5 s	55 s	0.7 s	226	500	1, 2, 3, 5, 6, 23, 31, 32, 40	\$5300
22 mV	0.1 A	100 ms, 1 V	300 $\Omega$ /V $\pm$ 2%	10 $\Omega$ /A $\pm$ 2%	1 V/V $\pm$ 3%	62 mV/A $\pm$ 7%	1.5 s	2 s	80 s	0.7 s	226	500	1, 2, 3, 5, 6, 23, 31, 32	\$5300
30 mV	1.3 mA	200 ms, 600 mV	300 $\Omega$ /A $\pm$ 2%	120 $\Omega$ /A	1 V/V	**	0.5 s	2 s	210 s	2 s	14	31	5, 10, 27, 28	\$825
44 mV	50 mA	100 ms, 2 V	300 $\Omega$ /V $\pm$ 2%	20 $\Omega$ /V $\pm$ 2%	1 V/V $\pm$ 3%	124 mV/A $\pm$ 7%	1.5 s	2 s	95 s	1 s	226	500	1, 2, 3, 5, 6, 23, 31, 32	\$5300
60 mV	35 mA	100 ms, 3 V	300 $\Omega$ /V $\pm$ 2%	28.6 $\Omega$ /A $\pm$ 2%	1 V/V $\pm$ 3%	177 mV/A $\pm$ 7%	1.5 s	2 s	75 s	1.6 s	226	500	1, 2, 3, 5, 6, 23, 31, 32	\$5300
60 mV	25 mA	100 ms, 5 V	300 $\Omega$ /V $\pm$ 2%	40 $\Omega$ /A $\pm$ 2%	1 V/V $\pm$ 3%	0.25 V/A $\pm$ 7%	1.5 s	2 s	120 s	2 s	226	500	1, 2, 3, 5, 6, 23, 31, 32	\$5600
60 mV	0.75 mA	200 ms, 3 V	300 $\Omega$ /V $\pm$ 2%	600 $\Omega$ /A	1 V/V	**	0.2 s	1 s	45 s	2 s	27.6	61	5, 10, 27, 28	\$1100

$\Delta$ For operation with a 50 Hz input (possible only with Option 005), the rms ripple and transient response specifications are increased by 50%.  
 $\Delta$ See page 260 for complete option and accessory descriptions. \*\*This feature is not available.

**Models 6428B, 6434B, 6439B, & 6448B:** 133 H x 483 W x 426 mm D (5.25" x 19" x 16.75").  
**Models 6453A, 6456B, & 6459A:** 356 H x 483 W x 464 mm D (14" x 19" x 18.25").  
**Models 6464C, 6466C, 6469C, 6472C, 6475C, 6477C, 6479C, & 6483C:** 667 H x 426 W x 664 mm D (26.25" x 19" x 26.13").

**Options:** see page 260 for complete options and accessory description. **Price**

**AC, input power**

**6428B-6448B**  
**Std:** 115 V ac,  $\pm$ 10%, single phase, 57-63 Hz N/C  
**027:** 208 V ac,  $\pm$ 10%, single phase, 57-63 Hz N/C  
**028:** 230 V ac,  $\pm$ 10%, single phase, 57-63 Hz N/C  
**005:** realignment for 50 Hz operation N/C

**6453A, 6456B, 6459A:** AC input connections are by means of a 4-conductor connector at rear of unit. A matching Hubbell No. 7413G plug (HP part number 1251-1570) is furnished.

**001:** 208 V ac,  $\pm$ 10%, 3-phase, 15.5 A/phase, 57-63 Hz N/C

**002:** 230 V ac,  $\pm$ 10%, 3-phase, 14 A/phase, 57-63 Hz N/C

**031:** 380 V ac,  $\pm$ 10%, 3-phase, 8.5 A/phase, 57-63 Hz add \$100

**032:** 400 V ac,  $\pm$ 10%, 3-phase, 8.0 A/phase, 57-63 Hz add \$100

**003:** 460 V ac,  $\pm$ 10%, 3-phase, 7 A/phase, 57-63 Hz \$100

**005:** realignment for 50 Hz operation N/C

**6464C-6483C:** AC input connections are by means of enclosed 4-wire terminal block.

**001:** 208 V ac,  $\pm$ 10%, 3-phase, 55 A/phase, 57-63 Hz N/C

**002:** 230 V ac,  $\pm$ 10%, 3-phase, 50 A/phase, 57-63 Hz N/C

**031:** 380 V ac,  $\pm$ 10%, 3-phase, 30 A/phase, 57-63 Hz add \$250

**032:** 400 V ac,  $\pm$ 10%, 3-phase, 28.5 A/phase, 57-63 Hz add \$250

**003:** 460 V ac,  $\pm$ 10%, 3-phase, 25 A/phase, 57-63 Hz add \$250

**005:** realignment for 50 Hz operation N/C

**006:** internal overvoltage protection crowbar

6459A, 6477C, 6479C, 6483C add \$345

6453A, 6456B add \$395

6472C, 6475C add \$460

6469C add \$510

6466C add \$570

**14545A:** casters for 6464C-6483C—set of four \$85





# POWER SUPPLIES

General Purpose: HP-IB Programmer  
Model 59501A

- HP-IB power supply control
- HP-IB-to-power-supply isolation
- Programmable range

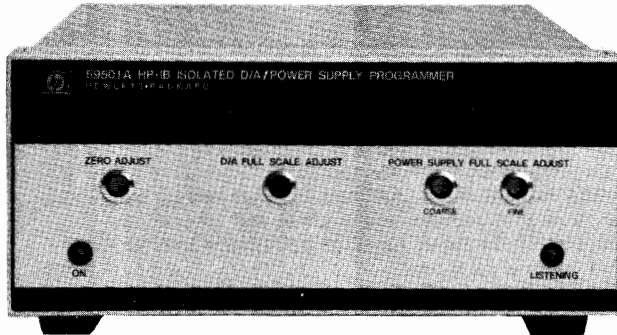

## Description

The 59501A is an isolated digital-to-analog converter designed to provide a convenient interface between the Hewlett-Packard Interface Bus and HP power supplies. With the 59501A, a wide range of DC voltages and currents becomes automatically controllable via the HP-IB. With proper wiring, the built-in isolation devices protect other instrumentation on the HP-IB from damage that could be caused by power supply outputs. In addition, an internal control circuit holds the output level near zero until programmed data is received. A programmable High/Low range control improves resolution by ten-to-one.

Power supply control is accomplished through the 59501A's programmable output voltage and programming network (see figure 1). By making the appropriate connections between the 59501A's rear terminals and the remote programming terminals on the supply, the output voltage (or current) of the supply can be programmed from zero to its full rated output. The 59501A front panel controls provide fast and easy calibration of power supply outputs. The Zero Adjust enables the user to correct for small offsets in power supply response to programmed inputs. The Power Supply Full Scale Adjust (part of programming network) enables the user to set the maximum output desired from the power supply when the 59501A is programmed to its maximum value. For example, this adjustment would normally be used to calibrate the maximum programmable output of a 320Vdc power supply to 320 volts. However, it could also be used to set the maximum to 200 volts.

In addition to its ability to program power supplies, the 59501A also can be used directly as a low level DC signal source. Unipolar and bipolar output modes are available with output voltages programmable from zero to 9.99 volts, or minus 10.0 to plus 9.98 volts. Output current up to 10 milliamps is available and is automatically limited to protect the 59501A and user equipment. The 59501A produces a full scale voltage change in approximately 250  $\mu$ s from the time the digital data is received.

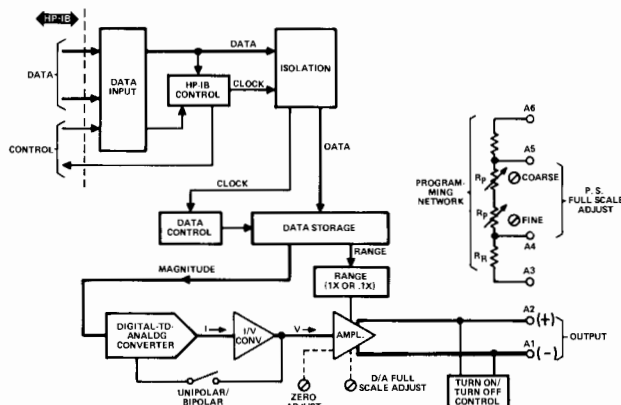

- Programmable 10-volt DC output
- Unipolar/Bipolar operation
- Fast digital to analog conversion

## Specifications

### Digital to Analog Converter

**DC Output voltage:** programmable in high or low ranges within the voltage limits shown below. Output mode is unipolar or bipolar and is selected by a rear panel switch.

**Unipolar:** 0 to 9.99 V (low range, 0 to 9.999 V).

**Bipolar:** -10 to +9.98 V, (low range, -1 to +0.998 V).

**DC Output current:** 10 mA maximum.

**PARD (Ripple and Noise):** 2 mV rms/10 mV p-p.

**Resolution:** unipolar, 10 mV (low range, 1 mV). Bipolar, 20 mV (low range, 2 mV).

**Accuracy:** specified at 23°C  $\pm$  5°C.

**Unipolar:** 0.1% + 5 mV (low range, 0.1% + 1 mV).

**Bipolar:** 0.1% + 10 mV (low range, 0.1% + 2 mV).

**Stability:** change in output over 8 hour interval under constant line, load, and ambient following a 30 minute warm-up. Stability is included in accuracy specification measurements over the temperature range indicated.

**Unipolar:** 0.04% + 0.5 mV (low range, 0.04% + .1 mV).

**Bipolar:** 0.04% + 1 mV (low range, 0.04% + .2 mV)

**Temperature Coefficient:** unipolar, 0.01%/°C + 0.5 mV/°C (low range, 0.1%/°C + 0.1 mV/°C). Bipolar, 0.01%/°C + 0.5 mV/°C (low range, 0.01%/°C + 0.1 mV/°C).

**Zero adjust:** plus or minus 250 millivolts.

**D/A Full scale adjust:** plus or minus 5%.

**Programming speed:** the time required for output to go from zero to 99% of programmed output change is 250  $\mu$ s (measured with resistive load connected to output terminals).

### Power Supply Programming

**Programming network specifications:** in the following specifications, M represents the calibrated full scale value of the supply being programmed and P is the actual programmed output. The full scale value (M) can be any value within the supply's output range and is calibrated with the 59501A programmed to its maximum high range output.

**Accuracy:** specified at 23°C  $\pm$  5°C.

**Unipolar:** 0.05% M + 0.25% P (low range, 0.01% M + 0.25% P).

**Bipolar:** 0.1% M + 0.25% P (low range, 0.02% M + 0.25% P).

**Isolation:** 600 V dc between HP-IB data lines and output terminals.

**Temperature Coefficient:** 0.005% M/°C + 0.015% P/°C (low range, 0.01% M/°C + 0.015% P/°C).

**Programming resolution:** 0.1% M (low range, 0.01% M).

**Programming speed:** D/A programming speed plus the programming speed of the power supply.

### General

**Temperature range:** operation: 0 to 55°C, Storage: -40 to 75°C.

**Power:** 100, 120, 220, or 240 Vac (+6% -13%) 47-63 Hz, 10 VA (selectable on rear panel).

**Size:** 101.6 H x 212.9 W x 294.6 mm D (4" x 8.38" x 11.6")

**Weight:** Net 1.36 kg (3 lb). Shipping 1.81 kg (4 lb).

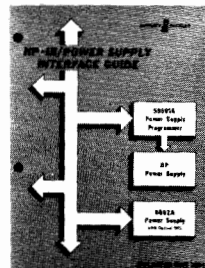

Ask for AN 250-1 for complete details on HP-IB control of power supplies

### Ordering Information

59501A HP-IB Isolated D/A Power Supply

Programmer	Price
10833A HP-IB cable 1 m (3.3 ft)	\$ 60
10833B HP-IB cable 2 m (6.6 ft)	\$ 65
10833C HP-IB cable 4 m (13.2 ft)	\$ 75
10833D HP-IB cable 0.5 m (1.7 ft)	\$ 60

### Price

- 200-watt autoranging dc output
- Constant-voltage / constant-current operation
- HP-IB programming option

- Built-in overvoltage protection crowbar
- CV/CC operating status indicators
- Remote analog programming and sensing

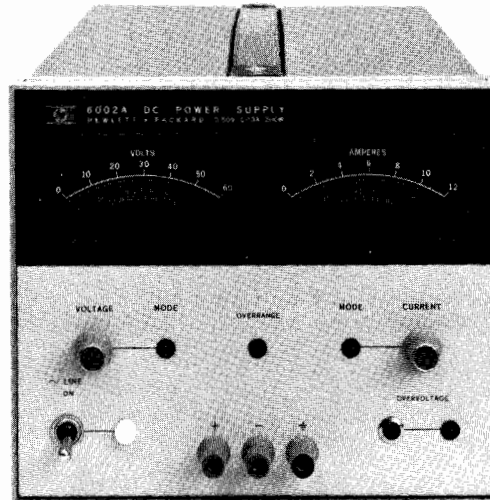

6002A

## Description

The Model 6002A offers a new level of performance and usefulness in laboratory power supplies. It employs a unique regulation control concept that automatically yields a continuous span of voltage and current ratings within the basic 200-watt power rating boundary. This is beneficial in that more current is available at lower voltages, and higher voltages are available at a given current level than can be obtained from conventional 200-watt supplies.

Conventional 200-watt power supplies, rated for 50 volts or 20 volts can operate only within the shaded regions shown in Figure 1. The 6002A not only provides the outputs of the two conventional supplies, but also delivers the extra output capability shown between 20 and 50 volts.

### Autoranging Output Characteristic

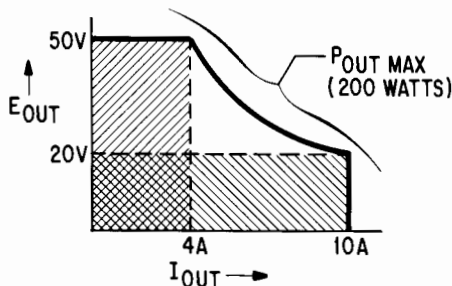

This "autoranging" capability of the 6002A provides the user with a single power supply that can cover a wide variety of applications in the lab or as a system component without his having to overspecify both the output voltage and current.

### System features/remote control

Analog programming of output voltages and current can be accomplished through the use of remotely controlled resistance or voltage applied to rear panel terminals. Additional control terminals are provided for remote load voltage sensing, auto-series or parallel operation, and for remotely activating the crowbar circuit. A pulse output from the crowbar terminal indicates the overvoltage circuit has been self-activated. A voltage step change appearing on terminal indicates a changeover to or from constant-current operation.

### HP-IB option

Digital programming via Opt 001 permits control of output voltage or current by the Hewlett-Packard Interface Bus (HP-IB). Two programmable ranges allow better resolution below 10 volts or 2 amps. The selection of HP-IB control of either voltage or current is done by rear panel switches.

## Specifications

**DC output:** voltage and current output can be adjusted over the ranges indicated by front panel controls, analog programming, or an optional HP-IB interface.

**Voltage:** 0-50 V. **Current:** 0-10 A.

Maximum 200 Watts output from 20 V to 50 V.

**Load effect:** constant-voltage, 0.01% +1 mV. Constant-current, 0.01% +1 mA.

**Source effect:** CV, 0.01% +1 mV; CC, 0.01% +1 mA.

**PARD (ripple and noise):** rms/p-p, 20 Hz to 20 MHz; CV, 1 mV/10 mV; CC, 5 mA rms.

**Temperature coefficient:** CV, 0.02% +200  $\mu$ V/ $^{\circ}$ C; CC 0.02% +5 mA/ $^{\circ}$ C.

**Drift:** CV, 0.05% +1 mV/8 hrs; CC, 0.05% +5 mA/8 hrs.

**Resolution:** front panel controls; CV, 10 mV; CC, 10 mA.

**Output impedance:** approximately 0.5  $\Omega$  in series with 1  $\mu$ H.

**Load transient recovery:** 100  $\mu$ s for output voltage to recover within 15 mV or nominal voltage setting following a load current change of 50% to 100% or 100% to 50% of full load current.

### Remote control coefficients:

Resistance programming: CV, 1 k $\Omega$ /V  $\pm$ 7%. CC, 100 $\Omega$ /A  $\pm$ 7%.

Voltage programming: CV 1 V/V  $\pm$ 20 mV. CC, 50 mV/A  $\pm$ 10%.

**Response time:** maximum time for output voltage to change between 0 to 99.9% or 100% to 0.1% of maximum rated output voltage. Up Programming: no load, 100 ms; full load, 100 ms. Down - Programming: no load, 400 ms; full load, 200 ms.

**Overvoltage protection:** trip voltage adjustable from 2.5 V to 60 V.

**DC output isolation:** 150 V dc.

**Power:** 100, 120, 220, or 240 V ac (-13%, +6%), 48-63 Hz.

**Temperature rating:** 0 $^{\circ}$ C to 55 $^{\circ}$ C operating, -40 $^{\circ}$ C to +75 $^{\circ}$ C storage. Supply is cooled by built-in fan.

**Size:** 180 H x 212 W x 422 mm D (6.97" x 8.36" x 16.6").

**Weight:** net, 14.5 kg (32 lb). Shipping, 15.9 kg (35 lb).

### HP-IB Option

**Programmable ranges:** high: 0-50 V or 0-10 A, low: 0-10 V or 0-2 A.

**Programming speed:** same as response time.

**Accuracy:** Hi range: CV, 0.2% +25 mV; CC, 0.2% +25 mA.

Lo range: CV, 0.2% +10 mV; CC, 0.2% +25 mA.

**Resolution:** Hi range: CV, 50 mV; CC, 10 mA.

Lo range: CV, 10 mV; CC, 2 mA.

**Isolation:** 250 Volts dc from bus data lines to power supply.

### Options

001: HP-IB Interface

6002A Autoranging DC Power Supply

**Price**

add \$475

\$1200



# POWER SUPPLIES

General Purpose: dual-tracking outputs

Models 6227B & 6228B

- Two 50-watt power supplies for independent or tracking operation
- Built-in overvoltage protection crowbars

- Auto-parallel and auto-series capability
- Constant-current in addition to constant-voltage outputs

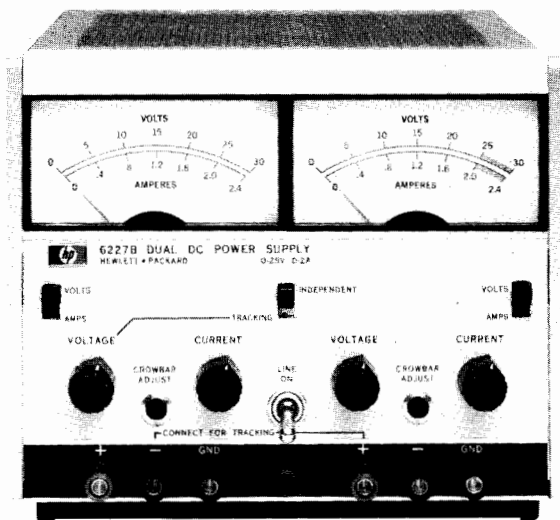

6227B

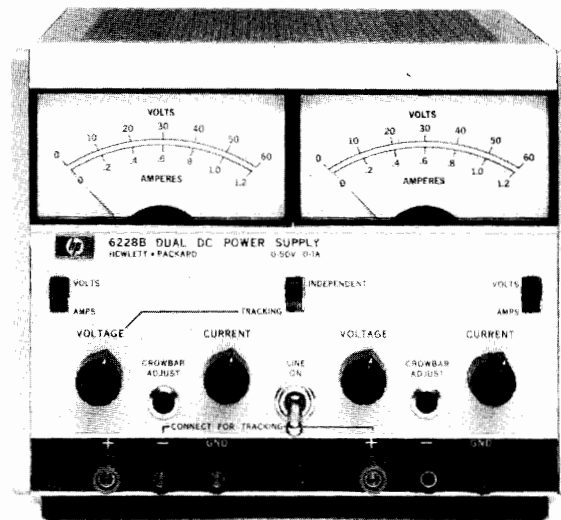

6228B

## Description

These versatile lab supplies each house two identical 50 W regulated power supplies. A convenient front panel switch selects either independent or tracking operation. In the track mode, the right supply tracks the left within 0.2%  $\pm$  2 mV. The tracking mode is especially useful for powering operational amplifiers, push-pull stages, deflection systems, or any application where plus and minus voltages must track with insignificant error. The independent mode permits operation of the two supplies individually, in auto-parallel or in auto-series.

Each side of the dual supply can be operated as a constant-voltage or constant-current source, and each has its own crowbar for over-voltage protection. In the tracking mode, an overvoltage condition in either supply trips both crowbars. The power supply outputs are isolated up to 300 V from output to chassis or output to output.

## Specifications

**DC output:** 6227B, 0-25 V @ 0-2 A; 6228B, 0-50 V @ 0-1 A.

**AC input:** 115 or 230 V ac  $\pm$  10%, 48-63 Hz, 260 W. Selected by rear panel switch.

**CV load effect (load regulation):** for a load current change equal to the current rating of the supply; 0.01% + 1 mV.

**CC load effect:** for a load voltage change equal to the voltage rating of the supply; 0.01% + 250  $\mu$ A.

**Source effect (line regulation):** for a change in line voltage between 104 and 127 V ac or 208 and 254 V ac at any output voltage and current within rating; CV, 1 mV; CC, 100  $\mu$ A.

**PARD (ripple and noise):** at any line voltage and under any load condition within rating (20 Hz to 20 MHz); CV, 250  $\mu$ V rms/4 mV p-p; CC, 250  $\mu$ A rms/2 mA p-p.

**Temperature coefficient:** output change per degree Celsius change in ambient following 30-minute warm-up; CV, 0.02% + 200  $\mu$ V; CC, 0.02% + 300  $\mu$ A (6227B); 0.02% + 150  $\mu$ A (6228B).

**Drift (stability):** total drift in output (dc to 20 Hz) over 8-hour interval under constant line, load, and ambient following 30-minute warm up; CV, 0.2% + 2 mV; CC, 0.2% + 3 mA (0.2% + 1.5 mA, 6228B).

**Remote resistance programming:** CV, 200 $\Omega$ /V  $\pm$  1%; CC, 500 $\Omega$ /A  $\pm$  10% (6227B), 1k $\Omega$ /A  $\pm$  10% (6228B).

**Programming speed (CV):** up-programming: no load, 40 ms/50 ms; full load, 200 ms/350 ms. Down-programming: no load, 400 ms/1 s; full load, 75 ms/50 ms.

**Output impedance (typical):** approximated by a resistance in series with an inductance; 2 m $\Omega$ /2 $\mu$ H (6227B); 6 m $\Omega$ /6 $\mu$ H (6228B).

**Resolution (fine control):** voltage, 5 mV (6227B), 10 mV (6228B); current, 1 mA (6227B), 0.5 mA (6228B)

**Internal overvoltage crowbars:** during independent operation, each supply is protected by its own crowbar. In the tracking mode, an overvoltage in either supply results in firing both crowbars.

**Trip voltage margin:** the minimum trip voltage above the operating output voltage of the supply to prevent false crowbar tripping: 7% of the output voltage + 1.5 V.

**Trip voltage range:** 6227B, 5-28 V dc. 6228B, 5-55 V dc.

**Tracking error:** in tracking mode, the slave supply is matched within 0.2%  $\pm$  2 mV of the master.

**Transient recovery time:** in constant voltage, the output will recover in 50  $\mu$ s to within 10 mV of its nominal value for a resistive load change demanding an output current change equal to the current rating of the supply. The nominal output voltage is defined as the mean between the no load and full load voltages.

## Temperature ratings

**Operating:** 0°C to 55°C.

**Storage:** -40°C to +75°C.

**Cooling:** natural convection.

**Weight (net/shipping):** 11/12.9 kg (24/28 lb).

**Size:** 155H x 197 W x 310 mm D (6.13" x 7.75" x 12.25").

**Finish:** mint gray panel with olive gray case.

## Options

**009:** four ten-turn output voltage and current controls replace all four concentric coarse and fine voltage and current controls.

**015:** four 3-digit graduated turns-counting dials and 10-turn controls replace concentric coarse and fine voltage and current controls.

**040:** interfacing for Multiprogrammer operation. Prepares standard HP power supplies for resistance programming by the HP Multiprogrammer.

## Accessories

5060-8762: rack kit for mounting one or two dual supplies \$70

5060-8760: filler panel to block unused half of rack when mounting only one dual supply \$21

## Ordering Information

6227B Dual Tracking Power Supply

6228B Dual Tracking Power Supply

Price  
add \$100

add \$250

add \$150

\$1075

\$1075



- Short circuit proof
- Precise voltage control—four decade thumbwheel or switch-and vernier
- Convection cooling

- Floating output—can be used as a positive or negative source
- Front-panel meters
- Bench or rack mounting

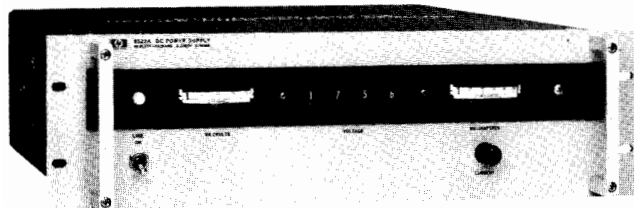

6521A, 6522A, 6525A

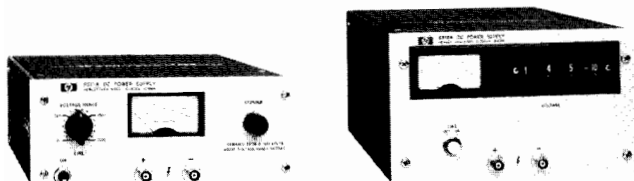

6515A

6516A

## Description

### 6521A, 6522A, 6525A

This series of high performance power supplies has broad application both in the laboratory and in the system. They have sufficient output current to power devices such as TWT's, klystrons, magnetrons, backward-wave oscillators, high-power gas lasers, electron-beam welding devices, etc. Output voltage is set easily and precisely by a three-decade thumbwheel switch plus a thumbwheel vernier providing 0.002% resolution. In constant-voltage operation, a single-turn current control allows the current-limit point to be set to any value within the current rating. In constant-current operation, the current control varies the output current while the voltage controls (thumbwheels) provide an adjustable voltage limit. The supplies are protected against reverse voltage that could be generated by an active load. Protection from reverse current requires pre-loading the supply with a dummy load to ensure that the supply outputs current through the entire operating cycle of the load. Either the positive or negative terminal may be grounded or the supply may be operated floating at up to 200 V above ground.

### 6515A and 6516A

These high-voltage power supplies are lower in cost and output power than the 6521A-6525A supplies. Their small size, low price, and short-circuit-proof operation make them excellent high-voltage laboratory supplies, or high-voltage systems supplies where current requirements are not more than 6 mA.

Model 6515A employs a sixteen-position rotary switch and a ten-turn vernier control to adjust the output voltage. The rotary switch selects output voltage increments from 1 to 1500 V in 100-volt steps; the vernier control permits fine adjustment (100 mV resolution) over any 100-volt span. Model 6516A uses a three-decade thumbwheel switch plus a thumbwheel vernier for convenient and precise (1.0 V resolution) output voltage control.

Non-adjustable current-limit protection is provided on both models. On Model 6516A, the current-limit point is fixed at approximately 8 mA. On Model 6515A, the current limit value varies with the selected output voltage range as follows (voltage range/current limit): 0-300 V/7.5 mA, 400-700 V/65 mA, 800-1100 V/32 mA, 1200-1500 V/25 mA. Both supplies are protected against reverse voltage that could be generated by an active load. Pre-loading is necessary to protect the supplies from reverse current. Either the positive or negative terminal may be grounded or the supply may be operated floating at up to 1000 V above ground. Units are packaged in half-rack-width cases. They may be bench operated or mounted individually or in pairs using accessory rack-mounting kits.

Models 6521A, 6522A, and 6525A may be operated on 230 Vac, 48-63Hz, only through the use of an external accessory 230V to 115V step-down transformer. Suitable transformers with built-in receptacle, line cord and grounding-type plug may be ordered with the power supply as a Special Option. Contact your local HP Field Engineer for ordering information regarding models 6521A Special Option J08, 6522A Special Option J16, and 6525A Special Option J13.

## Specifications

### 6521A, 6522A, 6525A

**Accuracy:** 1% of thumbwheel switch setting.

**Temperature rating:** operating 0 to 55°C; storage, -40 to +75°C.

**Temperature coefficient, per °C:** voltage, 0.012% of +1 mV. Current: 6521A, 0.2% + 0.2 mA; 6522A, 0.2% + 0.1 mA; 6525A, 0.2% + 0.05 mA.

**Output impedance, typical:** 0.1 ohm in series with 1 μH.

**Load effect transient recovery:** 50 μs to recover within 0.005% or 20 mV, whichever is greater.

**Output modes:** automatic cross-over constant-voltage/constant-current.

**Meters:** 2% of full scale accuracy. Scales: 6521A: 0-1 kV & 0-200 mA; 6522A: 0-2 kV & 0-100 mA; 6525A: 0-4 kV & 0-50 mA.

**Power:** 115 V ac ± 10%, 48-440 Hz, 4 A, 270 W (230 Vac available on special order).

**Weight:** net, 19 kg (42 lb). Shipping, 28.5 kg (63 lb).

**Size:** 133 H x 483 W x 457 mm D (5.25" x 19" x 18").

### 6515A and 6516A

**Accuracy:** 6516A, 1% of thumbwheel switch setting.

**Temperature rating:** operating, 0 to 55°C; storage, -40 to +75°C.

**Temperature coefficient, per °C:** voltage, 0.02% + 2 mV.

**Load effect transient recovery:** 100 μs to recover within 0.01% or 16 mV, whichever is greater.

**Output modes:** constant voltage with fixed current limit.

**Meters:** 2% of full scale accuracy. Scales: 6515A: 1.8 kV; 6516A: 3.5 kV.

**Power:** 6515A: 115 V ac ± 10%, 60 ± 0.3 Hz, 0.16 A, 19 W. (230 Vac available on special order) 6516A: 115 V ac ± 10%, 57-63 Hz, 1 A, 40 W.

**Weight:** 6515A: net, 4.1 kg (9 lb). Shipping, 5.0 kg (11 lb). 6516A: net, 7.7 kg (17 lb). Shipping, 9.5 kg (21 lb).

**Size:** 6515A, 89 H x 216 W x 299 mm D (3.50" x 8.50" x 11.75"). 6516A, 133 H x 216 W x 406 mm D (5.25" x 8.50" x 16").

RATINGS			PERFORMANCE								GENERAL			
DC Output		Model	Load Effect		Source Effect		PARD (rms/p-p)		Drift		Resolution		Options	Price
Volts	mA		Voltage	Current	Voltage	Current	Voltage	Current	Voltage	Current	V	C		
0-1000	0-200	6521A	0.005% or 20 mV	2% or 1 mA	0.005% or 20 mV*	1 mA	1 mV/500 mV	2 mA rms	0.036% + 3 mV	0.25% + 0.5 mA	20 mV	0.6 mA	J08	\$1725
0-1600	5	6515A	0.01% or 16 mV*	**	0.01% or 16 mV*	**	2mV/15 mV	**	0.05% + 5 mV	**	100 mV	**	15, 19	\$600
0-2000	0-100	6522A	0.005% or 20 mV*	2% or 1 mA*	0.005% or 20 mV*	1 mA	1mV/500 mV	1 mA rms	0.036% + 3 mV	0.25% + 0.25 mA	40 mV	0.3 mA	J08	\$1725
0-3000	6	6516A	0.01% or 16 mV*	**	0.01% or 16 mV*	**	1 mV/50 mV	**	0.05% + 5 mV	**	1 V	**	19	\$875
0-4000	0-50	6525A	0.005% or 20 mV*	2% or 1 mA*	0.005% or 20 mV	1 mA	1 mV/500 mV	500 μA rms	0.036% + 3 mV	0.25% + 0.12 mA	80 mV	0.15 mA	J08	\$1775

\*whichever is larger.

\*\* This feature is not available.

▲See page 260 for complete option and accessory descriptions. Models 6521A-J08, 6522A-J16, and 6525A-J13 are special options for 230 V operation.



# POWER SUPPLIES

Special purpose: precision source

Models 6111A-6116A

- 0.025% output voltage accuracy
- 5-minute warm-up
- Built-in overvoltage crowbar

- Constant-voltage / current-operation
- Thumbwheel or ten-turn voltage controls
- 0.1% output voltage accuracy



6111A, 6112A, 6113A, 6116A



6114A, 6115A

## Description

### 6114A, 6115A

These 40-watt precision power supplies are ideal for applications where an accurate, highly stable, and easy-to-use source of dc voltage is required. Both models feature automatic dual range operation. For example, Model 6114A can supply 0–20 V at 0–2 A, and 20–40 V at 0–1 A, without manual range switching. Automatic output current range crossover occurs when the supply is providing greater than one-half of the maximum rated output voltage.

### Output Voltage Controls

Pushbutton voltage controls on Models 6114A and 6115A allow the output voltage to be set rapidly and accurately. The setting is displayed in large, easy-to-read numerals. A fifth digit, set via a thumbwheel on the switch assembly, provides output voltage resolution of 200  $\mu$ V.

## Specifications†

RATINGS			PERFORMANCE								Drift (Stability)	
DC Output		Model	Load Effect		Source Effect		PARD (rms/p-p)		Temperature coefficient	8-hour		90 day
Volts	Amps		Voltage	Current	Voltage	Current	Voltage	Current		8-hour	90 day	
0-10	0-2	6113A	0.001% + 100 $\mu$ V	—	0.001%	—	40 $\mu$ V/100 $\mu$ V	—	0.001% + 10 $\mu$ V	0.01% + 100 $\mu$ V	—	
0-20	0-1	6111A	0.001% + 100 $\mu$ V	—	0.001%	—	40 $\mu$ V/100 $\mu$ V	—	0.001% + 10 $\mu$ V	0.01% + 100 $\mu$ V	—	
0-20, 20-40	0-2, 0-1	6114A	0.0005% + 100 $\mu$ V +100 $\mu$ V	0.01% +500 $\mu$ A	0.0005% +40 $\mu$ V	0.005% +40 $\mu$ A	40 $\mu$ V/200 $\mu$ V* 200 $\mu$ A/1 mA	200 $\mu$ V/100 $\mu$ V	0.001% + 15 $\mu$ V	0.0015% +15 $\mu$ V	0.0075% +30 $\mu$ V**	
0-40	0-0.5	6112A	0.001% + 100 $\mu$ V	—	0.001%	—	40 $\mu$ V/100 $\mu$ V	—	0.001% + 10 $\mu$ V	0.01% + 100 $\mu$ V	—	
0-50, 50-100	0-0.8 0-0.4	6115A	0.0005% + 50 $\mu$ V	0.01% +500 $\mu$ A	0.0005% +100 $\mu$ A	0.005% +20 $\mu$ A	40 $\mu$ V/200 $\mu$ V* 200 $\mu$ A/1 mA	200 $\mu$ V/100 $\mu$ V	0.001% + 15 $\mu$ V**	0.0015% +15 $\mu$ V	0.0075% +30 $\mu$ V	
0-100	0-200 mA	6116A	0.001%+100 $\mu$ V	—	0.001%	—	40 $\mu$ V/100 $\mu$ V	—	0.001%+10 $\mu$ V	0.01% + 100 $\mu$ V	—	

† Refer to page 237 for complete specification definitions and page 260 for option descriptions.

\*\* Specified with final decade pot set to zero. If pot is set to value other than zero, pot wiper jump effect may cause drift of 0.0015% + 200  $\mu$ V (90-day).

\* 200  $\mu$ V p-p noise is typical with a maximum 400  $\mu$ V p-p spike of less than 1  $\mu$ s duration occurring repetition rate of twice power line frequency under worst case conditions of high line, full output voltage. When operated at 400 Hz input, peak-to-peak ripple is less than 10 mV.



### Output Current Controls

A front-panel control allows the output current to be set to any desired value within the maximum rating. Using this control, the supplies can be operated as constant-current sources with 0.01% current regulation. A light-emitting diode current mode indicator immediately lights either when the supply is operated in the gross current limit region, or when the output current level established by the setting of the front panel control is reached.

### Remote Programming

These supplies can be remote programmed by means of an external voltage or resistance. When remote resistance programmed, put voltage accuracy is 0.01% plus the accuracy of the remote programming resistor, and output current accuracy is 0.25% plus the accuracy of the remote programming resistor.

For computer controlled applications, these supplies are designed to be digitally programmed with the HP Model 6940B Multiprogrammer or 6941B Multiprogrammer Extender. They can also be used with the 59501A HP-IB Isolated D/A Power Supply Programmer.

### Overvoltage Protection

A circuit technique used in these supplies causes the output voltage to drop completely to zero once the overvoltage protection circuit has been triggered, rather than to only 1–3 V as is typical with other SCR crowbars. This same circuit technique also permits the trip threshold to be set as low as 0.5 V, thus providing load protection at very low output voltage levels.

### 6111A, 6112A, 6113A and 6116A

Although these 20-watt precision power supplies do not provide quite the level of performance and flexibility of Models 6114A and 6115A, they are lower in cost and are suitable for many precision power applications. Output voltage is adjusted by a five-decade thumbwheel voltage programmer for convenient and precise (100  $\mu$ V resolution) adjustment of output voltage. A single-turn current control allows full-range adjustment of the current-limit point.

Additional features include a volt/ampere meter and associated meter function switch. The four-position function switch selects either of two output voltage or output current ranges (XI, X0.1) for display on the panel meter.

The d-c output of these supplies is floating, allowing the supplies to be used as either positive or negative sources. Terminals for +OUT, -OUT, and GND are provided on both the front and rear of the supply. The rear terminal strip also includes terminals for remote resistance programming, remote sensing, and auto-series, auto-tracking operations.

Units are packaged in 5/4-inch high, half-rack cases which may be bench operated or rack mounted using accessory rack mounting hardware.

### General Specifications—(See Table Also)

**Temperature rating:** all precision models; operating 0° to 50°C. Storage, -40° to +75°C.

**DC output isolation:** output terminals of precision models may be floated up to 300 V above ground.

**Remote sensing:** provided on all precision models.

**Power:** 104–127 or 208–250 V ac selected by switch, 48–440 Hz, 150 VA maximum.

**Size:** 166 H x 197 W x 336 mm D (6.5" x 7.75" x 13.25").

**Weight:** net, 7.7 kg (17 lb). Shipping, 9.5 kg (21 lb).

### 6111A, 6112A, 6113A and 6116A

**Power:** 115 V ac  $\pm$  10%, 43–63 Hz, 0.5 A, 52 W (for 230 V, order Optn. 028).

**Size:** 133 H X 216 W x 318 mm D (5.25" x 8.5" x 12.5").

**Weight:** net, 5 kg (11 lb). Shipping, 6.8 kg (14 lb).

### 6114A, 6116A

**Weight:** net, 7.7 kg (17 lb). Shipping, 9.5 kg (21 lb).

**Size:** 155 H x 197 W x 318 mm D (6" x 7.75" x 12.5").

## Specifications, Continued

Accuracy	Resolution	Output Z (Typical)	Load Transient Recovery	Output Mode	REMOTE CONTROL								GENERAL		
					Resistance Coefficient		Voltage Coefficient		UP $\uparrow$		DOWN $\downarrow$		Overvoltage Protection	Options	Price
					Voltage	Current	Voltage	Current	NL	FL	NL	FL			
0.1% + 1 mV	20 $\mu$ V	0.2 m $\Omega$ + 1 $\mu$ H	50 $\mu$ s 50 mV	CV/CL	1 k $\Omega$ /V $\pm$ 0.1%	—	1 V/V $\pm$ 0.1%	$\Delta$	—	—	—	—	Opt 11, 3–13 V	11, 28, 40	\$750
0.1% + 1 mV	200 $\mu$ V	0.5 m $\Omega$ + 1 $\mu$ H	50 $\mu$ s 50 mV	CV/CL	1 k $\Omega$ /V $\pm$ 0.1%	—	1 V/V $\pm$ 0.1%	$\Delta$	—	—	—	—	Opt 11, 2.5–23	11, 28, 40	\$700
0.025% + 1 mV	200 $\mu$ V	0.05 m $\Omega$ + 3 $\mu$ H	<50 $\mu$ s, 50 mV	CV/CC	2 k $\Omega$ /V $\pm$ 0.01%	500 $\Omega$ /A $\pm$ 0.25%	1V/V $\ddagger$	0.5 V/A $\pm$ 1%	1.75 s	1.75 s	350 ms	100 ms	STD, 0.5–45V	9, 15	\$1025
0.1% + 1 mV	200 $\mu$ V	2 m $\Omega$ + 1 $\mu$ H	50 $\mu$ s 50 mV	CV/CL	1 k $\Omega$ /V $\pm$ 0.1%	—	1 V/V $\pm$ 0.1%	$\Delta$	—	—	—	—	Opt 11, 2.5–44 V	11, 28, 40	\$700
0.025% + 1 mV	200 $\mu$ V	0.05 m $\Omega$ + 3 $\mu$ H	<50 $\mu$ s, 50 mV	CV/CC	2 k $\Omega$ /V $\pm$ 0.01%	1 k $\Omega$ /A $\pm$ 0.25%	1 V/V $\ddagger$	1 V/A $\pm$ 1%	4.5 s	4.5 s	500 ms	175 ms	STD, 0.5–110 V	9, 15	\$1025
0.1% + 1 mV	200 $\mu$ V	10 m $\Omega$ + 1 $\mu$ H	—	CV/CL	1 k $\Omega$ /V $\pm$ 0.1%	—	1 V/V $\pm$ 0.1%	$\Delta$	—	—	—	—	Opt 11, 20–106 V	11, 28	\$750

$\blacktriangle$  See page 280 for complete option and accessory descriptions.

$\blacklozenge$  UP = increasing output voltage. NL = No output load current. FL = Full rated output load current.

$\ddagger$  Accuracy is equal to accuracy of remote programming device  $\pm$  200  $\mu$ V.

$\Delta$  This feature is not available.

— Performance is not specified.

# POWER SUPPLIES

Special purpose: constant current sources  
Models 6177C, 6181C & 6186C

- Continuously variable voltage limit
- Output useful to micro-ampere region

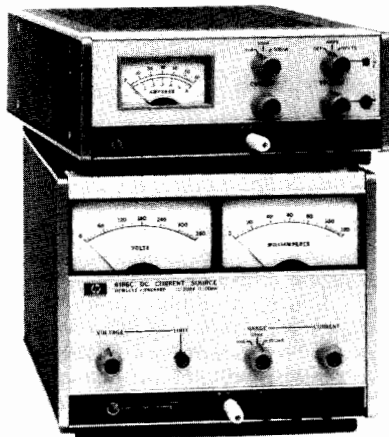

6177C, 6181C

6186C

## Description

These solid-state constant-current sources are ideal for semiconductor circuit development, component testing, and precision electroplating applications.

Their high-speed remote programming characteristics make these supplies useful in testing and sorting semiconductors, resistors, relays, meters, etc. The ability to superimpose ac modulation on the dc output permits the supplies to be used for measurement of dynamic or incremental impedance of circuit components.

## Specifications

**Load effect (load regulation):** less than 25 ppm of output + 5 ppm of range switch setting for a load change which causes the output

- High output impedance—no output capacitor

voltage to vary from zero to maximum.

**Source effect (line regulation):** less than 25 ppm of output + 5 ppm of range switch setting for a change in the line voltage from 104 to 127 V ac (or 127 to 104 V ac) at any output current and voltage within rating.

**Load effect transient recovery:** less than 800  $\mu$ s for recovery to within 1% of nominal output current following a full load change in output voltage. (On 6186C, recovery time for 100 mA/10 mA/1 mA ranges is 1 ms/1.6 ms/4 ms, respectively.)

**Temperature coefficient:** output change per degree C is less than 75 ppm of output current +5 ppm of range switch setting.

**Drift (stability):** less than 100 ppm of output current +25 ppm of range switch setting. Stability is measured for eight hours after one hour warm-up under conditions of constant line, load, temperature, and output setting.

**Resolution:** 0.03% of range switch setting.

**Temperature rating:** operating 0, to 55°C, storage, -40 to +75°C.

### Accessories

5060-8764: rack adapter for rack mounting one or two 6177C or 6181C supplies

5060-8762: rack adapter for rack mounting one or two 6186C supplies

5060-8530: filler panel for Models 6177C, 6181C

5060-8760: filler panel for Model 6186C

### Options

**015:** three-digit graduated turns-counting current control replaces front panel current knob

**028:** 230 V ac  $\pm$ 10%, single-phase input. Models 6177C and 6181C only

### Price

\$70

\$70

\$32.00

\$21

add \$75

N/C

### Ordering Information

6177C, 6181C Constant Current Source

6186C Constant Current Source

\$850

\$1300

Model		6177C	6181C	6186C
Output Current ††		0-500 mA	0-250 mA	0-100 mA
Voltage Compliance $\Delta$		0-50 V dc	0-100 V dc	0-300 V dc
Output Ranges	A	0-5 mA	0-2.5 mA	0-1 mA
	B	0-50 mA	0-25 mA	0-10 mA
	C	0-500 mA	0-250 mA	0-100 mA
AC Input		115V ac $\pm$ 10%, 48-63 Hz; 0.6 A, 55 W at 115 V ac For 230 V ac see Option 028	115 V ac $\pm$ 10%, 48-63 Hz; 0.6 A, 55 W at 115 V ac For 230 V ac see Option 028	115/230 V ac, 48-63 Hz; 0.9 A, 90 W at 115 V ac 115/230 V ac switch
Constant Current	Voltage Control (accuracy: 0.5% of output current +0.04% of range)	Range A	200 mV/mA	1 V/mA
		Range B	20 mV/mA	100 mV/mA
		Range C	2 mV/mA	10 mV/mA
Remote Programming	Resistance Control 1% of output control +0.04% of range)	Range A	400 ohms/mA	2 k $\Omega$ /mA
		Range B	40 ohms/mA	200 ohms/mA
		Range C	4 ohms/mA	20 ohms/mA
Voltage Limit Remote Programming	Voltage Control (Accuracy: 20%)		1 V/V	1 V/V
		Resistance Control	870 ohms/V	435 ohms/V
		Accuracy	25%	25%
Typical Output Impedance (R in parallel with C)*	Range A	R = 330 Meg, C = 500 pF	R = 1330 Meg, C = 10 pF	R = 10,000 Meg, C = 900 pF
	Range B	R = 33 Meg, C = 0.005 $\mu$ F	R = 133 Meg, C = 100 pF	R = 1,000 Meg, C = 700 pF
	Range C	R = 3.3 Meg, C = 0.05 $\mu$ F	R = 13.3 Meg, C = 1000 pF	R = 100 Meg, C = 1500 pF
PARD (Ripple and Noise): rms/p-p (dc to 20 MHz) with either output terminal grounded	Range A	1.6 $\mu$ A rms/40 $\mu$ A p-p	0.8 $\mu$ A rms/20 $\mu$ A p-p	0.2 $\mu$ A rms/5 $\mu$ A p-p
	Range B	16 $\mu$ A rms/200 $\mu$ A p-p	8 $\mu$ A rms/100 $\mu$ A p-p	2 $\mu$ A rms/50 $\mu$ A p-p
	Range C	160 $\mu$ A rms/1 mA p-p	80 $\mu$ A rms/500 $\mu$ A p-p	20 $\mu$ A rms/500 $\mu$ A p-p
Programming Speed: from 0 to 99% of range switch setting with a resistive load **(Output Current Modulation)		6 ms	6 ms	10 ms
Dimensions:		7.75" (W) x 3.44" (H) x 12.38" (D) 197 mm (W) x 88 mm (H) x 315 mm (D)	7.75" (W) x 3.44" (H) x 12.38" (D) 197 mm (W) x 88 mm (H) x 315 mm (D)	7.75" (W) x 3.44" (H) x 12.38" (D) 197 mm (W) x 158 mm (H) x 315 mm (D)
Weight: (Net/Shipping)		4.53 kg (10 lb)/5.9 kg (13 lb)	4.53 kg (10 lb)/5.9 kg (13 lb)	5.9 kg (13 lb)/7.7 kg (17 lb)

\* This network is a simplified representation of a complex network. The formula  $Z = R X_c / \sqrt{R^2 + X_c^2}$  is used for frequencies up to 1 MHz by substituting the values given for R and C. Above 1 MHz, the output impedance is greater than the formula would indicate.

\*\* Output current can be modulated 100% up to 50 Hz; percent modulation decreases

linearly to 10% at 500 Hz.

†† For operation above 40°C the maximum output current must be reduced linearly to 80% of rating at 55°C (maximum temperature).

$\Delta$  Minimum voltage obtainable with voltage limit control is 0.5 V.

- High speed remote programming
- Overload protection
- Wide-band response

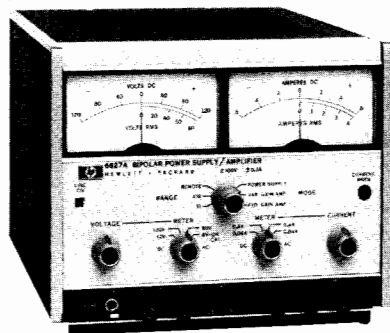

6825A-6827A

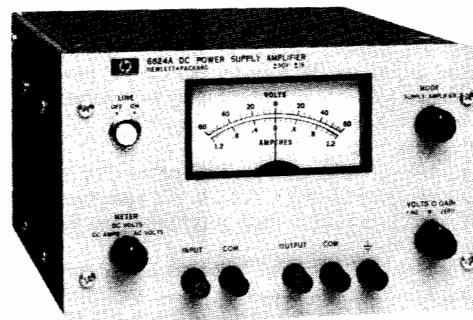

6824A

## Description

The Power Supply/Amplifier is a general-purpose instrument useful in any laboratory engaged in research and development of electronic systems, circuitry, or components. The unit can be operated in one of two basic operating modes: power supply or amplifier. Terminals at the rear permit access to various internal control points to further expand the operational capabilities of the instrument. The resulting flexibility lends the Power Supply/Amplifier to an almost unlimited number of applications.

### Models 6825A through 6827A

These models feature dual-range output and Constant-Voltage/Constant-Current operation. Output voltage and current as a dc supply, or gain as a power amplifier, are remotely controllable and are compatible with Hewlett-Packard Multiprogrammer Systems.

As a dc power supply, the unit can furnish a bipolar, Constant-Voltage or Constant-Current output. It can be remotely programmed with a resistance, voltage, or current and its high speed programming characteristics adapt it to a wide variety of laboratory and production testing applications. The supply can sink, as well as source, current permitting it to serve as a variable load device.

As a direct-coupled power amplifier, each unit offers a signal-to-noise ratio of approximately 80 dB at full output with low distortion and a frequency response up to 40 kHz in the fixed gain mode.

### Model 6824A

Although this model does not provide quite the level of performance and flexibility of Models 6825A through 6827A, it is lower in cost and is suitable for many applications.

As a power supply, this unit offers Constant-Voltage/Current-Limiting operation, remote programming, and Auto-Series, Auto-Parallel operation.

As a power amplifier, the unit exhibits a high signal-to-noise ratio with a 20 dB gain from dc to 10 kHz. It is useful in servo systems, as a pulse or oscillator amplifier, for motor control, and a variety of other applications.

### General Specifications

**Temperature:** operating, 0 to 55°C, storage, -40 to +75°C.

**Power:** 6824A, standard input voltage is 104-127 V ac, 48-63 Hz. Order Option 028 for 230 V ±10% operation. 6825A & 6826A, 6827A, switchable, 100, 120, 220, or 240 V ac, -13% +6%, 48-63 Hz, 150 W.

**Size:** 6824A, 131 H x 209 W x 303 mm D (5<sup>1</sup>/<sub>32</sub>" x 8<sup>7</sup>/<sub>32</sub>" x 11<sup>15</sup>/<sub>16</sub>" ). 6825A, 6826A & 6827A, 155 H x 198 W x 316 mm D (6<sup>1</sup>/<sub>32</sub>" x 7<sup>25</sup>/<sub>32</sub>" x 12<sup>7</sup>/<sub>16</sub>" ).

**Weight:** 6824A, 7.7 kg (17 lb), 6825A, 6826A & 6827A, 8.2 kg (18 lb).

## Power Supply Specifications

RATINGS			PERFORMANCE												
DC Output		Model	LOAD EFFECT		Source Effect		Pard (rms/p-p)		Transient Recovery		Resolution		Output Z (Typical)	Options ▲	Price
Volts	Amps		Voltage	Current	Voltage	Current	Voltage	Current	Time	Level	Voltage	Current			
-5 V to +5 V / -20 V to +20 V	0-2.0 A Both Ranges	6825A	0.01% + 1 mV	0.01% + 250 μA	0.01% + 2 mV	0.01% + 250 μA	10/30 mV	5/15 mA	100 μs	20 mV	40 mV	6 mA	0.5 mΩ, 1.5 μH	9	\$1125
-5 V to +5 V / -50 V to +50 V	0-1.0 A Both Ranges	6826A	0.01% + 1 mV	0.01% + 250 μA	0.01% + 5 mV	0.01% + 250 μA	6/35 mV	0.8/5 mA	100 μs	50 mV	100 mV	3 mA	1 mΩ, 1.5 μH	9	\$1125
-10 V to +10 V / -100 V to +100 V	0-0.5 A Both Ranges	6827A	0.01% + 1 mV	0.01% + 250 μA	0.01% 10 mV	0.01% + 250 μA	10/50 mV	0.4/5 mA	100 μs	100 mV	200 mV	1.5 mA	2 mΩ, 4 μH	9	\$1175
-50 V to +50 V	0-1.0 A	6824A	0.02% + 5 mV	—	0.02% + 5 mV	—	10 mV rms	—	100 μs	0.02% + 5 mV	—	—	—	9, 28	\$675

†Refer to page 237 for complete specification definitions.

▲See page 260 for complete option and accessory descriptions.

## Power Amplifier Specifications

RATINGS			PERFORMANCE									
Output		Model	Voltage Gain		Frequency Response, +1, -3dB		Distortion at full output		Input Z (Typical)	Programming Coefficients		
Volts	Amps		Fixed	Variable	Fixed Gain	Variable Gain	100 Hz	10 kHz		Gain*	Voltage	Current
10 V p-p or 40 V p-p	2 A pk	6825A	1X 4X	0-2X 0-8X	dc-40 kHz	dc-15 kHz	0.1% THD	0.5%	10 kΩ	Rf/10.24 kΩ 4 Rf/10.24	1 V/V 4 V/V	2 A/V
10 V p-p or 100 Vp-p	1 A pk	6826A	1X 10X	0-2X 0-20X	dc-40 kHz	dc-15 kHz	0.1% THD	0.5%	10 kΩ	Rf/10.24 kΩ 10 Rf/10.24 kΩ	1 V/V 10 V/V	1 A/V
20 V p-p or 200 V p-p or	0.5A pk	6827A	2X 20X	0-4X 0-40X	dc-30 kHz	dc-15 kHz	0.1% THD	1%	10 kΩ	2 Rf/10.24 kΩ 20 Rf/10.24 kΩ	2 V/V 20 V/V	1 A/V
100 V p-p	1 A pk	6824A	—	0-10X	—	dc-10 kHz	0.1% THD	—	2 kΩ	—	1 V/V	—

\*Rf is the gain programming resistance.





# POWER SUPPLIES

## Options and accessories

For low cost lab, general, and special purpose models

A wide range of options is available to modify standard models to meet the requirements of a particular application. Various low cost lab, general purpose and special purpose power supply description are found on pages 240 through 259. To determine which options are available for a particular power supply, refer to the appropriate product page. Always check the AC input voltage, current, and frequency requirements for the standard model and the AC power available in the area or country where the power supply will be used. If options are required, they must be specified with the order.

### Options

**005:** 50 Hz ac input: optimizes power supplies that require adjustment/modification for 50 Hz operation. Order only when listed as required in specifications for a particular model.

**009:** ten-turn output controls. Replaces single-turn output voltage and current controls (where applicable and available). 6114A, 6115A, 6206B-6209B, 6294A, 6299A and 6824A-6827A

**010:** chassis slides. For access to rack mounted power supplies. 6263B-6267B

**011:** internal overvoltage protection crowbar. Protects delicate loads against power supply failure or operator error. Dual output models have dual crowbars. Single output models, where available. Dual output models, 6205B, 6253A, & 6255A

**015:** three-digit graduated turns-counting dial and ten-turn controls for output voltage and current (where applicable and available). Improves resetability of power supply output

**016:** 115 V ac  $\pm 10\%$  single phase input. Consists of replacing power transformer and circuit breaker, and reconnecting bias transformer, RFI choke and fans. For model 6260B only

**019:** 230 V ac  $\pm 10\%$ , 50  $\pm 0.3$  Hz, single phase input. Consists of replacing input transformer, line cord and fuse. Option 019 applies only to models 6515A & 6516A

**022:** voltage and current programming adjust. Allows the V and I programming coefficients and zero output to be conveniently adjusted to 0.1% accuracy via access holes in the rear panel. Consists of four potentiometers and resistors located inside the rear panel. Option 022 applies only to models 6259B-6274B

**023:** rack mounting attachments. Factory installed for mounting model 6464C-6483C in a standard 19" rack.

**026:** 115 V ac  $\pm 10\%$ , single phase input. Consists of replacing the input circuit breaker and reconnecting the power transformer, bias transformer, RFI choke, and fans. Option 026 applies only to models 6259B, 6261B, and 6268B

**027:** 208 V ac,  $\pm 10\%$ , single phase input. Consists of reconnecting power transformer taps, and other components where necessary. Order only when listed in the specifications for a particular model

**028:** 230 V ac  $\pm 10\%$ , single phase input. Consists of reconnecting power transformer taps, and other components where necessary. Order only when listed in the specifications for a particular model

**040:** multiprogrammer interface. Prepares standard HP power supplies for resistance programming by the 6940B Multiprogrammer or 6941B Multiprogrammer Extender. This option includes Option 022, special calibration, and protection check-out procedures (where required)

**Price**  
N/C

\$30

\$60

\$100

\$85

\$160

\$250

\$70

\$130

\$75

\$75

\$100

\$125

\$250

\$80

\$50

\$60

\$30

N/C

N/C

N/C

6111A-6113A \$40  
 6205B, 6224B, 6226B, 6259B-6274B, & 6281A-6299A \$75  
 6464C, 6466C, 6469C, & 6472C \$100  
 6227B, 6228B, 6253A & 6255A \$150  
**100:** 87-106 V ac, 47-63 Hz, single phase input N/C  
**220:** 191-233 V ac, 47-63 Hz, single phase input N/C  
**240:** 208-250 V ac, 47-63 Hz, single phase input N/C  
 (Note: options 100, 220 and 240 are for models 6236B and 6237B only, and consist of setting an internal AC voltage selection switch and selecting appropriate line fuse.)

**Special Option J30:** Voltage to current converter. Required to prepare models 6427B-6448B and 6466C-6483C for use with the model 59501A HP-IB Isolated D/A Power Supply Programmer. Contact your local HP Field Engineer for ordering assistance. (Reference AN250-I, paragraph 4-37)

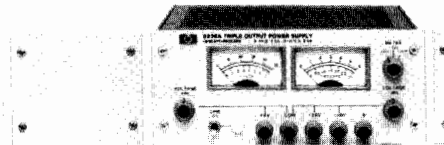

14513A Rack Kit for one 3.5" high supply  
 14515A Rack Kit for one 5.25" high supply

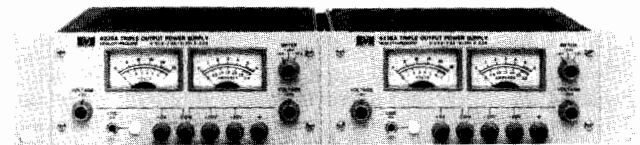

14523A Rack Kit for two 3.5" high supplies  
 14525A Rack Kit for two 5.25" high supplies

### Accessories

14513A and 14523A rack kits apply to the following models: 6200-6209B, 6237B, 6281A, 6284A, 6289A, 6294A, 6299, 6515A

**14513A:** high rack kit for one supply \$35  
**14523A:** 3.5" high rack kit for two supplies \$25

14515A and 14525A rack kits apply to the following models: 6111A-6113A, 6116A, 6282A, 6286A, 6291A, 6296A, 6516A, 6824A.

**14515A:** 5.25" high rack kit for one supply \$40  
**14525A:** 5.25" high rack kit for two supplies \$30  
**14521A:** rack kit for one, two or three supplies \$65  
 Includes two filler panels. 14521A rack kit applies to the following models: 6212A-6218A.

**5060-8762:** adapter frame for rack mounting one or two 1/2 rack widths units or one, two or three 1/3 rack width units \$70  
 This frame applies to the following models: 6114A, 6115A, 6186C, 6224B-6228B, 6825A, 6826A, 6827A.

**5060-8764:** adapter frame for rack mounting one or two 1/2 rack width units. \$70  
 This frame applies to the following models: 6177C, 6181C.

**5060-8759:** Blank Filler Panel \$22  
 This 1/2 rack width panel applies to the following models: 6224B, 6226B.

**5060-8760:** Blank Filler Panel \$21  
 This 1/2 rack width panel applies to the following models: 6114A, 6115A, 6186C, 6227B, 6228B, 6825A, 6826A, 6827A.

**5060-8530:** Blank Filler Panel \$32  
 This 1/2 rack width panel applies to the following models: 6177C, 6181C.

**14545A:** casters-set of four \$85  
 Snap-on casters for one 6464C-6483C power supply. (For rack mounting information on these supplies, see Opt 023.)

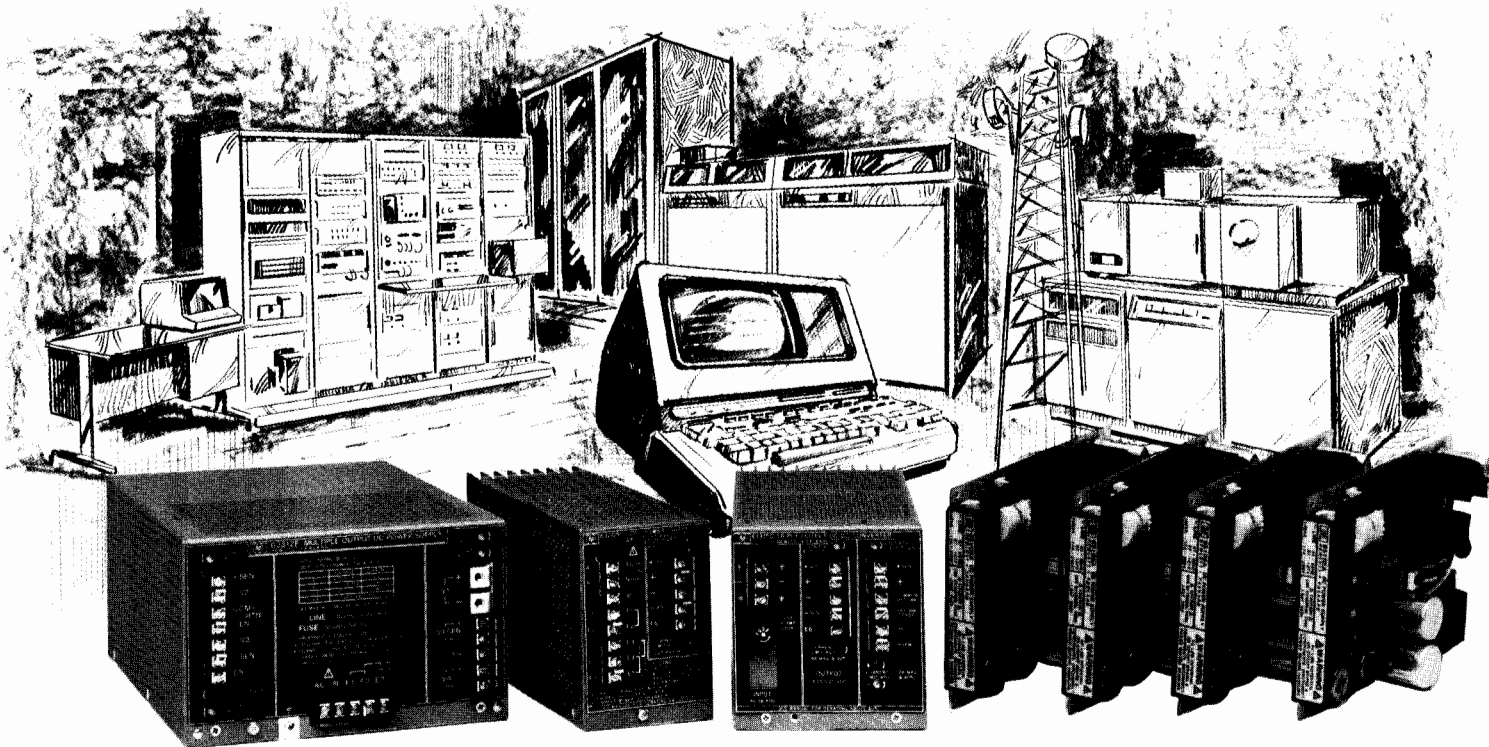

### Introduction

The selection of a power supply for today's system requires a critical and prudent evaluation. Sophisticated system electronics have placed more demands on the supply and, as always, the power supply is the very heart of your system. If it stops delivering power, your system will cease to operate.

Your evaluation should include not only the more obvious technical and cost considerations, but also a look at some of the less tangible factors that make up the total purchasing power of your OEM dollar.

### Quality

HP's OEM supplies are totally tested before they are introduced. Each product goes through a complete development cycle, consisting of: (a) Engineering Breadboarding; (b) Lab Prototyping; (c) Production Pilot Runs. At each phase the units are evaluated for safety, specification compliance, environmental performance, workmanship, and serviceability. In addition, all models undergo formal environmental testing at a certified facility before introduction.

### MTBF

Mean Time Between Failure (MTBF) is a figure of merit that can be calculated and actually verified. It is a number that is often quoted but seldom understood. Frequently, the MTBF's of different manufacturers cannot be compared because they are calculated by different means. HP employs a comprehensive and conservative method of determining MTBF. A component data base is maintained to provide actual component failure statistics and the MTBF is adjusted downward, if necessary, to reflect the actual working environment that the components will be exposed to.

Such is the case with the new 65105A 200 kHz FET-switching power supply, where Mil-Spec 781B, Test Plan III was utilized. As indicated by the curve, after 395,000 unit-hours of testing the design hypothesis of 100,000 hours MTBF at 25°C was verified.

### Life Test Acceptance Curve—65105A

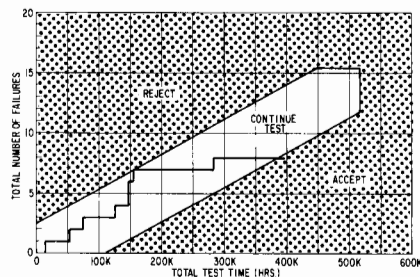

Although this method is expensive and time consuming, it assures you of the HP quality that you have come to expect.

### Safety

To assist you in complying with tightening safety regulations, all HP modular power supplies (including switching regulated) are designed to meet UL specs for U.S. applications. Considerations have also been given to international safety regulations (e.g. VDE 0730). Only when the manufacturer can provide you with a UL yellow card number, can you be assured of UL compliance.

### Service Support

Hewlett-Packard's service support is an

other contributing factor in the lasting value of their products. HP is ready to respond to your service needs with an extensive chain of world-wide service and spare parts facilities. Staffed by competent technical personnel, these facilities can provide minimum turn-around time and are backed by the full resources of the manufacturing division. In addition, all units are shipped with a complete Operating and Service Manual.

### Special Design Group

In some applications off-the-shelf power supplies may not meet your needs. In these instances, our Special Design Group can provide product modifications, assembled power systems, and applications assistance to help with your specific requirement.

### Make or Buy

A crucial question in the make or buy decision is whether or not you have the technical and financial resources available to manufacture your own supplies.

It is important not to underestimate the difficulty involved in a power supply design. When evaluating your technical capabilities keep in mind that: (a) Modern power supplies are state of the art components; (b) Time will be required for electrical and mechanical definition as well as for design, lab and production prototypes and evaluation; and (c) Engineers will be diverted from other projects.

To assist you in the cost aspects of your evaluation, we have prepared application note 236-1. This note assists you in conducting a Return on Investment (ROI) analysis by revealing both the obvious and hidden costs incurred in the manufacture of your own power supplies. Contact your local HP sales office for a free copy.



# POWER SUPPLIES

OEM Modular: The total solution concept

Model series 61000-65000

## EXAMPLE OF RATINGS AVAILABLE.

Contact your local HP Field Engineer for information on models to meet your specific requirements.

### Single Output—UL yellow card E51529

	Linear Regulated			20 kHz Switching Regulated			65000A-Series
	A-Series	E-Series	G-Series	63000C-Series	L-Series	M-Series	
5 V	62005A (2.0A)	62005E (8.0A)	62005G (16.0A)	63005C (22.0A)	62605L (60.0A)	62605M (100.0A)	65105A (10.0A)
12 V	62012A (1.5A)	62012E (6.0A)	62012G (12.0A)	(Note 2)	(Note 1)	(Note 1)	65112A (4.2A)
15 V	62015A (1.25A)	62015E (5.0A)	62015G (10.0A)	(Note 2)	(Note 1)	62615M (40.0A)	65115A (3.5A)
24 V	62024A (0.75A)	62024E (3.75A)	62024G (7.5A)	—	—	(Note 2)	—
28 V	62028A (0.7A)	62028E (3.25A)	62028G (6.5A)	—	—	(Note 2)	—
48 V	62048A (0.45A)	62048E (2.0A)	62048G (4.0A)	—	(Note 2)	(Note 2)	—
OEM Price*	\$310	\$375	\$575	\$585	\$750	\$815	\$195

### Dual-Output—UL yellow card E51529

±12V	62212A (1.4A)	62212E (3.3A)	62212G (6.0A)	—	—	—	—
±15 V	62215A (1.25A)	62215E (3.0A)	62215G (5.2A)	—	—	—	—
OEM Price *	\$350	\$425	\$650	—	—	—	—

### Triple-Output—UL yellow card E51529

	20 kHz Switching Regulated Model 63315D	200 kHz Switching Regulated Model 65312A	200 kHz Switching Regulated Model 65315A	200 kHz Switching Regulated Model 65317A
Output 1	4.75 to 5.25 V 18A (Note 3)	5 V 10A (Note 5)	5 V 10A (Note 5)	5 V 10A (Note 5)
Output 2	+11.4 to +15.75 V 2A (Note 3)	+12 V 1.5A (Note 5)	+15 V 1A (Note 5)	+18 V 1A (Note 5)
Output 3	-11.4 to -15.75 V 2A (Note 3)	-12 V 1.5A (Note 5)	-15 V 1A (Note 5)	-18 V 1A (Note 5)
OEM Price*	\$750	\$240	\$240	\$240

### Multiple-Output—UL yellow card E51529

	20 kHz Switching Regulated Model 63312F	200 kHz Switching Regulated Model 65512A	200 kHz Switching Regulated Model 65612A
Output 1	4.75 to 5.25 V 50A (Note 4)	5 V 10A (Note 5)	5 V 10A (Note 5)
Output 2	+11.4 to +15.75 V 10A (Note 4)	+16 V 1A (Note 5)	+16 V 1A (Note 5)
Output 3	-11.4 to -15.75 V 10A (Note 4)	-16 V 1A (Note 5)	-16 V 1A (Note 5)
Output 4	Up to 120 watts at customer specified voltage (Note 2 & 4)	5 to 12 V 0.3 to 1A (Note 5)	5 to 12 V 0.3 to 1A (Note 5)
Output 5	—	-5 to -12 V 0.3 to 1A (Note 5)	-5 to -12 V 0.3 to 1A (Note 5)
Output 6	—	—	-5 to -12 V 0.3 to 1A (Note 5)
OEM Price*	\$980	\$255	\$265

### DC-to-DC Converters

	Single Output	Triple Output
	Model 61005C	Model 61315D
Output Ratings	4.75 to 5.25 V at 22A	(Same as Model 63315D) Note 3
OEM Price*	\$550	\$695

- 1: Special ratings on special order basis at no additional cost.
- 2: Special ratings on special order basis at additional cost.
- 3: The outputs of the Models 61315D and 63315D can be operated anywhere within their 18A, 2A, and 2A individual current ratings providing the total output power is within a 110-watt total output rating.
- 4: The outputs of Model 63312F may be operated anywhere within their 50A, 10A and 10A individual current ratings provided total power is under 550 watts for three output operation.
- 5: The outputs of models 65105A through 65612A may be operated anywhere within their individual current ratings provided the total output power from the supply does not exceed 50 watts.

\*Quantity and OEM discount are available. All prices on this page are for OEM 100 unit quantity.

### New 65000-Series Power Supplies Feature 200 kHz Switching

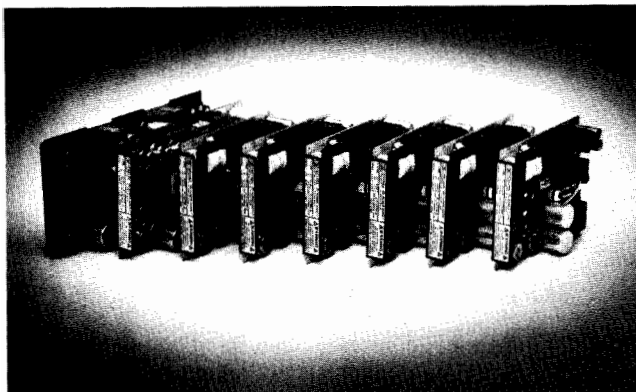

The 65000A-series of 50 watt power supplies has a selection of eight different models with one, three, five or six outputs as listed on page 262.

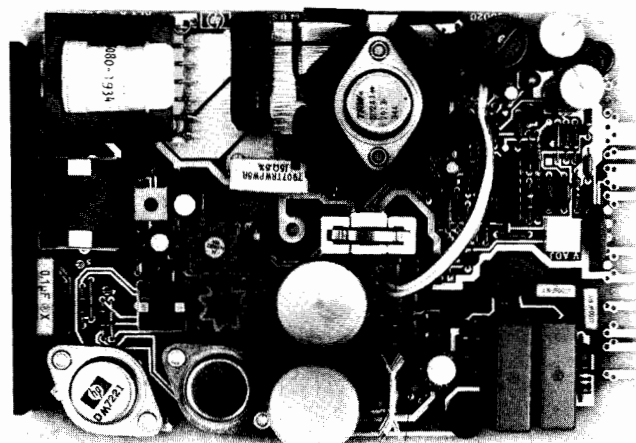

Reduced size and weight are achieved by using power FET switches operating at 200 kHz resulting in smaller filter components and transformer.

#### Description

Through the use of 200 kHz MOS Power FET Switching technology, Hewlett-Packard has designed a new family of 50 watt power supplies featuring reduced size and weight, and improved reliability. Designers can choose from eight different models specifically developed to power microprocessor-based products such as microcomputers and peripherals, communication devices and test equipment. See page 262 for output rating selections.

A key feature of the design is that selectable input voltage ranges make the supply adaptable to worldwide use. The supply is UL-recognized to UL478 and UL114, is certified to CSA 22.2 No. 143 and No. 154, and meets the requirements of VDE 0730 Part 2P and IEC 348. In addition, the supply is brownout-proof and has overvoltage and short-circuit protection. Power system management is provided by the remote shutdown terminal.

Three groups make up the family including single, triple, and five or six outputs. Each group uses a different printed circuit card with a form factor that makes mounting or removing the card from the mainframe simple. Optional board-edge connectors allow the designer to choose from a variety of plug-in and screw-type terminals.

The main output in each group, V1, uses a control reactor that adjusts the operating frequency to maintain 0.1% regulation. In multiple-output models, two semi-regulated V2 and V3 outputs also serve as a source for outputs V4, V5, and V6 via discrete regulators.

#### Power Systems

- Custom designed systems are available assembled, tested and documented by Hewlett-Packard
- System component units for "do it yourself" power system solutions

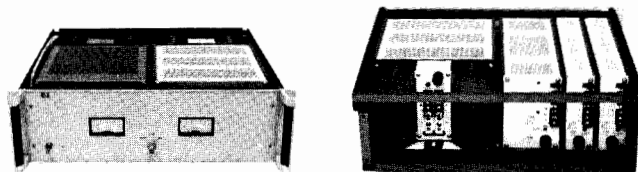

#### Custom Systems

Custom power systems can be assembled by installing suitable combinations of single and dual-output linear supplies and switching regulated supplies in rack mounting trays. If desired, Hewlett-Packard will assemble, wire, and test complete power supply systems to customer specifications using these modular power supplies and rack mounting accessories. Meters, switches, input and output connectors, and other components will be installed to meet your specific needs. Consult your local Hewlett-Packard Field Engineer for price and delivery information.

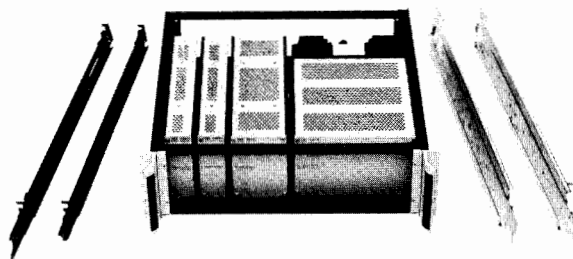

#### Accessories for Power Systems

The Model 62410A Rack Mounting Tray can accommodate any combination of Series 62000 linear supplies, Series 62200 dual linear supplies, Series 63000 switching-regulated supplies totaling a full rack width or less. It can be installed in a 19-inch rack directly or on slides. Detachable handles are included. The 62411A Blank Front Panel has a 2.25-inch clearance when installed on the tray for meters, switches, test jacks. Model 62413A Cooling Unit delivers 45 CFM of cooling air while occupying only 1.75-inches of rack space. The 62414A Slide Kit has a 20-inch slide for use with standard 19-inch wide racks of 20-inch depth (not for HP29400A or -B cabinets.) Model 62415A AC Distribution Panel is a mounting tray rear panel with a 3-terminal barrier strip, line cord, and fuse holder already installed. The 62416A Cooling Unit is 5.25 inches high and delivers 150 CFM of rack cooling air. The 12692B Slide Kit has 22-inch slides for use with HP 29400 or -B cabinets.

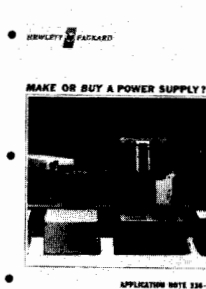

APPLICATION NOTE 126-1



OEM Modular Power Supply Selection Guide and AN 236-1 are available from your local HP Field Engineer.



## POWER SUPPLIES

Digitally controlled: binary or BCD

Models 6129C-6131C & 6140A

- Digitally programmable in binary or BCD
- HP-IB compatible option J99 & 59301A
- Fast, accurate, bipolar output
- Digital inputs isolated from analog output
- Internal storage of digital data
- Digitally programmable current latch (on DVS models)- or voltage limit (on DCS model)

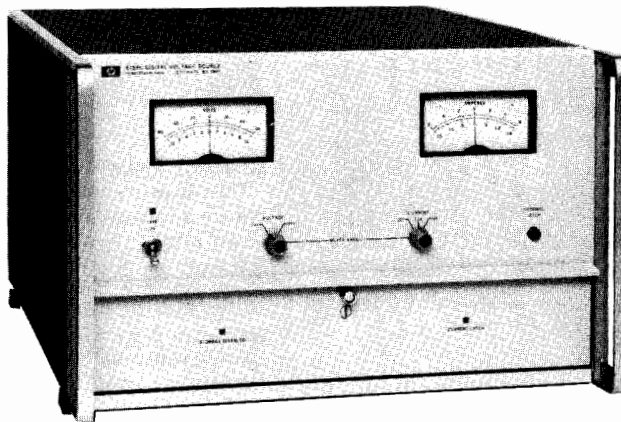

6129C

### Digital Voltage Sources

HP's family of digital voltage sources (DVS's) includes models 6129C, 6130C, and 6131C. All models are programmable in binary or 8421 BCD and have many system-oriented features that enhance their use in automatic testing and control environments. Among these features are: isolation between the digital input and analog output lines, digital storage of programmed inputs, programmable current latch, analog input, and current monitoring terminals.

### Isolation

All digital lines of the DVS's are isolated from the analog output. This feature is essential in automatic test systems to avoid forming ground loops that could impair system operation and damage the computer and instruments.

Nearly all computer manufacturers ground the power supplies for the digital I/O logic to the mainframe of the computer, which is connected to the ac power line ground. If a DVS did not have isolation, one of its analog output terminals would be connected to the digital input common line.

### Internal Storage

The DVS's internally store the computer's output magnitude (voltage setting), polarity, range, and output latch/limit digital inputs when the computer's gate command is received. When the DVS has finished processing the digital input, it notifies the computer by transmitting its flag. Since the DVS stores the digital data, the computer does not have to continually refresh the DVS; it is free to carry out other important tasks. The DVS maintains its programmed output indefinitely, changing the output only when the computer changes the digital input data and sends another gate command.

In addition to eliminating the need for redundant programming by the computer, internal storage also facilitates the control of multiple DVS's from a single computer I/O channel. The number of DVS's that can be controlled from a single I/O channel depends on the capabilities of the computer's I/O data bus drivers. Most computers can easily drive up to eight DVS's.

### Programmable Current Latch

Overcurrent protection is provided by a current latch circuit which can be externally programmed to one of eight values between 2% and 100% (six values for the 6131C) of the unit's rated output current. When activated, the current latch circuit turns off the output power amplifier reducing the output current to less than 20 mA. The reaction time of the current latch circuit (time between the start of a current overload and turn off of the power amplifier) can be adjusted by adding an external capacitor at the rear terminals. The upper current limit is safeguarded by a separate fixed current limit circuit that prevents the output current from exceeding 110% of the current rating. The computer is continuously informed of possible current overload or current latch conditions by status outputs which are fed back to the programming source.

### Analog Input

In automatic test systems, it is often desirable to inject an ac "wobble" on top of a programmable dc level to measure impedance at various voltage levels, to simulate worst case power supply conditions for a module under test, or measure component parameters such as dynamic gain or transconductance. Many automatic control systems require this feature to provide "dither" for the system. All DVS's provide an analog input to fulfill this need.

### Current Monitoring Terminals

The output current of all DVS's can be measured without upsetting voltage accuracy by connecting a voltmeter across the current monitoring terminals on the rear barrier strip.

### Digital Current Sources

The Digital Current Source, Model 6140A is ideally suited for system applications requiring a rapidly programmable, high-precision source of current.

The isolation, internal storage, and analog input features described for the DVS's also apply to the DCS's. In addition, the DCS's have programmable voltage limiting and voltage monitoring terminals.



Models 6129C-6131C, & 6140A (cont.)

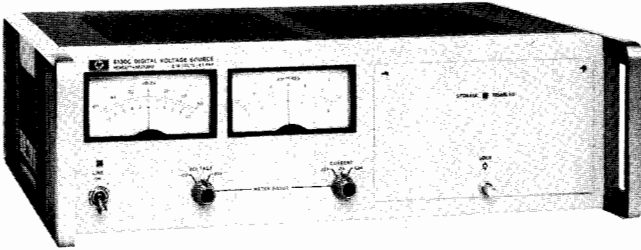

6130C, 6131C

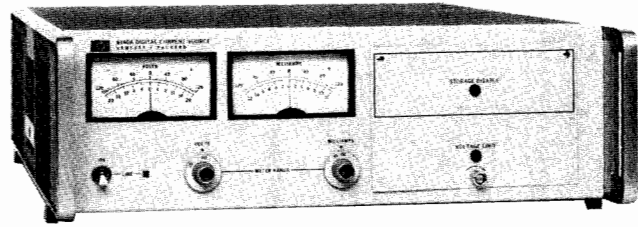

6140A

### Common Specifications

#### AC power input

- 6129C:** 115/230 V ac, 48-63 Hz; 6.4 A, 780 W @ 115 V ac; 115/230 V ac switch-selected.
- 6130C, 6131C:** 115 V ac  $\pm 10\%$ , 48-440 Hz; 1.2 A, 100 W.
- 6140A:** 115/230 V ac, 48-63 Hz; 1.2 A, 100 W @ 115 V ac; 115/230 V ac switch selected.

#### Dimensions

- 6129C:** 266.7 H x 425.5 W x 542.9 mm D (10.5" x 16.75" x 21.38").
- 6130C, 6131C:** 133.4 H x 425.5 W x 396.9 mm D (5.25" x 16.75" x 15.63").
- 6140A:** 133.4 H x 425.5 W x 542.9 mm D (5.25" x 16.75" x 21.38").

#### Weight

- 6129C:** net, 35 kg (78 lb). Shipping, 39 kg (85 lb).
- 6130C, 6131C:** net, 15 kg (32 lb). Shipping, 18 kg (40 lb).
- 6140A:** net, 17 kg (38 lb). Shipping, 20 kg (44 lb).

#### Cooling

- 6130C, 6131C:** are convection cooled.
- 6129C, 6140A:** are forced air cooled.

**Programming time:** less than 300  $\mu$ s for output to settle to within 0.1% of programmed change. Range change requires 2 ms.

### Software for HP Computers

Drivers in the form of punched paper tape with accompanying operating manuals are available for Hewlett-Packard BCS, DOS, RTE, and BASIC software operating systems. Contact your HP Field Engineer for prices and ordering information.

#### AC Power Option

**028:** transformer tap change for 230 V ac  $\pm 10\%$ , single-phase input on 6130C and 6131C.

Price

N/C

#### Standard Interface Options

**J20:** binary interface for 12661A I/O programmer card for Hewlett-Packard computers

N/C

**J99:** interfacing DCPS's with calculator-based test control systems. All DCPS's may be modified to be compatible with ASCII-to-Parallel Converter, Model 59301A in calculator-based systems. In addition to DCPS modification, two items are supplied as part of Option J99: (1) a 1.83 m cable to connect DCPS to Model 59301A; (2) J99 Interface Note, containing Installation Instructions, Software Listings, Operating Instructions, and Diagnostics.

\$170

**063:** BCD interface for microcircuit logic levels

N/C

**064:** binary interface for microcircuit logic levels

N/C

### Special Options

If none of the standard interface options meet your requirements, quotations for special options may be obtained from your Hewlett-Packard field engineer.

### Accessories Available

**14533B:** Pocket programmer permits manual programming of all input functions by switch closure \$275

**14534A:** Pocket programmer extension cable (3 ft) \$125

**14535A:** HP computer interface kit includes 12661A computer I/O card, 14539A cable, verification software and BCS Driver. Up to eight DCPS's may be controlled from one 14535A \$1700

**14539A:** cable connects the first DCPS in a chain of up to eight instruments to the 12661A DVS programming card for Hewlett-Packard computers \$170

**14536A:** chaining cable connects an additional DCPS to the existing chain of DCPS's \$250

### Ordering Information

**6129C:** Digital Voltage Source \$4500

**Opt 908:** Rack Flange Kit add \$31

**6130C, 6131C:** Digital Voltage Source \$2200

**6140A:** Digital Current Source \$4500

**Opt 908:** Rack Flange Kit add \$22

	Binary Instruments Option J20 & 064		BCD Instruments Option J99 & 063	
	X1 Range	X10 Range	X1 Range	X10 Range
6129C				
Output	$\pm 16.384$ V, 5 A	$\pm 50.00$ V, 5 A	$\pm 9.999$ V, 5 A	$\pm 50.00$ V, 5 A
Accuracy	1.5 mV	15 mV	1.5 mV	15 mV
Resolution	0.5 mV	5 mV	1 mV	10 mV
6130C				
Output	$\pm 16.384$ V, 1 A	$\pm 50.00$ V, 1 A	$\pm 9.999$ V, 1 A	$\pm 50.00$ V, 1A
Accuracy	1 mV	10 mV	1 mV	10 mV
Resolution	0.5 mV	5 mV	1 mV	10 mV
6131C				
Output	$\pm 16.384$ V, 0.5 A	$\pm 100.00$ V, 0.5 A	$\pm 9.999$ V, 0.5 A	$\pm 99.99$ V, 0.5 A
Accuracy	1 mV	10 mV	1 mV	10 mV
Resolution	0.5 mV	5 mV	1 mV	10 mV
6140A				
Output	$\pm 16.384$ mA, 100 V	$\pm 163.84$ mA, 100 V	$\pm 9.999$ mA, 100 V	$\pm 99.99$ mA, 100 V
Accuracy	1 $\mu$ A $\pm 0.01\%$	10 $\mu$ A, $\pm 0.01\%$	10 $\mu$ A, $\pm 0.01\%$	10 $\mu$ A, $\pm 0.01\%$
Resolution	0.5 $\mu$ A	5 $\mu$ A	1 $\mu$ A	10 $\mu$ A

### Accessories Furnished:

- 1251-0086 50-contact rear plug.
- 5060-7948 Plug-in extender board for DVS models.
- 5060-7948/5060-7982 Two plug-in extender boards for DCS.

# RECORDERS & PRINTERS

## General recorder information

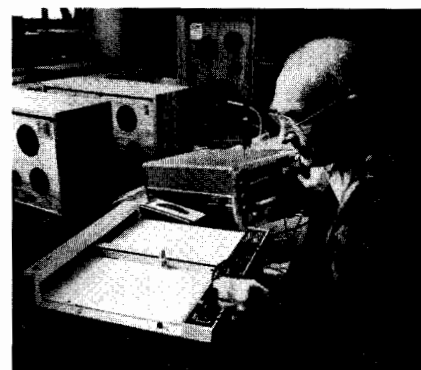

### Introduction

Hewlett-Packard offers a wide selection of recorders that capture and display data accurately, quickly, and consistently. This recorder line provides a choice of performance features to meet a variety of applications, including manufacturing, business, education, laboratory, and medical needs. Some of the criteria for selecting a recording device to satisfy present and future requirements are discussed below.

A major area of consideration for any precision instrument is reliability and serviceability. HP maintains the same high level of reliability for the entire recorder line, through rugged construction and extensive performance and environmental testing. Service is ensured by a responsive customer service program available through the worldwide network of HP sales and services offices.

### Selecting an X-Y Recorder

X-Y recorders are designed to plot Cartesian coordinate graphs from DC electrical information. There are three basic decision areas to consider in selecting an X-Y recorder in addition to reliability: static performance, dynamic performance, and features.

**Static performance:** Static performance relates to a recorder's response to DC voltages and very low frequency input signals. It includes accuracy and resolution. Accuracy is the degree of distortion of the recorded signal. Accuracy and resolution of the trace are functions of the electronic and mechanical characteristics of the recorder and also of its dynamic performance. The type of input signal will determine the range of sensitivity (input voltage) required.

**Dynamic performance:** Dynamic performance is a function of two characteristics: slewing speed and acceleration. Slewing speed is defined as the maximum speed attainable by the pen along either the X or Y axis. Its main contribution is the ability to record high amplitude, low frequency signals. Acceleration is defined as the peak pen acceleration when the pen responds to a step input. Acceleration's main contribution is the ability to respond to low amplitude, high frequency signals. As an instrument's rated acceleration decreases, response is more and more limited by acceleration, and slewing speed becomes less significant. High dynamic performance is essential to the capture of rapid, transient signal inputs. The types, speed, frequency, and range of the input signals determine the required dynamic performance characteristics.

**Features:** The importance of other features is determined by the application and the environment in which the recorder will be used. In some cases, there is a trade off. Unit size is one example. The larger the unit, the easier it is to scale for recognition and interpretation of the trace, but the more space is required to house the recorder. Selecting a 1 or 2-pen system depends on whether one or two independent variables are being recorded versus another variable. Use of a time base feature is determined by the need to record the variable or variables versus time. Other standard or optional features available on all HP X-Y recorders include electrostatic hold down, zero offset, and rack mounts.

### Selecting a Strip Chart Recorder

Strip chart recorders produce permanent records of slowly varying analog signals versus time. Selection criteria should include chart speeds, input voltage spans and the writing system.

**Chart speeds:** Recording speeds vary with each recorder capable of performing at multiple, user-selected speeds. Fast speeds capture rapid, close signals and slow speeds are ideal for long term recording and paper economy. The range selected will vary, based on your requirements and data input volume.

**Input voltage spans:** As with recording speeds, the input voltage spans vary widely. Some units have switch-selectable settings, while other ranges are determined by plug-in signal conditioner modules. The signal levels for your applications will determine the recorder sensitivity required.

**Writing systems:** A thermal writing system, which seldom requires pens to be changed, is ideal for long term unattended operation; an ink writing system contains durable stainless steel or convenient disposable pens. Both systems provide a clean, distinct trace. All 2-pen models permit both channels to use the full resolution of the chart width simultaneously, as the pens can overlap on the same chart without interference.

**Features:** Convenient features standard on all models include chart tables that tilt at three angles, front-panel thumbwheels that advance chart paper, methods for storing completed charts, and user-oriented documentation. The series offers models with 1 and 2 pens, modular construction, battery operation, compact size, event marker options, and remote capability.

### Selecting an Oscillographic Recorder

Direct writing oscillographs accurately record analog signals in excess of 100 Hz, whereas strip chart recorders are limited to about 1 Hz. Oscillographic recorders utilize a 40 to 50 mm channel width as opposed to the 125 or 250 mm channel width of the typical strip chart recorder. The selection of a specific oscillograph is dictated in large part by the number of channels and the type of writing system.

**Number of channels:** Generally available in 2, 4, or 8 channels, the number of channels you select on your oscillograph is influenced by the current and projected requirements. All channels provide precise time correlation relative to the other channels. As the number of channels increases, the cost per channel decreases.

**Writing system:** The writing system is a prime example of high durability, an area in which Hewlett-Packard oscillographs excel. Tungsten carbide ink-writing pen tips and ceramic thermal pen tips can last the life of the recorder. The pen structure is stainless steel to eliminate fatigue failures, including the types that are caused by sustained violent signals. The HP pen system design frees you from the problems of pen adjustment, pen lapping, and pen placement.

**Features:** Other features include a high pen resonance frequency, remote chart speed control, accessible preamplifier outputs, environmental specifications, and the same 5-pin shielded input connectors on all preamplifiers.

### Selecting a Recorder

The following chart provides the basic specifications and application information to identify the best type of recorder for present and future needs. Once the recorder is identified, full information for the unit can be found in this catalog; check the index for the page number.

#### X-Y Recorders

Description model	Application	Chart size cm (inches)	Writing system (# of pens)	Input voltage range	Dynamic perform slew speed (accel.)	Time base
High sensitivity 7047A	Recording of low level signals.	A3 or 28 x 42 cm (11 x 17")	Disp. pens (1)	ⓔ .02, .05, .1, .5, 1, 5 mV/cm; .01, .05, .1, .5, 1, 5 V/cm	>76 cm/s (8G)	Standard
Medium response 7044B	For most general laboratory.	A3 or 28 x 42 cm (11 x 17")	Disp. pens (1)	Ⓛ .25, .5, 1, 2.5, 5, 10, 25, 50, 100, 250, 500, mV/cm; 1, 2.5, 5 V/cm	>50 cm/s (2.5G)	Option
Fast Response 7045B	High-speed, wide range of quick-changing signals.	A3 or 28 x 42 cm (11 x 17")	Disp. pens (1)	Ⓛ	>76 cm/s (8G)	Option
7046B			Disp. pens (2)			
7047A			Disp. pens (1)			
Plug in 7034A	Wide selection of signal conditioners to meet recording needs.	22 x 28 cm (8.5 x 11")	Disp. pens (1)	Determined by plug in (max .25 mV/cm)	>76 cm/s (4G)	Plug in 17172A
7004B			28 x 42 cm (11 x 17")			
Low cost 7015B	Provide full capability where cost and space are a consideration.	A4 or 22 x 28 cm (8.5 x 11")	Disp. pens (1)	5, 50, 500 mV/cm	>50 cm/s	Standard
7035B		22 x 28 cm (8.5 x 11") only		.4, 4, 40, 400 mV/cm and 4 V/cm		Plug on 17108A (7035B only)
Two pen 7046B	X-Y <sub>1</sub> -Y <sub>2</sub> recording.	A3 or 28 x 42 cm (11 x 17")	Disp. pens (2)	.25, .5, 2.5, 5, 25 mV/cm;	>76 cm/s (8G)	Option
7004B/7034A	Combine with 17176 scanner & 17012B point plotter.	28 x 42 cm (11 x 17")/ 22 x 28 cm (8.5 x 11.4")	17012B point plotter	.05, .25, .5, 2.5, 5 V/cm	>76 cm/s (4G)	Plug in 17172A
Point plotter 17012B/C 7004B	Combined with null detector (17173A)	28 x 42 cm (11 x 17")	Disp. pens (1)	Determined by plug in (max .25 mV/cm)	>76 cm/s (4G)	Plug in 17172A
7034A		22 x 28 cm (8.5 x 11")				
OEM 7010B	Dedicated, single-purpose recording. Low cost, medium response.	A4 or 22 x 28 cm (8.5 x 11")	Disp. pens (1)	Specified by option (max 5 mV/cm)	>50 cm/s	Option
7046B	Two pen, fast response.		(2)	Ⓛ	76 cm/s (8G)	

#### Oscillographic Recorders

Model	No. of channels	Channel width	Writing method	Maximum sensitivity (determined by plug-in)	Frequency response Full scale 10% of full scale	Chart speeds
7402A	2	50 mm	Low pressure ink	50 μV full scale	40 Hz 140 Hz	1 mm/s to 125 mm/s
7404A	4	40 mm	Low pressure ink	50 μV full scale	50 Hz 150 Hz	5 mm/min to 200 mm/s
7414A	4	40 mm	Thermal	50 μV full scale	50 Hz 100 Hz	0.25 mm/s to 100 mm/s
7418A	8	40 mm	Thermal	50 μV full scale	50 Hz 100 Hz	0.5 mm/s to 200 mm/s

#### Strip Chart Recorders

Description Model	Application	Chart Size	Writing System	Number of pens	Input ranges	Chart speeds
Compact 680	Ideal for general purpose recording.	12 cm (5 in)	Ink	1	10 spans 6 mV to 120 V (5 mV to 100 V)	8 speeds ⓐ 2.5, 5, 10, 20 cm/min; 2.5, 5, 10, 20 cm/hr
Portable 7155B	Battery operable for field application. Convenient portable design.	12 cm	Disposable ink pen	1	16 spans 1.2 mV to 120 V	7 speeds ⓑ 30, 10, sec/cm; 30, 10, 5, 2.5, 1 min/cm
Plug in 7100B/7101B	Select signal conditioner to meet recording needs. Versatility.	25 cm (10 in)	Ink	2/1	Determined by plug in	12 speeds ⓒ 2.5, 5, 15, 30 cm/hr; 1.25, 2.5, 5, 15, 30 cm/min; 1.25, 2.5, 5 cm/sec
High sensitivity 7100B/7101B 17505A	Low level signal precision recording.	25 cm (10 in)	Ink	2/1	19 spans 0.1 mV through 100 V	12 speeds ⓒ
Wide range of chart speeds 7100B/7101B	Broad variety of input signals.	25 cm (10 in)	Ink	2/1	Determined by plug in	12 speeds ⓒ
Linear temperature 7100B/7101B 17502A	Specific temperature recording needs.	25 cm (10 in)	Ink	2/1	1 span determined by thermocouple range/type	12 speeds ⓒ
Thermal writing system 7132A/7133A Opt 054	Long term unattended operation.	25 cm (10 in)	Disposable ink pen (thermal option)	2/1	11 available spans 1 mV to 100 V	8 speeds ⓓ 2.5, 5, 10, 15 cm/hr
Two pen 7100B	Time -Y <sub>1</sub> -Y <sub>2</sub> recording.	25 cm (10 in)	Ink	2	Determined by plug in	12 speeds ⓒ
7132A	Time -Y <sub>1</sub> -Y <sub>2</sub> recording (remote 7132A input capability allows X-Y <sub>1</sub> -Y <sub>2</sub> recording).		Disposable ink pen (thermal operation)	2	11 spans 1 mV to 100 V	8 speeds ⓓ
OEM 680	Dedicated recording. Compact and versatile.	12 cm (5 in)	Ink	1	10 spans 6 mV to 120 V	8 speeds ⓐ
7155B	Portable for field application.	12 cm	Disposable ink pens	1	16 spans 1.2 mV to 120 V	7 speeds ⓑ
7130A/7131A	50 options available.	25 cm (10 in)	Disposable ink pens (thermal option)	2/1	11 available spans 1 mV to 100 V	Determined by option selected
7100B/7101B	Flexible and wide range.	25 cm (10 in)	Ink	2/1	Determined by plug in	12 speeds ⓒ
Plug ins 17500A	Medium sensitivity				10 spans 5 mV to 100 V	
17501A	High sensitivity				16 spans 1 mV to 100 V	
17505A	Highest sensitivity				19 spans 0.1 mV to 100 V	
17502A	Linear temperature				1 span determined by thermocouple	

Note: The circled lower case letters, such as ⓑ, signify that a specification has been defined previously in that column. To find the parameter, simply look for the same circled letter embedded in a previous specification.



# RECORDERS & PRINTERS

Low-cost, flexible X-Y recorders

Models 7010B, 7015B

- Low cost of ownership
- Choice of optional features

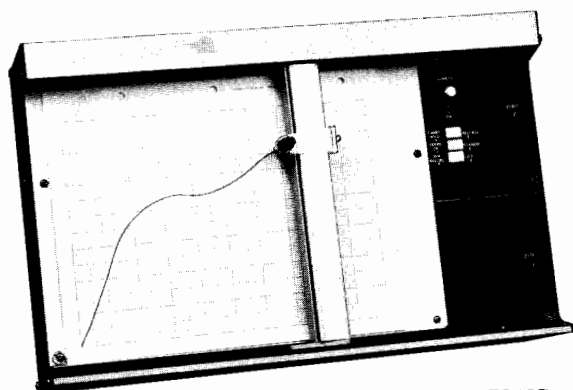

7010B

The 7010B and 7015B are low-cost, one-pen X-Y recorders that allow charting on paper sizes up to ISO A4 or 216 x 280 mm (8-1/2 x 11 in.). All paper sizes, up to the maximum, are held securely by the trouble-free electrostatic paper hold down. The units are mounted in sturdy cases made from single castings, assuring mechanical alignment and long life, even in rugged environments. Designed for the OEM market, the 7010B recorder features low cost, compact design, and a selection of options. The 7015B provides recording for a wide range of laboratory uses where there is a need for full capability at reasonable cost.

The 7010B for OEM applications, features electrical and mechanical flexibility by providing a choice of X and Y-axis sensitivities and X-axis sweep options. In addition, there are optional time base sweeps with remote TTL triggering, input filters, electric pen lift with TTL remote control, control panel, and carrying case.

The 7015B is a low-cost recorder with a full complement of capabilities. The standard features include an internal time base with sweep selections from 5 seconds to 20 minutes. The time base provides automatic pen control and accepts remote triggering from sweep start and reset. Also included are matched input filters; remote pen lift; and TTL-level remote control. The 7015B accepts TTL-level and low current (5 mA) contact closure for easy interface with external equipment.

## 7010B and 7015B Specifications

### Performance Specifications

#### Input voltages:

**7010B:** Single range, 0.1 V/in. (metric Opt: 50 mV/cm)

**7015B:** Metric option: 5 mV/cm, 50 mV/cm, 500 mV/cm

English: 0.01 V/in., 0.1 V/in., 1 V/in. Vernier adjustable overlapping all ranges

#### Time base:

**7015B:** 0.5, 1, 5, 10, 50, 100 s/in. (Option 001, metric calibration is 0.1, 0.5, 1, 5, 10, 50 s/cm). Remote sweep start and reset via TTL level or contact closure.

#### Input types:

**7010B:** Floating rear connector on circuit board

**7015B:** Floating binding posts or circuit board rear connector

#### Input resistance: 1M $\Omega$ constant.

**Normal mode rejection:** 7015B: Greater than 50 dB at 50 and 60 Hz (40 dB/decade roll-off above 60 Hz)

**Common mode rejection:** 100 dB DC, 90 dB AC (decreases 20 dB/decade step in attenuation). Measured with 1K unbalance in HI terminal on most sensitive range

**Common mode voltage:** 40V DC and peak AC maximum (conforms to IEC 348)

**Accuracy:** 7010B:  $\pm 0.3\%$  of full scale at 25°C (includes linearity and resettability). 7015B: Add  $\pm 0.2\%$  of deflection when not on most sensitive range. Temperature coefficient:  $\pm 0.2\%/^{\circ}\text{C}$ . Time base:  $1.5\% \pm 0.1\%/^{\circ}\text{C}$

**Resettability:** Less than 0.2% of full scale.

**Overshoot:** Less than 2% of full scale.

- Low price
- Full capability

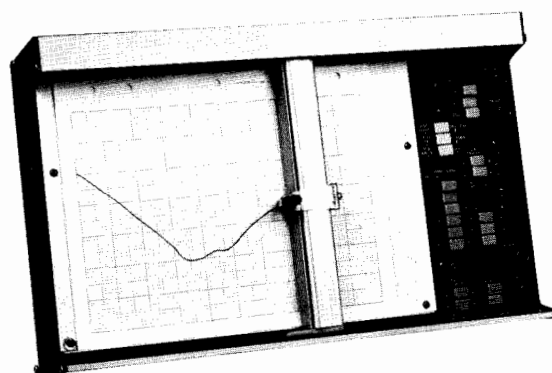

7015B

**Slewing speed:** Greater than 50 cm/s (20 in./s)

**Zero set:** 7015B: Zero may be placed anywhere on writing area or electrically off-scale up to one full scale from zero index. Adjustment by 10-turn high resolution control

**Environmental:** Operating temperature 0°C to 55°C; relative humidity 95% RH to 40°C

### General Specifications

**Writing system:** Fiber tipped disposable pen.

**Writing area:** 18 x 25 cm (7 x 10 in.)

**Platen size:** Holds up to ISO A4 (21 x 30 cm) and 8 1/2 x 11 in.

**Size:** 267 H x 432 W x 135 mm D (10 1/2 x 17 x 5 in.) Electrostatic paper hold down: ISO A4 chart size or less

#### Pen lift:

**7010B:** Manual (optional TTL remote control)

**7015B:** Electric (remote via TTL level or contact closure)

**Power:** Switch selectable for 100, 120, 220, 240 V AC +5 -10%; 47.5 to 440 Hz; 70 VA maximum.

**Weight:** Net, 7.2 kg (16 lb). Shipping 10 kg (22 lb)

### Options

Option no.	Description	Price
<b>7010B</b>		
001	Metric calibration	N/C
002	Control panel	\$95
003	Electric pen lift	85
004	Deletes recorder case	N/C
005	X-axis single sensitivity 5 mV/cm (10 mV/in.)	N/C
006	X-axis single sensitivity 0.5 V/cm (1 V/in.)	N/C
007	Y-axis single sensitivity 5 mV/cm (10 mV/in.)	N/C
008	Y-axis single sensitivity 0.5 V/cm (1 V/in.)	N/C
009	X-axis sweep rate of 0.5 s/cm (1 s/in.)	\$110
010	X-axis sweep rate of 5 s/cm (10 s/in.)	110
011	Carrying case (not for shipping use)	130
012	Input filter (both axes)	50
013	Rear connector (37-pin subminiature "D")	85

\*Options 009 and 010 include electric pen lift

<b>7015B</b>		
001	Metric calibration	N/C
004	Carrying case (not for shipping use)	\$125

### Ordering Information

7010B OEM X-Y recorder	\$1275
7015B Lab X-Y recorder	\$1550
OEM discounts available	

# RECORDERS & PRINTERS

General use X-Y recorder, plus time base  
Models 7035B, 17108A time base

- Precision recording
- Time base available

- Floating guarded inputs
- Ease-of-use design

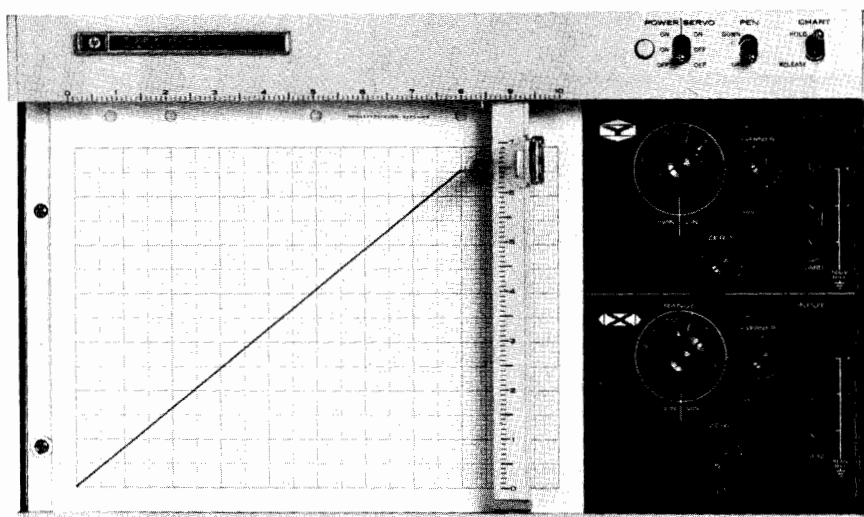

7035B

The 7035B combines precision with low cost and general-use design to provide users with one X-Y recorder that serves most recording needs where high dynamic performance is not a requirement. Compact in design, the 7035B is well adapted to rack mounting with the addition of only two optional wing brackets. Other features are silent, trouble-free electrostatic paper hold down for paper sizes up to 216 x 280 mm (8½ x 11 in.); floating guarded inputs to help eliminate the common mode voltage effects that are troublesome when recording from low level sources; and disposable pens with self-contained ink supply to allow simple, one-step replacement of ink, tip, and color.

Input connectors on the 7035B accept both open wire and plug-type connectors. In addition, the recorder provides five calibrated ranges (0.4 mV/cm to 4 V/cm) for each axis; signal scaling for full-scale deflection, and high input impedance (1 megohm, except the first two ranges).

### 17108A Time Base Explained

The 17108A is a self-contained external time base that operates on either axis of the 7035B. By simply plugging in the 17108A, the 7035B is provided with five sweep speeds from 0.2 to 20 s/cm (0.5 to 50 s/in.). This module, powered by a single self-contained battery, is controlled by its own six-position range switch and three-position mode switch.

### 7035B Specifications

#### Performance Specifications

**Input ranges:** 0.4, 4, 40, 400 mV/cm and 4 V/cm (1, 10, 100 mV/in.; 1 and 10 V/in.). Continuous vernier between ranges

**Input types:** Floating guarded signal pair; rear connector

**Input resistance:**

Range		Input resistance
0.4 mV/cm	(1 mV/in.)	Potentiometric (essentially, infinite at null)
Variable		11 KΩ
4 mV/cm	(10 mV/in.)	100 KΩ
Variable		100 KΩ
40 mV/cm & above	(100 mV/in.) & above	1 MΩ

**Normal mode rejection:** >30 dB at 60 Hz; then 18 dB/octave

**Maximum allowable source impedance:** No restrictions except on fixed 0.4 mV/cm (1 mV/in.) range. Up to 20 kΩ source impedance will not alter recorder's performance

**Accuracy:** ±0.2% of full scale

**Linearity:** ±0.1% of full scale

**Resettability:** ±0.1% of full scale

**Zero set:** Zero may be set up to one full scale in any direction from zero index. Lockable zero controls

**Slewing speed:** 50 cm/s (20 in./s) nominal at 115 V

**Common mode rejection:** 130 dB at DC & 100 dB at line frequency with up to 1 kΩ between the positive input and guard connection point and attenuator on most sensitive range. CMR decreased 20 dB per decade step in attenuation.

### General Specifications

**Electrostatic paper hold down:** Grips 216 x 280 mm (8½ x 11 in.) charts or smaller. Special paper not required.

**Pen lift:** Electric pen lift capable of being remotely controlled

**Size:** 265 H x 445 W x 121 mm D (10<sup>7</sup>/<sub>16</sub> x 17½ x 4¾ in.)

**Weight:** Net, 8 kg (18 lb). Shipping, 10.9 kg (24 lb)

**Power:** 115 or 230 V ±10%, 50 to 60 Hz, approximately 45 VA



17108A mounted on recorder

### 17108A Specifications

**Sweep speeds:** 0.2, 0.4, 2, 4, 20 s/cm (0.5, 1, 5, 10, 50 s/in.)

**Accuracy:** 5% of recorder full scale

**Linearity:** 0.5% of full scale (20°C to 30°C)

**Output Voltage:** 0 to 1.5 V

**Power:** Replaceable mercury battery (100 hr)

### 7035B & 17108A Options

Option no.	Description	Price
001	Metric calibration-7035B	N/C
003	Retransmitting potentiometer on X axis 5 KΩ ±3%	\$110
020	Modification for use with models 3580A and 3581 A/C	320
002	17108A Metric calibration	N/C

### Ordering Information

**7035B** General purpose X-Y recorder

**17108A** Time base plug-in

**Price**

\$1775

360

270

## RECORDERS & PRINTERS

High performance, general-use X-Y recorders

Models 7044B, 7045B, 7046B, 7047A

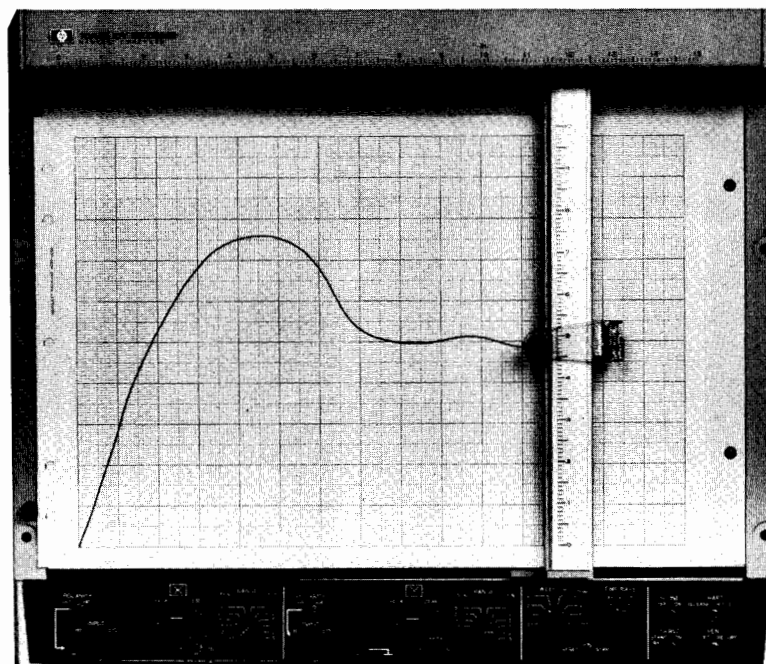

7044B

- High dynamic performance (3 G acceleration)
- Designed for many laboratory applications

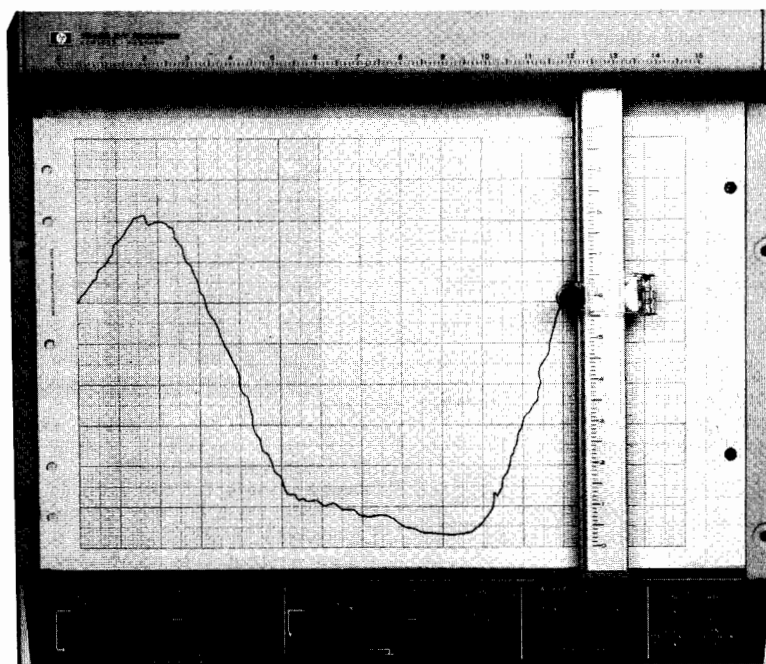

7045B

- Very high dynamic performance (8 G acceleration)
- Designed for most laboratory applications

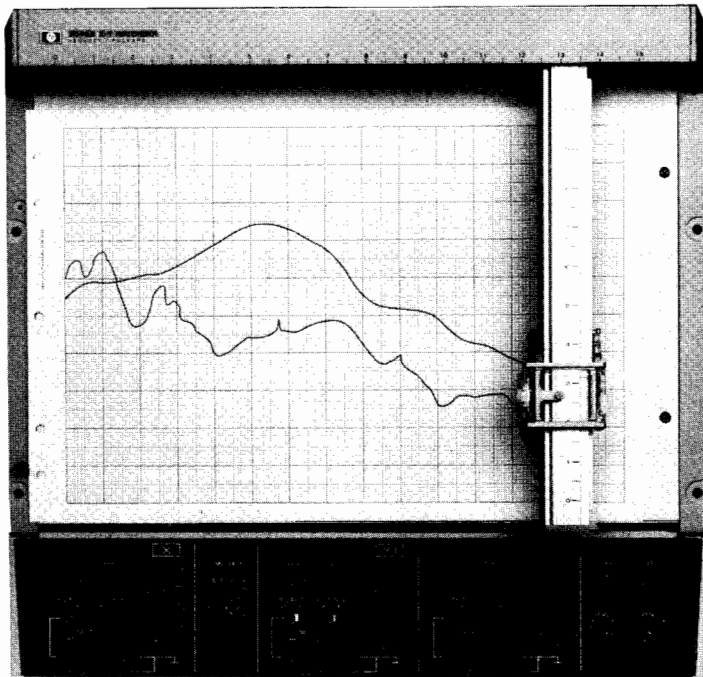

7046B

- Two-pen recording (X or T-Y1-Y2)
- Very high dynamic performance (6.5 G acceleration)

Four X-Y recorder designs (7044B, 7045B, 7046B, 7047A), provide a wide range of choices for those who need a quality general-use X-Y recorder.

**The 7044B, 7045B, & 7046B—Quality in common**

This series of general-use X-Y recorders has been designed to satisfy both current and future laboratory applications. The high-level performance and reliability of these recorders are the results of a design philosophy that has evolved through 30 years of Hewlett-Packard experience as a leading manufacturer of X-Y recorders.

Whether the buyer purchases the one-pen (X or T vs Y) 7044B or 7045B, or the two pen (X or T vs Y1 & Y2) 7046B, the recorder will provide the following quality features:

**Very high dynamic performance:** With a combination of high slewing speed and acceleration (greater than 8 G on the 7045B and 6.5 G on the 7046B), these recorders can capture fast changing signals that an ordinary recorder might miss. For example, the 7045B will, typically, record a signal from DC to 10 Hz at 2 cm peak-to-peak amplitude on either axis.

**Very high resolution vernier:** 10-turn verniers are provided for precise and repeatable adjustments on the 7044B, 7045B, and 7046B. These verniers provide continuous overlapping sensitivity adjustment for each adjacent pair of calibrated voltage ranges.

**Additional calibrated ranges:** 40% more calibrated voltage ranges and two more time base ranges have been added to the 7044B, 7045B, and 7046B. These increased capabilities further simplify the accommodation of different paper sizes.

**TTL remote control:** With TTL or simple contact closure to ground, a rear connector offers easy interface to measurement systems. TTL provides remote control of sweep start and reset, pen lift, servo mute, and chart hold. Pen lift, the most important action to be controlled remotely, is also available from a convenient rear-mounted banana jack connector.

**Wide chart size range:** The 7044B, 7045B, and 7046B increase their usefulness as general-purpose recorders by accepting ISO A3, ISO A4, 8½ x 11 in., 11 x 17 in. and, in fact, virtually any paper size under the maximum limit (ISO A3 or 11 x 17 in.). With this capability these recorders can fill a greatly increased variety of charting needs.

**Electrostatic paper hold down:** With this proven hold down system, all paper sizes that fit on the platen are held firmly, providing a smooth, solid surface for recording and hand annotations. The HP electrostatic paper hold down also offers “solid-state” reliability, silent operation, and a performance that is not affected by altitude or power line frequency

**Optional time base:** With this optional time base, these X-Y recorders can record data versus time. The user can apply eight calibrated sweep speeds to either the X or Y-axis. This furnishes a full range of speed rates from 50 s/cm to 0.25 s/cm. The time base provides automatic pen control and accepts remote triggering for start, sweep, and reset.

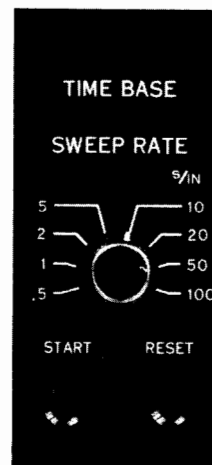

**Long-term reliability and accuracy:** With years of in-field use of HP X-Y recorders in a wide variety of environments, long-term reliability and low cost of ownership has been thoroughly demonstrated. Primarily, these major benefits are due to:

- A. Long-life slidewires that need minimal maintenance. Designed with basic servo simplicity, the location of the sensing point is virtually at the pen tip. Because of this design, the accuracy of the recorder is not affected by common types of mechanical wear that can cause gear backlash.

## RECORDERS & PRINTERS

High performance, general-use X-Y recorders  
Models 7044B, 7045B, 7046B, 7047A (cont.)

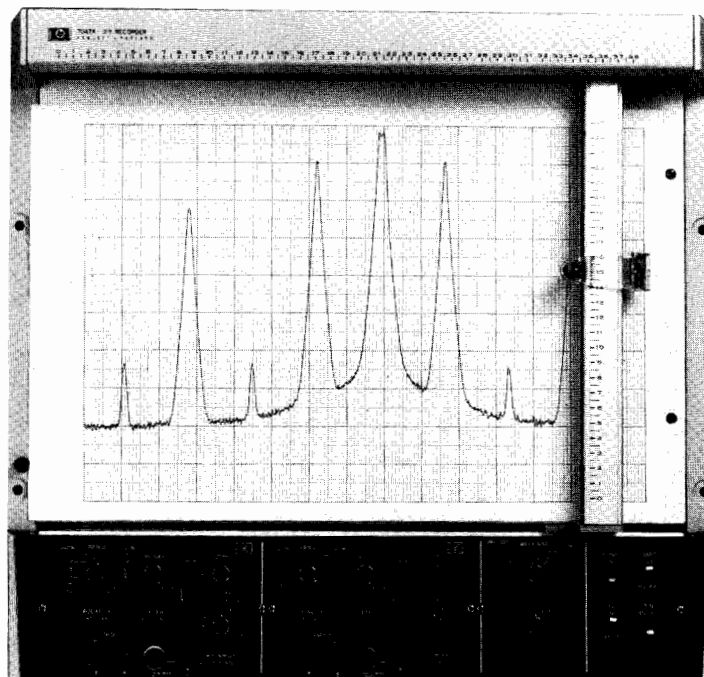

7047A

- Very high sensitivity ( $20 \mu\text{V}/\text{cm}$ )
- Ten scales of calibrated offset

**B.** All mechanical components are designed for rugged use and long life. For example, the servo mechanism is constructed to exceed 50 kilometers (average, 5 years of use) of pen travel without needing adjustment. In addition, all precision mechanical components critical to maintaining long-term alignment are mounted on a single-piece casting.

**C.** Each unit is designed to meet exacting Hewlett-Packard environmental specifications. For example, units are designed to meet performance specifications over a temperature range of  $0^\circ$  to  $55^\circ\text{C}$ ; 95% relative humidity at  $40^\circ\text{C}$ ; plus rugged shock, vibration, RFI, and altitude specifications.

**Other user-oriented features:** With this X-Y recorder line, the two main design objectives were to produce precision instruments and to make these units easy to use. Some of the major designed-in features to achieve these objectives are:

- Polarity reverse switch that eliminates need to reverse input leads
- Response switch on 7045B and 7046B that allows recorder response to be slowed to simplify initial set up
- Separate rear connector that provides a convenient remote pen lift control connection
- Long-life fiber tip pens that facilitate fast color change and easy replacement
- Built-in hardware that simplifies table or rack mounting

### The 7047A—Superior Sensitivity

The 7047A is a very high sensitivity X-Y recorder, designed specifically for low-level signal application. With a maximum sensitivity of  $20 \mu\text{V}/\text{cm}$ , the 7047A has a resolving capability of approximately  $1 \mu\text{V}$ . The use of this high sensitivity can be extended to larger amplitude signals by using the designed-in ten scales of calibrated zero suppression. Other major advantages of the 7047A include:

- High common mode rejection (130 dB) that provides low-level measurements with almost any input connection configuration
- Switchable input filter (40 dB of normal mode rejection) that eliminates the effects of most input noise
- TTL control that allows remote recording configurations
- Internal built-in time base that records data against time
- Electric paper hold down and fiber tipped pens that provide clean, sharp recording lines on any paper size up to the size of the platen

**Which X-Y Recorder?**—Simplifying the selection requirements is the key to selecting an X-Y recorder. Depending on budgets and frequency of each need, the recorder could be chosen to cover the most necessary requirement, or to cover a variety of present and future recording uses. Here are a few criteria:

- Relatively low frequency requirements? A dedicated application? Flexible needs for basic recording? . . . **Choose the 7044B**
- Multi-users and many applications? Fast pen response? No need to plot two simultaneous Y variables? . . . **Choose the 7045B**
- Maximum general-use capability need? Two pens to draw two or three simultaneous variables? . . . **Choose the 7046B**
- High sensitivity application, such as electrochemistry? . . . **Choose the 7047A**

# RECORDERS & PRINTERS

High performance, general-use X-Y recorders

Models 7044B, 7045B, 7046B, 7047A (cont.)

273



## 7044B, 7045B, 7046B, and 7047A Specifications

### Performance Specifications

	7044B HIGH SPEED	7045B VERY HIGH SPEED	7046B 2-PEN, VERY HIGH SPEED	7047A VERY HIGH SENSITIVITY
Type of input	Front and rear input. Floating, guarded. Polarity reversal switch on front panel.			Front input only. Floating, guarded. Common mode driver circuit eliminates need to connect CMV to recorder, if CMV < 10 V peak.
Input ranges	0.25, 0.5, 1, 2.5, 5, 10, 25, 50, 100, 250, 500 mV/cm. 1, 2.5, 5 V/cm. (0.5, 1, 2, 5, 10, 20, 50, 100, 200, 500 mV/in. 1, 2, 5, 10 V/in.) Continuous vernier between ranges.			0.05, 0.1, 0.5, 1, 5, 10 mV/in.; 0.05, 0.1, 0.5, 1.5, 10 V/in. (metric available in 0.02, 0.05, 0.1, 0.5, 1, 5 mV/cm; 0.01, 0.05, 0.1, 0.5, 1, 5 V/cm). Continuous vernier between ranges.
Input resistance	1 megohm constant on all ranges			
Source resistance	10 k ohm maximum on all ranges			10 k ohm max except 0.02 mV/cm, 0.05 mV/cm, and 0.1 mV/cm (0.05 mV/in. and 0.1 mV/in.) ranges are 2 k ohm max.
Accuracy	±0.2% of full scale (includes linearity and deadband) at 25°C. Temp coefficient ±0.01% per °C			
Range accuracy	±0.2% of full scale ±0.2% of deflection (includes linearity and deadband) at 25°C. Temp coefficient ±0.01% per °C.			
Deadband	0.1% of full scale			
Common mode rejection	110 dB and 90 dB AC (exceeds 130 dB DC and 110 dB AC under normal lab environmental conditions) with 1 k ohm between HI and LO terminals. CMV applied between ground and LO, and attenuator on most sensitive range. CMR decreases 20 dB per decade step in attenuation.			130 dB DC and 130 dB AC with 1 k ohm imbalance in HI or LO terminal (exceeds 150 dB under normal conditions). CMR decreases 20 dB per decade step in attenuation from most sensitive range.
Normal mode rejection	Internal filter not available			30 dB min at line frequency with FILTER IN. (50 dB typical at 60 Hz and 40 dB at 50 Hz.)

### Dynamic Performance Specifications

Slewing speed	50 cm/s (20 in./s), min.	97 cm/s (38 in./s) typical under normal lab conditions. 76 cm/s (30 in./s) minimum.		
Acceleration peak—Y axis	2540 cm/s <sup>2</sup> (1000 in./s <sup>2</sup> )	7620 cm/s <sup>2</sup> (3000 in./s <sup>2</sup> )	6350 cm/s <sup>2</sup> (2500 in./s <sup>2</sup> )	7620 cm/s <sup>2</sup> (3000 in./s <sup>2</sup> )
—X axis	1270 cm/s <sup>2</sup> (500 in./s <sup>2</sup> )	5080 cm/s <sup>2</sup> (2000 in./s <sup>2</sup> )	3800 cm/s <sup>2</sup> (1500 in./s <sup>2</sup> )	5080 cm/s <sup>2</sup> (2000 in./s <sup>2</sup> )
Overshoot	2% of full scale maximum.	1% of full scale maximum.		

### Offset Specifications

Zero offset	Zero may be placed anywhere on the writing area or electrically off scale up to one full scale from zero index.	11 calibrated scales of zero offset in both axes. Switchable in steps of full scale from +1 to -10.		
Offset accuracy at 25°C (applies to calibrated unit)	Not applicable	±0.1% of full scale times N where N = number of scales of offset.		
Temperature coefficient	Not applicable	±0.004% of full scale times N per °C.		

### Time Base Specification

Time base	8 speeds: 0.25, 0.5, 1, 2, 5, 10, 25, 50 s/cm (0.5, 1, 2, 5, 10, 20, 50, 100 s/in.)	6 speeds: 0.1, 0.5, 1, 5, 10, 50 s/cm (English is 0.5, 1, 5, 10, 50, 100 s/in. switchable to X or Y axis.		
Time base accuracy	1.0% at 25°C. Temp coefficient at ±0.1%/C°			

### General Specifications

Power	100, 120, 220, 240 Vac +5 -10%; 48 to 440 Hz; 135 VA	100, 120, 220, 240 Vac +5 -10%; 48 to 440 Hz; 175 VA	100, 120, 220, 240 Vac +5 -10%; 48 to 440 Hz; 175 VA	100, 120, 220, 240 Vac +5, -10%; 48 to 66 Hz; 180 VA
Pen lift	Electric (remote via TTL level)			
Writing area	25 x 38 cm (10 x 15 in.)			
Weight	Net 13.7 kg (30 lb)		Net 16 kg (35 lb)	Net 18.6 kg (41 lb)
Size	400 H x 483 W x 165 mm D (15 <sup>3</sup> / <sub>16</sub> x 19 x 6 <sup>1</sup> / <sub>2</sub> in.)		441 H x 483 W x 173 mm D (17 <sup>3</sup> / <sub>16</sub> x 19 x 6 <sup>1</sup> / <sub>16</sub> in.)	

### 7044B, 7045B, 7046B and 7047A Options

#### 7044B, 7045B

Option No.	Description	Price
001:	Time Base	\$255
002:	Event marker	\$120
006:	Metric calibration	N/C

#### 7046B

Option No.	Description	Price
001:	Time base	\$255
002:	Event marker	\$120
007:	Metric calibration	N/C

#### 7047A

Option No.	Description	Price
001:	Metric calibration	N/C
002:	Event marker	\$120

#### Ordering Information

Model	Description	Price
7044B	Medium speed recorder	\$2325
7045B	High speed recorder	\$2700
7046B	2-pen, high speed recorder	\$3950
7047A	High sensitivity, high speed recorder	\$4250
OEM discounts available		

# RECORDERS & PRINTERS

High performance modular X-Y recorders

Models 7034A, 7004B, with 17170 series preamps

- High dynamic performance
- Plug-in flexibility

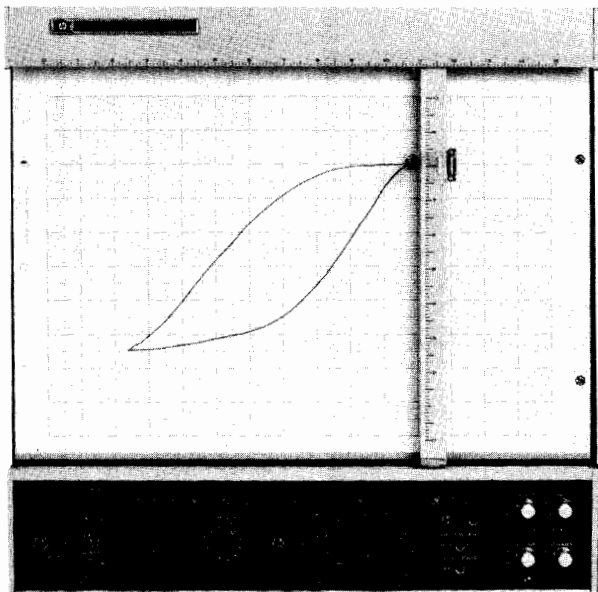

7004B

The 7034A and 7004B X-Y recorders provide high dynamic performance, plus plug-in flexibility. Precision recordings of rapidly changing input signals are assured, because the recorders have excellent dynamic performance, high slewing speed (greater than 75 cm/s), and high peak acceleration (3800 cm/s<sup>2</sup>). With this high peak acceleration, the pen can follow quick, small input changes, accelerating to 76 cm/s in less than 50 ms.

Both the 7034A and 7004B can be user reconfigured for many different recording needs by simply plugging in different preamp modules. The variety of signal conditioner modules now available permits the user to reconfigure the recorder not only for a specific purpose, but also to reconfigure the recorder to one of these three basic types:

- **Basic systems recorder**—50 mV/cm (100 mV/in.). Available with DC coupler (17170A).
- **General-purpose recorder**—High-sensitivity X-Y available with DC preamps (17171A). Can have X-T or Y-T, available with DC (17171A), plus time base (17172A).
- **Specialized recorder**—Point plotting available with null detector (17173A), “two-pen” simulation available with scanner (17176A) and wideband available with AC/DC converter (17177A).

In addition, other features may be added with other modules.

### The 7034A, 7004B offer many features

The 7034A and 7004B have front and rear guard terminals available for signal inputs. This guarding helps eliminate the common mode voltage effects that are particularly troublesome when recording from low level sources, such as thermocouples and strain gauges. In addition, the recorders are equipped with a silent, trouble-free electrostatic hold down that secures all paper sizes up to 210 x 280 mm (8½ x 11 in.) on the 7034A and 280 x 432 mm (11 x 17 in.) on the 7004B. Disposable ink pens are designed to provide clean, crisp, and continuous traces; while their self-contained ink supplies and fiber tips eliminate ink handling and pen cleaning. Other features include a Record/Setup switch, single-locking rear connector, easily accessible slidewires, knob locks, five-way binding posts, locking feet, tilt stand, and optional rack mounting brackets.

### 7034A and 7004B Specifications

#### Performance Specifications

**Plug ins:** Accept 4 single-width, 2 per axis

**Type of input:** Floating and guarded signal pair. Available through front panel or rear connector.

- Guarded inputs

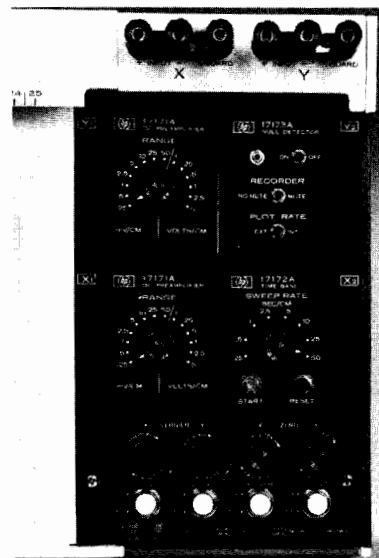

7034B

- Zero set:** May be set  $\pm 1$  fs from zero index
- Zero check switches:** pushbutton in each axis allows verification of recorder's zero position without removal or shorting of input signal.
- Mainframe accuracy:**  $\pm 0.2\%$  of full scale
- Range vernier:** Lockable, covers 2.5 times range setting
- Slewing speed:** More than 75 cm/s (30 in./s) independent of line voltage and frequency
- Acceleration (peak):** More than 3800 cm/s<sup>2</sup> (4 G)
- Reference stability:** Better than 0.003%/°C
- Terminal-based linearity:**  $\pm 0.1\%$  of full scale
- Resettability:**  $\pm 0.05\%$  of full scale

### General Specifications

**Electrostatic paper hold down:** Grips charts up to size of platen

**Pen lift:** Local and remote control (contact closure or TTL)

#### Size:

7004B: 445 H x 445 W x 121 mm D (17½ x 17½ x 4¾ in.)

7034A: 267 H x 445 W x 121 mm D (10½ x 17½ x 4¾ in.)

#### Weight:

7004B: Net 10.9 kg (24 lb). Shipping 14.5 kg (32 lb)

7034A: Net 7.7 kg (17 lb). Shipping 10.2 kg (23 lb)

**Power:** 115 or 230 V AC  $\pm 10\%$ , 50 to 400 Hz, approximately 85 VA (dependent on plug in)

### 17170 Series Plug-ins Specifications

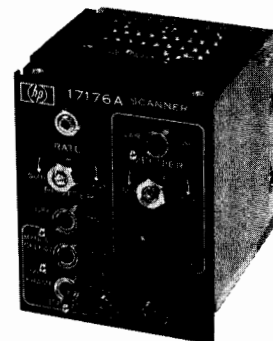

#### 17170A DC Coupler

**Input range:** Single, fixed calib. range of 50 MV/cm (100 mV/in.)

**Input resistance:** 1 M $\Omega$  constant

**Common mode rejection:** 120 dB at DC & 70 dB at 50 Hz & above with 100 $\Omega$  between low side & guard connect point with source impedance 10 k $\Omega$  or less

**17171A DC Preamplifier**

**Input Ranges:** 0.25, 0.5, 1, 2.5, 5, 10, 25 mV/cm., 0.05, 0.1, 0.25, 0.5, 1, 2.5, 5 V/cm (0.5, 1, 2, 5, 10, 20, 50 mV/in., 0.1, 0.2, 0.5, 1, 2, 5, 10 V/in.)

**Input resistance:** 1 MΩ

**Common mode rejection:** 120 dB at DC & 100 dB at 50 Hz & above with 100 Ω between low side & guard connect point at 0.25 mV/cm (0.5 mV/in.). CMR on others decreases 20 dB/decade step in attenuation.

**System accuracy:** ±0.2% full scale

**17172A Time Base**

**Sweep speeds:** 0.25, 0.5, 1, 2.5, 5, 10, 25, 50 s/cm (0.5, 1, 2, 5, 10, 20, 50, 100 s/in.)

**System accuracy,** ±1% of fs on 6 fastest ranges, ±2.5% on remaining two.

**17173A Null Detector (17012B/C required)**

**Plot rate:** Up to 50 plots/s

**Enable/disable:** Required disable voltage +3 V min. to +20 V max.

**Required enable voltage:** -0 V DC or no connect. Other voltage combinations available on request.

**Muting:** Local or remote

**Plotting accuracy:** ±0.25% of full scale

**17174B DC Offset**

**Offset:** <1 mV to approximately 1 V.

**Controls:** 2 lockable, 10-T high resolution controls (<1 mV to approximately 10 mV & <1 mV to approximately 1 V). An offset polarity switch allows upscale or downscale zero offset.

**Offset voltage stability:** >0.005%/°C

**17175A Filter**

**Input ranges:** -5 to +45 V DC, 10 V AC max p-p

**Maximum source impedance:** 1 kΩ; higher impedance decreases filter response

**Rejection:** >55 dB at 50 Hz & higher (¼ s rise time) or >70 dB at 50 Hz & higher (1 s rise time). Front panel selection.

**17176A Scanner (17012 B/C required)**

**Input:** Front panel miniature binding posts isolated from ground (high & low only). Mainframe input: Utilizes existing input connectors.

**Attenuator:** Fixed attenuator in decade steps from X1 to X0.001 Variable attenuator provides continuous coverage.

**Input impedance:** 100 kΩ

**Accuracy:** 0.2% of full scale

**Scan rate:** Adjustable from 0.1 to 4 s/scan

**17177A AC/DC Converter DC Preamplifier**

**Input ranges:** 2.5 mV/cm to 10 V/cm (5 mV/in. to 20 V/in.) in 1, 2, 5 steps

**Minimum usable input (AC only):** ±0.2% of full scale

**Maximum allowable input:** 300 V peak

**Input type:** Floating & guarded sig. pair. No rear inputs.

**Input impedance:** 1 MΩ shunted by less than 40 pF

**Maximum allowable source resistance:** 10 kΩ

**Common mode rejection:** 80 dB at DC & 50 Hz & above with 100 Ω between low side & guard connect point & at 2.5 mV/cm (5 mV/in.). CMR on other ranges decreases 20 dB/decade step in attenuation. Rise/fall time (AC only, 10-90%): Slow response (5 Hz to 100 kHz) 2.5 s max; fast response (50 Hz to 100 kHz) 0.5 s max

**Calibration (AC only):** Responds to average value of input waveform; calibrated in rms value of sinewave

**Accuracy:** (% of fs): DC: ±0.5%; AC (fast response): ±0.25% from 150 Hz to 50 kHz, ±0.5% from 50 Hz to 150 Hz & 50 kHz to 100 kHz; AC (slow response): ±0.25% from 30 Hz to 50 kHz from 5 Hz to 30 Hz & 50 kHz to 100 kHz

**Linearity (AC):** Expressed as % of fs, measuring from 0.5% of fs.

5 Hz	50 Hz	50 kHz	100 kHz
±0.35%	±0.25%	±0.35%	

**Warmup time:** 3 minutes nominal

**Zero drift** (referred to input): ±30 μV°C

**Offset:** Up to 1 fs of offset using recorder's zero

**Size:** Double width occupies both plug-in spaces in axis

**17178A DC Attenuator**

**Input ranges:** 0.05, 0.1, 0.25, 0.5, 1, 2.5, 5, 10, V/cm (0.1, 0.2, 0.5, 1, 2.5, 10, 20 V/in.)

**Input resistance:** 1 MΩ

**Common mode rejection:** 120 dB at DC & 70 dB at 50 Hz & above with 100Ω between low side & point where guard is connected (at 50 mV/cm or 100 mV/in.). Other ranges CMR decreases 20 dB/decade step in attenuation.

**System accuracy:** ±0.2 of full scale

**Options**

	<b>Price</b>
<b>001</b> Metrically scaled & calibrated (7004B/7034A)	N/C
<b>002</b> X-axis retrans. pot. 5kΩ ±0.1% linearity (7004B)	\$125
<b>001</b> Metric scaling (17170A/17171A/17172A/ 17177A/17178A)	N/C
<b>001</b> +3 to 20V enable, 0 V disable (17173A)	\$35
<b>002</b> -3 to -20 disable, 0 V enable (17173A)	35
<b>003</b> -3 to -20 V enable, 0 V disable (17173A)	35
<b>908</b> Rack mount kit	
For 7004B	30
For 7034B	25

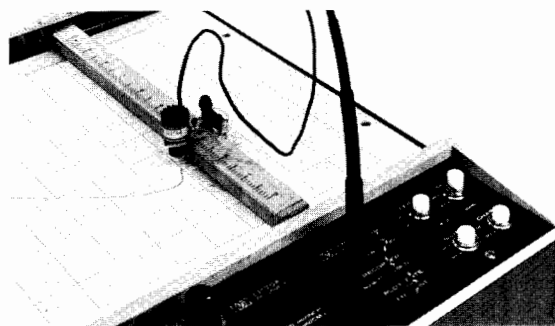

**17012B/C Point Plotter**

The 7004B or 7034A, equipped with 17012B or 17012C respectively, point plot when used with appropriate plug-in. Plotting rate is 50 points per second. Power is supplied from recorder.

**Option**

	<b>Price</b>
<b>001</b> 6-Symbol plotting capability (17012B/C)	\$70

**Ordering Information**

	<b>Price</b>
<b>7004B</b> X-Y recorder	\$2650
<b>7034A</b> X-Y recorder	2550
<b>17170A</b> DC coupler plug-in	75
<b>17171A</b> DC amplifier plug-in	500
<b>17172A</b> Time base plug-in	375
<b>17173A</b> Null detector	475
<b>17174B</b> DC offset plug-in	250
<b>17175A</b> Filter plug-in	210
<b>17176A</b> Scanner plug-in	675
<b>17177A</b> AC/DC converter plug-in	1000
<b>17178A</b> DC attenuator plug-in	250
<b>17012B/C</b> Point plotter	250





# RECORDERS & PRINTERS

## Low-cost strip chart recorder

Model 680

- Low-cost, high quality recording
- User-selectable speeds and spans
- Metric or English recording
- Compact design

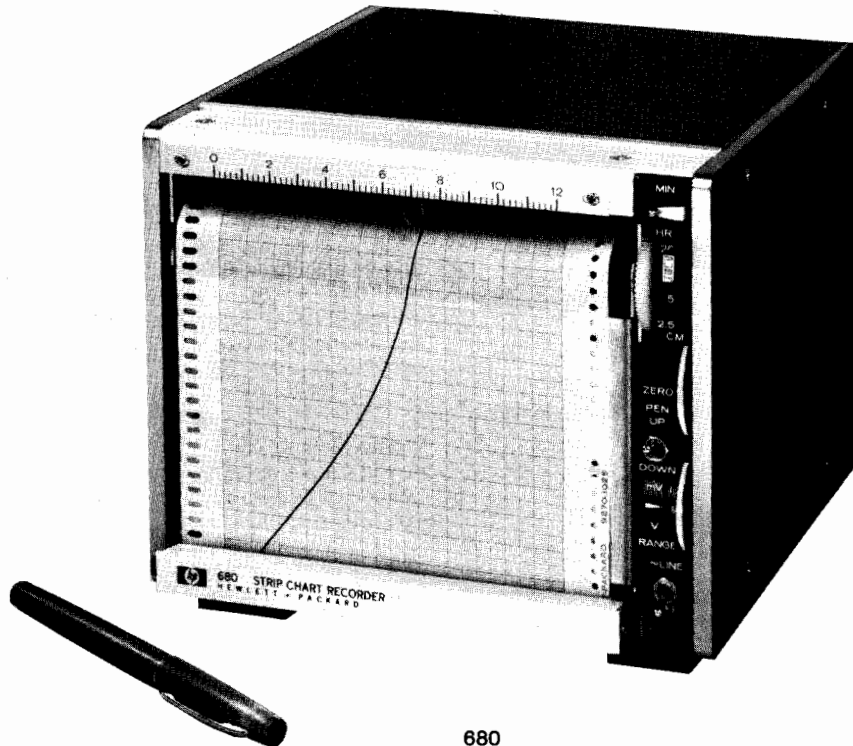

680

The compact 680 produces quality recordings on a 12 cm or 5 in. wide grid. The versatility of the 680 is demonstrated by the wide range of user-selectable speeds and spans, providing one small unit that fills many metric or English recording needs. Major areas of versatility include ten selectable voltage spans from 6 mV to 120 V (5 mV to 100 V for English recording) to magnify specific data; eight selectable speeds from 2.5 cm/hr to 20 cm/min (1 in./hr to 8 in./min for English recording) to use the most compatible speed with the data input rate; and two ink writing systems to provide a steel pen for maximum durability or optional disposable fiber and capillary tips to help prevent possible clogging, due to noisy data. The 680 also provides a remote electric pen lift, full-scale zero adjustment, and standard input filter to eliminate the effects of signal noise. Primary uses of the 680 are as a monitor for instrumentation with DC outputs and for digital devices using digital-to-analog converters.

### 680 Specifications

#### Performance Specifications

**Spans:** Ten calibrated spans; Metric—6, 12, 60, 120, 600 mV; 1, 2, 6, 12, 60, 120 V (English—5, 10, 50, 100, 500 mV; 1, 5, 10, 50, 100 V)

**Input type:** Floating; rear panel connector

**Maximum DC common mode voltage:** 500 V

**Input resistance:** 166 k $\Omega$ /V (200 k $\Omega$ /V, English) full scale, through 10 V span; 2 m $\Omega$  on all others.

**Common mode rejection:** DC 100 dB on most sensitive range. Decreases 20 dB per decade step in attenuation

**Accuracy:**  $\pm 0.2\%$  of full scale

**Response time:** Maximum, 0.5 s full scale

**Resettability:** 0.1% of full scale

**Chart speed:** Synchronous motor driver; metric—2.5, 5, 10, 20 cm/min; 2.5, 5, 10, 20 cm/hr (English—1, 2, 4, 8 in./min and

in./hr). Option 008, gear ratio 16/1 instead of 60/1 speeds—1/16, 1/8, 1/4, 1/2, 1, 2, 4, 8 in./min

**Zero set:** Adjustable over full span

### General Specifications

**Writing mechanism:** Ink

**Pen lift:** Electric, controlled by local switch or remote contact closure

**Power:** 115/230 V, 60 Hz, 22 VA

**Weight:** Net, 5 kg (11 lb); shipping 7.6 kg (17 lb)

**Size:** 165 H x 197 W x 219 mm D (6½ x 7¾ x 8⅝ in.)

### 680 Options

Option no.	Description	Price
001	With installed 5 k $\Omega$ , 0.1% linearity retransmitting potentiometer	\$125
002	With ink event marker installed	\$100
003	With installed high-low limit switches	190
008	With 16/1 instead of 60/1 speed reducer	70
009	With remote chart drive switch	55
010	For 50 Hz operation	N/C
014	Glass door with lock	\$195
018	Disposable pen tips	N/C
910	Extra manual	\$15
H01	1.2 mV span added (H01-680 for metric Opt 026)	90
	1 mV span added (H01-680)	90
026	Metric calibration	N/C

### Ordering Information

680 Strip chart recorder

### Price

\$1800

OEM discounts available

- Portable recording
- Internal battery or line current operation

- Rugged construction for hostile environments
- 16 calibrated voltage spans and 7 speeds

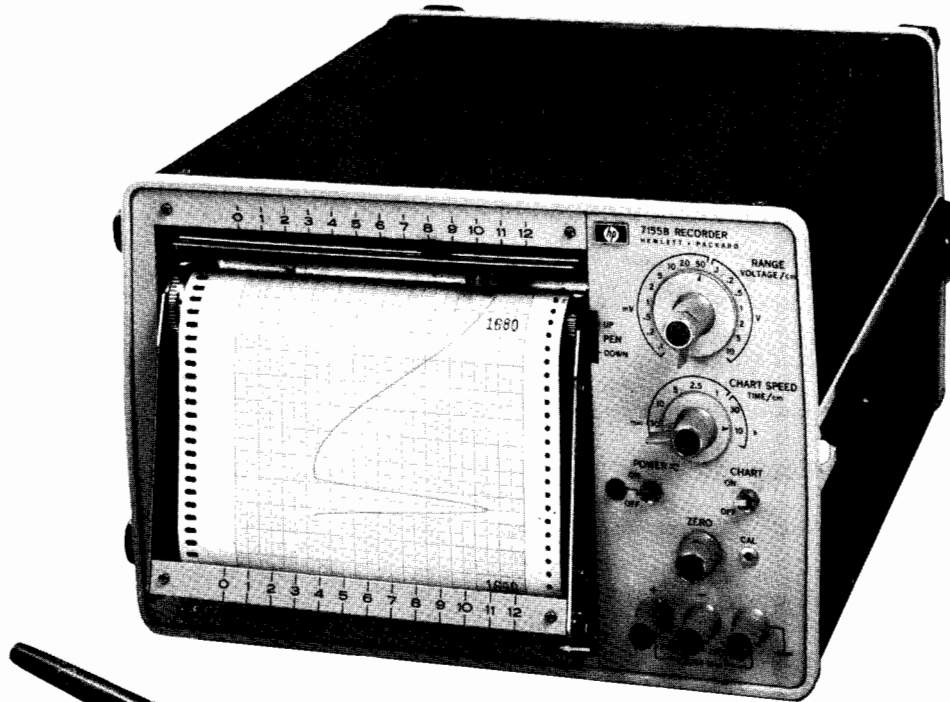

7155B

The portable 7155B metric strip chart recorder is both precise and rugged. Weighing only 14 kg (30 lb) with the optional internal batteries, the 7155B will record up to nine hours (at 25°C) on a 12 cm grid. Batteries can then be recharged with the built-in battery charger. The unit can also be run on external AC or DC or, with the batteries recharging, on external AC in the broad temperature range of -28°C to +65°C.

In addition to portability, this rugged metric recorder provides 16 calibrated voltage spans, so users can select spans from 0.1 mV/cm through 10 V/cm in a 1, 2, 5 sequence or additional spans using the overlapping vernier; seven chart speeds from 30 min/cm to 10 s/cm to select the best chart speed for the input; easy access to internal electronics for simplified servicing; three chart magazine tilt angles; and a snap-on plexiglas front cover to protect the unit from dust, dirt, and unwanted knob changes. The writing system includes disposable press-in pen-and-ink modules in two colors and coated paper to minimize heavy inking from slow traces and noisy data.

#### Optional Capabilities Provided

Several options are offered with the 7155B that extend its capabilities. These options include: Right-hand zero (Option 005) to provide pen deflection from right to left in order to record voltage; an event marker (Option 006) to note important events by marking the left edge of the paper; and an internal jellied electrolyte battery pack (Option 011) that operates up to nine hours at 25°C on a single charge. This battery pack can be recharged fully in approximately 14 hours.

#### 7155B Specifications

##### Performance Specifications

**Input range:** 0.1 mV/cm through 10 V/cm in a 1, 2, 5, sequence with overlapping vernier (12 cm full scale)  
**Input type:** Single ended, floating  
**Input resistance:** 1 megohm

**Maximum allowable source resistance:** 5kΩ for rated response  
**Common mode rejection:** 100 dB DC and 80 dB AC  
**Full scale response time:** 0.6 sec to within rate accuracy  
**Overshoot:** 1% of full scale maximum  
**Accuracy:** ±0.4% of full scale (includes linearity and deadband) at 25°C. Temp coefficient ±0.1% per °C  
**Range accuracy:** ±0.4% of full scale ±0.2% of deflection (includes linearity and deadband at 25°C). Temp coefficient ±0.01%/°C  
**Chart speeds:** 30, 10, 5, 2.5, 1 min/cm; 30 and 10 s/cm  
**Chart speed accuracy:** ±1%  
**Environmental (operating):** -28°C to +65°C <95% relative humidity (40°C)

#### General Specifications

**Writing mechanism:** Disposable ink pens

**Grid width:** 12 cm

**Chart length:** 21 metres (70 ft)

**Pen lift:** Mechanical

**Weight:** Net 14 kg (30 lb) with battery option installed

**Size:** 197 H x 304 W x 416 mm D (7¾ x 12 x 16½ in.)

**Power:** External AC (48 to 440 Hz, 85 V to 130 V or 172 V to 260 V). External DC (10.5 to 34 V, 0.5 amp typical, 0.9 amp maximum independent of voltage)

#### 7155B Options

Option	Description	Price
005	Right hand zero	N/C
006	Event marker. Contact closure on rear panel causes approximately 0.06 cm (0.025 in.) deflection of event pen.	\$195
011	Internal battery pack (shipped separately)	90

#### Ordering Information

**7155B Portable Strip Chart Recorder**  
 OEM discounts available

\$2750



# RECORDERS & PRINTERS

## Single-use strip chart recorders

Models 7130A, 7131A

- Economical models for OEM use

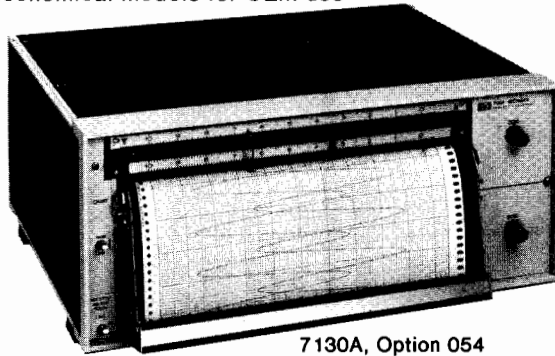

7130A, Option 054

The two-pen 7130A and one-pen 7131A are 25 cm or 10-inch strip chart recorders designed primarily for the OEM market. Providing an unusually large range of voltage span and chart speed options, these units are designed with the ruggedness, compactness, and performance required by OEM users.

### 7130A and 7131A Specifications

#### Performance Specifications

**Input ranges:** Single span, 1 mV through 100 V (specified by option)

**Input type:** Single ended, floating

**Maximum allowable source resistance (Rs):** 10 kΩ

**Normal mode rejection (at line frequency):** >40 dB

**Common mode rejection:** >120 dB at DC and >100 dB at line frequency

**Response time:** <1/2 s

**Overshoot:** <2% of full scale

**Accuracy (including linearity and deadband):** ±0.2% of full scale at 25°C

**Deadband:** ±0.1% of full scale

**Chart speeds:** Speed determined by option choice

**Chart speed accuracy:** ±0.08% plus line frequency accuracy

**Zero set:** Left hand, adjustable ±1 full scale

**Environmental (operation):** 0°C to 55°C, 95% RH (40°C)

#### General Specifications

**Writing mechanism:** Disposable ink pens (thermal writing optional)

**Grid width:** 25 cm or 10 in.

**Chart length:** 27 m or 90 ft

**Pen lift:** Manual (electric or independent optional)

**Size:** 178 H x 432 W x 340 mm D (7 x 17 x 13-3/8 in.)

**Power:** 115/230 V ±10%, 50 or 60 Hz, 120 VA

**Weight:** Net, 12.3 kg (27 lb). Shipping 17.4 kg (38 lb)

#### 7130A, 7131A Options

**Voltage spans:** Option numbers are listed for each span in this way: Upper channel/lower channel. The price is for either channel.

Option no.	Span	Price	Option no.	Span	Price
001/501	1 mV	\$230	008/508	1 V	\$60
002/502	5 mV	230	009/509	5 V	60
003/503	10 mV	175	010/510	10 V	60
004/504	50 mV	175	011/511	50 V	60
005/505	100 mV	175	012/512	100 V	60
006/506	500 mV	175			

One span must be specified for each channel; the 500 option numbers being for the only channel of the 7131A.

**Chart speed:** specify one basic speed.

Option no.	Speed	Price	Option no.	Speed	Price
016	6 in./min	\$30	022	15 cm/min	\$30
017	4 in./min	30	023	10 cm/min	30
018	1 in./min	30	024	5 cm/min	30
019	½ in./min	30	025	3 cm/min	30
020	¼ in./min	30	026	15 cm/hr	30
021	1 in./hr	30	027	3 cm/hr	30

**Speed reducer options**

**028** 60:1 speed reducer\* \$65

**029** 10:1 speed reducer\* 65

**030** 4:1 Speed reducer\* \$65

**031** 2:1 speed reducer\* 65

\*The slowest speed resulting from the addition of a speed reducer must not be less than 2.54 cm/hr (1 in./hr).

- Disposable pens or thermal writing option

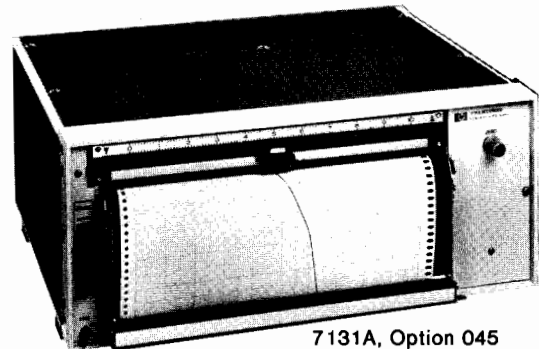

7131A, Option 045

#### Multiple speed options

**046** 4 speed: ¼, ½, 1, 2 in./min, plus external input \$195

**049** 4 speed: 0.625, 1.25, 2.5, 5 cm/min plus external input 195

#### Options requiring optional power supply

**041** Option power supply 90

**045** 8 chart speeds: 1, 2, 4, 6 in./min & in./hr plus external input 230

**048** 8 chart speeds: 2.5, 5, 10, 15 cm/min & cm/hr plus external input 230

**032** Remote speed change\* 65

**033** Remote chart on-off\* 65

**036** Remote pen lift\* 65

**037** Right hand event marker\* (not compatible with Option 054) 90

**038** Right hand event marker thermal\* (must order Option 054) 170

**537** Left hand event marker\* 80

\*Actuated by contact closure to ground or TTL levels. Closed circuit current 1.5 mA (maximum), open circuit voltage +1.5 V (minimum).

#### Other options

**Upper Channel** **Lower Channel** **Price**

**040** **540** Retransmitting potentiometers \$90

**044** **544** Limit switches\* 170

**007** **507** Input filter (1 - 500 mV) 120

**014** Right hand zero hard, scale 10 to 0 N/C

**015** Right hand zero soft, scale 10 to -0.5 N/C

**034** Independent mechanical pen lift (7130 only) N/C

**042** Rack slides \$90

**054** Thermal writing: Model 7130A\*\* 310

Model 7131A\*\* 230

**056** Rear control connector 65

**050,060** 50 Hz & 60 Hz operation N/C

**908** Rack mounting brackets \$20

**910** Extra manual 15

\*Contact rating 1 A at 1.5 V, 0.5 A at 250 V non-inductive.

\*\*Recommended for pen speeds below 5 in./s.

#### Analytical option combinations

The following options are for analytical applications and include 1 mV span each channel, right hand soft zero, front panel detector switch on the 7131A, and two chart speeds.

**Option no.** **7130** **7131**

**090** 2 speeds: ½ and ¼ in./min \$600 \$400

**091** 2 speeds: 1 and ¼ in./min 600 400

**092** 4 speeds: 2, 1, ½, ¼ in./min 750 500

#### Ordering Information

**7130A** Two-pen recorder \$2225

**7131A** One-pen recorder \$1825

OEM discounts available.

# RECORDERS & PRINTERS

Laboratory-use strip chart recorders

Models 7132A, 7133A

279



- One-pen or two-pen recording
- Modular design
- Disposable pens or thermal writing
- User-selectable voltage spans

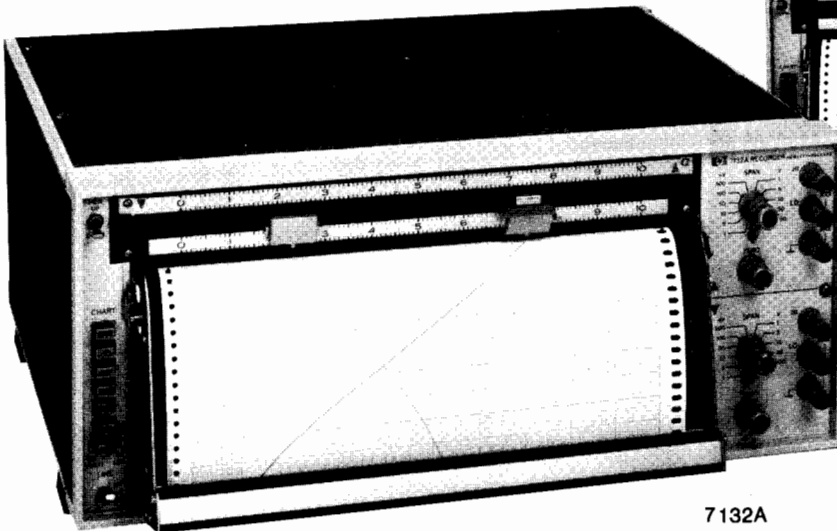

7132A

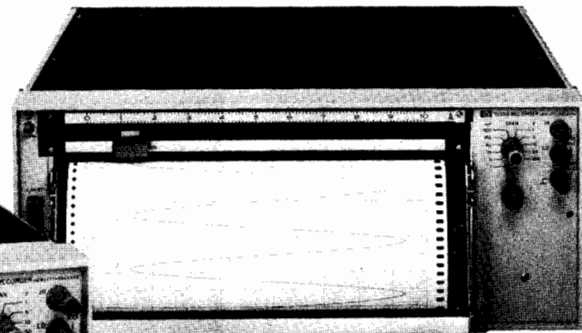

7133A



The two-pen 7132A and one-pen 7133A are designed with a stepper motor chart drive for sophisticated metric or English recording. This drive allows the chart advance to be controlled by an external pulse input, as well as by front-panel pushbuttons. When controlled by an external pulse, the chart speed is changed by variation in the rate at which pulses are applied to the motor; allowing the chart advance to be synchronized to an external event. Both recorders are manufactured with a belt-driven modular servo system for quiet, reliable operation. This modular design also helps cut maintenance costs by reducing the time necessary for routine inspections and maintenance. In addition, both recorders ensure significantly longer pen life by reducing the amplifier gain automatically if the pen is driven off scale.

The power of the 7132A and 7133A is demonstrated by features, such as 11 selectable voltage ranges with spans from 1 mV to 100 V in 1, 5, and 10 steps, plus front-panel control for overlapping span adjustment; 8 pushbutton selectable chart speeds from 15 cm/min to 2.5 cm/hr (6 in./min through 1 in./hr), plus external impulse control; and two writing systems, disposable ink pens or optional thermal writing for long-term, slow-speed, unattended operation. Thermal tips are designed with temperature sensing elements to maintain proper tip temperature for consistent trace quality.

### Optional Capabilities Provided

Both the 7132A and 7133A have options that fill a variety of recording needs, such as right-hand zero (Option 014) to deflect the pen from right to left for recording positive voltage; event markers (Options 037, 038, and 537) to mark the position of important events on the right or left margin; and thermal writing (Option 054).

### 7132A and 7133A Specifications

#### Performance Specifications

**Input ranges:** Eleven ranges from 1 mV to 100 V full scale in 1-5-10 sequence with overlapping vernier

**Input type:** Single ended, floating

**Input resistance:** 1 megohm on all ranges

**Maximum source resistance:** 10 kΩ (to within rated response)

**Normal mode rejection (at line frequency):** >40 dB

**Common mode rejection:** >120 dB DC and 100 dB AC

**Accuracy:** ±0.2% of full scale (includes linearity and deadband) at 25°C. Temp coefficient ±0.01% per °C

**Range accuracy:** ±0.2% of full scale ±0.2% of deflection (includes

linearity and deadband) at 25°C. Temp coefficient ±0.01% per °C

**Deadband:** 0.1% of full scale

**Response time:** Less than 0.5 second

**Overshoot:** Less than 2% of full scale

**Chart speeds:** 2.5, 5, 10, 15 cm/min, and cm/hr (1, 2, 4, 6 in./min, and in./hr)

**Chart speed accuracy:** ±0.08% plus line frequency accuracy

**Zero set:** Provides three full scales of offset

**Environmental (operating):** 0 to 55°C, less than 95% relative humidity (40°C)

**Accessories and supplies:** Request the HP Recorder Supplies Catalog from the local HP sales and service office.

### General Specifications

**Writing mechanism:** Disposable ink pens (thermal writing optional)

**Grid width:** 25 cm (10 in.)

**Chart length:** 30 m (100 ft)

**Pen lift:** Solenoid operated with remote capabilities

**Power:** 115/230 V ±10%, 50 or 60 Hz, 120 VA

**Size:** 178 H x 432 W x 340 mm D (7 x 17 x 13.38 in.)

**Weight:** Net, 12.3 kg (27 lb). Shipping, 17.4 kg (38 lb)

### Options and accessories

Options and accessories	Price
001 Metric calibration	N/C
014 Right hand zero (hard)	N/C
037 Right hand event marker (not compatible with Option 054)	\$100
038 Thermal event marker (Option 054 required)	180
050 50 Hz line power	N/C
054 Thermal writing. (recommended for pen speed below 5 in./sec)	
7132A	305
7133A	230
060 60 Hz line power	N/C
537 7132A only. Left hand event marker (not available with thermal writing, Option 054)	80

### Ordering Information

Ordering Information	Price
7132A Two-pen laboratory recorder	\$2800
7133A One-pen laboratory recorder	\$2250

# RECORDERS & PRINTERS

## Strip chart recorders with plug-in preamps

Models 7100B, 7101B with 17500A series preamps

- One and two-pen mainframes
- Wide range of chart speeds
- Plug-in versatility

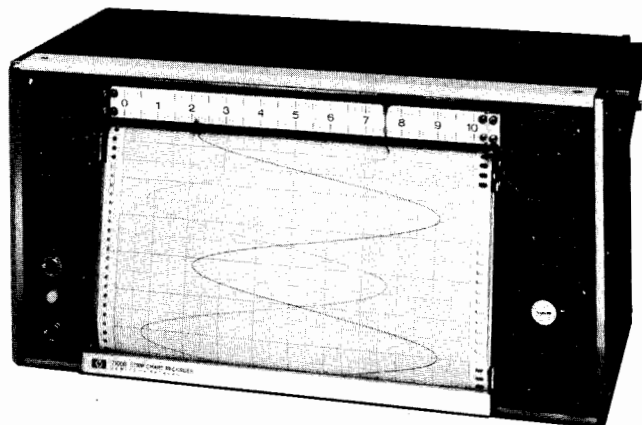

7100B with 17500A and 17501A preamps

The 2-pen 7100B and 1-pen 7101B are powerful metric or English strip chart recorders with a broad range of chart speeds; a 15 x 25 cm (6 x 10 in.) front-panel chart view area; and simple user switchable signal conditioner modules. The 7100B requires two signal conditioner modules; the 7101B requires one. Multispan modules, such as the 17500A, 17501A, and 17505A, provide high input resistance and continuously variable span control. The 17502A converts non-linear thermocouple output to a linear function, allowing the use of standard graph paper.

### 7100B and 7101B Specifications

#### Performance Specifications

**Response time:** <0.5 s (50 Hz), <0.6 s  
**Linearity** (terminal based): ±0.1% full scale  
**Resettability:** ±0.1% full scale  
**Chart speeds:** 2.5, 5, 15, 30 cm/hr; 1.25, 2.5, 5, 15, 30 cm/min; 1.25, 2.5, 5 cm/s (1, 2 in./hr; 0.1, 0.2, 0.5, 1, 2 in./min; 0.1, 0.2, 0.5, 1, 2 in./s)

**Chart speed accuracy:** Synchronous with line frequency

#### General Specifications

**Writing system:** Servo actuated ink pen with manual lift  
**Grid width:** 25 cm or 10 in. Chart length: 36 m or 120 ft  
**Power:** 115/230 V ±10%, 60 Hz (50 Hz optional).

7100B: 65 VA; 7101B: 42 VA

#### Net Weight:

7100B: 11.8 kg (26 lb). 7101B: 10.9 kg (24 lb).

**Cabinet size:** 304 H x 445 W x 210 mm D (12 x 17½ x 8¼ in.)

#### 7100B/7101B Options

Option	Price
004 Retransmitting potentiometer, channel 1	\$110
016 Retransmitting potentiometer, channel 2	110
005 High-low limit switches, channel 1	115
017 High-low limit switches, channel 2	110
018 High-low limit switches, both channels	220
012 Event marker, left side, ink	75
014 Event marker, both sides, ink	160
006 Remote pen lift	110
007 Remote chart ON-OFF	55
020 Right hand zero	N/C
010 50 Hz operation	N/C
011 Locking glass door	250
024 Disposable pen tips	N/C
026 Metric calibration	N/C

#### 17505A Options

Option	Price
003 50 Hz	N/C

#### Plug-in Module Specifications

	17500A	17501A	17505A	17502A
<b>Voltage spans</b>	10 spans, 5 mV thru 100 V, 1, 5, 10 steps	16 spans, 1 mV thru 100 V, 1, 2, 5, 10 steps	19 spans, 0.1 mV thru 100 V, 1, 2, 5, 10 steps	Matches thermocouple temperature.*
	Vernier provides continuous overlapping coverage			
<b>Input type</b>	Floating (500 Vdc max) front & rear connections			Rear input only
<b>Input resistance</b>	1 M ohm at null except 100 k ohms in vernier below 100 mV	1 M ohm at null on all spans		Potentiometric
<b>Max allowable source resistance</b>	10 k ohms on 4 most sensitive spans	10 k ohms on 6 most sensitive spans	10 k ohms on 9 most sensitive spans	—
	Source resistance will not alter recorder's performance on other spans			
<b>Normal mode rejection</b>	—	—	60 dB or 100 dB at 60 Hz	—
<b>Common mode rejection</b>	120 dB (DC) and 100 dB (60 Hz) 4 most sensitive spans	120 dB (DC) and 100 dB (60 Hz) 3 most sensitive spans	120 dB (DC) and 100 dB (60 Hz) most sensitive span	120 dB (DC) and 100 dB (60 Hz) single span
<b>Response time (full scale)</b>	See mainframe specifications		Filter OUT, 0.6 s; IN, 0.8 s	See mainframe specifications
<b>Accuracy</b>	±0.2% full scale		±0.25% full scale	±0.5% or ±1°C Refer to NBS CIR 561, 1965
<b>Reference stability</b>	Continuous Zener reference with temperature stability better than 0.005%/°C			—
<b>Zero set (left hand)</b>	±1 scale	5 scale zero suppression	+1 to -10 scales of calibrated offset in 1 scale steps. Accuracy ±0.25% per step	—
<b>Zero stability</b>	—	—	±1 μV after 1 hr warmup	—

\*Contact local HP Sales office for applicable temperature ranges

#### Ordering Information

7101B Strip Chart Recorder, single channel  
 7100B Strip Chart Recorder, dual channel  
 17500A Multiple Span Plug-in

#### Price

\$2350  
 2900  
 500

17501A Multiple Span Plug-in  
 17502A Temperature Plug-in  
 17505A High Sensitivity Plug-in

\$640  
 615  
 775

# RECORDERS & PRINTERS

281

Oscillographic recorders with plug-in preamps  
Models 7402A and 7404A with 17400A series preamps



- Records from DC to 150 Hz
- Draws traces with instant dry ink

- Provides pens designed for long-life use
- Allows configuration flexibility with plug-in modules

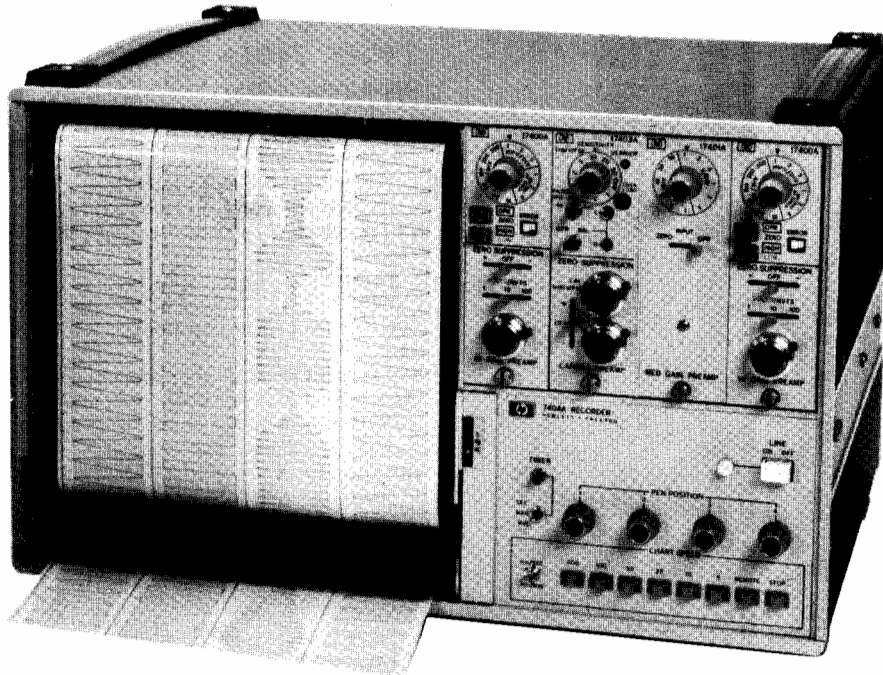

7404A

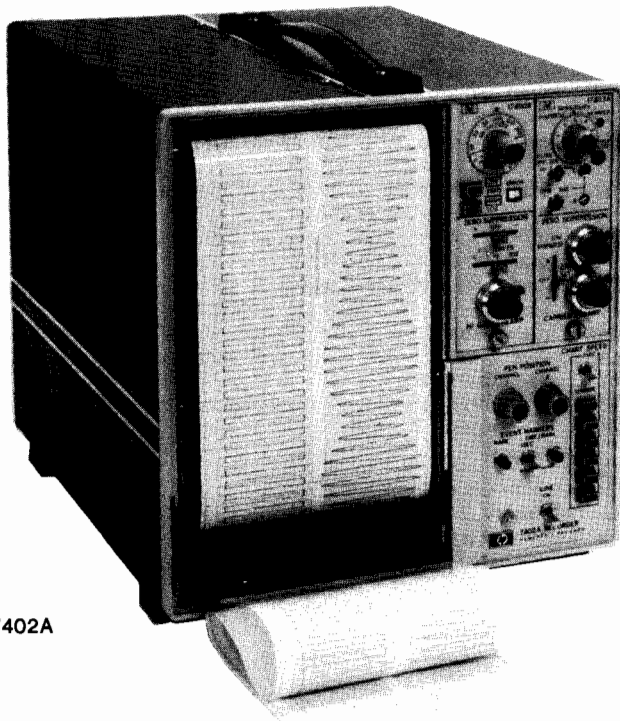

7402A

The 2-channel 7402A and 4-channel 7404A are direct writing oscillographic recorders capable of recording signals from DC through 150 Hz. Additional flexibility is provided with a choice of plug-in signal conditioner modules that can be changed easily by the user to configure the units to meet a variety of specific requirements.

### Long-life Pens Provided

Both recorders are equipped with pens designed to last for the life of the recorder. The pen body is made of stainless steel to eliminate failure from metal fatigue, even when subjected to sustained and violent signals. The pen tips are formed of tungsten carbide, a metal with extremely low wear characteristics. The combination of durable metals in this HP pen design provides a stability that frees the user from tip lapping, pen adjustment, or replacement.

The low pressure ink system produces a solid black trace that dries as it draws. The consistency of the trace, even at high chart speed, provides a smudge-proof, blot-proof permanent presentation of the charted data.

### User Plug-in Modules Available

Either recorder can be reconfigured by the user with a simple change of plug-in signal conditioner module. The range of modules to change both voltage and transducer compatibility are:

**17400A high gain preamplifier**—Max sensitivity of  $1 \mu\text{V}/\text{div}$  (50  $\mu\text{V}$  span) and 21 calibrated ranges. Input is differential, floated, and guarded. Module provides calibrated zero suppression.

**17401A medium gain preamplifier**—Max sensitivity of  $1 \text{ mV}/\text{div}$  (50 mV span) and 12 calibrated ranges. Input is differential and balanced to ground. Calibrated zero suppression is optional.



# RECORDERS & PRINTERS

Oscillographic recorders with plug-in preamps

Models 7402A and 7404A with 17400A series preamps (cont)

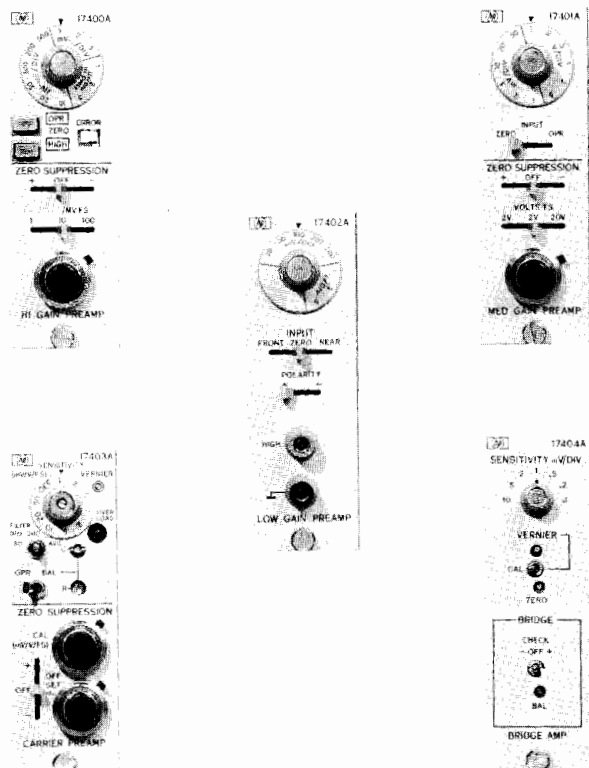

Preamps for 7402A and 7404A

**17402A low gain preamplifier:** Max sensitivity of 20 mV/div (1 V span) and 8 calibrated ranges. Inputs are single ended from both the front and rear connectors.

**17403A AC carrier preamplifier:** Max input sensitivity of 0.1 mV/V/full scale. Accepts inductive and resistive transducers, such as strain gauges, LVDTs, etc. Module supplies an excitation voltage of 5V at 2.4 kHz, 15 calibrated range steps, and calibrated zero suppression. When Module is used, a 2.4 kHz carrier frequency oscillator (Option 011) must be ordered with the mainframe.

**17404A DC bridge preamplifier:** Max input sensitivity of 0.1 mV/div (5 mV span). Module also supplies an excitation voltage of 5 V DC. A user-installable printed circuit board is provided that has space for calibration and bridge completion resistors. Designed for use with resistive transducers, such as strain gauges, this Module can also be used as a DC preamplifier.

## Other Mainframe Features Explained

All plug-in module outputs are available from the rear of the mainframe. The output voltage (0 to  $\pm 5$  V) can be used as signal input to other monitoring/recording instruments. The rear panel also implements remote selection of chart speeds, including Stop, using a contact closure or TTL level change.

Both the 7402A and 7404A are designed and tested to operate in extremely adverse environments. This includes vibration (5–55 Hz, 0.01 in. peak-to-peak); operating temperatures (0–55°C); and humidity (95% at 40°C).

Both units also are designed with a single high resonant pen frequency, approximately 800 Hz, that is well above the range of the recorder. This capability ensures proper pen response at higher operating frequencies without unwanted perturbations.

## 7402A, 7404A Specifications

### Analog channels:

**7402A:** 2 channels

**7404A:** 4 channels

**Chart description:** 84 m (275 ft) long with 50 div, full scale

**7402A:** 50 mm wide channels

**7404A:** 40 mm wide channels

**Chart speed:** Controlled by front panel, rear panel TTL or contact closure

**7402A:** 1, 5, 25, 125 mm/s

**7404A:** 5, 10, 25, 50, 100, 200 mm/s and mm/min

**Chart speed accuracy (25°C):**  $\pm 0.5\%$  plus power line frequency variation

**Chart weave:**  $\pm 0.25$  mm maximum

**Zero adjustment:**  $\pm 30$  div from grid center

**Writing system:** Black ink with rectilinear presentation; 55 cc throwaway ink cartridge

**Operating environment:** 0–55°C and up to 95% humidity

maximum from 25–40°C for mm/s speeds and up to 80% humidity for mm/min speeds

**Power:** 100, 120, 220, 240 Vac

**7402A:** +5% –10%, 60 Hz, 140 VA

**7404A:**  $\pm 10\%$ , 60 Hz, 300 VA

**Weight:**

**7402A:** 18.2 kg (40 lb); shipping: 26.9 kg (59 lb)

**7404A:** 31.4 kg (69 lb); shipping: 43.2 kg (95 lb)

**Size:**

**7402A:** 284 H x 253 W x 384 mm D (11 $\frac{1}{8}$  x 9 $\frac{7}{8}$  x 15 $\frac{1}{8}$  in.)

**7404A:** 290 H x 438 W x 384 mm D (11 $\frac{3}{8}$  x 17 $\frac{1}{4}$  x 15 $\frac{1}{8}$  in.)

## 17400A Series Specifications

### 17400A High Gain

**Input ranges:** 1, 2, 5, 10, 20, 50, 100, 200, 500  $\mu$ V/div and mV/div; 1, 2, 5 V/div continuous vernier between ranges

**Input type:** Differential, floated and guarded through rear connector

**Common mode rejection:** 150 dB DC and 140 dB at line frequency with 1 k ohm source imbalance; 90 dB DC and 80 dB at 60 Hz on 10  $\mu$ V/div and above

**Frequency response:** 10 divisions deflection: 3 dB at 110 Hz on 10  $\mu$ V/div range and above

**Typical rise time:** 7.5 ms (10 to 90% of full scale deflection)

**Overshoot:** Less than 2% of full scale

**Accuracy:**  $\pm 1\%$  of full scale; includes linearity (calibrated range, 25°C, temp coefficient 0.06%/°C)

**Range accuracy:**  $\pm 1\%$  of full scale;  $\pm 0.2\%$  of reading (25°C, temp coefficient 0.06%/°C). Linearity is included

**Zero suppression:** 1, 10, 100 V on 10 mV/div range and above; other ranges 1, 10, 100 mV. Continuous calibrated 10-turn vernier between suppression steps

**Zero suppression accuracy:**  $\pm 0.5\%$  of setting or of full scale, whichever is greater

### 17401A Medium Gain

**Input ranges:** 1, 2, 5, 10, 20, 50, 100, 200, 500 mV/div; 1, 2, 5 V/div. Continuous 10-turn vernier between ranges

**Input type:** Balanced to ground. Inputs through rear connector

**Input resistance:** 1 M ohm

**Common mode rejection:** Greater than 50 dB to line frequency. 100 ohm source imbalance

**Frequency response (10 divisions deflection):**

**7402A:** 3 dB at 140 Hz

**7404A:** 3 dB at 150 Hz

**Typical rise time:** 7.5 ms (10 to 90% of full scale deflection)

**Overshoot:** Less than 2% of full scale

**Accuracy:**  $\pm 1\%$  of full scale; includes linearity (calibrated range, 25°C, temp coefficient 0.06%/°C)



**Range accuracy:**  $\pm 1\%$  of full scale;  $\pm 0.2\%$  of reading ( $25^\circ\text{C}$ , temp coefficient  $0.06\%/^\circ\text{C}$ ). Linearity is included

**Zero suppression:**

**Optional:** 0.2, 2, 20 V. Continuous calibrated 10-turn vernier between ranges

**Zero suppression accuracy:**  $\pm 0.5\%$  of setting or of full scale, whichever is greater.

**17402A Low Gain**

**Input ranges:** 20, 50, 100, 200, 500 mV/div; 1, 2, 5 V/div. Continuous 10-turn vernier between ranges

**Input type:** Single ended. Inputs through front or rear connector.

**Input resistance:** 1 M ohm minimum

**Frequency response (10 divisions deflection):**

**7402A:** 3 dB at 140 Hz

**7404A:** 3 dB at 150 Hz

**Typical rise time:** 7 ms (10 to 90% of full scale deflection)

**Overshoot:** Less than 2% of full scale

**Accuracy:**  $\pm 1\%$  of full scale (calibrated range,  $25^\circ\text{C}$ , temp coefficient  $0.06\%/^\circ\text{C}$ ). Linearity is included

**Range accuracy:**  $\pm 0.2\%$  of reading. Linearity is included ( $25^\circ\text{C}$ , temp coefficient  $0.06\%/^\circ\text{C}$ )

**17403A Carrier**

**Input ranges:** 0.1, 0.2, 0.5, 1, 2, 5, 10, 20, 50 mV/V/full scale. Continuous vernier between ranges. Sensitivities shown above also divisible by 100

**Input type:** Differential, floating

**Common mode rejection:** 120 dB DC to line frequency with 1 k ohm source imbalance

**Frequency response (10 division deflection):**

**7402A:** 3 dB at 140 Hz

**7404A:** 3 dB at 150 Hz

**Typical rise time (10 to 90% of full scale deflection):** 7.5 ms with preamp filter switch to 50 or 200; 1 s with switch to AVG

**Overshoot:** Less than 2% of full scale

**Accuracy:**  $\pm 0.6\%$  of full scale (calibrated range,  $25^\circ\text{C}$ , temp coefficient  $0.06\%/^\circ\text{C}$ )

**Range accuracy:**  $\pm 0.2\%$  of reading ( $25^\circ\text{C}$ , temp coefficient  $0.06\%/^\circ\text{C}$ ). Linearity is included

**Zero suppression:** 10-turn controls from 1 to 100% of full scale

**Zero suppression accuracy:**  $\pm 0.5\%$  of setting or of full scale, whichever is greater

**Drift (zero line referenced to input):**  $\pm 0.2 \mu\text{V}/\text{V}/\text{week}$ , including excitation drift

**Balance control (R balance):**  $\pm 5 \text{ mV}/\text{V}$ . temp coefficient  $\pm 1.8 \mu\text{V}/\text{V}/^\circ\text{C}$

**Quadrature rejection:** 40 dB at 2.4 Hz. Quadrature tolerance: 2.1

**Transducer excitation:**

**Full bridge:** 5.0 V rms  $\pm 5\%$ , 2.4 kHz  $\pm 3\%$

**Half bridge:** one-half full bridge

**Excitation load resistance:** 100 ohms minimum; unlimited short circuit duration

**17404A Bridge**

**Input range:** 0.1, 0.2, 0.5, 1, 2, 5, 10 mV/div. Overlapping vernier between ranges

**Input type:** Differential, floating, and guarded

**Maximum allowable input (continuous):** 17 V DC or peak AC

**Input resistance:** 100 k minimum

**Common mode rejection:** 100 dB DC and 80 dB at line frequency with 1 k source imbalance

**Frequency response (10-division deflection):**

**7402A:** 3 dB at 140 Hz

**7404A:** 3 dB at 150 Hz

**Typical rise time:** 7 ms (10 to 90% of full scale deflection)

**Overshoot:** Less than 2% of full scale

**Accuracy:**  $\pm 1.0\%$  of full scale (calibrated range,  $25^\circ\text{C}$ , temp coefficient  $0.06\%/^\circ\text{C}$ ). Excludes excitation supply errors

**Range accuracy:**  $\pm 1.0\%$  of full scale, excluding excitation supply errors ( $25^\circ\text{C}$ , temp coefficient  $0.06\%/^\circ\text{C}$ ). Linearity is included

**Drift (zero line referenced to input):**  $\pm 0.2\% \mu\text{V}/\text{V}/\text{week}$ , including excitation drift

**Source resistance:** 1 k ohm maximum

**Transducer excitation:** 5 V DC  $\pm 1.0\%$

**Excitation load resistance:** 50 ohms minimum; unlimited short circuit duration

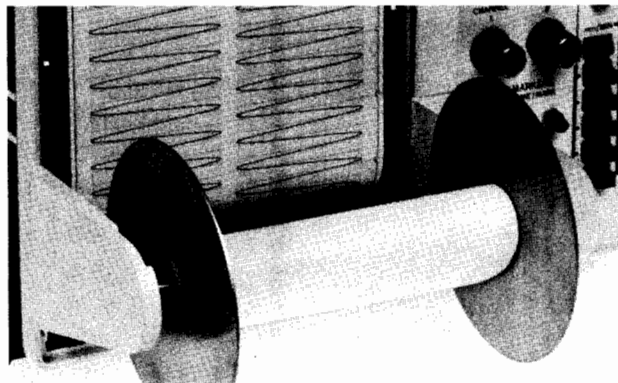

Paper Take Up (Option 005)

**7402A & 7404A Options**

Option no.	Description	Price
<b>7402A</b>		
001	Event marker, left hand	\$125
003	Event marker, left hand & event marker/timer, right hand for 1 s intervals	210
004	50 Hz power line operation	N/C
005	Paper take up, external	\$160
008	Event marker/timer, right hand, for minutes & seconds. Not compatible with Options 001 or 003	180
009	60:1 speed reducer	225
010	Hard cover. Not compatible with Options 005 or 908	60
011	2.4 kHz oscillator for 17403A	65
016	White paint	100
017	UL 544 listing & white paint	375
018	UL 544 listing and standard paint	325
908	Rack mounting adapter	130
<b>7404A</b>		
004	50 Hz power line operation	N/C
005	Paper take up, external	\$350
010	Hard cover. Not compatible with Options 005, 012 or 908	75
011	2.4 kHz oscillator for use with 17403A	65
012	Rack mount adapter for 1064A	135
013	Channel 2 event marker	65
014	Channel 3 event marker	65
015	Channel 4 event marker	65
016	White paint	100
908	Rack mount adapter	200

**Ordering Information**

	Price
Specify Option 016 for no charge white paint on preamps	
7402A Mainframe (less preamps)	\$3350
7404A Mainframe (less preamps)	6700
17400A High-gain preamplifier	860
17401A Medium-gain preamplifier	350
Option 001: (zero suppression) for 17401A	add 150
17402A Low-gain preamplifier	210
17403A AC carrier preamplifier	850
17404A DC bridge preamplifier	675





## RECORDERS & PRINTERS

### Four and eight-channel oscillographic recorders

Models 7414A, 7418A & 8800 series signal conditioners

- Versatile configurations
- Thermal writing

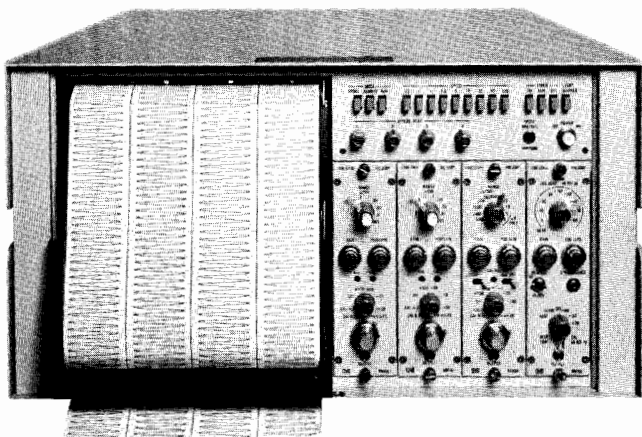

7414A

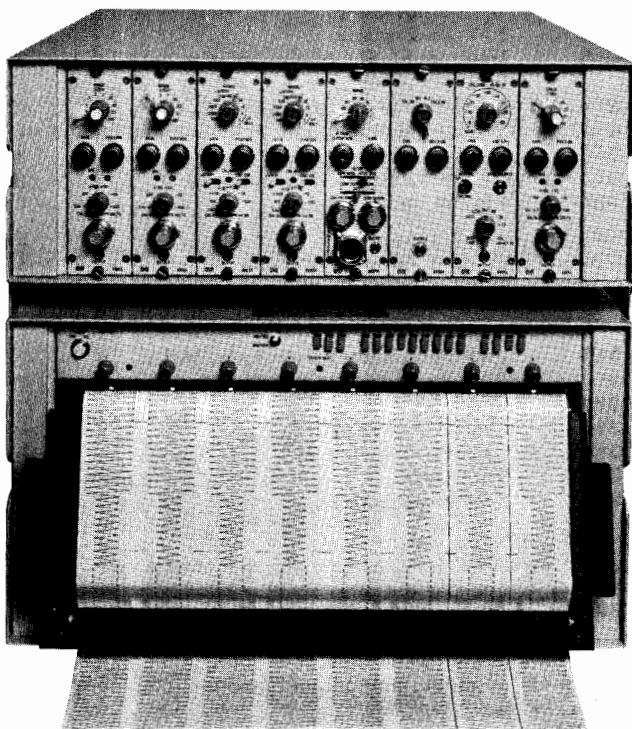

7418A

The Hewlett-Packard Models 7414A 4-channel, and 7418A 6- and 8-channel Oscillographic Recorders provide permanent reproducible records of multichannel, real-time, low frequency data. They can be contained in a single benchtop package, a mobile cart, or in an upright cabinet. The unit selected, depending upon channel needs, represents a unique combination of reliability, high performance, and flexibility. A complement of the 8800 Series Plug-In Signal Conditioners results in a system capable of meeting many measurement requirements.

Thermal writing tips in Models 7414A and 7418A, featuring long stylus life and rectilinear presentations, are provided. A Z-fold chart paper pack loads easily, allows for convenient data review, and storage capability. Two event markers are supplied. One is activated by either a one-second or one-minute front panel timer button, the other by the event button. Both markers can be activated remotely.

### 7414A, 7418A, 8800 Series Plug-in Specifications

#### 7414A General Specifications

**Chart speeds:** 0.25, 0.5, 1.0, 2.5, 10, 25, 50, 100 mm/s. Speed regulation  $\pm 1\%$ . Paper weave less than 0.5 mm. Speed selected via front panel pushbuttons.

**Limiting:** electrical limiting keeps stylus within a range of 1.5 mm beyond edge of channel.

**Markers:** event—local or remote control (monopolar), located on right side, between channels 3 and 4. Timed—1 min or 1 s interval (monopolar), located on left side, between channels 1 and 2.

**Chart paper:** four 40 mm wide channels each with 50 div; time lines every 1 mm; heat sensitivity Z-fold Permapaper® with black grid lines available in packs of 500 sheets, each 30 cm (12").

**Paper loading:** no threading required.

**Remote operation:** rear panel connector provides for chart drive and event marker.

**Power:** 115/230 V ac  $\pm 10\%$ , 60 Hz, 350 VA (includes plug-ins) 50 Hz optional.

**Size:** 266.7 H  $\times$  482.6 W  $\times$  577.9 mm D (10½"  $\times$  19"  $\times$  22¾"). Projection: 76.2 mm (3") from rack front.

**Weight:** net, 50.5 kg (112 lb). Shipping, 59.5 kg (132 lb).

#### 7418A General Specifications

**Chart speeds:** 0.5, 1, 2.5, 5, 10, 25, 50, 100, 200 mm/s. Speed regulation  $\pm 1\%$ . Paper weave less than 0.5 mm. Speed selected via front panel pushbuttons.

**Chart Paper:** Eight 40 mm wide channels each with 50 divisions; time lines every 1 mm. Heat sensitive Chemical Thermal Paper standard for all system recorders except option 050. Permapaper® for Option 050 recorders only. Chemical Thermal Paper available in packs of 400 sheets, each 30.1 cm (12") long  $\times$  40.2 cm (15.8") wide (part number 9270-0563). Permapaper available in packs of 500 sheets, each 30.1 cm (12") long  $\times$  40.2 cm (15.8") wide (part number 9270-0920).

**Remote operation:** rear panel connector provides for chart drive and event marker, optional extra markers. Remote connector supplies  $-20$  V.

**Power:** 115/230 V ac  $\pm 10\%$ , 60 Hz. Recorder only 575 VA; system plug-ins 695 VA.

**Size:** rack: 266.7 H  $\times$  482.6 W  $\times$  577.9 mm D (10½"  $\times$  19"  $\times$  22¾"). Projection: 76.2 mm (3") from front of rack.

**Weight:** 50 kg (110 lb) including driver amplifiers.

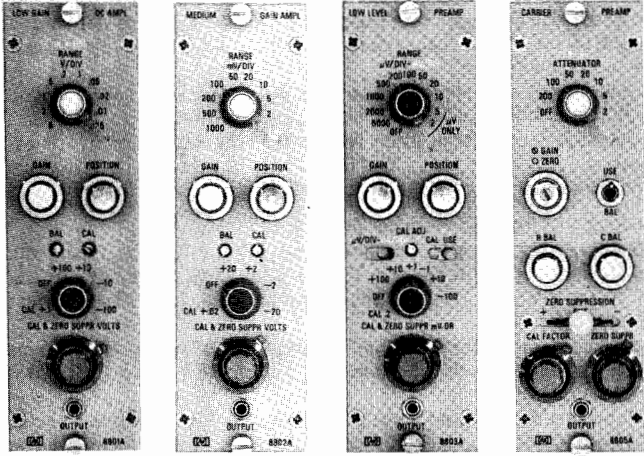

8801A      8802A      8803A      8805A

**8801A With 7414A and 7418A**

**Input ranges:** 5, 10, 20, 50, 100, 200, 500, 1000 mV/div; accuracy  $\pm 1\%$ .  
**Max calibrated sensitivity and max fs Input:** 5mV/div (gain 20) 250V.  
**Input circuit & input frequency range:** resist. 500 k $\Omega$   $\pm 1\%$  each side bal to gnd; parallel with approx. 100 pF  
**Rise time (10 div, 10-90%, 4% overshoot):** 5 ms.  
**Calibration (referred to input):** 100 mV,  $\pm 1\%$ , internal.  
**Output frequency response (-0.5 dB at 50 div):** 50 Hz.  
**Zero suppression:**  $\pm 10$  and  $\pm 100$  V for single-ended or diff. signals. 10-T pot sets precise values of zero suppression voltages;  $\pm 50$  V max suppress on 5, 10, 20 mV/div ranges; max error of suppression  $\pm 0.5\%$  of suppression range, and 1% of indicated suppression.  
**Output noise, max (less trace width):** 0.2 div, p-p.  
**Zero drift, 20° to 40°C, 103 to 127 V (less trace width):** temp—1.25 div/10°C, 0.5 div/hr, constant ambient. Line voltage—0.15 div.  
**Common mode rejection and tolerance:** 48 dB min, dc to 150 Hz;  $\pm 50$  V max on other ranges for  $< 1\%$  change in differential sensitivity.  
**Output linearity (less trace width):** 0.25 div, after calibration for zero error to center scale +20 div.  
**8802A With 7414A and 7418A**  
**Input ranges:** 1, 2, 5, 10, 20, 50, 100, 200, 500, 1000 mV/div; accuracy  $\pm 1\%$ .  
**Maximum calibrated sensitivity and max fs input:** 1 mV/div (gain 100) 50 V.  
**Input circuit and input frequency range:** resist 180 k $\Omega$   $\pm 1\%$ , each side bal to gnd, parallel with approx 100 pF.  
**Rise time (10 div, 10-90%, 4% overshoot):** 5 ms.  
**Calibration (referred to input):** 20 mV,  $\pm 1\%$ , internal.  
**Output frequency response (-0.5 dB at 50 div):** 50 Hz.  
**Zero suppression:**  $\pm 2$ V and 20 V for single-ended or differential signals; 10-T pot sets precise values of zero suppression voltages;  $\pm 12.5$  max suppression on 1, 2, 5 mV/div ranges; max error of suppression  $\pm 0.5\%$  of suppression range and 1% of indicated suppression.  
**Output noise, max (less trace width):** 0.2 div, p-p.  
**Zero drift, 20° to 40° C, 103 to 127 V (less trace width):** same as 8801A.  
**Common mode rejection and tolerance:** 48 dB min dc to 60 Hz, 1000 mV/div range; 48 dB min. dc to 150 Hz other ranges  $\pm 12.5$  V on 1, 2, 5 mV/div ranges;  $\pm 125$  V on 10, 20, 50 mV/div ranges;  $\pm 500$  V max other ranges for less than 1% change in differential sensitivity.  
**Output linearity (less trace width):** same as 8801A.

**8803A With 7414A and 7418A.**

**Input ranges:** 1, 2, 5, 10, 20, 50, 100, 200, 500, 1000, 2000, 5000  $\mu$ V/div; 10, 20, 100, 200, 500, 1000, 2000, 5000 mV/div; accuracy  $\pm 1\%$  on 5000  $\mu$ V/div to 20 $\mu$ V/div ranges,  $\pm 2\%$  on 10 uV/div to 1  $\mu$ V/div; accuracy of x 1000 attenuator  $\pm 1\%$ .  
**Maximum calibrated sensitivity and max fs Input** 1 $\mu$ V/div (gain 100,000) 250 V.  
**Input circuit and input frequency range:** 1 M $\Omega$  min on  $\mu$ V range, independent of gain; 5 M $\Omega$  on mV range; floating and guarded.  
**Rise time (10 div, 10-90%, 4% overshoot):** 5 ms. 6% overshoot.  
**Calibration (referred to input):** 200  $\mu$ V  $\pm 1\%$  internal on  $\mu$ V/div range; 200 mV  $\pm \%$  internal on mV/div range.  
**Output frequency response (-0.5 dB at 50 div):** 50 Hz.  
**Zero suppression:**  $\mu$ V ranges  $\pm 1$ ,  $\pm 10$ ,  $\pm 100$  mV; mV ranges  $\pm 1$ ,  $\pm 10$ ,  $\pm 100$  V, 10-T pot sets precise values of zero suppression voltages; accuracy  $\pm 1\%$  suppression range.  
**Output noise, max (less trace width):** 1.5 mm p-p at 1 $\mu$ V/div; 0.1 div, p-p min gain.  
**Zero drift, 20% to 40%, 103 to 127 V (less trace width):** temp— $\mu$ V range 1  $\Omega$ /10° referred to input,  $\pm 0.26$  div/10° C for 0 output &  $\pm 0.65$  div/10° C for fs output. mV range, 1 mV/10° C referred to input,  $\pm 0.26$  div/10° C for 0 output. Line voltage 0-0.07 div; fs 0.35 div.  
**Common mode rejection and tolerance:**  $\mu$ V range, max source unbal of 1 k $\Omega$ ; 160 dB min at dc, 120 dB min at 60 Hz; mV range, max source unbal of 500 k $\Omega$ ; 100 dB min at dc, 60 dB min at 60 Hz dc. 300 V pk; 60 Hz. 1  $\mu$ V/div, 10 V rms; 2  $\mu$ V/div, 20 V rms; 5  $\mu$ V/div, 50 V rms; 10  $\mu$ V/div and 10 mV/div, 100 V rms; 20  $\mu$ V to 5000  $\mu$ V/div and 20 mV to 5000 mV/div, 200 V rms.  
**Output linearity (less trace width):** 1 mV range 0.35 div, others 0.25 div after calibrating for zero error at center scale and +20 div.

**8805A/B With 7414A and 7418A**

**Input ranges:** X1, 2, 5, 10, 20, 50, 100, 200; accuracy  $\pm 2\%$ .  
**Maximum calibrated sensitivity and max fs input:** 10 $\mu$ V rms/div (gain 10,000 rms ac to dc); 100 mV rms.  
**Input circuit and input frequency range:** input impedance—8805A approx 10 k $\Omega$ ; 8805B 1 M $\Omega$   $\pm 10\%$ ; single-ended. Min load resistance across excitation 100 $\Omega$ . Max impedance in series with input (transducer output impedance) 5 k $\Omega$ . Excitation—floating source 5 V rms nominal at 2400 Hz  $\pm 2\%$ . Internal full bridge—half bridge switch grounds C.T. of excitation for use with half bridge transducer.  
**Rise time (10 div, 10-90%, 4% overshoot):** 5.6 ms.  
**Calibration (referred to input):** 2%  $\pm 0.02\%$  of transducer fs output. Adjust by Cal Factor control; accuracy  $\pm 55$   $\mu$ V/V out of 10mV/V. 8805B switchable Cal voltage to 2%, 10%, 50%, or 100%  $\pm 1\%$  of fs.  
**Output frequency response (-0.5 dB at 50 div):** 50 Hz.  
**Zero suppression:** 0-100% of transducer full load rating, for transducers having Cal Factor up to 10 mV/V at full load, 10-T pot with calibration dial; accuracy—1 dial div  $\pm 0.5\%$  of suppress range. Zero Supp Polarity switch, Separate R Bal control allows bucking of in-phase unbal to  $\pm 3$  mV/V regardless of Cal Factor.  
**Output noise, max (less trace width):** approx. 0.2 div, p-p.  
**Zero drift, 20% to 40%, 103 to 127 V (less trace width):** temp—0.45 div/10° C; Line voltage—0.25 div.  
**Common mode rejection and tolerance:** quadrature rejection and tolerance:  $> 40$ dB. Tolerance error:  $< \pm 2\%$  fs when quadrature voltage equal to twice in-phase signal required for center to edge deflection on chart. C Balance control permits bucking of transducer's quad unbalance of up to  $\pm 5$  mV/V.  
**Output linearity (less trace width):** 0.4 div after calibrating for zero error at center scale and +20 div.



# RECORDERS & PRINTERS

## Four and eight-channel oscillographic recorders

### Models 7414A, 7418A & 8800 series signal conditioners (cont.)

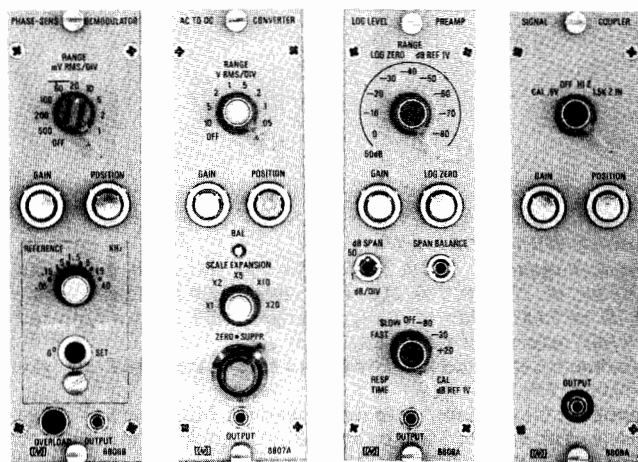

8806B

8807A

8808A

8809A

#### 8806B With 7414A and 7418A

**Input ranges:** sig input—0.5, 1, 2.5, 10, 20, 50, 100, 200, 500 mV/div;  $\pm 1\%$ , 50 Hz to 10 kHz;  $\pm 2\%$ , 10 kHz;  $\pm 3\%$ , 20 kHz to 40 kHz. Reference voltage—3 to 20 rms, 20 to 133 V rms.

**Maximum calibrated sensitivity and max fs input:** 0.5 mV rms/div (gain 200 rms ac to dc) 25 V rms.

**Input circuit and input frequency range:** signal input:—transformer isolated, floating point and guarded; resistance approx 1 M $\Omega$ . Reference input: differential, transformer coupled; resistance approx 500 k $\Omega$  each side to ground, may be used single ended. 50 Hz to 40 kHz in 6 bauds with variable frequency plug-in; 60 Hz, 400 Hz and 5 kHz fixed frequency phase shifter plug-in; special order phase shifter plug-ins 50 Hz to 40 kHz.

**Rise time (10 div, 10-90%, 4% overshoot):** 5 ms (5 kHz ref).

**Calibration (referred to input):** 1 V rms internal at carrier reference frequency;  $\pm 1\%$  50 Hz to 10 kHz;  $\pm 2\%$  10 kHz to 20 kHz;  $\pm 3\%$  20 kHz to 40 kHz.

**Zero suppression:** none. Phase shifter plug-ins allow control of reference phase over 360°. Fixed frequency: 0° to 90° dial; 2° graduations; any of 4 quadrants by panel switches; dial accuracy within  $\pm 3^\circ$ . Variable frequency: adjust thru 360°.

**Output noise, max (less trace width):** 7 $\mu$ V x sq root of frequency response, referred to input.

**Zero drift, 20° to 40°C, 103 to 127 V (less trace width):** temp: 0.5 div/10°C; Line voltage: 0.25 div.

**Common mode rejection and tolerance:** CM: >40 dB up to 10 kHz 500 V rms, max. Quadrature tolerance: equal to amplitude of a fs, in-phase signal.

**Output linearity (less trace width):** 0.4 div after calibrating for zero error at center scale and +20 div.

#### 8807A With 7414A and 7418A

**Input ranges:** 0.02, 0.05, 0.1, 0.2, 0.5, 1, 2, 5, 10 V rms/div,  $\pm 2\%$  (midband). Scale expansion: X1, 2, 5, 10, 20,  $\pm 2\%$ .

**Maximum calibrated sensitivity and max fs input:** 1 mV rms/div (gain 100 rms ac to dc). 20 mV rms/div with X1 scale expansion 500 V rms.

**Input circuit and input frequency range:** approx 1 M $\Omega$  resistive in parallel with 10 pF and stray cable capacitance; floating and guarded. Standard model: 330 Hz to 100 kHz; Opt 001: 50 Hz to 100 kHz.

**Rise time (10 div, 10-90%, 4% overshoot):** 11.2 ms. Opt 001: 70 ms, approx 10% overshoot.

**Calibration (referred to input):** 1 V internal  $\pm 1\%$ ; approx 500 Hz.

**Output frequency response (-0.5 dB at 50 div):** 54 Hz (3 dB at 10 div). Opt 001—9Hz.

**Zero suppression:** up to 100% of fs on any range can be suppressed; 10-T pot with calibrating dial. Scale expansion: 5, 10, 20, or 50% of fs can be expanded to cover full chart.

**Output noise, max (less trace width):** baseline offset/noise: 2 mV rms referred to input +0.025 div X scale expansion

**Zero drift, 20° to 40°C, 103 to 127 V (less trace width):** temp 0.03 div/10°C X scale expansion +0.35 div/10°C; at constant ambient 0.005 div/hr X scale expansion. Line voltage 0.005 div X scale expansion +0.1 div.

**Common mode rejection and tolerance:** 60 dB min at 60 Hz; 40 dB min at 400 Hz with up to 10 K source unbalance;  $\pm 500$  V pk.

**Output linearity (less trace width):** 0.55 div +0.05 div X scale expansion, 330 Hz to 5 kHz; Opt 001: 60 Hz to 5kHz, after calibration for zero error at lower and upper ends of printed coordinates.

#### 8808A With 7414A and 7418A

**Input ranges:** 50 dB span: bottom scale -80, -70, -60, -50, -40, -20, -10, and 0 dB below 1 V (i.e. 100 $\mu$ V, 320  $\mu$ V, 1, 3.2, 10, 32, 100, 320 mV and 1V). 100 dB span bottom scale -80, -70, -60, and -50 dB below 1 V.

**Maximum calibrated sensitivity and max fs input:** 100  $\mu$ V rms sine wave corresponds to bottom scale output, -80 dB below 1 V 320 V rms.

**Input circuit and input frequency range:** single ended, resistance 1 M $\Omega$  min. 5 Hz to 100 kHz for <3dB down from the midband level on "Slow" response range; 500 Hz to 100 kHz on "Fast" response range. **Rise time (10 div, 10-90%, 4% overshoot):** fast: 20.5 rms (875 dB/s) Slow: 2 s (9 dB/s).

**Calibration (referred to input):** internal from oscillator at approx 500 Hz. -80, -30, and  $\pm 20$  dBV = dB ref. to 1 V (100  $\mu$ V, 32mV and 10 V) -80 +20 dBV internally adjustable: -30 dBV accuracy  $\pm 0.25$  dB (at 115 V line at 25°C).

**Output noise, max (less trace width):** 50 dB range: 0.8 div, p-p, 100 dB range: 0.4 div, p-p (max noise at bottom of recording chart).

**Output linearity (less trace width):** departure from log characteristics 50 dB: 1.25 div, 100 dB: 1 div, after calibrating for zero error at lower and upper ends of printed coordinates.

#### 8809A With 7414B and 7418A

**Input ranges:** continuously adjustable from 20 to 50 mV/div.

**Max calibrated sensitivity and max fs input:** 30 mV/div (gain 3.33). 0 to +2.5 V or 0 to -2.5 V.

**Input circuit and input frequency range:** switch selected: 1500 $\Omega$   $\pm 2\%$  or 100 k $\Omega$  min, incremental; single ended.

**Rise time (10 div, 10-90%, 4% overshoot):** 5 ms.

**Calibration (referred to input):** 600 mV  $\pm 2\%$ , internal.

**Output frequency response (-0.5 dB at 50 div):** 50 Hz.

**Output noise, max (Less trace width):** 0.1 div, p-p.

**Zero drift, 20° to 40°C, 103 to 127 V (less trace width):** temp: 0.4 div/10°C at 30 mV sensitivity. Line voltage: 0.3 div.

**Common mode rejection and tolerance:** 50,000: 1 at dc.

**Output linearity (less trace width):** 0.4 div after calibrating for zero error at center scale and +20 div.

#### 8820A With 7418A

**Sensitivity:** 0.05 V/div (Amplifier Gain 2).

**Maximum fs input:** 250 V (edge to edge).

**Input ranges (attenuation):** 0.05, 0.1, 0.2, 0.5, 1, 2, 5 V/div. Attenuator accuracy  $\pm 2\%$ .

**Input circuit:** single ended, 1M $\Omega$  min.

**Frequency response:** dc to <0.5 dB down at 50 Hz (50 div p-p); dc to <3 dB down at 100 Hz (10 div p-p).

**Rise time (10 div, 10-90%, 4% overshoot):** <6 ms.

**Output linearity (less trace width):** linear within  $\pm 0.25$  div after setting mechanical zero of stylus to within  $\pm 1$  div of chart center and calibrating for zero error at center scale and  $\pm 20$  div.

**Drift, 20° -40°, 115 V  $\pm 10\%$ , 60 Hz (less trace width):** temp: <0.55%/10°C. Line voltage: <  $\pm 0.2$  div.

**Calibration:** 1 V  $\pm$  calibration voltage for all channels.

**Temp rating:** operating: 0°C to +55°C; storage: -40°C to 75°C.

#### 8821A With 7418A

**Sensitivity:** 0.001 V/div (Amplifier Gain 100).

**Maximum fs input:** 250 V (edge to edge).

**Input ranges (attenuation):** 0.001, 0.002, 0.005, 0.010, 0.020, 0.050, 0.1, 0.2, 0.5, 1, 2, 5 V/div. Attenuator accuracy (dc)  $\frac{1}{2}\%$  on 0.001 to 0.050 V/div ranges; 1% on 0.1 to 5 v/div ranges.

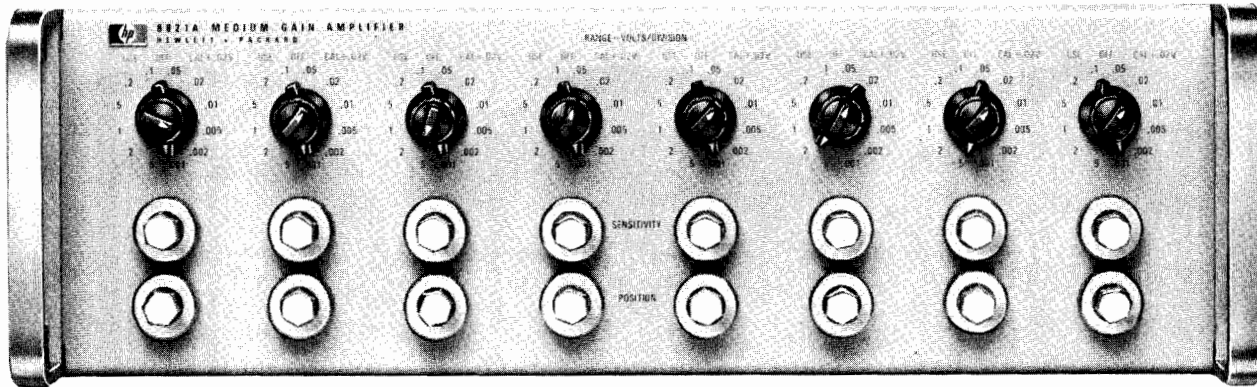

8821A

**Input circuit:** balanced, floating and guarded, 9 M $\Omega$  constant for all gain settings (0.001 to 0.050 V/div); 4.5 m $\Omega$  each side to ground (0.1 to 5 V/div).

**Common mode rejection:** 100 dB at 60 Hz, 0.001 V/div sensitivity, 1 k $\Omega$  source unbalance decreases to 66 dB at 0.05 V/div, 66 dB at 60 Hz, 0.01 to 5 V/div sensitivity. 1 k $\Omega$  source unbalance.

**Common mode tolerance:**  $\pm 20$  V on 0.001 to 0.05 V/div ranges (6 most sensitive);  $\pm 250$  V on 0.1 to 5 V/div ranges (6 least sensitive).

**Frequency response:** dc to  $<0.5$  dB down at 50 Hz (50 div, p-p). dc to  $<3$  dB down at 200 Hz (10 div p-p).

**Rise time (10 div, 10-90%, 4% overshoot):**  $<6$  ms.

**Output linearity (less trace width):** same as 8820A.

**Drift, 20° to 40°C, 115 V  $\pm 10\%$ , 60 Hz (less trace width):** same as 8820A.

**Calibration:**  $+0.02$  V  $\pm 1\%$  on 6 most sensitive ranges. Simulates  $+2$  V  $\pm 2\%$  at input on 6 least sensitive ranges.

**Temperature rating:** same as 8820A.

Ordering Information	Price	Opt 026: 60:1 speed reduction (60Hz)	add \$430
7414A 4-channel Oscillographic Recorder	\$7300	Opt 030: 8848A plug-in Preamplifier Power Supply, required for operation of 8800 preamplifiers	add \$2200
Opt 001: rack mount kit with slides and mounting hardware; delete case.	N/C	Opt 031: 8820A 8-channel Low Gain Bank Preamplifier	add \$3580
Opt 008: 50Hz operation	N/C	Opt 032: 8821A 8-channel Medium Gain Bank Preamplifier	add \$4600
Opt 015: extra Event Marker, between channels 2 & 3	add \$110	Opt 035: rack mount kit for HP29400 series cabinet	add \$310
Opt 025: 60:1 speed reduction (50Hz), requires Opt 008	add \$450	Opt 050: recorder equipped for permapaper operation only	N/C
Opt 026: 60:1 speed reduction (60Hz)	add \$450	8801A Low Gain Preamplifier	\$600
Opt 054: Installed in mobile cart. Includes paper take-up drawer	add \$1300	8802A Medium Gain Preamplifier	\$650
7418A 6 to 8-channel Oscillographic Recorder	\$9500	8803A High Gain Preamplifier	\$1350
Opt 001: 6 channel Hot-tip Thermal Recorder only; includes takeup tray. Plug-in preamplifiers require Opt 030 Power Supply; for 8-channel Bank Amplifiers (Power Supply included) select Opt 031 or 032	less \$620	8805A Carrier Preamplifier	\$1200
Opt 002: rack mount kit	add \$235	Opt 002: Harmonic Filter Kit, required when 267, 268, 270, or 1280B, C transducers are used	add \$35
Opt 003: bench-top configuration	add \$530	8805B Carrier Preamplifier with Harmonic Filter	\$1125
Opt 004: 63" (160 cm) cabinet with 7" (17.8 cm) paper takeup drawer	add \$2400	Opt 002: delete Harmonic Filter	less \$25
Opt 006: 28" (71 cm) Portable Cart, includes Opt 002	add \$1500	8806B Phase Sensitive Demodulator Preamplifier	\$1100
Opt 008: 50Hz operation	N/C	Opt 002: Variable Frequency Phase Shifter plug-in, 50Hz to 40kHz	add \$340
Opt 009: 230 V ac operation	N/C	Opt 003: 60Hz Phase Shifter plug-in	add \$205
Opt 014: extra Event Marker between channels 4 & 5	add \$100	Opt 004: 400Hz Phase Shifter plug-in	add \$250
Opt 015: extra Event Marker between channels 5 & 6	add \$100	Opt 005: 5kHz Phase Shifter plug-in	add \$165
Opt 025: 60:1 speed reduction (50Hz), requires Opt 008	add \$430	8807A AC/DC Converter Preamplifier	\$1600
		Opt 001: 50Hz to 100kHz Signal Filter	N/C
		Opt 002: DC Plug-in	N/C
		8808A Logarithmic Preamplifier	\$1350
		8809A Signal Coupler Preamplifier	\$320
		8820A Low Gain Bank Preamplifier (8-channel)	\$3580
		8821A Medium Gain Bank Preamplifier (8-channel)	\$4450

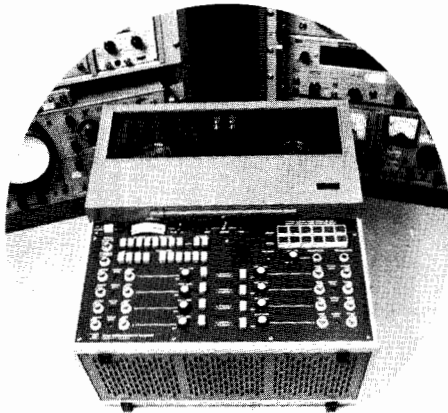

Laboratory

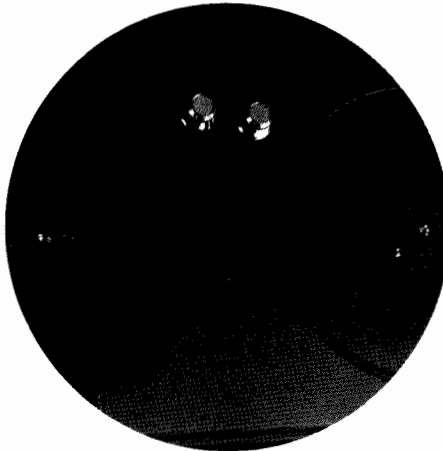
1/4-inch tape for accurate,  
low-cost recording

Medical

### Introduction

Instrumentation tape recorders (ITRs) are used to record, store, and reproduce test data for many and varied applications. The main reasons for using ITRs are economy, accurate data recording, and long-term data storage. ITR recording provides non-destructive reproduction, so data can be reproduced repeatedly without degrading the quality and time-base contraction or expansion. Data is contracted by using faster tape speeds to reproduce slow-speed data or expanded by doing the reverse to produce, for example, lower frequency data for use on a chart recorder.

ITRs are available with different capabilities. For instance, ITRs with 1/2-inch or 1-inch tape are often configured to record and reproduce frequencies in excess of 1 MHz; while the smaller 1/4-inch tape ITRs manufactured by Hewlett-Packard are designed specifically for applications under 64 kHz. In this range, the 4 or 8-channel 1/4-inch HP ITRs offer users both lower initial cost and lower cost of operation. The user recording with 1/4-inch tape, rather than 1/2-inch, can save over 50% on tape costs; a saving that continues for the life of the recorder.

### ITR Electronics Explained

The capability of an ITR is controlled primarily by the choice of electronics, the major portion of which relates to record/reproduce and the control of tape speed.

#### Record/Reproduce

Direct record/reproduce electronics accept frequencies above 100 Hz (approximate) and record the amplitude of the input signal on the tape as a proportional magnetic flux intensity. Because Direct electronics require a "linear" relationship, changing types of tape generally necessitates the re-equalization of each Direct channel. Direct electronics also require that each recorded tape be degaussed (erased) fully before being reused.

FM record/reproduce electronics accept very low frequencies, including DC. In FM, the amplitude of the input signal is recorded as a frequency deviation from a "center" frequency; the maximum input amplitude being recorded as a 40% deviation. Because amplitude is converted to a frequency, FM tends to be insensitive to tape drop outs; but sensitive to speed irregularities, such as flutter. With FM, tape types can be changed without re-equalizing and, as FM records to saturation, tape can be reused without degaussing with only a small (10 to 15 dB) loss in signal-to-noise ratio.

Generally, FM and Direct have a common segment of the frequency range in which either type of electronics can function. On Hewlett-Packard's ITRs this range is approximately 100 Hz to 5 kHz. The advantages of using Direct electronics in this range are high frequency response at slow tape speeds and a general insensitivity to flutter. The advantages of FM are DC response and a general insensitivity to tape drop outs.

### Tape Speed Control

The tape speed is usually controlled by a phase-lock servo system in one of two ways. The more common method uses the servo system to control the rotational speed of the tape capstan, employing a tachometer mounted on the capstan's shaft to monitor the speed. With this method, tape speed control is limited to approximately  $\pm 0.2\%$ , because of capstan irregularities, tape slippage, and tape stretching. The less common, but more precise, method uses a frequency reference placed on one track during record as the speed reference for the phase-lock servo during reproduce. Tape servo generates a reproduce speed that is virtually identical to the record speed.

Tach-servo and tape-servo systems are switch selectable on Hewlett-Packard's ITRs.

### Characteristics Explained

**Flutter:** Short-term tape speed variation. Produces time base perturbations in Direct electronics and noise in FM.

**Flutter compensation:** Method, in FM, of reducing noise caused by flutter. Compensation requires one data channel to record zero input signal. In reproduce, output noise on this channel is subtracted electronically from all other FM channels.

**Flutter compensation and tape servo:** Normally requires one dedicated FM and one dedicated Direct channel. With Hewlett-Packard ITRs the tape speed reference frequency and FM center frequency are the same, allowing flutter compensation to be combined with tape servo on a single FM channel. This capability saves an extra channel for recording data.

**Signal-to-noise ratio:** The ratio of maximum to minimum recordable amplitude expressed as a voltage ratio in dB. Basically, it represents the usable dynamic range.

**Tape degaussing:** A fully degaussed (erased) tape is essential to obtain the signal-to-noise ratio specification. Most ITRs do not contain "erase heads", because of the need to generate a sufficiently large field to fully degauss the tape. For this reason, tape is usually degaussed by external bulk degaussers. Direct electronics require degaussing before reusing a tape; FM electronics need not be degaussed if a 10 to 15 dB decrease in the signal-to-noise ratio is acceptable.

**Time base error:** Applies only to tape servo operation. Indicates the time difference between events in record and reproduce, assuming continuous phase-lock operation. This figure represents a short-term specification, because drop outs, etc., may cause momentary loss of phase lock.

**Tape selection:** It is recommended that instrumentation tape (such as 3M 890) always be used. Use of other types of tape may adversely affect head wear, signal-to-noise ratio, etc.

# RECORDERS & PRINTERS

Instrumentation tape recorders and degausser

Models 3964A, 3968A, and 13064A degausser

289



- Continuing savings by recording on 1/4-inch tape
- Choice of 4 or 8-channel recorders
- Selection of FM or Direct electronics

- Six tape speeds, including 15/32 ips
- Remote control (TTL or optional HP-IB)
- Switch selection of tach or tape servo

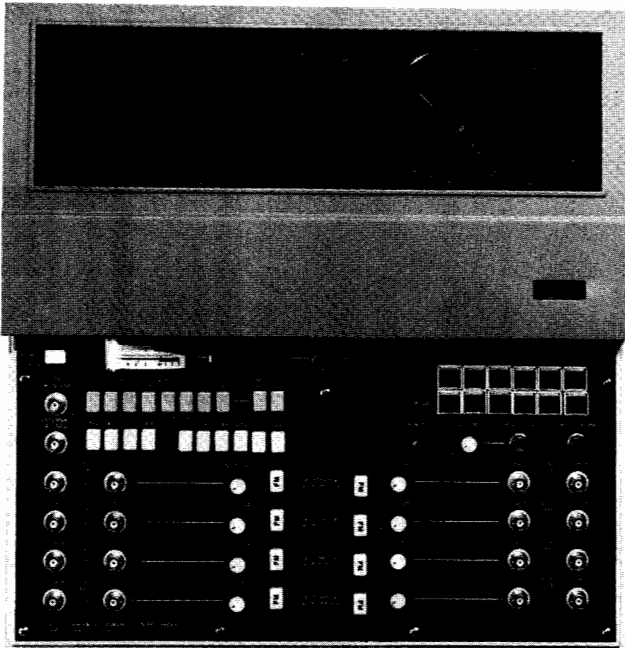

3968A

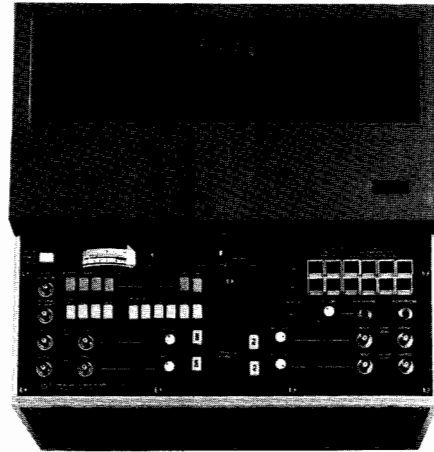

3964A

The 4-channel 3964A and 8-channel 3968A are quality instrumentation tape recorders (ITRs) that provide cost-saving operation by using 1/4-inch tape for a wide variety of recordings. Medical versions of the 3964A and 3968A (Options 009 and 010) are available. These versions include a UL 544 medical listing; making them useful in hospitals, medical offices, and research facilities.

The 13064A bulk tape degausser erases a complete roll of tape cleanly in seconds. A thoroughly clean tape is necessary to obtain maximum signal-to-noise ratio.

Both the 3964A and the 3968A are precision-built ITRs with features that cut costs; enhance the usefulness of the units; and simplify recording tasks in laboratory, medical, production, and field use. These features include:

**Cost-saving 1/4-inch tape:** Provides continuing savings for the life of the recorder. By using 1/4-inch tape, rather than 1/2-inch tape, users can save over 50% on tape costs.

**AC/DC callibrator:** Provides an internal voltage source that simplifies the set up of input and output levels for each data channel. Six voltages, AC or  $\pm$  DC, can be pushbutton selected, applied, and monitored to check out each channel. In addition, there is an external connector to allow the use of scopes or other monitoring devices.

**Tach or tape servo control:** Allows tape speed to be controlled by switch selection of tachometer (tach) servo or tape servo. Tach servo controls the capstan rotation speed; tape servo controls the tape speed by directly monitoring a frequency recorded on the tape. For minimum timing error between record and reproduce, tape servo is used. For less precise applications and to maximize the number of data channels, tach servo is used.

**Flutter compensation:** Improves the signal-to-noise ratio in FM by up to 12 dB in a vibrating environment. When switched on, flutter-generated noise introduced during record and reproduce is subtracted from all FM data channels during reproduce to improve performance. One FM channel is used for flutter compensation; this same channel can also be used for tape servo control, saving a data channel for recording when both flutter compensation and tape servo are required.

**Voice capability:** Provides voice annotation capability on the 4th channel of the 3964A or the 8th channel of the 3968A, using the press-to-talk microphone. The voice channel accepts data only, voice only, or data with a voice interrupt. Microphone, speaker, and headphone jack are provided with either recorder.

**FM electronics-to-electronics (e-e) mode:** Transfers the input signal automatically to output, bypassing the record/reproduce heads. This occurs when tape is below record/reproduce speed or in Fast Forward, Rewind, or Stop mode. E-E allows the unit to be set and calibrated without using tape.

## 3964A & 3968A Specifications

### Transport specifications

**Tape width:** 1/4 inch (6.3 mm)

**Reel size:** Standard 7-inch (18 cm) plastic reel, totally enclosed by reel cover

### Heads:

**3964A:** One 4-track record and one 4-track reproduce

**3968A:** One 8-track record and one 8-track reproduce

Tape Speed* (ips)	15	7 1/2	3 3/4	1 7/8	1 1/16	1 1/32
Flutter (% p-p)	0.35	0.35	0.40	0.50	0.70	1.5
Time base error (s)*	$\pm 4$	$\pm 5$	$\pm 7.5$	$\pm 15$	$\pm 25$	$\pm 50$
Start time (seconds) (typical)	3	1.5	0.9	0.5	0.5	0.5
Tape speed accuracy (s)	0.2	0.2	0.2	0.2	0.2	0.2

\*Tape servo operation

**Tape motion controls:** Pushbutton selectable Forward Record, Reverse Record, Forward Play, Reverse Play, Fast Forward, Fast Rewind, and Stop

**EOT sensing:** Tape drive stops automatically at the end of tape (EOT)

**Reel revolution counter:** 4-digit counter with pushbutton reset

# RECORDERS & PRINTERS

## Instrumentation tape recorders & degausser

Models 3964A, 3968A, 13064A degausser (cont.)

### FM Record/Reproduce Specifications<sup>1</sup>

Tape Speed	Passband <sup>2</sup> (Hz)	Signal-to-noise <sup>3</sup> Ratio	
		3964A	3968A
15	DC-5000	48	46
7½	DC-2500	48	46
3¾	DC-1250	48	46
1⅞	DC-625	46	46
15/16	DC-312	44	44
15/32	DC-156	40	40

- Based on use of 3M-890 tape or equivalent
- Frequency response over passband is ± 1.0 dB referenced to 10% of upper band edge frequency
- Signal measured with carrier deviation ± 40% of upper passband without flutter compensation. Output filters of reproduce amplifiers selected for constant amplitude response. May also be selected for linear phase (transient) response

**Flutter compensation:** Can improve signal-to-noise by up to 4 dB under static conditions and as much as 12 dB under conditions of vibration. Selected by rear panel switch.

**Distortion:** Total harmonic distortion < 1.2% @ 15 to 1½ ips, < 2% @ 15/16 to 15/32 ips.

**Linearity:** ± 1.0% of peak-to-peak output for best straight line through zero at ± 40% deviation.

**DC drift:** ± 0.1% (max) of full scale output per °C.

**Input level:** 1 V to 30 V (peak-to-peak); continuously adjustable.

**Input impedance:** 100 kΩ nominal, shunted by < 100 pF single-ended.

**Output level:** 1 to 5 V (peak-to-peak); continuously adjustable.

**Load impedance:** Minimum load impedance 660 ohms.

### Direct Record/Reproduce Specifications<sup>1</sup>

Tape Speed (ips)	Passband (± 3 dB) <sup>2</sup>		S/N Ratio (dB) <sup>3</sup>	
	3964A	3968A	3964A	3968A
15	70-64000 Hz	500-64000 Hz	38	36
7½	50-32000 Hz	250-32000 Hz	38	36
3¾	50-16000 Hz	100-16000 Hz	38	36
1⅞	50-8000 Hz	100-8000 Hz	38	36
15/16	50-4000 Hz	100-4000 Hz	38	35
15/32	50-2010 Hz	100-2000 Hz	37	35

- Based on the use of 3M-890 tape or equivalent
- Reference to 10% of upper band edge
- Referenced to a 500 Hz sine wave with a maximum of 1% third harmonic distortion when reproduced at 3½ ips

**Input level:** 1 V to 30 V (p-p); continuously adjustable

**Input impedance:** 100 kΩ nominal, single-ended

**Output level:** 0.5 to 5 V (p-p); continuously adjustable

**Load impedance:** Minimum load impedance 600 ohms

**Calibrator:** Internal signal source, peak AC and ± DC levels of 0, 1.0, 1.414, 2.5, 5.0, and 10.0 volts ± 2%

**Meter modes:** Peak AC or DC, input or output

### General Specifications

#### Size:

**3964A:** 400 H x 427 W x 256 mm D (15.7 x 16.8 x 10.1 in.)

**3968A:** 445 H x 427 W x 256 mm D (17.5 x 16.8 x 10.1 in.)

**Weight:** 3964A: 29.5 kg (65 lb). 3968A: 31.3 kg (69 lb)

**Power requirements:** 100, 120, 220, or 240 V, +5%, -10%, 48-440 Hz; 110 W average (except Opt 009, 010, 48-66 Hz)

**Temperature:** storage, -40°C to 75°C; operating, 0°C to 55°C; tape limit, 10°C to 40°C

**Altitude:** Storage, 15240 m (50000 ft); operating, 4500 m (15000 ft)

**Humidity:** The system, excluding tape limitations, will operate from 10% to 95% RH (25°C to 40°C), non-condensing

**Shock:** 30 g maximum (11 ms) non-operating

**Mounting:** Rack mounting kit for equipment racks, 19-inch

### 13064A Tape Degausser Specifications



13064A

**Tape size:** ¼-inch (6.33 mm) tape on reels up to 10½ inch (266 mm) in diameter

**Erasure:** 60 dB minimum

**Duty Cycle:** one minute ON - three minutes OFF

**Size:** 67 H x 133 W x 171 mm D (2.6 x 5.25 x 6.75 in.)

**Weight:** approximately 4.3 kg (9½ lb)

**Power requirements:** 115 V AC ± 10%, 50-60 Hz (Opt 001); 230 V AC ± 10%, 50-60 Hz (Opt 002)

### 3964A, 3968A Options

Option no.	Description	Price
001	Standard FM data card	\$360
030	Medical FM data card (must order Option 009 or 010)	360
Direct record/reproduce data cards. Option provides one data card. Specify one option for each channel:		
002	Standard data card	330
031	Medical data card (must order Option 009 or 010)	330
Medical or dental version with UL 544 listing and rear BNC connectors. Not compatible with options 001, 002, or 003.		
009	Medical version with white paint	375
010	Medical version with standard paint	325

### Other Options

Specify no more than one of each option per mainframe		
003	Rear panel with BNC input/output connectors for each channel.	80
004	Locking knobs (screwdriver adjustable)	35
005	Metric speed annotation on pushbuttons	N/C
007	HP-IB remote control of speeds and mode	\$350
024	Loop adapter (accommodates 5 to 30-ft loop)	625
026	Slides for 19 in. racks	100
027	Slides for HP cabinets	140
041	IRIG servo reference frequency	150
070	Overlap. For two units. Provides automatic play/record commands for 2nd recorder when 1st unit tape is low	225

### Ordering Information

Model	Description	Price
3964A	4-channel instrumentation tape recorder	\$5850
3968A	8-channel instrumentation tape recorder	7675
13064A	Tape degausser (specify Option 001 for 115 V ac or 002 for 230V ac)	125
13107A	Transit case for 3964A	375
13106A	Transit case for 3968A	375

# RECORDERS & PRINTERS

Alphanumeric, 20 column thermal printer

Model 5150A

291



- Silent operation
- Optional scanner and clock
- Alphanumeric

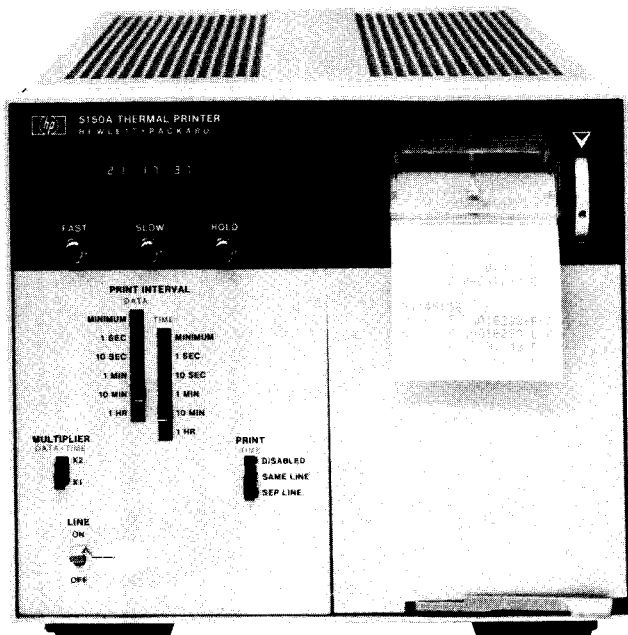

DESIGNED FOR  
**HP-IB**  
SYSTEMS

5150A Opt 004

## General

The 5150A Thermal Printer is a versatile instrumentation printer designed to accept and record up to 20 columns of data from most HP digital instruments. Because it uses a thermal printing technique, it is extraordinarily quiet while in operation. Two input interfaces are available (one must be specified with the order) to allow data input from the HP Interface Bus (use Option 001) or from BCD-coded sources (use Option 002). Other options which add to the flexibility of this printer are the Option 003 Scanner, which can sequentially address and interrogate up to 13 instruments on the HP-IB, and the Option 004 Clock, which can be used with either the HP-IB or BCD Interfaces.

## Opt 001 HP-IB Interface

With Option 001 installed, the printer can accept up to 20 ASCII characters per line via the HP-IB. Inputs are interpreted according to the 64 member upper-case ASCII character set. With this interface, the printer can also serve as an "addressable listener" in a controller-based HP-IB system. HP-IB cable not supplied.

## Opt 002 BCD Interface

With Option 002 installed, the printer will accept 10 columns of TTL-level BCD data. Two Options 002's may be installed for 20-column print-out from one or two sources. The standard 16-member character set consists of 0 through 9, +, -, V, A, R, and [blank]. Special characters set which draw from the 64-character upper-case ASCII set may also be specified.

## Opt 003 Scanner

With both Options 001 and 003 installed, the printers can log data from up to 13 instruments on the HP-IB. Operation is asynchronous; that is, the printer will address the lowest address instrument, wait for data, print, then go to the next instrument.

## Opt 004 Clock

Used with either the HP-IB Interface or BCD Interface, this option gives the printer two additional capabilities: it can control the elapsed time between successive data printouts, and it can print the time of day immediately following each data printout. When used with the Option 003 Scanner, the clock controls the elapsed time between the initiation of successive scans.

## Specifications

**Character printer:** 5 x 7 dot matrix.

**Printing rate:** 3 lines per second.

**Line spacing:** approximately 2.5 lines per cm. (6 lines per inch).

**Paper advance mechanism:** direct drive, stepping motor.

**Paper:** thermal sensitive, in rolls (one roll supplied).

**Operating environment:** 0°C to 50°C temperature; 95% relative humidity.

**Power:** 100, 120, 220, or 240 volts, 48 to 440 Hz (50 or 60 Hz only for Opt 004), 100 VA.

**Dimensions:** half-rack module, 178 mm H x 216 mm W x 356 mm D (7" x 8½" x 14¼").

**Weight:** approx. 7 kg (16 lb) (5150A +1 option).

## HP-IB Interface (Opt 001)

**Columns:** 20.

**Printed character set:** 64 ASCII characters (columns 2, 3, 4, and 5 of ANSI X3.4-1968, except "1" in column 5, row 14).

**Input Logic Levels:** TTL (low <0.4 V, high >2.5 V).

**Data format:** byte-serial with storage, compatible with HP-IB.

**Inhibit (output):** holds NRFD line of HP Interface Bus low following receipt of either CR or LF (selectable) until print is completed. This interval is approx. 250 ms minimum, or the duration of Option 004 Clock data print interval with clock in Hold mode.

## BCD Interface (Opt 002)

**Columns:** 10 (20 columns with two Options 002's installed).

**Character set:** 0 through 9, +, -, V, A, R, and [blank].

**Input logic levels:** TTL (low <0.4 V, high >2.5 V).

**Data format:** parallel BCD (8421); switch selects + or - true logic.

**Print command:** pos. or neg. TTL transition; 2 kΩ input impedance.

**Inhibit (output):** + or -, same levels as above; remains at true level until print is completed (approx. 250 ms minimum) or during Option 004 Clock data print interval with clock in Hold mode.

## Scanner (Opt 003)

**Instruments scanned:** 1 to 13.

**Cycle time of scan:** limited by the slowest of (a) response of instruments scanned, (b) 3 samples per second, or (c) Data Print Interval setting on Option 004 Clock.

**Compatibility:** HP Interface Bus (utilizes ASCII code).

**Identifier:** labels data line of each instrument with letters A-M.

**Protect feature:** bypasses non-responding instrument after 3 sec.

## Clock (Opt 004)

**Data print interval:** selectable by front panel switches: minimum, 1 s, 2 s, 10 s, 20 s, 1 min, 2 min, 10 min, 20 min, 1 hr, 2 hrs. Print interval will be that of input device if it is slower than the selected interval.

**Time print interval:** selectable by front panel switch, same intervals as above (intervals shorter than data interval prevented).

**Time print format:** selectable by front panel switch: disabled, same as data, or separate line from data.

**Display:** six-digit, seven-segment LED display of hours, minutes, seconds (00:00:00 to 23:59:59); settable via front panel switches.

**Time base:** line frequency (50 or 60 Hz, selectable by jumper).

## Operating Supplies/Accessories

	Price
9281-0401 6-Roll box of paper, 76 meters (250 feet) each	\$15
10533A BCD Interface Cable for 5300A	\$245
10631A Interface Bus Cable, 1 meter	\$70
10631B Interface Bus Cable, 2 meters	\$75
10631C Interface Bus Cable, 4 meters	\$85
10631D Interface Bus Cable, .5 meter	\$70

## Options

001: HP-IB Interface	add \$300
002: BCD Interface	add \$135
003: Scanner	add \$270
004: Clock	add \$390
005: BCD Interface Cable (562A-16C)	add \$95
910: Extra manual	add \$22.50

5150A Thermal Printer

\$1125



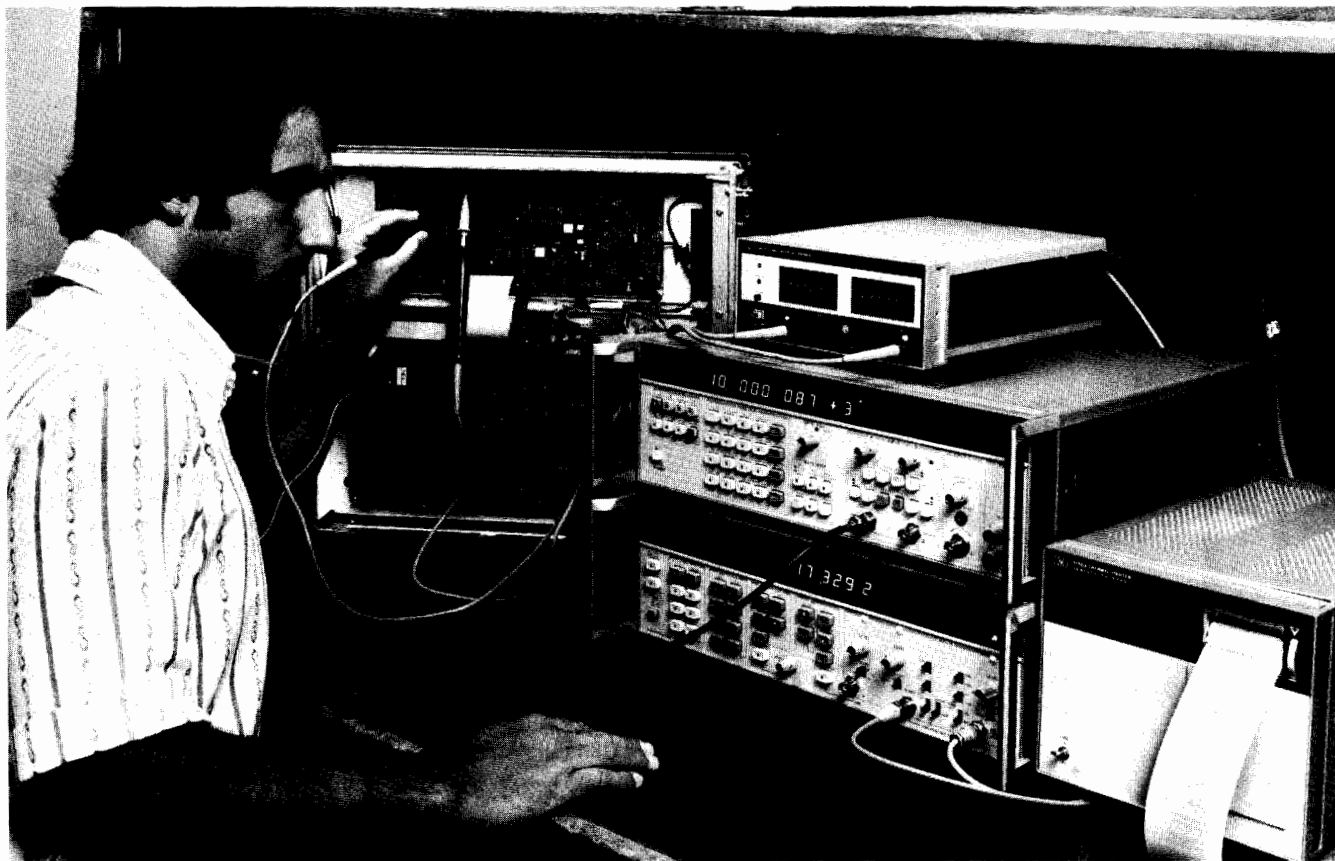

## Introduction

The digital electronic frequency counter has come a long way since the first versions appeared over two decades ago. Once the luxury of large meterology labs and some crystal manufacturers, the frequency counter is now common-place in laboratories, on production lines, as a service tool and in automatic instrumentation systems. Moreover, counters have become increasingly more versatile and more powerful in the measurements they perform, thereby finding much wider applications. When Hewlett-Packard introduced the 524A in 1952 it was considered a milestone; the counter could measure frequencies up to 10 MHz, or the time between two electrical events to a resolution of 100 ns. Twenty-seven years later, HP's product lines feature counters that can measure the frequency of a 70 mV signal at 40 GHz completely automatically, or can measure time intervals to 20 ps, the same time it takes light to travel 6 mm.

### Basic Counter Measurements

The basic measurements which counters are capable of performing are described in this section.

#### Frequency

This fundamental measurement is performed by totalizing the number of input cycles or events for a precisely known period of time. The total count that results is proportional to the unknown frequency, and logic circuits internal to the counter position the

decimal point such that the display directly indicates the input frequency. The time reference is usually derived from a precision quartz oscillator internal to the counter.

Using this basic technique allows measurements to 500 MHz to be made. Several methods are available, however, to extend this frequency range to 26.5 GHz and more. These are described in more detail below.

#### Period

This inverse of frequency capability is sometimes offered to provide the user with high resolution, low frequency measurements. In digital systems a period measurement represents the average bit to bit time of the input signal.

#### Totalize

The measurement is similar to frequency except that the user now controls the time over which the measurement takes place. With digital systems becoming more prevalent, this fundamental measurement assumes considerable importance. The HP 5345A, with its ability to totalize at a 500 megabit rate, represents the state of the art at this time.

#### Ratio

The ratio between two input frequencies is a measurement that is also offered by some counters. The major application for ratio is measurement of harmonically related signals.

#### Scaling

Some counters offer the capability of providing a digital output signal whose frequen-

cy is a scaled or divided version of the input frequency.

### Time Interval

The measurement of the time between two events or the time between two points on a common event, commonly referred to as time interval, is of major importance and is used in a wide variety of applications.

The  $\pm 20$  pS single shot resolution of the 5370A represents today's state of the art. This unit utilizes a new concept of phase locked vernier interpolation which eliminates quantization errors. HP also pioneered the concept of time interval averaging, whereby for repetitive inputs substantial improvement in resolution over the single shot measurement can be obtained.

Time interval averaging is offered in seven HP counters (5370A, 5345A, 5335A, 5328A, 5316A, 5315A/B and 5308A). Also available for precision time interval measurements is the 5363B Time Interval Probes box usable with any time interval counter. The 5363B has a wide dynamic range as well as a built in calibration feature and digitally set trigger voltages to eliminate the major uncertainties associated with TI measurements. The 5363B is fully programmable via the HP Interface Bus for systems applications.

All manner of time interval measurements are discussed in detail in Application Note AN 200-3 "Precision Time Interval Measurements Using an Electronic Counter" available on request from any Hewlett-Packard sales office.



## Application Note 200: Fundamentals of the Electronic Counters

This forty-four page application note describes in detail the measurements mentioned above. In addition, the key considerations in making frequency and time measurements, plus the major characteristics required of a counter for certain applications are also described. For those readers who require more than the brief resumé above, this application note is available on request at any Hewlett-Packard sales office.

The contents of AN 200 are as follows:

- Introduction
- Fundamentals of the Conventional Counters
- Functions
- Input Considerations
- Time Base Oscillator Considerations
- Main Gate Requirements
- Sources of Measurement Error
- Reciprocal Counters
- Time Interval Measurement
- Input Considerations
- Trigger Level
- Increasing Accuracy and Resolution
- Use of Time Interval Probes
- Automatic Microwave Frequency Counters
- Down-Conversion Techniques
- Comparison of Performance of the Down-Conversion Techniques

## The Major Types of Electronic Counters

While counters can potentially offer all the measurement capabilities described above, they essentially fall into three classes: frequency counters; universal counters; and microwave counters. These are described below.

### Frequency counters

These counters offer the basic capability of frequency measurement and in addition sometimes provide some or all of the other measurements described above except time interval. HP has a wide range of counters that fall into this class including: a) the 5380 low cost bench series, a family of three counters featuring 80 MHz—7 digit, 225 MHz—8 digit and 520 MHz—9 digit instruments; b) the 5300 portable, battery operated snap-on series with the 5303B snap-on covering 525 MHz and the 5305B 1300 MHz counter.

**Table 1. Frequency Counters Summary**

Model No.	Frequency Range	Number of Digits	Time Base	Other Functions*
5300/5301A	10 MHz	6	$3 \times 10^{-7}$	T
5381A	80 MHz	7	$3 \times 10^{-7}$	
5382A	225 MHz	8	$3 \times 10^{-7}$	
5383A	520 MHz	9	$3 \times 10^{-7}$	
5300/5303B	525 MHz	8	$3 \times 10^{-7}$	
5300/5305B	1300 MHz	8	$3 \times 10^{-7}$	
5340A	23000 MHz	8	$3 \times 10^{-7}$	
5342A	24000 MHz	11	$1 \times 10^{-7}$	A, Fo, Ao
5343A	26500 MHz	11	$1 \times 10^{-7}$	Fo

\* See legend next page

**Table 2. Universal Counter Summary**

Model No.	Frequency Range	Time Interval Resolution		Time Base	Other Functions*
		Single Shot	Averaging		
5300A/5304A	10 MHz	100 ns	—	$3 \times 10^{-7}$ per Month	MPA, T, R
5300/5302A	50 MHz	100 ns	—	$3 \times 10^{-7}$ per Month	P, MPA, T, R
5300A/5308A	75 MHz	100 ns	100 ps	$3 \times 10^{-7}$ per Month	P, MPA, T, R
5314A	100 MHz	100 ns	—	$3 \times 10^{-7}$ per Month	P, MPA, T, R
5316A/5315A/B	†100 MHz	100 ns	10 ps	$3 \times 10^{-7}$ per Month	P, MPA, T, R, E
5328A	†100 MHz	100 ns or 10 ns	10 ps	$3 \times 10^{-7}$ per Month	P, MPA, T, R, E, V**
5370A	100 MHz	±20 ps	1 ps	$3 \times 10^{-7}$ per Month	P, MPA, E
5335A	†200 MHz	2 ns	100 ps	$3 \times 10^{-7}$ per Month	P, MPA, T, R, E, Fo, V**
5345A	500 MHz	2 ns	2 ps	$5 \times 10^{-10}$ per Day	P, MPA, T, R

\* See legend next page

\*\* Optional function

† Higher frequency optional

### Universal counters

These instruments provide time interval capability in addition to the other measurements provided by the frequency counter.

The 5314A is a perfect example of such an instrument featuring 100 MHz frequency, 100 ns time interval plus period, ratio and totalize. The 5315A/B and 5316A provide all these functions plus time interval delay, time interval average and reciprocal frequency measurements. The 5300 family of snap-on modules starts with the frequency, period, time interval, ratio, and totalize capabilities of the 5302A. The 5304 adds time interval delay to this. Another member of the same family, the 5308A offers time interval averaging, totalizing (with electronic start and stop) and frequency to 75 MHz. The 5328A (100 MHz) and 5328A Opt 031 (1300 MHz) are high performance rack mount instruments programmable (Opt 011) via the HP Interface Bus. Time interval averaging gives resolution to 10 ps on repetitive signals and Opt 040 also has 10 ns one shot resolution. The 5335A takes the basic capabilities of the 5328A and expands on them by adding automatic triggering, reciprocal frequency, pulse width, rise and fall time, slew rate, duty cycle, phase, and inverse time interval measurements. Included are math capabilities such as offset, normalize, and scale, plus statistics. The 5345A offers a 500 MHz bandwidth, with totalizing, ratio and period capability to this speed (500 MHz), plus 2 ns single shot time interval and 2 ps time interval averaging. This extremely powerful instrument features plug-in flexibility (see page 291), and a reciprocal frequency measurement mode (see next page).

Finally, the 5370A offers the ultimate in time interval measurement resolution with 20 ps single shot and 1 ps time interval averaging!

### Microwave counters

These instruments provide high accuracy frequency measurements into the microwave spectrum. The 5342A harmonic heterodyne microwave counter automatically measures frequencies to 24 GHz under microprocessor control, and features 1 Hz resolution and wideband FM tolerance. The keyboard controls allow the user to program his own frequency offsets. The amplitude option will simultaneously display input frequency and input level for readily monitoring microwave devices and equipment. The 5343A extends this automatic frequency measurement to 26.5 GHz and increases the sensitivity. The 5354A is a 4 GHz heterodyne converter that plugs into the 5345A mainframe and provides extremely high resolution automatic measurements for CW and pulsed RF down to pulse widths of 20 ns. The 5355A is an automatic frequency converter plug-in for the 5345A mainframe. Together with the 5356A 18 GHz converter head, 5356B 26.5 GHz converter head, or the 5356C 40 GHz converter head, this plug-in provides a complete microwave counter solution for pulsed RF or CW microwave applications. Microprocessor control and a front panel keyboard provide user selectable offsets, diagnostic routines, automatic calibration and other user conveniences for the first time.

The 5340A automatic transfer oscillator counter can measure frequencies from 10 Hz to 23 GHz via a single input at up to -35 dBm sensitivity.

Application note 200-1 covers the fundamentals of microwave frequency counters and compares the various techniques. Application Note 291-1 discusses the use of the 5355/56 in a number of pulsed and CW microwave frequency measurement applications.

**Table 3. Microwave Counter Summary**

Model No.	Frequency Range	Technique	Time Base	Sensitivity	Number of Digits
5354A*	4 GHz	Auto Heterodyne	$5 \times 10^{-9}$ per Day	-10 dBm	11
5355A*	40 GHz	Auto Harm Heterodyne	$5 \times 10^{-9}$ per Day	-20 dBm	11
5255A**	to 18 GHz	Manual Heterodyne	$3 \times 10^{-9}$ per Day	-13 dBm	8
5257A**	18 GHz	Manual Transfer Osc.	$3 \times 10^{-9}$ per Day	-7 dBm	8
5340A	23 GHz	Auto Transfer Osc.	$3 \times 10^{-7}$ per Month	-35 dBm	8
5342A	24 GHz	Auto Harm Heterodyne	$1 \times 10^{-7}$ per Month	-25 dBm	11
5343A	26.5 GHz	Auto Harm Heterodyne	$1 \times 10^{-7}$ per Month	-33 dBm	11

\* Plug-in to 5345A Counter

\*\* Plug-in to 5245 Series or 5345A Counter with adapter



# ELECTRONIC COUNTERS

General information (cont.)

## Reciprocal Counting Technique

The extremely powerful reciprocal counting technique is employed in several counters available from Hewlett-Packard. The distinction between this and the conventional technique is that the latter provides 1 Hz resolution in one second, whereas the resolution of the reciprocal technique is proportional to the frequency of the internal counted clock. The five instruments available are summarized in Table 4 below. Note that the 5345A is a plug-in instrument and hence the high mainframe resolving power offered applies to any of the compatible plug-ins. It has pulsed RF measurement capability via an external gate mode. In addition the 5345A includes a unique frequency averaging mode that allows high resolution measurements on repetitive pulses even if pulse width is 50 nsecs. The 5370A extends the reciprocal technique by means of phase locked vernier interpolation to give the ultimate in resolution. Fre-

quency measurements to better than 10 digits may be made in 1 sec.

## HP Interface Bus

The more recently introduced counters (and other HP digital instruments) have a digital input/output structure which is compatible with the interface bus which is Hewlett-Packard's implementation of the IEEE Digital Interface Standard 488-1975. HP Desktop Calculators in the 9825/30 Series and Minicomputers in the HP 2100/21MX Series are also compatible with the in-

terface bus, making it possible to expand the capabilities of the individual instruments even into areas of real time data reduction and control. Interfacing is available for interconnecting up to 14 compatible devices on one I/O slot. The HP 59310B Computer Interface serves for minicomputers and the HP 98034A or 59405A HP-IB Calculator Interface interconnects up to 14 devices using one I/O slot and one ROM. At this time, compatible instruments are the 5345A, 5370A, 5340A, 5342A, 5343A, 5335A, 5328A, 5316A, and 5312A (for 5300B system).

**Table 4. Reciprocal Frequency Counters**

Model No.	Frequency Range	Measurement Resolution	Number of Digits	Time Base	Sensitivity
5300A/5307A	2 MHz	$3 \times 10^{-5}$	6	$3 \times 10^{-1}$ per Month	10 mV rms
5316A/5315A/B	100 MHz	$1 \times 10^{-7}$	8	$3 \times 10^{-1}$ per Month	10 mV rms
5370A	100 MHz	$1 \times 10^{-10}$	16	$3 \times 10^{-1}$ per Month	20 mV rms
5335A	200 MHz	$2 \times 10^{-9}$	12	$3 \times 10^{-1}$ per Month	25 mV rms
5345A	500 MHz	$2 \times 10^{-9}$	11	$5 \times 10^{-10}$ per Day	20 mV rms

**Table 5. Counter Selection Guide**

Classification	Description	Frequency	Functions*	Time Base	Price	Page
5381A, 5382A & 5383A Low Cost	Traditional HP quality and reliability at low prices.	To 520 MHz	F	$3 \times 10^{-4}$ /Mo. Optional $1 \times 10^{-1}$ /Mo.	From \$375	323
5314A Low Cost Universal Portable	Traditional HP quality and reliability at low price	100 MHz	F, P, MPA, TI, T, R	$3 \times 10^{-1}$ /mo. Optional $1 \times 10^{-1}$ /mo.	From \$425	317
5315A/B & 5316A Economic Reciprocal Portable	A high performance micro-processor controlled universal counter with sub nanosecond time interval averaging capability and optional high frequency coverage. 5315B offers rack/stack package and improved RFI.	To 1000 MHz	F, P, MPA, TI TI AVG, T, R, E	$3 \times 10^{-1}$ /mo. Optional $1 \times 10^{-1}$ /mo.	From \$875	314
5300 Series Economic Portable	Select from 8 plug-ons to meet present needs. Move up in functions or frequency range when needed. Battery pack, D to A converter and HP interface Bus output module extend versatility.	To 1300 MHz	F, P, MPA, TI TI AVG, T, R V, E	$3 \times 10^{-1}$ /Mo. Optional $1 \times 10^{-1}$ /Mo.	From \$800	318
5328A Universal Counter	A high performance universal counter with sub nanosecond time interval averaging capability that can include high frequency measurement, DVM or HP Interface Bus options.	To 1300 MHz	F, P, MPA, TI TI AVG, T, R, V, E	$3 \times 10^{-1}$ /Mo. Optional $1.5 \times 10^{-8}$ /Mo.	From \$1450	310
5335A Universal Counter	A new high performance Universal counter with auto trigger, pulse characterization, phase measurements, math, statistics, and HP-IB standard. Higher frequency & DVM optional.	To 1300 MHz	F, P, MPA, TI, TI AVG T, R, V, E, Fo	$3 \times 10^{-1}$ per Mo. Optional $1.5 \times 10^{-8}$ per Mo.	From \$2950	307
5245 Series General Purpose Plug-in Counters	A mainframe and 3 plug-ins provide unmatched versatility. Plug-ins provide up to 18 GHz frequency capabilities.	To 18 GHz	F, P, MPA, T, R	$1 \times 10^{-1}$ /Mo. ( $< 3 \times 10^{-6}$ /Day)	From \$6200	324
5345 Series High Performance Plug-in Counters	A series of high performance mainframe and plug-ins, providing 500 MHz direct count, 2 nsec time interval, and up to 40 GHz automatic pulsed RF measurements.	To 26.5 GHz	F, P, MPA, TI, TI AVG, T, R E	$1.5 \times 10^{-8}$ /Mo. ( $< 5 \times 10^{-10}$ /Day)	From \$5200	295
5340, 5342A, 5343A Automatic Counters	Broad band, high sensitivity, microwave frequency measurements 10 Hz-23 GHz; 10 Hz-24 GHz; 10 Hz-26.5 GHz.	To 26.5 GHz	F, Fo, A, Ao	Optional to $1.5 \times 10^{-4}$ /Mo. ( $< 5 \times 10^{-6}$ /Day)	From \$4600	300
5370A Universal Time Interval Counter	Highest resolution frequency measurements and time interval measurements to $\pm 20$ ps resolution	100 MHz	F, P, MPA, TI, TI AVG	$1.5 \times 10^{-1}$ /mo.	\$7500	304

\*Legend for Functions

F = Frequency	A = Amplitude	V = Voltage
P = Period	TI AVG = Time Interval Average	E = Electronically Controlled Totalize
MPA = Multiple Period Average	T = Totalize	Fo = Frequency Offsets
TI = Time Interval	R = Ratio	Ao = Amplitude Offsets

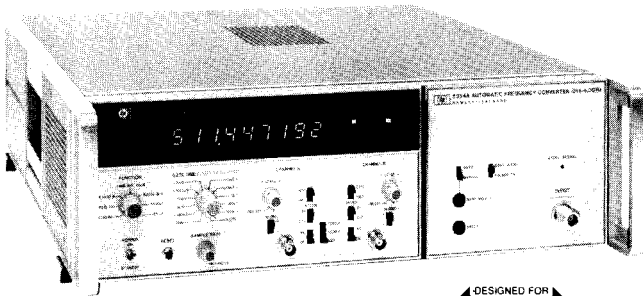

The 5345A Electronic Counter represents the most advanced general purpose instrument in the Hewlett-Packard Counter Product line. Utilizing state of the art monolithic bipolar integrated circuit technology especially designed and manufactured at Hewlett-Packard, this instrument provides unsurpassed power, versatility and flexibility in frequency and time measurements.

### Major Mainframe Features

**Frequency:** direct from DC to 500 MHz—Reciprocal technique provides high measurement resolution.

**Time Interval:** resolution of 2 ns single shot.

**Averaging:** new modulated clock technique gives true averages under all conditions. T.I. resolution extended to 2 ps. Frequency averaging improves RF pulse measurements similarly.

**Totalize:** to 500 megabit rate on both A and B inputs. A ± B functions also available.

**Ratio:** from DC to 500 MHz on both inputs.

**Fully programmable:** provides great flexibility when used with calculators and computers.

**Plug-in versatility:** three plug-ins presently available. In addition the 10590A plug-in adapter allows most existing 5245 plug-ins to be used.

### Signal Input Circuits

**Signal conditioning:** fully optimized front end includes switchable

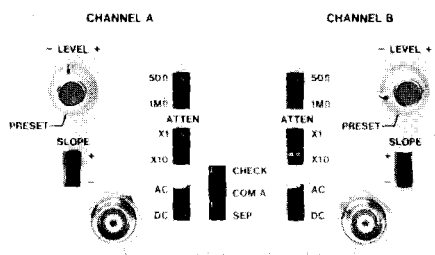

Figure 1. Input Switches

50Ω/1 MΩ input impedances, DC/AC coupling, and slope selection that assures triggering on any waveform.

**Sensitivity, dynamic range:** highly sensitive wideband amplifiers

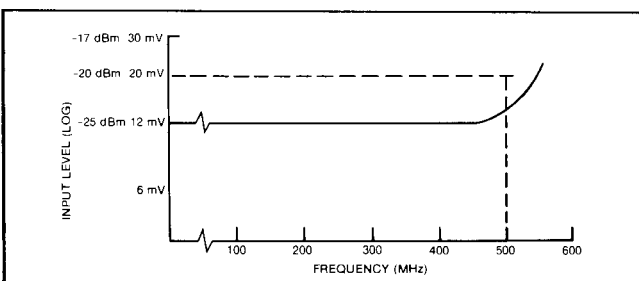

Figure 2. Typical Amplifier Sensitivity

- 500 MHz Direct Counting
- 20 mV Sensitivity DC to 500 MHz
- 2 ns Single Shot T.I. Resolution
- Averaging to 2 ps resolution
- Pulsed RF and Microwave Measurements
- Programmable for systems applications via HP-IB

assure measurements on even the lowest level sinusoidal and digital signals. The inputs also feature an extremely wide linear dynamic range of -2 to +5 V DC that greatly increases measurement versatility, especially on digital input signals.

### Frequency Measurements

**Reciprocal capability:** one of the advantages of measuring period

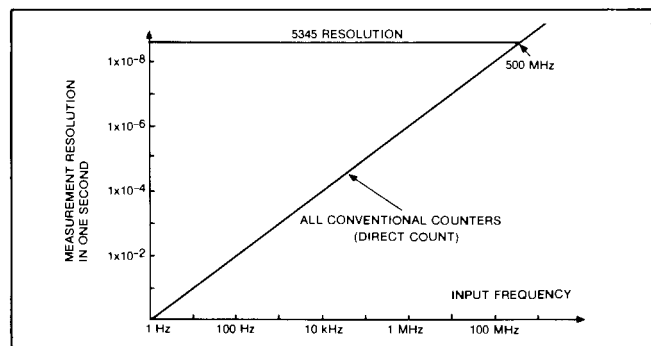

Figure 3. Measurement Resolution

and computing the frequency is that measurement resolution is independent of input frequency and at the maximum to which the instrument is capable of resolving. Thus for example, a 1 MHz input can be resolved to  $2 \times 10^{-9}$  (=0.002 Hz) in one second, whereas the conventional counter provides 1 Hz resolution, some 500 times less.

### Measurement speed

Mode of Operation	Readings per Second
Normal Operation (Max sample rate)	10
Externally armed	500
Externally gated	500
Computer dump	9,000

The extremely high resolution obtained in one second can be traded for measurement speed. For example of 100 μs gate time provides a resolution of  $2 \times 10^{-5}$  yet the measurement can now be made 5000 times a second, thus making the 5345A an invaluable tool in high speed data acquisition systems.

**Ext. gated capability:** via the rear panel gate control input; this capability allows the operator to determine at what point in real time and for how long the measurement is to be made. This capability essentially replaces the front panel "sample rate" and "gate time" controls.

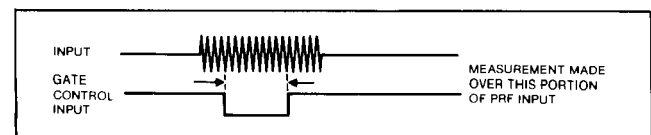

Figure 4. External Gate Control



The major application is in the measurement of pulsed RF signals.

**Frequency averaging:** the minimum pulse width for which the input frequency can be measured is 20 ns. The single shot measurement resolution is  $2 \times 10^{-9}$  divided by the GATE TIME. This resolution can be improved up to 1000 times by a unique mode of operation known as frequency averaging that is built into the mainframe. The only requirement for this mode is that the signal is repetitive.

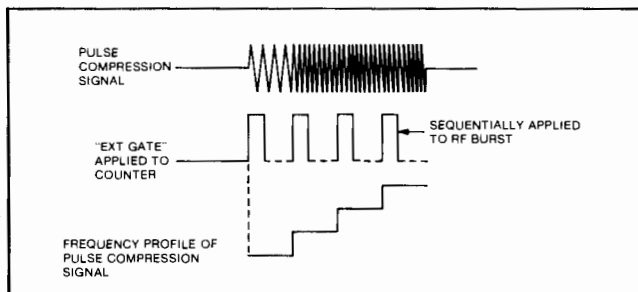

Figure 5. Frequency Averaging to Increase Resolution

In addition to greatly enhancing narrow pulse measurement capability, the frequency averaging mode also allows higher resolution on pulse profile measurements.

#### Time Interval

**Precision measurement:** the single shot time interval measurement resolution of the 5345A is 2 ns, which is the time it takes light to travel approximately 2 Ft—the 5345A is an extremely high resolving time measuring device.

**Trigger level:** quantitative high speed time interval measurements are provided by the 5345A since the user can simply determine where triggering occurs even on complex waveforms. The method of determination involves measuring the DC levels at which triggering occurs. These DC levels are available at rear panel BNC's.

The ability to determine trigger level, together with high sensitivity and wide dynamic range of the inputs greatly enhances the versatility and power of the 5345A in time interval measurements.

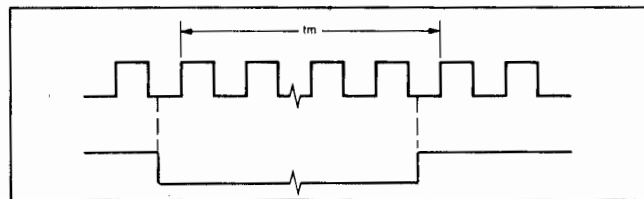

Figure 6. Using EXT GATE to Measure  $T_m$

**Ext. gate capability:** external gating adds even more versatility to the time interval measurements of the 5345A, as measurements such as that shown in figure (6) indicate.

**Time interval averaging:** for repetitive inputs a successive number of measurements may be automatically averaged by the 5345A, obtaining up to 1000 times improvement in resolution (2 ps). This averaging mode may be used irrespective of whether the instrument is in the conventional or ext. gate mode of operation.

#### Totalize

**High speed:** the 5345A has the ability to totalize to a 500 megabit

rate through either or both A and B inputs. Coupled with the high sensitivity and full signal conditioning of both channels, this capability enables measurements to be made on most modern digital systems.

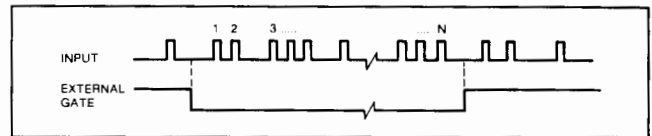

Figure 7. Selecting a Portion of a Pulse Train

**Ext. gate capability:** using the external gated mode allows the user to select only the desired portion of the input pulse train for measurement.

#### A ± B Modes

The A—B mode is used for comparison tests between high speed reference and test signals applied to the two mainframe inputs.

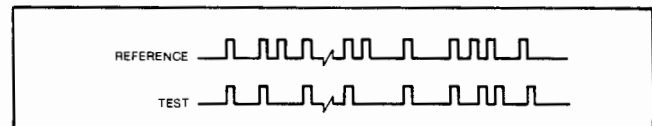

Figure 8. Comparison Measurements

Any difference between the total number of events accumulated in each channel is indicated by the 5345A display after the measurement is completed.

The primary application for the A + B mode is in the measurement of NRZ signals. By setting the "A" trigger slope to "+" and the B slope to "-" allows all transitions and hence bits of the NRZ signal to be counted. Thus 1 gigabit NRZ waveforms can be measured.

This mode of operation does not introduce any limitations—maximum input rate is 500 megabits on either channel and external gating may be used.

#### Ratio

This measurement represents the ratio of the number of events occurring through channel B divided by the number occurring through channel A. The major features are: a) that the measurement or comparison (similar to the A ± B totalize modes); and, b) the frequency or bit rate of either channel can vary from DC to 500 MHz. These features allow this measurement to be extremely useful in digital systems and synthesizer check out.

#### Digital I/O

Option 011 provides complete digital input-output capability (except slope and level control) to the 5345A. Digital output is a bit parallel, byte serial ASCII coded format and the I/O structure conforms to the Hewlett-Packard Interface Bus (HP-IB) standard. This option is particularly recommended for a bench top calculator controlled environment.

Option 012 is similar to Option 011, but includes programmable control of slope and level. Option 012 is recommended for a computer controlled environment.

The model 59310B Interface Kit provides a complete operational package for use with the HP 2100 Series Computers. Similarly, other interface kits allow the user to interface the 5345A Option 011 or 012 and other HP-IB compatible devices to the 9825 and 9830 Series HP Desktop Computers.



## 5345A Condensed Specifications

### Frequency/Period Measurements

**Range:** 0.00005 Hz to 500 MHz.

**Accuracy:**  $\pm \frac{2 \times 10^{-9}}{\text{gate time}} \pm \text{trigger error}^* \pm \text{time base error}$ .

**Gate time:** 1000 seconds to 100 nanoseconds in decade steps; <50 ns in MIN position.

### Time Interval/Time Interval Average

**Range:** 10 nsec to 20,000 sec.

**Minimum dead time:** 10 nsec.

**Trigger pulse width:** 1 nsec minimum width input at minimum voltage input.

**Accuracy:**

**Time Interval:**  $\pm \text{trigger error}^* \pm 2 \text{ ns} \pm \text{time base error}$ .

**Time interval averaging:**

$\pm \frac{\text{trigger error}^* \pm 2 \text{ nsec}}{\sqrt{\text{intervals averaged}}} \pm 0.7 \text{ nsec} \pm \text{time base accuracy}$

Not affected by harmonics of clock frequency.

**Resolution:**

**Time interval:** 2 nsec.

**Time interval average:**

$\pm \frac{2 \text{ nsec}}{\sqrt{\text{intervals averaged}}} \pm 2 \text{ picoseconds}$ .

**Ratio B/A**

**Range:** both channels accept dc to 500 MHz.

**Accuracy:**  $\pm \text{L.S.D.} \pm \text{trigger error}^*$ .

**Start/stop**

**Range:** both inputs dc to 500 MHz.

**Modes:** A, A  $\pm$  B determined by rear panel switch.

**Scaling**

**Range:** dc to 500 MHz.

**Scaling factor:** selectable by GATE TIME setting. Scaling factor equals GATE TIME setting/ $10^{-9}$  seconds.

**Input:** input signal through channel A.

**Output:** output frequency equals input frequency divided by scaling factor. Rear panel BNC supplies 80% duty cycle TTL compatible pulses.

**Input Channels A and B**

**Range:** 0 to 500 MHz dc coupled 50 $\Omega$  and 1 M $\Omega$ ; 4 MHz to 500 MHz ac coupled, 50 $\Omega$ ; 200 Hz to 500 MHz ac coupled, 1 M $\Omega$ .

**Impedance:** selectable, 1 M $\Omega$  shunted by less than 30 pF or 50 $\Omega$  (nominal).

**Sensitivity:** X1, 20 mV rms sine wave and 60 mV peak-to-peak pulse. X10, 250 mV rms sine wave and 750 mV peak-to-peak pulse.

**Dynamic range:** 50 $\Omega$  & 1 M $\Omega$ : 20 mV to 250 mV rms sine wave (X1); 250 mV to 2.0 V rms (X10).

**Trigger level:** adjustable over  $\pm 1.3$  V dc.

**Output:** rear panel BNC connectors bring out CHAN A TRIG LEVEL and CHAN B TRIG LEVEL for convenient DVM monitoring. Accurate to  $\pm 15$  mV.

**Common Input**

In this mode the signal is applied to channel A.

**Range:** ac coupled 50 $\Omega$ , 4 MHz to 400 MHz; ac coupled 1 M $\Omega$ , 300 Hz to 400 MHz.

**Impedance:** 50 $\Omega$  remains 50 $\Omega$ ; 1 M $\Omega$  becomes 500 k $\Omega$  shunted by <60 pF.

**Sensitivity:** 50 $\Omega$ : 40 mV rms; 1 M $\Omega$ : No change.

**Dynamic range:** 50 $\Omega$ : 40 mV to 500 mV rms (X1); 500 mV to 4 V rms (X10); 1 M $\Omega$ : No change.

**General**

**Display:** 11 digit LED display and sign. Annunciator displays ksec to nsec, k to n,  $\mu$ Hz to GHz. Decimal point is positioned with DISPLAY POSITION control or positioned after the first, second or third most significant digit if DISPLAY POSITION is in AUTO. Leading zeros are suppressed.

**Overflow:** asterisk is illuminated when display is overflowed.

**Sample rate:** continuously variable from <0.1 sec to >5 sec with front panel control. In HOLD position the last reading is maintained until the counter is reset.

**External arm input:** counter can be armed by a -1.0 V signal applied to the rear panel 50 $\Omega$  input.

**External gate input:** same conditions as for EXT ARM.

**Gate output:** >1 volt into 50 $\Omega$ .

**Time Base**

**Standard high stability time base:** crystal frequency, 10 MHz (10544A).

**Stability**

**Aging rate:** <5 x  $10^{-10}$  per day.

**Short term:** <1 x  $10^{-11}$  for 1 sec average.

**Temperature:** <7 x  $10^{-9}$ , 0°C to 55°C.

**Opt 001:** crystal frequency, 10 MHz.

**Stability:**

**Aging rate:** <3 x  $10^{-7}$  per month.

**Short term:** <2 x  $10^{-9}$  rms for 1 sec.

**Temperature:** <2 x  $10^{-8}$ , 25°C to 35°C.  
<5 x  $10^{-6}$ , 0°C to 55°C.

**Line voltage:** <1 x  $10^{-8}$ ,  $\pm 10\%$  from nominal.

**Self test:** a 100 MHz signal is internally applied.

**External frequency standard input:** input voltage >1.0 V rms into 1 k $\Omega$  required from source of 1, 2, 2.5, 5 or 10 MHz  $\pm 5$  x  $10^{-8}$  ( $\pm 5$  x  $10^{-6}$  for opt. 001). Input can be sine or square wave.

**Frequency Standard Output:** >1 V rms into 50 $\Omega$  at 10.0 MHz sine wave.

**Operating temperature:** 0°C to 55°C.

**Power requirements:** 100/120/220/240 V rms +5% -10% 48 to 66 Hz, maximum power 250 VA.

**Weight:** 17 kg (37 lb).

**Size:** 132.6 H x 425 W x 495 mmD (5.22" x 16.75" x 19.5").

**Options and Accessories**

Options and Accessories	Price
001: Room Temperature Time Base	less \$350
010: Digital output only. HP Interface Bus format, talk only. Useful with 59301A ASCII-to-Parallel Converter and 5050B or 5055A Digital Printers	add \$250
011: Digital Input/Output same as Opt 010, Compatible with HP Interface Bus and allows 5345A to be remotely programmed. (Does not include cable)	add \$800
012: Digital I/O similar to Opt 011. Includes slope and level control. (Does not include cable. See page 28)	\$1450
908: Rack flange kit	add \$22
K13-59992A: includes state machine tester as an aid for trouble-shooting the arithmetic processor	
10595A Board extender kit: useful for troubleshooting plug-in boards while in operation	\$650
10590A Plug-in adapter: adapts 5245 series plug-ins to 5345 (see next page)	\$750
K15-59992A Standby power unit: plug-in to maintain oscillator operation for prolonged periods without line voltage	

**Available Reference Material**

5345A Data Sheet

AN-173-1 Dynamic Measurement of Microwave VCO's

AN-174 Applications Series on Counter/Calculator Instrument Groupings

AN-200-3 Precision Time Interval Measurements

HP Journal June 1974

I.D. #90337D Color Video Tape Applications and Demonstrations

**5345A Plug-In Counter**

**\$5200**

$$* \text{trigger error} = \frac{1.4 \sqrt{(150 \mu\text{V})^2 + e_n^2}}{\text{Input Voltage slew rate at trigger point (V/S)}} \text{seconds rms}$$

where 150 $\mu$ V is the TYPICAL rms input amplifier noise on the 5345A and  $e_n$  is the rms noise of the input signal for a 500 MHz bandwidth.

# ELECTRONIC COUNTERS

## Model 5345A (Cont.)

- Fully automatic to 4 GHz
- Pulse Measurements
- Frequency averaging
- Count a group of events between A and B
- Frequency sum and difference measurements

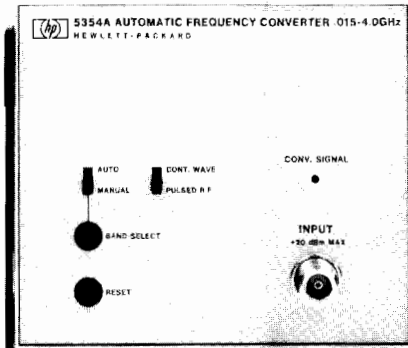

5354A

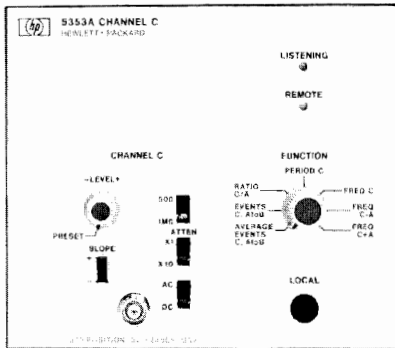

5353A

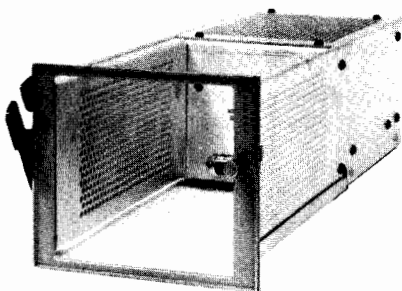

10590A

### 5354A Automatic Frequency Converter

The 5354A translates not only the microwave signal but all its modulation directly to the 500 MHz window of the counter (via the heterodyne technique). It allows signals with a large amount of FM to be easily characterized.

Perhaps even more powerful is its ability to take direct measurements on the carriers of very narrow microwave pulses. Pulse measurements can be easily automated.

**Range:** 15 MHz to 4 GHz.

**Sensitivity:** -10 dBm (70 mV rms) auto mode, -20 dBm typical (22 mV rms) Manual/Pulse mode to 20 dBm (2.2 V rms).

**Input signal capability:** CW signals. Pulsed microwave signals. Signals with very high FM content.

**RF Pulse width:** determined by counter GATE TIME setting.

**FM Sensitivity:** overlap at band edges  $\pm 10$  MHz. Maximum deviation at band center

$\pm 250$  MHz, above 1 GHz and below 500 MHz.

$\pm 125$  MHz, between 500 MHz and 1 GHz.

**Operating modes:** Automatic and Manual.

**Automatic:** measures lowest frequency signal of sufficient amplitude to trigger counter.

**Manual:** measures signal within selected band. Signals of sufficient amplitude between 15 MHz and 525 MHz will also be counted.

**Acquisition time:**

**Automatic mode:** CONT. WAVE,  $< 2$  ms; PULSED R.F.,  $< 1$  s.

**Manual mode:** when proper band has been selected CONT. WAVE  $< 5$   $\mu$ s; PULSED R.F.  $< 20$  ns.

#### Options

**011:** remote control via HP Interface Bus and L.O.  $\pm$  I.F. (Does not include cable)

**Price**  
add \$250

**5354A Automatic Frequency Converter**

**\$4800**

### 5353A Channel C Plug-in

The 5353A Channel C Plug-In consists of a third input to the 5345A Counter. When the plug-in counting capability is combined with the mainframe gating capability it becomes quite easy to make frequency sum and frequency difference measurements.

For high speed digital applications, the greatest benefit the plug-in offers is the ability to count a specific group of events while ignoring others. This measurement is required in many applications such as computer peripheral testing and digital communications systems. It is accomplished in the events C between A and B mode by applying a start signal to CHAN A and a stop signal to CHAN B while applying the data to be counted to CHAN C.

**Range:** dc coupled: 0 to 500 MHz; ac coupled: 1 M $\Omega$ : 200 Hz to 500 MHz; 50 $\Omega$ : 4 MHz to 500 MHz.

**Impedance:** 50 $\Omega$ ; (nominal), or 1 M $\Omega$  shunted by less than 30 pF.

**Sensitivity:** variable to 20 mV rms sine wave and 60 mV peak-to-peak pulse. Attenuator settings are X1 and X10.

**Modes of operation:** Frequency C + A; Frequency C - A; Period C; Frequency C; Ratio C/A; Average Events C, A to B; Events C, A to B.

**Events accuracy:** Plus or minus one count worst case.

#### Options

**011:** Digital Input. Full compatibility with HP Interface Bus. Provides for digital control over all functions excluding amplifier. (Does not include cable)

**Price**  
add \$250

**5353A Channel C Plug-in**

**\$1500**

### 10590 Plug-in adapter

The 10590A allows the user to interface any of the 5245 series of plug-ins (except the 5264A) to the 5345A (see page 301 for details on these plug-ins). The major application is to extend the frequency range to 18 GHz via the 5255A, 5256A and 5257A plug-ins. In addition the adapter is "intelligent" in that it detects the plug-in being used and automatically adjusts the 5345A accordingly.

**10590A Plug-in Adapter**

**\$750**



5355A

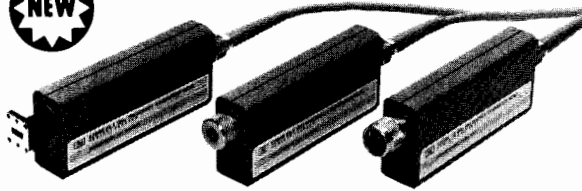

5356A/B/C

The 5355A automatic frequency converter, together with the 5356A, 5356B, or the new 5356C frequency converter head provides pulsed and CW frequency measurement capability to 18/26.5/40 GHz. A 0.4-1.6 GHz prescaled input offers pulsed and CW measurement for the lower microwave range even without one of the heads. The 5355A's internal microprocessor controls the measurement algorithm, computes the input microwave frequency and displays it on the eleven digit 5345A display.

Superior pulsed RF performance is provided with selectable resolution to 100 Hz and better, with accuracy to 3 kHz. Internal pulse detection circuitry sets the counters gate for maximum resolution for any pulse width down to 60 ns. External gating allows samples as small as 20 nsec for performing dynamic frequency profiling of "CHIRPS" and other FM on the RF burst. This is also an excellent CW microwave counter, providing 1 Hz resolution in 1 second. Automatic amplitude discrimination and 60 MHz FM tolerance allows this counter to correctly measure carrier frequencies in the most difficult transmitted signals.

Microprocessor control provides automatic operation and diagnostic routines for quick easy failure isolation. The front panel keyboard provides user definable offsets including an  $m \times \pm b$  offset mode for receiver testing where the local oscillator can be measured directly then multiplied by the appropriate harmonic number. Offsetting this by the receivers IF allows the counter to conveniently display the tuned receiver frequency.

#### Ordering Information

<b>5355A</b> Automatic Frequency Converter Plug-In (HP-IB Standard)	<b>Price</b> \$4550
<b>5356A</b> 18 GHz Frequency Converter Head	\$1500
Option 001 High Pass Filter	add \$125
<b>5356B</b> 26.5 GHz Frequency Converter Head	\$1800
Option 001 18-26.5 GHz Waveguide Input	add \$600
<b>5356C</b> 40 GHz Frequency Converter Head	\$2400
Option 001 26.5-40 GHz Waveguide Input	add \$500

- Now fully automatic to 40 GHz
- Pulsed RF or CW measurement
- 60 ns minimum pulse width
- User definable offsets from front panel

### Specifications

#### Input Specifications (Pulse and CW Mode)

	5356A	5356B	5356C
<b>Frequency Range</b>	1.5-18 GHz	1.5-26.5 GHz	1.5-40GHz
<b>Sensitivity:</b> 1.5-12.4 GHz	-20 dBm	-20 dBm	-25 dBm
12.4-18 GHz	-15 dBm	-15 dBm	-20 dBm
18-26.5 GHz	—	-15 dBm	-20 dBm
26.5-34 GHz	—	—	-15 dBm
34-40 GHz	—	—	-10 dBm
<b>Maximum Input</b>			
1.5-12.4 GHz	+5 dBm	+5 dBm	+5 dBm
12.4-18 GHz	+5 dBm	+5 dBm	+15 dBm
18-26.5 GHz	—	+5 dBm	+15 dBm
26.5-40 GHz	—	—	+15 dBm
<b>Damage Level</b>	+25 dBm peak	+25 dBm peak	+25 dBm peak
<b>Impedance</b>	50 Ω NOMINAL	50 Ω NOMINAL	50 Ω NOMINAL
<b>SWR:</b> 1.5-10 GHz	<2:1	<2:1	<2:1
10-18 GHz	<3:1	<3:1	<3:1
18-26.5 GHz	—	<3:1	<3:1
26.5-34 GHz	—	<3:1	<3:1
34-40 GHz	—	—	<5:1
<b>Connector</b>	N Male	SMA Male	APC 3.5

#### CW Mode

	5356A/B/C Auto Mode	5356A/B/C Man Mode
<b>FM Tolerance</b>	15 MHz p-p (60 MHz p-p in special FM mode) rate: dc -10 MHz	80 MHz p-p rate: dc -10 MHz
<b>AM Tolerance</b>	Any modulation index provided the minimum signal level is greater than the counter sensitivity.	
<b>Multiple Signal Discrimination</b>	Automatic Amplitude Discrimination (AAD). Automatically measures largest signal provided signal is 8 dB (TYPICAL) greater than any signal within 500 MHz and 20 dB (TYPICAL) greater than any signal over range 1.5-26.5 GHz.	
<b>Acquisition Time</b>	5356A/B = 400 ms 5356C = 1.4 s	15 ms
<b>LSD Displayed</b>	1 Hz ± 5345A Gate Time	
<b>Resolution</b>	± 2 x LSD ± 10 <sup>-9</sup> rms x FREQ	
<b>Accuracy</b>	± 2 x LSD ± 1 x 10 <sup>-9</sup> rms x FREQ ± time base error x FREQ	

#### Pulse Mode

	5356A/B/C Input Auto Mode	5356A/B/C Input Man Mode
<b>FM Tolerance</b>	50 MHz p-p Chirp	80 MHz p-p Chirp
<b>Acquisition Time</b>	5356A/B/C Input Man Mode: 0 5356A/B Input Auto Mode: 100 μs + (EXT GATE WIDTH x PRF) + 650 ms for EXT GATE ≤ 100 μs (2 ÷ PRF) + 650 ms for EXT GATE > 100 μs 5356C Input Auto Mode: (8 ÷ PRF) + 1.55s + 100 μs ÷ (EXT GATE WIDTH x PRF) for EXT GATE ≤ 100 s. (10 ÷ PRF) + 1.55 s for EXT GATE > 100 μs.	
<b>Pulse Width</b> Min:	100 ns	60 ns
Max:	20 ms	20 ms
<b>Pulse Repetition Frequency</b> Min:	50 Hz	50 Hz
Max:	2 MHz	2 MHz
<b>Minimum ON/OFF RATIO</b>	25 dB TYPICAL (35 dB TYPICAL for PRF <100 Hz)	
<b>Maximum Video Feed-Through</b>	15 mV p-p TYPICAL for rf burst rise and fall times >10 ns	
<b>Minimum EXT GATE WIDTH</b>	20 ns	
<b>LSD Displayed</b>	1 Hz ± 5345A GATE TIME	
<b>Resolution</b>	± 2 x LSD ± rms jitter*	
<b>Accuracy</b>	± 2 x LSD ± rms jitter* ± $\frac{.04}{\text{EXT GATE WIDTH}}$ ± 3 KHz ± Time base error X FREQ	

\* rms jitter =  $X + 1 \div \sqrt{(5345A \text{ GATE TIME}) (EXT \text{ GATE WIDTH})}$ ;  
X = 100 Hz rms

For EXT GATE signals generated by the 5355A, the EXT GATE WIDTH equals the input PULSE WIDTH minus 30 ns (TYPICAL) for the 5356A/B/C input and equals input PULSE width minus 40 ns (TYPICAL) for the 5355 0.4-1.6 GHz input.





# ELECTRONIC COUNTERS

## Automatic Microwave Counters

Models 5342A & 5343A

- Microprocessor Controlled
- Automatic Measurement to 18 GHz / 26.5 GHz
- Wide FM Tolerance

- Simultaneous Display of Input Level
- High Sensitivity
- Automatic or Manual Operation



5342A

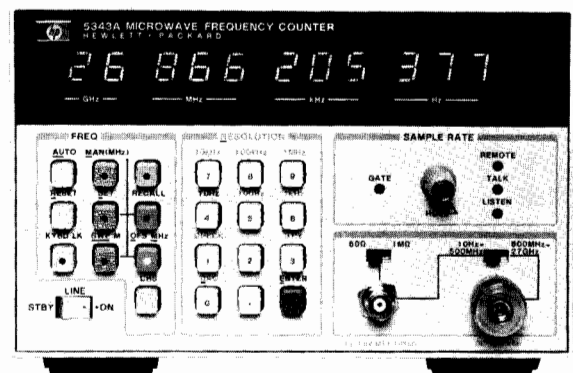

5343A



### Description

The 5342A and 5343A Microwave Counters provide Automatic Frequency Measurement up to 18 or 26.5 GHz in highly portable packages.

The powerful and versatile microprocessor controlled keyboards can accomplish offset tasks as a standard feature as well as providing user interactive diagnostic information. The eleven-digit display is sectionalized for easy readout to one hertz resolution.

Both units utilize the Harmonic Heterodyne down conversion technique which combines the best performance features of the Heterodyne Converter and Transfer Oscillator Techniques. Now Wide FM Tolerance is achievable along with high input sensitivity and automatic amplitude discrimination. This allows the counter to automatically measure the largest signal present within the counters' spectrum while ignoring all others.

#### Amplitude Measurements (Option 002) (5342A Only)

Option 002 adds the ability to measure the input level of the incident sinewave signal. The instrument then displays this level in dBm. The eleven-digit LED display simultaneously presents frequency to 1 MHz resolution and amplitude to 0.1 dBm resolution. An added benefit from Option 002 is that dynamic range is extended so that frequency measurements to +22 dBm are accomplished. This extended dynamic range is also available without the amplitude measurement capability by ordering Option 003 (5342A only).

#### FM Tolerance

The ability to measure a carrier frequency while being frequency modulated has broad appeal in the communications industry and elsewhere. The 5342A can tolerate 50 MHz peak-to-peak worst case FM in the wide mode, or the normal mode with accompanying faster acquisition time can be selected which gives 20 MHz peak-to-peak

worst case FM. The 5343 offers a selection of three (3) acquisition times including a 200 ms "fast" acquisition time with 6 MHz peak-to-peak worst case FM Tolerance.

#### Offset Functions

The power and versatility of the microprocessor controlled keyboard allows the user to perform offset functions by means of a few key strokes. Frequency values to 1 Hz resolution can be added to or subtracted from the measured frequency for IF offset application and also for monitoring variances about a given frequency. The 5343A also offers an  $m \times \pm b$  mode for receiver testing where the measured local oscillator can be multiplied by the appropriate harmonic number. Adding the IF as an offset has the counter displaying the received frequency.

With Option 002 installed (5342A) this offset capability can be applied to the amplitude measurements. These offset values can be recalled to the display at any time for reviewing.

#### Digital-To-Analog Converter (Option 004)

The ability to convert any three consecutive displayed digits (frequency or amplitude) into an analog voltage output on the rear panel is added by Option 004. This makes the monitoring of microwave oscillator frequency drift easy to make with only a strip chart recorder.

#### HP Interface Bus For Systems Use (Option 011)

The full power of HP-IB (IEEE 488-1975) is brought to fruition with the addition of Option 011. Front and rear panel controls can now be remotely programmed and measurement results can be outputted to HP-IB-compatible instruments, calculators, or computers. This interface also can select a given frequency in the manual mode and reduce acquisition time to typically less than 80 msec.

## 5342A Specifications

### Signal Input

#### Input 1

**Frequency range:** **5342A:** 500 MHz to 18 GHz

**5343A:** 500 MHz to 26.5 GHz

**Sensitivity:** **5342A:** 500 MHz to 12.4 GHz: -25 dBm  
12.4 GHz to 18 GHz: -20 dBm

**5343A:** 500 MHz to 12.4 GHz: -33 dBm

12.4 GHz to 18.0 GHz: -28 dBm

18.0 GHz to 26.5 GHz: -23 dBm

**Maximum input:** +7 dBm (See OPT 002, 003 for higher levels)

**Impedance:** 50 ohms, nominal

**Connector:** **5342A:** precision Type N female

**5343A:** APC 3.5 male with collar

**Damage level:** +25 dBm, peak

**Coupling:** DC to Load, AC to instrument.

**SWR:** < 2:1, 500 MHz-10 GHz

< 3:1, 10 GHz-18 GHz/26.5 GHz

**FM tolerance:** switch selectable (rear panel)

**Wide:** 50 MHz p-p worst case

**Normal:** 20 MHz p-p worst case

**Narrow:** (5343A only) 6 MHz p-p worst case

For Modulation Rates from DC to 10 MHz.

**AM tolerance:** any modulation index provided the minimum signal level is not less than the sensitivity specification.

**Automatic amplitude discrimination:** automatically measures the largest of all signals present, providing that signal is 6 dB above any signal within 500 MHz; 20 dB above any signal, 500 MHz-18 GHz/26.5.

#### Modes of operation:

**Automatic:** counter automatically acquires and displays highest level signal within sensitivity range.

**Manual:** center frequency entered to within  $\pm 40$  MHz of true value.

#### Acquisition time

##### Automatic mode:

Narrow FM 200 ms worst case (5343A only)

Normal FM 530 ms worst case

Wide FM 2.4 s worst case

**Manual mode:** 80 ms after frequency entered

#### Input 2

**Frequency range:** 10 Hz to 520 MHz direct count.

**Sensitivity:** 50  $\Omega$ : 10 Hz to 520 MHz: 25 mV rms. 1 M $\Omega$ : 10 Hz to 25 MHz: 50 mV rms.

**Impedance:** selectable 1 M $\Omega$ , <50 pF or 50  $\Omega$  nominal.

**Coupling:** AC.

**Connector:** Type BNC female.

**Maximum input** 50  $\Omega$ : 3.5 V rms (+24 dBm) or 5 V DC, fuse protected

1 M $\Omega$ : 200 V DC + 5 V rms

#### Time Base

**Crystal frequency:** 10 MHz.

#### Stability

**Aging rate:** <1 x 10<sup>-7</sup>/month

**Temperature:** <  $\pm 1$  x 10<sup>-6</sup> over the range 0°C to 50°C

**Short term:** <1 x 10<sup>-9</sup> for 1 second averaging time.

**Line variation:** <  $\pm 1$  x 10<sup>-7</sup> for 10% change from nominal.

**Output frequency:** 10 MHz,  $\geq 2.4$  V square wave (TTL compatible) 1.5 p-p V into 50  $\Omega$  available from rear panel BNC.

**External time base:** requires 10 MHz, 2.0 V p-p sine wave or square wave into 1 K $\Omega$  via rear panel BNC connector. Switch selects either internal or external time base.

#### Optional Time Base (Option 001)

**Crystal frequency:** 10 MHz.

#### Stability

**Aging rate:** <5 x 10<sup>-10</sup>/day after 24-hour warmup

**Temperature:** <7 x 10<sup>-9</sup> over the range 0°C to 50°C

**Short term:** <1 x 10<sup>-10</sup> for 1 second averaging time

**Line variation:** <1 x 10<sup>-10</sup> for 10% change from nominal

**Warm-up:** <5 x 10<sup>-9</sup> of final value 20 minutes after turn-on, at 25°C.

### General

**Accuracy:**  $\pm 1$  count  $\pm$  time base error.

**Resolution:** front panel push buttons select 1 Hz to 1 MHz

**Display:** 11 digit LED display, sectionalized to read GHz, MHz, kHz, and Hz.

**Self-check:** selected from front panel pushbuttons displays 75 MHz for resolution chosen.

**Frequency offset:** selected from front panel pushbuttons. Displayed frequency is offset by entered value to 1 Hz resolution.

**Frequency multiply:** (5343A only) (mx  $\pm$  b) measured data is multiplied by any integer up to 99. Offset can then be added or subtracted. Front panel selectable.

**Totalize (5343A only):** input 2 can totalize at rates up to 520 MHz. Readout on the fly is controlled by front panel or HP-IB.

**Sample rate:** variable from less than 20 ms between measurements to HOLD which holds display indefinitely.

**IF out:** rear panel BNC connector provides 25 MHz to 125 MHz output of down-converted microwave signal.

**Power requirements:** 100/120/220/240 V rms, +5%, -10%, 48-66 Hz; 100 VA max.

**Weight:** net 9.1 kg (20 lb.). Shipping 12.7 kg (28 lb.).

**Size:** 133 mm H x 213 W x 498 mm D (5.25" x 8.39" x 19.6").

### Amplitude Measurement (OPT 002) (5342A Only)

#### Input 1

**Frequency range:** 500 MHz-18 GHz.

**Dynamic range (frequency and level):**

-22 dBm to +22 dBm 500 MHz to 12.4 GHz

-15 dBm to +22 dBm 12.4 GHz to 18 GHz

**Maximum operating level:** +22 dBm

**Damage level:** +25 dBm, peak

**Resolution:** 0.1 dBm

**Accuracy:**  $\pm 1.5$  dB (excluding mismatch uncertainty).

**SWR:** <2:1 (amplitude measurement).

<5:1 (frequency measurement).

**Measurement time:** 100 ms + frequency measurement time.

**Display:** simultaneously displays frequency to 1 MHz resolution and level. (Option 011 provides full frequency resolution on HP-IB).

#### Input 2 (50 $\Omega$ impedance only)

**Frequency range:** 10 MHz-520 MHz.

**Dynamic range (frequency and level):** -17 dBm to +20 dBm

**Damage level:** +24 dBm.

**Accuracy:**  $\pm 1.5$  dB (excluding mismatch uncertainty).

**SWR:** <1.8:1.

**Measurement time:** 100 ms + frequency measurement time.

**Display:** Simultaneously displays frequency and input level.

### Extended Dynamic Range (OPT 003) (5342A Only)

**Frequency range:** 500 MHz to 18 GHz.

**Sensitivity:** 500 MHz to 12.4 GHz: -22 dBm

12.4 GHz to 18 GHz: -15 dBm

**Maximum operating level:** +22 dBm

**Dynamic range:** 500 MHz to 12.4 GHz: 44 dB

12.4 GHz to 18 GHz: 37 dB

**Damage level:** +25 dBm, peak

**SWR:** <5:1

### Options and Accessories

**001:** High Stability Time Base add \$575

**002:** Amplitude Measurement (5342A Only) add \$1000

**003:** Extended Dynamic Range (5342A Only) add \$400

**004:** Digital-To-Analog Converter add \$250

**005:** Frequency Extension to 24 GHz (5342A Only) add \$350

**011:** Digital Input/Output (HP-IB) (Cable Not Incl) add \$350

**908:** Rack Mounting Adapter Kit \$45

**K70-59992A:** Rack Mounting Adapter Kit With Slot

For access to front connectors from rear.

**10842A:** Extender Board Kit \$300

**5342A Frequency Counter \$4600**

**5343A Frequency Counter \$5200**



# ELECTRONIC COUNTERS

## Automatic microwave counter

Model 5340A

- Single input 10 Hz to 18 GHz
- Automatic amplitude discrimination
- High sensitivity-35 dBm
- Optional extension to 23 GHz
- High AM and FM tolerance
- Exceptional reliability

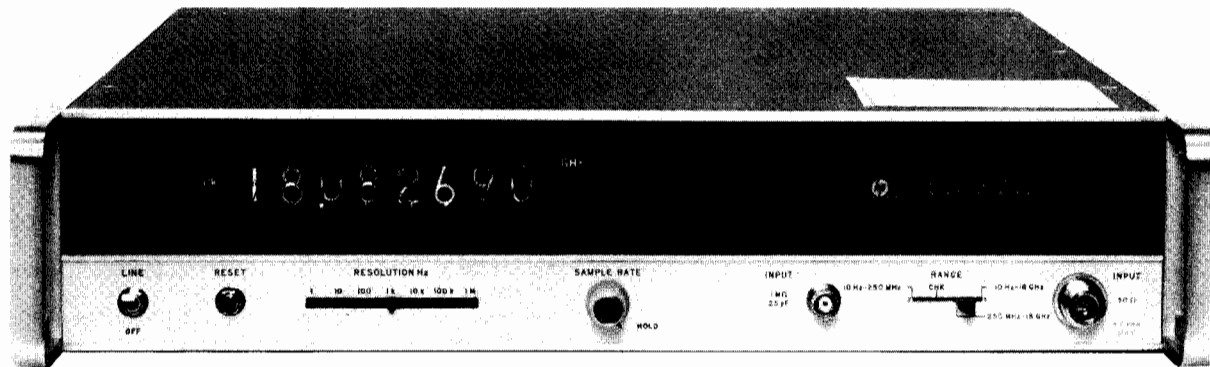

5340A



The 5340A Frequency Counter provides a modern, easily used, more versatile instrument for the direct measurement of frequencies from 10 Hz through 18 GHz via a single input connector. Utilizing new microwave samplers incorporated in advanced phase-lock loops, this counter excels in virtually every specification parameter. It is therefore suited to a wider range of applications than ever before possible for a fully automatic microwave counter.

The exceptional sensitivity of this instrument enhances measurement in the microwave field, where signals are commonly low level and many times are connected via directional couplers or lossy devices. Wide tolerance of AM, FM, and residual noise insure accurate measurement of microwave carrier frequencies despite the presence of these deviations. Automatic amplitude discrimination allows the 5340A to choose the largest signal in a spectrum (250 MHz to 18 GHz) and measure only that signal's frequency, ignoring all others.

Access to the HP Interface Bus via Option 011 provides a particularly flexible system interface. The ability to program octave range via this input allows reduction of acquisition time to typically less than 40 ms. AN 181-1 describes the use of a calculator-controlled measurement system built around the HP Interface Bus for microwave component testing.

### 5340A Specifications

#### Signal Input

##### Input 1

**Range:** 10 Hz to 18 GHz.

**Symmetry:** sinewave or squarewave input (40% duty factor, worst case).

**Sensitivity:** -30 dBm, 10 Hz to 500 MHz; -35 dBm, 500 MHz to 10 GHz; -25 dBm, 10 to 18 GHz.

**Dynamic range:** 37 dB, 10 Hz to 500 MHz; 42 dB, 500 MHz to 10 GHz; 32 dB, 10 GHz to 18 GHz.

**Impedance:** 50Ω.

**VSWR:** <2:1, 10 Hz-12.4 GHz; <3:1, 12.4-18 GHz.

**Connector:** Precision Type N.

**Coupling:** dc to load, ac to instrument.

**Damage level:** +30 dBm. Total power (ac + dc) not to exceed 1 watt.

**Acquisition time:** <150 ms mean typical.

##### Input 2

**Range:** 10 Hz-250 MHz direct count.

**Sensitivity:** 50 mV rms. 150 mV p-p pulses to 0.1% duty factor; minimum pulse width 2 ns.

**Impedance:** 1 MΩ shunted by <25 pF.

**Connector:** type BNC female.

**Coupling:** ac

**Maximum input:** 200 V rms, 10 Hz to 100 Hz; 20 V rms, 100 Hz to 100 kHz; 2 V rms, 100 kHz to 250 MHz.

**Automatic amplitude discrimination:** automatically selects the strongest of all signals present (within 250 MHz to 18 GHz phase-lock range), providing signal level is: 6 dB above any signal within 200 MHz; 10 dB above any signal within 500 MHz; 20 dB above any signal, 250 MHz-18 GHz.

**Maximum AM modulation:** any modulation index as long as the minimum voltage of the signal is not less than the sensitivity specification.

#### Time Base

**Crystal frequency:** 10 MHz.

#### Stability

**Aging rate:** <3 × 10<sup>-7</sup> per month.

**Short term:** <5 × 10<sup>-10</sup> rms for 1 second averaging time.

**Temperature:** <±2 × 10<sup>-6</sup> over the range of 0°C to 50°C.

**Line variation:** <±1 × 10<sup>-7</sup> for 10% line variation from nominal.

**Output frequency:** 10 MHz, ≥2.4 V square wave (TTL compatible) available from rear panel BNC.

**External time base:** requires 10 MHz approximately 1.5 V p-p sine wave or square wave into 1 kΩ via rear panel BNC. Switch selects either internal or external time base.

**Optional time base (Opt 001) aging rate:** <5 × 10<sup>-10</sup> per day after 24 hour warm-up for less than 24 hour off-time.

#### General

**Accuracy:** ±1 count ± time base error.

**Resolution:** front panel switch selects 1 MHz, 100 kHz, 10 kHz, 1 kHz, 100 Hz, 10 Hz, or 1 Hz.

**Display:** eight in-line long life display tubes with positioned decimal point and appropriate measurement units of kHz, MHz, or GHz.

**Self check:** counts and displays 10 MHz for resolution chosen.

**Sample rate:** controls time between measurements. Continuously adjustable from 50 ms typical to 5 seconds. HOLD position holds display indefinitely. RESET button resets display to zero and activates a new measurement.

**Operating temperature:** 0°C to 50°C.

**Power:** 115 V or 230 V ±10%, 48-66 Hz, 100 VA.

**Weight:** net, 11.3 kg (25 lb). Shipping, 14.1 kg (31 lb).

**Size:** 88.2 H × 425 W × 467 mm D (3.47" × 16.75" × 18.39").

#### Options

**001:** High Stability Time Base

**002:** Rear Panel Connectors

**005:** Frequency Extension to 23 GHz

**011:** Remote Programming-Digital Output (HP-IB).

Cable not included, see page 30.

**908:** Rack Flange Kit

**5340A Frequency Counter**

**Price**

add \$575

add \$105

add \$500

add \$390

add \$30

**\$7200**

- Capable of 100,000 measurements/second

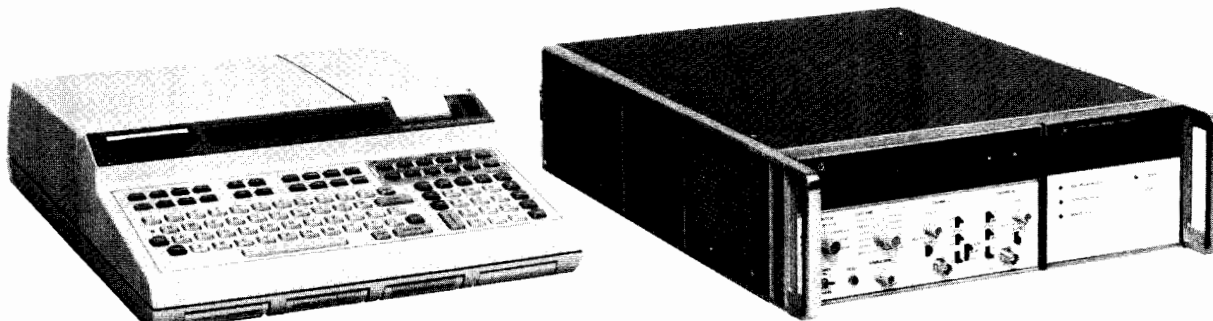

5391A Frequency and Time Data Acquisition System

### General

The HP5391A Frequency and Time Data Acquisition System combines the power of the HP5345A Universal Counter with the speed and storage capability of the HP5358A Measurement Storage Plug-In to allow you to make and store frequency or time measurements at rates as high as 100,000 measurements per second. The 5391A can help you characterize pulse width jitter by measuring and storing each pulse width and then computing statistical parameters such as min, max, mean, and standard deviation. Other application areas include nuclear time of flight studies, explosive testing and characterization, and frequency profile measurements.

The 5391A is a compact HP-IB system consisting of the 5345A Universal Counter with the 5358A Measurement Storage Plug-In, the 9825B Computing Controller, and a versatile software package providing utility application routines and diagnostic service routines.

### Application Example

Frequencies, periods, ratios, and time intervals may be measured and stored by the 5391A. A typical application, shown in the figure, is to measure and store every pulse width in a burst of pulses:

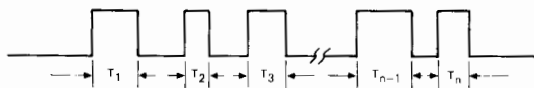

The 5345A counter makes a single shot time interval measurement (2 nanosecond resolution) for each pulse width. During the dead time between successive time intervals, the 5345A transfers the data to the 5358A Measurement Storage Plug-In. The time required for this transfer is  $7 \mu s + 1 \mu s/\text{digit transferred}$ . The graph plots transfer time required versus the time interval measured. If the dead time immediately following a measured time interval is greater than the required transfer time, the 5391A can make the measurement.

The 5391A, with its 9825B Controller, is capable of making and storing up to 1200 consecutive measurements for time intervals less than 2 milliseconds. Above 2 milliseconds, the 8K memory of the 5358A will limit the number, depending on the time interval.

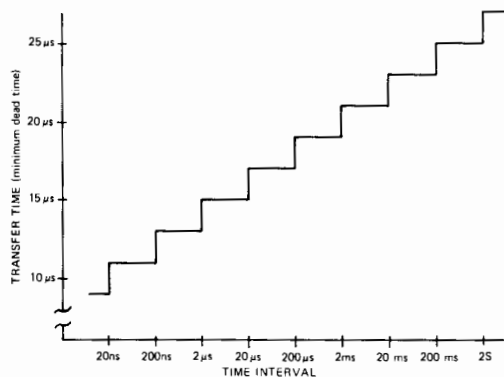

When the desired number of measurements in a run exceeds the maximum allowable, the maximum is taken and then stored as a block on the 9825B cassette. Subsequent blocks of measurements are taken and stored on cassette until the total desired number of measurements has been accumulated. The time required to transfer the measurement data from the 5358A to the 9825B and store it on cassette is on the order of seconds. During this time, no measurements can be made. The total number of measurements is program selectable from 1 to 9999.

### Systems Options

**325:** Deletes 9825B Controller (as well as HP-IB Interface)

**Price**  
less \$8,200

### Ordering Information

**5391A Basic System Includes:**

- 5345A Option 011 Electronic Counter
- 5358A Measurement Storage Plug-in with 8K bytes of memory
- 9825B Computing Controller (Includes 32K Bytes of Memory, and all needed ROMs)
- 98034A HP-IB Interface
- System Software Cartridge
- System and Instrument Manuals

**5391A Basic System**

**\$19,050**



# ELECTRONIC COUNTERS

## Universal Time Interval Counter

MODEL 5370A

- 20 ps single shot time interval counter
- Statistics
- Automatic calibration of systematic errors
- Positive or negative time intervals
- Frequency and period to 100 MHz

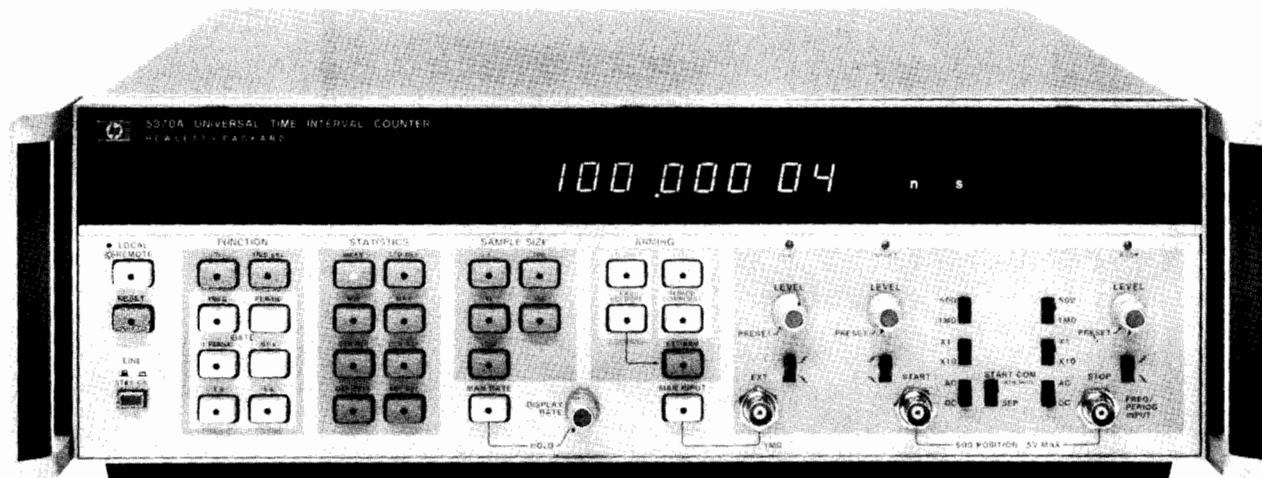

5370A



The 5370A Universal Time Interval Counter represents the highest resolution single-shot time interval counter available today. The counter utilizes a new concept of phase locked vernier interpolation, which allows single-shot time interval measurements with  $\pm 20$  pS resolution. This technique allows positive, zero and negative time intervals to be measured. High resolution period and frequency measurements may also be made.

All major front panel controls including trigger level are programmable by means of the Hewlett-Packard Interface Bus (HP-IB).

User convenience is increased by the inclusion of a microprocessor, which extends the usefulness of the instrument by offering the statistical functions of mean, standard deviation, max, and min for repetitive time intervals. A user-defined time interval reference is included for the cancellations of systematic errors.

The high resolution time interval capability makes the instrument ideal for IC testing, radar and laser ranging, digital communications, ballistics and nuclear measurements.

### Functions

**TI:** Time Interval function measures time difference from the START to the STOP channel. In the  $\pm$  TI mode, the counter will measure the time from the first event in either channel to the first event in the other channel. The microprocessor affixes a negative sign to the display if the stop channel event occurred first.

The negative time feature allows applications like differential phase measurement between two waveforms to be continuously monitored even though the phase changes from a positive to a negative drift. Statistical functions are available in both TI modes.

**Trig Lev:** Measures the trigger levels of START and STOP channels and displays both levels simultaneously with 10 mV resolution. Additional equipment like oscilloscopes or DVM's is not required.

**Freq:** Measures the frequency of the STOP channel signal by taking the reciprocal of a period average. Both timed gates and single period gates are available. In the single period mode, resolution may be improved by using a larger sample size. Statistics are available in the single period mode.

The exceptionally high resolution (11-12 digits per second) of the 5370A makes the instrument ideal for directly measuring the drift of oscillators and other applications requiring exceptionally high frequency resolution.

**Period:** Measures the period average of STOP channel events. Statistics are available in the single period mode, but not with timed gates.

### Statistics

Statistical functions allow much more complete characterization of time intervals. In addition to the mean, both the max and min within a selected sample size are available and also the standard deviation. In many cases, these parameters are of more interest than the mean. For example, in a digital communications system, the limits of pulse jitter as described by the max and min could be of primary interest. For a normal distribution of jitter, the standard deviation gives the rms jitter directly.

**Sample size:** push-button selectable to 1, 100, 1K, 10K, and 100K samples.

**Mean:** displays the mean estimate which is the average for the selected sample size.

**Std dev:** displays a standard deviation estimate for the selected sample size.

**Min:** displays the minimum time interval measured within the selected sample size.

**Max:** displays the maximum time interval measured within the selected sample size.

### Arming

Extremely flexible arming greatly extends the usefulness of the 5370A into new applications. "Hold-off" features allow complex pulse trains to be measured by preventing "stop channel" arming until the removal of an external "gating" signal. An example could be the measurement of time from a radar or laser send pulse to the return pulse, where depending on the range of the object, several return pulses may occur before the return pulse of interest.

Other methods of arming allow the counter to be externally gated by an input waveform which very precisely controls both measurement duration and the time position at which the measurement occurs. Applications are in the frequency profiling of VCO's, pulsed RF bursts, or sweep linearity investigations.

The following modes of arming are available:

**+TI**

Internally armed – no hold-off

Externally armed – no hold-off

Externally armed – external hold-off

**$\pm$  TI**

External arming

Internal arming



## Programming

Major controls are programmable as standard via the HP-IB making the 5370A an economical, versatile unit for systems applications.

## Data output rate

- 1) HP-IB: 10-20 readings per second.  
Dead time between measurements within a sample is 330  $\mu$ s.
- 2) Fast Binary: 6 kHz  
Dead time between measurements is 165  $\mu$ s.

## 5370 Specifications

**Sensitivity:** 100 mV p-p, 35 mV rms sine wave  $\times$  attenuator setting.

**Impedance:** Selectable 1 M $\Omega$ //30 pF or 50  $\Omega$  nominal.

**Trigger level:** -1.3V to 0.5V, adjustable; 10 mV displayed resolution.

**Trigger slope:** independent selection of + or - slope.

**Attenuators:**  $\times 1$  and  $\times 10$  nominal.

### Dynamic range (preset):

- 50  $\Omega$   $\times 1$ :** 100 mV to 1 V p-p pulse;  **$\times 10$ :** 1 V to 7 V p-p pulse  
**1 M $\Omega$   $\times 1$ :** 100 mV to 1 V p-p pulse;  **$\times 10$ :** 1 V to 10 V p-p pulse  
 Dynamic range for rms sine wave is one-third of the above values.

### Signal operating range:

- 50  $\Omega$   $\times 1$ :** -2.5 V to 1 V;  **$\times 10$ :** -7 V to 7 V  
**1 M $\Omega$   $\times 1$ :** -2.5 V to 1 V;  **$\times 10$ :** -25 V to 10 V

**Coupling:** AC or DC switch selectable.

**Minimum pulse width:** 5 ns

### Maximum input:

- 50  $\Omega$   $\times 1$ :**  $\pm 7$  V DC  
 7 V rms below 5 MHz  
 3.5 V rms (+24 dBm) above 5 MHz  
 **$\times 10$ :**  $\pm 7$  V DC, 7 V rms (+30 dBm)  
**1 M $\Omega$   $\times 1$ :**  $\pm 350$  V DC  
 250 V rms to 20 kHz decreasing to 3.5 V rms  
 above 5 MHz  
 **$\times 10$ :**  $\pm 350$  V  
 250 V rms to 20 kHz decreasing to 35 V rms  
 above 5 MHz

### Common Input

All specifications are the same as for separate operation with the following differences:

**Impedance:** 1 M $\Omega$  becomes 500 k $\Omega$  shunted by <60 pF. 50  $\Omega$  same as in separate.

### Sensitivity (preset):

- 50  $\Omega$   $\times 1$ :** 200 mV p-p, 70 mV rms;  **$\times 10$ :** 2 V p-p, 700 mV rms  
**1 M $\Omega$ :** same as in separate

### Dynamic range (preset):

- 50  $\Omega$   $\times 1$ :** 200 mV to 2 V p-p pulse;  **$\times 10$ :** 2 V to 5 V p-p pulse  
**1 M $\Omega$ :** same as in separate

### Maximum input:

- 50  $\Omega$   $\pm 5$  V DC or 5 V rms  
 1 M $\Omega$  same as in separate

**Attenuators:** Becomes  $\times 2$  and  $\times 20$  for 50  $\Omega$

## Time Interval Measurements

### Time interval range

- $\pm$  **Mode:** -10 seconds to +10 seconds including 0 seconds  
 + **Only Mode:** 10 ns to 1 seconds  
**Sample Size. (N):** 1, 100, 1000, 10,000, 100,000  
 1 to 16777215 via HP-IB

**Statistics:** Mean, Standard Deviation, Maximum, Minimum. Time between measurements 330  $\mu$ s; minimum rise time 1 ns

**Least Significant Digit Displayed:** 20 ps /  $\sqrt{N}$

### Resolution:

( $\pm 100$  ps rms  $\pm$  Start Trigger Error  $\pm$  Stop Trigger Error)  $\div \sqrt{N}$

**Accuracy:**  $\pm$  Resolution  $\pm$  Time Base Error  $\times$  Time Interval  
 $\pm$  Trigger Level Timing Error  $\pm 1$  ns Systematic

**Trigger error =**

$$\frac{\sqrt{(150 \mu\text{V})^2 + e_n^2}}{\text{Input voltage slew rate (V/s) at trigger point}} \text{ secs rms}$$

where 150  $\mu$ V is the typical rms input amplifier noise on the 5370A and  $e_n$  is the rms noise of the input signal for a 500 MHz bandwidth.

**Trigger level timing error =**

$$25 \text{ mV} \div \text{Input voltage slew rate (V/s) at trigger point}$$

## Frequency Measurements

**Frequency range:** 0.1 Hz to 100 MHz

### Timed gates

**Internal gate time:** 1 period, 0.01, 0.1, 1 seconds

**Least Significant Digit Displayed:**  $\frac{20 \text{ ps}}{\text{Gate Time}} \times \text{FREQ}$

### Resolution:

$$\pm \frac{100 \text{ ps}}{\text{Gate Time}} \times \text{FREQ} \pm 1.4 \frac{\text{Trigger Error}}{\text{Gate Time}} \times \text{FREQ}$$

**Accuracy:**  $\pm$  Resolution  $\pm$  (Time Base Error)  $\times$  FREQ  
 $\pm$  (100 ps Systematic  $\div$  Gate Time)  $\times$  FREQ

**Statistics:** Mean

### Sample mode (single period)

**Sample size:** same as Time Interval

**Least Significant Digit Displayed:** 20 ps /  $\sqrt{N} \times \text{FREQ}$

### Resolution:

$$\pm \frac{100 \text{ ps}}{\text{Gate Time}} \times \text{FREQ} \pm 1.4 \frac{\text{Trigger Error}}{\text{Period} \sqrt{N}} \times \text{FREQ}$$

**Accuracy:**  $\pm$  Resolution  $\pm$  (Time Base Error)  $\times$  FREQ  
 $\pm$  (100 ps Systematic  $\div$  Period)  $\times$  FREQ

**Statistics:** Mean, Standard Deviation, Maximum, Minimum.

### External Gate

**Gate input:** 20 ns to 1 seconds/sample size

**Resolution and accuracy** estimates may be made with the same specifications as Timed Gates above.

## Period Measurements

**Period range:** 10 ns to 10 seconds

### Timed gates

**Internal gate time:** 1 period, 0.01, 0.1, 1 seconds

**Least Significant Digit Displayed:**  $\frac{20 \text{ ps}}{\text{Gate Time}} \times \text{PERIOD}$

### Resolution:

$$\pm \frac{100 \text{ ps}}{\text{Gate Time}} \times \text{PERIOD} \pm 1.4 \frac{\text{Trigger Error}}{\text{Gate Time}} \times \text{PERIOD}$$

**Accuracy:**  $\pm$  Resolution  $\pm$  Time Base Error  $\times$  PERIOD  
 $\pm$  (100 ps Systematic  $\div$  Gate Time)  $\times$  PERIOD

### Sample Mode (single period)

**Sample size (N):** Same as Time Interval.

**Least Significant Digit Displayed:** 20 ps /  $\sqrt{N}$

**Resolution:**  $\pm 100 \text{ ps} / \sqrt{N} \pm 1.4 \text{ Trigger Error} / \sqrt{N}$

**Accuracy:**  $\pm$  Resolution  $\pm$  Time Base Error  $\times$  PERIOD  
 $\pm 100 \text{ ps Systematic}$

**Statistics:** Mean, Standard Deviation, Maximum Minimum

### External Gate

**Gate input:** 20 ns to 10 seconds

**Resolution and Accuracy** estimates may be made with the same specifications as timed measurements above.

## Time Base (HP Model 10811A)

Standard High Stability Oven Oscillator

**Frequency:** 10 MHz

**Aging:**  $< 5 \times 10^{-10}$  per day

**Temperature:**  $< 2.5 \times 10^{-9}$  0 $^\circ$  C to 50 $^\circ$  C

## General

**Display:** 16 digits, suppressed leading zeros.

**Size:** 133 H  $\times$  426 W  $\times$  521 mm D (5.25"  $\times$  16.75"  $\times$  20.5").

**Weight:** 32 lbs.

**Power Requirements:** 100, 120, 220, or 240 V ac +5%–10%, 48 to 66 Hz, less than 250 VA.

**Front Handles:** supplied with instrument.

**5370A Universal Time Interval Counter**  
**10870A: Service Kit Accessory**

**\$7500**  
 add \$430

# ELECTRONIC COUNTERS

## Time interval probes

Model 5363B

- Solves major T.I. problems
- Precisely defines trigger points
- Greatly improves dynamic range

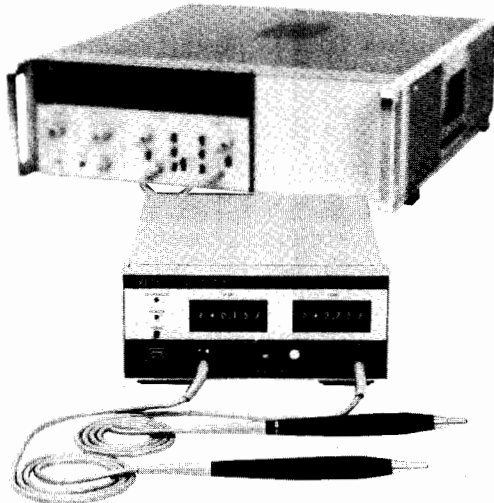

HP-IB programmable Time Interval Probes



### Repeatable Measurements

The 5363B provides the necessary input signal conditioning to allow a precision time interval counter to make highly accurate and repeatable measurements on time varying waveforms. No longer are counters restricted to "event" type measurements such as pulse width or pulse to pulse. Counters such as the 5345A, 5328A, 5335A, and 5370A can now be adapted to make measurements such as rise time, fall time, slew rate, propagation delay and phase jitter analysis.

### Trigger Point Calibration

A unique scheme of Trigger Point Calibration is used instead of hysteresis compensation to insure that the value selected on the digital dials or via the HP-IB is the actual triggering point rather than some unspecified "best estimate" of the trigger point or the center of the hysteresis window.

### 20 V Operating Range with 10 mV Resolution

Greatly improved dynamic range allows the trigger point to be selected in 10 mV increments from -9.99 V to +9.99 V covering the range of most commonly used logic circuits. The use of attenuators on traditional T.I. counters to extend their range increases the effective hysteresis window by the same attenuation amount. This prevents trigger points close to the top or bottom (i.e. 10% or 20% points) of the waveform from being selected and sometimes creates "holes" where certain trigger points cannot be selected at all. The wide dynamic range of the 5363B overcomes these problems.

### Minimized Circuit Loading

Active high impedance, low capacitance probes minimize circuit loading and pulse distortion. Each probe contains both a start and stop channel so that a rise time into a device can be measured with one probe, the rise time out of the device with the other and the propagation delay through the device can be measured between the probes.

### Systematic Timing Errors Eliminated

Delays through probes, cables and the inherent differential delays inside the counter's timing channels (i.e., <700 ps in 5345A) limit the absolute accuracy of the time interval measurement to some unknown but fixed amount.

The 5363B calibration procedure equalizes out such system delays and allows the counter and probes to be set for 0.0 ns. When a counter with a minimum T.I. range is used (such as HP 5345A or 5328A) a fixed offset of 10.0 ns can be switched in allowing the counter to measure down to zero time interval.

- Equalizes system timing errors
- Active probes minimize circuit loading
- Measures to zero time interval

### Automatic Operation

Under desktop computer control the standard HP-IB capability allows the probes and a counter to perform a wide variety of automatic waveform analysis. In the lab or production line complex measurements or go-no-go decisions can be made with push button simplicity.

### Specifications

- Operating range:** ± 10 V.
- Minimum input voltage:** ± 100 mV above and below the trigger point.
- Damage level:** ± 30 V.
- Voltage resolution:** 10 mV.
- Time resolution:** depends on counter used (typically 10 ps with 5345A T.I. Avg.; 35ps single shot with the 5370A).
- Impedance:** 1 MΩ shunted by <20 pF.
- Effective bandwidth:** 350 MHz (or 1 ns rise time).
- Minimum pulse width:** input signal must remain below and above trigger point for at least 5 ns (i.e., max repetition rate of square wave = 100 MHz).
- Output to counter:** separate start and stop channels, -0.5 V to +0.5 V into 50 Ω, slew rate through zero volts is greater than 0.25 V/ns.
- Trigger level outputs:** trigger point setting ± 75 mV.
- Delay compensation range:** 2 ns adjustable about 0.0 ns or 10.0 ns.
- Power:** 100, 120, 220, or 240 V ac +5 -10%; 48 to 440 Hz; 40 VA max.
- Weight:** net 3.0 kg (6.5 lb); shipping 5.5 kg (12 lb).
- Dimensions:** rack height 88.1 mm (3.5"); half rack module 212 mm (8.38"); depth 248 mm (11.6"). Probe length 122 cm (4 ft.).
- Environmental:** operating temperature 0°C to 55°C.

### Absolute accuracy

$$\begin{aligned}
 & \pm 1 \text{ ns} \pm \frac{\text{START trigger level accuracy} + \text{START noise trigger error}}{\text{START signal slew rate at trigger point}} \\
 & \pm \frac{\text{STOP trigger level accuracy} + \text{STOP noise trigger error}}{\text{STOP signal slew rate at trigger point}}
 \end{aligned}$$

### Trigger level accuracy:

Trigger Level	-5 to +9 V	-5 V to -10 V	+9 V to +10 V
*Trigger level accuracy	± 8 mV ± 0.4 mV/°C	± 1% trigger voltage	50 mV
*Differential trigger level accuracy	± 0.15% trigger voltage	± 1% trigger voltage	100 mV

\*Differential trigger level accuracy applies when both START and STOP trigger level voltages are set equal and identical waveforms applied.

\*\*After calibration and within the range between 100 mV or 8% whichever is greater from the top or bottom of the input signal.

**Noise trigger error:**  $\sqrt{(125 \mu\text{V})^2 + e_n^2}$  volts where 125 μV is the typical input noise on the 5363B and  $e_n$  is the input signal noise for a 350 MHz bandwidth.

### Recommended Counters

Counter	Price
5345A Electronic Counter; 2 ns single shot T.I., True T.I. averaging	\$5200
5328A Opt. 040 Universal Counter; 10 ns single shot T.I., True T.I. averaging	\$1800
5370A Universal Time Interval Counter 20 ps single shot	\$7500

### 5363B Accessories

10229A Hook Tip	\$10
10218A BNC BNC to Probe Adapter	\$15
1250-0655 BNC Tee to Probe Adapter	\$15
10100C 50 Ω Feedthru termination for non-50 Ω T.I. counter	\$25
10821A Accessory Kit with 2 each of above plus adapters	\$125

### 5363B Time Interval Probes

**\$2650**

# ELECTRONIC COUNTERS

200 MHz Universal Counter

Model 5335A



- A High Performance 200 MHz/2ns Universal Counter
- Built-In Automatic Rise Time, Duty Cycle, Pulse Width, Slew Rate and Phase Measurements
- Unique Advanced Automatic Triggering Capabilities
- HP-IB plus Math and Statistics Functions Standard



5335A

## Remarkable Automatic Measurement Power

The HP-5335A is an advanced universal counter with automatic measurement power built-in. Designed either for bench or systems applications, the counter has 16 front-panel measurement functions, plus four "phantom" functions. All automatically selected by push button or by HP-IB. These twenty functions, plus greatly expanded arming and triggering capability make the 5335A a most powerful universal counter. In addition, math and statistics features, matched Channel A and B input amplifiers, and HP-IB, are all included in the standard unit, making the 5335A easily the most advanced universal counter available at its price.

The 5335A has all the measurement functions normally found in a universal counter. Plus, it has automatic operation. Beyond these features, it possesses new measurements not previously included in this type of instrument.

## Pulse Characterization Measurements

Most HP universal counters provide you with a fairly complete measurement set. The 5335A possesses all these expected universal measurements, and does them better than ever before. But, beyond the expected measurement set, the 5335A has the ability to automatically measure waveform characteristics for various applications. Op Amp Characterization is one area where a number of measurements are needed to define the amplifiers performance. Using the 5335A and a signal source, rise and fall times, output slew rate, and propagation times can be measured with one test set-up. Also, duty cycle can be measured to see the distortion on a square wave through the amplifier due to different rising and falling slew rates. Lastly, phase measurements are also push-button selectable and automatically performed by the counter.

## Complete Triggering Capability

To get good measurement results, a counter must properly trigger on the input signal. The 5335A employs both manual and automatic trigger modes to quickly and easily set the right trigger points.

### Manual Triggering

The counter has a  $\pm 5$  VDC range to help reduce input attenuator use for most input signals, including TTL.

### Automatic Triggering

Two auto trigger modes help you trigger automatically. Just press *auto trig* or select auto trig on the HP-IB; and the counter automatically selects 10%-90% Rise/Fall time trigger points, 50% phase trigger points, or the pre-set value of your choice. Then it tracks the signal's DC offset continuously to stay on the right trigger point.

## Trigger Level DVM

Built-in to the basic counter. Just press TRG LVL to see both input channel trigger levels displayed.

## A Full Set Of Universal Measurement Functions

In addition to waveform characterization features, the 5335A has an extremely wide set of measurement functions covering frequency, time, events and volts. These functions let you characterize signals quicker and more thoroughly than ever before possible.

## Frequency

Frequency is the most common measurement performed by counters. The 5335A measures to 200 MHz in Channel A, 100 MHz in Channel B, and 1.3 GHz in its optional Channel C. Due to the counter's advanced design and reciprocal measurement technique, resolution is a constant 9 digits per second of gate time across its entire measurement range.

## Time

In a universal counter, a time interval measurement equates to a stopwatch measurement started and stopped by unique events. Precision is dependent on the counter's circuitry.

To ensure precision, the 5335A has matched custom input amplifiers to greatly reduce trigger errors that might be produced if the start and stop signals were amplified differently. Further, the counter employs an analog interpolation technique that turns its 10 MHz clock into the equivalent of a 1 GHz time base. The 5335A is thus able to resolve single shot time interval measurements to better than 2 nanoseconds (100 ps with averaging). This analog interpolation eliminates the need found in some counters for a phase-modulated (jittered) time base for time interval average measurements.

## Math and Statistics

Averaging techniques are often used to extend the resolution of a counter. For averaging, the 5335A provides sample sizes of  $N = 100$  or  $N = 1,000$ . Best of all, averaging can be employed for all measurements except phase. In addition to mean, and selection of sample size, the counter takes standard deviations of the current measurement for the sample size selected.

Math functions are another built-in feature that provide operator convenience. These functions let you convert the display into direct indications of parameters like flow, speed, pressure, and temperature. Additionally, the counter remembers the offset, scale, and normalize factors for each measurement function.







## Model 5335A (cont.)

**Specifications****Input Characteristics (Channel A and B)****Range**

DC coupled, 1 to 100 MHz.

AC 1 M $\Omega$ , 30 Hz to 100 MHz.AC 50 $\Omega$ , 200 KHz to 100 MHz

NOTE: Channel A range 200 MHz when in Frequency A and Ratio modes.

**Sensitivity (X1):**

25 mV rms sinewave

75 mV peak-to-peak pulse at minimum pulse width of 5 ns.

**Dynamic Range (X1):**

75 mV to 5V peak-to-peak, to 100 MHz.

75 mV to 2.5V peak-to-peak, &gt;100 MHz.

**Signal Operating Range (X1, DC):**

-5V dc to +5V dc.

**Trigger Level Range (X1):****Auto Trigger OFF:**

Preset: Set to 0V dc NOMINAL

Adjustable: -5V dc to +5V dc

**Auto Trigger ON:**

Preset: Set to nominal 50% point of input signal.

Adjustable: nominally between + and - peaks of input signal.

**Auto Trigger (X1):****Range (50% duty cycle):**

DC coupled, 30 Hz to 200 MHz.

AC 1 M $\Omega$ , 30 Hz to 200 MHzAC 50 $\Omega$ , 200 kHz to 200 MHz**Minimum Signal:** 100 mV rms.**Duty Cycle Range:** 10% to 90%.**Response Time:** 3 seconds, typical.

NOTE: Auto Trigger requires a repetitive signal.

**Coupling:** AC or DC, switchable.**Impedance:** 1M $\Omega$ , nominal, shunted by <35pf or 50 $\Omega$  nominal, switchable. In COMMON A, 1M $\Omega$  is shunted by <50pf.**Attenuator:** X1 or X10 nominal, switchable.**Slope:** Independent selection of + or - slope.**Channel Input:** SEPARATE or COMMON A, switchable.**Frequency A****Range:** 0 to 200 MHz, prescaled by 2**LSD Displayed:**

$$\frac{1 \text{ ns}}{\text{Gate Time}} \times \text{FREQ. (e.g. 9 digits in a second)}$$

**Resolution:**

$$\pm (2 \times \text{LSD}) \pm 1.4 \times \frac{\text{Trigger Error}}{\text{Gate Time}} \times \text{FREQ.}$$

**Accuracy:**  $\pm$  (Resolution)  $\pm$  (Time Base Error)  $\times$  FREQ.**PERIOD A****Range:** 10 ns to 10<sup>7</sup> s.**LSD Displayed:**

$$\frac{1 \text{ ns}}{\text{Gate Time}} \times \text{PER. (e.g. 9 digits in a second)}$$

**Period Average:** User selects MEAN function, and n = 100, or n = 1,000.**Time Interval A  $\rightarrow$  B****Range:** 0 ns to 10<sup>7</sup> s.**LSD Displayed:** 1 ns (100 ps using MEAN)**Resolution:**  $\pm$  (2  $\times$  LSD)  $\pm$  (START Trigger Error)  $\pm$  (STOP Trigger Error)**Accuracy:**  $\pm$  (Resolution)  $\pm$  (Time Base Error)  $\times$  TI  $\pm$  (Trigger Level Error)  $\pm$  (2 ns)**Gate Mode:** MIN only.**Time Interval Average:** User selects MEAN function, and n = 100, or n = 1,000**Time Interval Delay (Holdoff)**Front panel Gate Adjust control inserts a variable delay between START and enabling of STOP. Electrical inputs during delay are ignored. Delay ranges are same as gate time ranges (100  $\mu$ s, to 4s NOMINAL) for gate modes of Fast, Norm, and Manual.**Inverse Time Interval A  $\rightarrow$  B****Range:** 10<sup>-10</sup> to 10<sup>9</sup> units/secondLSD Displayed, Resolution, and Accuracy are inverse of Time Interval A  $\rightarrow$  B specifications.**Rise and Fall Time A****Range:** 20 ns to 10 ms transition with 50 Hz to 25 MHz repetition rates (50% duty cycle).**Minimum Pulse Height:** 500 mV peak-to-peak.**Minimum Pulse Width:** 20 ns.**Duty Cycle Range:** 20% to 80%.LSD Displayed and Resolution are same as Time Interval A  $\rightarrow$  B Specifications.**Pulse Width A****Range:** 5 ns to 10<sup>7</sup> s.**Trigger Point Range:** 40% to 60% of pulse height.LSD Displayed and Resolution are same as Time Interval A  $\rightarrow$  B specifications.**Duty Cycle A****Range:** 1% to 99%, 0 to 100 MHz.**Trigger Point Range:** 40% to 60% of pulse height.

$$\text{LSD Displayed: } \frac{1 \text{ ns}}{\text{PER}} \times 100\%$$

NOTE: Constant duty cycle required during measurement.

**Slew Rate A****Range:** 50 V/s to 10<sup>8</sup> V/s slew rate with 50 Hz to 25 MHz repetition rates (50% duty cycle). Minimum Pulse Height, Width, and Duty Cycle Range are same as Rise and Fall Time A.**Input Mode:** Automatically set to COMMON A with 10% and 90% trigger levels.**Ratio A/B****Range:** Channel A, 0 to 200 MHz (prescaled by 2).  
Channel B, 0 to 100 MHz

$$\text{LSD Displayed: } \frac{\text{RATIO}}{\text{FREQ} \times \text{Gate Time}} \quad \text{where FREQ is higher frequency after prescaling.}$$

**Totalize A****Range:** 0 to 100 MHz.**LSD Displayed:** 1 count of input**HP-IB Output:** At end of gate.**Manual:****Count Reset:** Via RESET key.**HP-IB Output:** Totalize data on-the-fly sent if cycle mode set to Single. Input frequency range in this mode is 0 to 50 Hz nominal.**Gated:****Count Reset:** Automatic after measurement.**PHASE A REL B****Range:** -180° to 360°, Range Hold off, or 0° to 360°, Range Hold on, with signal repetition rates of 30 Hz to 1 MHz.**Minimum Signal:** 100 mV rms.**LSD Displayed:** 0.1°**Gate Time****Range:** 100 ns to 10<sup>7</sup> s.**LSD Displayed:** Up to three digits with Ext. Arm Enable OFF, 100 ns when ON. MIN Gate Mode display zero.

**Trigger Level**

**Range:** X1, +5 to -5 volts; X10, +50 to -50 volts.

**Resolution:** X1, 10 mV; X10, 100 mV.

**Accuracy (X1):** ±20 mV, ±0.5% of reading

**Time Base**

**Standard Crystal:**

**Frequency:** 10 MHz

**Aging Rate:** < 3 × 10<sup>-7</sup>/month.

**Temperature:** < 4 × 10<sup>-6</sup>, 0 to 50°C.

**Line Voltage:** < 1 × 10<sup>-7</sup> for 10% change.

**High Stability Crystal:** See Option 010.

**External Time Base Input:** Rear panel BNC accepts 5 or 10 MHz, 200 mV rms into 1 kΩ; 5V rms maximum

**Time Base Out:** 10 MHz, >1V p-p into 50Ω via rear panel.

**Statistics**

**Sample Size:** Selectable between either n = 100 or n = 1,000 samples.

**Std. Dev.:** Displays a standard deviation of selected sample size.

**Mean:** Displays mean estimate of selected sample size.

**Smooth:** Performs a weighted running average and truncates unstable least significant digits from display.

**Math**

All measurement functions, with exception of GATE TIME and TRIG LVL, may be operated upon by Math functions. Offset, Normalize, and Scale may be used independently or together as follows:

$$\text{Display} = \frac{\text{Measurement} + \text{Offset}}{\text{Normalize}} \times \text{Scale}$$

**Number Value Range:** ±1 × 10<sup>-9</sup> to ±9 × 10<sup>9</sup>

**Last Display:** Causes value of previous display to Offset (negative value), Normalize, or Scale all subsequent measurements.

**Measurement t-l:** Causes each new measurement to be Offset (negative value), Normalized, or Scaled by each immediately preceding measurement.

**Hewlett-Packard Interface Bus**

**Programmable Controls:** All measurement functions, Math, Statistics, Reset, Range Hold, Ext. Arm Enable/Slope, Check, Gate Adj. (~ 1 ms to 1 s), Gate Open/Close (gate times to ∞), Gate Mode Cycle, Preset, Slope, Common A, Auto Trigger.

**Special Functions:** FREQ B, PULSE B, TIME B → A, TOT A-B, LEARN, MIN, MAX, all internal diagnostic routines.

**HP-IB Commands:** Trigger, Clear, Remote, Local, Local Lockout, Require Service.

**Data Output:** Fixed output format consisting of 19 characters plus CR and LF output is typically 8 ms.

**General**

**Gate:** Minimum, manual, or continuously variable (NORM/FAST) via Gate Adj. control

**NORM:** 20 ms to 4 s NOMINAL.

**FAST:** 100 μs to 20 ms NOMINAL.

**MIN:** Minimum gate time. Actual time depends on function.

**MANUAL:** Each press opens or closes gate.

**Cycle:** Determines delay between measurements.

**NORM:** No more than 4 readings per second, nominal.

**MIN:** Updates display as rapidly as possible (~ 15 readings per second, depending on function).

**SINGLE:** One measurement taken with each press of button.

**Arming:** Ext. Arm Enable key allows rear panel input to determine Start and/or Stop point of a measurement. External gate defined by both Start and Stop armed. All measurements are armable except Manual Totalize, Phase, and Trigger Level.

**Start Arm:** + or - slope of arm input signal starts measurement.

**Stop Arm:** + or - slope of arm input signal stops measurement. When used, Start Arm must occur before Stop Arm.

**Ext. Arm Input:** Rear panel BNC accepts TTL into 20 kΩ. Minimum Start To Stop Time: 200 ns.

**Trigger Level Out:** DC output into 1 MΩ via rear panel BNC's for Channel A and B; not adjusted for attenuators.

**Accuracy at DC (X1):** ±15mV ±0.5% of TRIG LVL reading.

**Gate Out:** TTL level into 50Ω; goes low when gate open; rear panel BNC.

**Range Hold:** Freezes decimal point and exponent of display.

**Reset:** Starts a new measurement cycle when pressed.

**Check:** Performs internal self test and lamp test.

**Display:** 12-digit LED display in engineering format; exponent range of +18 to -18.

**Operating Temperature:** 0 to 50°C.

**Power Requirements:** 100, 120, 220, 240 VAC (+5%, -10%), 48-66 Hz; 130 VA max.

**Weight:** Net, 8.8 kg (19 lbs. 8 oz.); shipping, 13.6 kg (30 lbs.)

**Dimensions:** 425.5 mm W × 132.6 mm H × 345.4 mm D (16¼" × 5¼" × 13½"), not including removable handles.

**Options**

**Option 010: High Stability Time Base (Oven)**

**Frequency:** 10 MHz.

**Aging Rate:** < 5 × 10<sup>-10</sup>/day after 24 hour warm up.

**Short Term:** < 1 × 10<sup>-10</sup> rms for 1s average.

**Temperature:** < 7 × 10<sup>-9</sup>, 0 to 50°C

**Line Voltage:** < 1 × 10<sup>-10</sup> for 10% change.

**Warm-Up:** Within 5 × 10<sup>-9</sup> of final value in 20 minutes.

**Option 020: DC Digital Voltmeter**

**Range:** 4 digits, autoranging, autopolarity, in ±10, ±100, ±1000 V ranges.

**Sensitivity:** 100 μV, 1 mV, 10 mV, 100 mV for ±1V, ±10 V, ±100 V, ±1000 V readings.

**LSD Displayed:** Same as sensitivity.

**Input Type:** Floating pair

**Input Impedance:** 10 MΩ ± 1%

**Option 030: 1.3 GHz C Channel**

**Input Characteristics**

**Range:** 150 MHz to 1.3 GHz

**Sensitivity:** 10 mV rms sinewave (-27 dBm) to 1 GHz. 100 mV rms sinewave (-7 dBm) to 1.3 GHz.

**Frequency C**

**Range:** 150 MHz to 1.3 GHz, prescaled by 20. LSD Displayed, Resolution, and Accuracy are same as Frequency A.

**Ratio C/A**

**Range:** Channel A, 0 to 200 MHz

Channel C, 150 to 1300 MHz.

**Definitions**

**Duty Cycle:** Percentage of time a signal is high or low, depending on Slope A setting. Trigger point is high/low dividing point.

$$\text{DUTY CY} = \frac{\text{PULSE}}{\text{PER}} \times 100\%$$

**Slew Rate:** Effective slope between 10% and 90% points of rising or falling signal depending on Slope A setting.

$$\text{SLEW} = \frac{V_B - V_A}{T_I}$$

**Phase:** Angle, with respect to B signal, between 50% points of channel A and B signals, trigger slopes selected by Channel A and B slope switches.

$$\text{PHASE} = (T_{I1} + T_{I2}) \div \frac{2}{\text{PER}} \times 360^\circ,$$

T<sub>I1</sub> is time between 50% points of A then B signals using slopes defined during Phase measurement.

T<sub>I2</sub> is time between 50% points of A then B signals using complement slopes to T<sub>I1</sub>.

**Front Handles:** supplied with instrument.

**Ordering Information**

**Option 010:** Oven Oscillator

**Option 020:** DVM

**Option 030:** C Channel

**5335A Universal Counter**

**Price**

add \$650

add \$275

add \$450

**\$2,950**



# ELECTRONIC COUNTERS

100 MHz Universal counter

Model 5328A

- 100 MHz, 512 MHz and 1300 MHz
- 100 ns or 10 ns time interval
- T.I. averaging to 10 ps resolution
- "Armed" measurements
- DVM options
- HP-IB interface option

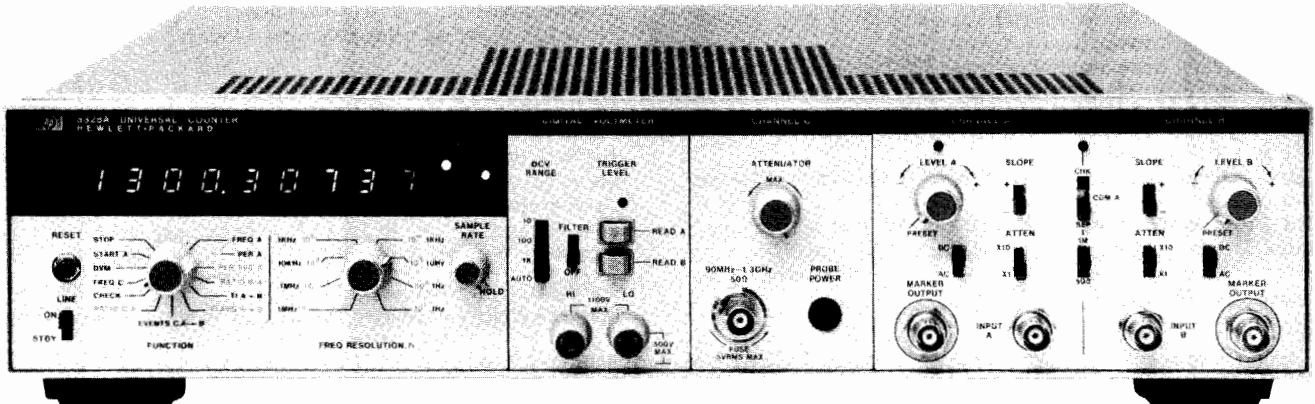

5328A with Opt 021,031,041



## Description

The 5328A, thru the use of the latest technology (such as a ROM controlled measurement cycle) and a modular design, provides you with the optimum in universal counter price/performance. Optional modules allow you to tailor the performance of the 5328A to meet your particular measurement needs. In many instances, however, the standard 5328A offers all the capability you're likely to need.

**Burst and CW measurements to 100 MHz:** special gating circuits start a measurement only when the input signal is present, allowing burst frequencies to be measured as easily as CW signals. The option 030 channel C extends this capability to 512 MHz; option 031, to 1300 MHz.

**Single shot time interval measurements:** the standard universal module's 100 ns single shot resolution meets or exceeds the requirements for a wide range of applications such as mechanical and electromechanical device timing (relays), time of flight measurements (ballistics), sonar ranging, radio ranging and navigation

**Time interval averaging:** resolution better than 10 ps ( $10^{-11}$  seconds) for repetitive time intervals as short as 100 ps.

**Period, period average, ratio, totalize, scale:** extra problem solving power for your special requirements.

**Armed measurements:** versatile arming modes (controlled by a rear panel switch) allow real time control over when a measurement begins. Useful for measurements such as frequency burst profile and frequency sweep linearity.

**Trigger lights:** trigger light blinks when channel is triggering; light is ON when input is above trigger level; OFF when input is below trigger level. Simplifies trigger level adjustments

**High performance marker outputs:** marker outputs (operational to 100 MHz) indicate where channel is triggering in real time for oscilloscope monitoring applications. Provides measurement feedback to the operator for greatly simplified measurement set-ups.

These features and capabilities make the 5328A an excellent choice for general purpose lab use, electronic service, and production test. For more demanding applications, a variety of options offer extended performance at a modest increase in price.

## Summary of Characteristics

Model No.	Description	Features	Note
5328A	Universal Counter	Frequency to 100 MHz; 100 ns single shot T.I.; T.I. averaging; Period; Period Avg; ratio; totalize	
Opt. 010	High Stability Time Base	Oven oscillator with aging rate $< 5 \times 10^{-10}$ /day	
Opt. 011	HP-IB Interface	Allows 5328A to output data and be controlled via the HP Interface Bus.	
Opt. 020	DVM	Single ended DVM for trigger level and external voltage measurements	
Opt. 021	High Performance DVM	Floating DVM for trigger level and high accuracy external voltage measurements.	
Opt. 030	512 MHz Channel C	Frequency measurements to 512 MHz; 9 digit display.	
Opt. 031	1300 MHz Channel C	Frequency measurements to 1300 MHz; 9 digit display.	
Opt. 040	High Performance Universal Module	Same as standard 5328A but with 10 ns single shot T.I.; improved T.I. averaging; improved T.I. accuracy; measurements with delay; T.I.A-B marker; hysteresis compensation; switchable input impedance (1 M $\Omega$ /50 $\Omega$ ).	
Opt. 041	Programmable Input Module	Full remote programming of all universal module controls thru opt. 011; 10 ns single shot T.I.; switchable 1 M $\Omega$ /50 $\Omega$ input impedance.	Opt. 011 Required for HP-IB use



## 5328A Option Descriptions

### High Stability Time Base (Opt 010)

The standard time base for the 5328A is a room temperature 10 MHz crystal providing a long term aging rate of less than 3 parts in  $10^7$  per month. The option 010 oven oscillator offers excellent short term and temperature stability which can contribute to higher measurement accuracy. The low aging rate of  $<5 \times 10^{-10}$ /day permits longer intervals between time base calibrations.

### HP Interface Bus for Systems Use (Opt 011)

The option 011 HP-IB Interface brings the full capability and power of the HP Interface Bus. The 5328A can accept program code words over the HP-IB which remotely program various front and rear panel controls. In addition, measurement results may be output over the bus to HP-IB compatible instruments, calculators, or computers.

Remotely programmable controls include FUNCTION selection, RESOLUTION selection, ARMING, SAMPLE RATE (max. or manual), RESET, measurement modes, output modes, and display modes. Option 041 adds programming of channel A and B input signal conditioning controls.

### Digital Voltmeters (Opt 020, 021)

The unique combination of an integrating digital voltmeter with a universal counter produces a superb general purpose measuring instrument. By using a voltage-to-frequency conversion technique, the incremental cost of adding DVM capability to the 5328A is very low.

Two DVM options are available; the option 020 DVM with single-ended input and the option 021 High Performance DVM with floating input. You can use these DVMs to measure channel A and B trigger levels and external voltages. Since a built-in DVM greatly simplifies time interval measurement set-ups, it is highly recommended that one of the DVM options be selected, particularly if time interval measurements are one of your major applications.

### High Frequency Channel C (Opt 030, 031)

With a high frequency channel C module the 5328 is ideally suited for use in a wide variety of communications measurements. Option 030 gives direct count measurements to 512 MHz with 15 mV rms sensitivity; option 031 counts to a full 1300 MHz with 20 mV rms sensitivity. Typical applications include servicing, maintaining, calibrating, and monitoring communications transmitters and receivers such as found in two-way radio, radio and television broadcasting, mobile radio, and common carrier multiplexing and transmission.

### Extended Capability Universal Modules (Opt 040, 041)

Options 040 and 041 give extended performance for time interval measurements. Option 040 is designed for bench use and includes "delay" capability for increased measurement versatility. Option 041 adds full programming of the input signal conditioning controls.

Both of these options generate a 100 MHz clock to give 10 ns single shot resolution for time interval measurements. This resolution is useful in applications such as computer/peripheral timing measurements, logic timing measurements, radar ranging, and optical ranging.

For improved time interval averaging performance, the options have input channels adjusted for delay matching to better than 2 ns. Additionally, options 040 and 041 use a jittered clock in T.I. AVG. function to give averaging even for those cases when the input repetition rate is synchronous with the counter's internal time base.

Selectable input impedance adapts the counter to the measurement environment: 50 $\Omega$  for fast signals in a 50 $\Omega$  environment, 1 M $\Omega$  to reduce circuit loading or to use with scope probes.

The "delay" feature of option 040 allows you to disable the inputs from triggering for selected periods of time (20  $\mu$ s to 20 ms). Delay is useful for ignoring high amplitude noise such as from chattering relays or ignoring stop pulses in multiple stop T.I. measurements.

Option 041 allows remote programming of input trigger level, slope, coupling, and attenuator setting. Under remote control, the input impedance is independently selectable on the A and B channels. Also, a remote "Invert" function switches the A and B channel signals internally. "Invert" gives exceptional flexibility for two channel time interval measurements.

### Measurements with Delay (Opt 040)

Delay mode is activated by the inner concentric knob on Level A control of option 040 Universal Module. A red LED indicates delay is activated. In delay mode, Channel A triggers and is then disabled from triggering again until the delay times out (disabled state occurs within 1  $\mu$ s after triggering.) Channel B is continuously disabled until the delay times out. After the delay, both A and B are enabled. The delay time may be measured by placing the counter in T.I.A $\rightarrow$ B and the Universal Module in check (CHK).

**Delay range:** 20  $\mu$ s to 20 ms continuously adjustable.

**Minimum dead time:** 1  $\mu$ s between stop and next start (T.I. average measurements only).

### General

**Display:** 9 digit LED display, ninth digit used only with channel C functions (FREQ. C, Ratio C/A, Events C, A $\rightarrow$ B).

**Blanking:** suppresses display of unwanted zeros to left of most significant digit.

**Storage:** holds reading between samples; can be overridden by rear panel switch.

**Sample rate:** variable from less than 2 ms between measurements to HOLD which holds display indefinitely.

**Gate output:** rear panel output, TTL levels; high when counter gate open.

**Time base output:** rear panel output: TTL levels.

**Check signal:** with function switch in CHECK, counter should display 10 MHz  $\pm$  1 count. With options 040 and 041, place function switch in FREQ. A and universal module in CHECK (CHK). Counter should display 100 MHz  $\pm$  1 count.

**Operating temperature:** 0 $^\circ$  to 50 $^\circ$  C.

**Power requirements:** 100/120/220/240 V rms, +5%, -10% (switch selectable), 48-66 Hz; 150 VA max.

### Time base oscillators

#### Standard crystal oscillator

**Frequency:** 10 MHz.

**Aging rate:**  $<3 \times 10^{-7}$ /month.

**Temperature:**  $\pm 2.5 \times 10^{-6}$ , 0 $^\circ$  to 50 $^\circ$  C.

**Line voltage:**  $<1 \times 10^{-7}$  for 10% change.

#### Opt 010 oven oscillator

**Frequency:** 10 MHz.

**Aging rate:**  $<5 \times 10^{-10}$ /day after 24-hour warm-up.

**Short term:**  $<1 \times 10^{-10}$  rms/s.

**Temperature:**  $<7 \times 10^{-9}$ , 0 $^\circ$  to 50 $^\circ$  C.

**Line voltage:**  $\pm 5 \times 10^{-9}$  for 10% variation.

**Warm-up:** within  $5 \times 10^{-9}$  of final value in 20 min.

**Ext. freq. std. Input:** 30 kHz to 10 MHz signal of amplitude  $>1.0$  V rms into 1 k $\Omega$ . Maximum input: 5 V p-p. With options 040 and 041 the following constraints apply: ext. freq. std. must be 10 MHz for Period Avg., T.I. Avg., Period (N = 1), and T.I. (N = 1).

### HP-IB Interface (Opt 011)

Option 011 provides digital output of measurement data ("talker") as well as input for remote program control ("listener"). HP-IB cable not supplied.

**Programmable features:** function, resolution, sample rate (max or manual control), arming, display modes, measurement cycle modes, output modes, and reset commands. Option 041 adds control of channel A and B trigger level, slope, attenuator, coupling, input impedance, and SEP-COM-CHECK selection.

**HP-IB commands:** responds to the following bus commands (see HP-IB Users Guides for definitions)—Unlisten, Untalk, Local Lockout, Device Clear, Serial Poll Enable, Serial Poll Disable, Go to Local, Selected Device Clear, and Group Execute Trigger.

**Service request (SRQ):** if enabled, indicates end of measurement.

**Maximum data output rate:** 500 readings/sec.

### Accessories

5363B Time Interval Probes: solve many of the "hidden" problems of precision time interval measurements. The 5363B Time Interval Probes minimize circuit loading, give calibrated trigger level settings, increase input dynamic range, and allow differential channel delay calibration.

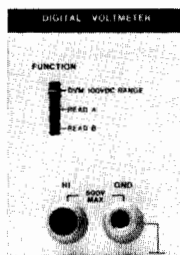
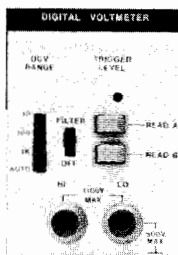
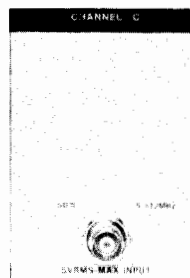
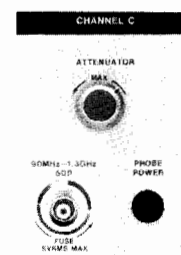
Opt 020  
DVMOpt 021  
High Performance DVMOpt 030  
512 MHz  
Channel COpt 031 1300 MHz  
Channel C

### Accessories

**10855A Preamp:** (for use with Opt 031): gives >22 dB gain with  $\pm 1$  dB flatness over the entire frequency range of the Opt 031 1300 MHz Channel C.

### Digital Voltmeter Modules

#### Digital Voltmeter Measurements†

**DVM (Opt 020 and 021):** trigger levels of input channels A and B and external voltages may be measured.

Maximum sensitivity	Opt 020	Opt 021
<b>Meas. time:</b>		
10 s (N = 10 <sup>3</sup> )	1 mV	10 $\mu$ V
1 s (N = 10 <sup>2</sup> )	1 mV	100 $\mu$ V
0.1 s (N = 10 <sup>1</sup> )	2 mV	1 mV
10 ms (N = 10 <sup>0</sup> )	20 mV	10 mV
1 ms (N = 10 <sup>-1</sup> )	200 mV	100 mV
<b>Range</b>	0 to $\pm 125$ V dc	$\pm 10$ , $\pm 100$ , $\pm 1000$ V dc, and Autorange
<b>Accuracy</b> (20 min. warm-up)	$\pm 0.5\%$ reading $\pm 4$ mV	$\pm 0.03\%$ reading $\pm 0.004\%$ range; for 1000 V range: $\pm 0.087\%$ reading $\pm 0.004\%$ range
<b>Input terminals</b>	Single ended	Floating pair
<b>Input impedance</b>	10 M $\Omega$	10 M $\Omega$
<b>Normal mode rejection ratio</b>	>60 dB at 60 Hz (50 Hz) $\pm 0.1\%$	>80 dB at 50 Hz or greater with filter on
<b>Effective common mode rejection ratio</b> (1 k $\Omega$ unbalance)		DC: >120 dB AC: >120 dB for multiples of 60 Hz (50 Hz) with filter on
<b>Maximum input</b>	$\pm 500$ V	HI to LO: $\pm 1100$ V all ranges; LO to chassis ground: $\pm 500$ V
<b>Trigger level measurements</b>	2 mV display resolution	1 mV display resolution: trigger level reading automatically multiplied by setting of attenuator switch if using Opt 040 or 041 universal modules

†Performance: 60 days at 23°C  $\pm 5^\circ$ C and RH <60%

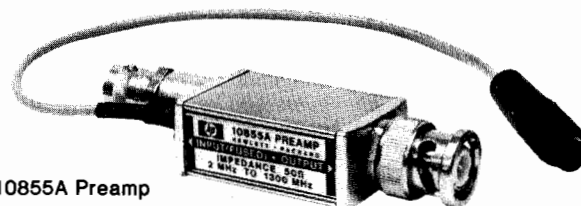

10855A Preamp

### Channel C Modules

Input characteristics	Opt 030	Opt 031
<b>Sensitivity</b>	15 mV rms	20 mV rms
<b>Coupling</b>	dc	ac
<b>Trigger level</b>	0 V, fixed	0 V, fixed
<b>Impedance</b>	50 $\Omega$	50 $\Omega$
<b>Maximum input</b>	5 V rms	5 V rms, $\pm 5$ V dc
<b>Input protection</b>	fused	fused
<b>Attenuator</b>	No	Variable for optimum noise suppression on signals to 5 V rms

#### Frequency C measurements

Range	5-512 MHz (direct count)	90-1300 MHz (prescaled, $\pm 4$ )
<b>Resolution</b>	1 MHz to 0.1 Hz in decade steps	1 MHz to 0.1 Hz in decade steps
<b>Accuracy</b>	$\pm 1$ count $\pm$ time base error	$\pm 1$ count $\pm$ time base error

#### Ratio C/A measurement

Range: A C	0-10 MHz 5-512 MHz	0-10 MHz 90-1300 MHz
---------------	-----------------------	-------------------------

#### General

Probe power	No	Power to operate 10855A Preamp or HP active probe
-------------	----	---

### Events C, A to B (with Opt 030 only)

The number of events at the C input are totalized during the synchronized time interval defined by inputs to channels A and B. The synchronized time interval is a multiple of 100 ns with the standard universal module; a multiple of 10 ns with Opt 040 or 041 universal modules.

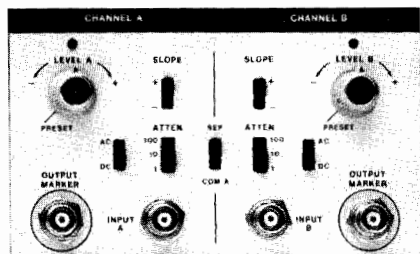

Standard Universal Module

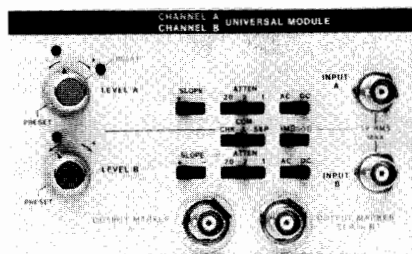

Opt 040 High Performance Universal Module

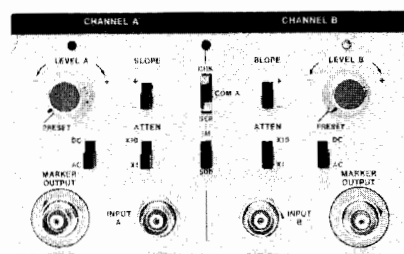

Opt 041 Programmable Input Universal Module

**Universal Modules, Channels A and B**

Input characteristics	Standard	Opt 040, Opt 041
<b>Sensitivity:</b> 0-40 MHz (dc coupled) 20 Hz-40 MHz (ac coupled) 40-100 MHz	25 mV rms 25 mV rms 50 mV rms	25 mV rms 25 mV rms 50 mV rms
<b>Min pulse width</b>	5 ns, 140 mV p-p	
<b>Coupling</b>	ac or dc, switchable	
<b>Impedance</b>	1 MΩ, 40 pF shunt	1 MΩ or 50Ω, switchable
<b>Trigger level</b>	variable ± 2.5 V times atten. setting	
<b>Trigger slope</b>	independent selection of + or - slope	
<b>Attenuators</b>	X1, X10, X100	Opt 040: X1, X2, X20 Opt 041: X1, X10
<b>Dynamic range</b>	25 mV to 1 V rms times attenuator setting for 0-40 MHz; 50 mV to 500 mV times attenuator setting for 40-100 MHz	
<b>Channel input</b>	Separate or Common A	Separate, Common A, or Check
<b>Delay</b>	No	Opt 040 only: 20μs to 20 ms
<b>Programmable Controls</b>	No	Opt 041 only: level, slope coupling, atten, impedance SEP-COM-CHK

**Frequency A measurement**

<b>Range</b>	0-100 MHz, direct count
<b>Resolution</b>	1 MHz to 0.1 MHz in decade steps

**Period A measurement**

<b>Range</b>	0-10 MHz
<b>Resolution</b>	100 ns to 1 s in decade steps

**Period Average A measurements**

<b>Range</b>	0-10 MHz
<b>Resolution</b>	100 ns to 0.01 ps in decade steps

**Time interval A to B measurements**

<b>Range</b>	100 ns to 10 <sup>6</sup> s	10 ns to 10 <sup>7</sup> s
<b>Resolution</b>	100 ns to 1 s in decade steps	10 ns to 0.1 s in decade steps

**Time interval average A to B**

<b>Range</b>	0.1 ns to 10 s	0.1 ns to 1 s
<b>Resolution</b>	±100 ns ± trigger error √N ±10 ps	±10 ns ± trigger error √N ±10 ps
<b>Min. pulse width</b>	25 ns	10 ns
<b>Min. dead time</b> (from each stop event to next start event)	150 ns	40 ns

**Ratio B/A measurement**

<b>Range: A B</b>	0-10 MHz 0-100 MHz
<b>Totalizing and scaling, Start A</b> The number of counts at the A input are totalized for N = 1 on the resolution switch. For N > 1, A/N is totalized and the scaled output (A/N) is available at the Time Base Out rear panel connector.	
<b>Range: N = 1 N &gt; 1</b>	0-100 MHz 0-10 MHz

Front Handles supplied with instrument

Options and Accessories	Price
<b>010:</b> High Stability Time Base	\$650
<b>011:</b> HP-IB Interface	\$350
<b>020:</b> DVM	\$220
<b>021:</b> High Performance DVM	\$550
<b>030:</b> 512 MHz Channel C	\$440
<b>031:</b> 1300 MHz Channel C	\$650
<b>040:</b> High Performance Universal Module	\$350
<b>041:</b> Programmable Input Controls Module (Requires Option 011 for HPIB use)	\$950
<b>908:</b> Rack Flange Kit	\$20
<b>10855A:</b> Preamp	\$295
<b>5363B:</b> Time Interval Probes	\$2650

**5328A Universal Counter \$1450**



## Electronic Counters

### Universal Counters

Models 5315A/B, 5316A

- Frequency, Period, Ratio, and Totalize to 100 MHz
- Three Versions: Portable, Rackable, or HPIB

- Uses Reciprocal Technique for Full Low-frequency Resolution
- 100 ns Time Interval, 10 ps T.I. Averaging

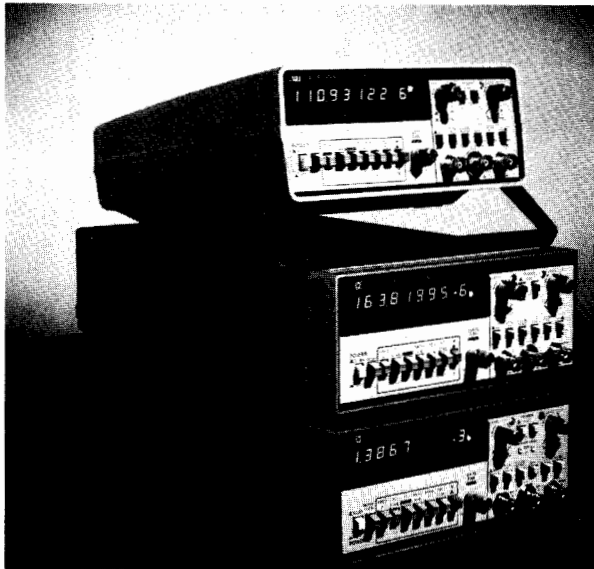

### A Quiet Revolution in Capability . . .

HP's economical 5315A/B, and 5316A counters provide all the universal counter capability you've come to expect at much higher prices. That's because they use a unique custom circuit called the MRC (Multiple Register Counter) which packs counting and computing power into this popular counter series. To a user, the differences in operation from conventional direct models can be listed quickly: operation is by push-button rather than dials and knobs, low frequency resolution is an outstanding 7 digits per second of gate time, and reliability is extremely good due to the counter's low chip count.

Much of the counter's performance is based on reciprocal counting techniques first pioneered in HP's high-performance 5360A computing counter, and the current model 5345A Universal Counter. The use of these techniques coupled with HP's MRC and a microprocessor provide a quiet but powerful revolution in counter performance within the 5315A/B and 5316A. For example, this counter gives you its full 7-digits/second resolution over the following range: 1 Hz to 100 MHz. Think of it: seven digits of resolution at 1 Hz, in one second of gate time. That, simply stated, shows the power of the MRC and reciprocal counting.

### High Performance, Low Price

In addition to its economy, the MRC counter offers a full set of universal counter measurements, and there are very few limitations to this capability.

### Frequency to 100 MHz, C-Channel to 1.0 GHz

The basic MRC counter measures frequency to 100 MHz. Additionally the optional C-Channel measures to 1.0 GHz for both CW and pulsed RF signals as narrow as 60 ms. The C-Channel option is particularly useful in navigation and communications equipment testing due to this pulsed RF measurement feature.

### Time Interval to 100 ns, T.I. Averaging to 10 ps

The MRC counter provides three time measurement modes. Single-shot time interval allows measurements over a range of 100 ns to 100,000 seconds. This capability can be used to measure pulse width. Time interval averaging provides greater resolution for repetitive events. Finally, time interval delay avoids measurement of spurious signals by holding off the counter's trigger point by a precise, operator-selectable amount of time.

### A Full Set of Measurements

Besides the frequency and time functions mentioned above, the MRC counter has other measurement functions that make it a truly impressive value:

**Period A**—allows single period measurements via Channel A.

**Ratio A/B**—allows frequencies to 100 MHz into both Channel A and B

**A By B**—provides the gated totalize function of A gated by B

**Totalize**—a manually gated totalize mode of operation

### Input Signal Conditioning

A full complement of input signal conditioning controls are provided for both channels. These include  $\pm$  slope,  $\pm 2.5$  VDC trigger level, and AC/DC coupling. Other controls are a Separate/Common switch, and a 100 KHz low-pass filter for Channel A.

### A Choice of Three Models

The MRC counter is available in three different versions: **5315A**: A portable, light-weight unit best suited for field applications. This unit has a convenient carrying handle and optional battery power is available for up to 4 hours continuous operation. Despite its high impact plastic case, the 5315A possesses low RFI/EMC characteristics making it equally suitable for bench use.



**5315B:** A rackable, stackable counter that is designed to meet the most demanding RFI/EMC specs, the 5315B is intended primarily for rack mount use. This model has an optional Offset-Normalize (006) module that mathematically modifies the counter's display and so provides readouts directly in engineering units of the user's choice. The 5315B Option 006 is also rackable and stackable.

## 5315A/B 5316A Specifications

### Input Characteristics (Channel A and Channel B)

**Range:** DC coupled 0 to 100 MHz.

AC coupled 30 Hz to 100 MHz.

**Sensitivity:** 10 mV rms sine wave to 10 MHz.

25 mV rms sine wave to 100 MHz.

75 mV peak-to-peak pulse at minimum pulse width of 5 ns.

Sensitivity can be varied continuously up to 500 mV rms *NOMINALLY* by adjusting sensitivity control. In sensitivity mode, trigger level is automatically set to 0 V *NOMINAL*.

### Dynamic range:

30 mV to 5 V peak-to-peak, 0 to 10 MHz.

75 mV to 5 V peak-to-peak, 10 to 100 MHz.

**Coupling:** AC or DC, switchable.

**Filter:** Low pass, switchable in or out of Channel A. 3 dB point of *NOMINALLY* 100 kHz.

**Impedance:** 1 M $\Omega$  *NOMINAL* shunted by less than 40 pf.

500 K $\Omega$  *NOMINAL* shunted by less than 70 pf (COMMON A).

**Signal operating range:** +2.5 Vdc to -2.5 Vdc.

**Attenuator:** X1 or X20 *NOMINAL*.

**Trigger level:** Variable between +2.5 Vdc and -2.5 Vdc.

**Slope:** Independent selection of + or - slope.

**Channel input:** SEPARATE or COMMON A.

### Damage level:

AC & DC x 1:

DC to 2.4 kHz	250 V (DC + AC rms)
2.4 kHz to 100 kHz	6 x 10 <sup>5</sup> V rms Hz/FREQ
> 100 kHz	6 V rms

AC & DC x 20:

DC to 28 kHz	500 V (DC + AC peak)
28 kHz to 100 kHz	1 x 10 <sup>7</sup> V rms Hz/FREQ
> 100 kHz	100 V rms

### Frequency (Channel A)

**Range:** .1 Hz to 100 MHz (burst or CW).

**LSD displayed:** 10 Hz to 1 n Hz depending upon gate time and input signal. At least 7 digits displayed per second of gate time.

### Period

**Range:** 10 ns to 10<sup>5</sup> s.

**LSD displayed:** 100 ns to 1 fs depending upon gate time and input signal. At least 7 digits displayed per second of gate time.

### Time Interval

**Range:** 100 ns to 10<sup>5</sup> s.

**LSD displayed:** 100 ns.

### Time Interval Average

**Range:** 0 ns to 10<sup>5</sup> s.

**LSD displayed:** 100 ns to 10 ps depending upon gate time and input signal. See table in definitions section.

**Number of intervals averaged (N):** N = Gate Time x FREQ.

**Minimum dead time (stop to start):** 200 ns.

### Time Interval Delay (Holdoff)

Front panel gate time knob inserts a variable delay of *NOMINALLY* 500  $\mu$ s to 20 ms between START (Channel A) and enabling of STOP (Channel B). Electrical inputs during delay time are ignored. Delay time may be digitally measured by simultaneously pressing T.I. Averaging, T.I. Delay and blue key. Other specifications of T.I. Delay are identical to Time Interval.

**5316A:** This model possesses all the characteristics of both the 5315A and 5315B, and it has HP-IB capability built-in as standard equipment. It has low RFI, it is rackable, and it is functionally identical to the 5315A/B. In addition to programmable measurement functions, the user can also select DC trigger level and  $\pm$  slope under HP-IB control. Channel A and B trigger levels are brought out to the front panel on this unit for easy measurement with a DVM.

### Ratio

**Range:** 0.1 Hz to 100 MHz, both channels

**LSD:**  $\frac{2.5 \times \text{Period A}}{\text{Gate Time}} \times \text{Ratio}$ . (rounded to nearest decade)

### Totalize

#### Manual:

**Range:** 0 to 100 MHz.

#### A gated by B:

Totalizes input A between two events of B. Instrument must be reset to make new measurement. Gate opens on A slope, closes on B slope.

**Range:** 0 to 100 MHz.

### General

**Check:** Counts internal 10 MHz reference frequency over gate time range *NOMINALLY* 500  $\mu$ s to 20 ms.

**Error light:** LED warning light activated if logic error is found during instrument turn-on self-check.

**Display:** 8 digit amber LED display, with engineering units annunciator.

**Overflow:** Only frequency and totalize measurements will overflow. In case of overflow, eight least significant digits will be displayed and amber front panel overflow LED will be actuated.

All other measurements which would theoretically cause a display of more than 8 digits will result in the display of the 8 most significant digits.

**Gate time:** Continuously variable, *NOMINALLY* from 60 ms to 10 s or 1 period of the input, whichever is longer.

**Sample rate:** Up to 5 readings per second *NOMINAL* except in time interval mode, where it is continuously variable *NOMINALLY* from 250 ms to 10 s via Gate Time Control.

**Operating temperature:** 0° to 50°C.

**Power requirements:** 100, 120, 220, 240 V (+5%, -10%) 48-66 Hz; 15 VA maximum

**Weight:** Net, 2.2 Kg (4 lbs. 12 oz.); shipping, 4.1 Kg (9 lbs.).

**Dimensions:** 238 mm W x 98 mm H x 276 mm D (9 $\frac{3}{8}$  x 3 $\frac{3}{8}$  x 10 $\frac{7}{8}$  in.)

### Time Base:

**Frequency:** 10 MHz.

**Aging rate:** < 3 parts in 10<sup>7</sup>/mo.

**Temperature:**  $\leq$  5 parts in 10<sup>6</sup>, 0 to 50°C.

**Line voltage:**  $\leq$  1 part in 10<sup>7</sup> for  $\pm$  10% variation.

### Additional 5315B Specifications

Rack and stack metal case with rear panel, switchable AC power line module. Specifications same as 5315A except as follows:

**Rack mount:** 5315B is recommended for rack mounting via Rack Mount Kit 5061-0072.

**Oscillator output:** 10 MHz, 50 mV pk-pk into 50  $\Omega$  load, on rear panel.

**External frequency standard input:** 10 MHz, 1 V RMS into 500  $\Omega$ , on rear panel. Not available with option 001.

**Dimensions:** 212 mm W x 88 mm H x 345 mm D (8 $\frac{3}{8}$  x 3 $\frac{1}{2}$  x 13 $\frac{3}{8}$  in.).

**Weight:** Net, 3.2 Kg (7 lbs. 2 oz.); shipping, 4.5 Kg (10 lbs.).





# Electronic Counters

## Universal Counters

Models 5315A/B, 5316A (cont.)

### HP-IB (5316A Only)

#### Data Output

**Format:** (alpha character)  $\pm$  (Reading) (Exponent)  $\pm$  (2 digits)

**Data Output Rate:** 10 Readings/Sec. Max.

**Talk Only Mode:** Selectable by rear panel switch.

#### Operating Commands

**5316A:** Reset, Initialize (to Freq. A), Wait State ON/OFF, Service Request Enabled/Disabled, Gate Time Range.

**HP-IB:** Group Executive Trigger, Device Clear, Selective Device Clear, Interface Clear, Local, Remote, Local Lockout, Read Status (Serial Poll Enable).

#### Programmable Controls and Functions

**Frequency Functions:** Frequency A, Freq A armed by B, Totalize, A Gated by B, Ratio A/B, and Frequency C.

**Period Function:** Period A

**Time Interval Functions:** Time A $\rightarrow$ B, Time Int. Average A $\rightarrow$ B, Time Int. Delay

**Trigger Level Commands:** Set Channel A Slope ( $\pm$ ) Set Channel B Slope ( $\pm$ ), A Trigger Level:  $\pm$  X.XX, B Trigger Level:  $\pm$  X.XX.

**Gate Time Command:** Sets Gate Time Range

**Miscellaneous Functions:** Gate Time Check, Display Test, 10 MHz Check, Interface Test.

### Additional 5316A Specifications

Rack and stack metal case with rear panel, switchable AC power line module, Specifications same as 5315A except as follows:

**Rack Mount Kit:** 5061-0072 recommended.

**Oscillator Output:** 10 MHz, 50 mV p-p into 50  $\Omega$  load on rear panel.

**External Frequency Standard Input:** 1, 5, 10 MHz, 1 V rms into 500  $\Omega$ , or rear panel.

**Trigger Level Output:**  $\pm$ 5%,  $\pm$ 15 mV, over  $\pm$ 2.0 VDC range at front panel connectors.

**Dimensions:** 212 mm W x 88 mm H x 415 mm D (8 3/8 x 3 1/2 x 16 1/2 in.)

**Weight:** Net, 3.9kg (8 lbs. 10 oz.); Shipping, 6.3kg (14 lbs.)

#### Options

**Opt. 001:** High Stability Time Base (TCXO)

**Frequency:** 10 MHz.

**Aging rate:**  $<$  1 part in  $10^7$ /mo.

**Temperature:**  $<$  1 part in  $10^6$ ,  $0^\circ$  to  $40^\circ$ C.

**Line voltage:**  $<$  1 part in  $10^6$  for  $\pm$  10% variation.

**Opt. 002:** Battery (5315A only)

**Type:** Rechargeable lead-acid (sealed).

**Capacity:** TYPICALLY 4 hours of continuous operation at  $25^\circ$ C.

**Recharging time:** TYPICALLY 16 hours to 98% of full charge, instrument non-operating. Charging circuitry included with Option. Batteries not charged during instrument operation.

**Low voltage indicator:** Instrument turns itself off automatically when low battery condition exists. *Discharge* LED flashes slowly when this happens. *Discharge* LED is on whenever battery is supplying power to instrument.

*Charge* LED indicates state of charge of battery during charging only and is on whenever battery is charged to 95% *NOMINAL* of capacity. *Charge* LED flashes when 90% *NOMINAL* of charge taken out is replaced. *Charge* LED is off if charge is less than 70% *NOMINAL* of capacity.

**Line failure protection:** Instrument automatically switches to battery in case of line failure.

**Weight:** Opt. 002 adds 1.4 Kg (3 lbs.) to weight of instrument.

**Option 003:** C Channel

#### Input characteristics

**Range:** 50 to 1000 MHz, prescaled by 10.

**Sensitivity:** 15 mV rms sinewave ( $-23.5$  dBm) to 650 MHz. 75 mV rms sinewave ( $-9.5$  dBm) to 1000 MHz.

Sensitivity can be decreased continuously by up to 20 dB *NOMINAL*, 50 to 500 MHz and 10 dB *NOMINAL*, 500 to 1000 MHz by adjusting sensitivity control. Trigger level is fixed at 0 V *NOMINAL*.

**Dynamic range:** 15 mV to 1 V rms (36 dB), 50 to 650 MHz. 75 mV to 1 V rms (20 dB), 650 to 1000 MHz.

**Signal operating range:** +5 Vdc to  $-5$  Vdc.

**Coupling:** AC

**Impedance:** 50  $\Omega$  *NOMINAL* (VSWR,  $<$  2.5:1 TYPICAL).

**Damage level:**  $\pm$ 8 V (DC + AC peak), fuse protected. Fuse located in BNC connector.

#### Frequency (Channel C)

**Range:** 50 to 1000 MHz (burst or CW).

**LSD displayed:** 100 Hz to 1 Hz depending upon gate time. At least 7 digits per second of gate time.

### Option 006: Offset-Normalize Module

**Measurements (X) Operated On:** Frequency, Period, Time Interval, Time Interval Delay, Ratio, and Check. Time Interval place holding zeros are not operated upon.

**Modes:** Normalize (X/A), Offset (X + B), Normalize and Offset ((X/A) + B); switch selectable. Dividing by zero results in a display of zero.

**A and B Value Selection:** Entered by thumbwheel switch with 8-digit mantissa and 1-digit exponent with sign. B may be positive or negative value.

**Display:** 999.99999 x  $10^9$  to  $<$ 1 x  $10^{-9}$  range. For negative numbers, the minus sign reduces resolution by one digit.

**Overflow:** Frequency measurements will overflow 3 decades after which LSD will be truncated.

**Rack Mount Kit:** 5061-0074 recommended.

**Weight:** Option 006 adds 1.8 kg (4 lbs. 1 oz.) to weight of instrument.

#### Dimensions:

**5315B plus Option 006:** 425 mm W x 88 mm H x 345 mm D (16 3/4 x 3 1/2 x 16 1/2 in.)

### Ordering Information

		5315A	5315B	5316A	Price
Option 001	High Stability Oscillator (TCXO)	X	X	X	Add: \$100
Option 002	Battery Pack	X			Add: \$225
Option 003	C-Channel (1.0 GHz)	X	X	X	Add: \$250
Option 006	Offset-Normalize Module		X		Add: \$650

All 5315A orders must include one (1) of these line power options:

Option 100:	90-105 VAC	N/C
Option 120:	108-126 VAC	N/C
Option 220:	198-231 VAC	N/C
Option 240:	216-252 VAC	N/C

5315A 100 MHz/ 100 ns Universal Counter	\$875
5315B 100 MHz/ 100 ns Universal Counter in Metal Rack/Stack Package	\$1050
5316A 100 MHz/ 100 ns Universal Counter (HP-IB version)	\$1500

- 100 MHz
- 100 ns Time Interval
- Portable

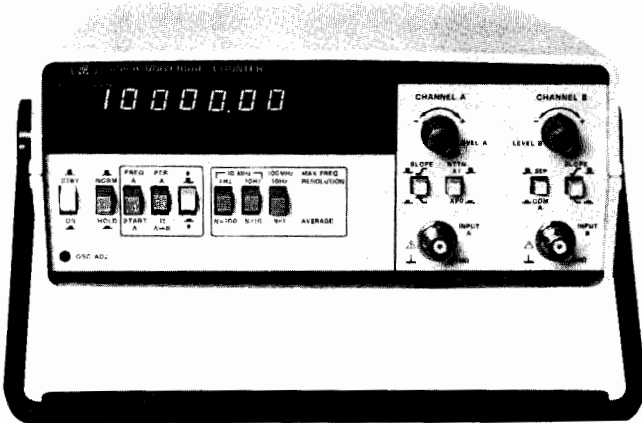

5314A

The 5314A Universal Counter is the newest result of HP's continuing low cost counter product development effort. It combines excellent performance and traditional HP quality at a very attractive price. This counter is designed to deliver reliable, high quality operation in such areas as: Production Test, Frequency Monitoring, Education, Training, Service and Calibration. Additionally, the optional battery (option 002) makes the 5314A especially attractive for field and portable applications.

#### Input Characteristics (Channels A and B):

**Range:** CHANNEL A: 10 Hz to 10 MHz Direct.  
1 MHz to 100 MHz Prescaled.

CHANNEL B: 10 Hz to 2.5 MHz.

**Sensitivity:** CHANNEL A: 25 mv rms to 100 MHz.  
75 mv peak-to-peak at minimum pulse width of 5 ns (100 MHz range).

CHANNEL B: 25 mv rms to 2.5 MHz.  
75 mv peak-to-peak at minimum pulse width of 200 ns.

**Coupling:** AC.

**Impedance:** 1 M $\Omega$  NOMINAL shunted by less than 30 pf.

**Attenuator:** X1 or X20 NOMINAL (A channel only).

**Trigger Level:** Continuously variable  $\pm$  350 mV times attenuator setting around average value of signal.

**Slope:** Independent selection of + or - slope.

**Channel Input:** Selectable SEPARATE OR COMMON A.

**Dynamic Range:** 75 mV p-p to 4 V p-p.

#### Frequency:

**Range:** 10 Hz to 10 MHz direct count.  
10 Hz to 100 MHz prescaled by 10.

**Least Significant Digit (LSD) Displayed:** Direct count 0.1 Hz, 1 Hz, 10 Hz switch selectable. Prescaled 10 Hz, 100 Hz, 1 KHz switch selectable.

**Resolution:**  $\pm$  LSD.

**Accuracy:**  $\pm$  LSD  $\pm$  (time base error) x Freq.

#### Period:

**Range:** 10 Hz to 2.5 MHz.

**LSD Displayed:** 100 N ns for N=1 to 1000 in decade steps of N.

**Resolution:**  $\pm$  LSD  $\pm \frac{(1.4x \text{ TRIGGER ERROR})}{N}$  x Per.

**Accuracy:**  $\pm$  LSD  $\pm \frac{(1.4x \text{ TRIGGER ERROR})}{N}$  x Per.

$\pm$  (time base error) x Per.

#### Time Interval:

**Range:** 250 ns to 1 sec.

**LSD Displayed:** 100 ns.

**Resolution:**  $\pm$  LSD  $\pm$  START trigger error  $\pm$  STOP trigger error.

**Accuracy:**  $\pm$  LSD  $\pm$  START trigger error

$\pm$  STOP trigger error  $\pm$  (time base error) x TI.  
External arming required for START/STOP channels.

#### Ratio:

**Range:** 10 Hz to 10.0 MHz CHANNEL A.  
10 Hz to 2.5 MHz CHANNEL B.

**LSD Displayed:** 1/N in decade steps of N for N = 1 to 1000.

**Resolution:**  $\pm$  LSD  $\pm$  (B trigger error x Frequency A)/N.

**Accuracy:**  $\pm$  LSD  $\pm$  B trigger error x Frequency A.

#### Totalize:

**Range:** 10 Hz to 10 MHz.

**Resolution:**  $\pm$  1 count of input.

Totalize controlled by front panel switch.

#### General:

**Check:** Counts internal 10 MHz oscillator.

**Display:** 7 digit amber LED display with gate and overflow indication.

**Max Sample Rate:** 5 readings per second.

**Operating Temperature:** 0 $^{\circ}$  to 50  $^{\circ}$ C.

**Power Requirement:** 100/120/230/240 V RMS +5%, -10%, 48-66 Hz; 10 VA max.

**Weight:** 2.0 kg (4.4 lb.).

**Dimension:** 238 mm W x 98 mm H x 276 mm D (9 $\frac{3}{8}$  x 3 $\frac{7}{8}$  x 10 $\frac{7}{8}$  in.).

**Time Base:**

**Frequency:** 10 MHz.

**Aging Rate:** < 3 part in 10 $^7$  per month.

**Temperature:** <  $\pm$  10 parts in 10 $^6$ , 0 to 50 $^{\circ}$ C.

**Line Voltage:** <  $\pm$  1 part in 10 $^7$  for  $\pm$  10% variation.

#### Options:

**Option 001:** High stability time base (TCXO).

**Frequency:** 10 MHz.

**Aging Rate:** < 1 part in 10 $^7$  per month.

**Temperature:** <  $\pm$  1 part in 10 $^6$ , 0 to 40 $^{\circ}$ C.

**Line Voltage:** <  $\pm$  1 part in 10 $^8$  for  $\pm$  10% variation.

**Option 002:** Battery.

**Type:** Rechargeable lead-acid (sealed).

**Capacity:** Typically 8 hours of continuous operation at 25 $^{\circ}$ C.

**Recharging Time:** Typically 16 hours to 98% of full charge, instrument non-operating. Charging circuitry included with option. Batteries not charged during instrument operation.

**Battery Voltage Sensor:** Automatically shuts instrument off when low battery condition exists.

**Line Failure Protection:** Instrument automatically switches to batteries in case of line failure.

**Weight:** Option 002 adds typically 1.5 kg (3.3 lb.) to weight of instrument.

#### Definitions:

**Resolution:** Smallest discernible change of measurement result due to a minimum change in the input.

**Accuracy:** Deviation from the actual value as fixed by universally accepted standards of frequency and time.

**Trigger Error:** (RMS)

$$\sqrt{(80 \mu\text{V})^2 + e_n^2} / \text{input slew rate at trigger point } (\mu\text{V/s}).$$

Where  $e_n$  is the RMS noise of the input for a 100 MHz bandwidth in CHANNEL A and 10 MHz bandwidth in CHANNEL B.

#### Options

**001** High stability time base

**Price**

add \$100

**002** Battery

add \$95

**910:** Extra product manual

add \$9.50

All orders must include one (1) of these line power options:

**Option 115:** 86-127V

N/C

**Option 230:** 190-250V

N/C

**5314A 100 MHz/100 ns Universal Counter**

**\$425**

# ELECTRONIC COUNTERS

Plug-on modular/portable counter system

Model 5300 A/B system & 5301A-5312A



## 5300 Measuring system

### Features Include

- 10 MHz, 50 MHz, 525 MHz and 1.3 GHz
- 100 ns time interval resolution and time interval averaging
- Up to 8 digits
- Auto ranging
- Unique time interval hold off
- Expandable with interchangeable modules
- Optional FCC type approved TCXO time base
- Portable-battery operation with all modules
- Compact and rugged
- High reliability MOS/LSI circuitry and LED display
- Designed for quick & easy owner-servicing
- Output via BCD, HP Interface Bus (HP-IB), or D to A converters

### Description

Large scale integration and solid state display technology have helped to produce a uniquely versatile and capable counter at a surprisingly low cost. Easy to use and reliable, this counter does what is important—solves your measurement problems while saving your money. Versatility and antiobsolescence come from modular construction. Take your choice from two mainframes and select the snap

on module that you need now. Expand the capability later with more modules, if and when you need them.

### Autoranging

Autoranging is included in many of the functions, enhancing the ease of operation by automatically selecting a correct gate time to fill the display. Any frequency within the range of the 5301A, 5302A, 5304A, 5307A and 5308A may be counted, with the counter's logic circuits automatically selecting the correct gate time (up to 1 second) for maximum resolution without exceeding the display range.

### Time Interval Holdoff

Time interval holdoff is a unique feature of the 5304A Timer/Counter module. This feature allows you to add a fixed delay between the start of a time interval measurement and the enabling of the stop channel. Thus any electrical pulses or irregularities in a waveshape that occur between the desired trigger points can be ignored.

### Digital and Analog Output

Digital output is available in BCD format (standard in 5300A mainframe) or ASCII format via the HP Interface Bus (to be used with 5300B mainframe) to provide interfacing with digital printers or with desktop calculators and other data processing equipment. Analog output for long term monitoring with strip chart recorders is provided by a digital-to-analog converter.

### Battery Pack

A snap between battery pack provides a truly portable, light weight, go-anywhere measuring system for any of the 5300 Systems.

### Serviceability

Reliability and easy servicing have been major design criteria for all of the 5300 modules. A check function is built into most of the functional modules to allow immediate checking of the basic counter circuits from the front panel. A user-oriented service support package is available that provides plug-in cards with automatic diagnostic routines that allow the 5300 mainframes to troubleshoot themselves.

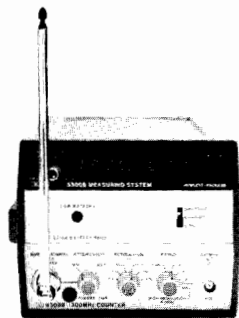

## Typical Configurations

Frequency Measurement System  
for Mobile Communications.  
Go Anywhere Portability

5300B, 5310A, 5305B

Model	Frequency MHz	Period	Period Average	Time Interval	Time Interval Average	Totalize	Ratio	Multimeter ACV, DCV, $\Omega$	High Resolution Reciprocal	
5300A 6 DIGIT MAINFRAME										\$650 319
5300B 8 DIGIT MAINFRAME										\$550 319
5310A BATTERY PACK										\$285 322
5311B DIGITAL TO ANALOG CONVERTER										\$420 322
5312A HP-IB INTERFACE										\$365 322
5301A	10					•				\$250 320
5302A	50	•	•	•		•	•			\$400 320
5303B	525									\$925 320
5304A	10		•	•		•				\$450 320
5305B	1300									\$950 321
5306A	10							•		\$700 321
5307A	2								•	\$450 321
5308A	75	•	•	•	•	•	•			\$550 321

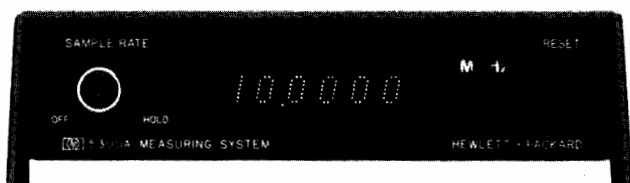

5300A



5300B



## 5300A and 5300B Measurement System Mainframe

The mainframe units provide the system with power, reference frequency, display, counting logic and timing control.

The 5300A has a 6-digit dot matrix display, standard time base, external time base input and BCD output as a standard rear panel output. The 5300B has an 8-digit 7-segment display, standard time base or optional TCXO time base, external time base input and no digital output from the mainframe. See mainframe/plug-on display chart below for number of display digits with a particular mainframe and plug-on combination.

### Time Base

**Standard crystal frequency:** 10 MHz.

### Stability

**Aging rate:** <3 parts in  $10^7$ /mo.

**Temperature:** <±5 parts in  $10^6$ , 0° to 50°C.

**Typically:** <±2 parts in  $10^6$ , 15° to 40°C.

**Line voltage:** <±1 part in  $10^7$  for 10% line variation.

**Oscillator output:** 10 MHz, approximately 1 V rms at rear panel BNC, 100Ω source impedance.

**External input:** 1 MHz to 10 MHz, 1 V rms into 200Ω.

### Opt 001 High Stability Time Base (5300B Only)

**Frequency:** 10 MHz.

### Stability

**Aging rate:** <1.2 parts in  $10^6$ /year.

**Temperature:** <±5 parts in  $10^7$ , 0° to 50°C.

**Line voltage:** <±5 parts in  $10^8$  for 10% line variation.

**Oscillator output:** 10 MHz, approximately 1 V rms at rear panel BNC, 100Ω source impedance.

**External input:** 1 to 10 MHz, 1 V rms into 500Ω.

### General

**Display:** 6-digit, dot matrix (5300A) or 8-digit, 7-segment matrix (5300B), solid state LED display (gallium arsenide phosphide light emitting diodes) including decimal point and annunciator units.

**Overflow:** LED light indicates when display range is exceeded.

**Display storage:** holds reading between samples. Sample rate: Sample rate control adjusts the delay from the end of one measurement to the start of a new measurement. Continuously variable from less than 50 msec to greater than 5 seconds. HOLD position: display can be held indefinitely. Reset: Front panel pushbutton switch resets all registers and initiates new measurement. Reset input by contact closure to ground or TTL type low level also available on rear panel connector (5300A only).

**Operating temperature:** 0° to 50°C.

**Power requirements:** 115 V + 13, -17% 48-440 Hz; 230 V + 13, -17% 48-60 Hz, 25 VA maximum (depends on plug-on module). Mainframe power without plug-on nominally 5 watts. Battery operation: with 5310A re-chargeable battery pack (see 5310A specifications).

**Dimensions:** (with snap-on module): 89 mm H x 160 mm W x 248 mm D (3.5" x 6.25" x 9.75").

### Digital output (5300A only)

Digital serial, 4-bit BCD parallel available at rear panel connector.

The 10533A Digital Recorder Interface accessory provides an interface between the 5300A measurement system mainframe and a standard parallel-input recorder such as the HP 5055A. The interface module provides conversion from the 5300A serial data output to a standard parallel format.

**Code:** 4-line 1-2-4-8 BCD; "1" state low TTL levels.

**Decimal point:** floating decimal point automatically inserted at correct digit position.

**Print command:** negative step, TTL levels.

**Inhibit input:** +2.0 V or higher prevents the 5300A from recycling.

**Note:** digital output for 5300B Mainframe is provided by 5312A HP-IB Interface module.

### Mainframe/Plug-on Compatibility

Plug-on	Display Digits	
	with 5300A	with 5300B
5301A	6	7
5302A	6	7
5303B	6	8
5304A	6	7
5305B	N/A	8
5306A (Frequency)	6	7
(ACV,DCV,OHMS)	5	5
5307A	6	6
5308A	N/A	8

### Accessories

**10533A Digital Recorder Interface:** (for use with 5300A) \$245

**10548A Service support package:** Contains an interface card and 4 diagnostic cards for easy troubleshooting of 5300A or 5300B \$95

**18019A Leather carrying case:** Holds 5300A or 5300B, snap-on module and 5310A battery pack plus accessories \$45

### Rack mount kits

10851A Single \$40

10852A Double \$40

10853A Single/with plug-between \$65

10854A Double/with plug-between \$65

### Ordering Information

**5300A** 6 digit mainframe \$650

**5300B** 8 digit mainframe \$550

**Opt 001:** TCXO (5300B only) add \$195

## 5300A/B System (cont.)

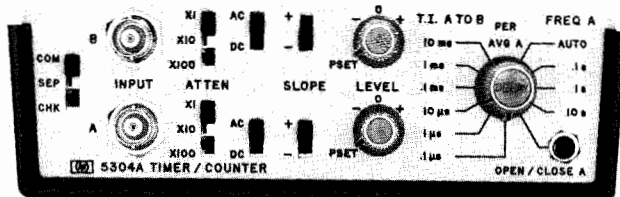
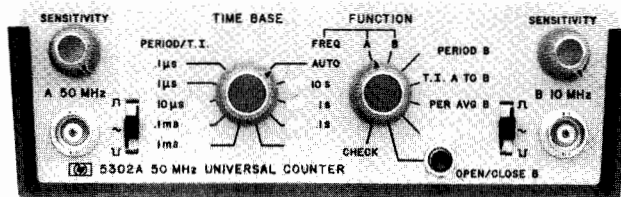
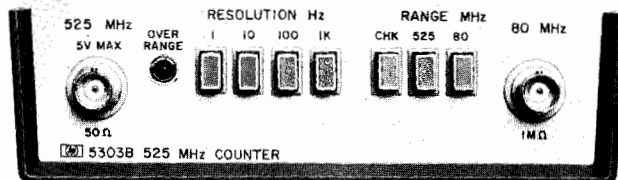
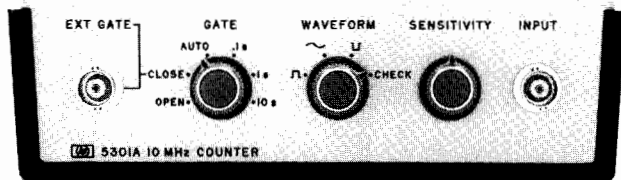
**5301A 10 MHz Frequency Counter Module****Input****Range:** 10Hz to 10MHz.**Sensitivity (min):** 25mV rms sine wave 50Hz to 1MHz, 50mV rms sine wave 10Hz to 10MHz.**Frequency Measurement****Range:** 10Hz to 10MHz.**Gate times:** manually selected 0.1, 1, or 10 seconds AUTO position selects gate time of 1 second for maximum resolution.**Open/Close (Totalizing)****Range:** 10MHz max count rate.**5302A 50MHz Universal Counter Module****Input Channels A and B****Range:** Channel A: 10 Hz to 50 MHz, Channel B: 10 Hz to 10 MHz.**Sensitivity (min):** 25 mV rms sine wave 50 Hz to 1 MHz. 50 mV rms sine wave 10 Hz to 10 MHz. 100mV rms sine wave at 50 MHz. 150mV p-p pulse at minimum pulse width, 50 ns.**Trigger level:** selectable position, negative, or zero volts.**Marker outputs:** rear BNC, TTL low level while gate is open.**Frequency****Range:** Channel A: 10 Hz to 50 MHz, prescaled by 10; Channel B: 10 Hz to 10 MHz.**Gate times:** manually selected 0.1, 1, or 10 seconds. AUTO position selects gate time of 1 second for maximum resolution.**Time Interval A to B****Range:** 50 nsec to 1000 seconds.**Resolution:** 100 ns to 1 ms in decade steps.**Period B****Range:** 10 Hz to 1 MHz.**Resolution:** 100 ns to 1 ms in decade steps.**Period Average B****Range:** 10 Hz to 1 MHz.**Periods averaged:** 1 to 10<sup>3</sup> automatically selected.**Frequency counted:** 10 MHz.**Ratio****Display:** F<sub>A</sub>/F<sub>B</sub> times multiplier (N), N = 10 to 10<sup>7</sup>.**Range:** Channel A: 10 Hz to 1 MHz, Channel B: 10 Hz to 10 MHz.**Open/Close (Totalizing)****Range:** 10 MHz max.**5303B Frequency Counter Module****Input Channel A (CW or Burst)****Range:** DC to 525MHz, prescaled by 8.**Sensitivity (fixed):** 100 mV rms sine wave, dc to 500 MHz. 125 mV rms sine wave, 500 MHz to 525 MHz. Signal must pass through zero.**Input Channel B (CW or Burst)****Range:** 50 Hz to 80 MHz, direct.**Sensitivity (automatic):** 25 mV rms sine wave, 100 Hz to 50 MHz. 50 mV rms sine wave, 50 Hz to 100 Hz and 50 MHz to 80 MHz. Sensitivity is adjusted automatically by Automatic Gain Control.**Frequency Measurement****Resolution:** selectable: 1, 10, 100, 1000Hz.**Opt 001: High Stability Time Base** (for use with 5300A)**Frequency:** 10MHz.**Stability****Aging rate:** < 1.2 part in 10<sup>6</sup>/year.**Temperature:** < ±5 parts in 10<sup>7</sup>, 0° to 50°C.**Line voltage:** < ±5 parts in 10<sup>8</sup> for 10% line variation.**Oscillator output:** 10 MHz, approx. 1V rms at rear panel BNC.**External input:** 1 to 10 MHz, 1 V rms into 500Ω.**5304A Timer/Counter Module****Input Channels A and B****Range:** DC coupled; 0 to 10 MHz; AC coupled: 100 Hz to 10 MHz.**Sensitivity (min):** 25 mV rms sine wave to 1 MHz, 50 mV rms sine wave to 10 MHz, 150 mV p-p pulse at minimum pulse width, 40 nsec. Attenuator reduces sensitivity by 10 or 100 times.**Trigger level:** PRESET position centers triggering about 0 volts, or continuously variable over the range of -1 V to +1 V.**Gate output:** rear panel BNC. TTL low level while gate is open.**Time Interval A to B****Range:** 500 ns to 10<sup>4</sup> sec.**Resolution:** 100 ns to 10 ms in decade steps.**Time interval holdoff:** inserts variable delay of approximately 100 μs to 100 ms between START and enabling of STOP, may be disabled. Electrical inputs during delay time are ignored.**Period Average A****Range:** 10 Hz to 1 MHz.**Periods averaged:** 1 to 10<sup>3</sup> automatically selected.**Frequency counted:** 10 MHz.**Frequency A****Range:** 0 to 10 MHz.**Gate times:** manually selected 0.1, 1, or 10 seconds. AUTO position selects gate time to 1 second for maximum resolution.**Open/Close (Totalizing)****Range:** 10 MHz max.**Ordering Information**

5301A 10 MHz Frequency Counter Module

**Price**

\$250

5302A 50 MHz Universal Counter Module

\$400

5303B 525 MHz Counter

\$925

Opt 001: High Stability Time Base

add \$190

5304A Timer/Counter Module

\$450

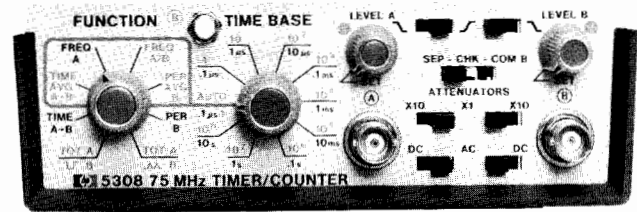
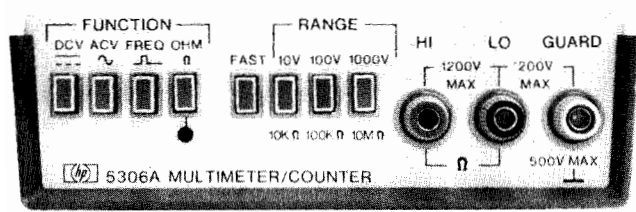
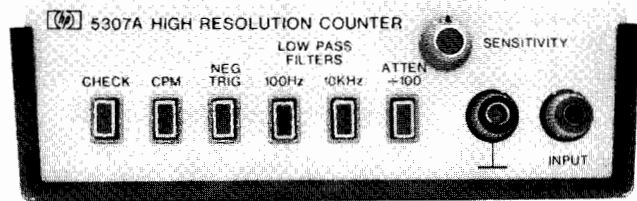
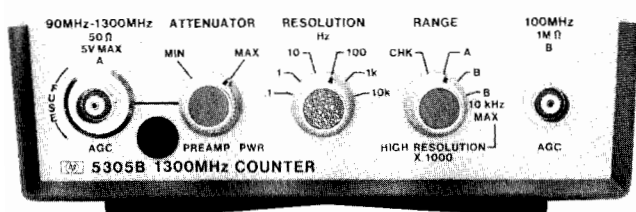

### 5305B 1300 MHz Frequency Counter Module

**Input Channel A (CW or Burst)**  
**Range:** 90 MHz to 1300 MHz, prescaled by 16.  
**Sensitivity:** 20 mV rms.  
**Impedance:** 50Ω.  
**Attenuator:** continuously variable for signals up to 3.5 V rms.  
**Operating dynamic range:** >47 dB

**Input Channel B (Normal and High Resolution Mode)**  
**Range:** 50 Hz to 100 MHz in normal mode. 50 Hz to 10 kHz in high resolution mode.  
**Sensitivity:** 20 mV rms.

**Frequency Measurement**  
**Resolution (selectable)**  
**Normal mode (50 Hz to 1300 MHz):** 0.1 Hz to 10,000 Hz corresponding to gate times of 10 s to 0.0001 s on channel B and to gate times of 160 s to 0.0016 s on channel A.  
**High resolution mode (50 Hz to 10 kHz):** 0.0001 to 10 Hz corresponding to 10 to 0.0001 second gate times on channel B.

### 5306A Digital Multimeter/Counter Module

**DC Voltage**  
**Sensitivity:** 100 μV for 10 V range, 1 mV for 100 V range, 10 mV for 1000 V range.  
**Sample Times:** Normal, 0.5 sec; fast, 0.05 sec.

**Effective Common Mode Rejection (1 kΩ imbalance):** DC: > 80dB; 50Hz or 60Hz ± 0.1%: >80dB.

**Normal Mode Rejection:** 50 Hz or 60 Hz ± 0.1%: > 50 dB.

**AC Voltage**  
**Frequency:** 40 Hz to 100 kHz for 10 V range, 40 Hz to 500 Hz for 100 V range, 40 Hz to 500 Hz for 1000 V range.  
**Effective Common Mode Rejection (1 kΩ imbalance):** DC: > 80 dB; 50 Hz or 60 Hz ± 0.1%: > 50 dB.

**Ohms**  
**Sensitivity:** 0.1 Ω for 10 kΩ range, 1 Ω for 100 kΩ range, 100 Ω for 1 MΩ range.  
**Current Through Unknown:** 1 mA on 10 kΩ range; 100 μA on 100 kΩ range; 1 μA on 1 MΩ range.

**Frequency**  
**Range:** 40 Hz to 10 MHz.  
**Sensitivity (min):** 50mV rms to 1MHz; 125mV rms to 10MHz.  
**Trigger Level:** Automatically adjusts to 40% of peak level of input.  
**Gate Times:** normal: 1 sec, fast: 0.1 sec.

### 5307A High Resolution Counter Module

**Input**  
**Range:** Hz mode: 5 Hz to 2 MHz. CPM mode: 50 to 10 M counts/minute (0.8333 Hz to 166 KHz).  
**Sensitivity (min.):**

	Hz	CPM
10 mV rms	5 Hz-1.2 MHz	120 CPM-10 MCPM
25 mV rms	1.2 MHz-2.0 MHz	50 CPM-120 CPM

**Pulses:** For low duty-cycle pulses (<15%); 15 mV peak for 250 nsec pulses, 100 mV peak for 100 nsec pulses.  
**Low pass filters:** (3 dB point) 100 Hz 10 kHz  
 Max. attenuation 60 dB 40 dB  
 Roll-off 20 dB per decade

**Frequency Measurement**  
**Periods averaged:** automatically selected for maximum resolution.  
**Measurement time:** varies from 312 ms to 815 ms.

### 5308A Universal Timer/Counter Module

**Input (Channels A and B)**  
**Range:** DC coupled; 0 to 75 MHz, AC coupled; 20 Hz to 75 MHz.  
**Sensitivity (min):** 25 mV rms to 10 MHz, 50 mV rms to 75 MHz, 150 mV p-p pulse at pulse width of 10 nsec.  
**Trigger level:** variable over the range of ±2.0 V and ±20 V.  
**Rear outputs:** gate, trigger levels and time base/scaling.

**Frequency**  
**Range:** 0 to 75 MHz, Channel A or Channel B.  
**Gate times:** 8 selectable times from 1 μs to 10 s.  
**Frequency Ratio**  
**Display:** Fa/Fb, 1 to 10<sup>8</sup> periods selectable manual or auto.  
**Range:** Channel A: 0 to 75 MHz, Channel B: 0 to 5 MHz.

**Period**  
**Range:** 0 Hz to 5 MHz, Channel B.  
**Resolution:** 100 nsec to 10 sec.

**Period Average**  
**Range:** 0.1-5 MHz; (200 nsec to 10 sec), Channel B.  
**Periods averaged:** 1-10<sup>8</sup> selectable manual or automatic.

**Time Interval A → B**  
**Range:** 200 nsec to 10<sup>9</sup> sec. 25 ns minimum pulse width.  
**Resolution:** 100 nsec to 10 sec.

**Time Interval Average A → B**  
**Range:** 1 ns to 10 s, 200 ns dead time between intervals.  
**Intervals averaged:** 1 to 10<sup>8</sup>, selectable manual or automatic.

**Totalize**  
 totalizes Channel A while Channel B is low.  
 totalizes Channel A between pulses on channel B.  
**Range:** 75 MHz in X1 position, 5 MHz in X10<sup>n</sup> positions.

**General**  
**Auto position:** automatically sets time base to give maximum resolution within 1.1 seconds measurement time for Frequency, Frequency Ratio, Period Average, and Time Interval Average.

Ordering Information	Price
5305B 1300 MHz Counter	\$950
10855A: Preamp: 22dB gain with ±1 dB flatness from 2 MHz to 1300 MHz.	\$295
5306A Digital Multimeter/Counter	\$700
5307A High Resolution Counter	\$450
5308A 75 MHz Timer/Counter	\$550



# ELECTRONIC COUNTERS

## 5300A/B System (cont.)

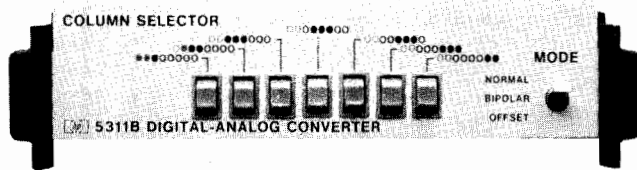

### 5311B Digital-to-Analog Converter Module

#### Operating Modes

Three modes selectable by switch on front panel.

Mode	Output		
	0 to 50% of Scale	50% of Scale	50% to 100% of Scale
Normal	0 to 499	500	501 to 999
Plus/Minus	-999 to -001	000	001 to 999
Offset	500 to 999	000	001 to 499

#### Output Selection

Manual pushbuttons to select any three consecutive digits or the last two digits of the mainframe display.

#### Output Ranges

**Potentiometric recorder output:** 0.1 V, 1.0 V, or 10 V full scale into >20 k $\Omega$ . Dual banana plugs.

**Galvanometer recorder output:** 1 mA full scale into <1.5 k $\Omega$  phone jack.

#### General

**Accuracy:**  $\pm 0.25\%$  of range  $\pm 50 \mu\text{V}/^\circ\text{C}$  on potentiometric output,  $\pm 20 \text{ nA}/^\circ\text{C}$  on galvanometer output after calibration for appropriate range.

**Calibration:** zero and full scale calibration switch and adjustments on rear panel.

**Transfer time:** <5 ms.

**Operating temperature:**  $0^\circ$  to  $50^\circ\text{C}$ .

**Power requirements:** nominally 1 watt.

**Weight:** net, 0.8 kg (1.7 lb). Shipping, 1.4 kg (3.0 lb).

**Size:** Digital-to-Analog Converter plugs between Mainframe and plug-on module. Increases height of instrument by 38.4 mm (1.5").

### 5311B Digital-Analog Converter

\$420



### 5310A Battery Pack Module

**Battery capacity:** 48 watt-hours, nominal. Minimum 3, typically 5, hours of continuous operation at charging and operating temperature ( $20^\circ$  to  $30^\circ\text{C}$ ).

**Recharging time:** 18 hours from minimum level (indicated by Low Voltage Indicator) to full charge.

**Battery voltage:** 12 Vdc.

**Low voltage indicator:** solid state warning light begins to glow at approximately 90% discharge.

**Line failure protection:** allows instrument to be operated in LINE position with automatic switch-over to battery power if line voltage fails. Batteries receive trickle charge in LINE position to maintain charge.

**Operating temperature:** operating  $0^\circ$  to  $50^\circ\text{C}$ . Charging:  $0^\circ$  to  $40^\circ\text{C}$ , mainframe not operating.

**Power requirements:** charging power via mainframe, nominal 7.5 watts.

### 5310A Battery Pack Module

\$285



### 5312A HP-IB (ASCII) Interface Module

The 5312A outputs fifteen characters of information in the following format.

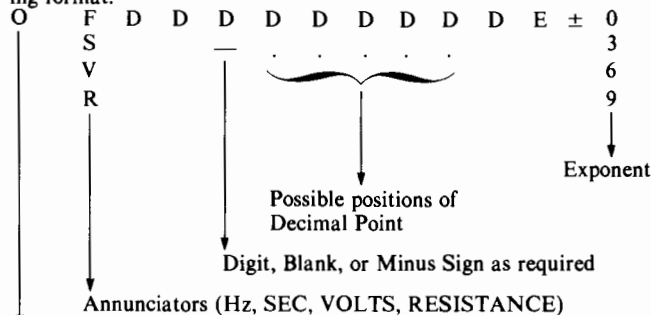

Overflow indicator

#### General

**Sample rate:** controlled by mainframe front panel control or by setting rate of reset command (when in listening mode, counter can be reset by sending "initialize" command).

**Transfer time:** 20 milliseconds.

**Transfer rate:** maximum of 40 reading/sec depending on capabilities of plug-on.

**Programmability:** 5300 measuring system front panel controls are not programmable.

**Note:** the 5312A is not compatible with the 5300A mainframe which contains its own BCD digital output.

### 5312A HP-IB Interface

\$365

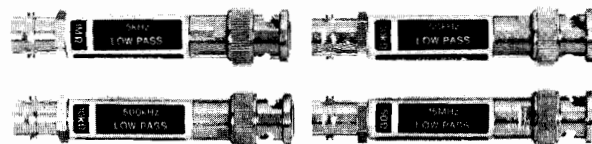

### 10856A Low Pass Filter Kit

The four low pass filters of the 10856A filter kit are recommended for use with any HP frequency counter to reduce high frequency noise or unwanted signals that cause frequency or period measurement errors. For use in calibration of frequency standards or instrument time bases, a 15 MHz, 50  $\Omega$  filter has been included. Further applications for the kit include reducing noise (trace fuzz) in oscilloscope and spectrum analyzer displays.

#### Specifications

Cut Off Frequency (NOMINAL)	5 KHz	50 KHz	500 KHz	15 MHz
Input Impedance (NOMINAL)	1 M $\Omega$	100 k $\Omega$	10 k $\Omega$	50 $\Omega$
Signal Rejection, 100 MHz to 500 MHz	>40 dB	>40 dB	>40 dB	>20 dB

**Roll-Off:** 20 dB per decade.

**Attenuation:**  $\times 2$ , reduces signal voltage by a factor of 2.

**Output Impedance:** for use with 1 M $\Omega$  input instruments.

### 10856A Low Pass Filter Kit

\$125

# ELECTRONIC COUNTERS

Low cost counters for frequency measurements

Models 5381A, 5382A & 5383A

323

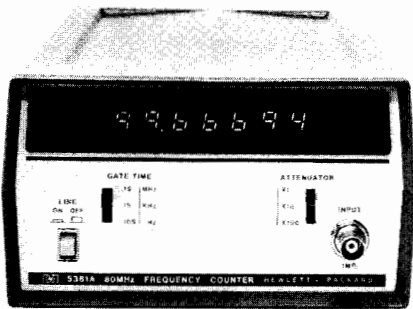

5381A

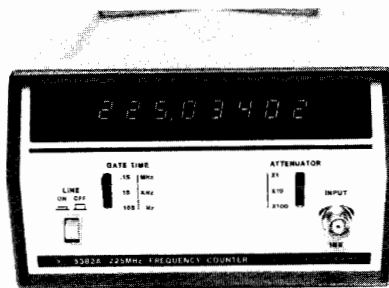

5382A

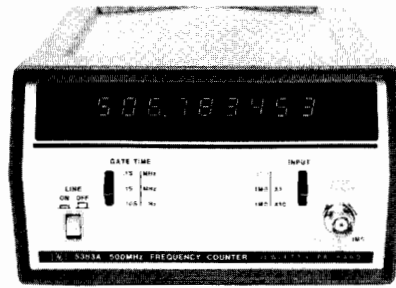

5383A

## Description

### General

The 5381A, 5382A and 5383A are a logical result of HP's long-standing leadership in frequency counter development. Leadership in quality, technology and efficient production procedures allows HP to offer a price/performance combination in these three precision instrument unsurpassed in their product category. These counters are designed to deliver reliable, high quality operation in such diverse areas as: production line testing, service and calibration (2-Way Radio and test equipment), frequency monitoring, education and training.

### Resolution

The 5381A, 5382A and 5383A employ the direct counting technique and, with 7, 8 and 9 digits respectively, offer resolution of 10 Hz in 0.1 sec., 1 Hz in 1 sec and 0.1 Hz in 10 seconds.

## Specifications

### 5381A

**Frequency range:** 10 Hz to 80 MHz.

**Sensitivity:** 25 mV rms—30 Hz to 20 MHz, 50 mV rms—10 Hz to 80 MHz.

**Input impedance:** 1 M $\Omega$ , <50 pF.

**Input attenuation:** X1, X10, X100.

**Accuracy:**  $\pm 1$  count  $\pm$  time base error.

**Resolution:** direct count; 1 Hz in 1 second.

**Gate times:** 0.1 second, 1 second, 10 seconds.

**Display:** 7 LED digits.

**Rear panel input:** sensitivity: TTL levels or 2.5 V rms.

**Ratio:** Rear Panel Input, 10 kHz to 2 MHz.

**External frequency standard:** Rear Panel Input, 1 MHz.

#### Time base

**Frequency:** 1 MHz.

**Aging:** <0.3 ppm/month.

**Temperature:**  $\pm 10$  ppm 0°C to 40°C.

**Line voltage:**  $\pm 1$  ppm for 10% line change.

### 5382A

**Frequency range:** 10 Hz to 225 MHz.

**Sensitivity:** 25 mV rms—30 Hz to 10 MHz, 50 mV rms—10 Hz to 225 MHz.

**Input impedance:** 1 M $\Omega$ , <40 pF.

**Input attenuation:** X1, X10, X100.

**Accuracy:**  $\pm 1$  count  $\pm$  time base error.

**Resolution:** direct count; 1 Hz in 1 second.

**Gate time:** 0.1 second, 1 second, 10 seconds.

**Display:** 8 LED digits, nonsignificant zero blanking.

**Rear panel input:** sensitivity: 250 mV rms.

**Ratio:** Rear Panel Input, 100 kHz to 10 MHz.

**External frequency standard:** Rear Panel Input, 10 MHz.

#### Time base

**Frequency:** 10 MHz.

**Aging:** <0.3 ppm/month.

**Temperature:**  $\pm 2.5$  ppm 0°C to 40°C.

**Line voltage:**  $\pm 0.5$  ppm for 10% line change.

### 5383A

**Frequency range:** 10 Hz to 520 MHz.

#### Sensitivity:

**1 M $\Omega$ :** 25 mV rms—20 Hz to 10 MHz.

50 mV rms—10 Hz to 50 MHz.

**50 $\Omega$ :** 25 mV rms—20 Hz to 520 MHz.

**Input impedance:** selectable: 1 M $\Omega$ , <40 pF or 50 $\Omega$ .

**Input attenuation:** 1 M $\Omega$  x 1, x 10; 50 $\Omega$  x 1—fuse protected.

**Accuracy:**  $\pm 1$  count  $\pm$  time base error.

**Resolution:** direct count; 1 Hz in 1 second.

**Gate time:** 0.1 second, 1 second, 10 seconds.

**Display:** 9 LED digits, nonsignificant zero blanking.

**Display test:** RESET function (activated with GATE TIME switch) illuminates all segments of all digits.

**Rear panel input:** sensitivity: 250 mV rms.

**Ratio:** Rear Panel Input, 100 kHz to 10 MHz.

**External frequency standard:** Rear Panel Input, 10 MHz.

#### Time base output

**Frequency:** 10 MHz.

**Voltage:** 200 mV p-p into 50 $\Omega$  load.

**Control:** active with Rear Panel Internal/External switch in internal position.

#### Time base

**Frequency:** 10 MHz.

**Aging:** <0.3 ppm/month.

**Temperature:**  $\pm 2.5$  ppm 0°C to 40°C.

**Line voltage:**  $\pm 0.5$  ppm for  $\pm 10\%$  line change.

#### TCXO Option

**Opt 001:** (available for all models) Temperature Compensated Crystal Oscillator time base

**Frequency:** 10 MHz.

**Aging:** <0.1 ppm/month.

**Temperature:** <1 ppm 0°C to 40°C.

**Line voltage:**  $\pm 0.1$  ppm for  $\pm 10\%$  line change.

**Note:** Time base output available for both 5382A and 5383A with Option 001. Rear Panel Input not available.

### 5380 Family General Data

**Overflow:** LED lamp indicator when most significant digit overflows.

**Reset:** manual selection of reset occurs when GATE TIME switch is between three normal positions.

**Package:** rugged, high strength metal case.

**Operating temperature:** 0°C to 40°C.

**Power requirements:** 100, 120, 220, 240, V rms (+5%, -10%) 48-440 Hz; 20 VA maximum.

**Weight:** net, 2.2 kg (4 1/2 lb). Shipping, 2.8 kg (6 lb).

**Dimensions:** 98 H x 60 W x 248 mm D (3.5" x 6.25" x 9.75").

### Ordering Information

5381A Frequency Counter

5382A Frequency Counter

5383A Frequency Counter

Opt 001: TCXO (all models)

### Price

\$375

\$475

\$725

add \$100



# ELECTRONIC COUNTERS

## General purpose plug-in counters

Model 5245L; Models 5253B, 5255A, 5257A plug-ins

- High performance in a general purpose counter
- Extremely high reliability proven from over forty million hours of field operation

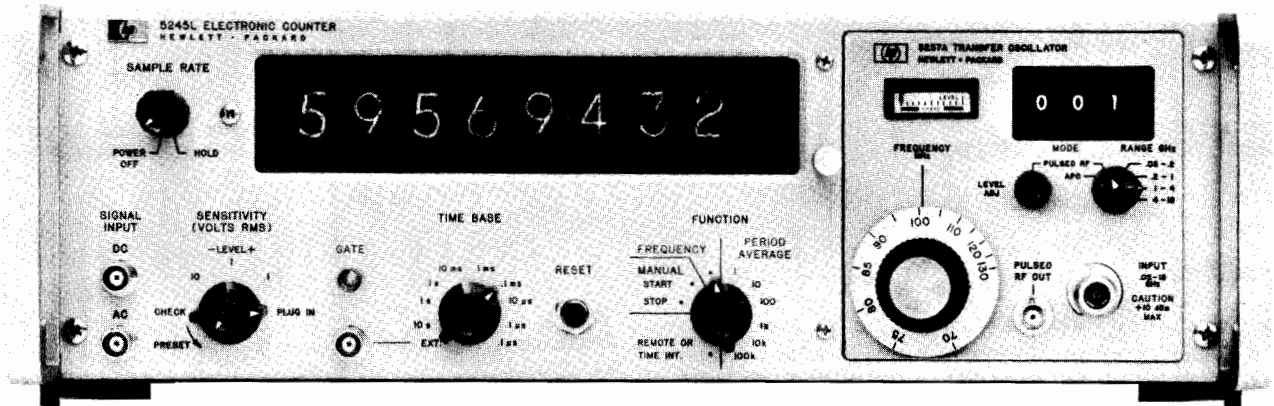

5245L

The 5245L has gained unprecedented popularity due to its high performance, flexibility and years of proven stability.

The 5245 series consists of a mainframe and a series of plug-ins. The plug-ins provide frequency measurement to 18 GHz. The appropriate choice of mainframe and plug-ins means that a wide range of measurement tasks can be accomplished.

The 5245 series counters are not only leaders in terms of performance and versatility, they are unsurpassed in the industry for ruggedness, wide operating temperature range, and field-proven reliability.

The 5245 series of plug-ins adds greatly to the versatility of the 5245 series of plug-in counters. In addition, these plug-ins enhance the measurement capability of the 5345A Electronic Counter by the use of plug-in adapters which provide an interface between the plug-in and the 5345A mainframe. Brief specifications of the individual plug-ins follow; refer to the 5245 series data sheet for complete details and specifications for all the plug-ins.

### Brief Specifications

#### 5245L Electronic Counter

##### Frequency measurements

**Range:** dc to 50 MHz.

**Gate time:** 1 μs to 10 seconds in decade steps.

**Accuracy:** ±1 count ± time base accuracy.

##### Period average measurements

**Range:** dc to 1 MHz for single period; dc to 300 kHz for multiple period.

**Periods averaged:** 1 period to 10<sup>5</sup> periods in decade steps.

**Accuracy:** ±1 count ± 1 time base accuracy ± trigger error\*.

**Mainframe measurement functions:** frequency, period, period average, ratio, scaling.

##### Signal input

**Sensitivity:** 100 mV rms.

**Coupling:** AC and DC.

**Impedance:** 1 MΩ in parallel with approx. 25 pF all ranges.

**Attenuation:** step attenuator provides nominal sensitivities of 0.1, 1, and 10 V rms (SENSITIVITY switch).

**Trigger Level:** continuously adjustable over ±3 V multiplied by the setting of the SENSITIVITY switch.

**Compatible 5245 series plug-ins:** all.

**Time base:** 10 MHz oscillator, aging rate < 3 × 10<sup>-9</sup>/day.

**Display:** 8 digits.

**Operating temperature range:** -20°C to +65°C.

**Weight:** net, 14.4 kg (32 lb) with blank plug-in panel.

**Size:** 133 H × 425 W × 416 mm D (5.25" × 16.75" × 16.38").

#### 5245L 50 MHz Electronic Counter

**\$6200**

**Opt. 908:** Rack Flange Kit

add \$40

\*Trigger error is < (±0.3% of one period ÷ number periods averaged) for signals with 40 dB signal-to-noise ratio and 100 mV rms amplitude; error decreases as signal to noise ratio increases.

### Brief Specifications

#### 5253B Heterodyne Converter

**\$1750**

**Frequency range:** 50 MHz to 512 MHz.

**Sensitivity:** -13 dBm to +13 dBm.

**Mixing frequencies:** 50 to 500 MHz in 10 MHz steps.

**Input coupling:** ac.

**Accuracy:** maintains counter accuracy.

**Input impedance:** 50Ω.

#### 5255A Heterodyne Converter

**\$3700**

**Frequency range:** 3 GHz to 12.4 GHz.

**Sensitivity:** -7 dBm to +10 dBm.

**Mixing frequencies:** 2.8 to 12.4 GHz in 200 MHz steps.

**Input coupling:** dc.

**Accuracy:** maintains counter accuracy.

**Input impedance:** 50Ω.

**Auxiliary input:** 1 MHz-200 MHz at 5 mV sensitivity.

**Auxiliary output:** 1 MHz-200 MHz.

#### 5257A Transfer Oscillator

**\$4800**

**Frequency range:** 50 MHz to 18 GHz.

**Input signal:** CW, pulsed RF or FM modulated.

**Sensitivity:** -7 dBm, 50 MHz to 15 GHz; -4 dBm, 15 GHz to 18 GHz.

**APC lock range:** approximately ±0.2% of input frequency.

**Pulse carrier frequency measurements:** minimum pulse width: 0.5 μs. Minimum repetition rate: 10 pulses per second.

**Input impedance:** 50Ω.

**VFO stability:** typically 1 × 10<sup>-7</sup> per minute after 2 hours.



Hewlett-Packard offers frequency standards and clocks which provide accurate frequency, time interval and timekeeping capabilities. Further, Hewlett-Packard standards provide means for comparing these quantities against national standards such as the National Bureau of Standards (NBS) and the U.S. Naval Observatory. Units of frequency or time cannot be kept in a vault for ready reference. They must be generated for each use, hence be regularly compared against recognized primary standards.

Frequency standard and clock systems manufactured by Hewlett-Packard are used for control and calibration at observatories, national centers for measurement standards, physical research laboratories, missile and satellite tracking stations, communication systems, radio navigation systems, manufacturing plants and radio monitoring and transmitting stations.

### Types of Frequency Standards

At the present time, three types of frequency standards are in common use. These are:

1. The cesium atomic beam controlled oscillator.
2. The rubidium gas cell controlled oscillator, and
3. The quartz crystal oscillator.

Hewlett-Packard manufactures all three types of frequency standards. Of these three standards, the first is a primary frequency standard and the last two are secondary frequency standards. The distinction between a primary standard and a secondary standard is that the primary standard does not require any other reference for calibration; whereas the secondary standard requires calibrations both during manufacturing and at intervals during use depending on the accuracy desired.

### Cesium Beam Frequency Standard

Cesium beam standards are in use wherever the goal is a very high accuracy primary frequency standard. In fact, the NBS frequency standard itself is of the cesium beam type. The cesium beam standard is an atomic resonance device which provides access to one of nature's invariant frequencies in accord with the principles of quantum mechanics. The cesium standard is a true primary standard and requires no other reference for calibration.

The HP Model 5061A and the newer 5062C are portable cesium beam standards proved capable of realizing the cesium transition frequency approaching levels of accuracy and long term stability achieved by large-scale laboratory models. Recent beam tube improvements have made the short-

TABLE 1 Comparison of Frequency Standards

Standard	Principal construction feature	Principal advantage
Cesium Atomic Beam Resonator Controlled Oscillator.	Beam of free Cesium atoms, spatially state selected, is subjected to a microwave signal at resonance frequency.	High intrinsic reproducibility and long-term stability. Designated as primary standard for definition of time interval.
Rubidium Gas Cell Resonator Controlled Oscillator.	Gas buffered resonance cell with optically pumped state selection.	Compact and light weight. High degree of short-term stability.
Quartz Crystal Oscillator.	Piezoelectrically active quartz crystal with electronic stabilization.	Very compact, light and rugged. Inexpensive.

term stability comparable to that of the rubidium frequency standard. With this improved performance cesium standards now have the capability of rapid measurement to high precision along with the excellent long term stability necessary for timekeeping.

### Rubidium Frequency Standard

Rubidium frequency standards feature a high order of both short-term and long-term frequency stability. These are both important in certain fields such as deep-space communications, satellite ranging, and doppler radar.

Rubidium standards are similar to cesium beam standards in that an atomic resonant element prevents drift of a quartz oscillator through a frequency lock loop. Yet the rubidium gas cell is dependent upon gas mixture and gas pressure in the cell. It must be calibrated and then it is subject to a small degree of drift. The drift is typically 100 times less than the best quartz crystal standard.

### Quartz Crystal Oscillators

Quartz oscillators are used in virtually every frequency control application including atomic standards. The excellent short-term stability and spectral purity of the quartz oscillators used in Hewlett-Packard atomic standards contribute to the high quality of the output signal of these standards. For less demanding applications where some long-term drift can be tolerated, quartz oscillators are used as independent frequency sources. The quartz oscillator designs have improved over the years to provide a relatively low cost, small-size source of frequency.

However, an inherent characteristic of crystal oscillators is that their resonant frequency changes with time. After an initial aging period of a few days to a month, the rate-of-change of frequency, or aging rate, is almost constant. Over a long period the accumulated drift could amount to a serious error, and periodic frequency checks are needed to maintain an accurate quartz crystal frequency standard.

### Stability

Stability is specified in two ways. Long term stability refers to slow changes in the average frequency with time due to secular

changes in the resonator and is usually expressed as a ratio,  $\Delta f/f$  for a given period of time. For quartz oscillators this is often termed "aging rate" and specified in "parts per day." Rubidium standards being more stable are specified in "parts per month." On the other hand, cesium beam standards are primary units with no systematic drift. Therefore, the frequency of these primary standards is guaranteed to a specified accuracy.

Short-term stability refers to changes in frequency over a time sufficiently short so that change in frequency due to long term effects is negligible.

Since short-term stability is a very broad term, it may refer to a number of different measurement methods and types of instability. In order to be clear when testing or specifying frequency standards, there are two classes of variations and two classes of measurement methods to be considered. The two classes of frequency variation are random, and non-random (or systematic, periodic, discrete, secular). The two classes of measurement are time domain (example: two sample deviation) and frequency domain (example: spectral density). Each of these measurement methods responds to both random and non-random variations.

### Time Domain

The subcommittee on Frequency Stability of the Technical Committee on Frequency and Time of the IEEE Group on Instrumentation and Measurement\* has established a standard method of measuring frequency stability in the time domain as the rms of the differences between adjacent pairs of frequency measurements, normalized, called the two-sample-deviation (also square root of Allan variance). Figure 1 is a comparison of the two-sample-deviation of various frequency standards.

### Frequency Domain

In a frequency domain measurement, the spectrum of phase or frequency variations can be plotted, hence the term, spectral purity.

\*Barnes et al. (May 1971) IEEE Transactions on Instruments & Measurements Vol. 1M-20, 105-120.

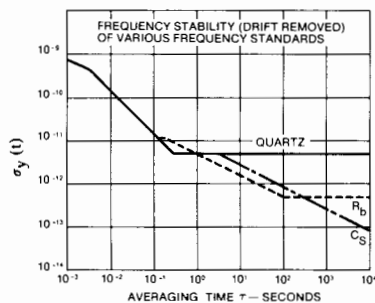

Figure 1. Time Domain stability of various standards.

Spectral purity is the degree to which a signal is coherent, or, expressed in another way, a single frequency with a minimum of sideband noise power. It is very desirable to have high spectral purity in a standard signal. This is especially important in applications where the standard frequency is multiplied to very high or microwave frequencies (so that the frequency spectrum of the multiplied signal will be reasonably narrow).

The signal and its frequency spectrum are analogous to a frequency modulated wave where the total power is constant. If the frequency multiplying device is broadband, the ratio of the total sideband power to the signal power increases as the square of the multiplying factor. With frequency multiplication the signal-to-noise ratio will be degraded 6 dB per octave and 20 dB per decade.

Frequency Domain measurements respond to both random and non-random variations, but in many cases, the effects are more readily separated and identified. For example, clearly separate measurements can be made of white noise combined with discrete spectral components ("bright lines").

The recommended specifications for the frequency domain are  $S_V$  and  $S_\phi$ . The widely used  $\mathcal{L}$  or single-sideband phase-noise-to-signal-ratio is, for low modulation index, one half of  $S_\phi$  (or  $\mathcal{L}(f) \sim S_\phi(f) - 3$  dB).

Hewlett-Packard oscillators are designed to give high spectral purity. Figure 2 shows the performance of the HP 5061A, Opt. 004 Cesium Beam Atomic Frequency Standard.

### Frequency Standards and Clocks

Frequency standards and clocks have no fundamental differences—they are based

upon dual aspects of the same phenomenon. Time and frequency are intangible quantities which can be measured only with respect to some physical quantity. The basic unit of time, the second, is defined as the duration of 9,192,631,770 periods of transition within the cesium atom. Conversely an unknown frequency is determined by counting the number of cycles over the period of a second. The Master Clock at the U.S. Naval Observatory, one of the world's most accurate clocks, is made of an ensemble of more than a dozen Hewlett-Packard cesium beam frequency standards, "flying clocks," are used to periodically check the synchronization between these stations and the Master Clock.

Hewlett-Packard cesium beam standards are widely used to drive precision clocks because of the extremely good long-term stability and reliability of this primary standard. If a quartz oscillator or other secondary standard is used, it must be evaluated for rate of drift and be corrected periodically.

### Time Scale

The time interval of the atomic time scale is the International Second, defined in October 1967 by the Thirteenth General Conference of Weight and Measures. Since January 1972 the frequency offset between UTC and Atomic Time has been zero and the UTC time scale is kept in synchronism with the rotation of the earth to within  $\pm 0.9$  second by step-time adjustments of exactly 1 second, when needed (see Hewlett-Packard Application Note 52-2).

The U.S. National Bureau of Standards (NBS) and USNO provide the official basis for Standard Time for the United States. The UTC signal is broadcast from the NBS stations WWV and WWVB and by several other stations throughout the world. (See Hewlett-Packard Application Note 52-1, Fundamentals of Time and Frequency Standards, for a list of stations broadcasting time signals).

### Standby Power Supplies

Minimum down-time, important for any system, is vital to a time standard. Its worth depends directly on continuity of operation. Noninterrupted operation is also important to ultra-precise quartz oscillators.

Hewlett-Packard standby power supplies ensure continued operation despite line interruptions, and operate over a range of ac line voltage to supply regulated dc to operate frequency standards and frequency dividers and clocks. The batteries in the supplies assume the full load immediately when ac power fails.

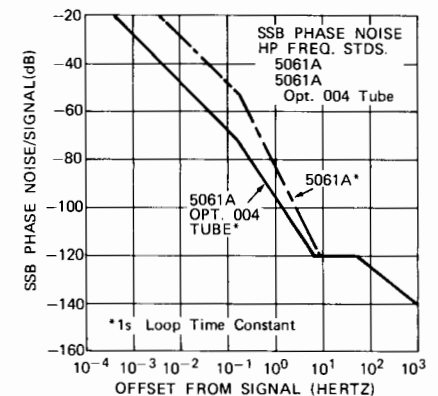

Figure 2. 5061A Phase Noise

### Hewlett-Packard Time and Frequency Standard

The Hewlett-Packard House Standard at the Santa Clara Division consists of an ensemble of four Hewlett-Packard Cesium Beam Standards each with the Option 004 High Performance Tube.

The standard is compared to the U.S. Naval Observatory Master Clock in Washington, D.C. by means of Loran C and TV Line 10 measurements through the USASTRAT-COM satellite system. It is also compared with the U.S. National Bureau of Standards Frequency Standard (NBS FS) at Boulder, Colorado by means of Loran-C through the Naval Observatory. The frequency uncertainty of the standard is within a few parts in  $10^{13}$  with respect to the standards maintained by the NBS and the USNO.

Time is maintained relative to the Naval Observatory and the National Bureau of Standards master clocks to an accuracy of better than  $\pm 2.5$  microseconds. This accuracy is verified with flying clock trips from the Naval Observatory to both Hewlett-Packard Santa Clara Division and Hewlett-Packard Geneva. Both locations have been designated U.S. Naval Observatory Time Reference Stations.

# FREQUENCY & TIME STANDARDS

Component Oscillator

Models 10811A, B

327



- New "SC" crystal cut
- Excellent spectral purity
- Low power
- Fast warm-up

- High reliability
- Rugged
- Compact
- Field repairable

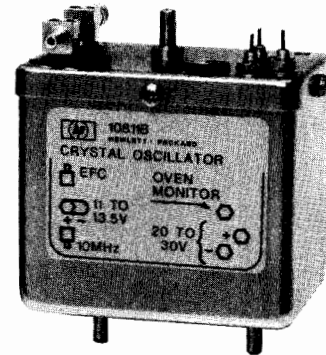
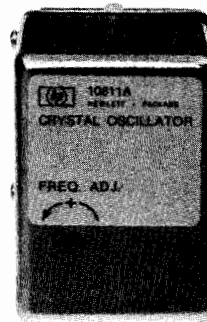
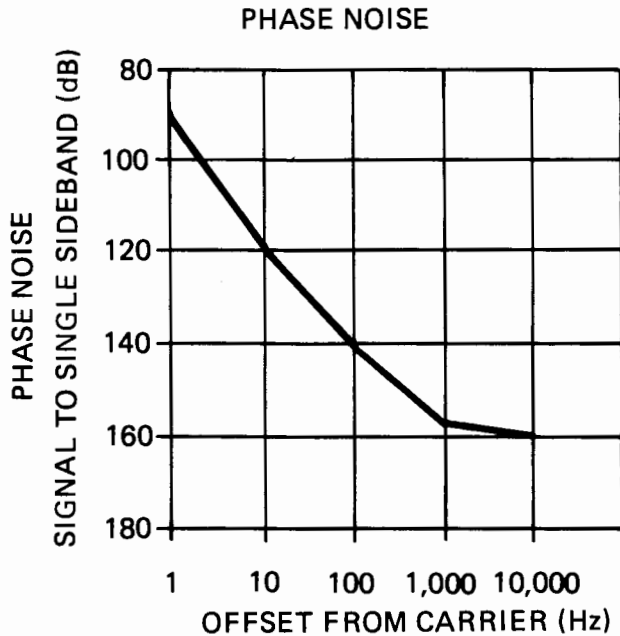

## Description

The 10811 Crystal Oscillators were developed by Hewlett-Packard to meet the ever increasing requirements for compact, high stability oscillators in test equipment and systems. These oscillators are used extensively in Hewlett-Packard test instruments and contribute in part to the superior performance of those instruments. Their excellent short-term stability and high spectral purity are especially desirable in applications where multiplication and synthesis are used to generate microwave frequencies. Rugged construction and high quality components assure high reliability and optimum performance. With the extremely low aging rate of these oscillators, significant cost savings can be realized at the end user by reducing the frequency of calibration needed to stay within FCC accuracy requirements.

The crystal for the oscillator is supported by a rugged mounting in a cold-welded, high bake-out enclosure. The housing around the crystal enclosure is massive with high thermal conductivity which contributes both to rapid warmup and excellent temperature stability. The oscillator, AGC amplifier and oven control circuits are all inside a thermally insulated oven. Rigid plastic foam with extremely low thermal conductivity is used to provide thermal insulation and firm mechanical support for the oven enclosure.

The 10811 oscillator has lower power consumption than previous designs due to a highly efficient new oven design. The oven controller is of the dc proportional type which results in very good phase noise and time domain stability specifications.

The differences between the A and B versions are primarily in the type of external connectors used. The A version uses a PC-board connector for all external connections; the B version uses SMB snap-on rf connectors for the 10 MHz output and the EFC input and solder-type connectors for the remainder of the connections. Additionally, the B version has provision for shock mounting.

The oscillators are ideally suited for use in communication and navigation systems, synthesizers, time-code generators, counters and spectrum analyzers. The 10 MHz output frequency is a convenient starting point since it is easily divided or multiplied.

A screwdriver adjustment through the top of the oven enclosure permits frequency adjustment over a range of  $2 \times 10^{-6}$  (20 Hz), yet the control is sensitive enough to allow adjustment to better than  $1 \times 10^{-9}$  (0.01 Hz). Frequency can also be controlled electronically (EFC) over a 1 Hz range with an externally applied voltage.

## Specifications

**Output:** 10 MHz

$1.0 \pm 0.2$  V rms into 1000  $\Omega$ , or  $0.55 \pm 0.05$  V rms into 50  $\Omega$

**Aging rate (after 24-hour warmup):**  $< 5 \times 10^{-10}$ /day.

**Short term stability:**

**Averaging time**

$10^{-3}$ s	$1.5 \times 10^{-10}$
$10^{-2}$ s	$1.5 \times 10^{-11}$
$10^{-1}$ s	$5 \times 10^{-12}$
$10^0$ s	$5 \times 10^{-12}$
$10^1$ s	$5 \times 10^{-12}$
$10^2$ s	$1 \times 10^{-11}$

**Temperature:**  $< 2.5 \times 10^{-9}$  (0 to 71°C)

**Load:**  $< 5 \times 10^{-10}$  for a  $\pm 10\%$  change in 50  $\Omega$  load or  $\pm 25\%$  change in 1000  $\Omega$  load.

**Warmup:** within  $5 \times 10^{-9}$  of final value 10 min. after turn on.

**Frequency adjustment**

**Coarse:**  $> 2 \times 10^{-6}$  (20 Hz)

**Fine (EFC):**  $> 1 \times 10^{-7}$  (1 Hz)

**Harmonic distortion:**  $> 25$  dB from rated output

**Spurious phase modulation:** down more than 100 dB from rated output

**SSB phase noise ratio (1 Hz bw)**

**For offsets of:**

1 Hz:	-90 dBc
10 Hz:	-120 dBc
100 Hz:	-140 dBc
1000 Hz:	-157 dBc
10000 Hz:	-160 dBc

**Power:** 2W

**Case size:** 72 H x 52 W x 62 mm D (2.8" x 2" x 2.4").

**Weight:** 0.31 kg

	Price	
<b>Quantity</b>	<b>10811A</b>	<b>10811B</b>
1 to 4:	\$800 ea	\$900 ea
5 to 9:	\$768 ea	\$864 ea
10 to 24:	\$736 ea	\$828 ea
25 to 49:	\$672 ea	\$756 ea

# FREQUENCY & TIME STANDARDS

## Atomic frequency standards

Models 5061A, 5062C, 5065A

### 5061A

- Primary standard,  $\pm 1 \times 10^{-11}$  accuracy
- Proven reliability
- World-wide usage

### 5061A, Opt 004

- Accuracy  $\pm 7 \times 10^{-12}$
- Settability  $\pm 1 \times 10^{-13}$
- Time domain stability  $5 \times 10^{-12}$  (1 s avg)

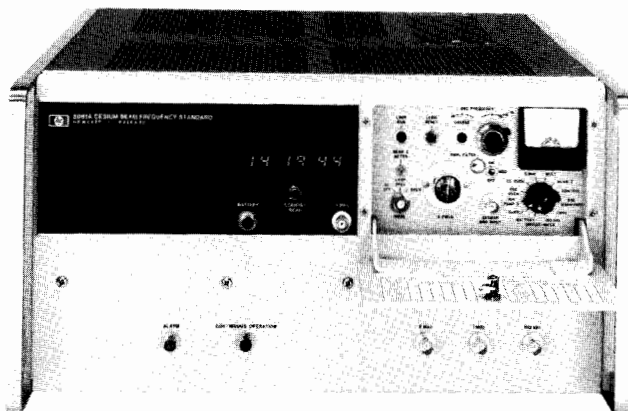

5061A

## Introduction

Hewlett-Packard Atomic Frequency Standards have become the world-wide standards for frequency and time keeping since the introduction of the 5060A Cesium Standards in 1964. With the introduction of the 5062C, the user now has a choice of four different frequency standards to satisfy a wide variety of applications:

1) 5061A Cesium Beam Frequency Standard. This standard with an accuracy of  $\pm 1 \times 10^{-11}$  was introduced in 1967 to replace the 5060A. The high accuracy and excellent reliability of these units have gained world-wide acceptance of HP frequency standards.

2) 5061A with Option 004 High Performance Cesium Beam Tube. With the unique design features in this improved Cesium Beam Tube, the 5061A accuracy is  $\pm 7 \times 10^{-12}$  and short term stability is improved by a factor of 10.

3) 5062C Cesium Beam Frequency Reference. This unit with its small cesium beam tube is designed for on-line system applications where a rugged primary standard is required.

4) 5065A Rubidium Frequency Standard. This instrument features excellent long and short term stability performance at approximately one-half the cost of a cesium standard.

The units are described in detail on the following pages and the specifications are combined in a table to facilitate the comparison and selection of the best unit to suit the user's application.

## Principles of Operation

The basic block diagram of both cesium and rubidium standards is the same (see Figure 1). The output of the 5 MHz crystal oscillator

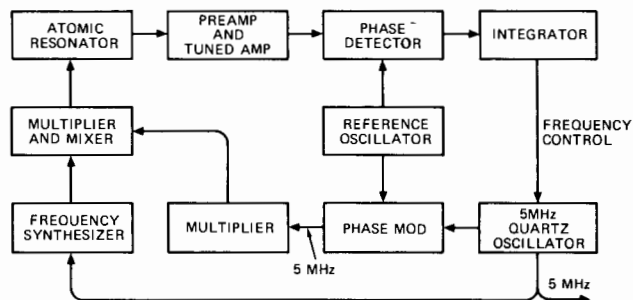

Figure 1. Block diagram of atomic frequency standards.

is multiplied and synthesized to the atomic resonance frequency (6834+ MHz for rubidium and 9192+ MHz for cesium). The signal is frequency modulated to sweep through the atomic resonance frequency causing the beam intensity in the cesium tube or transmitted light through the rubidium cell to vary. The output signal is amplified

and through a phase detector controls the frequency of a low noise 5 MHz quartz crystal oscillator. The oscillator provides the 5 MHz output. Dividers produce 1 MHz and 100 kHz outputs.

The invariant resonance frequency of the cesium atoms passing through the microwave cavity maintain the output frequency of the cesium standard constant to extremely high accuracy. The accuracy is in part a function of the microwave cavity length and is highest in the 5061A with the long cavity of the high performance beam tube.

In the rubidium standard a buffer gas is required to reduce collisions between the rubidium atoms in the gas cell and the resonant frequency varies slightly with the pressure of the buffer gas. As a result, the rubidium standard has to be calibrated and the frequency drifts slowly with time because of small changes in gas pressure and other effects within the rubidium cell and lamp. Offsetting this disadvantage are: 1) high signal-to-noise ratio of the rubidium cell output which results in excellent short term stability and; 2) a lower cost standard because of the simpler rubidium cell and associated electronics.

Each of the instruments has front panel controls, a circuit check switch and meter for monitoring performance. These and other controls are protected by a panel door. Front panel lights indicate any interruption of continuous operation and that the crystal oscillator is locked to the atomic resonance.

**Applications:** starting with their initial usage as reference standards in national laboratories the applications of HP atomic standards have expanded to include use in operational systems such as the Loran C and Omega navigation transmitters, satellite tracking and guidance stations, very long base line interferometers, navigation receivers based on direct distance measurement (Loran Rho-Rho), geophysical survey positioning systems and communications systems. Precise timing for frequency control is required for some secure communications systems and to improve efficiency of PCM and spread spectrum systems.

**Cesium standard accuracy:** the cesium beam standard is a primary frequency standard. A cesium beam tube carefully constructed along with the required supporting electronics will, when independently aligned, put out the correct frequency within very narrow limits. The frequency spread of the output for over 250 independently aligned 5061A standards with the standard beam tube is shown in Figure 2. It can be seen from this data that the frequency perturbations in the standard beam tube are so small that all the units are within  $\pm 5 \times 10^{-12}$  of each other and of NBS frequency. The one sigma standard deviation is  $1 \times 10^{-12}$  between units. This performance is intrinsic to the 5061A and is achieved without calibration. The absolute accuracy, intrinsic reproducibility and absence of any perceptible long-term drift or aging are important advantages of cesium standards and assure that the output frequency of a cesium standard is always within the specific accuracy.



E21-5061A

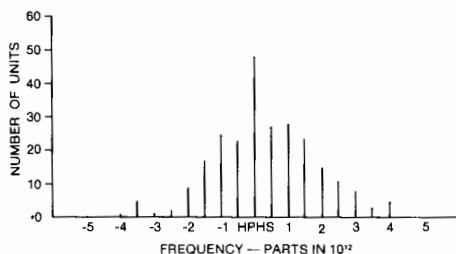

Figure 2. Frequency of independently aligned 5061A Cesium Beam Standards with standard beam tube.

### 5061A Cesium Beam Standard

The first Hewlett-Packard Cesium Beam Standard, the 5060A, was introduced in 1964. This was followed in 1967 with the improved 5061A and in 1973 with the high performance beam tube option for the 5061A. Since this time the accuracy and reliability of Hewlett-Packard cesium beam standards has been demonstrated and these standards have become the world-wide standard for frequency and time keeping. The 5061A has provision for an optional digital divider and reliable, easy-to-read LED clock (Option 001) and for a battery with ½ hour standby power capacity with automatic charging (Option 002).

**Reliability and Warranty:** over 60 million operation hours have proven the performance and reliability of Hewlett-Packard cesium beam standards in various world-wide applications. The units have provided dependable microsecond accuracy in aircraft, ship and fixed environments.

A three-year warranty on the 5061A standard cesium beam tube is provided as a result of proven field reliability over an extended period. This warranty includes replacement of the cesium beam tube if it should fail within the warranty period. Typically, beam tube life has been in excess of five years.

### 5061A with Opt 004, High Performance Cesium Beam Tube

The Hewlett-Packard Model 5061A primary frequency standard with the Option 004 Cesium Beam Tube offers increased stability and accuracy in the instrument which has become the worldwide standard of frequency and time keeping since its introduction in 1967. Improvements in magnetic shielding, ruggedization and environmental performance permit improved performance and expansion of navigation and communication systems that have been made practical by the 5061A.

The design concept of the high performance beam tube includes unique HP designed dual beam optics with higher beam intensity to accomplish better short term stability and greater immunity to effects of shock and vibration. A 50 percent increase in resonance cavity length without change in the overall beam tube size contributes to better accuracy and settability because of the high Q of the narrower resonant line width. This tube retains the unique cesium standard feature of virtually no long term instability or aging.

The intrinsic accuracy is improved to  $\pm 7 \times 10^{-12}$  which provides an excellent reference standard without need of calibration. If desired, as in many timekeeping applications, two or more units may be calibrated to determine the difference in rate or may be adjusted to the same frequency. With the improved settability specifications of  $1 \times 10^{-13}$  small changes in frequency are accomplished rapidly and accurately. A provision for degaussing the tube without adversely affecting the instrument operation allows removal of any residual magnetic field in the tube. This is important in achieving the settability performance.

The short term stability specification is improved by a factor of ten with this tube. The  $5 \times 10^{-12}$  (1 s avg.) performance compares very favorably with that of rubidium type standards which are noted for their excellent short term stability. An important advantage from the better short term stability is the capability to make measurements to 1 sigma precision of  $1 \times 10^{-12}$  in about one minute compared to the two hours required previously. The 5061A with the Option 004 High Performance Tube has the same high reliability as the 5061A with the standard tube. The new high performance tube is warranted for one year, but is designed to have the same long life as the standard tube.

### 10638 Degausser

The Model 10638A Degausser is designed for use with the Option 004 High Performance Beam Tube to achieve settability of  $\pm 1 \times 10^{-12}$  and reproducibility of  $\pm 3 \times 10^{-12}$ . The degausser removes residual magnetic fields in the beam tube which slowly decay and cause a small frequency change. The degausser should be used when initially setting up the 5061A with Option 004 or after the instrument has been moved or adjusted.

### E21-5061A Flying Clock

The E21-5061A consists of a 5061A Cesium Beam Standard with Option 001 LED Clock and K02-5060A Power Supply joined together to make one portable unit. The power supply, which can be operated from 6 or 12 V dc, 24 to 30 V dc, or 115/230 V  $\pm 10\%$ , 50 to 400 Hz, will provide approximately 7 hours standby power (from sealed nickel-cadmium batteries) for the 5061A Cesium Beam Standard.

This wide range of operating power capabilities enable the E21-5061A to operate on local power in virtually any country in the world. Operation is approved aboard commercial aircraft. The seven hours standby capability make it possible to travel where there is no power available and, of course, allow the E21-5061A to conveniently be transported between power sources and operated in almost any air or surface vehicle as a "flying clock" (see Hewlett-Packard Journal, August 1966 and December 1967).

The Option 004 tube, because of the improved shielding, offers a significant increase in accuracy under the varying earth's magnetic field conditions experienced by flying clocks and is a desirable addition to the E21-5061A. In addition, the better short term stability permits more accurate and rapid comparison of standards. The Option 002 Battery may also be added to increase standby capability.

# FREQUENCY & TIME STANDARDS

## Atomic frequency standards

Models 5061A, 5062C, 5065A (cont.)

- Primary frequency/time reference
- Fast warm-up
- Rugged, reliable

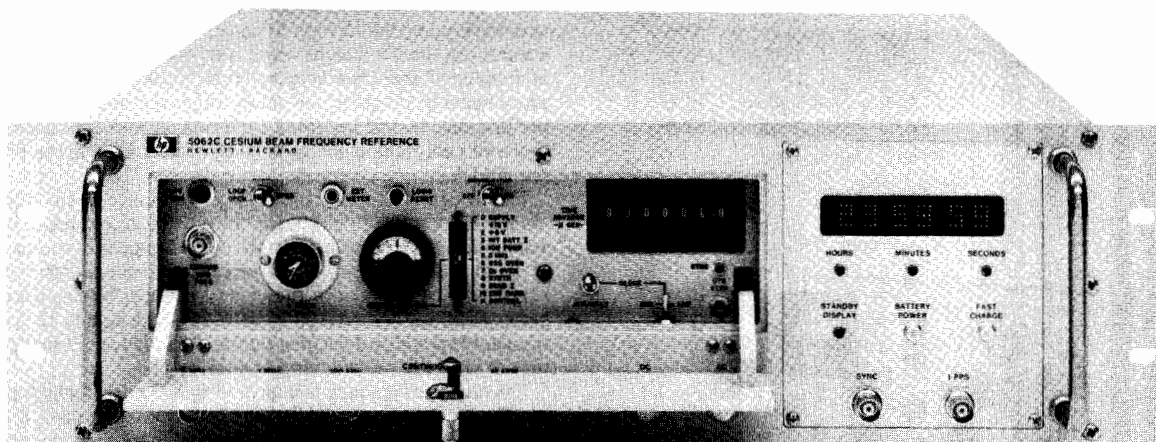

5062C

### 5062C Cesium Beam Frequency Reference

The Model 5062C Cesium Beam Frequency Reference is a rugged and compact precision oscillator designed for use in surface and airborne systems such as shipboard navigation systems and air transport communication systems. It combines the precision of a laboratory primary standard with the rugged, compact features required for on-line system operations in the extreme environments sometimes encountered in ships and aircraft.

Features important for system operation are the expanded operating temperature range ( $-28^{\circ}\text{C}$  to  $+65^{\circ}\text{C}$ ), 20 minute warm-up, frequency accuracy of within  $\pm 3$  parts in  $10^{11}$  (including temperature and magnetic field effects) with negligible long-term drift and no need for calibration.

The basic design of the Model 5062C is patterned after that of the Hewlett-Packard Model 5060A and the 5061A Cesium Beam Clocks, but this rugged unit is 25% smaller in size. Yet, space is provided for an optional clock and standby batteries. Other features such as special output frequencies or a time code generator may be added. The key to the smaller size is a small, rugged cesium beam tube. This tube, approximately six inches long and four inches in diameter, includes all the features of the sixteen inch tube used in the HP 5061A to insure high accuracy and stability plus long life. In addition, multiple cesium beams assure accuracy under the shock, vibration and acceleration encountered in operating systems.

Compact electronics compliment the small beam tube in accomplishing the 5062C design. Plug-in keyed printed circuit cards assure ease of maintenance. Particular attention has been given to both the electronics and mechanical design to the temperature, shock and vibration encountered in system applications. The resulting rugged design assures stable operation under extreme environmental conditions. The 5062C meets many of the requirements of MIL-E-16400 specification for ship and shore equipment. These include the wide operating temperature range, the 400 pound hammer blow specified by MIL-S-901 and the Type I shipboard vibration of MIL-STD-167-1 (4—50 Hz).

With minor circuit additions the rugged, commercial, design of the 5062C meets the operating requirements of military specification MIL-F-28811 (EC). The nomenclature, 0-1695/U has been assigned to this version of the instrument which is identified as the 5062C, Option 010. The added features are described below.

**Reliability:** the unit incorporates conservatively designed circuits to

insure reliability. Similar designs in the 5061A Cesium Beam Standard have demonstrated mean time between failures (MTBF) in excess of 40,000 hours in laboratory environments.

Ease of maintenance was included along with reliability and ruggedness as design goals of the 5062C. The front panel circuit monitoring switch and meter permit checks for proper operation and monitoring of critical functions. In the event of a malfunction, troubleshooting is simplified by well marked test points on the circuit cards and mother boards. Board extenders permit access to individual boards while operating. The circuit boards are keyed to assure that they are properly located. The few board adjustments are readily accessible when the instrument covers are removed. The 5062C is supplied with pivot slides for easy access when the unit is rack mounted. All these features simplify troubleshooting and minimize mean time to repair (MTTR) in the event of failure.

**Options:** the 5062C is designed to include clock and battery options and space is available to add other features required to meet systems requirements. Special output frequencies, time code generators, and additional buffered outputs may be added. The following standard options are available.

**Option 001 Digital Clock:** this option adds a front panel LED display of hour, minutes and seconds. A digital divider generates one pulse-per-second from 5 MHz. This master pulse may be synchronized to a reference pulse. The digital clock and the clock 1 PPS are adjustable in phase with respect to the master pulse in 0.1 micro-second steps.

**Option 002 Standby Battery:** the sealed gelled-electrolyte battery provides a minimum of one hour standby at  $25^{\circ}\text{C}$  after full charge. The battery is automatically recharged after use. When external power fails, the standby battery assures continuous output without interruption.

**Option 003 Digital Clock and Standby Battery:** this option combines Option 001 and 002.

**Option 010 Time-code Generator:** this option includes the Option 001 Digital Clock and Option 002 Standby Battery along with other special features required to meet the operating requirements of the 0-1695/U Frequency Standard, Cesium Beam in accordance with Military Specification MIL-F-28811(EC). These include a time code generator, four one-pulse-per-minute outputs, additional 5 MHz outputs, added RFI shielding and special rear panel and mating connectors. The rugged design of the 5062C meets the environmental requirements of the military specification.

- Compact, low-price atomic standard
- Long term drift rate  $< 1 \times 10^{-11}/\text{mo}$
- Time domain stability  $< 5 \times 10^{-13}$  (100 s avg)

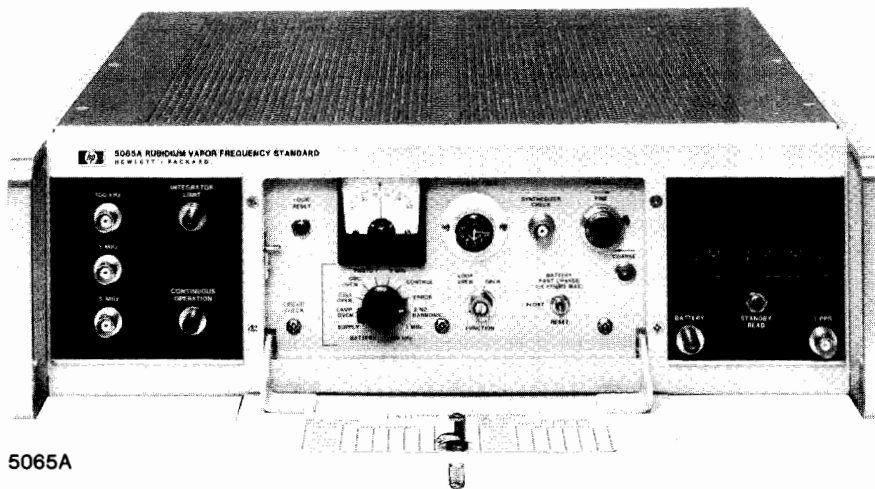

### 5065A Rubidium Frequency Standard

The HP Model 5065A is an atomic-type secondary frequency standard which uses a rubidium vapor resonance cell as the stabilizing element. As a result, it has long term stability of better than  $1 \times 10^{-11}$  per month which exceeds that of high quality quartz oscillator frequency standards by 50 to 100 times. Furthermore, it has excellent short term stability. These features contribute to its desirability as a coherent signal source, as a master oscillator for radio and radar systems where special requirements for stability and/or narrow bandwidth must be met, as a precision time keeper where the better performance of a cesium beam primary standard is not required, and as a house frequency standard for improved accuracy with fewer NBS calibrations compared to that required with quartz standards.

Front panel controls and circuit check meter of the 5065A are protected by a panel door. The magnetic field control provides fine frequency adjustment with which the frequency can be set to a precision of better than  $2 \times 10^{-12}$  without reference to a chart. The 5 MHz low noise quartz oscillator is phase locked to the atomic frequency and provides the standard 5 MHz, 1 MHz, and 100 kHz outputs. The circuit check meter with selector switch monitors key voltages and currents for routine maintenance readings, calibration procedures, and fault finding.

The 5065A is designed for assured operation—to give the user confidence that the standard output signals are correct and locked to the atomic frequency. Logic within the unit maintains power to a “continuous” operation light on the front panel. If operation is interrupted, even momentarily, for any reason the light goes out and stays out until manually reset. An integrator limit light warns when the frequency correcting servo loop is approaching the limit of its dynamic range.

The HP Model 5065A is contained in a small sized package and is lightweight in comparison to a cesium beam standard. Additionally the rubidium resonance cell is much more frequency stable than quartz oscillators while subjected to shock and vibration, EMC, humidity, and magnetic field effects.

**Reliability and warranty:** the most significant module in the HP 5065A in terms of performance is the Rubidium Vapor Frequency Reference (RVFR). This temperature controlled, magnetically shielded unit includes the Rb gas cell and a photo sensitive detector

designed for maximum possible reliability. Field experience, including several million hours of operation, have demonstrated this reliability and the module is now warranted for a period of three years. This increased warranty protects the owner in the event of random failure.

The Option 001 Digital Clock has an easy to read LED time-of-day display. The olive black upper panel provides a dark background around the readout for excellent contrast and readability. Initial clock setting is accomplished by means of pushbuttons easily accessible by removing the top cover. The LED display offers high reliability, freedom from errors due to mechanical shock, and performance over the full environmental range of the 5065A. A sync button on the digital divider permits automatic synchronization of this 1 PPS pulse to an external pulse. The clock 1 PPS is adjustable in decade steps from  $1 \mu\text{s}$  to 1 s, with respect to the synchronized reference, with 6 thumbwheel switches. A screwdriver adjustment allows fine continuous adjustment over a range of  $1 \mu\text{s}$ .

To conserve battery power, the display is not illuminated when ac power is not available. A STANDBY READ pushbutton below the display is used for readout when operating on the internal battery or external dc.

The Option 002 Standby Battery provides the 5065A with a minimum of 10 minutes standby power at 25°C. Switchover from line to battery is automatic so there is no interruption of operation if ac line power should fail. A front panel ac interruption light warns when ac power has failed or has been disconnected. Fast or float charging rates may be selected when ac power is available.

The Option 003 combines the Option 001 Clock and Option 002 Battery and should be specified if both Options 001 and 002 are required.

### E21-5065A Portable Time Standard

E21-5065A Portable Time Standard is a complete system for precision timekeeping and for transporting time from one location to another. It consists of the 5065A Rubidium Standard with digital clock and divider (Option 001) and the K02-5060A Power Supply with 6 or more hours standby capability. The component units are held together by side bars, and the interconnecting cables are protected by a back cover.





# FREQUENCY & TIME STANDARDS

Atomic frequency standards

Models 5061A, 5062C, 5065A (cont.)

## Specifications

Instrument:	5061A Option 004	5061A	5062C	5065A
Type of Standard:	Cesium	Cesium	Cesium	Rubidium
Accuracy: maintained in magnetic field to 2 gauss and over temperature range of:	$\pm 7 \times 10^{-12}$ 0 to 50°C	$\pm 1 \times 10^{-11}$ 0 to 50°C	$\pm 3 \times 10^{-11}$ -28°C to +65°C	
Stability: Long Term: Short Term 5 MHz <sup>(2)</sup> : Averaging time: 0.01 1 10 100	$\pm 3 \times 10^{-12(1)}$ $1.5 \times 10^{-10}$ $5 \times 10^{-12}$ $2.7 \times 10^{-12}$ $8.5 \times 10^{-13}$	$\pm 5 \times 10^{-12(1)}$ $1.5 \times 10^{-10}$ $5.6 \times 10^{-11}$ $2.5 \times 10^{-11}$ $8 \times 10^{-12}$	$\pm 1 \times 10^{-11(1)}$ $4 \times 10^{-10}$ $7 \times 10^{-11}$ $2.2 \times 10^{-11}$ $7 \times 10^{-12}$	$\pm 1 \times 10^{-11}$ /month $1.5 \times 10^{-10}$ $5 \times 10^{-12}$ $1.6 \times 10^{-12}$ $5 \times 10^{-13}$
SSB Phase Noise Signal (1 Hz BW) Offset from signal: Hz: 10 <sup>-3</sup> 10 <sup>-2</sup> 10 <sup>-1</sup> 0 10 <sup>1</sup> 10 <sup>2</sup> 10 <sup>3</sup>	-28 dB -48 dB -68 dB -96 dB -120 dB -125 dB -140 dB	-8 dB -28 dB -48 dB -82 dB -120 dB -125 dB -140 dB	-6 dB -26 dB -46 dB -74 dB -114 dB -134 dB -144 dB	-25 dB -52 dB -72 dB -93 dB -120 dB -126 dB -140 dB
Reproducibility	$\pm 3 \times 10^{-12(3)}$	$\pm 5 \times 10^{-12}$	$\pm 1 \times 10^{-11}$	
Settability (frequency):	$\pm 1 \times 10^{-13(3)}$	$\pm 7 \times 10^{-13}$	$\pm 2 \times 10^{-12}$	$\pm 2 \times 10^{-12}$
DC Magnetic Field Stability:	$< \pm 2 \times 10^{-13}$ 2 Gauss Field	$< \pm 2 \times 10^{-12}$ 2 Gauss Field	$< \pm 2 \times 10^{-12}$ 2 Gauss Field	$< \pm 5 \times 10^{-12}$ 1 Gauss Field
Warm-up:	At 25°C 30 Min.	At 25°C 45 Min.	At -28°C 20 Min.	At 25°C 1 x 10 <sup>-10</sup> 1 hr. 5 x 10 <sup>-11</sup> 4 hrs.
Sinusoidal Outputs: Output Voltage	5 MHz, 1 MHz, 100 kHz, Front & Rear BNC 1 V into 50 ohms			
Harmonic Distortion: (below rated output)	>40 dB	>40 dB	>30 dB	>40 dB
Non-Harmonic related output: (below rated output)	>80 dB	>80 dB	>80 dB	>80 dB
Under vibration or AC Mag Field:	>60 dB	>60 dB	>60 dB	>60 dB
Signal-to-Phase Noise Ratio in 30 kHz noise BW (1 and 5 MHz):	>87 dB	>87 dB	>87 dB	>87 dB
<b>Environmental</b>				
Temperature, operating with Option 001, 002 or 010 <sup>(4)</sup> Freq. change from 25°C:	0 to 50°C <5 x 10 <sup>-12</sup>	0 to 50°C <5 x 10 <sup>-12</sup>	-28 to +65°C <2 x 10 <sup>-11</sup>	0 to 50°C <4 x 10 <sup>-11</sup>
Temperature, non-operating without options: with Option 001: with Option 002 or 010 <sup>(4)</sup>	-40°C to 75°C -40°C to 75°C -40°C to 50°C	-40°C to 75°C -40°C to 75°C -40°C to 50°C	-62°C to 75°C -40°C to 75°C -40°C to 60°C	-40°C to 75°C -40°C to 75°C -40°C to 50°C
Humidity, operating: 95% up to	40°C	40°C	50°C	40°C
Altitude, operating: Max. frequency change:	12.2 km (40,000 ft.) 2 x 10 <sup>-12</sup>	12.2 km (40,000 ft.) 2 x 10 <sup>-12</sup>	15.2 km (50,000ft.) 5 x 10 <sup>-12</sup>	12.2 km (40,000 ft.) 2 x 10 <sup>-11</sup>
NOTES: (1) For life of beam tube. (2) Short-term stability for the 5061A with both standard and high performance tubes is given for the normal loop time constant. For improved short-term stability in controlled environments the long time constant may be used. (3) With 10638 Degausser. (4) 5062C only.				

# FREQUENCY & TIME STANDARDS

333

Atomic frequency standards

Models 5061A, 5062A, 5065A (cont.)



Instrument	5061A Opt 004	5061A	5062C	5065A
AC Magnetic Field: 50, 60 and 400 Hz $\pm$ 10%	$<2 \times 10^{-12}$ for 2 Gauss peak	$<2 \times 10^{-12}$ for 2 Gauss peak	$<2 \times 10^{-12}$ for 2 Gauss peak	$<5 \times 10^{-12}$ for 1 Gauss peak
Vibration: with isolators:	MIL-STD-167-1 MIL-T-21200	MIL-STD-167-1 MIL-T-21200	MIL-STD-167-1	MIL-STD-167-1
Shock:	MIL-E-5400, Class 1 (30G)			
	1-MIL-T-21200, C.1		MIL-E-16400	MIL-T-21200, C.1
EMC:	MIL-STD-461, Notice 3, Class A			
<b>General</b>				
Power: AC:	50, 60 or 400 Hz $\pm$ 10%, 115/230 V $\pm$ 10%			
DC:	43 W 22 to 30 V 27 W	43 W 22 to 30 V 27 W	48 W 22 to 30 V 33 W	49 W 23 to 30 V 35 W
Option 001: add (AC/DC)	10/7.5 W	10/7.5 W	12/7.5 W	10/7.5 W
Option 002: add (AC/DC)	22/4.5 W	22/4.5 W	25/3W	6/0 W
Option 010: add (AC/DC)			62/15 W	
Dimensions (H x W x D): mm:	221 x 425 x 416	221 x 425 x 416	133 x 482 x 533	133 x 425 x 416
	inches: 8.7 x 16.7 x 16.4	8.7 x 16.7 x 16.4	5.2 x 19 x 21	5.2 x 16.7 x 16.4
Weight: (lb/kg)	70/31.8	67/30.5	50/22.7	34/15.4
Option 001: add (lb/kg)	2/0.9	2/0.9	5/2.3	2/0.9
Option 002: add (lb/kg)	5/2.3	5/2.3	15/6.8	3.5/1.6
<b>Option 001, Clock</b>				
1 PPS Outputs: Master: Clock:	Front & Rear BNC	Front & Rear BNC	Rear BNC Front & Rear BNC	Front & Rear BNC
Amplitude:	10 V peak into 50 $\Omega$ load			
Width:	20 $\mu$ s min	20 $\mu$ s min	20 $\mu$ s min $\pm$ 5%	20 $\mu$ s min
Rise Time:	<50 ns	<50 ns	<20 ns	<50 ns
Fall Time:	<2 $\mu$ s	<2 $\mu$ s	<1 $\mu$ s	<2 $\mu$ s
Jitter, pulse-to-pulse:	<5 ns, rms	<5 ns, rms	<5 ns, rms	<5 ns, rms
Synchronization:	Automatic, 10 $\pm$ 1 $\mu$ s delay	Automatic, 10 $\pm$ 1 $\mu$ s delay	Auto., to within $\pm$ 500 ns	Auto., 10 $\pm$ 1 $\mu$ s delay
Clock pulse adjustment range:	1 $\mu$ s to 1 s	1 $\mu$ s to 1 s	0.1 $\mu$ s to 1 s	1 $\mu$ s to 1 s
Clock display:	Solid State Digital			
Option 002, Standby Power Supply Capacity at 25°C with Option 001 Clock:	30 Minutes	30 Minutes	One Hour	10 Minutes
Recharge, Fast/Float:	Automatic, fast charge			Switch

## Ordering information

5061A Cesium Beam Frequency Standard

**Price**

- Opt 001: Clock add \$2,600
- Opt 002: Standby Power Supply add \$1,200
- Opt 003: Clock and Standby Power Supply add \$3,800
- Opt 004: High Performance Beam Tube add \$4,500
- Opt 908: Rack Flange Kit add \$23

E21-5061A Flying Clock

Add \$5,050

**Consists of:** 5061A with Opt 001 (not included in E21 price) and K02-5060A Standby Power Supply.

**Weight:** 64 kg (141 lb).

**Size:** 425 H x 405 W x 546 mm D (16.7" x 15.9" x 21.5") (includes handles).

10638A Degausser

\$1,050

**Weight:** 1.2 kg (3 lb).

**Size:** 130 H x 77 W x 279 mm D (5.1" x 3" x 11").

5062C Cesium Beam Frequency Reference

\$26,000

- Opt 001: Clock add \$2,600
- Opt 002: Standby Power Supply add \$1,200
- Opt 003: Clock and Standby Power Supply add \$3,800
- Opt 010: Clock, Battery, Time-Code Generator add \$7,500

5065A Rubidium Frequency Standard

\$13,500

- Opt 001: Clock add \$2,600
- Opt 002: Standby Power Supply add \$600
- Opt 003: Clock and Standby Power Supply add \$3,200
- Opt 908: Rack Flange Kit add \$22

E21-5065A Portable Time Standard

add \$5,125

**Consists of:** 5065A with Opt 001 (not included in E21 price) and K02-5060A Standby Power Supply.

**Weight:** 50 kg (110 lb).

**Size:** 425 H x 405 W x 546 mm D (16.7" x 15.9" x 21.5") (includes handles).

# FREQUENCY & TIME STANDARDS

## Distribution amplifier

Model 5087A

- Versatile with 3 input and 12 output channels
- Low noise, high stability, and isolation

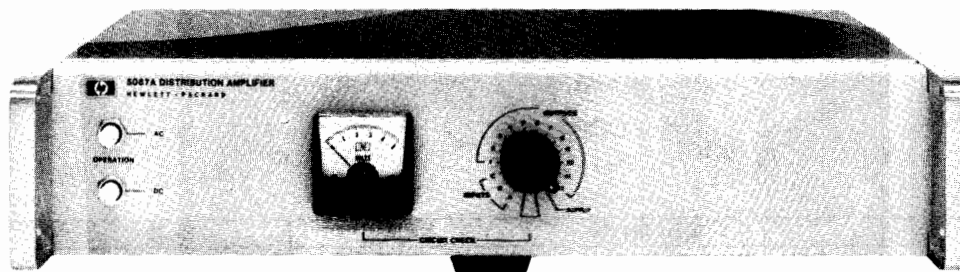

The Hewlett-Packard Model 5087A Distribution Amplifier provides the isolation and flexibility required for distribution of the output of high quality frequency standards. Low distortion and excellent isolation make it ideal for providing multiple outputs from atomic or crystal frequency standards. The 3 input channels will accept 10 MHz, 5 MHz, 1 MHz or 100 kHz in any combination. The number of outputs for each channel is selectable up to a total of 12 outputs. The output levels are individually adjustable from 0 to 3 V rms. All input and output levels are monitored on a front panel meter.

The Distribution Amplifier features plug-in modular construction, short circuit isolation, exceptional phase stability, low noise and cross-talk, and uninterrupted switchover to standby dc in event of ac power failure.

The shielding around each input and output plug-in amplifier assures minimum noise and crosstalk. The tuned output amplifiers provide clean signals and high channel-to-channel isolation.

The instrument is designed for maximum versatility and can be supplied to meet a wide variety of special requirements. The standard configuration of input and output amplifiers is shown in Figure 1.

Several other commonly used configurations are also available and special combinations of the various input and output modules can be supplied. Input and output amplifiers can be added or the configuration easily changed at any time.

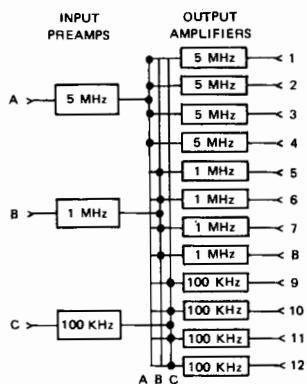

Figure 1. 5087A Distribution Amplifier with Option 031, Standard Configuration input and output amplifiers.

### Specifications

**Inputs:** (up to three, rear panel BNC).

**Frequencies:** 10 MHz, 5 MHz, 1 MHz or 100 kHz.

**Level:** 0.3 to 3.0 V rms, 50 ohms.

**Outputs:** (up to 12 rear panel BNC).

**Frequencies:** 10 MHz, 5 MHz, 1 MHz or 100 kHz.

**Level:** 0–3 V into 50 ohms (screwdriver adjustment).

**Harmonic distortion:** >40 dB below rated output.

**Non-harmonic distortion:** >80 dB below rated output

### Isolation

**Load** (open or short on any other channel)

**Amplitude change:** 0.1 percent.

**Phase change:** <0.1 ns at 5 or 10 MHz.

<0.5 ns at 1 MHz.

<5.0 ns at 100 kHz.

**Injected signal:** 1 V signal up to 50 MHz applied to any output except 10 MHz, will be down more than 60 dB in all other outputs; 10 MHz output channel will be down more than 50 dB.

**SSB phase noise (5 MHz):** >145 dB below signal in 1 Hz BW for frequencies > 1 kHz from carrier.

**Short term stability degradation (5 MHz):** < 1 x 10<sup>-12</sup> in 10 kHz band. (1 s average).

### Environmental

**Temperature:** MIL-E-16400, Class 4.

**Operating:** 0–50°C; storage: –62° to +75°C.

**Stability:**

**Amplitude:** ±0.5 dB, 0° to 50°C.

**Phase:** <0.1 ns/°C., 5 and 10 MHz.

**EMC:** MIL-STD-461A.

**Humidity:** 95% at 40°C.

**Vibration:** MIL-STD-167.

**Altitude:** up to 30,000 ft.

**Shock:** MIL-T-21200, Class 1 and MIL-E-5400 (30 Gs).

### General

**Power:** 115 or 230 V ±10%, 48 to 440 Hz, 20 VA, max, or 22–30 V dc, 500 milliamperes, max.

**Dimensions:** 88 H x 425 W x 286 D (3.5" x 16.7" x 11.3").

**Weight:** typical, Opt 031–Net 7 kg (15 lb).

### Options

**Normal configurations** (input and output amplifiers)

**Price**

**031:** 5, 1 and 0.1 MHz inputs and 4 outputs at each frequency

add \$1300

**032:** Single 5 MHz input and 12 outputs

add \$1300

**033:** Single 10 MHz input and 12 outputs

add \$1300

**034:** Single 5 MHz input, 4 each outputs at 5, 1 and 0.1 MHz

add \$1500

### Special configurations

**Input preamplifiers** (up to 3 total)

**004:** Input Preamplifier (0.1 to 10 MHz)

add \$45

**005:** 5 to 1 MHz Input Divider

add \$110

**006:** 1 to 0.1 MHz Input Divider

add \$110

**011:** 5 to 10 MHz Input Doubler

add \$110

**013:** 10 to 5 MHz Input Divider

add \$110

**014:** 10 to 1 MHz Input Divider

add \$110

**Output amplifiers** (up to 12 total)

**001:** 5 MHz Output Amplifier

add \$110

**002:** 1 MHz Output Amplifier

add \$110

**003:** 0.1 MHz Output Amplifier

add \$110

**012:** 10 MHz Output Amplifier

add \$110

**908:** Rack Flange Kit

add \$25

**5087A: Distribution Amplifier Mainframe**

**\$1300**

# FREQUENCY & TIME STANDARDS

Standby power supplies

Models 5085A & K02-5060A



- 12 Amp-hr capacity
- Sealed nickel-cadmium cells
- Used in "flying clocks"

- 18 Amp-hr capacity
- Vented nickel-cadmium cells

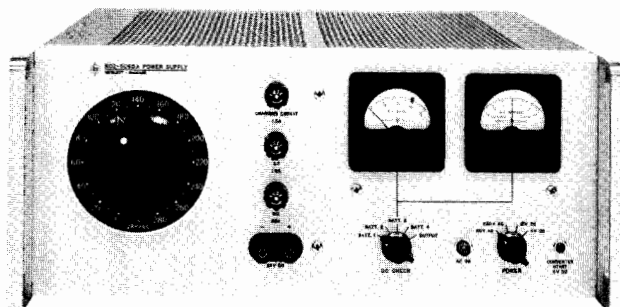

K02-5060A

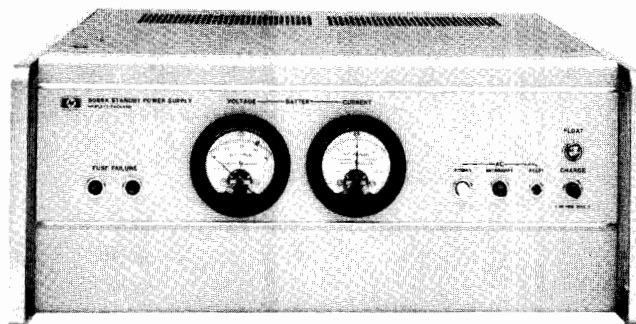

5085A

The HP Models 5085A and K02-5060A Standby Power Supplies furnish dc power to keep frequency or time standard systems operating during extended interruptions of ac line power. For applications where it is essential to maintain continuous operation and avoid loss of precise time, the use of a standby power supply is an absolute necessity. These units are designed for use with the Hewlett-Packard Cesium Beam Standards, Rubidium Vapor Standards, Quartz Oscillators and other equipment which will operate from 22 to 30 V dc. No switching is used in transferring power from line to battery operation and back again thus assuring uninterrupted operation.

### HP K02-5060A

The K02-5060A is a very versatile unit which was designed specifically as a portable power supply for the 5061A and 5065A "Flying Clocks" where it is necessary to operate from a wide range of power sources along with the standby capability to maintain continuous operation where no external power is available. A special inverter permits operation from a 6 or 12 V dc car battery in addition to the 115/230 V ac and 24-30 V dc capability. The 12 ampere-hour standby batteries are the sealed, nickel-cadmium type and thus spill-proof. Mounting hardware is available to attach the K02-5060A to either the 5061A or 5065A Standards to make a portable standard, the E21-5061A or E21-5065A.

### HP5085A

The HP 5085A is intended for installation where 115 or 230 V ac is available. Vented nickel-cadmium batteries with an 18 ampere-hour guaranteed capacity (derated from 25) are used. They provide about 10 hours of standby power for the 5061A Cesium Standard or 5065A Rubidium Standard (at average ambient temperature of 25°C).

Front panel lights indicate mode of operation, report fuse failure, and ac interrupt. A float-charge switch permits rapid recharge after an ac power failure.

### K02-5060A Specifications

#### Input and Output Voltages

Input	Output
6 or 12 V dc	0-230 V, 60 Hz nominal
115 or 230 V ac, 50-400 Hz	0-230 V ac
24-30 V dc	24-30 V dc

Standby battery, 26 ± 4 V dc available at all times.

AC and both dc inputs may be connected simultaneously.

**Output current:** 0.5A ac, 2 A dc.

**Standby capacity:** 12 ampere-hour at 25°C, 7 hours standby when used in E21-5061A, 6 hours in E21-5065A.

**Recharging:** 1.6 hours recharging time required for each ampere hour of discharge.

**Alarm indicator:** external power failure.

**Panel meters:** voltmeter, ammeter indicating voltage and current of 4 internal batteries and load.

**Battery:** four paralleled rechargeable battery packs each containing 20 sealed nickel-cadmium cells. Packs may be removed individually without interfering with power supply operation.

#### Temperature

**Operating:** 0 to 50°C.

**Storage:** -40 to 60°C

**Size:** 177 H × 425 W × 416 mm D (7" × 16.7" × 16.4").

**Weight:** net, 30.5 kg (67 lb).

### 5085A Specifications

**Output voltage:** 24 ± 2 V dc at rated current.

**Output current:** 2 amperes (2.5 A for 30 min.).

**Standby capacity:** (at 25°C) 18 amp-hrs. after 48 hours charge.

**Alarm indicators:** panel lamps indicate: (1) FUSE FAILURE, (2) AC POWER, (3) AC INTERRUPT, (4) CHARGE.

**Remote alarm provisions:** SPDT relay contacts provided at rear terminals for operating remote alarm from separate power system.

**Panel meters:** battery voltage and charge/discharge current.

**Power requirements:** 115 or 230 ± 10% V ac; 50 to 400 Hz (2.0 A max. at 115 V line).

**Battery (supplied):** vented nickel-cadmium 25 ampere-hour capacity derated to 18 ampere-hours. Periodic maintenance required.

**Additional (external) battery provision:** rear connector.

#### Temperature

**Operating:** 0 to 50°C.

**Storage:** -40 to 75°C.

**Size:** 177 H × 425 W × 416 mm D (7" × 16.7" × 16.4").

**Weight:** net, 34.1 kg (75 lb). Shipping, 45.9 kg (101 lb) including battery. Option 001 (no batteries) is 22.8 kg (50 lb) less.

### Ordering Information

5085A (complete with batteries)

Opt 001: without batteries

K02-5060A

### Price

\$4500

less \$640

\$4400

# PULSE & DATA GENERATORS

## General information

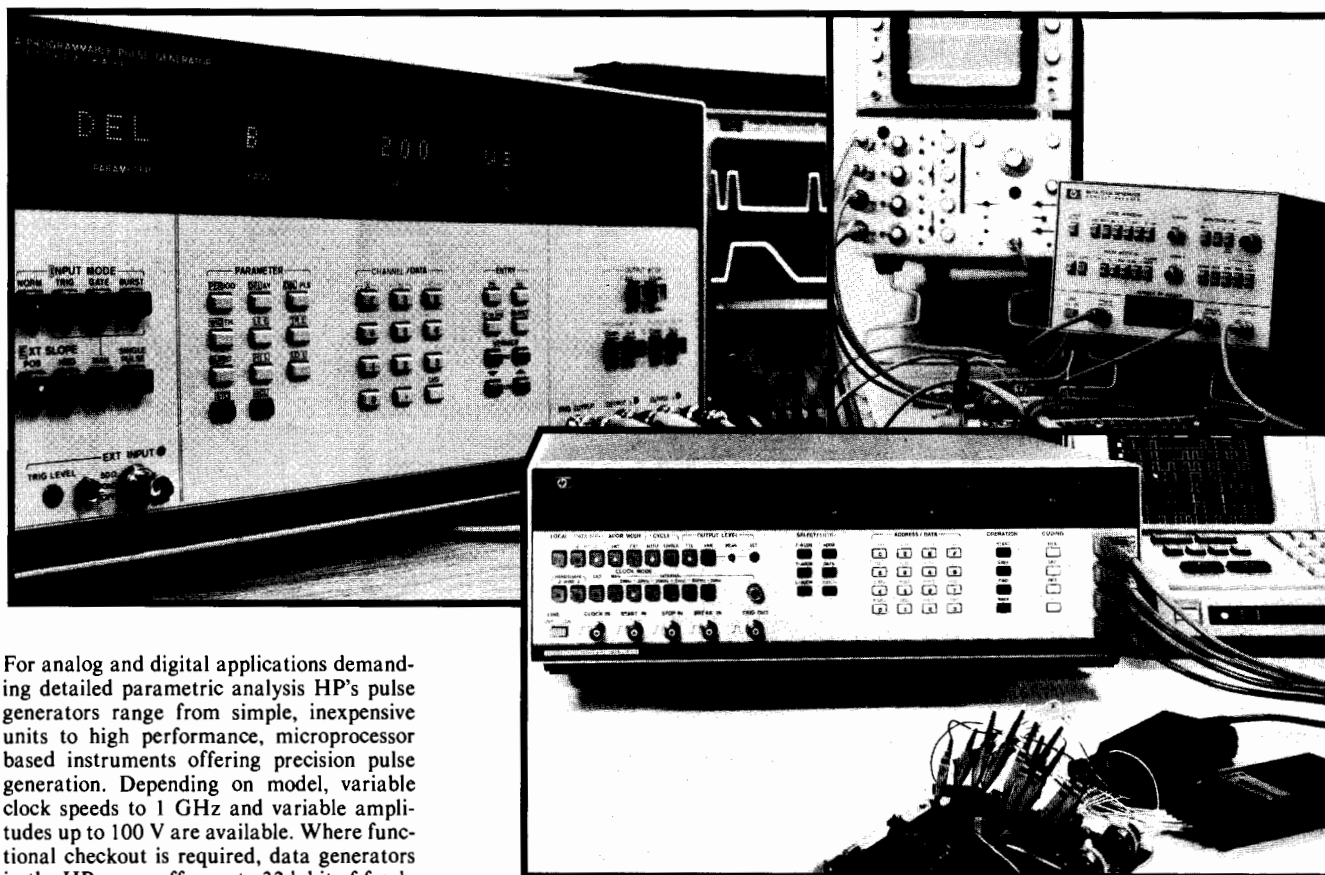

For analog and digital applications demanding detailed parametric analysis HP's pulse generators range from simple, inexpensive units to high performance, microprocessor based instruments offering precision pulse generation. Depending on model, variable clock speeds to 1 GHz and variable amplitudes up to 100 V are available. Where functional checkout is required, data generators in the HP range offer up to 32 k bit of freely programmable memory.

Logical front panel layout helps quick familiarization and rapid, error-free use. In addition, great emphasis is placed on ruggedness, reliability and serviceability. The generators are developed and produced using high quality standard components and custom-designed ICs. Resultant technical benefits are, for example, broad operating temperature range and clean 50-ohm output impedance.

The more recent additions to the pulse/data generator range are microprocessor managed. Many user oriented features emerge such as: storage of complete mode and parameter sets, identical command sequences for both remote and front panel operation, LED display of individual parameter values, and precise error indication for rapid correction of incompatible instructions. Direct benefits of this new generation of HP

test instruments are faster setup times in bench applications, and reduced software costs in automatic test systems.

### Data Generators

Hewlett-Packard's range of data generators offers multi-channel and single channel capability to suit parallel or serial data needs. Standard features include:

- freely programmable memory.
- manual and remote memory programming for bench and automatic test setups.
- variable clock speeds for dynamic test capability.
- switchable output levels for easy logic family selection. These levels are also adjustable so that marginal conditions can be determined.
- versatile synch capability simplifies stimulus/device/response hook-up and gives positive recognition of events in the data stream.

### Serial Applications

Some generators offer pseudo-random binary sequences (prbs) as well as programmed data. Thus avionic, telecommunications, fiber optic and other equipment requiring extremely long, non-repetitive data streams can be stimulated. Even preamble-data-postamble encoding such as that used in PCM telephone networks can be conveniently simulated by selecting a mode which combines prbs with programmed data. For research,

data rates up to 300 Mbit/s with very fast pulse edges are available.

### Parallel Applications

To meet parametric and functional needs, multichannel data is available with variable slew and pulse width. Thus, combined with bit rate and output magnitude variability, the performance limits of ICs and digital PC boards can be rapidly established.

For shared-bus devices, comprehensive control features are essential. Handshake and address capabilities ensure thorough checkout under 'real' conditions, independent of other system components.

### Data Generator Selection Chart

	8080 System	8018A	8016A	8170A
Max. rep. rate (MHz)	300	50	50	2
No. of channels	1	2	9	8/16
Bits per channel	16/32/64	1024 (var.)	32	4k/2k
Serialized bits	Up to 64	Up to 2048	Up to 256	
Output V into 50Ω	±2/ECL	15	ECL-TTL (var.)	TTL CMOS (Not 50Ω)
Width/Delay control			●	
RZ/NRZ format	●	●	●	NRZ
PRBS		●		
Programmable		HP-IB	HP-IB	HP-IB RS232C

### Logic Family Selection Chart

Logic Family	Parametric Test	Functional Test
CMOS	8011A, 8015A, 8160A	8018A, 8170A
TTL	8012B, 8013B, 8015A, 8160A, 8016A	8016A, 8018A, 8170A
S-TTL	8007B, 8082A, 8016A	8016A, 8018A
ECL	8082A, 8016A, 8080 System	8080 System, 8016A, 8018A



## Pulse Generators

Pulse generators range from pure bench units to high performance models which offer precision control over all pulse parameters, full HP-IB capability and microprocessor control. Dual channel models with complex waveform capabilities are included.

## Independent Parameters, Thorough Specifications

All variable parameters of HP pulse generators can be independently adjusted and are thoroughly specified under all operating conditions. For quick reference, however, this catalog shows only the leading properties. Detailed specifications including perturbation and jitter, are contained in the instrument data sheets.

For more convenient reference to published specifications, the main terms used to specify HP pulse generator performance are outlined in the panel below.

## Counted Burst Capability

HP's burst mode, with entirely automatic pulse counting, ensures absolutely stable bursts. With a certain burst length selected, all pulse parameters can be varied without affecting the number of pulses generated. Requiring neither internal nor external gate signals, gate jitter is eliminated.

## Pulse Generators Selection Chart

Feature	Pulse Generators									Programmable Pulse Generators	Time Synthesizer
	214B	8005B	8011A	8012B	8013B	8015A	8007B	8082A	8080 System	8160A	5359A
Max. rep. rate (MHz)	10	20	20	50	50	50	100	250	1000	50	10
Output V into 50 Ω	± 100	± 10	± 16	± 10	± 10	± 16	± 5	± 5	± 1.2	± 20	± 5
Offset V into 50 Ω	± 2			± 2.5	± 2.5	± 14	± 4	± 2	± 1.2	± 20	± 1
Number of outputs	1	3	1	1	2	3	1	2	2	2	2
Selectable Z <sub>s</sub>	•	•	•	•	•	•					
Transition times	15 ns	10 ns var.	10 ns	5 ns var.	3.5 ns	6 ns var.	2 ns var.	1 ns var.	300 ps	6 ns var.	< 4 ns
Min. width	25 ns	25 ns	25 ns	10 ns	10 ns	10 ns	5 ns	2 ns	500 ps	10 ns	5 ns
Delay	•	•	•	•	•	•	•	•	•	•	0-160 ms
Double pulse mode	•	•	•	•	•	•	•	•	•	•	
Ext trigger mode	•	•	•	•	•	•	•	•	•	•	•
Gate mode	•	•	•	•	•	•	•	•	•	•	
Burst mode	option		option			option					
Programmable						analog				HP-IB	HP-IB

## Convenient 50-Ohm Output Impedance

All HP's pulsers have a constant 50-ohm source impedance. Signal reflections are thus absorbed so that re-reflections into the circuit-under-test are avoided. The 50-ohm source allows back-terminated operation so that high-impedance loads may be driven without an external terminating resistor.

In addition, for applications requiring a high source impedance, many HP pulse generators offer a selectable 1K ohm output.

## Pulse addition, branching, inversion

In addition to the dual channel and complex waveform capabilities of standard pulse

generators, handy accessories are also available for more hookup flexibility. Refer to page 679.

## Time Synthesizers

Time Synthesizers are mainly used in radar and laser ranging, component and circuit testing, and precise triggering and calibrating applications. They give a precisely timed output pulse with an accurate, adjustable delay which may be incremented in steps as small as 50 pico-seconds. A fixed, virtually jitter-free insertion delay allows phase locking to equipment under test.

## Parameter Definitions [where appropriate, IEC terms are included in square brackets]

### Pulse Amplitude

**Magnitude.** Pulse excursions are defined by:

- high level [top] and low level [base]
- amplitude and mesial line offset.

The absolute magnitude limits are expressed by the term 'window'.

**Output Impedance.** This is the effective value of amplifier internal (source) impedance, Z<sub>s</sub>.

**Perturbation, Preshoot, overshoot and ringing** are distortions preceding or following a transition. Preshoot and overshoot are peak voltages expressed as a percentage of pulse amplitude. Ringing is measured on positive and negative peaks, e.g. +3, -5%. Ringing and overshoot are usually combined in a single specification such as <math>\pm 5\%</math>. This implies:

- an overshoot which does not exceed the amplitude by more than 5%.
- the largest peak of the damped oscillation on the pulse top is less than 5% of pulse amplitude.

**Settling Time** is the time taken for the pulse top to settle within the magnitude accuracy specification. Not defined by IEC.

**Fluctuation, Pulse magnitude instability, Droop [Tilt]** is the slope (V/s) of the pulse top or base. Unless stated otherwise, the pulse magnitude accuracy specification includes both forms of distortion.

**Non-Linearity** is the largest voltage difference between the 10-90% portion of a transition and a linear reference, expressed as a percentage of pulse amplitude. The reference is the best straight line drawn through the transition.

### Pulse Timing

**Pulse Width [Pulse Duration].** This is the time interval between the mesial points on the pulse edges.

**Leading/Trailing Edge Transition Times [First/Last Transition Durations].** These are the time intervals between the 10 and 90% amplitude points on the respective edge.

**Roll-Off** is the time shift of the projected edge start with change in transition time. Specified as a percentage of transition time. Not defined by IEC.

### Waveform Timing

**Pulse Period [Pulse Repetition Period].** In continuous mode, the pulse period is defined as the time interval between consecutive trigger output pulses. Repetition Rate [Pulse Repetition Frequency] is the reciprocal of Pulse Period.

**Trigger Delay.** This is the time interval between the trigger point of the input signal and the trigger output pulse's leading edge mesial. Applies in trigger, gate and burst modes.

**Pulse Delay.** The time interval between leading edge mesials of the trigger output pulse and the output pulse.

**Double Pulse Delay.** The time interval between leading edge mesials of the double pulse.

**Pulse Separation.** The time interval between the trailing edge mesial of the leading pulse and the leading edge mesial of the trailing pulse.

**Interchannel Delay.** The time interval between leading edge mesials.

**Duty Cycle [Duty Factor].** The percentage ratio of pulse width to pulse period.

**Jitter** is the timing instability of one event with respect to another, measured as the p-p change in time and expressed as a percentage of the main parameter.



# PULSE & DATA GENERATORS

Programmable pulse generator

Model 8160A

- 50 MHz repetition rate
- 20 V output amplitude
- Full dual channel capability (option 020)
- 1-3% pulse parameter accuracy
- HP-IB programming interface
- Storage of operating parameters

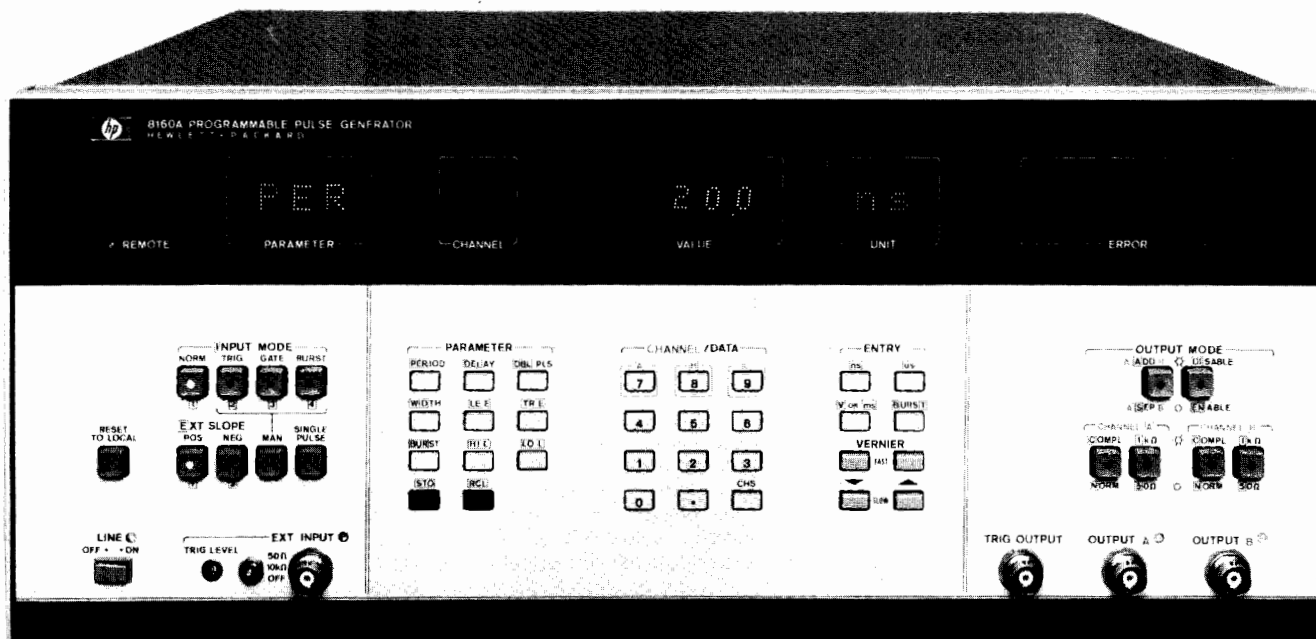

8160A Option 020



## Introduction

The 8160A is a fully programmable 50 MHz pulse generator designed for high performance applications on the bench and in automatic systems. Its single or dual (option 020) output channels provide 20 V, 6 ns variable transition time pulses ideal for the majority of testing requirements. Combining high programming accuracy with microprocessor-based control capabilities, pulses can be set up without a measuring instrument. Pulse parameters are entered and displayed numerically, whereupon the desired pulse is generated with an accuracy of 1-3%, depending upon parameter.

An easy-to-use HP-IB interface brings model 8160A's high accuracy pulses to automatic test. All parameters and operating modes are remotely programmable using straight-forward command sequences. Faster, easier program generation and reduced software costs are direct benefits.

## Precision Pulse Generation

Model 8160A provides precision control over all parameters of its 50 MHz, 20 V output pulse. Leading and trailing edge transition times may be independently programmed down to 6 ns. With ratios up to 20:1 possible, triangular and sawtooth waveforms are easily generated.

Variable pulse edges match to application needs: a slower edge, for example, can reduce reflections dramatically.

Direct entry of the high and low levels of the output pulse enables easy simulation of logic signals. Pulse width is variable from 10 ns to 1 s, giving a wide range of duty cycle programmability. Delay shifts the output pulse in relation to the trigger output or, in double pulse mode, defines the pulse spacing. In the dual-channel version, double pulse can be selected in either or both channels.

## Counted Burst

Using Burst Mode, a predetermined number of pulses is generated independent of frequency. Bursts from 0 to 9999 pulses in length may be produced, and can be triggered via an external signal, manually or with an HP-IB command.

## Complex Signals

Independent pulse parameters plus individual programmability of the Option 020's dual outputs are augmented by the A ADD B mode. Summation allows complex signals to be precisely and easily set up. Here are some examples:

Applications such as radar coincidence circuits and special codes in communications require 3- and 4-level signals. These are conveniently generated by combining channel A and channel B pulses.

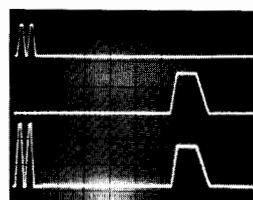
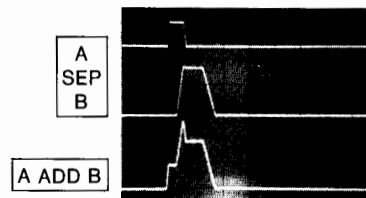

Transponder circuits need accurate delays, often with respect to a double-pulse interrogation signal. In the 8160A, this is arranged by operating one channel in double pulse mode and setting up the transponder delay in the other.

Operation of both channels in double pulse mode generates a signal with two independent delays, useful for calibration and comparison.

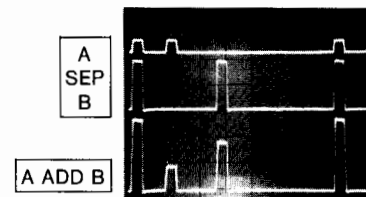



### Wide temperature range for system reliability

Exceeding the environmental conditions in system racks, the 8160A's 0-50°C operating range ensures calculable performance. Indeed, temperatures will generally be between 15-35°C where there is no 8160A derating factor.

### User Features

#### Fast, reliable setup

Microprocessor control promotes highly accurate pulses. Parameters are directly entered via the instrument's keyboard, and are then displayed on numeric LED's with 3-digit resolution.

In bench applications, the vernier controls give a fine adjust capability to "tweak-in" any pulse parameter. You can increment or decrement the selected parameter either in single steps or at speed.

Error detection by the microprocessor further simplifies pulse setup by solving the old problem of incompatible settings. Should pulse width exceed pulse period, for example, the microprocessor indicates a TIMING error. All possible mis-settings are detected and the type of error is indicated to aid rapid correction.

#### HP-IB Programming

Microprocessor control over all interface functions makes remote programming as easy and straight-forward as manual control. The 8160A employs keystroke programming so that data entry via the HP-IB is an exact simulation of manual entry. Bus commands for each front panel key simply replace manual keystrokes.

### Specifications (50 Ω source into 50 Ω load)

#### Timing (With Minimum Transition Times)

##### Period

**Range:** 20.0 ns to 999 ms.

**Accuracy:** 3% of progr. value ± 0.3 ns (period < 100 ns).  
2% of progr. value (period ≥ 100 ns)

**Max. Jitter:** 0.1% of programmed value + 50 ps.

##### Width

**Range:** 10.0 ns to 999 ms.

**Accuracy:** 1% of programmed value ± 1 ns.

**Max. Jitter:** 0.1% + 50 ps (width ≤ 999 ns).  
0.05% (999 ns < width ≤ 9.99 μs).  
0.005% (width > 9.99 μs).

##### Delay

**Range:** 0.00 ns to 999 ms (measured from 50% point of leading edge of trigger output).

**Accuracy:** 1% of progr. value ± 1 ns.

**Max. Jitter:** 0.1% + 50 ps (delay ≤ 999 ns)  
0.05% (999 ns < delay ≤ 9.99 μs)  
0.005% (delay > 9.99 μs)

#### Double Pulse (DBL)

**Range:** 20.0 ns to 999 ms

**Accuracy:** 1% of programmed value ± 1 ns

**Max. Jitter:** 0.1% + 50 ps (DBL ≤ 999 ns).  
0.05% (999 ns < DBL ≤ 9.99 μs)  
0.005% (DBL > 9.99 μs)

### Output Signals

#### Output levels

**High level range:** -9.89 V to 9.99 V

**Low level range:** -9.99 V to 9.89 V

**Amplitude:** min 0.10 V, max 9.99 V (increases to 19.9 V with high source or load impedance).

**Accuracy:** 1% of progr. value ± 50 mV ± 1% of amplitude.

**Settling Time:** 40 ns to specified accuracy.

#### Transition times (10-90% amplitude).

**Leading edge:** 06.0 ns to 9.99 ms.

**Trailing edge:** 06.0 ns to 9.99 ms. Leading and trailing edge transition times are independently programmable within a common range. Ranges are overlapping.

**Accuracy:** 3% of progr. value ± 1 ns.

**Linearity:** 3% for transition times > 30 ns.

**Preshoot, overshoot, ringing:** 5% amplitude ± 10 mV.

**A ADD B:** adds channel A and B outputs (option 020).

**Output format:** normal or complement.

**Source impedance:** 50 Ω/1 kΩ selectable.

### Parameter Storage

The 8160A stores complete parameter and mode information for 9 independent instrument set-ups. Waveforms may be stored and recalled either manually or via the HP-IB.

By utilizing a single command to recall an entire instrument set-up, controller time is saved. In simple repetitive testing applications, storage of test waveforms gives a high degree of user convenience without an external controller.

### Learn Mode

When interrogated by the system controller, the 8160A outputs a character string to the interface bus. This string completely describes the pulser's current set-up or any one of its stored parameter sets. Using Learn Mode, you can enter and try out waveforms manually and then automatically transfer them via the HP-IB to the controller for storage in a program.

### Verification Software

Test system accuracy is guaranteed by accessory software which verifies the 8160A's performance standards. The software is fully documented and comes recorded on a cassette suitable for Model 9825A Desktop Computer.

In the event of a failure, downtime is minimized because the software also delivers diagnostic information to accelerate repair and calibration.

### Auxiliary Inputs and Outputs

#### External input

**Trigger level:** +10 V to -10 V.

**Max. input:** ± 12 V in 50 Ω, ± 20 V in 10 kΩ.

**Minimum amplitude:** 500 mVpp.

**Slope:** positive or negative.

**Min. pulse width:** 3 ns.

**Typical input resistance:** 50 Ω or (also in OFF) 10 kΩ.

**Delay, trig input/trig output:** 90 ns ± 10 ns.

#### Trigger output

**Amplitude:** ≥ 2.5 V into 50 Ω.

**Typical source resistance:** 50 Ω.

**Typical pulse width:** 8 ns (period < 100 ns)

40 ns (100 ns < period < 1 μs)

400 ns (period ≥ 1 μs)

### HP-IB Capability

All modes and parameters can be programmed.

**Memory:** 9 programmable locations plus 1 for prevailing parameters.

**Capacity:** 1 complete operating state per location.

### General

**Repeatability:** 50% of specified accuracy.

**Power-off storage:** batteries maintain all stored data for up to 2 weeks with instrument off. Hard-wired addressable location contains fixed operating state for confidence check.

**Power:** 115/230 Vac + 10%, -22%; 48-66 Hz; 675 VA max.

**Temperature range:** 15-35°C as specified.

**Accuracy derating factors for temp:** 0-15°C or 35-50°C.

**Delay, width, double pulse:** 0.07%/°C

**Period, high level, low level:** 0.14%/°C

**Leading edge, trailing edge:** 0.21%/°C

**Weight:** net 20.8 kg (46 lbs). Shipping 25 kg (55 lbs).

**Size:** 178 H × 426 W × 500 mm D (7 × 16.8 × 19.7 in.)

### Ordering Information

	<b>Price</b>
<b>8160A Programmable Pulse Generator</b>	\$11,000
<b>Opt. 001:</b> Rear panel inputs and outputs	N/C
<b>Opt. 020:</b> Second channel	add \$5,700
<b>Opt. 907:</b> Front handle kit (Part No. 5061-0090)	add \$40
<b>Opt. 908:</b> Rack flange kit (Part No. 5061-0078)	add \$30
<b>Opt. 909:</b> Opt. 907, 908 combined (Part No. 5061-0084)	add \$65
<b>Opt. 910:</b> Additional operating manual	add \$120
<b>HP-IB Cables:</b> Refer to page 30.	
<b>08160-39910 Verification Software</b>	\$120



# PULSE & DATA GENERATORS

## High Resolution Time Synthesizer

### Model 5359A

- Precise digital delays 0-160 ms
- Jitter < 100 ps
- Increments 50 ps
- Programmable
- Fully synchronous to external trigger
- Automatic Calibration

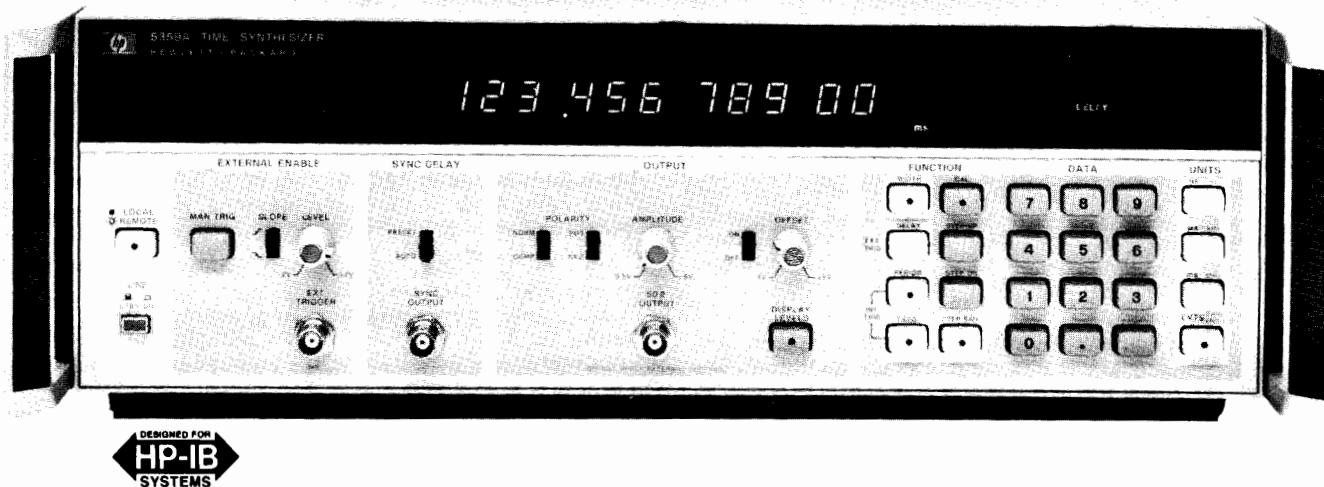

The 5359A Time Synthesizer produces two extremely precise, low jitter time delays. These delays,  $T_d$  and  $T_w$ , are individually selectable by means of the keyboard, in 50 ps or greater steps to generate delays of up to 160 ms.

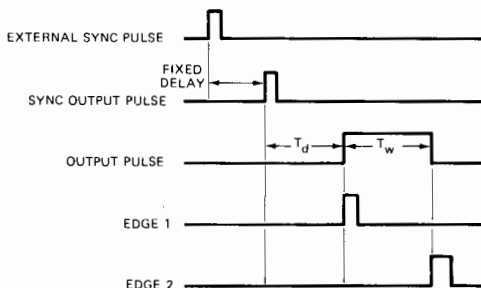

The 5359A has many applications and may be used for the calibration of Radar, Loran, DME and Tacan Systems, or for precision generation of delayed sweeps in oscilloscopes, and for extremely accurate "time positioning" control of external gates on frequency counters. In component and circuit test, the instrument may be used for extremely accurate delay line simulation.

## Specifications

### Modes

**External Trigger Mode:** the delays from the sync out to the beginning of the output pulse, and the width of the output pulse, are selected.

**Internal Trigger Mode:** the "period" or "frequency", and the width of the output pulse, are selected.

### Range

**Delay  $T_d$ :** 0 ns to 160 ms.

**Width  $T_w$ :** 5 ns to 160 ms (width & delay  $\leq$  160 ms).

**Period:** 100 ns min. or width + 80 ns, 160 ms max.

**Frequency:** same as corresponding "period".

**Repetition rate:** 10 MHz max.

**Accuracy:**  $\pm 1$  ns  $\pm$  time base error.

**Insertion delay:** fixed at < 150 ns; selectable as < 50 ns for delays > 100 ns.

**Jitter:** typical 100 ps rms; maximum 200 ps rms

**External trigger input:** -2 V to + 2 V slope selectable.

**Sync output:** 1 V - 50 $\Omega$ ; 5 V - 1M $\Omega$ . Width 35 ns nominal.

### Output pulse

**Amplitude:** 0.5 V to 5 V into 50 $\Omega$ .

**Polarity:** positive or negative.

**Offset:** -1 V to 1 V, or OFF.

**Transition time:** < 5 ns.

External voltage must not be applied. Offset and Amplitude voltage into 50 $\Omega$  may be displayed.

**EDGE 1 OUTPUT (rear panel):** occurs in Sync with leading edge of output pulse (same spec. as Sync out).

**EDGE 2 OUTPUT (rear panel):** occurs in Sync with falling edge of output pulse (same spec. as Sync out).

**Events mode:** substitutes external input (to 100 MHz) for the internally counted clock (Delay and width must both be specified in events and not time).

**Triggered frequency mode:** the same as internal frequency mode except the output is a burst beginning in synchronism with an external trigger signal, and continues for the duration of this signal.

**Calibrate mode:** performs an internal calibration to remove the effects of internal delay differences.

**External probes:** provides outputs to control the 5363B probes and accepts inputs from the probes to include external devices in the calibration loop.

**HP-IB:** All controls except trigger levels are programmable as standard. HP-IB cable not included, see page 28.

**Time base** (10811A High Stability Oven Oscillator)

**Frequency:** 10 MHz

**Aging:**  $< 5 \times 10^{-10}$ /day

**Temperature:**  $< 2.5 \times 10^{-9}$ , 0°C to 50°C

**Line voltage:**  $< 1 \times 10^{-10}$ ,  $\pm 10\%$  from nominal

**Size:** 146.1 H  $\times$  425.5 W  $\times$  520.7 mm D (5.25"  $\times$  16.75"  $\times$  20.50").

**Weight:** 30 lbs.

**Power Requirements:** 100, 120, 220, or 240 Vac +5% -10%, 48 to 66 Hz, less than 250 VA

**Front Handles:** supplied with instrument.

### Options and Accessories

**089:** Rack Flange Kit for supplied handles

**908:** Rack Flange Kit for use w/o handles

**909:** Order option 089

**10870A:** Service Kit

**5359A Time Synthesizer**

**Price**

add \$25

add \$25

add \$430

**\$7500**

# PULSE & DATA GENERATORS

Fast, high power pulse generator

Model 214B



- High power 100 V, 2 A output
- 10 MHz repetition rate

- Constant duty cycle
- Counted pulse burst option

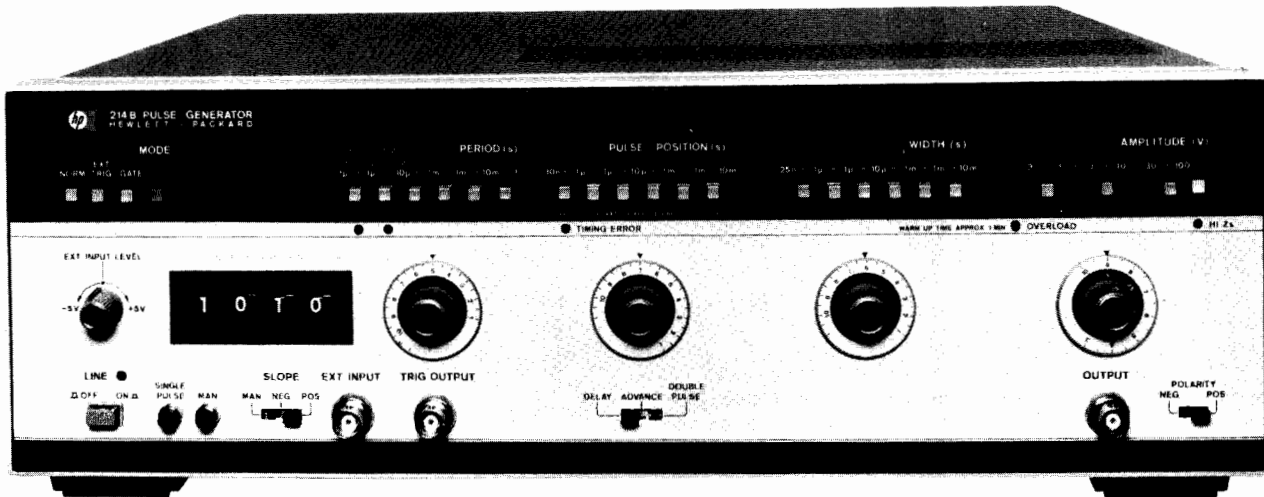

214B (with option 001)

The HP 214B pulse generator employs semiconductor technology for high power pulse generation at up to 10 MHz repetition rate. Delivering 100V pulses with 15 ns risetimes, the 214B meets the speed demands of today's applications.

State-of-the-art VMOS FETS used as current sources for the output amplifier tubes enable pulse width to be specified down to 25 ns. The 214B is thus well-equipped for low duty cycle applications such as laser diode pulsing or transient simulation.

Where changing duty cycle threatens destruction to the device under test, the 214B Constant Duty Cycle (CDC) mode provides device protection. In CDC operation the duty cycle, hence power, remains constant as frequency is varied. The 214B is itself protected against excessive duty cycles via an overload protect circuit.

Easy operation is assured by the timing error indication. Calibrated dials enable fast accurate adjustments. Operating into unmatched loads, clean pulse shape is guaranteed by the low reactance 50  $\Omega$  source impedance. Pulse distortions such as preshoot and overshoot are specified as 5% at all amplitudes.

## Specifications

### Timing

**Repetition rate:** 10 Hz to 10 MHz in 6 ranges. In 30V - 100V amplitude range, maximum rep. rate is 4 MHz. Calibrated vernier provides continuous adjustment within ranges. **Vernier accuracy:**  $\pm(10\%$  of setting + 1% full scale). **Period Jitter:**  $\leq 0.1\% + 300$  ps.

**Pulse delay/advance:** pulse can be delayed/advanced with respect to the trigger output from 10 ns to 10 ms ( $\pm$  fixed delay of 45 ns) in 5 ranges. Calibrated vernier provides continuous adjustment within ranges. **Vernier accuracy:**  $\pm(10\%$  of setting + 1% full scale) + fixed delay. **Position Jitter:**  $\leq 0.1\% + 500$  ps

**Maximum pulse position duty cycle:**  $\geq 50\%$   
**Double pulse:** 5 MHz maximum in all ranges except 30V - 100V range which is max. 2 MHz. Minimum separation is 100 ns.

**Pulse width:** 25 ns to 10 ms in 6 decade ranges. Calibrated vernier provides continuous adjustment within ranges. **Accuracy:**  $\pm(10\%$  of setting + 1% full scale) + 5 ns. **Width Jitter:**  $\leq 0.1\% + 500$  ps.

**Max. duty cycle:**  $\geq 10\%$  for 30 - 100V range.  $\geq 50\%$  all other ranges.

**Constant duty cycle mode (disabled in ext. trigger mode):** duty cycle of output pulse remains constant as the period is varied. The duty cycle limits in this mode are typically 8% fixed for the 10 M - 1 MHz range (max. 4 MHz); 2.5% to 10% for 1 MHz - .1 MHz range; .25% to 10% for .1 MHz - 10 kHz range; 0.1% for all other ranges. Calibrated vernier provides continuous adjustment within ranges.

**Accuracy:**  $\pm(15\%$  of setting + 1% of full scale).

### Trigger output:

**Amplitude:**  $\geq +5$  V (50 ohm into open circuit).

**Pulse width:** 10 ns typical.

### Externally Controlled Operation

#### External input (impedance 10 k ohm, dc coupled)

**Repetition rate:** dc to 10 MHz. **Sensitivity:** 500 mVpp, dc coupled.

**Slope:** pos. or neg. **Trigger level:** +5 V to -5 V adjustable.

**Maximum input level:**  $\pm 100$  V. **Trigger pulse width:**  $\geq 10$  ns.

**EXT TRIG mode:** An output pulse is generated for each input pulse. **GATE mode:** gate signal turns on rep. rate generator synchronously. Last pulse always completed.

**BURST mode (optional):** preselected number of pulses generated on receipt of trigger signal. **Number of pulses:** 1 to 9999. Minimum spacing between bursts: 200 ns.

**Manual:** pushbutton can be used for triggering single pulses (EXT TRIG mode), generating gate signals (GATE mode) or triggering pulse bursts (BURST mode).

### Output

**Amplitude:** 0.3 V to 100 V in 5 ranges. Calibrated vernier provides adjustment within ranges. **Vernier accuracy:**  $\pm 10\%$  of setting.

**Source impedance:** fixed 50  $\Omega$  nominal on ranges up to 10 V. Selectable 50  $\Omega$  nominal or HI-Z, on 10 - 30 - 100 V ranges (with 50  $\Omega$  / 50  $\Omega$  impedance, amplitude decreases to 5 - 15 - 50 V).

**Polarity:** pos. or neg. selectable.

**Transition times:**  $\leq 15$  ns for leading and trailing edges.

**Pulse top perturbations:**  $\leq \pm 5\%$  of amplitude.

### General

**Operating temperature:** 0°C to 55°C.

**Power:** 100/120/220/240 Vrms; +5%, -10%, 48 to 66 Hz, 360 VA max.

**Size:** 133 mm H x 426 mm W x 422 mm D (5.2 x 16.8 x 16.6 in.)

**Weight:** net 13.6 kg (30 lb), shipping 15.6 kg (34.3 lb).

### Ordering Information

#### 214B Pulse Generator

**Opt 001:** Counted Burst

**Opt 907:** Front Handle Kit (part number 5061-0089).

**Opt 908:** Rack Mount Kit (part number 5061-0077).

**Opt 909:** Opt 907, 908 Combined (part number 5061-0083).

**Opt 910:** extra Operating and Service Manual

### Prices

**\$3300**

add \$390

add \$32

add \$25

add \$55

add \$14

# PULSE & DATA GENERATORS

## 20 MHz pulse sources

Models 8005B, 8011A

- Dual outputs, +10 V and -10 V
- TTL output
- Gating, square wave, double pulse modes

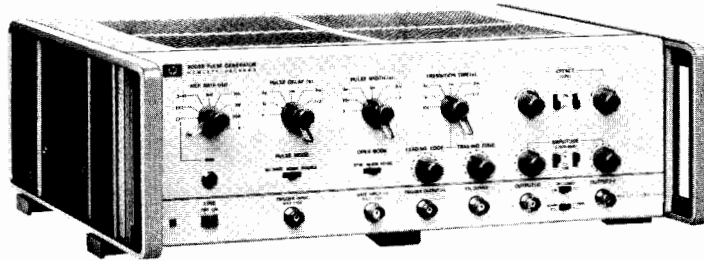

8005B

The 8005B is a general purpose, triple output pulse generator. This instrument has all parameters variable and produces simultaneous pos. and neg. pulses. It also has a TTL output with all parameters variable except amplitude. This feature, together with the normal/complement facility, greatly improves the ease of operation.

### 8005B Specifications

#### Pulse Characteristics

**Transition times:**  $\leq 10$  ns to 2 s. Edges independently variable.  
**Non-linearity:** for transition times  $> 30$  ns,  $< 4\%$  of pulse amplitude.  
**Preshoot, overshoot, ringing:**  $< 5\%$  of pulse amplitude.  
**Pulse width:**  $< 25$  ns to 3 s. **Jitter:**  $< 0.1\%$  of setting + 50 ps.  
**Max. duty cycle:**  $> 80\%$  (0.3 Hz - 1 MHz),  $> 50\%$  (1-20 MHz).  
**Square wave:** 0.15 Hz - 10 MHz.  
**Pulse delay:**  $< 100$  ns to 3 s. **Jitter:**  $< 0.1\%$  of setting + 50 ps.  
**Pulse outputs:** simultaneous pos., neg. and TTL outputs.  
**Pulse amplitude:** 300 mV to 10 V.  
**Output protection:** max. external voltage  $\pm 10$  V.  
**Source impedance:** 50 ohms  $\pm 10\%$  or high impedance selectable.  
**TTL compatible output:** +4.6 V norm. or comp. 50 $\Omega$  impedance.

#### Repetition Rate and Trigger

**Repetition rate:** 0.3 Hz to 20 MHz in 5 ranges. **Jitter:**  $< 0.1\%$  + 50 ps.  
**Double pulse:** 10 MHz max. Simulates 20 MHz.  
**Trigger output:**  $> +2$  V ampl. across 50 ohms. **Width:**  $> 6$  ns.

#### Externally Controlled Operation

##### External triggering (dc to 20 MHz)

**Delay:** approx. 35 ns trig. input to trig. output.  
**Maximum input:**  $\pm 10$  V. **Sensitivity:** sine 2 V<sub>pp</sub>.  
**Impedance:** approx. 1 k ohms, dc coupled. **Pulses:**  $\pm 1$  V<sub>peak</sub>.  
**Input pulse width:**  $\geq 10$  ns.

##### Gating

**Synchronous:** gate signal turns on repetition rate. Last pulse is always completed.

**Asynchronous:** gate signal controls output of rate generator.

##### Gate input (impedance 1 k ohms dc coupled).

**Amplitude:** 2 V to 20 V (max.). **Polarity:** negative.

#### General

**Operating temperature:** 0°C to 55°C.  
**Power:** 115/230 Vrms; +10%, -15%; 48 to 440 Hz, 180 VA max.  
**Weight:** net 7 kg (15.5 lb). Shipping 9 kg (20 lb).  
**Size:** 130 H x 426 W x 290 mmD (5.1" x 16.8" x 11.4").

#### Ordering Information 8005B, 8011A

8011A Pulse Generator	\$775
Opt 001: Pulse Burst	add \$350
Opt 910: extra Operating and Service Manual	add \$20
15179A (for 8011A): Adapter frame, Rack mount for 2 units.	\$195
8005B Pulse Generator.	\$2250
Opt 908: Rack Flange Kit (part number 5060-8740).	add \$22
Opt 910: extra Operating and Service Manual.	add \$28

#### Prices

- Repetition rate 0.1 Hz to 20 MHz
- Positive/negative/symmetrical output
- Normal/complement switch



8011A  
Opt 002

The 8011A is a versatile, reliable, low cost pulse generator. This compact instrument features an uncomplicated design using high quality components to ensure long, dependable service. Ease of operation results from the logical and simple front panel layout. These qualities and the many pulse formats available emphasize the Model 8011A's cost-effectiveness in a wide application range.

### 8011A Specifications

#### Pulse Characteristics (50 ohm Source/Load Impedances)

**Transition times:**  $< 10$  ns fixed.  
**Overshoot, ringing and preshoot:**  $< \pm 5\%$  of pulse amplitude. May increase to 10% at counter-clock wise positions of amplitude vernier.  
**Pulse width:** 25 ns to 100 ms in four ranges. Vernier provides continuous adjustment within each range.  
**Width jitter:**  $< 0.1\%$  + 50 ps on any width setting.  
**Maximum duty cycle:**  $> 50\%$  (100% using pulse complement)  
**Maximum output:** 8 V. With internal 50 $\Omega$  and external Hi-Z or internal Hi-Z/external 50 $\Omega$ , then 16 V max.  
**Attenuator:** 3-step attenuator provides the ranges 0.25 V - 1 V - 4 V - 16 V. Vernier provides continuous adjustment within each range.  
**Source impedance:** 50 $\Omega$   $\pm 10\%$  shunted by 30 pF, except in 4 V - 16 V range which is 50 $\Omega$ /Hi-Z, switch selectable.  
**Polarity/Format:** pos., neg., or sym./norm. or compl., switch select.

#### Repetition Rate and Trigger

0.1 Hz to 20 MHz in 5 ranges. Vernier provides continuous adjustment within each range. **Period jitter:**  $< 0.1\%$  + 50 ps of per. setting.  
**Square Wave:** 0.05 Hz to 10 MHz.  
**Trigger output:** dc coupled 50 $\Omega$  (typ.) source delivering  $\geq +1$  V into 50 $\Omega$  (can increase to +5 V). **Trigger pulse width:** 20 ns  $\pm 10$  ns.

#### Externally Controlled Operation

**Input impedance:** 50 $\Omega$   $\pm 10\%$ . **Trigger polarity:** positive.  
**Maximum input:**  $\pm 5$  V. **Sensitivity:** 1 V.  
**Manual:** front panel pushbutton for generating single pulse.  
**Repetition rate:** 0 to 20 MHz. In square wave, output frequency is half the input frequency.  
**Trigger source:** manual or ext. signal. Min. ext. signal width 20 ns.  
**Pulse burst mode (option 001):** preselected number of pulses generated on receipt of trigger.  
**Burst trigger source:** man. or ext. signal. Min. signal width 25 ns.

#### General

**Operating temperature:** 0°C to 55°C.  
**Power:** 100/120/220/240 Vrms; +5%, -10%; 48 Hz to 440 Hz, 70 VA max.  
**Weight:** net, 4 kg (9 lb). Shipping, 6.5 kg (14.6 lb).  
**Dimensions:** 126 H x 200 W x 280 mmD (5" x 7.9" x 11")

# PULSE & DATA GENERATORS

50 MHz pulse sources

Models 8012B & 8013B



- Variable transition times down to 5 ns
- $\pm 10$  V amplitude; selectable source impedance
- Ideal for testing TTL

- Fixed 3.5 ns transition times
- 10 V amplitude; selectable source impedance
- 2 outputs

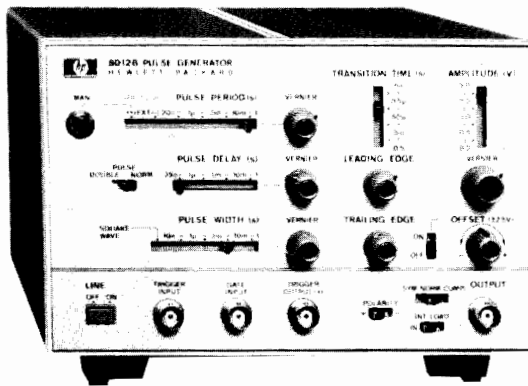

8012B

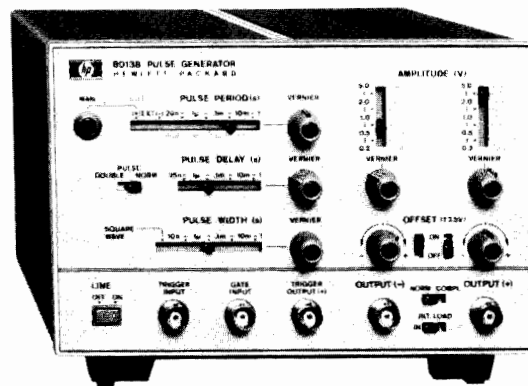

8013B

The 8012B and 8013B are at the top of their class for versatility, ease of operation and wide range of application. They provide the ideal solution to almost all digital logic testing problems with fixed 3.5 ns transition times on the 8013B and variable transition times down to 5 ns on the 8012B. The well-composed layout of the front panel controls (horizontal controls for horizontal parameters, vertical controls for vertical parameters) enables output pulses to be set up quickly and accurately with minimum risk of incompatible settings. Both models feature normal and complement outputs and a switchable internal 50 ohm source.

## Specifications

### Pulse Characteristics

Parameter	8012B		8013B	
	Int. load IN	Int. load OUT	Int. load IN	Int. load OUT
Transition times	5 ns—0.5s 4 ranges. Verniers provide separate control of both edges within ranges up to max. ratios of 100:1 or 1:100.	6 ns—0.5s	3.5 ns fixed	5 ns fixed
Source impedance	50 ohms $\pm 10\%$ shunted by typically 20 pF	>50 ohms	50 ohms $\pm 3\%$ shunted by typically 20 pF	>50 ohms

Parameter	8012B/8013B	
	Internal load IN	Internal load OUT
Overshoot ringing	$\pm 5\%$ of pulse amplitude	May increase to $\pm 10\%$ when amplitude is between 0.4—4 V
Maximum output	5 V across 50 ohms, 10 V across open circuit. Short cct. protection.	10 V across 50 ohms, Short cct. protection.
Attenuator	4-step, reduces output to 0.2 V.	4-step, reduces output to 0.4 V.
DC offset	$\pm 2.5$ V across 50 ohms. Independent of amplitude settings.	DC offset switched off.

**Linearity (8012B):** for transition times  $> 30$  ns, maximum straight line deviation is 5% of pulse amplitude.

**Preshoot:**  $< \pm 5\%$  of pulse amplitude.

**Pulse width:**  $< 10$  ns to 1 s in four ranges. Vernier provides continuous adjustment within ranges.

**Width jitter:**  $< 0.1\% + 50$  ps on any width setting.

**Maximum duty cycle:**  $> 75\%$  from 1 Hz to 10 MHz, decreasing to  $\geq 40\%$  at 50 MHz. Up to 100% in COMPL mode.

**Polarity:** 8012B; positive or negative selectable, NORM/COMPL/SYM selectable; 8013B, one positive + one negative channel, NORM/COMPL selectable.

**Pulse delay:**  $< 35$  ns to 1 s (with respect to trigger output) in four ranges; vernier provides continuous adjustment within ranges.

**Delay jitter:**  $< 0.1\% + 50$  ps on any setting.

### Repetition Rate and Trigger

1 Hz to 50 MHz in four ranges, continuous adjustment within ranges.

**Period jitter:**  $< 0.1\% + 50$  ps on any rate setting.

**Square wave:** 0.5 Hz to 25 MHz in four ranges. Duty cycle 50%  $\pm 5\%$  up to 1 MHz, tolerance increases to  $\pm 15\%$  at 25 MHz.

**Trigger output:**  $> +1$  V across 50 $\Omega$ , 16 ns  $\pm 10$  ns wide.

### External Triggering

0 to 50 MHz; for square wave output, frequency divided by factor 2.

**Trigger input:** sine waves 1.5 V p-p (about zero) or pulses  $> 0.8$  V either polarity,  $> 7$  ns wide. Maximum input  $\pm 7$  V.

**Impedance:** 50 $\Omega \pm 10\%$ , dc coupled.

**Delay:** 25 ns  $\pm 8$  ns leading edge trig. input to trig. output.

**Manual:** pushbutton for single pulse.

### Gating

**Synchronous gating:** gating signal turns generator "on". Last pulse is completed even if the gate ends during pulse.

**Gate input:** dc-coupled; voltage at open connector approx. +1.8 V. Shorting current  $\leq 12$  mA. Input impedance  $\approx 160\Omega$

**Gate input signal:** voltage  $> +1.5$  V or resistor  $> 1$  k $\Omega$  to ground enables rep. rate generator. Voltage  $< +0.8$  V or resistor  $< 160\Omega$  disables rep. rate generator. Input TTL compatible, max.  $\pm 5$  V.

### External Width and RZ

**External width:** output pulse width determined by width of drive input signal. Amplitude, transition times selectable. Trigger output independent of external width input signal.

**RZ mode:** external drive input switched to delay generator. Period determined by period of drive input signal. Delay, amplitude and width selectable.

**Input signal:**  $> +1$  V,  $> 7$  ns wide. Max.  $\pm 5$  V. 50 $\Omega$  dc coupled.

### General

**Operating temperature:** 0°C to 55°C.

**Power:** 100/120/220/240 V rms; +5%, -10%; 48 to 400 Hz, 100 VA max.

**Weight:** net, 4kg (8.8 lb). Shipping, 6.5 kg (14.6 lb).

**Size:** 126 H  $\times$  200 W  $\times$  280 mm D (5  $\times$  7.9  $\times$  11 in.)

### Ordering Information

8012B Pulse Generator

Opt 910: extra operating and service manual

8013B Pulse Generator

Opt 910: extra operating and service manual

15179A Adapter frame. Rack mounting for two units

### Prices

\$1400

add \$20

\$1200

add \$13

\$195

# PULSE & DATA GENERATORS

## 50 MHz, dual output

### Model 8015A

- Two independent  $\pm 16$  V outputs
- Additional TTL output
- Remote control and counted burst options
- Complex waveforms

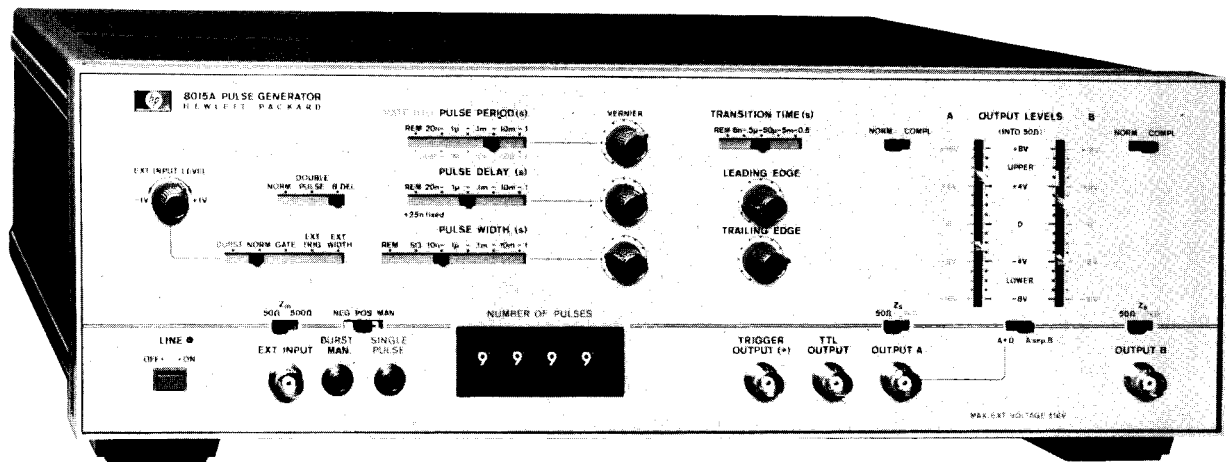

8015A Option 002

Offering B Delay mode in addition to variability of all pulse parameters, the 8015A is ideal for analyzing critical timing conditions, or generating 2-phase clocks.

A + B mode gives a 30 V output within a  $\pm 16$  V window. Combined with B Delay mode, three-level signals, special codes or simulated biomedical signals can be generated.

Option 002 Burst mode generates an exact number of pulses by means of an internal counter.

Direct access to either or both output amplifiers (Option 007) converts to MOS/CMOS levels. Alternatively, high-level tracking capability ensures that clock and data signals follow the supply, and thus safeguards CMOS devices.

For use in automatic test, Option 003 allows all pulse parameters to be controlled remotely.

## Specifications

### Timing

**Repetition rate:** 1 Hz to 50 MHz (square wave and double pulse to 25 MHz, A + B mode to 40 MHz, B delay 20 MHz).

**Width:** 10 ns to 1 s or square wave.

**Delay:** 20 ns to 1 s (both channels, interchannel or double pulse).

**Jitter:** 0.1% + 50 ps.

**Output** (50  $\Omega$  Output Impedance into 50  $\Omega$  termination. Voltages double in 50  $\Omega$  / 1 k $\Omega$  or 1 k $\Omega$  / 50 $\Omega$  operation).

**Magnitude:** 1 V to 8 V amplitude (2 V to 16 V in A + B mode).

**High level:** -7 V to +8 V. **Low level:** -8 V to +7 V.

**Transition times:** 6 ns to 0.5 s in four ranges, independent leading/trailing vernier adjustment.

**Non-linearity:** 5% for transitions > 30 ns.

**Preshoot, overshoot and ringing:** 5%.

**A + B mode:** sum of channel A and channel B outputs.

**Complement:** independently selectable.

**Impedance:** 50  $\Omega$  / 1 k $\Omega$ , independently selectable.

### Trigger Input

**Impedance:** 50  $\Omega$  / 500  $\Omega$  selectable.

**Level:** adjustable +1 V to -1 V (50  $\Omega$ ), +10 V to -10 V (500  $\Omega$ ).

**Slope:** + or - selectable.

### Auxiliary Outputs

**TTL:** 50  $\Omega$  output impedance, timing as channel A.

**Trigger output:** 1 V, 50  $\Omega$  into 50  $\Omega$ .

### Option 002 Burst Mode

**Burst length:** 1-9999 pulses, selectable.

**Pulse Repetition rate:** 1 Hz to 40 MHz.

**Burst trigger:** trigger input.

**Minimum Burst Separation:** 200 ns.

### Option 003 Remote Control

**Timing ranges:** TTL or contact closure.

**Timing verniers:** current, voltage or resistor programming.

**Output levels:** voltage programming.

**Burst:** BCD, TTL/contact closure.

### Option 007 Amplifier and Tracking Modes Dual Amplifier Mode

**Gain:** 0.8 to 6.4.

**Frequency response (-3 dB):** 0 to 80 MHz.

### Upper Level Tracking Mode

**Upper level:** input voltage  $\pm 5\%$ .

**Lower level:** 0 V  $\pm 250$  mV.

**Settling time:** 400  $\mu$ s to  $\pm 5\%$  of final value.

### General

**Operating temperature:** 0°C to 55°C.

**Power:** 100/120/220/240 V rms; +5%, -10%; 48 to 440 Hz, 180 VA max.

**Weight:** net, 11 kg (24.26 lb); shipping, 14.7 kg (32.4 lb).

**Size:** 133 H x 426 W x 346 mm D (5.2" x 16.75" x 13.6").

### Ordering Information

8015A Pulse Generator	Price
8015A Pulse Generator	\$3700
Opt 002: Pulse Burst	add \$650
Opt 003: Remote Control	add \$1400
Opt 007: Dual Amplifier and Level Tracking modes	add \$435
Opt 907: Front Handle Kit (Part No. 5061-0089)	add \$32
Opt 908: Rack Flange Kit (Part No. 5061-0077)	add \$25
Opt 909: Opt. 907, 908 combined (Part No. 5061-0083)	add \$55
Opt 910: Additional Operating and Service Manual	add \$38

- Variable transition times down to 2 ns.

- Extremely linear slopes

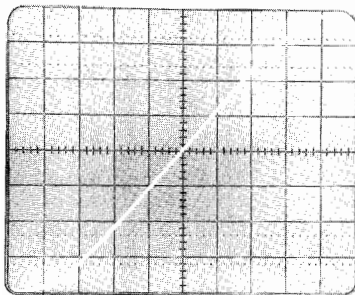
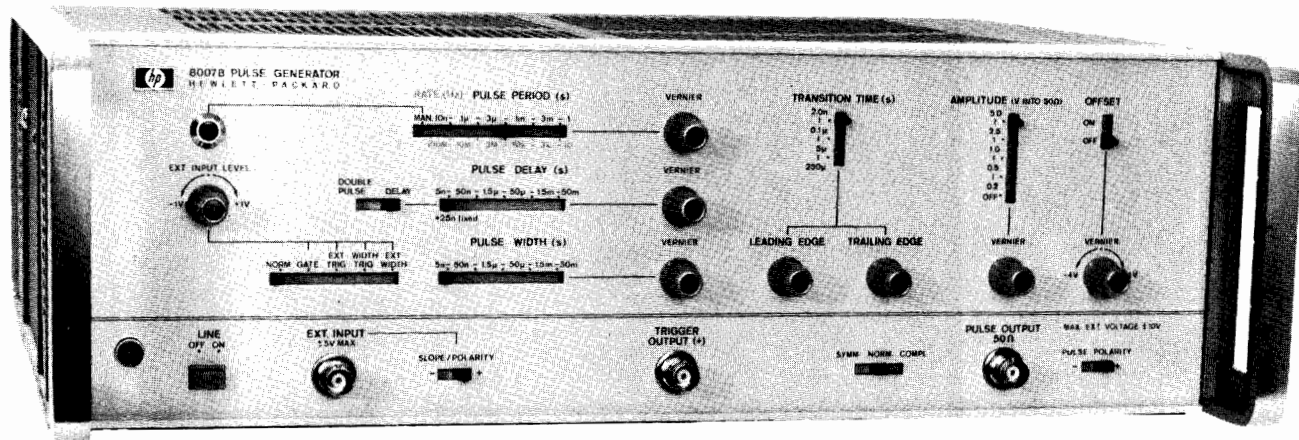

1 ns/cm  
0.5 V/cm  
1 GHz bandwidth

The 8007B is a high speed pulse generator that is well suited for STTL and ECL applications.

The output can be set to positive or negative polarity, complement or symmetrical to ground. A high dc-offset of up to  $\pm 4$  V is also included.

External triggering and synchronous gating are provided. The trigger level is adjustable for all externally controlled modes with the slope polarity selectable. This is very useful for avoiding malfunctions caused by noise and ringing on the external trigger signal.

In "External Width" mode the external input and pulse output have equal width. Transition times and amplitude of the output pulse can be set by the front panel controls. This mode is useful for shaping NRZ signals, as the width information is passed on to the output pulse unchanged.

The "Width Trigger" mode is suitable for RZ signal shaping. Delay, width, transition times and amplitude are determined by the front panel controls.

## Specifications

### Pulse Characteristics (50Ω Source and Load Impedance)

**Transition times:**  $< 2$  ns to 250  $\mu$ s, three ranges (common for both transition times). Independent verniers for adjusting leading and trailing edge within each range up to maximum ratios of 1:50 or 50:1.  
**Linearity:** maximum deviation from a straight line between 10% and 90% points  $\leq 5\%$  of pulse amplitude.

**Preshoot, overshoot, ringing:**  $< \pm 5\%$  of pulse amplitude.

**Pulse width:**  $< 5$  ns to 50 ms in five ranges. Vernier provides continuous adjustment within ranges.

**Width jitter:**  $< 0.1\%$  on any width setting.

**Maximum duty cycle:** normal  $> 50\%$ ; complement approx. 100%.

**Amplitude:** 5 V max (10 V across open circuit) to 0.2 V in four ranges; vernier adjustment within ranges. Pulse can be switched off.

**Pulse output:** + or - polarity selectable; normal, complement, or symmetrical to ground.

**Source impedance:**  $50\Omega \pm 4\Omega$  shunted by typ. 10 pF.

**DC-offset:**  $\pm 4$  V across 50Ω load. Independent of amplitude setting, can be switched off.

**Pulse delay:**  $< 30$  ns to 50 ms with respect to trigger output. Five ranges, with continuous adjustment within ranges.

**Delay jitter:**  $< 0.1\%$  on any delay setting.

### Repetition Rate and Trigger

10 Hz to 100 MHz in 5 ranges. Continuous adjustment within ranges.

**Period jitter:**  $< 0.1\%$ .

**Double pulse:** available only up to pulse rate setting of 50 MHz, representing an output pulse rate of 100 MHz.

**Trigger output:**  $> +1$  V across 50Ω, 4ns  $\pm 2$  ns wide.

### External Triggering (0 to 100 MHz)

**Delay:** approx. 15 ns between trig. input and trig. output.

**Manual:** front panel pushbutton for single pulse.

### External Width and Width Trigger

**External width:** output pulse width determined by width of drive input.

**Width trigger:** external drive input switched to the width generator. Pulse width determined by front panel width setting.

**Rate generator:** provides trigger pulses independent of drive input.

### Synchronous Gating

Gating signal turns generator "on." Last pulse is completed even if gate ends during pulse.

### External Input

**Impedance:** 50Ω, dc-coupled. Max input  $\pm 5$  V.

**Level:** adjustable from +1 V to -1 V, Polarity: + or -.

**Sensitivity:** sine waves 1 V p-p; pulses 1 V.

### General

**Operating temperature:** 0°C to +55°C.

**Power requirements:** 115 or 230 V rms; +10%, -15%; 48 to 440 Hz, 100 VA (maximum).

**Weight:** net, 8 kg (17.6 lb). Shipping, 9 kg (19.8 lb).

**Size:** 128 H x 426 W x 345 mm D (5" x 16.8" x 13.6").

### Ordering Information 8007B Pulse Generator

**Opt 908:** Rack Flange Kit (P/N)

**Opt 910:** Additional Operating and Service Manual

**Price  
\$3150**

add \$22

add \$28



# PULSE GENERATORS

## 250 MHz fast pulse source

Model 8082A

- <1 ns variable transition times
- Ultra-clean 50 ohm source

- Switch-selectable ECL levels
- Dual  $\pm 5$  V outputs

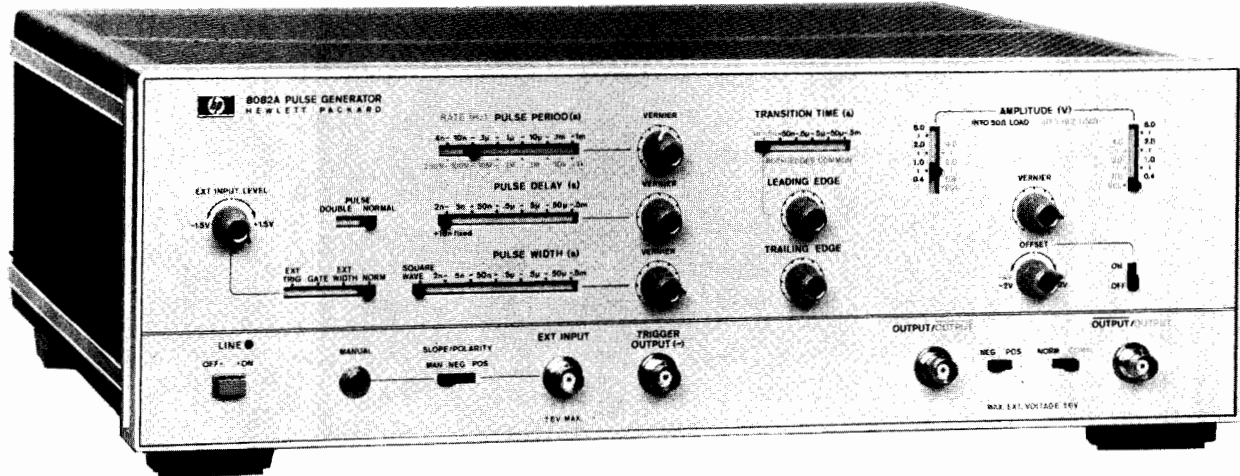

The 8082A is Hewlett-Packard's fastest pulse generator with all pulse parameters variable. With repetition rates to 250 MHz, transition times down to 1 ns and amplitudes to 5 V, the 8082A is ideally suited for state-of-the-art TTL and ECL logic designs. Using the 8082A, you can rapidly test logic circuits under all operating conditions by simply varying pulse parameters. Although a highly sophisticated instrument, the 8082A is still easy to operate because of its logical front panel layout and switch selectable ECL output levels. Another feature that contributes to ease of operation is the square wave mode. You can, for example, carry out toggle rate tests in this mode up to 250 MHz without having to worry about pulse duty cycle.

Hybrid IC's, manufactured by Hewlett-Packard, are used extensively in the design of the 8082A. These ICs eliminate the need for fans, reduce power consumption and enable a low reactance 50 ohm source impedance to be used. This source impedance absorbs 98% of reflections from signals up to 4 V amplitude.

### Specifications

#### Pulse Characteristics (50 $\Omega$ Source and Load Impedance)

**Transition times:** <1 ns - 0.5 ms (10% to 90%) in 6 ranges. <750 ps (20% to 80%). Leading/trailing edges controlled together on fastest range, independently variable over 1:10 ratio on other ranges.

**Overshoot and ringing:**  $\leq \pm 5\%$  of pulse amplitude may increase to  $\pm 10\%$  with amplitude vernier CCW.

**Preshoot:**  $\leq \pm 5\%$  of pulse amplitude.

**Linearity:** linearity aberration for both slopes  $\leq 5\%$  for transition times >5 ns.

**Output:** maximum amplitude is 5 V from 50 $\Omega$  into 50 $\Omega$ . Maximum output voltage is  $\pm 5$  V (amplitude + offset).

**Offset:**  $\pm 2$  V, into 50 $\Omega$ .

**DC-source impedance:** 50 $\Omega \pm 5\%$ .

**Reflection coefficient:** reflection is 2% typical for steps with 1 ns rise time applied to output connector on all amplitude ranges except 5 V range. On the 5 V range, the reflection may be 15%.

**Output protection:** cannot be damaged by open or short circuits or application of ext.  $\leq \pm 6$  V or  $\pm 200$  mA independent of control settings.

**Attenuator:** two separate three step-attenuators reduce the outputs to 1 V. Vernier is common for both outputs and reduces the output to 0.4 V minimum. A further position provides ECL-compatible outputs (-0.9 V to -1.7 V typ. open circuit).

#### Timing

**Repetition rate:** 250 MHz to 1 kHz in 6 ranges.

**Period jitter:** <0.1% of setting +50 ps.

**Delay:** 2 ns - 0.5ms in 6 ranges plus typ. 17 ns fxd. with respect to trigger output. Duty cycle >50%.

**Delay jitter:** <0.1% of setting +50ps.

**Double pulse:** up to 125 MHz max. (simulates 250 MHz).

**Pulse width:** <2 ns - 0.5 ms in 6 ranges.

**Width jitter:** <0.1% of setting +50 ps.

**Width duty cycle:** >50%.

**Square wave:** delay and double pulse are disabled, max. Rep. Rate 250 MHz. Duty cycle is 50%  $\pm 10\%$  up to 100 MHz, 50%  $\pm 15\%$  for >100 MHz.

**Trigger output:** negative going Square Wave (50% duty cycle typ.) >500 mV from 50 $\Omega$  into 50 $\Omega$ . Internal 50 $\Omega$  can be switched off by slide-switch on PC-board. Amplitude up to 1 V into 50 $\Omega$  up to 200 MHz.

**Trigger output protection:** cannot be damaged by short circuit or application of external  $\pm 200$  mA.

### Externally Controlled Operation

#### External Input

**Input impedance:** 50 $\Omega \pm 10\%$ . DC coupled.

**Maximum input:**  $\pm 6$  V.

**Trigger level:** adjustable -1.5 V to +1.5 V.

**Slope control:** positive, negative or manual selectable. In the manual position all ext. functions can be controlled by push button. Button pushed in simulates an "on-signal."

**Sensitivity:** sine-wave >200 mV p-p pulses >200 mV.

**Repetition rate:** 0 to 250 MHz.

#### External-controlled modes:

**External trigger:** there is approximately 7 ns delay between the external input and the trigger output. Rep. rate is externally controlled (is triggered by external signal). Trigger output provides the pulse-shaped input signal. Square wave mode is disabled.

**Synchronous gating:** gating signal turns rep. rate generator on. Last pulse normal width even if gate ends during pulse.

**External width:** output pulse width determined by width of drive input. Rep. rate and delay are disabled. Trigger output provides shaped input signal.

### General

**Operating temperature:** 0°C to 55°C.

**Power:** 100/120/220/240 Vrms; +5%, -10%; 48-440 Hz. 85 VA max.

**Weight:** net, 7.9 kg (17.44 lb). Shipping 8.9 kg (19.63 lb).

**Size:** 133 mm H x 426 W x 345 mm D(5.2" x 16.75" x 13.6").

### Ordering Information

#### 8082A Pulse Generator

**Opt 907:** Front Handle Kit (part number 5061-0089).

**Opt 908:** Rack Flange Kit (part number 5061-0077).

**Opt 909:** Opt 907, 908 Combined (part number 5061-0083).

**Opt 910:** Additional Operating and Service Manual

#### Price

**\$4400**

add \$32

add \$25

add \$55

add \$28



- 300 ps transitions
- Interchannel delay for rapid timing measurements
- Clock + 1/2-rate data capability for effortless setup and hold time measurements

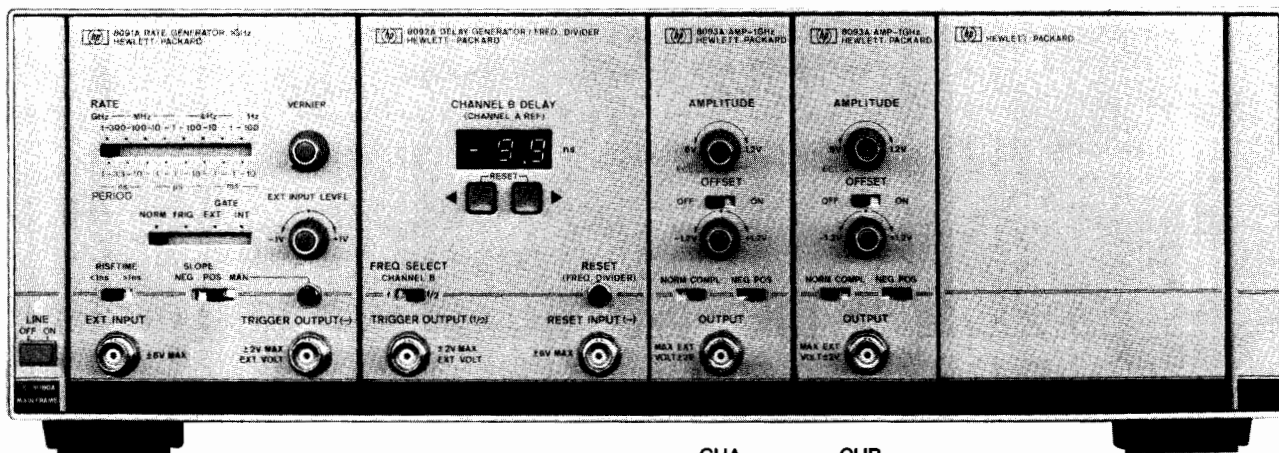

8091A  
Rate Generator

8092A  
Delay Generator

CHA CHB  
8093A  
Output Amplifiers

8080A  
Mainframe

## 8080 System

Research and development in advanced technologies such as sub-nanosecond ICs, fiber optics and nucleonics, require fast rectangular pulses for evaluating products and experimental equipment. Additionally, where digital techniques are used, programmable data is necessary for functional verification.

For a cost-effective stimulus solution in high-technology environments, the ability to adapt to changing requirements is as important as meeting state-of-the-art needs. Consequently, the 8080 System has been designed with a modular structure for flexibility as well as the technology for today's fast pulse applications.

Your local HP office will be happy to quote a configuration for your special needs. Two popular examples are presented on this and the following page.

### 1 GHz Pulse Generator Example

The configuration illustrated above is a dual output 1 GHz generator with very fast, 300 ps, pulse edges. Internal/external trigger and gate capabilities are offered. With separate output amplifiers, the dual channels are independently adjustable in terms of amplitude, offset, polarity and logic inversion. ECL levels are rapidly selected by turning the amplitude vernier to a detent position. Additionally, channel B can be delayed or advanced with respect to channel A. The delay is set in 100 ps steps by convenient up/down pushbuttons and indicated on a clear 2-digit LED display.

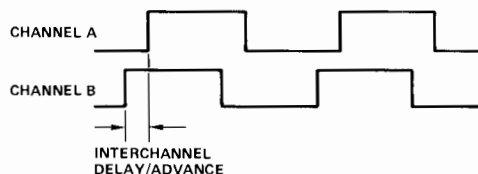

For rapid setup and hold measurements, the delay generator has an additional feature which allows a clock signal and a half-frequency data stream—representing alternate 0s and 1s—to be generated simultaneously.

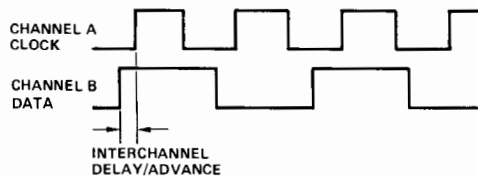

## 8080 Main Specifications for 1 GHz Pulse Generator example

### Timing

**Repetition rate:** 100 Hz–1 GHz, jitter  $\leq 0.1\% \pm 20$  ps. Ext trigger and gate; trigger level  $-1$  V to  $+1$  V variable, slope selectable. Manual or remote selection of divider reduces Channel B frequency by factor 2.

**Delay/Advance:**  $\pm 9.9$  ns in 100 ps steps.

**Width:** Square wave.

### Output

Normal/complement, neg/pos selectable; 50 $\Omega$  source

**Amplitude:** (into 50 $\Omega$ ): 0.6 V to 1.2 V variable, offset zero or variable in the range  $\pm 1.2$  V. Vernier detent gives ECL levels ( $-0.8$  V,  $-1.6$  V), capable of  $\pm 0.9$  V internal offset adjustment.

**Transition times:** (10% to 90%):  $\leq 300$  ps. Preshoot, overshoot, ringing  $\leq 10\%$  ( $\leq 15\%$  above 500 MHz).

### Options and Accessories

#### For Mainframe

Options and Accessories	Price
Opt 907: Front handle kit (part number 5061-0089)	add \$32
Opt 908: Rack flange kit (part number 5061-0077)	add \$25
Opt 909: Opt 907, 908 combined (part number 5061-0083)	add \$55
Opt 910: Additional manual (includes system binder)	add \$28
15400A: Blank Panel, quarter mainframe width	\$60
15401A: Blank Panel, eighth mainframe width	\$60
15402A: Feedthru panel (6 BNCs), eighth mainframe width	\$120

#### For Modules

Opt 910: Additional manual, per module	\$28
8084A Opt 001: Front Panel connectors for Clock In, Gate Out, Word Out	add \$190

### Ordering Information

8080A Mainframe	\$1850
8081A 300 MHz Rep Rate Generator module	\$1200
8083A 300 MHz Output Amplifier module	\$1200
8084A 300 MHz Word Generator module	\$3150
8091A 1 GHz Rep Rate Generator module	\$3350
8092A 1 GHz Delay Generator/module/Frequency Divider	\$3030
8093A 1 GHz Output Amplifier module	\$1750

8080 system continued next page.





# PULSE & DATA GENERATORS

## 8080 System: 300 MHz serial data generator example

Models 8080A, 8081A, 8083A and 8084A

- 800 ps transitions
- Dual complement outputs,  $\pm 2V/ECL$
- RZ/NRZ data format
- 16/32/64-bit word lengths

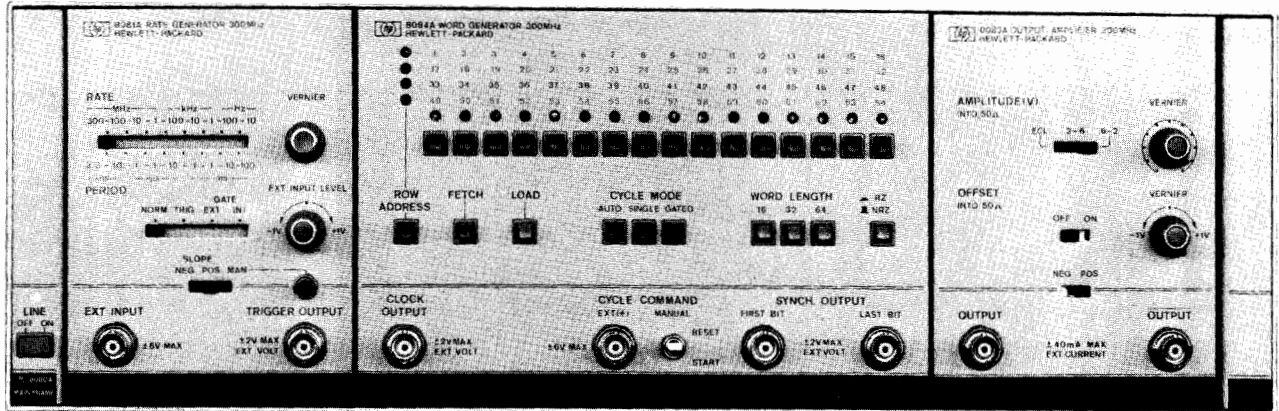

8080A Mainframe      8081A Rate Generator      8084A Word Generator      8083A Output Amplifier

The 8080 system introduced on the previous page can also be configured as a data generator. The following example provides data streams suitable for fast serial digital devices and data links.

### 8080 300 Mbit/s Data Generator Example

By means of the Word Generator module, serial data can be freely programmed in 16, 32 or 64-bit word lengths. Depending on operating mode, a word can be single shot triggered or continuously cycled.

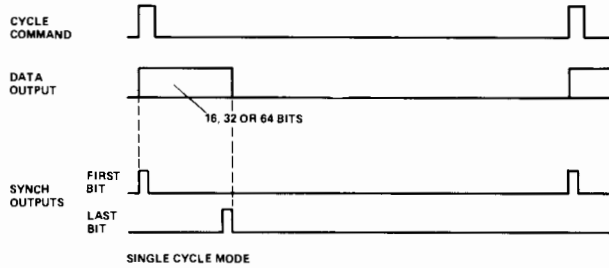

Furthermore, gate mode allows continuous cycling for the duration of the gate.

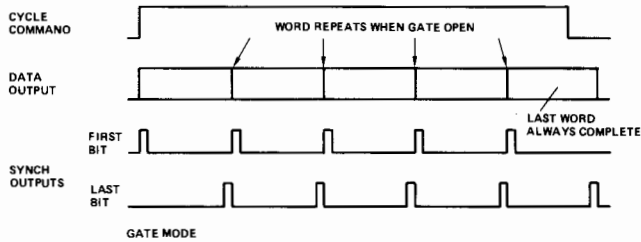

Data content is programmed by means of 16 pushbuttons with LED indicators. For word lengths greater than 16 bits, the pushbuttons are successively reassigned to the word segment being programmed. Data format is selectable, NRZ mode giving additionally a means of adjusting pulse width and frequency division by data programming.

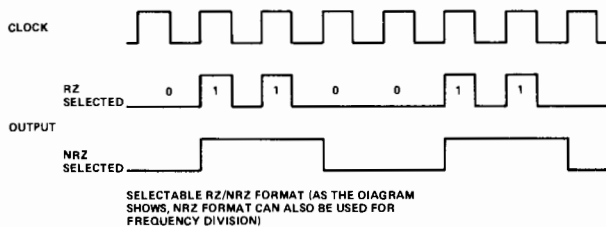

With the 8083A Output Amplifier, normal and complement outputs are available simultaneously. Amplitude, offset and polarity adjustments apply to both outputs, and a switch provides easy selection of ECL levels. If faster transitions or independent output level controls are needed, two 8093A Output Amplifiers could be used instead.

### 8080 Specifications for 300 Mbit/s Data Generator Example

#### Timing

**Repetition rate:** 10 Hz - 300 MHz, jitter  $\leq 0.1\% \pm 50$  ps. Ext trigger and gate; trigger level  $-1$  V to  $+1$  V variable, slope selectable.  
**Data:** Serial data stream of 16, 32, or 64 bits, single/continuous cycle or gateable. Clock and First Bit and Last Bit Synch outputs. Data output RZ/NRZ selectable.

#### Output

Simultaneous normal and complement outputs, neg/pos selectable; 50 $\Omega$  source.  
**Amplitude:** (into 50 $\Omega$ ): 0.2 V to 2 V variable, offset zero or variable in the range  $\pm 1$  V. Switch position gives ECL levels ( $-0.8$  V,  $-1.6$  V).  
**Transition times:** (10% to 90%): 800 ps. Preshoot, overshoot, ringing  $\leq 10\%$ .

#### General

**Operating Temperature:** 0°C to 55°C.  
**Power:** 115/230 V rms;  $+10\%$ ,  $-22\%$ ; 48 to 66 Hz, 200 VA max.  
**Weight:** (typical, 8080A Mainframe plus full complement of modules) 9.4 kg (16.6 lbs) net; 19.7 kg (43.3 lbs) shipping.  
**Size:** (8080A Mainframe): 133 H  $\times$  426 W  $\times$  422 mm D (5.24"  $\times$  16.77"  $\times$  16.61")

Options, Accessories, Ordering Information—see previous page.

# PULSE & DATA GENERATORS

50 MHz serial data/PRBS generator

Model 8018A

349



- 2048 bit, dual channel memory
- Variable word and pattern length

- TTL, ECL, CMOS compatible
- Programmable, prbs and mixed data

Option 001

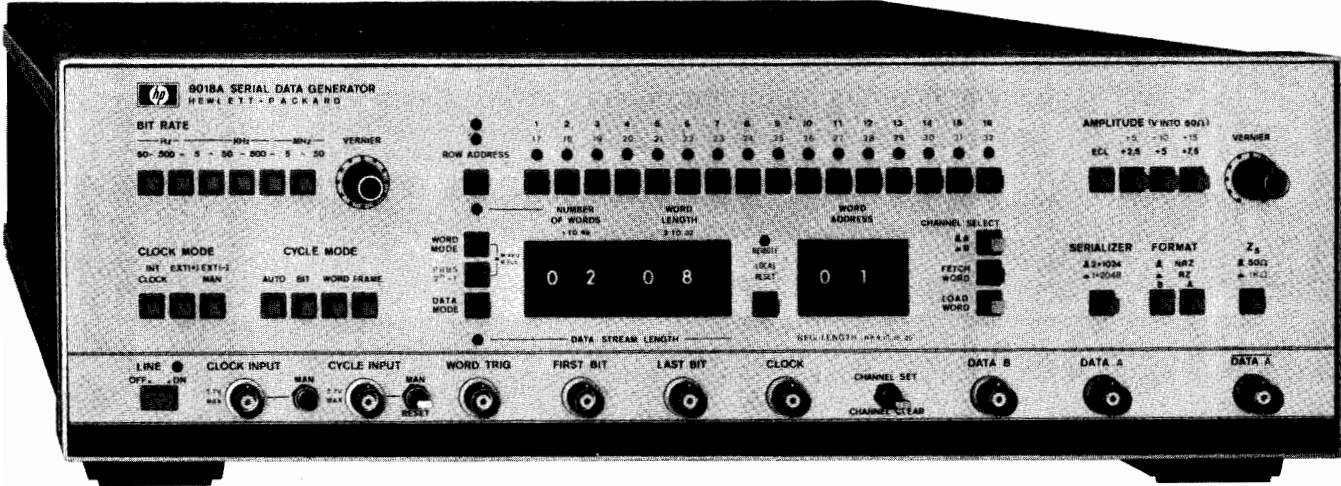

With 2048 programmable bits, and a choice of pseudo-random binary sequences (prbs) ranging to over 1M bits, the 8018A is a powerful stimulator for serial digital systems and devices requiring high bit rate and fast pulses. Even preamble-data-post-amble data link patterns are feasible by combining prbs and programmed data. Useful synch outputs simplify testing by locking scope or analyzer to unique points in the data stream. Variable 15 V pulses and selectable ECL levels allow direct connection to all logic families. Data can be programmed by HP-IB (Option 001) and Card Reader (Option 002).

## Specifications

### Data Capacity and Modes

**Programmable memory:** 2 channels, each 1k bit, serializable. Thumbwheel switches define data stream length or frame length (N words of M bits), and set up synch signals accordingly.

**Prbs:** pseudo-random binary sequences of 511, 1023, 32767 and 1048575 bits. Synch pulse at beginning of sequence.

**Mixed:** prbs is inserted after every odd-numbered programmable word.

### Data Outputs

**Channel A:** Simultaneous normal and complement outputs. ECL levels or variable +15 V amplitude. Selectable 50 $\Omega$ /1k $\Omega$  output impedance, RZ/NRZ format.

**Data length:** up to 1024 bit or (serialized with B data) 1025 to 2048 bit.

**Transitions (50 $\Omega$  into 50 $\Omega$ ):**  $\leq 6$  ns (ECL  $\leq 5$  ns)

**Preshoot, overshoot, ringing:**  $\leq 10\%$  (ECL  $\leq 15\%$ )

**Channel B:** normal output, 2.4 V (50 $\Omega$  into 50 $\Omega$ ), up to 1024 bits, RZ/NRZ selectable.

### Bit Rate

**Internal:** 50 Hz to 50 MHz (40 MHz in Mixed mode), jitter 0.2%

**External:** dc to 50 MHz (40 MHz in Mixed mode) or manual.

### Data Cycling

**Auto:** Sequence recycles continuously.

**Bit:** bits are triggered/gated by external pulses/level.

**Word:** words are triggered/gated by external pulses/level.

**Frame:** sequence is triggered/gated by external pulses/level.

**Manual:** switch triggers single bits/words/frame.

### General

**Power:** 100/120/220/240 V rms; +5%, -10%; 48 to 440 Hz. 230 V A max.

**Temperature Range:** 0°C to 50°C.

**Weight:** net 12 kg (26.5 lbs); shipping 16 kg (35.3 lbs).

**Size:** 133 H x 426 W x 422 mm D (5.2" x 16.8" x 16.6").

### Ordering Information

**8018A Serial Data Generator**

**Opt 001:** HP-IB for data loading\* \$3850

**Opt 002:** 15263A Card Reader. Option 001 required. \$650

**Opt 907:** Front Handle Kit (Part No. 5061-0089) \$735

**Opt 908:** Rack Flange Kit (Part No. 5061-0077) \$32

**Opt 909:** Opt. 907, 908 combined (Part No. 5061-0083) \$25

**Opt 908:** Opt. 907, 908 combined (Part No. 5061-0083) \$55

\* HP-IB cables: refer to page 30.

### Accessory for 8016A, 8018A, 8170A

**Card Reader  
Model 15263A**

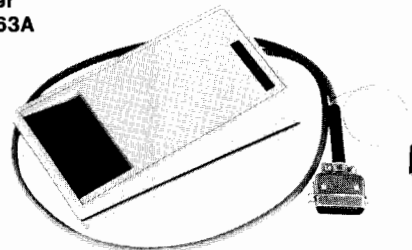

To save manual re-entry, or tying up a system controller for a bench job, marked cards and HP 15263A Card Reader provide permanent storage and easy re-loading. The 8016A Option 001, 8018A Option 001 and 8170A all provide the necessary power jack and HP-IB capability for operating with the 15263A.

## Specifications

### General

**Power:** +5V, 550mW.

**Weight:** 0.6 kg (1.3 lb); shipping 1.6 kg (3.5 lb)

**Size:** 57 H x 115 W x 195 mm D (2.2" x 4.5" x 7.6")

**Accessories Supplied:** 50 cards (Part No. 9320-0595)

### Ordering Information:

**15263A Card Reader**

Note: If ordering Card Reader same time as 8016A or 8018A order 8016A or 8018A Option 001 + 002

**Price**

\$775

# PULSE & DATA GENERATORS

Logic pattern generator for bus stimulation

Model 8170A

- 8 k memory (32 k option)
- 8 bit / 16 bit parallel output
- 2 wire / 3 wire handshake capability
- Internal and external addressing

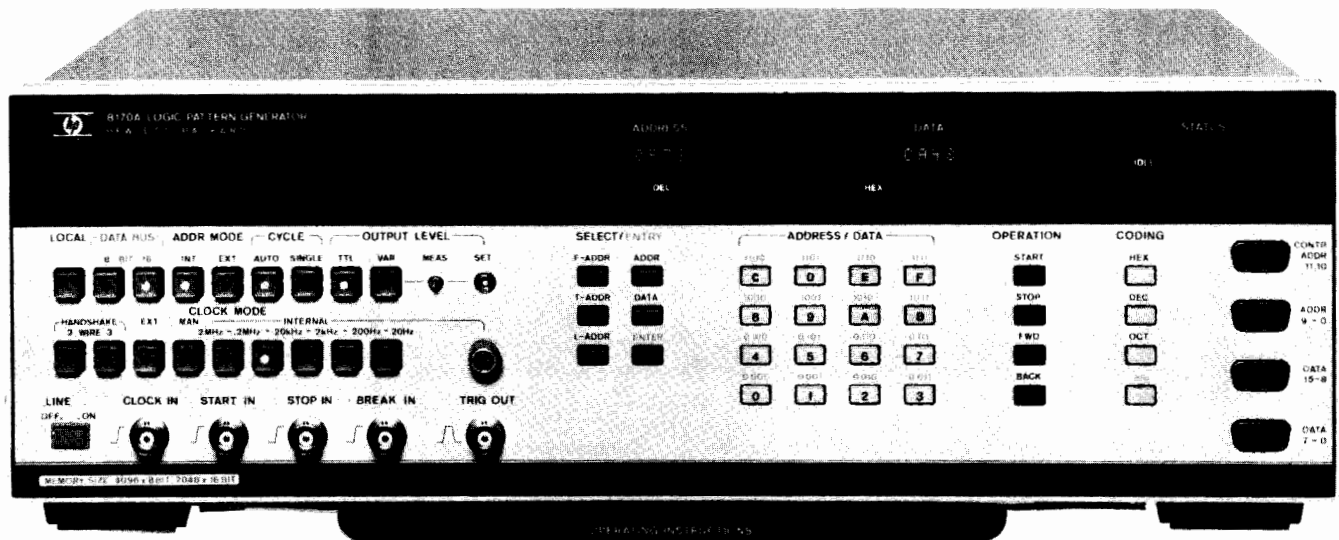

## Introduction

The 8170A Logic Pattern Generator is a real-time test stimulus for functional checkout of today's multi-channel logic devices and subassemblies. With data traffic in modern digital systems routed over a shared bus, the 8170A's direct bus driving capability makes design verification at every stage in system development and production a quick, straightforward task.

Data generation by the 8170A is in parallel 8-bit or 16-bit format, to a memory depth of 1024 or 512 words respectively (optionally extendable to four times that capacity). This, combined with a variable clock rate up to 2 MHz permits thorough functional testing at full system operating speed. In addition, output levels of the 8170A ensure a direct match to today's most widely employed logic families—TTL and CMOS, while specially designed mini-probes minimize hook-up problems to the device under test.

## Selectable Codes

Designed around the 6800 microprocessor, the 8170A's control scheme permits data, address and operating modes to be entered directly via the instrument keyboard. A sophisticated feature of keyboard programming is the multi-code format available for address and data. Codes include octal, decimal and hexadecimal (see specifications), the microprocessor automatically performing code conversion to the binary base. When fast program check or recall is required, alphanumeric LED's display individual data-address lines in the selected code.

## Internal Address Mode

The 8170A's internal address mode is specifically intended for driving digital busses. Typical bus traffic is simulated by generating data in an ascending address sequence, the first and last address being pre-

set by the user. The 8170A can be thus programmed for detailed investigation of selected bus functions.

Whether the tested bus operates synchronously or asynchronously, the 8170A generates the necessary test signal. With NORM selected, the 8170A outputs data in response to a clock signal (internal, external or manual). Where a bus operates in an asynchronous 2-wire or 3-wire handshake system, the 8170A generates data and data valid signals in accordance with the selected protocol.

## External Address Mode

In external address mode, 8170A operation is analogous to the RE-PROM. Data is output according to the state of externally applied address and enable lines. The main advantage using the 8170A is the ease with which data can be loaded or modified via the keyboard—as opposed to generally complicated processes demanded by RE-PROM's. Where time is a valuable commodity such as in software test and development, the 8170A presents significant savings in this mode.

## HP-IB

With full programmability via the HP-IB interface bus, the 8170A's application base extends to automated test systems. Employing microprocessor control over all interface functions, a syntax has been developed to make remote programming of the 8170A as simple as manual operation.

## RS 232C-CCITT V.24

In many applications, a multi-line readout is necessary for quick program set-ups and checks. For this reason, the 8170A is designed to be compatible with the serial RS 232C/CCITT V.24 interface standard. By linking the 8170A to a low cost data terminal over this interface, the multi-line listing of the 8170A memory enables fast data modification.



## Specifications

### Memory Size

**Capacity:** 8 kbit.

**Data bus format:** 8 bit or 16 bit wide.

### Operating States

**Idle:** permits entry of address, data and operating parameters.

**Active:** continuous data output.

**Break:** pause in data output. FWD/BACK enables further data output.

### Address Modes

**Internal:** data generation in ascending address sequence from F-ADDR to L-ADDR (F-ADDR, L-ADDR = user-defined first and last addresses).

**External:** data output follows external address and enable signals. DAV generated at each new address. Data and DAV high impedance when instrument not enabled. Clock and cycle modes disabled.

**Maximum address rate:** 2 MHz.

**Address to output delay:** 400 ns typ., 550 ns max.

**Enable to output delay:** 100 ns typ., 130 ns max. DAV at min.delay.

### Clocking

**Internal:** 20 Hz to 2 MHz in 5 decade ranges.

**Rate jitter:** <0.2%

**External:** dc to 2 MHz. For inp. specs, see "Auxiliary inputs".

**Manual:** operated by FWD and BACK key.

**Handshake:** 2-wire/3-wire handshake capability selectable.

### Cycle Modes

**Auto cycle:** data is continuously generated between F- and L-ADDR.

**Single cycle:** data is generated once between F- and L-ADDR. After cycle completion, 8170A returns to IDLE state.

### Output Signals

**Data:** pods provide 16 output lines D0-D7 (model 15455A), low byte, and D8-D15 (model 15456A), high byte. Pos./neg. true select on rear panel.

**Control:** data valid (DAV) generated with each word. Pos./neg. true selectable on rear panel.

#### DAV delay (adjustable on rear panel)

**Non-handshake:** 100 ns to 700 ns.

**2- or 3-wire handshake:** 300 ns to 800 ns.

**Status:** idle, active and break states indicated on lines ACS and BRS.

### Pod Output Levels

#### TTL setting

**Fan out:** 5 standard TTL max.

**Levels:** high +4.5 V to +5 V; low -0.5 V to +0.4 V; idle 6 mA to ground.

**Transition times (+0.4 V to +2.4 V):** 25 ns typ. 50 ns max.

#### Variable setting

**Maximum load:** 50 pF (high impedance)

**Levels:** high +3 V to +15 V adj., low -0.5 V to +0.4 V.

**Transition times (20% to 80%):** 35 ns typ. 60 ns max.

### Auxiliary Outputs

**Trigger:** generated at trigger address (T-ADDR).

**Format:** NRZ.

**Levels:** standard TTL.

**Fan out:** 5 standard TTL.

**Probe:** +5 V dc.

**Address driver outputs (Opt. 002):** provides 10 address output lines A0 to A9, positive true.

**Fan out:** 10 standard TTL.

**Levels:** high +2.4 V; low +0.5 V; idle 1.5 mA to +5 V.

**Transition times (+0.5 V to +2.4 V):** 50 ns.

### Pod Input Signals

**Input RC:** >10 k $\Omega$ /≤25 pF.

**Levels:** high ≥+2.0 V; low ≤+0.8 V.

**Max. external voltage:** ±18 V.

**Address input pod (Model 15453A):** 10 addressable input lines A0-A9 for operation in external address mode.

**Control input pod (Model 15454A):** following inp. lines available:

**Ready for data (RFD), data accepted (DAC):** for handshake mode. In 2-wire handshake RFD level selectable pos./neg. true. In 3-wire handshake, fixed levels for RFD, DAC (see IEE Std. 488-1975)

**Enable E1, E2 (E3, E4 at rear panel):** for operation in ext. address mode. Selectable levels pos./neg./don't care.

**Address A10, A11:** for extended memory, option 001.

### Auxiliary inputs

**Clock in:** for external clock signal input.

**Start in:** external signal starts data generation. Prompts 8170A transition from idle/break to active state.

**Stop in:** external signal stops data generation. Prompts 8170A transition from active/break state to idle state.

**Break in:** external signal halts 8170A at current address, outputs remain active. Prompts 8170A transition from active to break state.

#### Input conditions (all positive edge triggered)

**Input RC:** >10 k $\Omega$ /≤25 pF.

**Levels:** high ≥+2.0 V, low ≤+0.8 V.

**Min. width (at +1.3 V):** Clock 40 ns; Start/Stop/Break 20 ns.

**Max. external voltage:** ±18 V.

### HP-IB

**Keyboard mode:** remote programming of all front panel keys and functions. Coded loading and readout of data.

**Data mode:** fast binary loading and readout of data only.

### RS 232C/CCITT V.24.

Remote editing and listing of memory content, and display of current data bus format and address/data coding.

**Baud rate:** 110, 150, 300, 600, 1200, 2400, 4800, 9600 selectable.

### General

**Power:** 100/120/220/240 V rms; +5% - 10%; 48 - 66 Hz, 110 VA max.

**Operating Temperature:** 0°C to 55°C.

**Weight:** net 11 kg (24.3 lbs), shipping 15 kg (33.2 lbs).

**Dimensions:** 133 H x 426 W x 422 mm D (5.2 x 16.8 x 16.6 in).

### Accessories Supplied

2 data output pods (15455A/6A), 1 address input pod (15453A), 1 control pod (15454A), a 2 m power cord and an operating/service manual. Each pod includes Snap-on Assembly 15458A for clip connection to DUT.

### Ordering Information

Ordering Information	Price
8170A Logic Pattern Generator*	\$5950
Opt 001: 32 kbit Memory	add \$545
Opt 002: Address Driver Pod (Model 15452A).	add \$330
Opt 907: Front Handle Kit (part number 5061-0089).	add \$32
Opt 908: Rack Mount Kit (part number 5061-0077).	add \$25
Opt 909: Opt 907, 908 Combined (part number 5061-0083).	add \$55
Opt 910: Extra Operating and Service Manual.	add \$70
15457A Pod Connector (Pods can be easily plugged into DUT when this accessory is wired in).	add \$48
15263A Card Reader: rapid memory loading	\$775
*HP-IB cables not furnished, see page 30.	

# PULSE & DATA GENERATORS

9-bit parallel, 32-bit serial, 50 MHz word generator  
Model 8016A

- 2 complementary outputs per channel, RZ/NRZ formats
- Channel serializer
- Variable RZ width, 4 delay channels
- TTL/ECL output levels selectable

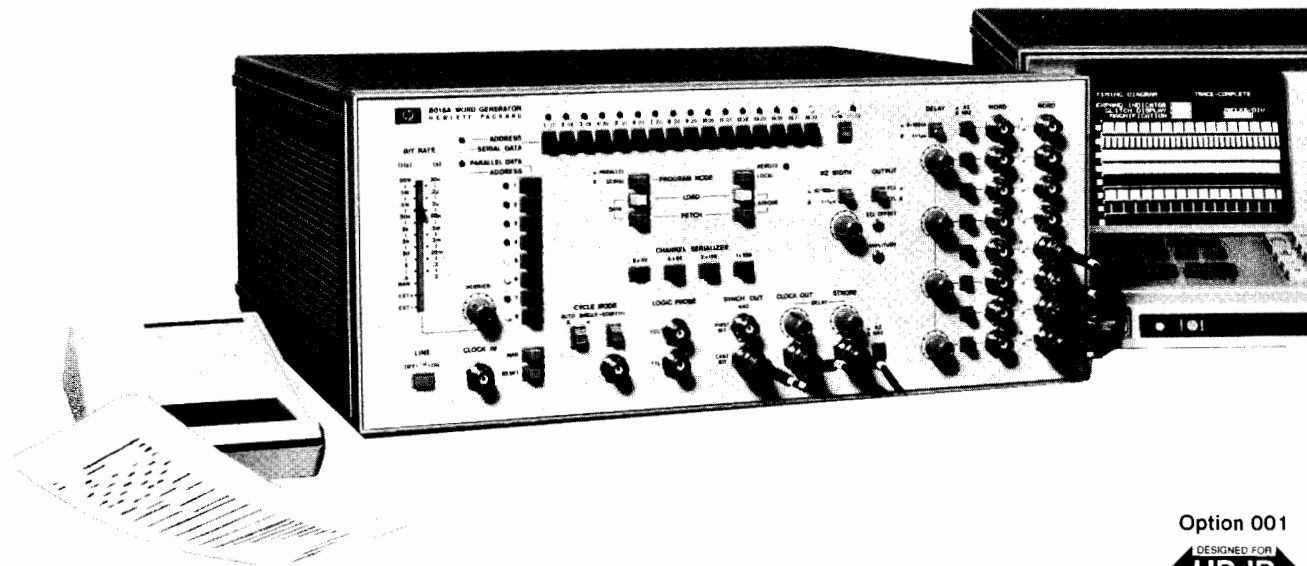

8016A Option 001 + 002

Option 001



The 8016A is a 9-channel data generator capable of serialization up to 256 bits. For the digital designer the 8016A is a natural companion to multichannel data display devices such as logic analyzers. As a bench or systems component, the 8016A provides programmable digital patterns plus adjustable timing parameters necessary for testing ICs and circuit boards.

### Functional Test

Bit pattern programmability combined with fast cycle time (50 MHz clock) make the 8016A especially effective in simulating worst case conditions, e.g. high speed IC testing. The 8016A saves time in component evaluation environments because test setups can be rapidly built and reconfigured to meet the demands of testing small quantities of a wide variety of IC types.

### Parametric Test

Complete testing of digital circuits and systems requires not only digital patterns for functional test but control of the analog parameters of the pulses as well. Adjustable pulse widths, levels, and inter-channel delays contribute to measurements such as setup and hold times, clock pulse width sensitivities, and system sensitivity to propagation delay variations. To meet these testing requirements, the 8016A includes 6 independent delay circuits. Output levels of the 8016A's 50Ω output amplifiers are selectable for ECL or TTL test specifications and can be adjusted. In addition, a choice of RZ or NRZ formats with variable RZ pulse width is provided.

### Specifications

**Data Capacity:** 8 data channels plus 1 strobe channel, each 32 bits. 8 data channels can be serialized as four 64-bit channels, two 128-bit channels or a single 256-bit channel.

**Data Loading:** address channel, enter 32 serial bits in that channel. Alternatively, address parallel word, enter (max 8) bits in that word. Addressing/entry by pushbuttons/LEDs or via HP-IB (option 001).

**Data Outputs:** (50Ω source into 50Ω load).

**Format:** independent RZ/NRZ selection in each channel.

**RZ Width:** single continuous adjustment in ranges 10-100 ns, 0.1-1μs.

**Width jitter:** ≤0.2% + 50ps

**Complement:** Simultaneous normal and complement outputs for each channel.

**Delay:** channels 2, 4, 6, 8 can be delayed independently within the ranges 0-100 ns, 0.1-1 μs with respect to odd channels.

**Jitter:** ≤ 0.1% + 5 ps

**Skew (undelayed):** ± 1 ns

**Levels:** ECL/TTL selectable

**Transition Times:** ≤ 3.0 ns (ECL ≤ 2.5 ns)

**Bit Rate**

**Internal:** 0.5 Hz to 50 MHz.

**External:** dc to 50 MHz, or manual.

### Data Cycling

**Auto:** Sequence recycles continuously.

**Single Cycle:** Sequence is triggered/gated by external pulse/level.

### General

**Operating temperature:** 0°C to +50°C.

**Power:** 100/120/220/240 Vrms; +5%, -10%; 48 Hz to 66 Hz, 200 VA (maximum)

**Weight:** net, 14.5 kg (32 lb). Shipping 16 kg (35.3 lb).

**Size:** 177 H × 426 W × 422 mm D (7" × 16.8" × 16.6").

### Ordering Information

<b>8016A</b> Word Generator	\$8050
<b>Opt 001:</b> HP-IB for data loading*	add \$650
<b>Opt 002:</b> 15263A Card Reader. Option 001 required	add \$735
<b>Opt 907:</b> Front Handle Kit (Part No. 5061-0090)	add \$40
<b>Opt 908:</b> Rack Flange (Part No. 5061-0078)	add \$30
<b>Opt 909</b> Opt 907, 908 combined (Part No. 5061-0084)	add \$65
<b>Opt 910:</b> Additional Operating and Service Manual	add \$48

\*HP-IB cables: Refer to page 30.

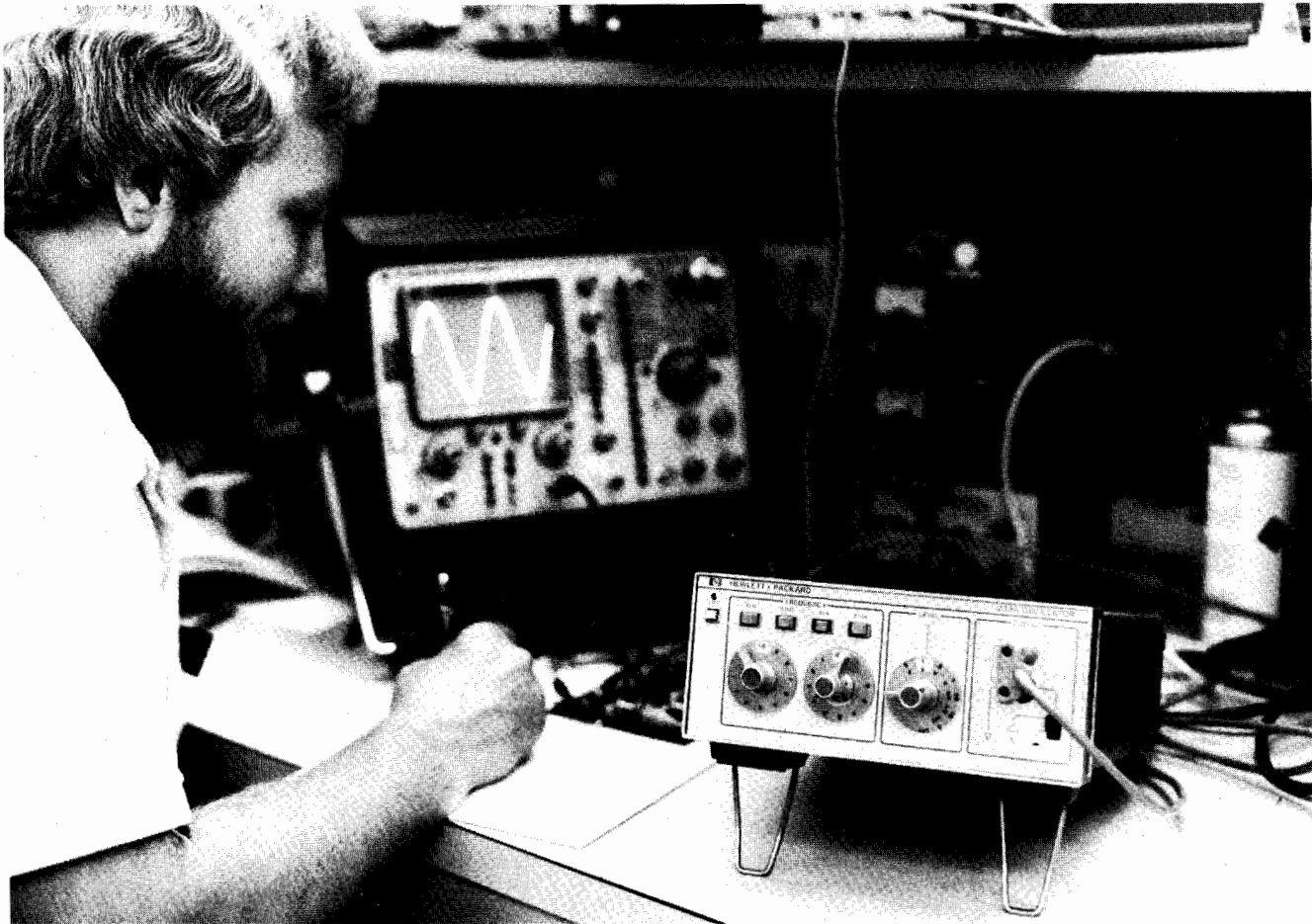

Signal sources are described by various names: oscillators, audio signal generators, function generators, etc. The names are typically associated with the application area. Signal generator describes an oscillator which has modulation capability. The term oscillator refers exclusively to a sinusoidal source while function generator always provides additional wave shapes, most often square waves, triangle waves, and increasingly, pulses.

In this section, we are considering oscillators covering the audio through video frequency range.

### Basic Considerations

In choosing a particular oscillator, frequency range, output level and distortion (THD) are the key considerations. Typically, oscillators used for testing of audio equipment, filters, amplifiers, etc., require total harmonic distortion (THD) to be at least 65 dB and often as high as 95 dB. Oscillators used in video testing must provide signals to at least 6 MHz and often to 10 MHz. For many general purpose applications, high level signals are needed, an example being 10 volts in 600 ohms. Hewlett-Packard offers oscillators that meet all of these requirements. Table 1 is a summary chart comparing the main features of all the products.

### Distortion

Distortion in total harmonic terms is a measure of the oscillator's signal purity. It is presented as a ratio of the total harmonic

content to the fundamental and expressed either as dB's below the fundamental or as a percentage of it. A typical value for audio work might be a THD of  $-60$  dB ( $\approx 0.1\%$ ).  $-95$  dB is becoming more necessary especially in the audio entertainment and Hi-Fi areas. Hewlett-Packard offers this high level of signal purity in the 239A Oscillator.

### Frequency Stability

Frequency stability of an oscillator determines the ability of the instrument to maintain a selected frequency over a period of time. Component aging, power-supply variations and temperature changes all affect stability. Carefully chosen components, such

as precision resistors and variable capacitors in the frequency-determining networks, contribute to long-term stability. Technology, particularly large scale integration, minimizes the adverse effects of temperature and in such situations all but eliminates the effects of discrete component aging.

### Amplitude Stability

Amplitude stability with time and over a desired frequency range is an important characteristic in most applications. Hewlett-Packard uses negative feedback techniques to minimize variations in amplitude with time and pays great attention to circuit elements that influence the frequency response of the oscillator.

Oscillator Summary

INSTRU. NO.	FREQUENCY RANGE							POWER OUTPUT	THD	PAGE
	1 Hz	10	100	1 kHz	10 kHz	100 kHz	1 MHz			
200CD	—————							160 mW	0.2%	354
201C		—————						3 W	0.5%	354
204C	—————							10 MW	0.1%	356
204D	—————							10 MW	0.1%	356
209A	—————							40 MW	0.1%	356
239A		—————						17 MW	0.0018%	355
651B		—————						200 MW	1%	357
652A		—————						200 MW	1%	357
654A		—————						200 MW	1%	357

# OSCILLATORS

## 5 Hz to 600 kHz audio oscillators

### Models 200CD & 201C



200CD

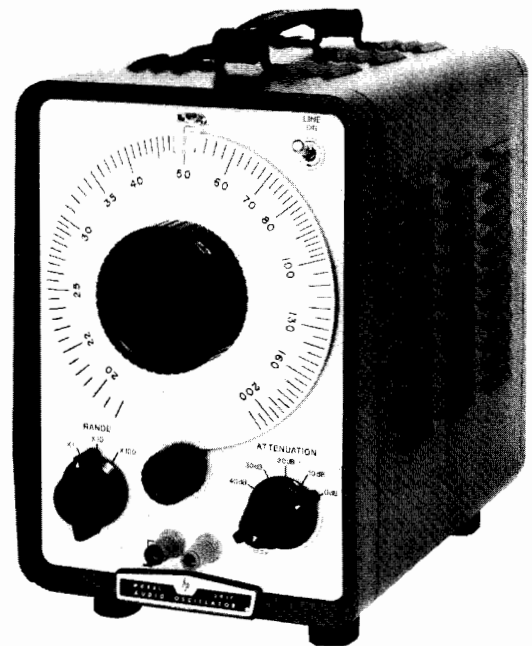

201C

### Description

These Hewlett-Packard oscillators have high stability and accuracy, easily resettable tuning circuits. Low-impedance operating levels, together with superior insulation, guarantee peak performance throughout years of trouble-free service. The instruments have a wide frequency range, long dial lengths and feature an improved vernier frequency control.

### Accessories Available

11000A Cable Assembly	\$17
11001A Cable Assembly	\$17
11004A Line Matching Transformer	\$95
11005A Line Matching Transformer	\$195

<b>Price</b>	
	\$17
	\$17
	\$95
	\$195

### Specifications

	200CD	201C
Frequency Range	5 Hz to 600 kHz	20 Hz to 20 kHz
Number of Ranges	5 overlapping	3 overlapping
Dial Accuracy	±2%	±1%
Frequency Response	±1 dB (1 kHz ref)	±1 dB (1 kHz ref)
Output (into 600Ω load)	>160 mW (10 V)	3 W (42.5 V rms)
Output Impedance	600Ω ± 10%	600Ω ± 10%, 20, 30 and 40 dB settings <600Ω, 0 dB and 10 dB settings
Output Balance	Balance and floating better than 0.1% at lower frequencies and approx. 1% at higher frequencies	One terminal at ground potential
Distortion	0.2%, 20 Hz to 200 kHz 0.5%, 5 Hz to 20 Hz and 200 kHz to 600 kHz	<0.5%, 50 Hz to 20 kHz at 1 W <1%, 20 Hz to 20 kHz at 3 W
Hum and Noise	<0.1% of rated output	<0.1% of rated output (amplitude control at max)
Attenuator	Bridged *T*	0 to 40 dB in 10 dB steps, coarse and fine controls
Input Power	115 or 230 V, 48 to 440 Hz, 90 VA	115 or 230 V, 48 to 440 Hz, 75 VA
Weight (kg (lb))	Net: 9.9 kg (22 lb) Shipping: 10.8 kg (24 lb)	Net: 7.2 kg (16 lb) Shipping: 8.6 (19 lb)
H x W x D Dimensions	292 mm x 187 mm x 365 mm (11.5" x 7.4" x 14.4")	292 mm x 191 mm x 318 mm (11.5" x 7.5" x 12.5")
Price	<b>200CD: \$850</b>	<b>201C: \$850</b>

- < -95 dB THD to 20 kHz
- Calibrated Attenuator
- 10 Hz to 110 kHz

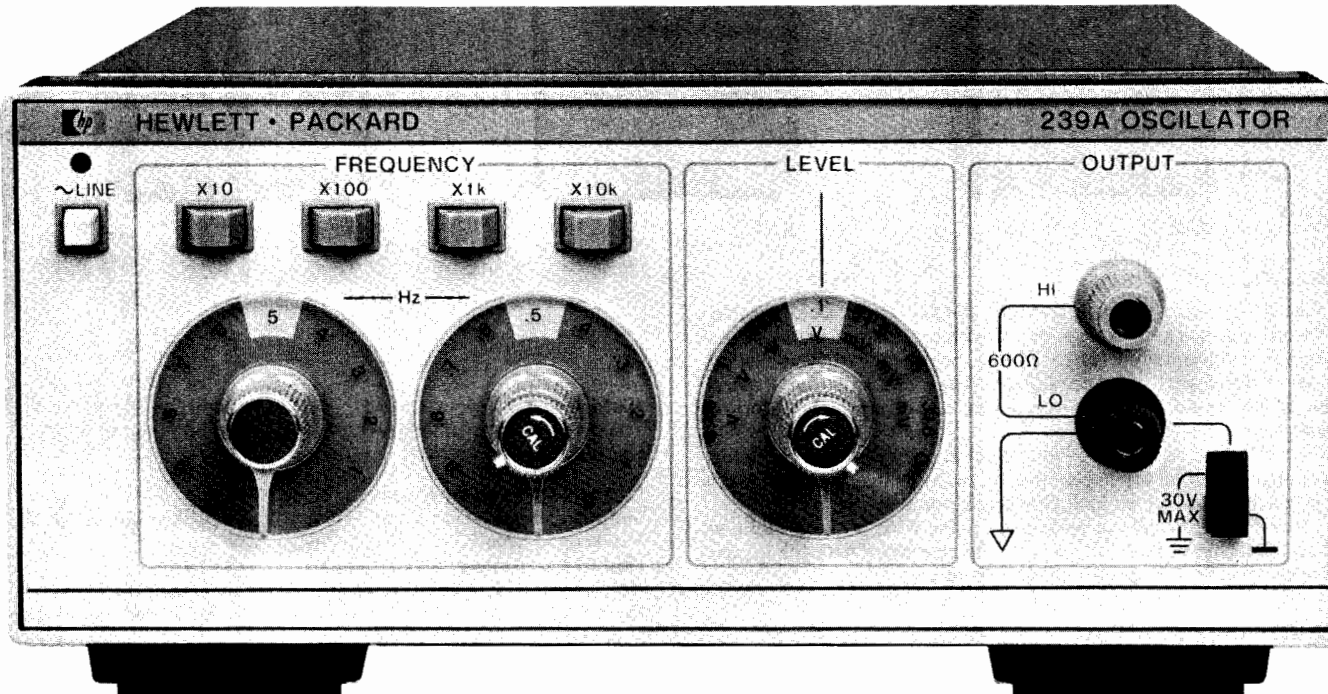

239A

### Description

The HP 239A Oscillator provides a low distortion sine-wave output with > 3 Vrms amplitude from 10 Hz to 110 kHz and less than -95 dB (.0018%) total harmonic distortion (THD) to 20 kHz, increasing to -70 dB (.032%) at 110 kHz. Low THD performance combined with a 600Ω output that can be floated to 30 V peak makes the 239A an excellent general purpose audio test source.

### Companion Oscillator for Distortion Measurements

The 239A Oscillator is electrically similar to the built-in oscillator used in the HP 339A Distortion Measurement Set and can be used in conjunction with the 339A where a remote audio source is needed for low distortion measurements such as broadcast studio through transmitter tests. Use of the 239A can improve the range of distortion measurements with earlier model analyzers. Its small size and weight makes the 239A convenient to use on the bench or easy to carry for remote tests.

### Calibrated Output Attenuator

The accurately calibrated output allows measurements to be made without time consuming external calibration. The output level can be changed in 10 dB steps with ± 0.25 dB/step accuracy over a 60 dB range from a maximum calibrated output of + 10 dBV (3.16 Vrms). The output is continuously variable between steps down to a level of 1 mV with the amplitude vernier control.

Level flatness is ± 0.1 dB from 20 Hz to 20 kHz and less than ± 0.2 dB over the full frequency range.

### Accurate Frequency Selection

Frequency selection with ± 2% accuracy is easily made with 2-digit resolution using rotary knob tuning and the multiplier push-buttons. The frequency vernier control provides continuous frequency coverage between the second digit switch settings.

### 239A Specifications

**Frequency:** 10 Hz to 110 kHz in 4 overlapping decade ranges with 2-digit resolution. Frequency vernier provides continuous frequency coverage between second digit switch settings. Frequency accuracy: ± 2% of selected frequency (with Frequency Vernier in CAL position).

**Output level:** Maximum calibrated output (1 kHz, 600Ω load): + 10 dBV (3.16 Vrms) ± .2 dB

Output variable from < 1 mV to 3.16 Vrms into 600 ohms.

**Output attenuator:** Range: 60 dB in 10 dB steps; Accuracy: ± .25 dB/10 dB step. Maximum Cumulative Error ± 1 dB; Output Vernier: > 10 dB range, continuously variable

**Level flatness:** 20 Hz to 20 kHz: ≤ ± 0.1 dB; 10 Hz to 110 kHz: ≤ ± 0.2 dB

**Distortion (≥ 600Ω Load, ≤ 3 V Output):** 10 Hz to 20 kHz: < -95 dB (0.0018%) THD; 20 kHz to 30 kHz: < -85 dB (0.0056%) THD; 30 kHz to 50 kHz: < -80 dB (0.01%) THD; 50 kHz to 110 kHz: < -70 dB (0.032%) THD

**Output impedance:** 600Ω ± 5%

Output terminals may be floated up to 30 V peak.

**Operating environment:** Temperature: 0°C to 50°C (+32°F to +122°F)

**Humidity Range:** < 95%, 0°C to 40°C (+32°F to +104°F)

**Storage Temperature:** -40°C to +75°C (-40°F to +167°F)

**Power:** 100/120/220/240 V, +5%, -10%, 48 to 66 Hz, 10 VA max.

**Weight:** Net 2.5 kg (5.5 lbs.); Shipping 3.9 kg (8.5 lbs.)

**Size:** 213 mm W x 88 mm H x 269 mm D (8.4" x 3.5" x 10.6")

239A Oscillator

\$625





# OSCILLATORS

4 Hz to 2 MHz sine, square wave oscillators

Models 209A, 204C & 204D

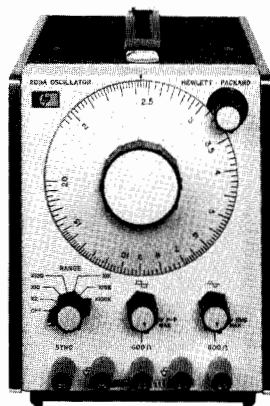

209A

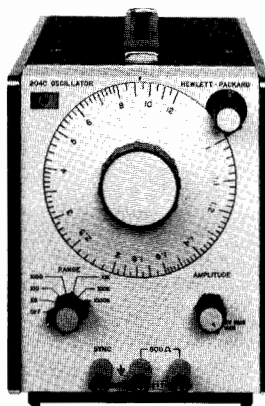

204C

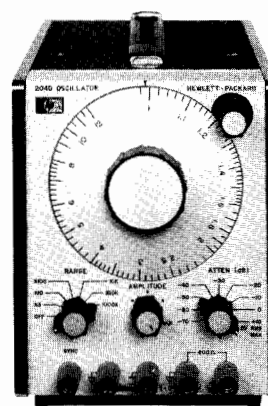

204D

## Description

The HP 209A is a small, lightweight, sine/square oscillator. Stable, accurate signals can be synchronized with an external source over a frequency range from 4 Hz to 2 MHz. Separately adjustable sine/square outputs are located on the front panel. Distortion and flatness can be minimized at low frequencies by a rear panel low distortion mode switch.

The HP 204C is a small, lightweight capacitive-tuned oscillator. Interchangeable power packs, line or rechargeable batteries make this instrument ideal for both field and laboratory use.

The HP 204D Oscillator is identical to the 204C with the addition of an 80 dB attenuator and vernier. The attenuator with the vernier provides excellent output amplitude settability.

## 209A Specifications

**Frequency:** 4 Hz to 2 MHz in 6 ranges.

**Dial accuracy:**  $\pm 3\%$  of frequency setting.

**Flatness** at maximum output into 600 $\Omega$  load, 1 kHz reference

Low distortion mode	+1%	$\pm 0.5\%$	$\pm 1\%$	$\pm 5\%$
Normal mode	+5%, -1%	$\pm 0.5\%$	$\pm 1\%$	$\pm 5\%$
	4	100	300 k	1 M
	2 M (Hz)			

**Distortion:** 200 Hz to 200 kHz, 0.1% (-60 dB); 4 Hz to 200 Hz, <0.2% (-54 dB); 200 kHz-2 MHz, <1% (-40 dB).

**Hum and noise:** <0.01% of input.

### Output Characteristics Sine Wave

**Output voltage:** 5 V rms (40 mW) into 600 $\Omega$ ; 10 V open circuit.

**Output impedance:** 600 $\Omega$ .

**Output control:** >26 dB range continuously adjustable.

**Output balance:** >40 dB below 20 kHz. Output can be floated up to  $\pm 500$  V peak between output and chassis ground.

### Output Characteristics Square Wave

**Output voltage:** 20 V p-p open circuit symmetrical about 0 V. Output can be floated up to  $\pm 500$  Vp.

**Rise and fall time:** <50 ns into 600 $\Omega$ . Symmetry:  $\pm 5\%$ .

**Output impedance:** 600 $\Omega$ .

### Synchronization

**Sync output:** sine wave in phase with output; 1.7 V rms, >1 V rms, 50 kHz to 2 MHz into 10 Kohm shunted by 100 pF.

**Sync input:** same as 204C.

## 204C Specifications

**Frequency:** 5 Hz to 1.2 MHz in 6 overlapping ranges.

**Dial accuracy:**  $\pm 3\%$  of frequency setting.

**Flatness** at maximum output into 600 $\Omega$  load, 1 kHz reference

Low distortion mode	$\pm 1\%$	$\pm 0.5\%$	$\pm 1\%$
Normal mode	+5%, -1%	$\pm 0.5\%$	$\pm 1\%$
	5	100	300 k
	1.2 M (Hz)		

**Distortion:** 30 Hz to 100 kHz, 0.1% (-60 dB); 5 Hz to 30 Hz, <0.6% (-44 dB); 100 kHz-1.2 MHz, linearly derated to <1%.

**Hum and noise:** <0.01% of output.

### Output Characteristics

**Output voltage:** >2.5 V rms (10 mW or +10 dBm) into 600 $\Omega$ ; >5 V rms open circuit.

**Output impedance:** 600 $\Omega$ .

**Output control:** >40 dB range; continuously adjustable.

**Output balance:** >40 dB below 20 kHz. Can be floated up to  $\pm 500$  V peak between output and chassis ground.

### Synchronization

**Sync output:** sine wave in phase with output; >100 mV rms into <100 pF over entire range; impedance 10 k $\Omega$ .

**Sync input:** oscillator can be synchronized to external signal. Sync range, the difference between sync frequency and set frequency, is a linear function of sync voltage.  $\pm 1\%/V$  rms for sine wave with a maximum input of  $\pm 7$  V peak ( $\pm 5$  V rms).

## 204D Specifications

(Identical to 204C except "output control" is replaced by the following):

### Output Attenuator

**Range:** 80 dB in 10 dB steps.

**Overall accuracy:**  $\pm 0.3$  dB, +10 dB through -60 dB ranges;  $\pm 0.5$  dB on -70 dB range.

**Output vernier:** >10 dB range, continuously adjustable.

### General

**Operating temperature:** Specifications are met from 0°C to 55°C.

**Power:** standard: AC-line 115 V or 230 V  $\pm 10\%$ , 48 Hz to 440 Hz, <7 VA max. Opt. 002: line/rechargeable batteries 115V or 230V  $\pm 10\%$ , 48 Hz to 440 Hz, <7 VA max. 22 hours operation per recharge.

**Size:** 155 mm H (without removable feet)  $\times$  130 mm W  $\times$  203 mm D (6.1"  $\times$  5.1"  $\times$  8").

**Weight:** net 2.7 kg (6 lb). Shipping, 3.6 kg (8 lb).

### Options and Accessories

	Price
Option 002, 204 C/D (for rechargeable batt/AC-line)	add \$100
00204 - 80003 Rechargeable battery/AC power pack for 204C/D	\$240
11075A Instrument case	\$165
5060-8762 Rack adapter frame	\$84

### Ordering Information

209A Sine, square wave oscillator	\$650
204C Sine wave oscillator	\$550
204D Sine wave oscillator	\$625

# OSCILLATORS

## 10 Hz to 10 MHz test oscillators

Models 651B, 652A, 654A

357  
hp

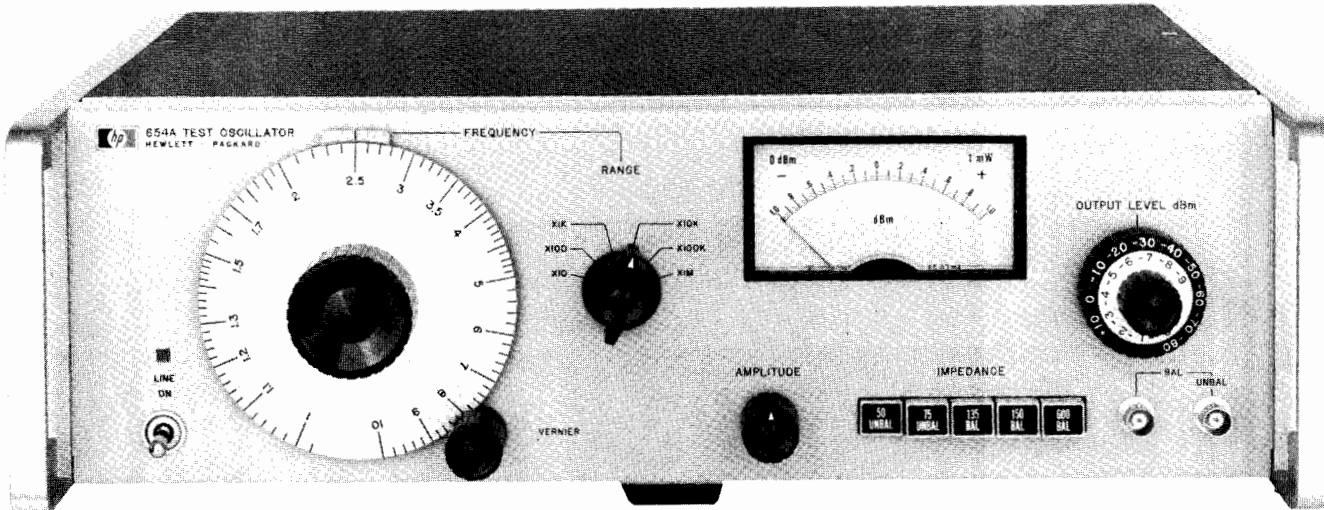

654A

### Specifications & General Information

MODEL NO.	651B	652A	654A
Description	Amplitude and frequency stability of this solid state capacitance-tuned test oscillator provides high quality signals for general purpose lab or production measurements.	Similar to Model 651B, HP's Model 652A offers an expandable output monitor for amplitude control to 0.25% across its entire frequency band for greater output and resettability.	Similar to the 651B Test Oscillator, HP's 654A has balanced outputs of 135 $\Omega$ , 150 $\Omega$ , and 600 $\Omega$ , automatic leveling over entire frequency range, and expanded meter.
Frequency Range	10 Hz to 10 MHz, 6 bands.		
Frequency Accuracy	$\pm 2\%$ , 100 Hz to 1 MHz; $\pm 3\%$ , 10 Hz to 100 Hz and 1 MHz to 10 MHz.		$\pm 2\%$ 100 Hz to 5 MHz; $\pm 3\%$ 10 Hz to 100 Hz; $\pm 4\%$ 5 MHz to 10 MHz.
Frequency Response (Flatness)	$\pm 2\%$ , 100 Hz to 1 MHz; $\pm 3\%$ , 10 Hz to 100 Hz; ( $\pm 4\%$ , 1 MHz to 10 MHz applies only at 50 $\Omega$ or 75 $\Omega$ output and amplitude readjusted to a reference on the output monitor.)	$\pm 0.25\%$ , 3 V and 1 V range; $\pm 0.75\%$ , 0.3 V to 0.3 mV range; $\pm 1.75\%$ , 0.1 mV range. (Amplitude readjusted using expanded scale on output monitor.)	( $\pm 10$ dBm and 0 dBm) $\pm 0.5\%$ from 10 Hz to 10 MHz for unbalanced outputs and 10 Hz to 5 MHz for 135 $\Omega$ and 150 $\Omega$ outputs, and 10 Hz to 1 MHz for 600 $\Omega$ output.
Distortion	$<1\%$ , 10 Hz to 2 MHz; $<2\%$ , 2 MHz to 5 MHz; $<4\%$ , 5 MHz to 10 MHz.		10 Hz to 1 MHz, $>40$ dB below fundamental; 1 MHz to 10 MHz, $>34$ dB below fundamental.
Output	3.16 V into 50 $\Omega$ or 600 $\Omega$ ; 6.32 V open circuit. 0.1 mV to 3.16 V full scale. 10 steps in 1, 3, 10 sequence; $-70$ dBm to $+23$ dBm (50 $\Omega$ output) full scale. 10 dBm per step; 20 dB coarse and fine adjustable amplitude control.		$+11$ dBm to $-90$ dBm, 10 dB and 1 dB steps with adjustable $\pm 1$ dB meter range, calibrated for each impedance of 50 $\Omega$ and 75 $\Omega$ unbalanced and 135 $\Omega$ , 150 $\Omega$ and 600 $\Omega$ balanced.
Output Monitor (Monitor's Level at input of attenuator)	Top scale calibrated in volts, bottom scale in dB. Accuracy $\pm 2\%$ of full scale.	Same as 651B plus Expand Scale which expands reference voltage of the normal scale from 0.9 to 1.0 or 2.8 to 3.2	$\pm 1$ dBm with full scale with 0.02 dB resolution. Accuracy $\pm 0.05$ dB.
Output* Connectors	BNC connectors.		
Attenuator	90 dB range in 10 dB steps; $\pm 0.075$ dB, $-60$ dBm to $+20$ dBm; $\pm 0.2$ dB, $-70$ dBm to $-60$ dBm.		99 dB range in 10 dB and 1 dB steps; $\pm 1.5\%$ (0.15 dB) except $\pm 10\%$ (1 dB) at output levels below 60 dBm at frequencies $>300$ kHz.
Temperature Range	0 $^{\circ}$ C to $+50^{\circ}$ C (32 $^{\circ}$ F to 122 $^{\circ}$ F).		
Power	115V $\pm 10\%$ , 48 Hz to 400 Hz; 230 V $\pm 10\%$ 48 to 66 Hz; 35 VA max.		
Weight	Net, 7.6 kg (17 lb). Shipping, 9.90 kg (22 lb).		Net, 9.4 kg (21 lb). Shipping, 11.8 kg (26 lb).
Dimensions	133 mm H x 425 mm W x 286 mm D (5.21" x 16.75" x 11.25").		
PRICE	\$1200	\$1375	\$1550

\*Maximum dc voltage that can be applied to output:  $< \pm 3$  V p.

# OSCILLATORS

## 10 Hz to 1 MHz Digital Oscillator

Model 4204A

- 0.2% frequency accuracy
- Accurate 80 dB output attenuator
- 0.01% frequency repeatability
- Excellent stability
- Flat frequency response



### Description

Hewlett-Packard's 4204A Digital Oscillator provides accurate, stable test signals for both laboratory and production work. This one instrument does the job of an audio oscillator, an ac voltmeter, and an electronic counter when an accurate frequency source of known amplitude is required.

Any frequency between 10.0 Hz and 999.9 kHz can be digitally selected with an in-line rotary switch to four significant figures. As many as 36,900 discrete frequencies are available. Infinite resolution is provided by one vernier control, which also extends the upper frequency limit to 1 MHz. Frequency accuracy is better than  $\pm 0.2\%$  and repeatability is typically better than  $\pm 0.01\%$ .

A built-in high impedance voltmeter measures output. The meter is calibrated to read volts or dBm into a matched 600 ohm load. (0 dBm = 1 mW into 600 Ohms.) The output attenuator has an 80 dB range, adjustable in 10 dB steps with a 20 dB vernier. Maximum output power can be increased to 10 volts (22 dBm) into 600 Ohms or 20 volts open circuit.

Frequency response is flat with less than  $\pm 3\%$  variation over the entire frequency range at any attenuator setting. Frequency stability is better than 10 parts in  $10^6$  per minute.

### Specifications

**Frequency range:** 10 Hz to 1 MHz, 4 ranges.

**Frequency accuracy:**  $\pm 0.2\%$  or  $\pm 0.1$  Hz (at 25°C).

**Frequency stability**

$\pm 10\%$  line voltage variation: less than  $\pm 0.01\%$ .

**Change of frequency with temperature:**  $< \pm 100$  ppm/°C.

**Drift:**  $< 10$  ppm/minute.

**Frequency response:** flat within  $\pm 3\%$ , 9.999 kHz ref. (25°C  $\pm 5^\circ$ C).

**Output:** 10 V (22 dBm) into 600 ohms (160 mW). 20 V open circuit.

**Output attenuator:** 80 dB in 10 dB steps:  $< \pm 0.5$  dB error.

**Output monitor:** voltmeter monitors level at input of attenuator in volts or dB.

**Accuracy:**  $\pm 2\%$  of full scale.

**Flatness:**  $\pm 1\%$  at full scale, 10 Hz to 500 kHz;  $\pm 2\%$  at full scale, 500 kHz to 1 MHz.

**Distortion:** less than 0.3%, 30 Hz to 100 kHz. Less than 1%, 10 Hz to 600 kHz. Less than 1.2%, 10 Hz to 1 MHz.

**Hum and noise:** less than 0.05% of output.

**Temperature range:** 0°C to +50°C.

**Power:** 115 V/230 V switch,  $\pm 10\%$ , 10 VA, 50 to 60 Hz.

**Weight:** net, 8.5 kg (19 lb). Shipping, 11 kg (28 lb).

**Size:** 141 mm H x 426 mm W x 336 mm D (5½" x 16¾" x 13¼").

### Accessories Available

Accessories Available	Price
11000A Cable: dual banana plugs	\$17
11001A Cable: banana plug to BNC male connector	\$17
11004A Line Matching Transformer has a frequency response of 5 kHz to 600 kHz providing fully balanced outputs for 135 or 600 ohms.	\$95
11005A Line Matching Transformer has a frequency response of 20 Hz to 45 kHz providing full balanced output into 600 ohms.	\$195
16252A Matching Transformer has a frequency response of 10 kHz to 1 MHz providing unbalanced 75 ohm output, terminated in UG-657/U female BNC connector.	\$140

### Options

001: 4204A Output Monitor top scale calibrated in dBm/600Ω. Bottom scale calibrated in volts	add \$26
908: Rack Flange Kit	add \$22
910: Extra Manual	add \$9

**4204A Digital Oscillator**

**\$2175**

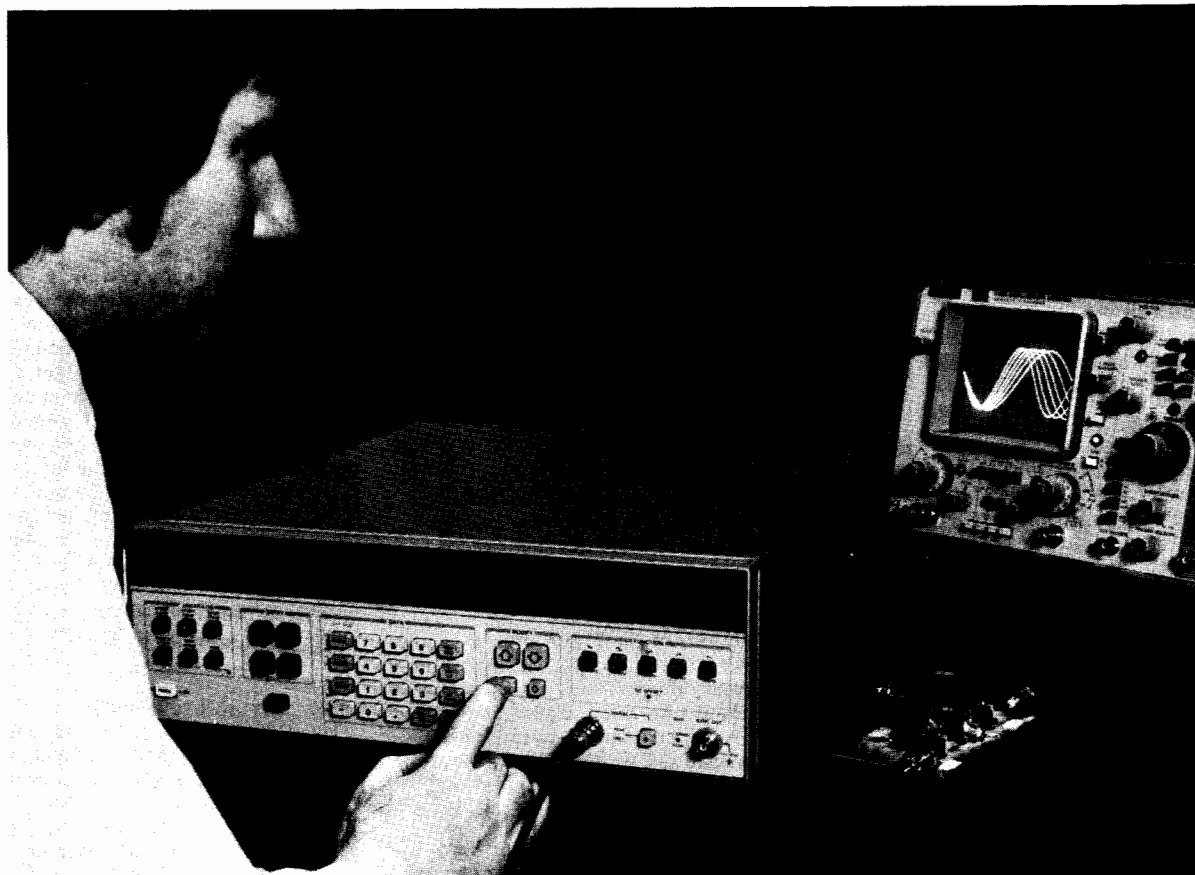

Today's measurement needs are placing increasingly stringent requirements on signal sources for greater frequency resolution and stability. Narrowband component testing, satellite and terrestrial communications, local oscillator and automatic test systems are only a few of the many applications that continually require higher precision sources.

Square waves, triangle waves and pulses are signals typically associated with non-synthesized sources. This situation is changing. Precision signals of these types are finding important applications in mechanical, civil and environmental engineering.

Increased amplitude accuracy and resolution are also must requirements in many applications. The telecommunication industry's Frequency Division Multiplex (FDM) systems require high amplitude accuracy and resolution (0.01 dB) as well as high frequency resolution and stability. These requirements are becoming commonplace in R & D and production test situations.

With technology continuing to reduce the cost of synthesis techniques, the traditional oscillator is giving way to a synthesizer as the primary signal in multi-function sources.

### Frequency Synthesis Techniques

Synthesis techniques fall into two major categories: direct and indirect. In this section, only indirect techniques are used. Traditional approaches to indirect synthesis require a phase locked loop for every decade (digit) of frequency resolution required. This does provide adequate performance but is expensive in component parts, leading to an

expensive product. A new technique has been developed by Hewlett-Packard which avoids this problem, enabling a single phase locked loop to offer multidigit resolution. The process is called Fractional Frequency Synthesis or Fractional N—a method of relating the PLL output VCO frequency to the crystal reference frequency by other than an integer N. Up to 11 digits of frequency resolution can be achieved from a single phase locked loop with this new technique. Significant cost savings and increased reliability result.

### Signal Quality

The common specifications which describe signal sources include in addition to frequency range and resolution, amplitude range and

resolution, distortion and stability. The two primary additional specifications pertinent to the synthesizer are phase noise and spurious content.

**Phase noise:** Phase noise describes the short term frequency stability of a signal source. Internal short-term frequency fluctuations will produce phase modulation sidebands about the nominal frequency. Phase noise is a measure of the magnitude of these sidebands. There are two common methods of specifying phase noise—a sideband plot and integrated phase noise.

The first method expresses phase noise as the ratio of the power in one phase noise sideband per hertz of bandwidth to the total

### Function Generator Summary

FUNCTIONS					FREQUENCY RANGE	POWER OUTPUT	INST.	PAGE
~	sq	tri	tri	tri				
●	●	●	●	●	0.001 mHz to 10 MHz	560 mW	3310A/B	361
●	●	●	●	●	0.01 Hz to 10 MHz	250 mW	3312A*	363
●	●	●	●	●	0.1 Hz to 10 MHz	20 mW	3311A	362
●	●	●	●	●	0.001 mHz to 10 MHz	250 mW	3325A**	364
●	●	●	●	●	0.001 mHz to 50 MHz	1.4 W	8165A***	

\*Two Generators, AM, FM, Sweep, Trigger/Gate  
 \*\*Synthesizer/Function Generator, AM, PM, Sweep, HP-IB; Opt. 002, 400 mW to 1 MHz.  
 \*\*\*Synthesizer/Function Generator, AM, FM, Sweep, Trigger/Gate, Burst, HP-IB

# FUNCTION GENERATORS & FREQUENCY SYNTHESIZERS

## General information (cont.)

signal power. A sideband plot of the phase noise graphically displays the magnitude and frequency components (spectral density) of the phase noise.

Integrated phase noise is the ratio of the rms value of the total phase noise sidebands in a 30 kHz bandwidth around the carrier (excluding  $\pm 1$  Hz) to the power of the carrier.

For a detailed treatment of the subject of phase noise refer to Application Note #207.

**Spurious signals:** Spurious signals are discrete, non-harmonically related signals appearing in the output. The spurious output specification is the maximum level, in dB below the carrier, of any spurious signal.

### Synthesizers

Hewlett-Packard offers a wide range of high quality frequency synthesizers covering the frequency range of DC to 18 GHz. In addition to being high performance synthesizers, they incorporate many additional features which allow them to fulfill the needs for either bench or programmable precision signal sources or as versatile programmable signal generators.

### Synthesized Signal Generators

The combined frequency ranges of the HP 8660A/C, 8662A, and 8672A Synthesized Signal Generators span 10 kHz to 18 GHz. These generators couple the frequency accuracy and stability of synthesizers with the modulation capability and precise, calibrated, wide-range level control of high quality signal generators. In addition, each of these generators offer HP-IB remote control of frequency, level, and modulation.

### Synthesized Level Generator

The HP 3335A is a synthesized level generator covering the range of 200 Hz to 80 MHz. This instrument is ideal as a stand-alone generator with synthesizer stability or as a companion generator for the HP 3745A/B SLMS and 3586 A/B/C selective level meter. It offers the traditional range of connectors and output impedances, balanced and unbalanced, required by the telecommunications industry. The new 3336A is a 21 MHz synthesized level generator with a similar set of telecommunications features. It too, is ideal as a stand-alone generator or as a companion for HP's new 3586A Selective Level Meter. For more information on these generators, refer to the Telecommunications section.

### Sweep Capability

The 3330B, 3335A, 8660C, and 8662A are among the most linear sweepers ever built. Keyboard control of built-in microprocessors gives these instruments digital sweep (a point-by-point sweep with frequency synthesizer accuracy).

The 3325A and the 3336A offer a phase continuous rather than digital sweep over the full frequency range of their output.

The 3330B also offers digital amplitude sweeps. Amplitude can be swept in increments as small as 0.01 dB to test level sensitive circuits like voltage-controlled oscillators and automatic gain control loops.

### Synthesizer/Function Generators

The HP 3325A is a function generator whose functions are derived from a primary synthesized oscillator. It provides a high purity synthesized sinewave from .000001 Hz

to 21 MHz, precision squarewaves to 11 MHz, linear ramps and triangle waveforms to 11 kHz, 11 digit resolution ( $1 \mu\text{Hz} < 100 \text{ kHz}$ ), wideband phase continuous sweep, and HP-IB programmability. The low price makes the 3325A an excellent choice for low frequency systems or bench applications.

### Function Generator (non-synthesized)

The function generator is a versatile, multi-waveform signal source capable of very wide frequency coverage. Available are functions ranging from modulation (3312A), sweep (3312A), and trigger/gated waveforms (3310A/B, 3312A). These units provide the full range of commonplace waveforms such as sinewaves, square waves, triangle and ramp waves. The function generator is an indispensable general purpose signal source for production testing, instrument repair, and the electronics laboratory. Diverse fields of applications in which the function generator is being used include medical research, education, chemical, communications, geophysics, industrial control, military, and aerospace.

### Programmability (HP-IB)

The 3320B, 3325A, 3335A, 3336 A/B/C, 8660A/C, 3330B, 8165A, 8660A/C, 8662A, 8671A, and 8672A are programmable via the Hewlett-Packard Interface Bus (HP-IB), Hewlett-Packard's implementation of IEEE STD 488-1975. Multiple signal sources interfaced to the same interface bus each may be independently programmed for different functions or frequencies.

## Synthesizer Summary

HP Model	Frequency Range	Frequency Resolution	Frequency Stability	Level Range dBm - 50 $\Omega$	Level Resolution	Remote Control	Other Features*
3320B (Pg. 366)	DC-13 MHz 5 ranges	0.01 Hz to 10 kHz (4 digits)	10 <sup>-7</sup> /day	-73 to +27	0.01 dB (4 digits)	Freq. & Ampl.	1, 8
3325A*** (Pg. 364-5)	DC-21 MHz (sine) DC-11MHz (square)	.000001 Hz or .001 Hz (11 digits)	5 x 10 <sup>-8</sup> /yr	-56.02 to +23.98 (sine)	.01 dB or .001 mV to .01V (4 digits)	Freq. Ampl. Sweep & Phase	8, 11, 12, 13
3330B (Pg. 367)	DC-13 MHz	0.1 Hz (9 digits)	10 <sup>-8</sup> /day	-87 to +13	0.01 dB (4 digits)	Freq. & Ampl.	2, 3, 4, 6, 8
3335A (Pg. 368)	200 Hz-80 MHz	.001 Hz	10 <sup>-8</sup> /day	-87 to +13	0.01 dB (4 digits)	Freq. & Ampl.	2, 3, 8
3336A/B/C (Pg. 370)	DC-21 MHz (Pg. 370)	.001 Hz or 11 digits	1.5 x 10 <sup>-8</sup> /day	-71 to 8	0.01 dB	Freq. Ampl. Sweep & Phase	8, 11, 12, 13
8660A/C** (Pg. 374)	10kHz to 2600 MHz (3 plug-ins)	1 Hz or 2 Hz (10 digits)	3 x 10 <sup>-8</sup> /day	-146 to +13	Local: 10 dB steps plus Vernier Remote: 1dB Steps	Freq., Ampl. & Modulation	8660A: 5, 7, 8 8660C: 3, 5, 7, 8
8662A** (Pg. 372)	10 kHz-1280 MHz	0.1 Hz or 0.2 Hz (11 digits)	5 x 10 <sup>-8</sup> /day	-139.9 to +13	0.1 dB (4 digits)	Freq. Ampl. Modulation & Sweep	3, 8, 14
8671A (Pg. 380)	2 to 6.2 GHz	1 kHz	5 x 10 <sup>-8</sup> /day	>+ 8	—	Freq., FM Modulation	8, 9
8672A** (Pg. 378)	2 to 18 GHz	1, 2, 3 kHz	5 x 10 <sup>-8</sup> /day	-120 to +3	Local: 10 dB steps plus Vernier Remote: 1 dB Steps	Freq., Ampl. & Modulation	8, 10

\* Other features: (1) 10<sup>-8</sup>/day freq. stability optional, (2) 5 x 10<sup>-10</sup>/day, (3) digital freq. sweep, (4) digital ampl. sweep, (5) internal AM/FM,  $\phi$ M, (6) External AM, (7) 3 x 10<sup>-9</sup>/day stability Opt. 001 (8) HP-IB, (9) External FM, (10) External AM & FM, (11) 5 X 10<sup>-8</sup>/week stability optional, (12) external AM &  $\phi$ M, (13) phase continuous sweep, (14) Internal & External AM & FM.

\*\* The 8660A/C, 8662A and 8672A are synthesized signal generators. They are discussed in detail in the section labeled "Signal Generators."

\*\*\* The 3325A Synthesizer/Function Generator includes squarewaves, positive and negative ramps, and triangle waveforms in addition to sinewaves.

# FUNCTION GENERATORS & FREQUENCY SYNTHESIZERS

0.0005 Hz to 5 MHz function generators

Model 3310A/B

361

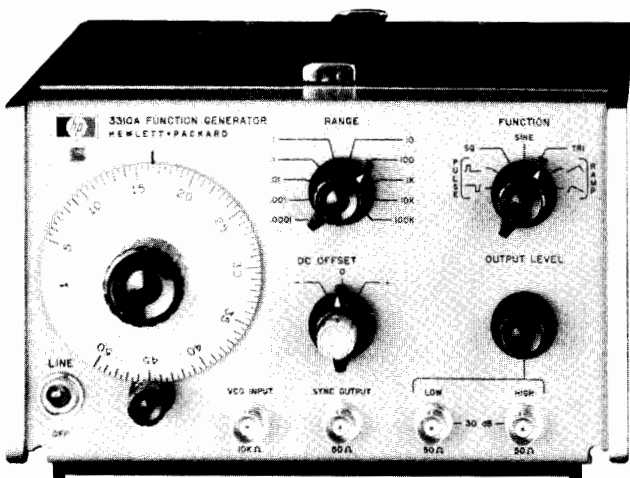

3310A

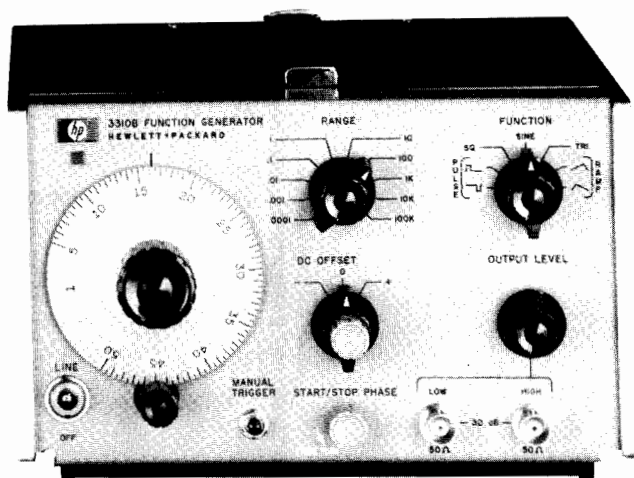

3310B

## Description

The 3310A Function Generator is a compact voltage-controlled generator with 10 decades of range. Ramp and pulse functions are available in addition to sine, square and triangle. DC offset and external voltage control provide wide versatility. A fast rise time sync output is provided. Aspect ratio of nonsymmetrical function is 15%/85%.

The 3310B has all the features of the standard 3310A plus single and multiple cycle output capability.

## 3310A Specifications

**Output waveforms:** sinusoidal, square, triangle, positive pulse, negative pulse, positive ramp and negative ramp. Pulses and ramps have a fixed 15% or 85% duty cycle.

**Frequency range:** 0.0005 Hz to 5 MHz in 10 decade ranges.

### Sine Wave Frequency Response

**0.0005 Hz to 50 kHz:**  $\pm 1\%$ ; 50 kHz to 5 MHz:  $\pm 4\%$ . Reference, 1 kHz at full amplitude into 50 $\Omega$ .

### Dial Accuracy

**0.0005 Hz to 500 kHz all functions:**  $\pm (1\% \text{ of setting} + 1\% \text{ of full scale})$ .

**500 kHz to 5 MHz sine, square and triangle:**  $\pm (3\% \text{ of setting} + 3\% \text{ of full scale})$ .

**500 kHz to 5 MHz pulse and ramps:**  $\pm (10\% \text{ of setting} + 1\% \text{ of full scale})$ .

**Maximum output on high:**  $> 30 \text{ V p-p}$  open circuit:  $> 15 \text{ V p-p}$  into 50 $\Omega$  (except for pulses at frequency  $> 2 \text{ MHz}$ ).

**Pulse (frequency  $> 2 \text{ MHz}$ ):**  $> 24 \text{ V p-p}$  open circuit:  $> 12 \text{ V p-p}$  into 50 $\Omega$ .

**Minimum output on low:**  $< 30 \text{ mV p-p}$  open circuit:  $< 15 \text{ mV p-p}$  into 50 $\Omega$ .

**Output level control:** range  $> 30 \text{ dB}$ . High and low outputs overlap for a total range of  $> 60 \text{ dB}$ ; low output is 30 dB down from high output.

### Sine Wave Distortion

**0.0005 to 10 Hz:**  $> 40 \text{ dB}$  (1%).

**10 Hz to 50 kHz (on 1 k range):**  $> 46 \text{ dB}$  (0.5%).

**50 kHz to 500 kHz:**  $> 40 \text{ dB}$  (1%).

**500 kHz to 5 MHz:**  $> 30 \text{ dB}$  (3%).

**Square wave and pulse response:**  $< 30 \text{ ns}$  rise and fall times at full output.

**Triangle and ramp linearity:** 0.0005 Hz to 50 kHz,  $< 1\%$ .

**Impedance:** 50 $\Omega$ .

### Sync

**Amplitude:**  $> 4 \text{ V p-p}$  open circuit,  $> 2 \text{ V p-p}$  into 50 $\Omega$ .

## DC Offset

**Amplitude:**  $\pm 10 \text{ V}$  open circuit,  $\pm 5 \text{ V}$  into 50 $\Omega$  (adjustable).

**Note:** max V ac peak + V dc offset is  $\pm 15 \text{ V}$  open circuit,  $\pm 7.5 \text{ V}$  into 50 $\Omega$ .

**External frequency control:** 50:1 on any range.

**Input requirement:** with dial set to low end mark, a positive ramp of 0 to  $+10 \text{ V} \pm 1 \text{ V}$  will linearly increase frequency 50:1. With dial set at 50, a linear negative ramp of 0 to  $-10 \text{ V} \pm 1 \text{ V}$  will linearly decrease frequency 50:1. An ac voltage will FM the frequency about a dial setting within the limits  $(1 < f < 50) \times \text{range setting}$ .

**Linearity:** ratio of output frequency to input voltage ( $\Delta F/\Delta V$ ) will be linear within 0.5%.

**Sensitivity:** approximately 100 mV/minor division.

**Input impedance:** 10 k $\Omega$ .

## General

**Power:** 115 V or 230 V  $\pm 10\%$ , 48 Hz to 440 Hz,  $< 20 \text{ VA}$  max.

**Size:** 114 mm H (without removable feet), 197 mm W, 203 mm D (4.5" x 7.8" x 8").

**Weight:** net, 2.7 kg (6 lb); shipping, 4.5 kg (10 lb).

## Accessories Available

For rack mounting, order HP 5060-8762 Rack Adapter Frame; 5060-8540, 5060-8760 Filler panels.

## 3310B Specifications

Same as 3310A with the following additions:

**Modes of operation:** free run, single cycle, multiple cycle.

**Triggered frequency range:** 0.0005 Hz to 50 kHz (usable to 5 MHz in normal mode).

**Single cycle<sup>\*\*</sup>:** ext trigger (ac coupled) requires a positive-going square wave or pulse from 1 V p-p to 10 V p-p. The triggering signal can be dc offset, but  $(V \text{ ac peak} + V \text{ dc}) \leq \pm 10 \text{ V}$  ext gate (dc coupled) will trigger a single cycle on any positive waveform  $\geq 1 \text{ V}$  but  $\leq 10 \text{ V}$  which has a period greater than the period of the 3310B output, and a duty cycle less than the period of the 3310B output. The gate signal cannot exceed 10 V.

**Multiple cycle<sup>\*\*</sup>:** manual trigger will cause the 3310B to free run when depressed. When the trigger button is released, the waveform will stop on the same phase as it started. Ext. gate will cause the 3310B to free run when the gate is held at between +1 and +10 V. When the gate signal goes to zero, the 3310B will stop on the same phase as it started.

**Start-stop phase:** the start-stop phase can be adjusted over a range of approximately  $\pm 90^\circ$ .

## Ordering Information

3310A Function Generator

3310B Function Generator

## Price

\$900

\$975

<sup>\*\*</sup>This specification applies on the X.0001 to X 1 k range only.



# FUNCTION GENERATORS & FREQUENCY SYNTHESIZERS

0.1 Hz to 1 MHz

Model 3311A

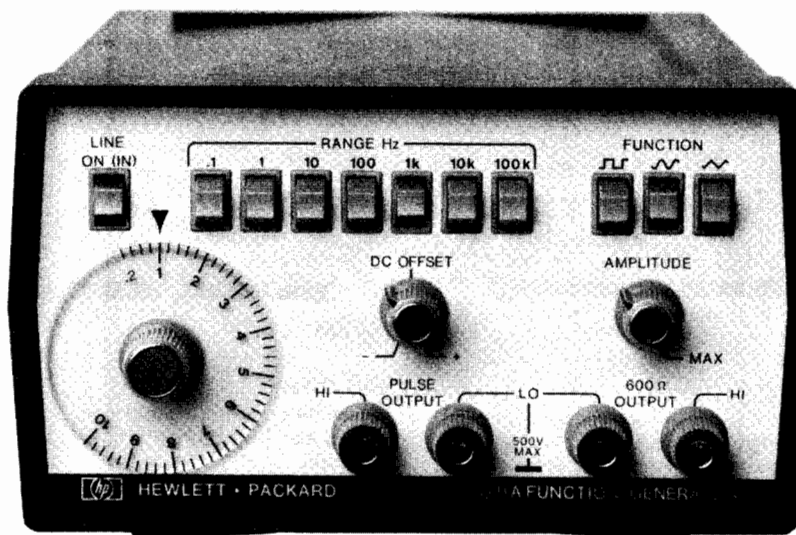

## Description

The 3311A Function Generator offers wide functional capability at a modest price. This compact unit has seven decades of range from 0.1 Hz to 1 MHz. Pushbutton range and function selection add convenience to versatility. Added features normally not found on function generators in this price range are 10:1 voltage control and a separate pulse output suitable for synchronization or driving TTL logic circuits.

### Output

Ten V p-p into 600Ω (20 V p-p O.C.). This output may be attenuated by >30 dB by a variable attenuator and offset by ±5 V. The DC offset allows the sine, square, and triangle functions to be positioned to the most desired level. This feature adds to the usefulness of all three functions.

### VCO

The DC coupled voltage control allows the use of an external source to sweep the 3311A > 10:1 in frequency.

### Pulse Output

A separate TTL compatible pulse output provides current sinking for up to 20 TTL loads. The pulse has a 15/85 aspect ratio with a <25 ns rise time.

## Specifications

**Waveforms:** sinusoid, square, triangle, and positive pulse.

**Frequency range:** 0.1 Hz to 1 MHz in seven decade ranges.

**Dial accuracy:** ±5% of full scale.

**Isolation:** using an external supply, outputs may be floated up to ±500 V relative to the instrument case (earth ground).

### 600 Ohm Output

**Maximum output amplitude:** 20 V p-p open circuit; 10 V p-p into 600Ω.

**Amplitude control:** continuously variable, >30 dB range. DC off-

set: up to ±10 V open circuit, ±5 V into 600Ω, continuously adjustable and independent of amplitude control. Maximum  $V_{ac\ peak} + V_{dc}$  offset without clipping is ±10 V open circuit, ±5 V into 600Ω.

**Output impedance:** 600Ω ± 10%.

**Sine wave amplitude flatness:** within ±3% of 10 kHz reference (maximum output amplitude) to 100 kHz, ±6% to 1 MHz.

**Sine wave total harmonic distortion:** <3% (maximum output amplitude).

**Triangle linearity:** deviation <1% from best straight line at 100 Hz (maximum output amplitude).

**Square wave transition time:** rise time: <100 ns; fall time: <100 ns.

**Square wave time axis symmetry error:** ±2% maximum to 100 kHz.

### Pulse Output

**Output amplitude:** >3 V positive (open circuit) TTL compatible.

**Duty cycle:** 13.5% to 16.5% of the total period.

**Transition times:** <25ns.

### External Frequency Control

**VCO range:** >10:1 on any frequency range.

**Input requirement:** with frequency dial set to 1.0, a linear ramp of 0.0 V to -10 V ±2 V will linearly increase frequency >10:1

**Input impedance:** 10 kΩ ± 10% in parallel with <60 pF.

### General

**Operating temperature:** 0°C to 55°C; specifications apply from +15°C to +35°C.

**Storage temperature:** -40°C to +75°C.

**Power:** 100/120/220/240 V -10%, +5% switchable: 48 Hz to 66 Hz; ≤12 VA.

**Size:** 89 mm H x 159 mm W x 248 mm D (3.5" x 6.3" x 9.8").

**Weight:** net, 1.5 kg (3.3 lb); shipping, 2.5 kg (5.5 lb).

**Rack Mount Kits:** 10851A for one 3311A, 10852A for two.

**3311A Function Generator**

**\$295**



- Two Function Generators In One Instrument
- AM-FM, sweep, trigger, gate and burst

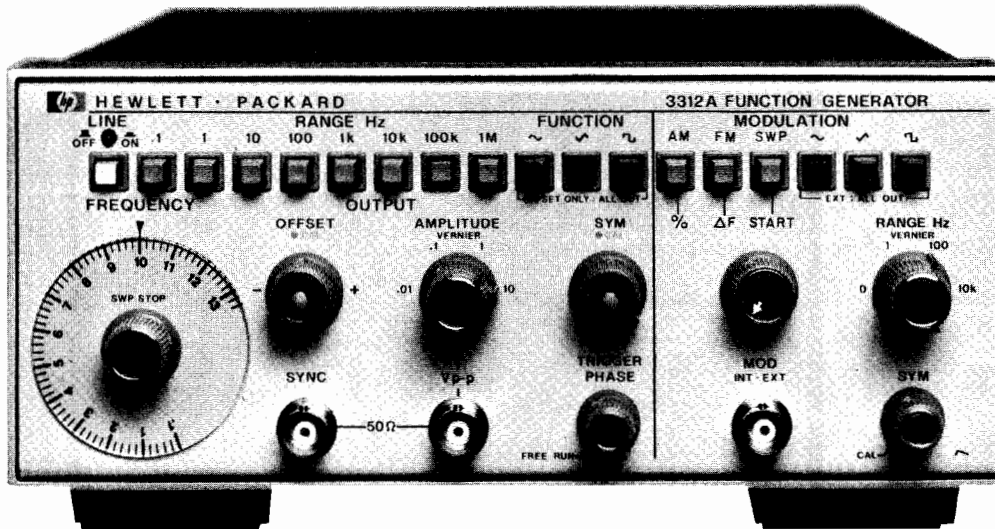

## Description

Hewlett-Packard's 3312 A Function Generator combines two separate, independent function generators with a modulator section in one compact instrument.

The main generator can—via pushbutton control—be triggered by the modulation generator to provide sweep functions, AM, FM or tone burst.

Ten V p-p into 50 $\Omega$  provides adequate power for most applications. The output attenuator has a range of more than 10,000:1 so clean low-level signals from 10 V to 1 mV p-p into 50 $\Omega$  can be obtained. The main generator includes dc offset up to 10 volts p-p into 50 $\Omega$ .

Hewlett-Packard's 3312A is an effective low cost solution for generating a multitude of functions.

## Specifications

**Output waveforms:** sine, square, triangle,  $\pm$  ramp, pulse, AM, FM, sweep, triggered and gated.

### Frequency Characteristics

**Range:** 0.1 Hz to 13 MHz in 8 decades ranges.

**Dial accuracy:**  $\pm 5\%$  of full scale.

**Square wave rise or fall time (10% to 90%):** <18 nsec.

**Aberrations:** <10%.

**Triangle linearity error:** <1% at 100 Hz.

**Variable symmetry:** 80:20:80 to 1 MHz.

**Sine wave distortion:** <0.5% (-46dB) THD from 10 Hz to 50 kHz. >30 dB below fundamental from 50 kHz to 13 MHz.

### Output Characteristics

**Impedance:** 50 $\Omega$   $\pm$  10%.

**Level:** 20 V p-p into open circuit, 10 V p-p into 50 $\Omega$ .

**Level flatness (sine wave):**  $\leq \pm 3\%$  from 10 Hz to 100 kHz at full rated output (1 kHz reference).  $\leq \pm 10\%$  from 100 kHz to 10 MHz.

**Attenuator:** 1:1, 10:1, 100:1, 1000:1 and >10:1 continuous control.

**Attenuator error:** <5%.

**Sync output:** impedance: 50 $\Omega$   $\pm$  10%, >1 V p-p square wave into open circuit. Duty cycle varies with symmetry control.

**DC offset:** Variable up to  $\pm$  10 volts. Instantaneous ac voltage + Vdc offset cannot exceed  $\pm$  10 V (open circuit) or  $\pm$  5 V (terminated 50 ohm).

### Modulation Characteristics

**Types:** internal AM, FM, sweep, trigger, gate or burst; external AM, FM, sweep, trigger, gate or burst.

**Waveforms:** sine, square, triangle, ramp or variable symmetry pulse.

**Frequency range:** 0.01 Hz to 10 kHz.

**Output level:** >1.0 V p-p into 10 k $\Omega$ .

### Amplitude Modulation

**Depth:** 0 to 100%.

**Modulation frequency:** 0.01 Hz to 10 kHz (internal). DC to >1 MHz (external).

**Carrier 3 dB bandwidth:** <100 Hz to >5 MHz.

**Carrier envelope distortion:** <2% at 70% sine wave modulation with  $f_c = 1$  MHz,  $f_m = 1$  kHz.

**External sensitivity:** <10 V p-p for 100% modulation.

### Frequency Modulation

**Deviation:** 0 to  $\pm 5\%$  (internal).

**Modulation frequency:** internal: 0.01 Hz to 10 kHz; external: DC to >50 kHz.

**Distortion:** <-35 dB at  $f_c = 10$  MHz,  $f_m = 1$  kHz, 10% modulation.

### Sweep Characteristics

**Sweep width:** >100:1 on any range.

**Sweep rate:** 0.01 Hz to 10 kHz, 90:10 ramp, and 0 Hz Range (provides manual setting of "Sweep Start" without modulation generator oscillating).

**Sweep mode:** repetitive linear sweep between start and stop frequency settings. Retrace time can be increased with symmetry control.

**Ramp output:** 0 to >-4 p-p into 5 k $\Omega$ .

### Gate Characteristics:

**Start/stop phase range:** +90 $^\circ$  to -80 $^\circ$ .

**Frequency range:** 0.1 Hz to 1 MHz (useful to 10 MHz).

**Gating signal range (external):** DC to 1 MHz, TTL compatible.

### External Frequency Control

**Range:** 1000:1 on any range.

**Input requirement:** with dial set at 10, 0 to -2 V  $\pm$  20% will linearly decrease frequency >1000:1. An ac voltage will FM the frequency about a dial setting within the limits (0.1 < f < 10) x range setting.

**Linearity:** the frequency versus voltage curve will be linear within 0.5% over a 100:1 frequency range.

**Input impedance:** 2.8 k $\Omega$   $\pm$  5%.

### General

**Operating temperature:** 0 $^\circ$ C to +55 $^\circ$ C; specifications apply from 0 $^\circ$ C to 40 $^\circ$ C.

**Storage temperature:** -40 $^\circ$ C to +75 $^\circ$ C.

**Power:** 100 V, 120 V, 220 V, 240 V +5%, -10%, switchable; 48 Hz to 440 Hz;  $\leq$ 25 VA.

**Size:** 102 mm H x 213 mm W x 377 mm D (4" x 8.4 x 14.8").

**Weight:** net, 3.8 kg (8.4 lb). Shipping, 5.9 kg (13 lb).

3312A Function Generator

\$975





# FUNCTION GENERATORS & FREQUENCY SYNTHESIZERS

## 1 $\mu$ Hz to 21 MHz Automatic Synthesizer

Model 3325A

- Function Generator
- Sweeper
- Programmable

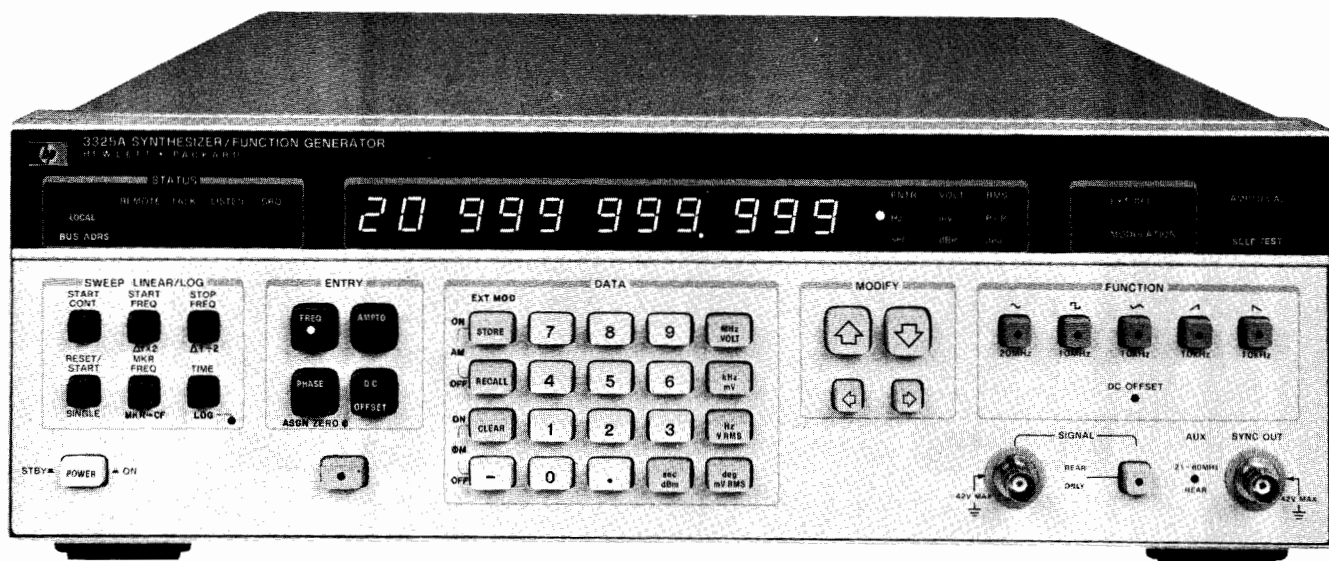

3325A



### Description

The 3325A Synthesizer/Function Generator is an uncompromising, high performance synthesizer with 11 digit resolution, a function generator with precision waveforms, a wideband sweeper, and a fully programmable systems instrument.

### Synthesizer

The 3325A is first with microhertz resolution below 100 kHz along with frequency coverage from .000001 Hz to 20.999 999 999 MHz. Signal purity, accuracy and stability are as good or better than earlier stand-alone HP synthesizers. Harmonics are 65 dB down below 50 kHz and you can externally modulate with AM and PM.

### Function Generator

The 3325A is also a high performance function generator providing precision waveforms with synthesizer accuracy and resolution. Squarewaves to 10.999 999 999 MHz have 20 ns rise and fall times. Triangles and ramps with .05% linearity are available up to 10.999 999 999 kHz. All waveforms can be DC and phase offset.

### A Wideband Sweeper

A major contribution is wideband phase continuous sweep, covering up to the full frequency range of each waveform. Sweep log or linear, single or continuous without the phase discontinuities usually associated with synthesizers. Phase lock loop testing is made easier.

Make convenient swept frequency network measurement on filters, amplifiers or any passive or active network. Use the TTL marker to check the frequency of points of interest on a swept frequency display desired. Use the convenient "zoom" functions  $\Delta F \times 2$  and  $\Delta F \div 2$  to quickly change the frequency span for the display desired.

### Fully Programmable

All necessary functions are programmable on the HP-IB, including frequency, amplitude, all functions, phase and DC offset, modulation, all sweep parameters, amplitude cal and self-test, making the 3325A a very versatile and powerful addition to automatic test systems. The isolated interface combined with floating outputs and inputs and talk mode make the 3325A easy to use in Automatic Test Systems.

### More Features

The phase of the output can be changed  $\pm 719.9^\circ$  with  $.1^\circ$  resolution. The phase is advanced (or retarded) with respect to the starting

phase. Two 3325A units can be phase locked together for dual phase output applications.

DC offset is capable of  $\pm 4.5$  VDC on the standard instrument. The high voltage option (Opt 002) allows AC voltages up to 40 Vpp and AC + DC up to  $\pm 18$  V Total (AC peak + DC).

Ten storage registers can be programmed with ten different combinations of function/parameter settings from the front panel, stored and then recalled.

The 3325A can display 11 digits of frequency and 4 digits of volts or millivolts from 1 mV to 10 volts peak to peak. Conversion to RMS or dBm is simple with the touch of a button.

### New Technology

The 3325A provides unprecedented performance per dollar thanks to several major contributions from advances in HP technology. A single loop Fractional-N synthesis technique allows synthesizer accuracy with 11 digits of resolution, and as an added bonus... phase continuous frequency sweep. Fewer parts and integrated circuit technology make the difference. A unique method of triangle and ramp waveform generation provides excellent linearity. Add micro-processor control and Hewlett-Packard Interface Bus (HP-IB) operation and the result is more performance, flexibility and versatility on the bench, or in automatic test systems than previously available, and at a lower cost.

### Specifications

Refer to the 3325A Data Sheet for complete specifications.

#### Waveforms

Sine, Square, Triangle, negative and positive Ramps

#### Frequency

##### Range:

**Sine:** 1  $\mu$ Hz to 20.999 999 999 MHz

**Square:** 1  $\mu$ Hz to 10.999 999 999 MHz

**Triangle/Ramps:** 1  $\mu$ Hz to 10.999 999 999 kHz

**Resolution:** 1  $\mu$ Hz, < 100 kHz  
1 mHz  $\geq$  100 kHz

**Aging Rate:**  $\pm 5 \times 10^{-6}$ /year, 20° to 30°C

**Warm-up Time:** 20 minutes to within specified accuracy



## Main Signal Output (All Waveforms)

**Impedance:** 50  $\Omega$

**Connector:** BNC; switchable to front or rear panel, nonswitchable with option 002, except by internal cable change.

### Amplitude

**Range:** 1 mV to 10 V p-p in 8 amplitude ranges, 1-3-10 sequence (10 dB steps), into 50  $\Omega$  load.

Function	Sine		Square		Triangle/Ramps	
	min	max	min	max	min	max
Units Displayed						
peak-peak	1.000 mV	10.00 V	1.000 mV	10.00 V	1.000 mV	10.00 V
rms	0.354 mV	3.536 V	0.500 mV	5.000 V	0.289 mV	2.887 V
dBm (50 $\Omega$ )	-56.02	+23.98	-53.01	+26.99	-57.78	+22.22

**Resolution:** 0.03% of full range or 0.01 dB (4 digits).

**Amplitude Accuracy:** (without dc offset, with no attenuation, relative to programmed amplitude and accuracy)

#### Sinewave amplitude accuracy:

1 MHz to 100 kHz:  $\pm 1$  dB,  $\geq 3$  Vpp;  $\pm 2$  dB,  $< 3$  Vpp

100 kHz to 20 MHz:  $\pm 4$  dB,  $\geq 3$  Vpp;  $\pm 6$  dB,  $< 3$  Vpp

#### Squarewave amplitude accuracy:

1 MHz to 100 kHz: 1%,  $\geq 3$  Vpp; 2.2%,  $< 3$  Vpp

100 kHz to 10 MHz: 11.1%,  $\geq 3$  Vpp; 13.6%,  $< 3$  Vpp

#### Triangle amplitude accuracy:

1 MHz to 2 kHz: 1%,  $\geq 3$  Vpp; 2.2%,  $< 3$  Vpp

2 kHz to 10 kHz: 6.1%,  $\geq 3$  Vpp; 7.3%,  $< 3$  Vpp

### Sinewave Spectral Purity

**Phase noise:** -60 dB for a 30 kHz band centered on a 20 MHz carrier (excluding  $\pm 1$  Hz about the carrier).

**Spurious:** All non-harmonically related output signals will be more than 70 dB below the carrier (60dB with DC offset), or less than -90 dBm, whichever is greater.

**Sinewave harmonic distortion:** Harmonically related signals will be less than the following levels (relative to the fundamental) at full output for each range:

Frequency Range	Harmonic Level
0.1 Hz to 50 kHz	-65 dB
50 kHz to 200 kHz	-60 dB
200 kHz to 2 MHz	-40 dB

### Squarewave Characteristics

**Rise/fall time:**  $\leq 20$  ns, 10% to 90% at full output

**Overshoot:**  $\leq 5\%$  of peak to peak amplitude, at full output

**Settling time:**  $< 1$   $\mu$ s to settle to within .05% of final value.

### Phase Offset

**Range:**  $\pm 719.9^\circ$  with respect to arbitrary starting phase or assigned zero phase

**Resolution:** 0.1 $^\circ$

**Accuracy:**  $\pm 0.2^\circ$

### DC Offset

**Range:** DC only (no AC signal): 0 to  $\pm 5.0$  V/50  $\Omega$ .

DC + AC: Maximum DC offset  $\pm 4.5$  V on highest range, decreasing to  $\pm 4.5$  mV on lowest range.

**Resolution:** 4 digits

### Sinewave Amplitude Modulation

**Modulation depth at full output for each range:** 0-100%

**Modulation frequency range:** DC -50 kHz (0-21 MHz carrier frequency)

**Sensitivity:**  $\pm 5$  V peak for 100% modulation

### Sinewave Phase Modulation

**Range:**  $\pm 850^\circ$ ,  $\pm 5$  V input

**Modulation frequency range:** DC -5 kHz

### Frequency Sweep

#### Sweep time

**Linear:** 0.01 s to 99.99 s

**Logarithmic:** 2 s to 99.99 s single, 0.1 s to 99.99 s continuous

**Maximum sweep width:** Full frequency range of the main signal output for the waveform in use, except minimum log start frequency is 1 Hz.

**Phase continuity:** Sweep is phase continuous over the full frequency range of the main output.

## Auxiliary Inputs and Outputs

**Reference input:** For phase-locking 3325A to an external frequency reference signal from 0 dBm to +20 dBm into 50  $\Omega$ . Reference signal must be a subharmonic of 10 MHz from 1 MHz to 10 MHz.

**Auxiliary frequency output:** 21 MHz to 60.999 999 999 MHz, under range coverage to 19.000 000 001 MHz, frequency selection from front panel. 0 dBm; output impedance: 50  $\Omega$

**Sync output:** Square wave with V (high)  $\geq 1.2$  V, V (low)  $\leq 0.2$  V into 50  $\Omega$ .

**X-Axis drive:** 0 to  $> +10$  V DC linear ramp proportional to sweep frequency, linearity, 10-90%,  $\pm .1\%$  of final value.

**Sweep marker output:** High to low TTL compatible voltage transition at selected marker frequency.

**Z-Axis blank output:** TTL compatible voltage levels capable of sinking 200 mA from a positive source.

**1 MHz reference output:** 0 dBm output for phase-locking additional instruments to the 3325A.

**10 MHz oven output:** 0 dBm internal high stability frequency reference output for phase-locking 3325A. (Opt. 001 only)

### Option 001 High Stability Frequency Reference

**Aging rate:**  $\pm 5 \times 10^{-8}$ /week,  $1 \times 10^{-7}$ /mo.

**Accuracy:**  $\pm 5 \times 10^{-8}$  (0 $^\circ$  to +50 $^\circ$ C).

**Warm-up time:** Reference will be within  $\pm 1 \times 10^{-7}$  of final value 20 minutes after turn-on for an off time of less than 24 hours.

### Option 002 High Voltage Output

**Frequency range:** 1  $\mu$ Hz to 1 MHz

#### Amplitude

**Range:** 4.00 mVpp to 40.00 Vpp (500  $\Omega$ ,  $< 500$  pf load).

#### Accuracy and flatness at full output:

**Sine and squarewave:**  $\pm .2$  dB ( $\pm 2\%$ ), 10 Hz - 10 kHz;  $\pm .9$  dB ( $\pm 10\%$ ) 10 kHz - 1 MHz

**Trianglewave:**  $\pm .2$  dB ( $\pm 2\%$ ) 10 Hz - 2 kHz;  $\pm .6$  dB ( $\pm 6\%$ ) 2 kHz - 10 kHz

**Ramps:**  $\pm .2$  dB ( $\pm 2\%$ ) 10 Hz - 2 kHz;  $\pm 1.0$  dB ( $\pm 11\%$ ) 2 kHz - 10 kHz

**Sinewave distortion:** Harmonically related signals will be the same as the standard instrument to 1 MHz

**Maximum output current:** 40 mApp.

**Output impedance:**  $< 2$   $\Omega$  at DC,  $< 10$   $\Omega$  at 1 MHz

**DC offset range:** 4 times the specified range of the standard instrument.

## General

### Operating environment:

**Temperature:** 0 $^\circ$ C to 55 $^\circ$ C.

**Relative humidity:** 95%, 0 $^\circ$ C to 40 $^\circ$ C.

**Altitude:**  $\leq 15,000$  ft.

**Storage temperature:** -40 $^\circ$ C to +75 $^\circ$ C.

**Storage altitude:**  $\leq 50,000$  ft.

**Power:** 100/120/220/240 V, +5%, -10%, 48 to 66 Hz; 60 VA, 100 VA with all options; 10 VA standby.

**Weight:** 9 kg (20 lbs.) net; 14.5 kg (32 lbs.) shipping

**Size:** 132.6 H  $\times$  425.5 W  $\times$  497.8 mm D (5.25"  $\times$  16.75"  $\times$  19.63")

**Accessories:** 11356A Ground Isolator for breaking signal grounds between input/output connectors.

### Ordering Information\*

	Price
3325A Frequency Synthesizer	\$3300
Opt. 001 High Stability Frequency Reference	add \$550
Opt. 002 High Voltage Output	add \$200
Opt 907 Front Handle Kit (stand alone orders P/N 5061-0089)	\$32
Opt 908 Rack Flange Kit (stand alone orders P/N 5061-0077)	\$25
Opt 909 Rack Flange and Handle Combination Kit (stand alone orders P/N 5061-0083)	\$55
11356A Ground Isolator	\$50

\*HP-IB cable not supplied. See page 30.

# FUNCTION GENERATORS & FREQUENCY SYNTHESIZERS

.01 Hz to 13 MHz frequency synthesizer

Model 3320B

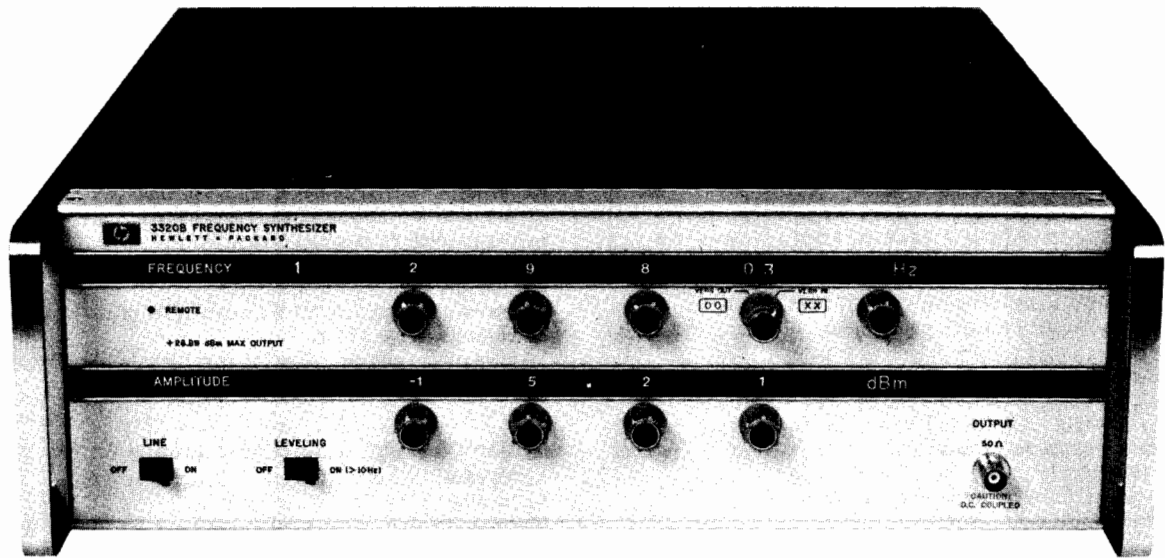

3320B

## Specifications

Refer to the 3320B data sheet for complete specifications.

**Frequency range:** 0.01 Hz to 13 MHz in 7 ranges.

**Frequency ranges:** 10 MHz, 1000 kHz, 100 kHz, 10 kHz, 1000 Hz, 100 Hz and 10 Hz (optional). 30% overrange on all ranges.

**Frequency resolution:**

Range	Vernier Out (local or remote)	Vernier In (local)	Vernier In (remote)
10 MHz	10 kHz	10 Hz	1 kHz
1000 kHz	1 kHz	1 Hz	100 Hz
100 kHz	100 Hz	0.1 Hz	10 Hz
10 kHz	10 Hz	0.01 Hz	1 Hz
1000 Hz	1 Hz	1 mHz	0.1 Hz
100 Hz	0.1 Hz	0.1 mHz	0.01 Hz
10 Hz	0.01 Hz	0.01 mHz	0.001 Hz

## Frequency Accuracy

**Vernier out:**  $\pm 0.001\%$  of setting for 6 mo, 0°C to 55°C.

**Vernier in:**  $\pm 0.01\%$  of range for 6 mo, 0°C to 55°C.

## Frequency Stability

**Long term:**  $\pm 10$  parts in  $10^6$  of setting per year (vernier out) with ambient temperature reference. Optional high stability crystal reference oven available (Option 002).

**Signal-to-phase noise (Integrated):**  $>40$  dB down in 30 kHz band, excluding  $\pm 1$  Hz, centered on carrier. 10 MHz range, vernier out. Improves on lower frequency ranges.

**Harmonic distortion:** with output frequencies  $>0.1\%$  of range at full output amplitude, any harmonically related signal will be less than the following levels:  $-60$  dB with output from 5 Hz to 100 kHz;  $-50$  dB with output from 100 kHz to 1 MHz;  $-40$  dB with output from 1 MHz to 13 MHz.

**Spurious:**  $>60$  dB down.

**Internal frequency standard:** 20 MHz crystal.

**Phase locking:** the 3320B may be phase locked with a 200 mV to 2 V rms signal that is any subharmonic of 20 MHz.

**Rear panel output:** front or rear panel output is standard.

## Auxiliary Outputs

**Tracking outputs:** 20 MHz to 33 MHz offset signal.  $>100$  mV rms/50 $\Omega$ .

**1 MHz reference output:** 220 mV rms/50 $\Omega$  ( $>0$  dBm/50 $\Omega$ ).

**Low level output:** same frequency as main output but remains between 50 mV rms and 158 mV rms (into 50 $\Omega$ ) depending on main output level setting.

## 3320B Amplitude Section

**Amplitude range:**  $+26.99$  dBm ( $\frac{1}{2}$  watt) to  $-69.99$  dBm ( $-73.00$  dBm under remote control) into 50 $\Omega$ . ( $+26.99$  dBm = 5 V rms into 50 $\Omega$ ).

**Amplitude resolution:** 0.01 dB.

**Frequency response (10 kHz reference):**

dc	"LEVELING OFF"		"LEVELING ON"		
	10 Hz	13 MHz	10 Hz	13 MHz	
$\pm 0.5$ dB	$\pm 0.05$ dB		$\pm 0.1$ dB		$+26.99$ dBm
	$\pm 0.1$ dB		$\pm 0.2$ dB		$-3.00$ dBm
	$\pm 0.2$ dB		$\pm 0.4$ dB		$-23.00$ dBm
	$\pm 0.4$ dB				$-53.00$ dBm
					$-73.00$ dBm

**Amplitude accuracy (absolute):**  $+26.99$  dBm,  $\pm 0.05$  dB at 10 kHz and (20°C to 30°C).

**Output impedance:** 50 $\Omega$  (75 $\Omega$  Option 001).

## General

**Operating temperature:** 0°C to 55°C.

**Storage temperature:**  $-40$ °C to  $+70$ °C.

**Power requirements:** 115 V or 230 V  $\pm 10\%$ , 48 Hz to 63 Hz, 110 VA max.

## Weight

**3320B:** net, 15.9 kg (35 lb). Shipping, 19.5 kg (43 lb).

**Size:** 132.6 mm H, 425 mm W, 542.9 mm D ( $5\frac{1}{32}$ "  $\times$   $16\frac{3}{4}$ "  $\times$   $21\frac{3}{8}$ ").

## Options and Accessories

**3320B Opt 001:** 75 $\Omega$  output

**3320B Opt 002:** Crystal Oven

**3320B Opt 004:** BCD remote control

**3320B Opt 006:** 100 Hz/10 Hz ranges

**3320B Opt 007:** HP-IB remote control

**11048C:** 50 $\Omega$  feedthrough termination

**11094B:** 75 $\Omega$  feedthrough termination

**11473-74A:** Balancing Transformers. (see page 679)

**11475A:** Balancing Transformers. (see page 679)

## Price

N/C

\$540

\$460

\$260

\$820

\$20

\$20

\$400

\$375

## Ordering Information\*\*

**3320B Frequency Synthesizer**

\$4600

\*Field installable.

\*\*Except last vernier digit and line switch.

\*\*\*HP-IB cable not supplied. See page 30.

# FUNCTION GENERATORS & FREQUENCY SYNTHESIZERS

0.1 Hz to 13 MHz automatic synthesizer

Model 3330B

367



- Digital sweeping of frequency and amplitude

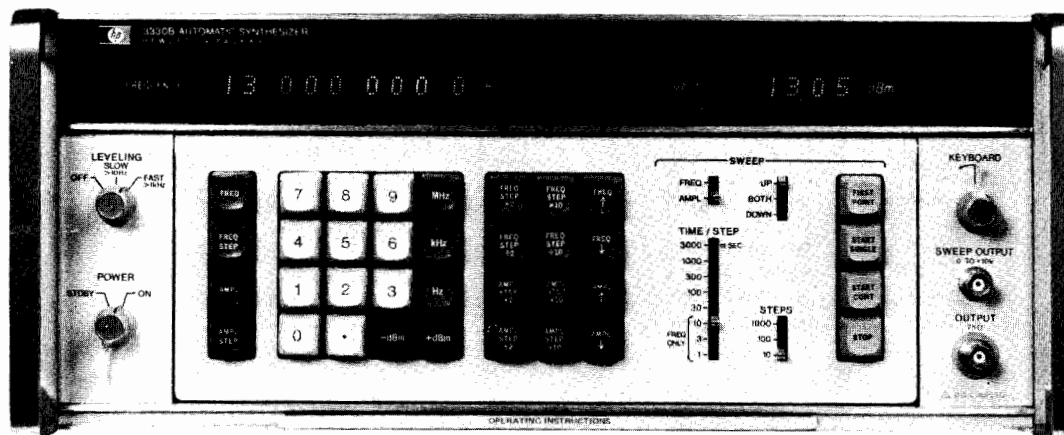

## Abbreviated Specifications

(For complete specifications, refer to data sheet)

**Frequency range:** 0.1 Hz to 13,000,999.9 Hz.

**Frequency resolution:** 0.1 Hz (8 digits + overrange).

### Frequency Stability

**Long term:**  $\pm 1 \times 10^{-8}$  of frequency per day.  $\pm 1 \times 10^{-7}$  of frequency per month.

**Temperature:**  $\pm 1 \times 10^{-8}$  of frequency at  $25^\circ\text{C} \pm 10^\circ\text{C}$ .  $\pm 1 \times 10^{-7}$  of frequency at  $0^\circ\text{C}$  to  $55^\circ\text{C}$ .

**Signal to phase noise (integrated):** 50 dB down in a 30 kHz band, excluding  $\pm 1$  Hz, centered on carrier.

**Harmonic distortion:** with full output amplitude, any harmonically related signal will be less than the following specified levels.

**5 Hz to 100 kHz:** -60 dB.

**100 kHz to 1 MHz:** -50 dB.

**1 MHz to 13 MHz:** -40 dB.

### Spurious

All nonharmonically related spurious signals will be greater than 70 dB below selected output level or  $\leq 110$  dBm/50 $\Omega$ , whichever is greater.

### Auxiliary Outputs

**20 - 33 MHz tracking output:** >100 mV rms/50 $\Omega$ .

**1 MHz reference output:** >220 mV rms/50 $\Omega$  (0 dBm/50 $\Omega$ ).

**Synthesized search or tune:** a frequency step (0.1 Hz min) may be entered. This step may be added to or subtracted from the synthesized output signal. Rate of search or tune is selected by the time per step control.

**Digital sweeping of frequency:** accomplished by entering and setting the center frequency, a frequency step, number of steps, time per step, and sweep direction.

**Sweep width:** the product of the step size and number of steps.

**Step size:** continuously adjustable in 0.1 Hz increments.

**Step accuracy:**  $\pm 1 \times 10^{-8}$  per day for standard reference crystal.

**Number of steps:** 10, 100, or 1000.

**Time per step:** 1 ms, 3 ms, 10 ms, 30 ms, 100 ms, 300 ms, 1000 ms, and 3000 ms.

**Direction of sweep:** up, both, down.

**Single sweep:** initiated by momentary pushbutton.

**Continuous sweep:** initiated by momentary pushbutton.

**Manual sweep:** accomplished by holding down the freq  $\uparrow$  or freq  $\downarrow$  keys. Display will follow output.

**Sweep output:** stepped dc voltage proportional to sweep position, 0 to +10V.

**Accuracy:**  $\pm 0.2\%$  of full scale.

**Linearity:**  $\pm 0.1\%$  of full scale.

## Amplitude Section

**Amplitude:** maximum 2.1 V rms into open circuit; maximum 1.05 V rms into 50 $\Omega$ .

**Amplitude range:** +13.44 dBm to -86.55 dBm into 50 $\Omega$ .

**Amplitude resolution:** 0.01 dB.

**Output impedance:** 50 $\Omega$  (75 $\Omega$  Opt 001).

**Display:** four digit readout in dBm with reference to 50 $\Omega$ .

**Leveled frequency response:** (10 kHz reference) 10 Hz-13 MHz.\*

+13.44 dBm to -16.55 dBm:  $\pm 0.05$  dB.

-16.55 dBm to -36.55 dBm:  $\pm 0.1$  dB.

-36.55 dBm to -66.55 dBm:  $\pm 0.2$  dB.

-66.55 dBm to -86.55 dBm:  $\pm 0.4$  dB.

**Amplitude attenuator accuracy:**  $\pm 0.02$  dB/10 dB step (at 10 kHz) of attenuation down from maximum output.

**Amplitude accuracy (absolute):**  $\pm 0.05$  dB at 10 kHz and +13.44 dBm ( $15^\circ\text{C} \pm 5^\circ\text{C}$ ). (For absolute accuracy at other frequencies and amplitudes, add 0.05 dB to the leveled frequency response specification, plus the attenuator accuracy specification.)

**Amplitude modulation:** requires external modulation source. Rear panel BNC. ALC switch must be in slow position.

**Modulating signal:** 100 Hz to 100 kHz.

**Modulation depth:** 0.95 V rms modulating signal for 95% modulation depth.

## General

**Operating temperature:**  $0^\circ\text{C}$  to  $+55^\circ\text{C}$ .

**Storage temperature:**  $-40^\circ\text{C}$  to  $+70^\circ\text{C}$ .

**Turn on time:** application of power to "On": 20 min to within  $\pm 1 \times 10^{-7}$  of the final frequency.

"Standby" to "On": 15 s to full specifications.

**Power requirements:** 115 V or 230 V  $\pm 10\%$ , 48 Hz to 63 Hz, 20 W standby, 200 W on.

**Weight:** net, 22.6 kg (53 lb). Shipping, 26.8 kg (63 lb).

**Size:** 177 mm H  $\times$  426 mm W  $\times$  547 mm D (7"  $\times$  16.8"  $\times$  21.5").

## Options

001: 75 $\Omega$ -1 V output

002: High stability crystal oven

003: deletion of oven

005: 5 V-50 $\Omega$  output

## Price

N/C

add \$610

less \$150

add \$310

**3330B Automatic Synthesizer**  
(includes isolated HP-IB)

**\$8270**

# FUNCTION GENERATORS & FREQUENCY SYNTHESIZERS

200 Hz to 80 MHz automatic synthesizer

Model 3335A

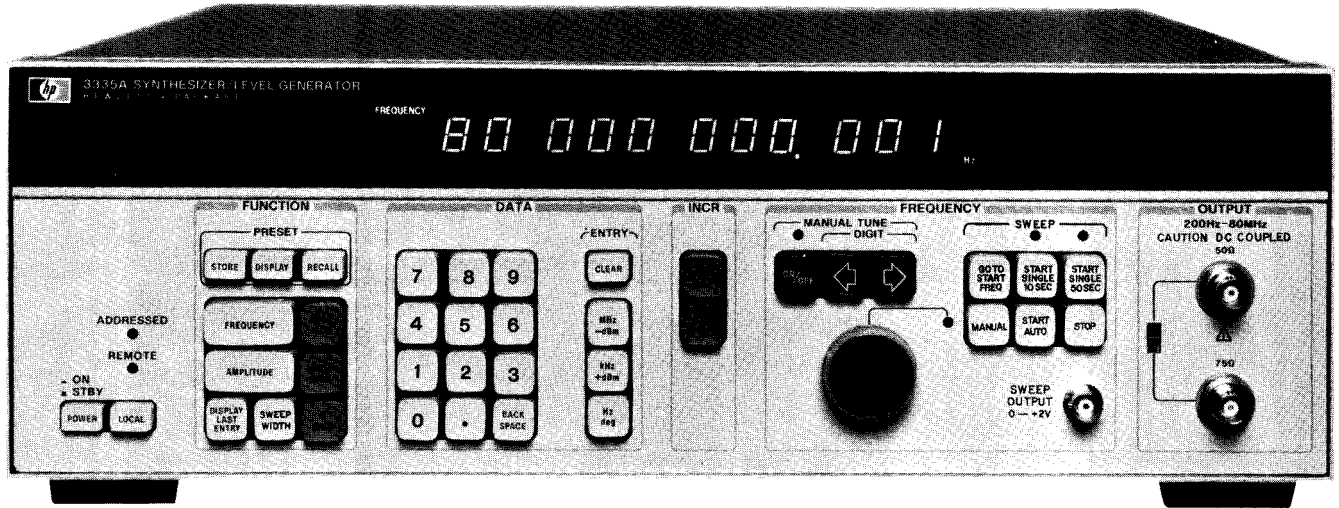

- 1 mHz Resolution
- High Spectral Purity
- Precision Amplitude Control
- Program Storage
- HP-IB



## Description

Covering a frequency range of 200 Hz–80 MHz, the 3335A Synthesizer/Level Generator has performance characteristics that make it ideally suited for the telecommunications industry, as well as for traditional synthesizer applications, including testing of Frequency Division Multiplex (FDM) equipment and R & D and production testing of communications systems. It features precision level control, milli-Hertz resolution, high spectral purity, internal frequency sweep, HP-IB programmability and numerous user conveniences.

## Internal Storage

Up to 10 different front panel settings (frequency, level, 0 incr, etc.) can be stored in internal memory registers for later recall. The DISPLAY key allows viewing of register contents without altering the synthesizer output.

## Precision Amplitude

Increasing channel capacity of Frequency Division Multiplex (FDM) systems is continually placing more stringent requirements on the testing of transmission parameters. To meet these performance standards, the 3335A incorporates a state-of-the-art attenuator resulting in attenuator accuracies of up to  $\pm 0.03$  dB over the 80 MHz frequency range.

## Programmability

The 3335A is fully programmable via the Hewlett-Packard Interface Bus (HP-IB), HP's implementation of IEEE Standard 488–1975. Most Hewlett-Packard 9800 Series Programmable Calculators, as well as Models 21 MX and 2100 series minicomputers, are easily interfaced to the HP-IB.

## Frequency Stability

The 3335A synthesizes its output frequency from an internal temperature-controlled crystal oscillator which provides  $\pm 1 \times 10^{-8}$ /day frequency stability ( $\pm 5 \times 10^{-10}$  is optional). The 3335A can also be phase-locked to any external frequency standards.

## Automatic Frequency Sweep

The 3335A combines the precision frequency accuracy and stability of a synthesizer with the time-saving convenience of a digital sweeper.

## SLMS - Tracking Generator

The 3335A operates as a tracking generator with the HP 3745A/B Selective Level Measuring Set (SLMS), or the 3586A/B/C Selective

Level Meter for automatic or semi-automatic testing of FDM systems. For closed-loop tracking where the 3335A and 3745A/B are in the same location, the frequency of the generator is controlled by the microprocessor in the SLMS.

## Abbreviated Specifications

(complete specifications are shown on the 3335A data sheet.)

### Frequency

**Range:** 200 Hz–80.999 999 999 MHz.

**Resolution:** 0.001 Hz.

**Stability (higher stability available with Opt 001):**  $\pm 1 \times 10^{-8}$ /day;  $\pm 1 \times 10^{-7}$ /month.

**Frequency switching and settling time:** <20 ms to within 90° of final phase.

### Spectral Purity

**Harmonic components (relative to fundamental, full output):**

200 Hz – 10 MHz: –45 dB.

10 MHz – 80 MHz: –40 dB.

**Spurious:** all non-harmonically related outputs will be greater than 75 dB below the carrier or –125 dBm, whichever is greater.

**Integrated Phase noise (30 kHz band, excluding  $\pm 1$  Hz centered on the carrier):** 9.9 MHz: –63 dB; 20 MHz: –70 dB; 40 MHz: –64 dB; 80 MHz: –58 dB.

### Amplitude

#### Range

50Ω: +13.01 dBm to –86.98 dBm; 75Ω: +11.25 dBm to –88.74 dBm.

**Resolution:** 0.01 dB.

**Absolute accuracy (full amplitude at 100 kHz, 10°C to 35°C):**  $\pm 0.05$  dB

**Note:** To determine absolute accuracy tolerances at other frequencies or amplitudes, the flatness and attenuator specifications must be added to the above accuracy specification.

**Flatness (relative to 100 kHz, full amplitude):** 1 kHz – 25 MHz:  $\pm 0.07$  dB; 200 Hz – 80 MHz:  $\pm 0.15$  dB.

### Attenuator

**Range:** 98 dB in 2 dB steps.

**Accuracy (1 year)**

Z <sub>o</sub>	ATTENUATION (dB)	FREQUENCY	
		200 Hz	25 MHz 80 MHz
50 Ω 75 Ω	0 to 18	$\pm 0.03$ dB $\pm 0.04$ dB	$\pm 0.15$ dB
50 Ω 75 Ω	20 to 58	$\pm 0.07$ dB $\pm 0.09$ dB	$\pm 0.25$ dB
50 Ω 75 Ω	60 to 98	$\pm 0.2$ dB $\pm 0.2$ dB	$\pm 0.50$ dB



**Amplitude switching time:** <500 ms to within  $\pm 0.02$  dB of final value.

### Sweep Characteristics

#### Sweep Modes:

**Single:** 10 or 50s single sweep from min. to max. frequency.

**Auto:** repetitive sweep from min. to max. frequency at a nominal 125 ms rate.

**Number of steps:** 10 sec., 50 sec., MANUAL: 1000 steps; AUTO (125 ms): 100 steps.

**Phase discontinuities:** there will be no significant phase discontinuities provided the following breakpoints are not crossed:

200 Hz – <10 MHz: 1 MHz points, e.g. 1 MHz, 2 MHz, etc.

10 MHz – <20 MHz: 250 kHz points, e.g. 10.25 MHz, 10.5 MHz, etc.

20 MHz – <40 MHz: 500 kHz points.

40 MHz – 80 MHz: 1 MHz points.

### Opt 001 (High Stability Frequency Reference)

**Aging rate:**  $\pm 5 \times 10^{-10}$ /day;  $\pm 2 \times 10^{-8}$ /month;  $\pm 1 \times 10^{-7}$ /year.

### Opt 002/004

For specifications not listed below, refer to standard instrument specifications, or the 3335A data sheets.

#### Frequency

**Range:** 75 $\Omega$ : 200 Hz–80.999 999 999 MHz; 124 $\Omega$ : 10 kHz–10 MHz; 135 $\Omega$ : 10 kHz–2 MHz.

**Resolution:** .001 Hz.

#### Amplitude

**Range:** +11.25 dBm to –88.74 dBm.

**Resolution:** 0.01 dB.

#### Flatness (relative to 100 kHz at full amplitude):

75 $\Omega$ : 1 kHz – 25 MHz:  $\pm 0.07$  dB; 200 Hz – 80 MHz:  $\pm 0.15$  dB

124 $\Omega$ : 50 kHz – 10 MHz:  $\pm 0.15$  dB; 10 kHz – 10 MHz:  $\pm 0.40$  dB

135 $\Omega$ : 10 kHz – 2 MHz:  $\pm 0.18$  dB

**Accuracy at full output (100 kHz, 10°C to 35°C):** 75 $\Omega$ :  $\pm 0.05$  dB; 124 $\Omega$ /135 $\Omega$ :  $\pm 0.10$  dB

**Amplitude accuracy (includes the effects of flatness and attenuator)**

75 $\Omega$	200 Hz	1 kHz	25 MHz	80 MHz
+ 11.25				
- 8.74	$\pm 0.25$ dB	$\pm 0.15$ dB	$\pm 0.35$ dB	
-48.74	$\pm 0.30$ dB	$\pm 0.20$ dB	$\pm 0.45$ dB	
-88.74	$\pm 0.40$ dB	$\pm 0.30$ dB	$\pm 0.70$ dB	

124 $\Omega$	10 kHz	50 kHz	10 MHz
+ 11.25			
- 8.74	$\pm 0.60$ dB	$\pm 0.35$ dB	
-48.74	$\pm 0.65$ dB	$\pm 0.40$ dB	
-70.0*	$\pm 1.1$ dB	$\pm 0.85$ dB	

135 $\Omega$	10 kHz	2 MHz
+ 11.25		
- 8.74	$\pm 0.35$ dB	
-48.74	$\pm 0.40$ dB	
-70.0*	$\pm 0.85$ dB	

\*Levels down to –88.74 dBm can be selected, however, accuracies are unspecified due to spurious noise floor of –100 dBm.

### Outputs

**Output Impedances:** 75 $\Omega$  unbalanced, 124 $\Omega$  balanced, 135 $\Omega$  balanced

**Signal Balance (100 kHz):** >60 dB.

### Opt 002

75 $\Omega$ : commercial equivalent of WECO type 477B (accepts WECO plug 358A).

124 $\Omega$ : commercial equivalent of WECO type 477B at 16 mm (0.625") spacings (accepts WECO plug 372A)

135 $\Omega$ : commercial equivalent of WECO type 223A at 16 mm (0.625") spacings (accepts WECO plug 241A).

### Opt 004

75 $\Omega$ : commercial equivalent of WECO type 560 A (accepts WECO plug 439A or 440A).

124 $\Omega$ : commercial equivalent of WECO type 560A at 12.7 mm (0.5") spacings (accepts WECO plug 443A).

135 $\Omega$ : commercial equivalent of WECO type 223A at 16 mm (0.625") spacings (accepts WECO plug 241A).

### Opt 003

#### Frequency

**Range:** 75 $\Omega$ : 200 Hz – 80.999 999 999 M Hz; 150 $\Omega$ : 10 kHz – 2 MHz

**Resolution:** .001 Hz.

#### Amplitude

**Range:** + 11.25 to –88.74 dBm.

**Resolution:** 0.01 dB.

**Flatness (relative to 100 kHz at full amplitude):** 75 $\Omega$ : 1 kHz–25 MHz:  $\pm 0.07$  dB, 200 Hz–80 MHz:  $\pm 0.15$  dB; 150 $\Omega$ : 10 kHz–2 MHz:  $\pm 0.18$  dB.

**Accuracy at full output (100 kHz, 10°C to 35°C):** 75 $\Omega$ :  $\pm 0.05$  dB; 150 $\Omega$ :  $\pm 0.10$  dB.

**Amplitude accuracy (includes the effects of flatness and attenuator)**

75 $\Omega$	200 Hz	1 kHz	25 MHz	80 MHz
+ 11.25				
- 8.75	$\pm 0.25$ dB	$\pm 0.15$ dB	$\pm 0.35$ dB	
-48.74	$\pm 0.30$ dB	$\pm 0.20$ dB	$\pm 0.45$ dB	
-88.74	$\pm 0.40$ dB	$\pm 0.30$ dB	$\pm 0.70$ dB	

150 $\Omega$	10 kHz	2 MHz
+ 11.25		
- 8.74	$\pm 0.35$ dB	
-48.74	$\pm 0.40$ dB	
-70.0*	$\pm 0.85$ dB	

\*Levels down to –88.74 dBm can be selected, however accuracies are unspecified due to spurious noise floor of –100 dBm.

### Outputs

**Output Impedances:** 75 $\Omega$  Unbalanced, 150 $\Omega$  Balanced

**Signal Balance (100 kHz):** >60 dB

#### Connectors

75 $\Omega$ : BNC; 150 $\Omega$ : Pair of BNC's at 20 mm (0.8") spacings

#### General

##### Operating environment

**Temperature:** 0°C to 55°C.

**R.H.:** <95%, 0°C to +40°C.

**Storage temperature:** –40°C to +75°C.

**Power:** 100/120/220/240 V, +5%, –10%; 48 to 66 Hz; 195 VA.

**Weight:** net: 18.2 kg. (40 lbs). Shipping: 26.8 kg. (59 lb).

**Size:** 132.6 mm H x 425.5 mm W x 497.8 mm D (5¼" x 16¾" x 19½").

#### Ordering Information\*

3335A

Opt 001

Opt 002

Opt 003

Opt 004

\*HP-IB cable not supplied. See Page 30.

#### Price

\$7700

add \$580

add \$300

add \$200

add \$300

370



# FUNCTION GENERATORS & FREQUENCY SYNTHESIZERS

## Synthesizer/Level Generator

### Model 3336 A/B/C

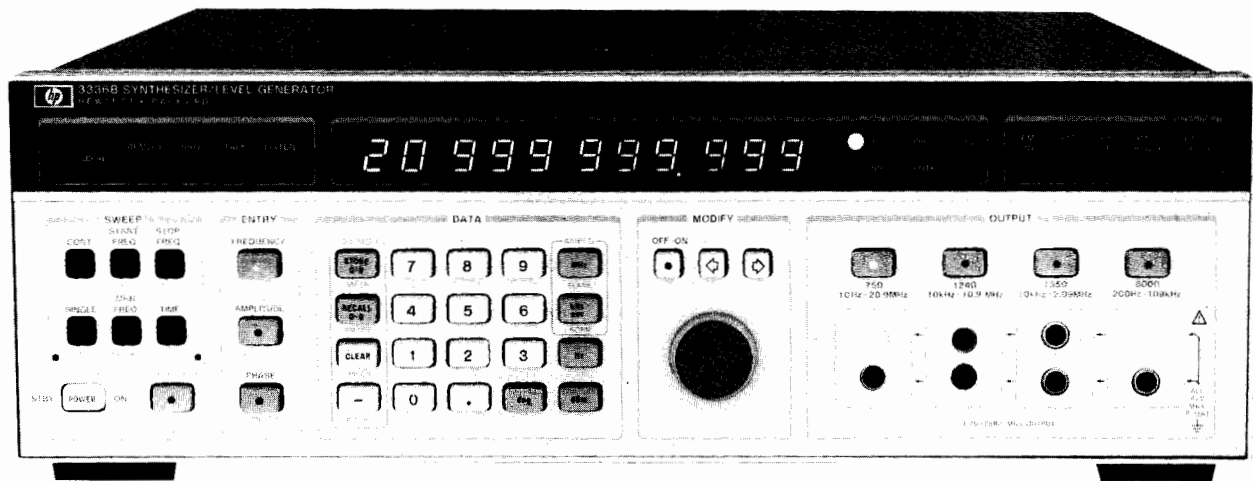

3336B

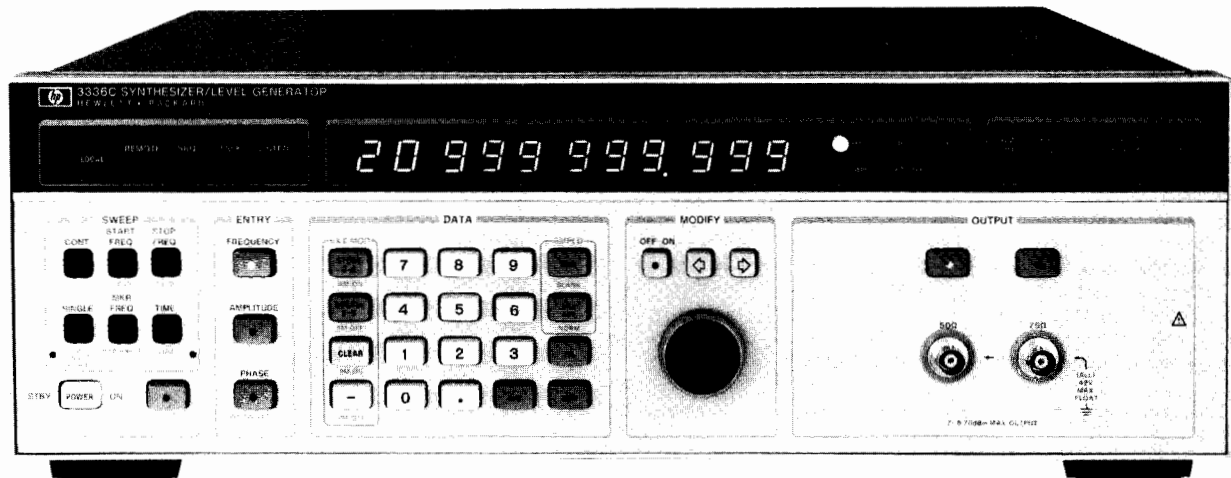

3336C



### Description

Covering a frequency range of 10 Hz to 20,999 MHz, the 3336A (CCITT) and 3336B (Bell) Synthesizer/Level Generators have performance characteristics that make them ideally suited for the telecommunications industry. The 3336C is designed for traditional synthesizer applications as well as R&D and production testing of systems or components. All three feature precision level control, high spectral purity, optional frequency stability of  $\pm 5 \times 10^{-8}$ /week, internal frequency sweep and numerous user conveniences. All models include HP-IB (IEEE Std. 488-1975) as a standard feature for use in automatic test systems.

### Precision Frequency Measurements

Major advances in HP technology have provided a single loop, fractional-N synthesis technique which allows synthesizer accuracy with 11 digits of resolution, plus... completely phase continuous frequency sweep over any of the instrument's frequency ranges. Microhertz resolution below 100 kHz allows precise frequency measurements over a range of 10 Hz to 20,999 999 999 MHz. Harmonics are below 60 dB over the range from 50 Hz to 1 MHz (50 dB to 20 MHz), with spurious signals below 70 dBc or -100 dBm in the standard instrument, -115 dBm with an option.

### $\pm 0.05$ dB Amplitude Accuracy

New HP attenuator technology coupled with custom designs in leveling loops and thermal converters produce amplitude accuracies seen only in instruments at much greater cost. The fast leveling loop makes extremely flat sweeps possible at fast sweep speeds. External leveling is also available for those custom applications where a control loop is desired.

### HP-IB

The 3336A, B and C come standard with HP-IB. Remote programming of major front panel controls makes these instruments a versatile and powerful addition to automatic test systems. The isolated interface combined with floating inputs and outputs contributes to ease of use in systems applications.

### Other Features

Both the 3336 A & B have true balanced outputs which can be floated. All three models (the 3336A, B & C) have 10 storage registers; amplitude blanking capability during frequency switching; linear or logarithmic phase continuous sweep capabilities; RPG (rotary pulse generator) to simplify modification of any digit in the display; phase offset capability; output connector and impedance flexibility; AM and PM modulation, and many other features. Refer to the data sheet for complete information.



## Abbreviated Specifications

### Frequency

Signal Output	3336A	3336B	3336C
50 $\Omega$ Unbalanced			10 Hz to 20.999 999 999 MHz
75 $\Omega$ Unbalanced	10 Hz to 20.999 999 999 MHz		
124 $\Omega$ Balanced		10 kHz to 10.999 999 999 MHz	
135 $\Omega$ Balanced		10 kHz to 2.099 999 999 MHz	
150 $\Omega$ Balanced	10 kHz to 2.099 999 999 MHz		
600 $\Omega$ Balanced	200 Hz to 109.999 999 kHz		

**Resolution:** 1  $\mu$ Hz for frequencies < 100 kHz, 1 mHz for frequencies  $\geq$  100 kHz

**Accuracy:**  $\pm 5 \times 10^{-6}$  of programmed frequency (20° to 30°C)

**Aging rate:**  $\pm 5 \times 10^{-6}$ /year (20° to 30°C)

**Warm-up time:** 30 minutes to within specified accuracy

### Amplitude

**Range:** 50  $\Omega$ : -71.23 to +8.76 dBm; 75  $\Omega$  and 600  $\Omega$ : -72.99 to +7.00 dBm; 124  $\Omega$ , 135  $\Omega$ , 150  $\Omega$ : -78.23 to +1.76 dBm

**Absolute accuracy:**  $\pm .05$  dB, 20° to 30°C (for the top 9.99 dB of amplitude range at 10 kHz, 50 kHz for 124  $\Omega$ , 135  $\Omega$ , 150  $\Omega$ );  $\pm .08$  dB, 0° to 55°C

**Flatness:** 50/75  $\Omega$ ,  $\pm .1$  dB ( $\pm .07$  dB with option 005) referenced to 10 kHz, 124, 135, 150  $\Omega$ ,  $\leq \pm .15$  dB referenced to 50 kHz.

**Attenuator accuracy:** (Instruments without Option 005)

	10 Hz	1 MHz	10 MHz	20.9 MHz
10 to 19.99 dB	$\pm .1$ dB	$\pm .15$	$\pm .2$ dB	$\pm .2$ dB
20 to 39.99 dB	$\pm .15$ dB	$\pm 2$ dB	$\pm .25$ dB	$\pm .25$ dB
40 to 79.99 dB	$\pm 2$ dB	$\pm 25$ dB	$\pm 3$ dB	$\pm 3$ dB

Note: Amplitude Accuracy is the sum of the Absolute Accuracy and, as necessary, Flatness and Attenuator Accuracy. See page 592 (3336 A/B) for overall amplitude. Accuracy specification expressed versus output level.

**Amplitude blanking:** output drops to less than -85 dBm during frequency switching

### Main Signal Outputs

#### Return loss (on carrier), balance

Output	Return Loss	Balance
50 $\Omega$ (3336C)	>30 dB, 10 Hz to 10 MHz, >25 dB, 10 MHz to 20 MHz	Unbalanced
75 (3336 A/B/C)	>30 dB, 10 Hz to 20 MHz	Unbalanced
124 $\Omega$ (3336B)	>20 dB, 10 kHz to 30 kHz >30 dB, 30 kHz to 10 MHz	>30 dB 10 kHz to 10 MHz
135 $\Omega$ (3336B)	>20 dB, 10 kHz to 30 kHz >30 dB, 30 kHz to 2 MHz	>36 dB 10 kHz to 2 MHz
150 $\Omega$ (3336A)	>20 dB, 10 kHz to 30 kHz >30 dB, 30 kHz to 2 MHz	>36 dB 10 kHz to 2 MHz
600 $\Omega$ (3336 A/B)	Not specified	>38 dB 300 Hz to 50 kHz

### Spectral Purity:

**Harmonic distortion:** harmonically related signals will be less than the following levels relative to the fundamental (normal leveling):

Frequency Range*	Harmonic Level
50 Hz to 1 MHz	-60 dB
1 MHz to 5 MHz	-55 dB
5 MHz to 20 MHz	-50 dB

**Integrated phase noise:** (3336C) -64 dB, over a 30 kHz band, centered on a 20 MHz carrier, excluding 1 Hz about the carrier; (3336A & B) -72 dB for a 3 kHz band, 2 kHz either side of carrier.

**Spurious:** all non-harmonically related signals will be more than 70 dB below the fundamental or -100 dBm (-115 dBm with Option 005)

\*Refer to data sheet for specifications below 50 Hz.

### Phase Offset

**Range:**  $\pm 719.9^\circ$  with respect to arbitrary reference phase.

**Resolution:** 0.1°

**Accuracy:**  $\pm 0.2^\circ$

### Frequency Sweep

**Sweep time:** linear; 0.01 s to 99.99 s. Single Log; 2 s to 99.99 s. Continuous Log; 0.1 s to 99.99 s.

**Maximum sweep width:** specified frequency range of selected output

**Minimum sweep width:** log; 1 decade. Linear; minimum BW (Hz) = .1 (Hz/s) x Sweep Time (s)

**Phase continuity:** phase is continuous over full frequency range.

**Sweep flatness:** fast leveling;  $\pm .15$  dB, 10 kHz to 20 MHz, .03 s

**Sweep time:** normal leveling;  $\pm .15$  dB, 50 Hz to 1 MHz, .5s sweep time.

### Amplitude Modulation

**Modulation depth:** 0 to 100%

**Modulation frequency range:** 50 Hz to 50 kHz

**Envelope distortion:** < -30 db to 80% modulation (1 kHz modulating frequency)

### Phase Modulation

**Range:** 0° to  $\pm 850^\circ$

**Linearity:**  $\pm 0.5\%$  from best fit straight line

**Modulation frequency range:** dc to 5 kHz

**Input sensitivity:**  $\pm 5$  V peak for 850° phase shift (170°/volt)

### Auxiliary Outputs

**AUX 0 dBm:** frequency range is 21 MHz to 60.999 999 999 MHz

**SYNC OUT:** TTL square wave with  $V_{high} > 1.2$  V into 50 ohms.

**REF OUT:** 0 dBm (50  $\Omega$ ), 1 MHz signal for phase locking.

**10 MHz OVEN OUT:** Instruments with Opt 004 only. 0 dBm (50  $\Omega$ ). 10 MHz temperature stabilized, crystal oscillator.

**X DRIVE:** 0 to  $> +10$  Vdc linear ramp.

**Z BLANK:** sweep related TTL compatible voltage levels.

**MARKER:** TTL compatible high to low level transition at the programmed Marker Frequency.

### Auxiliary Inputs

**EXT REF IN:** For phase-locking the Model 3336 to an external frequency reference. Signal from 0 dBm to +20 dBm (50  $\Omega$ ).

**AMPD MOD:** See Amplitude Modulation specifications.

**PHASE MOD:** See Phase Modulation specifications.

**EXTERNAL LEVELING:** Input from an External Leveling voltage source to regulate the signal amplitude at a remote point.

**Option 004:** High Stability Frequency Reference (all models)

**Accuracy:**  $\pm 5 \times 10^{-8}$

**Aging rate:**  $\pm 5 \times 10^{-8}$ /week after 72 hours continuous operation  
 $\pm 1 \times 10^{-7}$ /month after 15 days continuous operation

**Ambient stability:**  $\pm 5 \times 10^{-8}$  maximum, 0° to 55°C.

**Option 005:** High Accuracy Attenuator (Models 3336 A/B/C)

**Accuracy:** attenuation

10 to 19.99 dB	$\pm .035$ dB
20 to 29.99 dB	$\pm .06$ dB
40 to 79.99 dB	$\pm .1$ dB

### General

#### Operating environment:

**Temperature:** 0° to 55°C

**Relative humidity:**  $\leq 85\%$ , 0° to 40°C

**Altitude:** 15,000 ft,  $\leq 4600$  meters

**Storage temperatures:** -50° to +65°C

**Storage altitude:**  $\leq 50,000$  ft, 15,240 meters

**Power requirements:** 100/120/220/240 V, +5%, -10%, 48 to 66 Hz, 60 VA, (100 VA with all options), 10 VA standby

**Size:** 132.6 H x 425.5 W x 497.8 D or 5.2" x 16.8" x 19.6"

**Weight:** net, 10 kg. (22 lbs.); shipping, 15.5 kg. (34 lbs.)

### Ordering Information\*

3336A Synthesizer/Level Generator (CCITT) \$4100

3336B Synthesizer/Level Generator (N. American) \$4100

3336C Synthesizer/Level Generator (General Purpose) \$3800

Opt 004 High Stability Frequency Reference add \$550

Opt 005 High Accuracy Attenuator add \$550

Opt 907 Front Handle Kit add \$32

Opt 908 Rack Flange Kit add \$25

Opt. 909 Rack Flange and Handle Kit add \$55

\*HP-IB cables not furnished. See page 3.10.





# FUNCTION GENERATORS & FREQUENCY SYNTHESIZERS

## 50 MHz programmable signal source

Model 8165A

- Pulse/function capability
- Sine, triangle, square to 50 MHz
- Pulses and ramps to 20 MHz
- Trigger, gate and counted burst
- Synthesizer stability, precision amplitude
- Storage of operating parameters

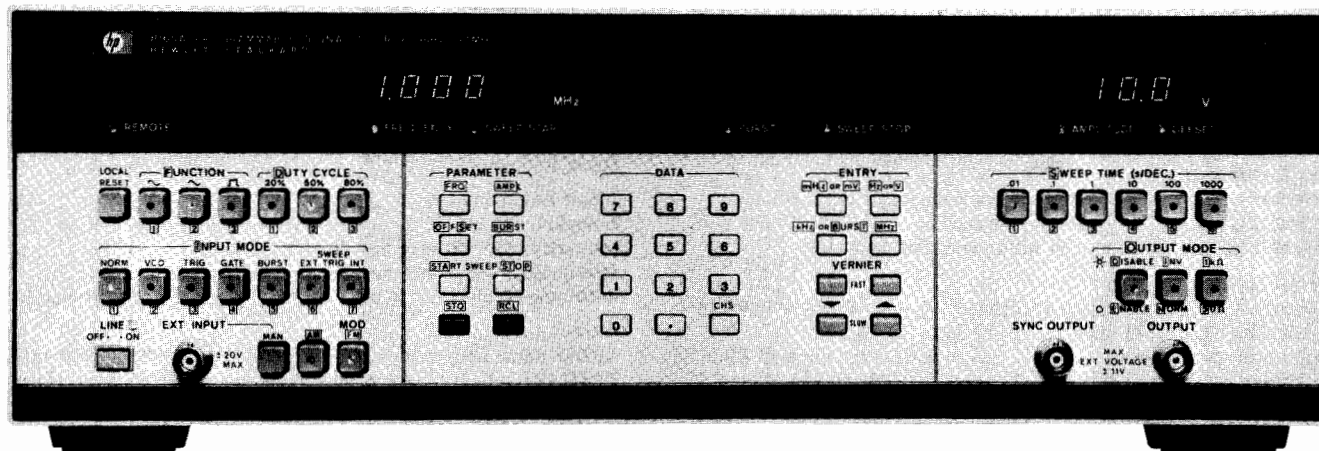

8165A Option 002

### Versatility and Simplicity for Systems and Bench

The 8165A Programmable Signal Source is a versatile function generator with good accuracy and many trigger features. Micro-processor control assures rapid, accurate setup whether programming locally or via HP-IB.

### Operating Set Storage

Ten complete sets of operating information can be stored and recalled. In the event of power failure, battery back up retains all data plus the active settings.

### Stability and Resolution

Very stable frequency is ensured with phase lock loop techniques and internal crystal reference. The four-digit frequency display means a 1  $\mu$ Hz resolution in the 1 to 9.999 MHz range.

### Specifications

#### Waveforms and frequency range

**Sine, square/pulse (20, 50, 80% duty cycle):** 1.000 mHz to 50.00 MHz.

**Triangle/ramp (20, 50, 80% symmetry):** 1.000 mHz to 19.99 MHz.

#### Output Characteristics

**Range:** amplitude and offset independently variable within  $\pm 10$  V window.

**Source impedance:** selectable 50  $\Omega \pm 1\%$  or 1 k $\Omega \pm 10\%$

**Amplitude:** 10.0 mV<sub>pp</sub> to 10.0 V<sub>pp</sub> (50  $\Omega$  into 50  $\Omega$ )  
2.00 V<sub>pp</sub> to 20.0 V<sub>pp</sub> (1 k $\Omega$  into 50  $\Omega$ )

**Accuracy:** (sine, square)  $\pm 2\%$ ,  $\pm 5\%$  above 5 MHz

**Offset:** 0  $\pm 10$  mV to  $\pm 5.00$  V (50  $\Omega$  into 50  $\Omega$ )  
0  $\pm 20$  mV to  $\pm 10.0$  V (1 k $\Omega$  into 50  $\Omega$ )

**Accuracy:**  $\pm 1\%$  programmed value  $\pm 1\%$  signal V<sub>pp</sub>  $\pm 20$  mV.

#### Sine characteristics

**Distortion:** total harmonic distortion (THD) for fundamental up to 1 MHz:  $\pm 1\%$ .

**Harmonic signals:** (fundamental 1-10 MHz):  $\leq -36$  dB

**Harmonic signals:** (fundamental above 10 MHz):  $\leq -30$  dB.

**Non-harmonic:**  $\leq -40$  dB.

#### Square/pulse characteristics

**Transition times:** (10% to 90%):  $\leq 5$  ns (50  $\Omega$  into 50  $\Omega$ ),  $\leq 7$  ns (1 k $\Omega$  into 50  $\Omega$ )

**Preshoot/Overshoot/ringing:**  $\leq \pm 5\%$  (50  $\Omega$  into 50  $\Omega$ ),  $\pm 10\%$  (1 k $\Omega$  into 50  $\Omega$ ).

#### Triangle/ramp characteristics

**Linearity:** (10% to 90%):  $\leq \pm 1\%$  ( $\leq \pm 5\%$  above 5 MHz).

#### Operating Modes

**Norm** (continuous phase locked), **VCO** (external sweep voltage), **Trig** (ext or man. one-shot), **Gate**, **Burst** (1-9999 counted cycles), **Frequency modulation**.

**HP-IB:** control and learn capability for all modes and parameters.

#### General

**Memory:** non volatile. 10 addressable locations plus one for active operating state. Each location can store a complete set of operating parameters and modes.

**Power:** 100/120/220/240 Vrms;  $\pm 5\%$ ,  $-10\%$ ; 48 to 66 Hz, 200 V A max.

**Operating Temperature:** 0° to 50°C

**Weight:** net 12 kg (26.5 lbs). Shipping 16 kg (35.3 lbs).

**Size:** 133 H  $\times$  426 W  $\times$  422 mm D (5.2"  $\times$  16.8"  $\times$  16.6").

#### Ordering Information

**8165A Programmable Signal Source\***

**Opt 002:** Sweep + AM

**Opt 003:** Rear Panel Connectors

**Opt 907:** Front Handle Kit (Part No 5061-0089)

**Opt 908:** Rack Mounting Kit (Part No 5061-0077)

**Opt 909:** Opt 907, 908 combined (Part No 5061-0083)

**Opt 910:** additional Operating and Service Manual

\*HP-IB cables not supplied, see page 30.

**Price**

\$6270

add \$710

N/C

add \$32

add \$25

add \$55

add \$70



# SIGNAL GENERATORS

## Signal Generators to 40 GHz



Hewlett-Packard offers a complete line of easy to use HF, VHF, UHF, and SHF signal generators covering a frequency range from 10 kHz to 40 GHz. This line includes synthesized signal generators and solid-state mechanically tuned generators as well as performance-proven vacuum tube signal generators. Each includes the following features: 1) accurately calibrated variable frequency, 2) accurately calibrated variable output level and 3) wide modulation capability.

HP signal generators ensure the utmost convenience and accuracy for a wide variety of measurements, including receiver tests such as sensitivity and selectivity. Signal generators are also used for signal simulation measurements such as signal-to-noise ratio, gain bandwidth, conversion loss, and antenna gain. They also provide power to drive mixers, bridges, slotted lines, etc.

### Synthesized Signal Generators

Synthesized signal generators combine the frequency stability, resolution and programmability of a high quality synthesizer with the calibrated variable output and modulation of a signal generator. Collectively covering a frequency range from 10 kHz to 18 GHz, these highly versatile programmable signal generators find application in a wide variety of automated systems and high performance applications.

### 0.1 to 990 MHz Low Cost Synthesized Signal Generator

The 8656A, HP's lowest cost programmable RF signal generator, provides synthesized signals from 0.1 to 990 MHz. With 100 and 250 Hz resolution, standard HP-IB programmability, and sufficient frequency switching speed for most automatic applications, the 8656A sets a value standard for synthesized signal generators. An internal microprocessor allows keyboard control of all functions, including front panel Store/Recall

and Sequence and the ability to key-increment each parameter. Reverse power protection to 50 watts is also a standard feature.

Excellent output level accuracy of  $\pm 1.5$  dB and precise output level resolution of 0.1 dB allow increased measurement accuracy, repeatability, and settability. Low RFI leakage allows the 8656A to be used for low-level testing of RFI susceptible devices. The 8656A offers the flexibility needed for general-purpose lab use, while the rugged design and ease of servicing make the 8656A ideal for a variety of production and service applications.

The 8656A is optimized for in-channel receiver testing. Modulation capability includes AM, FM, and simultaneous AM and FM with external modulating signals or internal 400 Hz and 1 kHz tones. Receiver channels are easily selected with the frequency increment feature. And because HP-IB programmability is a standard feature, the 8656A is a cost-effective programmable solution for these in-channel measurements, as well as being an ideal general-purpose RF source for other automatic system applications.

### 10 kHz to 1280 MHz Low Noise Synthesized Signal Generator

The HP 8662A covers 10 kHz to 1280 MHz with calibrated output level from +13 to -140 dBm. A high performance AM/FM Signal Generator, the 8662A achieves extremely low phase noise and spurious signals while maintaining fast frequency switching. The low phase noise close to the carrier ( $-112$  dBc/Hz at a 100 Hz offset) optimizes the 8662A for the most critical low noise applications (e.g., local oscillator). The low phase noise at typical channel spacings ( $-132$  dBc/Hz at a 10 kHz offset) now allows both in-channel and out-of-channel receiver measurements to be made under programmable control.

The 8662A utilizes an internal microprocessor to provide ease of operation, in-

cluding keyboard control and incrementing capability of all functions. Totally HP-IB programmable, the 8662A also features a powerful precision digital sweep.

### 10 kHz to 2600 MHz Synthesized Signal Generator

The HP 8660A/C is a particularly versatile synthesized signal generator family, offering two mainframes and a variety of RF and modulation plug-ins. The 8660A mainframe utilizes thumbwheel switches for frequency selection. The 8660C has a more versatile keyboard control featuring synthesized digital sweep and frequency-step capability. Both HP-IB and BCD programming interfaces are available.

Three plug-in RF sections provide separate frequency ranges: 10 kHz to 110 MHz, 1 MHz to 1300 MHz, and 1 MHz to 2600 MHz. Output levels are calibrated over  $>140$  dB range. Five different modulation plug-ins provide versatile combinations of AM, FM,  $\Phi$ M and pulse modulation.

### 2 to 18 GHz Microwave Synthesized Signal Generator

The HP 8672A is an AM/FM Signal Generator providing synthesized signals from 2 to 18 GHz. Calibrated output level from +3 to -120 dBm is standard, with Option 008 providing high power output to +8 dBm.

A companion unit, the 8671A, is a synthesizer only, with a minimum output of +8 dBm from 2 to 6.2 GHz and internal FM capability only. Both units are programmable via the HP Interface Bus.

Typical 8672A applications include use as a programmable signal simulator in automatic test systems, for satellite receiver testing requiring highly stable signals, general purpose lab use and production use.

The 8671A is used in local oscillator applications requiring up-conversion or frequency multiplication. A clean source, SSB noise is  $-86$  dB/Hz below the carrier at a 10 kHz offset, with nonharmonic spurious  $<-70$  dB.

## Solid State, Mechanically Tuned Generators

### HF to UHF

The high performance leaders of the solid-state, mechanically tuned family are the 8640A and 8640B signal generators, covering 450 kHz to 550 MHz. Frequency coverage can be extended to 1024 MHz with an internal doubler (Option 002), and an optional built-in audio oscillator extends the CW range down to 20 Hz (Option 001). The 8640 provides wide output level range and high power output from +19 to -145 dBm. Featuring high performance AM and FM with low phase noise at typical channel spacings, the 8640 is an ideal generator for a wide variety of receiver measurements.

The 8640B with built-in counter has the ability to count external signals at frequencies up to 550 MHz and to phase-lock the generator's RF output to the counter time base for frequency stability of better than  $5 \times 10^{-8}$ /hour. The 8640A utilizes a mechanical slide rule frequency dial.

For Avionics navigation and communications applications, the 8640B Option 004 combines digital frequency readout and phase lock features with a demodulated output and special AM circuitry. Combined with suitable external modulation sources, the 8640B Option 004 provides for testing and calibration of aircraft VOR/ILS and Marker Beacon receivers.

### Compact, Field Portable

Compact, portable signal generators form another part of the solid-state, mechanically tuned family. The 8654A and 8654B cover from 10 to 520 MHz, providing output power from +10 to -130 dBm. Small size and light weight make them well suited for field maintenance and operational readiness checks in addition to general purpose signal generator applications. The 8654B has fully calibrated and metered AM and FM, whereas the 8654A is an AM generator with uncalibrated FM capability.

The 8655A Synchronizer/Counter is used with either 8654 to phase-lock the generator's RF output to the counter time base for frequency stability of better than 0.1 ppm/hr. In addition, the 8655A is an RFI-proof counter with the capability to count external signals to 520 MHz.

### Performance-proven Vacuum Tube Signal Generators

#### HF to UHF

The 606B, 608E, and 612A signal generators collectively cover frequencies from 50 kHz to 1.23 GHz. All feature low residual FM and a low broadband noise floor, and include internal and external amplitude (sine, square-wave, pulse) modulation capability.

#### UHF to SHF

Hewlett-Packard's microwave vacuum tube signal generators provide coverage from

800 MHz to 21 GHz. The 618C, 620B, 626A, and 628A incorporate cavity-tuned klystron oscillators with low drift and residual FM. Pulse, square-wave and frequency modulation capabilities make them useful for microwave receiver testing as well as SWR and transmission line measurements.

The 8614A and 8616A Signal Generators, covering 0.8 to 2.4 GHz and 1.8 to 4.5 GHz, feature built-in PIN diode modulators. These modulators allow internal or external output power leveling as well as high performance pulse and amplitude modulation.

HP 938A and 940A Frequency Doubler Sets provide low-cost signal generator capability in the 18 to 40 GHz range by doubling the frequency of signal sources in the 9 to 20 GHz range.

### Signal Generator Accessories

A variety of accessories are available to enhance the operation of HP signal generators. These include a spectrum generator, frequency doublers, output terminations, a fuse holder, balanced mixers, filters, a series of PIN modulators, a pulse modulator and a down converter. The HP 11720A Pulse Modulator provides high performance pulse modulation capability over the range of 2 to 18 GHz. The 11710B Down Converter extends the frequency range of the 8640 and 8654 down to 10 kHz.

## Signal Generator Summary

Model	Frequency Range	Characteristics	Page
8656A	0.1 to 990 MHz	$\pm 1.5$ dB absolute level accuracy from +13 dBm to -127 dBm in 0.1 dB steps. Calibrated AM and FM. Frequency resolution of 100 Hz or 250 Hz. Time base aging rate of $\pm 2$ ppm/year.	376
8662A Synthesized Generator	0.01 to 1280 MHz	Low noise. 0.1 Hz frequency resolution, $5 \times 10^{-8}$ /day stability. Calibrated and leveled output from +13 to -140 dBm. Digital sweep. Completely HP-IB programmable. AM/FM modulation.	378
8660A/C Synthesized Generators	0.01 to 110 MHz 1 to 1300 MHz 1 to 2600 MHz	1 Hz frequency resolution, $3 \times 10^{-8}$ /day stability. Calibrated and leveled output from +13 to -146 dBm. HP-IB and BCD programmable. AM, FM, $\Phi$ M, pulse modulation. Plug-ins determine frequency range and modulation capability.	380
606B Signal Generator	0.05 to 65 MHz	Calibrated and leveled output from +23 to -127 dBm, dc to 20 kHz AM. Low noise, low distortion. Auxiliary RF output.	394
8640A/B Signal Generators	0.5 to 1024 MHz	Calibrated and leveled output from +19 to -145 dBm. AM, FM, and ext. pulse modulation. 8640B has built-in counter and phase lock capability.	387
8640B Opt 004 Avionics Generator	0.5 to 512 MHz	Same as 8640B with AM phase shift $< \pm 0.01^\circ$ at 30 Hz, demodulated AM output, 1 dB step attenuator. For use with external VOR/ILS audio generators.	390
8654A/B Signal Generators	10 to 520 MHz	Calibrated and leveled output from +10 to -130 dBm. Amplitude and frequency modulation. Compact, portable (17.5 lb).	392
8655A Synchronizer/Counter	10 to 520 MHz	Phase lock frequency stabilizer for 8654A and B. 6-digit LED display. Lock resolution, 500 Hz. Low RFI, external count capability to 520 MHz.	393
608E Signal Generator	10 to 480 MHz	Calibrated and leveled output from +13 to -127 dBm. AM, pulse modulation. Low noise, low distortion. Auxiliary RF output.	395
3200B Oscillator	10 to 500 MHz	+13 to -107 dBm output into 50 $\Omega$ , 120 dB attenuator range, 0.002% stability. Compact, portable (15 lb). 13515A Doubler extends frequency to 1000 MHz.	391
612A Signal Generator	450 to 1230 MHz	Output +7 to -127 dBm into 50 ohms. AM, wide mod. BW 20 Hz to 5 MHz; pulse or square-wave modulation.	396
8614A, 8616A Signal Generators	0.8 to 2.4 GHz 1.8 to 4.5 GHz	Output +10 (8616: +3 dBm above 3 GHz) to -127 dBm into 50 ohms, leveled below 0 dBm. Internal square-wave; external pulse, AM and FM. Auxiliary RF output.	397
8671A Synthesizer	2 to 6.2 GHz	1 kHz frequency resolution, $5 \times 10^{-8}$ /day stability, +8 dBm minimum output. Completely HP-IB programmable. Ext. FM.	386
8672A Synthesized Generator	2 to 18 GHz	1 to 3 kHz frequency resolution, $5 \times 10^{-8}$ /day stability. Calibrated and leveled output from +3 to -120 dBm. Completely HP-IB programmable. Metered external AM and FM.	384
618C, 620B Signal Generators	3.8 to 7.6 GHz 7 to 11 GHz	Output +0 to -127 dBm into 50 ohms. Int. pulse, frequency or square-wave modulation; ext. FM or pulse modulation. Auxiliary RF output.	398
626A, 628A Signal Generators	10 to 15.5 GHz 15 to 21 GHz	Output +10 to -90 dBm; Int. pulse, frequency or square-wave modulation; ext. FM or pulse modulation.	399
938A, 940A Frequency Doublers	18 to 26.5 GHz 26.5 to 40 GHz	Driven by 9 to 13.25 GHz, 13.25 to 20 GHz sources (HP 626A, 628A, 8690 and 8620 series sweepers or klystrons). 100 dB precision attenuator.	399

376



# SIGNAL GENERATORS

## Synthesized signal generator

### Model 8656A

- 100 kHz to 990 MHz
- $\pm 1.5$  dB absolute output level accuracy
- 0.1 dB output level resolution
- Versatile modulation
- Increments and Store/Recall/Sequence
- Fully HP-IB programmable

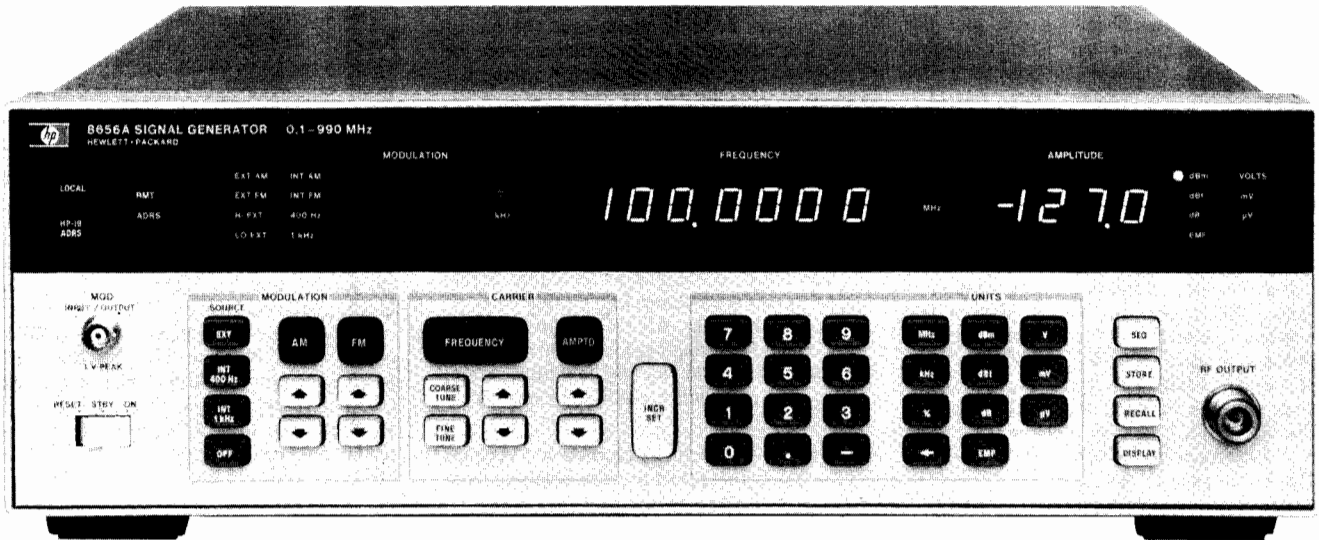

## Description

The 8656A is a programmable synthesized signal generator that offers exceptional value through versatility, ease of operation, and a broad range of standard features.

## Frequency

The 8656A provides frequency coverage from 0.1 to 990 MHz (with under-range to 10 kHz). This wide range covers the IF and LO frequencies as well as the RF frequencies of most receivers. It also allows testing in a variety of communication systems including the 800 MHz FM mobile band and some telemetry bands. Frequency resolution of 100 Hz or 250 Hz allows convenient setting of increments including 6.25 kHz channel spacings. Frequency accuracy and stability are determined by the reference used. The standard internal reference has an aging rate of 2 ppm/year. Improved stability and accuracy can be achieved by adding the optional  $1 \times 10^{-9}$ /day high stability time base (Option 001) or using an external reference of 1, 5, or 10 MHz.

## Output

The 8656A features  $\pm 1.5$  dB absolute accuracy and 0.1 dB resolution for more accurate receiver sensitivity tests, circuit characterization, and R&D applications. The output levels are calibrated from +13 to -127 dBm and may be set and displayed in convenient units including dBm, volts, dB $\mu$ V, or EMF. Shielding keeps leakage at  $<1 \mu$ V for testing RFI susceptible devices, and standard resettable reverse power protection for up to 50 watts guards against accidental damage from transmitters.

## Modulation

The 8656A has versatile modulation capabilities: internal 400 Hz and 1 kHz tones, simultaneous and mixed modulation modes (AM-AM, FM-FM, AM-FM) from internal and external sources, and the ability to accept low frequency digital unquenching signals. For calibrated external modulation, a 1V peak signal is required. HI/LO annunciators on the 8656A indicate when the external signal is within 5% of the correct amplitude.

## Ease of Operation

A microprocessor-based controller provides a broad range of operating features for simple but efficient control. Keyboard data entry uses a function/data/units format, and all function entries are made using a left-to-right keystroke sequence. All information entered is visible via LED displays and annunciators. Modulation, frequency, and level functions can be individually incremented by step sizes that are set by convenient keyboard entries. In addition, resolution control keys allow coarse and fine tuning of output frequency in decade steps.

Up to ten front-panel setups can be stored and recalled. A sequence function allows you to cycle through stored setups at the touch of a key or via remote control.

## HP-IB Programmability

Full HP-IB programmability is standard in the 8656A. Each programming command has an easy-to-remember, two-character, alphanumeric HP-IB code, and all functions are quickly programmed using the same format as in the manual mode.

## 8656A Specifications

### Frequency

**Range:** 100 kHz to 990 MHz (8 digit LED display).

**Resolution:** 100 and 250 Hz.

**Accuracy and stability:** same as internal time base.

### Time base characteristics:

Typical Characteristics	Standard Time Base	Option 001 Time Base
Aging Rate	± 2 ppm/year	1 x 10 <sup>-9</sup> /day
Frequency	50 MHz	10 MHz
External Reference Input (rear panel)	Accepts any 10, 5 or 1 MHz (± 0.002%) frequency standard at a level > 0.15 Vrms into 50 ohms.	

**Typical: Frequency Switching Speed:** < 2 seconds to be within 100 Hz of final frequency

### Spectral Purity

**Spurious signals (≤ +7 dBm output levels)**

**Harmonics:** < -30 dBc.

**Non-harmonic spurious (greater than 5 kHz from carrier in CW mode):** < -60 dBc.

**Sub-harmonic spurious:** none.

### Residual FM:

Post Detection Noise Bandwidth	Frequency Range (MHz)			
	0.1 to 123.5	123.5 to 247	247 to 494	494 to 990
0.3 to 3 kHz	< 15 Hz rms	< 3 Hz rms	< 6 Hz rms	< 15 Hz rms
0.05 to 15 kHz	< 30 Hz rms	< 8 Hz rms	< 16 Hz rms	< 30 Hz rms

**Residual AM (0.05 to 15 kHz post detection noise bandwidth):** < -70 dBc.

### Typical SSB phase noise (CW only):

Offset from Carrier	0.1 to 123.5 MHz (dBc/Hz)	123.5 to 247 MHz (dBc/Hz)	247 to 494 MHz (dBc/Hz)	494 to 990 MHz (dBc/Hz)
20 kHz	< -115	< -127	< -121	< -115
500 kHz	< -125	< -135	< -131	< -125

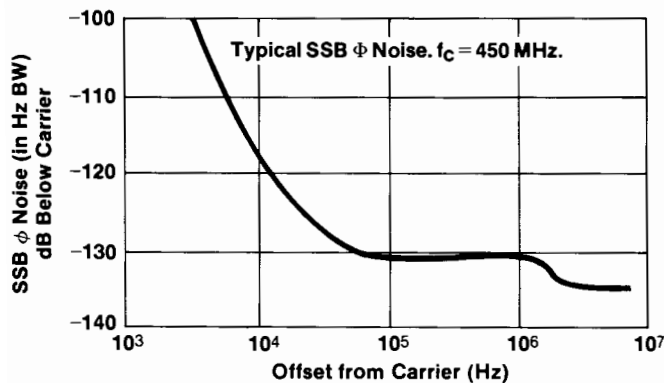

### Output

**Level range (into 50 ohms):** +13 dBm to -127 dBm (3½ digit LED display).

**Resolution:** 0.1 dB.

**Absolute level accuracy:** ≤ 1.5 dB.

**Level flatness (100 kHz to 990 MHz):** ≤ ± 1.0 dB at an output level setting of 0.0 dBm.

**Reverse power protection:** protects signal generator from application of up to 50 watts (typical) of RF power to 990 MHz into generator output; dc voltage cannot exceed 25V.

### Modulation

#### Amplitude modulation (2 digit LED display)

**AM depth<sup>1</sup>:** 0 to 99% to +7 dBm and 0 to 30% to +10 dBm.

**Resolution:** 1%.

**AM rate:** internal 400 Hz and 1 kHz, ± 3%; external (1 dB bandwidth), 25 Hz to 25 kHz.

**AM distortion (at internal rates):** < 1.5%, 0-30% AM; < 3%, 31-70% AM; < 5% 71-90% AM.

**Indicator accuracy (for depths < 90% and internal rates)<sup>1</sup>:** (± 4% of reading) ± 2%.

**Incidental phase modulation (at 30% AM depth and internal rates):** < 0.3 radian peak.

#### Frequency modulation (2 digit LED display)

##### FM peak deviation:

Center Frequency ( $f_c$ )	Maximum Peak Deviation ( $\Delta f_{pk}$ )*	
	Rates ≥ 60 Hz	Rates < 60 Hz
0.1-123.5 MHz	99 kHz	1600 x Rate
123.5-247 MHz	25 kHz	400 x Rate
247-494 MHz	50 kHz	800 x Rate
494-990 MHz	99 kHz	1600 x Rate

\*FM not specified for  $f_c - \Delta f_{pk} < 100$  kHz.

**Resolution:** 100 Hz for deviations less than 10 kHz; 1 kHz for deviations greater than 10 kHz.

**FM rate:** internal 400 Hz and 1 kHz, ± 3%; external (1 dB bandwidth, ac coupled), 25 Hz to 25 kHz.

**FM distortion:** < 0.5% for 100 Hz to 99 kHz peak deviations and internal rates.

**Indicator accuracy<sup>1</sup>:** ± 5% or reading at internal rates. (Add ± 5% if 250 Hz frequency increments are used).

**Incidental AM:** < 0.1% for < 20 kHz peak deviation and internal rates.)

**Digital FM:** will accept typical digital unscrambling signals. Sag of resultant demodulated signal is typically less than 8% at 1 kHz deviation for a 10 Hz square-wave modulating signal.

### Remote Programming

**Interface:** HP-IB (Hewlett-Packard's implementation of IEEE Standard 488).

**Interface function:** the 8656A is strictly a listener; no status information is output.

### General

**Operating temperature range:** 0 to +55°C.

**Leakage:** conducted and radiated interference is within the requirements of methods CE03 and RE02 of MIL STD 461A, VDE 0871, and CISPR Publication 11. Furthermore, RF leakage of less than 1.0 μV is induced in a two-turn loop, 2.5 cm in diameter, held 2.5 cm away from the front surface.

**Power requirements:** 100, 120, 220, or 240V, (+5, -10%); 48 to 66 Hz; 125 VA maximum.

**Weight:** net, 18.1 kg (40 lb); shipping, 24.5 kg (54 lb).

**Size:** 133 H x 425 W x 520 D mm (5.25" x 16.75" x 20.5").

**Rack slides and transit case:** HP part numbers are: slide kit, 1494-0018; tilt slide kit, 1494-0025; full module transit case, 9211-2661.

### Ordering Information

**8656A Signal Generator<sup>2</sup>**

**Option 001:** High stability time base

**Option 907:** Front handle kit

**Option 908:** Rack flange kit

**Option 909:** Rack flange and front handle kit

**Option 910:** Extra operating & service manual

### Price

\$6,250

add \$850

add \$32

add \$25

add \$55

add \$30

<sup>1</sup>AM depth and FM deviation are further limited by Indicator Accuracy specifications.

<sup>2</sup>HP-IB cables not supplied, see page 30 for description and prices.



# SIGNAL GENERATORS

## Synthesized signal generator

Model 8662A

- 10 kHz to 1280 MHz frequency range
- 0.1 Hz frequency resolution
- <420  $\mu$ s frequency switching speed
- SSB phase noise <-144 dBc/Hz at 10 kHz offset
- $\pm 1$  dB level accuracy
- Fully HP-IB programmable

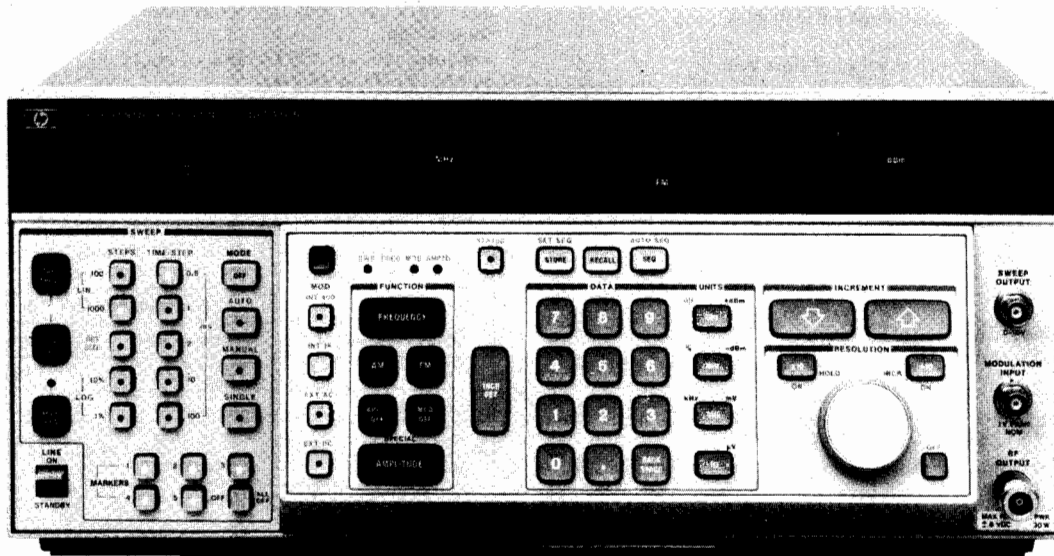

8662A



### 8662A Synthesized Signal Generator

The 8662A is a high performance synthesized signal generator covering the wide frequency range of 10 kHz to 1280 MHz in a single instrument while providing a wide range of accurately calibrated output power as well as full AM/FM capability.

#### Precision Synthesized Signal Generator

The 8662A derives exceptional RF performance from an indirect frequency synthesis technique that results in frequency resolution of 0.1 Hz (0.2 Hz above 640 MHz). Its frequency accuracy and stability are determined by a low noise quartz reference oscillator which has an aging rate of less than  $5 \times 10^{-10}$ /day.

The 8662A output level ranges from +13 dBm (+16 dBm in over-range) to -139.9 dBm with 0.1 dB resolution in both manual and remote (HP-IB) operation. From +13 to -120 dBm the absolute level accuracy is held to  $\pm 1$  dB using microprocessor correction. These exceptional output level characteristics make the 8662A an ideal generator for performing precise receiver sensitivity tests either manually or in automated systems.

The 8662A offers versatile phase-locked AM/FM using either internal 400 Hz and 1 kHz rates or externally applied modulating signals, which can be either dc or ac coupled. Several different modes of simultaneous modulation (such as AM + FM or FM + FM) are possible using internal and external modulation as well as a rear panel auxiliary FM input.

#### Exceptional Spectral Purity

The key contribution of the 8662A is spectral purity. Fast-tuning, switched-inductance oscillators combined with a low noise reference oscillator result in very low SSB phase noise, especially at small offsets from the carrier. The phase noise at 20 to 50 kHz offsets is comparable to that of the best cavity-tuned fundamental oscillators. Such excellent noise performance combined with programmability makes possible complete automation of receiver adjacent channel selectivity measurements.

With its excellent long and short-term frequency stability, high output power, fine frequency resolution, and broad frequency range the 8662A also meets the requirements of the most critical low noise local oscillator applications. In addition, its fast frequency switching and sweep capabilities also permit its use in many frequency agile and swept local oscillator applications.

#### Measurement Efficiency

An advanced microprocessor-based controller allows convenient keyboard control of all 8662A functions. For example, all functions can be incremented and decremented in any user-defined step size within the resolution of the synthesizer using the "increment" keys and the "knob". Up to nine full front panel setups can be stored in the 8662A's memory and recalled for later use in any user-defined sequence at the touch of a pushbutton. This permits time-saving semi-automation of generator operation in production setups where the generator must perform many different tests.

The microprocessor controller also allows convenient HP-IB programmability of all generator functions with the same resolution as manual operation. Each front panel button is represented by a two-character alphanumeric HP-IB programming code. The sequence of HP-IB commands used in remote operation is identical to the sequence of keystrokes used in manual operation. In addition, two special programming "learn" modes allow the HP-IB controller to store 8662A front panel settings or decrease the 8662A frequency switching time to under 420 microseconds. Partial remote 8662A operation without an HP-IB controller is possible using a rear panel auxiliary control connector.

#### Precision Digital Sweep

Fast frequency switching combined with microprocessor control gives the 8662A a powerful sweep capability. Automatic, single, and manual modes are available for both linear and logarithmic sweeps with user-selectable step size and number of steps. Five different sweep speeds can be chosen and up to five amplitude or Z-axis markers can be set for calibrating swept frequency displays. All sweep parameters can be controlled with full synthesizer resolution.

With this kind of sweep capability, the 8662A is ideal for the characterization of extremely narrow-band devices such as crystal filters. By storing two different sweep setups in the 8662A memory and using its "auto-sequence" capability, both wide-band and narrow-band swept characteristics of a device under test can be viewed simultaneously on an oscilloscope or network analyzer.

## 8662A Specifications

### Frequency

**Range:** 10 kHz to 1280 MHz (1279.9999998 MHz).

**Resolution:** 0.1 Hz (0.2 Hz above 640 MHz).

**Accuracy and stability:** same as reference oscillator.

**Internal reference oscillator:** 10 MHz quartz oscillator. Aging rate  $< 5 \times 10^{-10}$ /day after 10 day warm-up (typically 24 hrs in normal operating environment).

### Spectral Purity

**Residual SSB phase noise in 1 Hz BW ( $320 \leq f_c < 640$  MHz):**

Offset from carrier	10 Hz	100 Hz	1 kHz	10 kHz	100 kHz
SSB phase noise in 1 Hz BW (CW and AM mode)	-100 dBc	-112 dBc	-121 dBc	-131 dBc	-132 dBc

**SSB broadband noise floor in 1 Hz BW at 3 MHz offset from carrier:**  $< -146$  dBc for  $f_c$  between 120 and 640 MHz at output levels above +10 dBm.

### Spurious signals:

	Frequency range (MHz)				
	0.01 to 120	120 to 160	160 to 320	320 to 640	640 to 1280
Spurious non-harmonically related <sup>1,2</sup>	-90 dBc	-100 dBc	-96 dBc	-90 dBc	-84 dBc
Sub-harmonically related ( $\frac{f}{2}$ , $\frac{3f}{2}$ , etc.)	none	none	none	none	-75 dBc
Power line (60Hz) related or microphonically generated (within 300 Hz) <sup>3</sup> .	-90 dBc	-85 dBc	-80 dBc	-75 dBc	-70 dBc
Harmonics	$< -30$ dBc				

### Output

**Level range:** +13 to -139.9 dBm (1 V to 0.023  $\mu$ V<sub>rms</sub> into 50  $\Omega$ ).

**Resolution:** 0.1 dB.

**Absolute level accuracy (+15° to +45°C):**  $\pm 1$  dB between +13 and -120 dBm,  $\pm 3$  dB between -120 and -130 dBm.

### Amplitude Modulation

**Depth:** 0 to 95% at output levels of +8 dBm and below (+10 dBm in uncorrected mode). AM available above these output levels but not specified.

**Resolution:** 1%, 10 to 95% AM; 0.1%, 0 to 9.9% AM.

**Incidental PM (at 30% AM):** 0.15-640 MHz,  $< 0.12$  radian peak; 640-1280 MHz,  $< 0.09$  radian peak.

**Incidental FM (at 30% AM):** 0.15-640 MHz,  $< 0.12 \times f_{mod}$ ; 640-1280 MHz,  $< 0.09 \times f_{mod}$ .

**Indicated accuracy:**  $\pm 5\%$  of reading  $\pm 1\%$  AM. Applies for rates given in table below, internal or external mode, for depths  $\leq 90\%$ .

**Rates and distortion with internal or external modulating signal:**

Frequency range	AM rate	AM Distortion		
		0-30% AM	30-70% AM	70-90% AM
0.15-1 MHz	dc-1.5 kHz	2%	4%	5.75%
1-10 MHz	dc-5 kHz	2%	4%	5.75%
10-1280 MHz	dc-10 kHz	2%	4%	5.75%

### Frequency Modulation

**FM rates (1 dB bandwidth):** external ac, 20 Hz to 100 kHz; external dc, dc to 100 kHz.

**FM deviation:** from 25 to 200 kHz depending on carrier frequency. **Indicated FM accuracy:**  $\pm 8\%$  of reading plus 10 Hz (50 Hz to 20 kHz).

**FM resolution:** 100 Hz for deviations  $< 10$  kHz, 1 kHz for deviations  $> 10$  kHz.

**Incidental AM (AM sidebands at 1 kHz rate and 20 kHz deviation):**  $< -72$  dBc,  $f_c < 640$  MHz;  $< -65$  dBc,  $f_c \geq 640$  MHz.

**FM distortion:**  $< 1.7\%$  for rates  $< 20$  kHz,  $< 1\%$  for rates  $< 1$  kHz.

**Center frequency accuracy and long term stability in AC mode:** same as CW mode.

### Remote Programming

**Interface:** HP-IB (Hewlett-Packard's implementation of IEEE Standard 488).

**Functions controlled:** all functions controlled from the front panel with the exception of the line switch are programmable with the same accuracy and resolution as in manual mode.

### General

**Operating temperature range:** 0° to +55°C.

**Leakage:** meets radiated and conducted limits of MIL STD 461A methods RE02 and CE03 as well as VDE 0871. Furthermore, less than 1  $\mu$ V is induced in a two-turn, 1-inch diameter loop 1 inch away from the front panel and measured into a 50 ohm receiver.

**Power requirements:** 115 (90-126) V or 230 (198-252) V; 48 to 66 Hz; 420 VA max.

**Weight:** net 30 kg (65.5 lb); shipping 36 kg (80 lb).

**Size:** 178 mm H x 425 mm W x 572 mm D (7" x 16.75" x 22.5"); depth includes front panel depth of 45 mm (1.75").

### Supplemental Characteristics

#### Typical SSB Phase Noise:

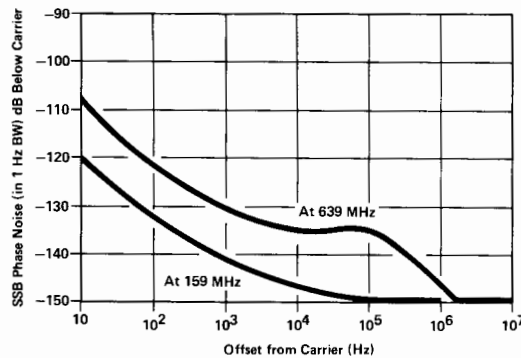

**Frequency switching speed:**<sup>4</sup> From 420  $\mu$ sec to 12.5 msec, depending on the programming mode.

### Ordering Information

8662A Synthesized Signal Generator

**Price**  
\$29,000

(Note: HP-IB cables not supplied; see page 30)

**Option 001:** Rear-panel RF output

add \$175

**Option 907:** Front handle kit

add \$40

**Option 908:** Rack flange kit

add \$30

**Option 909:** Rack flange & front handle kit

add \$65

**Option 910:** Extra Operating & Service Manual

add \$35

11721A External frequency doubler for operation to 2.56 GHz

\$285

11714A Service Support Kit (required for service)

\$450

<sup>1</sup>In the remote mode it is possible to have microprocessor clock related spurious signals spaced 3 MHz apart at an absolute level of typically less than -145 dBm.

<sup>2</sup>Spurious signals can be up to 3 dB higher in the dc FM mode.

<sup>3</sup>At a 50 Hz line frequency, power line or microphonically related spurious signals may be up to 3 dB higher and appear at offsets as high as 1 kHz from the carrier.

<sup>4</sup>Due to automatic leveling loop bandwidth changes, brief (30 msec) level inaccuracies may occur when switching through 150 kHz and 1 MHz RF output frequencies.





# SIGNAL GENERATORS

## Synthesized Signal Generators

Models 8660A and 8660C

- 10 kHz to 2600 MHz
- Synthesizer stability and accuracy
- 1 Hz resolution (2 Hz above 1300 MHz)
- Calibrated output over > 140 dB range
- AM, FM,  $\Phi$ M, or pulse modulation
- Fully TTL programmable

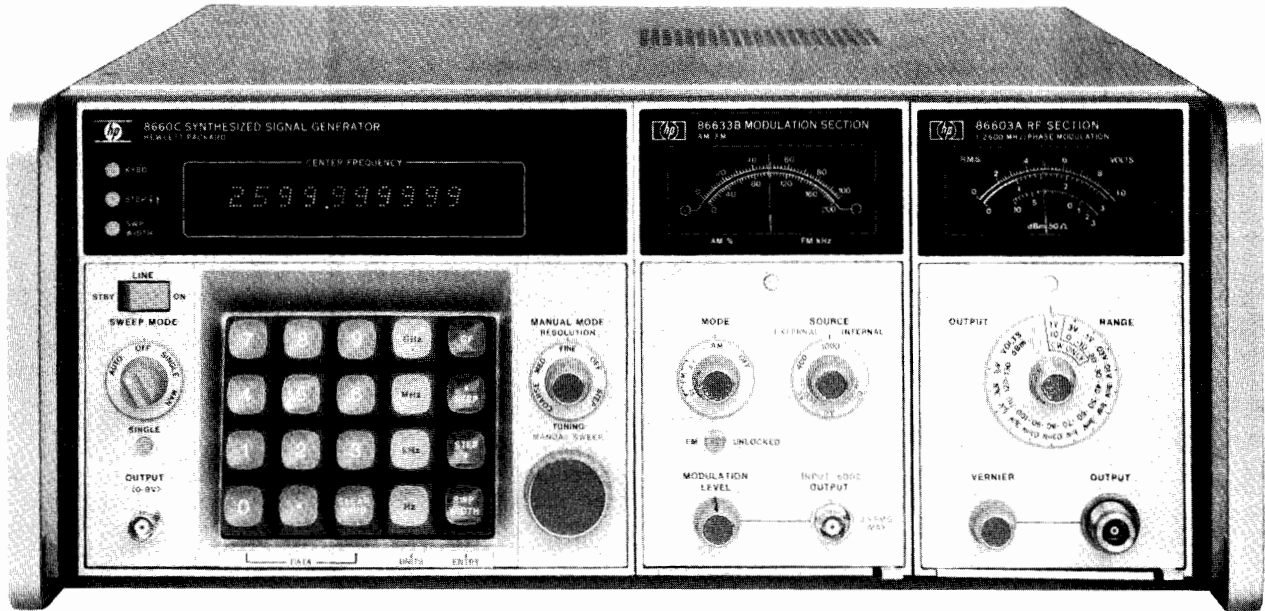

8660C



### 8660A, 8660C Synthesized Signal Generators System Concept

The 8660A/C family is a modular solid-state plug-in system. Each system includes: 1) a programmable synthesized signal generator mainframe, 2) at least one RF section plug-in, and 3) at least one modulation section. This modular plug-in construction allows an 8660 system to be configured for any specific application while minimizing the added expense of unnecessary features.

As its name implies, the 8660 is a true frequency synthesizer. Yet it is finding even broader appeal as a high performance signal generator. And being completely programmable, the 8660 is an excellent choice for most automated receiver or component testing situations.

#### Mainframes

There are two different synthesized signal generator mainframes to choose from. Both feature complete TTL programming of frequency, output levels, and most modulation functions. The standard programming interface is BCD and an optional HP-IB interface is available. Both mainframes can operate from an internal crystal reference or external frequency standard.

The 8660A mainframe uses thumbwheel switches to select CW output frequencies. Frequencies up to 1300 MHz can be entered directly with 1 Hz resolution. For applications requiring frequencies above 1300 MHz the 8660A must be used with the 86603A Option 003. The frequency selection process involves selecting one-half of the desired RF output frequency and activating the 86603A Option 003 front panel doubler switch.

The 8660C keyboard mainframe provides direct keyboard entry of CW frequencies up to 2600 MHz. Added capabilities of the 8660C include digital sweep, frequency stepping, synthesized search, and a ten-digit numerical display.

Swept testing of very narrowband devices such as crystal filters is made possible by the 8660C's digital sweep. Since the RF output consists of discrete synthesized steps, the result is a very linear sweep with extremely low residual FM. A 0-8 V horizontal sweep output is provided for driving XY plotters, oscilloscopes, etc.

For applications which require frequency to be changed in uniform increments, a frequency stepping capability is provided on the 8660C.

For example, if a receiver with 50 kHz channel spacing is being tested, a 50 kHz step size can be entered and the frequency stepped to the next higher or lower channel with a single keystroke.

Synthesized search provides the dial tuning convenience of a signal generator while maintaining synthesizer signal quality. As the dial is turned the output frequency is tuned up or down in discrete synthesized steps which may be chosen as small as 1 Hz.

#### Plug-In RF Sections

There are three RF sections to choose from. The 86601A covers the 10 kHz to 110 MHz frequency range with calibrated output of +13 to -146 dBm. The 86602B (used with the 11661B Frequency Extension Module) covers 1 MHz to 1300 MHz with output of +10 to -146 dBm. The 86603A (also used with the 11661B) covers 1 MHz to 2600 MHz with output of +7 to -136 dBm. All RF sections have 1 Hz frequency resolution except for 2 Hz above 1300 MHz with the 86603A. In the remote mode, output level can be programmed in 1 dB steps over the full operating range.

#### Plug-In Modulation Sections

There are five modulation sections to choose from. The 86632B and 86633B are both AM/FM modulation sections. An accurate modulation meter indicates % AM or FM peak deviation. The 86633B differs from the 86632B in that the carrier is phase locked for FM rates and deviations up to 100 kHz. The 86632B utilizes a free-running VCO during FM but allows rates and deviations up to 1 MHz. Any drift can be removed by depressing the FM CF CAL button.

The 86634A offers phase modulation at rates to 10 MHz and metered deviations to 100° below 1300 MHz and 200° above 1300 MHz. The 86635A  $\Phi$ M/FM Modulation Section is similar in performance to the 86634A except rates are limited to 1 MHz and FM capability is also included. (The 86634A and 86635A must be used with Option 002 RF sections.)

The 86631B Auxiliary Section provides both external AM and pulse modulation. The 86631B Auxiliary Section must be used when another modulation section is not installed.

All modulation functions of the 86632B, 86633B, and 86635A are fully programmable.

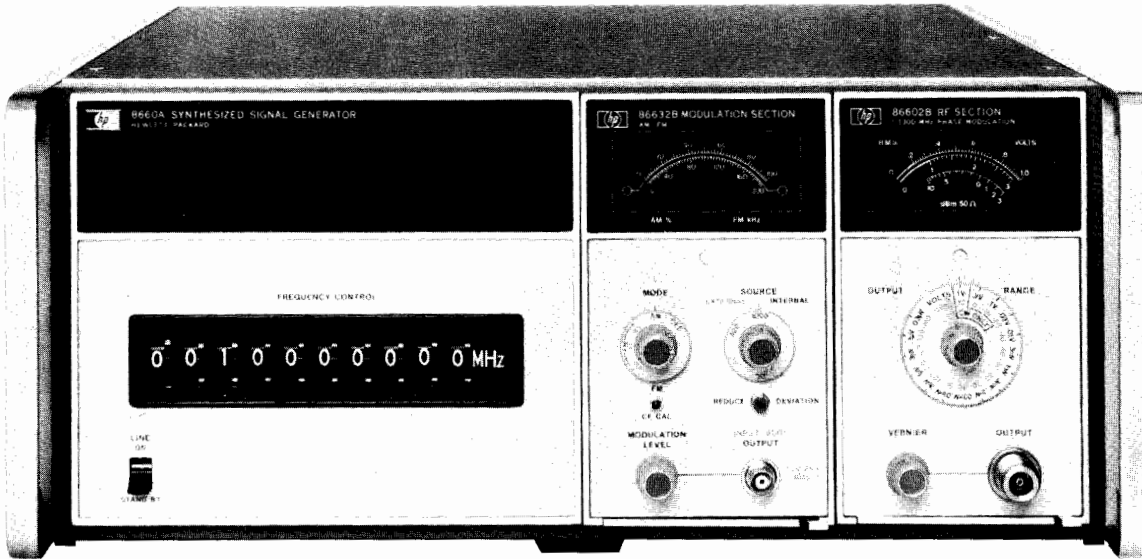

8660A



**8660A, 8660C Mainframe Specifications**

**Frequency accuracy and stability:** CW frequency accuracy and long term stability are determined by internal reference oscillator ( $3 \times 10^{-8}$ /day), or by external reference.

**Reference oscillator**

**Internal:** 10 MHz quartz oscillator. Aging rate less than  $\pm 3$  parts in  $10^8$  per 24 hours after 72 hours warm-up ( $\pm 3$  parts in  $10^8$  per 24 hours, Option 001).

**External:** rear panel switch allows operation from 5 MHz or 10 MHz frequency standard at a level between 0.5 V and 2.5 Vrms into 170 ohms.

**Reference output:** rear panel BNC connector provides output of reference signal selected at level of at least 0.5 Vrms into 170 ohms.

**Digital sweep (8660C):** auto, single, or manual. Selectable speeds 0.1, 1, or 50 seconds.

**Remote Programming Functions**

**8660A:** all front panel frequency and output level (and most modulation functions) are programmable.

**8660C:** CW frequency, frequency stepping (STEP $\uparrow$ , STEP $\downarrow$ ), and output level (and most modulation functions) are programmable. Note: digital sweep is NOT programmable.

**Programming input**

**Connector type:** 36-pin Cinch type 57 (mating connector supplied). Optional HP-IB interface; 24-pin Cinch type 57 (mating connector NOT supplied).

**Logic:** TTL compatible (negative true).

**Switching time:** less than 5 ms to be within 100 Hz of any new frequency selected. (Less than 100 ms to be within 10 Hz.)

**General**

**Operating temperature range:** 0 to +55°C.

**Power:** 100, 120, 220, or 240 volts +5%, -10%, 48-66 Hz. Approximately 350 watts.

**Weight (mainframe only):** net, 23.2 kg (51 lb); shipping, 28.6 kg (63 lb).

**Supplemental Characteristics**  
Typical single sideband phase noise

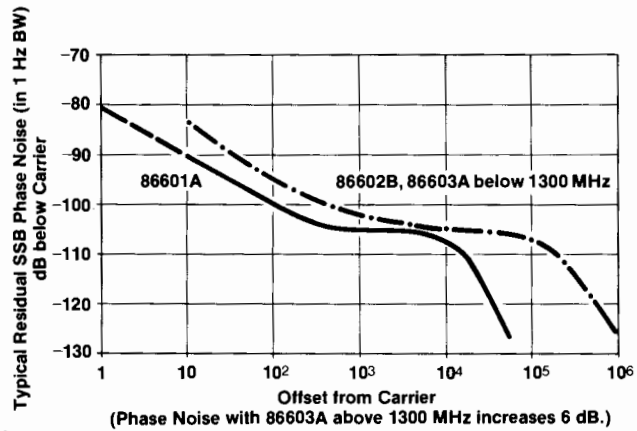

**RF Section Specifications** (Installed in 8660A or 8660C mainframe)

		86601A	86602B (with 11661B)	86603A (with 11661B)
FREQUENCY CHARACTERISTICS	Frequency Range	0.01-110 MHz (109.999999 MHz)	1-1300 MHz (1299.999999 MHz)	1-2600 MHz (2599.999998 MHz)
	Frequency Resolution	1 Hz	1 Hz	
	Harmonics	<-40 dBc	<-30 dBc (<-25 dBc above +3 dBm)	
	Spurious Non Harmonically Related	-80 dBc	-80 dBc below 700 MHz -80 dBc above 700 MHz within 45 MHz of carrier -70 dBc above 700 MHz >45 MHz from carrier -50 dBc on +10 dBm range	-74 dBc within 40 MHz of carrier <sup>1</sup> -64 dBc >45 MHz from carrier <-64 dBc
	Power Line Related (CW, AM, $\phi$ M only) <sup>2</sup>	-70 dBc	<-70 dBc	
	Signal To Phase Noise Ratio (CW, AM, $\phi$ M only) <sup>2</sup>	>50 dB	>45 dB	

<sup>1</sup>For output levels +3 dBm and below; slightly higher +3 to +7 dBm.

<sup>2</sup>Measured in a 30 kHz band centered on the carrier excluding a 1 Hz band centered on the carrier.



10 kHz to 110 MHz

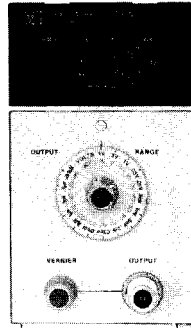

86601A

1 MHz to 1300 MHz

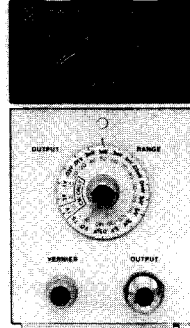

86602B

1 MHz to 2600 MHz

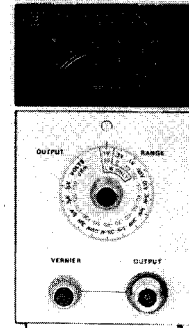

86603A

## RF Section Specifications (cont.)

		86601A	86602B (with 11661B)	86603A (with 11661B)		
		0.01-110 MHz	1-1300 MHz	1-1300 MHz	1300-2600 MHz	
OUTPUT CHARACTERISTICS	Output Level (into 50Ω)	+13 dBm to -146 dBm	+10 to -146 dBm	+10 to -136 dBm	+7 to -136 dBm <sup>3</sup>	
	Output Accuracy (local and remote)	±1 dB, +13 to -66 dBm ±2 dB, -66 to -146 dBm	±1.5 to -76 dBm ±2.0 to -146 dBm	±2.5 dB to -76 dBm <sup>3</sup> ±3.5 dB to -136 dBm		
	Flatness (output level variation with frequency)	< ±0.75 dB	< ±1.0 dB	< ±2.0 dB (1-2600 MHz)		
	Impedance	50Ω				
MODULATION CHARACTERISTICS	AM	AM Modulation Depth	0 to 95%	0 to 90% <sup>4</sup>	0 to 50% <sup>4</sup>	
		3 dB Bandwidth: 0-30%	200 Hz, CF < 0.4 MHz 10 kHz, 0.4 ≤ CF < 4 MHz 100 kHz, CF ≥ 4 MHz	10 kHz, CF < 10 MHz 100 kHz, CF ≥ 10 MHz	10 kHz	
		0-70%	125 Hz, CF < 0.4 MHz 6 kHz, 0.4 ≤ CF < 4 MHz 60 kHz, CF ≥ 4 MHz	6 kHz, CF < 10 MHz 60 kHz, CF ≥ 10 MHz	N/A	
		0-90%	100 Hz, CF < 0.4 MHz 5 kHz, 0.4 < CF < 4 MHz 50 kHz, CF ≥ 4 MHz	5 kHz, CF < 10 MHz 50 kHz, CF ≥ 10 MHz	N/A	
	Distortion, <sup>5</sup> THD at 30% AM at 70% AM at 90% AM	<1%, 0.4-110 MHz <3%, 0.4-110 MHz <5%, 0.4-110 MHz	<1% <3% <5%	<5% N/A N/A		
	FM	FM Rate	dc to 1 MHz with 86632B 20 Hz to 100 kHz with 86633B	dc to 200 kHz with 86632B and 86635A 20 Hz to 100 kHz with 86633B		
		Maximum Deviation (peak)	1 MHz with 86632B 100 kHz with 86633B	200 kHz with 86632B and 86635A 100 kHz with 86633B	400 kHz w/86632B, 86635A 200 kHz w/86633B	
		Distortion, THD (at rates up to 20 kHz)	<1% up to 200 kHz dev. <3% up to 1 MHz dev.	<1% up to 200 kHz dev.	<1% up to 400 kHz dev.	
	PULSE	Pulse Rise/Fall Time	200 ns	50 ns		
		ON/OFF Ratio (with pulse level control at max.)	>50 dB	>40 dB	>60 dB	
ΦM	ΦM Rate	N/A	dc to 1 MHz with 86635A dc to 1 MHz for CF < 100 MHz } with 86634A dc to 10 MHz for CF ≥ 100 MHz }			
	Maximum Peak Deviation	N/A	0 to 100 degrees	0 to 200 degrees		
	Distortion, THD	N/A	<5% up to 1 MHz rates <7% up to 5 MHz rates <15% up to 10 MHz rates			
GENERAL	Weight	Net 5 kg (11 lb) Shipping 6.8 kg (15 lb)	Net 4.1 kg (9 lb) Shipping 5.5 kg (12 lb)	Net 5 kg (11 lb) Shipping 6.4 kg (14 lb)		
		11661B: Net 2.3 kg (5 lb); shipping 2.7 kg (6 lb)				

3. For +3 to +7 dBm output levels, output accuracy and flatness will be slightly degraded (above 1300 MHz only).  
4. For RF output level meter readings from +3 dB to -8 dB and only at +3 dBm and below.

5. Applies only at 400 Hz and 1 kHz rates with output meter set between 0 and +3 dB. At -8 dB meter setting the distortion approximately doubles.  
6. Phase modulation is only possible with Option 002 RF Sections.

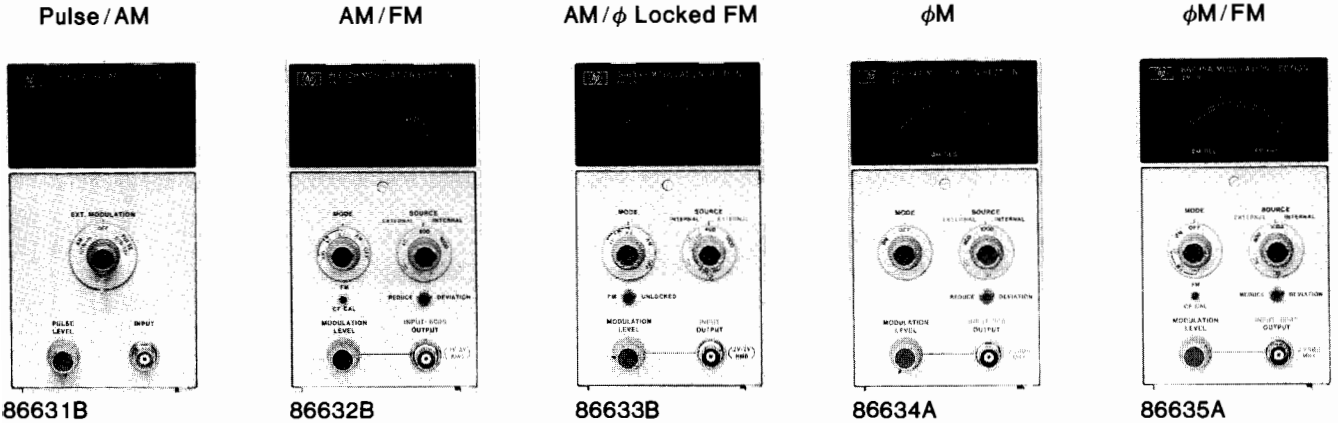

**Modulation Section Specifications**

		86631B	86632B	86633B	86634A	86635A
AM	Functions	Ext. Only	Int. and Ext.	Int. and Ext.	—	—
	Indicated Accuracy (at 400 and 1000 Hz rates)	—	±5% of full scale With 86601A RF Section: ± 7%, center frequency ≥100 MHz. With 86603A RF Section: ± 10%, center frequency ≥1300 MHz.		—	—
FM	Functions	—	Int. and Ext., FM CF CAL	Int. and Ext.	—	Int. and Ext., FM CF CAL
	Center Frequency Long Term Stability	—	Typically less than 200 Hz/h	Same as in CW Mode ( $3 \times 10^{-8}$ /day)	—	Typically less than 200 Hz/h
	Indicated Accuracy (up to 20 kHz rates)	—	±5% of full scale		—	±5% of full scale
Pulse	Functions	Ext. Only	—	—	—	—
φM	Functions	—	—	—	Int. and Ext.	Int. and Ext.
	Indicated Accuracy (15°C to 35°C)	—	—	—	±5% of full scale up to 100 kHz rates ±8% of full scale up to 2 MHz rates ±15% of full scale up to 10 MHz rates	
Meter		—	0—100% AM 0—10, 100, 1000 kHz FM Pk. Dev. (0—20, 200, 2000 kHz FM for CF ≥1300 MHz)	0—100% AM 0—10, 100 kHz FM Pk. dev. (0—20, 200 kHz FM for CF ≥1300 MHz)	0—100° Peak φM (0—200° for CF ≥ 1300 MHz)	0—10, 100, 1000 kHz FM, 0—100° Pk φM (0—20, 200, 2000 kHz FM, 0—200° Pk. φM for CF ≥1300 MHz)
Internal Modulation Source Output		None —	400 Hz and 1 kHz ±5% 200 mV minimum into 10kΩ. Available at front panel BNC connector			
Input Impedance		50Ω Pulse 600Ω AM	600Ω	600Ω	50Ω	600Ω
Weight		Net, 1.4 kg (3 lb) Shipping, 2.3 kg (5 lb)	Net, 2.7 kg (6 lb) Shipping, 4.1 kg (9 lb)	Net, 2.7 kg (6 lb) Shipping, 4.1 kg (9 lb)	Net, 1.8 kg (4 lb) Shipping, 3.2 kg (7 lb)	Net, 2.7 kg (6 lb) Shipping, 4.1 kg (9 lb)

**Ordering Information**

**8660A** Synthesized Signal Generator Mainframe \$7700  
**8660C** Synthesized Signal generator Mainframe \$10,500

**Options for 8660A, 8660C**

**Option 001:** ±3 x 10<sup>-9</sup>/day internal reference oscillator add \$210  
**Option 002:** no internal reference oscillator less \$300  
**Option 003:** operation from 50 to 400 Hz line add \$155  
**Option 004:** 100 Hz frequency resolution (200 Hz above 1300 MHz) less \$350  
**Option 005:** HP-IB programming interface \$250

**Note:** HP-IB cables not supplied, see page 30.  
**Option 009:** (8660A only) LED display indicates selected frequency in 1-2-4-8 BCD code add \$210  
**Option 100:** 11661B factory installed inside mainframe add \$4300  
**Option 908:** Rack Flange Kit \$20,500

**Price**

**86601A** RF Section \$4300  
**86602B** RF Section \$5375  
**86603A** RF Section \$7950  
**Option 001:** no RF output attenuator (all RF Sections) less \$600  
**Option 002:** adds phase modulation capability (86602B, 86603A only) add \$1650  
**Option 003:** allows operation of 86603A with 8660A mainframe add \$250

**11661B** Frequency Extension Module \$4300  
**86631B** Auxiliary Section \$300  
**86632B** AM/FM Modulation Section \$2350  
**86633B** AM/FM Modulation Section \$2500  
**86634A** φM Modulation Section \$1950  
**86635A** φM/FM Modulation Section \$2750  
**11672A** Service Accessory Kit \$650  
**11707A** Test Plug-in \$1100

# SIGNAL GENERATORS

## Synthesized signal generator

Model 8672A

- 2 to 18 GHz frequency range
- 1 to 3 kHz frequency resolution
- Low spurious and phase noise
- +3 to -120 dBm calibrated output
- $<5 \times 10^{-10}$ /day stability
- Metered AM/FM

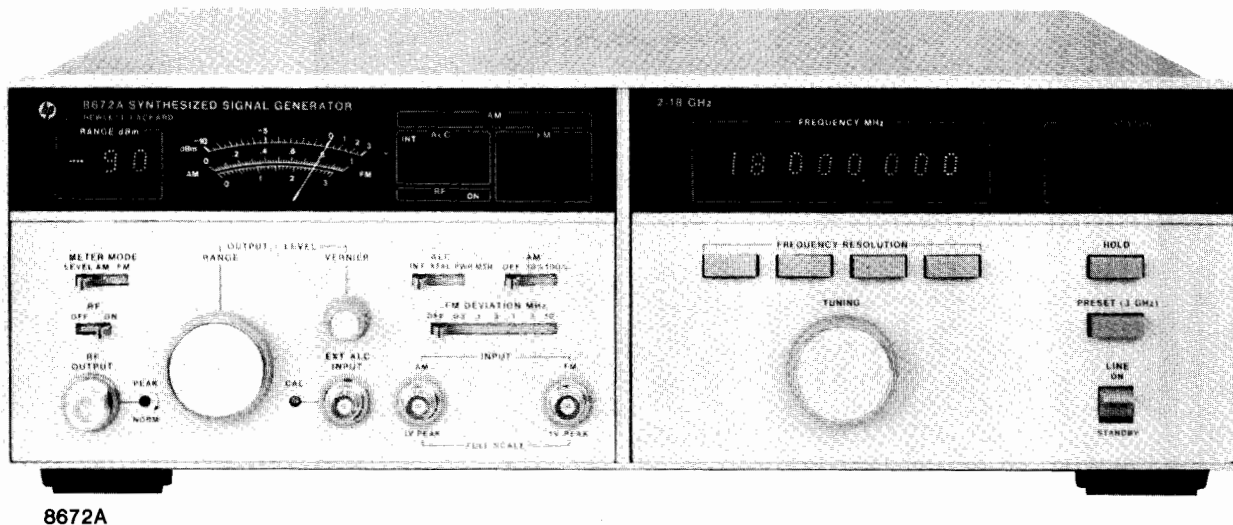

8672A



### 8672A Synthesized Signal Generator

The 8672A synthesized signal generator covers the entire 2.0 to 18.0 GHz frequency range in one compact solid-state package (133 mm, 5.25 in. high) while providing calibrated output and complete AM/FM modulation capability. The 8672A can replace two, three, or even four instruments in many applications.

#### Advanced Thin Film Technology

An indirect synthesis technique is used to phase lock a wideband 2.0 to 6.2 GHz YIG-tuned transistor oscillator (YTO) to the internal (or external) time base. The output of the YTO drives a YIG-tuned multiplier (YTM), a product made possible by HP's advanced microcircuit technology, to attain the 2 to 18 GHz coverage. The YTM produces spectrally pure harmonics of the input frequency and selects the proper harmonic automatically.

#### Excellent Spectral Purity

The 8672A has been designed for very low single-sideband phase noise (see figure 2). This characteristic is very important for LO

applications and many tests on communication and radar systems. Non-harmonic spurious signals are also controlled to prevent undesired responses. Such signals are -70 dBc from 2 to 6.2 GHz and -60 dBc from 12.4 to 18 GHz, excluding power line related frequencies.

#### Wide Dynamic Output Range

For broadband component and receiver testing applications the 8672A incorporates an exceptionally flat frequency response across the full 2 to 18 GHz range. The calibrated 110 dB RF step attenuator on the output results in accurate output control from +3 to -120 dBm, enabling very sensitive receiver tests to be made. For LO applications, an "overrange" position provides additional power at most frequencies across the full 2 to 18 GHz band. Even more power is available from the 8672A Option 008, which provides a leveled +8 dBm from 2 to 18 GHz. Typical maximum unleveled output power from both the 8672A and 8672A Option 008 are shown in figure 1.

#### Calibrated AM/FM Modulation

To expand the versatility of the 8672A for accurate receiver testing, AM/FM capability is provided (with externally applied modulation signals). AM depth at rates up to 100 kHz can be accurately set using the front panel meter. FM is allowed at rates and peak deviations up to 10 MHz. The meter can also be used to monitor peak deviations on any of six selectable ranges. Both AM depth and FM deviation are linearly controlled by varying the input voltage up to 1 volt maximum. The 8672A remains phase locked in both the AM and FM modes.

#### All Functions Fully Programmable

The 8672A provides full programmability of all its front panel functions: frequency, output level (in 1 dB steps), and modulation selection. The 8672A has an HP-IB interface (standard on all units) and can be used with any HP 9800 series calculator or minicomputer for automatic systems application.

#### Fast Pulse Capability Available

High performance pulse modulation of the 8672A output is available via the 11720A Pulse Modulator (see page 401). This pulse modulator provides >80 dB on/off ratios with 5 nanosecond (typical) rise and fall times over the 2 to 18 GHz range of the 8672A.

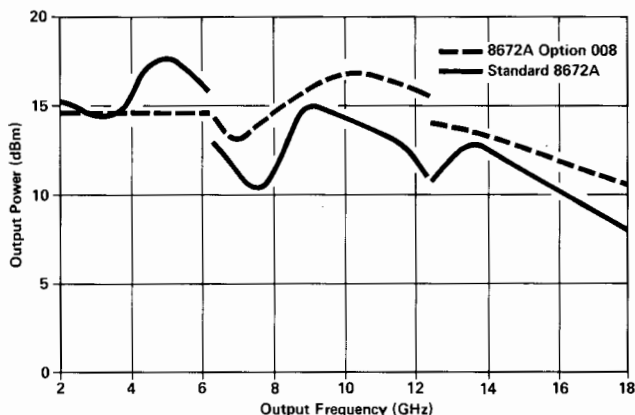

Figure 1. Maximum power typically available from standard and Option 008 instruments at 25°C.



## 8672A Specifications

(See technical data sheet for complete specifications)

### Frequency Characteristics

**Frequency range:** 2.0–18.0 GHz (with overrange to 18.599997 GHz).

**Frequency resolution:** 1 kHz to 6.2 GHz, 2 kHz to 12.4 GHz, 3 kHz to 18.0 GHz.

**Time base:** internal 10 MHz ( $<5 \times 10^{-10}$ /day aging rate) or external 5 or 10 MHz.

**Frequency switching time:**  $<15$  ms to be within 1 kHz, 2–6.2 GHz; 2kHz, 6.2–12.4 GHz; 3 kHz, 12.4–18 GHz.

### Spectral Purity

**Harmonics, subharmonics and multiples ( $\leq 18$  GHz):**  $<-25$  dBc.

**Single-sideband phase noise (1 Hz BW, CW mode):**

F <sub>c</sub>	Offset from F <sub>c</sub>				
	10Hz	100 Hz	1kHz	10kHz	100kHz
2.0-6.2 GHz	-58 dBc	-70 dBc	-78 dBc	-86 dBc	-110 dBc
6.2-12.4 GHz	-52 dBc	-64 dBc	-72 dBc	-80 dBc	-104 dBc
12.4-18.0 GHz	-48 dBc	-60 dBc	-68 dBc	-76 dBc	-100 dBc

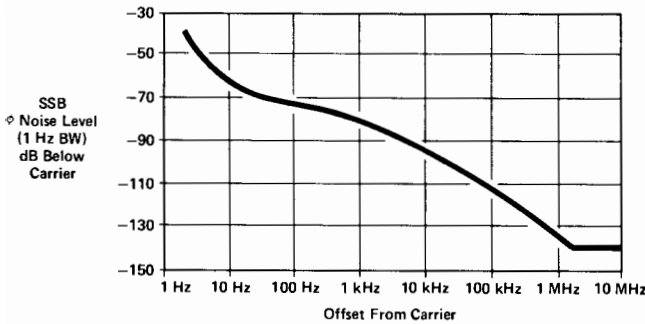

Figure 2. Typical 8672A single-sideband phase noise performance using the internal standard, 2.0-6.2 GHz.

### Spurious (CW and AM modes)

#### Non-harmonically related:

- $<-70$  dBc, 2.0-6.2 GHz.
- $<-64$  dBc, 6.2-12.4 GHz.
- $<-60$  dBc, 12.4-18.0 GHz.

**Power line related (CW mode, and within 5 Hz below line frequency, and multiples):**

F <sub>c</sub>	Offset from F <sub>c</sub>		
	$<300$ Hz	300 Hz to 1 kHz	$>1$ kHz
2.0-6.2 GHz	-50 dBc	-60 dBc	-65 dBc
6.2-12.4 GHz	-44 dBc	-54 dBc	-59 dBc
12.4-18.0 GHz	-40 dBc	-50 dBc	-55 dBc

### Output Characteristics

**Output level (+15°C to +35°C):** +3 to -120 dBm

**Total indicated meter accuracy (+15°C to +35°C):**

Frequency Range	Output Level Range			
	0 dBm	-10 dBm	-20 dBm	-30 dBm and below
2.0-6.2 GHz	$\pm 1.75$ dB	$\pm 2.25$ dB	$\pm 2.45$ dB	$\pm 1.75$ dB $\pm 0.3$ dB/10 dB step below 0 dBm range
6.2-12.4 GHz	$\pm 2.0$ dB	$\pm 2.5$ dB	$\pm 2.7$ dB	$\pm 2.0$ dB $\pm 0.3$ dB/10 dB step below 0 dBm range
12.4-18.0 GHz	$\pm 2.25$ dB	$\pm 2.85$ dB	$\pm 3.05$ dB	$\pm 2.25$ dB $\pm 0.4$ dB/10 dB step below 0 dBm range

**Remote programming accuracy:** 0.75 dB better than indicated meter accuracy.

**Flatness (+15°C to +35°C):**  $\pm 0.75$  dB, 2.0-6.2 GHz;  $\pm 1.00$  dB, 2.0-12.4 GHz;  $\pm 1.25$  dB, 2.0-18.0 GHz.

**Output level switching time:**  $<20$  ms.

**Source impedance:** 50Ω.

### Amplitude Modulation

**AM depth (for RF output meter readings  $\leq 0$  dB, +15°C to +35°C):**

0-75%, 2.0-6.2 GHz; 0-60%, 6.2-12.4 GHz; 0-50%, 12.4-18.0 GHz.

**Sensitivity:** 30%/V, 100%/V ranges. Max. input 1 V peak into 600Ω.

**Rates (3 dB BW):** 10 Hz-100 kHz.

**Indicated AM meter accuracy (100 Hz – 10 kHz rates):**  $\pm 5\%$  of range.

**Distortion (rates  $\leq 10$  kHz, RF output  $\leq 0$  dB, +15°C to +35°C):**  $<3\%$  at 30% depth.

### Frequency Modulation

**Peak deviation (max.):** the smaller of

10 MHz or  $f_{mod} \times 5$ , 2.0–6.2 GHz.

10 MHz or  $f_{mod} \times 10$ , 6.2–12.4 GHz.

10 MHz or  $f_{mod} \times 15$ , 12.4–18.0 GHz.

**Sensitivity:** 30, 100, 300 kHz/V and 1, 3, 10 MHz/V ranges; max. input 1 volt peak into 50Ω.

**Rates (3 dB BW typical):** 30, 100 kHz/V ranges: 50 Hz to 10 MHz; 300 kHz/V and 1, 3, 10 MHz/V ranges: 1 kHz to 10 MHz.

**Distortion:**  $<12\%$  for rates  $<3$  kHz decreasing linearly with frequency to 5% at 20 kHz;  $<5\%$  for 20 kHz to 100 kHz rates.

**Indicated FM meter accuracy (100 kHz rate, +15°C to 35°C):**  $\pm 10\%$  of full scale.

**Residual FM in FM and CW modes, 2-6.2 GHz:**

Range	Post Detection BW	
	20 Hz–1 kHz <sup>1</sup>	20 Hz–3kHz <sup>1</sup>
CW, 30, 100, 300 kHz/V; and 1, 3, MHz/V	6 Hz rms	12 Hz rms
10MHz/V	10 Hz rms	20 Hz rms

<sup>1</sup>Residual FM doubles for 6.2–12.4 GHz, triples for 12.4–18 GHz

### Remote Programming Capability

**Frequency:** programmable over full range with same resolution as in manual mode.

**Output level:** programmable over full range in 1 dB steps.

**AM modulation:** OFF, 30%/V, and 100%/V ranges.

**FM modulation:** OFF, 30, 100, 300 kHz/V and 1, 3, 10 MHz/V ranges.

**Other:** RF ON/OFF, ALC INT./EXT. (crystal or power meter).

**Programming format:** HP-IB (Hewlett-Packard Interface Bus).

### General

**Operating temperature range:** 0 to +55°C.

**Power:** 100, 120, 220, 240 V +5, -10%; 48-66 Hz; 300 VA max.

**Weight:** net, 27 kg (60 lb); shipping, 32.5 kg (72 lb).

**Size:** 133 mm H x 425 mm W x 603 mm D (5.25" x 16.75" x 23.75").

### Ordering Information

**8672A Synthesized Signal Generator**

(Note: HP-IB cable not supplied with instrument. See page 30)

	<b>Price</b>
<b>8672A Synthesized Signal Generator</b>	<b>\$31,600</b>
<b>Option 001:</b> No RF output attenuator	less \$600
<b>Option 002:</b> No internal reference oscillator	less \$550
<b>Option 003:</b> Operation at 400 Hz line only	add \$250
<b>Option 004:</b> Rear panel RF output	add \$ 75
<b>Option 005:</b> Rear panel RF output without RF attenuator	less \$525
<b>Option 006:</b> Chassis slide kit	add \$ 45
<b>Option 008:</b> +8 dBm output level	add \$3500
<b>Option 907:</b> Front panel handle kit	add \$32
<b>Option 908:</b> Rack mounting flange kit	add \$25
<b>Option 909:</b> Front panel handle kit plus rack mounting flange kit	add \$55
<b>Option 910:</b> Extra manual	add \$25
<b>11712A Support Kit</b>	<b>\$525</b>

# SIGNAL GENERATORS

## Microwave frequency synthesizer

### Model 8671A

- 2-6.2 GHz frequency range
- 1 kHz frequency resolution
- $<5 \times 10^{-10}$ /day stability
- Low spurious and phase noise
- +8 dBm minimum output power
- HP-IB programmability

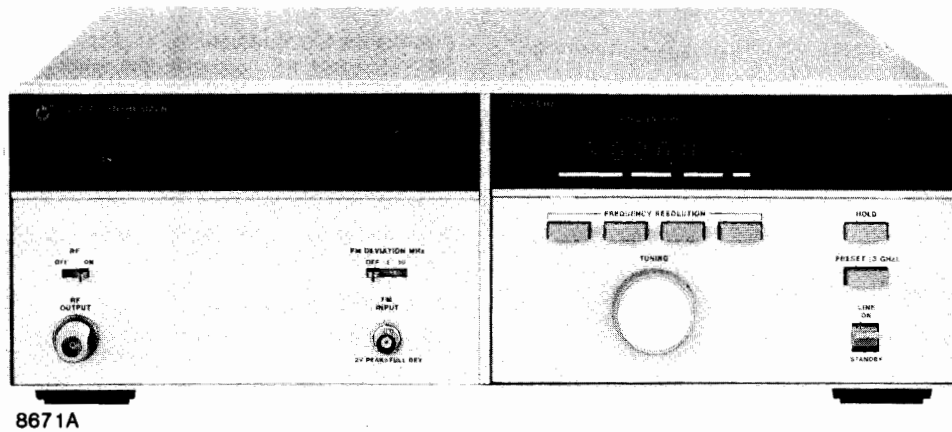

### 8671A Synthesizer

The 8671A microwave frequency synthesizer covers the frequency range of 2.0 to 6.2 GHz in 1 kHz steps with excellent stability and spectral purity. It is well suited for most LO applications that require state-of-the-art performance as well as broadband capability.

#### Spectral Purity

Spurious responses (except power line related) are greater than 70 dB below the carrier across the full frequency band. Phase noise, a critical parameter in many applications, is low enough to permit extremely sensitive measurements.

#### Output Power

The 8671A has a guaranteed output of +8 dBm at all frequencies. This is well within the operating range of most commercial mixers. However, for the few applications requiring greater power, the 8671A produces clean outputs as high as +10 dBm at many frequencies.

#### Wideband FM

The 8671A also has frequency modulation capability at rates up to 10 MHz and peak deviations up to 10 MHz (with externally applied signals). Carrier phase-lock is maintained in the FM mode.

#### HP-IB Programmability

The standard programming interface offered with the 8671A is directly compatible with the Hewlett-Packard Interface Bus. Programmable functions include frequency, FM, and RF ON/OFF.

### 8671A Specifications

(See technical data sheet for complete specifications.)

#### Frequency Characteristics

- Frequency range:** 2.0-6.2 GHz (6.199999 GHz).
- Frequency resolution:** 1 kHz.
- Time base:** internal 10 MHz ( $<5 \times 10^{-10}$ /day aging rate) or external 5 or 10 MHz.
- Switching time:**  $<15$  ms to be within 1 kHz.
- Harmonics:**  $<-15$  dBc.
- Single-sideband phase noise (1 Hz BW, CW mode)**

	Offset from $F_c$				
	10 Hz	100 Hz	1 kHz	10 kHz	100 kHz
SSB level	-58 dBc	-70 dBc	-78 dBc	-86 dBc	-110 dBc

#### Spurious

- Non-harmonically related:**  $<-70$  dBc.
- Power line related (CW mode, and within 5 Hz below any line related frequency)**

	Offset from $F_c$		
	$<300$ Hz	300 Hz to 1 kHz	$>1$ kHz
Power line spurious	-50 dBc	-60 dBc	-65 dBc

### Output Characteristics

**Power (unleveled):** +8 dBm (min.), +15 to 35°C.

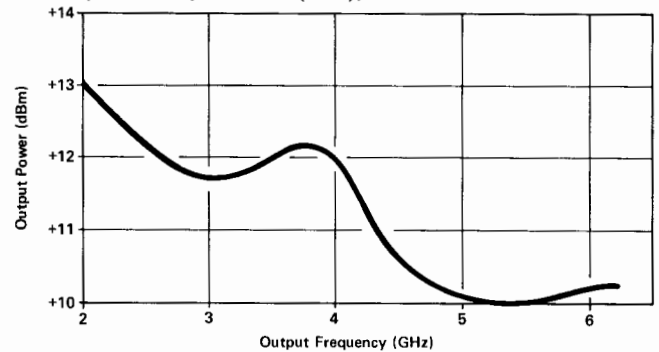

Figure 1. Typical output power available.

**Flatness:**  $<6$  dB total variation across full frequency band.

**Source impedance:** 50Ω

#### Frequency Modulation

- Peak deviation (max):** 10 MHz or  $f_{mod} \times 5$ , whichever is smaller.
- Sensitivity:** 50 kHz/V and 5 MHz/V ranges; max input 2V peak.
- Rates (3 dB BW):** 50 Hz to 10 MHz typical.

#### Remote Programming

- Frequency:** programmable over full range with 1 kHz resolution.
- FM modulation:** OFF, 50 kHz/V, and 5 MHz/V ranges.
- Other:** RF ON/OFF.
- Programming format:** HP-IB (Hewlett-Packard Interface Bus).

#### General

- Operating temperature range:** 0 to 55°C.
- Power:** 100, 120, 220, or 240 V +5, -10%; 48-66 Hz; 300 VA max.
- Weight:** net, 24 kg (53 lb); shipping, 29.5 kg (65 lb).
- Size:** 133 H x 425 W x 603 mm D (5.25" x 16.75" x 23.75").

#### Ordering Information

**8671A Microwave Frequency Synthesizer**  
(Note: HP-IB cable not supplied. See page 30.)

- |   |              |
|---|--------------|
| <b>Option 002:</b> No internal reference                            | less \$550   |
| <b>Option 003:</b> Operation at 400 Hz line only                    | add \$250    |
| <b>Option 005:</b> Rear panel RF output                             | add \$ 75    |
| <b>Option 006:</b> Chassis slide kit                                | add \$ 45    |
| <b>Option 907:</b> Front panel handle kit                           | add \$32     |
| <b>Option 908:</b> Rack mounting flange kit                         | add \$25     |
| <b>Option 909:</b> Front panel handle plus rack mounting flange kit | add \$55     |
| <b>Option 910:</b> Extra manual                                     | add \$30     |
| <b>11712A Support Kit</b>   | <b>\$525</b> |

**Price**  
**\$18,500**



- 0.5 to 512 MHz frequency range with optional coverage to 1024 MHz
- +19 to -145 dBm output power range
- Low broadband and close-in noise
- Calibrated, metered AM and FM
- The 8640B also features: internal phase lock / synchronizer, external counter to 550 MHz

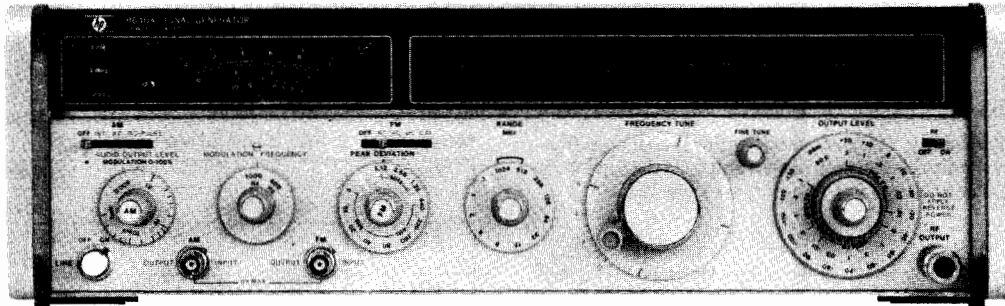

8640A (with Option 002)

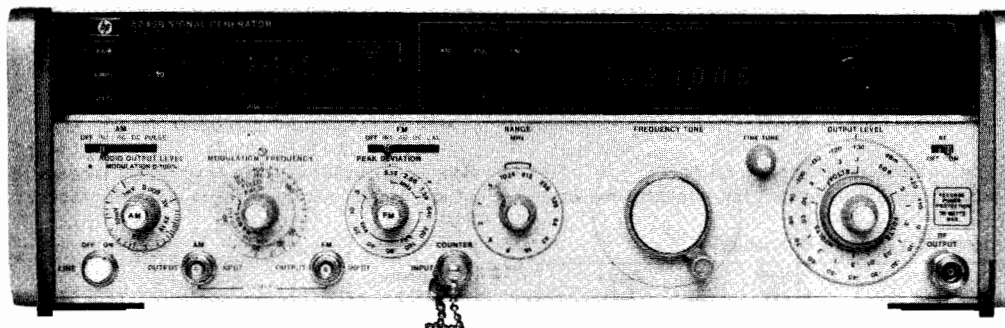

8640B (with Option 001, 002, 003)

### 8640A and 8640B Signal Generators

The 8640 Signal Generator covers the frequency range 500 kHz to 512 MHz (450 kHz to 550 MHz with band overrange) and can be extended to 1024 MHz with an internal doubler (Opt 002). Using the 11710B Down Converter, the 8640 frequency range can be extended down to 10 kHz. An optional audio oscillator (Opt 001) is also available with a frequency range of 20 Hz to 600 kHz. This broad coverage, together with calibrated output and modulation, provides for complete RF and IF performance tests on virtually any type of HF, VHF, or UHF receiver.

Both solid state generators, 8640A and B have an output level range of +19 to -145 dBm (2V to 0.013  $\mu$ V) which is calibrated, metered, and leveled to within  $\pm 0.5$  dB across the full frequency range of the instrument.

The 8640A/B generators provide AM, FM, and pulse modulation for a wide range of receiver test applications. This modulation is calibrated and metered for direct readout under all operating conditions.

A reverse power protection option (Opt 003) is available to eliminate instrument damage due to accidental transmitter keying. This module protects against up to 50 watts of applied power and automatically resets upon removal of the excessive signal.

#### Spectrally Pure Output Signals

Noise performance of the 8640 is state-of-the-art for a solid-state generator. The high-Q cavity oscillator has been optimized with use of a low-noise microwave transistor for spectrally pure output signals. At 20 kHz offsets from 230 to 450 MHz, SSB phase noise is  $> 130$  dB/Hz below the carrier level and rises to 122 dB/Hz at 550 MHz. The SSB phase noise level decreases by approximately 6 dB for each division of the output frequency down to the broadband noise floor of better than 140 dB/Hz. This exceptional noise performance is also preserved during FM modulation and in the phase-locked mode of the 8640B.

#### Mechanical Dial or Built-in Counter

There are two versions of the 8640 Signal Generators. One, the 8640A, has an easy-to-read slide rule dial with scales for each of the 10 output frequency ranges. There is an additional scale to provide direct readout of the output frequency even in the INTERNAL DOUBLER band, 512-1024 MHz.

The 8640B has the same performance features as the 8640A, but incorporates a built-in 550 MHz frequency counter and phase lock synchronizer.

The built-in 6 digit counter displays the output frequency and can also be used to count external input signals from 20 Hz to 550 MHz. This eliminates the need for a separate frequency counter in many measurement systems.

#### Internal Pushbutton Synchronizer

At the push of a button, the 8640B built-in phase lock synchronizer locks the RF output frequency to the crystal time base used in the counter. In this locked mode, the output stability is better than  $5 \times 10^{-8}/h$  and the spectral purity and FM capability of the unlocked mode are preserved. For higher stability, it is possible to lock to an externally applied 5 MHz standard. Two 8640B's can also be locked together for various 2-tone measurements.

In the phase locked mode, increased resolution is available by using the  $\frac{1}{2}$  digit increment button. For example, 500 Hz resolution is possible for frequencies between 100 and 1000 MHz.

#### FM while Phase Locked

In the phase locked mode, full FM capability is preserved down to modulation rates of 50 Hz. The narrow bandwidth of the phase lock loop ( $< 5$  Hz) provides for FM modulation up to 250 kHz rates and assures no degradation in noise from the unlocked mode. This crystal stability, coupled with the precision modulation and low noise, makes the 8640B ideal for testing narrowband FM or crystal-controlled receivers.



# SIGNAL GENERATORS

Precision, high stability, AM-FM VHF signal generator

Models 8640A, 8640B (cont.)

## 8640A and 8640B Specifications

(See technical data sheet for complete specifications). All specifications apply over the nominal frequency ranges and over the top 10 dB of the output level vernier range unless otherwise specified.

### Frequency

**Range:** 500 kHz to 512 MHz in 10 octave ranges (to 1024 MHz with option 002 internal frequency doubler).

**Ranges and range overlap:** ranges extend 10% below and 7% above the nominal frequency ranges shown below.

Frequency ranges (MHz)		
0.5-1	8-16	128-256
1-2	16-32	256-512
2-4	32-64	512-1024
4-8	64-128	(opt 002)

### Fine Tuning

**8640A and 8640B unlocked:** > 1000 ppm total range.

**8640B locked mode:** > ± 20 ppm by varying internal time base vernier.

**Internal counter resolution (8640B unlocked)**

Frequency Ranges (MHz)	Normal Mode	Expand X10	Expand X100
0.5-1	10 Hz	1 Hz	0.1 Hz
1-16	100 Hz	10 Hz	1 Hz
16-128	1 kHz	100 Hz	10 Hz
128-1024	10 kHz	1 kHz	100 Hz

**Optimum counter resolution when phase-locked (8640B)**

Frequency Ranges (MHz)	With 6 Digits	+½ Digit
0.5-0.9999995	1 Hz	0.5 Hz
1.0-9.999995	10 Hz	5 Hz
10.0-99.99995	100 Hz	50 Hz
100.0-999.9995	1 kHz	500 Hz
1000-1024	10 kHz	5 kHz

### Accuracy

**8640A:** mechanical dial; accuracy better than ± 1.0%, resettability better than 0.1%.

**8640B:** 6½ digit LED display with X10 and X100 expand; accuracy depends on internal or external reference used.

**Stability (after 2 hour warmup)**

**Normal:** < 10 ppm/10 min.

**Locked:** (8640B) < 0.05 ppm/h.

**Restabilization time after frequency change**

**Normal:** < 15 min.

**Locked (8640B):** < 1 min. after relocking to be within 0.1 ppm of steady state frequency.

### Output

**Range:** 10 dB steps and 18 dB vernier provide the following output power settings into 50Ω.

Frequency Range (MHz)	8640A/B	With Option(s)		
		002	003	002/003
0.5 to 512	+19 to -145 dBm	+18.5 to -145 dBm	+18.5 to -145 dBm	+18 to -145 dBm
512 to 1024 (Option 002)		+13 to -145 dBm		+12 to -145 dBm

**Level flatness (referred to output at 50 MHz and applies to 1 V range and for top 10 dB of vernier range)**

Frequency Range (MHz)	8640A/B	With Option(s)		
		002	003	002/003
0.5 to 64	± 0.5 dB	± 0.5 dB	+0.75 dB -1.25 dB	+1.0 dB -2.0 dB
64 to 512		± 1.0 dB		
512 to 1024 (Option 002)		± 1.5 dB		± 2.0 dB

**Level accuracy:** (worst case as indicated on level meter) ± 1.5 dB to ± 4.5 dB depending on level, frequency, and options installed.

### Spectral Purity

**Harmonics (at 1 volt, +10 dBm output range and below):**

> 30 dB below fundamental, 0.5 to 512 MHz.

> 12 dB below fundamental, 512 to 1024 MHz (option 002).

**Spurious output signals (excluding frequencies within 15 kHz of the signal whose effects are specified in residual AM and FM)**

Frequency Range (MHz)	Subharmonically Related		Non-harmonically Related	
	8640A	8640B	8640A	8640B
0.5 to 512	none detectable	> 100 dBc	none detectable	> 100 dBc
512 to 1024 (Option 002)	> 20 dBc <sup>1</sup>			

<sup>1</sup>dBc = dB below the carrier.

**Residual AM (averaged rms):** 0.3 to 3 kHz post-detection noise bandwidth > 85 dBc.

**Residual FM (averaged rms):** 0.3 to 3 kHz post-detection noise bandwidth. (CW and up to ¼ maximum allowable peak deviation.)

0.5 to 512 MHz < 5 Hz.

512 to 1024 MHz < 10 Hz.

**Measured SSB noise (typical):** in graph below, triangular markers indicate specified limits

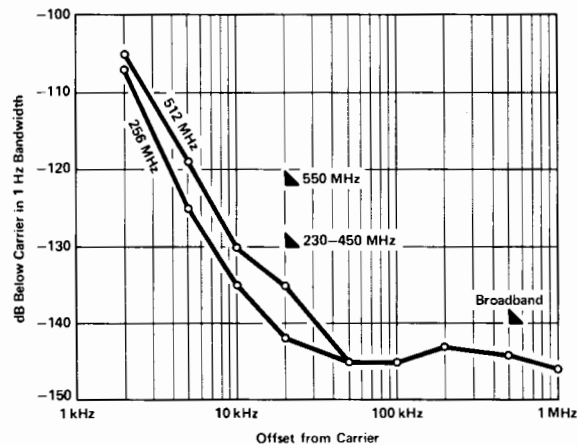



## Modulation

### General

**Types:** Internal AM and FM; External AM, FM, and PULSE; simultaneous AM and FM or PULSE and FM.

**Internal modulation sources** (independently adjustable output level is available at front panel):

**Standard:** 8640A or 8640B.

**Frequency:** fixed 400 Hz and 1 kHz,  $\pm 3\%$ .

**Output level:** 1 mV to 1 V rms into 600 $\Omega$ .

**Optional** (internal variable audio oscillator Option 001, 8640A or 8640B):

**Frequency:** variable 20 Hz to 600 kHz,  $\pm 15\%$  plus fixed 400 Hz and 1 kHz  $\pm 3\%$ .

**Output level:** 1 mV to 3 V rms into 600 $\Omega$ .

### Amplitude Modulation

#### Depth

**0.5 to 512 MHz:** 0 to 100% for output levels from +13 dBm and below.

**512 to 1024 MHz:** 0 to 100% for output levels of +7 dBm and below, excluding the top 6 dB of output vernier range.

**AM Rates:** INT and EXT ac, 20 Hz to AM 3 dB bandwidth; EXT dc, dc to AM 3 dB bandwidth.

#### AM 3 dB bandwidth

Frequency Ranges	0 to 50% AM	50 to 90% AM
0.5 to 2 MHz	20 kHz	12.5 kHz
2 to 8 MHz	40 kHz	25 kHz
8 to 512 MHz	60 kHz	50 kHz
512 to 1024 MHz	60 kHz	50 kHz

#### AM distortion (at 400 Hz and 1 kHz rates)

Frequency Ranges	0 to 30% AM	30 to 50% AM	50 to 80% AM
0.5 to 512 MHz	<1%		<3%
512 to 1024 MHz	<10%	<20%	

#### External AM sensitivity (400 Hz and 1 kHz rates)

**0.5 to 512 MHz:** (0.1  $\pm$  0.005)% AM per mV peak into 600 $\Omega$  with AM vernier at full clockwise position.

**512 to 1024 MHz:** nominal 0.1% AM per mV peak into 600 $\Omega$  with AM vernier at full clockwise position.

#### Indicated AM accuracy (400 Hz and 1 kHz rates using internal meter)

**0.5 to 512 MHz:**  $\pm 5.5\%$  of reading  $\pm 1.5\%$  of full scale from 0 to 50°C.

**512 to 1024 MHz:** not specified; each generator can be individually calibrated using operating manual procedure.

#### Peak incidental phase modulation (at 30% AM)

**0.5 to 128 MHz:** <0.15 radian.

**128 to 512 MHz:** <0.3 radian.

**512 to 1024 MHz:** <0.6 radian.

**Peak incidental frequency deviation:** equals peak incidental phase modulation x modulation rate.

### Pulse Modulation<sup>1</sup>

	Frequency Ranges (MHz)					
	0.5-1	1-2	2-8	8-32	32-512	512-1024
Rise and Fall Times	<9 $\mu$ s	<4 $\mu$ s	<2 $\mu$ s	<1 $\mu$ s		<1 $\mu$ s typical
Pulse Repetition Rate	50 Hz to 50 kHz		50 Hz to 100 kHz	50 Hz to 250 kHz	50 Hz to 500 kHz	
Pulse Width Minimum <sup>2</sup>	10 $\mu$ s		5 $\mu$ s	2 $\mu$ s		
Pulse ON/OFF ratio at max. vernier	>40 dB				>60 dB	
Peak Input Required	Nominally +0.5 V (5 V max). Sinewave or Pulse return to zero into 50 $\Omega$ .					

<sup>1</sup>Pulse performance degrades below 500 Hz repetition rates.

<sup>2</sup>For level accuracy within 1 dB of CW (>0.1% duty cycle).

### Frequency Modulation

**Deviation:** maximum allowable deviation equals 1% of lowest frequency in each nominal output frequency range.

Frequency Range (MHz)	Maximum Peak Deviation (kHz)
0.5-1	5
1-2	10
2-4	20
4-8	40
8-16	80
16-32	160
32-64	320
64-128	640
128-256	1280
256-512	2560
512-1024	5120

**FM 3 dB Bandwidth:** internal and external ac, 20 Hz to 250 kHz; external dc, dc to 250 kHz. (8640B locked mode: FM above 50 Hz only.)

#### FM distortion (at 400 Hz and 1 kHz rates):

<1% for deviations up to 1/3 maximum allowable.

<3% up to maximum allowable deviation.

**External FM sensitivity:** 1 volt peak into 600 $\Omega$  yields maximum deviation indicated on PEAK DEVIATION switch with FM vernier at full clockwise position.

**Indicated FM accuracy (400 Hz and 1 kHz rates from 15° to 35°C, using internal meter):**  $\pm$  (7% of reading +1.5% of full scale).

#### Incidental AM (at 400 Hz and 1 kHz rates)

**0.5 to 512 MHz:** <0.5% AM for FM up to 1/3 maximum allowable deviation; <1% AM for FM at maximum allowable deviation.

**512 to 1024 MHz (Opt 002):** <1% AM for FM up to 1/3 maximum allowable deviation.

### Counter (8640B)

#### External RF Input

**Frequency range:** 1 Hz to 550 MHz.

**Sensitivity:**  $\geq 100$  mV rms into 50 $\Omega$ , ac only.

**Resolution:** 6-digit LED DISPLAY.

Mode	Normal	Expand X10	Expand X100
0-10 MHz	100 Hz	10 Hz	1 Hz
10-550 MHz	10 kHz	1 kHz	100 Hz

**External reference input:** 5 MHz, nominally >0.5 V p-p (5 V maximum) into 1 k $\Omega$ .

#### Internal Reference (after 2 h warm-up and calibration at 25°C)

**Aging Rate:** <0.05 ppm/h; <2 ppm/90 days.

#### Temperature Drift:

<  $\pm 2$  ppm from 15° to 35°C.

<  $\pm 10$  ppm from 0° to 50°C.

**Typical Overall Accuracy (within 3 months of calibration and from 15° to 35°C):**  $\pm 2$  ppm.

### General

**Operating temperature range:** 0 to 55°C.

**Power Requirements:** 100 or 120 volts (+5%, -10%) from 48 to 440 Hz; or 220 or 240 volts (+5%, -10%) from 48 to 66 Hz. 175 VA max (Option 002: 190 VA max).

**Weight (8640A and 8640B):** net, 20.8 kg (46 lb); shipping, 24.1 kg (53 lb).

**Dimensions:** 140 H x 425 W x 476 D (5.5" x 16.75" x 18.75").

#### Ordering Information

**8640A** Signal Generator \$6000

**8640B** Signal Generator \$7500

**Option 001:** internal variable audio oscillator,

20 Hz to 600 kHz (8640A/B) add \$275

**Option 002:** internal doubler 512-1024 MHz (8640A/B) add \$850

**Option 003:** reverse power protection (8640A/B) add \$300

**Option 004:** avionics option (8640B only) add \$800

**Option 908:** Rack mount kit add \$22

**Option 910:** Extra Operating and Service manual add \$25

# SIGNAL GENERATORS

Avionics VHF signal generator

Model 8640B Option 004

• Demodulated output from RF detector, ac and dc

• Phase shift less than 0.01° at 30 Hz

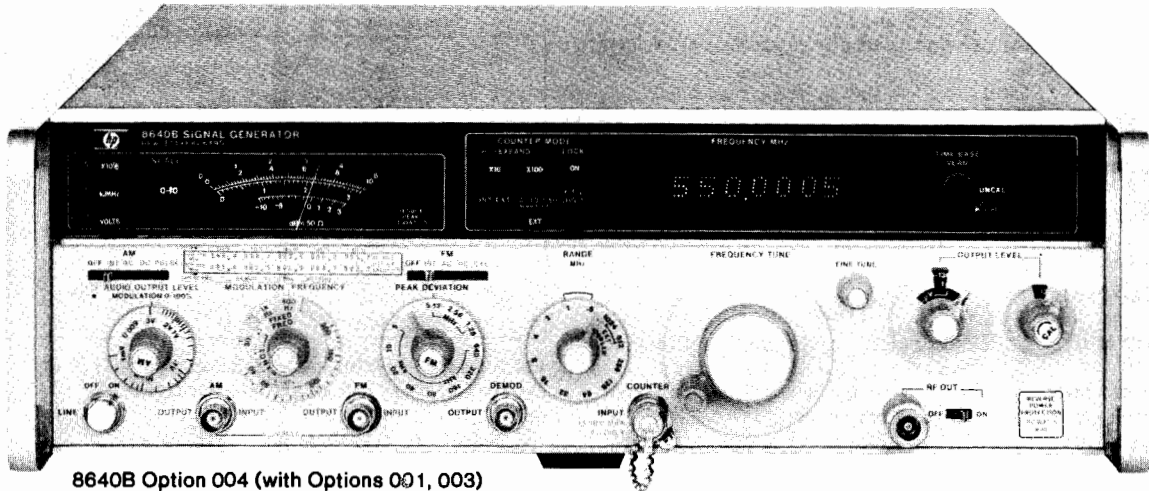

8640B Option 004 (with Options 001, 003)

## 8640B Avionics Option 004 Signal Generator

The Hewlett-Packard Model 8640B Option 004 NAV/COM Signal Generator is an 8640B AM/FM Signal Generator specially adapted for testing ILS (Marker Beacon, Localizer and Glide Slope), VOR and VHF communications receivers used throughout the aviation industry. VOR, LOCALIZER and VHF communications frequencies (108 to 136 MHz) are available on one frequency band for rapid channel selection. GLIDE SLOPE (329 to 335 MHz) and MARKER BEACON (75 MHz) frequencies are also easily set using the 6-digit LED display.

The 8640B Option 004 provides highly stable, spectrally pure RF signals for testing narrow-channel, crystal controlled receivers. For avionics testing, external audio generators are required to provide the composite modulation. Designed with versatile AM and FM modulation, Option 004 features low distortion modulation when used with suitable, external VOR/ILS Audio Generators.

Operation and specifications of the 8640B Option 004 are the same as the Standard 8640B AM/FM Signal Generator with the following additions:

### Demodulated Output

One front panel BNC connector provides demodulated output from the RF peak detector for precise AM settings. A choice of combined ac/dc at 1 V rms or ac only at 5 V rms is provided.

### Output Level Setting

To ensure the best possible demodulated output linearity, Option 004 combines a 10 dB step attenuator and a 1 dB step attenuator with a vernier. This provides output levels from +15 dBm to -142 dBm (1.3 V to 0.018  $\mu$ V). The output level can be read directly from the attenuator dial in dBm or from the front panel meter in dBm or volts.

### External AM Input Impedance

External AM input impedance of 2 k $\Omega$  allows compatible operation with old and new generations of external audio generators.

### Low Distortion Modulation

The 8640B Option 004 provides flat AM response and minimum phase shift at 30 Hz and 9960 Hz as well as constant group delay between 9 kHz and 11 kHz for accurate VOR and ILS testing.

## 8640B Option 004 Specifications

(These specifications apply to 8640B Option 004 in addition to standard 8640B specifications. See 8640B AM/FM Signal Generator technical data for complete specifications.)

### Spectral Purity

**Noise:** SSB broadband noise floor greater than 1 MHz offset from carrier: > 130 dB down.

## Output Characteristics

**Range:** +15 dBm to -142 dBm (1.3 V to 0.018  $\mu$ V).

**Attenuators:** a 10 dB step attenuator plus a 1 dB step attenuator with vernier allow selection of any output level over the full output level range.

**Vernier:** 2 dB continuously variable from a CAL detent position.

**Level flatness:** <  $\pm 0.75$  dB from 0.5 to 512 MHz referred to output at 190 MHz; <  $\pm 0.5$  dB from 108 to 336 MHz referred to output at 190 MHz. (Flatness applies from +10 to -10 dBm.)

**Level accuracy:**

Output Level (dBm)	+15 to -10	-10 to -50	-50 to -142	With Option 003
Total Accuracy as Indicated on Level Meter	$\pm 1.5$ dB	$\pm 2.0$ dB	$\pm 2.5$ dB	Add $\pm 0.5$ dB except from 108 to 336 MHz

## Modulation Characteristics

**Demodulated output (Output vernier in CAL position, 108 to 118 and 329 to 336 MHz):** an internal selector switch allows selection of ac only or ac and dc at the demodulated output.

**AC only output:** directly proportional to AM depth (90 to 150 Hz modulation frequency).

**%AM equals:** ( $20 \pm 0.6$ )% per V rms, 0 to 55°C; ( $20 \pm 0.4$ )% per V rms, 20 to 30°C; ( $20 \pm 0.2$ )% per V rms (using calibration sheet provided).

**AC and DC output:** AC output voltage is directly proportional to AM depth (90 to 150 Hz modulation frequency). DC output equals (1.414  $\pm 0.010$ ) V dc with vernier in CAL position.

**%AM equals:** ( $100 \pm 3$ )% per V rms, 0 to 55°C; ( $100 \pm 2$ )% per V rms, 20 to 30°C; ( $100 \pm 1$ )% per V rms (using calibration sheet provided).

## AM Characteristics (+10 dBm Output and Below)

**External input impedance:** nominally 2 k $\Omega$ .

**Frequency response:** < 0.1 dB from 90 Hz through 150 Hz (108 to 118 and 329 to 335 MHz); < 0.1 dB, 9 kHz through 11 kHz (108 to 118 MHz);  $\pm 3$  dB (0 to 50% AM), dc through 50 kHz (8 to 512 MHz);  $\pm 3$  dB (0 to 70% AM), dc through 35 kHz (8 to 512 MHz).

**Phase shift from audio input to demodulated output (108 to 118 MHz, AM EXT DC mode, meter function on VOLTS):**

30 Hz <  $\pm 0.01^\circ$ ; 30 Hz to 10 kHz <  $\pm 3^\circ$ ; 9 kHz to 11 kHz <  $\pm 2^\circ$ .

## Ordering Information

**8640B Signal Generator with Avionics Option 004**

**Option 001:** Internal variable audio oscillator, 20 Hz to 600 kHz

**Option 002:** not available with Option 004

**Option 003:** Reverse power protection

**Option 908:** Rack mount kit

**Option 910:** Extra Operating and Service Manual

## Price

\$8300

add \$275

add \$300

add \$22

add \$25



- 10 to 500 MHz
- to 1000 MHz with doubler probe

- Extends frequency range down to 10 kHz on all 8640 and 8654 series generators
- Preserves calibrated output level and modulation

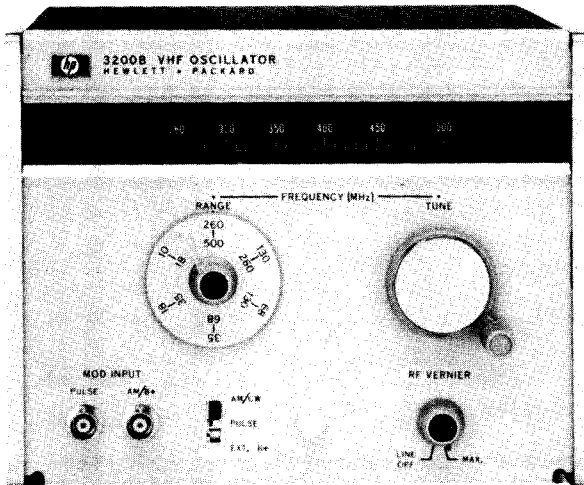

3200B

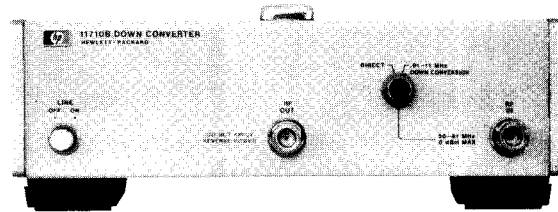

11710B

### 3200B VHF Oscillator

The VHF oscillator, Model 3200B, provides low cost, stable, 10 to 500 MHz RF for testing receivers and amplifiers and driving bridges, slotted lines, antennas, and filter networks. Good pulse modulation sensitivity allows standard audio oscillators to be used to provide usable square wave modulation; a 2.5-volt sine wave will provide adequate drive for this type of application. An optional accessory frequency doubler probe, model 13515A, provides additional frequency coverage from 500 to 1000 MHz.

The 3200B is well suited for bench use and may be adapted for standard 483 mm (19 in.) rack mounting.

#### 3200B Specifications

**Frequency range:** 10–500 MHz in six bands: 10–18.8 MHz; 18.5–35 MHz; 35–68 MHz; 68–130 MHz; 130–260 MHz; 260–500 MHz.

**Frequency accuracy:** within  $\pm 2\%$  after  $\frac{1}{2}$  hour warmup.

**Frequency calibration:** increments of less than 4%.

**Frequency stability (after 4 hour warm-up under 0.2 mW load):** short term (5 min),  $\pm 20$  ppm; long-term (1 hour),  $\pm 200$  ppm; line voltage (5V change),  $\pm 10$  ppm.

#### RF output

**Maximum power (across 50 ohm external load):**  $> 200$  mW (10–130 MHz);  $> 150$  mW (130–260 MHz);  $> 25$  mW (260–500 MHz).

**Range:** 0 to  $> 120$  dB attenuation from maximum output.

**Load impedance:** 50 ohms nominal.

**RF leakage:** sufficiently low to permit measurements at  $1 \mu\text{V}$ .

**RFI:** meets requirements of MIL-I-6181D.

**Amplitude modulation:** externally modulated.

**Depth:** 0 to 30%.

**Distortion:** Typically  $< 3\%$  at 30% AM and 1 kHz rate.

**External requirements:** approximately 32 volts rms into 600 ohms for 30% AM, 200 Hz to 100 kHz.

**Pulse modulation:** externally modulated.

**External requirements:** 2.5 volt negative pulse into 2000 ohms.

**Power:** 105 to 125 V or 210 to 250 V, 50 to 1000 Hz, 50 VA maximum.

**Size:** 167 mm H x 194 mm W x 333 mm D (6.6" x 7.6" x 13.1").

**Weight:** net, 6.8 kg (15 lb); shipping, 9 kg (19 lb).

#### 13515A Frequency Doubler Probe

**Frequency range:** 500 to 1000 MHz with the 3200B operating 250 to 260 MHz (130 to 260 MHz range) and 260 to 500 MHz.

**RF output:** more than 4 mW across external 50 ohm load.

### 11710B Down Converter

The 11710B Down Converter is an accessory for the 8640 and 8654 series signal generators. Frequency inputs from 50.01 to 61 MHz are down converted to the 10 kHz to 11 MHz range respectively. The output level and modulation functions of the 8640 and 8654 remain calibrated. A straight-through selection switch allows the input to pass through unchanged and thus minimizes the necessity to move cables when testing. Option 001 provides rails and semi-rigid coax for combining the 11710B with an 8654A/B Signal Generator.

#### 11710B Specifications

##### Input

**Down-conversion mode:** 50.01 to 61.00 MHz at  $\leq 0$  dBm.

**Straight-through mode:** 0.01 to 1100 MHz (dc coupled).

##### Down-converted Output

**Frequency range:** 10 kHz to 11 MHz.

**Level range:** 0 to  $-107$  dBm.

**Level flatness:** RF source flatness  $\pm 0.5$  dB (referred to 4.0 MHz).

**Total level accuracy:**  $\pm 1$  dB plus input level accuracy.

**Harmonics:**  $> 35$  dB below the carrier (dBc).

**Intermixing spurious:**  $> 60$  dBc.

**Local oscillator feed-through (50 MHz):**  $< -100$  dBm.

##### Internal Reference Characteristics

**Time base output:** 1 MHz or 5 MHz selectable, nominally  $> 0.5$  V p-p into  $500\Omega$ . This will drive an 8640B or 8655A external time base input.

**Typical overall accuracy:** within 3 months of calibration and from  $15^\circ\text{C}$  to  $35^\circ\text{C}$ :  $\pm 2$  ppm.

##### General

**Operating temperature range:** 0 to  $55^\circ\text{C}$ .

**Power requirements:** 100, 120, 220, 240 V (+5%,  $-10\%$ ), 48 to 440 Hz; 25 VA maximum.

**Weight:** net, 3.2 kg (7 lb); shipping, 4.5 kg (9 lb).

**Size:** 102 H x 266 W x 295 mm D (4" x 10.5" x 11.6").

#### Ordering Information

3200B VHF oscillator

Option 910: Extra manual

13515A Frequency doubler probe

11710B Down Converter

Option 001: Combining Kit

Option 910: Extra manual

#### Price

\$1700.00

add \$5.00

\$150.00

\$1250.00

add \$60.00

add \$3.50

# SIGNAL GENERATORS

Rugged solid-state generator 10 to 520 MHz; synchronizer/counter

Models 8654A, 8654B, 8655A

- Calibrated output power
- Calibrated AM, FM; internal, external, independent
- 25 Watt reverse power protection (optional)

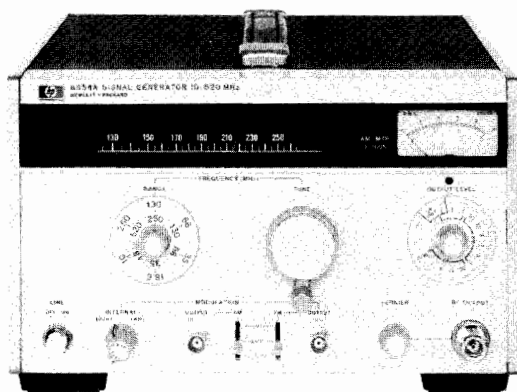

8654A

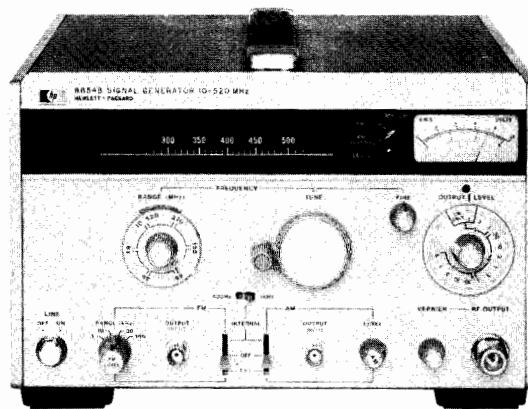

8654B

## 8654A/B Signal Generators

The HP 8654A/B Signal Generators are portable, low-cost solid-state generators providing calibrated output and versatile modulation capabilities over the 10 to 520 MHz frequency range. The 8654 provides clean RF signals with harmonics  $< -20$  dBc (dB relative to carrier) and subharmonics and spurious  $< -100$  dBc for testing receivers, amplifiers, antennas, and filter networks. The 8654B has calibrated AM and FM while the 8654A has uncalibrated FM.

Its compactness and small size allow the 8654 to fit easily into production, mobile, airborne, and shipboard test locations. Its rugged, lightweight construction is also suitable for field maintenance and service applications.

Internal oscillators provide both amplitude modulation and frequency modulation at 400 Hz and 1000 Hz, or external modulation can be accomplished using standard audio oscillators.

A front-panel meter accurately indicates amplitude modulation depth from 0 to 90% when the meter mode switch is in the AM position. Additionally, the 8654B provides calibrated and metered FM over four deviation ranges: 0 to 3 kHz, 0 to 10 kHz, 0 to 30 kHz, and 0 to 100 kHz.

Reverse power protection is available (Option 003) to protect against accidental triggering of transceivers of up to 25 watts into the signal generator.

Effective RF shielding and output range permit receiver sensitivity measurements to be made down to power levels of 0.1  $\mu$ V.

## 8654A/B Specifications

Specifications apply from 10 to 520 MHz for output power  $\leq +10$  dBm and over the top 10 dB of output level vernier range unless otherwise specified.

### Frequency Characteristics

**Range:** 10 to 520 MHz in 6 ranges.

**8654A ranges (MHz):** 10 to 18.6, 18.6 to 35, 35 to 66, 66 to 130, 130 to 250, 250 to 520.

**8654B ranges (MHz):** 10 to 19, 19 to 35, 35 to 66, 66 to 130, 130 to 270, 270 to 520.

**Accuracy:**  $\pm 3\%$  after 2-hour warm-up.

**Settability:** settable to within 5 ppm of the desired frequency with an external indicator after 1-hour warm-up.

**Stability (after 2-hour warm-up and 15 min. after frequency change):**  $< (1 \text{ kHz plus } 20 \text{ ppm})/5 \text{ min.}$

### Spectral Purity

**Harmonic distortion (output power  $\leq +3$  dBm):**  $< -20$  dBc;  $< -15$  dBc with Option 003.

**Subharmonics and non-harmonic spurious (excluding line related):**  $< -100$  dBc.

**Residual AM (average rms):**  $< -55$  dBc in a 50 Hz to 15 kHz post-detection noise bandwidth.

**Residual FM on CW (averaged rms deviation):**  $< 0.3$  ppm in a 0.3 to 3 kHz post-detection noise bandwidth;  $< 0.5$  ppm in a 50 Hz to 15 kHz post-detection noise bandwidth.

### Output Characteristics

**Range:** 10 dB steps and a 13 dB vernier provide power settings from +10 dBm to  $-130$  dBm (0.7 V to 0.07  $\mu$ V) into 50 $\Omega$ . With Option 003, maximum output power is +8 dBm (0.56 V).

**Impedance:** 50 $\Omega$  ac coupled. SWR  $< 1.3$  on 0.1 V range or lower. With Option 003, SWR  $< 1.5$  on 0.1 V range or lower.

**Level accuracy (total as indicated on level meter):** +10 to  $-7$  dBm,  $\pm 1.5$  dB;  $-7$  to  $-57$  dBm,  $\pm 2.0$  dB;  $-57$  to  $-97$  dBm,  $\pm 2.5$  dB;  $-97$  to  $-127$  dBm,  $\pm 3$  dB.

**Level flatness:**  $\pm 1$  dB referenced to the output at 250 MHz for output levels  $> -7$  dBm.

**Auxiliary RF output:**  $> -7$  dBm (100 mV) into 50 $\Omega$ .

**Leakage (with all RF outputs terminated properly):** leakage limits are below those specified in MIL-I-6181D. Furthermore, with an output level  $< 0.01$  V, less than 0.5  $\mu$ V is induced in a 2-turn, 25 mm diameter loop 25 mm away from any surface and measured into a 50 $\Omega$  receiver.

**Reverse power protection (Option 003):** protects signal generator from accidental applications of up to 25 W (+44 dBm) of RF power (between 10 and 520 MHz) into generator output.

### Modulation Characteristics

**Amplitude modulation:** specifications apply for output power  $< +3$  dBm.<sup>1</sup>

**Depth:** 0 to 90%.

**Modulation rate:** internal, 400 and 1000 Hz  $\pm 10\%$ ; external 3 dB bandwidth, dc to  $> 20$  kHz.

**External AM sensitivity:<sup>2</sup>** (0.1  $\pm 0.01$ )% AM/mV pk into 600 $\Omega$ .

**Indicated AM accuracy:<sup>2</sup>**  $\pm 5\%$  of reading +5% of full scale).

**Peak incidental frequency deviation (30% AM):<sup>2</sup>**  $< 200$  Hz.

**Envelope distortion:<sup>2</sup>**  $< 3\%$ , 0 to 70% modulation;  $< 5\%$ , 70 to 90% modulation.

### Frequency Modulation

**8654B:** fully calibrated.

**Peak deviation:** 0 to 30 kHz from 10 to 520 MHz.

0 to 100 kHz from 80 to 520 MHz.

**Deviation ranges:** 0 to 3 kHz, 0 to 10 kHz, 0 to 30 kHz, 0 to 100 kHz.

**Modulation rate:** internal, 400 and 1000 Hz  $\pm 10\%$ ; external 3 dB bandwidth, dc to  $> 25$  kHz.

**FM distortion:<sup>2</sup>**  $< 2\%$  for deviations up to 30 kHz,  $< 3\%$  for deviations up to 100 kHz.

<sup>1</sup>AM is possible above +3 dBm as long as the combination of the AM depth plus carrier output level does not exceed +9 dBm.

<sup>2</sup>400 and 1000 Hz modulation rates.



- Synchronize 8654A/B, stability 0.1 ppm/hour
- 500 Hz lock resolution
- Low RFI counter to 520 MHz

**External FM sensitivity (with FM vernier fully clockwise):**<sup>2</sup> 1 volt peak yields maximum deviation indicated on peak deviation meter.  
**Sensitivity accuracy (15° to 35°C):**<sup>2</sup> ± 12%. For 100 kHz deviation above 130 MHz, add 3%.

**Indicated FM accuracy (15° to 35°C):**<sup>2</sup> ± (12% of reading + 3% of full scale). For 100 kHz deviation above 130 MHz, add 3% of reading.

**Incidental AM:**<sup>2</sup> < 1% AM at 30 kHz deviation.

**Frequency modulation, 8654A:** uncalibrated.

**Deviation:** > 0.1% of carrier frequency, maximum.

**Modulation rate:** internal, 400 & 1000 Hz ± 10%. External 3 dB bandwidth, dc coupled to > 25 kHz driven from 600Ω or less.

**External FM sensitivity:** 10 V<sub>pk</sub> into 600Ω yields > 0.1% deviation (± 15 volts max).

### General Characteristics

**Power:** 100 or 120 volts (+5%, -10%) from 48 to 440 Hz; or 220 to 240 volts (+5%, -10%) from 48 to 66 Hz. Power consumption is 25 VA max. 2.3m (7.5 ft.) power cable furnished with mains plug to match destination requirements.

**Weight:** net, 8.0 kg (17.5 lb). Shipping, 9.5 kg (21 lb).

**Size:** 178 H x 267 W x 306 mm D (7" x 10.5" x 12").

### 8655A Synchronizer/Counter

The HP 8655A Synchronizer/Counter is a phase-lock frequency stabilizer that provides the HP 8654A and 8654B Signal Generators with crystal-oscillator frequency stability. It is also a frequency counter with very low RFI leakage. When used with an 8654 Signal Generator, the frequency can be phase-locked at any frequency from 10 to 520 MHz. In the locked mode the spectral purity and FM capability of the unlocked 8654 are preserved. This performance allows testing of crystal controlled receivers.

Phase locking the 8654 is simple with the 8655A Synchronizer. A push of the LOCK button establishes lock at the frequency shown on the LED display. Maximum lock resolution is 500 Hz. If lock is broken, the LED display flashes. Lock can be re-established by retuning and again pushing the LOCK button.

The 8655A can also be used to count external input signals from 1 kHz to 520 MHz. Input sensitivity is better than 100 mV into 50 ohms. Using the EXPAND button it is possible to achieve a resolution of 1 Hz in the 1 kHz—10 MHz EXT COUNT mode or 100 Hz in both the 10—520 MHz EXT COUNT and SYNCHRONIZE COUNT modes.

RF leakage from an 8654B/8655A system is < 1.5 μV in a 2-turn, 25 mm diameter loop 25 mm away from any surface and measured into a 50 ohm receiver.

### 8655A Specifications

#### Counter Characteristics

**Range:** 1 kHz to 520 MHz.

**Sensitivity:** < 100 mV rms (-7 dBm), ac coupled into 50 ohms. (Typically < -20 dBm, 10 kHz to 200 MHz.)

**Maximum input:** AC: 707 mV (± 10 dBm) for accurate count. DC: ± 25 V on EXTERNAL COUNT INPUT, 0 V dc (ac only) on rear panel SYNCHRONIZE COUNT INPUT. Both inputs are protected with common fuse.

**Count resolution:** 6-digit LED display:

Mode	Normal	X10 EXPAND <sup>2</sup>
1 kHz to 10 MHz (EXTERNAL)	10 Hz	1 Hz
10 MHz to 520 MHz (EXTERNAL & SYNCHRONIZE COUNT)	1 kHz	100 Hz

**Accuracy:** ± 1 count ± time base accuracy.

<sup>2</sup>Will continue to accurately count from 1 to 10 MHz and 100 to 520 MHz with loss of most significant digit (indicated by overflow light). Phase lock is not allowed.

<sup>3</sup>Frequency correction error is a function of the unlocked 8654B frequency drift. For optimum FM accuracy, this error may be eliminated by unlocking, returning to the desired frequency, and relocking.

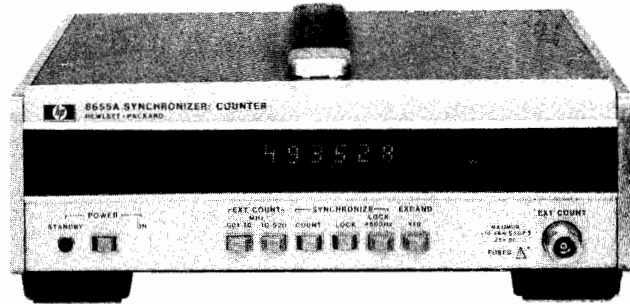

8655A

#### Time base characteristics

**Frequency:** 1 MHz temperature-compensated crystal oscillator.

**Aging (constant operating temperature):** < 0.1 ppm/h, < 2 ppm/90 days.

**Temperature:** ± 5 ppm from 0° to 50°C (referenced to 25°C).

**Typical overall accuracy (after 2 hour warm-up and within 3 months of calibration):** better than ± 2 ppm from 15° to 35°C. (Optional higher stability time base available.)

**Rear output:** 1 MHz, nominally > 0.5 V peak-to-peak into 500 ohms.

**External reference input:** 1 MHz, nominally > 0.5 V peak-to-peak into 1000 ohms. (Not available with optional high stability time base.)

#### 8654A/B-8655A Synchronization Characteristics

**Frequency range:** 10—520 MHz.

**Frequency count resolution:** 1 kHz, or 100 Hz in X10 EXPAND.

**Frequency lock resolution:** 1 kHz. Depressing LOCK + 500 Hz button allows a locked resolution of 500 Hz.

**Frequency accuracy:** same as time base accuracy.

**Lock time duration (after 5 minute warm-up, constant ambient):** 45 min. typical.

**FM rate while synchronized:** 50 Hz to > 25 kHz (with 8654B only).

**FM accuracy (with 8654B only):**

$$\left[ \begin{array}{c} \text{Total FM} \\ \text{Accuracy} \end{array} \right] = \left[ \begin{array}{c} \text{8654B FM} \\ \text{Accuracy} \end{array} \right] \pm \left[ \begin{array}{c} \text{Frequency} \\ \text{Correction Error} \end{array} \right]$$

Frequency correction error<sup>4</sup> is typically < ± 4%.

#### General

**RF leakage (when operated with 8654B using furnished interface cables):** less than 1.5 μV in a 2-turn, 25 mm diameter loop 25 mm away from any surface and measured into a 50 ohm receiver.

**Power:** 100, 120, 220, or 240 volts +5%, -10%, 48 to 440 Hz, 100 VA maximum. 2.9 m (7.5 ft) power cable.

**Weight:** net, 6 kg (13.0 lb); shipping, 6.5 kg (14 lb).

**Size:** 102 H x 267 W x 318 mm D (4" x 10.5" x 12.5").

#### Ordering Information

**8654A AM/FM Signal Generator** \$2600

**8654B AM/FM Signal Generator** \$3200

**Option 003:** Reverse power protection (for 8654A/B) add \$300

**8655A Synchronizer/Counter** \$2400

**Option 001:** High stability time base (for 8655A) add \$450

**Option 910:** Extra manuals (8654A/B and 8655A) add \$10

# SIGNAL GENERATORS

## HF signal generator Model 606B

- 50 kHz to 65 MHz
- Excellent signal purity

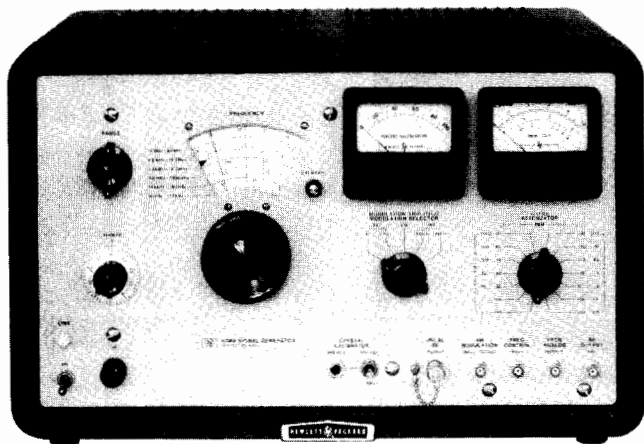

606B

### 606B HF Signal Generator

The Hewlett-Packard 606B Signal Generator provides you with high quality, versatile performance with distinctive ease of operation in the important and widely used 50 kHz to 65 MHz frequency range. Output signals are stable and accurately known, output amplitude can be set precisely over a very wide dynamic range, and versatile modulation satisfies virtually all measurement requirements. Convenient size and shape, together with a simple, straightforward control panel layout, make the 606B well suited for production line use as well as laboratory or field applications.

#### Design

The 606B is a master oscillator-power amplifier (MOPA) design with a broadband buffer amplifier stage between the oscillator and power amplifier circuits for isolation. The MOPA design permits optimization of the oscillator circuit for highest stability, including low drift, minimum residual FM, low harmonics, etc., without restricting the modulation characteristics. Modulation is applied to the power amplifier circuit with negligible effect on the oscillator frequency (because of the buffer stage). Very fine frequency settability is achieved by a  $\Delta F$  control which provides better than 10 ppm resolution.

### 606B Specifications

Unless otherwise noted, output and modulation characteristics apply over the top 10 dB of the output level vernier range. RF output terminated with a 50 ohm load.

#### Frequency and Output Characteristics

**Range:** 50 kHz to 65 MHz in 6 bands.

**Accuracy:**  $\pm 1\%$ .

**Drift:** (1 V output and below) less than 50 ppm (or 5 Hz, whichever is greater) per 10 min period after 2-h warmup; less than 10 min to restabilize after changing frequency.

**$\Delta F$  Control:** better than 10 ppm settability; range of  $\Delta F$  control approximately 0.1%.

**Resettability:** better than 0.15% after warmup.

**Crystal calibrator:** provides frequency checkpoints every 100 kHz and 1 MHz; jack provided for audio frequency output; crystal frequency accuracy better than 0.01% from 0° to 50°C.

**Residual FM:** less than  $\pm 1$  ppm or  $\pm 20$  Hz peak, whichever is greater, in a 10 kHz post-detection bandwidth.

**Output level:** continuously adjustable from 0.1  $\mu V$  to 3 V into 50-ohm resistive load, calibrated in voltage and dBm.

**Frequency response and output accuracy:** at output below 1 V, output level variation with frequency is less than 2 dB; output accuracy is better than  $\pm 1$  dB at any frequency.

**Impedance:** 50 ohms, SWR less than 1.2 on 0.3 V attenuator range and below.

**RFI:** meets all conditions specified in MIL-I-6181D; permits receiver sensitivity measurements down to at least 0.1  $\mu V$ .

**Harmonic output:** at least 25 dB below the carrier.

**Spurious AM:** hum and noise sidebands are 70 dB below carrier down to the thermal level of 50-ohm output system.

**Auxiliary RF output:** (fixed level CW) on front panel; minimum output: 100 mV rms into 50 ohms from 50 kHz to 19.2 MHz, 200 mV rms from 19 to 65 MHz.

#### Modulation Characteristics

##### Internal AM

**Frequency:** 400 and 1000 Hz,  $\pm 5\%$ .

**Modulation level:** 0 to 95% on 1 V attenuator range and below; 0 to at least 30% on 3 V range.

**Incidental FM (attenuator on 1 V range and below, 30% modulation):** less than  $5 \times 10^{-6} + 100$  Hz peak.

**Carrier envelope distortion:**  $< 1\%$  at 30% AM,  $< 3\%$  at 70% AM (attenuator on 1 V range and below).

##### External AM

**Frequency:** dc to 20 kHz maximum, dependent on carrier frequency ( $f_c$ ) and percent modulation as follows.

##### Maximum modulation frequency:

30% Mod.	70% Mod.	Square wave Mod.
$0.06 f_c$	$0.02 f_c$	$0.003 f_c$ (3 kHz max.)

**Modulation level:** 0 to 95% on 1 V attenuator range and below, 0 to at least 30% on 3 V range.

**Input required:** 4.5 V peak produces 95% modulation (maximum input 50 V peak); input impedance 1000 ohms.

**Carrier envelope distortion:**  $< 3\%$  at 70% AM ( $\leq 1$  V output).

**Modulation meter accuracy:**  $\pm (5\%$  of full scale  $+ 5\%$  of reading) 0 to 90% modulation for modulation frequencies to 10 kHz;  $\pm 10\%$  of full scale for frequencies from 10 kHz to 20 kHz.

**Modulation level constancy (Internal or external AM; attenuator on 1 V range and below):** modulation level stays constant within  $\pm 0.5$  dB regardless of carrier frequency and output level changes for modulation levels up to 70%.

#### General

**Power:** 115 or 230 V  $\pm 10\%$ , 50 to 400 Hz, 135 VA.

**Dimensions:** cabinet, 318 mm H x 527 mm W x 375 mm D (12.5" x 20.75" x 14.75"); rack 265.9 mm H x 483 mm W x 371 mm D behind panel (10.5" x 19" x 14.63").

**Weight:** cabinet, net 25 kg (55 lb), shipping 30 kg (66 lb); rack, net 22.7 kg (50 lb), shipping 29.5 kg (65 lb).

#### Accessories available:

11507A Output Termination provides 3 positions: 50 ohms, 5 ohms and IEEE Standard Dummy Antenna.

11509A Fuseholder, protection for 606B transceiver tests.

10534A Mixer, for use as a nanosecond pulse modulator.

#### Ordering Information

606B HF Signal Generator (cabinet)

606BR HF Signal Generator (rack)

Option 910: Extra Operating and Service manual

#### Price

\$4800

\$4800

add \$5

- Versatility and value, 10-480 MHz
- Low noise floor
- High frequency stability, excellent spectral purity

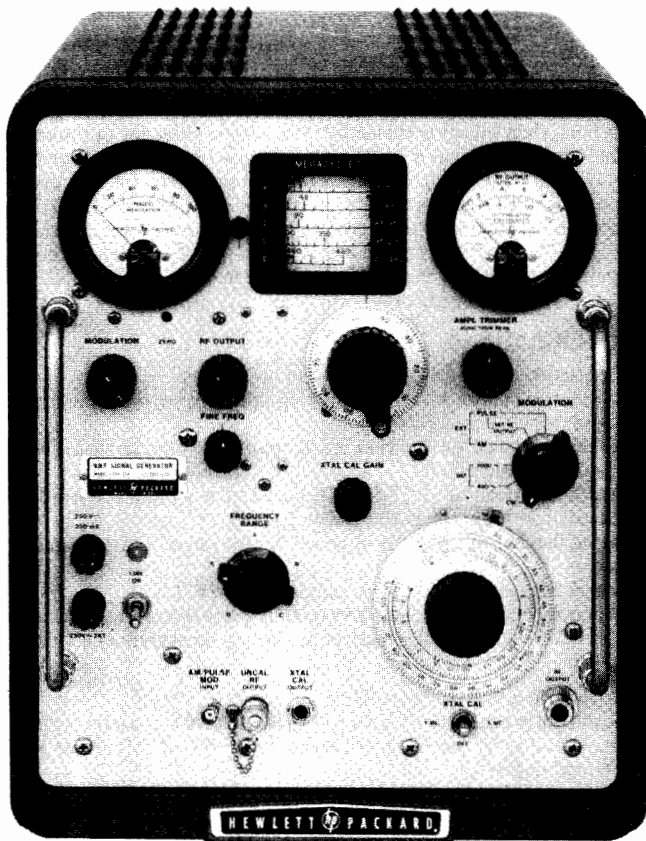

608E

## 608E VHF Signal Generator

Model 608E provides high-quality, versatile performance with distinctive ease of operation. The 608E provides an output of up to 1 volt over the range from 10 to 480 MHz.

The instrument is a master oscillator-power amplifier (MOPA) type with a broadband buffer amplifier stage between the oscillator and power amplifier. This design permits optimization of the oscillator stage for high stability of 0.005% per 10 minutes, minimum residual FM, and low harmonics without restricting the modulation characteristics. Modulation is applied to the power amplifier stage with negligible effect on the oscillator frequency.

### 608E Specifications

#### Frequency Characteristics

**Range:** 10-480 MHz in five bands.

**Accuracy:**  $\pm 0.5\%$  with cursor adjustment.

**Drift:** less than  $50 \times 10^{-7}/10$  min after one hour warmup.

**Resettability:** better than  $\pm 0.1\%$  after initial warmup; fine-frequency-adjust provides approximately 25 kHz settability at 480 MHz.

**Crystal calibrator:** provides frequency check points every 1 MHz up to 270 MHz or every 5 MHz over total range; jack provided for audio frequency output; crystal frequency accuracy better than 0.01% at room temperature.

**Residual FM:** less than  $\pm 5$  parts in  $10^7$  in a 10 kHz post-detection bandwidth.

**Harmonic output:** at least 35 dB below the carrier for harmonic frequencies below 500 MHz.

#### Output Characteristics

**Output level:** continuously adjustable from 0.1  $\mu\text{V}$  to 1.0 V into a 50-ohm resistive load; output calibrated in volts and dBm.

**Accuracy:** within  $\pm 1$  dB of attenuator dial reading at any frequency when RF output meter indicates "ATTENUATOR CALIBRATED."

**Impedance:** 50 $\Omega$  with a maximum SWR of 1.2 for attenuator setting below  $-7$  dBm.

**RFI:** meets all conditions specified in MIL-I-6181D; permits receiver sensitivity measurements down to at least 0.1  $\mu\text{V}$ .

**Auxiliary RF output:** at least 180 mV rms into 50 $\Omega$  provided at front panel.

#### Modulation Characteristics

##### Internal AM

**Frequency:** 400 and 1000 Hz,  $\pm 10\%$ .

**Modulation level:** 0 to 95% modulation at carrier levels 0.5 V and below.

**Carrier envelope distortion:** less than 2% at 30% AM, less than 5% at 70% AM.

##### External AM

**Frequency:** 20 Hz to 20 kHz.

**Modulation level:** 0 to 95% modulation at carrier levels of 0.5 V and below; continuously adjustable from front panel MOD LEVEL control; input required, 1-10 V rms (1000 $\Omega$  input impedance).

**Carrier envelope distortion:** less than 2% at 30% AM, less than 5% at 70% AM (modulation source distortion less than 0.5%).

**Modulation meter accuracy:**  $\pm 5\%$  of full scale 0 to 80%,  $\pm 10\%$  from 80% to 95% (for INT AM or 20 Hz to 20 kHz EXT AM).

**Incidental FM (at 400 and 1000 Hz modulation):** less than 1000 Hz peak at 50% AM for frequencies above 100 MHz; below 100 MHz, less than 0.001% at 30% AM.

#### External Pulse Modulation

**Rise and decay time:** from 40 MHz to 220 MHz, combined rise and decay  $< 4 \mu\text{s}$ ; above 220 MHz, combined rise and decay time  $< 2.5 \mu\text{s}$ .

**On-off ratio:** at least 20 dB for pulsed carrier levels of 0.5 V and above.

**Input required:** positive pulse, 10-50 V peak, input impedance 2 k $\Omega$ .

#### General

**Power:** 115 or 230 V  $\pm 10\%$ , 50 to 400 Hz; approx. 220 VA.

**Size:** cabinet, 416 H x 337 W x 533 mm D (16.38" x 13.25" x 21"); rack mount, 355.6 H x 483 W x 467 mm D behind panel (14" x 19" x 18.4").

**Weight:** cabinet mount: net, 28 kg (62 lb); shipping 33.4 kg (74 lb); rack mount: net, 28 kg (62 lb); shipping, 37.4 kg (83 lb).

#### Accessories available:

11508A Output Cable for high impedance circuits.

11509A Fuse Holder protection for transceiver tests.

10514A Mixer for use as nanosecond pulse modulator.

11690A Doubler for extending frequency range.

11710B Down Converter for low frequency extension.

#### Ordering Information

608E VHF Signal Generator (cabinet)

608ER VHF Signal Generator (rack)

Option 910: Extra Operating and Service manual

#### Price

\$6400

\$6400

add \$5





# SIGNAL GENERATORS

## UHF signal generator

### Model 612A

- 450 to 1230 MHz
- Wide band modulation

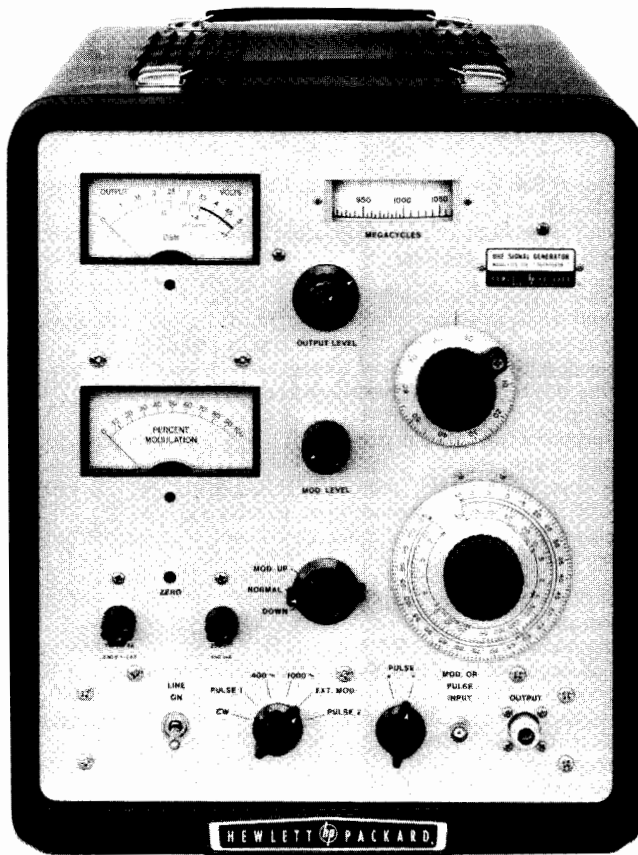

612A

## 612A UHF Signal Generator

Here is an all-purpose, precision signal generator particularly designed for utmost convenience and applicability throughout the important UHF-TV frequency band. It is ideally suited for measurements in UHF-television broadcasting, studio-transmitter links, citizen's band radio, and public service communications systems. The HP 612A also covers the important frequencies used in aircraft navigation aids such as DME, TACAN, and airborne transponders. Accessory modulators, available from many of the manufacturers of these navigational aids, enable the 612A to provide the complex modulation patterns required for testing and aligning these systems. In the laboratory, the 612A is a convenient power source for driving bridges, slotted lines, antennas, and filter networks. In addition, the HP 8731 PIN Modulators can be used with the 612A to obtain RF pulses with 30 ns rise time, 0.1  $\mu$ s minimum duration, and on-off ratios approaching 80 dB.

### MOPA Circuit

The master oscillator-power amplifier circuit in the HP 612A provides 0.5 volt into 50 ohms over the full frequency range of 450 to 1230 MHz. There is very low incidental FM (less than 0.002% at 30% AM) and excellent amplitude modulation capabilities at all frequencies from 20 Hz to 5 MHz. The degree of modulation is easily read from the large percent modulation meter. The instrument can be amplitude-modulated (either internally or externally), and provision is made for external pulse modulation as well. Pulse modulation can be applied to the amplifier or directly to the oscillator when high on-off signal ratios are required (signal may be completely cut off between pulses). Modulation can be up or down from a preset level to simulate TV modulation characteristics accurately.

### Cavity Oscillator

The oscillator-amplifier circuit in the 612A employs high frequency pencil triodes in a cavity-tuned circuit for precise tracking over the entire band. Noncontacting cavity plungers are die-cast to precise tolerances, then injection-molded with a plastic filler for optimum Q. The frequency drive is a direct screw-operated mechanism, free from backlash. A waveguide-beyond-cutoff piston attenuator and crystal monitor circuit ensure accurate, reliable output down to 0.1  $\mu$ V. The attenuator is calibrated over a range of 131 dB and has been carefully designed to provide a constant impedance-versus-frequency characteristic. The SWR of the 50-ohm output system is less than 1.2 over the complete frequency range.

### Specifications

#### Frequency and Output Characteristics

**Frequency range:** 450 to 1230 MHz in one band; scale length approximately 381 mm (15").

**Calibration accuracy:** within  $\pm 1\%$ , resettability better than 5 MHz at high frequencies.

**Output level:** +7 to -127 dBm (0.1  $\mu$ V to 0.5 V) into 50-ohm load; calibrated in V and dBm (0 dBm = 1 mW).

**Output accuracy:**  $\pm 1$  dB, 0 to -127 dBm over entire frequency range.

**Output impedance:** 50 ohms; maximum SWR 1.2.

**RFI:** conducted and radiated leakage limits are below those specified in MIL-I-6181D; permits receiver sensitivity measurements down to 1  $\mu$ V.

#### Modulation Characteristics

**Amplitude modulation:** above 470 MHz, 0 to 90% at audio frequencies, indicated by panel meter; accuracy  $\pm 10\%$  of full scale, 30 to 90% modulation.

**Incidental FM:** less than 0.002% for 30% AM.

**Internal modulation:** 400 and 1000 Hz  $\pm 10\%$ ; envelope distortion less than 3% at 30% modulation.

**External modulation:** 20 Hz to 5 MHz; above 470 MHz, 2 V rms produces 85% AM at modulating frequencies up to 500 kHz, at least 40% AM at 5 MHz; modulation may be up or down from the carrier level or symmetrical about the carrier level; positive or negative pulses may be applied to increase or decrease RF output from the carrier level.

#### Pulse Modulation

**Pulse 1 (pulse applied to amplifier):** positive or negative pulses, 4 to 40 V peak produce an RF on-off ratio of at least 20 dB; minimum RF output pulse length, 1.0  $\mu$ s.

**Pulse 2 (pulse applied to oscillator):** same as Pulse 1, but no RF output during off time.

#### General

**Power:** 115 or 230 volts  $\pm 10\%$ , 48 to 440 Hz, 360 VA.

**Dimensions:** cabinet 419mm H x 343mm W x 584 mm D (16.5" x 13.5" x 23"); rack mount 335mm H x 483 mm W x 552 mm D behind panel (14" x 19" x 21.7").

**Weight:** cabinet - 25.2 kg (56 lb) net, 30.6 kg (68 lb) shipping; rack mount - 25.2 kg (56 lb) net, 34.6 kg (77 lb) shipping.

**Accessories available:** 11500A RF Cable Assembly; 360B Low-Pass Filter (may be used where harmonic output must be reduced to a minimum, as in slotted line measurements).

#### Ordering Information

612A UHF Signal Generator (cabinet)

612AR UHF Signal Generator (rack)

Option 910: Extra Operating and Service manual

#### Price

\$5100

\$5100

add \$5

- Stable, easy to use, 800-2400MHz, 1800-4500MHz

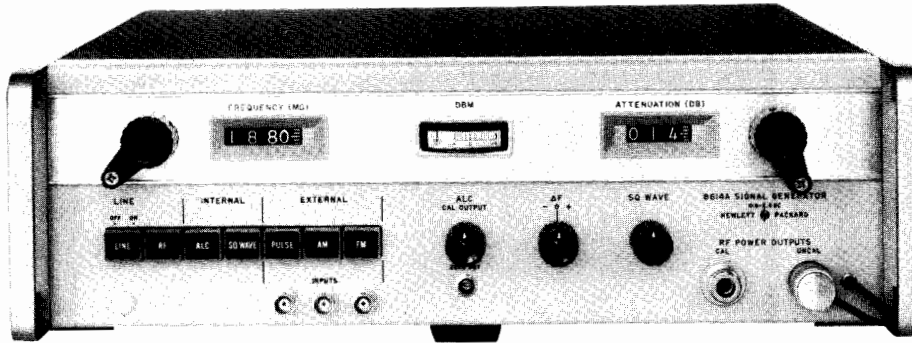

8614A

## 8614A, 8616A Signal Generators

The HP 8614A and 8616A Signal Generators provide stable, accurate signals from 800 to 2400 MHz (8614A) and from 1800 to 4500 MHz (8616A). Both frequency and attenuation are set on direct-reading digital dials, while selectable functions include CW, leveled output, square-wave modulation, and external AM, FM and pulse modulation. Modulation can be accomplished simultaneously with or without leveling.

Two RF power outputs are simultaneously available from separate front-panel connectors. One provides at least 10 mW (2 mW above 3000 MHz) or a leveled output from 0 to -127 dBm. The other is at least 0.5 mW across the band. This signal can be used for phase-locking the signal generators for extreme stability, or it can be monitored with a frequency counter for extreme frequency resolution without adversely affecting the primary output.

A unique PIN diode modulator permits amplitude modulation from dc to 1 MHz or RF pulses with a 2 μs rise time. This broad modulation bandwidth permits remote control of output level or precise leveling using external equipment. The internal leveling is also obtained by using a PIN modulator.

The 8614A and 8616A can also be used with companion modulators, HP 8403A modulators and HP 8730-series PIN modulators to provide 80 dB pulse on/off ratio (see page 400). In addition, TWT amplifiers can be used with these generators to provide high power levels.

### Specifications

#### 8614A

**Frequency range:** direct reading within 2 MHz, 800 to 2400 MHz.

**Vernier:** ΔF control has a minimum range of 1.0 MHz for fine tuning.

**Frequency calibration accuracy (0 dBm & below):** ± 5 MHz.

**Frequency stability:** approximately 50 ppm/°C change in ambient temperature, less than 2500 Hz peak residual FM; 30 ppm change for line voltage variation of ± 10%.

**RF output power:** +10 dBm (0.707 V) into 50 Ω load. Output attenuation dial directly calibrated in dBm from 0 to -127 dBm. A second uncalibrated output (approximately -3 dBm) is provided on front panel.

**RF output power accuracy (with respect to attenuation dial):** ± 0.75 dB + attenuator accuracy (0 to -127 dBm) including leveled output variations.

**Attenuator accuracy:** +0, -3 dB from 0 to -15 dBm; ± 0.2 dB ± 0.06 dB/10 dB from -15 to -127 dBm; direct reading dial, 0.2 dB increments.

**Output impedance:** 50 Ω; SWR < 2.0.

**Modulation:** on-off ratio at least 20 dB for square wave, pulse.

**Internal square wave:** 950 to 1050 Hz. Square wave can be synchronized with a +1 to +10 V signal at PULSE input.

**External pulse:** 50 Hz to 50 kHz; 2 μs rise time, +20 to +100 V peak input.

**External AM:** dc to 1 MHz.

**External FM:** front-panel connector capacity-coupled to repeller of klystron; four-terminal rear-panel connector (Cinch-Jones type S304AB) is dc-coupled to repeller of klystron.

**Power source:** 115 or 230 V ± 10%, 50 to 60 Hz, approximately 130 W.

**Dimensions:** 141 H x 425 W x 467 mm D (5.5" x 16.75" x 18.4"); rack mount, 133 H x 416 W x 483 mm D (5.2" x 16.4" x 19").

**Weight:** net, 19.5 kg (43 lb); shipping, 22.7 kg (50 lb).

#### 8616A

**Frequency range:** direct reading within 2 MHz, 1800 to 4500 MHz.

**Vernier:** ΔF control has a minimum range of 1.0 MHz for fine tuning.

**Frequency calibration accuracy (0 dBm & below):** ± 10 MHz.

**Frequency stability:** approximately 50 ppm/°C change in ambient temperature, less than 2500 Hz peak residual FM; 30 ppm change for line voltage variation of ± 10%.

**RF output power:** +10 dBm (0.707 V) to -127 dBm into 50 Ω load, 1800 to 3000 MHz; +3 dBm to -127 dBm from 3000 to 4500 MHz into a 50 Ω load. Output attenuation dial directly calibrated in dBm from 0 to -127 dBm. A second uncalibrated output (approximately -3 dBm) is provided on the front panel.

**RF output power accuracy (with respect to attenuation dial):** ± 1.0 dB + attenuator accuracy (0 to -127 dBm).

**Attenuator accuracy:** +1, -2 dB from 0 to -10 dBm; ± 0.2 dB ± 0.06 dB/10 dB from -10 to -127 dBm.

**Output impedance:** 50 Ω; SWR < 2.0.

**Modulation:** on-off ratio at least 20 dB for square wave, pulse.

**Internal square wave:** 950 to 1050 Hz. Other frequencies available on special order.

**External pulse:** 50 Hz to 50 kHz; 2 μs rise time, +20 to +100 V peak input.

**External AM:** dc to 1 MHz.

**External FM:** front panel connector capacity-coupled to repeller of klystron; four-terminal rear panel connector (Cinch-Jones type S304AB) is dc-coupled to repeller of klystron.

**Power Source:** 115 or 230 V ± 10%, 50 to 60 Hz, approximately 130 W.

**Dimensions:** 141 mm H x 425 mm W x 467 mm D (5.5" x 16.75" x 18.4"); rack mount, 133 mm H x 416 mm W x 483 mm D (5.2" x 16.4" x 19").

**Weight:** net, 19.5 kg (43 lb); shipping, 22.7 kg (50 lb).

### Ordering Information

**8614A Signal Generator (800-2400 MHz)** \$5450.00

**8616A Signal Generator (1800-4500 MHz)** \$5450.00

### 8614A and 8616A Options

**Option 001:** External modulation input connectors add \$25.00 on rear panel in parallel with front-panel connectors; RF connectors on rear panel only.

**Option 908:** Rack Flange Kit add \$22.00

**Option 910:** Extra operating and service manual add \$7.50

# SIGNAL GENERATORS

## SHF Signal generators

Models 618C, 620B

- Signal simulations, 3.8-7.6 GHz, 7-11 GHz
- FM, Pulse modulation

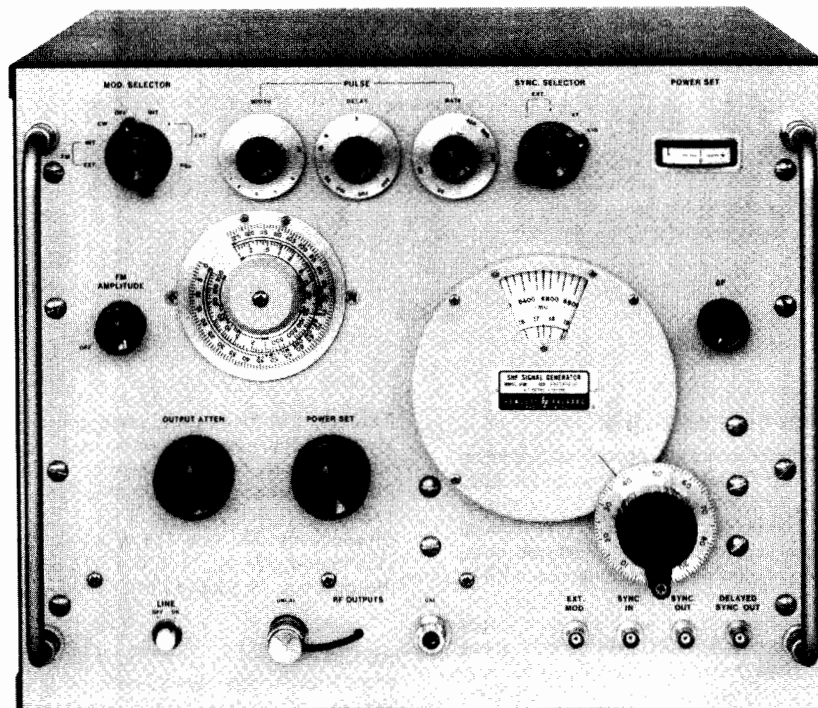

618C

The Models 618C and 620B SHF Signal Generators provide versatility, accuracy, and stability in the range from 3.8 to 11 GHz. Frequency is set on a large, direct-reading dial. A  $\Delta F$  vernier control provides ultra-fine tuning capability. There is also a provision for remote fine tuning.

A calibrated output from 0 to  $-127$  dBm (0.224 volt to 0.1 microvolt) is also set on a large, direct-reading dial. The dial is calibrated in both dBm and volts. An auxiliary output of at least 0.3 milliwatt is available and is independent of attenuator setting. Thus, it can be used for phase-locking the signal generator when crystal-oscillator stability is required, or it can be monitored with a frequency counter for extreme frequency resolution.

The 618C and 620B Generators each feature a reflex klystron oscillator with an external resonant cavity. Oscillator frequency is determined by a movable plunger which varies the length of the cavity. Oscillator output is monitored by a temperature-compensated detector circuit. This circuit operates virtually unaffected by ambient temperature conditions.

Modulation includes internal pulse, square wave, and frequency modulation plus external pulse and frequency modulation.

### 618C, 620B Specifications

#### Output

##### Frequency range

**618C:** 3.8 to 7.6 GHz in a single band.

**620B:** 7 to 11 GHz in a single band; repeller voltage automatically tracked and proper mode automatically selected.

**Calibration:** direct reading; frequency calibration accuracy better than  $\pm 1\%$ .

**Frequency stability:** with temperature, less than 60 ppm/ $^{\circ}$ C change in ambient temperature; with line voltage, less than 200 ppm change for line voltage variation of  $\pm 10\%$ ; residual FM  $< 15$  kHz peak.

**Output range:** 0.224 volt to 0.1 microvolt (0 dBm to  $-127$  dBm) into 50 ohms; directly calibrated in dBm and volts; coaxial type N connector.

**Output accuracy:** within  $\pm 2$  dB from  $-7$  to  $-127$  dBm, within  $\pm 3$  dB from 0 to  $-7$  dBm, terminated in 50-ohm load.

**Source Impedance:** 50 ohms nominal; SWR  $< 2.0$ .

#### Modulation

**Internal pulse modulation:** repetition rate variable from 40 to 4,000 pps, pulse width variable 0.5 to 10 microseconds.

**Sync out signals:** simultaneous with RF pulse, positive; in advance of RF pulse, positive, variable 3 to 300 microseconds (better than 1 microsecond rise time and 20 to 100 volts amplitude into 1,000-ohm load).

**External synchronization:** sine wave: 40 to 4,000 Hz, 5 to 50 V rms; pulse: 40 to 4,000 pps, 5 to 50 V peak, positive or negative, 0.5 to 5  $\mu$ s wide, 0.1 to 1  $\mu$ s rise time.

**Internal square-wave modulation:** variable 40 to 4,000 Hz.

**Internal FM:** sawtooth sweep rate adjustable 40 to 4,000 Hz; frequency deviation to 5 MHz peak-to-peak over most of the frequency range.

**External pulse modulation:** requires pulse amplitude from 15 to 70 volts positive or negative, width 0.5 to 2,500 microseconds.

**External FM:** frequency deviation approximately 5 MHz peak-to-peak over most of the band; sensitivity approximately 20 V/MHz at front-panel connector, approximately 10 V/MHz at rear-panel connector (mating connector supplied); front-panel connector is capacitively coupled to klystron repeller; rear-panel connector is dc-coupled to klystron repeller and is suitable for phase-lock control input.

#### General

**RFI:** Radiated interference is within the limits of VDE 0871 and CISPR publication 11.

**Power source:** 115 or 230 volts  $\pm 10\%$ , 50 to 60 Hz, approximately 230 W.

**Dimensions:** cabinet, 353 mm H x 445 mm W x 518 mm D (13.9" x 17.5" x 20.4"); rack mount, 355 mm x 483 mm x 483 mm (14" x 19" x 19").

**Weight:** net, 31.1 kg (69 lb); shipping, 33.5 (74 lb).

**Accessory furnished:** 11500A Cable Assembly, 1830 mm (6 ft) of RG-214A/U 50-ohm coax, terminated on each end by type N male connectors.

#### Ordering Information

**618C or 620B SHF Signal Generator (cabinet mount)** \$6150.00

**618CR or 620BR SHF Signal Generator (rack mount)** \$6150.00

**Option 910:** Extra operating and service manual add \$7.50

# SIGNAL GENERATORS

SHF generators, doublers

Models 626A, 628A, 938A, 940A

399



- Stable calibrated signals, 10-15.5 GHz, 15-21 GHz

- Doubler sets for signals 18-26.5 GHz, 26.5-40 GHz

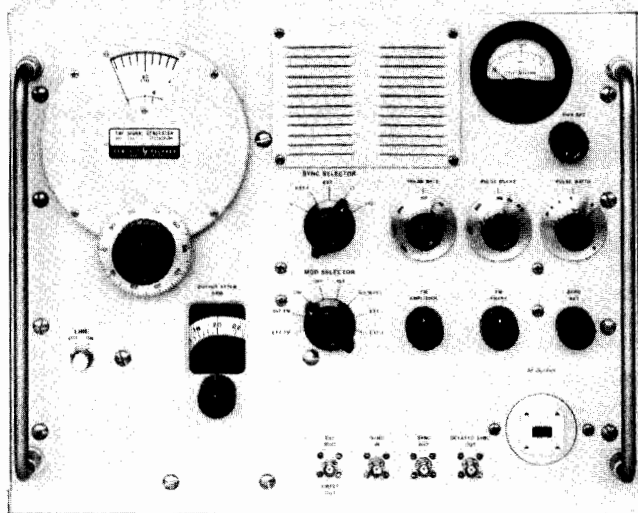

628A

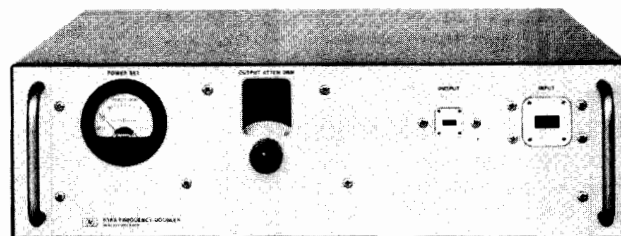

938A

## Description

The 626A covers frequencies 10 to 15.5 GHz, and the 628A covers frequencies 15 to 21 GHz. In design and operation, the instruments are similar to Hewlett-Packard generators for lower frequency ranges. Carrier frequency is set and read directly on the large tuning dial. No voltage adjustment is necessary during tuning because repeller voltage is tracked with frequency changes automatically. Oscillator output is also set and read directly, and no frequency correction is necessary throughout operating range. A frequency logging scale permits frequency to be reset within 0.1%.

Both the 626A and 628A offer internal pulse, squarewave and frequency modulation, plus external pulse and frequency modulation. The pulse generators may be synchronized with an external sine wave and positive or negative pulse signals.

The high power output of these signal generators makes them ideally suited for driving HP 938A and 940A Frequency Doubler sets. These doubler sets retain the modulation and stability of the driving source and have accurate power monitors and attenuators.

## 626A, 628A Specifications

**Frequency range:** 626A, 10 to 15.5 GHz; 628A, 15 to 21 GHz.

**Frequency calibration:** dial direct-reading in GHz, accuracy better than  $\pm 1\%$ .

**Output range:** 10 mW to 1 pW (+10 dBm to -90 dBm); attenuator dial calibrated in output dBm.

**Source SWR:**  $< 2.5$  at +10 dBm;  $< 1.35$  at 0 dBm and below.

**Output monitor accuracy:** better than  $\pm 1$  dB; temperature-compensated thermistor bridge circuit monitors RF oscillator power level.

**Output connector:** 626A: WR75 waveguide, flat cover flange, 21.6 x 12.0 mm (0.85 x 0.475 in.). 628A: WR51 waveguide, flat cover flange, 15.0 x 8.5 mm (0.59 x 0.335 in.).

**Output attenuator accuracy:** better than  $\pm 2\%$  of attenuation in dB introduced by output attenuator.

**Modulation:** internal pulse, FM, or square wave; external pulse and FM.

**Internal pulse modulation:** repetition rate variable from 40 to 4000 pps; pulse width variable 0.5 to 10  $\mu$ s.

**Internal square-wave modulation:** variable 40 to 4000 Hz controlled by "pulse-rate" control.

**Internal frequency modulation:** power line frequency; deviation up to  $\pm 5$  MHz.

**External pulse modulation:** requires pulse amplitude of 15 to 70 volts peak positive or negative; width 1 to 2500  $\mu$ s.

**External frequency modulation:** provided by capacitive coupling to the klystron repeller; maximum deviation approximately  $\pm 5$  MHz.

**Sync out signals:** positive 20 to 100 V peak into 1000-ohm load; better than 1  $\mu$ s rise time; 1) simultaneous with RF pulse, positive; 2) in advance of RF pulse, positive, variable 5 to 300  $\mu$ s.

**External synchronization:** sine wave, 40 to 4000 Hz, 5 to 50 V rms amplitude; pulse signals, 40 to 4000 pps, 5 to 50 V amplitude, positive or negative, 0.5 to 5  $\mu$ s width, 0.1 to 1  $\mu$ s rise time.

**Power:** 115 or 230 volts  $\pm 10\%$ , 50 to 60 Hz, approx. 200 watts.

**Size:** cabinet, 356 mm H x 432 mm W x 381 mm D (14" x 17" x 15"); rack mount, 356 mm H x 483 mm W x 313 mm D (14" x 19" x 12.8").

**Weight:** net, 26.8 kg (59 lb); shipping, 29.8 kg (66 lb).

**Accessories furnished:** 626A, MX 292B and MP 292B Waveguide Adapters; 628A, NP 292A and NK 292A Waveguide Adapters.

**Accessories available:** M362A low-pass filter.

## Frequency Doubler Sets

Model 938A supplies power from 18 to 26.5 GHz and Model 940A from 26.5 to 40 GHz when driven by 9 to 13.25 GHz and 13.25 to 20 GHz sources respectively. For a swept output, use a swept-frequency source such as Model 8690B or Model 8620A/B series with appropriate RF units.

## 938A, 940A Specifications

**Frequency range:** 938A, 18 to 26.5 GHz; 940A, 26.5 to 40 GHz.

**Conversion loss:** less than 18 dB at 10 mW input.

**Output power:** approximately 0.5-1 mW when used with typical 626A, 628A signal generators; input power 100 mW maximum.

**Output attenuator:** accuracy,  $\pm 2\%$  of reading or  $\pm 0.2$  dB, whichever is greater; range, 100 dB.

**Output reflection coefficient:** approx. 0.33 at full output; less than 0.2 with attenuator set to 10 dB or greater.

**Output flange:** 938A, K-band flat cover flange for WR-42 waveguide; 940A, R-band flat flange for WR-28 waveguide.

**Size:** 137 mm H x 489 mm W x 457 mm D (5.4" x 19.25" x 18").

**Weight:** net, 9 kg (20 lb); shipping, 11.8 kg (26 lb).

## Ordering Information

626A or 628A SHF Signal Generator (cabinet)

Price

\$8950.00

626AR or 628AR SHF Signal Generator (rack)

\$8950.00

Option 910: Extra operating & service manual

add \$7.50

938A or 940A Frequency Doubler

\$5900.00

Option 910: Extra operating & service manual

add \$1.00

# SIGNAL GENERATORS

PIN modulators, pulse driver

8730 Series, 8403A

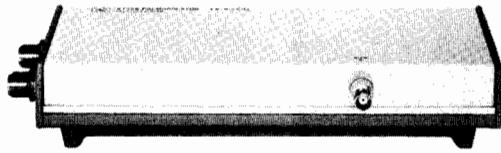

8730B Series

## 8730 Series PIN Modulators

With HP 8730 series PIN Modulators, signal sources, including klystrons, can be pulse-modulated, leveled or amplitude-modulated with sinusoidal and complex waveforms. Fast-rise times, low incidental FM and a nearly constant impedance match to source and load are typical of these absorption-type modulators.

## 8403A Modulator

The Model 8403A provides complete control of the PIN modulators, supplying the appropriate modulation wave shapes and bias levels for fast rise times, rated on/off ratios and amplitude modulation. An internal square-wave and pulse modulator with PRF of 50 Hz to 50 kHz and adjustable pulse width and delay also provide square wave and pulses for general pulse applications. For applications requiring an absorption-type modulator plus controls in a single unit, a PIN modulator can be installed in the Model 8403A.

## 8403A Specifications

**Output characteristics** (available separately at front panel).

**For driving 8730 PIN modulators:** AM and pulse output, pulse output specially shaped for optimum RF rise and decay times.

**For general pulse applications:** positive dc-coupled pulse 25 to 30 volt in amplitude, approximately symmetrical about 0 volt; no AM signal.

### Modulation

#### Internal square wave

**Frequency:** variable from 50 Hz to 50 kHz.

**Symmetry:** better than 45/55%.

#### Internal pulse

**Repetition rate:** variable from 50 Hz to 50 kHz.

**Delay:** variable from 0.1  $\mu$ s to 100  $\mu$ s, between sync out pulse and RF output pulse.

**Width:** variable from 0.1  $\mu$ s to 100  $\mu$ s.

#### External sync

**Signal:** 5 to 20 volts peak, + or -, pulse or sine wave.

**Input impedance:** approximately 2000 ohms, dc-coupled.

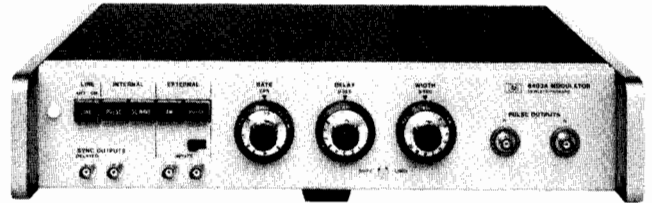

8403A

### Trigger out

**Sync out:** simultaneous with or 0.1 to 100  $\mu$ s in advance of RF pulse, as set by delay control.

**Delayed sync out:** simultaneous with output pulse.

**Amplitude:** approximately -2 volts.

**Source impedance:** approximately 330 ohms.

### External Pulse

**Amplitude and polarity:** 5 volts to 20 volts peak, + or -.

**Repetition rate:** maximum average PRF, 500 kHz/s.

**Input impedance:** approximately 2000 ohms, dc-coupled.

**Width:** minimum 0.1  $\mu$ s; maximum 1/PRF - 0.4  $\mu$ s.

### Amplitude Modulation (with 8730 series)

**Frequency response:** dc to approximately 10 MHz (3 dB).

**Sensitivity:** approximately 10 dB/volt with HP 8730A series; approximately 20 dB/volt with HP 8730B series.

**Input impedance:** approximately 1000 ohms.

### General

**Power:** 115 or 230 volts  $\pm$  10%, 50 to 400 Hz, approximately 10 watts.

**Size:** 96 H x 425 W x 467 mm D (3.75" x 16.73" x 18.4").

**Weight:** net, 7.4 kg (16.5 lb); shipping, 9 kg (20 lb).

### Ordering Information

#### 8403A Modulator

#### Option

**001:** 8731A PIN Modulator installed in 8403A

**002:** 8731B PIN Modulator installed in 8403A

**003:** 8732A PIN Modulator installed in 8403A

**004:** 8732B PIN Modulator installed in 8403A

**005:** 8733A PIN Modulator installed in 8403A

**006:** 8733B PIN Modulator installed in 8403A

**007:** 8734A PIN Modulator installed in 8403A

**008:** 8734B PIN Modulator installed in 8403A

**009:** Input and Output Connectors on rear panel

**908:** Rack flange kit

**910:** Extra Manual

### Price

\$1900

add \$890

add \$1250

add \$890

add \$1350

add \$950

add \$1480

add \$1050

add \$1400

add \$50

add \$25.00

add \$7.50

## 8730 Series Specifications

HP Model	8731A	8731B	8732A	8732B	8733A	8733B	8734A	8734B	8735A	8735B	8731B-H10*
Frequency range (GHz)	0.8-2.4	0.8-2.4	1.8-4.5	1.8-4.5	3.7-8.3	3.7-8.3	7.0-12.4	7.0-12.4	8.2-12.4	8.2-12.4	0.4-1.2
Dynamic range (dB)	35	80	35	80	35	80	35	80	35	80	35
Max. residual atten. (dB) <sup>1</sup>	<1.5	<2.0	<2.0	<3.5 <sup>2</sup>	<2.0	<3.0	<4.0	<5.0	<4.0	<5.0	<2.0
Typical rise time (ns) <sup>3</sup>	40	30	40	30	30	30	30	30	30	30	40
Typical decay time (ns) <sup>3</sup>	30	20	30	20	20	20	20	20	20	20	30
SWR, min. attenuation	1.5	1.6	1.5	1.6 <sup>4</sup>	1.8	2.0	1.8	2.0	1.7	2.0	1.5 <sup>4</sup>
SWR, max. attenuation	1.8	2.0	1.8	2.0	2.0	2.2	2.0	2.2	2.0	2.2	2.0 <sup>4</sup>
Forward bias input resistance (ohms)	300	100	300	100	300	100	300	100	300	100	300
RF connector type	N(f)	N(f)	N(f)	N(f)	N(f)	N(f)	N(f)	N(f)	W/G <sup>5</sup>	W/G <sup>5</sup>	N(f)
Weight, net kg (lb)	1.4 (3.0)	2.5 (5.5)	1.4 (3.0)	2.7 (6.0)	1.0 (2.1)	1.4 (3.0)	1.3 (2.8)	1.4 (3.0)	1.4 (3.0)	1.4 (3.0)	2.5 (5.5)
shipping kg (lb)	1.9 (4.2)	3.3 (7.3)	1.9 (4.2)	3.5 (7.8)	1.4 (3.2)	1.9 (4.2)	1.8 (3.9)	1.9 (4.2)	1.9 (4.1)	1.9 (4.2)	3.3 (7.3)
Dimensions											
Height, mm(in)	57 (2.25)	57 (2.25)	57 (2.25)	57 (2.25)	57 (2.25)	57 (2.25)	57 (2.25)	57 (2.25)	57 (2.25)	57 (2.25)	57 (2.25)
Width, mm (in)	83 (3.25)	124 (4.9)	83 (3.25)	124 (4.9)	83 (3.25)	83 (3.25)	83 (3.25)	83 (3.25)	83 (3.25)	83 (3.25)	124 (4.9)
Depth, mm (in)	283 (11.1)	289 (11.4)	283 (11.1)	289 (11.4)	213 (8.4)	311 (12.3)	213 (8.4)	311 (12.3)	171 (6.75)	267 (10.5)	289 (11.4)
Prices	\$840	\$1200	\$840	\$1300	\$900	\$1350	\$950	\$1350	\$950	\$1350	\$1200

Maximum ratings: maximum input power, peak or CW: 1 W; bias limits: +20 V, -10 V.  
Bias polarity: negative voltage increases attenuation.  
RFI: radiated leakage limits are below those specified in MIL-I-6181D at input levels <1 mW; at all input levels radiated interference is sufficiently low to obtain rated attenuation.

1. With +5 V bias.  
2. 4 dB, 4 to 4.5 GHz.  
3. Driven by HP 8403A Modulator.  
4. 2.0 SWR, 4 to 4.5 GHz.

5. Fits 1 x 1/2 in. (WR 90) waveguide.  
6. External high-pass filters required.  
7. Excluding high-pass filters.

# SIGNAL GENERATORS

Pulse modulator, frequency doublers

11720A, 11721A, 10515A, 11690A



- 2 to 18 GHz
- <10 ns rise and fall times
- >80 dB ON/OFF ratio

- Increased signal generator frequency range

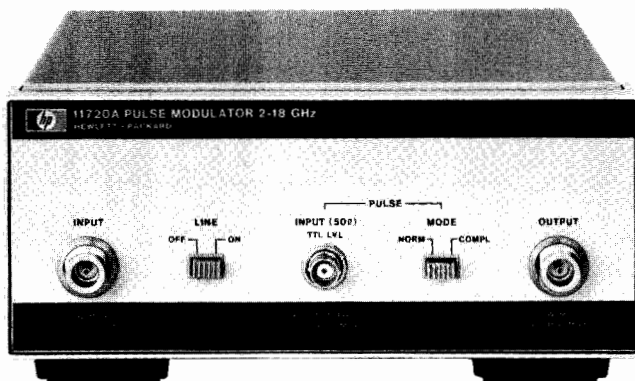

11720A



11721A



11690A

## 11720A Pulse Modulator

The 11720A Pulse Modulator is a high performance microwave pulse modulator covering the range of 2 to 18 GHz. Because of this wide frequency coverage, it can be used to increase the modulation capabilities of many microwave sources (sweepers or signal generators) and eliminate the need for several individual modulators in broadband applications.

In addition to wide frequency coverage, the 11720A features extremely short rise and fall times (<10 ns) and a high on/off ratio (>80 dB) making it suitable for almost any pulsed RF application.

The modulator used in the 11720A is a unique series-shunt PIN diode switch offering superior performance to that of a simple shunt-diode switch which reflects the input power back to the source in the "off" state. In the 11720A the series components reduce this reflection without significantly increasing the insertion loss.

The 11720A contains all the necessary modulator drive circuitry to achieve specified performance so that a standard pulse generator, or any other source that can deliver >3 V peak into 50 ohms, can supply the input. In addition, a normal/complement function is provided to adapt the 11720A to positive-true or negative-true logic inputs.

### 11720A Specifications

**Frequency range:** 2 to 18 GHz.

**ON/OFF ratio:** >80 dB.

**Rise and fall times:** <10 ns.

**Insertion loss:** <6 dB, 2 to 12.4 GHz; <10 dB, 2 to 18 GHz.

**Maximum RF input power:** +20 dBm.

**Maximum repetition rate:** >5 MHz.

**Minimum RF pulse width:** <50 ns.

**Video feedthrough:** <60 mV peak-to-peak.

#### Pulse input

**Normal mode:** >3 V (on), <0.5 V (off).

**Complement mode:** <0.5 V (on), >3 V (off).

**Impedance:** 50 Ω nominal.

**Operating temperature:** 0°C to 55°C.

**Power:** 100, 120, 220, 240 V +5, -10%, 48-400 Hz; 25 VA max.

**Weight:** net, 2.6 kg (5 lb 12 oz); shipping, 3.6 kg (8 lb).

**Size:** 101 mm H x 212 mm W x 290 mm D (4.0" x 8.4" x 11.4").

## 11721A Frequency Doubler

The 11721A Doubler is an ideal accessory for extending the useable frequency range of signal generators, frequency synthesizers, or other signal sources. Operating on input frequencies of 50 MHz to 1300 MHz, it provides a doubled output in the range of 100 MHz to 2600 MHz. The 11721A will work well with any RF source with an output in the range 50 to 1300 MHz.

The 50 Ω passive circuit of the 11721A offers low conversion loss, low spurious, and excellent flatness over its entire frequency range when operated above +10 dBm.

### 11721A Specifications

**Input frequency range:** 50 to 1300 MHz.

**Output frequency range:** 100 to 2600 MHz.

**Conversion loss (+13 dBm input, 50 to 1280 MHz):** <15 dB.

**Spurious referenced to desired output frequency f (+13 dBm input with harmonics <-50 dBc, 50 to 1280 MHz):** f/2, -15 dB; 3f/2, -15 dB.

**Input SWR:** 1.5 typical.

**Input/output impedance:** 50 Ω nominal.

**Operating temperature range:** 0 to +55°C.

**Connectors:** input, type N male; output, type N female.

**Size:** 161 L x 30 W x 20.5 mm H (6 5/8" x 1 3/16" x 13/16").

**Weight:** net, 181 g (6.4 oz); shipping, 335 g (11.8 oz).

## 11690A Frequency Doubler

The 11690A extends the frequency range of all HP 8640 series Signal Generators by doubling the 256-512 MHz frequency band up to 1024 MHz (to 1100 MHz with band overrange). All 8640's indicate the correct doubled output frequency on a dial or counter when the 512-1024 MHz range is selected. The 11690A will also perform well with any source meeting the input requirements of 200-550 MHz at +10 to +19 dBm. Conversion loss is <13 dB, output flatness has <4 dB total variation, and the 1st and 3rd input harmonics are suppressed >20 dB. Connectors are BNC.

## 10515A Frequency Doubler

The 10515A is an ideal accessory to extend the frequency range of signal generators, sources, and frequency synthesizers such as the HP 606, 608, and 8660 Signal Generators. With input frequencies of 0.5-500 MHz, it provides a doubled output in the range of 1-1000 MHz. Its transformer-coupled full-wave rectifier circuit has a very flat frequency response (typically <±2 dB over the entire frequency range). It can also be used as a very broadband detector for low level amplitude modulation because it has no internal dc return path. Conversion loss is <14 dB worst case for inputs between +7 and +23 dBm, and connectors are BNC.

### Ordering Information

**11720A** Pulse modulator

**Option 910:** Extra Operating & Service Manual

**11721A** Frequency doubler

**11690A** Frequency doubler

**10515A** Frequency doubler

### Price

\$2600

add \$ 5

\$ 285

\$ 180

\$ 200

# SIGNAL GENERATORS

## Accessories

Models 10511A, 10514A, 10534A, 11507A, 11508A, 11509A, 11687A, 11697A/B/C

- Additional Capabilities for Signal Generators

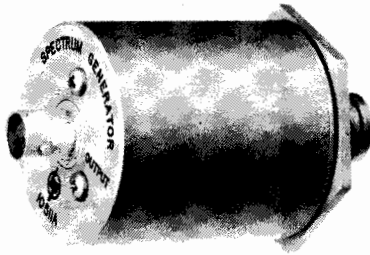

10511A

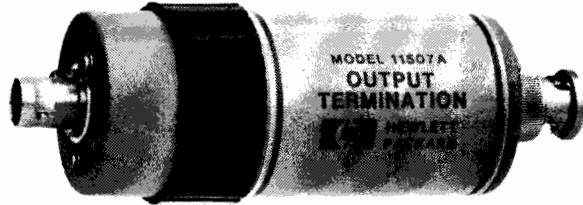

11507A



11509A



11687A

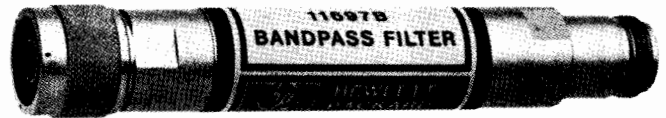

11697B

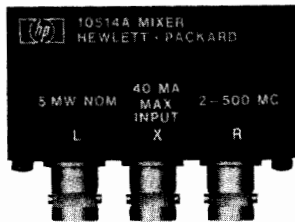

10514A

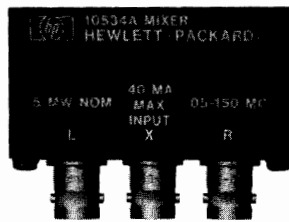

10534A

### 10511A Spectrum Generator

The 10511A extends the useful frequency range of signal generators, sources, and frequency synthesizers by providing a spectrum of output harmonics up to 1 GHz. It generates a train of 1 nsec-wide pulses when driven by a sinusoid. The input should be a sine-wave between 10 and 75 MHz at +13 to +23 dBm into 50Ω. The harmonic power produced is at least -19 dBm for harmonics 1 through 10. Connectors are BNC.

### 10514A, 10534A Double Balanced Mixers

These mixers are excellent in a variety of mixing applications as well as AM, pulse, and square-wave modulation applications. The careful balancing of the hot carrier diodes in the 10514A and 10534A provides excellent output suppression of the local oscillator and input frequencies. Frequency ranges are 0.2-500 MHz for the 10514A and 0.05-150 MHz for the 10534A. Connectors are BNC.

### 11507A Output Termination

This multi-purpose termination with BNC connectors enhances the usefulness of any signal generator over a 50 kHz to 65 MHz range by providing:

1. A matched 50Ω termination with <1 dB attenuation to permit use into high impedance circuits.
2. A 20 dB attenuation (10:1) terminated voltage driver which reduces the source impedance to 5Ω for low impedance circuits.
3. A 20 dB attenuation dummy antenna having the IEEE standard characteristics for receiver measurements (driven from a 10:1 divider, operating from 0.54 to 23 MHz).

### 11508A Output Cable

The 11508A provides a 50Ω termination and dual banana plug binding posts at one end of a 610 mm cable (with a Type N connector at the other end). It allows direct connection of a signal generator to high impedance circuits.

### 11509A Fuseholder

Accidental burnout of attenuators in HP 8640, 8654, 606, and 608 Signal Generators can be prevented by using this fuse element between the signal generator and a transceiver. Otherwise, many watts of RF power can be applied to the signal generator attenuator if the transceiver is accidentally switched to "Transmit." The fuseholder

has a frequency range of dc to 480 MHz, insertion loss of ≤1 dB, SWR of ≤1.35 (50Ω load), and Type N connectors. Ten extra fuses are furnished.

### 11687A 50-75Ω Adapter

This 50-75Ω Adapter with Type N connectors is recommended for use with HP 8640, 8654, 8660, 608, and 612 Signal Generators for measurements in 75Ω systems. The voltage calibration on the output level meter is unaffected by use of the adapter, but 1.76 dB must be subtracted from the dB scale on the meter to determine the output in dBm into 75Ω. Frequency range is dc to 1300 MHz.

### 11697A/B/C Bandpass Filters

These filters are specifically designed to reduce any harmonic and subharmonic-related spurious signals present in the output of doubled signal sources (such as the HP 8640 Signal Generator with Option 002 Internal Doubler or 11690A external Frequency Doubler). The 11697A and 11697B cover the USA UHF television band (512-674 MHz and 674-890 MHz respectively). The 11697C covers the 800-1100 MHz range used for navigation aids and mobile radio. Midband attenuation is ≤0.6 dB, pass band attenuation is ≤1.1 dB, and pass band SWR is ≤1.4. Connectors are Type N.

#### Rejection band attenuation:

Model	Below Passband		Above Passband	
	Frequency (MHz)	Attenuation	Frequency (MHz)	Attenuation
11697A	≤337	≥20 dB	768-3000	≥20 dB
11697B	≤445	≥20 dB	1011-3000	≥20 dB
11697C	≤550	≥20 dB	1333-3000	≥20 dB

#### Ordering Information

Ordering Information	Price
10511A Spectrum Generator	\$400
10514A Double Balanced Mixer (0.2-500 MHz)	\$135
10534A Double Balanced Mixer (0.05-150 MHz)	\$116
11507A Output Termination	\$175
11508A Output Cable	\$50
11509A Fuseholder	\$80
11687A 50Ω-75Ω Adapter	\$135
11697A Bandpass Filter (512-674 MHz)	\$325
11697B Bandpass Filter (674-890 MHz)	\$325
11697C Bandpass Filter (800-1100 MHz)	\$325

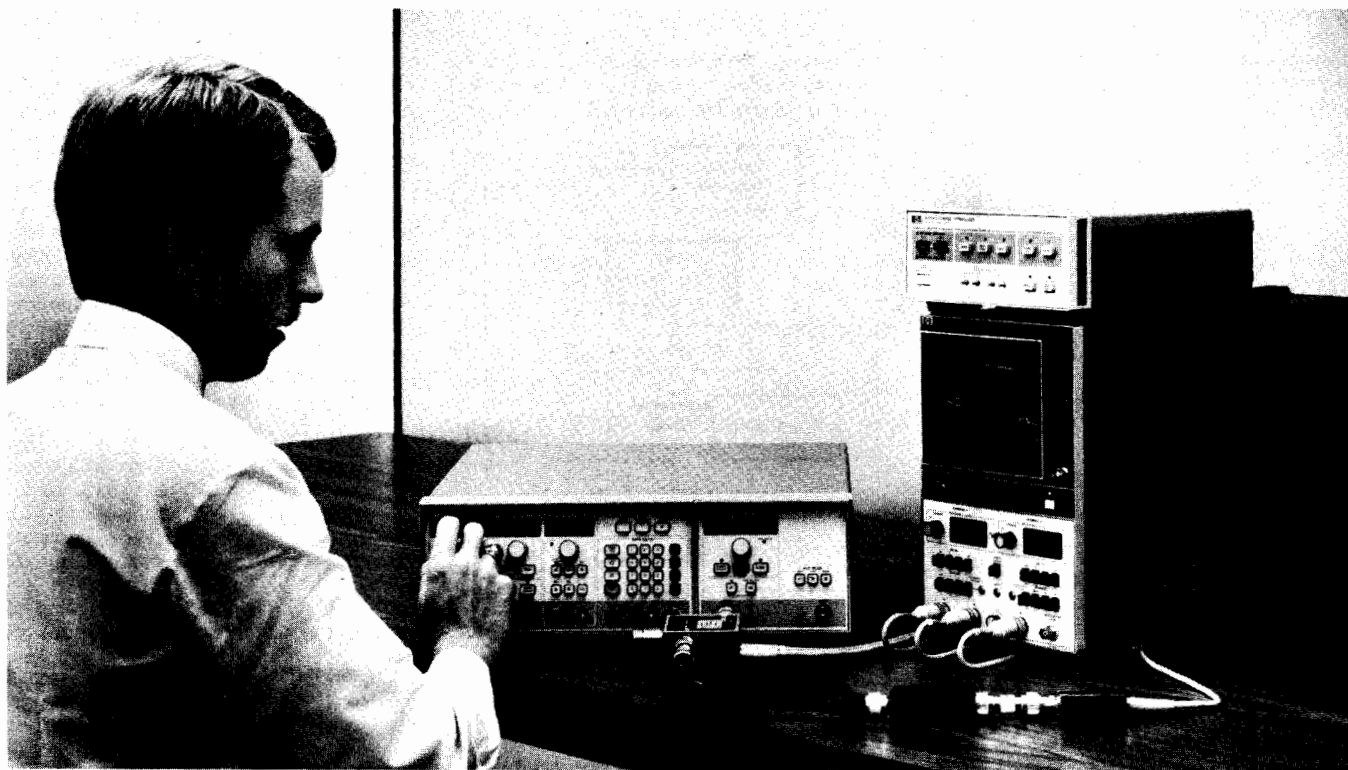

## Sweep Oscillators

Swept frequency oscillators are used in applications where the characteristics of a device must be determined over a wide, continuous range of frequencies. Combined with a broadband detector and display test set, sweep oscillators provide many benefits compared to CW frequency sources. A swept measurement provides a dynamic display of the data. The results of any adjustments to the unknown test device are seen immediately (real time) on the display. By replacing laborious point-by-point techniques swept measurements increase the speed and convenience of broadband testing. The continuous frequency characterization of the unknown device also eliminates the chance of missing important information between frequency points. Swept techniques are applicable in all phases of design, manufacture and maintenance.

### Hewlett-Packard Sweep Oscillators

Hewlett-Packard sweepers cover the entire frequency spectrum from dc to 50 GHz. Self-contained, multi-octave sweepers cover the frequency range to 110 MHz. The 8690 series of backward wave and solid state oscillators features plug-ins from 400 kHz to 50 GHz. The 8620 family of solid state oscillators provide a versatile choice of configurations—single band, straddle band, or very wide band plug-ins from 10 MHz to 22 GHz. 10 MHz to 26.5 GHz coverage including 10 MHz to 20 GHz in one ultra-wide band plug-in is available in the all new 8350 family of plug-in sweep oscillators. A chart of the individual frequency bands available appears on page 405.

### Sweep Oscillator Features

#### Sweep flexibility

Every HP sweeper has several different

sweep modes available for setting the frequency limits of the instrument. A full band or independently adjustable start/stop frequency sweep can be selected. Alternatively, a marker sweep or a symmetrical  $\Delta F$  sweep about the desired center frequency can be chosen. Switching from one sweep mode to another is a simple pushbutton operation. In the auto mode the sweep retriggers automatically. Sweep times from 0.01 to more than 100 seconds can be selected. A manual sweep is also available as a front panel control, a real convenience for calibrating displays such as X-Y recorders. An external trigger is provided as well for applications where the sweeper must be synced to other instrumentation or remotely controlled.

On all sweeps a linear voltage proportional to frequency is available on an external connector which is useful for driving the horizontal of the display. Blanking and pen lift signals are also provided at rear output connectors during flyback time when the RF is off.

Marker capability, both Z-axis intensity dots and RF pipe, are available on HP sweepers to note your important measurement frequencies. More than two independent markers are offered on all sweepers with up to five markers on the new 8350A mainframe. Crystal markers are offered with the 86222B and 83522A 10 MHz to 2.4 GHz RF plug-ins.

Another powerful feature available on the new 8350A sweeper mainframe is Save/Recall Mode. With Save/Recall Mode up to nine complete front panel states can be stored in memory and later recalled when the measurement is repeated. This saves considerable time when repetitive tests are required.

### Power output and leveling

Power output is continuously adjustable at the front panel over approximately a 10 dB range, all plug-ins. Built-in attenuators are also available for greater power control. Internal or external leveling is employed to obtain (1) a constant power output and (2) a good source match (low VSWR). This ensures high accuracy when making swept measurements.

The new 83500 series of plug-ins offer calibrated output power and internal leveling as standard features. Power is calibrated over a 10 dB range with 0.1 dB resolution (programmable to 0.02 dB); with Option 002, internal step attenuator, the calibrated range is extended to 80 dB.

Power as well as frequency can be swept using the 8350A and 83500 series plug-ins. This means that both the frequency response and power response of level sensitive devices like transistors and amplifiers can be measured using the same test setup. Using the Power Sweep function 1 dB gain compression can easily be measured at a CW frequency (Figure 1). Also, the ability to alternate

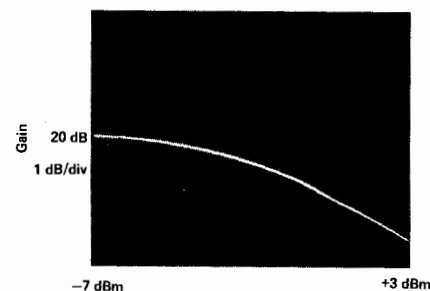





# SWEEP OSCILLATORS

## General information

between two discrete power levels on successive sweeps (8350A and 83500 series plug-ins) allows swept measurements of 1 dB power characteristics can be optimized simultaneously.

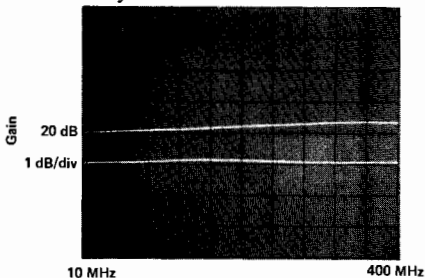

### Modulation

Modulation capabilities further extend the sweeper's usefulness both as a sweeper and a signal generator for signal simulations. Wide AM and FM bandwidths are useful for a variety of tests on communication receivers. The flexible FM capability allows remote analog frequency programming which is important for many applications.

External pulse modulation is also available on many plug-ins. Most plug-ins also accept the 27.8 kHz square wave modulation required by the HP8755 Frequency Response Test Set directly eliminating the need for an external modulator. The 8350A mainframe will even supply the 27.8 kHz square wave modulation directly to the plug-in.

### MLA Compatibility

In communications applications where up-converter simulation is required in conjunction with the HP Microwave Link Analyzer, the 86200 series of plug-ins provides this capability as an option in frequency ranges from 500 MHz to 18 GHz. Group delay of less than 1 nanosecond and linearity of better than 0.5% across 30 MHz across most of the frequency range permit very accurate RF to RF, RF to IF and RF to BB distortion measurements.

### Programming

The 8350A mainframe and 83500 series plug-ins are the first sweep oscillator system to offer total HP-IB control of all front panel functions. Not only CW frequencies, but sweeps, markers, power levels, etc., can be remotely programmed via the HP-IB. This means there are no limitations to designing customized automatic systems for either component or system testing.

The 8620C solid state sweeper mainframe provides optional BCD or HP-IB programming capability. More than ten thousand frequency points per band permit very fine frequency control. In addition, band selection, sweep mode, RF attenuator, and remote-local can be controlled remotely. This allows the sweeper to be used in a wide variety of automatic systems and sophisticated signal simulation applications.

For example, a 1 MHz to 18.6 GHz frequency synthesizer can be configured using a controller, the 86290B/8350A 2-18.6 GHz Sweep Oscillator, and the 8660 UHF Synthesizer. (See Figure 3). Harmonics of the 8660 are used to phase lock the sweeper to the accuracy and stability of the synthesizer. The desktop computer is then used to control

the sweeper, the UHF synthesizer, and RF switches to allow keyboard control of a CW signal or to step the source across a band of interest.

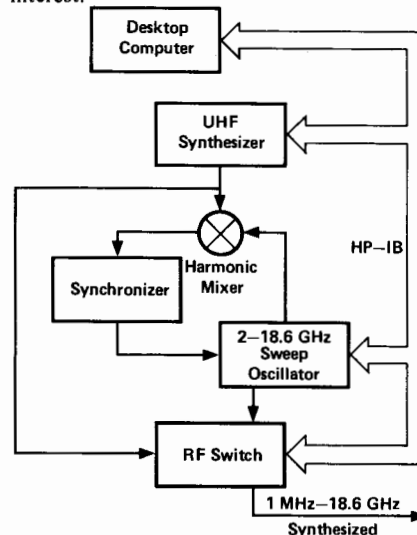

Figure 3.

In addition to controlling sweeper frequency, a computer can be used to assimilate data from a frequency response test set (HP-8755) or network analyzer (HP8410). With systems such as the one in Figure 4 the com-

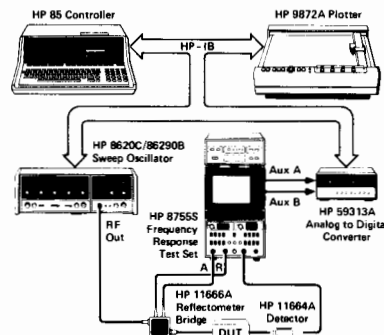

Figure 4.

puter can completely set up the measurement, sweep width, markers, power level, etc., and then document the measurement results in a printed or plotted format. For operations requiring a minimum of user interactions specification comparisons can be made for automatic "go no-go" testing. Using the programmable power capability of the 83500 series plug-ins automatic power as well as frequency response testing is possible (see figure 5).

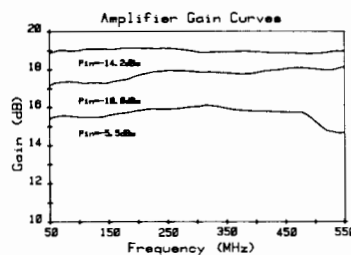

Figure 5.

### Digital Sweeping Synthesizers

The 3325A, 3330B, 3325A, 8660C, and 8662A combine the precision frequency accuracy and stability of a synthesizer with the time saving convenience of a sweeper. Parameters such as start/stop/center frequencies, sweep width, frequency step and sweep time are entered and executed through a convenient keyboard or remote programming. Some additional features are phase continuous linear/log sweep in the 3325A and amplitude sweeping in steps as small as 0.01 dB in the 3330B. This in conjunction with frequency sweeping can provide a comprehensive family of curves.

### Sweeper Applications

Sweepers are used extensively with swept frequency test sets to characterize the amplitude response of broadband devices or with network analyzers when the phase characteristics of the device (or S-parameters) are needed as well. Two RF measurements—transmission and reflection—are basic to both types of analyzer. Hewlett-Packard offers a complete line of directional couplers, power splitters, and other transducers which together with the analyzers and sweep oscillators provide a total swept measurement solution.

The HP8755 Frequency Response Test Set operates over the 10 MHz to 26.5 GHz frequency range. It is a two channel diode detection receiver system with  $-50$  dBm sensitivity and ratio capability. Combined with the 8350A and the broadband plug-ins like the 83592A (.01 - 20 GHz) it is ideal for simultaneous scalar transmission and reflection measurements. Convenience is enhanced since the 8350A provides the required 27.8 kHz modulation directly. With the new 8755C alternate sweep testing is possible, since Channel 1 is only permitted to respond to the 8350A's current state while channel 2 responds to the alternate state. This allows "simultaneous" measurements of both filter skirt and passband responses (see Figure 6).

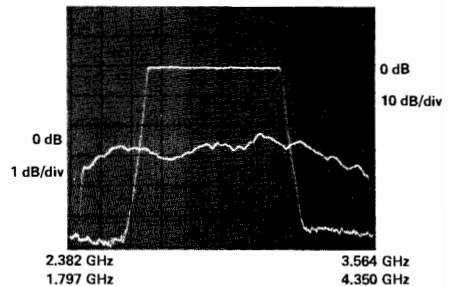

Figure 6.

For measurements requiring more sensitivity and/or phase information, sweepers may be used with network analyzers. These measurements can easily be made across many octaves of frequency. Previously the 8410 had to be retuned every octave. Now, for example, with the 83522A or 86222A/B and the 8410B, phase-magnitude transmission or reflection coefficients can be measured across the full, 0.11-2.4 GHz range in one continuous sweep at full sweep speed. Since the 8410 is a tuned receiver this means a spurious-free sensitivity of  $-78$  dBm.

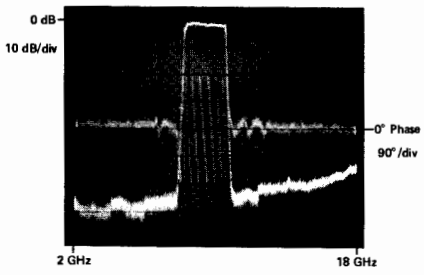

Figure 7

Figure 7 is a CRT photo of simultaneous phase and magnitude transmission characteristics of an 8 to 10 GHz using the 86290 Sweep Oscillator Plug-in.

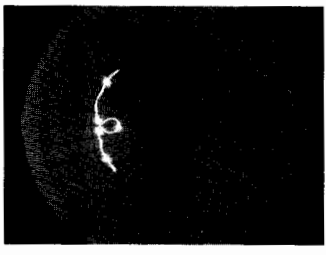

Figure 8

Figure 8 shows an 8414A Polar Display with all five 8350A markers used to note critical frequencies.

For high power applications such as RFI-susceptibility tests and high attenuation measurements. Hewlett-Packard offers TWT amplifiers which provide better than 1 watt from 1 to 18 GHz.

Synthesizer accuracy and stability can be obtained by phase-locking the Hewlett-Packard sweep oscillators to a harmonic of a very stable source. This high stability is important in many applications including microwave spectroscopy and high-Q swept frequency measurements.

Two-tone sweep testing of devices such as mixers and receiver front ends requires two signals offset from each other by the IF. This is accomplished by phase-locking the difference frequency of two sweep oscillators to a very stable source. The sweepers may then be swept across the band of interest.

The modulation and built-in attenuator features of Hewlett-Packard sweep oscillators make them useful in many traditional CW signal generator applications.

In addition, accuracy, linearity, and flatness of the broadband plug-ins like the 83592A, 86290A/B/C, 83525A, and 83522A make them more than adequate in

many applications requiring a general purpose CW generator.

For wideband applications the 83592A .01-20 GHz plug-in, the 83525A .01-8.4 GHz plug-in, the 86290A/B, 2-18 GHz plug-ins and the 86222A/B and 83522A 0.01-2.4 GHz plug-ins feature performance that rivals octave band oscillators in the area of frequency purity and accuracy, harmonics, flatness, and power.

For a complete discussion of swept frequency measurements the following application notes and others are available from your local Hewlett-Packard sales office.

- AN 155-1 "Active Device Measurements with the 8755 ..."
- AN 155-2 "100 dB Dynamic Range Measurements, using the 8755 Frequency Response Test Set"
- AN 183 "High Frequency Swept Measurements"
- AN 187-2 "Configuration of a 2-18.6 GHz Synthesized Frequency Source using the 8620C Sweep Oscillator"
- AN 187-4 "Configuration of a Two-Tone Sweeping Generator"
- AN 187-5 "Calculator Control of the 8620C Sweep Oscillator using the HP-IB"
- AN 187-6 "Frequency Performance of the 8620C Sweep Oscillator Under Remote Programming"

**Sweep Oscillator—Summary Chart**

Frequency Range*	Model Number				100 kHz	1 MHz	10 MHz	100 MHz	1 GHz	2 GHz	4 GHz	8 GHz	12 GHz	18 GHz	26 GHz	40 GHz
	8350 Series	8620 Series**	8690 Series	Other Sweepers												
0.1 Hz-13 MHz 10 Hz-21 MHz 1 μHz-21 MHz 1 mHz-50 MHz 200 Hz-80 MHz 10 kHz-1280 MHz 10 kHz-2600 MHz				3312A 3336A/B/C 3325A 8165A 3335A 8662A 8660C	←	←	←	←	←	←	←	←	←	←	←	←
100 kHz-110 MHz 400 kHz-110 MHz 10 MHz-1.3 GHz 10 MHz-2.4 GHz 10 MHz-8.4 GHz 10 MHz-20 GHz	83522A 83525A 83592A	86220A 86222A/B	8698B	8601A	←	←	←	←	←	←	←	←	←	←	←	←
0.1-4.0 GHz 1.0-2.0 GHz 1.4-2.5 GHz 1.7-4.2 GHz			8699B 8691A/B 8691A Opt 200 8692B Opt 100		←	←	←	←	←	←	←	←	←	←	←	←
1.7-4.3 GHz 1.8-2.4 GHz 2-4 GHz 2-8.4 GHz 3.6-8.6 GHz 2-18.6 GHz 2-22 GHz	83540A	86235A 86230B 86240A/B 86240C 86290A/B/C 86290A/B Opt H08	8692A/B		←	←	←	←	←	←	←	←	←	←	←	←
3.2-6.5 GHz 3.5-6.75 GHz 3.7-8.3 GHz 4-8 GHz		86241A	8693A Opt 200 8693B Opt 100 8693A/B		←	←	←	←	←	←	←	←	←	←	←	←
5.9-9.0 GHz 5.9-12.4 GHz 7-11 GHz 8-12.4 GHz 8-18 GHz	83545A	86242D 86245A 86250D Opt H08 86250D	8694A/B Opt 200 8694A/B 8694A/B Opt 300		←	←	←	←	←	←	←	←	←	←	←	←
10-15.5 GHz 12.4-18 GHz 17-22 GHz 18-26.5 GHz 26.5-40 GHz 33-50 GHz	83570A	86260B 86260A 86260C	8695A Opt 100 8695A/B 8696A 8697A 8697A Opt H50		←	←	←	←	←	←	←	←	←	←	←	←

\*Other Special Frequency Ranges Can Be Provided Upon Request.  
\*\*86200 Series RF Plug-Ins are usable with the 8350A Mainframe via the 11869A Adapter

406



# SWEEP OSCILLATORS

## 8350 Family: 10MHz – 26.5 GHz

### Model 8350A

- Versatile Microprocessor-Controlled Mainframe
- Single-Band, Straddle-Band and Broad Band Plug-ins
- 10 MHz to 20 GHz in one Plug-In
- 10 mW Output Power to 26.5 GHz
- Total HP-IB Programmability

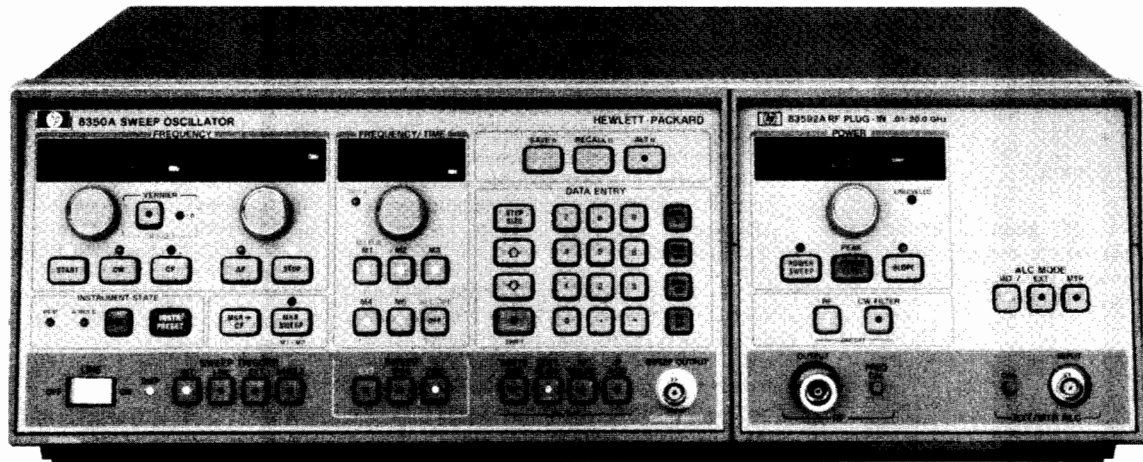

8350A



### 8350 System

The HP 8350 is a powerful RF and microwave source for swept measurements, wideband CW signal generation and automatic testing. It incorporates the efficiency of microprocessor control with state-of-the-art YIG-tuned oscillators and GaAs FET amplifiers to produce a high performance sweep oscillator system ideally suited for either manual or automatic measurements.

You can easily configure a source to meet your application's frequency coverage and power requirements. Just combine the versatile 8350A mainframe with any of the 24 standard RF plug-ins (see table at right) and you are ready to make measurements. Both the advanced 83500 series plug-ins and the existing 86200 series plug-ins (via the 11869A adapter) are accepted by the 8350A mainframe.

### 8350A Mainframe

The 8350A has been designed to include many features that not only speed and simplify measurements but also improve accuracy. In addition, it is the first sweep oscillator to provide total computer control of all front panel function settings.

All function values (sweep limit frequencies, marker frequencies, etc.) are indicated on high resolution digital displays, thus eliminating the time consuming task of reading and interpolating between dial scale graduations. Function values are easily modified using the appropriate knob, step keys, or data entry keyboard. The knob provides a "continuous" analog feel while the step keys allow values to be increased or decreased by specific amounts. Fast entry of precise values is made from the data entry keyboard.

Five independent, continuously variable markers are available to note your measurement frequencies. The active marker frequency or the difference frequency between any two markers is read easily from high resolution digital display. You can also use marker sweep to zoom in on a particular frequency span while retaining your original sweep limits.

Another particularly useful feature in making repetitive measurements is the 8350A's Save/Recall Mode. Once the sweeper has been set for a particular measurement, all front panel settings (8350A and 83500 series plug-in) can be *Saved* and later *Recalled* to repeat the measurement by accessing one of nine internal storage registers.

In the past, HP-IB programming of sweepers was limited to a series of CW frequencies. With the 8350A all front panel functions, e.g. sweeps, markers, sweep time, even output power (83500 series plug-ins) can be programmed. This means there are no limitations in designing your own customized test systems. Utilizing the Learn Mode function, the 8350A becomes a "talker" as well as "listener" on the bus, transferring all manually entered front panel controls to the computer.

Full compatibility with both the HP 8410B Network Analyzer and the HP 8755 Frequency Response Test Set are provided for convenient vector and scalar measurement with the 8350A. The HP 5343A Counter can be combined with the 8350A to measure Start, Stop, or marker frequencies with up to 100 kHz accuracy even while sweeping.

### 83500 Series Plug-ins

Broadband frequency coverage from 10 MHz to 26.5 GHz with high output power is provided in the 83500 series RF plug-ins. One plug-in, the 83592A, operates over the entire 10 MHz to 20 GHz range without sacrificing output power (10 mW minimum) or frequency accuracy (20 MHz at 20 GHz). The 18 GHz to 26.5 GHz band is filled by the 83570A RF plug-ins and boasts a 10 mW power level (comparable to most BWO's).

The 83500 series plug-ins offer output power level control previously unavailable on a swept source. First, power level control is calibrated with 0.1 dB resolution and up to 80 dB range (with Opt 002 attenuator). Second, calibrated power sweeps are available for characterizing device performance as a function of power. And third, slope and internal leveling controls are standard on all units.

All 83500 series front panel functions and HP-IB programmable including power level. This means your automatic test systems can now characterize a device both as a function of frequency and input power level.

### 86200 Series Plug-ins

Simply combining the 86200 series plug-in (including the one you may already own) with an 11869A Adapter makes all the convenient digital controls, markers, and HP-IB capability of the 8350A immediately available to you. The 86200 series are a particularly attractive plug-in choice when economical single-band operation is desired with the 8350A mainframe. For measurements with HP Microwave Link Analyzer specially characterized 86200 series plug-ins can be used with the 8350A to create an upconverter for communications distortion measurements.

The 86290A/B/C plug-ins cover the 2-18 GHz frequency range with 5 mW, 10 mW, and 20 mW of output power respectively. A special option, the 86290B-H08 operates from 2-22 GHz with a 3 mW output. Frequency accuracy at 18 GHz is 20 MHz exceeding that available on most single-band plug-ins. Both 83500 series and 86200 series plug-ins compatible with the 8350A Mainframe are summarized in the table below. Note that the 11869A Adapter is required with all 86200 series plug-ins. See specifications on page 416.

# SWEEP OSCILLATORS

407

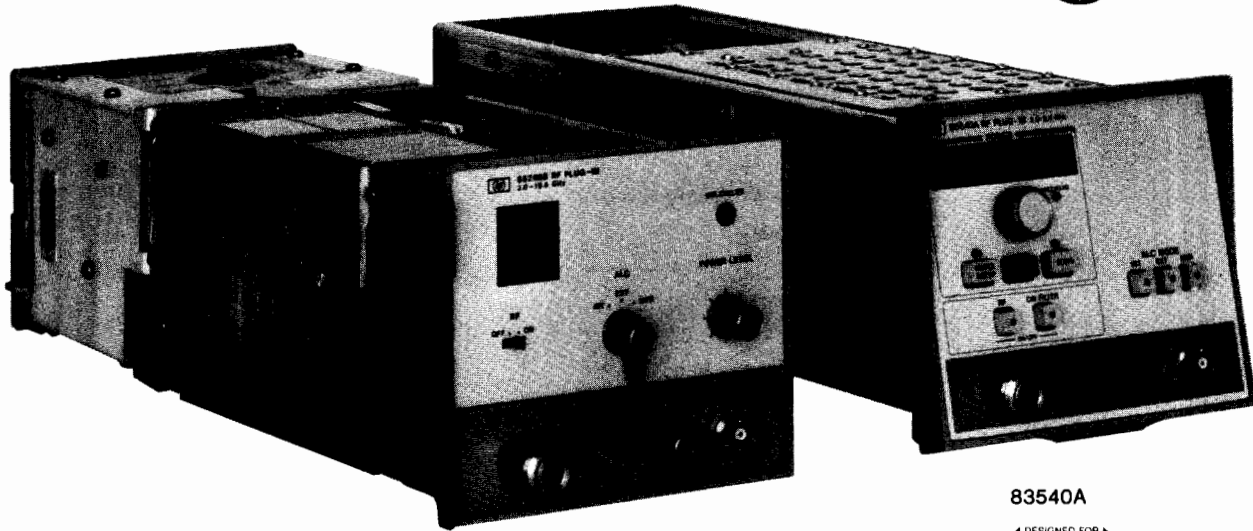

86290B

83540A



	Model number	Frequency range (GHz)	Leveled power output	Frequency accuracy (MHz)	Complete specifications on page
Broad-band Plug-ins	83592A	.01-20	10 mW	±20	410, 411
	83525A	.01-8.4	20 mW	±20	412, 413
	83522A	.01-2.4	20 mW	±10	412, 413
	86222A/B	.01-2.4	20 mW	±10	419
	86290A	2-18	5 mW	±20	420
	86290B	2-18.6	10 mW	±20	420
	86290C	2-18.6	20 mW	±20	420
	86290B-H08	2-22	3 mW	±20	420
Straddle-band Plug-ins	83540A	2-8.4	40 mW	±20	414, 415
	86240A	2-8.4	40 mW	±20	421
	86240B	2-8.4	20 mW	±20	421
	86240C	3.6-8.6	40 mW	±20	421
Single-band Plug-ins	86220A	.01-1.3	10 mW	±10	422, 423
	86230B	1.8-4.2	10 mW	±15	422, 423
	86235A	1.7-4.3	40 mW	±20	422, 423
	86241A	3.2-6.5	3.2 mW	±30	422, 423
	86242D	5.9-9	10 mW	±35	422, 423
	83545A	5.9-12.4	50 mW	±40	414, 415
	86245A	5.9-12.4	50 mW	±40	422, 423
	86250D	8.0-12.4	10 mW	±40	422, 423
	86260B	10-15.5	10 mW	±50	422, 423
	86260A	12.4-18	10 mW	±50	422, 423
	86260C	17-22	10 mW	±50	422, 423
	83570A	18-26.5	10 mW	±40	414, 415

NOTE: The 11889A Adapter is required to interface 86200 series plug-ins with the 8350A mainframe.

## SWEEP OSCILLATORS

- Accurate, high resolution, digital displays
- Five markers with Marker  $\Delta$  and Marker Sweep
- Save/Recall 9 complete front panel states
- Accepts new 83500 series plug-ins
- Total HP-IB programmability

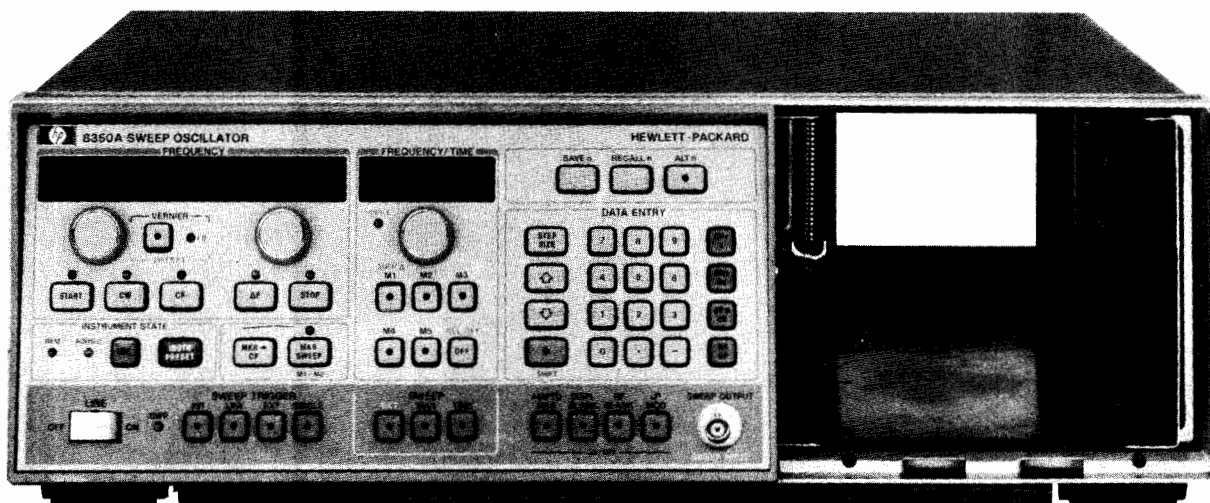

8350A



### 8350A Mainframe:

Sweep Oscillator applications are greatly expanded by the new features of the HP8350A. Along with the traditional swept and CW frequency functions the 8350A adds five markers with extensive capabilities, versatile data entry and complete HP-IB programmability. The 8350A mainframe accepts the 86200 series plug-ins via the 11869A Adapter as well as the new wideband 83500 series plug-ins. In order to aid system set ups, the 8350A is directly compatible with the HP 8410B and HP8755 network analyzers. The frequency accuracy is easily enhanced when the HP5343 Counter is used to count the START, STOP, or ACTIVE MARKER frequency.

The 8350A has three methods of changing function values; control knobs, keyboard entry, or step key entry. The traditional control knob provides an analog "feel" of control which is useful for continuous parameter adjustment. Numerical keyboard entry allows for fast, accurate input. Finally, quantized inputs are possible with step keys.

Five markers are available with the 8350A. These markers combined with the high resolution digital readout make the accurate location of important frequency responses easy. A key marker feature, marker  $\Delta$ , computes the difference between any two markers. While the markers are in this mode the trace is intensified between the two markers, thereby aiding the user's visual comprehension. This feature is particularly useful for measurements such as the determination of the bandwidth between 3 dB points. With the extensive marker capabilities key frequency ranges may be marked and swept. The markers can modify the center frequency (marker — CF) or the START/STOP frequency (marker Sweep). These expanded marker capabilities simplify sophisticated measurements.

A necessity in making repetitive measurements or automatic tests is the Save/Recall Feature. Once the 8350A controls have been set for a particular measurement, all of the front panel controls can be "saved" in a memory location and later "recalled" when the measurement is

repeated. This feature supplies nine memory locations, each storing a complete front panel set up. Memory storage or access may be done randomly or sequentially. Option 001 provides a non-volatile memory in which all memories are retained even when line power is removed.

The HP8350A makes "simultaneous" comparison of two separate frequency ranges or power levels easy via the alternate sweep mode. When the alternate sweep mode is activated the 8350 alternates between the current front panel setting and any stored memory setting on successive sweeps. The output from this function may be processed through a network analyzer such as the HP8755C and viewed on a two channel display.

All front panel controls (except the ac line power switch) may be programmed or controlled via the HP-IB. The 8350A may interact as a listener or as a talker on the HP-IB. As a talker the 8350A is capable of outputting the manually entered front panel information to a controller. The HP-IB capabilities of the 8350 are far more extensive than in other sweepers hence increasing its range of applications.

As a result of the 8350's internal microprocessor design, a self test is performed at turn on or whenever the instrument pre-set function is activated. This function verifies that the 8350A is functioning properly. If there is a problem, error codes are displayed on the front panel to help locate the problem quickly to the board and component level.

In the 8350A the frequency resolution is determined by the digital to analog converters that are used to produce the tuning voltage and marker pulses. The center frequency resolution is 0.024% of the full band (4096 points across the band). A vernier is used to increase the CF resolution by adding 64 points between each CF point which increases the CF resolution to 0.00038% of the full band range. The  $\Delta F$  resolution is variable, such that higher resolution is provided for narrow sweep widths. The  $\Delta F$  resolution is 0.1% of the full band range for full bands sweeps and improves to 0.0015% of the full band range for very narrow band sweeps.



## 8350A Specifications

### Instrument Control

**Control knobs, Step Keys and Data Entry Keyboard:** All instrument parameters whether time, frequency or power may be set three ways: control knobs, keyboard entry, or step keys. The step size either can be entered by the user or the pre-programmed default values may be used. The SHIFT key is used to effect the functions written in blue.

### Frequency Control Functions

**Range:** Determined by RF plug-in unit used

**Linearity:** Refer to RF unit specifications

**START/STOP Sweep:** Sweeps up from the START frequency to the STOP frequency.

**CF/ΔF Sweep:** Sweeps symmetrically upward, centered on CF

**ΔF:** Frequency Width of sweep. Continuously adjustable from zero to 100% of frequency range.

**ΔF Accuracy:** Refer to RF unit specifications.

**CF Accuracy:** Refer to RF unit specifications.

**CF Resolution:** 0.24% (4096 points across band)

**ΔF Resolution:** 0.1% of full band (1024 points across band)  
0.012% of band for 1/8 of band or less  
0.0015% of band for 1/64 of band or less

**Display Resolution:** 5 digits

**CW Operation:** Single frequency RF output.

**CW Accuracy:** Refer to RF unit specifications.

**CW Resolution:** Same as CF.

**Vernier:** Adjusts CW frequency or swept center frequency up to 0.05% of RF plug-in band being swept.

**Vernier Resolution:** 4 ppm (64 points between each CW point; 262, 144 points across band)

**Offset:** Allows the CW frequency or center frequency to be offset by any amount up to the full range of the plug-in.

**Resolution:** same as CF

**Accuracy:** Refer to RF unit specifications

**Frequency Markers:** Five frequency markers are independently adjustable and fully calibrated over the entire sweep range. Amplitude or intensity markers available.

**Resolution:** 0.4% of selected sweep width (256 points/sweep)

**Accuracy:** Refer to frequency accuracy.

**Marker Output:** Rectangular pulse, typically -5 volts peak available from the POS Z BLANK connector on rear panel.

**Marker Sweep:** RF output is swept between Marker 1 and Marker 2.

**Marker—CF:** Causes the CW or the swept center frequency to equal the frequency of the active marker.

### Sweep and Trigger Modes

**Internal:** Sweep recurs automatically

**Line:** Sweep triggered by ac power line frequency.

**External Trigger:** Sweep is actuated by external trigger signal.

**Single:** Selects mode and triggers a single sweep.

**Sweep Time:** Continuously adjustable from 10 msec to 100 seconds.

**Manual Sweep:** Front panel controls provide continuous manual adjustment of frequency between end frequencies.

**External Sweep:** Sweep is controlled by external signal applied to front or rear panel SWP OUTPUT/SWP INPUT connector.

**Sweep Output:** Direct-coupled sawtooth, zero to approximately ±10 volts, at front or rear panel concurrent with swept RF output.

### Instrument State Storage

**Save n/Recall n:** Up to 9 different front panel settings can be stored in the 8350A via the Save n (n = 1 through 9) function. Settings can be recalled randomly or in sequence.

**Alt n:** Causes the RF output to alternate on successive sweeps between the current front panel setting and a setting stored in memory.

### Instrument State

**Instrument Preset:** Sets the front panel of the 8350A into a pre-determined state. It also causes an internal analog and digital self-test to occur. If internal errors or failures are detected they are indicated via error codes.

**Local Operation:** This key is used to return the 8350A to local control from the remotely controlled state. The REM lamp indicates remote control. The ADRS'D lamp indicates transmitted or received data over the HP-IB.

### Modulation

**External AM:** Refer to RF unit specifications.

**Internal AM:** Square wave modulation available at all sweep speeds. Factory preset to 27.8 kHz although selectable to 1000 Hz or 27.8 kHz. On/off ratio, refer to RF unit specifications.

**External FM:** Refer to RF unit specifications.

**Phase-lock:** Refer to RF unit specifications.

### Remote Programming (HP-IB)

8350A has both input and output capability. The HP-IB address can be displayed on the front panel and is selectable (any number from 0 to 31).

**Input Mode Functions:** All front panel controls except the ac line power switch are programmable. Numerical values typically have greater entry resolution than is displayed.

**Frequency Resolution:** Same as CF/ΔF plus vernier.

**Power Resolution:** See 83500 Series Plug-ins.

**Output Mode Functions:** The 8350A can output to a controller an instrument state message that describes the present instrument status.

### General Specifications

#### Non Volatile Memory:

**Option 001:** Continuous memory that retains the contents of all instrument state storage registers, the HP-IB address, and current instrument state when ac line power is off.

#### Blanking:

**RF:** When enabled, RF turns off during retrace and remains off until next sweep.

**Display:** POS Z BLANK; direct-coupled rectangular pulse approximately +5.0 volts during retrace and bandswitch points of sweep. NEG Z BLANK; direct-coupled rectangular pulse approximately -5.0 volts coincident in time with RF blanking.

**Pen Lift:** Output to control the pen lift function of XY recorder at end point of sweep.

**Counter Trigger (CNTR TRIG):** Output for controlling the external trigger input of the HP 5343A Frequency Counter.

**Stop Sweep:** Input for stopping the progress of a forward sweep, used with HP 5343A Frequency Counter.

**Program Connector:** Additional control of and information on the 8350A instrument state is provided via a 25 pin rear panel connector.

**8410B Interface Cable:** Permits multi-octave operation of HP 8410B Network Analyzer with 8350A.

**Furnished:** 2.29m (7.5 foot) power cable with NEMA plug; spare fuses; two extender boards for servicing; 1.0 m (3.3 foot) HP-IB cable; mating connector for Auxiliary Program Connector.

**Operating Temperature Range:** 0°C to +55°C

**Power:** 100, 120, 220 or 240 volts +5-10%, 50 to 60 Hz (Option 400, 60 to 400 Hz). Approximately 270 volt-amperes including RF unit.

**Weight (not including RF unit):** Net 16.5 kg (36.4 lb). Shipping 22.7 kg (50 lb)

**Dimensions:** 425 mm wide, 133.3 mm high, 422 mm deep (16.75" x 5.25" x 16.6")

### Ordering Information

#### 8350A Sweep Oscillator Mainframe

**Price**  
\$4250

#### Options:

<b>001:</b> Non-Volatile Memory	add \$250
<b>400:</b> 400 Hz Power Line Frequency Operation	add \$200
<b>907:</b> Front Handles Kit	add \$32
<b>908:</b> Rack Mounting Kit	add \$25
<b>909:</b> Rack Mounting/Front Handles Kit	add \$55
<b>910:</b> Extra Manual	add \$25

# SWEEP OSCILLATORS

## 8350 Family: Broadband Plug-ins

### Model 83592A

- +10 dBm from 0.01–20 GHz
- Calibrated output power with 0.1 dB resolution
- Calibrated power sweep
- 20 MHz frequency accuracy
- Internal leveling and slope standard
- HP-IB

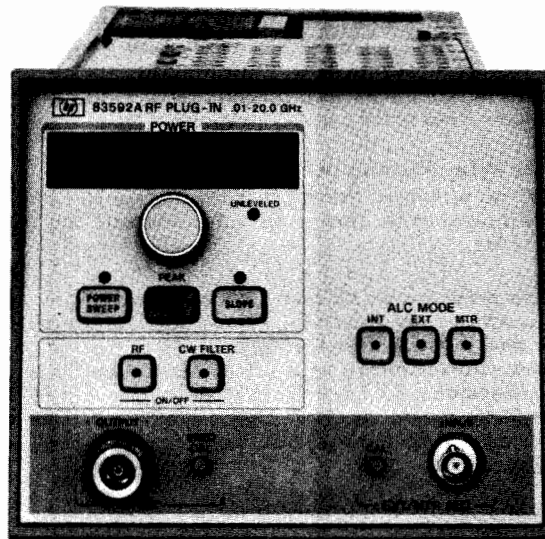

83592A



### Description:

With an ultra-wideband frequency range of 10 MHz to 20.0 GHz, the 83592A plug-in combined with 8350A mainframe is the source for broadband, high frequency applications. Although the 83592A features broadband sweeps, it maintains narrowband precision. The frequency output exhibits excellent stability and accuracy. At 20 GHz the 83592A maintains an accuracy of  $\pm 20$  MHz. The 83592A does not sacrifice power for high frequency. The output power is internally leveled for a minimum  $\pm 10$  dBm output with  $\pm 0.9$  dB flatness even at 20 GHz. Power output capabilities have been expanded to provide power sweep and slope control. In addition the 83592 is completely HP-IB programmable.

The most outstanding feature of the 83592A plug-in is its broad frequency range. Innovative technology is used to create this precision frequency range. The principle behind this technology is the Switched YIG Tuned Multiplier circuit (SYTM). This circuit contains a pin diode switch and a YIG Tuned Multiplier (YTM) in a single package. More specifically, the YTM circuit uses the output of a fundamental oscillator to drive a high-efficiency multiplier that has been integrated together with a tracking YIG filter in order to create and select high order harmonics to be used as output frequencies. The PIN diode allows the low frequency heterodyne band to be switched to the output for a single 0.01–20 GHz sweep. From this method, four frequency bands may be identified; one from the heterodyne, and then three bands resulting from the 1st, 2nd, or 3rd harmonics. For wideband sweeps these bands have very small overlap areas ( $\leq 20$  MHz), yet for narrow band sweeps these bands are flexible enough to contain the complete sweep in one band.

Another figure of merit for the 83592A is its flat power output over the entire frequency range. The output power is internally leveled within 0.9 dB for a minimum output power of 10 dBm, with a displayed resolution of 0.1 dB. The typical power calibrated control range is 15 dB or with Option 002 (70 dB Step Attenuator) this range increases to 80 dB.

Since power parameters are critical to high frequency measurements the 83592 (along with all 83500 series plug-ins) offers many modes of power output. In addition to a single power output, the

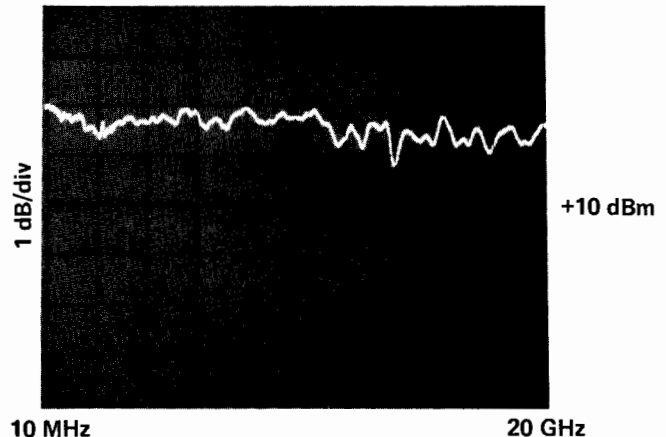

83592A offers a power sweep function. The power sweep function sweeps a power range for characterizing level sensitive devices like amplifiers and transistors. The slope mode is also supplied to provide compensation for cable or test set losses. In all these modes the power output is internally monitored and leveled. If preferred, the power may be externally leveled.

HP-IB programmability is an essential feature when the 83592A is used in automatic test systems. For example, the automated tests of amplifiers for gain compression are possible. The 83592 is completely programmable which means the power mode may be set, or the power level may be set with .02 dB resolution.

The 83592A plug-in is the source for high frequency, broadband network measurements. To provide 0.01 to 20.0 GHz scalar measurements the 83592 modulates a 27.8 KHz squarewave from the 8350 mainframe and hence becomes directly compatible with the HP8755 Frequency Response Test Set. By eliminating the need for an external modulator, full sweeper power is available at the test device. Phase/Amplitude network analysis over the 0.01 to 20 GHz range is possible when the 83592A is used in conjunction with the HP8410B Network Analyzer. The 8410B becomes automatically phase locked over multi-octave sweeps when it is interfaced with a source control cable from the 8350A mainframe and the 1 V/GHz from the 83592A.

### General Specifications

**Sweep Time (minimum):** 15 msec for a single band (Bands 1, 2, 3, 4). 25 msec for .01–20 GHz band.

**Switch Points:** Internal bands are .01–2.4 GHz, 2.3–7.0 GHz, 6.9–13.5 GHz and 13.4–20 GHz. Broadband switch points are at approximately 2.4 GHz, 7.0 GHz, and 13.5 GHz.

**Auxiliary Output:** Rear Panel 2.5–7 GHz fundamental oscillator output, nominally 0 dBm

**Frequency Reference Output:** Nominal 1V/GHz (.01–19 GHz)  $\pm 20$ mV rear panel BNC output

**RF Output Connector:** Type N female (Option 005 APC-7 RF Output Connector)

**Weight:** Net 6.0 kg (13.2 lb.) Shipping 9.2 kg (20 lb.)



### Output Characteristics

**Impedance:** 50  $\Omega$  nominal

**VSWR:** <1.5:1 below 2 GHz, <1.9:1 above 2 GHz.

**Power Sweep** (with option 002 Power Sweep cannot cross an attenuator step)

**Calibrated Range:** >10 dB (>15 dB typical)

**Accuracy** (Including Linearity): < $\pm$ 1.5 dB typical

**Resolution:** 0.1 dB

**Slope Compensation** (with option 002 Slope cannot cross an attenuator step)

**Calibrated Range:** 1 dB/GHz (10 dB over full range, typically 15 dB)

**Linearity:** <.3 dB typical

**Resolution:** .1 dB/GHz

### Modulation Characteristics

#### External AM

**Frequency Response:** Typically 150 kHz

**Input Impedance:** Approximately 10 k $\Omega$

**Range of Amplitude Control:** Typically 15 dB

**Sensitivity:** 1 dB/V typical

**Maximum Input:** 15 V

#### Internal AM

Selectable (by internal jumper in 8350A) to 1 kHz or 27.8 kHz square wave modulation. 27.8 kHz modulation guarantees operation with HP 8755 Frequency Response Test Set.

**On/Off Ratio:** 30 dB (>50 dB above 2.4 GHz)

#### External FM

##### Maximum Deviations for Modulation Frequencies

**DC to 100 Hz:**  $\pm$ 75 MHz

**100 Hz to 1 MHz:**  $\pm$ 10 MHz

**1 MHz to 2 MHz:**  $\pm$ 5 MHz

**2 MHz to 10 MHz:**  $\pm$ 1.5 MHz

##### Sensitivity

**FM Mode:** -20 MHz/V typical

**Phase-lock Mode:** -6 MHz/V typical

**Input Impedance:** 2 k $\Omega$  nominal

**Frequency Response:** (DC to 2 MHz):  $\pm$ 3 dB

#### Ordering Information

83592A +10 dBm .01 to 20 GHz RF Plug-In

#### Options

**002:** Programmable 70 dB Step Attenuator (10 dB steps)

**004:** Rear Panel RF Output

#### Price

\$23,500

add \$900

add \$150

### Frequency Characteristics

Range	.01-20 GHz				
	.01-2.4	2.4-7.0	7.0-13.5	13.5-20	.01-20
<b>Bands (GHz)</b>					
<b>Accuracy<sup>1</sup></b> (25°C $\pm$ 5°C)					
CW Mode: (MHz)	$\pm$ 5	$\pm$ 5	$\pm$ 15	$\pm$ 20	
Typically: (MHz)	$\pm$ 1.5	$\pm$ 3	$\pm$ 6	$\pm$ 9	
All Sweep Modes (<100 msec Sweep Time): (MHz)	$\pm$ 15	$\pm$ 20	$\pm$ 25	$\pm$ 30	$\pm$ 50
<b>Linearity:</b> Typ. (MHz)	$\pm$ 2	$\pm$ 2	$\pm$ 4	$\pm$ 6	$\pm$ 10
<b>Stability</b>					
With Temperature: Typically (MHz/ $^{\circ}$ C)	$\pm$ .5	$\pm$ .5	$\pm$ 1	$\pm$ 1.5	$\pm$ 2
With 10% Line Voltage Change: (kHz)	$\pm$ 50	$\pm$ 50	$\pm$ 100	$\pm$ 150	$\pm$ 150
With 10 dB Power Level Change: (kHz)	$\pm$ 200	$\pm$ 200	$\pm$ 400	$\pm$ 600	$\pm$ 600
With 3:1 Load VSWR: (kHz)	$\pm$ 100	$\pm$ 100	$\pm$ 200	$\pm$ 300	$\pm$ 300
With Time (in 10 minute period after 1 hour warmup): Typically (kHz)	<100	<100	<200	<300	<300
Residual FM (10 Hz-10 kHz bandwidth, peak): (kHz)	$\pm$ 10	$\pm$ 10	$\pm$ 20	$\pm$ 30	

<sup>1</sup>When calibrated using FREQ CAL adjustment.

### Output Characteristics

Bands (GHz)	.01-2.4	2.4-7.0	7.0-13.5	13.5-20	.01-20
<b>Maximum Leveled Power:</b> (mW)					
(25°C $\pm$ 5°C)	10	10	10	10	10
With Option 002: (mW)	10	7.1	6.3	5	5
<b>Power Level Accuracy</b>					
(Internally Leveled): (dB)	< $\pm$ 1	< $\pm$ 1.3	< $\pm$ 1.3	< $\pm$ 1.4	< $\pm$ 1.5
With Option 002: (dB)	< $\pm$ 1.2	< $\pm$ 1.5	< $\pm$ 1.5	< $\pm$ 1.6	< $\pm$ 1.7
<b>Calibrated Range:</b> (dB)	10	10	10	10	10
Typically: (dB)	15	15	15	15	15
With Option 002: (dB)	80	80	80	80	80
<b>Attenuator Accuracy (per 10 dB step):</b> (dB)	$\pm$ .4	$\pm$ .4	$\pm$ .4	$\pm$ .4	$\pm$ .4
<b>Remote Programming Resolution Displayed:</b> (dB)	.1	.1	.1	.1	.1
Settable: (dB)	.02	.02	.02	.02	.02
<b>Power Variation (Max. Rated Pwr)</b>					
Internally Leveled: (dB)	< $\pm$ .5	< $\pm$ .7	< $\pm$ .7	< $\pm$ .8	< $\pm$ .9
Externally Leveled (Excludes Coupler/Detector Variation) For Negative Crystal Detector and HP 432A/B/C Power Meter: (dB)	< $\pm$ .15	< $\pm$ .15	< $\pm$ .15	< $\pm$ .15	< $\pm$ .15
With Temperature: (dB/ $^{\circ}$ C)	.1	.1	.1	.1	.1
<b>Residual AM in 100 kHz Bandwidth:</b> (dBc)	<50	<50	<50	<50	<50
<b>Spurious Signals</b>					
Harmonically Related: (dBc)	<25	<25	<25	<25	<25
Non-Harmonics: (dBc)	<25	<50	<50	<50	<25





# SWEEP OSCILLATORS

## 8350 Family: Broadband Plug-Ins

Models 83522A and 83525A

- 10MHz-2.4 GHz and 10 MHz-8.4 GHz in one continuous sweep
- Calibrated Output Power
- Power Sweep
- 1, 10, and 50 MHz Crystal Markers

- Complete HP-IB programmability
- Internally leveled flatness
  - ± .25 dB over full band 83522A
  - ± 1 dB over full band 83525

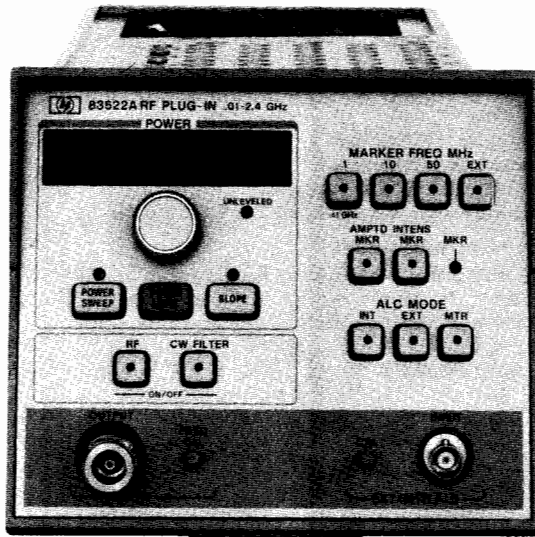

83522

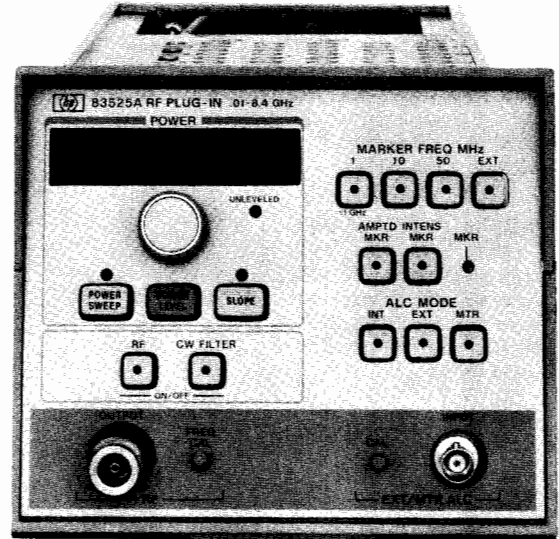

83525



Broadband frequency measurements may be made with the HP83522 (10 MHz to 2.4 GHz) plug-in and the 83525 (10 MHz to 8.4 GHz) plug-in. These plug-ins have similar functions as well as individual merits which are all described in the following article.

### 83522

The 83522 uses a heterodyne circuit to provide high performance 10 MHz to 2.4 GHz frequency coverage. This frequency range is covered in one continuous sweep having excellent frequency characteristics. Frequency accuracy is maintained within 5 MHz and the linearity is within 2 MHz over the full band. The power output is internally leveled to  $\pm 0.25$  dB flatness over the entire 10 MHz to 2.4 GHz range while maintaining a power level  $\geq 13$  dBm.

### 83525

The 83525 covers the unmatched frequency range of 10 MHz to 8.4 GHz with excellent frequency stability, accuracy, and output power. This wide frequency range is created by automatically switching two bands together with a PIN diode switch. The lower frequency band covers 0.01-2.1 GHz which results from a heterodyne circuit. The upper frequency band is produced by a 2-8.4 GHz YIG oscillator. This 0.1 GHz frequency overlap is provided to enable smooth, narrowband sweeps around the switch point. On a full band sweep (10 MHz to 8.4 GHz) the band discontinuity at the switchpoint will be typically  $< 15$  MHz. The 83525 maintains excellent frequency parameters with a lower band accuracy within  $\pm 5$  MHz and an upper band accuracy within 15 MHz. Full band Frequency linearity is  $\pm 6$  MHz while the lower band maintains a linearity of  $\pm 2$  MHz.

The 83525 plug-in, with its extremely broad frequency range, does not sacrifice power. The output power is internally leveled to at least 13 dBm with a flatness of  $\pm 1$  dB.

### 83522/83525 Common Features

#### Crystal Marker Capability

A powerful feature offered by both the 83522 and the 83525 is Crystal Marker Capability. This capability provides harmonic markers at 10 or 50 MHz intervals over the full range of the 83522A and

below 2 GHz with the 83525A. In addition, 1 MHz harmonic markers are available below 1 GHz with both plug-ins. These markers may either be seen as intensity spots or amplitude dips. The x-axis intensity markers are compatible with the HP8755 Swept Frequency Response Test Set. These crystal markers simplify and speed up precision frequency measurements.

#### Power Output

Both the 83522 and the 83525 have a calibrated output power range of typically 15 dB that may be extended to 80 dB with Option 002 (70 dB attenuator). The output power level accuracy is within 1 dB on the 83522 and within 1.5 dB on the 83525. The front panel digital resolution enables the power to be manually set to a 0.1 dB resolution. The power may be remotely HP-IB programmed to 0.02 dB resolution.

These plug-ins also offer a variety of power functions. An innovative feature offered on these plug-ins is Power Sweep, which sweeps the output power from one level to another. With this function power response measurements may be made in a single test. Slope compensation is provided for situations that involve lossy cables or test set ups. This function slopes the power to compensate for high frequency losses via a "SLOPE" control.

#### Programmability

The 83522 and the 83525 are completely programmable plug-ins. This infers that the power level, power mode (Power Sweep, slope, etc.), crystal markers and other plug-in functions may be externally controlled via the HP-IB. Programmability is a key feature for automatic test systems or production environments requiring multiple, repetitive tests.

#### Network Measurements

Increased dynamic range scalar measurements can be made using either the HP83522 or the 83525 with the HP8755 Swept Frequency Response Test Set. The dynamic range is increased by internally modulating the RF output with the required 27.8 KHz square wave (produced by the 8350A). This causes the output to be modulated before it is passed through the output amplifier, thereby avoiding modulation of the amplifier noise. The advantage of increased dynamic range is complemented by the simple interface between the sweep and the HP8755.



### Frequency characteristics

Range	83522A		83525A	
	.01-2.4 GHz		.01-2 GHz	2-8.4 GHz
<b>Accuracy* (25°C ± 5°C)</b>				
CW Mode:	± 5 MHz	± 5 MHz	± 15 MHz	
Typically:	± 1.5 MHz	± 1.5 MHz	± 3.5 MHz	
All Sweep Modes	± 15 MHz	± 15 MHz	± 20 MHz	
Linearity Typically:	± 2 MHz	± 2 MHz	± 6 MHz	
<b>Stability</b>				
With Temperature: Typically	± 200 kHz/°C	± 200 kHz/°C	± 200 kHz/°C	
With 10% Line Voltage Change:	± 20 kHz	± 20 kHz	± 20 kHz	
With 10 dB Power Level Change:	± 100 kHz	± 100 kHz	± 1 MHz	
With 3:1 Load SWR:	± 10 kHz	± 10 kHz	± 250 kHz	
With Time (in 10 minute period one hour after warmup): Typically	< ± 100 kHz	< ± 100 kHz	< ± 200 kHz	
Residual FM (10 Hz-10 KHz Bandwidth), peak	< 5 kHz	< 5 kHz	< 9 kHz	

\*When calibrated using internal crystal markers and FREQ CAL adjustment.

**Range of Amplitude Control:** 15 dB Typically

**Sensitivity:** 1 dB/V Typically

**Maximum Input:** 15 V

**Pulse Modulation:** (83525A, 2-8.4 GHz)

**Rise/Fall Time:** 20 nsec Typically

**Minimum Pulse Width:** Leveled: 400 nsec Typically

Unleveled: 50 nsec Typically

### Internal AM

Selectable (by Internal Jumper in 8350A) to 1 kHz or 27.8 kHz square wave modulation. 27.8 kHz Modulation guarantees operation with HP 8755 Frequency Response Test Set.

**On/Off Ratio:** > 30 dB (> 40 dB above 2 GHz)

### External FM

Maximum Deviations for Modulation Frequencies

**DC to 100 Hz:** ± 75 MHz

**100 Hz to 1 MHz:** ± 10 MHz

**1 MHz to 2 MHz:** ± 5 MHz

**2 MHz to 10 MHz:** ± 1.5 MHz

### Sensitivity

**FM Mode:** -20 MHz/V Typical

**Phase-lock Mode:** -6 MHz/V Typical

**Input Impedance:** 2 kΩ nominal

**Frequency Response (DC to 2 MHz):** ± 3 dB

### Crystal marker capability

**Internal Crystal Markers:** Harmonic markers of 10 and 50 MHz are available over the full range of the 83522A and below 2 GHz with 83525A. 1 MHz harmonic markers are available below 1 GHz with the 83522A and 83525A. Markers are output as intensity spots through the POS Z BLANK connector on the 8350A or as amplitude dips on the RF output.

**Accuracy of Center Frequencies (25°C):** ± 5 x 10<sup>-6</sup>

Typical Marker Width Around Center Frequency

**1 MHz Markers:** ± 100 kHz

**10 MHz Markers:** ± 200 kHz

**50 MHz Markers:** ± 300 kHz

**Temperature Stability:** ± 2 x 10<sup>-6</sup>/°C Typically

**External Marker Input:** Generates amplitude or Z-axis marker when sweep frequency equals external input frequency.

**Frequency Range:** .01 to 2.4 GHz

**Marker Width:** ± 300 kHz

**Marker Indicator Light:** LED lights when coincident with crystal or external marker for accurate CW calibration.

### General specifications

**Sweep Time (minimum over full band)**

**83522A (.01-2.4 GHz):** 10 ms

**83525A (.01-8.4 GHz):** 17 ms

**Switch Points (83525A Only):** Low Band .01-2.1 GHz, High Band 2.0-8.4 GHz. Internal band switch point at 2.0-2.1 GHz

**Frequency Reference Output:** Nominal 1 V/GHz (over full sweep range) ± 10 mV rear panel BNC output.

**RF Output Connector:** Type N female

**Weight:** Net 4.5 kg. (10 lb.). Shipping 7.7 kg. (17 lb.)

### Ordering Information

**83522A +13 dBm .01-2.4 GHz RF Plug-in**

**Price**

\$7,450

### Options:

**002:** Programmable 70 dB Step Attenuator (10 dB steps) add \$700

**004:** Rear Panel RF Output add \$150

**83525A +13 dBm .01-8.4 GHz RF Plug-in**

\$12,500

### Options:

**002:** Programmable 70 dB Step Attenuator (10 dB steps) add \$800

**004:** Rear Panel RF Output add \$150

### Output characteristics

	83522A		83525A	
			.01-2 GHz	2-8.4 GHz
<b>Maximum Leveled Output Power</b> (25°C ± 5°C)				
With Option 002	+20 mW	+20 mW	+20 mW	+16 mW
<b>Power Level Accuracy</b> (Internally Leveled):	± 1 dB	± 1.5 dB	± 1.5 dB	± 1.5 dB
<b>Calibrated Range:</b>	10 dB	10 dB	10 dB	10 dB
Typical:	15 dB	15 dB	15 dB	15 dB
With Option 002:	80 dB	80 dB	80 dB	80 dB
<b>Attenuator Accuracy</b> (per 10 dB step):	± .3 dB	± .3 dB	± .3 dB	± .3 dB
<b>Resolution (displayed):</b>	.1 dB	.1 dB	.1 dB	.1 dB
<b>Remote Programming (Settable):</b>	± .02 dB	± .02 dB	± .02 dB	± .02 dB
<b>Power Variation (Max. Rated Pwr)</b>				
Internally Leveled:	± .25 dB	± 1 dB	± 1 dB	± 1 dB
Externally Leveled (Excludes Coupler/Detector Variation) For Negative Crystal Detector and HP 432A/B/C Power Meter:	< ± .1 dB	< ± .1 dB	< ± .1 dB	< ± .1 dB
With Temperature:	± .02 dB/°C	± .02 dB/°C	± .02 dB/°C	± .02 dB/°C
<b>Residual AM in 100 kHz Bandwidth:</b>	> 50 dBc	> 50 dBc	> 50 dBc	> 50 dBc
<b>Spurious Signals</b>				
Harmonics:	> 25 dBc	> 25 dBc	> 20 dBc	> 20 dBc
Typical:	> 30 dBc	> 30 dBc	> 30 dBc	> 30 dBc
Non-Harmonics:	> 25 dBc	> 30 dBc	> 60 dBc	> 60 dBc
Typical:	> 35 dBc	> 40 dBc	> 60 dBc	> 60 dBc
<b>Output VSWR (internally leveled)</b>	< 1.5	< 1.5	< 1.5	< 1.6

**Impedance:** 50 Ω nominal

### Power Sweep

**Calibrated Range:** > 10 dB (> 15 dB Typical)

**Accuracy (Including Linearity):** < ± 1.5 dB Typical

**Resolution:** 0.1 dB

### Slope Compensation

**Calibrated Range:** up to 1 dB/GHz (10 dB over full range, typically 15 dB)

**Linearity:** < .2 dB Typical

**Resolution:** .1 dB/GHz

### Modulation characteristics

#### External AM

**Frequency Response:** 100 kHz Typically

**Input Impedance:** Approximately 10 kΩ

# SWEEP OSCILLATORS

8350 Family: RF Plug-Ins  
Models 83540A, 83545A, 83570A

- 83570A offers 10 mW internally leveled 18-26.5 GHz output
- 83540A offers 40 mW internally leveled 2-8.4 GHz output
- 83540A offers 50 mW internally leveled 5.9-12.4 GHz output
- Calibrated Output Power with 0.1 dB resolution
- Power Sweep
- Complete HP-IB programmability

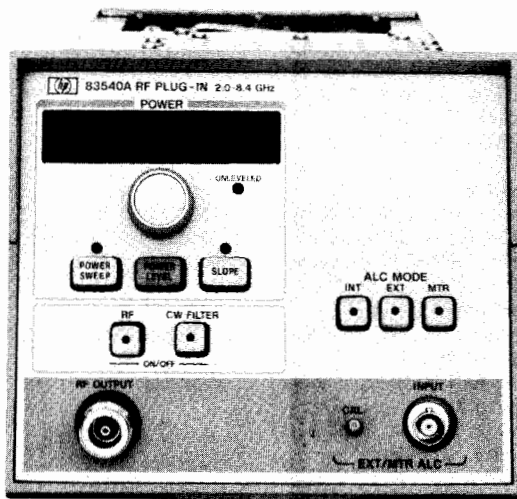

83540A

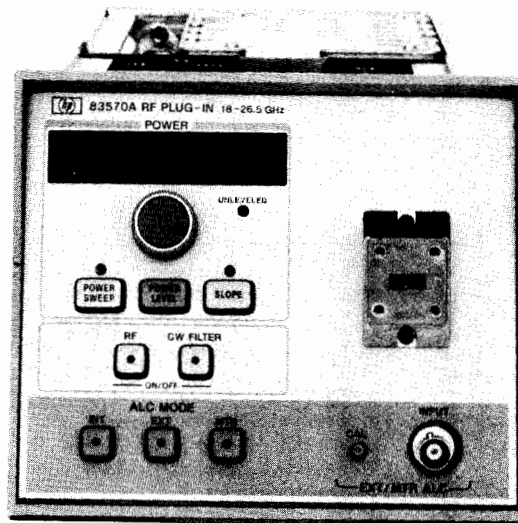

83570A



## 83570A

Now precision measurements to 26.5 GHz are possible with the solid state 83570 plug-in. The 83570 plug-in maintains a minimum leveled output power of 10 dBm which is comparable to the output power of Backward Wave Oscillators. Power is internally leveled to a flatness  $< \pm 1.0$  dB. At the output, power losses are minimized with a waveguide output connector (a coaxial output connect may be made using the HP K281C Adapter). Full range coverage of the 83570 extends from 18 GHz to 26.5 GHz. This frequency range maintains a 30 MHz frequency accuracy and 0.1% linearity. With high frequency coverage, complete HP-IB programmability and outstanding leveled output power, the 83570 plug-in, combined with the many features of the 8350A mainframe adds a new dimension to microwave measurements above 18 GHz.

The output power has a calibrated range of 15 dB which can be extended with external attenuators such as the HP 8495K. The power level may be manually set to a 0.1 dB resolution, or the power level may be remotely HP-IB programmed to a 0.02 dB resolution. In addition to a single output power, the 83570 also has a power sweep function. This function sweeps the power from one level to another. Another important feature that the 83570 offers is slope compensation. This compensates for high frequency power losses in external tests by attenuating the power at lower frequencies.

Scalar measurements at high frequencies may be easily made since the 83570 provides internal 27.8 KHz modulation required to interface with the HP 8755 Swept Frequency Response Test Set. In addition to simplifying the interface circuitry, internal modulation reduces connection losses which are critical at high frequencies.

The 18-26.5 GHz signal is generated by doubling the output of a 9-13.25 GHz YIG oscillator. This half frequency is coupled off to an output which may be used for phase locking or counting. Key to the high power of the HP 83570 is a single doubler package. This package contains the frequency doubler, amplifier, modulator and the leveling coupler with detector. This single package configuration significantly reduces power losses.

## 83540A

High power, high performance, straddle band frequency coverage from 2-8.4 GHz is provided by the 83540 plug-in. The output power is leveled at a minimum of 16 dBm with variations less than 1 dB.

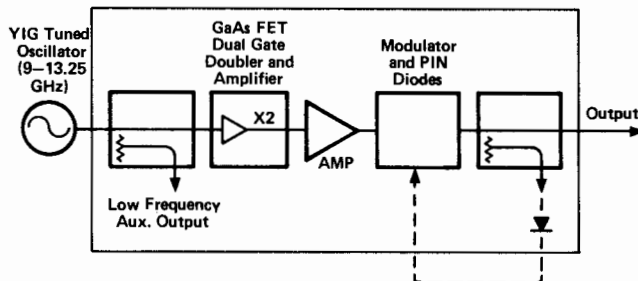

83570A Block Diagram

The calibrated power output range is 15 dB which may be extended to 80 dB with Option 002 (70 dB Step Attenuator). This plug-in also features Power Sweep which allows power response measurements to be made in a single test. Another power function is slope compensation which adjusts for high frequency cable or test set losses. All plug-in features are completely HP-IB programmable. The frequency outputs are accurate within 15 MHz while maintaining a full band linearity typically within 0.1%. In addition to its sweeper functions, the 83540 is also directly compatible with the HP 8755 Swept Frequency Response Test Set and the HP 8410B Network Analyzer.

## 83545A

The 83545 plug-in features high performance 5.9-12.4 GHz frequency coverage with exceptionally high output power. The output power is internally leveled to at least 17 dB, with power variations less than 0.6 dB! The calibrated output power has a range of 15 dB which is expandable to 80 dB with Option 002 (70 dB Step Attenuator). A power sweep function is available for power response measurements. In addition, the 83545 provides slope compensation and complete HP-IB programmability. The frequency output is accurate to 20 MHz with excellent stability and linearity (typically 0.1%). Network



analysis is simplified since the 83545 provides 27.8 kHz internal modulation for direct compatibility with the HP 8755 Swept Frequency Response Test Set and it is also directly compatible with the HP 8410B Network Analyzer.

#### Frequency Characteristics

**Linearity:** (83540A, 83545A, 83570)  $\pm 0.1$  Typically

**Reference Output:** (83540A, 83545A) DC-coupled voltage proportional to RF frequency. Typically 1V/GHz (up to 20V) with accuracy of  $\pm 100$  mV.

#### Output Characteristics

**Power Level Accuracy:**  $\pm 1$  dB Typically

**Option 002 (70 dB Step Attenuator):** (83540A, 83545A)  $\pm 0.2$  dB/10 dB step

#### RF Power Leveling:

**Internal:** Selected by front panel switch; Refer to chart for figures. Standard

#### External:

**Crystal Input:** Approximately  $-20$  to  $-250$  mW for specified leveling at rated output; For use with negative polarity detectors such as 780 Series Directional Detectors, 423A/B and 424 Series Crystal detectors.

**Power Meter Input:** Switch selects proper compensation for HP 432A/B/C Power Meters.

**Indicator:** Front panel indicator lights when RF power becomes unlevelled. Residual AM in 100 kHz Bandwidth:  $> 50$  dBc

#### Power Sweep:

**Calibrated Range:** 10 dB (15 dB Typically)

**Accuracy:**  $\pm 1$  dB

**Resolution:** 0.1 dBm

**Slope Compensation:** Compensates for high frequency power losses in external test sets by attenuation power at lower frequencies:

**Calibrated Range:** up to 1 dB/GHz (10 dB max., typically 15 dB)

**Linearity:**  $> .2$  dB Typical

**Resolution:** 0.1 dB/GHz

#### General Specifications

**Auxiliary Output:** (83570A) Rear Panel 9-13.25 GHz fundamental oscillator output, nominally 0 dBm

**Weight:** 83540A, 83545A: Net 3.8 kg (8.4 lbs); Shipping 7 kg (15.4 lbs). 83570A: Net 5.4 kg (12 lbs); Shipping 8.7 kg (19 lbs).

#### Ordering Information

**83540A** 2-8.4 GHz Plug-in (Internal leveling standard) \$7500

**83545A** 5.9-12.4 GHz Plug-in (Internal leveling standard) \$8250

**83545A** 5.9-12.4 GHz Plug-in (Internal leveling standard) \$9500

#### Options

**002:** 70 dB Step Attenuator (83540A, 83545A) Add \$800

**004:** Rear Panel RF Output Connector (83540, 83545, 83570) Add \$150

Frequency Characteristics Range:	2-8.4 GHz	5.9-12.4 GHz	18-26.5 GHz
<b>Accuracy</b> (25°C $\pm 5^\circ$ C) CW Mode: Typical: All Sweep Modes: (for sweep time $> 100$ msec)	$\pm 15$ MHz $\pm 3.5$ MHz $\pm 20$ MHz	$\pm 20$ MHz $\pm 10$ MHz $\pm 30$ MHz	$\pm 30$ MHz $\pm 20$ MHz $\pm 40$ MHz
<b>Stability</b> With Temperature: With 10% Line Voltage Change: With 10 dB Power Level Change: With 3:1 Load SWR Change: With Time (after warmup): Typ/10 min. Residual FM: (in 10 kHz bandwidth, CW mode):	$\pm 500$ kHz/ $^\circ$ C $\pm 20$ kHz $\pm 1$ MHz $\pm 250$ kHz $\pm 200$ kHz $< 10$ kHz peak	$\pm 700$ kHz/ $^\circ$ C $\pm 40$ kHz $\pm 1.5$ MHz $\pm 250$ kHz $\pm 200$ kHz $< 15$ kHz peak	$\pm 700$ kHz/ $^\circ$ C $\pm 80$ kHz $\pm 1$ MHz $\pm 500$ kHz $\pm 400$ kHz $< 50$ kHz peak
<b>Output Characteristics</b> Maximum Leveled Power (25°C $\pm 5^\circ$ C Opt 002 (70 dB step atten.))	$> 40$ mW $> 32$ mW	$> 50$ mW $> 40$ mW	$> 10$ mW
<b>Power Variation</b> (At max. rated power) Internally Leveled: Unleveled: Typically Externally Leveled (Excluding coupler and detector variation): Crystal Detector or Power Meter	$< \pm 1$ dB $< \pm 2$ dB $< \pm 1$ dB	$< \pm 6$ dB $< \pm 3$ dB $< \pm 1$ dB	$< \pm 1$ dB $< \pm 2$ dB $< \pm 1$ dB
<b>Spurious Signals:</b> (Below fundamental at specified maximum power) Harmonically Related:	$> 20$ dB (@ 20 mW) $> 16$ dB (@ 40 mW) $> 60$ dB	$> 17$ dB 5.9-7 GHz $> 30$ dB 7-12.4 GHz $> 60$ dB	$> 25$ dB  $> 60$ dB
<b>Non-Harmonics:</b> Source VSWR: 50 nominal impedance Internally Leveled: Unleveled: Typically			
<b>Modulation Characteristics</b> External FM Maximum Deviations for Modulation Frequencies DC to 100 Hz: 100 Hz to 1 MHz: 1 MHz to 2 MHz: 2 MHz to 10 MHz: <b>Sensitivity:</b> Nominal FM Mode: Phase-lock Mode:	$\pm 75$ MHz $\pm 10$ MHz $\pm 5$ MHz $\pm 1.5$ MHz -20 MHz/V -6 MHz/V	$\pm 75$ MHz $\pm 10$ MHz $\pm 5$ MHz $\pm 1.5$ MHz -20 MHz/V -6 MHz/V	$\pm 75$ MHz $\pm 10$ MHz $\pm 1.5$ MHz -20 MHz/V -6 MHz/V
<b>External AM</b> Input Impedance: nominal Frequency Response: Typical Range: Typical	5K $\Omega$ 100 kHz 15 dB	5K $\Omega$ 100 kHz 40 dB	5K $\Omega$ 100 kHz 20 dB
<b>Pulse Modulation</b> Rise/Fall Time: Typical Minimum Pulse Width Leveled: Typical Unleveled: Typical	20 nsec  1 sec 100 nsec	10 nsec  1 sec 100 nsec	10 nsec  1 sec 100 nsec
<b>Square Wave Response</b> ON/Off Ratio: Typical Symmetry: Typical	$> 40$ dB 40/60	$> 40$ dB 40/60	$> 30$ dB 40/60
<b>Internal AM:</b> Selectable to 1 kHz or 27.8 kHz square wave (Guarantees HP 8755 Frequency Response Test Set compatibility) On/Off Ratio:	$> 40$ dB	$> 40$ dB	$> 30$ dB

# SWEEP OSCILLATORS

## 8350 Family: Plug-In adapter

Model 11869A

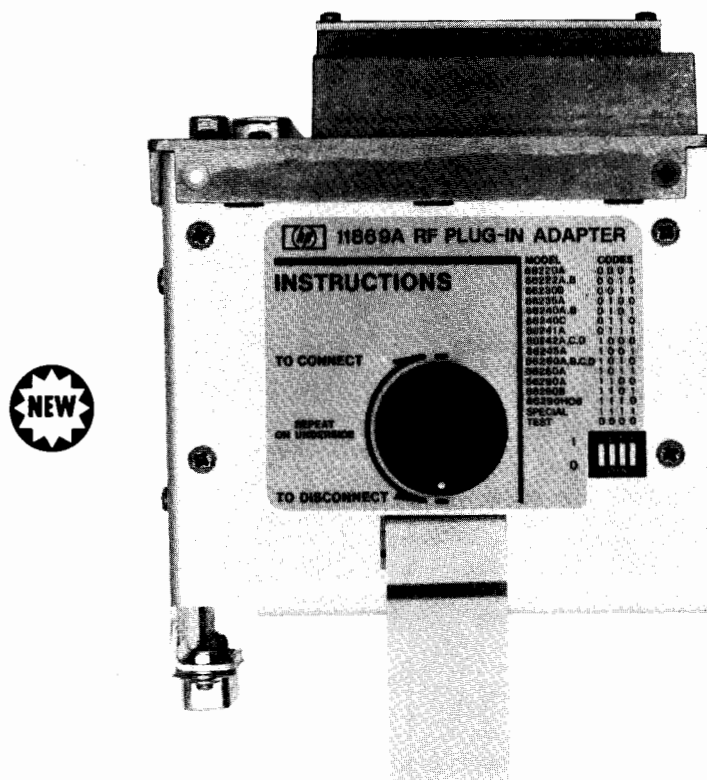

### 11869A Adapter

The 11869A Adapter provides the electrical and mechanical interface between the 8350A and 86200 series plug-in. All of the 8350A's standard operating features including HP-IB remote programming are available. However, specific plug-in functions (output power level, RF on/off, etc.) cannot be controlled or remotely programmed by the 8350A mainframe.

### Plug-ins with rear panel RF output

Option 004 allows the adapter to be used in 86200 plug-ins equipped with rear panel RF output. Supplied with Option 004 are two pre-shaped, semi-rigid coax cables with the appropriate mating connectors so that the RF output can be extended to the rear panel of the adapter.

### Rear Panel Description

On the rear panel of the 11869A are five hole plugs that pop out to allow connections to be made to the rear panel. Four of the holes are for low frequency (small diameter) cables while one is for high frequency (large diameter) RF cable. For user convenience four of the holes are labeled — EXT ALC IN, PULSE IN, FREQ REF AND RF OUT.

Three BNC cables are supplied to extend the plug-in rear panel inputs/outputs to the rear panel of the adapter. A separate cable (BNC/Multi-pin) is provided for connection of the plug-in FM input to the adapter/mainframe.

### Plug-ins Compatible with the 11869A Adapter

The 11869A Adapter attaches to the back of the plug-in and is equipped with a switch for setting the specific interface code for the plug-in being used.

The following plug-ins will operate in the 8350A by using the 11869A Adapter.

86220A (0.01–1.3 GHz)	86242A/C/D (5.9–9.0 GHz)
86222A/B (0.01–2.4 GHz)	86245A (5.9–12.4 GHz)
86230B (1.8–4.2 GHz)	86250A/B/C/D (8.0–12.4 GHz)
86235A (1.7–4.3 GHz)	86260A (12.4–18.0 GHz)
86240A/B (2.0–8.4 GHz)	86290A (2.0–18.0 GHz)
86240C (3.6–8.6 GHz)	86290B (2.0–18.6 GHz)
86241C (3.2–6.5 GHz)	86290B H08 (2.0–22 GHz)

### Special Plug-ins

For factory modified 86200 series plug-ins with non-standard frequency coverage a special PROM must be inserted in the 11869A Adapter. Consult your local HP Sales and Service Office for further information.

### Plug-ins Not Compatible with the 11869A Adapter

The 8621B RF Drawer and 86300 series RF modules are not compatible with the 11869A and will not operate in the 8350A.

**Furnished:** Three BNC cables for extending plug-in rear panel inputs/outputs to adapter rear panel; BNC/multi-pin cable for connecting plug-in FM input to adapter/mainframe; plug-in handle assembly for simplified installation in the 8350A mainframe.

### Ordering Information

#### 11869A Adapter

**Option 004:** Extension Cables for Plug-ins with Rear Panel RF Output (Opt. 004) Add \$200

**Special PROM module:** For plug-ins with non-standard frequency coverage. (Consult Sales and Service Office)

Approx. \$200

#### Price:

\$200

# SWEEP OSCILLATORS

Solid state sweeper family, 10 MHz to 22 GHz  
Model 8620 System



- Single-band, straddle-band and broadband plug-ins
- > 10 mW to 22 GHz



## 8620 System

The Hewlett-Packard 8620 solid state sweeper system offers the flexibility of the 8620C mainframe in addition to a choice of single-band, multiband, straddle-band, and broadband plug-ins. The 8620 system also offers high output with solid state reliability—greater than 10 mW leveled to 22 GHz.

The fundamental oscillators used in the plug-ins and modules are YIG tuned transistor or bulk effect circuits. YIG tuning results in exceptional tuning linearity, low noise, and low spurious content; it also allows frequency modulation at high rates and wide deviations with low distortion.

Typical unlevelled power output

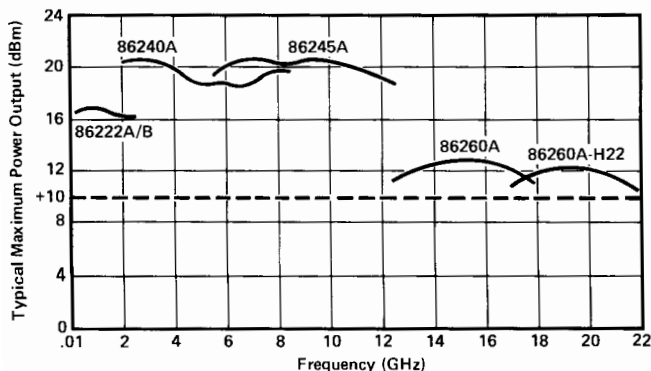

## 8620C Sweeper Mainframe

The 8620C has many features which are highly useful in stringent applications. With convenient functionally grouped controls and lighted pushbutton indicators the mainframe offers extreme ease of operation and flexibility. In addition, it can be a completely programmable source, either HP-IB or BCD, an indispensable feature for automatic systems and signal simulation applications.

### 86222A/B and 86290A/B/C Broadband Plug-ins

Now the 10 MHz to 18.6 GHz frequency range can be covered with just two plug-ins—the 86222A/B and 86290A/B. Besides their broad frequency range these plug-ins offer many special features including unique crystal markers in the 86222B and better than  $\pm 30$  MHz frequency accuracy in a 86290A/B even at 18 GHz.

### 86240A/B Straddle-Band Plug-ins

Covering more than two octaves of frequency the 86240A and B span 2 to 8.4 GHz with major advances in power output and signal purity. The 86240A offers more than 40 mW leveled output across the full band. The 86240B specifies harmonics of  $> 45$  dBc which can be very important when making measurements across more than one octave.

### 86200 Series Single-Band Plug-ins

The 86200 series of plug-ins covers both ends of the frequency spectrum from 10 MHz to 22 GHz with a choice of more than nine plug-ins.

### Plug-In Compatibility with 8350A

The entire line of 86200 series plug-ins can be used in the 8350A Sweep Oscillator mainframe with no degradation in performance by using the 11869A Adapter.

### Ordering Information

**Opt A91:** Panel color change to previous standard (olive black/mint gray) for compatibility with existing 8620C/86200 sweepers.

Price  
N/C

# SWEEP OSCILLATORS

8620 Family: mainframe

Model 8620C

- Optional BCD or HP-IB Programming
- 3 Markers

- 100%  $\Delta F$  Capability, fully calibrated

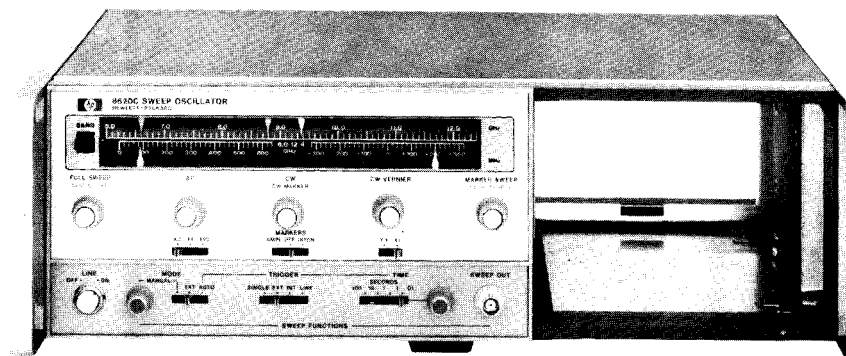

The 8620C offers many features as standard equipment. For example, up to four separate bands and their respective frequency scales can be selected with a band select lever to the left of the dial scale. Pushbuttons, concentrically located in the frequency control knobs, light when actuated to indicate the sweep function in use. The sweep functions available are: FULL SWEEP, MARKER SWEEP, CW/ $\Delta F$  and CW. Three markers are available, controlled by the START MARKER, STOP MARKER, and CW MARKER knobs.

The 8620C is fully and continuously calibrated for any  $\Delta F$  sweep width. The sweep is symmetrical about the CW MARKER setting and three continuously variable  $\Delta F$  ranges are available by using the range switch below the  $\Delta F$  knob. This allows calibrated sweep widths of up to 1%, 10% or 100% of full band.

When in CW/ $\Delta F$  or CW modes, the CW VERNIER knob allows for excellent frequency resolution. In terms of improved frequency resolution the vernier increases the effective length of the dial scale to 7.5 meters (300 inches).

Another feature is the capability to fully program the sweeper. The standard 8620C includes inputs for band selection, sweep function selection, and analog frequency control. In addition to this, more flexible digital frequency programming options are available to control the 8620C via the HP-IB (Option 011) or by BCD programming (Option 001).

## 8620C Specifications

### Frequency

**Frequency range accuracy and linearity:** determined by band select lever and RF unit specs.

### Sweep functions

**FULL SWEEP:** sweeps the full band as determined by the plug-in and the band select lever.

**MARKER SWEEP:** sweeps from START MARKER to STOP MARKER frequency settings: up to the full range of the plug-in can be set to sweep either up or down in frequency.

**$\Delta F$  Sweep:** sweeps symmetrically upward in frequency, centered on CW setting, CW vernier can be activated for fine control of center frequency.

**Width:** continuously adjustable and calibrated from zero to 1%, zero to 10%, or zero to 100% of frequency band.

**CW operations:** single-frequency RF output controlled by CW MARKER knob selected by depressing pushbutton in CW MARKER control.

**CW vernier:** calibrated directly in MHz about CW setting. CW vernier activated by pushbutton in CW vernier control. Zero to  $\pm 0.5\%$  or zero to  $\pm 5\%$  of full bandwidth, selectable with front panel switch.

**Frequency markers:** three constant width frequency markers are fully calibrated and independently adjustable over the entire range in FULL SWEEP function, controlled by START MARKER, STOP MARKER, and CW MARKER controls. In  $\Delta F$  sweep START and STOP MARKERS are available, and in MARKER SWEEP the CW MARKER is available. Front panel switch provides for the selection of either amplitude or intensity markers (amplitude modulating the RF output or Z-axis modulating the CRT display).

**Marker output:** rectangular pulse, typically  $-5$  volts peak available from Z-axis BNC connector on rear panel. Source impedance, approximately 1000 ohms.

### Sweep Modes (auto, line or externally triggered)

**Sweep time:** continuously adjustable from 0.01 to 100 seconds. Single sweep, manual sweep and external sweep control also available.

**Sweep output:** direct-coupled sawtooth, zero to approximately +10 volts, at front panel BNC connector, concurrent with swept RF output.

### Modulation

External AM, FM and phase-lock capability; internal 1000 Hz square wave AM modulation available.

### Remote Control

**Remote band select:** frequency range can be controlled remotely by three binary contact closure lines available at rear panel connector.

### Remote Frequency Programming, Opt 001 (BCD) and 011 (HP-IB)

#### Functions

**Band:** manual enable or remote control of four bands.

**Mode:** seven modes are selectable, including digital control in three modes with a resolution of 10,000 points. For more information on remote control of the 8620C refer to Application Note 187-5.

### General

#### Blanking

**RF:** with blanking switch enabled, RF automatically turns off during retrace, and remains off until start of next sweep.

**Display (Z-AXIS/MKR/PEN LIFT Output):** direct-coupled rectangular pulse approximately +5.0 volts coincident in time with RF blanking is on rear panel.

**Negative (Negative blanking output):** direct-coupled rectangular pulse approximately  $-5.0$  volts coincident in time with RF blanking.

**Pen lift:** for use with X-Y recorders having positive power supplies. Transistor-switch signal is available on Z-AXIS/MKR/PEN LIFT connector. This signal is also available on the programming connector.

**Furnished:** 2.29 m (7½-foot) power cable with NEMA plug; 2 spare 3 amp fuses; extender board for servicing; calibration scale; incandescent lamp; and 50 pin connector that mates with rear panel programming connector. With Option 011, an HP-IB connector/adaptor and a 2 m (6.6 foot) HP-IB cable (10631B) are also included.

**Power:** 100, 120, 220, or 240 volts  $\pm 5 - 10\%$ , 50 to 400 Hz. Approximately 140 watts.

**Weight:** (not including RF unit): Net, 11.1 kg (24 lb). Shipping 13.4 kg (30 lb).

**Size:** 132.6 mm H x 425 mm W x 337 mm D (5.29" x 16.75" x 13.25").

### Ordering Information

8620C Sweep Oscillator Mainframe

Opt 001: BCD Frequency Programming

Opt 011: HP-IB Frequency Programming

Opt 908: Rack Flange Kit

Opt A91: Panel color change to previous standard

(olive black/mint gray) for compatibility with existing 8620C/86200 sweepers.

### Price

\$2850

add \$650

add \$950

add \$22

N/C

# SWEEP OSCILLATORS

8620 Family: 10 MHz to 2.4 GHz plug-ins

Models 86222A and 86222B



- 10 MHz to 2.4 GHz in ONE, CONTINUOUS sweep
- Internally leveled FLATNESS  $\pm 0.25$  dB over full range

- 1, 10, and 50 MHz crystal marker combs with 86222B
- Marker accuracy even in CW with 86222B

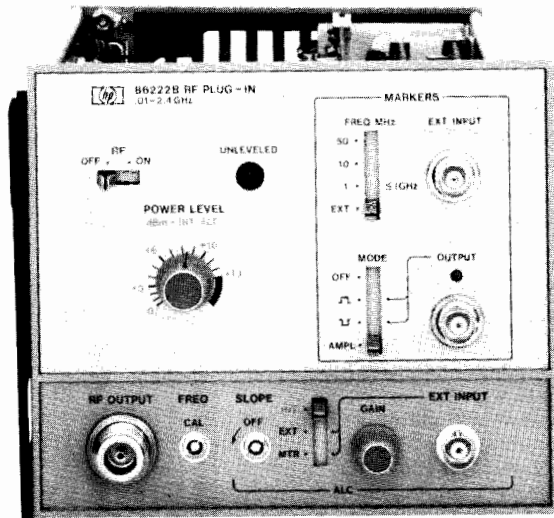

86222B

The 86222A and 86222B RF plug-ins can provide CW or continuous swept 10 MHz to 2.4 GHz frequency coverage. Power output is calibrated from 0 to +13 dBm in 1 dB increments with  $\pm 0.25$  dB flatness and excellent linearity (2 MHz) over the entire 0.01 to 2.4 GHz range. For applications demanding precise frequency identification, the 86222B offers a crystal marker system which provides a comb of markers at 1, 10 or 50 MHz. Markers may be displayed as intensified spots on a CRT or as amplitude dips on the RF output (often useful for XY recordings). In addition, when the output frequency is coincident with a 50, 10 or 1 MHz comb of the internal crystal oscillator, a front panel LED lights for independent CW frequency calibration (75 kHz accuracy at 1 GHz). For scalar measurements, the 27.8 kHz square wave modulation from the HP 8755 Frequency Response Test Set is accepted directly through the external AM input. For phase/magnitude network analysis the interfacing between the sweeper and the 8410B Network Analyzer permits the 8410B to automatically phase-lock over multi-octave sweeps.

## Specifications with Plug-in Installed in an 8620C Mainframe

### Frequency Characteristics

**Range:** 10 MHz to 2.4 GHz.

**Accuracy (25°C)**

**CW mode:**  $\pm 10$  MHz.

**Remote programming:** typically  $\pm 1.5$  MHz.

**All sweep modes:**  $\pm 15$  MHz ( $> 100$  msec sweep time). Accuracy of 86222B may be enhanced to better than  $\pm 200$  kHz through use of crystal markers.

**Linearity:** typically  $\pm 2$  MHz.

### Stability

**With temperature:**  $\pm 500$  kHz/ $^{\circ}$ C.

**With 10% line voltage change:**  $\pm 20$  kHz.

**With 10 dB power level change:**  $\pm 100$  kHz.

**With 3:1 load SWR, all phases:**  $\pm 10$  kHz.

**With time (after 1-hour warm-up):** typically  $\pm 100$  kHz/10 min.

**Residual FM:** (10 kHz bandwidth; FM switch in NORM; CW Mode):  $< 5$  kHz peak.

### Output Characteristics

**Maximum leveled power (25°C):**  $> 20$  mW (+13 dBm); typically  $> +15$  dBm.

**Power level accuracy (internal leveling only):**  $\pm 1$  dB.

**Attenuator Opt 002:** add  $\pm 0.2$  dB/10 dB step.

### Power Variation (at max. rated power)

#### Internally leveled

**0.01 to 2.4 GHz:**  $\pm 0.25$  dB.

**Stability with temperature:** typically  $\pm 0.02$  dB/ $^{\circ}$ C.

### Externally leveled (excluding coupler and detector variation)

**Crystal detector:** (-10 to -100 mV at rated output):  $\pm 0.1$  dB.

**Power meter (with HP 432A/B/C Series power meters):**  $\pm 0.1$  dB.

**Residual AM in 100 kHz BW:**  $> 50$  dBc.

**Spurious signals:** (below fundamental)

**Harmonics:**  $> 25$  dB at +13 dBm; typically  $> 30$  dB at +10 dBm.

### Non-Harmonics

**0.01 to 2.3 GHz:**  $> 30$  dB at +13 dBm; typically  $> 40$  dB at +10 dBm.

**2.3 to 2.4 GHz:**  $> 25$  dB at +13 dBm; typically  $> 35$  dB at +10 dBm.

**Broadband noise in 100 kHz bandwidth:** typically  $< -70$  dBm.

**Impedance:** 50  $\Omega$  nominal.

**SWR:**  $< 1.5$  internally leveled.

**Slope control:** allows variable compensation for frequency dependent losses in test set-up.

**RF output connector:** type N female.

### Modulation Characteristics

#### External AM

**Input impedance:** approximately 10 k $\Omega$ .

**Frequency response:** typically 150 kHz.

**Square wave response:**

**On/Off ratio:**  $> 30$  dB.

**Symmetry:** 40/60, for  $> 10$  dBm output power.

**Attenuation for +6 V input:**  $> 30$  dB.

#### Internal AM

**1 kHz square-wave On/Off ratio:**  $> 30$  dB.

**RF blanking On/Off ratio:**  $> 30$  dB.

#### External FM

**Maximum deviations for modulation frequencies**

**DC to 100 Hz:**  $\pm 75$  MHz.

**100 Hz to 1 MHz:**  $\pm 5$  MHz.

**1 MHz to 2 MHz:**  $\pm 2$  MHz.

**Sensitivity (typically)**

**FM mode:** -20 MHz/V.

**Phase-lock mode:** -6 MHz/V.

### Crystal Marker Capabilities (86222B Only)

**Internal crystal markers:** harmonic markers of 10 and 50 MHz usable over full 0.01 to 2.4 GHz range and 1 MHz markers usable 0.01 to 1 GHz. Positive ( ) or negative ( ) voltage output pulses can be selected to Z-axis intensify a scope trace; or RF amplitude pips can be selected (at maximum sweep speed pulse width optimized for approximately 10 markers/sweep).

**Accuracy of center frequencies (25°C):**  $\pm 5 \times 10^{-6}$ .

**Typical marker width around center frequency**

**1 MHz markers:**  $\pm 75$  kHz.

**10 MHz markers:**  $\pm 200$  kHz.

**50 MHz markers:**  $\pm 300$  kHz.

**Temperature stability:** typically  $\pm 2 \times 10^{-6}/^{\circ}$ C.

**Marker output mode:** nominally  $> 3$  V.

**mode:** nominally -4 to -9 V, internally adjustable.

**Amplitude mode:** typically 0.5 dB, internally adjustable.

### General

**Weight:** net, 2.5 kg (5.5 lb). Shipping 4 kg (9 lb).

### Ordering Information

86222A 0.01-2.4 GHz RF Plug-In (internal leveling standard) \$4700

86222B 0.01-2.4 GHz RF Plug-In with Crystal and External Markers (internal leveling standard) \$5750

**Opt 002:** 70 dB Step Attenuator (10 dB steps) add \$400

**Opt 004:** Rear Panel RF Output add \$150

**Opt A91:** Panel color change to previous standard N/C

(olive black/mint gray) for compatibility with existing 8620C/86200 sweepers.



# SWEEP OSCILLATORS

## 8620 Family: broadband plug-ins

Models 86290A and 86290B

- +13 dBm 2 to 18.6 GHz with 86290C
- 2 to 22GHz with Option H08

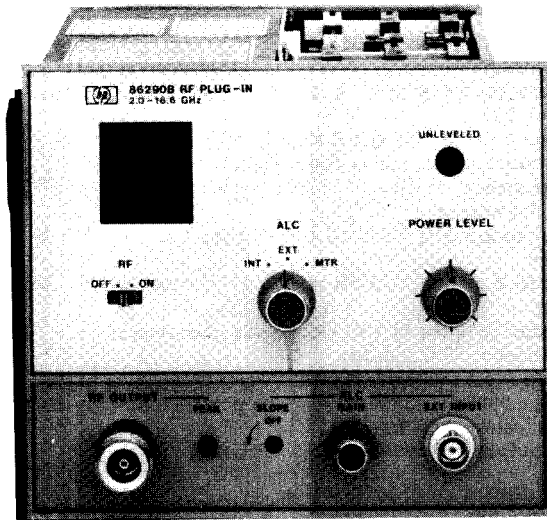

86290B

The 86290A and 86290B broadband plug-ins set new standards in sweeper performance and versatility. For broadband testing, a continuous sweep from 2 to 18.6 GHz (18 GHz with the 86290A) is provided. In addition, higher frequency resolution is achieved by covering the 2 to 18.6 GHz range in three individual bands of 2 to 6.2, 6 to 12.4, 12 to 18.6 (or 18 GHz). The 86290A/B offers outstanding electrical performance producing >10 mW (5 mW for the 86290A) swept output over the 2 to 18.6 GHz range along with excellent linearity and low spurious and harmonic content. For scalar measurements the 17.8 kHz square wave modulation from the HP 8755 Frequency Response Test Set is accepted directly through the EXTERNAL AM input. When performing phase/amplitude network analysis the interfacing between the sweeper and the HP 8410B Network Analyzer permits the 8410B to automatically phase lock over multi-octave sweeps for continuous swept 2 to 18.6 GHz phase and amplitude measurements.

### Specifications with Plug-in Installed in an 8620C Mainframe Frequency Characteristics

	Band 1	Band 2	Band 3	Band 4
Range: (GHz) 86290A	2-6.2	6-12.4	12-18	2-18
86290B	2-6.2	6-12.4	12-18.6	2-18.6
Accuracy (25°C)				
CW mode (or >100 ms sweep time): (MHz)	±20	±30	±30	±100
Remote programming: (typ.)	±2.5	±2.5	±3.5	—
All sweep modes: (MHz)	±30	±30	±30	±80
Marker: (MHz)	±30	±30	±30	±80
Linearity (MHz) typ.:	±8	±8	±8	±30
Frequency Stability				
With temperature: (MHz/°C)	±0.5	±1.0	±1.5	±2.0
With 10% line voltage change: (kHz)	±100	±100	±100	±100
With 10 dB power level change: (MHz)	±0.6	±1.2	±1.8	±1.8
With 3:1 load VSWR, all phases: (kHz)	±100	±200	±300	±300
With time (in 10 minute period after 30 minute warmup): typically (kHz)	±300	±600	±900	±900
Residual FM (10 kHz bandwidth CW mode): (kHz peak)	<10	<20	<30	<30

### Output Characteristics

#### Maximum leveled power (25°C):

- 86290A: +7 dBm, 2 to 18 GHz. (Opt. 004: +6.5 dBm)
- 86290B: +10 dBm, 2 to 18.6 GHz. (Opt. 004: +9.5 dBm)
- 86290C: +13 dBm, 2 to 18.6 GHz. (Opt. 004: +12 dBm)

Power level control range: >10 dBm

	Band 1	Band 2	Band 3	Band 4
Power Variation (Max Rated Pwr)				
Internally leveled: (dB)	±0.7	±0.7	±0.8	±0.9
Externally leveled (excluding coupler and detector variation)				
Crystal detector: -20 to -250 mV for specified leveling at rated output: (dB)	±0.15	±0.15	±0.15	±0.15
Power meter: internal leveling amplifier with compensation for HP models 432A/B/C provided: (dB)	±0.15	±0.15	±0.15	±0.15
With temperature, typically (dB/°C)	±0.1	±0.1	±0.1	±0.1

Residual AM in 100 kHz BW: >55 dBc.

#### Spurious signals

Harmonically related signals: >25 dBc.

Non-harmonics: >50 dBc.

Impedance: 50Ω nominal.

SWR: <1.9 internally leveled.

RF output connector: type N female.

#### Modulation Characteristics

##### External AM

Input impedance: approximately 1000Ω.

Frequency response: typically 300 kHz leveled.

Square wave response

On/Off ratio: >30 dB.

Symmetry: 40/60.

Attenuation for +5V input: >30 dB.

##### Internal AM (1000 Hz):

Square-wave On/Off ratio: >25 dB.

RF blanking On/Off ratio: >30 dB.

##### External FM:

Maximum deviations for modulation frequencies

DC to 100 Hz: ±75 MHz.

100 Hz to 2 MHz: ±5 MHz.

Sensitivity (typically)

FM mode: -20 MHz/V.

Phase-lock mode: -6 MHz/V.

#### General

Sweep time (min): 10 ms single bands. 60 ms on 2 to 18 GHz band.

Auxiliary output: rear panel 2 to 6.2 GHz fundamental oscillator output, nominally -10 dBm.

Slope control: front panel control allowing compensation for frequency dependent test setup losses.

Peak control: front panel control for peaking power over desired frequency range.

Frequency reference output: nom. 1 V/GHz (2-18.6 volts) ±35 mV rear panel BNC output.

Weight: net, 4.4 kg (9.6 lb). Shipping, 5.9 kg (13 lb).

#### Ordering Information

86290A 2 to 18 GHz +7 dBm (5mW) plug-in (internal leveling standard) **Price** \$14,250

86290B 2 to 18.6 GHz +10 dBm (10 mW) plug-in (internal leveling standard) \$16,250

86290C 2 to 18.6 GHz +13 dBm (2 mW) plug-in (internal leveling standard) \$18,750

Opt 004: rear panel RF output: add \$80

Opt 005: APC-7 RF output connector: add \$40

Opt 060: (86290A only), 08620-60099 Kit for modifying 8620A mainframes with serial prefix 1427A and below. (86290B can only be used with the 8620C): add \$300

Opt A91: Panel color change to previous standard (olive black/mint gray) for compatibility with existing 8620C/86200 sweepers. N/C

Opt H08: 2 to 22 GHz operation, 86290A/B add \$3000

86290C: 2 to 18.6 GHz +13 dBm (2 mW) plug-in (internal leveling standard) \$18,750

# SWEEP OSCILLATORS

## 8620 Family: straddle band plug-ins

Models 86240A, 86240B, and 86240C



- Up to 40 mW output power with 86240A
- 45 dBc harmonics with 86240B
- MLA compatibility with 86240C

has 10 MHz FM bandwidth, flat to  $\pm 1.5$  dB for noise loading applications, power control and optional leveling. In addition, to being optimized for communications systems applications the 86240C is an ideal general purpose microwave source. For further information on MLA Upconverter Simulation refer to the Telecommunications Test Equipment section on page 607.

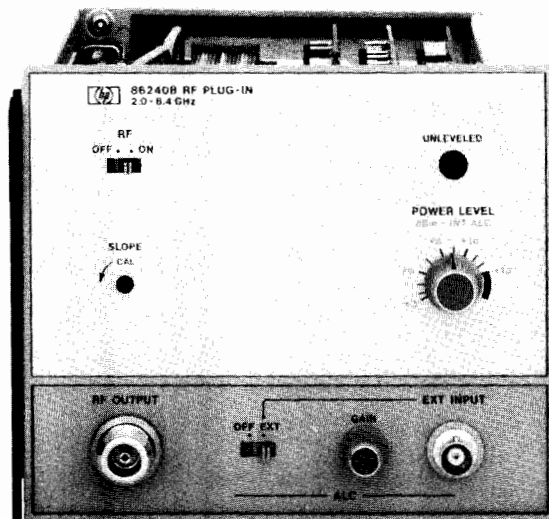

86240B

### 86240A, 8A6240B: 2-8.4 GHz

The 86240A features up to 40 mW of output power, competitive harmonics, at an attractive price. With the internal leveling option the 86240A also provides calibrated output power and slope control.

The 86240B was designed for low harmonic distortion having narrow-band harmonic performance of at least 45 dBc. Internal leveling of  $\pm .5$  dB is standard along with slope control as well as up to 20 mW of output power.

### 86240C RF Distortion analysis of mW links: 3.6-8.6 GHz

The 86240C can be used for MLA Upconverter Simulation. It is optimized for group delay of less than 1 ns peak-to-peak over 30 MHz, linearity better than 0.5% and power output up to 40 mW. It

### Specifications

#### with plug-in installed in an 8620C mainframe

#### Frequency Characteristics

**Linearity:** typically  $\pm 0.1\%$ .

**Residual FM** (in 10 kHz bandwidth, FM switch in NORM, CW Mode):  $< 9$  kHz peak.

**Reference output:** DC-coupled voltage proportional to RF frequency, voltage approximately 1 V/GHz.

#### Output Characteristics

##### RF power leveling

**Internal, option 001:** Selected by front panel switch; refer to RF plug-in specifications. (Standard on 86240B)

**Source SWR:** 50 $\Omega$  nominal impedance

**Internally leveled** (Option 001):  $< 1.6$  SWR.

**Unleveled:** Typically 3 SWR.

**RF output connector:** Type N female.

#### 86240C Modulation Characteristics

**External FM** (Maximum deviation for modulation frequencies)

**DC to 100 Hz:**  $\pm 1.5$  MHz

**90 kHz to 10 MHz:**  $\pm 1.5$  MHz

**Frequencies response, DC to 10 MHz:**  $\pm 1.5$  dB

**Nominal sensitivity**

**FM mode:**  $\pm 20$  MHz/volt

**Upconverter mode:**  $\pm 20$  MHz/volt

#### General

**Weight:** Net, 2.3 kg (5 lb). Shipping, 3.2 kg (7 lb).

#### Options

**002:** 70 dB Step Attenuator

**004:** Rear Panel RF Output

**Opt A91:** Panel color change to previous standard (olive black/mint gray) for compatibility with existing 8620C/86200 sweepers.

#### Price

add \$450

add \$80

N/C

	86240A	86240B	86240C
<b>FREQUENCY</b>			
Frequency Range (GHz):	2.0-8.4	2.0-8.4	3.6-8.6
<b>Frequency Accuracy:</b> (25°C)			
CW Mode (MHz):	$\pm 25$	$\pm 25$	$\pm 25$
CW Remote Programming typically (MHz):	$\pm 3.5$	$\pm 3.5$	$\pm 3.5$
All Sweep Modes (for sweep time $> 100$ ms) (MHz):	$\pm 40$	$\pm 50$	$\pm 35$
<b>POWER OUTPUT</b>			
Maximum Leveled Power (25°C) (mW):	$> 40$	$> 20$	$> 40$
With Option 002 (mW):	$> 32$	$> 16$	$> 32$
<b>Power Variation:</b> (At Max Rated Power)			
Unleveled (Typically) (dB):	$< \pm 2$		$< \pm 2$
Internally Leveled (Opt 001) (dB):	$< \pm 1$	$< \pm 0.5$	$< \pm 0.8$
Externally Leveled (Excluding Coupler and Detector Variation) Crystal Detector and Power Meter (dB):	$< \pm 0.1$	$< \pm 0.1$	$< \pm 0.1$
<b>Spurious Signals:</b> (dB below fundamental at specified maximum power)			
Harmonics:	$> 20$ (20 mW) $> 16$ (40 mW)	$> 45$	$> 20$ (20 mW) $> 16$ (40 mW)
Nonharmonics:	$> 60$	$> 60$	$> 60$
<b>PRICE</b>			
Plug-in:	\$5050	\$6700	\$5450
Opt 001 (Internal Leveling):	add \$650	Included	add \$650



# SWEEP OSCILLATORS

## 8620 Family: single band plug-ins

### Model 86200 Series and 11869A Adapter

- 10 MHz to 22 GHz coverage
- >50 mW from 5.9 to 12.4 GHz
- Compatible with 8350A Mainframe via 11869A Adapter

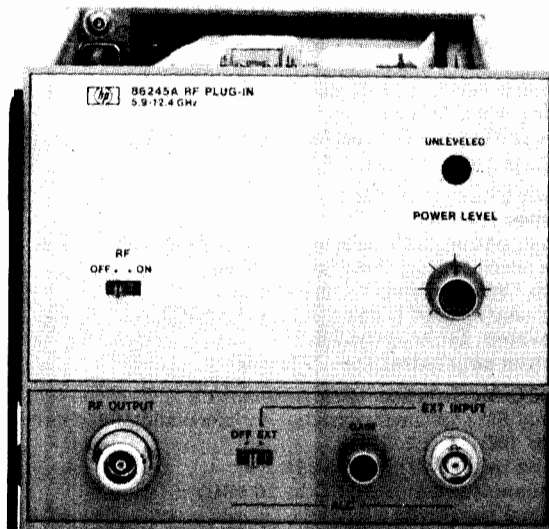

86245A

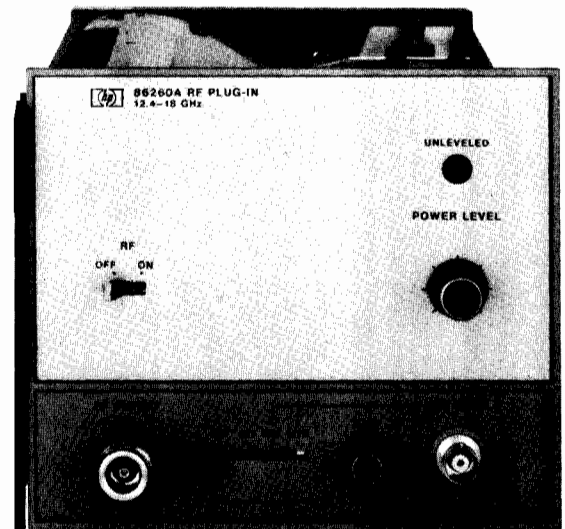

86260A

### 86200 Series

The 86200 series plug-ins feature a wide choice of bandwidths and power specifications for covering the 10 MHz to 22 GHz frequency range. The 86222A/B 10 MHz to 2.4 GHz plug-ins, the 86240A/B/C 2 GHz to 8.6 GHz plug-ins, and the 86290A/B 2 GHz to 18.6 GHz plug-ins cover multi-octave frequency ranges with exceptional frequency precision and RF output characteristics. See preceding pages for specifications on these plug-ins. For octave band applications, smaller range plug-ins covering, for instance, 5.9 GHz to 12.4 GHz are available with optional capability to operate as up-converters for MLA measurements.

### 11869A Adapter

The 86200 series can be used in the 8350A Sweep Oscillator mainframe with the addition of the 11869A Adapter. The 11869A provides the electrical and mechanical interface between the 86200 plug-in and the 8350A so that digital control of the plug-in is possible. All of the performance and features of the 8350A Sweep Oscillator Mainframe are available when using the 86200 plug-ins and 11869A Adapter. For more information on the 11869A see page 416.

### Specifications

**With plug-in installed in an 8620C Mainframe**

**Frequency linearity:** typically  $\pm 1\%$ .

**Frequency reference output:** typically 1 V/GHz dc-coupled voltage is available for referencing or phase-locking external equipment to the plug-in or for multi-octave operation with an 8410B.

**RF power leveling:** internal dc-coupled leveling amplifier and PIN modulator provided.

**Internal, Opt 001:** selected by front panel switch; refer to RF plug-in specifications (standard on 86220A).

#### External

**Crystal input:** approximately -20 to 250 mV for specified leveling at rated output; for use with negative polarity detectors such as 780

Series Directional Detectors, 423A/B and 8470 Series Crystal Detectors.

**Power meter input:** leveling amplifier with compensation for HP 432A power meter included internally in all plug-ins except the 86230B and 86241A which require the use of an 8404A Leveling Amplifier and the EXT AM input on the 8620 Mainframe.

**Indicator:** front panel indicator lights when RF power level is set too high to permit leveling over entire selected sweep range or when operating in unlevelled mode.

**Residual AM in 100 kHz bandwidth:** >50 dB below fundamental at specified maximum power.

#### External AM

**Frequency response:** typically dc to 100 kHz unlevelled, dc to 50 kHz leveled (at maximum leveled power).

**Input impedance:** approximately 5000 ohms.

**RF output connector:** type N Female.

**8350A Compatibility:** The 11869A Adapter provides the electrical and mechanical interface so that the 86200 series plug-ins can be used in the 8350A Sweep Oscillator mainframe. For more information see the section on 11809A Adapter page 416.

**Weight:** net, 2.3 kg (5 lb). Shipping, 3.2 kg (7 lb).

### Options

**001:** Internal leveling. Refer to RF plug-in specifications.

**002:** 70 dB attenuator in 10 dB steps, available in 86220A and 86235A

**004:** rear panel RF output

**005:** APC-7 RF output connector available on 86260A

### Price

See model number

add \$400 or \$550

respectively add \$150

add \$75

**Upconverter simulation options:** options are available which guarantee compatibility with the HP Microwave Link Analyzer. For further information on these plug-ins refer to the Telecommunications Test Equipment Section beginning on page 607.

## Single Band Plug-ins

Refer also to broadband models 86222A/B (0.01-2.4 GHz), 86240A/B/C (2-8.6 GHz), and 86290A/B (2-22 GHz)

Specifications with plug-in installed in 8620C	86220A	86230B	86235A	86241A	86242D	86245A	86250D	86260B	86260A	86260C
<b>Frequency range<sup>1</sup></b> (GHz):	0.01-1.3	1.8-4.2	1.7-4.3	3.2-6.5	5.9-9.0	5.9-12.4	8.0-12.4	10.0-15.5	12.4-18.0	17.0-22.0
<b>Frequency accuracy</b> CW mode (MHz):	±10	±15	±20	±30	±35	±40	±40	±50	±50	±50
Remote programming typically (MHz):	±7.5	±2.5	±2.5	±10.5	±5.5	±10.5	±8.5	±5.5	±5.5	±6.8
All sweep modes (sweep time >100 ms) (MHz):	±15	±20	±30	±33	±40	±50	±50	±70	±70	±70
<b>Stability:</b> With Temperature:	±600 kHz/°C	±500 kHz/°C	±500 kHz/°C	±650 kHz/°C	±750 kHz/°C	±1.2 MHz/°C	1.2 MHz/°C	±5.4 MHz/°C	±5.4 MHz/°C	±5.4 MHz/°C
With 10% Line Voltage Change:	±20 kHz	±20 kHz	±40 kHz	±30 kHz	±40 kHz	±40 kHz	±40 kHz	±180 kHz	±180 kHz	±180 kHz
With 10 dB Power Level Change:	±20 kHz	±1 MHz	±1 MHz	±1 MHz	±1.5 MHz	±1.5 MHz	±1.5 MHz	±6 MHz	±6 MHz	±6 MHz
With 3:1 Load SWR Change, all Phases:			±250 kHz		±250 kHz	±250 kHz	±250 kHz			
With Time (after warm-up): Typ/10 min.	±200 kHz	±200 kHz	±200 kHz	±200 kHz	±600 kHz	±200 kHz	±600 kHz		±450 kHz	
Residual FM: (in 10 kHz bandwidth CW mode):	<5 kHz peak	<7 kHz peak	<7 kHz peak	<7 kHz peak	<15 kHz peak	<15 kHz peak	<15 kHz peak	<25 kHz peak	<25 kHz peak	<25 kHz peak
<b>Residual FM</b> (10 kHz BW, FM switch in NORM) CW mode (kHz peak):	<5	<7	<7	<7	<15	<15	<15	<25	<25	<25
<b>Maximum leveled power<sup>1</sup></b> (mW):	10	>10	>40	>6.3	>10	>50	>10	>10	>10	>10
<b>Power variation</b> Internally leveled (dB):	<±0.5	<±1.2	<±0.8	<±0.8	<±0.5	<±0.6	<±0.5	<±4	<±0.7	<±4
Externally leveled (dB) (excluding coupler & detector variation):	N/A	<±0.1	<±0.1	<±0.1	<±0.1	<±0.1	<±0.1	<±0.1	<±0.1	<±0.1
<b>Spurious signals:</b> (dB below fundamental, at specified max power) Harmonics:	>25	>20	>20	>16(3.2-3.8 GHz) >20(3.8-6.5 GHz)	>30	>17(5.9-7 GHz) >30(7-12.4 GHz)	>30	>25	>25	>25
Nonharmonics:	>50	>60	>60	>60	>60	>60	>60	>60	>50	>50
<b>Source SWR:</b> (50Ω nom, Internally leveled)	<1.3	<1.6	<1.6	<1.6	<1.6	<1.6	<1.6		<1.6	
<b>External FM:</b> Max deviations (MHz) for modulation frequencies: DC-100 Hz:	±15	±25	±75	±25	±150	±150	±150	±75	±75	±75
DC-1 MHz:	±0.5	±2	±5	±2	±7	±7	±7	±5(DC-200 kHz)	±5(DC-200 kHz)	±5(DC-200 kHz)
Sensitivity (nom, MHz/V):	+3.5	-4	-20/-6	-6	-20/-6	-20/-6	-20/-6	-20/-6	-20/-6	-20/-6
<b>AM:</b> Internal 1 kHz Square wave On/Off ratio & EXT AM sensitivity To -10 V (dB):	>35	>25	>30	>25	>40	>40	>40	>25	>25	>25
EXT AM Response compatible with 8755 Mod drive signal:	No	No	Yes	No	Yes	Yes	Yes	No	No	No
<b>Price:</b> Plug-in:	\$3300	\$2950	\$3700	\$3150	\$3450	\$5950	\$3550	\$4550	\$4350	\$5950
Opt 001 (int. lev):	Included	+\$390	+\$550	+\$390	+\$500	+\$500	+\$500		+\$550	

1. Special frequency bands and high power outputs available on request.

# SWEEP OSCILLATORS

## 8690 Sweeper family, 400 kHz to 50 GHz

### Model 8690 System

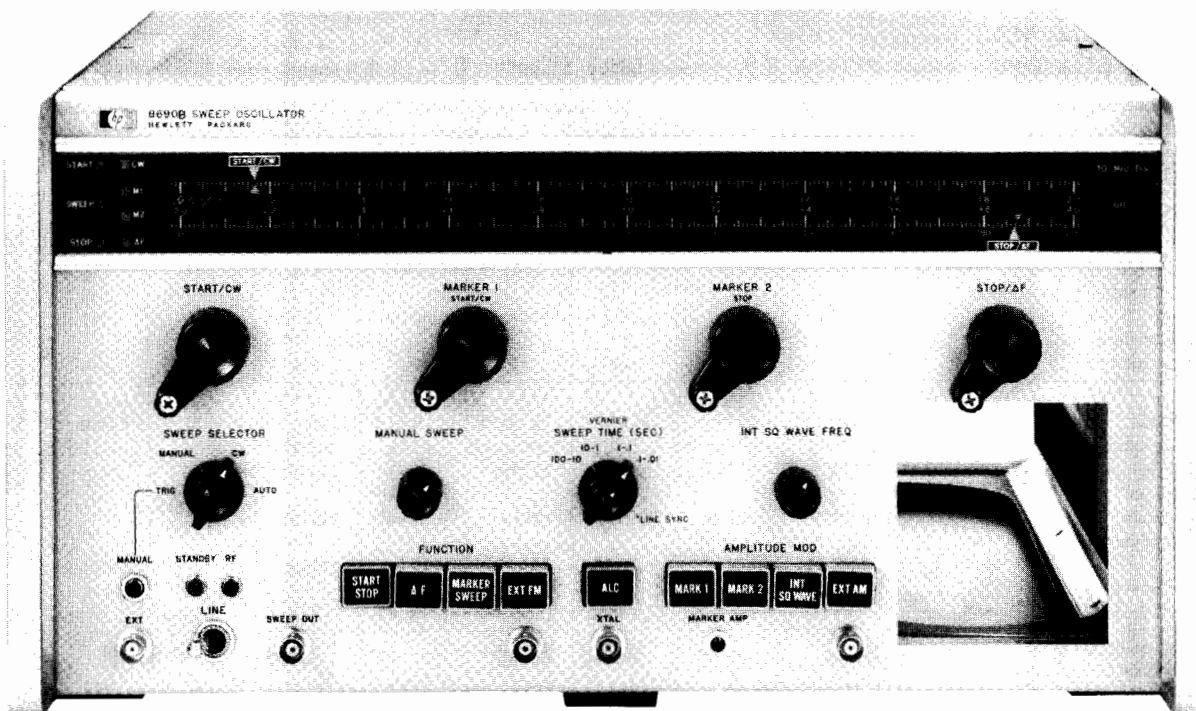

8690B

### 8690 System

The familiar 8690 BWO sweeper family offers exceptional value in performance, operation and versatility. With the ability to accept both BWO and solid state plug-ins, the 8690 mainframe allows BWO coverage where necessary, and more reliable, high performance solid state coverage at lower frequencies.

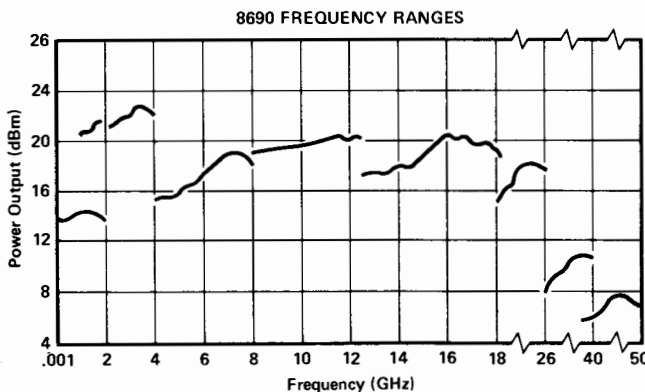

### 8690B Mainframe Specifications

#### Sweep Functions

**START/STOP sweep:** sweeps from "start" to "stop" frequency setting. Both settings continuously adjustable over entire frequency range.

**MARKER sweep:** sweeps from "Marker 1" to "Marker 2" frequency setting. Both settings continuously adjustable over entire frequency range and accurate to 1% of full scale for all RF units.

**ΔF sweep:** sweeps upward in frequency, centered on CW setting. Width is continuously adjustable from zero to 10% of the frequency band and is calibrated in MHz. Accuracy is  $\pm 1\%$  of maximum  $\Delta F$  plus  $\pm 10\%$  of  $\Delta F$  being swept.

**CW operation:** single-frequency RF output selected by START/CW or MARKER 1 control, depending on sweep function selected.

#### Sweep Modes

Auto, manual, and triggered sweep modes; sweep indicator lights during each sweep.

**Sweep time:** continuously adjustable in four decade ranges, 0.01 to 100 seconds.

**Sweep output:** direct-coupled sawtooth, zero to approximately +15 V, concurrent with swept RF output, regardless of sweep width or direction.

#### General

**Frequency markers:** two markers independently adjustable over entire frequency range accurate to 1% of full scale. Amplitude is adjustable from front panel. A -5 V triangular pulse is available as an intensity marker on the rear panel.

**Internal AM:** square wave modulation continuously adjustable from 950 to 1050 Hz.

**External AM:** frequency response dc to 350 kHz unlevelled, dc to 50 kHz levelled.

**Blanking:** both negative (-4 V) and RF blanking available along with pen lift output.

**Weight:** net, 23.9 kg (53 lb). Shipping, 32 kg (71 lb).

**Size:** 222 mm H x 425 mm W x 467 mm D (8.75" x 16.75" x 18.38").

**8690B Sweeper Mainframe**

**\$4500**

- Solid state plug-ins
- Both pin and grid leveled BWO plug-ins
- Frequency coverage to 50 GHz

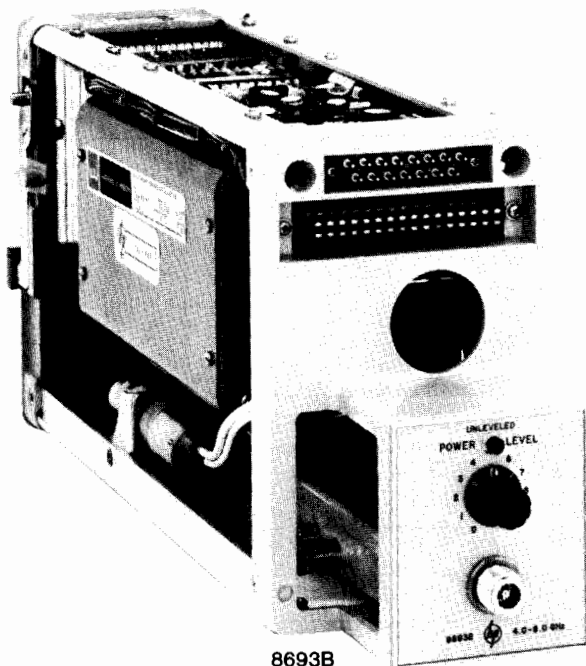

8693B



8709A



8404A

## Solid State and BWO Plug-ins

Solid state plug-ins from 400 kHz to 4 GHz are available for the 8690 mainframe. BWO replacement is both expensive and inconvenient. Solid state plug-ins not only offer high reliability, but also provide low residual FM and good spectral purity. This capability allows one mainframe to cover high frequency, high power BWO applications, yet facilitate high performance, longer life solid state coverage of lower frequencies. There are two solid state plug-ins. The 8698B covers 400 kHz to 110 MHz while the 8699B plug-in has a 100 MHz to 4 GHz range.

Both grid leveled and pin leveled BWO plug-ins are available covering 1 to 50 GHz. Grid leveled BWO oscillators achieve power and leveling control by varying bias on the BWO grid. Although some degradation in frequency performance specifications is seen by this method, grid leveling provides an economical means of power control and delivers higher power output since there are no components (pin modulators) between BWO and front panel output.

PIN leveled BWO plug-ins offer superior frequency stability characteristics. As in all solid state plug-ins, leveling is accomplished through use of a pin diode modulator between oscillator and output. Use of the pin allows the oscillator to work at constant bias and into a constant impedance load, resulting in very low residual FM and very little frequency pulling. Pin leveling also results in a better source impedance match.

### Common Specifications: BWO Plug-ins

**Warranty:** all BWO's are unconditionally warranted for one year.  
**Spurious signals:** harmonics, >20 dB below CW output, nonharmonics, >40 dB below CW output.

**Residual AM:** >40 dB below CW output.

**Magnetic shielding:** all plug-ins except the 8691A/B have shielded BWO's.

**Reference output:** dc voltage proportional to frequency output  $\approx 40$  V/octave.

**Leveling indicator:** front panel light indicates unlevelled operation.

#### Power variation

**Unleveled:** <10 dB over full band.

**Externally leveled:**  $\pm 0.2$  dB for A units.  
 $\pm 0.1$  dB for B units.

**Frequency stability with temperature:**  $\pm 0.01\%/^{\circ}\text{C}$ .

#### Weight

**8691-8692:** net, 7.7 kg (17 lb). Shipping, 11.3 kg (25 lb).

**8693-8697:** net, 5.4 kg (12 lb). Shipping, 9 kg (20 lb).

**8698-8699:** net, 5.0 kg (11 lb). Shipping, 8.6 kg (19 lb).

## 8709A Phase Lock Synchronizer

The 8709A Synchronizer is a phase comparator designed to stabilize the frequency of both HP BWO and solid state sources by phase locking to a reference oscillator. Under these conditions system stability is determined primarily by the stability of the reference oscillator. Phase lock capability is standard on solid state plug-ins from 0.01 to 22 GHz. Order Option J54 for BWO plug-ins. Information on complete phase-locked systems available on request.

### Specifications

**Input frequency:** the locking frequency of the 8709A is 20 MHz. This signal is obtained by multiplying and mixing the reference oscillator with the microwave signal.

**Sensitivity:**  $-65$  dBm.

**Minimum output voltage:** high level  $\pm 12.0$  V dc; low level  $\pm 8.0$  V dc.

**Modulation sensitivity:** 8690 BWO Option J54 plug-ins, 0.5 to 6.0 MHz/V. 8620 solid state plug-ins 6.0 MHz/V.

**Weight:** net, 4.5 kg (10 lb). Shipping, 5.3 kg (11.6 lb).

## 8404A Power Meter Leveling Amplifier

The 8404A Leveling Amplifier permits the 431B/C or 432A/B/C Power Meter to level both the 8620 and 8690 sweeper plug-ins. RF output is leveled to  $\pm 0.5$  dB or less when connected to the AM input of the sweeper.

### Ordering Information

**8404A Power Meter Leveling Amplifier**

**Opt 001:** 4 line BCD level control

**8709A Phase-Lock Synchronizer**

### Price

\$850

add \$210

\$1600

# SWEEP OSCILLATORS

## 8690 Sweeper family (cont.)

### PIN Leveled Solid State Plug-Ins

Frequency Range	Model Number	Maximum Leveled Power	Frequency Accuracy	Frequency Stability With		Residual FM <sup>2</sup>	Int. Leveling Power Variation	Connector	Price
				Temperature	10 dB Power Level Change				
0.4-11 MHz	8698B	>20 mW	±1% ±50kHz	±0.05%/°C	—	<300 Hz rms	±0.3 dB	BNC <sup>1</sup>	\$2850
11-110 MHz		>20 mW	±1% ±500kHz	±0.05%/°C	—	<500 Hz rms	±0.3 dB		
0.1-2 GHz	8699B	>20mW	±10 MHz	±750 kHz/°C	<100 kHz	<3 kHz rms	—	Type N	\$6000
2-4 GHz		>6 mW	±10 MHz	±750 kHz/°C	<500 kHz	<3 kHz rms	—		

1. 8698B Opt 001: 75Ω BNC output, Add \$55.
2. Residual FM measured with 10 kHz bandwidth cw mode

### Grid and PIN Leveled BWO Plug-ins

Frequency	Model Number	Power Control	Maximum Leveled Power	Frequency Accuracy	Freq. Stability With Power Level Change <sup>1</sup>	Residual FM Peak <sup>2</sup>	Option 001 Int. Leveling Power Variation	Connector	Price	Option 001 Int. Leveling Price-Add
1.0-2.0 GHz	8691A	GRID	>100 mW	±1%	<20 MHz	<30 kHz	±0.4 dB	Type N	\$4800	\$360
	8691B	PIN	>70 mW	±10 MHz	±500 kHz	<10 kHz	—	Type N	\$5400	—
1.4-2.5 GHz	8691A Opt. 200	GRID	>100 mW	±1%	<30 MHz	<30 kHz	—	Type N	\$5080	—
1.7-4.2 GHz	8692B Opt. 100	PIN	>15 mW	±25 MHz	±4 MHz	<20 kHz	—	Type N	\$5900	—
2.0-4.0 GHz	8692A	GRID	>70 mW	±1%	<40 MHz	<30 kHz	±0.4 dB	Type N	\$4500	\$360
	8692B	PIN	>40 mW	±20 MHz	4 MHz	<15 kHz	—	Type N	\$5400	—
3.5-6.75 GHz	8693A Opt. 200	GRID	>40 mW	±1%	<80 MHz	<50 kHz	—	Type N	\$5400	—
3.7-8.3 GHz	8693B Opt. 100	PIN	>5 mW	±45 MHz	±1 MHz	<20 kHz	±0.4 dB	Type N	\$5200	\$390
4.0-8.0 GHz	8693A	GRID	>30 mW	±1%	<80 MHz	<50 kHz	±0.5 dB	Type N	\$3900	\$390
	8693B	PIN	>15 mW	±40 MHz	±1 MHz	<15 kHz	±0.4 dB	Type N	\$4800	\$390
7.0-11.0 GHz	8694A Opt. 200	GRID	>25 mW	±1%	<160 MHz	<60 kHz	±0.75 dB	Type N	\$3955	\$490
	8694B Opt. 200	PIN	>15 mW	±40 MHz	±1 MHz	<20 kHz	±0.75 dB	Type N	\$5255	\$490
7.0-12.4 GHz	8694A Opt. 100	GRID	>25 mW	±1%	<160 MHz	<60 kHz	±0.75 dB	Type N	\$4260	\$490
	8694B Opt. 100	PIN	>15 mW	±50 MHz	±1 MHz	<20 kHz	±0.75 dB	Type N	\$5600	\$490
8.0-12.4 GHz	8694A	GRID	>50 mW	±1%	<160 MHz	<60 kHz	±0.75 dB	Type N	\$3900	\$490
	8694B	PIN	>30 mW	±40 MHz	±1 MHz	<15 kHz	±0.75 dB	Type N	\$5200	\$490
8.0-18.0 GHz	8694A Opt. 300	GRID	>10 mW	±1%	±150 MHz	<150 kHz	—	Type N	\$7400	—
	8694B Opt. 300	PIN	>5 mW±	±1%	±1 MHz	<50 kHz	—	Type N	\$8700	—
10-15.5 GHz	8695A Opt. 100	GRID	>25 mW	±1%	<0.25 GHz	<150 kHz	—	Flat Flange for WR-75WG	\$6900	—
12.4-18.0 GHz	8695A	GRID	>40 mW	±1%	<0.25 GHz	<150 kHz	—	UG-419/U	\$4100	—
	8695B	PIN	>15 mW	±56 MHz	±1 MHz	<25 kHz	—	UG-419/U	\$4600	—
18.0-26.5 GHz	8696A	GRID	>10 mW	±1%	<0.36 GHz	<200 kHz	—	UG-595/U	\$4300	—
26.5-40 GHz	8697A	GRID	>5 mW	±1%	<0.53 GHz	<350 kHz	—	UG-599/U	\$6900	—
33-50 GHz	8697A Opt. H50	GRID	>3 mW	±1%	<0.68 GHz	<450 kHz	—	UG-383/U	\$12,500	—

1. Power level change specification for B units typically 10 dB, A units 6 dB.
2. Residual FM measured with 10 kHz bandwidth, cw mode

Opt 004: rear output 8691-8694, 8698-8699  
 Opt 004: rear output 8695-8697  
 Opt J54: phase lock input

add \$80  
 add \$155  
 add \$350

# SWEEP OSCILLATORS

Digital marker & generator/sweeper  
Models 8600A and 8601A



8600A

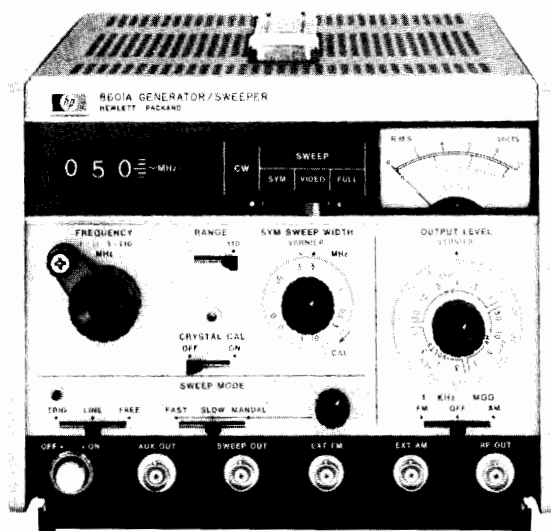

8601A

Covering 100 kHz to 110 MHz, the Model 8601A Generator/Sweeper combines the high linearity and flatness of a precision sweeper with a signal generator's frequency accuracy and wide range of calibrated power levels. Though it's small and lightweight, it does the work of two instruments easily and conveniently.

## 8601A Specifications

**Frequency range:** low range, 0.1-11 MHz; high range, 1-110 MHz.  
**Frequency accuracy:** approximately  $\pm 1\%$  of frequency.  
**Power output:** +20 to -110 dBm; 10-dB steps and 13-dB vernier provide continuous settings over entire range. Meter monitors output in dBm and rms volts into 50 $\Omega$ .  
**Power accuracy:**  $\pm 1$  dB accuracy for any output level from +13 dBm to -110 dBm.  
**Flatness:**  $\pm 0.25$  dB over full range,  $\pm 0.1$  dB over any 10 MHz portion (+10 dBm step or below).

**Impedance:** 50 $\Omega$ , SWR <1.2 on 0 dBm step and below.  
**Harmonics and spurious signals:** (CW above 250 kHz, output levels below +10 dBm) harmonics at least 35 dB below carrier. Spurious at least 40 dB below carrier.  
**Residual FM:** noise in a 20 kHz bandwidth including line related components (dominant component of residual FM is noise).  
**CW:** <50 Hz rms, low range; <500 Hz rms high range.  
**SYM 0, sweep:** <100 Hz rms, low range; <1 kHz rms, high range.  
**Residual AM:** AM noise modulation index (rms, 10 kHz bandwidth) is <-50 dB; (typically -60 dB at 25°C).  
**Crystal calibrator:** internal 5 MHz crystal allows frequency calibration to  $\pm 0.01\%$  at any multiple of 5 MHz.  
**Sweep modes:** full, video, and symmetrical.  
**Internal AM:** fixed 30%  $\pm 5\%$  at 1 kHz.  
**External AM:** 0 to 50%, dc to 400 Hz; 0 to 30%, up to 1 kHz.  
**Internal FM:** 1 kHz rate, fixed 75 kHz  $\pm 5\%$ , deviation, high range; 7.5 kHz  $\pm 5\%$ , deviation, low range; <3% distortion.  
**External FM:** sensitivity, 5 MHz per volt  $\pm 5\%$ , high range, 0.5 MHz per volt  $\pm 5\%$ , low range; negative polarity; FM rates to 10 kHz.  
**Weight:** net, 9.5 kg (21 lb). Shipping, 12.3 kg (27 lb).  
**Size:** 155 mm H x 190 mm W x 416 mm D (6  $\frac{3}{32}$ " x 7  $\frac{25}{32}$ " x 16  $\frac{3}{8}$ ").

The Model 8600A Digital Marker provides five independent, continuously variable frequency markers over the range 0.1-110 MHz when used with the HP 8601A or 8690B/8698B Generator Sweeper.

The high resolution controls and 6-digit readout permit 0.05% frequency settability. The frequency of any marker may be read while sweeping, simply by pushing a button within the marker control. The marker selected is brighter than the others and points in the opposite direction, ensuring positive marker identification.

## 8600A Specifications

**Marker accuracy:** any marker may be placed at a desired frequency  $\pm (0.05\%$  of sweep width + sweeper stability).  
**Weight:** net, 5.9 kg (13 lb); shipping 8.2 kg (18 lb).  
**Size:** 99 mm H x 413 mm W x 337 mm L (3  $\frac{7}{8}$ " x 16  $\frac{3}{4}$ " x 13  $\frac{1}{4}$ ").

## Ordering information

<b>8600A Digital Marker</b>	<b>Price</b>
Opt 001: Modification kit for 8690B/8698B	\$1950
<b>8601A Generator/Sweeper</b>	N/C
Opt 008: 75 $\Omega$ BNC output	\$3300
	add \$50



### Average Power Measurements

At microwave frequencies, power is the best measure of signal amplitude because, unlike voltage and current, power remains constant along a lossless transmission line. For this reason, power meters are almost indispensable for microwave measurement. Typical applications include monitoring transmitter power levels, calibrating signal generators, leveling signal sources, and measuring transmission characteristics of unknown devices.

To satisfy the requirements of this broad range of applications Hewlett-Packard has developed a family of general purpose microwave power meters. These power meters use a diode, thermocouple, or thermistor as the power sensing element, and it is important to understand the merits of each of these sensors before choosing a particular power meter.

### Power Meters and Sensors

Hewlett-Packard makes five average-reading power meters. The 435B and the 436A are analog and digital meters, respectively, which are designed to operate with HP's line of thermocouple and diode power sensors. The 432 power meters are designed to operate with HP's line of thermistor mounts. The 432A is an analog power meter. The 432B is digital with BCD output, and the 432C is like the 432B but is fully programmable and auto-ranging.

Thermocouple power sensors use the latest technology and are generally preferred for measuring power because they exhibit lower SWR and wider dynamic range than previously used thermistor elements. Low SWR is directly responsible for superior accuracy since mismatch errors are lower.

HP thermocouple sensors (8481, 8482, 8483, 8485A) are available from 100 kHz to 26.5 GHz and range from -30 dBm to +44 dBm. The model 8484A diode sensor operates with the same meters and extends the input level down to -70 dBm. This sensor uses a Low-Barrier Schottky diode to achieve exceptional 100 pW (-70 dBm) sensitivity, and low noise and drift. Because the diode is always operated in its square law region (voltage out  $\propto$  power in), the 8484A can be used to measure the true power of complex as well as CW waveforms.

Thermistor power sensors (478A, 486A series) operate with the 432A, 432B and 432C power meters. They are used whenever a direct dc-substitution technique is required since these power meters are based on balanced bridge principles. In addition, waveguide thermistor mounts are available from 8.20 to 40 GHz.

### Peak Power Measurement

A frequent requirement in microwave work is the measurement of peak power in a periodic pulse. This may be done by various indirect techniques using thermocouples or thermistors. Hewlett-Packard also produces a versatile instrument that conveniently measures peak power directly in the 50 MHz to 2 GHz frequency range. Model 8900B utilizes a video comparator technique to bring a known dc voltage, supplied by the instrument in a known impedance, to a level which is equal to the pulse being measured. This allows simple measurement of peak pulse power with a basic accuracy of 1.5 dB even when the waveform is not rectangular. A custom calibration chart increases accuracy to 0.6 dB for critical applications.

### Noise Figure Measurements

In RF and microwave communications, radar, etc., the weakest signal that can be detected is usually determined by the amount of noise added by the receiving system. From a performance standpoint, providing an increase in the receiver signal-to-noise ratio by reducing the amount of added noise is more economical than increasing the power of the transmitter.

The figure of merit that expresses how added noise obscures weak signals in a receiver, amplifier, or device is noise figure. Noise figure is the ratio, expressed in dB, of the actual output noise power of the device compared to the noise power which would be available if the device were perfect and merely amplified

the thermal noise of the input termination rather than contributing any noise of its own.

The Hewlett-Packard system of automatic noise figure measurement depends upon the periodic insertion of a known excess noise power at the input of the device under test. Subsequent detection of noise power results in a pulse train of two power levels. The power ratio of these two levels contains the desired noise figure information. Hewlett-Packard noise figure meters automatically measure and present this ratio directly in dB of noise figure.

Noise figure is discussed in detail in Hewlett-Packard AN 57, **Noise Figure Primer** and AN 64-3, **Accurate and Automatic Noise Figure Measurements**. AN 57 derives noise figures formulas, describes general noise figure measurements, and discusses accuracy considerations. AN 64-3 describes a highly repeatable and accurate noise figure measurement system for the 10 MHz to 18 GHz frequency range.

### Automatic Noise Figure Measurements

AN 64-3 describes an automatic system for measuring noise and gain of devices such as amplifiers, mixers and complete receiver systems (see Figure 1). The desktop computer, in addition to automating the measurements, processes the data, corrects for its own noise contribution and accounts for many small effects that, in manual noise measurement systems, are bothersome to correct and are often accepted as measurement errors. The cali-

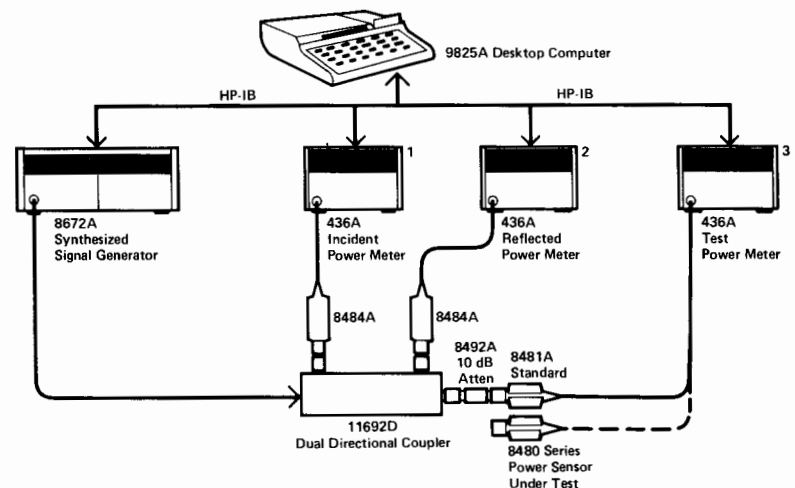

Figure 1. System for measuring calibration factor of power sensors.

bration data, stored on the system tape cartridge, allows significant accuracy improvements that would otherwise require tedious calculations. Maximum flexibility is insured through the use of standard instruments which can be put to a variety of alternate uses.

### Measurement System

The noise figure measurement system (Figure 2) uses the 346B noise source, the 436A Power Meter, an 8484A Power Sensor and other auxiliary equipment to reduce instrumentation uncertainty by a factor of one-third over most noise figure meters. The 436A measures the Y factor from which the computer calculates the corresponding noise figure. The 436A makes this measurement to an accuracy of  $\pm 0.04$  dB.

### Computer Convenience

The computer is optional equipment which simplifies the measurement procedure and gives the system more capability than most noise figure meters. It commands the noise source ON and OFF, reads the power meter, and computes the noise figure.

In addition, the computer corrects for ambient temperature effects, corrects for variations of noise source output with frequency, tunes the frequency of the receiver and corrects for the noise contributed by the receiver to indicate the noise figure of the DUT alone.

### Flexibility

Flexibility is another advantage of this system. The user can choose the IF frequency anywhere in the 10 MHz to 18 GHz band. Merely changing the IF bandwidth changes the bandwidth of the noise figure measurement. This means a narrow band filter just ahead of the 8484A Power Sensor can measure spot noise figure at a desired portion of the IF pass band.

### Application Notes

Information on virtually all aspects of microwave power measurement is contained in Hewlett-Packard application notes. The AN 64 series is intended as the definitive publication for general theory, product oriented how-to descriptions, and a complete treatment of new, innovative automatic systems.

**AN64-1, Fundamentals of RF and Microwave Power Measurements**, deals with the general theory of microwave power measurements. It covers the basic principles of measurement, calculation of measurement uncertainty, traceability, etc.

**AN64-2, Extended Applications of Automatic Power Meters**, discusses an automatic power meter system for measuring attenuation, gain saturation, and the calibration factor of power sensors.

**AN 64-3, Accurate and Automatic Noise Figure Measurements**, describes a highly repeatable and accurate noise figure measurement system for the 10 MHz to 18 GHz frequency range. Automatic data processing

and error correcting features make the system easy to use. This system consists of mostly standard HP instruments that can be put to a variety of uses.

#### Application Note 64-3

#### Accurate and Automatic Noise Figure Measurements

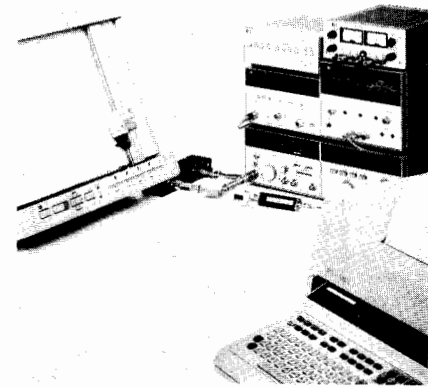

**AN196, Automated Measurements Using the 436A Power Meter**, contains several typical uses of the 436A with the HP-IB Interface bus.

All of these application notes and the **Coxial & Waveguide Catalog** are available without charge. See page 703.

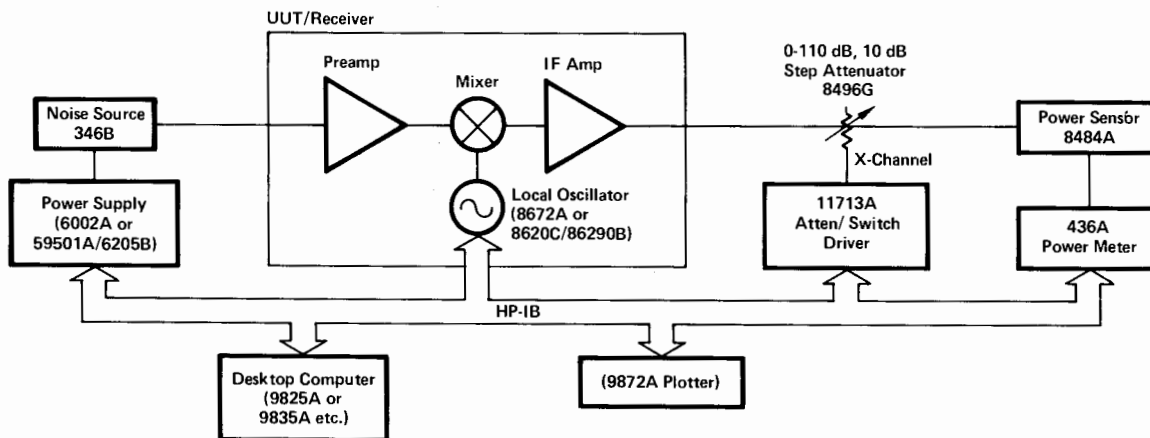

Figure 2. Noise figure measurement system.

# POWER & NOISE FIGURE METERS

Thermocouple power meter  
Model 436A



436A



## 436A Power Meter

The HP Model 436A Power Meter is a general purpose digital power meter intended for manual and automatic RF and microwave power measurements. It is compatible with the entire series of 8480 power sensors. Depending on which power sensor is used, the 436A can measure power from  $-70$  dBm (100 pW) to  $+44$  dBm (25W) at frequencies up to 26.5 GHz.

The logically organized and uncluttered front panel, and the convenience of push-button operation and digital display make the 436A both easy to interpret and easy to use in any application. The auto ranging capability allows for "hands-off" operation.

The 436A measures either absolute or relative power. It displays absolute power in either watts or dBm, while relative power is displayed in dB.

The 436A Power Meter also features optional programmability; both Hewlett-Packard Interface Bus (HP-IB) and BCD interfaces are available. These interfaces allow full remote control of all power meter functions (CAL function can be programmed to either 100 percent or the CAL factor which has been manually set on the front panel). These options may be added by the user at a later time.

## 436A Specifications

**Frequency range:** 100 kHz to 26.5 GHz (depending on power sensor used).

**Power Range** (display calibrated in watts, dBm, and dB relative to reference power level).

**With 8481A, 8482A, 8483A, 8485A sensors:** 50 dB with 5 full-scale ranges of  $-20$ ,  $-10$ ,  $0$ ,  $10$ , and  $20$  dBm (10  $\mu$ W to 100 mW).

**With 8481B or 8482B sensors:** 44 dB with 5 full-scale ranges of 10, 20, 30, 40, and 44 dBm (10 mW to 25 W).

**With 8481H or 8482H sensors:** 45 dB with 5 full-scale range of 0, 10, 20, 30 and 35 dBm (1 mW to 3 W).

**With 8484A sensor:** 50 dB with 5 full-scale ranges of  $-60$ ,  $-50$ ,  $-40$ ,  $-30$ , and  $-20$  dBm (1 nW to 10  $\mu$ W).

## Accuracy

### Instrumentation

**Watt mode:**  $\pm 0.5\%$ .

**dBm mode:**  $\pm 0.02$  dB  $\pm 0.001$  dB/ $^{\circ}$ C.

**dB (REL) mode<sup>1</sup>:**  $\pm 0.02$  dB  $\pm 0.001$  dB/ $^{\circ}$ C.

<sup>1</sup> Specifications are for within range measurements. For range-to-range accuracy add another  $\pm 0.02$  dB.

**Zero:** automatic, operated by a front-panel switch.

**Zero set:**  $\pm 0.5\%$  of full scale on most sensitive range, typical;  $\pm 1$  count on other ranges.

**Zero carry over:**  $\pm 0.2\%$  of full scale when zeroed on the most sensitive range.

**Noise** (typical, at constant temperature, peak change over any one-minute interval): 20 pW (8484A); 40 nW (8481A, 8482A, 8483A, 8485A); 40  $\mu$ W (8481B, 8482B); 4  $\mu$ W (8481H, 8482H).

**Power reference:** internal 50 MHz oscillator with Type N female connector on front panel (or rear panel, Option 003 only).

**Power output:** 1.0 mW. Factory set to  $\pm 0.7\%$  traceable to the National Bureau of Standards.

**Accuracy:**  $\pm 1.2\%$  worst case ( $\pm 0.9\%$  rss) for one year ( $0^{\circ}$ C to  $55^{\circ}$ C).

## Supplemental Characteristics

**Drift** (1 hour, typical, at constant temperature after 24-hour warm-up): 20 pW (8484A); 10 nW (8481A, 8482A, 8483A, 8485A); 10  $\mu$ W (8481B, 8482B); 2.5  $\mu$ W (8481H, 8482H).

**Response time** typical, measured at recorder output, 0 to 99% of reading:

Range 1 (most sensitive range)  $< 10$  seconds

Range 2  $< 1$  second

Ranges 3 through 5  $< 100$  milliseconds

**Cal factor:** 16-position switch normalizes meter reading to account for calibration factor. Range 85% to 100% in 1% steps.

**Cal adj:** front-panel adjustment provides capability to adjust gain in meter to match power sensor in use.

**Recorder output:** proportional to indicated power with 1 volt corresponding to full scale and 0.316 volts to  $-5$  dB; 1 k $\Omega$  output impedance, BNC connector.

**RF blanking:** open collector TTL; low corresponds to blanking when auto-zero mode is engaged.

**Display:** four-digit display with 20% over-range capability on all ranges; analog uncalibrated peaking meter to show fast changes.

**Power consumption:** 100, 120, 220, or 240 V ( $+5\%$ ,  $-10\%$ ), 48 to 66 Hz, and 360 to 440 Hz;  $< 20$  W ( $< 23$  W with option 022 or 024).

**Weight:** net, 4.5 kg (10 lb); shipping, 5.5 kg (12 lb).

**Size:** 134 H x 213 W x 279 mm D (5.2 x 8.4 x 11.0 in.).

## Accessories

**Furnished:** 1.5 m (5 ft) cable for power sensor; 2.3 m (7.5 ft) power cable. Mains plug shipped to match destination requirements.

**Available:** To rack mount one 436A by itself, order **5061-0057** Rack Mount Adapter Kit.

## Coaxial & Waveguide Catalog & Microwave Measurement Handbook

96 pages with over 350 measurement accessories. Request card at back of this catalog.

## Ordering Information

	Price
<b>436A</b> Power Meter	\$2250
<b>Option 002:</b> Input connector on rear panel in parallel with front	add \$25
<b>Option 003:</b> Input connector and reference oscillator output on rear panel only	add \$10
<b>Option 009:</b> 3 m (10 ft) cable for power sensor	add \$30
<b>Option 010:</b> 6.1 m (20 ft) cable for power sensor	add \$55
<b>Option 011:</b> 15.2 m (50 ft) cable for power sensor	add \$105
<b>Option 012:</b> 30.5 m (100 ft) cable for power sensor	add \$155
<b>Option 013:</b> 61 m (200 ft) cable for power sensor	add \$260
<b>Option 022:</b> Digital input/output, fully compatible with HP Interface Bus (HP-IB)	add \$425
<b>Option 024:</b> Digital input/output BCD Interface	add \$325
<b>Option 908:</b> Kit for rack mounting one 436A	\$25
<b>Option 910:</b> Extra manual	add \$25

# POWER & NOISE FIGURE METERS

Thermocouple power meter, range calibrator

Model 435B, 11683A

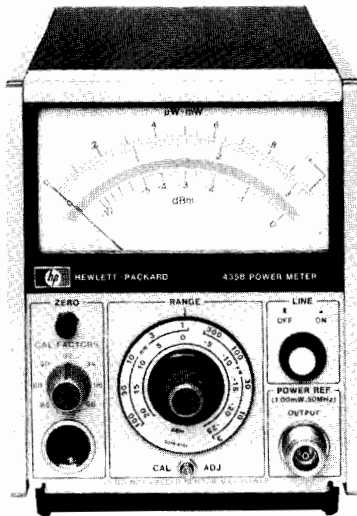

435B



11683A

## 435B Power Meter

The 435B Power Meter is an analog power meter, compatible with the entire series of 8480 power sensors. Depending on which sensor is used, the 435B can measure power from  $-65$  dBm to  $+44$  dBm, full scale, at frequencies from 100 kHz to 26.5 GHz. This versatile instrument also features  $<1\%$  instrumentation uncertainty, low noise and drift, auto-zero, recorder output, optional battery operation, and long cable options up to 61 m (200 ft).

## 11683A Range Calibrator

The 11683A calibrator is specifically designed for use with the 435B and 436A power meters. It allows verification of full-scale meter readings on all ranges, as well as meter tracking. Simply connect the cable between the power meter and calibrator. The CAL ADJ control on the power meter is used to set the meter to full scale on the 1 mW range. The calibrator and meter are then stepped through the other ranges verifying accuracy within  $\pm 1\%$  plus noise and drift. The 11683A also has a polarity switch which tests the Auto-Zero circuit.

## 435B Specifications

**Frequency range:** 100 kHz to 26.5 GHz (depending on power sensor used).

**Power range** (calibrated in watts and dB in 5 dB steps).

With 8481A, 8482A, 8483A or 8485A:  $-25$  dBm ( $3 \mu\text{W}$ ) to  $+20$  dBm (100 mW) full scale.

With 8481B or 8482B:  $+5$  dBm (3 mW) to  $+44$  dBm (25 W) full scale.

With 8481H or 8482H:  $-5$  dBm (0.3 mW) to  $+35$  dBm (3 W) full scale.

With 8484A:  $-65$  dBm (300 pW) to  $-20$  dBm ( $10 \mu\text{W}$ ) full scale.

## Accuracy

**Instrumentation:**  $\pm 1\%$  of full scale on all ranges.

**Zero:** Automatic, operated by front-panel switch.

**Zero set:**  $\pm 0.5\%$  of full scale on most sensitive range, typical.

**Zero carryover:**  $\pm 0.5\%$  of full scale when zeroed on the most sensitive range.

**Noise** (typical, at constant temperature, peak change over any one-minute interval): 20 pW (8484A); 40 nW (8481A, 8482A, 8483A, 8485A); 40  $\mu\text{W}$  (8481B, 8482B); 4  $\mu\text{W}$  (8481H, 8482H).

**Power reference:** Internal 50 MHz oscillator with Type N female connector on front panel (or rear panel, Option 003 only).

**Power output:** 1.00 mW. Factory set to  $\pm 0.7\%$  traceable to the National Bureau of Standards.

**Accuracy:**  $\pm 1.2\%$  worst case ( $\pm 0.9\%$  rss) for one year ( $0^\circ\text{C}$  to  $55^\circ\text{C}$ ).

## Supplemental Characteristics

**Drift** (1 hour, typical, at constant temperature after 24-hour warm-up): 40 pW (8484A); 15 nW (8481A, 8482A, 8483A, 8485A); 15  $\mu\text{W}$  (8481B, 8482B); 1.5  $\mu\text{W}$  (8481H, 8482H).

**Response Time** (Typical, measured at recorder output, 0 to 99% of reading).

Range 1 (most sensitive range)  $< 10.0$  seconds

Range 2  $< 3.8$  seconds

Range 3  $< 1.3$  seconds

Ranges 4 to 10  $< 500$  milliseconds

**Cal factor:** 16-position switch normalizes meter reading to account for calibration factor. Range 85% to 100% in 1% steps.

**Recorder output:** proportional to indicated power with 1 volt corresponding to full scale: 1 k $\Omega$  output impedance, BNC connector.

**RF blanking output:** provides a contact closure to ground when auto-zero mode is engaged.

**Cal adj:** front-panel adjustment provides capability to adjust gain of meter to match power sensor in use.

**Power consumption:** 110 or 120 V ( $+5\%$ ,  $-10\%$ ), 48 to 66 Hz and 360 to 440 Hz; also 220 or 240 V ( $+5\%$ ,  $-10\%$ ), 48 to 66 Hz only:  $< 4\text{W}$  ( $< 10\text{W}$  for option 001 when recharging battery).

**Weight:** net, 2.6 kg (5.75 lb); shipping, 4.2 kg (9.2 lb).

**Size:** 155 H x 130 W x 279 mm D (6.1 x 5.1 x 11 in.).

## Accessories

**Furnished:** 1.52 m (5 ft) cable for the power sensor; 2.3 m (7.5 ft) power cable. Mains plug shipped to match destination requirements.

**Available** (see page 692)

11076A: Carrying case.

5060-8762: Rack adapter frame (holds three instruments the size of the 435B).

**Combining cases** (see page 692)

1051A: 286 mm (11.25") deep.

1052A: 416 mm (16.4") deep.

These combining cases accept  $\frac{1}{2}$ -module Hewlett-Packard instruments for bench use or rack mounting.

## 11683A Range calibrator

**Calibration functions:** outputs corresponding to meter readings of 3, 10, 30, 100 and 300  $\mu\text{W}$ ; 1, 3, 10, 30, and 100 mW.

**Calibration uncertainty:**  $\pm 0.25\%$  in all ranges.

**Power:** 115 or 230 V  $\pm 10\%$ ; 50-400 Hz, less than 2 W.

**Weight:** net, 1.13 kg (2.5 lb); shipping, 1.9 kg (4.2 lb).

**Size:** 89 H x 133 W x 216 mm D (3.5 x 5.25 x 8.5 in.).

## Ordering Information

11683A Range Calibrator

435B Power Meter

435B Options

001: Rechargeable battery installed provides up to 16 hours of continuous operation add \$100

002: Input connector placed on rear panel in parallel with front add \$25

003: Input connector and reference oscillator output on rear panel only add \$10

009: 3.0 m (10-foot) cable for power sensor add \$30

010: 6.1 m (20-foot) cable for power sensor add \$55

011: 15.2 m (50-foot) cable for power sensor add \$105

012: 30.5 m (100-foot) cable for power sensor add \$155

013: 61 m (200-foot) cable for power sensor add \$260

910: Extra manual add \$7.50

## Price

\$600

\$1050



# POWER & NOISE FIGURE METERS

## Power Sensors

Models 8481A/B, 8481H, 8482A/B, 8482H, 8483A, 8484A, 8485A, 11708A

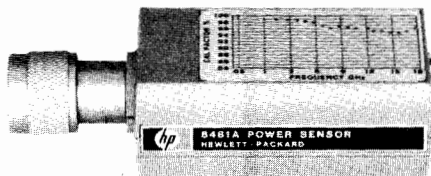

8481A

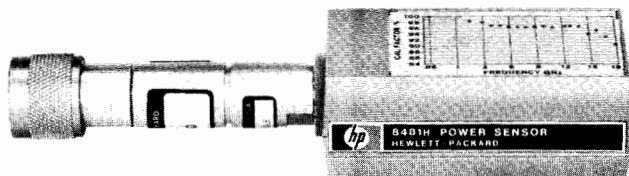

8481H

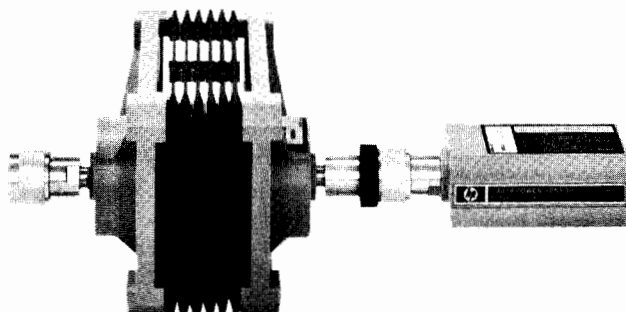

8481B

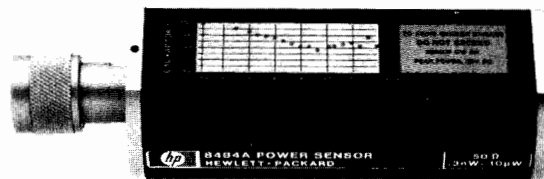

8484A



11708A

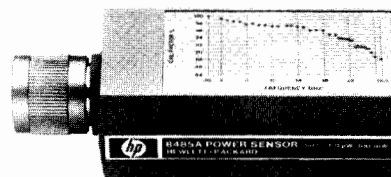

8485A



### High Power Sensors to 25 Watts

The new 8481B and 8482B high power sensors both have a power range of 1 mW to 25 watts. The 8481B covers a frequency range of 10 MHz to 18 GHz and the 8482B has a frequency range of 100 kHz to 4.2 GHz.

Previous methods of measuring medium power levels usually required adding a separate attenuator in front of a low power sensor. With the 8481/82B power sensors, the attenuator and sensor have been combined into one unit. This reduces mismatch uncertainty error and improves accuracy by including the attenuator in the measured Calibration Factor curves. In addition, the design of the 8481/82B incorporates light-weight, heat-dissipating fins to prevent burns from the attenuator.

### Medium Power Sensors to 3 Watts

Model 8481H measures power from 100  $\mu$ W to 3 watts over a frequency range of 10 MHz to 18 GHz. The 8482H measures power from 30  $\mu$ W to 3 watts over a frequency range of 100 kHz to 4.2 GHz.

### Standard Sensors to 100 mW

The 8481A, 8482A, 8483A, and 8485A power sensors all measure power over a range of 0.3  $\mu$ W to 100 mW. The 8481A is a 50-ohm sensor with a frequency range of 10 MHz to 18 GHz. The 8482A is a 50-ohm sensor with a frequency range of 100 kHz to 4.2 GHz. The 8485A is a 50-ohm sensor with a frequency range of 50 MHz to 26.5 GHz. The 8483A is a 75-ohm sensor and covers a frequency range of 100 kHz to 2 GHz.

### High Sensitivity Sensors

The 8484A measures power from 0.1 nW to 10  $\mu$ W over a frequency range of 10 MHz to 18 GHz. It is furnished with the 11708A 50 MHz Reference Attenuator for precise calibration with 1 mW Power Meter Reference Oscillator. Noise and drift have been reduced to less than 5% of full scale on the 300 pW range—only 15 pW when it is used with the 435B Power Meter. Noise and drift are even less with the 436A Power Meter.

### Power Sensors

The 8485A thermocouple power sensor covers a frequency range of 50 MHz to 26.5 GHz and a power range of  $-30$  dBm to  $+20$  dBm (1  $\mu$ W to 100  $\mu$ W). Low SWR ( $<1.25$  at 26.5 GHz) reduces mismatch uncertainty which increases power measurement accuracy. The ruggedized APC-3.5 input connector is SMA compatible and repeatable. The actual Cal Factor is plotted on each 8485A label at 34 frequencies. Each unit is also shipped with a print-out which lists Cal Factor plus the actual SWR (reflection coefficient) in magnitude and phase.

### 8480 Series Power Sensors

The 8480 series of power sensors have been designed for use with the 435B and 436A Power Meters. They feature wide frequency and amplitude ranges in addition to very low SWR.

The power measurement range of these sensors is from 0.1 nW to 25 Watts. With just three sensors a power measurement range of 114 dB can be achieved.

#### Wide Frequency Range for Many Applications

Power measurements can be made over a frequency range of 100 kHz to 26.5 GHz. The four frequency ranges covered with these units are 10 MHz to 18 GHz, 100 kHz to 4.2 GHz, 50 MHz to 26.5 GHz, and a 75-ohm unit from 100 kHz to 2 GHz.

#### Low SWR for Low Measurement Uncertainty

The 8481/82/83/85 series of sensors use a silicon monolithic thermocouple as the sensing element. The small physical size of the thermocouple enables the sensors to have a very low SWR even at 26.5 GHz. A low SWR reduces mismatch uncertainty error, which is one of the largest single sources of error in power measurements. The 8484A sensor uses a crystal detector for higher sensitivity detection without degrading the SWR.

#### Individually Calibrated for More Confidence in Results

Each sensor is individually calibrated, traceable to the National Bureau of Standards. A Cal Factor control on the meter compensates for power sensor efficiency at any frequency. In addition, a precise Automatic Network Analyzer printout for Cal Factor and reflection coefficient in magnitude and phase is supplied. This means you can significantly reduce mismatch uncertainty by calculating the mismatch error.

## 8480 Series Specifications

Model	Nominal Impedance	Frequency Range	Power Range	Maximum Power	Power Linearity <sup>a</sup>	Maximum SWR (Reflection Coefficient)	Size mm (in.)	Shipping Weight kg (lb)	RF Connector	Price
8481A	50Ω	10 MHz-18 GHz	1 μW to 100 mW	300 mW avg. 15 W peak 30 W • μs (per pulse)	+10 to +20 dBm +1.5, -1.0%	10 MHz - 30 MHz: 1.40 (0.166) 30 MHz - 50 MHz: 1.18 (0.083) 50 MHz - 2 GHz: 1.10 (0.048) 2 - 12.4 GHz: 1.18 (0.083) 12.4 - 18 GHz: 1.28 (0.123)	30 x 38 x 105 (1.2 x 1.5 x 4.1)	0.5 (1)	N (m)	\$485
Option 001									APC-7	add \$25
8481B	50Ω	10 MHz-18 GHz	0-35°C, 1 mW-25W; 35°C-55°C, 1 mW-20 W	0-35°C: 30 W avg. <sup>1</sup> 35°C-55°C: 25 W avg.  10 MHz-7 GHz 500 W peak 7-18 GHz 125 W peak  500 W • μs (per pulse)	+35 to +44 dBm ±4%	10 MHz - 2 GHz: 1.10 (0.048) 2-12.4 GHz: 1.18 (0.083) 12.4-18 GHz: 1.28 (0.123)	83 x 114 x 248 (3.25 x 4.5 x 9.75)	1.5 (3.2)	N (m)	\$990
8481H	50Ω	10 MHz-18 GHz	100 μW to 3W	3.5 W avg. 100 W peak 100 W • μs (per pulse)	+25 to +35 dBm ±5%	10 MHz - 8 GHz: 1.20 (0.091) 8-12.4 GHz: 1.25 (0.110) 12.4 - 18 GHz: 1.30 (0.130)	30 x 38 x 149 (1.2 x 1.5 x 5.9)	0.5 (1)	N(m)	\$625
8482A	50Ω	100 kHz-4.2 GHz	1.0 μW to 100 mW	300 mW avg. 15 W peak 30 W • μs (per pulse)	+10 to +20 dBm +1.5, -1.0%	100-300 kHz: 1.60 (0.231) 300 kHz - 1 MHz: 1.20 (0.091) 1 MHz - 2 GHz: 1.10 (0.048) 2-4.2 GHz: 1.30 (0.130)	30 x 38 x 105 (1.2 x 1.5 x 4.1)	0.5 (1)	N(m)	\$455
8482B	50Ω	100 kHz-4.2 GHz	0-35°C, 1 mW-25W; 35°C-55°C, 1 mW-20 W	0-35°C: 30 W avg. <sup>1</sup> 35°C-55°C: 25 W avg.  500 W peak  500 W • μs (per pulse)	+35 to +44 dBm ±4%	100 kHz - 2 GHz: 1.10 (0.048) 2 GHz - 4.2 GHz: 1.18 (0.083)	83 x 114 x 248 (3.25 x 4.5 x 9.75)	1.5 (3.2)	N (m)	\$965
8482H	50Ω	100 kHz-4.2 GHz	100 μW to 3W	3.5 W avg. 100 W peak 100 W • μs (per pulse)	+25 to +35 dBm ±5%	100 kHz-4.2 GHz: 1.20 (0.091)	30 x 38 x 149 (1.2 x 1.5 x 5.9)	0.5 (1)	N(m)	\$590
8483A	75Ω	100 kHz-2 GHz	1.0 μW to 100 mW	300 mW avg. 10 W peak 30 W • μs (per pulse)	+10 to +20 dBm +1.5, -1.0%	100-600 kHz: 1.80 (0.286) 600 kHz - 2 GHz: 1.18 (0.083)	30 x 38 x 105 (1.2 x 1.5 x 4.1)	0.5 (1)	N(m) 75Ω	\$455
8484 <sup>a</sup>	50Ω	10 MHz-18 GHz	0.1 mW to 10 μW	200 mW avg. 200 mW peak		10-30 MHz: 1.40 (0.166) 30 MHz - 4 GHz: 1.15 (0.070) 4-10 GHz: 1.20 (0.091) 10-18 GHz: 1.30 (0.130)	40 x 50 x 170 (1.6 x 2 x 6.7)	0.5 (1)	N(m)	\$650
8485A	50Ω	50 MHz-26.5 GHz	1 μW to 100 mW	300 mW avg. 15 W peak 30 W • μs (per pulse)	+10 to +20 dBm ±2%	50 MHz-100 MHz: 1.15 100 MHz-2 GHz: 1.10 2-12.4 GHz: 1.15 12.4-18 GHz: 1.20 18-26.5 GHz: 1.25	30 x 40 x 95 (1.25 x 1.5 x 4)	0.2 (0.5)	APC3.5(m)	\$700

<sup>1</sup>For pulses greater than 30 W the maximum average power (Pa) is limited by the energy per pulse (E) in W • μs according to Pa = 30-0.02E.

<sup>2</sup>Negligible deviation except for those power ranges noted.

<sup>3</sup>Includes 11708A 30 dB attenuator for calibrating against a 0 dBm, 50 MHz power reference. 11708A is factory set to 30 dB ± 0.05 dB at 50 MHz.

### Uncertainty of calibration factor data for 8482A and 8483A

Frequency (MHz)	Sum of Uncertainties (%) <sup>1</sup>			Probable Uncertainties (%) <sup>2</sup>		
	8482A	8482B	8483A	8482A	8482B	8483A
0.1	1.85	5.7	3.05	1.33	2.8	1.79
0.3	1.85	5.7	3.05	1.33	2.8	1.79
1.0	1.85	5.7	3.05	1.33	2.8	1.79
3.0	1.85	5.7	3.05	1.33	2.8	1.79
10.0	1.85	5.7	3.05	1.33	2.8	1.79
30.0	1.85	5.7	3.05	1.33	2.8	1.79
50.0	0(ref)	2.7	0(ref)	0(ref)	2.7	0(ref)
100.0	2.95	5.6	3.25	1.58	3.3	1.61
300.0	2.95	5.6	3.25	1.58	3.3	1.61
1000.0	2.95	5.7	3.25	1.58	3.3	1.61
2000.0	3.45	5.5	3.75	1.92	3.1	1.94
4000.0	2.95	5.5	—	1.58	3.1	—

### Uncertainty of calibration factor data for 8481A/B, 8484A and 8485A

Frequency (GHz)	Sum of Uncertainties (%) <sup>1</sup>				Probable Uncertainties (%) <sup>2</sup>			
	8481A	8481B	8484A	8485A	8481A	8481B	8484A	8485A
2.0	3.45	5.8	4.70	3.6	1.92	3.1	2.25	2.1
4.0	2.95	5.8	4.36	3.8	1.58	3.1	1.97	2.2
6.0	2.95	5.8	4.55	4.0	1.58	3.1	2.00	2.3
8.0	2.85	6.0	4.47	4.4	1.46	3.1	1.91	2.5
10.0	2.85	6.2	4.42	4.7	1.46	3.3	1.89	2.7
12.4	2.85	7.8	4.71	5.2	1.46	4.1	1.98	3.0
14.0	5.05	7.9	7.00	5.6	2.95	4.1	3.24	3.2
16.0	5.45	8.0	7.62	5.8	3.07	4.2	3.40	3.4
18.0	5.45	8.3	7.15	5.9	3.07	4.3	3.30	3.6
26.5	—	—	—	7.3	—	—	—	4.0

<sup>1</sup>Includes uncertainty of reference standard and transfer uncertainty. Directly traceable to NBS.

<sup>2</sup>Square root of sum of the individual uncertainties squared (RSS).

# POWER & NOISE FIGURE METERS

## Thermistor power meters

Models 432A/B/C

- Automatic zero
- High accuracy

- Recorder outputs, analog & digital
- Long cable options



432A



432B



432C

### 432A/B/C Power Meters

**High accuracy—no thermoelectric error:** High accuracy over a wide temperature range is featured on the 432 Power Meters. By measuring the output voltage of the thermistor bridges, and computing the corresponding power, even higher accuracy of  $\pm 0.2\% \pm 0.5 \mu\text{W}$  can be obtained.

Accuracy can be maintained on even the most sensitive range because the error due to thermoelectric effect is reduced to a negligible level.

**Calibrated mounts:** Each thermistor mount is furnished with data stating the Calibration Factor\* and Effective Efficiency\* at various frequencies across the operating range. For easy and accurate power measurements, the front panel of the 432 contains a calibration factor control, calibrated in 1% steps from 88% to 100%, that compensates for losses in the mount and eliminates the need for calculation.

**Instrument type:** automatic, self-balancing power meter for use with temperature-compensated thermistor sensor.

\*"Calibration Factor" and "Effective Efficiency" are figures of merit expressing the ratio of the substituted signal measured by the power meter to the microwave power incident on and absorbed by the sensor respectively.

### Specifications (Partial)

#### Power range

**432A:** seven ranges with full-scale readings of 10, 30, 100, and 300  $\mu\text{W}$ , 1, 3, and 10 mW; also calibrated in dBm from -20 dBm to +10 dBm full scale in 5 dB steps.

**432B, 432C:** four ranges with full-scale readings of 10 and 100  $\mu\text{W}$ , and 1 and 10 mW.

**Noise:** Less than 0.25% of full scale peak (typical).

**Response time:** At recorder output, 35 ms time constant (typical).

**Fine zero:** Automatic, operated by front panel switch. Remote fine zero may be accomplished with 432C.

**Zero carryover:** Less than 0.50% of full scale when zeroed on most sensitive range.

#### Meter

**432A:** taut-band suspension, individually calibrated, mirror-backed scales. Milliwatt scale more than 108 mm (4.25 in.) long.

**432B, 432C:** three digits with one digit overrange. 20% overrange capability on all ranges.

**Calibration factor control:** 13-position switch normalizes meter reading to account for thermistor sensor calibration factor. Range 100% to 88% in 1% steps.

**Thermistor sensor:** Thermistor sensors are required for operation of the 432A/B/C. For microwave sensors HP 478B, 8478B and 486 series see page 435. For Fiber Optic Sensor 84801A see page 436.

**Recorder output:** Proportional to indicated power with 1 volt corresponding to full-scale. 1 k $\Omega$  output impedance.

**BCD output:** 8, 4, 2, 1 code: "1" positive. TTL compatible logic. Operates with HP 5055A Digital Recorder. "Print" and "Inhibit" lines available. (432B and 432C only.)

**Model 432C control lines:** Instrument is referenced to +5 V, "Logic 0" is equivalent to 0 V.

#### Power consumption

**432A:** 115 or 230 V ac  $\pm 10\%$ , 50 to 400 Hz, 2.5 watts.

**432B:** 115 or 230 V ac  $\pm 10\%$ , 50 to 400 Hz, 10 watts.

**432C:** 115 or 230 V ac  $\pm 10\%$ , 50 to 400 Hz, 16 watts.

#### Weight

**432A:** net, 2.3 kg (5.5 lb); shipping, 4.6 kg (10 lb).

**432B:** net, 3 kg (6.5 lb); shipping, 4.8 kg (10.5 lb).

**432C:** net, 3.2 kg (7.2 lb); shipping, 5 kg (11 lb).

**Size:** 130 W x 155 H x 279 mm D (5.2 x 6.1 x 11.0 in.)

### Ordering Information

**432A** Power meter

**Price**

\$950

**432B** Power meter

\$1625

**432C** Power meter

\$2500

#### 432A/B/C Options

**001:** rechargeable battery installed, provides up to 24 hours continuous operation (432A only) add \$105

**002:** input connector placed on rear panel in parallel with front add \$25

**003:** input connector on rear panel only add \$10

**009:** 3.1 m (10 ft) cable for 110-ohm or 200-ohm sensor add \$30

**010:** 6.1 m (20 ft) cable for 100-ohm or 200-ohm sensor add \$55

**011:** 15.2 m (50 ft) cable for 100-ohm or 200-ohm sensor add \$105

**012:** 30.5 m (100 ft) cable for 100-ohm or 200-ohm sensor add \$155

**013:** 61 m (200 ft) cable for 100-ohm or 200-ohm sensor add \$260

**100:** 100 Vac operation no charge

**910:** extra operating and service manual add \$5

# POWER & NOISE FIGURE METERS

435

Thermistor mounts, peak power calibrator & power meter calibrator

Models 478A, 8478B, 486 Series, 8900B, 8477A



478A

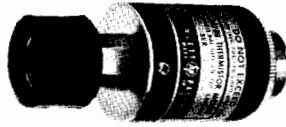

8478B



486 Series

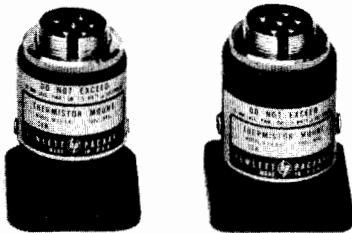

## Temperature Compensated Thermistor Mounts

High efficiency and good RF match are characteristic of the HP 478A and 8478B Coaxial and 486A Series Waveguide Thermistor mounts. Used in conjunction with the 432 Power Meter they provide high accuracy even in routine power measurements. These thermistor mounts are temperature-compensated for low drift, even in the presence of thermal shocks, permitting measurement of microwave power as low as one microwatt. Each mount contains data showing Calibration Factor and Effective Efficiency at six frequencies, directly traceable to the National Bureau of Standards at those frequencies where NBS provides calibration service.

## 486, 478, 8478B Specifications

Model	Frequency range, GHz	Maximum SWR	Operating Resistance (Ohms)	Price
478A	10 MHz to 10 GHz	1.75, 10 to 25 MHz 1.3, 25 MHz to 7 GHz 1.5, 7 to 10 GHz	200	\$260
8478B <sup>1</sup>	10 MHz to 18 GHz	1.75, 10 to 30 MHz 1.35, 30 to 100 MHz 1.1, 0.1 to 1 GHz 1.35, 1 to 12.4 GHz 1.6, 12.4 to 18 GHz	200	\$400
X486A	8.20 to 12.4	1.5	100	\$300
M486A	10.0 to 15.0	1.5	100	\$450
P486A	12.4 to 18.0	1.5	100	\$350
K486A <sup>2</sup>	18.0 to 26.5	2.0	200	\$450
R486A <sup>2</sup>	26.5 to 40.0	2.0	200	\$500

<sup>1</sup>Option 011: furnished with APC-7 RF connector add \$25

<sup>2</sup>Circular flange adapters:

K-band (UG-425/U) HP 11515A \$135  
R-band (UG-381/U) HP 11516A \$135

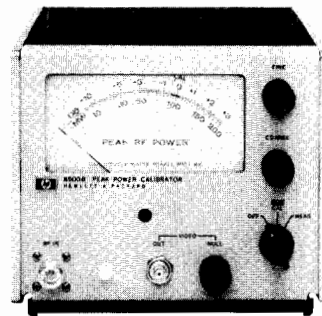

8900B

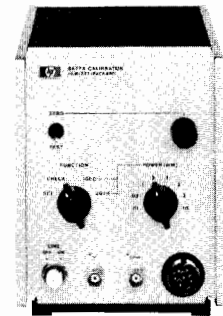

8477A

## 8900B Peak Power Calibrator

The HP 8900B peak power calibrator provides a convenient means for measuring the peak RF power of pulses in the range from 50 to 2000 MHz. The power level is read out directly on the panel meter and is completely independent of repetition rate and pulse width ( $>0.25 \mu\text{sec}$ ).

## 8900B Specifications

### Radio Frequency Measurement Characteristics

**Frequency range:** 50 to 2000 MHz.

**RF power range:** 10-200 mW peak full scale (may be readily increased through use of external attenuators or directional couplers).

**RF power accuracy:**  $\pm 1.5 \text{ dB}$  ( $\pm 0.6 \text{ dB}$  with custom calibration curve furnished with instrument).

**RF power precision:** 0.1 dB.

**RF pulse width:**  $>0.25 \mu\text{s}$ .

**RF repetition rate:** 1.5 MHz maximum.

**RF impedance:** 50 ohms.

**RF VSWR:**  $<1.25$ .

### Monitor Output

**Level:**  $>0.2$  volt for 20 mW input (nominal).

**Impedance:** 150 ohms nominal.

**Bandwidth:**  $>7 \text{ MHz}$ .

### Physical Characteristics

**Size:** 156 H x 197 W x 279 mm D (6.1 x 7.75 x 11 in.).

**Weight:** net, 4.5 kg (10 lb); shipping, 5.9 kg (13 lb).

**Power consumption:** 105 to 125 or 210 to 250 volts, 50 to 60 Hz.

## 8477A Power Meter Calibrator

The 8477A Calibrator is specifically designed for use with the 432 Power Meter. It allows you to verify full-scale meter readings on all ranges, and meter tracking. Simply connect three cables between the power meter and calibrator; no charts or additional instruments are required.

## 8477A Specifications

**Calibration points:** outputs corresponding to meter readings of: 0.01, 0.03, 0.1, 0.3, 1.0, 2.0, 3.0, and 10 mW (for mount resistance switch settings of both 100 and 200 ohms).

**Calibration uncertainty:**  $\pm 0.2\%$  on the top five ranges, and  $\pm 0.5\%$  on the 0.01 and 0.03 mW ranges from  $+20^\circ$  to  $+30^\circ\text{C}$ .

**RFI:** meets all conditions specified in MIL-I-6181D.

**Power:** 115 or 230 V  $\pm 10\%$ , 50-400 Hz, approximately 2 W.

**Weight:** net, 2.0 kg (4.5 lb). Shipping, 2.9 kg (6.25 lb).

**Size:** 155 H x 130 W x 203 mm D (6.1 x 5.1 x 8 in.).

## Ordering Information

8900B Peak power calibrator

8477A Power meter calibrator

Price

\$1100

\$600



# POWER & NOISE FIGURE METERS

## Fiber optic power sensor and meters

Models 84801A; 432A, B, C

- Accurate, repeatable measurements
- 600 to 1200 nm (500 to 2000 nm option)
- -30 to +10 dBm

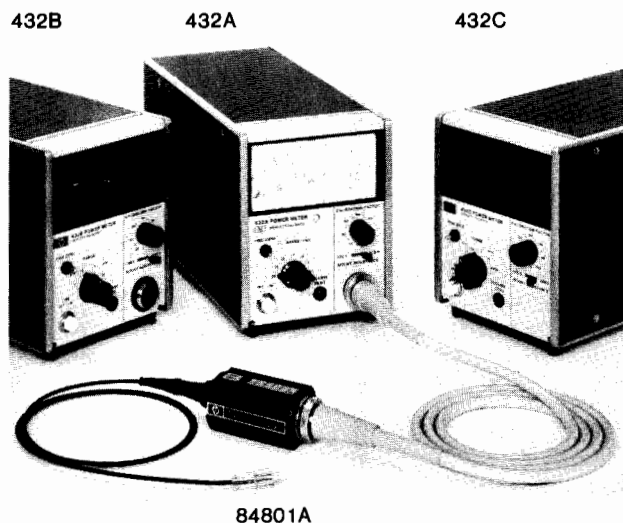

### 84801A Fiber Optic Power Sensor

The 84801A is an optical power sensor dedicated to fiber optics. Used in conjunction with any of the 432 series power meters, it measures power from -30 dBm to +10 dBm (1  $\mu$ W to 10 mW) over a spectral range of 600-1200 nm. The measurement is inherently accurate and repeatable because it is based on a closed-loop electrical substitution method. This method also provides long term stability of the sensor's calibration.

A temperature-compensated thermistor with near black-body characteristics is used as the detector, providing a flat linear response over a broad spectral range. The small changes in coupling efficiency that occur at different wavelengths are expressed in terms of a calibration factor; a typical curve appears below. Absolute calibration is provided at four wavelengths with others (from 500-2000 nm) available on request.

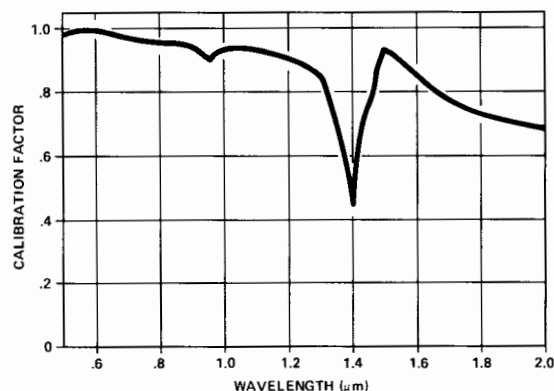

Input to the 84801A is made through a large diameter single fiber. Alignment can be made either with or without a user supplied connector. Since its core diameter is larger than that of most high performance optical fibers, coupling loss is inherently low.

### Specifications

**Dynamic Range:** 10  $\mu$ W (-20 dBm) to 10 mW (+10 dBm) full scale.

**Spectral Range:** 600 nm to 1200 nm.

**Cal-Factor Calibration<sup>1</sup>:** 650, 800, 1050, and 1150 nm. (Other wavelengths from 500 to 2000 nm available upon request.)

**Cal-Factor Accuracy:** 7% at 650 nm; 8% at 800, 1050, and 1150 nm.

**Operating Temperature:** 0 to 55°C.

**Maximum Average Power<sup>2</sup>:** 30 mW.

### Supplemental Characteristics

#### Input Fiber Characteristics<sup>3</sup>

**Nominal Calculated Numerical Aperture:** 0.4.

**Nominal Core Diameter:** 200  $\mu$ m.

**Length Supplied:**  $\geq$  1 m.

**Attenuation:** 0.04 dB/m at 775 nm; 0.05 dB/m at 820 nm.

**Nominal Index of Refraction:** 1.456

**Maximum Peak Power<sup>4</sup>:** 200 W.

**Maximum Energy Per Pulse<sup>4</sup>:** 10 microjoules.

**Weight:** net 0.2 kg (7 oz); shipping, 0.72 kg (1.6 lb).

**Size:** 76 L x 41 H x 36 mm W (3" x 1.65" x 1.4").

**Accessories Furnished:** carrying case for protection of fiber pig-tail.

### Power Meters

The electrical substitution method used by the 84801A is performed automatically by the 432 power meter. In addition, a single knob adjustment will automatically include the 84801A calibration factor in the meter reading. There are three versions in the series of 432 power meters that provide flexibility in the choice of display and capability. The 432A is an economical analog display calibrated in watts and dBm. The 432B provides a 3½-digit display in milliwatts and a rear panel connector provides a corresponding digital output in an 8421 BCD code. The 432C offers a 3½-digit readout in milliwatts, automatic ranging, and full BCD programming capability.

**Accessories Furnished:** 1.5 m (5 ft) electric cable for HP Fiber Optic power sensor; 2.3 m (7.5 ft) power cable. Mains plug shipped to match destination requirements.

**Accessories Available:** 8477A Power Meter Calibrator, 11076A Carrying Case.

**For Further Information:** See page 434.

### Ordering Information

	Price
<b>84801A Fiber Optic Power Sensor</b>	\$600
<b>Option H01:</b> Calibration at user-specified wavelengths every 50 nm from 500 to 1200 nm plus 1300, 1500, 1700, and 2000 nm.	add \$105 plus \$30 per wavelength
<b>432A Power Meter</b>	\$950
<b>432B Power Meter</b>	\$1620
<b>432C Power Meter</b>	\$2500
<b>432A, B, C Options</b>	
<b>001:</b> Rechargeable battery installed; provides up to 24 hours continuous operation (432A only)	add \$105
<b>002:</b> Input connector on rear panel in parallel with front connector	add \$25
<b>003:</b> Input connector on rear panel only	add \$10
<b>100:</b> 100 Vac operation	no charge
<b>910:</b> Extra operating and service manual	add \$5

<sup>1</sup>Calibration referred to power coupled into fiber input.

<sup>2</sup>Thermistor assembly is field adjustable so that zero set capability can be restored in the event of inadvertent overload.

<sup>3</sup>DuPont plastic clad silica fiber PFX-S120R

<sup>4</sup>Based on theoretical calculations.

# POWER & NOISE FIGURE METERS

437

Noise figure meters, noise sources

Models 340B, 342A, 343A, 345B, 346B, 347A, 349A, 11711A

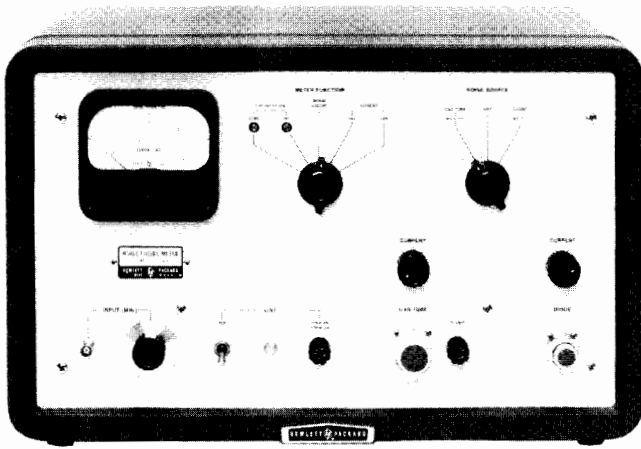

340B

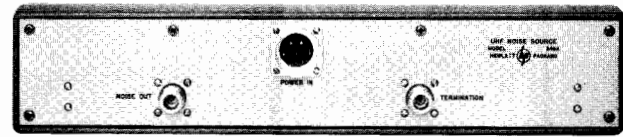

349A



X347A

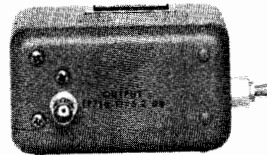

343A

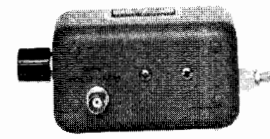

345B



346B

## Noise Figure Meters and Noise Sources

Model 340B Noise Figure Meter, when used with the appropriate HP noise source, automatically measures and continuously displays noise figure for equipment with IF frequencies of 30 and 60 MHz. Model 342A is similar, and operates on frequencies of 30, 60, 70, 105 and 200 MHz.

HP noise sources provide calibrated noise for measurements on various equipment from IF amplifiers to complete radar systems. Model 343A VHF source operates from 10 to 600 MHz with 50 ohm impedance. 345B IF source is tuned for 30 or 60 MHz with 50, 100, 200, or 400 ohm outputs.

The 347A waveguide sources are argon gas discharge tubes carefully mounted in waveguide sections for frequencies from 3.95 to 18 GHz. Model 349A also uses an argon tube in a coaxial configuration for frequencies from 400 to 4000 MHz.

### 340B and 342A Partial Specifications

**Noise Figure Range:** with a 5.2 dB noise source, 0 to 15 dB, indication to infinity; with a 15.2 dB noise source, 3 to 30 dB, indication to infinity.

**Accuracy (Excluding Source Accuracy):** noise diode scale:  $\pm 0.5$  dB, 0 to 15 dB; gas tube scale:  $\pm 0.5$  dB, 10 to 25 dB,  $\pm 1$  dB, 3 to 10 dB and 25 to 30 dB.

**Input Frequency:** 340B: 30 or 60 MHz, selected by switch; 342A: 30, 60, 70, 105, and 200 MHz, selected by switch. Other frequencies available; prices and details on request.

**Bandwidth:** 1 MHz minimum.

**Input:** 50 ohms nominal;  $-60$  to  $-10$  dBm signal level.

**Power Input:** 115 or 230 volts  $\pm 10\%$ , 50 to 60 Hz, 435 watts, max.

**Size:** cabinet, 324 H x 527 W x 368 mm D (12.8 x 20.3 x 14.5 in.).

**Weights:** net, 19.4 kg (43 lb); shipping, 23.9 kg (53 lb).

### 346B Broadband Noise Source

Model 346B solid state noise source offers an extremely broadband coverage of 10 MHz to 18 GHz at an economical price. With its wide frequency coverage and improved performance, the 346B can replace several narrowband noise sources.

The 346B features very low SWR, ON/OFF, (1.25 at 18 GHz) which lowers the mismatch uncertainty considerably; thus improving the overall measurement uncertainty.

Each 346B is provided with a printout of the actual ENR and the ON/OFF reflection coefficient at one GHz intervals.

The DC biasing voltage for the 346B is 28 volts. The 11711A Noise Source Adapter enables the 346B to work with the Hewlett-Packard 340B and 342A Noise Figure Meters.

### 343A, 345B, 346B, 349A Partial Specifications

HP Model	Freq. Range (MHz)	Excess Noise Ratio dB	Max. SWR 50 $\Omega$ Nominal	RF Connector	Price
343A	10-600	5.2 $\pm$ 0.5	1.3 ON or OFF	BNC (f)	\$315
345B	30 or 60 selectable by switch	5.2	Variable Z <sub>d</sub> , 50, 100, 200, 400 $\Omega$	BNC (f)	\$500
346B	10-18000	15.2 $\pm$ 0.5	1.25 ON or OFF	APC-3.5	\$1250
349A	400-4000	15.6 $\pm$ 0.6	2.0 ON 3.0 OFF	Type N (f)	\$620

### 347A Specifications

HP Model	Freq. Range (GHz)	Excess Noise Ratio dB	W/G WR	Equiv. Flange UG(-) /U	Price
G347A	3.95-5.85	15.2 $\pm$ 0.5	187	407	1000
J347A	5.30-8.20	15.2 $\pm$ 0.5	137	441	1000
H347A	7.05-10.0	15.6 $\pm$ 0.5	112	138	1075
X347A	8.20-12.4	15.7 $\pm$ 0.4	90	39	925
P347A	12.4-18.0	15.8 $\pm$ 0.5	62	419	950

Reflection coefficient for all models, fired or unfired,  $< 0.091$  (SWR 1.2) max.

**Coaxial & Waveguide Catalog & Microwave Measurement Handbook:** 96 pages with over 350 measurement accessories. Request card at back of this catalog.

### Ordering Information

340B Noise Figure Meter (cabinet)	\$2300
340BR Noise Figure Meter (rack mount)	\$2275
342A Noise Figure Meter (cabinet)	\$2350
342AR Noise Figure Meter (rack mount)	\$2325
11711A Noise Source Adapter (adapts 346B to 340B and 342A)	\$135

# MICROWAVE TEST EQUIPMENT

Microwave measurements and products



## Microwave Test Equipment Product Line

Hewlett-Packard offers a complete line of microwave coaxial and waveguide measuring equipment. Measuring systems can be assembled from this equipment to make accurate reflection and transmission measurements on other components such as filters, mixers, cables, etc.

The bulk of microwave measurements made in production test, maintenance, and calibration require amplitude information only. These are sometimes referred to as scalar measurements.

The tables to the right summarize HP capabilities in scalar microwave measurements. More detailed information is available in the following publications:

AN 64-2 Extended Applications of Automatic Power Meters

AN 64-3 Accurate and Automatic Noise Figure Measurements

AN 183 High Frequency Swept Measurements

AN 196 Automated Measurements

Using the 436A Power Meter Coaxial and Waveguide Catalog and Microwave Measurement Handbook

Complimentary copies are available from HP offices or you can use the request card at the back of this catalog.

## HP Impedance/SWR Measuring Techniques and Capabilities

Measurement Technique	Coaxial Freq. Range	Waveguide Freq. Range	Typical Range	Remarks/Cost/Accuracy/Speed
Manual Slotted Line	500-4000 MHz 1-18 GHz	3.95-18 GHz (4 Bands)	30-35 dB	Lowest cost, high accuracy, slow, point-by-point
Swept Slotted Line	1.8-18 GHz	—	34 dB	Moderate cost, high accuracy, good speed, comprehensive
Reflectometer Square-Law	100-4000 MHz 2-18 GHz	3.95-40 GHz (6 Bands)	35-40 dB	Moderate cost, moderate accuracy, fast, comprehensive
Reflectometer RF-Substitution	100-4000 MHz 2-18 GHz	3.95-40 GHz (6 Bands)	50 dB	Moderate cost, high accuracy, fast, requires display storage
Bridge	1-110 MHz 40 MHz-18 GHz	—	40 dB	Multi-octave, good for coax, best for low SWR, 9 dB insertion loss

## HP Insertion Loss Measuring Techniques and Capabilities

Measurement Technique	Coaxial Freq. Range	Waveguide Freq. Range	Typical Range	Remarks/Cost/Accuracy/Speed
Square-Law	10 MHz-18 GHz	2.6-40 GHz (7 Bands)	50 dB	Low cost, moderate accuracy, simple, fast
RF Substitution	10 MHz-18 GHz	2.6-18 GHz 18-40 GHz	50-100 dB 50-80 dB	Moderate cost, high accuracy fast, requires display storage
IF Substitution	10 MHz-18 GHz	2.6-18 GHz (5 Bands)	30-120 dB	High cost, very high accuracy, best range, moderate speed
Desktop computer mini-system	100 kHz-4 GHz 10 MHz-18 GHz	—	40-70 dB	Moderate cost, very high accuracy, automated

# MICROWAVE TEST EQUIPMENT

Variable attenuators and OEM step attenuators

Models 375 series, 382 series, 393A, 394A, 33300 series, 33320 series

439

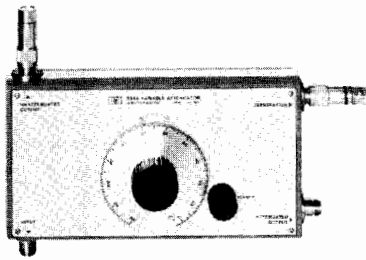

394A

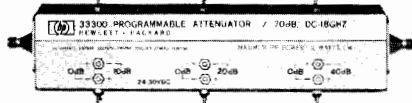

33300A

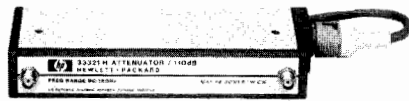

33321H

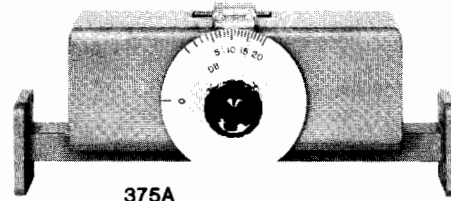

375A

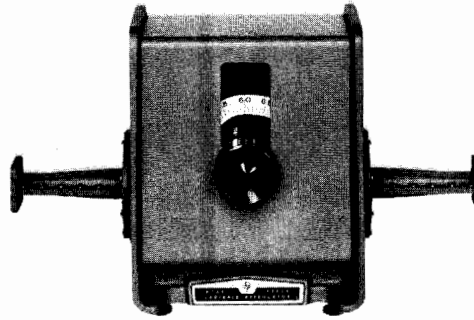

P382A

## 393A, 394A Coaxial Variable Attenuator 33300 Series, 33320 Series OEM Step Attenuators

Models 393A and 394A are high power, variable coaxial attenuators for the 0.5 to 2 GHz range. They use the principle of a variable directional coupler to achieve up to 120 dB range with 200 watt power handling capability.

33300 series step attenuators provide wideband programmable signal level control. Magnetic latching solenoids switch individual attenuating elements into and out of contact with a 50-ohm transmission line. C/D models have separate indicator contacts and A/B models have no indicator contacts. Three digit connector options (OXY) must be specified. X is the input connector, Y is output connector, first digit is always 0. See specifications table for option numbers.

33320 series step attenuators are compact versions of the 8494/5/6 bench attenuators on the previous page (same specifications) and are

## 393A, 394A, 33300 Series, 33320 Series Specifications

Model	Freq Range (GHz)	Mode	Range	Remarks	Price
393A	0.5-1	Manual	5-120 dB Variable	200 W average	\$1500
394A	1-2	Manual	6-120 dB Variable	200 W average	\$1420
33300 A/B C/D	dc-18	Prog.	0-70 dB 10 dB steps	A&C models 12-15 V	\$ 960 \$ 995
33301 A/B C/D	dc-18	Prog.	0-42 dB 6 dB steps	B&D models 24-30 V	\$ 960 \$ 995
33304 A/B C/D	dc-18	Prog.	0-11 dB 1 dB steps	Connector options available:	\$1270 \$1310
33305 A/B C/D	dc-18	Prog.	0-110 dB 10 dB steps	0: N(f), 1: N(m) 2: 7mm(f), 3: 7mm(m) 5: SMA(f), 6: SMA(m)	\$1270 \$1310
33320A B	dc-4 dc-18	Manual	1-11 dB 1dB steps	Specifications identical to 8494 series previous page	\$ 540 \$ 700
33320G H	dc-4 dc-18	Prog.			\$ 855 \$1085
33321A B D	dc-4 dc-18 dc-26.5	Manual	0-70 dB 10 dB steps	Specifications identical to 8495 series previous page	\$ 385 \$ 510 \$ 765
33321G H K	dc-4 dc-18 dc-26.5	Prog.			\$ 710 \$ 810 \$1165
33322A B	dc-4 dc-18	Manual	0-110 dB 10 db steps	Specifications identical to 8496 series previous page	\$ 540 \$ 710
33322G H	dc-4 dc-18	Prog.			\$ 845 \$1120

configured for designing into microwave systems and instruments. Manual or electrically-activated versions are available. The manual models take less than 1.5 square inches of panel space. OEM quantity discounts are available for 33300 and 33320 series.

## 375 Series, 382 Series Waveguide Attenuators

Operation of these 382 series rotary-vane, continuously variable attenuators depends on a mathematical law, rather than on the resistivity of the attenuator card. They are direct-reading and provide accurate attenuation from 0 to 50 dB (60 dB for S382C) regardless of temperature and humidity.

375A series variable flap attenuators consist of a short slotted section of waveguide in which a matched resistive strip is inserted.

## Coaxial and Waveguide Catalog & Microwave Measurement Handbook

96 pages with over 350 measurement accessories. Request card at back of this catalog.

## 375A Series 382 Series Specifications

Model	Frequency Range (GHz)	Accuracy	Attenuation Range (dB)	Waveguide & Equivalent Flange	Price
S382C	2.6-3.95	±1% of reading or 0.1 dB whichever greater ±2% above 50 dB	0-60	WR 284 UG-584/U	\$3120
G382A	3.95-5.85	±2% of reading or 0.1 dB whichever greater	0-50	WR 187 UG-407/U	\$2100
J382A	5.3-8.2	±2% of reading or 0.1 dB whichever greater	0-50	WR 137 UG-441/U	\$1760
H382A	7.05-10.0	±2% of reading or 0.1 dB whichever greater	0-50	WR 112 UG-138/U	\$1760
X382A	8.2-12.4	±2% of reading or 0.1 dB whichever greater	0-50	WR 90 UG-135/U	\$1040
P382A	12.4-18.0	±2% of reading or 0.1 dB whichever greater	0-50	WR 62 UG-419/U	\$1040
K382A	18.0-26.5	±2% of reading or 0.1 dB whichever greater	0-50	WR 42 UG-597/U	\$1760
R382A	26.5-40.0	±2% of reading or 0.1 dB whichever greater	0-50	WR 28 UG-599/U	\$1700
X375A	8.2-12.4	±1 dB, ±2 dB	0-20	WR 90 UG-39/U	\$ 500
P375A	12.4-18	±1 dB, ±2 dB	0-20	WR 62 UG-419/U	\$ 500



# MICROWAVE TEST EQUIPMENT

## Coaxial fixed attenuators

Models 8491A/B, 8492A, 8493A/B, 8498A, 11581/2/3A

- Flat frequency response
- Low SWR
- Specifications traceable to NBS



11581A

### 8491A/B, 8492A, 8493A/B Fixed Attenuators

Hewlett-Packard coaxial fixed attenuators provide precision attenuation, flat frequency response, and low SWR over broad frequency ranges at low prices. Attenuators are available in nominal attenuations of 3-dB and 6-dB and also 10-dB increments from 10 dB to 60 dB. These attenuators are swept-frequency tested to ensure meeting specifications at all frequencies. Calibration points are provided on a nameplate chart attached to each unit.

### 11581A, 11582A, 11583A Attenuator Sets

A set of four Hewlett-Packard attenuators, 3, 6, 10 and 20 dB are furnished in a handsome walnut accessory case. The 11581A set consists of 8491A attenuators. A set of 8491B attenuators is contained in the 11582A, while the 11583A is comprised of 8492A attenuators. In addition to the calibration stamping on the bodies of the attenuators, the set includes a calibration report. The calibration report is certified traceable to the National Bureau of Standards, and includes both the attenuation and the reflection coefficients for each attenuator at four frequencies for the 11581A (dc, 4, 8, 12.4 GHz) and five frequencies for the 11582A and 11583A (dc, 4, 8, 12.4, 18 GHz). By specifying option 890, calibration data is given at 26 frequencies (11581A) or 42 frequencies (11582A and 11583A). See next page for exact frequency lists.

These sets are ideal for calibration labs or where precise knowledge of attenuation and SWR is desired.

### 8498A High Power Attenuator

The 8498A Option 030 is designed to meet the needs of high power attenuation applications in the RF and microwave frequency range. It is specified from dc to 18 GHz at 25 watts average, 500 watts peak from dc to 5.8 GHz, and 125 watts peak from 5.8 to 18 GHz. Available only in a 30 dB model (option 030), the unit offers low SWR ( $<1.30$  at 18 GHz) and good accuracy ( $\pm 1$  dB at 18 GHz). The unit also features 'human engineered' cooling fins that prevent operator burns even under continuous maximum input power conditions.

HEWLETT PACKARD OPTION 890 CALIBRATION REPORT					
MODEL: 8492A OPT 010		SERIAL NO: 9061		TECHNICIAN: 02387	
DATE: 03-22-78		CALIBRATION SYSTEM: 8493B SYSTEM B		PORT IDENTIFICATION: WITH LABEL FACING THE USER, PORT 1 IS ON THE LEFT AND PORT 2 IS ON THE RIGHT.	
FREQUENCY (MHz)	ATTENUATION (dB)	SWR PORT 1	SWR PORT 2		
100.00	10.01	1.029	1.006		
500.00	10.01	1.025	1.005		
1000.00	10.01	1.023	1.007		
1500.00	10.03	1.027	1.010		
2000.00	10.03	1.027	1.013		
2500.00	9.92	1.024	1.009		
3000.00	10.00	1.014	1.009		
4000.00	10.00	1.109	1.109		
5000.00	10.00	1.103	1.110		
6000.00	10.01	1.110	1.118		
7000.00	10.02	1.105	1.109		
8000.00	10.04	1.094	1.101		
9000.00	10.00	1.092	1.097		
10250.00	9.96	1.082	1.087		
11500.00	9.95	1.055	1.060		
12750.00	9.95	1.108	1.084		
14000.00	9.94	1.099	1.054		
15250.00	9.98	1.087	1.053		
16500.00	9.93	1.099	1.065		
17750.00	9.91	1.097	1.077		
19000.00	9.45	1.074	1.088		

Option 890

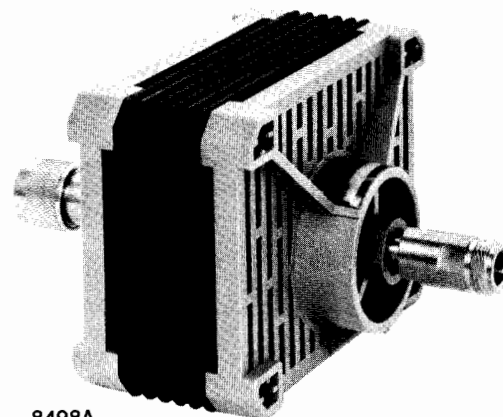

8498A  
Option 030

### Option 890 Calibration Data

Extensive calibration data is now available on HP attenuators at low cost. By specifying option 890 on the fixed attenuators or microwave step attenuators, standardized calibration data from 100 MHz to the upper frequency bound of the unit is provided, with frequency steps no larger than 500 MHz. This data is generated from measurements made on an HP 8542 Automatic Network Analyzer and features excellent accuracy (traceable to NBS) and low cost (averages less than \$1 per frequency for three measurements). Data is given for attenuation and the SWR of each port, and provided in a plastic envelope.

Calibration data has important uses in applications such as RF substitution measurements and test system verification. By using the actual calibration data rather than data sheet specifications, the attenuation uncertainty can be reduced 60% or more. Also, the calculated mismatch uncertainty for a test system will be lower if the actual SWR data for the attenuators is used. Similar calibration data is used in HP production areas to verify the performance of manual and automated test systems. For automated system checkout, the calibrated unit is tested and the results are compared to the previously stored calibration data. If the differences are within the measurement uncertainty, proper operation is ensured. For step attenuators, the calibration data can be used in automated test systems to more accurately characterize a device's characteristics. By storing the calibration data for the individual steps, the measurement results can be adjusted by the actual amount of attenuation (for example, when a nominal 10 dB step is actually 9.6 dB).

The calibration data frequencies, prices, and ordering information for fixed attenuators are found on the adjacent page, and the same information for step attenuators is found on page 443.



8491A/B series



8492 series

**Ordering example**

Include appropriate frequency range/connector and attenuation designations from the ordering example below with every attenuator order.

**Calibration Data**

Include "Option 890" in addition to attenuation option when ordering calibration data.



8493A/B series

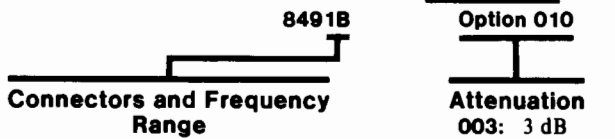

**Connectors and Frequency Range**

- 1A: Type N (m,f), dc-12.4 GHz
  - 1B: Type N (m,f), dc-18 GHz
  - 2A: APC-7, dc-18 GHz
  - 3A: SMA (m,f), dc-12.4 GHz
  - 3B: SMA (m,f), dc-18 GHz
  - 8A: Type N (m,f), dc-18 GHz
- 8498 is only available in a 30 dB model

**Attenuation**

- 003: 3 dB
- 006: 6 dB
- 010: 10 dB
- 020: 20 dB
- 030: 30 dB
- 040: 40 dB\*
- 050: 50 dB\*
- 060: 60 dB\*

\* Not available for 8493A/B

**Coaxial & Waveguide Catalog & Microwave Measurement Handbook**

96 pages with over 350 measurement accessories. Request card at back of this catalog.

**Ordering Information**

- 11581A 3, 6, 10, 20 dB 8491A set
- Option 890 Calibration Data
- 11582A 3, 6, 10, 20 dB 8491B set
- Option 890 Calibration Data
- 11583A 3, 6, 10, 20 dB 8492A set
- Option 890 Calibration Data

**Price**

- \$360
- Add \$80
- \$490
- Add \$100
- \$865
- Add \$100

**8491A/B, 8492A, 8493A/B, 8498A, Option 890 Specifications**

Model	Frequency Range GHz	SWR Maximum	Maximum input Power	Attenuation Accuracy									Connector	Price (Specify option)
				3 dB (Option 003)	6 dB (Option 006)	10 dB (Option 010)	20 dB (Option 020)	30 dB (Option 030)	40 dB (Option 040)	50 dB (Option 050)	60 dB (Option 060)			
8491A 3-30 dB	dc-12.4	dc-8 GHz: 1.2 8-12.4 GHz: 1.3	2 W Avg. 100 W Peak	±0.3 dB	±0.4 dB	±0.6 dB	±0.6 dB	±1 dB	—	—	—	N(m,f)	\$80	
				—	—	—	—	—	±1.5 dB	±1.5 dB	±2 dB		\$110	
8491B 3-30 dB	dc-18	dc-8 GHz: 1.2 8-12.4 GHz: 1.3 12.4-18 GHz: 1.5	2 W Avg. 100 W Peak	±0.3 dB	±0.3 dB ±0.5 dB: 12.4-18 GHz	±0.5 dB	±0.5 dB ±1.0 dB: 12.4-18 GHz	±1 dB	—	—	—	N(m,f)	\$100	
				—	—	—	—	—	±1.5 dB	±1.5 dB	±2 dB		\$145	
8492A 3-30 dB	dc-18	dc-8 GHz: 1.15 dc-12.4 GHz: 1.25 12.4-18 GHz: 1.35	2 W Avg. 100 W Peak	±0.3 dB	±0.3 dB ±0.5 dB: 12.4-18 GHz	±0.5 dB	±0.5 dB ±1.0 dB: 12.4-18 GHz	±1 dB	—	—	—	APC-7	\$180	
				—	—	—	—	—	±1.5 dB	±1.5 dB	±2 dB		\$215	
8493A 3-20 dB	dc-12.4	dc-8 GHz: 1.2 8-12.4 GHz: 1.3	2 W Avg. 100 W Peak	±0.3 dB	±0.4 dB	±0.6 dB	±0.6 dB	—	—	—	—	SMA (m,f)	\$80	
				—	—	—	—	±1 dB	—	—	—		\$90	
8493B 3-20 dB	dc-18	dc-8 GHz: 1.2 8-12.4 GHz: 1.3 12.4-18 GHz: 1.5	2 W Avg. 100 W Peak	±0.3 dB	±0.3 dB ±0.5 dB: 12.4-18 GHz	±0.5 dB	±0.5 dB ±1.0 dB: 12.4-18 GHz	—	—	—	—	SMA(m,f)	\$100	
				—	—	—	—	±1 dB	—	—	—		\$110	
8498A Option 030	dc-18	dc-2GHz: 1.1 2-12.4GHz: 1.2 12.4-18GHz: 1.35	25W Avg. 500W Peak (dc-7GHz) 125W Peak (7-18 GHz) 500 Watt-µsec max. per pulse	—	—	—	—	±1 dB	—	—	—	N(m,f)	\$525	
Option 890 Calibration Data Information				Models		Calibration Frequencies (MHz)						Option 890 Price		
				8491A, 8493A		100, 500, 1000, every 500 MHz to 12000, 12400. (26 frequencies)						add \$20		
8491B, 8492A, 8493B, 8498A		Same as above plus 12500 to 16000 in 500 MHz steps, 16000 to 18000 in 250 MHz steps. (42 frequencies)						add \$25						

# MICROWAVE TEST EQUIPMENT

## Coaxial step attenuators

Models 355 series, 8494/5/6 series, 11713A, 11716A

- Excellent repeatability
- Manual and programmable
- Calibration data available

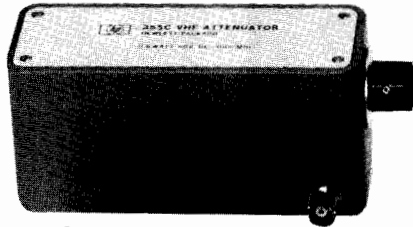

355C

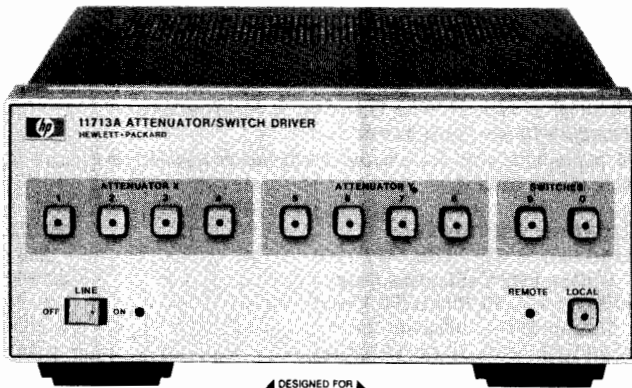

11713A



### 355C/D/E/F Manual and Programmable Step Attenuators, dc to 1000 MHz

Precision attenuation from dc to 1000 MHz is available with these Hewlett-Packard attenuators. Models 355C/E provide 0 to 12 dB in 1-dB steps and models 355D/F provide 0 to 120 dB in 10-dB steps. For the 355E and 355F models, attenuation programming is done through a 7-pin connector. All standard models are equipped with BNC connectors.

### 8494A/B/G/H, 8495A/B/D/G/H/K, 8496A/B/G/H Manual and Programmable Step Attenuators, dc to 26.5 GHz

Three attenuation ranges are available: 0 to 11 dB in 1-dB steps (Model 8494), 0 to 70 dB in 10-dB steps (Model 8495) and 0 to 110 dB in 10-dB steps (Model 8496). There is choice of three connectors Type N (f), SMA (f), and APC-7 (APC-3.5 on 8495D/K only). Manual and programmable versions are available as well as coverage of three frequency ranges (dc-4GHz, dc-18 GHz, and dc-26.5 GHz). Calibration data (SWR and attenuation) is available on the 8494/5/6 models as option 890. The data is generated by an automatic network analyzer test system and is given for each step of the attenuator at 14 frequencies (dc-4 GHz models) or 47 frequencies (dc-18 GHz models); see frequency lists on next page. This data is very useful for improving measurement accuracy in manual and automated test systems.

Each attenuator consists of three or four attenuation sections connected in cascade. Attenuator sections are inserted and removed by cam-actuated "edge line" contacts. These contacts are gold-plated leaf-springs that ensure long life (over a million steps) and high repeatability (typically 0.03 dB).

The G, H, and K programmable models offer the same high performance as the manual models with the addition of fast switching solenoids. Attenuation programming is done through a 12-pin connector. For ease of connection to the driving circuit, each attenuator is provided with a five-foot cable assembly that includes the mating con-

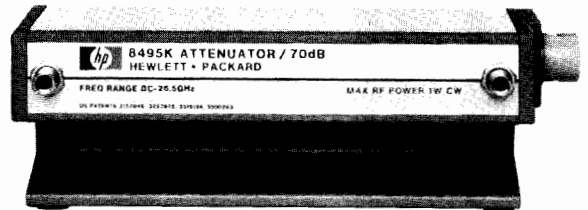

8495K option 004

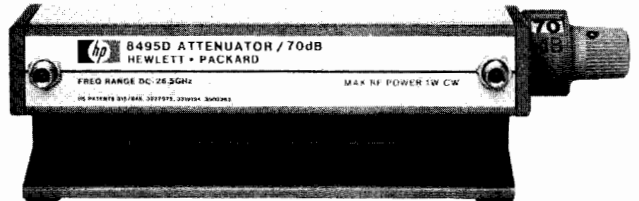

8495D option 004

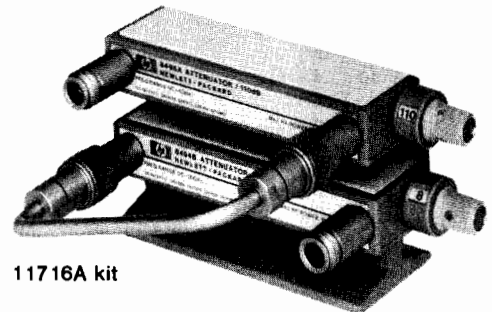

11716A kit

ductor. With the HP 11713A Attenuator Driver, the attenuators are easily integrated into a Hewlett-Packard Interface Bus (HP-IB) automated system.

### 11716A/B Interconnection Kit

Convenient interconnection of 1 dB and 10 dB models is provided with the 11716A/B. These kits provide a rigid RF cable, mounting bracket, and screws to connect any pair of 8494/5/6 attenuators in series (see picture above). Attenuators must be ordered separately.

Equivalent versions of these attenuators for incorporation in equipment (i.e., "OEM") are available under HP model numbers 33320, 33321, and 33322. See following pages.

### 11713A Attenuator Switch Driver

This instrument has all of the necessary features to provide HP-IB control of up to two programmable attenuators of the 8494/5/6 or 33320/1/2 series and concurrently up to two electro-mechanical switches (e.g. 8761B or 33311 series). Alternatively, the 11713A can be used to supply +24 V common and ten pairs of transistor switches (total current less than 1.25A) to control up to ten relays. The 11713A includes an integral power supply (with short circuit protection) that can simultaneously provide 125 milliamps at 24 volts to all contacts for control of the attenuators and switches, so no external power supply is needed. The 11713A is provided with two (2) plug-in drive cables for the programmable attenuators which simplifies connection to the driver.

The 11713A also features convenient front panel control so that the user can manually activate the individual attenuation sections and switches when in the "local" mode. Switching time for the drivers is less than 10 milliseconds.

### Ordering Information

	Price
11713A Attenuator/Switch Driver	\$1260
11716A Interconnection Kit for Type N (f) Connectors	\$145
11716B Interconnection Kit for APC-7 Connectors	\$205

### How to Order the 8494/5/6 Series Attenuators

Each order must include basic model number, suffix letter, and connector option.

Optional calibration data.

#### 8494 A Option 001 Option 890

4 (1dB step, 11 dB max)	A (Manual, dc—4 GHz)	001 (N-Female)
5 (10 dB step, 70 dB max)	B (Manual, dc—18 GHz)	002 (SMA Female)
6 (10dB step, 110 dB max)	D (Manual, dc—26.5 GHz)*	003 (APC-7)
	G (Programmable, dc—4 GHz)	004 (APC-3.5 Female)*
	H (Programmable, dc—18 GHz)	
	K (Programmable, dc—26.5 GHz)*	

\* Option 004 is only available on 'D' and 'K' models.

### 355 Series, 8494/5/6 Series Specifications

Model and (Switching Mode)	Frequency Range (GHz)	Incremental Attenuation (dB)	SWR Maximum (500 Nominal)	Insertion Loss (0 dB setting)	Attenuation Accuracy	Power Rating, Minimum Life	Solenoid Voltage Speed Power	Size, Shipping Weight	Connector Options Available	Price
355C (Manual)	dc—1	0—12 1 dB steps	dc—0.25 GHz: 1.2 dc—0.5 GHz: 1.3 dc—1.0 GHz: 1.5	0.11 dB + 1.39 dB/GHz	±0.1 dB @ 1000 Hz ±0.25 dB: dc—0.5 GHz ±0.35 dB: dc—1.0 GHz	0.5 W avg 350 W peak 0.6 million steps	—	67 H x 70 W x 152 mm D (2.6 x 2.75 x 6 in.)	BNC (f) See Note 1	\$265
355E (Programmable)							15—18 V <65 ms 3.0 W			1.4 kg (3 lb)
355D (Manual)	dc—1	0—120 10 dB steps	dc—0.25 GHz: 1.2 dc—0.5 GHz: 1.3 dc—1.0 GHz: 1.5	0.11 dB + 1.39 dB/GHz	±0.3 dB @ 1000 Hz ±1.5 dB to 90 dB, and ±3 dB to 120 dB @ 1 GHz	0.5 W avg 350 W peak 0.6 million steps	—	67 H x 70 W x 152 mm D (2.6 x 2.75 x 6 in.)	BNC (f) See Note 1	\$265
355F (Programmable)							15—18 V <65 ms 3.0 W			1.4 kg (3 lb)
8494A (Manual)	dc—4	0—11 1 dB Steps	1.5	0.6 dB + 0.09 dB/GHz	±0.2 dB: 1—2 dB ±0.3 dB: 3—6 dB ±0.4 dB: 7—10 dB ±0.5 dB: 11 dB	1 W avg 100 W peak 10 μs max. 1 million steps	—	43 H x 73 W x 159 mm D (1.7 x 2.9 x 6.2 in.)	001 002 003 See Note 2	\$550
8494G (Programmable)							20—30 V <20 ms 2.7 W			0.9 kg (2 lb)
8494B (Manual)	dc—18	0—11 1 dB steps	dc—8 GHz: 1.5 dc—12.4 GHz: 1.6 dc—18 GHz: 1.9	0.6 dB + 0.09 dB/GHz	dc—12.4 GHz ±0.3 dB: 1—2 dB ±0.4 dB: 3—4 dB ±0.5 dB: 5—6 dB ±0.6 dB: 7—10 dB ±0.7 dB: 11 dB dc—18 GHz ±0.7 dB: 1—5 dB ±0.8 dB: 6—9 dB ±0.9 dB: 10—11 dB	1 W avg 100 W peak 10 μs max. 1 million steps	—	43 H x 73 W x 159 mm D (1.7 x 2.9 x 6.2 in.)	001 002 003 See Note 2	\$710
8494H (Programmable)							20—30 V <20 ms 2.7 W			0.9 kg (2 lb)
8495A (Manual)	dc—4	0—70 10 dB steps	1.35	0.4 db + 0.07 dB/GHz	±1.7% of setting or ±0.4 dB, whichever is greater	1 W avg 100 W peak 10 μs max. 1 million steps	—	43 H x 73 W x 130 mm D (1.7 x 2.9 x 5.1 in.)	001 002 003 See Note 2	\$395
8495G (Programmable)							20—30 V <20 ms 2.7 W			0.9 kg (2 lb)
8495B (Manual)	dc—18	0—70 10 dB steps	dc—8 GHz: 1.35 dc—12.4 GHz: 1.5 dc—18 GHz: 1.7	0.4 dB + 0.07 db/GHz	±3%: dc—12.4 GHz ±4%: dc—18 GHz % in dB from Atten. Setting	1 W avg 100 W peak 10 μs max. 1 million steps	—	43 H x 73 W x 130 mm D (1.7 x 2.9 x 5.1 in.)	001 002 003 See Note 2	\$520
8495H (Programmable)							20—30 V <20 ms 2.7 W			0.9 kg (2 lb)
8495D (Manual)	dc—26.5	0—70 10 dB steps	dc—12.4 GHz: 1.6 12.4—18 GHz: 1.9 18—26.5 GHz: 2.2	0.5 dB + 0.13 dB/GHz	±3%: dc—12.4 GHz ±4%: dc—18 GHz ±7%: dc—26.5 GHz % in dB from Atten. Setting	1 W avg 100 W peak 10 μs max. 1 million steps	—	43 H x 52 W x 159 mm D (1.7 x 2.1 x 6.2 in.)	004 APC-3.5 See Note 2	\$775
8495K (Programmable)							20—30 V <20 ms 2.7 W			0.9 kg (2 lb)
8496A (Manual)	dc—4	0—110 10 dB steps	1.5	0.6 dB + 0.09 dB/GHz	±1.7% of setting or ±0.4 dB, whichever is greater	1 W avg 100 W peak 10 μs max. 1 million steps	—	43 H x 73 W x 159 mm D (1.7 x 2.9 x 6.2 in.)	001 002 003 See Note 2	\$550
8496G (Programmable)							20—30 V <20 ms 2.7 W			0.9 kg (2 lb)
8496B (Manual)	dc—18	0—110 10 dB steps	dc—8 GHz: 1.5 dc—12.4 GHz: 1.6 dc—18 GHz: 1.9	0.6 dB + 0.09 dB/GHz	±3%: dc—12.4 GHz ±4%: dc—18 GHz % in dB from Atten. Setting	1 W avg 100 W peak 10 μs max. 1 million steps	—	43 H x 73 W x 159 mm D (1.7 x 2.9 x 6.2 in.)	01 002 003 See Note 2	\$720
8496H (Programmable)							20—30 V <20 ms 2.7 W			0.9 kg (2 lb)
<b>Option 890 Calibration Data Information</b>		<b>Option 890 Frequency List (MHz)</b>				<b>Models</b>				<b>Option 890 Price</b>
		DC to 4 GHz Models: 100, 300, 500, 700, 900, 1000, 1250, 1500, 1750, 2000, 2500, 3000, 3500, 4000				8494A/G, 8496A/G, 33320A/G, 33322A/G 8495A/G, 33321A/G				add \$130 add \$110
		DC to 18 GHz Models: Same as above to 4000 MHz, every 500 MHz to 16000 (plus 12400 MHz), every 250 MHz from 16000 to 18000.				8494B/H, 8496B/H, 33320B/H, 33322B/H 8495B/H, 33321B/H				add \$170 add \$150
Note 1: 355C/D/E/F connector options (BNC (f) standard) Option 001 N(f) Option 005 TNC(f) Option 007 Transistor protection			Price add \$25 add \$10 add \$55			Note 2: 8494/5/6 orders must specify connector option. See ordering example above. Option 001 N(f) Option 002 SMA(f) Option 003 APC-7 Option 004 APC-3.5 (8495D/K only)			N/C N/C add \$55 N/C	



# MICROWAVE TEST EQUIPMENT

Coaxial single and dual-directional couplers

Models 770 series, 790 series, 11691D, 11692D

- Broadband coverage
- High directivity
- Close tracking

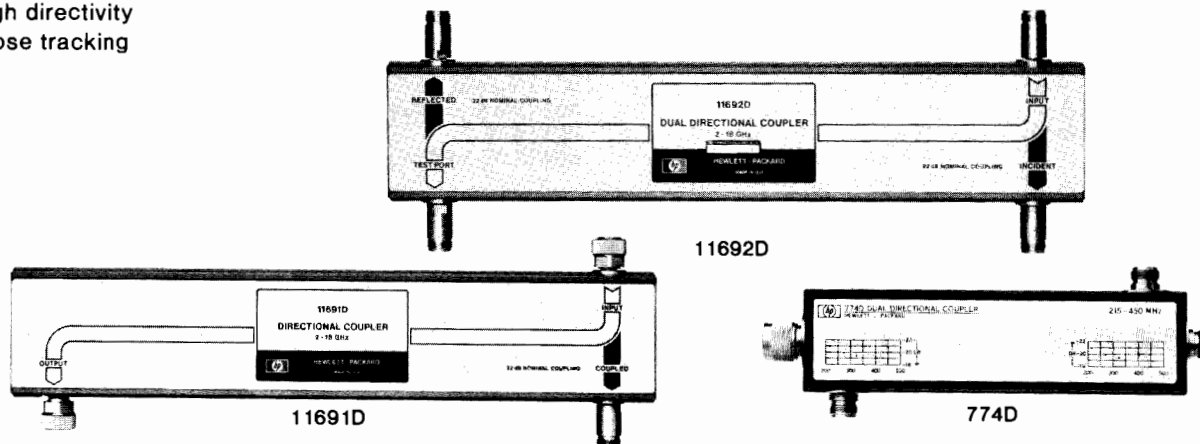

## 779D Directional Coupler

The HP 779D spans more than two octaves from 1.7 to 12.4 GHz with excellent directivity. With increased coupling factor (typically 24 dB), the 779 is useful down to 500 MHz. Upper frequency usefulness extends to 18 GHz with directivity reduced to about 15 dB. Various connector options are available.

## 790 Series Directional Couplers (Octave Bands)

The 790 directional couplers are ultra-flat, high directivity couplers which are ideal for power-monitoring applications in coaxial systems. Output coupling (ratio of output power from main and auxiliary arms) is specified rather than coupling factor. Thus, no correction factor is required to account for insertion loss in the main arm.

## 11691D Directional Coupler

The 11691D is an ultra-wide-band single-directional coupler covering 2 to 18 GHz with high directivity. It is useful as a power monitoring or leveling coupler, or for making reflection measurements. Couplers are preferred over broadband bridges in reflectometer applications in situations where the power level of the source is limited, or where simultaneous measurement of return loss and insertion loss is desired.

## 774D-777D Dual-Directional Couplers (Octave Bands)

The economical 774D-777D couplers cover frequency spreads of more than two-to-one, each centered on one of the important VHF/UHF bands. With their high directivity and a mean coupling accuracy of  $\pm 0.5$  dB, these couplers are ideal for reflectometer applications. Furthermore, the close tracking of the auxiliary arms makes these couplers particularly useful for reflectometers driven by externally leveled sweep oscillators such as the HP 8690B and 8620C. Power ratings are 50 W average, 500 W peak.

## 778D, 11692D Dual-Directional Couplers (Multi-Octave Bands)

These couplers are ideal for swept-frequency reflectometer testing of broadband coaxial components. The 778D covers 100 MHz to 2 GHz and the 11692D covers 2 to 18 GHz. High directivity and close tracking of the auxiliary arms are featured. Various connector options are available. Both couplers handle 50 W average power. Peak power: 778D, 500W; 11692D, 250 W.

## 779D, 790 Series, 11691D Specifications

Model	Frequency Range (GHz)	Mean Output Coupling (dB)	Output Coupling Variation (dB)	Minimum Directivity (dB)	Equivalent <sup>1</sup> Source Match	Price
779D	1.7-12.4	20 $\pm$ 0.5	$\pm$ 0.75	1.7-4 GHz: 30 4-12.4 GHz: 26	1.2	\$750
796D	0.96-2.11	20 $\pm$ 0.5	$\pm$ 0.2	30	1.13	\$445
797D	1.9-4.1	20 $\pm$ 0.5	$\pm$ 0.2	26	1.16	\$445
798C	3.7-8.3	10 $\pm$ 0.3	$\pm$ 0.3	20	1.25	\$525
11691D	2-18	22 Nominal	$\pm$ 1.0	2-8 GHz: 30 dB 8-18 GHz: 26 dB	1.2	\$1075
<b>796D-798C Standard connectors</b> Primary Line: N(f), N(m) Auxiliary Arm: N(f)						
<b>779D Standard connectors</b> Primary Line: N(f) input, N(f) output; Auxiliary Arm: N(f)						
Option 010: Primary Line N(f) input, N(m) output Other options: APC-7 on any or all ports						N/C Contact HP
<b>11691D Standard connectors</b> Primary line: APC-7, APC-7; Auxiliary Arm: N(f)						
Option 001: All N(f) Option 005: All APC-7						less \$30 add \$25
<sup>1</sup> Apparent SWR at the output port of a coupler when used in a closed-loop leveling system.						

## 774D, 775D, 776D, 777D, 778D, 11692D Specifications

Model	Frequency Range (GHz)	Nominal Coupling (dB)	Maximum Coupling Variation (dB)	Minimum Directivity (dB)	SWR Primary Line Maximum (50:1 Nom.)	Price
774D	0.215-0.450	20	$\pm$ 1	40	1.15	\$550
775D <sup>1</sup>	0.450-0.940	20	$\pm$ 1	40	1.15	\$570
776D <sup>1</sup>	0.940-1.90	20	$\pm$ 1	40	1.15	\$550
777D	1.90-4.0	20	$\pm$ 0.4	30	1.2	\$650
778D	0.10-2.0	20	$\pm$ 1	0.1-1 GHz: 36 <sup>2</sup> 1-2 GHz: 32	1.1	\$665
11692D	2.0-18.0	22	$\pm$ 1 incident to test port	2-8 GHz: 30 8-18 GHz: 26 <sup>2</sup>	2-12.4 GHz: 1.3 12.4-18 GHz: 1.4	\$1850
<b>774D-777D Standard connectors</b> Primary Line: N(m), N(f) Auxiliary Arm: N(f), N(f)						
<b>778D Standard connectors</b> Primary Line: N(m), N(f); Auxiliary Arms: N(f), N(f)						
Option 011: Primary Line, APC-7, N(f)						add \$25
Option 012: Primary Line, N(m), N(f)						N/C
<b>11692D Standard connectors</b> Primary line: N(f), APC-7; Auxiliary Arms: N(f), N(f)						
Option 001: Primary Line, N(f), N(f)						less \$15
Option 002: Primary Line, N(f), N(m)						less \$15
<sup>1</sup> Maximum auxiliary arm tracking: 0.3 dB for 776D; 0.5 dB for 777D <sup>2</sup> 30 dB, 0.1 to 2 GHz, input port. <sup>3</sup> 24 dB with Type N connector on the test port.						

# MICROWAVE TEST EQUIPMENT

Coaxial directional detectors and waveguide directional couplers

Models 780 series, 752 series

445



- Flat frequency response
- Low equivalent source match
- High directivity to > 40 dB

- Low SWR
- Coverage to 40 GHz

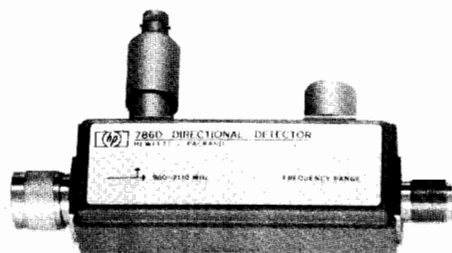

786D

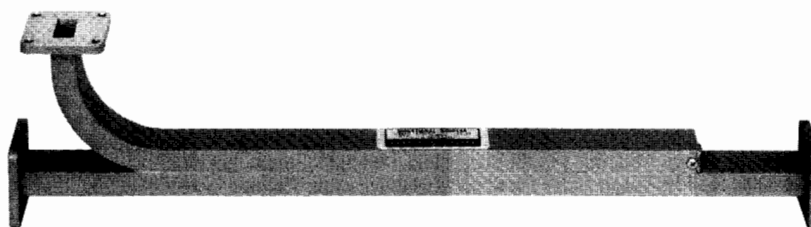

X752A

## 780 Series Directional Detectors

The 780 series detectors are directional couplers with built-in crystal detectors. The couplers have flat frequency response and good directivity, while the detectors have good frequency response plus high sensitivity. The configuration of the directional detector reduces the number of ambiguities over the standard system of separate coupler and detector and makes possible tighter correlation between main-arm power and detected signal. The directional detector is well suited for sweep oscillator leveling and can also be used to monitor power with a voltmeter or oscilloscope.

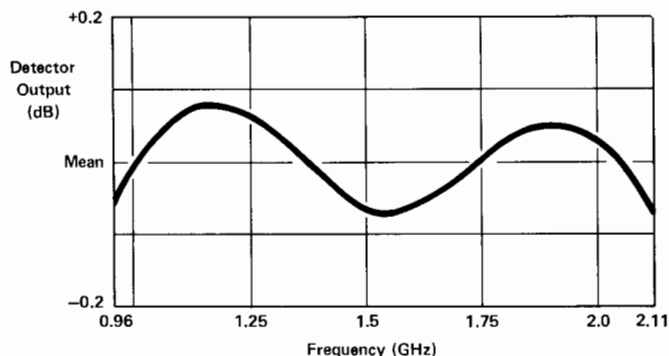

Figure 1. Typical 786D Frequency Response.

## 780 Series specifications

### Standard connectors

Output: All models, N (f)

Input: 786D-788C, N (m); 789C, N (f)

Model	Frequency Range (GHz)	Frequency <sup>1</sup> Response	Equivalent <sup>2</sup> Source Match	Price
786D	0.96-2.11	±0.2	1.13	\$565
787D	1.9-4.1	±0.2	1.16	\$565
788C	3.7-8.3	±0.3	1.25	\$700
789C	8-12.4	±0.5	1.25	\$850

<sup>1</sup>Includes coupler and detector variation with frequency as read on a meter calibrated for square-law detector (e.g., HP 415E).

<sup>2</sup>Apparent SWR at the output port of the directional detector when used in a closed-loop leveling system.

## 752 Series Waveguide Directional Couplers

The HP 752 series couplers are specified to meet a wide variety of microwave applications. Every coupler has a minimum directivity of 40 dB over its entire frequency range. Each coupler is swept-frequency tested to ensure that the main guide SWR and directivity specifications are accurate. Performance characteristics are unaffected by humidity, temperature, and time, making these units especially useful in microwave "standards" measurements.

The 752 couplers are an essential part of many waveguide measurement systems. Attenuation measurements, reflectometer setups, power measurements, source leveling and network analysis are just a few areas in which these couplers are used.

## 752 Series Specifications

Model	Frequency Range (GHz)	Nominal Coupling (dB)	Mean Coupling Accuracy (dB)	Maximum Coupling Variation (dB)	Minimum Directivity (dB)	Waveguide & Flange	Price
J752A	5.85-8.2	3	±0.4	±0.5	40	WR137 UG-441/U	\$865
J752C	5.85-8.2	10	±0.4	±0.5	40		\$865
J752D	5.85-8.2	20	±0.4	±0.5	40		\$865
H752A	7.05-10.0	3	±0.4	±0.5	40	WR112 UF-138/U	\$640
H752C	7.05-10.0	10	±0.4	±0.5	40		\$640
H752D	7.05-10.0	20	±0.4	±0.5	40		\$640
X752A	8.2-12.4	3	±0.4	±0.5	40	WR90 UG-135/U	\$480
X752C	8.2-12.4	10	±0.4	±0.5	40		\$480
X752D	8.2-12.4	20	±0.4	±0.5	40		\$480
P752A	12.4-18.0	3	±0.4	±0.5	40	WR62 UG-419/U	\$450
P752C	12.4-18.0	10	±0.4	±0.5	40		\$450
P752D	12.4-18.0	20	±0.4	±0.5	40		\$475
K752A	18.0-26.5	3	±0.7	±0.5	40	WR42 UG-595/U	\$585
K752C	18.0-26.5	10	±0.7	±0.5	40		\$585
K752D	18.0-26.5	20	±0.7	±0.5	40		\$585
R752A	26.5-40.0	3	±0.7	±0.5	40	WR28 UG-599/U	\$640
R752C	26.5-40.0	10	±0.7	±0.5	40		\$620
R752D	26.5-40.0	20	±0.7	±0.6	40		\$620

# MICROWAVE TEST EQUIPMENT

## Coaxial crystal detectors

Models 420C, 423A/B, 8470A/B, 8471A, 8472A, 8473B/C, 33330B/C

- Flat frequency response
- High burnout protection



33330B



8470B Opt 012



423B



8470B

- Low SWR
- Field replaceable detector elements



423A



8470A



8472A



8471A

### 423A, 8470A, 8471A, 8472A Point-Contact Detectors

These point-contact detectors have been widely used for many years and provide high performance at an economical price. The 8470A, 8470A Opt 012, and 8472A provide APC-7, Type N, and SMA connector versions to 18 GHz. Matched pairs are available for applications requiring close detector tracking, and all but the 8472A can be supplied with video loads for optimum conformance to square law.

### Coaxial & Waveguide Catalog & Microwave Measurement Handbook

96 pages with over 350 measurement accessories. Use request card at back of this catalog.

### 423B, 8470B, 8473B/C, 33330B/C Low Barrier Schottky (LBS) Detectors

The low-barrier Schottky (LBS) detectors are a state-of-the-art addition to the HP family of high performance detectors. Various models provide coverage to 12.4, 18, and 26.5 GHz and input connectors are Type N, APC-7, or APC-3.5 depending on frequency range. Output connector is BNC (f) except for the 33330B/C (SMC).

Matched pairs (Opt 001), square law load (Opt 002), and positive polarity output (Opt 003) are available for most models.

### Coaxial Crystal Detector Specifications

Model	Frequency Range (GHz)	Frequency Response (dB)	SWR Maximum (50Ω Nom.)	Low Level Sensitivity	Maximum Input (Peak or Average)	Short-Term Maximum Input (<1 min.)	Option 001 Matched Pair (order 2 units for each pair)	Options Available	Input Connector	Price
420C	0.01-12.4 Point Contact	±2	2.0	>0.15 mV/ μW	100 mW	0.1 watt	±1 dB	001 003	N (m)	\$110
423B	0.01-12.4 LBS	±0.2/octave to 8 GHz ±0.3 overall	<1.15 to 4 GHz <1.3 to 12.4 GHz	>0.5 mV/ μW	200 mW	1 watt	±0.2 dB to 12.4 GHz	001 002 003	N (m)	\$215
423A	0.01-12.4 Point Contact	±0.2/octave to 8 GHz ±0.5 overall	<1.2 to 4.5 GHz <1.35 to 7 GHz 1.5 to 12.4 GHz	>0.4 mV/ μW	100 mW	0.1 watt	≥0.2 dB to 8 GHz ±0.3 dB to 12.4 GHz	001 002 003	N (m)	\$165
8470B	0.01-18.0 LBS	±0.2/octave to 8 GHz ±0.3 to 12.4 GHz ±0.6 to 18 GHz	<1.15 to 4 GHz <1.3 to 15 GHz <1.4 to 18 GHz	<0.5 mV/ μW	200 mW	1 watt	±0.2 dB to 12.4 GHz ±0.3 dB to 18 GHz	001 002 003	APC-7	\$260
8470B Opt 012									N (m)	\$250
8470A	0.01-18.0 Point Contact	±0.2/octave to 8 GHz ±0.5 to 12.4 GHz ±1.0 to 18 GHz	<1.2 to 4.5 GHz <1.35 to 7 GHz <1.7 to 18 GHz	>0.4 mV/ μW	100 mW	0.1 watt	±0.2 dB to 8 GHz ±0.3 dB to 12.4 GHz ±0.6 dB to 18 GHz	001 002 003	APC-7	\$205
8470A Opt 012				<1.5 to 12.4 GHz					N (m)	\$190
8473B	0.01-18.0 LBS	±0.2/octave to 8 GHz ±0.6 to 18 GHz	<1.2 to 12.4 GHz <1.5 to 18 GHz	>0.5 mV/ μW	200 mW	1 watt	±0.2 dB to 12.4 GHz ±0.3 dB to 18 GHz	001 003	APC-3.5 (m)	\$245
8473C	0.01-26.5 LBS	±0.6 to 20 GHz ±1.5 with a -3.5 dB slope, 20 to 26.5 GHz	<1.2 to 4 GHz <1.5 to 18 GHz <2.2 to 26.5 GHz	>0.5 mV/μW to 18 GHz >0.18 mV/μW to 26.5 GHz	200 mW	1 watt	±0.2 dB to 12.4 GHz ±0.3 dB to 18 GHz ±0.5 dB to 26.5 GHz	001 003	APC-3.5 (m)	\$285
8472A	0.01-18.0 Point Contact	±0.2/octave to 8 GHz ±0.5 to 12.4 GHz	<1.2 to 4.5 GHz <1.35 to 7 GHz <1.5 to 12.4 GHz <1.7 to 18 GHz	>0.4 mV/ μW	100 mW	0.1 watt	±0.2 dB to 8 GHz ±0.3 dB to 12.4 GHz ±0.6 dB to 18 GHz	001 003	SMA (m)	\$190
33330B	0.01-18.0 LBS	±0.6	<1.5	>0.5 mV/ μW	200 mW	1 watt	≥0.3 dB	001 003	APC-3.5 (m)	\$240
33330C	0.01-26.5 LBS	±0.6 to 20 GHz ±1.5 with a -3.5 dB slope 20 to 26.5 GHz	<1.5 to 18 GHz <2.2 to 26.5 GHz	>0.5 mV/μW to 18 GHz Degrades to 0.18 mV/μW at 26.5 GHz	200 mW	1 watt	±0.3 dB to 18 GHz ±0.5 dB to 26.5 GHz	001 003	APC-3.5 (m)	\$275
8471A	100 kHz-1.2 GHz Point Contact	±0.6 (typical) ±0.1/100 MHz	1.3 (typical) 50Ω	>0.35 mV/ μW	3 V rms	3 V rms	No	004 005 006	BNC (m)	\$75

#### Options

All applicable models

001: matched pair

002: square law load

Models 423A, 8470A, 8472A

003: positive output

#### Price

add \$25/unit

add \$25/unit

add \$35

Models 423B/8470B/8473B/C, 33330B/C

003: positive output

\$35

Model 8471A

004: positive output

N/C

005: 75 ohm negative output

add \$10

006: 75 ohm positive output

add \$10

# MICROWAVE TEST EQUIPMENT

Waveguide crystal detectors; frequency meters

Models 422A, 424A, 532 Series, 536A, 537A

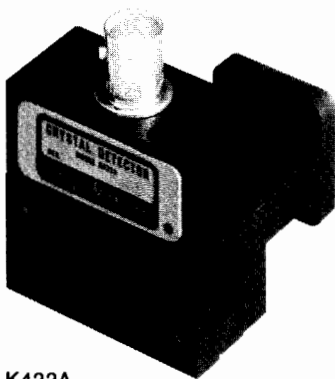

K422A



J424A

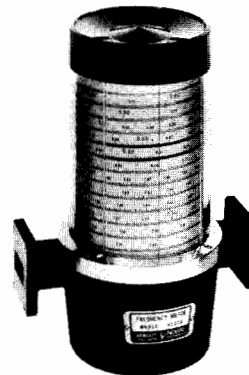

H532A

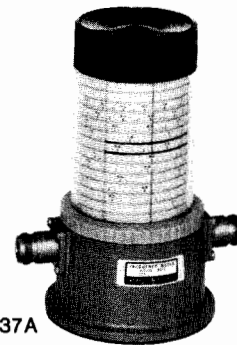

537A

## 422 Series, 424 Series Crystal Detectors

The 422A and 424A families of crystal detectors combine high sensitivity with flat frequency response and low SWR to provide waveguide band coverage from 3.95 to 40 GHz. They deliver between 0.2 and 0.4 mV/ $\mu$ W output at low level and handle 100 mW peak input. SWR ranges from 1.35 at G-band to 3 at R-band.

For reflectometer applications in which both flat frequency response and square-law characteristics are important, these models can be supplied as matched pairs (Option 001) and also with an optimum square-law load (Option 002).

## 422 Series, 424 Series Waveguide Crystal Detector Specifications

Model	Frequency Range (GHz)	Frequency Response (dB)	Option 001 Matched Pair Tracking (dB)	Option 003 Positive Output Available	Waveguide & Equivalent Flange	Price
G424A	3.95-5.85	$\pm 0.2$	$\pm 0.2$ dB	Yes	WR187 UG-407/U	\$260
J424A	5.2-8.2	$\pm 0.2$	$\pm 0.2$ dB	Yes	WR137 UG-441/U	\$260
H424A	7.05-10.0	$\pm 0.2$	$\pm 0.2$ dB	Yes	WR112 UG-138/U	\$260
X424A	8.2-12.4	$\pm 0.3$	$\pm 0.3$ dB	Yes	WR90 UG-135/U	\$220
M424A	10.0-15.0	$\pm 0.5$	$\pm 0.5$ dB	Yes	WR75 Cover	\$315
P424A	12.4-18.0	$\pm 0.5$	$\pm 0.5$ dB	Yes	WR62 UG-419/U	\$250
K422A	18.0-26.5	$\pm 2$	$\pm 1$ dB	No	WR42 UG-595/U	\$625
R422A	26.5-40.0	$\pm 2$	$\pm 1$ dB	No	WR28 UG-599/U	\$625
Option 001—Matched Pair (Must Order Quantity (2) Detectors for Each Matched Pair) 422 Models 424 Models						Add \$45/Unit Add \$20/Unit
Option 002—Optimum Square Law Load (Available for All Models)						Add \$20/Unit
Option 003—Positive Output (Available for 424 Models Only)						N/C

## 532 Series, 536A, 537A Frequency Meters

These direct-reading frequency meters measure frequencies from 5.30 to 40 GHz in waveguide and from 960 MHz to 12.4 GHz in coax quickly and accurately. Their long scales and numerous calibration marks provide high resolution which is particularly useful when measuring frequency differences or small frequency changes. Frequency is read directly in GHz so neither interpolation nor charts are required.

The instruments comprise a special transmission section with a high-Q resonant cavity which is tuned by a choke plunger. A 1 dB or greater dip in output indicates resonance; virtually full power is transmitted off resonance. Overall accuracy of each frequency meter includes allowance for 0 to 100 percent relative humidity and temperature variation from 13 to 33°C. Except for the J532A, there are no spurious modes or resonances.

## Coaxial & Waveguide Catalog Microwave Measurement Handbook

96 pages with over 350 measurement accessories. Request card at back of this catalog.

## 532 Series, 536A and 537A Specifications

Model	Frequency Range (GHz)	Overall Accuracy (%)	Calibration Increment (MHz)	W/G-Coax Equivalent Flange (Connector)	Price
536A	0.96-4.20	0.96 to 1 GHz: 0.22 1 to 4.2 GHz: 0.17	2	Coax Type N(f)	\$1125
537A	3.7-12.4	0.170	10	Coax Type N (f)	\$800
J532A	5.30-8.20	0.065	2	WR137 UG-441/U	\$1520
H532A	7.05-10.0	0.075	2	WR112 UG-138/U	\$1520
X532B	8.20-12.4	0.080	5	WR90 UG-39/U	\$800
P532A	12.4-18.0	0.100	5	WR62 UG-419/U	\$770
K532A	18.0-26.5	0.110	10	WR42 UG-595/U	\$1070
R532A	26.5-40.0	0.120	10	WR28 UG-599/U	\$1045

# MICROWAVE TEST EQUIPMENT

Slotted lines, carriage, probes

Models 440A, 442B, 444A, 447B, 805C, 809C, 810B series, 816A, 817A

- Precision reflection measurements 0.5 to 18 GHz

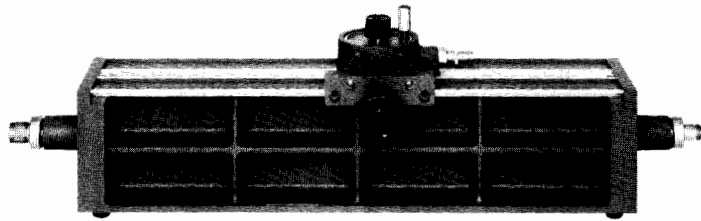

805C

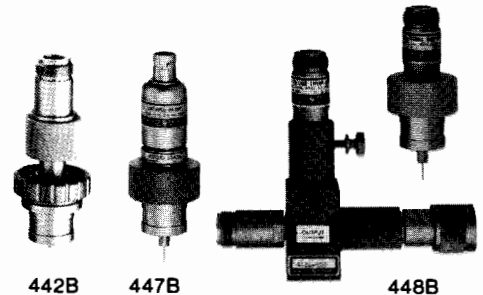

442B

447B

448B

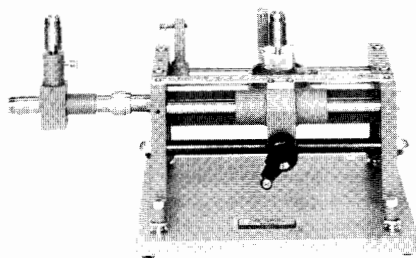

817B

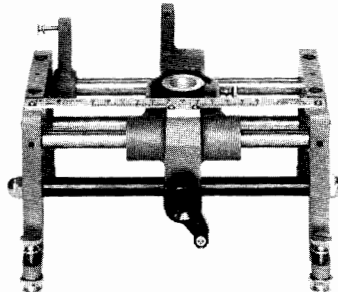

809C



X810B



816A

## 805C Coaxial Slotted Line System, 0.5 to 4 GHz

Model 805C slotted line system, employs 5 parallel ground planes and a rigid center conductor. This configuration has negligible slot radiation and is less sensitive to probe depth. The probe is tunable from 500 to 4000 MHz.

## 817B Coaxial Swept Slotted Line System, 1.8 to 18 GHz

817B fully tested system provides comprehensive swept frequency reflection data with the accuracy inherent in slotted lines. 817B consists of the 816A line, 809C carriage, and the 448B sweep adapter which accepts the detectors of the HP8755 Frequency Response Test Set.

### 805C, 817B Specifications

Model	Frequency Range (GHz)	SWR Residual	Connectors	Remarks	Price
805C	0.5-4.0	1.04	AN(m) N(f)	11512A N(m) short, 11511A N(f) short furnished	\$1935
817B	1.8-18.0	1.06	APC-7 N(f)	11512A N(m) short, 11565A APC-7 short furnished	\$1960
817B Options	001: APC-7 connectors on 448B probes				add \$55
	022: N(m) and N(f) connectors on 816A slotted section				less \$15

## 809C Slotted Line Carriage

The 809C carriage operates with the 816A coaxial slotted section and four 810B waveguide slotted sections. It is compatible with the 442B, 444A, 447B, and 448B coaxial probes. The carriage has a centimeter scale with a vernier reading to 0.1 mm, and provision is made also for mounting a dial gauge if more accurate probe position reading is required.

## 810B Series, 816A Slotted Sections

810B waveguide and 816A coaxial slotted sections are used with the 809C carriage. The 810B waveguide sections accept the 444A untuned probe or the 442B probe plus 440A tuned detector. The 816A coaxial line accepts the 447B probe or the 448B adapter sets.

## 810B Series, 816A Specifications

Model	Frequency Range (GHz)	SWR Residual	WG & Flange or Coax Conn.	Remarks	Price	
J810B	5.3-8.2	1.01	WR 137 UG-441/U	Use with 809C Carriage, 444A or 442B + 440A Probes	\$665	
H810B	7.05-10.0	1.01	WR 112 UG-138/U		\$480	
X810B	8.2-12.4	1.01	WR 90 UG-135/U		\$640	
P810B	12.4-18.0	1.01	WR 62 UG-419/U	Use with 809C carriage 444A Probe	\$480	
816A	1.8-18.0	1.02-1.04	Coaxial APC-7 N(f)	11512A N(m) Short 11565A APC-7 Short	\$715	
Opt 011			Both APC-7	furnished Use with	809C Carriage 447B Probe or 448B Sweep Adapter	Add \$25
Opt 022			N(m), N(f)			Less \$15

## 440A, 442B, 444A, 447B, 448B Probes/Adapters

440A is a tunable mount (1N21 crystal not supplied) for 2.4-12.4 GHz, to be used on the 442 broadband probe. 442B fits the 809C carriage and provides sampled rf at a Type N jack.

444A is an untuned probe for 2.6-18 GHz for use with the 809C carriage or other 3/4 inch (19 mm) mounting hole and the 810B waveguide sections. 447B is similarly used with the 809C and the 816A coaxial section for 1.8 to 18 GHz.

448B sweep adapter probe has Type N connectors for mating with the detectors of the HP8755 Frequency Response Test Set.

## Coaxial & Waveguide Catalog

96 pages with over 350 measurement accessories. Use request card at back of this catalog.

## Ordering Information

440A Detector mount	\$250
442B RF probe	\$185
444A Untuned probe	\$175
447B Detector probe	\$270
448B Slotted line sweep adapter probes 1.8-18 GHz	\$575
809C Slotted line carriage	\$690



- Precision loads and shorts for measurements to 40 GHz

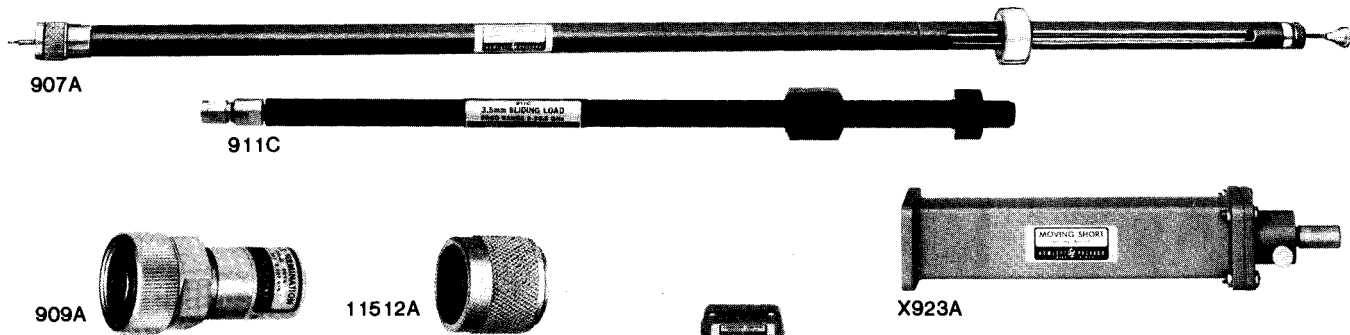

### 905A, 907A, 911A, 911C Coaxial Sliding Loads

The 905A, 907A and 911A are movable, low reflection 50Ω loads for precision measurements. The 905A and 907A are supplied with three interchangeable connectors, N-male, N-female and APC-7. The 911A is supplied with SMA male and female.

The 911C is a sliding load designed for 3.5 mm coaxial transmission lines and uses the APC-3.5 connector. This permits mode-free operation to 26.5 GHz. The 911C is furnished with interchangeable male and female connectors in a carrying case.

#### 905A, 907A, 911A, 911C Specifications

HP Model	Frequency range (GHz)	Load SWR	Power rating	Length (mm) in.	Shipping weight	Price
905A	1.8-18	1.05	1 W avg. 5 kW pk	(440) 17.25	(1.4 kg) 3 lb	\$455
907A	1-18	1.1, 1-1.5 GHz; 1.05, 1.5-18 GHz	1 W avg. 5 kW pk	(778) 30.62	(4.1 kg) 9 lb	\$835
911A	2-18	1.1, 2-4 GHz; 1.05, 4-18 GHz	1 W avg. 5 kW pk	(380) 14.87	(1.4 kg) 3 lb	\$440
911C	2-26.5	1.2, 2-10 GHz; 1.07, 10-26.5 GHz	1 W avg. 5 kW pk	(266) 10.5	(1.7 kg) 3.8 lb	\$800

### 908A, 909A Coaxial Fixed Terminations

The 908A and 909A terminations are low-reflection loads for terminating 50Ω coaxial systems in their characteristic impedance.

#### 908A, 909A Specifications

HP Model	Frequency Range (GHz)	Impedance	SWR	Power Rating	Connector	Price
908A	dc-4	50 ohms	1.05	½ W avg. 1 kW pk	N male	\$65
909A	dc-18	50 ohms	1.05, 0-4 GHz; 1.1, 4-12.4 GHz; 1.25, 12.4-18 GHz	2 W avg. 300 W pk	APC-7	\$120
909A Option 012 and Option 013	dc-18	50 ohms	1.06, 0-4 GHz; 1.11, 4-12.4 GHz; 1.3, 12.4-18 GHz	2 W avg. 300 W pk	Opt. 012 N male Opt. 013 N female	Less \$15

### 920A/B, X923A, X930A Waveguide Shorts

The 920A/B are movable shorts, adjustable through at least half a wavelength at the low end of the band. The X923A is also a movable short, but is adjustable through about two wavelengths at 8.2 GHz.

The X930A is a shorting switch. SWR is less than 1.02 in the "through" position and greater than 125 in the "short" position.

#### 920A/B, X923A, X930A Specifications

Model	Frequency Range (GHz)	Waveguide Size EIA	Price
J920A	5.3-8.2	WR137	\$285
H920A	7.05-10.0	WR112	\$380
X923A	8.2-12.4	WR90	\$360
P920B	12.4-18	WR62	\$375
K920B	18.0-26.5	WR42	\$535
R920B	26.5-40.0	WR28	\$485
X930A	8.2-12.4	WR90	\$535

### 910A/B, 914A Waveguide Fixed and Movable Terminations

The 910A/B are fixed terminations for waveguide systems. The 914A/B are similar to the 910A/B, except that their absorptive elements are movable and locking plungers control the position of the elements.

#### 910A/B, 914A/B Specifications

Model	Frequency Range (GHz)	SWR	Power Rating	Type	Waveguide Size (EIA)	Price
J910A	5.3-8.2	1.02	1 watt	fixed	WR137	\$230
H910A	7.05-10.0	1.02	1 watt	fixed	WR112	\$150
X910B	8.2-12.4	1.015	1 watt	fixed	WR90	\$160
P910A	12.4-18	1.02	1 watt	fixed	WR62	\$130
J914A	5.3-8.2	1.01	2 watt	sliding	WR137	\$475
H914A	7.05-10.0	1.01	1 watt	sliding	WR112	\$440
X914B	8.2-12.4	1.01	1 watt	sliding	WR90	\$325
P914A	12.4-18	1.01	½ watt	sliding	WR62	\$325
K914B	18-26.5	1.01	½ watt	sliding	WR42	\$535
R914B	26.5-40	1.01	½ watt	sliding	WR28	\$490

### 11511A, 11512A, 11565A Coaxial Shorts

These shorts are used for establishing measurement planes for known reflection phase and magnitude in 50Ω and 75Ω coaxial systems for various connectors.

#### Ordering Information

11511A N-female short (50 ohm)	\$30
1250-1531 N-female short (75 ohm)	\$22
11512A N-male short (50 ohm)	\$25
1250-1530 N-male short (75 ohm)	\$25
11565A APC-7 short (50 ohm)	\$65
0960-0054 SMA-female short (50 ohm)	\$25
0960-0055 SMA-male short (50 ohm)	\$25

### Coaxial & Waveguide Catalog & Microwave Measurement Handbook

96 pages with over 350 measurement accessories. Request card at back of this catalog.

# MICROWAVE TEST EQUIPMENT

## Filters, mixers, and tuners

Models 360 series, 362 series, 870A, P932A, 934A

- Effective elimination of undesirable signals
- Low insertion loss through passband



X362A



360D

### 360 Series Coaxial Low Pass Filters, 362 Series Waveguide Low Pass Filters

These Hewlett-Packard low-pass filters facilitate microwave measurements by eliminating undesirable signals (such as harmonics) from the measurement system. Suppression of such signals is particularly important in applications such as broadband reflection and transmission measurements or slotted line measurements, where harmonics generated by the signal source could otherwise impair measurement accuracy.

### X870A, P870A Waveguide Slide-Screw Tuners

Waveguide slide-screw tuners are used primarily for correcting discontinuities or for "matching" waveguide systems. X870A covers 8.2-12.4 GHz in WR 90 waveguide and P870A covers 12.4-18.0 GHz in WR 62 waveguide. Both can correct a SWR of 20 to a value of 1.02, with a maximum loss of 2 dB.

- Correct waveguide discontinuities
- Measure microwave frequencies

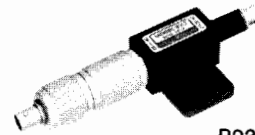

P932A

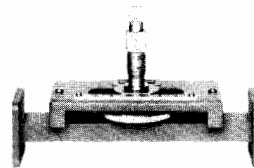

X870A

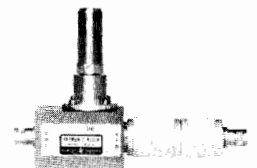

934A

### 934A, P932A Harmonic Mixers

These mixers can be used for frequency measurements and phase lock applications from 2 to 18 GHz. Both accept stable VHF signals from 100 to 1000 MHz and provide broadband, high sensitivity mixing with microwave signals. 934A handles coaxial inputs from 2 to 12.4 GHz while P932A mixes signals from 12.4 to 18 GHz in WR 62 waveguide. With 0 dBm input signal 934A provides 1.4 mV p-p output and P932A 0.4 mV p-p.

### Coaxial and Waveguide Catalog

96 pages with over 350 measurement accessories. Use request card at back of this catalog.

### Ordering Information

X870A Waveguide tuner  
P870A Waveguide tuner  
P932A Waveguide harmonic mixer  
934A Coaxial harmonic mixer

### Price

\$560  
\$600  
\$620  
\$385

### 360 Series Coaxial Filter Specifications

Model	Cut-off Frequency (MHz)	Insertion Loss	Rejection	Impedance	VSWR Maximum	Connectors	Overall Length mm (in)	Shipping Weight kg (lb)	Price
360A	700	Less than 1 dB below 0.9 times cut-off frequency	Greater than 50 dB at 1.25 times cut-off frequency	50Ω	<1.6 to within 100 MHz of cut-off	N (m, f)	276 (10.9)	0.9 (2)	\$285
360B	1200			50Ω	<1.6 to within 200 MHz of cut-off	N (m, f)	183 (7.2)	0.9 (2)	\$255
360C	2200			50Ω	<1.6 to within 300 MHz of cut-off	N (m, f)	274 (10.8)	0.9 (2)	\$180
360D	4100			50Ω	<1.6 to within 300 MHz of cut-off	N (m, f)	187 (7.4)	0.45 (1)	\$180

### 362 Series Waveguide Low Pass Filter Specifications

Model	Passband (GHz)	Stopband (GHz)	Passband Insertion Loss	Stopband Rejection	SWR Maximum	Waveguide Size	Equivalent Flange	Length mm (in)	Shipping Weight kg (lb)	Price
X362A	8.2-12.4	16-37.5	<1 dB	At least 40 dB	1.5	WR 90	UG-39/U	136 (5.4)	0.9 (2)	\$825
M362A	10.0-15.5	19-47			1.5	WR 75	Cover	114 (4.5)	0.9 (2)	\$750
P362A	12.4-18.0	23-54			1.5	WR 62	UG-419/U	94 (3.7)	0.37 (13 oz)	\$845
K362A <sup>1</sup>	18.0-26.5	31-80			1.5	WR 42	UG-595/U	64 (2.5)	0.15 (5.3 oz)	\$685
R362A <sup>1</sup>	26.5-40.0	47-120	<2 dB	>35 dB	1.8	WR 28	UG-599/U	42 (1.7)	0.11 (4 oz)	\$605
<sup>1</sup> Circular Flange Adapters available: For K-Band, specify 11515A (UG-425/U). For R-Band, specify 11516A (UG-381/U).										\$135

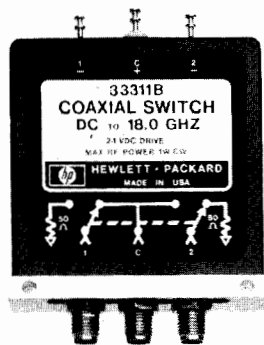

33311B

### 33311B/C Coaxial Switches

The 33311B and 33311C are high isolation, single-pole, double-throw coaxial switches with excellent characteristics. They are designed for use in 50 ohm systems and the ungated port is automatically terminated internally with 50 ohms, thus eliminating the need for three-switch trees. This feature makes them particularly useful in systems which require low SWR on their lines at all times. The switches are controlled by latching solenoids and switching current is automatically cut off when switching is completed. The 33311C utilizes the APC-3.5 connector which is SMA compatible and extends the operating frequency range to 26.5 GHz.

### 8761A/B Coaxial Switches

The 8761 is a single-pole, double-throw coaxial switch with low standing-wave ratio, low insertion loss, and excellent isolation from dc to 18 GHz. Mechanically, the switch is a break-before-make type controlled by a latching solenoid. Any of seven coaxial connectors, or a 50-ohm termination, may be specified for each port.

#### HP-IB Compatible

The 33311B/C and the 8761A/B switches can be remotely controlled by HP-IB with either the 11713A or the 59306A. The 11713A Attenuator Switch Driver is referenced on page 442. The 59306A HP-IB Relay Actuator is referenced on page 28.

#### 33311B/C Specifications

##### Frequency range

**33311B:** dc to 18 GHz.

**33311C:** dc to 26.5 GHz.

##### SWR (50 ohm characteristic impedance)

**33311B:** <1.25, dc to 12.4 GHz; 1.5, 12.4 to 18 GHz.

**33311C:** <1.3, dc to 10 GHz; <1.5, 10 to 16 GHz; <2.3, 16 to 26.5 GHz.

##### Insertion loss

**33311B:** <0.25 dB, dc to 2 GHz; <0.5 dB, 2 to 18 GHz.

**33311C:** <0.25 dB, dc to 2 GHz, < 0.5 dB, 2 to 10 GHz; <0.8 dB, 10 to 16 GHz; <1.4 dB, 16 to 26.5 GHz.

##### Isolation

**33311B:** >90 dB, dc to 18 GHz.

**33311C:** >90 dB to 12.4 GHz; >85 dB, 12.4 to 18 GHz; >50 dB, 18 to 26.5 GHz.

##### RF Connectors

**33311B:** (3) SMA female.

**33311C:** (3) APC-3.5 female (SMA compatible).

**Power:** 1 W average, 100 W peak (10  $\mu$ sec duration).

**Solenoid voltage (dc or pulsed):** 24 volts. Diode protected to reduce voltage transients.

**Switching speed:** <30 ms (including settling time).

**Life:** >1,000,000 switchings.

**Size:** 54 H x 53 W x 14 mm D (2.13 x 2.13 x 0.56 in.) excluding connectors and solenoid terminals.

**Weight:** net, 88 gm (0.2 lb); shipping, 220 gm (0.5 lb).

**Options:** 011, 5-volt solenoid voltage (only on 33311B).

PORT 1 PORT 2

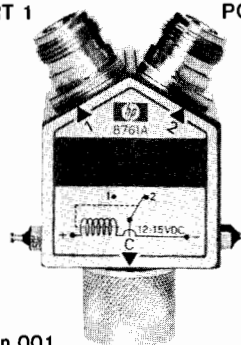

8761A Option 001

PORT C

### 8761A/B Specifications

**Characteristic impedance:** 50 ohms.

**Frequency range:** dc to 18 GHz.

**Standing-wave ratio**

Frequency	SWR		
	7-mm	N	SMA
dc-12.4 GHz	1.15 (1.20)	1.20 (1.25)	1.30 (1.30)
dc-18 GHz	1.20 (1.25)	1.25 (1.30)	1.35 (1.35)

SWR in parentheses applies to switch with built-in termination

**Insertion loss:** <0.5 dB, dc to 12.4 GHz; <0.8 dB, dc to 18 GHz.

**Isolation:** >50 dB, dc to 12.4 GHz; >45 dB, dc to 18 GHz.

**Power:** 10 W average, 5 kW peak; built-in termination rated at 2 W average, 100 W peak.

**Switching energy:** 1.5 W for 20 ms (permanent magnet latching).

**Solenoid voltages (dc or pulsed):** 12 to 15 V, 8761A; 24 to 30 V, 8761B.

**Switching speed:** 35 to 50 ms (including settling time).

**Life:** >1,000,000 switchings.

**Size:** 41 H x 38 W x 38 mm D (1.6 x 1.5 x 1.5 in.) excluding connectors and solenoid terminals.

**Weight:** net, 140 to 220 gm (0.3 to 0.5 lb); shipping, 220 to 300 gm (0.5 to 0.7 lb).

#### How to Order 8761A/B Switches

Specify solenoid voltage and connectors (including built-in 50-ohm termination) by the alphabetic suffix on the switch model number and the appropriate three-digit option number.

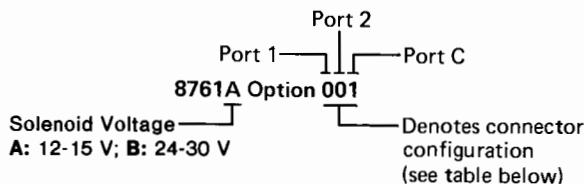

Option Code	Connector Type	Option Code	Connector Type
0	N (f)	4	APC-7 for UT-250 Coax
1	N (m)	5	SMA (f)
2	APC-7 w/Threaded sleeve	6	SMA (m)
3	APC-7 w/Coupling nut	7	50 $\Omega$ Termination

#### Ordering Information

**8761A/B** order must include option number

**8761A/B** Coaxial Switch (quantity 1-9)

**8761A/B** Coaxial Switch (quantity 10-24)

**8761A/B** Coaxial Switch with 50-ohm termination

**33311B** Coaxial Switch (quantity 1-9)

**33311B** Coaxial Switch (quantity 10-24)

**33311C** Coaxial Switch (quantity 1-9)

**33311C** Coaxial Switch (quantity 10-24)

#### Price

Each \$235

Each \$225

add \$35

Each \$450

Each \$420

Each \$585

Each \$545



# MICROWAVE TEST EQUIPMENT

Adapters, waveguide stands, air lines

Models 281A/B/C, 292A/B

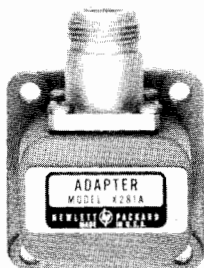

X281A

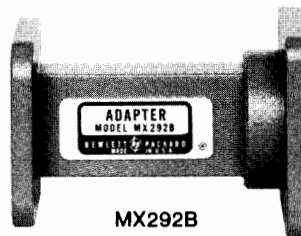

MX292B



X281C



P281C



K281C



## 281A/B Coax to Waveguide Adapters

HP 281A,B adapters transform waveguide transmission line into 50-ohm coaxial line. Power can be transmitted in either direction, and each adapter covers the full frequency range of its waveguide band with SWR less than 1.25.

## 281C Coax to Waveguide Adapters

The 281C family adds high precision measurement capability to HP's waveguide to coax adapter line. Low SWR permits excellent matching of waveguide systems to coaxial instruments. The stepped-taper internal structure acts as an impedance transformer and compensating filter. This significantly reduces mismatch uncertainty which makes more accurate measurements possible.

## 292A/B Waveguide Adapters

Models 292A,B waveguide-to-waveguide adapters connect two different waveguide sizes with overlapping frequency ranges. The 292A consists of a short tapered section of waveguide. The 292B is broached waveguide with a step transition between waveguide sizes.

### 281A/B/C Specifications

HP Model	SWR	Frequency Range (GHz)	Waveguide Size EIA	Coaxial Connector	W/G Flange UG-( ) U	Price
S281A	1.25	2.60-3.95	WR284	N Female	584	\$135
G281A	1.25	3.95-5.85	WR187	N Female	407	\$135
J281A	1.25 <sup>1</sup>	5.30-8.20	WR137	N Female	441	\$105
H281A	1.25	7.05-10.0	WR112	N Female	138	\$95
X281A	1.25	8.20-12.4	WR90	N Female	135	\$85
X281B	1.25	8.20-12.4	WR90	APC-7 <sup>2</sup>	135	\$205
P281B	1.25	12.4-18.0	WR62	APC-7 <sup>2</sup>	419	\$165
X281C	1.05	8.20-12.4	WR90	APC-7	135	\$250
P281C	1.06	12.4-18.0	WR62	APC-7	419	\$250
K281C	1.07	18.0-26.5	WR42	APC-3.5(f)	597	\$280

<sup>1</sup> 1.3 from 5.3 to 5.5 GHz.

<sup>2</sup> Option 013. Furnished with stainless steel N-female connector.

less \$15.

### 292A/B Specifications

HP Model	Frequency Range (GHz)	SWR	W/G Size Flange	to	W/G Size Flange	Price
HX292B	8.2-10.0	1.05	WR 112 UG-51/U		WR 90 UG-39/U	\$125
MX292B	10.0-12.4	1.05	WR 75 Cover		WR 90 UG-39/U	\$170
MP292B	12.4-15.0	1.05	WR 75 Cover		WR 62 UG-419/U	\$135
NP292A	15.0-18.0	1.05	WR 51 Cover		WR 62 UG-419/U	\$125
NK292A	18.0-22.0	1.05	WR 51 Cover		WR 42 UG-595/U	\$135

# MICROWAVE TEST EQUIPMENT

453

Adapters, waveguide stands, air lines

Models 11515/6/A, 11524/5/A, 11533/4/A, 11540 series, 11566/7/A, 11588A, 11606A



11515A

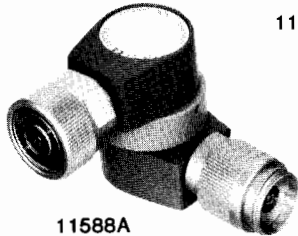

11588A



11567A



11566A

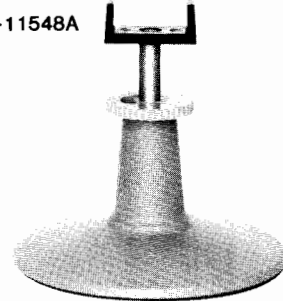

11540A



11606A

## 11515A, 11516A Waveguide Adapters

The 11515A is a square to circular flange adapter for K-band (UG-425 to UG-595). The 11516A is a square to circular flange adapter for R-band (UG-381 to UG-599).

## 11524A, 11525A, 11533A, 11534A Coax to Coax Adapters

These coaxial adapters permit easy interconnection of 50-ohm precision 7-mm (APC-7) connectors and 50-ohm Type N or SMA (3-mm type) connectors. See illustrations page 681.

## 11588A Swivel Adapter, 11606A Rotary Air Line

The 11606A rotary air line and the 11588A swivel adapter are capable of a full 360° of rotation. A combination of the air line and the adapter permits rigid coax movement in three dimensions. Even the most awkwardly shaped devices can be easily connected or disconnected in a coax system with the aid of these components. Insertion loss is <0.5dB and uncertainty due to rotation is -57dB.

### 11515A, 11516A Specifications

HP Model	Frequency Range (GHz)	SWR	W/G Size Flange	to	W/G Size Flange	Price
11515A	18.0-26.5	—	WR 42 UG-425/U		WR 42 UG-595/U	\$135
11516A	26.5-40.0	—	WR 28 UG-381/U		WR 28 UG-599/U	\$135

### 11524A, 11525A, 11533A, 11534A Specifications

HP Model	Description	Shipping Weight	Price
11524A	APC-7 to N female	110 g (4 oz)	\$110
11525A	APC-7 to N male	140 g (5 oz)	\$120
11533A	APC-7 to SMA male	140 g (5 oz)	\$160
11534A	APC-7 to SMA female	140 g (5 oz)	\$160

## 11566A, 11567A Air Line Extension

**Impedance:** 50 ohms.

**Frequency:** dc-18 GHz.

**Reflection coefficient:** 0.018 + 0.001 (frequency in GHz).

**Connector:** APC-7

**Length:** 11566A, 102.5 mm (4 in.); 11567A, 202.5 mm (8 in.).

**Shipping Weight:** 0.45 kg (1 lb).

## 11540 Series Waveguide Stand, Waveguide Holders

The 11540A waveguide stand locks HP waveguide holders at any height from 70 to 133 mm (2.75 in. to 5.25 in.). The stand is 64 mm (2.25 in.) high, and the base measures 121 mm (4.75 in.) in diameter. The waveguide holders are offered in seven sizes to hold waveguide covering frequencies from 3.95 to 40 GHz.

### 11588A, 11606A Specifications

HP Model	Frequency Range 6 Hz	SWR	Connectors	Dimensions mm (in)	Shipping Weight kg (lb)	Price
11588A	DC-12.4	1.1	APC-7(m)(f)	42 x 59 x 30 (1 1/2 x 2 3/8 x 1 1/8)	0.28 (10 oz.)	\$375
11606A	DC-12.4	1.1	APC-7(f)	100 x 19 (4 x 3/4)	0.45 (1 lb)	\$310

### Ordering Information

11566A	Air line extension	\$195
11567A	Air line extension	\$220
11540A	Waveguide stand	\$35
11542A	G-Band Waveguide holder	\$30
11543A	J-Band Waveguide holder	\$20
11544A	H-Band Waveguide holder	\$20
11545A	X-Band Waveguide holder	\$20
11546A	P-Band Waveguide holder	\$25
11547A	K-Band Waveguide holder	\$20
11548A	R-Band Waveguide holder	\$20

### Price

# MICROWAVE TEST EQUIPMENT

Frequency response test sets, 10 MHz to 26.5 GHz  
Model 8755 System

- 10 MHz to 26.5 GHz frequency range
- Absolute & ratio measurement capability
- Complete complement of measurement accessories

- 60 dB dynamic measuring range for each detector
- Excellent stability with time and temperature
- Free of interference from stray fields or unwanted signals.

## 8750A Storage-Normalizer

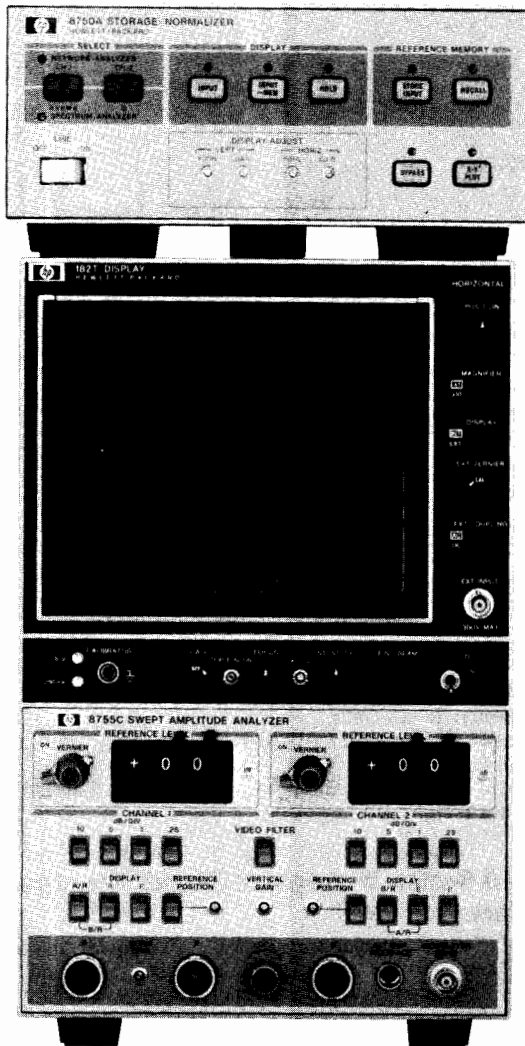

182T Display / 8755C Plug-in  
11664A Detectors

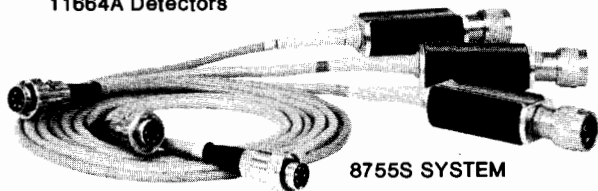

## 8755S Frequency Response Test System

The 8755S is an economy network measurement system designed to make absolute power and ratio measurements over the 10 MHz to 26.5 GHz frequency range. It is a versatile system capable of fulfilling the majority of scalar (amplitude only) impedance and transmission measurement requirements. The 8755S system consists of the following separate instruments: (1) 8755C Swept Amplitude Analyzer, (1) 182T display unit, (1) 8750A Storage Normalizer, and (3) 11664A Schottky diode detectors.

The 8755C has two independent channels and three detector inputs allowing simultaneous ratio measurement capability. All three detectors have a +10 dBm to -50 dBm dynamic range, are interchangeable, and require no calibration. For each channel a resolution of 10, 5, 1, or .25 dB per division is available (also combinations of these, e.g., 15 dB/division) as well as a calibrated offset of  $\pm 59$  dB in 1 dB increments. The 8750A Storage-Normalizer connects directly to the 8755/182T by a single cable to provide digital normalization and storage capability for both channels.

Common measurements made with the 8755 are simultaneous insertion and return loss, amplifier gain and gain compression, and mixer conversion loss and return loss, all on a swept frequency basis. The 8755S system has many features that improve both the accuracy and the versatility compared with other scalar measurement systems.

The 8755C uses an ac detection system which can reject undesired RF signals such as local oscillator feedthrough in mixer measurements, external traffic in antenna measurements, and broadband noise in amplifier measurements. The 8755C provides the 27 kHz squarewave drive to AM modulate the RF sweeper output either directly (most HP 8620 and all 8350 RF sweeper plug-ins are directly compatible with the 8755) or by using the 11665B External Modulator.

In addition to making absolute or relative power measurements with a single detector, the 8755 will also measure the logarithmic difference in power between two detectors, i.e., ratio measurements. Ratio measurement techniques improve accuracy by providing better equivalent source match and immunity to source power variations. A ratio technique can also allow dynamic range expansion up to 100 dB. When used with the 8350A Sweeper, a special interface allows two independent frequency and power ranges to be displayed on consecutive sweeps.

The 8750A Storage-Normalizer improves both the accuracy and convenience of swept frequency measurements. System frequency response error is eliminated by subtracting a digitally stored calibration trace from the measurement trace using the 8750 input minus memory mode. The input minus memory mode also facilitates comparison measurements by providing a single trace display of the difference between two devices. The 8750A has digital storage for flicker-free displays so that a complete trace is seen independently of the RF sweep rate. This is a real benefit when device constraints require a slow sweep rate as when making narrow band filter measurements. The 8750A also makes x-y plotting much more convenient by automatically outputting the x, y and penlift signals from digital memory at the push of a single button.

A number of accessories are available for use with the 8755S system to meet most signal separation and filtering requirements. These include the HP 11666A Reflectometer Bridge, the HP 11667A Power Splitter, and the HP 11678 Filter Kits. The HP 11679A and B Extension Cables are also available for use with the 11664 Detectors or the 11666A Bridge to make remote measurements without performance degradation.

## Typical applications

### Simultaneous Insertion and Return Loss

One common setup for making simultaneous insertion loss and return loss measurements is shown in the diagram following. The R detector in the 11666A measures the incident power while the A detector measures reflected power. The ratio A/R then provides return loss information while the B/R trace displays insertion gain/loss data simultaneously. A display of a bandpass filter measurement using this setup is shown in the photo. The ability to monitor the effects of adjustments on both parameters is especially advantageous. System frequency response error is eliminated using the 8750A *input minus memory* mode. The difference between the measurement and calibration traces is displayed directly, eliminating the frequency response common to both traces. In addition, both the *input minus memory* and the *input* modes of the 8750 provide a flicker-free display independent of the RF sweep rate allowing the complete frequency response to be seen even at very slow sweep rates.

Simultaneous Insertion and Return Loss

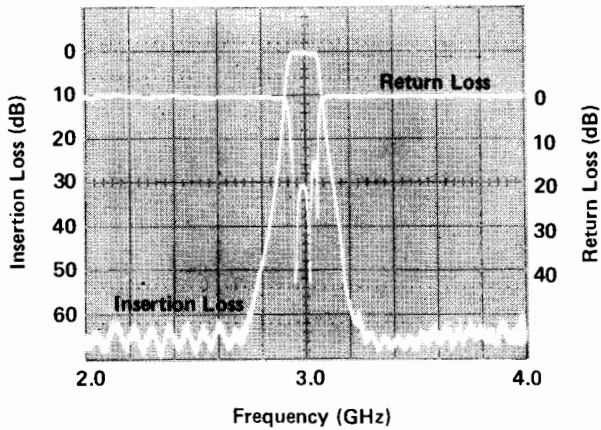

Amplifier Gain Compression

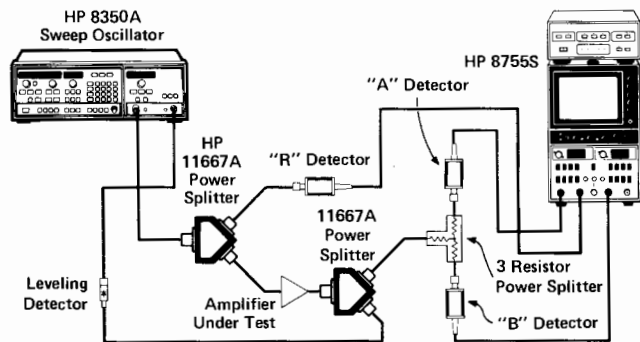
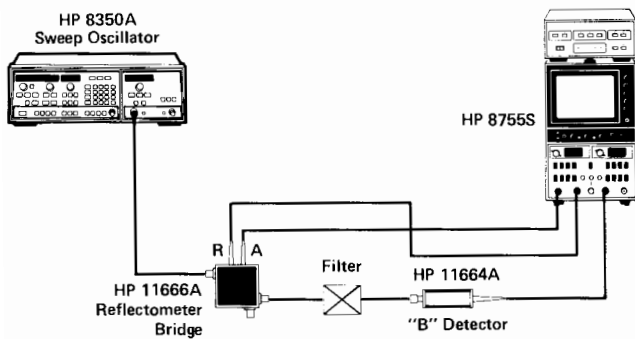
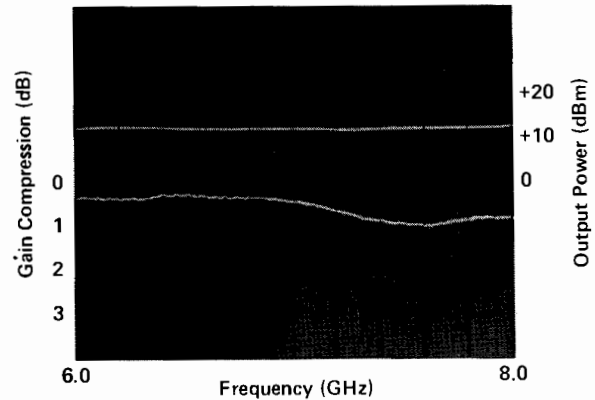

Expanded Dynamic Range

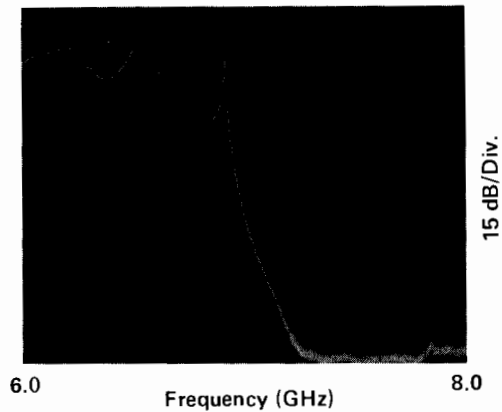

**Amplifier Gain Compression**

The ability to make absolute power measurements along with normalized ratio measurements is very useful for amplifier characterization. The top right setup can measure amplifier gain, gain flatness, output power, and gain compression, all on a swept frequency basis. The photo displays the amplifier gain compression and output power over the 6–8 GHz range of the amplifier. The 8750A *input minus memory* mode provides the important ability to compare differences between the small signal gain response with successively compressed gain responses. Once the gain is compressed 1 dB at any frequency the output power indicated by the B detector is the output power for 1 dB gain compression.

**Expanded Dynamic Range**

Each detector channel of the 8755 has a 60 dB dynamic range. By using the lower right setup, the dynamic range for each channel is added together to make a 100 dB dynamic range measurement on a lowpass filter. The ac processing of the 8755 allows the detector to reject the broadband noise from the amplifier providing up to 20 dB more dynamic range than would be possible with a dc type detection system. In addition, the full 100 dB dynamic range can be viewed on the CRT display by selecting the 5 and 10 dB per division resolution buttons together, giving 15 dB/division. The amplifier gain variations enter into the measurement as frequency response common to both calibration and measurement traces. The 8750A Storage-Normalizer *input minus memory* mode displays the difference between the calibration and measurement traces thus eliminating the effects of frequency response.

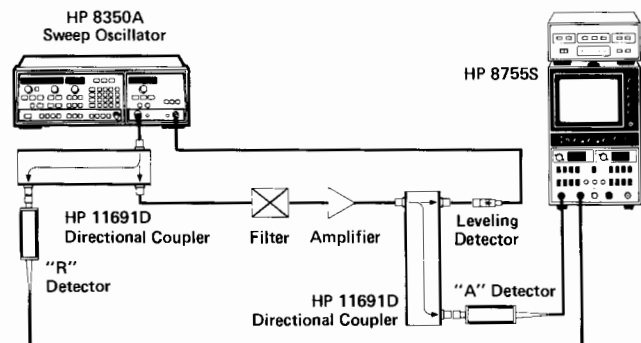

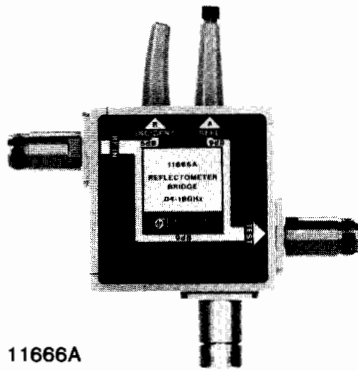

11666A

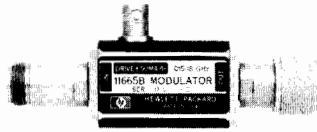

11665B

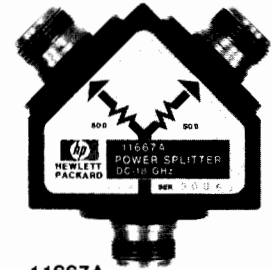

11667A

### 11666A Reflectometer Bridge

Reflection measurements covering from 40 MHz to 18 GHz with one directional device can be made with the Model 11666A Reflectometer Bridge. Operation of this type of directional device is based on principles of the resistive Wheatstone Bridge extended to microwave frequencies. When three bridge arms are 50Ω, the voltage across corners of the bridge is directly proportional to the reflection coefficient of the device connected in the fourth arm. Equivalent directivity is then a measure of how well the bridge circuit is balanced with a 50Ω termination connected. (Ideally this would create a voltage null representing infinite return loss.) The high equivalent directivity achievable over wide bandwidths makes the bridge configuration attractive.

The 11666A is completely dedicated to the 8755; two Schottky diode detectors (which sample the incident and reflected signals for ratioing by the 8755) are incorporated as an integral part of the bridge unit. The effective external leveling achieved by ratioing thus isolates the measurement port from source/bridge input mismatch. With the addition of an external 11664A Detector, two simultaneous ratio measurements of insertion and return loss can be made. Small size combined with its wide frequency range and high directivity make the 11666A ideal for production use.

**Specifications 11666A** (connected to the 8755B Analyzer)  
**Frequency Range:** 40 MHz to 18 GHz.

Frequency Range	Equivalent Directivity	Equivalent Output SWR
40 to 100 MHz	30 dB	1.25
0.1 to 1 GHz	38 dB	1.25
1 to 2 GHz	36 dB	1.25
2 to 4 GHz	33 dB	1.25
4 to 8 GHz	29 dB	1.25
8 to 12 GHz	27 dB	1.27
12 to 18 GHz	26 dB	1.52

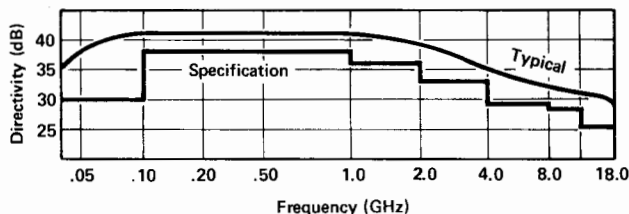

### Frequency tracking

(between incident and reflected arms): <3.2dB  
(between incident and test port, including 1.1 dB from 11664A Detector): <4.3dB

**Nominal coupling:** 6-dB incident arm. 9-dB reflected arm. 9-dB transmission loss.

**Input SWR:** 1.8.

**Maximum input power:** +15 dBm.

**Connectors:** Type N-Female on input and output. APC-7 Optional.  
**Size:** 69.9 mm H x 69.9 mm W x 46.4 mm D (2<sup>3</sup>/<sub>16</sub>" x 2<sup>3</sup>/<sub>16</sub>" x 1<sup>7</sup>/<sub>32</sub>").  
**Cable length,** 1219 mm (48").

**Weight:** net, 0.7 kg (1.5 lb). Shipping, 2.26 kg (5.13 lb).

**Accessories furnished:** 11512A Short, Type N-Male (11565A short, APC-7 with Opt 002 and 003).

### 11667A Power Splitter

The 11667A Power Splitter is recommended when making wide-band transmission measurements using the 8755 Test Set. This two-resistor type splitter provides excellent output SWR at the auxiliary arm when used for source leveling or ratio measurement applications. The 0.25 dB tracking between output arms over a frequency range from dc to 18 GHz allows wideband measurements to be made with a minimum of uncertainty.

**Frequency range:** dc to 18 GHz.

**Impedance:** 50Ω.

	dc-4 GHz	dc-8 GHz	dc-18 GHz
<b>Input SWR:</b>	≤1.15	≤1.25	≤1.45
<b>Equivalent output SWR:</b> leveling or ratio	1.10	1.20	1.33
<b>Output tracking:</b> (between output arms)	<0.15 dB	<0.20 dB	<0.25 dB

**Insertion loss:** 6 dB nominal (input to either output).

**Maximum input power:** +27 dBm (0.5 watt).

**Connectors:** Type N female on all ports.

**Size:** 46 H x 50 W x 19 mm D (1<sup>13</sup>/<sub>16</sub>" x 2" x 3/4").

**Weight:** net, 0.06 kg (2 oz). Shipping 0.22 kg (8 oz).

### Other Signal Separation Devices

Many other signal separation devices are available from HP for use with the 8755. Coaxial couplers from 0.1 to 18 GHz are available with the 770 series, the 790 series, and the 11692. Higher directivity 752 series waveguide couplers can also be used with the 8755S with the addition of appropriate 281 series waveguide to coax adaptors.

### 11665B Modulator

**Function:** absorptive on-off modulator designed for and powered by the 8755B plug-in.

Frequency Range	Return Loss On and Off	Insertion Loss On Off
15-40 MHz	≥10 dB	≤7.0 dB ≥35 dB
40 MHz-4 GHz	≥15 dB	≤3.2 dB ≥35 dB
4-8 GHz	≥12 dB	≤3.8 dB ≥40 dB
8-12.4 GHz	≥8 dB	≤4.3 dB ≥45 dB
12.4-18 GHz	≥8 dB	≤5.0 dB ≥45 dB

**Modulator drive feedthrough:** ≤8 mV (peak) at 27.8 kHz at either port when powered by the 8755B. Reduced to ≤1mV (peak) using the 11668A. (See 11668A High Pass Filter).

**Drive current:** nominally +50 mA in ON condition, -50 mA Off condition.

**Weight:** net, 0.17 kg (6 oz). Shipping, 0.9 kg (2 lb).

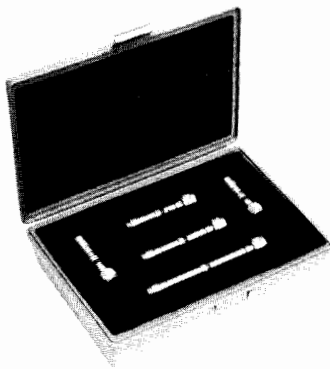

11678A



11668A

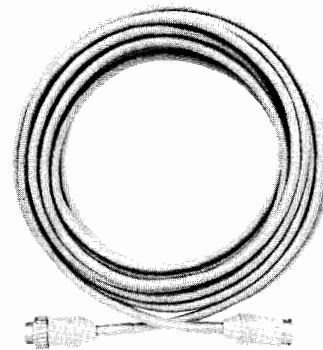

11679A

### 11678A Low Pass Filter Kit

The 11678A Low Pass Filter Kit contains five filters conveniently matched to HP 8620 sweeper bands. These filters have  $<1.1$  dB insertion loss at 0.95 fc with  $> 40$  dB rejection at 1.25 fc. Filter use is recommended to reduce undesirable harmonics causing errors in broadband detector measurements.

**Frequency range:** low pass filters, cutoff frequency fc: 11688A, 2.8 GHz; 11689A, 4.4 GHz; 11684A, 6.8 GHz; 11685A, 9.5 GHz; 11686A, 13.0 GHz.

**Connectors:** N-Male, N-Female.

**Weight:** net 0.44 kg (1 lb). Shipping 1.2 kg (2.9 lb).

### 11668A High Pass Filter

The 11668A High Pass Filter accessory is recommended when making measurements on active devices which have gain below 50 MHz. Use of the 11668A, placed after the 11665B, reduces the modulator drive feedthrough from 8 mV to 1 mV and prevents possible amplifier saturation. Use of the 11668A filter is not necessary for passive measurements since the feedthrough from the 11665B is  $-65$  dBm and causes no degradation in system performance.

**Frequency range:** 50 MHz to 18 GHz.

	Insertion Loss	Return Loss
50–100 MHz	$\leq 2.5$ dB	$\geq 12$ dB
100 MHz–8 GHz	$\leq 1.0$ dB	$\geq 16$ dB
8–12 GHz	$\leq 1.0$ dB	$\geq 14$ dB
12–18 GHz	$\leq 1.5$ dB	$\geq 14$ dB

**Maximum input:** +27 dBm.

**Connectors:** N-female, N-male

**Weight:** 0.13 kg (5 oz). Shipping 0.28 kg (10 oz).

### 11679A/B Extension Cables

11679A 25-foot Extension Cable and 11679B 200-foot Extension Cable fit directly between 11664A Detector and display. Remote detector operation is permitted without performance degradation.

## Common System Specifications

### Power Measurement Range:

**Single Channel:** +10 dBm to  $-50$  dBm (noise level).

**System Accuracy (Ratio Measurements):**

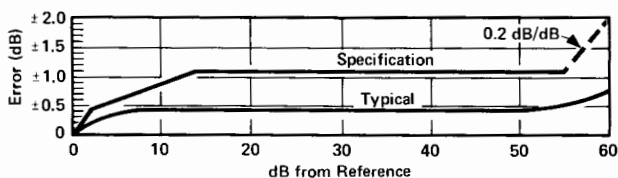

Accuracy curve shows system uncertainty for a relative measurement with +10 dBm incident at the test detector when the 0-dB reference is set. Accuracy when calibration levels below +10 dBm are used remains the same, except the additional 0.2 dB/dB uncertainty should be added for measurements below  $-45$  dBm. This curve includes system noise, offset uncertainty, and crosstalk, and assumes the reference detector power remains fixed between calibration and test. System frequency response is specified separately.

### Absolute Measurements:

Absolute power incident on a detector is displayed with respect to the 0 dBm POSITION line when the OFFSET CAL switch is turned OFF. Accuracy at any power level is typically  $\pm 0.5$  dB not including detector frequency response or mismatch errors. For applications requiring more precision, increased accuracy can be obtained if the 8755 display is calibrated at a specific power level using a power meter. The stability of the 8755 then permits accurate power measurements repeatable to hundredths of dBs.

### General

**Resolution:** Independent for each channel in steps of 10, 5, 1, or 0.25 dB per division. Combinations of steps can be engaged, e.g. 10 dB/div. and 5 dB/div. to achieve 15 dB/div.

**Offset:** Independent for each channel.  $\pm 59$  dB in 1 dB increments.

**Graticule:** 8755S, 1 Div.  $\approx 1.29$  cm. 8755S Option 001, 1 Div.  $\approx 1$  cm.

**Temperature Range:** Operation, 0 to 55°C; storage,  $-40$ °C to 75°C.

**Power:** 48 to 440 Hz, 115/230 V  $\pm 10\%$ , typically 100 watts.

### 8755S Specifications

Consists of:

- 8755C Swept Amplitude Analyzer
- 182T Display
- 11664A Detectors (3 each)
- 8750A Storage-Normalizer

**Frequency Range:** 10 MHz to 18 GHz (determined by the 11664A Detectors)

### 8755S Option 001 Specifications

Consists of:

- 8755C Swept Amplitude Analyzer
- 180TR Display
- 11664A Detectors (3 each)
- 8750A Storage-Normalizer

### 8755S Option 002 Specifications

Consists of:

- 8755C Swept Amplitude Analyzer
- 182T Display
- 11664A Detector (1 each)
- 11666A Reflectometer Bridge
- 8750A Storage-Normalizer

**Frequency Range:** 40 MHz to 18 GHz (determined by the 11666A Bridge).

### 8755S Option 003 Specifications

Adds 11665B External Modulator.

**Frequency Range:** 15 MHz to 18 GHz (determined by the 11665B Modulator).

### 8755S Option 004 Specifications

Deletes the 8750A Storage-Normalizer.

### 8755S Option 005 Specifications

Consists of:

- 8755C Swept Amplitude Analyzer
- 182T Display
- 11664B Detectors (3 each)
- 8750A Storage-Normalizer

**Frequency Range:** 10 MHz to 26.5 GHz (determined by the 11664B Detectors).

# MICROWAVE TEST EQUIPMENT

## 8755 System

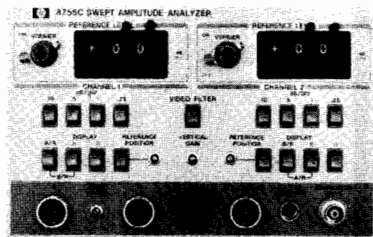

8755C

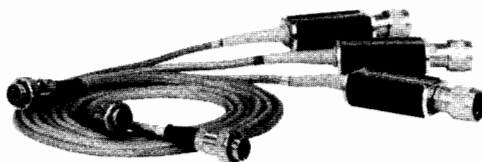

11664A

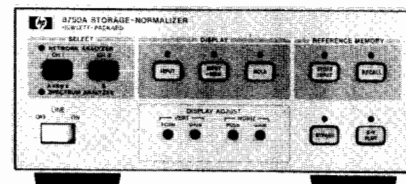

8750A

### Individual instrument specifications

#### 8755C Plug-in

**Function:** The 8755C plug-in processes demodulated 27.8 kHz signals from the 11664 Detectors (R,A,B) for logarithmic display on 180 series oscilloscopes.

**Resolution:** Independent for each channel in steps of 10, 5, 1, or 0.25 dB per division.

**Offset:** Independent for each channel.  $\pm 59$  dB in 1dB increments.

#### Display Units

180 "T" series displays are recommended for use with the 8755C. They provide zero offset recorder outputs, and both positive and negative 5-volt retrace blanking inputs.

**Large screen (Model 182T):** This display unit is contained in the 8755S standard configuration. It has an 8 x 10 division internal graticule with 1 div = 1.29 cm. and medium persistence P39 phosphor.

**Rack mount (Model 180TR):** This display unit is contained in the 8755S Option 001 system configuration. It has an 8 x 10 division internal graticule with 1 div = 1 cm. and medium persistence P39 phosphor.

The 182T and 180TR are directly compatible with the 8750A Storage-Normalizer. As a result of the 8750A compatibility, the 182T and 180TR cannot be used with time domain plug-ins.

**Variable persistence/storage (Model 181T, Cabinet Model 181TR, Rack Mount):** These displays can be ordered individually for use with the 8755C. Because they offer CRT storage, they have not been made compatible with the 8750A Storage-Normalizer. They have an 8 x 10 division internal graticule with 1 div = 0.95 cm. and offer variable persistence phosphor for storing single or multiple traces.

#### 11664A Detectors

**Function:** Designed specifically for use with the 8755C Swept Amplitude Analyzer, the 11664A detects the envelope of the 27.8 kHz modulated microwave signal. It uses a biased Schottky diode to achieve -50 dBm sensitivity.

**Frequency range:** 10 MHz to 26.5 GHz.

**Tracking between two 11664A Detectors:**

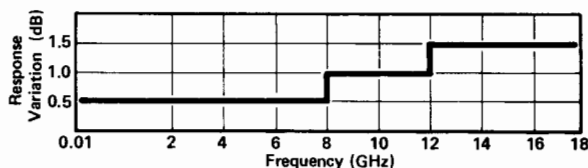

#### Typical frequency response:

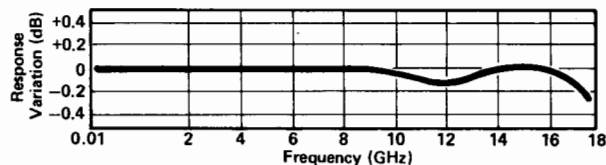

#### Return loss:

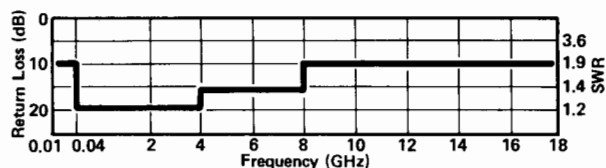

**Impedance:** 50 ohms nominal

**Connector:** N-Male.

#### 11664B Detectors

(All specifications are the same as the 11664A with the following differences):

**Frequency range:** 10 MHz to 26.5 GHz.

**Tracking between two 11664B Detectors:** Tracking between two detectors at the same power level is typically <2 dB from 10 MHz to 26.5 GHz.

**Return Loss:**

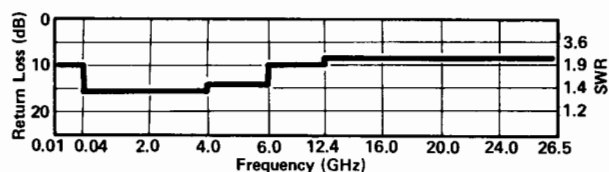

**Connector:** APC 3.5 Male.

#### 11664C Detector Adapter

**Function:** Allows the 8755 to be used with many available diode detectors. Two adjustments allow the detector to be mated with the 8755 to provide absolute power as well as ratio with a frequency range that is determined by the diode detector used.

**Connector:** BNC male

#### 8750A Storage-Normalizer

**Function:** Provides digital storage display and digital normalization for both channels of the 8755. The 8750A connects directly to the 8755/182T via a single cable.

#### Ordering Information

The 8755S system and its options are configured of separate instruments and components solely for ordering convenience. If a different display or optional connectors are desired, each part of the system should be listed separately.

	Price
8755S Complete Test Set	\$7205
Opt 001: Rack mount version	\$25
Opt 002: deletes (2) 11664 Detectors, adds 11666A Reflectometer Bridge	add \$1880
Opt 003: adds 11665B Modulator	add \$750
Opt 004: deletes 8750A Storage-Normalizer	less \$1750
Opt 005: Replaces (3) 11664A with (3) 11664B	add \$645
8755C Test Set Plug-in only	\$2100
11665B 15 MHz 18 GHz Modulator	\$750
11664A 10 MHz 18 GHz Detector	\$360
Opt 001: APC-7 Connector	add \$25
11664B APC 3.5 10 MHz to 26.5 GHz Detector	\$575
11664C Detector Adapter	\$225
182T Large Screen Cabinet Scope Display	\$2275
180TR Standard Screen Rack Display	\$2300
181T Storage, Cabinet Display	\$3100
181TR Storage, Rack Display	\$3200
11666A Reflectometer Bridge	\$2600
11679A 7.6 m (25 ft) Detector Extension Cable	\$75
11679B 61 m (200 ft) Detector Extension Cable	\$275
11668A 50 MHz High Pass Filter	\$375
11667A DC to 18 GHz Power Splitter	\$775
11678A Low Pass Filter Kit	\$950
Individual filters: specify model number	\$190



415E

The Hewlett-Packard Model 415E SWR Meter is a low noise, tuned amplifier-voltmeter calibrated in dB and SWR for use with square law detectors. It is an extremely useful instrument for measuring SWR, attenuation, and gain directly from metered scales, or as a tuned amplifier for driving an X-Y recorder when making RF substitution measurements. The 415E responds to a standard tuned frequency of 1000 Hz. This frequency is front panel adjustable over a range of 7% for exact matching to the internal 1 kHz modulation of the signal source being used. Amplifier bandwidth is also adjustable from 15 to 130 Hz. The narrow bandwidth allows maximum sensitivity at CW frequencies while the wider bandwidths enable swept tests to be displayed on an oscilloscope or X-Y recorder.

A precision 60 dB attenuator with an accuracy of 0.05 dB/10 dB assures high accuracy in making substitution measurements. An expand-offset feature allows any 2 dB range to be expanded to full scale for maximum resolution. Linearity is  $\pm 0.02$  dB on expanded ranges and is limited only by meter resolution on normal scales. This performance, together with the inherently low noise figure, allows maximum measurement range with exceptional resolution and linearity.

The Model 415E operates with either crystal or bolometer detectors. Both high and low-impedance inputs are available for crystal detectors. Precise bias currents of 4.5 and 8.7 mA (200 $\Omega$ ) are available for operation with bolometers as selected at the front panel. This bias is peak limited for positive bolometer protection.

Both ac and dc outputs located on the rear panel allow use of the 415E as a high-gain tuned amplifier or for X-Y recorder operation. In addition, the 415E can be operated with an internally mounted battery pack (Option 001) for completely portable use.

## Specifications

**Sensitivity:** 0.15  $\mu$ V rms for full-scale deflection at maximum bandwidth (1  $\mu$ V rms on high impedance crystal input).

**Noise:** at least 7.5 dB below full scale at rated sensitivity and 130 Hz bandwidth with input terminated in 100 or 500 $\Omega$ ; noise figure less than 4 dB.

**Range:** 70 dB in 10 and 2-dB steps.

**Accuracy for low xtal impedance settings:** 10 dB to 50 dB range,  $\pm 0.05$  dB/10 step; 50 dB to 60 dB range,  $\pm 0.10$  dB/10 dB step; maximum cumulative error between any two 10 dB steps is  $\pm 0.10$  dB; maximum cumulative error between any two 2 dB steps is  $\pm 0.05$  dB.

**Accuracy for high xtal impedance and bolometer settings:**  $\pm 0.05$  dB/10 dB step; maximum cumulative error between any two dB steps is  $\pm 0.10$  dB; maximum cumulative error between any two 2 dB steps is  $\pm 0.05$  dB.

**Linearity:**  $\pm 0.02$  dB on expanded scales, determined by inherent meter resolution on normal scales.

**Input:** unbiased low and high impedance crystal (50-200 and 2500-10,000 $\Omega$  optimum source impedance respectively for low noise); biased crystal (1 V into 1 k $\Omega$ ); low and high current bolometer (4.5 and 8.7 mA  $\pm 3\%$  into 200 $\Omega$ ), positive bolometer protection; input connector, BNC female.

**Input frequency:** 1000 Hz adjustable 7%; other frequencies between 400 and 2500 Hz available on special order.

**Bandwidth:** variable, 15-130 Hz; typically less than 0.5 dB change in gain from minimum to maximum bandwidth.

**Recorder output:** 0-1 V dc into an open circuit from 1000 $\Omega$  source impedance for ungrounded recorders; output connector, BNC female.

**Amplifier output:** 0-0.3 V rms (Norm), 0-0.8 V rms (Expand) into at least 10,000 $\Omega$  for ungrounded equipment; output connector, dual banana jacks.

**Meter scales:** calibrated for square-law detectors; SWR: 1-4, 3.2-10 (Norm); 1-1.25 (Expand). dB: 0-10 (Norm); 0-2.0 (Expand); battery: charge state.

**Meter movement:** taut-band suspension, individually calibrated mirror-backed scales; expanded dB and SWR scales greater than 108 mm (4 1/4") long.

**RFI:** conducted and radiated leakage limits are below those specified in MIL-I-6181D.

**Power:** 115-230 V  $\pm 10\%$ , 50-400 Hz, 1 W; optional rechargeable battery provides up to 36 hr continuous operation.

**Weight:** net 4 kg (9 lb). Shipping 5.8 kg (13 lb).

**Size:** 155 H, 190 W, 279 mmD (6.09" x 7.78" x 11").

## Ordering Information

415E SWR Meter

Opt 001: rechargeable battery installed

Opt 002: rear panel input connector in parallel with front panel connector

## Price

\$1050

add \$105

add \$25



# NETWORK ANALYZERS

Complete characterization of linear networks

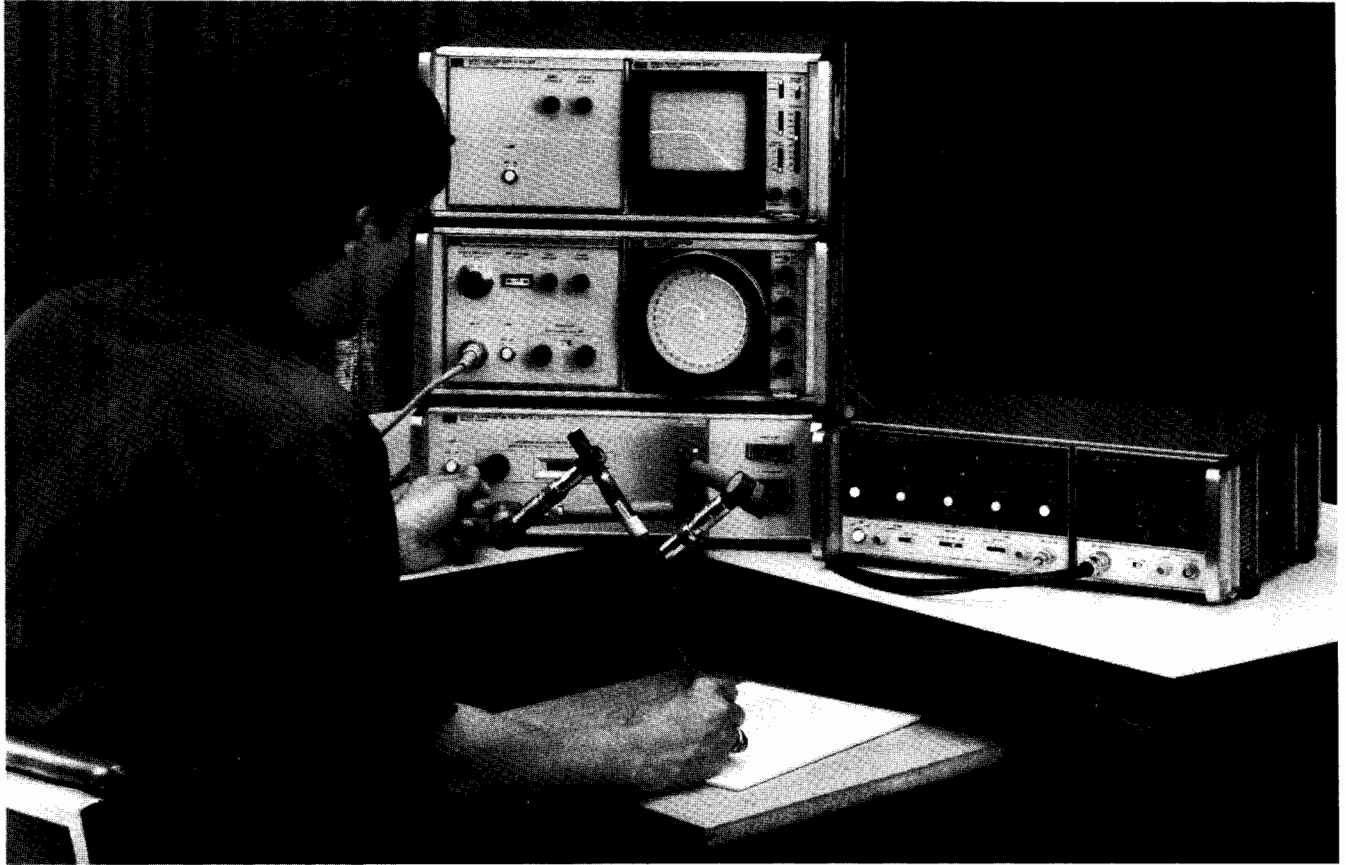

## Why Network Analysis?

Characterizing the behavior of linear networks that will be stimulated by arbitrary signals and interfaced with a variety of other networks is a fundamental problem in both synthesis and test processes. For example, the engineer designing a multi-component network must predict with some certainty the final network performances from his knowledge of the individual components. Similarly, a production manager must know allowable tolerances on the products he manufactures and whether the final products meet the specified tolerances. Network analysis offers a solution to these problems through complete description of linear network behavior in the frequency domain.

Network analysis accomplishes the description of both active and passive networks by creating a data model of such component parameters as impedances and transfer functions. However, these parameters not only vary as a function of frequency but are also complex variables in that they have both magnitude and phase. Until the advent of the modern network analyzer, phase was difficult to measure at CW frequencies and often involved laborious calculations; these measurements were accomplished by conventional oscilloscopes at lower frequencies and slotted lines at microwave frequencies. However, swept network analyzers now measure magnitude and phase (the total complex quantity) as a function of frequency with less difficulty than conventional CW measurements. Impedance and transfer functions can then be conveniently displayed on a swept CRT, X-Y recorder, or computer controlled

peripherals such as a printer and/or a plotter. HP computers also combine with network analyzers to give new levels of speed and accuracy in swept measurements that could only be attained previously by long calculations at CW frequencies.

Thus, network analysis satisfies the engineering need to characterize the behavior of linear networks quickly, accurately, and completely over broad frequency ranges. In design situations, this minimizes the time required to test new designs and components, allowing more time to be spent on the design itself. Likewise, production test times may be minimized while reducing the uncertainties surrounding the test.

## What is Network Analysis?

Network analysis is the process of creating a data model of transfer and/or impedance characteristics of a linear network through sine wave testing over the frequency range of interest. All network analyzers in the HP product line operate according to this definition.

Creating a data model is important in that actual circuit performance often varies considerably from the performance predicted by calculations. This occurs because the perfect circuit element doesn't exist and because some of the electrical characteristics of a circuit may vary with frequency.

At frequencies above 1 MHz lumped elements actually become "circuits" consisting of the basic elements plus parasitics like stray capacitance, lead inductance, and unknown absorptive losses. Since parasitics depend on

the individual device and its construction they are almost impossible to predict. Above 1 GHz component geometries are comparable to a signal wavelength, intensifying the variance in circuit behavior due to device construction. Further, lumped-element circuit theory is useless at these frequencies and distributed-element (or transmission-line) parameters are required to completely characterize a circuit.

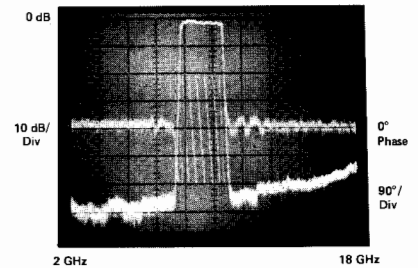

Figure 1. 2 GHz to 18 GHz measurement of magnitude and phase in a single sweep

Data models of both transfer and impedance functions must be obtained to completely describe the linear behavior of a circuit under test. At lower frequencies, h, y, and z-parameters are examples of transfer and/or impedance functions used in network description; at higher frequencies, S-parameters are used to characterize input-output impedances and transfer functions. Therefore, a network analyzer must measure some form of a circuit's transfer and impedance functions to achieve its objective of complete network characterization.

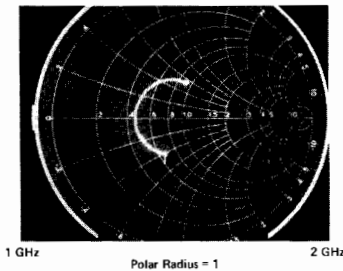

Figure 2. Input impedance of microcircuit amplifier is read directly with Smith Chart Overlay for Polar Display

Network analysis is limited to the definition of linear networks. Since linearity constrains networks stimulated by a sine wave to produce a sine wave output, sine wave testing is an ideal method for characterizing magnitude and phase response as a function of frequency. In non-linear measurements phase is often meaningless and amplitude has to be defined with respect to individual frequency components. For non-linear measurements see sections on spectrum analyzers and wave analyzers.

## Network Analyzers

Hewlett-Packard Network Analyzers are instruments that measure transfer and/or impedance functions of linear networks through sine wave testing. A network analyzer system accomplishes these measurements by configuring its various components around the device under test. The first requirement of the measurement system is a sine wave signal source to stimulate the device under test. Since transfer and impedance functions are ratios of various voltages and currents, a means of separating the appropriate signals from the measurement ports of the device under test is required. Finally, the network analyzer itself must detect the separated signals, form the desired signal ratios, and display the results.

## Signal Sources and Signal Separation

In the general case, any sine wave source meeting the network analyzer's specifications can be used to stimulate the device under test. For CW measurements a simple oscillator may suffice; for greater CW frequency accuracy a signal generator or synthesizer may also be desirable. If the analyzer is capable of swept measurements, great economies in time can be achieved by stimulating the device under test with a sweep oscillator or sweeping synthesizer. This allows quick and easy characterization of devices over broad frequency ranges. Some network analyzers will operate only with a companion source which both stimulates the device under test and acts as the analyzer's local oscillator.

At low frequencies it is not particularly difficult to separate the appropriate voltages and currents required for transfer and impedance function measurements. Signal separation is merely the process of establishing the proper shorts, opens, and connections at

the measurement ports of the device under test. As frequencies increase, the problem of signal separation usually involves traveling waves on transmission lines and becomes correspondingly more difficult. Hewlett-Packard manufactures test sets (often called "transducers") applicable for separating the appropriate traveling waves in a variety of high frequency measurements.

## Broadband and Narrowband Detection

After the desired signals have been obtained from the test set (or transducer) they must be detected by the network analyzer; HP network analyzers can use one of two detection methods. Broadband detection accepts the full frequency spectrum of the input signal while narrowband detection involves tuned receivers which convert CW or swept RF signals to a constant IF signal. There are certain advantages to each detection scheme.

Broadband detection reduces instrument cost by eliminating the IF section required by narrowband analyzers but sacrifices noise and harmonic rejection. However, noise is not a factor in many applications, and careful measurement techniques, using filters, can eliminate harmonic signals that would otherwise preclude accurate measurements. Broadband systems are generally source independent while some narrowband systems require companion tracking sources. Finally, broadband systems can make measurements where the input and output signals are not of the same frequency, as in the measurement of the insertion loss of mixers and frequency doublers. Narrowband systems cannot make these measurements.

Narrowband detection makes a more sensitive low noise detection of the constant IF possible. This allows increased accuracy and dynamic range for frequency selective measurements (as compared to broadband systems) and high resolution through IF substitution using precision IF attenuators. Source dependent narrowband systems utilize a companion tracking source not only to stimulate the device under test, but also to produce a signal offset from the RF by a fixed frequency for tuning the analyzer's constant IF.

## Signal Processing and Display

Once the RF has been detected, the network analyzer must process the detected signals and display the measured quantities. All HP network analyzers are multi-channel receivers utilizing a reference channel and at least one test channel; absolute signal levels in the channels, relative signal levels (ratios) between the channels, or relative phase difference between channels can be measured depending on the analyzer. Using these measured quantities, it is possible to either display directly or compute the magnitude and phase of transfer or impedance functions.

Magnitude measurements fall into two categories, relative and absolute; absolute measurements involve the exact signal level in each channel while relative measurements involve the ratios of the two signal channels.

Absolute measurements are usually expressed in voltage (dBV) or in power (dBm). The units dBV are derived by taking the log ratio of an unknown signal in volts to a one volt reference. Similarly, dBm is the log ratio of unknown signal power to a one milliwatt reference.

Relative ratio measurements are usually made in dB, which is the log ratio of an unknown signal (Test Channel) with a chosen reference signal (Reference Channel). This allows the full dynamic range of the instrumentation to be used in measuring variations of both high and low level circuit responses. For example, 0 dB implies the two signal levels have a ratio of unity while  $\pm 20$  dB implies a 10:1 voltage ratio between two signals.

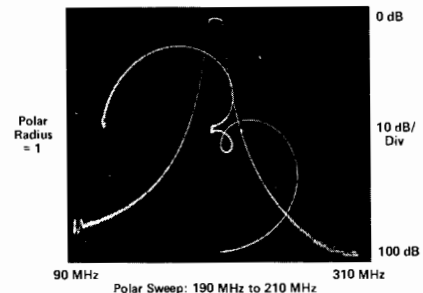

Figure 3. Simultaneous measurement of transmission response and passband reflection coefficient

All network analyzer phase measurements are relative measurements with the reference channel signal considered to have zero phase. The analyzer then measures the phase difference of the test channel with respect to the reference channel.

Measurement results at CW frequencies may be displayed on analog meters, LEDs or computer controlled printers. Swept frequency measurements of amplitude and phase may be displayed versus frequency on CRTs or X-Y plotters. The addition of digital storage and normalization to network analyzer CRT's assures flicker-free traces and removal of frequency response errors for fast, real-time displays of test device responses versus frequency.

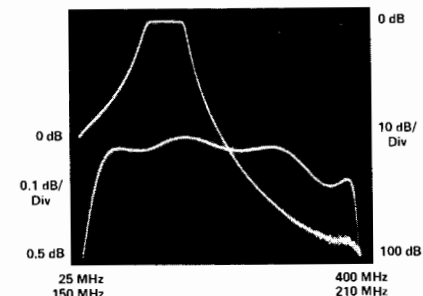

Figure 4. Automatic alternate sweep for coincident measurement of filter passband and skirts



# NETWORK ANALYZERS

## Complete characterization of linear networks (cont.)

### Low Frequency Network Analysis

Networks operating at frequencies below 10 MHz are generally characterized by measuring the gain and phase changes through the network and the associated input and output impedances; h, y, and z-parameters as well as other lumped-component models are typical analytical and computational tools used to represent these measurements. The first derivative of phase with respect to frequency, group delay, is an important measurement of distortion in communication systems. Hewlett-Packard produces a broad line of instrumentation capable of measuring all of these parameters.

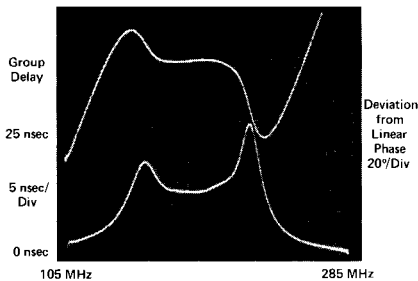

Figure 5. Two independent techniques for measuring filter phase distortion

Phase information complements amplitude data in the measurement of low frequency parameters because it is more sensitive to network behavior and because it is a required component of complex impedance and transfer functions. For instance, phase is more sensitive than amplitude in determining the frequency of network resonances (poles) and anti-resonances (zeroes). This is because the phase shift of a network transfer function is exactly zero at the frequency of resonance. Phase information is also vital in circuit design, particularly loop design, where phase margins are critical.

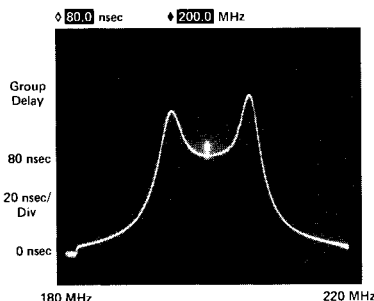

Figure 6. Direct Measurement of Group Delay with digital readout at marker

Phase data are also required to measure delay distortion or group delay of networks. Delay distortion occurs when different frequency components of a complex waveform experience nonlinear phase shifts as they are transmitted through a network. Group delay is a measure of this distortion and is defined as:

$$T_g = \frac{d\theta}{d\omega}$$

There are several techniques for measuring group delay; the most common techniques

are phase slope, amplitude modulation, frequency modulation, and frequency deviation. Most HP network analyzers can make measurements with at least one of these techniques while several analyzers measure and display group delay directly. Choice of a group delay measurement technique is dependent on the particular device under test and the resolution required.

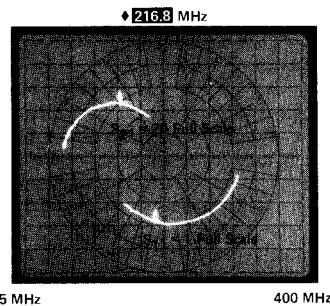

Figure 7. Simultaneous measurement of transistor S-parameters

An alternative method for measuring phase distortion is deviation from linear phase or differential phase. Deviations from linear phase can be measured by introducing enough electrical length in the network analyzer's reference channel to linearize a device's phase shift. Once this has been accomplished it is possible to observe any variations in phase shift linearity at high resolution. Since group delay is the derivative of phase ( $d\theta/d\omega$ ), nonlinearities in phase shift correspond directly to changes in a device's group delay. Introduction of electrical length in the measurement channel may be accomplished by physically adding cable, or it may be accomplished electronically on some network analyzers.

At lower frequency (typically  $\leq 50$  kHz) digital signal analysis using Fast Fourier Transformations (FFT) can also be used to determine the magnitude and phase of transfer characteristics. This subject is treated in the Signal Analysis section of this catalog.

### High Frequency Network Analysis

Measurements of voltages and currents become more and more difficult as frequency increases. Consequently, H, Y, and Z parameters lose their usefulness at high frequencies. High frequency network behavior can be better described using transmission line theory in terms of forward and reverse traveling waves. Thus, travelling waves make a logical replacement for voltages and currents in high frequency measurements.

Scattering parameters or S-parameters were developed to characterize linear networks at high frequencies. S-parameters define the ratios of reflected and transmitted traveling waves measured at the network ports.  $S_{11}$  is the complex reflection coefficient at port 1 and is the ratio of  $E_{r1}/E_{i1}$ , if  $E_{i2} = 0$  (port 2 terminated in its characteristic impedance).  $S_{21}$  is the complex transmission coefficient from port 1 to port 2,  $E_{r2}/E_{i1}$ , if  $E_{i2} = 0$ .  $E_i$  and  $E_r$  represent the

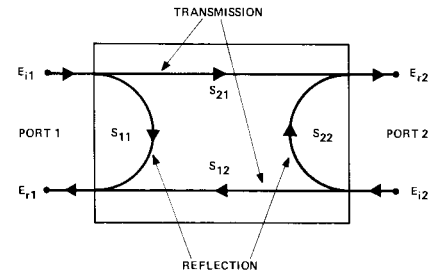

Figure 8. S-parameter model for a two-port linear network

amplitude and phase of the incident and emerging or reflected traveling waves. By reversing the ports and terminating port 1 in its characteristic impedance,  $S_{22}$  and  $S_{12}$  can be similarly defined. From these definitions, the following equations can be derived:

$$E_{r1} = S_{11}E_{i1} + S_{12}E_{i2}$$

$$E_{r2} = S_{21}E_{i1} + S_{22}E_{i2}$$

where incident signals act as independent variables determining the signals leaving the network. The definition of an S-parameter can be easily extended to multiport networks; measurement is also easily accomplished by terminating additional ports in their characteristic impedances. Thus, S-parameters completely describe linear network behavior in the same manner as low frequency parameters.

S-parameters offer numerous advantages to the microwave engineer because they are both easy to use and easy to measure. They are easy to measure because the device is terminated in its characteristic impedance allowing swept broadband frequency measurement without tuning, enhancing the stability of active devices, and permitting a test set up to be used for different devices. The design process is simplified because S-parameters are directly applicable to flow graph analysis. HP network analyzers and the appropriate test sets will measure and directly display  $S_{21}$  or  $S_{12}$  as gain or attenuation and  $S_{11}$  or  $S_{22}$  as reflection coefficient, return loss or impedance. Also, S-parameters may be directly related to h, y, and z-parameters through algebraic transformations.

### Additional Capabilities

The computational capabilities of a digital computer can complement the network analyzer's versatility through simplifying and speeding measurements, data processing, and accuracy enhancement. Hewlett-Packard has combined network analyzers and computers into computer systems and now offers some analyzers that may be easily interfaced with HP desktop computers through the Hewlett-Packard Interface Bus.

Precision design work and important manufacturing tolerances demand highly accurate measurements, but most errors in network measurements are complex quantities that vary as a function of frequency, making manual error correction prohibitive. However, the computer can make great contributions to measurement confidence by quickly and easily performing the complex mathematics for sophisticated error correction.



Aside from new levels of accuracy, computer controlled network analyzers can be programmed to set up and make many measurements automatically. The measurement process is further accelerated by the computer's ability to store, transform, summarize, and output data in a variety of formats on a number of peripherals. These capabilities make the computer controlled network analyzer ideal for both computationally aided design or automatic production testing.

#### Network Analyzer Product Line

Hewlett-Packard offers a complete line of network analyzers capable of measurements through the 1 Hz to 40 GHz frequency range. Further information and detailed specifications on individual network analyzers are available on the following pages (see matrix for specific page numbers).

#### 3575A

The 3575A measures Phase and Amplitude or Gain. With the 3575A, the complete response picture is available at a reasonable cost from a single instrument, over an 80 dB range, from 1 Hz to 13 MHz. The 3575A uses a broadband measurement technique, which is attractive because the measurement is not constrained by internal tracking source or dedicated external device. The 3575A is not dependent on the wave shape, thus measurements can be made on a variety of waveforms such as triangle and square waves.

#### 3040A/3042A

The 3040A is a network analysis system capable of measuring amplitude and phase to 13 MHz. Group delay is an optional capability. The system consists of a synthesizer signal source and a two-channel tracking detector. Measurement applications include filter design and production, amplifier testing, delay measurements on communication devices, and measurements on any linear two-port device.

The 3042A is a fully automatic system which uses the HP 9825T Desktop Computer as a computing controller. The memory, computational power and decision-making power of the computing controller extend the measurement solutions to complex networks in the lab or rapid production line testing. Accuracy can be improved by subtracting system errors from the measurements by using the memory and algebraic powers of the computer and supplied software.

#### 8407A

The 8407A Network Analyzer tracks the 8601A generator/sweeper (or the 8690B/8698B sweeper) from 100 kHz to 110 MHz. Measurement capabilities include:

- 1) Transmission (gain, loss, phase shift) and reflection (return loss, impedance) measured quickly and easily in either 50 $\Omega$  or 75 $\Omega$  by sweeping over the frequency range of interest.
- 2) Complex impedance [Z],  $\theta$ , or  $R \pm jX$  over the wide impedance range 0.1 $\Omega$  to > 10 k $\Omega$ .
- 3) Voltage and current transfer functions.
- 4) High impedance in-circuit probing.

A rectangular and polar display and various CRT overlays permit direct readings of parameters of interest as frequency is swept.

Applications are detailed in Application Notes 121-1, 121-2.

#### 8405A

The 8405A Vector Voltmeter is a dual-channel RF millivoltmeter and phasemeter. It reads the absolute voltages on either of two channels and simultaneously determines the phase relationship between them. CW measurements can be made over the frequency range 1 MHz to 1 GHz.

Besides its use as a voltmeter, applications of the 8405A include:

- 1) Transmission measurements (gain, loss, phase shift and return loss) in 50 $\Omega$  systems.
- 2) Group delay and amplitude modulation index.
- 3) In-circuit probing.
- 4) S-parameters in 50 $\Omega$  systems.

Application Notes 77-1, 77-3, 77-4, and 91 are available for more detail on the above measurements.

#### 8754A

The 8754A is a completely integrated stimulus/response system for testing a wide variety of networks (like filters, amplifiers, and attenuators) in the 4 to 1300 MHz frequency range. By combining a swept source, three channel tuned receiver, and polar/rectilinear CRT display into a single compact package outstanding performance can be achieved at an economical price. Magnitude, phase, polar reflection coefficient and impedance are all measured directly over 80 dB of spurious free dynamic range. Frequency accuracy is provided by a crystal marker system and since three receiver inputs are available, network transmission and reflection parameters can be measured simultaneously. Additionally, a complete line of 50 $\Omega$  and 75 $\Omega$  power splitters, transmission/reflection test sets, and S-parameter test sets, are available. High impedance probe can also be used if necessary and an external signal generator can be used directly to characterize narrow-band devices like crystal filters.

#### 8505A/8507B/8507C

The 8505A Network Analyzer provides measurement capability from 500 kHz to 1.3 GHz. Three RF input ports, each with 100 dB of dynamic range, makes possible simultaneous network measurements of reflection and transmission parameters. Two independent yet identical display channels are each capable of displaying magnitude, phase, deviation from linear phase and group delay of either the transmission or reflection characteristics of an RF network. These parameters can be displayed in rectangular, in polar coordinates or both formats at the same time. The swept source, which is an integral part of the analyzer, offers extreme frequency flexibility through seven different modes of operation.

The 8507B and 8507C are Automatic Network Analyzers using the 8505A with HP-IB interface and HP Desktop Computers as controllers. The "Learn" mode of operation extends the traditional automatic operation to a new level of operator convenience. Accuracy enhancement, formatting of data, and the speed and ease with which data can

be accumulated and summarized are all network measurement contributions made by the 8507B and 8507C.

#### 8755S

The 8755S Frequency Response Test Set is a magnitude only network analyzer system covering the frequency range of 10 MHz to 26.5 GHz. Further information available in the following pages.

#### 8410B/8409B

The 8410B network analyzer system measures the transmission and reflection characteristics of linear networks in the form of gain, attenuation phase shift, reflection coefficient, normalized impedance and S-parameters in the frequency range of 110 MHz to 40 GHz.

Harmonic frequency conversion of the RF to a constant IF is accomplished by the 8411A Harmonic Frequency Converter from 110 MHz to 12.4 GHz; the 8411A Option 018 operates from 110 MHz to 18 GHz. In the frequency ranges 18–26.5 GHz (K-band) and 26.5–40 GHz (R-band), the K8747A and R8747A Reflection/Transmission Test units use crystal mixers and a local oscillator to heterodyne the signals down into the range of the 8410B/8411A. In this manner, waveguide components can be measured from 18 to 40 GHz.

The 8410B is a ratiometer using both reference and test signal inputs; consequently, the sweeper output must be divided into channels. This is accomplished by a "Test Set" whose other major function can be to provide the switching required for making transmission and reflection measurements with minimum or no changes in the measurement setup. Hewlett-Packard offers test sets covering various frequency ranges and switching functions.

Another major instrument required in the 8410 measurement system is a unit for the detection and display of the IF amplitude and phase. Three plug-in displays (for the 8410B mainframe) are available for this purpose: a phase-gain indicator with meter readouts for CW measurements; a phase-gain display for displaying log amplitude and phase versus frequency; and a polar display for displaying amplitude and phase in polar coordinates.

The 8410B is capable of swept measurements over multi-octave bands through 18 GHz. Between 18 GHz and 40 GHz, 2 GHz windows may be viewed. Measurements of more than 60 dB of attenuation and 40 dB of gain are possible.

The HP 8409B Semi-Automatic Network Analyzer System is a practical solution to the need for automatic error-corrected RF and microwave network measurements using a simple and economical configuration. It is a complete measurement system consisting of the programmable 8620C Sweeper, the 8410B Network Analyzer System, and the 9825T Desktop Computer. It brings the major advantages in accuracy, speed, data collection, and operating convenience at a modest cost increase over the manual network analyzer system. Further information is available in Application Notes 117-1, 117-2 and 221A.

# NETWORK ANALYZERS

Complete characterization of linear networks (cont.)

## Network Analyzer Product Line Summary

Model	Frequency Range	Source	Measurement Capabilities
3582A Spectrum Analyzer Page 538	20 mHz to 25.599 kHz	Built-in source that is selectable as either random or pseudorandom. The noise signal is automatically band-limited and band-translated to match the analysis.	Transfer function amplitude and phase. Coherence function. Transient capture and analysis.
5420A Digital Signal Analyzer Page 544	16 mHz–25.6 kHz	Built-in random noise source.	Transfer function, coherence, power spectral density, Histogram, time record average, impulse response.
5451C Fourier Analyzer Page 546	DC to 50 kHz	Optional random pseudo-random or periodic source.	Same as 5420A
3575A Gain Phase Meter Page 468	1 Hz–13 MHz	None	Gain, Phase and Amplitude Low Frequency Analysis
3040A Manual Network Analyzer Page 465	50 Hz–13 MHz	3320B or 3330B Synthesizer	Amplitude and Phase Optional Group Delay Gain or Loss Linear Frequency Sweep
3042A Automatic Network Analyzer Page 466	50 Hz–13 MHz	3330B Synthesizer	9825T Desktop Computer as Systems Controller Complex Network Analysis Decision Making Ability Computational Capability
8407A Network Analyzer Page 480	100 kHz–110 MHz	8601A Generator / Sweeper 8690B/8698B Sweep Oscillator	Transfer Functions, Impedance in 50 $\Omega$ , 75 $\Omega$ Systems Complex Impedance 0.1 $\Omega$ to >10 k $\Omega$ High Impedance In-Circuit Probing S-parameters in 50 $\Omega$ , 75 $\Omega$ systems
8405A Vector Voltmeter Page 482	1 MHz–1 GHz (CW)	3200B Oscillator, VHF Signal Generators, 608E (VHF), 612A (UHF) 8654 (UHF), and 8640 A/B	Voltmeter Transfer Functions, Impedance in 50 $\Omega$ systems Group Delay, Amplitude Modulation Index S-parameters in 50 $\Omega$ systems
8754A Network Analyzer Page 470	4–1300 MHz	Swept source included external source usable.	Magnitude and phase transmission coefficient reflection coefficient and return loss S-parameters, impedance.
8505A RF Network Analyzer Page 472	500 kHz–1.3 GHz	Swept Source Included	Complex Transfer functions—Gain/Loss or S-parameters Complex Impedance— $\Gamma$ , Return Loss, $R \pm jX$ Distortion—Group Delay, Deviation from Linear Phase Digital Readout of Data while sweeping Frequency Counter included HP-IB with Learn Mode
8507B and 8507C Automatic Network Analyzers Page 478	500 kHz to 1300 MHz	Swept Source Included	8507B 9825T Desktop Computer with 8505A and 8501A 8507C 9845T Desktop Computer with 8505A and 8501A Automatic Measurements with Data Formatting and Graphics. Error Corrected Measurements
8755S Frequency Response Test Set Page 454	10 MHz to 26.5 GHz	8350, 8620, or 8690 Series Sweep Oscillators	Simultaneous Amplitude Measurements of Reflection and Transmission Characteristics of High Frequency Networks.
8410B Network Analyzer Page 483	110 MHz–40 GHz	8350, 8620, 8690 Series Sweep Oscillators	Transmission/Reflection Characteristics, S-Parameters 50 $\Omega$ Coax Measurements 110 MHz to 18 GHz Waveguide Measurements 8.2 GHz to 40 GHz Continuous Multioctave Measurements with 8620 Series Sweepers DC Bias for Semiconductor Measurements
8409B Automatic Network Analyzer Page 490	110 MHz–18 GHz	8350 or 8620 Series Sweep Oscillators	Automatic Transmission/Reflection Measurements Full Error Correction in Transmission/Reflection Measurements 8410B Network Analyzer System 9825S or 9845T Desktop Computer

# NETWORK ANALYZERS

Network analysis from 50 Hz to 13 MHz  
Model 3040A



- High resolution digital amplitude and phase measurements
- 100 dB dynamic range
- Precision digital sweep capability
- Narrow band analysis
- Optional group delay and limit test
- Full digital control via HP-IB

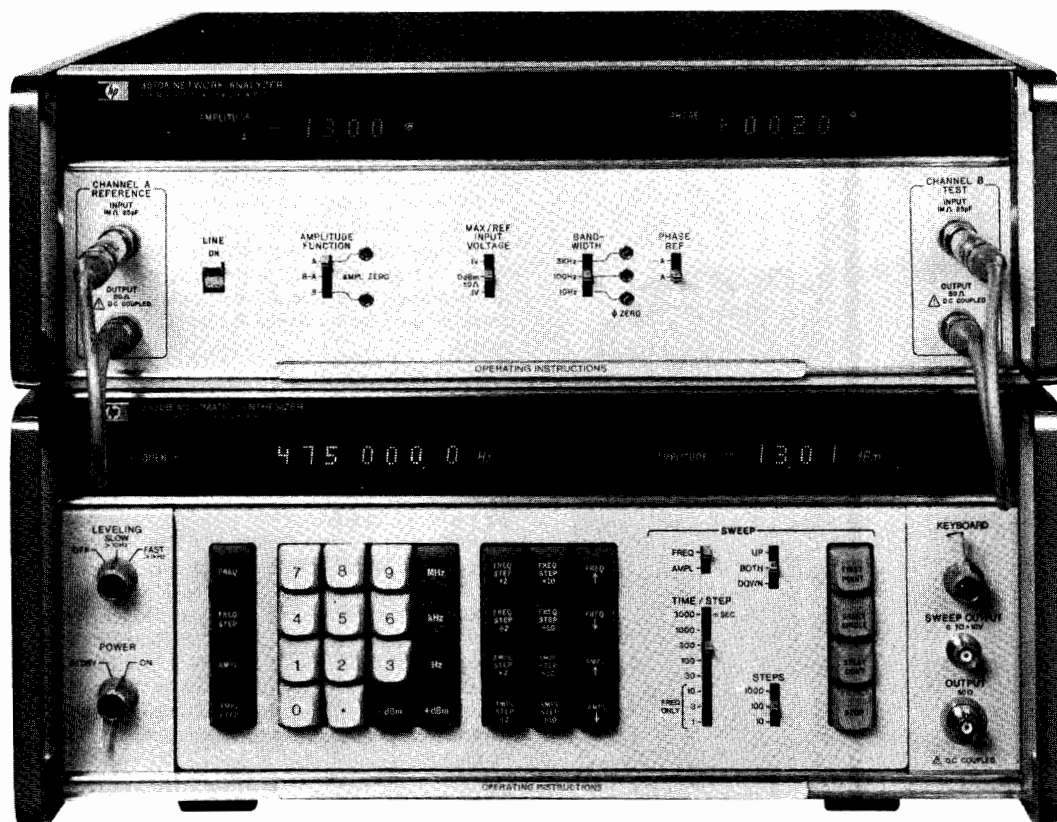

## Description

The 3040A Network Analyzer is designed to meet the demand for precise and fast characterization of both active and passive linear two-port devices. The Network Analyzer is a powerful bench system that makes digital amplitude, phase and group delay response (optional) measurements over a 50 Hz to 13 MHz frequency range. It uses the 3330B Automatic Synthesizer with leveled output and digital sweep capability to generate the local oscillator signal for the 3570A Tracking Receiver and to provide the stimulus to the device under test.

This system effectively combines the wide dynamic range and the high accuracy of the 3570A Tracking Receiver with the high resolution and stability of the 3330B Synthesizer, giving design, production and Q.A. engineers working at audio, video and RF frequencies the precision, convenience, and high information content of swept-frequency response measurements, but with the point by point accuracy of synthesized incremental frequency sweeps.

Residual FM, often a serious limitation to the frequency resolution of swept frequency measurements, is very low ( $\ll 1$  Hz) in the 3040A System, allowing accurate narrow band sweeps.

The 3570A Analyzer (Tracking Receiver) has two identical channels for fast, high accuracy "B-A" measurements of gain or insertion loss of two-port devices and to measure the phase shift between input and output ports. It can also function as a limit comparator to determine how closely the gain and phase response of a device matches that of a reference.

Both the passband and the stopband of a device can be examined in detail because the 3570A Analyzer has both a wide amplitude range of 120 dB (1  $\mu$ V to 1 V) and a high resolution display (0.01 dB increments). The digital readout also displays phase readings with 0.01° resolution.

Beyond the basic amplitude and phase measurements, the 3040A offers several automatic features (optional) not found in more conventional network analyzers.

One is Digital Offset: Values of amplitude and/or phase measured on a reference device are stored in the instrument's memory at the push of a button. Future measurements can then be displayed relative to the stored values. This could be used, for example, to quickly find the -3 dB passband limits of a filter or amplifier.

Another feature is Group Delay: As the synthesizer is stepped in frequency, the analyzer's internal digital processor calculates group delay from two phase shift measurements as  $T_d = \Delta\phi/360\Delta f$  sec.

A third one is Limit Test: High and low limits can be entered as digital words from an external controller. The analyzer can be set to stop or output a marker when a limit is reached. This capability is useful, for example, to precisely find the center frequency of a resonant circuit by stopping at the 0° phase reading.

The 3040A Network Analyzer introduces precision, convenience and built-in "intelligence" to the problem of characterizing the behavior of linear networks on the bench.



# NETWORK ANALYZERS

Automatic network analysis from 50 Hz to 13 MHz

Model 3042A

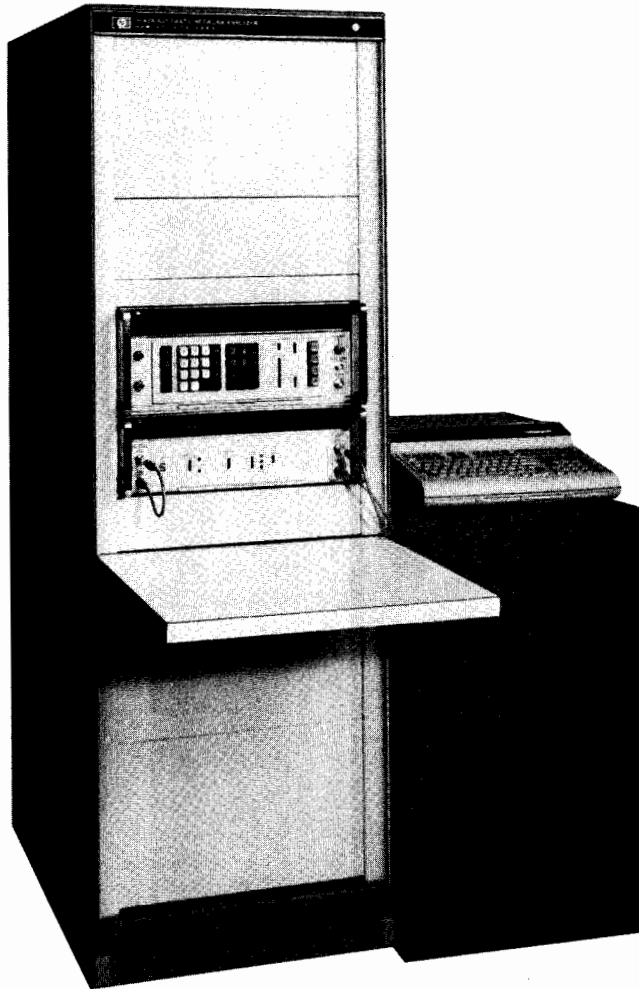

3042A Automatic Network Analyzer



## Description

The 3042A Automatic Network Analyzer is a highly powerful, fully automatic system that is designed to meet the demand for precision, speed, automation, simple operation and low cost in the area of fully characterizing active or passive linear two-port devices.

The 3042A system uniquely integrates the:

- wide dynamic range and high resolution of the 3570A Network Analyzer (tracking receiver)
- accuracy and high stability of the 3330B Synthesizer and
- the powerful computation, data processing and smart peripheral control capabilities of the 9825T Desktop Computer.

The resulting system provides a unique set of contributions to solve the problem of characterizing the behavior of linear two-port devices over the frequency range of 50 Hz to 13 MHz:

- Amplitude, phase and group delay measurement
- Wide amplitude range and high resolution
- Speed and precision in measurements
- Simplicity and flexibility in operation
- Data analysis and presentation of results
- Simple programming and powerful output
- Accuracy enhancement and decision making
- Full automation and substantial reduction in costs

- Amplitude, Phase and Group Delay Measurements
- Full automation and low cost
- Speed and precision in measurements
- Accuracy enhancement of results
- Data analysis and presentation of results
- Simplicity and flexibility in operation
- HP-IB systems interfacing
- 9825T Desktop Computer

The 3042A is a fully automatic two-channel Network Analyzer System that provides digital amplitude, phase and group delay measurements, on line data analysis, data reduction and decision making capability plus formatted graphic or tabular representation of results or data storage for further processing at a later time.

Environments such as production, quality assurance and the laboratory are now provided with the capability of extending precision network analysis to applications that were previously impractical because of the length of time it took to make the necessary measurements.

## Production Applications

In production applications the 3042A substantially reduces the time and cost of making a range of simple or complicated test on all types of components (e.g., crystals, amplifiers, filters and other analog devices). The system can run through a long series of tests on a device, checking performance at all specified points and deliver a simple pass/fail answer.

Additionally, automatically compiled test data provides excellent statistics for improved production control, more precise scheduling and accurate production cost analysis.

Test programs with built-in operator instructions minimize requirements for highly trained technicians, and uniform test procedures may easily be established. The 3042A's impact in the production environment can lead directly to a substantial increase in total production throughput while at the same time increasing the number of test parameters, resulting in greater product confidence and lower production cost.

## Quality Assurance Applications

In quality assurance applications, the 3042A significantly reduces the cost of test equipment necessary to assure a comprehensive product testing job. In addition, the system's inherently flexible HP-IB interface structure allows the system configuration to be easily changed by either simple software modifications or hardware additions. Adapting the 3042A System to an application, which may require a programmable power supply or contact closure to drive the device under test, becomes as simple as connecting the additional instruments via the standard HP-IB connector, loading a different program from the computing controller's cassette and running it. Skilled technicians may be relieved from repetitive yet demanding tasks and placed in positions that maximize the use of their knowledge and skills. The 3042A provides reliable and repeatable results. Various parameters may be tested in greater detail and in less time, resulting in greater product confidence and quality, in addition to lower warranty costs.

Automatically compiled test data provides excellent quality assurance statistics which can easily be presented in any formatted graphic or tabular form by an HP-IB plotter or line printer.

## Laboratory Applications

In laboratory applications, engineers gain greater insight into their circuit design due to the speed and ease with which data can be accumulated and summarized with the 3042A. The easy-to-use programming format allows easy-to-write, customized programs which solve specialized measurement problems in a fraction of the time required to manually perform and evaluate the same measurements or to write a corresponding computer program. In addition, the accuracy enhancement software furnished with the 3042A System increases accuracy of the system seven times over that of a single channel measurement (three times over a "B-A" measurement) by judiciously combining the capabilities of the instruments and the controller.

### System Control and Interface

The 3042A Automatic Network Analyzer incorporates the 9825T Desktop Computer as system controller, operator interface and data processor. The 9825T offers the power and speed of much larger computers but features a high level programming language and editing capabilities that allow nearly instant use of the system with minimal effort. System-operator interface is greatly simplified through the 9825T's alphanumeric display and typewriter-like keyboard.

### Summary

The 3042A Automatic Network Analyzer provides a complete solution to production, quality assurance and laboratory applications at audio, video and RF frequencies with accurate, reliable, repeatable and fast results plus the high information content that automatic gain-phase-delay measurements can give.

### Specifications 3040A and 3042A systems

**Sources** (Channel A & B outputs are isolated and electrically identical)

#### Frequency

**Range:** 0.1 to 13,000,999.9 Hz.

**Resolution:** 0.1 Hz (9 digits).

#### Amplitude

**Range:** +13.44 to -86.55 dBm (50Ω).

+11.68 to -88.31 dBm (75Ω option).

**Resolution:** 0.01 dB.

#### Accuracy

**Leveled frequency response (10 kHz reference)\***

10 Hz	13 MHz	
±0.05 dB		+13.44 dBm
±0.1 dB		-16.55 dBm
±0.2 dB		-36.55 dBm
±0.4 dB		-66.55 dBm
		-86.55 dBm

\*Add 0.5 dB for leveling switch in off position.

**Attenuator:** (10 kHz reference, 25°C ± 5°C) ± 0.2 dB/10 dB step of attenuation down from maximum output.

**Absolute:** (10 kHz, maximum output, 25°C ± 5°C) ± 0.45 dB.

**Stability:** (24 hr., 25°C ± 1°C): ± 0.01 dB.

**Impedance:** 50 or 75Ω (optional) ± 2%.

**Receivers** (Channel A & B inputs are electrically identical and both tuned precisely to the signal source's frequency)

#### Frequency

**Range:** 50 Hz to 13 MHz.

**Resolution:** 0.1 Hz.

**Selectivity:** 10 Hz, 100 Hz and 3 kHz bandwidths (60 dB/3 dB bandwidths, 20:1).

**Amplitude:** (Output is in dB relative to 1 V, 0 dBm or 0.1 V, corresponding to the position of the "Max/Ref Input Voltage" switch.)

**Measurement range:** 1 V rms to 1 μV rms.

**Dynamic range:** 0 to -100 dB (using A or B amplitude function), -100 dB to +100 dB (using B-A amplitude function).

**Resolution:** 0.01 dB.

**Accuracy:** (25°C ± 5°C): Accuracy of the 3042A is enhanced with software supplied with the system from 50 Hz to 10 MHz and over the top 20 dB of the dynamic range as shown below.

**Frequency response:** A or B "Amplitude Function" ± 0.5 dB; B-A "Amplitude Function" ± 0.1 dB; using Accuracy Enhancement Software ± 0.03 dB furnished with 3042A system.

### Linearity: (A or B amplitude function)

0 to -20 dB	± 0.2 dB
	± 0.06 dB with Accuracy Enhancement
-20 to -80 dB	± 0.5 dB
-80 to -100 dB	± 1.5 dB

### Stability (8 hr., 25°C ± 1°C after 3 hr. warmup)

	Temp. Coefficient (20°C-30°C)	
100 Hz & 3 kHz BW	± 0.05 dB	± 0.08 dB
10 kHz BW	± 0.08 dB	± 0.15 dB
	0 dB	-20 dB -80 dB

### Phase (Phase Reference is Channel A)

**Range:** -179.5° to +179.5° (display recycles).

**Resolution:** 0.01°.

**Accuracy:** (25°C ± 5°C).

**Frequency response** (Channel at 0 dB)

± 0.8°	± 0.2°	± 1°
50 Hz	100 Hz	1 MHz 13 MHz

**Amplitude response** Channel B within 6 dB of Channel A

± 0.4°	± 0.6°	± 1°
0 dB	-20 dB	-70 dB -80 dB

For channels at different levels (specification determination by lowest input).

± 1.3°	± 1.5°	± 3.5°
0 dB	-20 dB	-60 dB -80 dB*

\*Only specified to -70 dB for frequencies from 50 Hz to 80 kHz.

**Linearity:** ± 0.2° (Channel B within 6 dB of Channel A).

**Input impedance:** 1 MΩ ± 2% shunted by < 30 pF.

### General

**Programmability:** all controls, except power switches, are programmable using the HP-IB format.

**Ultra-high accuracy:** the 3040A/3042A systems can be coupled with an external device such as a calibrated attenuator to provide relative measurements whose amplitude accuracy is limited to the amplitude stability of the receiver and source and the accuracy of the external device.

### 3040A Options

The basic 3040A system options are listed below. For more information refer to the 3040A/3042A data sheet.

(Order Opt 110 or 111 and Opt 120 or 121)

<b>110:</b> standard 50Ω 3570A	\$8200
<b>111:</b> standard 75Ω 3570A	\$8200
<b>112:</b> Delay/Limit Test/Offset (Hardware)	\$490
<b>113:</b> Cable and Load Kit	\$95
<b>120:</b> standard 50Ω 3330B	\$8270
<b>121:</b> standard 75Ω 3330B	\$8270

### 3042A Options

The basic 3042A system options are listed below. For more information refer to the 3040A/3042A data sheet

<b>200:</b> 50Ω System	N/C
<b>201:</b> 75Ω System	N/C
<b>204:</b> 1201B Oscilloscope	\$3300

The 3042 system is fully integrated, tested, verified and specified as a system. It is supplied with complete software and documentation.

### 3042A Automatic Network Analyzer

Consisting of: 3330B Synthesizer, 3570A Network Analyzer, 9825T with 64k Bytes of memory, ROMs, Interface and documentation, 56" Rack.

**\$28,200**



# NETWORK ANALYZERS

Gain/phase meter  
Model 3575A

- dBV, dB ratio and degrees from 1 Hz to 13 MHz

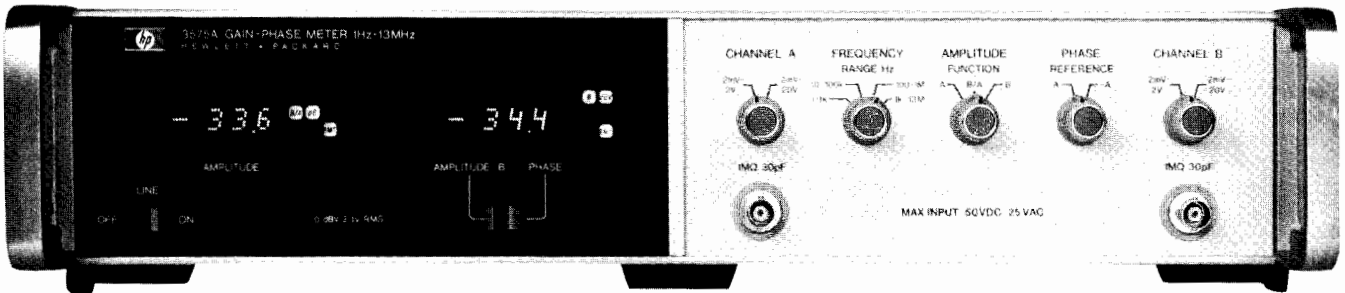

3575A Option 001 dual panel meters

## Description

The HP 3575A Gain-Phase Meter is a versatile two-channel analyzer which can measure and display the absolute amplitude level or amplitude ratio of signals present at the inputs. In addition, the 3575A can measure the phase relationship of the two signals. This analyzer is a broadband detector, which is easy to use because no frequency tuning is required.

Since a dedicated tracking source is not required to operate with the 3575A, a wide selection of stimuli is possible. This flexibility coupled with a variety of possible amplitude, gain and phase outputs (LED display, analog outputs, and optional BCD) give you a wide choice of cost/results tradeoffs. For example, you may wish to manually plot your network response data on a Bode diagram in which case a low cost sinewave oscillator stimulus may be used. For easier, quicker results you may select a sweeping oscillator and an x-y plotter and let the instruments plot your response. You may use a calculator or computer to control a programmable stimulus source and the 3575A to provide automatic measurements. Here you have a wide range of computation and output possibilities.

## Phase

The phase relationship of two signals is indicated over a range of  $\pm 192$  degrees with 0.1 degree resolution. A unique logic circuit (patent) design allows the 3575A to make stable phase measurements in the presence of noise. This feature minimizes the error to less than two degrees for a signal-to-noise ratio of 30 dB. One of three band limiting filters may be selected to get further noise rejection.

The 3575A is also capable of measuring the phase relationship of a variety of waveforms, such as square waves and triangle waves. Even harmonic and in-phase odd harmonic components of these signals cause no phase measurement error. For out-of-phase odd harmonic signal-to-harmonic ratios of 40 dB, measurement errors are less than 0.6 degree as shown in Figure 1.

## Amplitude

The amplitude of either channel or the ratio of the two can be measured over an 80 dB dynamic range and 100 dB measurement range. Resolution is 0.1 dB. Results are displayed in dBV for channel amplitude and dB for ratio measurements. Digit blanking and channel overload annunciators will turn on if the maximum allowable signal level at either channel input is exceeded.

## Readout

The standard three-digit LED display may be selected by the operator to indicate the amplitude of channel A or B, gain or phase. A second three-digit LED display is optionally available for simultaneous display of amplitude and phase readings. Lighted annunciators identify the measurement function, units and remote status.

## Programmable

Two programmable options both offer full control of front panel functions and BCD output of information (amplitude, ratio or phase) contained in both digital displays. The two options give the user a choice of negative true or positive true outputs.

## Applications

The 3575A can solve network analysis problems in the 1 Hz to 13 MHz frequency range where complex measurements (gain or phase or both) are required. A few of the many measurements it can make are: gain and phase response of feedback systems, envelope delay and return loss of transmission lines, complex impedance of components, and insertion loss of mixers and frequency doublers. Bode plots and Nichols charts are useful graphical tools for analyzing many of these response data.

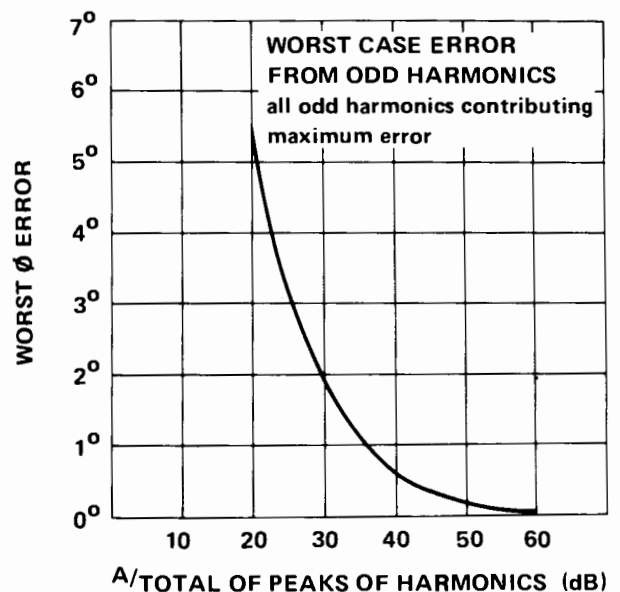
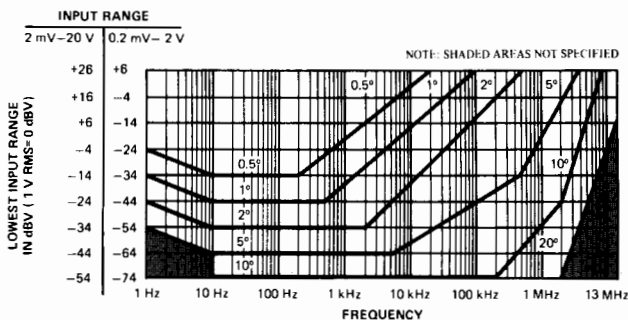

Figure 1. Worst case error from odd harmonics.

## Specifications

### Phase Accuracy\*



\*Conditions: Temperature: 25°C ± 10°C; Frequency range switch on lowest applicable range; Analog Output accuracy (rear panel).

**Input signal range:** 200 μV rms to 20 V rms.

### Harmonic Rejection

**Even harmonics:** no error.

**Odd harmonics:** (in phase) no error.

**Odd harmonics:** (out of phase) 0.57° worst case error when total odd harmonic distortion is 40 dB below the fundamental.

**Noise tolerance:** 2° error for a 10 kHz, 1 V sine wave on one channel. One volt sine wave added to Gaussian noise (limited to a 1 MHz bandwidth and 30 dB S/N ratio) on the other channel. The 100 Hz to 1 MHz frequency range was used.

### Display

**Range:** ±180° with 12° of overrange.

**Resolution:** 0.1°.

**Panel meter accuracy:** ±3 counts (0.3 degrees dB/dBV). The panel meter error must be added to the phase and amplitude errors to obtain the display error.

### Inputs

**Impedance:** 1 MΩ 30 pF.

**Protection:** ±50 V dc, 25 V rms.

**Response time to achieve 90% of final reading**

Frequency Range	Time
1 Hz to 1 kHz	20 s
10 Hz to 100 kHz	2 s
100 Hz to 1 MHz	0.2 s
1 kHz to 13 MHz	20 ms

Rear terminal inputs are available as a special (3575A-C09). Digital (Opt. 002). 0, +5 V; ground true. Twelve lines to fully program all functions.

### Outputs

#### Analog

**Phase:** 10 mV/degree.

**Amplitude:** 10 mV/dB or dBV.

**Output impedance:** 1 kΩ

**Digital (Opt 002):** 0, +5 V; ground true. 31 output lines (1-2-4-8 BCD).

**Digital readout:** 3½ digits with sign and annunciators. Four readings per second, fixed.

### Amplitude Accuracy\*

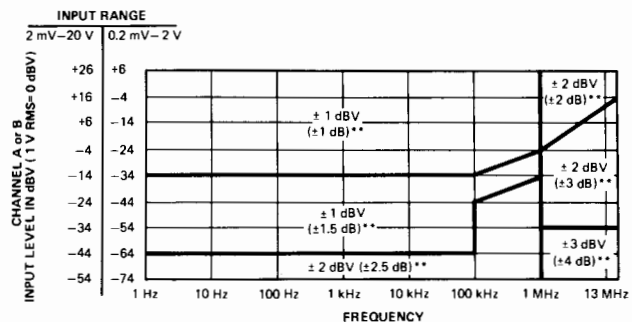

\*Conditions: Temperature: 25°C ± 10°C; accuracy applies to dB V and ratio measurements with the same frequency on both channels; for ratio measurements, the lowest level channel determines accuracy; analog output accuracy (rear panel).

\*\*Ratio (B/A) tolerances

**Amplitude functions:** A dBV, B dBV or B/A dB.

**Amplitude reference:** (A dBV, B dBV) 1 V rms = 0 dBV.

### Display

**Range:** A dBV, B dBV: -74 dBV to +26 dBV (in two ranges). B/A dB: -100 to +100 dB. (Both input signals must be within the range of 0.2 mV rms to 20 V rms)

**Resolution:** 0.1 dBV, 0.1 dB.

### Options

**001 Dual panel meters:** HP's 3575A Opt 001 is equipped with two digital readouts and two analog outputs for simultaneous amplitude and phase readings. This option has no additional measurement capability over the standard instrument.

**Dual analog outputs:** rear panel BNC connectors provide dc output voltages that correspond to the respective panel meter readings.

**002/003 Programmable:** 3575A Opt 002 and Opt 003 are equipped with dual panel meters and dual analog outputs (same as Opt 001) plus BCD outputs and complete remote control capability. Opt 002 has negative true output levels and Opt 003 has positive true output levels. BCD information from the 3575A (Opt 002) can be read by the 9800 series HP Desktop Computers with appropriate interfacing.

**908:** Rack Flange Kit.

### General

**Power:** 115 V/230 V ± 10%, 48 Hz to 60 Hz, 40 VA.

**Weight:** net, 8.3 kg (18.4 lb). Shipping, 11.3 kg (25.8 lb).

**Size:** 88 H x 425 W x 337 mm D (3.47" x 16.75" x 13.25").

**Accessories furnished:** extender boards, line cable and 50-pin connector (Opt 002 and 003 only).

### Options

**001:** Dual Readout

**002:** Programmable (negative true output levels)

**003:** Programmable (positive true output levels)

**908:** Rack Flange Kit

**910:** Extra Product Manual

### Price

add \$565

add \$980

add \$980

add \$25

add \$23

**3575A Gain/Phase Meter**

**\$3500**



# Network Analyzers

## RF Network Analyzer, 4 MHz to 1300 MHz (optional to 2600 MHz)

### Model 8754A

- New H26 option covers 4 to 2600 MHz
- Integrated source, receiver, and display
- Three inputs, two measurement channels
- 80 dB dynamic range

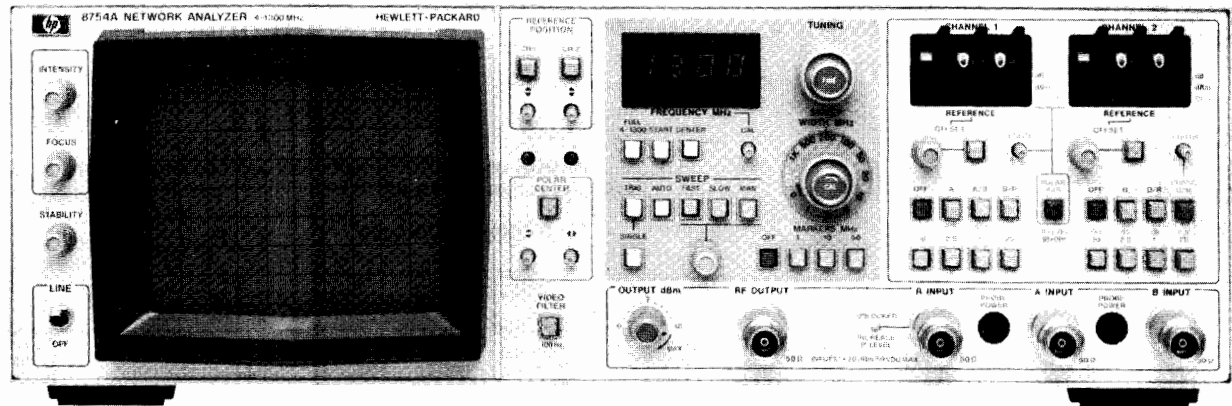

### Description

The 8754A is a complete stimulus/response test system which combines a 4-1300 MHz swept source, three-input narrowband, tuned receiver, and both rectilinear and polar displays in a compact package. The convenient built-in source incorporates digital display of the start or center frequency, the ability to sweep all or any portion of the 4-1300 MHz range, and crystal markers at 1, 10, or 50 MHz intervals to enable accurate frequency calibration and measurement. The receiver provides 80 dB dynamic range in two independent measurement channels to allow simultaneous measurement of any two transmission or reflection parameters using a single test setup. Measurements of absolute power, magnitude ratio, phase angle, and reflection coefficient are displayed on the fully calibrated CRT with resolutions up to 0.25 dB and 2.5 degrees per major division. With these features the 8754A offers a new level of operating convenience and technical performance to swept magnitude and phase measurements in laboratory, production, and field testing applications at an economical price.

A comprehensive line of 50Ω and 75Ω test sets allow maximum versatility in a wide range of applications. Matched cable sets, precision adapters, and transistor fixtures provide convenient reliable connections to the test device. Adding the 8750A Storage-Normalizer provides flicker-free rectilinear displays regardless of sweep rate and eliminates the need for grease pencils through automatic normalization of frequency response errors. For applications that require exceptional frequency accuracy and stability, the 8754A may be used with external sources such as the HP 8660 or HP 8640 signal generators.

Now, insertion and return loss measurements to 2600 MHz can be made with the H26 options of the 8754A Network Analyzer, the 8502A Test Set, and the 11850A Power Splitter. For a complete description of these options, ask your HP Field Engineer for a data sheet (HP Publication 5952-9298).

### 8754A Network Analyzer Specifications

#### Source

**Frequency range:** 4 MHz to 1300 MHz (optional to 2600 MHz).

**Sweep modes:** Linear full sweep (4 MHz to 1300 MHz) and calibrated sweep widths with variable start or center frequency.

**Sweep widths:** Selectable sweep width ranges from 1 to 1000 MHz in a 1, 2, 5 sequence, plus CW. A vernier allows continuous adjustment of sweep width within each range.

**Digital frequency readout:** Indicates start or center frequency with 1 MHz resolution.

**Markers:** Internal, crystal-generated harmonic markers at 50, 10, or 1 MHz intervals ( $\pm 0.01\%$  accuracy).

**Output power range:** 0 to typically +13 dBm;  $\pm 0.5$  dB flatness.

**Spectral purity (+10 dBm RF output level):**

**Residual FM** (swept and CW):  $\leq 7$  kHz RMS (10 kHz bandwidth).

**Harmonics:**  $-28$  dBc.

#### Receiver

**Frequency:** 4 MHz to 1300 MHz.

**Input Channels:** Two test inputs (A and B) and one reference (R) input.

**Impedance:** 50Ω ( $\leq 1.22$  SWR).

**Maximum input level:** 0 dBm at R, A, and B inputs.

**Damage level:** +20 dBm (50 Vdc).

**Noise level:**  $< -80$  dBm, A and B inputs.

**Minimum R input level:**  $-40$  dBm ( $\geq -40$  dBm required to operate R input phase-lock).

**Crosstalk between channels:**  $> 83$  dB.

**Magnitude frequency response** (flatness): Absolute (A, B):  $\leq \pm 1$  dB, Ratio (A/R, B/R):  $\leq \pm 0.3$  dB.

**Magnitude dynamic accuracy** (20 - 30°C):  $\pm 0.3$  dB from 0 to  $-50$  dBm,  $\pm 0.5$  dB from  $-50$  to  $-60$  dBm,  $\pm 1$  dB from  $-60$  to  $-70$  dBm,  $\pm 2.5$  dB from  $-70$  to  $-80$  dBm.

**Magnitude reference offset range:**  $\pm 199$  dB in 1 dB steps ( $\pm 0.1\%$ ). Vernier provides variable offset for calibration.

**Absolute power measurements** (A, B, and R): Typically  $\pm 0.5$  dBm at 0 dBm, 50 MHz input.

**Phase frequency response:**  $\pm 2.5^\circ$ .

**Phase range:**  $\pm 180^\circ$

**Phase dynamic accuracy:**  $\pm 2^\circ$  from 0 to  $-50$  dBm,  $\pm 4^\circ$  from  $-50$  to  $-70$  dBm.

**Phase reference offset range:**  $\pm 199^\circ$  in  $1^\circ$  steps ( $\pm 1\%$ ). Vernier provides variable offset for calibration.

**Electrical length/Reference plane extension:** Typically 0 to 16 cm length for transmission phase; typically 0 to 8 cm reference plane extension adjustment at reflection test port.

#### Display

**Measurement functions:** CRT displays either polar trace or Channel 1 and Channel 2 rectilinear traces.

**Reference position:** Independent reference lines for Channel 1 and Channel 2 and Polar center can be set to any position.

**Video filter:** Typically 100 Hz (10 kHz without filter).

**Graticule size:** Rectilinear, 10 cm by 8 cm; polar 8 cm in diameter.

**Smith chart overlays:** 2, 1, 0.2, and 0.1 full scale.

**CRT photography:** Tektronix C-5B Oscilloscope Camera is recommended. (UV illumination will not provide graticule exposure.)

**Resolution:** 10, 2.5, 1, 0.25 dB/major division. 90, 45, 10, 2.5°/major division.

**Accuracy:**  $\pm 2\% \pm 0.05$  divisions for rectilinear trace; within 2.5 mm for polar trace.

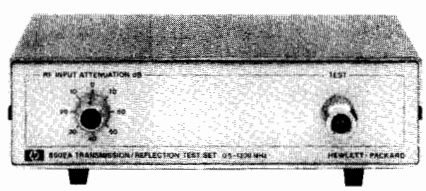

8502A

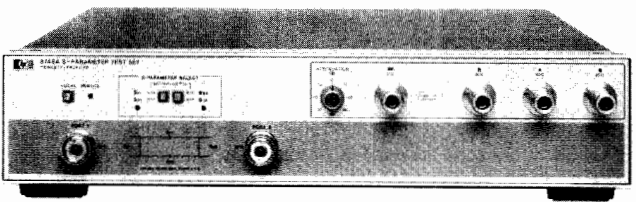

8748A

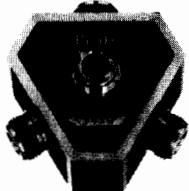

11850A

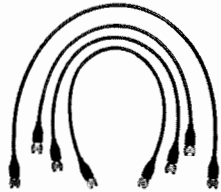

11851A

**General**

**Sweep output:** -5V to +5V.  
**External sweep inputs:** 0 to 10 V nominal.  
**X-Y recorder/External CRT output:**  
**Horizontal and vertical:** 0.1V/div.  
**Penlift/Blanking:** +5V Blanking and Penlift.  
**External marker input:** Typically -13 dBm RF signal produce a marker at the frequency of the RF signal.  
**Magnitude/Phase Output:** -10 mV/Degree and -100 mV/dB.  
**Probe power:** Two +15 Vdc and -12.6 Vdc.  
**Storage-Normalizer interfaces:** Directly compatible with the HP 8750A Storage-Normalizer. HP 8501A Storage-Normalizer requires a single internal adjustment for compatibility.  
**Programming connector:** Outputs include magnitude/phase and sweep outputs and inputs described above as well as measurement mode selection by TTL levels or contact closures.  
**External source:** The 8754A sweep-out voltage is provided to frequency modulate (sweep) an external signal generator for narrow-band measurement applications. A sweep input is provided to synchronize the CRT display for use with an externally swept source (8620 Series).  
**Temperature:**  
**Operating:** 0° to 55°C except where noted.  
**Storage:** -40°C to +75°C.  
**EMI:** VDE 0871/0875 and CISPR publication 11.  
**Safety:** Conforms to the requirements of IEC 348.  
**Power:** Selection of 100, 120, 220 and 240V +5% -10%. 48 to 66 Hz, 20 VA max.  
**Size:** 425.5 mm wide, 133 mm high, 505 mm deep (16 3/4 in x 5 1/4 in x 19 7/8 in).  
**Weight:** Net 16.8 kg (37 lb). Shipping 19 kg (42 lb).

**11850A 50Ω Three-Way Power Splitter**  
**11850B 75Ω Three-Way Power Splitter**

**General:** One output port provides the reference output and the other two output ports can be used for independent transmission measurements. Use the 11851A RF Cable Set for interconnections. Detailed specifications on page 477.

**8502A 50Ω Transmission/Reflection Test Set**  
**8502B 75Ω Transmission/Reflection Test Set**

**General:** Contains a power splitter and directional bridge to allow simultaneous transmission and reflection measurements. Use the 11851A RF Cable Set for interconnections. Detailed specifications on page 477.

**11851A RF Cable Set**

**General:** Three 61 cm (24") 50Ω cables, phase matched to ±4° and one 86 cm (34") 50Ω cable. Used with 8502A/B and 11850A/B. Detailed specifications on page 476.

**8748A 50Ω S-parameter Test Set Specifications**

**Frequency range:** 4 MHz to 1.3 GHz  
**Directivity:** ≥40 dB.  
**Frequency Response:**  
**Transmission<sup>1</sup> (S<sub>21</sub>, S<sub>12</sub>):** ±1 dB, ±12°  
**Reflection<sup>1</sup> (S<sub>11</sub>, S<sub>22</sub>):** ±2 dB, ±15°.  
**Port match<sup>2</sup>:**  
**Test Port 1 and 2:** ≥26 dB Return Loss (≤1.11 SWR).  
**Test Port 1 and 2 open/short ratio:** ≤±0.75 dB and ±6° from 4 to 1000 MHz; ≤0.9 dB and ±7.5° from 1000 MHz to 1300 MHz.  
**Insertion loss:**  
**Input to Test Port 1 or 2:** 13 dB nominal.  
**Input to Port A, B, or R:** 19 dB nominal.  
**Maximum operating level:** +20 dBm.  
**RF attenuator range:** 0 to 70 dB in 10 dB steps.  
**Test port connectors:** APC-7.  
**DC bias input range:** ±30 Vdc, ±200 mA.  
**Includes:** Cables for connection to 8754A and Reference Plane Extension Cable Kit.  
**Recommended accessory:** 11857A Test Port Extension Cables, 11608A Transistor Fixture, or 11600B, 11602B Transistor Fixtures.  
**Power:** 20 Vdc, supplied from 8754A via interface cable.  
**Size:** 432 mm wide, 90 mm high, 495 mm deep (17 in. × 3 1/2 in × 19 1/2 in.).  
**Weight:** Net, 9.1 kg (20 lb). Shipping, 11.3 kg (25 lb).

**11857A APC-7 Test Port Extension Cables**

**General:** Two precision 50Ω cables phase matched to ±2° to connect test device between 8748A test ports. Detailed specifications on page 477.

**Transistor fixtures**

**General:** Three transistor fixtures can be used with the 8748A. The 11600B and 11602B require use of the 11858A Transistor Fixture Adapter. The 11608A transistor fixture connects directly to the 8748A. Detailed specifications on pages 487 and 488.

**Adapter kits**

**General:** The 11853A, 11854A, 11855A, and 11856A accessory kits are available to provide precision Type N and BNC adapters and calibration standards for use with the 11850A/B, 8502A/B, and 8748A test setups. Detailed specifications on page 477.

<sup>1</sup> ± degrees, specified as deviation from linear phase.  
<sup>2</sup> Effective port match for ratio measurements.

**Ordering Information:**

	<b>Price</b>
<b>8754A Network Analyzer</b>	\$12,400
<b>Opt H26:</b> 4-2600 MHz	add \$1700
<b>Opt 907:</b> Front Handle Kit	add \$32
<b>Opt 908:</b> Rack Flange Kit	add \$25
<b>Opt 909:</b> Rack Mount Flange/Front Handle Kit	add \$55
<b>11850A 50Ω Three-Way Power Splitter</b>	\$675
<b>Opt H26:</b> 4-2600 MHz (50Ω)	add \$100
<b>11850B 75Ω Three-Way Power Splitter</b>	\$675
<b>8502A 50Ω Transmission/Reflection Test Set</b>	\$2,250
<b>Opt H26:</b> 4-2600 MHz (50Ω)	add \$300
<b>8502B 75Ω Transmission/Reflection Test Set</b>	\$2,250
<b>11851A RF Cable Set</b>	\$600
<b>11857A Test Port Extension Cables</b>	\$725
<b>8748A 50Ω S-Parameter Test Set</b>	\$5,600
<b>Opt 907:</b> Front Handle Kit	add \$28
<b>Opt 908:</b> Rack Flange Kit	add \$20
<b>Opt 909:</b> Rack Mount Flange/Front Handle Kit	add \$41

# NETWORK ANALYZERS

RF network analyzer, 500 kHz to 1.3 GHz  
Model 8505A

- 100 dB of dynamic range
- Digital readout of data with analog display
- Direct group delay and deviation from linear phase
- High performance sweep oscillator
- Complete family of 50Ω and 75Ω test sets
- Digital storage and normalization

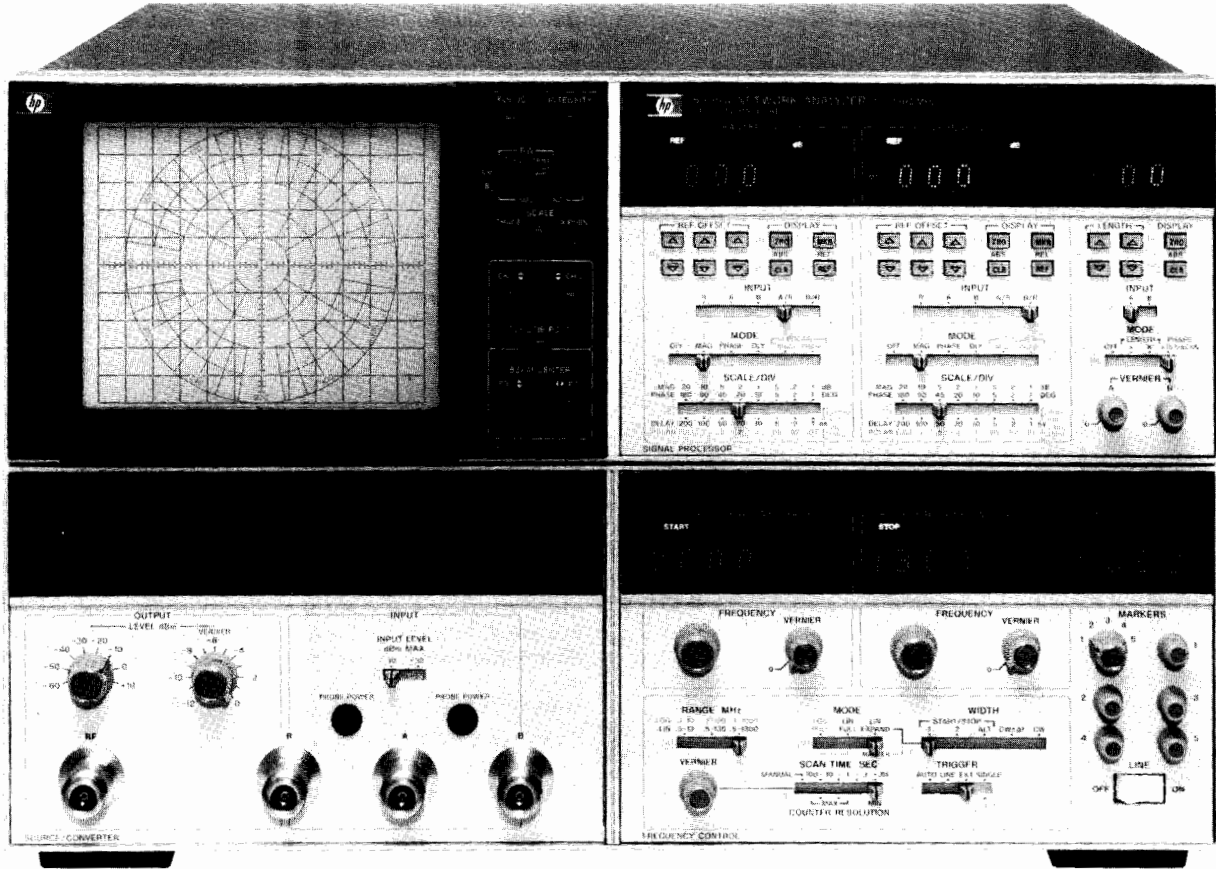

8505A



The HP 8505A is a high performance RF network analyzer operating over the 500 kHz to 1.3 GHz frequency range. It accurately and easily measures complex impedance, transfer functions and group delay of coaxial components and semiconductors. Because both magnitude and phase are measured, it is possible to completely characterize the linear behavior of either active or passive networks.

Since magnitude and phase can be measured and displayed over 100 dB of dynamic range (-10 to -110 dBm), it is a simple process for the 8505A to measure transmission loss of high rejection devices such as filters or gain and return loss of small signal devices like amplifiers. Distortion parameters like group delay, deviation from linear phase, and deviation from constant amplitude are measured in an equally straightforward manner. Group delay is measured and displayed directly to resolutions of 1 ns per major division using a new linear FM measurement technique. A unique new electrical line stretcher compensates for the linear phase shift of the device under test so that phase non-linearities may be examined at high resolution (1° per major division). Amplitude deviations with frequency can be similarly observed to resolutions 0.1 dB per major division with clear, crisp trace stability. In addition, it is possible to read out swept amplitude, phase and delay digitally at any one of five continuously variable markers with resolutions of 0.01 dB, 0.1°, and 0.1 ns respectively.

Many of the 8505A's high performance features and operating conveniences are derived from the fact that it is a completely integrated system including both the sweep oscillator and receiver. The basic instrument also includes a built-in frequency counter, polar and rectangular displays on the same CRT, the new electronic line stretcher, group delay measurement, and frequency selective digital readings of swept amplitude, phase and delay. The frequency counter with resolutions up to 100 Hz adds further precision to the measurements by allowing frequency as well as amplitude, phase and delay to be read out at any of the five markers. The 8505A is fully programmable in a straightforward fashion using the Hewlett-Packard Interface Bus (HP-IB operation is standard). The user can configure a customized automatic system or for convenience HP offers two fully configured systems, the 8507B and 8507C. (See pages 478, 479.)

Companion instruments include the 11850A Three Way Power Splitter for high resolution transmission comparison measurements, the 8502A Transmission/Reflection Bridge for simultaneous transmission and reflection measurements, and the 8503A S-parameter Test Set for complete characterization of two port devices in a single test set-up. The 8501A Storage-Normalizer adds digital storage, normalization, signal averaging, increased resolution, and graphics to 8505A measurements.



## 8505A Specifications

### Source

#### Frequency characteristics

**Frequency range:** 500 kHz to 1.3 GHz in three ranges; 500 kHz to 13 MHz, 500 kHz to 130 MHz and 500 kHz to 1.3 GHz.

**Swept frequency accuracy:**  $\pm 1\%$  of range for linear sweep.

**CW frequency accuracy:**  $\pm 2$  counts  $\pm$  time-base accuracy.

**Frequency stability:** better than  $\pm 0.01\%$  of reading  $\pm 0.01\%$  of frequency range over 10 minutes after warm-up.

**Frequency counter characteristics:** frequency counter measurements are made at any one of five continuously variable marker positions without interrupting the swept RF signal.

#### Resolution (least significant digit)

Frequency Range (MHz)	0.5 to 13	0.5 to 130	0.5 to 1300
10 ms Sweep time	10 kHz	100 kHz	1 MHz
100 ms Sweep time	1 kHz	10 kHz	100 kHz
>1 second Sweep time	100Hz	1 kHz	10 kHz

**Counter accuracy:**  $\pm 2$  counts  $\pm$  time-base accuracy.

**Marker frequency accuracy:**  $\pm 0.002\%$  of scan width  $\pm$  counter accuracy. Measured in CW  $\pm \Delta F$

**Time-base accuracy:**  $\pm 5$  ppm  $\pm 1$  ppm/ $^{\circ}\text{C}$   $\pm 3$  ppm/90 days

#### Output characteristics

**Output power range:**  $+10$  dBm to  $-72$  dBm.

**Attenuator accuracy:**  $\pm 1.5$  dBm over 70 dB range.

**Vernier accuracy:**  $\pm 1$  dB.

**Leveling:**  $\pm 0.5$  dB from 500 kHz to 1.3 GHz.

**Impedance:** 50 $\Omega$ ;  $\geq 16$  dB return loss at  $-10$  dBm output level ( $< 1.38$  SWR).

#### Residual FM

Frequency Range (MHz)	0.5 to 13	0.5 to 130	0.5 to 1300
Residual FM	20 Hz rms	200 Hz rms	2 kHz rms
Bandwidth	20 Hz-1 kHz	20 Hz-1 kHz	20 Hz-10 kHz

**Harmonics:**  $> 25$  dB below main signal at  $+10$  dBm output level.

**Sub-harmonics and spurious signals:** below  $-50$  dBm at  $+10$  dBm output level.

#### General characteristics

**Sweep modes:** Linear Full, Log Full, Start/Stop 1, Start/Stop 2, Alternate, CW  $\pm \Delta F$ , and CW.

**Sweep times:** 10 ms to 100 s in decade ranges.

**Trigger modes:** auto, line sync., single scan or external sync.

**RF Output connector:** Type N female

#### Receiver

**Frequency range:** 500 kHz to 1.3 GHz

#### Input characteristics

**Input channels:** three channels (R, A, and B) with 100 dB dynamic range.

**Damage level:**  $+20$  dBm or  $\geq 50$  V dc.

**Noise** (10 kHz BW):  $-110$  dBm from 10 to 1300 MHz;  $-100$  dBm from 2 to 10 MHz;  $-95$  dBm from 0.5 to 2 MHz.

**Impedance:** 50 $\Omega$ ;  $\geq 20$  dB return loss ( $< 1.22$  SWR). Typically  $> 26$  dB return loss ( $< 1.11$  SWR).

#### Magnitude characteristics

**Absolute frequency response** (A, B, R):  $\pm 1.5$  dB

**Ratio frequency response** (A/R, B/R):  $\pm 0.3$  dB from 0.5 MHz to 1.3 GHz.

**Dynamic accuracy:**  $\pm 0.01$  dB/dB from  $-20$  to  $-40$  dBm;  $\pm 0.2$  dB from  $-10$  to  $-50$  dBm;  $\pm 0.5$  dB from  $-50$  to  $-70$  dBm;  $\pm 1.0$  dB from  $-70$  to  $-90$  dBm;  $\pm 2.0$  dB from  $-90$  to  $-100$  dBm;  $\pm 4.0$  dB from  $-100$  to  $-110$  dBm.

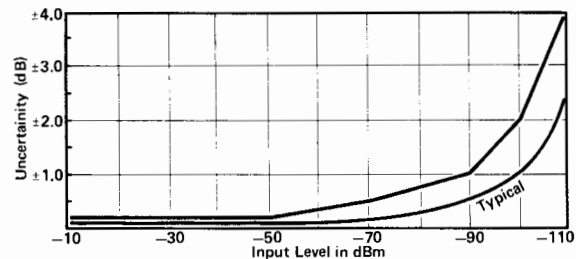

**Crosstalk error limits:**  $> 100$  dB isolation between inputs.

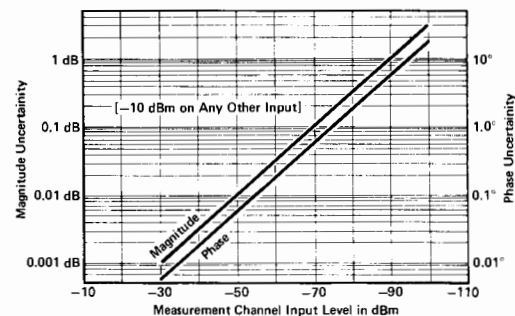

**Reference offset range:**  $\pm 199.9$  dB

**Reference offset accuracy:**  $\pm 0.03$  dB  $\pm 0.003$  dB/dB of offset

**Marker measurement resolution:** 0.01 dB over any  $< 10$  dB range; 0.1 dB over any  $\geq 10$  dB range.

**CRT Display resolution:** 0.1 dB to 20 dB/division in 1, 2, 5 sequence.

#### Phase characteristics

**Frequency response:**  $\pm 3^{\circ}$  from 500 kHz to 750 MHz;  $\pm 5^{\circ}$  from 750 MHz to 1.3 GHz.

**Range:**  $\pm 180^{\circ}$ .

**Accuracy:**  $\pm 0.01^{\circ}$ /degree for  $\pm 170^{\circ}$ ;  $\pm 0.01^{\circ}$ /degree  $\pm 0.5^{\circ}$  for  $\pm 180^{\circ}$ .

**Dynamic accuracy** (in 10 kHz Bandwidth):  $\pm 0.02^{\circ}$ /dB from  $-20$  to  $-40$  dBm;  $\pm 0.5^{\circ}$  from  $-10$  to  $-50$  dBm;  $\pm 1^{\circ}$  from  $-50$  to  $-70$  dBm;  $\pm 3^{\circ}$  from  $-70$  to  $-90$  dBm.

**Crosstalk:** see amplitude crosstalk specification.

**Reference offset accuracy:**  $\pm 0.3^{\circ} \pm 0.5\%$  of offset.

**Marker measurement resolution:**  $\pm 0.1^{\circ}$  over  $< 100^{\circ}$  range and  $1^{\circ}$  for  $\geq 100^{\circ}$  range.

**CRT display resolution:**  $1^{\circ}$  to  $180^{\circ}$  per division in 8 steps.

**Polar characteristics:** Frequency Response, Dynamic Response, Reference Offset and Marker Measurement specifications are the same as magnitude and phase characteristics.

**CRT display accuracy:** actual value is within less than 3 mm circle of the displayed value.

**Tracking between dB offset controls and polar full switch positions:**  $\leq 0.2$  dB.

**Full scale magnitude range:** 1 to 0.01 in a 1, 0.5, 0.2 sequence.

#### Delay characteristics

**Frequency response:**  $\pm 1$  ns from 500 kHz to 1.3 GHz.

**Delay accuracy:**  $\pm 3\%$  of reading  $\pm 3$  units (Units = 1ns for 0.5 to 1300 MHz range, 10 ns for 0.5 to 130 MHz range, and 100 ns for 0.5 to 13 MHz range.)

<sup>1</sup>  $\pm 3$  units may be calibrated out with thru connection.

# NETWORK ANALYZERS

RF network analyzer, 500 kHz to 1.3 GHz (cont.)

Model 8505A

### Range resolution and aperture

Frequency Range (MHz)	0.5 to 13	0.5 to 130	0.5 to 1300
Range	0 to 80 $\mu$ s	0 to 8 $\mu$ s	0 to 800 ns
Resolution			
CRT:	100 ns	10 ns	1 ns
Marker:	100 ns	10 ns	1 ns
Marker with Delay scale/Div Switch set to:	10 ns (<1 $\mu$ s)	1 ns ( $\leq$ 100 ns)	0.1 ns ( $\leq$ 10 ns)
Aperture <sup>1</sup>	7 kHz	20 kHz	200 kHz

Reference offset range:  $\pm$  1999 dB

Reference offset accuracy:  $\pm$  0.3 units  $\pm$  0.3% of offset.

Electrical length/ref. plane extension characteristics

Calibrated electrical length range and resolution:<sup>2</sup>

Frequency Range (MHz)	0.5 to 13	0.5 to 130	0.5 to 1300
Range X1	$\pm$ 19.9 m	$\pm$ 1.99 m	$\pm$ 19.9 cm
X10	$\pm$ 100 m	$\pm$ 10 m	$\pm$ 1 m
Resolution X1	10 cm	1 cm	0.1 cm
X10	1 m	10 cm	1 cm

Calibrated electrical length accuracy:  $\pm$  3% of reading  $\pm$  1% of range.

Linear phase substitution (degrees/scan) Range:  $\pm$  1700° per scan with 0° offset.

$$\frac{\pm 1.4 \text{ km}}{\text{scan width (MHz)}} \quad \text{or} \quad \frac{\pm 4.7 \mu\text{s}}{\text{scan width (MHz)}}$$

Linear phase substitution resolution: 10°

Linear phase substitution accuracy:  $\pm$  3% of reading  $\pm$  10°/scan

Phase compensation linearity: <0.2% of phase slope inserted.

### General Characteristics

RF input connectors: type N Female

Display bandwidth: selectable IF bandwidths of 10 kHz and 1 kHz. A video filter position is also provided.

CRT overlays: Smith Charts (2, 1, 0.5, 0.2, 0.1 full scale), Log Charts (10 MHz, 100 MHz and 1000 MHz).

CRT photography: HP 197A Opt 006 camera or HP 197A with 10375A Bezel Adapter required to fit 8505A display. A CRT illumination control is provided.

### Auxiliary outputs

Channel 1 and 2 outputs: 0.25 V/display division.

Sweep output: 0.25 V/display division.

Pen lift: DC coupled, 200 mA current sink.

### Programming

The 8505A has a remote programming interface using the Hewlett-Packard Interface Bus with Learn Mode. Included are one 2 m (HP 10631B) and one 0.5 m (HP 10631D) HP-IB cables.

Power: selection of 100, 120, 200 or 240 V +5% -10%. 50 to 60 Hz approximately 275 watts.

Size: 279 H x 426 W x 553 mm D (11 x 16.75 x 21.75 in.).

## 8505A Opt 005 Specifications (Phase-Lock Operation)

### Source

#### Frequency characteristics

Modes (8505A): CW and CW  $\pm$   $\Delta$ F only.

Range and Resolution (8505A and 8660C/86602B/86632B): the total frequency range is 1 to 1300 MHz with a CW resolution of 1 Hz (set on the 8660C). The maximum  $\pm$   $\Delta$ F and  $\pm$   $\Delta$ F resolution is 1.3 kHz and 1 Hz from 0.5 to 13 MHz, 13 kHz and 10 Hz from 0.5 to 130 MHz, and 130 kHz and 100 Hz from 0.5 to 1300 MHz respectively.

Range and Resolution (8505A and 8640B Opt 002): (Total Frequency Range: 0.5 to 1024 MHz).

	8640 Frequency Ranges (MHz)	8505A Frequency Range (MHz)		
		0.5-13	0.5-130	0.5-1300
CW Resolution (Set on 8640B)	0.5-1 1-13 16-128 128-1024	0.1 Hz 1 Hz	10 Hz	10 Hz 100 Hz
$\pm$ $\Delta$ F Resolution (Set on 8505A)	All freq. Ranges	1 Hz	10 Hz	100 Hz
Max $\pm$ $\Delta$ F	0.5-8 8-16 16-1024	1.3 kHz 1.3 kHz	13 kHz 13 kHz	130 kHz

Typical system residual FM: the Residual FM of a phase-locked 8505A approaches that of the 8660C/86602B/86632B or 8640B.

### Output characteristics

Power output, harmonics, spurious outputs, RF noise, etc. are determined by the 8660C with 86602B and 86632B or the 8640B.

### Receiver

Magnitude and phase characteristics are unchanged with the exception of the dynamic range specification.

### Delay characteristics

Accuracy:  $\pm$  3% of reading  $\pm$  3 units. Units: 1  $\mu$ s for 0.5-1300 MHz; 10  $\mu$ s for 0.5-130 MHz; 100  $\mu$ s for 0.5-13 MHz.

Range, resolution and aperture: (8660C/86602B/86632B or 86640B)

(8505A indicated units x 1000)

	8505 Frequency Range (MHz)		
	0.5-13	0.5-130	0.5-1300
Range	0-80 ms	0-8 ms	0-800 $\mu$ s
Resolution:			
CRT & Digital Marker	100 $\mu$ s	10 $\mu$ s	1 $\mu$ s
Digital Marker with	10 $\mu$ s	1 $\mu$ s	100 ns
Delay Switch Setting	<1 ms	<100 $\mu$ s	<10 $\mu$ s
Aperture <sup>1</sup>	1.5 kHz	2.0 kHz	4.0 kHz

### Electrical length characteristics

Accuracy:  $\pm$  3% of reading  $\pm$  3% of range.

Calibrated electrical length, range, and resolution: (8660C/86602B/86632B or 8640): (8505A digital readouts x 1000) give electrical length 1000 times larger and resolution divided by 1000.

### General Characteristics

#### RF Inputs

L.O. drive input level: 10 dBm  $\pm$  2 dB (Rear panel BNC).

RF drive input level: 0 dBm  $\pm$  2 dB (Rear panel BNC).

Tunable FM output:  $\pm$  1.3 V maximum (rear panel BNC with output level controlled by  $\pm$   $\Delta$ F control on front panel of 8505A).  $\pm$  1.3 V output is obtained independent of the frequency range switch setting.

Capture range of phase-lock loop: 100 kHz (0.5-13 MHz Range); 400 kHz (0.5-130 MHz Range); 4 MHz (0.5-1300 MHz Range).

Standard/phase-lock operation: rear panel switch can disable all phase-lock circuitry when using the instrument in its standard (non phase-lock) operating mode.

<sup>1</sup>Typical measurement Aperture using linear FM modulation technique.

<sup>2</sup>Vernier provides continuous adjustment of electrical length. Calibrated Electrical Length Linearity:  $\Delta\phi = 0.7\% \times 1.2 f(\text{MHz}) \times 1$  (meters).

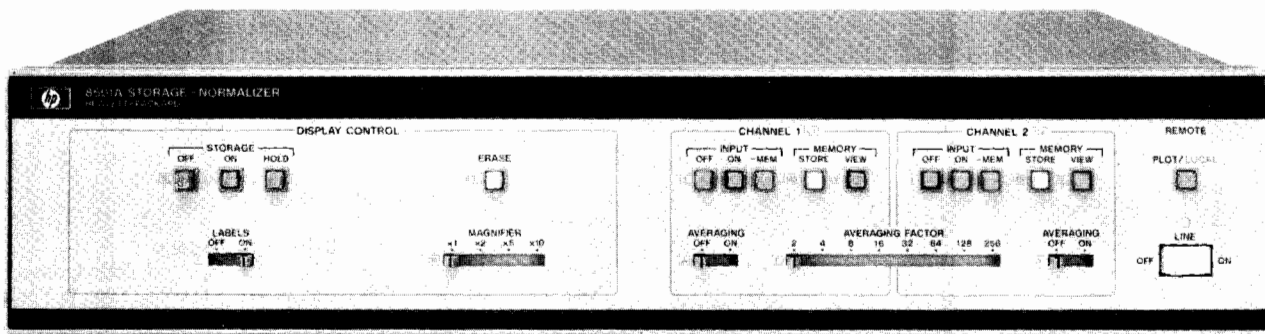

8501A



## Description

The 8501A high performance Storage-Normalizer is a dedicated accessory that extends the measurement capability of your HP 8505A RF Network Analyzer (500 kHz to 1.3 GHz). Flicker free displays with digital storage and CRT annotation of major control settings provide convenient easy documentation. Using normalization, frequency response errors are simply removed. In addition the 8501A can digitally average signals to dramatically improve signal-to-noise ratios and magnify the display for high accuracy measurements. With a desktop computing controller, computer graphics capability is added to the 8505A for displaying corrected data, operator messages, or computer programs.

## 8501A Specifications

### Display

#### Rectangular displays

**Horizontal display resolution:** two display channels, 500 points per channel (0.2% of full scale, 0.24 mm).

**Vertical display resolution:** 500 points displayed full scale (0.2% of full scale) plus a 50% overrange (250 points) both above and below full screen.

#### Polar displays

**Display resolution:** two display channels, 250 points per polar display (0.2% of full scale, 0.2 mm in X and Y).

**Display tracking:** visual offsets between direct 8505A and stored displays are approximately  $\pm 1/2$  CRT minor division ( $\pm 1$  mm).

**Horizontal input sweep times:** 100 sec max/10 ms min.

**Conversion time:** 10 ms max for 500  $\pm 2$  data points (20  $\mu$ s per point).

**Display refresh time:** nominally 20 ms depending upon information displayed.

**Line generator:** a line generation technique is used to connect points on a CRT display, yielding a smooth continuous trace.

**Markers:** all five markers are also available in the digital display mode.

### Output

**Auxiliary outputs XYZ:** (BNC female connectors on rear panel).

X—1 V full screen, 83 mV/div (12 div).

Y—1 V full screen, 100 mV/div (10 div).

Z—1 volt blanks display, +2 volt unblanks display. (Signal compatible for all HP CRT displays such as 1332, 1304, or 1310).

**Offsets:** The X, Y, and polar display offsets can be adjusted over a  $\pm 10\%$  range of screen by means of potentiometers on the rear panel of the 8501A.

**Labeling interface:** all major control settings of the 8505A and 8503A and phase-lock indication are displayed on the CRT.

## HP-IB Interface

### HP-IB Interface capabilities

#### Remote programming

**Learn mode:** this feature provides the ability to output the current instrument state to a computing controller.

**Input data:** data for graphics or other purposes can be sent to the 8501A at a rate of:

**ASCII mode:** 600 points per second.

**Binary mode:** 10000 points per second.

**Output data:** data can be read from the 8501A at a rate of:

**ASCII mode:** 800 points per second.

**Binary mode:** 9000 points per second.

**Graphics:** data for graphics can be read into the 8501A and viewed in two types of displays.

**Text displays:** 22 lines of text with 54 characters per line can be displayed on the CRT.

**Vector display:** lines can be drawn on the display between any two points with a resolution of 432 points in x and 360 points in y (nominal).

### General

#### Display controls

**Storage Off:** the 8501A is bypassed so the display returns to normal analog operation.

**Storage On:** turns on digitally stored display.

**Storage Hold:** the current display is not updated and is frozen for CRT photography or further analysis.

**Erase:** display and memory are erased.

**Labels:** switches all display labeling on or off.

**Magnifier:** expands the display by a factor of 1, 2, 5, or 10.

#### Processing functions (Channel 1 and 2)

**Input Off:** display of channel 1 (2) is blanked.

**Input On:** channel 1 (2) measurement is displayed.

**Input Mem:** the difference between the channel 1 (2) measurement and the stored memory content is displayed (normalization).

**Memory Store:** the current measurement is stored in memory.

**Memory View:** the stored memory content is displayed.

**Averaging:** the data averaging function for channel 1 (2) is switched on or off.

**Averaging Factor:** the degree of averaging is selectable from 2, 4, 8 ... to 256. The current averaged trace is always displayed and updated at the sweep rate.

**Local:** returns the 8501A control to the front panel from remote HP-IB control.

**Includes:** 0.5 m HP-IB cable and the processor interconnect cable.

**Accessories:** the 11864A Accessory Kit provides the labeling interface boards and connectors for the 8505A. 8505A Opt 007 has these boards and connectors installed.

**Power:** selection of 100, 120, 220, or 240 V +5%–10%, 50 to 60 Hz and <140 VA (<140 watts).

**Size:** 90 H x 426 W x 534 mm D (3.5 x 16.75 x 21.0 in.).

**Weight:** net, 12.25 kg (27 lb). Shipping, 14 kg (31 lb).





# NETWORK ANALYZERS

RF network analyzer, 500 kHz to 1.3 GHz (cont.)

Model 8505A

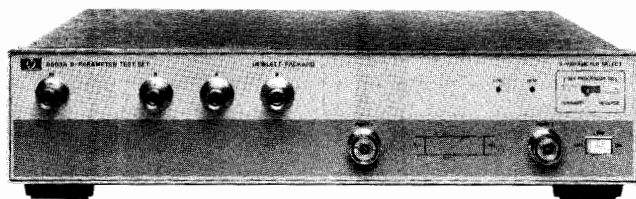

8503A

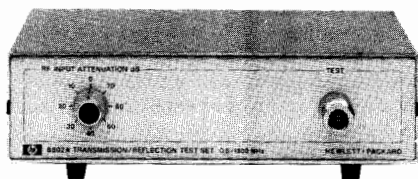

8502A

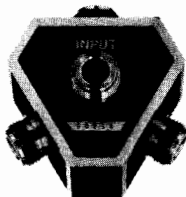

11850A

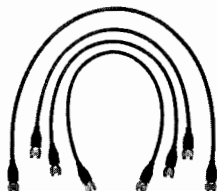

11851A

## 8502A 50Ω Transmission/Reflection Test Set

## 8502B 75Ω Transmission/Reflection Test Set

**Frequency range:** 500 kHz to 1.3 GHz.

**Impedance:** 8502A, 50Ω; 8502B 75Ω.

**Directivity:**  $\geq 40$  dB.

### Frequency response

**Transmission:**  $\leq \pm 0.8$  dB and  $\leq \pm 8^\circ$ .

**Reflection:**  $\leq \pm 1.5$  dB and  $\leq 15^\circ$  from 0.5–1300 MHz;  $\leq \pm 10^\circ$  from 2–1300 MHz.

### Port match

**Test port:**  $\geq 26$  dB return loss from 2–1300 MHz ( $\geq 24$  dB for 8502B);  $\geq 20$  dB return loss from 0.5–2 MHz ( $\geq 18$  dB for 8502B).

**Test port open/short ratio:**  $\pm 0.75$  dB and  $\pm 6^\circ$  from 2–1000 MHz ( $\pm 0.9$  dB and  $\pm 7.5^\circ$  for 8502B);  $\pm 0.9$  dB and  $\pm 7.5^\circ$  from 1000–1300 MHz;  $\pm 1.25$  dB and  $\pm 10^\circ$  from 0.5–2 MHz.

**Reference and reflection ports:**  $\geq 25$  dB return loss from 2–1000 MHz;  $\geq 23$  dB return loss from 0.5–1300 MHz.

**Input port:**  $\geq 23$  dB return loss.

### Nominal insertion loss:

**Input to Test Port:** 13 dB (8502A), 19 dB (8502B).

**Input to Reference Port:** 19 dB (8502A), 19 dB (8502B).

**Input to Reflection Port:** 19 dB (8502A), 31 dB (8502B).

**Maximum operating level:** +20 dBm.

**Damage level:** 1 watt CW.

**RF Attenuator range:** 0 to 70 dB in 10-dB steps.

**Connectors test port:** 50Ω Type N Female for 8502A and 75Ω Type N Female for 8502B; all other RF ports 50Ω Type N Female; Bias input, BNC Female.

**DC Bias input:**  $\pm 30$  V dc and  $\pm 200$  mA.

**Includes:** 8502B includes 50Ω/75Ω minimum loss pad.

**Recommended accessory:** 11851A RF Cable Kit for either 8502A or 8502B.

**Size:** 61.5 H x 101 W x 204 mm D (2.44 x 7.5 x 8.0 in.).

**Weight:** net, 1.7 kg (3.25 lb). Shipping, 3.1 kg (7 lb).

## 8503A 50Ω S-Parameter Test Set

## 8503B 75Ω S-Parameter Test Set

**Frequency range:** 500 kHz to 1.3 GHz.

**Impedance:** 8503A, 50Ω; 8503B, 75Ω.

**Directivity:**  $\geq 40$  dB.

### Frequency response

**Transmission ( $S_{12}$ ,  $S_{21}$ ):**  $\pm 1$  dB,  $\pm 12^\circ$  from 0.5–1300 MHz.

**Reflection ( $S_{11}$ ,  $S_{22}$ ):**  $\pm 2$  dB,  $\pm 20^\circ$  from 0.5–1300 MHz;  $\pm 15^\circ$  from 2–1300 MHz.

### Port match

**Test ports 1 and 2:**  $\geq 26$  dB return loss from 2–1300 MHz ( $\geq 24$  dB for 8503B),  $\geq 20$  dB return loss from 0.5–2 MHz ( $\geq 18$  dB for 8503B).

**Test port 1 and 2 Open/Short Ratio:**  $\leq \pm 0.75$  dB and  $\pm 6^\circ$  from 2–1000 MHz ( $\pm 0.9$  dB and  $\pm 7.5^\circ$  for 8503B);  $\leq \pm 0.9$  dB and  $7.5^\circ$  from 1000–1300 MHz;  $\pm 1.25$  dB and  $\pm 10^\circ$  from 0.5–2 MHz.

**Reference and return ports:**  $\geq 23$  dB return loss from 2–1000 MHz;  $\geq 20$  dB return loss from 0.5–2 MHz and 1000–1300 MHz.

**RF input port:** 20 dB return loss from 0.5–1300 MHz.

**Maximum operating level:** +20 dBm.

**Damage level:** 1 watt CW.

**Connectors:** test ports. 50Ω APC-7 for 8503A and 75Ω Type-N Female for 8503B; all other RF connectors, 50Ω Type-N Female; Bias inputs BNC Female.

**DC Bias input:** 30 V dc,  $\pm 200$  mA.

**Includes:** four 19 cm (7.5") cables for connection to 8505A.

**Recommended accessory:** 11857A 50Ω Test Port Extension Cables or 11857B/C 75Ω Test Port Extension Cables.

**Programming:** Programming via HP-IB. 0.5 m HP-IB cable included.

**Power:** 100, 120, 220, or 240 V +5%–10%, 50 or 60 Hz. Approx. 10 watts (15 watts for 8503B).

**Size:** 90 H x 426 W x 553 mm D (3.5 x 16.75 x 21.0 in.).

**Weight:** net, 9.1 kg (20 lb). Shipping, 11.3 kg (25 lb).

## Accessories

### 11850A 50Ω Power Splitter

### 11850B 75Ω Power Splitter

**Frequency range:** DC to 1.3 GHz.

**Impedance:** 11850A, 50Ω; 11850B, 75Ω.

**Tracking between any two output ports:**  $\leq 0.1$  dB and  $\leq 1.5^\circ$ .

**Equivalent source match (ratio or leveling):**  $\geq 32$  dB return loss ( $\leq 1.05$  SWR).

**Input port match:**  $\geq 20$  dB return loss.

**Nominal insertion loss:** 9.54 dB for 11850A; 7.78 dB for 11850B.

**Frequency response absolute:** Input to Output  $\leq 0.2$  dB.

**Maximum operating level:** +20 dBm.

**Burn-out level:**  $\geq 1$  watt CW.

**Connectors:** 11850A, 50Ω Type N female; 11850B, three outputs 75Ω Type N female, RF input 50Ω Type N female.

**Recommended accessory:** 11851A RF Cable Kit.

**Includes:** 11850B includes three (3) 50Ω/75Ω Minimum Loss Pads

**Size:** 46 H x 67 W x 67 mm D (1.88 x 2.63 x 2.63 in.).

**Weight:** net, 1.8 kg (4 lb). Shipping, 3.1 kg (7 lb).

**11851A RF Cable Kit**

**General:** Three 610 mm (24 in.) 50Ω cables phase matched to 4° at 1.3 GHz and one cable 860 mm (34 in.). Connectors are Type N Male. Recommended for use with 8502A/B Transmission/Reflection Test Set and 11850A/B Power Splitter.

**Weight:** net, 0.91 kg (2 lb). Shipping, 1.36 kg (3 lb)

**11852A 50Ω/75Ω Minimum Loss Pad**

**General:** the 11852A is a low SWR minimum loss pad required for transmission measurements on 75Ω devices with 8505A receiver (50Ω).

**Frequency range:** DC to 1.3 GHz.

**Insertion loss:** 5.7 dB.

**Return loss:** 75Ω side, 50Ω side terminated: Typically ≥34dB (≤1.04 SWR). 50Ω side, 75Ω side terminated: Typically ≥30 dB (≤1.06 SWR).

**Typical Flatness:** ≤0.1 dB from DC to 1.3 GHz.

**Maximum input power:** 250 mW (+24 dBm).

**Connectors:** 50Ω Type N female and 75Ω Type N male.

**Size:** 14 D x 70 mm L (0.56 x 2.75 in.).

**Weight:** net, 0.11 kg (4 oz). Shipping, 0.26 kg (9 oz).

**11853A 50Ω Type N Accessory Kit**

**General:** the 11853A furnishes the RF components required for measurement of devices with 50 Type N Connectors using the 11850A, 8502A, or 8503A (8503A also requires the 85032A). Kit contains a Type N Female short, a Type N Male short, two Type N Male barrels, two Type N Female barrels and storage case.

**Weight:** net, 0.91 kg (2 lb). Shipping, 1.36 kg (3 lb).

**11854A 50Ω BNC Accessory Kit**

**General:** the 11854A furnishes the RF components required for measurement of devices with 50 BNC Connectors using the 11850A, 8502A, or 8503A (8503A also requires the 85032A). Kit contains two Type N Male to BNC Female adapters, two Type N Male to BNC Male adapters, two Type N Female to BNC Female adapters, two Type N Female to BNC Male adapters, a BNC Male short and storage case.

**Weight:** net, 1.13 kg (2½ lb).

**11855A 75Ω Type N Accessory Kit**

**General:** the 11855A provides the RF connecting hardware generally required for measurement of devices with 75Ω Type N connectors using the 8502B, 8503B or 11850B. Kit contains two 75Ω Type N Male barrels, two Type N Female barrels, a 75Ω Type N Female short, a 75Ω Type N Male short, a 75Ω Type N Male termination, and storage case.

**Weight:** net, 0.91 kg (2 lb). Shipping, 1.36 kg (3 lb).

**11856A 75Ω BNC Accessory Kit**

**General:** the 11856A provides the RF connecting hardware generally required for measurement of devices with 75Ω BNC connectors using the 8502B, 11850B, or 8503B. Kit contains two Type N Male to BNC Female adapters, two Type N Male to BNC Male adapters, two Type N Female to BNC Female adapters, two Type N Female to BNC Male adapters, a BNC Male short, a 75Ω BNC Male termination, and storage case.

**Weight:** net, 0.91 kg (2 lb). Shipping, 1.36 kg (3 lb).

**11857A 50Ω APC-7 Test Port Extension Cables**

**General:** two precision 61 cm (24 in.) cables, phase matched to 4° at 1.3 GHz for use with 8503A S-parameter test set. Connectors are 50Ω APC-7.

**Weight:** net, 0.91 kg (2 lb). Shipping, 2.3 kg (5 lb).

**11857B 75Ω Type N Test Port Extension Cables**

**General:** two precision 61 cm (24 in.) cables, phase matched to 2° at 1.3 GHz for use with 8503B S-parameter test set. One cable has a 75Ω Type N Male connectors on both ends; the other has one Type N Male and one Type N Female connector.

**Weight:** net, 0.91 kg (2 lb). Shipping, 2.3 kg (5 lb).

**11858A Transistor Fixture Adapter**

**General:** the 11858A adapts the 11600B and 11602B transistor Fixtures (vertical test port configuration) to the 8503A S-parameter test set. Connectors are APC-7.

**Weight:** net, 0.91 kg (2 lb). Shipping, 1.36 kg (3 lb).

**Ordering Information**

	<b>Price</b>
8505A RF Network Analyzer	\$32,500
Opt 005: Phase Lock	\$1,000
Opt 007: Labeling Interface	\$600
Opt 907: Front Handle Kit	\$64
Opt 908: Rack Mounting Kit	\$50
Opt 909: Rack Mounting/Front Handle Kit	\$110
Opt 910: Extra Manual	\$75
8503A 50Ω S-Parameter Test Set	\$5,600
Opt 907: Front Handle Kit	\$28
Opt 908: Rack Mounting Kit	\$32
Opt 909: Rack Mounting/Front Handle Kit	\$51
Opt 910: Extra Manuals	\$10
8503B 75Ω S-Parameter Test Set	\$5,600
Opt 907: Front Handle Kit	\$28
Opt 908: Rack Mounting Kit	\$32
Opt 909: Rack Mounting/Front Handle Kit	\$45
Opt 910: Extra Manual	\$10
8501A Storage Normalizer	\$6,100
Opt 907: Front Handle Kit	\$28
Opt 908: Rack Mounting Kit	\$32
Opt 909: Rack Mounting/Front Handle Kit	\$51
Opt 910: Extra Manual	\$25
8502A 50Ω Transmission/Reflection Test Set	\$2,250
Opt 910: Extra Manual	\$6
8502B 75Ω Transmission/Reflection Test Set	\$2,250
Opt 910: Extra Manual	\$6
11850A 50Ω Power Splitter	\$675
11850B 75Ω Power Splitter	\$675
11851A RF Cable Kit	\$600
11852A 50Ω to 75Ω Minimum Loss Pad	\$140
11853A 50Ω Type N Accessory Kit	\$150
11854A 50Ω BNC Accessory Kit	\$165
11855A 75Ω Type N Accessory Kit	\$200
11856A 75Ω BNC Accessory Kit	\$260
11857A 50 Ω APC-7 Test Port Extension Cables	\$725
11857B 75Ω Type N Test Port Extension Cables	\$1,175
11858A Transistor Fixture Adapter	\$575
11864A Labeling Interface Kit	\$725

# NETWORK ANALYZERS

Automatic network analyzers, 500 kHz to 1.3 GHz

Models 8507B/C

- Improve productivity in lab and factory
- Accuracy enhancement
- Ease of operation via HP-IB
- 9825T or 9845T Desktop Computer
- Learn mode
- Graphics Transfer with 8507C

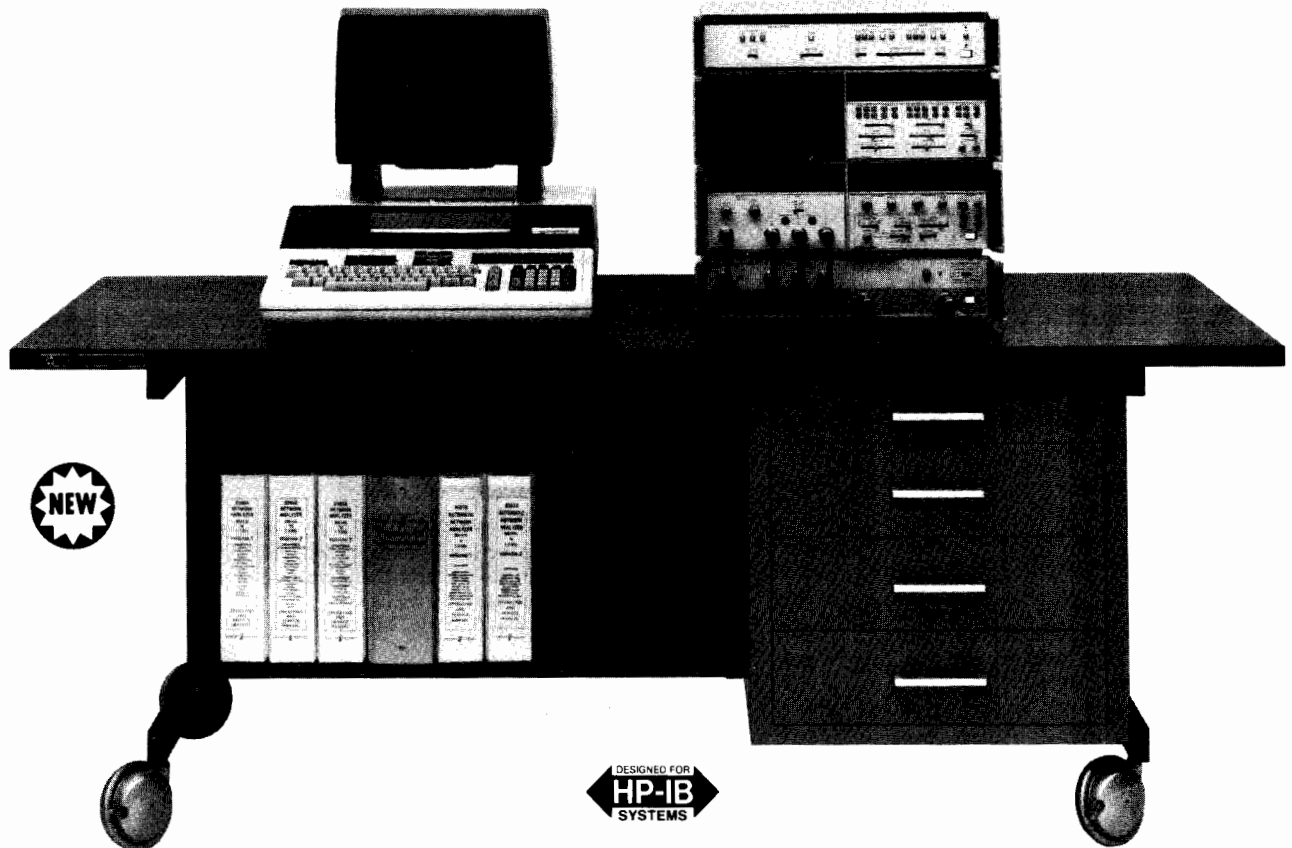

8507C

## Description

Two factory-configured automatic systems based on the 8505A Network Analyzer are available. The 8507B is controlled by the 9825T Desktop Computer; the new 8507C is controlled by the 9845T. Mating the versatile, easy-to-use desktop computer with the completely programmable network analyzer produces a powerful RF network measurement tool for both lab and production uses.

## Cost Effective Solutions

In laboratory applications, engineers gain greater circuit insight via the speed and ease with which the 8507B/C accumulate and summarize data. With only a few hours training, engineers with no previous programming experience have been able to write customized programs which solve specialized measurement problems. In production environments, the 8507B/C can dramatically reduce the time and cost of making complicated limit tests on all types of components. Testing programs with built-in operator instructions can minimize training cost, assure uniform test procedures and eliminate subjective decisions.

## Simplicity and Flexibility of HP-IB

Configuration of the standard 8507B/C or your own customized system is a simple matter since it is programmed via the Hewlett-Packard Interface Bus. For example, perhaps your RF measurement application requires a programmable power supply for transistor biasing or a digital voltmeter. Simply choose an instrument from the selection of HP-IB interfaceable instruments and add it to your 8507B/C using universal HP-IB cables.

It is equally easy to get started making measurements since the 8507B/C come with software that complements the Hewlett-Packard hardware. Included are programs for accuracy enhancement and general network analyzer applications. In addition, a system check-out program is provided. This is all made possible because HP-IB is not just IEEE-488, but the hardware, documentation and support that delivers the shortest path to a measurement system.

## Learn Mode Operation

The "Learn" mode of operation has extended traditional automatic operation to a new level of operator convenience. The desktop computer can accept (Learn) a data string from the network analyzer which defines all of the manually set front panel control settings. This is accomplished by a single keystroke. Once stored in the desktop computer (or permanently recorded on a cartridge) this data string can then be used to automatically return the network analyzer to its exact original test conditions. And this can all be done without the operator ever writing a single program line!

## Programmability Features

- 1) The unique marker mode operation provides a real time display simultaneously with digital data logging. This mode insures that no glitches are missed, even when taking a limited number of data points.
- 2) The human-engineered HP-IB coding alleviates complex code tables. To program a function, simply type its name (shortened to first letter if you like) and its switch position number (numbered 1 to N left to right).

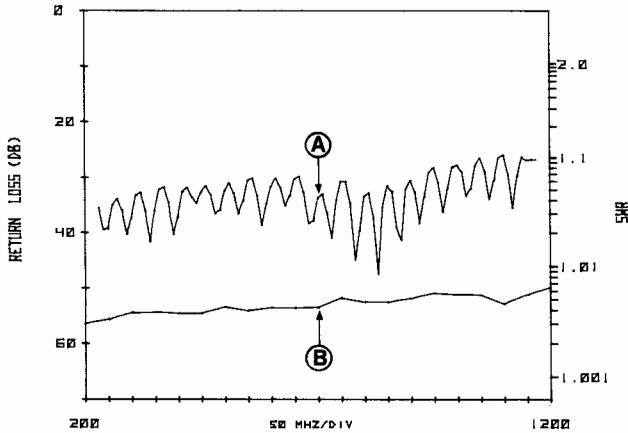

### Accuracy enhancement

Each 8507B/C system is supplied with a program that permits frequency tracking, mismatch, and directivity errors to be characterized by applying known standards. These stored system errors are then removed from the measurement of the unknown to provide a degree of accuracy exceeding that possible with the standard 8505A.

### An example

The plots on the left show the result of software accuracy enhancement. Curve A depicts raw measurements on a 50 dB return loss termination at the end of a six-foot RG 214 cable—a typical application problem in testing in temperature chambers. Curve B shows the results after calibrating at the end of the cable—a 25 dB improvement.

### Data in the form you need

With these desktop computers, it is a simple matter to obtain customized printed or plotted outputs. Or you may want to store data on tape for later analysis. Data can be analyzed or statistically summarized directly, bypassing the laborious and error-prone task of manually recording and re-entering data. Data reformatting such as converting return loss to SWR or S-parameters to y-parameters can be accomplished also.

## 8507B/C Automatic Network Analyzers

### Includes:

- 8505A Network Analyzer
- 8503A S-Parameter Test Set
- APC-7 Calibration Kit (85031A)
- Systems Table and Cables
- System Assembly and check-out

### And with the 8507B:

- 9825T Desktop Computer (62K bytes memory) with String-Advanced Programming, Plotter-General I/O—Extended I/O 9866 Printer, cradle and interface
- HP-IB interface

### With the 8507C:

- 9845T Desktop Computer with 187k bytes memory
- Graphics ROM & subsystem, I/O ROM
- Second tape cartridge drive
- Thermal line printer
- HP-IB interface

**Power:** 8507B—115 or 230 V, 50–60 Hz, 750 VA.

8507C—115 or 230 V, 50–60 Hz, 735 VA

**Weight:** 8507B—net 227 kg (500 lb). Shipping, 272 kg (600 lb)

8507C—net 255 kg (561 lb). Shipping, 312 kg (686 lb)

### Ordering information

	<b>Price</b>
<b>8507B</b> Automatic Network Analyzer	\$63,280
<b>Opt 002:</b> Delete Systems Table	less \$900
<b>Opt 003:</b> Delete 9825T Calculator	less \$14,250
<b>Opt 005:</b> Phase lock	\$1,000
<b>Opt 910:</b> Extra Set of Manuals	\$175
<b>8507C</b> Automatic Network Analyzer	\$74,105
<b>Opt 002:</b> Delete Systems Table	less \$900
<b>Opt 003:</b> Delete 9845T	less \$24,850
<b>Opt 005:</b> Phase Lock	\$1,000
<b>Opt 910:</b> Extra Set of Manuals	\$200
<b>85010B</b> Basic Measurements Program Pac for 8501A and 9825T	\$100
<b>85030B</b> Applications Pac Software for 8505A/8503A/9845T	\$250
<b>85030C</b> Applications Pac Software for 8505A/8501A/8503A/9845T	\$250
<b>85031A</b> Verification/APC-7 Calibration Kit (Included with 8507B/C)	\$600
<b>85032A</b> Type-N Calibration Kit	\$83
<b>85033A</b> SMA Calibration Kit	\$700
<b>85036A</b> 75Ω Type-N Calibration Kit	\$1200

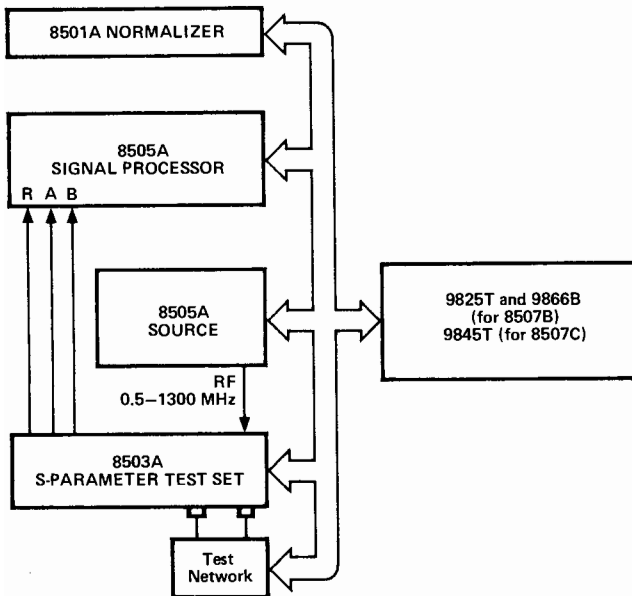

## 8507B Calibration Kits

### 85031A Verification and APC-7 Calibration Kits

Included with 8507B/C. Contains Precision APC-7 Load, APC-7 Short, and two verification standards.

### 85032A Type N Calibration Kit

For use with 8507B/C. Contains 2 APC-7 to N-Male Adapters, 2 APC-7 to N-Female Adapters, 1 N-Male Load, 1 N-Female Load, 1 N-Female Short, 1 N-Male Short.

### 85033A SMA Calibration Kit

For use with 8507B/C. Contains 2 APC-7 to SMA-Male Adapters, 2 APC-7 to SMA-Female Adapters, 1 SMA-Male Load, 1 SMA-Female Load, 1 SMA-Female Short, and 1 SMA-Male Short.

### 85036A 75Ω Type N Calibration Kit

For use with the 8507B/C Opt E75 75Ω Automatic Network Analyzer. Contains 1 Type N Male Termination, 1 Type N Female Termination, 1 Type N Male Short, 1 Type N Female Short, 1 Type N Male Barrel, and 1 Type N Female Barrel.

# NETWORK ANALYZERS

## RF network analyzer system, 100 kHz to 110 MHz

### Model 8407 system

- Complete swept characterization of linear networks
- Modular system flexibility
- 50Ω and 75Ω measurements
- Digital storage

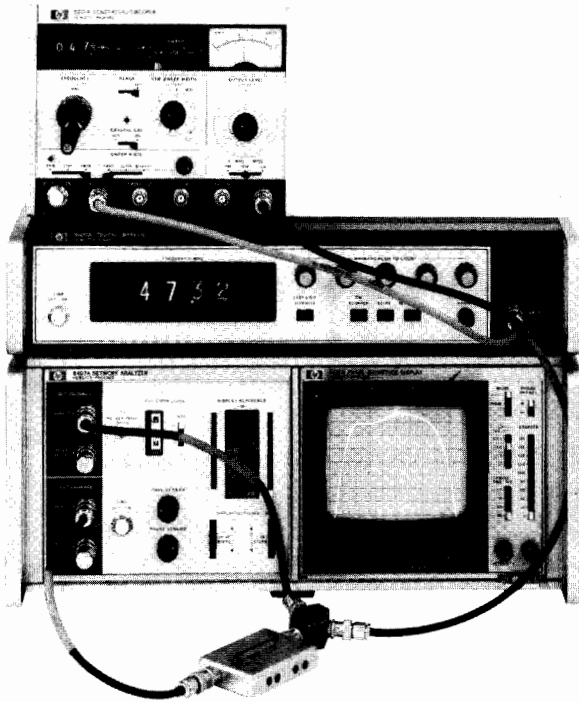

Swept measurements for either designing or testing are made with ease by HP's versatile 8407 Network Analyzer System. Since phase as well as magnitude is measured by a Network Analyzer, the behavior of both active and passive linear networks can be completely characterized from 100 kHz to 110 MHz by swept measurement.

Measurements of gain, loss, phase shift (compute group delay), return loss, and complex reflection coefficient are all possible in either 50Ω or 75Ω systems. These measurements allow the linear behavior of the networks under test to be completely characterized by their complex S-Parameters. Swept complex impedance [Z] and  $\theta$  (for [Z] from 0.1Ω to >10 kΩ) as well as voltage and current transfer functions are also measured quickly and easily by the 8407 system. Typical linear networks designed and tested with the 8407 are filters, amplifiers, attenuators, antennas, detectors, cables, and recording heads.

Much of the 8407's versatility stems from its modular construction which allows the system to perform a variety of measurements or be economically tailored to one application. The basic instruments of the 8407 system are: The HP 8407A Network Analyzer, one of two REQUIRED sources (HP 8601A Sweeper/Generator or HP 8690B/8698B Sweep Oscillator), choice of two plug-in displays (HP 8412A Phase-Magnitude Display or HP 8414A Polar Display), an optional digital marker (HP 8600A), and one of four transducers (HP 11652A, 11654A, 11655A, or 1121A) depending on the measurement. Because the 8407A is a tracking receiver, the HP 8601A and HP 8690B/8698B are the only sources providing the VTO output required to operate the network analyzer. Thus, an operating system must be configured with one of the required sources, the network analyzer, a display and one or more of the transducers depending on the device under test and the network parameters desired.

## Specifications

### 8407A

**General:** 8407A is a two input tracking receiver, using both inputs (reference and test channels) to form their magnitude ratio and phase difference before routing to display.

**Frequency range:** 0.1–110 MHz.

**Impedance:** 50Ω, SWR < 1.08; Option 008: 75 Ω, SWR < 1.08.

**Dynamic range:** 80 dB.

**Test input:** DIRECT –10 to –90 dBm signal range. ATTENUATED, +20 to –50 dBm signal range. Damage level +26 dBm/50 V dc.

**Reference input:** DIRECT level required, –10 to –60 dBm. ATTENUATED level required +20 to –20 dBm. Damage level +26 dBm/50 V dc.

**Amplitude accuracy:** FREQUENCY RESPONSE  $\pm 0.2$  dB for DIRECT input (test input > –60 dBm), 0.1–110 MHz;  $\pm 0.05$  dB over any 10 MHz portion; may be calibrated out. Typically  $\pm 0.05$  dB for DIRECT inputs (REFERENCE level of –10 dBm). DISPLAY REFERENCE, <0.05 dB/1 dB step, total error  $\leq 0.1$ dB; <0.1dB/10 dB step, total error  $\leq 0.25$  dB. ATTENUATED INPUTS, 40 dB  $\pm 0.5$  dB. REFERENCE CHANNEL GAIN CONTROL, 20 dB and 40 dB steps  $\pm 0.5$  dB/step. CROSSTALK, <0.03 dB when test/ref = –40 dB to <4 dB when test/ref = –80dB.

**Power:** 65 watts, 50–60 Hz, 115/230  $\pm 10\%$  V ac.

**Weight:** net, 14.6 kg (32 lb). Shipping, 17.8 kg (39 lb).

### 8412A

**General:** plug-in PHASE-MAGNITUDE CRT Display. Displays magnitude and/or phase vs. frequency.

**Amplitude accuracy:** display, 0.08 dB/dB from midscreen. Rear output: 0.03 dB/dB variation from 0 volt output.

**Phase Accuracy:** DISPLAY, 0.065°/degree from midscreen. PHASE OFFSET, 0.3°/20° step,  $\leq 3^\circ$  for 360° change, positive or negative direction. VS. DISPLAYED AMPLITUDE, <1°/10 dB; total <6° over 80 dB range.

**Rear panel inputs:** sweeping,  $\leq 15$  V dc. Blanking, –4 V dc blanks CRT. Z axis (marker), –5 V dc intensifies and +5 V dc blanks trace.

**Power:** 23 watts, supplied by 8407A.

**Weight:** net, 7.8 kg (17 lb). Shipping, 10 kg (22 lb).

Detailed Specifications on page 486.

### 8750A

**General:** the 8750A Storage-Normalizer provides digitally stored and normalized CRT displays when used with the 8412A Phase-Magnitude Display. Measurements are faster, easier, and more accurate when the 8750A is employed because the CRT is flicker-free and frequency response errors are eliminated. The 8750A is not compatible with the 8414A Polar Display.

**Power:** selection of 100, 120, 220, or 240 V +5%–10%, 48 to 440 Hz and  $\leq 20$  VA ( $\leq 20$  watts).

**Weight:** net, 2.72 kg (6 lbs). Shipping, 5.0 kg (11 lbs).

Detailed Specifications on page 491.

### 8414A

**General:** normalized POLAR coordinate display with magnitude calibration in 0.2 of full scale gradations. Full scale is determined by DISPLAY REFERENCE on 8407A; phase calibration is in 10° increments over 360° range. Smith Chart overlays available.

**Accuracy:** all errors in amplitude and phase due to display are contained within a circle of 3mm about measurement point.

**Rear panel inputs:** blanking, –4 to –10 V dc blanks CRT. Marker, intensified trace with –4 to –10 V dc.

**Rear panel outputs:** horizontal and vertical both  $\pm 2.5$  V for full scale deflection.

**Power:** 35 watts, supplied by 8407A.

**Weight:** net, 5.9 kg (13 lb). Shipping, 8.0 kg (18 lb).

Detailed specifications on page 486.

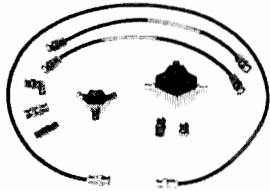

11652A

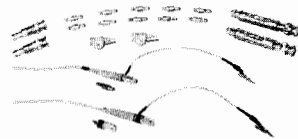

11654A

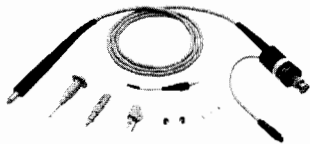

1121A

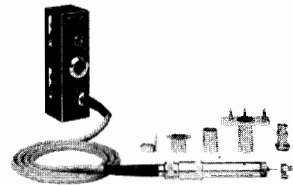

11655A



11658A



85428B

### 8601A

**General:** GENERATOR/SWEEPER operating in either CW or SWEPT modes. Sweep modes are full, variable stop frequency, and symmetrical (up to 10 MHz). Features very low residual FM, spurious, harmonics, and drift. 8601A provides the VTO signal required to operate the 8407A.

**Frequency:** 0.1–11 MHz in two sweep ranges, 0.1–11 MHz and 1–110 MHz.

**Impedance:** 50Ω VSWR < 1.2. Option 008: 75Ω. VSWR < 1.2.

**Accuracy:** 1% of frequency, 0.5% linearity, and 2% of sweep width.

**Calibrated output:** ± 0.25 dB flatness over full range, output accuracy ± 1 dBm from +10 to -110 dBm.

**Auxiliary outputs:** sweep out, blanking (for 8412 and 8414), VTO (required by 8407A), and auxiliary output (0.1–11 MHz both ranges) for 8600 counter/digital marker.

Detailed specifications on page 427.

### 8600A

**General:** DIGITAL MARKER used with 8601A generator/sweeper to provide five continuously variable markers on a display while reading out the frequency of any one marker. Six digit display.

**Markers/accuracy:** 5 markers accurate at desired frequency ± (0.05% sweep width + sweep stability).

**Counter frequency range:** 0.1–15 MHz (automatically scales up by ten when 8601A on 0.1–110 MHz range).

Detailed specifications on page 427.

### 11652A

**General:** REFLECTION-TRANSMISSION KIT containing power splitter, 8721A DIRECTIONAL BRIDGE, precision termination, calibrating short, three BNC adapters, and four matched, low-leakage cables for both transmission and reflection measurements. All 50 Ω BNC connectors, Option 008 75Ω.

**Directional bridge:** 8721A: 6 dB insertion loss and 6 dB coupled to auxiliary arm. Frequency response ± 0.5 dB (0.1–110 MHz). Directivity > 40dB (1 to 110 MHz). Load port return loss > 30 dB ( $\rho < 0.03$ ). Max input power + 20 dBm. 50Ω, Option 008: 75Ω.

**Power splitter:** 6 dB through each arm. Max input power +20 dBm. 50 Ω.

**50Ω termination:** return loss > 43 dB.

**Weight:** net, 0.7 kg (1.5 lb). Shipping, 1.2 kg (2.5 lb).

### 11654A

**General:** passive probe kit for measuring current and voltage transfer functions and accurate complex impedance below 11 MHz. Contains

a pair of six resistive divider probes (1:1, 5:1, 10:1, 20:1, 50:1, 100:1), current probes and a variety of adapters.

**Weight:** net, 0.9 kg (2 lb). Shipping, 1.4 kg (3 lb).

### 11655A

**General:** swept or CW impedance probe mounting directly to 8407A. Mount contains internal calibrator,  $100\Omega \pm 5\%$  and  $0^\circ \pm 2^\circ$ ; parasitics capacitances are calibrated out; and simple charts are available for calculating out residual resistances. Contains component adapter, probe to BNC adapter, probe to type N adapter, and various ground assemblies.

**Frequency:** 0.5–110 MHz (usable to 0.1 MHz).

**Measurement range:** amplitude, 0.1Ω to > 10 kΩ; phase,  $0^\circ \pm 90^\circ$ .

**CW accuracy:** amplitude ± 5%; ± 5° for  $Z > 3.16\Omega$ .

**Swept accuracy:** typically ± 5% in amplitude (3–110 MHz), ± 5° in phase (5–110 MHz); accuracy decreases below 3 MHz. Note all accuracy specs valid only for proper input levels and calibration.

**Max external voltage to probe:** 50 V dc, 5 V rms.

**Weight:** net, 0.9 kg (2 lb). Shipping, 2.7 kg (6 lb).

### 11658A

**General:** 50Ω to 75Ω matching resistor for matching the 50Ω of the 8407A to a 75Ω environment. Two 11658A's are very useful for frequent 50Ω to 75Ω changes. The 11658A's mount directly on the front panel, of 8407A. FREQUENCY, 0.1–110 MHz. INSERTION LOSS, 3.5 dB. RETURN LOSS, > 40 dB. CONNECTORS, 50Ω BNC male and 75Ω BNC female.

**Net Weight:** 28 g (1 oz).

### 1121A

**General:** 1:1 active probe for making measurements without disturbing circuitry and measuring voltage transfer functions in systems different from 50Ω. 10:1 and 100:1 dividers and BNC adapter also furnished.

**Frequency response:** ± 0.5 dB and ± 2% from 0.1–110 MHz with a bandwidth (3 dB) of 1 kHz to > 500 MHz and gain 0 dB ± 1 dB.

**Input impedance:** 100 kΩ, shunt capacitance of 3 PF at 100 MHz. With 10:1 or 100:1 divider, 1 MΩ, shunt capacitance 1 PF at 100 MHz.

**Output impedance:** 50Ω nominal.

**Maximum input:** 300 mV rms, +80 V dc; with 10:1 divider, 30 V rms, ± 350 V dc.

**Power:** supplied by 8407A through PROBE PWR jacks.

**Weight:** net, 0.7 kg (1.5 lb). Shipping, 1.2 kg (2.5 lb).

### 85426A

**General:** bias insertion network providing DC biasing to devices under test on RF transmission lines. Operating frequency range is 0.1–500 MHz with insertion loss < 0.4 dB and return loss > 28 dB. Max biasing current of 750 mA and max biasing voltage of 70 V. Connectors are BNC for DC biasing and APC-7 for RF.

**Weight:** net, 0.5 kg (1 lb). Shipping, 0.8 kg (1.7 lb).

### 85428B

**General:** 50Ω to 75Ω minimum loss pad. Pad operates from 0.1–110 MHz with an insertion loss of 5.7 dB and VSWR < 1.05. Connectors are 50Ω BNC male and 75Ω BNC female.

**Weight:** net, 0.1 kg (2 oz). Shipping, 0.2 kg (6 oz).

### Ordering Information

	<b>Price</b>
8407A Network Analyzer	\$6000
Opt 00B: 75Ω input	add \$115
8412A Phase Magnitude Display	\$3000
8750A Storage-Normalizer	\$1750
8414A Polar Display	\$2700
8601A Sweeper/Generator	\$3300
Opt 00B: 75Ω output	add \$50
8600A Digital Marker	\$1950
11652A Reflection/Transmission Kit (50Ω)	\$525
Opt 00B: 75Ω	add \$75
11654A Passive Probe Kit	\$550
11655A Impedance Probe Kit	\$2100
11658A Matching Resistor	\$75
1121A AC Probe Kit	\$700
85426A Bias Insertion Network	\$775
85428B Minimum Loss Pad	\$240
8721A Directional Bridge (50Ω)	\$250
Opt 00B: 75Ω	add \$20



## Vector voltmeter

Model 8405A

- Accurate voltage and phase measurement
- 1 to 1000 MHz

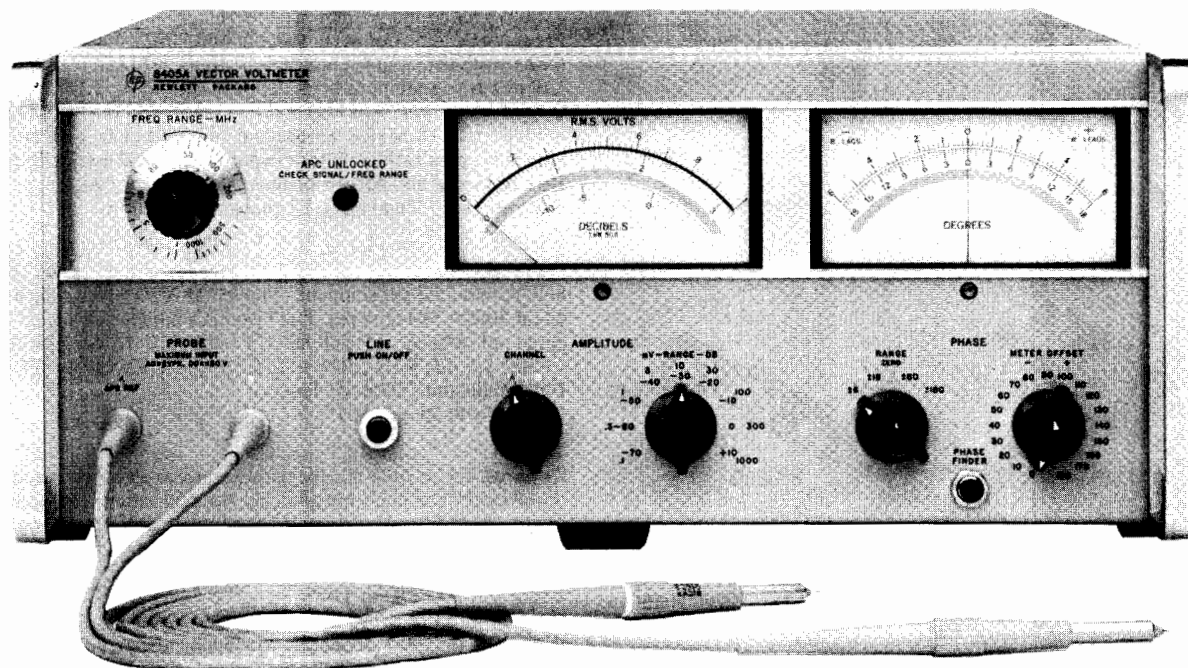

The 8405A Vector Voltmeter measures voltage vectors described by both magnitude and phase. This capability makes the 8405A a unique instrument for about any design and test application in the frequency range 1 to 1000 MHz.

In addition to absolute voltage measurements, capabilities include insertion loss and computed group delay of bandpass filters and other transmission devices, gain and phase margin of amplifiers, complex impedance of mixers, antennas, matching the electrical lengths of cables, s-parameters of transistors, amplitude modulation index, RF distortion measurements and in-circuit probing.

The 8405A achieves this measurement versatility through its two-channel capability enabling voltage magnitude measurements in either channel, thus allowing ratio measurements, and phase difference measurements between the two channels. Gain or loss in excess of 90 dB and phase measurements with 0.1° resolution over a 360° phase range are possible.

Accuracy is achieved through the 1 kHz bandwidth entailing response only to the fundamental frequency of the input signal. Also, phase-locked coherent sampling to translate 1 to 1000 MHz RF signals to 20 kHz IF signals enables accurate detection of voltage magnitude and phase. Automatic phase-locked tuning makes it possible to select the one of 21 overlapping octave ranges which contains the input signal frequency by simply rotating a switch.

### Specifications

**Frequency range:** 1 MHz to 1 GHz in 21 overlapping octave bands; tuning automatic within each band.

**Isolation between channels:** 1 to 300 MHz, >100 dB; 300 to 1,000 MHz >80 dB.

**Maximum input:** ac, 2 V peak; dc,  $\pm 50$  V.

**Input impedance (nominal):** 0.1 M $\Omega$  shunted by 2.5 pF; 1 M $\Omega$  shunted by 2 pF when 11576A 10:1 Divider is used; 0.1 M $\Omega$  shunted by 5 pF when 10216A Isolator is used. AC coupled.

### Voltage Range (rms)

Channel	1-10 MHz	10-500 MHz	500-1000 MHz
A	1.5 mV - 1.0 V	300 $\mu$ V - 1.0 V	500 $\mu$ V - 1.0 V
B	<20 $\mu$ V - 1.0 V	<20 $\mu$ V - 1.0 V	<20 $\mu$ V - 1.0 V

**Voltmeter ranges:** 100  $\mu$ V to 1 V rms full scale in 10 dB steps.

**Voltage ratio accuracy:** 1-200 MHz, 0.2 dB for -60 to 0 dB ranges and 0.5 dB for -70 dB to +10 dB ranges; 200-1000 MHz, 0.2 dB for -60 to -10 dB ranges, 0.5 dB for -70 dB to 0 dB ranges and 1.5 dB for +10 dB range.

**Phase range:** 360° indicated on zero-center meter with end-scale ranges of  $\pm 180^\circ$ ,  $\pm 60^\circ$ ,  $\pm 18^\circ$ , and  $\pm 6^\circ$ .

**Phase resolution:** 0.1° at any phase angle.

**Phase meter offset:**  $\pm 180^\circ$  in 10° steps.

**Phase accuracy:**  $\pm 1.5^\circ$  (equal voltage Channel A and B).

**Accessories furnished:** two 11576A 10:1 Dividers, two 10216A Isolators, two 10218A BNC Adapters, six ground clips for 11576A or 10216A; six replacement probe tips.

**Bandwidth:** 1 kHz.

**Power:** 115 or 230 V  $\pm 10\%$ , 50 to 60 Hz, 35 W.

**Weight:** net, 13.9 kg (31 lb). Shipping, 16.3 kg (36 lb).

**Size:** 177 H x 425 W x 467 mm D (7.0 in x 16.75 in x 18.38 in).

### 11570A Accessory Kit

**50 $\Omega$  Tee:** 11536A: for monitoring signals on 50 $\Omega$  transmission lines without terminating line. Kit contains two with type N RF fittings.

**50 $\Omega$  Power Splitter:** 11549A: all connectors Type N female.

**50 $\Omega$  Termination:** 908A: for terminating 50 $\Omega$  coaxial systems in their characteristic impedance.

**Shorting plug:** 11512A: Shorting Plug, Type N male.

### Ordering Information

8405A Vector Voltmeter

Opt 002: linear dB scale

11570A Accessory Kit (measurement in 50 $\Omega$  systems only)

Price

\$4500

add \$25

\$630

# NETWORK ANALYZERS

Microwave network analyzer, 110 MHz to 40 GHz

Model 8410S systems

483



- Complete microwave measurement systems
- Measures all network parameters
- Multioctave swept frequency measurements

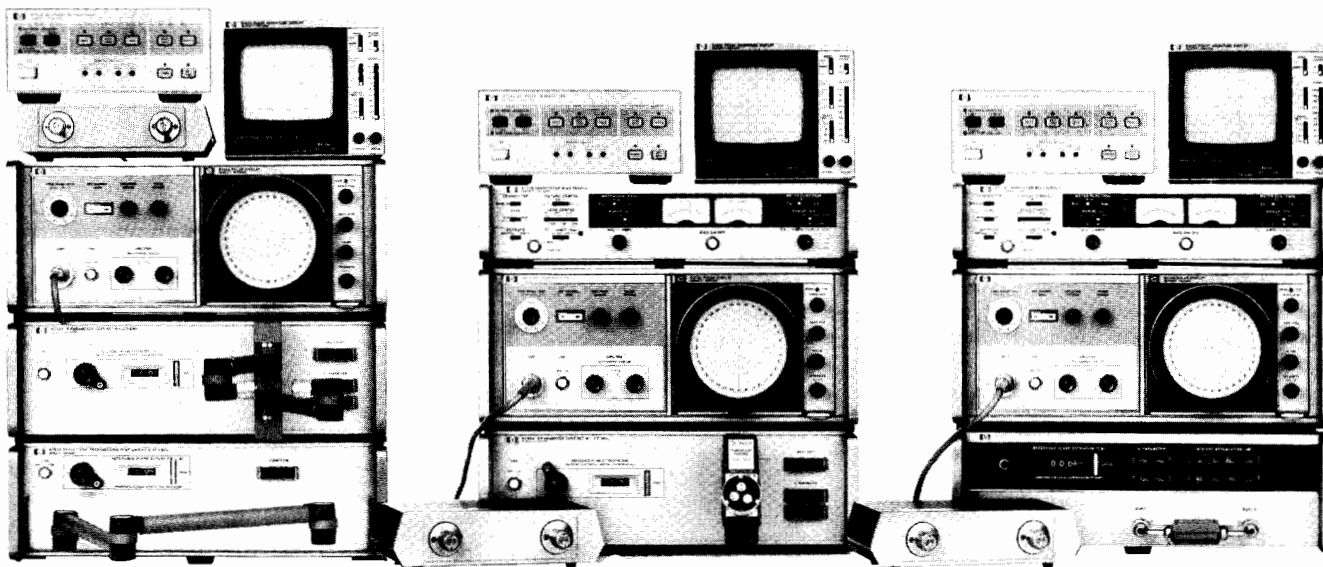

8410S Opt 310

8410S Opt 400

8410S Opt 500

All 8410S Systems measure transmission and reflection parameters of coaxial or semiconductor components in the form of gain, attenuation, phase, reflection coefficient or impedance. Each option has been configured for making general measurements on coaxial or semiconductor devices in a variety of package styles. The 8410S Systems enable the operator to view a real time CRT display over octave or multioctave bands with a dynamic range of 60 dB amplitude and 360° phase. Multioctave, continuous network measurements over the

frequency range of 2 to 18 GHz are possible when the 8410B is used with the HP 8620/86290 Sweep Oscillator.

The 8410S Systems' upper frequency limit for coaxial and semiconductor measurements is 12.4 GHz; however, individual instruments may be ordered that will expand coaxial measurement capability to 18 GHz (option 018 instruments) and waveguide measurements from 8.2 GHz to 40 GHz (8747A series).

## 8410S Network Analyzer Systems Table

GENERAL PURPOSE MEASUREMENTS			All 8410S Systems Include the Following Instrument Model Numbers: 8410B, 8411A, 8412A, 8414A, 11609A, and 8750A										
Frequency Range	Option No.	Measurement Port Configuration	8743A	8745A	8746A	8717B	11600B	11602B	11608A	11604A	11605A	11650A	Price
0.11 to 2 GHz	110	Coaxial (APC-7)		X						X		X	\$25,955
0.11 to 12.4 GHz	310	Coaxial (APC-7)	X	X						X	X	X	\$32,480
2 to 12.4 GHz	210	Coaxial (APC-7)	X								X	X	\$24,030
SEMICONDUCTOR CHARACTERIZATION													
0.11 to 2 GHz	400	T018/T072 Packages		X		X	X						\$26,945
0.11 to 2 GHz	401	T05/T012 Packages		X		X		X					\$26,945
0.5 to 12.4 GHz	500	Stripline			X	X			X				\$29,545



# NETWORK ANALYZERS

Model 8410S Systems (cont.)

## Specifications

### 8410S Common Performance Specifications

**Function:** all systems measure transmission and reflection parameters on a swept-frequency or CW basis with readout of attenuation, gain, phase shift, reflection coefficient, return loss, impedance, depending on display unit.

**Transmission measurement (using 8412A):** accuracy curves show overall system uncertainty as a function of the amplitude and phase value. Sources of error included are IF gain control, display accuracy, phase offset, system noise and cross-talk. System frequency responses is specified separately and is not included in accuracy curves.

#### Amplitude accuracy (60 dB dynamic range)

**IF gain control:** 69 dB in 10 dB and 1 dB steps.

±0.1 dB/10 dB ±0.2dB maximum cumulative  
±0.05 dB/1 dB

**Display:** 0.08 dB/dB from midscreen.

#### Phase accuracy

**Phase offset:** 0.3°/20° step; maximum 3° for 360° change.

**Display:** 0.065°/degree from midscreen.

**Connectors:** RF Input, Type N female stainless steel; Measurement Ports, APC-7 precision 7-mm connectors.

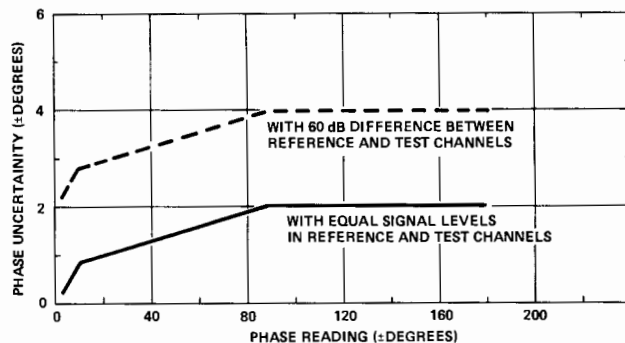
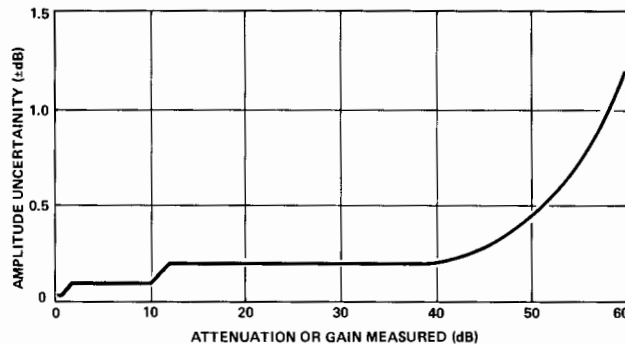

### 8410S Opt 110 Specifications

**Function:** the 8410S option 110 measurement system gives all four S-parameters for a two-port network with pushbutton ease over the frequency range of 110 MHz to 2 GHz.

**Frequency range:** 0.11 to 2.0 GHz.

**RF input:** 20 dB range between +5 dBm and -12 dBm.

**Source reflection coefficient:** ≤0.067, 0.11–2.0 GHz.

**Termination reflection coefficient:** ≤0.11, 100–200 MHz; ≤0.07, 200–2000 MHz.

**Directivity:** ≥28 dB 0.11–1.0 GHz; ≥27 dB 1.0–2.0 GHz.

**Insertion loss, RF input to test port:** 4 dB nominal.

#### Frequency response

**Transmission:** typically < ±0.35 dB amplitude and < ±5° phase.

**Reflection:** typically < ±0.06 magnitude and ±5° phase with a short on the test port.

**Transmission measurement accuracy:** (see common performance specifications).

**Reflection measurement accuracy (using 8414A):** sources of error included in the accuracy equations are directivity, source match, and polar display accuracy.

#### Magnitude accuracy:

$\rho_u = \pm(0.0398 + 0.03 \rho_L + 0.067 \rho_L^2)$  0.11–1.0 GHz.

$\rho_u = \pm(0.0447 + 0.03 \rho_L + 0.067 \rho_L^2)$  1.0–2.0 GHz.

$\rho_u$  = magnitude uncertainty.

$\rho_L$  = measured reflection coefficient magnitude.

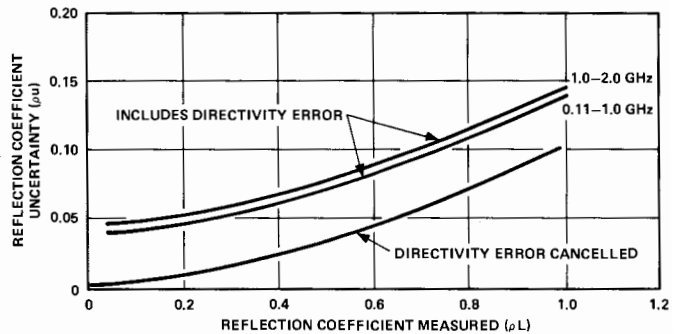

#### Phase accuracy:

$\Phi_u = \sin^{-1} \rho_u / \rho_L$  for  $\Phi_u < 90^\circ$ .

$\Phi_u$  = phase uncertainty.

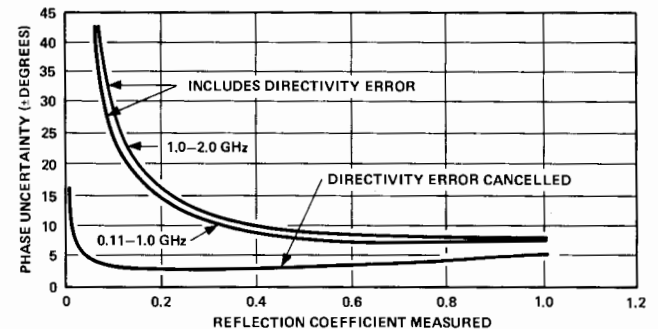

See 8410S Network Analyzer Systems Table for price and instrument breakdown.

### 8410S Opt 210 Specifications

**Function:** The 8410S Option 210 measurements system covers a frequency range of 2 to 12.4 GHz. With just one simple setup and calibration both transmission and reflection measurements are easily made by pushing a button.

**Frequency range:** 2.0 to 12.4 GHz.

**RF input:** 20 dB range between +12 dBm and -5 dBm.

**Source reflection coefficient:** ≤ 0.09, 2–8 GHz; ≤0.13, 8–12.4 GHz.

**Termination reflection coefficient:** ≤ 0.09, 2–8 GHz; ≤ 0.13, 8–12.4 GHz.

**Directivity:** ≥ 30 dB, 2–12.4 GHz.

**Insertion loss, RF input to test port:** 20 dB nominal.

#### Frequency response

**Transmission:** typically < ±0.5 dB amplitude and < ±5° phase.

**Reflection:** typically < ±0.09 magnitude and < ±6° phase, with a short on the unknown port.



**Transmission measurement accuracy:** (see Common Performance Specifications).

**Reflection measurement accuracy (using 8414A):** sources of error included in the accuracy equations are directivity, source match, and polar display accuracy.

**Magnitude accuracy:**

$$\rho_u = \pm (0.0316 + 0.03 \rho_L + 0.09 \rho_L^2) \text{ 2-8 GHz.}$$

$$\rho_u = \pm (0.0316 + 0.03 \rho_L + 0.13 \rho_L^2) \text{ 8-12.4 GHz.}$$

$\rho_u$  = magnitude uncertainty.

$\rho_L$  = measured reflection coefficient magnitude.

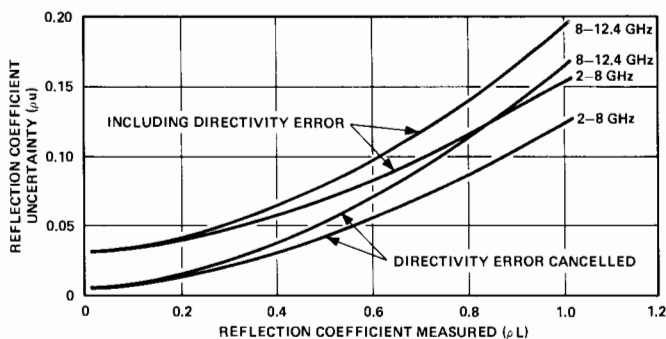

**Phase accuracy:**

$$\Phi_u = \sin^{-1} \rho_u / \rho_L \text{ for } \Phi_u < \pm 90^\circ.$$

$\Phi_u$  = phase uncertainty.

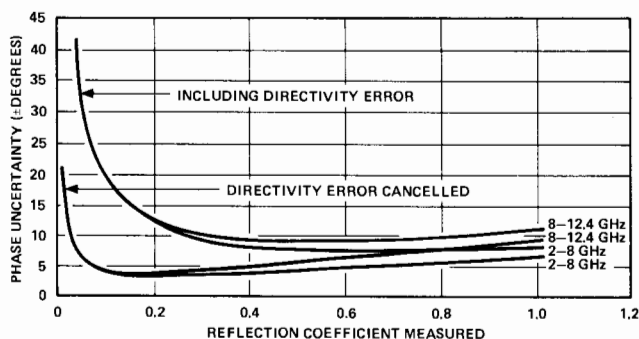

See 8410S Network Analyzer Systems Table for price and instrument breakdown.

#### 8410S Opt 310 Specifications

**Function:** The 8410S Option 310 measurement system encompasses both the 8410S Option 110 and 210 system specifications and flexibility. The two RF transducer units cover the frequency range of 110 MHz to 12.4 GHz and both offer calibrated line stretchers for extending the reference plane. Coaxial rotary joints and air-lines mounted on the front of the transducer units allow easy connections to the test device.

See 8410S Network Analyzer System Table for price and instrument breakdown.

#### 8410S Opt 400/401 Specifications

**Function:** The 8410S Option 400/410 S-parameter measurement system provides two port S-parameters for semiconductors in TO-18/TO-72 (Option 400) or TO-5/TO-12 (Option 401) packages. A short circuit Termination and a 50 ohm through section are included with each type fixture for reference plane calibration.

**Frequency range:** 0.11 to 2.0 GHz.

**Transistor dc bias selection:** front panel slide switches establish proper dc biasing for both Bi-polar and FET transistors. The voltage and current controls operate independently and are continuously adjustable over a current range of 0 to 500 mA and a voltage range of 0 to 30 Vdc.

**RF input:** 20 dB range between +12 dBm to -5 dBm.

**Source reflection coefficient**

**Opt 400:** typically -0.062.

**Opt 401:** typically -0.073.

**Termination reflection coefficient**

typically <0.11, 100 to 200 MHz.

<0.08, 0.2 to 1.0 GHz.

<0.11, 1.0 to 2.0 GHz.

**Directivity**

typically <30 dB, 0.11 to 1.0 GHz.

<27 dB, 1.0 to 2.0 GHz.

**Frequency response**

**Transmission:** typically < ±0.35 dB, ±5°.

**Reflection:** typically < ±0.6 dB, ±5°.

**Transmission measurement accuracy:** (see Common Performance Specifications).

**Reflection measurement accuracy (using 8414A):** sources of error included in the accuracy equations are directivity and source match.

**Magnitude accuracy**

**Opt 400/401:**

$$\rho_u = \pm (0.029 + 0.048 \rho_L + 0.06 \rho_L^2) \text{ 0.11 to 1 GHz.}$$

$$\rho_u = \pm (0.045 + 0.051 \rho_L + 0.073 \rho_L^2) \text{ 1.0 to 2.0 GHz.}$$

$\rho_u$  = magnitude uncertainty.

$\rho_L$  = measured reflection coefficient magnitude.

**Phase accuracy:**

$$\Phi_u = \sin^{-1} \rho_u / \rho_L \text{ for } \Phi_u < 90^\circ.$$

$\Phi_u$  = phase uncertainty.

See 8410S Network Analyzer Systems Table for price and instrument breakdown.

#### 8410S Opt 500 Specifications

**Function:** The 8410S Option 500 S-parameter measurement system provides the capability of biasing and measuring all four S-parameters of strip-line transistors. A short circuit termination and a 50-ohm through section are included with each fixture for reference plane calibration.

**Frequency range:** 0.5 to 12.4 GHz.

**Transistor dc bias selection;** front panel slide switches establish proper dc biasing for both Bi-polar and FET transistors. The voltage and current controls operation independently and are continuously adjustable over a current range of 0 to 500 mA and a range of 0 to 30 Vdc.

**RF input:** 20 dB range between +12 and -5 dBm.

**Incident attenuation range:** 0 to 70 dB in 10 dB steps.

**Source reflection coefficient:** (typically) ≤0.132, 0.5 to 4.0 GHz; ≤0.135, 4.0 to 8.0 GHz; ±0.141, 8.0 to 12.4 GHz.

**Termination reflection coefficient:** (typically) <0.139, 0.5 to 4.0 GHz; <0.148, 4.0 to 8.0 GHz; ±0.170, 8.0 to 12.4 GHz.

**Directivity:** ≥28 dB, 0.5 to 4.0 GHz; ≥24 dB, 4 to 8.0 GHz; ≥23 dB, 8.0 to 12.4 GHz.

**Frequency response:** (typically) <0.5 dB, ±7 degrees, 0.05 to 4.0 GHz; <0.75 dB, ±7 degrees, 4.0 to 8.0 GHz; <1.25 dB, ±7 degrees, 8.0 to 12.4 GHz.

**Transmission measurement accuracy:** (see Common Performance Specifications).

**Reflection measurement accuracy:** sources of error included in the accuracy equation are directivity and source match.

**Magnitude accuracy:**

$$\rho_u = \pm (0.04 + 0.08 \rho_L + 0.13 \rho_L^2) \text{ 0.5 to 4.0 GHz.}$$

$$\rho_u = \pm (0.06 + 0.09 \rho_L + 0.135 \rho_L^2) \text{ 4.0 to 8.0 GHz.}$$

$$\rho_u = \pm (0.074 + 0.098 \rho_L + 0.14 \rho_L^2) \text{ 8.0 to 12.4 GHz.}$$

$\rho_u$  = magnitude uncertainty.

$\rho_L$  = measured reflection coefficient magnitude.

**Phase accuracy:**

$$\Phi_u = \sin^{-1} \rho_u / \rho_L \text{ for } \Phi_u < 90^\circ.$$

$\Phi_u$  = phase uncertainty.

See 8410S Network Analyzer Systems Table for price and instrument breakdown.



# NETWORK ANALYZERS

## Individual instruments

### 8410 family

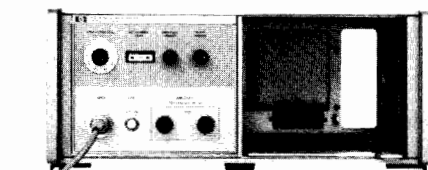

8410B



8411A

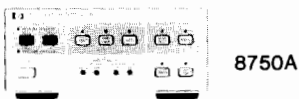

8750A

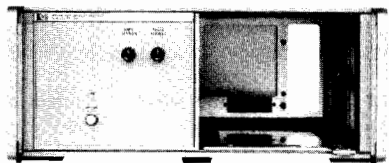

8418A

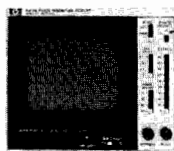

8412A



8413A



8414A

## Specifications

### 8410B/8411A Network Analyzer

**Function:** 8411A converts RF signals to IF signals for processing in 8410B mainframe. 8410B is the mainframe for display plug-in units. Mainframe includes tuning circuits (octave bands or multioctave bands when used with HP 8620/86290 sweep oscillator), IF amplifiers and precision IF attenuator. 8410B option H17 allows injection of an external local oscillator used in automatic applications to lock the 8410 receiver to an external source such as the HP 3335A.

**8410B frequency range:** 0.11 to 18 GHz.

**8411A frequency range:** 0.11 to 12.4 GHz.

**Opt O18:** 0.11 to 18 GHz.

**8411A input impedance:** 50 ohms nominal. SWR <1.5, 0.11 to 2.0 GHz; <2.0, 2.0 to 16.0 GHz; 3, 6.0 to 18.0 GHz.

**Channel isolation:** >65 dB, 0.1 to 6 GHz; >60 dB, 6 to 12.4 GHz; >50 dB, 12.4 to 18 GHz.

### Magnitude Range

**Reference channel:** -18 to -35 dBm, 0.11 to 12.4 GHz; -18 to -25 dBm from 12.4 to 18.0 GHz.

**Test channel:** -10 to -75 dBm from 0.11 to 12.4 GHz; -10 to -68 dBm from 12.4 to 18 GHz.

**Maximum RF input to either channel:** 50 mW.

**IF gain control:** 69 dB range in 10 dB and 1 dB steps with a maximum cumulative error of  $\pm 0.2$  dB.

### Phase

**Phase range:** 0 to 360°

**Control:** vernier control  $\leq 90^\circ$

**Connectors (8411A):** APC-7.

**Power:** 115 or 230 V  $\pm 10\%$ , 50-60 Hz, 70 watts (includes 8411A).

### Weight

**8410B:** net, 14.9 kg (33 lb). Shipping, 18.5 kg (41 lb).

**8411A:** net, 3.2 kg (7 lb). Shipping, 4.5 kg (10 lb).

### Size

**8410B:** 191 H x 425 W x 467 mm D (7.5" x 16.75" x 18.38").

**8411A:** 67 x 228 W x 143 mm D (2.63" x 9" x 5.63") exclusive of connectors and cable.

### 8412A Phase-Magnitude Display

**Function:** plug in CRT display unit for 8410B. Displays relative amplitude in dB and/or relative phase in degrees between reference and test channel inputs versus frequency.

### Amplitude

**Range:** 80 dB display range with selectable resolutions of 10, 2.5, 1 and 0.25 dB/division.

**Accuracy:** 0.08 dB/dB from midscreen.

### Phase

**Range:**  $\pm 180^\circ$  display range with selectable resolutions of 90, 45, 10, and 1°/division.

**Accuracy:** 0.065°/degree from midscreen.

**Phase offset:** 0.3°/20° step cumulative  $< 3^\circ$ .

**Power:** 23 watts supplied by mainframe.

**Weight:** net, 7.8 kg (17 lb). Shipping, 10 kg (22 lb).

**Size:** 152 H x 186 W x 395 mm D (6" x 7.28" x 15.56") excluding front panel knobs.

### 8750A Storage-Normalizer

**General:** the 8750A Storage-Normalizer provides digitally stored and normalized CRT displays when used with the 8412A Phase Magnitude Display. Measurements are faster, easier and more accurate when the 8750A is employed because the CRT is flicker-free and frequency response errors are eliminated. The 8750A is not compatible with the 8414A Polar Display.

**Power:** selection of 100, 120, 220, or 240V  $\pm 5\%$  -10%. 48 to 440 Hz and  $\leq 20$  VA  $\leq 20$  watts).

**Weight:** net, 2.72 kg (6 lbs). Shipping, 5.0 kg (11 lbs).

Detailed specifications on page 491.

### 8413A Phase-Gain Indicator

**Function:** plug-in meter display unit for 8410B. Displays relative amplitude in dB or relative phase in degrees between reference and test channel inputs. Pushbutton selection of meter function and range.

### Amplitude

**Range:**  $\pm 30$ ,  $\pm 10$ , and  $\pm 3$  dB full scale.

**Accuracy:**  $\pm 3\%$  of end scale.

**Log output:** 50 millivolts per dB up to 60 dB total.

### Phase

**Range:**  $\pm 180$ ,  $\pm 60$ ,  $\pm 6$  degrees full scale.

**Accuracy:**  $\pm 2\%$  of end scale.

**Output:** 10 millivolts per degree.

**Phase offset:**  $\pm 180$  degrees in 10-degree steps.

**Accuracy:**  $\pm 0.2^\circ + 0.3^\circ/10^\circ$  step, cumulative  $< 2^\circ$ .

**Power:** 15 watts supplied by mainframe.

**Weight:** net, 4.9 kg (11 lb). Shipping, 6.7 kg (15 lb).

**Size:** 152 H x 186 W x 395 mm D (6" x 7.28" x 15.56").

### 8414A Polar Display

**Function:** plug-in CRT display unit for 8410B. Displays amplitude and phase data in polar coordinates on 5-in. cathode ray tube.

**Range:** normalized polar coordinate display; magnitude calibration 20% of full scale per division. Scale factor is a function of IF setting on 8410B. Phase calibrated in 10-degree increments over 360-degree range. Option H07 allows external contact closure control of the beam center function.

**Accuracy:** error circle on CRT  $\pm 3$  mm.

**Power:** 35 watts supplied by mainframe.

**Weight:** net, 5.8 kg (13 lb). Shipping 8.1 kg (18 lb).

**Size:** 152 H x 186 W x 395 mm D (6" x 7.28" x 15.56") excluding front panel knobs.

### 8418A Auxiliary Display Holder

**Function:** the 8418A Auxiliary Display Holder provides power for operating of the 8412A, 8413A or the 8414A display units. Used in conjunction with the 8410B Network Analyzer, it provides the capability of viewing amplitude and phase readout in both rectangular and polar coordinates simultaneously. Option H01 adds a remotely programmable 0-70 dB IF attenuator required for autoranging in automatic applications.

**Weight:** net, 11.2 kg (25 lb). Shipping, 19.7 kg (44 lb).

**Size:** 177 H x 483 W x 450 mm D (6.97" x 19" x 17.13").

### Ordering Information

Ordering Information	Price
8410B mainframe	\$4800
Opt H17: External Local Oscillator Input	add \$1000
Opt 908: Rack Flange Kit	add \$25
8411A Frequency Converter	\$3800
Opt O18: 2 to 18 GHz	add \$500
8412A Phase-Magnitude Display	\$3000
8413A Phase-Gain Display	\$2100
8414A Polar Display	\$2700
Opt H07: Remote Beam Center	add \$300
8418A Auxiliary Display Holder	\$2200
Opt H01: Programmable 0-70 dB IF Attenuator	add \$1500
Opt 908: Rack Flange Kit	add \$25
8750A Storage-Normalizer	\$1750

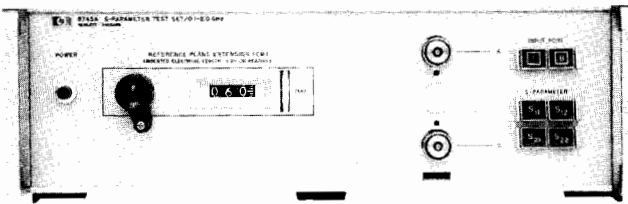

8745A

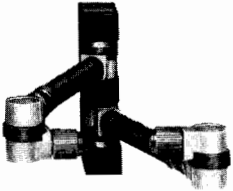

11604A

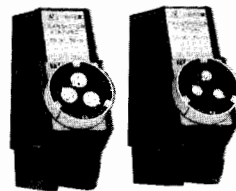

11602B

11600B

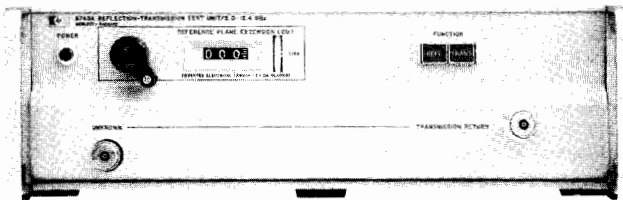

8743A

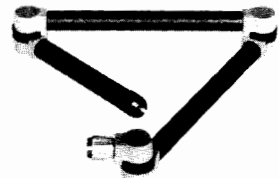

11605A

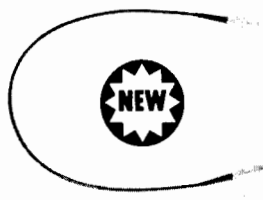

11610B

### 8745A S-Parameter Test Set

**Function:** wideband RF power splitter and reflectometer with calibrated line stretcher. Pushbutton operated for either forward or reverse transmission or reflection measurements with network analyzer.

**Frequency range:** 100 MHz to 2 GHz.

**Impedance:** 50 ohms nominal.

**Source reflection coefficient:**  $\leq 0.057$ , 0.11 to 2.0 GHz.

**Termination reflection coefficient:**  $< 0.10$ , 100, to 200 MHz;  $< 0.063$ , 200 MHz to 2.0 GHz.

**Directivity:**  $\geq 36$  dB, below 1 GHz;  $\geq 32$  dB, 1 to 2 GHz.

**Reference plane extension:** 0 to 15 cm for reflection; 0 to 30 cm for transmission.

**Maximum RF power:** 2 watts.

**Connectors:** RF input type N female; all other connectors APC-7; Option 001, type N female.

**Remote programming:** ground closure.

**Power:** 115 or 120 V  $\pm 10\%$ , 50 to 400 Hz, 40 watts.

**Weight:** net, 15.4 kg (34.25 lb). Shipping, 18.0 kg (40 lb).

**Size:** 140 H x 425 W x 654 mm D (5.50" x 16.75" x 25.75").

### 11604A Universal Extension

**Function:** mounts on front of 8745A; connects to device under test. Rotary air-lines and rotary joints connect to any two port geometry.

**Frequency range:** dc to 2 GHz.

**Impedance:** 50 ohms nominal.

**Reflection coefficient:** 0.035.

**Acc. Included:** semi-rigid coax. cable, HP Part #11604-20021.

**Weight:** net, 1.8 kg (4 lb). Shipping, 2.2 kg (5 lb).

**Size:** 127 H x 32 W x 267 mm D (5" x 1.25" x 10.50").

### 11600B/11602B Transistor Fixtures

**Function:** mounts on front of 8745A S-parameter test set; holds devices for S-parameter measurements in a 50 ohm, coax circuit. Both fixtures provide bias for bipolar transistors and FETs. Other devices also fit the fixture (tunnel diodes, etc.).

#### Transistor base patterns

**Model 11600B:** accepts TO-18/TO-72 packages.

**Model 11602B:** accepts TO-5/TO-12 packages.

**Calibration references:** short circuit termination and a 50 ohm through-section.

**Frequency ranges:** dc to 2 GHz.

**Impedance:** 50 ohm nominal.

**Reflection coefficient:**  $< 0.05$ , 100 MHz to 1.0 GHz;  $< 0.09$ , 1.0 to 2 GHz.

**Connectors:** hybrid APC-7; Option 001, type N female.

**Weight:** net 1.1 kg (2.38 lb). Shipping, 1.8 kg (4 lb).

**Size:** 152 H x 44 W x 229 mm D (6" x 1.75" x 9").

### 8743A Reflection/Transmission Test Unit

**Function:** wideband RF power splitter and reflectometer with calibrated line stretcher. Pushbutton operated for either transmission or reflection measurement with network analyzer.

**Frequency range:** 2 to 12.4 GHz, (Opt 018: 2 to 18 GHz).

**Impedance:** 50 ohms nominal.

**Source reflection coefficient:**  $\leq 0.09$ , 2.0 to 8.0 GHz;  $\leq 0.13$ , 8.0 to 12.4 GHz;  $< 0.2$ , 12.4 to 18 GHz.

**Termination reflection coefficient:**  $\leq 0.13$  in reflection mode, 2.0 to 12.4 GHz;  $\leq 0.2$  in transmission mode, 2.0 to 12.4 GHz; typically  $< 0.2$ , 12.4 to 18 GHz.

**Directivity:**  $\geq 30$  dB, 2.0 to 12.4 GHz;  $\geq 18$  dB, 12.4 to 18 GHz.

**Reference plane extension:** 0 to 15 cm for reflection; 0 to 30 cm for transmission.

**Connectors:** RF input, type N female; all other connectors APC-7.

**Remote programming:** ground closure.

**Power:** 115 or 230 V  $\pm 10\%$ , 50-400 Hz, 15 W.

**Weight:** net, 12.1 kg (29 lb). Shipping, 15.3 kg (34 lb).

**Size:** 140 H x 425 W x 467 mm D (5.50" x 16.75" x 18.38").

### 11605A Flexible Arm

**Function:** Mounts on front of 8743A; connects to device under test. Rotary air-lines and rotary joints connect to any two-port geometry.

**Frequency range:** dc to 12.4 GHz. (Opt 018, 2 to 18 GHz).

**Impedance:** 50 ohms nominal. Reflection coefficient of ports:  $\leq 0.11$ , dc to 12.4.

**Opt 018:**  $\leq 0.23$ , 2.0 to 12.4 GHz;  $\leq 0.31$ , 12.4 to 18 GHz.

**Connectors:** APC-7,

**Weight:** net, 1.8 kg (4 lb). Shipping, 2.7 kg (6 lb).

**Length:** 257 mm (10.09") closed; 648 mm (25.50") extended.

### 11610B Test Port Extension Cable

**Function:** A high quality semirigid coaxial cable used with the 8409B Automatic Network Analyzer at frequencies up to 18 GHz. It is designed for applications which require excellent magnitude and phase repeatability from connection to connection. The cable exhibits minimum change in transmission characteristics when flexed during normal use.

**Frequency range:** dc to 18 GHz.

**Impedance:** 50 ohms nominal. Reflection coefficient of ports  $< 0.14$ .

**Insertion loss:**  $< 0.7$  dB + 0.12 db/GHz.

**Stability with three repeated flexings:**  $< 0.3$  dB,  $< 0.5$  degrees 0.12 degrees/GHz change.

**Connectors:** APC-7.

### Ordering Information

	Price
8745A Test Set	\$6300
Opt 001: Type N Test Port Connectors	N/C
Opt 908: Rack Flange Kit	add \$22
11604A Universal Arm Extension	\$1950
11600B/11602B Transistor Fixtures	\$950
Opt 001: Type N Female Connectors	less \$30
8743A Reflection/Transmission Test Unit	\$5000
Opt 018: 2 to 18 GHz	add \$800
Opt 908: Rack Flange Kit	add \$22
11605A Flexible Arm	\$1525
Opt 018: 0.11 to 18 GHz	add \$575
11610B Test Port Extension Cable	\$650



8410 family (cont.)

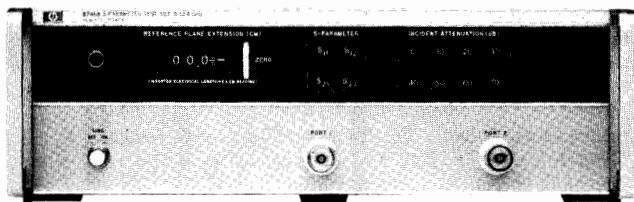

8746B



11608A

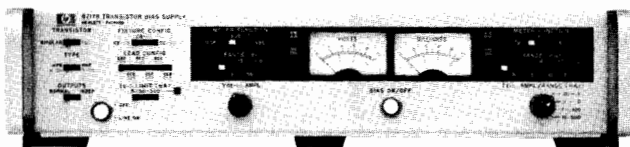

8717B

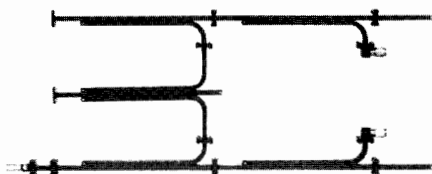

X8747A and P8747A

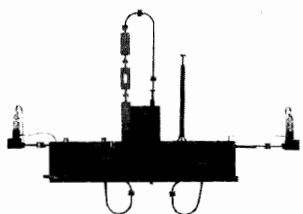

K8747A and R8747A

### 8746B S-Parameter Test Set

**Function:** wideband RF power divider and reflectometer with calibrated stretcher and a selectable 0-70 dB incident signal attenuator. Provides internal bias for completely characterizing two port active devices.

**Frequency range:** 0.5 to 12.4 GHz.

**Source and termination reflection coefficient:**  $\leq 0.13$ .

**Directivity:**  $\geq 30$  dB, 0.5 to 4.0 GHz;  $\geq 26$  dB, 4.0 to 12.4 GHz.

**Incident attenuation:** 0-70 dB in 10 dB steps  $\pm 5\%$ .

**Reference plane extension:** adds 0 to 15 cm for reflection; 0 to 30 cm for transmission.

**Remote programming:** ground closure.

**Transistor biasing:** via 36 Pin connector.

**Connectors:** input type N female, test ports APC-7.

**Opt 001:** provides 10 dB higher power level at the test port.

**Power:** 115 or 230 V  $\pm 10\%$ , 48 to 440 Hz, 110 VA max.

**Weight:** net, 16.1 kg (35 lb). Shipping, 19.1 kg (42 lb).

**Size:** 140 H x 425 W x 467 mm D (5.5" x 16.75" x 18.38").

### 11608A Transistor Fixture

**Function:** provides the capability of completely characterizing stripline transistors in either the TO-51 or HPAC-200 package styles. For special package styles, a through-line microstrip and bolt-in grounding structure machineable by customer is available.

**Frequency range:** dc to 12.4 GHz.

**Reflection coefficient:**  $< 0.05$ , dc to 4 GHz;  $< 0.07$ , 4.0 to 8.0 GHz;  $< 110$ , 8 to 12.4 GHz.

**Package styles**

**Opt 001:** Customer machineable.

**Calibration references:** options 002 and 003 only, short circuit termination and a 50-ohm through-section.

**Connectors:** APC-7 Hybrid (Option 100 type N female).

**Weight:** net, 0.9 kg (2 lb). Shipping, 1.4 kg (3 lb).

**Size:** 25 H x 143 W x 89 mm D (1" x 5.63" x 3.5").

### 8717B Transistor Bias Supply

**Function:** for manual or programmable transistor testing. It is particularly useful with the 11600B, 11602B, and 11608A Transistor Fixtures. The 8717B has two meters for independently monitoring current and voltage on any of the three leads of a transistor under test. Bias connections are conveniently selected for all transistor configurations with a front panel switch. Special circuitry protects sensitive devices from excessive current transients which commonly occur in less sophisticated supplies.

**Voltage ranges:** 1, 3, 10, 30, 100 V.

**Current ranges:** 0.1, 0.3, 1, 3, 10, 30, 100, 300, 1000 mA.

**Accuracy:** 4% of full scale for both current and voltage.

**Option 001:** programmable D/A converter.

**Weight:** net, 9.0 kg (20 lb). Shipping, 11.0 kg (25 lb).

**Size:** 86 H x 425 W x 336 mm D (3.38" x 16.75" x 13.5").

### X, P 8747A Reflection/Transmission Test Units

**Function:** waveguide setup for measuring reflection and transmission parameters of waveguide devices with the network analyzer.

**Frequency range:** X8747A: 8.2-12.4 GHz; P8747A: 12.4-18 GHz.

### K, R 8747A Reflection/Transmission Test Units

**Function:** waveguide setup for measuring reflection and transmission parameters of waveguide devices with the network analyzer; down-converts with built-in mixers to the frequency range of the 8411A.

**Frequency range:** K8747A: 18-26.5 GHz; R8747A: 26.5-40 GHz.

### Ordering Information

	Price
8746B Test Unit	\$9100
Opt 001: Large Signal	N/C
Opt 908: Rack Flange Kit	add \$25
11608A Transistor Fixture (must specify Option 001, 002, or 003)	
Opt 001: Customer Machineable	\$750
Opt 100: Type N Female Connectors	less \$30
8717B Transistor Bias Supply	\$3400
Opt 001: Programmable D/A Converter	add \$670
Opt 908: Rack Flange Kit	add \$25
X8747A Waveguide Test Set	\$3475
P8747A Waveguide Test Set	\$3625
K8747A Waveguide Test Set	\$10,025
R8747A Waveguide Test Set	\$10,575

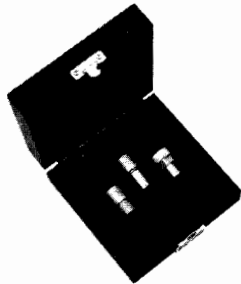

11866A

#### 11866A APC-7 Calibration Kit

**Function:** a 50Ω (> 52 dB return loss @ 2 GHz) termination, a short circuit and a shielded open circuit are used with the 8409 to quantify directivity, source match, and frequency tracking errors.

**Weight:** net 0.57 kg (1.25 lb). Shipping 0.91 kg. (2.0 lb).

**Size:** 50.8 H x 7 W x 12.7 D (2.0" x 5.0" x 5.0").



11650A

#### 11650A Accessory Kit

**Function:** accessories normally used for transmission and reflection tests with the 8745A and 8743A.

**Weight:** net, 1.34 kg (3 lb). Shipping, 2.23 kg (5 lb).

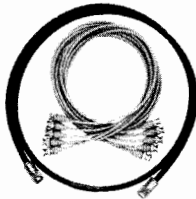

11609A

#### 11609A Cable Kit

**Function:** interconnecting cables normally required for network measurements using the 8410 network analyzer.

**Weight:** net, 0.9 kg (2 lb). Shipping, 1.36 kg (3 lb).

#### 11589A and 11590A Bias Networks

**Function:** auxiliary units for use with the 11600B, 11602B and 11608A transistor fixtures. These bias networks provide dc bias to the center conductor of a coaxial line while blocking the dc bias from the input RF circuit.

**Frequency range:** 11589A—0.1 to 3.0 GHz; 11590A—1.0 to 12.4 GHz.

**Connectors:** BNC for dc biasing; type N female for RF (Option 001; APC-7).

**Weight:** net, 0.3 kg (0.67 lb). Shipping, 0.5 kg (1 lb).

**Size:** 29 H x 76 W x 114 mm D (1.38" x 3" x 4.5").

#### 11599A Quick Connect Adapter

**Function:** quickly connects and disconnects the 8745A and the transistor fixtures or 11604A universal extension.

**Weight:** net, 0.4 kg (0.88 lb). Shipping, 0.9 kg (2 lb).

**Size:** 127 H x 76 W x 108 mm D (5" x 3" x 4.5").

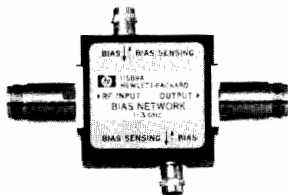

11589A and 11590A

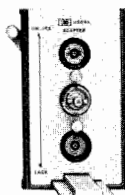

11599A

#### 11607A Small Signal Adapter

**Function:** used with the 8745A S-parameter test set. The incident signal levels to the test device are reduced to the -20 to -40 dBm range.

**Weight:** net 4.1 kg (4.63 lb). Shipping, 4.5 kg (10 lb).

**Size:** 60 H x 413 W x 244 mm D (2.38" x 16.25" x 9.63").

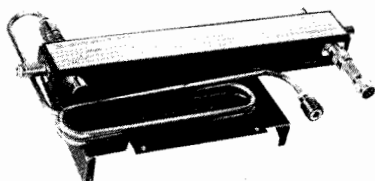

11607A

#### Ordering Information

	Price
11650A Accessory Kit	\$1055
11866A APC-7 Calibration Kit	\$360
11609A Cable Kit	\$145
11589A Bias Network	\$400
Opt 001: APC-7 Connectors	add \$30
11590A Bias Network	\$450
Opt 001: APC-7 Connectors	add \$30
11599A Quick Connect Adapter	\$200
11607A Small Signal Adapter	\$850

# NETWORK ANALYZERS

Automatic network analyzer, 110 MHz to 18 GHz

Model 8409B

- Synthesized Network Analyzer with phase-locked source
- 0.11 to 18 GHz operation
- 12 term vector error-correction
- Easy user interaction

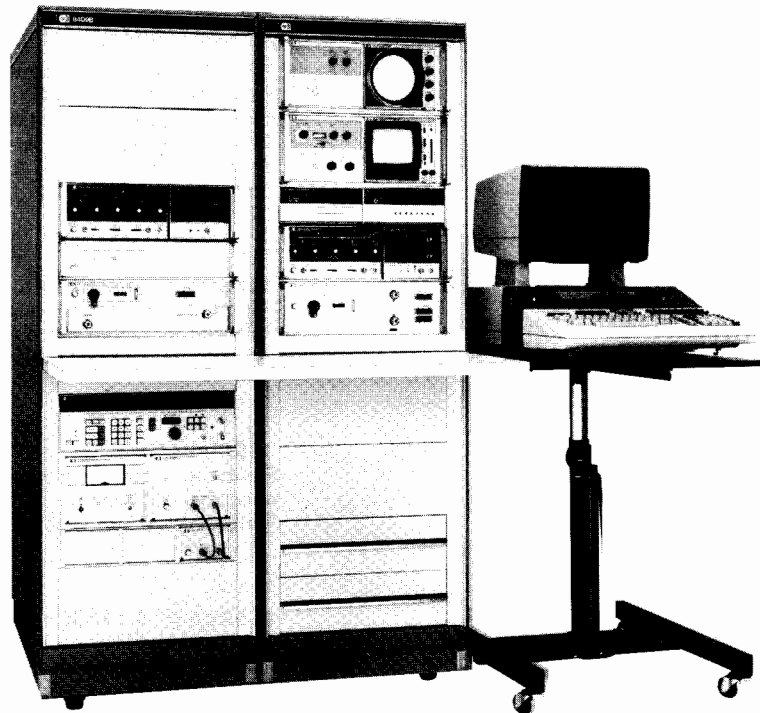

## Description

The HP 8409B Automatic Network Analyzer is a complete microwave network measurement system comprised of a network analyzer (receiver), reflection/transmission test set, programmable source, programmable synthesizer (for phase-locking the source and receiver), desktop computer, and software applications pac that uses a comprehensive vector error-correction model. The system covers the 110 MHz to 18 GHz frequency range in two bands: 110 MHz to 2 GHz, and 2 to 18 GHz, with the appropriate source and test set outputs automatically switched to the network analyzer.

Vector-error correction can substantially increase the accuracy of magnitude and phase measurements. Reducing measurement uncertainty allows guard band tolerances to be tightened and consequently improves production yields. In the case of highly reflective devices such as transistors, vector error correction actually permits measurements that were previously not possible.

The vector-error correction used in the 8409B is user selectable between a simple 8-term model and a more comprehensive 12-term model. This allows flexibility in making tradeoffs between measurement accuracy and speed depending on unique measurement requirements. The system calibrates with a precision sliding load, a short, a shielded open, and a through connection to quantify the directivity, source match, load match, tracking and isolation errors at each frequency. These RF hardware errors, which can become substantial at higher frequencies, are removed during the measurement sequence as the analyzer tunes back to each calibration frequency, measures the device response, and performs the error correction computation.

## 8409A Automatic Network Analyzer System Components

Basic configuration includes:

### Network Analyzer

8410B Network Analyzer

8411A Opt 018 Harmonic Frequency Converter

8412A Phase-Magnitude Display

8418A Opt H01 Auxiliary Display Holder

8414A Opt H07 Polar Display

### Test Sets

8745A S-Parameter Test Set (0.11 to 2 GHz)

11857A Test Port Extension Cables

8743A Opt 018 Reflection/Transmission Test Set (2 to 18 GHz)

11610A Test Port Extension Cable

8327A Test Set Selector

### Source

8620C Opt 011 Sweep Oscillator Mainframe with HP-IB Interface

86222B (.01 to 2.4 GHz)

86290B (2 to 18.6 GHz)

### HP-IB Accessories

59313A Analog-to-Digital Converter

59306A Relay Actuator

### Controller

9845T Desktop Computer

98034A Opt 445 HP-IB Interface System Controller Table

APC-7, Type N, and SMA Calibration Accessories,  
11863B Software, Interconnect Cables and System Integration

### Ordering Information

8409A Automatic Network Analyzer

Opt 001: (2 to 18 GHz) deletes 0.11 to 2 GHz test set and sweeper plug-in.

Opt 002: delete controller less \$25,050

11863D Applications Software Pac for the 9845T Desktop Computer

### Price

\$122,500

\$250

- Digital storage and normalization
- Simple CRT photos and x-y recordings
- Use with HP network and spectrum analyzers

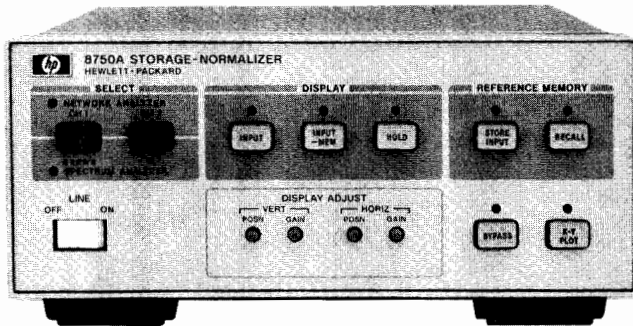

With HP's versatile 8750A Storage-Normalizer, you can make your network analyzer or spectrum analyzer measurements faster, easier, and more accurately through the simple addition of digital storage and normalization. This useful instrument accessory is directly compatible via a single interface cable with the following recently produced or appropriately modified Hewlett-Packard instruments; the 8755 Frequency Response Test Set, the 8407A/8412A, the 8410/8412A, the 8754A and the 8505A Networks Analyzers and 8557A, 8558B, 8565A and 8559A Spectrum Analyzers. A special I/O Adapter (opt 001 or opt 002) is available for interfacing instruments (like 140 Series Spectrum Analyzers) that are not directly compatible with the 8750A. An external oscilloscope can then be used for digitally stored and normalized displays. (The 8750A is not compatible with the 8414A Polar Display or the polar mode of the 8505A or the 8754A.)

In network analyzer applications, digital storage always yields a flicker-free display of the complete device response, facilitating easy adjustment of test devices under slow sweep conditions. Measurement accuracy is also improved since frequency response errors can be automatically removed through digital normalization. This effectively eliminates the need to manually record calibration traces on a CRT or x-y recorder and allows high resolution measurements of attenuator, amplifier, or filter passband flatness.

In spectrum analyzer applications, the 8750A's digital storage feature simplifies many difficult tests requiring slow scan times such as high resolution modulation measurements. Drift tests are also easy since two traces, a stored reference and the current input, can be displayed simultaneously.

Hard copy documentation can be obtained quickly and easily since data can be frozen on the CRT for straightforward CRT photography or outputted to an x-y recorder at a constant 30 second sweep rate.

## Supplemental Performance Characteristics

### Display

**Horizontal memory resolution:** two display channels, 256 points per channel (0.4% of full scale, 8 bit word)

**Vertical memory resolution:** 512 points displayed full scale (0.2% of full scale, 10 bit word) plus a 50% overrange (256 points) both above and below full screen.

**Horizontal input sweep rates:** 100 sec max./10 ms. min.

**Display refresh rate:** 6 ms.

### Video detection

**Network analyzer:** Average Detection (20 kHz).

**Spectrum analyzer:** Peak Detection.

### Input/output

#### A/D Horizontal Input

**Network analyzer:** 0 to 10 V nominal. Offset  $\pm 0.5$  V and Gain Adjust for 6 to 15 V sweep.

**Spectrum analyzers:**  $\pm 5$  V nominal. Offset  $\pm 0.5$  V and Gain Adjust for  $\pm 4.5$  to  $\pm 5.5$  V.

#### A/D Vertical Input

**Network analyzer:**  $\pm 1$  V min. and  $\pm 2$  V max, with continuous gain adjustment. Offset  $\pm 0.3$  V.

**Spectrum analyzer:** 0 to 0.8 V or 0 to  $-0.8$  V. Offset  $\pm 0.1$  V and Gain Adjust  $\pm 10\%$ .

#### D/A Horizontal output

**Network analyzer:** gain adjustment for 1 to 3 V peak. Offset adjustment  $+5$  to  $-1.5$  V.

**Spectrum analyzer:** gain adjustment for 1 to 3 V peak. Offset  $+5$  to  $-1.5$  V.

#### D/A Vertical output

**Network analyzer:** same as Vertical Input with  $\pm 10\%$  adjustment range.

**Spectrum analyzer:** same as Vertical Input with  $\pm 10\%$  adjustment range.

#### X-Y Recorder outputs

**Horizontal range and accuracy:** 0  $\pm 20$  mV to 1 V nominal, settable within  $\pm 3\%$  of full scale. BNC female output (rear panel).

**Vertical range and accuracy:**  $\pm 4$  V  $\pm 3\%$  BNC female output (rear panel).

**Sweep time:** 30 sec per displayed trace.

**Penlift output:** BNC female (rear panel with open collector driver 20 V maximum.)

#### Controls

**Select:** LED display indicates Network or Spectrum Analyzer operation depending on the plug-in interface card.

#### Display

**Input:** initiates digital storage.

**Input-Mem (Input minus Memory):** Stored Reference trace is subtracted from input data (normalization).

**Hold:** freezes display for CRT photos or further analysis.

#### Reference memory

**Store input:** current input trace is stored as Reference.

**Recall:** displays stored Reference trace.

**Bypass:** bypasses 8750A so display is returned to conventional analog operation.

**X-Y Plot:** initiates X-Y plots.

#### General

**Interface Cards:** The 8750A is supplied with two general plug-in interface cards. One for use with the HP Spectrum Analyzers listed above, one for use with the 8407A/8412A and 8505A Network Analyzers. When the 8750A is to be used primarily with an 8755B/C Frequency Response Test Set and 8620C Sweeper, 8410B/8412A Network Analyzer and 8620C Sweeper, or the 8754A Network Analyzer, calibration and adjustment of the 8750A to these instruments can be greatly simplified by ordering one of the plug-in interface cards dedicated to these instruments (Opt. 003 and 004.) All offset and gain adjustments are significantly reduced. When Opt. 003 or 004 are ordered the two general interface cards are also included so you have the flexibility to change your test set up at any time.

**Power:** selection 100, 120, 220, or 240 V  $+5\%$   $-10\%$ . 48 to 440 Hz and  $<20$  VA ( $<20$  watts).

**Size:** 102 H x 212 W x 280 mm D (4 x 8.4 x 11.2 in).

**Weight:** net. 2.72 kg (6.1 lbs). Shipping, 5.0 kg (11 lbs).

#### Ordering Information

8750A Storage-Normalizer

Price

\$1750

**Opt 001:** BNC Interface Adapter (Deletes direct interface cable)

N/C

**Opt 002:** BNC Interface Adapter (Retains direct interface cable)

add \$125

**Opt 003:** 8755B/C or 8412A/8620C Plug-in Interface Card

add \$100

**Opt 004:** 8754A Plug-in Interface Card

add \$100



# SIGNAL ANALYZERS

Wave, distortion, modulation, spectrum and Fourier analyzers

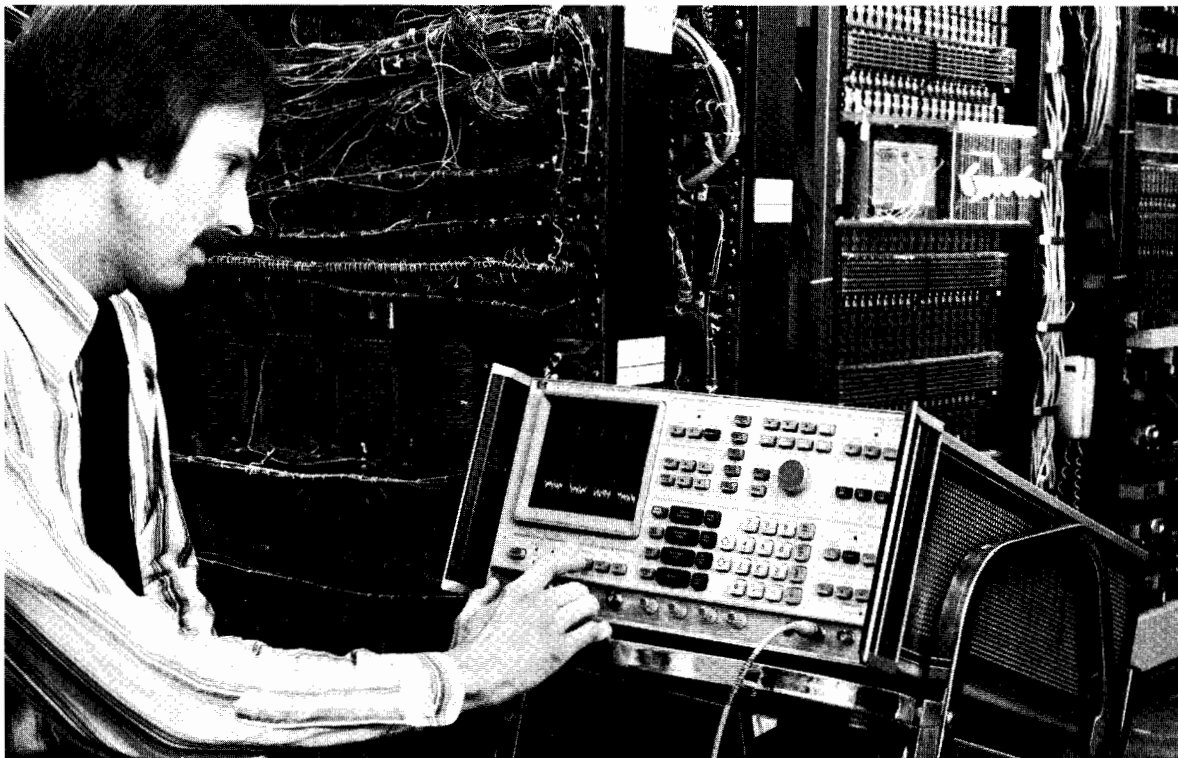

Analysis of signals in the frequency domain is an important measurement concept which is widely used for providing electrical and physical system performance information. Several examples will illustrate some important applications where signal analyzers are useful.

### Mechanical Measurements

Noise and vibration levels are of major concern to manufacturers and users of mechanical structures such as aircraft, automobiles, and bridges. With an appropriate motion-to-electrical signal transducer the spectrum analyzer or the Fourier analyzer can examine vibration signals in the frequency domain. This makes it possible to monitor and analyze vibration components of rotating machines associated with unbalance, worn bearings or worn gears, and to identify a structure's natural modes of vibration.

### Communications

In the fields of telecommunications, the spectrum, modulation, wave and audio analyzers provide vital operational performance verification of transceivers and multiplex systems. Unwanted signals such as carrier leak signals, out-of-band noise, and cross modulated signals must be identified. System gain, loss, distortion and pilot tone measurements must also be made. These measurements are discussed in more detail in the Telecommunications Test Equipment section of this catalog.

### Electronic Testing

Finally, in the general field of electronics, there are four primary uses for the signal analyzer. First, the analyzer is used to identify and measure signals which result from non-linear effects in the process of amplification, filtering, and mixing. Second, the purity of signal sources is commonly observed.

Third, the modulation analyzer serves a special purpose in analyzing modulated communication signals by measuring and displaying RF power, frequency and modulation characteristics. Fourth, the signal analyzer with a companion tracking generator is used as a network analyzer for frequency response measurements of filters, amplifiers, and many other types of networks.

### Basic Analyzers

This section discusses the definition and use of several types of instruments for frequency response signal analysis: spectrum analyzers, digital Fourier analyzers, wave analyzers, distortion analyzers, audio analyzers and modulation analyzers.

Each of these instruments measure basic properties of a signal in the frequency domain, but each uses a different technique. The spectrum analyzer is a swept receiver that provides a visual display of amplitude versus frequency. It shows on a single display how energy is distributed as a function of frequency, displaying the absolute value of Fourier components of a given waveform. The Fourier analyzer uses digital sampling and transformation techniques to form a Fourier spectrum display that has phase as well as amplitude information. The wave analyzer is the true tuned voltmeter, showing on a meter the amplitude of the energy in a specific frequency window which is tunable over a specific frequency range. The distortion analyzer performs an almost reciprocal function to that of the wave analyzer. It collectively measures the energy outside a specific bandwidth tuning out the fundamental signal and displaying the energy of the harmonics and other distortion products on a meter. The Audio Analyzer performs the same measurement function as a distortion analyzer but also includes the additional

measurement functions of SINAD, signal to noise ratio, frequency count, true rms dvm and dc dvm. The modulation analyzer tunes to the desired signal and recovers the entire modulation envelope of AM, FM and phase modulation for processing and display.

### Different Views

Figure 1 shows a graphical representation of the way four of the analyzers view a signal and one harmonic. The time domain scan of the signal is presented in Figure 1a.  $A(t)$  is the complex voltage waveform as it would be viewed on an oscilloscope. The dashed lines represent the vector components of the signal:  $A_1(t)$ , the fundamental and  $A_2(t)$  the second harmonic. In 1b, the spectrum analyzer displays the frequency spectrum showing both vector components and their amplitude relationship. Spectrum analysis is useful from 5 Hz to over 40 GHz.

The Fourier analyzer uses digital signal processing techniques to extract both the amplitude and phase information about each spectral component. Conceptually the Fourier analyzer can be viewed as measuring a large number (up to 2048) of parallel filters as shown in Figure 1c. These filters are actually very specialized digital filters so that precise, repeatable results can be obtained. With this arrangement of parallel filters the complete display is generated in the time that it takes to analyze the lowest frequency component. HP Fourier analyzers presently cover the range of DC to 100 kHz.

The wave analyzer in Figure 1d, measures the amplitude and frequency of the signal in the frequency window to which it is tuned. This window can be moved to measure the amplitude of the second harmonic, thereby making a precise comparison with the fundamental. This technique is practical from 15 Hz to above 32 MHz.

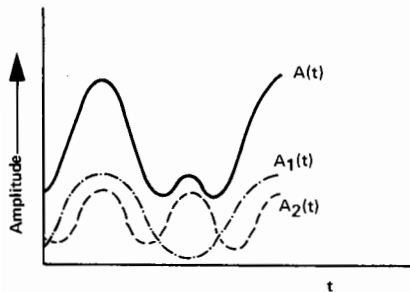

Figure 1a. Waveform

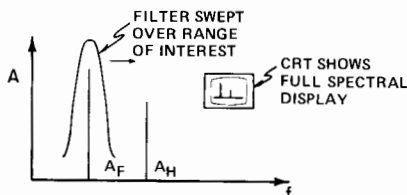

Figure 1b. Spectrum analyzer

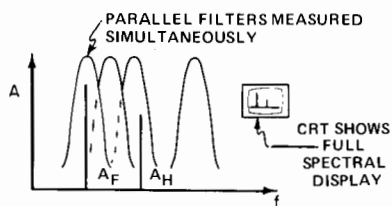

Figure 1c. Fourier analyzer

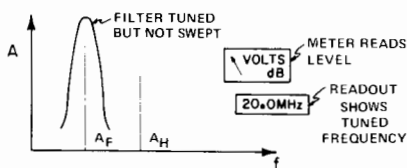

Figure 1d. Wave analyzer

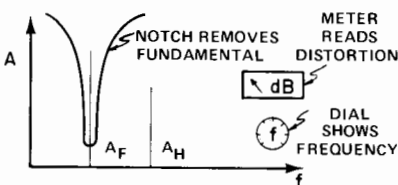

Figure 1e. Distortion analyzer

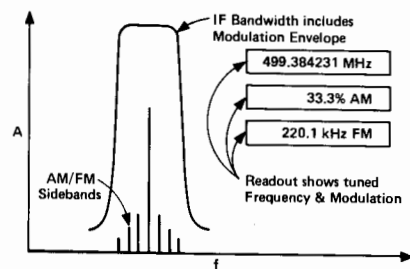

Figure 1f. Modulation analyzer

The distortion analyzer as pictured in Figure 1e. rejects the fundamental to which it has been tuned and measures the energy everywhere else within the instrument's frequency spectrum. Distortion, as a percentage or in dB down from the fundamental, is displayed directly on a meter. Hewlett-Packard distortion analyzers cover 5 Hz to 600 kHz.

The modulation analyzer of Figure 1f. tunes to a desired frequency just as the wave analyzer. Its IF bandwidth and detection system are designed to pass the entire modulation envelope so that percent modulation, distortion, residual and peak deviation measurements can be made. All close-in spectral components, of course, are combined in the measurement.

The following section considers each instrument technique, showing the particular strength and flexibility of each.

### Spectrum Analyzers

To display useful information about a frequency scan, a spectrum analyzer must be sensitive, frequency stable, free of spurious responses over a wide band, and have calibrated accuracy in the CRT display. The examples which follow best demonstrate the wide variety of information which can be measured on the spectrum analyzer.

### Measurements with the Spectrum Analyzer

**CW signal:** the most basic spectrum analysis measurement is the single CW signal.

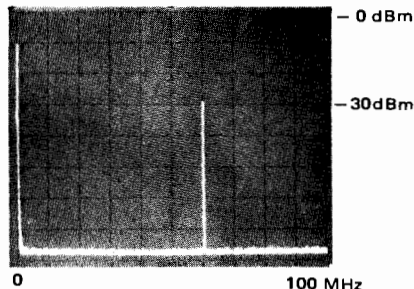

Pictured is a -30 dBm signal at 60 MHz. The zero frequency indicator is at the far left graticule.

**Spectral purity of a CW signal:** one very important oscillator signal measurement is spectral purity. This 70 MHz carrier has power line related sidebands ( $\pm 60$  Hz) which are 65 dB down.

Such sidebands may result from power supply ripple. The 50 Hz/division spectrum analyzer scan and the 10 Hz analyzer bandwidth provide the high degree of resolution required to see these sidebands.

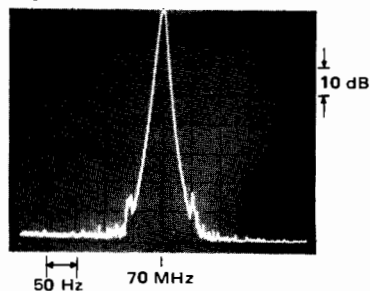

**Frequency conversion products:** the spectrum analyzer is well suited for frequency conversion measurements such as the output of a balanced mixer as shown.

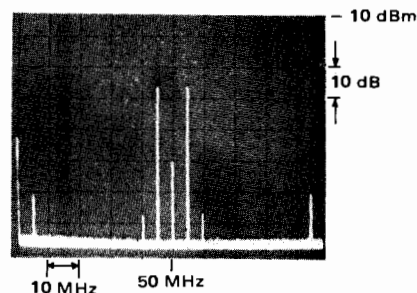

With the 50 MHz local oscillator input at 0 dBm and a 5 MHz, -30 dBm mixer signal, two sidebands at 45 MHz and 55 MHz result. The sidebands are -36 dBm, giving the mixer a 6 dB conversion loss. The local oscillator has 60 dB isolation and the 5 MHz signal has 41 dB isolation. Second order distortion products at 40 and 60 MHz are 40 dB below the desired mixer outputs.

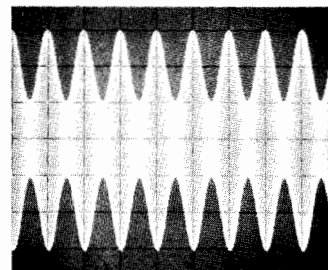

Oscilloscope

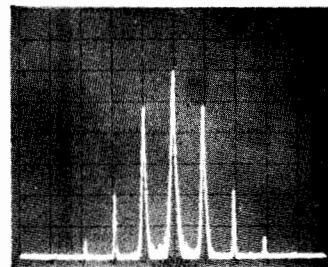

Spectrum Analyzer

**Amplitude modulation:** percent amplitude modulation is often more easily measured with the spectrum analyzer than it is with the oscilloscope. This is especially true for low level modulation.

With the oscilloscope time display, percent modulation,  $M$ , is measured as a ratio of the signal's dimensions:  $M = 100(6-2)/(6+2) = 50\%$ . In the spectrum analyzer display, whose vertical calibration is 10 dB/division, the carrier and sidebands differ by 12 dB, the voltages in the sidebands are  $1/4$  of that of the carrier and again,  $M = 50\%$ . At the same time the second and third harmonic distortion of the sidebands can be measured at 28 and 44 dB respectively.

# SIGNAL ANALYZERS

## Wave, distortion, modulation, spectrum and Fourier analyzers (cont'd)

**Frequency modulation:** information transmitted by FM can be characterized by the spectrum analyzer.

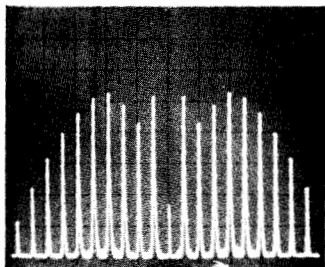

Low Deviation FM

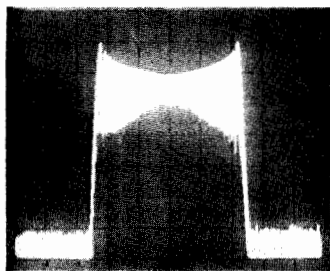

High Deviation FM

Low deviation FM is applied to a 60 MHz carrier in the first photo. The deviation has been adjusted for the second carrier null ( $M = 5.52$ ). The sideband spacing is 10 kHz, the modulation frequency; therefore,  $\Delta f_{\text{peak}} = 5.52 \times 10 \text{ kHz} = 55.2 \text{ kHz}$ .

The second photo is an example of a high deviation FM. The transmission bandwidth is 2.5 MHz.

**Pulsed CW power:** by viewing the spectra of a repetitive RF pulse on the spectrum analyzer, pulse width, average and peak power, occupied bandwidth, and duty cycle can be determined.

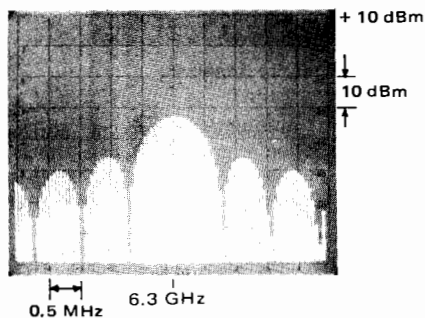

From the spectral output shown the pulse's complete characteristics are determined: 6.3 GHz RF at 0 dBm, pulsed at 50 kHz rate. The pulse width is 1.3  $\mu\text{s}$ .

**Noise:** spectrum analysis is effective in measuring impulse noise, random noise, carrier to noise ratio, and amplifier noise figure.

**Phase noise:** the short term frequency fluctuations of a sine wave source can be measured directly as phase modulation sidebands. Hewlett-Packard spectrum analyzers with narrow resolution and synthesized internal frequency sources can make many phase noise measurements directly. Bandwidth corrections, analyzer corrections, data averaging and setup calibration factors can be accounted for by Hewlett-Packard microprocessor controlled spectrum analyzers. All instrument controls, data transfer and data reduction can be handled by easy-to-write software for Automatic Spectrum Analyzers.

**Frequency response:** using a tracking signal source and a spectrum analyzer the frequency response of filters can be displayed with ease.

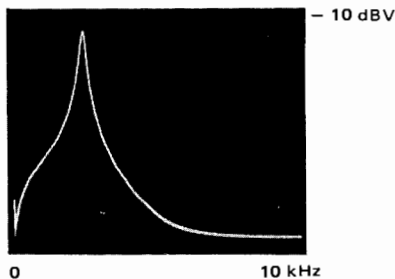

In this case, an audio filter used in a communications system is being measured. Since the input reference level to the filter is -13 dBV, the insertion loss at 2.4 kHz is 4 dB. Extremely high Q devices can be measured with this system.

### Spectrum Analyzer Capabilities

To be useful in making measurements in the frequency domain, the analyzer must be capable of making quantitative measurements. Specifically, an analyzer must:

1. make absolute *frequency* measurements
2. make absolute *amplitude* measurements
3. operate over a *large amplitude dynamic range*
4. have *high resolution* of frequency and amplitude
5. have *high sensitivity*
6. provide means of *observing, preserving, and recording* its output in a convenient and rapid manner by using variable persistence, digital storage and adaptive sweep. Hewlett-Packard spectrum analyzers excel in these six measures of performance. Let us consider each of these performance standards in greater detail.

**Absolute frequency measurements:** Frequency readout accuracy depends upon the tuning and readout techniques employed, as well as the stability of the spectrum analyzer's frequency reference. The absolute frequency accuracy read off the slide-rule type of frequency dial is approximately 1% of full scale. Synthesized local oscillators allow accuracies to  $\pm 4 \text{ Hz}$  at 1500 MHz in narrow

frequency spans. When the spectrum analyzer is used in conjunction with a tracking generator (a source whose frequency is the same as the analyzer tuning frequency) accuracy much better than 1% can be achieved by counting the generator output.

**Absolute amplitude measurements:** all Hewlett-Packard spectrum analyzers are absolutely calibrated for amplitude measurements. This means the spectrum analyzer indicates to the user what the log/reference level or linear sensitivity is regardless of control settings. Either a warning light or CRT message indicates an uncalibrated condition, making operation of the analyzer easy and foolproof.

Microprocessor controlled analyzers feature built-in calibration routines which account for changes in analyzer controls such as the resolution bandwidth and RF attenuator.

**Dynamic range:** the dynamic range of a spectrum analyzer is defined as the difference between the input signal level and the average noise level or distortion products whichever is greater. Hence, dynamic range can be either distortion limited, noise limited or display limited. Hewlett-Packard microprocessor controlled analyzers can be set to ensure that distortion products of on-screen signals will be below a certain level.

**Frequency and amplitude resolution:** frequency resolution is the ability of the analyzer to separate signals closely spaced in frequency. The frequency resolution of an analyzer is a function of three factors: 1) minimum IF bandwidth, 2) IF filter shape factor, 3) spectrum analyzer stability.

The minimum IF bandwidth ranges down to 1 Hz on Hewlett-Packard spectrum analyzers.

One way to define IF filter shape factor is the ratio of 60 dB bandwidth to 3 dB bandwidth. Filter shape factor specifies the selectivity of the IF filter. Hewlett-Packard spectrum analyzers have IF filter shape factors as low as 5:1.

Analyzer frequency stability also limits resolution. The residual FM (short term stability) should be less than the narrowest IF bandwidth. If not, the signal would drift in and out of the IF pass band. Hewlett-Packard analyzers have excellent stability. The residual FM ranges from  $< 1 \text{ Hz}$  at low frequency, to  $< 100 \text{ Hz}$  at microwave frequencies, enabling the measurement of noise sidebands. The stabilization circuitry is completely automatic and foolproof. No signal recentering, phase-lock loop, manual search, or checking is required.

Amplitude resolution is a function of the vertical scale calibration. Hewlett-Packard analyzers offer both log calibration for observing large amplitude variations (10, 5, 2 and 1 dB/div) and linear calibration for observing small amplitude variations.

**Sensitivity:** sensitivity is a measure of an analyzer's ability to detect small signals, and is often defined as the point where the signal level is equal to the noise level or  $(S+N)/N=2$ . Since noise level decreases as the bandwidth is decreased, sensitivity is a function of bandwidth. The maximum attainable sensitivity ranges from  $-150$  dBm to  $-125$  dBm with Hewlett-Packard analyzers.

**Variable persistence, digital storage, and adaptive sweep:** high resolution and sensitivity both require narrow bandwidths and consequently slow sweep rates. Because of these slow sweeps, both digital display and variable persistence are virtually indispensable in providing a bright, steady flicker-free trace.

The digital storage feature on Hewlett-Packard analyzers covering audio to microwave frequency ranges make measurements and CRT photography simple. It gives the CRT display a dot matrix connected by line generators for an unbroken and uniform intensity scan. In addition, the microprocessor controlled analyzers feature CRT annotation to completely describe the data characteristics displayed.

On low frequency analyzers, adaptive sweep effectively speeds the measurement times. On the very slow sweep times (required when using the 1 Hz bandwidth), adaptive sweep allows the scan to sweep rapidly when no signals occur and slow down when a signal is above a preset level. The measurement time savings can be greater than 20:1.

### Tracking Preselector

The only way to simultaneously avoid spurious, multiple, harmonic and image responses is to filter the RF signal through a tracking preselector. This is an electronically tuned bandpass filter that automatically tracks the analyzer's tuning. A preselector improves the spurious-free range of the analyzer from 70 dB to 100 dB.

### Tracking Generator

A tracking generator expands the measurement capability of the spectrum analyzer by providing a signal source which tracks the tuning frequency of the analyzer. The source/receiver combination can be used to measure insertion loss, frequency response, return loss and allow precision frequency counting.

It helps make these additional measurements with increased distortion-free dynamic range, sensitivity and selectivity. The tracking generator is also an excellent stable sweeping generator. The residual FM varies from  $\pm 1$  Hz for low frequency tracking generators to  $\pm 400$  Hz for microwave tracking generators.

### Automatic Spectrum Analyzers

The measurement capability of a spectrum analyzer can be greatly enhanced by allowing a desktop computer to control instrument functions and record frequency and ampli-

tude information. Data can be gathered and processed into a variety of formats at a very rapid rate. Through comprehensive self-calibration, automatic spectrum analysis offers amplitude accuracy of up to  $\pm 0.2$  dB with 0.02 dB resolution. User cost savings are realized through faster measurements, lower operator skill requirements, and unattended operation capability.

Further discussion of computer based automatic spectrum analysis can be found on page 514.

### Frequency Stability Analysis

Frequency stability and spectral purity are important parameters when characterizing precision frequency sources. Long term stability or frequency drift due to aging or temperature effects is generally measured with a precision frequency counter such as the HP 5345A; random fluctuations in frequency or phase stability can be measured in the time domain with an electronic counter and the Allan Variance technique.

Another measure of frequency stability is the phase spectral density. The most common method of making this measurement is to mix two signals together and feed the output into a lower frequency wave analyzer or spectrum analyzer. The technique works well for offset frequencies far away enough from the carrier to be compatible with the bandwidths of the analyzer.

For offset frequencies close to the carrier, (e.g. below 100 Hz) the bandwidths of analog analyzers become large in comparison to the frequencies being measured. As 1 Hz is approached, measurements become extremely difficult.

An automatic system for making phase spectral density measurements very close to the carrier is the HP 5390A Frequency Stability Analyzer which is based upon a high performance electronic counter and a programmable calculator. The counter is ideally suited to make measurements in the time domain, and the calculator can transform the data into the frequency domain. This technique allows measurements to be made from 0.01 Hz away from the carrier out to 10 kHz. Sensitivities greater than  $-150$  dBc can typically be obtained at a 1 Hz offset on carriers ranging from 500 kHz to 18 GHz. The standard 5390A requires two sources which can be offset from one another. The 5390A option 010, based on the dual mixer time difference technique, can perform these same measurements on non-offsettable sources. For a more complete description of this automated technique refer to the 5390A Frequency Stability Analyzer on page 556.

### Fourier Analyzers

The Fourier analyzer uses digital signal processing techniques to provide measurement capability over and above that of a swept spectrum analyzer. Some of these include the precise measurement of random signals obscured by noise, measurement of

the joint properties or relationships of two or more signals, measurements of statistical properties of signals, and measurements of very low frequency (e.g. below 5 Hz) or very closely spaced (e.g. less than 1 Hz) signals.

Fourier analyzers are based on the calculation of the Discrete Fourier Transform using a highly efficient algorithm known as the Fast Fourier Transform. As shown in Figure 2, this algorithm calculates the magnitude and phase of each frequency component from a block of time domain samples of the input signal.

The block diagram that is involved is shown in Figure 3. First, the input signal is filtered to remove out-of-band components. Next, the input is sampled and digitized at regular  $\Delta t$  intervals until a full block of samples called a time record has been collected. The processor then executes the desired series of computations on the time data to produce the frequency domain results. These results, which are stored in memory, can be analyzed on a CRT display, plotted, or processed further to provide the user additional useful information.

$$X(k \Delta f) = \sum x(n \Delta t) e^{-j2\pi(n)k/N}$$

EACH FREQUENCY POINT IS COMPOSED OF A MAGNITUDE AND PHASE VALUE

EACH FREQUENCY POINT CONTAINS INFORMATION FROM ALL TIME DOMAIN SAMPLES

COMPLEX FACTOR

Figure 2

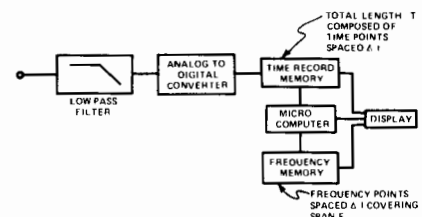

Figure 3

When two or more input channels are provided, signals can be sampled simultaneously. The processor can then additionally compute joint properties of the signals. This is useful for characterizing the transfer function of a linear device and for investigating cause/effect relationships.

The digital nature of Fourier analysis insures *high accuracy, stability and repeatability*. In addition, there are several specific advantages that are achieved.

### Low Frequency Coverage

The Fourier transform calculates equally spaced frequency components from DC to the maximum frequency. By simply varying the sample rate it is possible to make measurements down to a few micro Hertz. For such low frequency measurements, the laws of physics dictate a long observation time. Since the Fourier transform simultaneously calculates all frequency points from one set of observation points, a one to two order of magnitude speed improvement over a swept measurement is possible.

# SIGNAL ANALYZERS

## Wave, distortion, modulation, spectrum and Fourier analyzers (cont'd)

### High Frequency Resolution

By digitally translating a band of frequencies down to DC it is possible to provide very high frequency resolution over the entire range. This technique, known as Band Selectable Fourier Analysis, can provide resolution of a few millihertz as shown in Figure 4. Here a 5 Hz band of frequency located at 3 kHz is analyzed showing 0.48 Hz sidebands over 20 dB down.

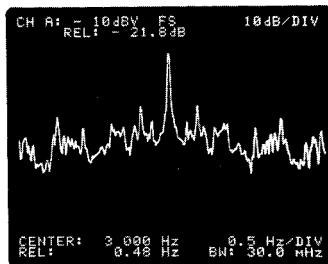

Figure 4

### Direct Transfer Function Measurements

With simultaneous sampling of both the input and output of an electrical, mechanical, or acoustical system, it is possible to directly characterize transfer functions. Since the Fourier analyzer measures the frequency components simultaneously, energy must also be provided at these frequencies. This can be done with a broadband white noise signal, a pseudorandom noise signal or an impulse. Results presented in magnitude/phase or real/imaginary format help quickly illustrate the performance characteristics of a system.

The measurement of the coherence function can additionally provide a measure of the validity of a transfer function. It can distinguish portions of the output power that are not directly caused by the input, but may instead be due to additive noise, distortion products, or unmeasured inputs.

### Systems Compatibility

Since the Fourier analyzer is basically all digital, interfacing to a computing controller or other digital peripherals is relatively simple. Remote programming and data input/output can considerably expand the range of potential applications.

### Fourier Analyzer Applications

The versatility and performance of the Fourier analyzer make it an ideal tool for a variety of applications as a few specific examples will illustrate.

In the general area of electronics, the Fourier analyzer functions as a very high performance spectrum and network analyzer. It can be very useful for measuring phase noise or for characterizing filters.

In the field of communications, the Fourier analyzer can be very useful for characterizing audio signals, such as modems and touch tone signals.

When combined with a microphone the Fourier analyzer can be useful in characterizing acoustic devices, such as loud speakers.

With a motion transducer the Fourier analyzer can be used to analyze the vibration signatures of rotating machines. This can be very useful in helping to establish scientific maintenance policies.

The transfer function of a mechanical structure can illustrate how the structure responds to vibration inputs. This is extremely important in optimizing the design of structures that will be subjected to substantial vibration.

### Wave Analyzers/SLM's

Wave analyzers are known by several different names: frequency selective voltmeter, carrier frequency voltmeter, and selective level meter. These names describe the instrument's function rather well.

As mentioned in the introduction to this section a wave analyzer can be thought of as a finite bandwidth window filter which can be tuned throughout a particular frequency range.

Signals will be selectively measured as they are framed by the frequency window. Thus, for a particular signal, the wave analyzer can indicate its frequency (window position) and amplitude. Amplitude is read on an analog meter; frequency is read on either a mechanical or electronic readout.

The uses of wave analyzers can be categorized into three broad areas: 1) amplitude measurement of a single component of a complex frequency system, 2) amplitude measurement in the presence of noise and interfering signals and, 3) measurement of signal energy appearing in a specified, well defined bandwidth.

### Wave Analyzer/SLM

#### Considerations

#### Frequency characteristics

**Range:** should be selected with the future in mind as well as present requirements.

**Accuracy and resolution:** should be consistent with available bandwidths. Narrow bandwidths require frequency dial accuracy to place the narrow window in the proper position for measurement. Accuracy of instruments with selectable bandwidths is determined by the basic center frequency accuracy of the IF bandwidth filters in addition to the local oscillator frequency accuracy.

**Readout:** usually an LED display.

**Stability:** frequency stability is important when using narrow bandwidths and for long term signal monitoring. Stability is best

achieved with automatic frequency control (AFC) or frequency synthesis. AFC locks the local oscillator to the incoming signal and eliminates any relative drift between the two. A frequency synthesized local oscillator allows frequency accuracy of  $<1 \times 10^{-5}$  with 0.1 Hz resolution.

**Sweep:** some instruments are equipped with sweep to allow use as a spectrum analyzer. Readout is a CRT or X-Y recorder.

### Amplitude Characteristics

**Range:** the amplitude range is determined by the input attenuator and the internal noise of the instrument. Sensitivity is defined as the lowest measurable signal equal to the noise level for a unity signal-to-noise ratio (often called tangential sensitivity). Sensitivity will vary with bandwidth and input impedance.

**Dynamic Range:** defined as the dB ratio of the largest and smallest signals that can be simultaneously accommodated without causing an error in the measurement.

**Attenuators:** the amplitude range switch is an attenuator in the input and IF stages. Intermodulation distortion is lowest when the input amplifier has the minimum signal applied and the IF gain is greatest. Conversely the internal noise, important when making sensitive measurements, is lowest with maximum input signal and lowest IF gain. Newer instruments use auto-ranging techniques.

**Accuracy:** amplitude accuracy is a function of frequency, input attenuator response. IF attenuator performance, calibration oscillator stability and accuracy, and meter tracking. Often specifications are expanded to separately describe each contributor.

**Readout:** amplitude readout is usually a meter calibrated in dB and/or volts or a LED digital display. Linear voltage meters are used to allow the user to see down into the noise at the bottom of the scale. Digital readouts are often used with an analog meter to aid in tuning to signals. Expanded scale meters allowing expansion of any 1 or 2 dB portion of the scale into a full scale presentation allow resolution of input level changes of a few hundredths of a dB while LED displays allow .01 dB resolution. This is useful when the wave analyzer is used as a sensitive indicator in bridge or comparison measurements. The expanded scale meter is included in some instruments and is an optional accessory on others.

### Input Characteristics

**Impedance:** may be high impedance bridging input or terminating impedance to match standard transmission lines. High frequency measurements require matched systems to avoid error-producing standing waves on interconnecting cables. The measure of impedance accuracy is usually return loss or

reflection coefficient ( $RL=20 \log \rho$ ). In low frequency instruments, percent accuracy is used. High input impedance instruments are usually poorer in high frequency and noise performance and are usually low frequency instruments. High impedance at high frequencies is accomplished by using a bridging probe to place the impedance at the point of measurement. The probe may be active with unity gain or passive with 20-30 dB insertion loss.

**Input arrangement:** input may be balanced to ground or unbalanced. Communications system usage typically requires balanced input. Standard 600 and 135/150 $\Omega$  balanced inputs are limited in frequency to less than 1 MHz and 124 $\Omega$  balanced to less than 10 MHz in most instruments. The impedance may be balanced to ground with the center point grounded or may be completely isolated from ground. Unbalanced inputs do not have frequency range limitations.

### Network Analysis Application

**Frequency response testing:** with its tracking generator output, the wave analyzer is particularly useful for measuring filter and amplifier frequency responses. If a notch filter is being measured, for example, a narrow band measurement like that provided by a wave analyzer is essential for obtaining acceptable accuracy. A broadband technique will lead to some misleading results. For example, a notch filter may be driven with a flat oscillator and the response measured with a broadband voltmeter. The notch filter will reject the oscillator's fundamental tone, but pass its harmonics which are in voltmeter's measurement range. Thus, an error results. If the voltmeter were frequency selective, like a wave analyzer, the harmonics would be rejected and the true level of the notch would be measured. Accurate and fast measurements can be made because Hewlett-Packard wave analyzers track and detect on the tracking generator frequency.

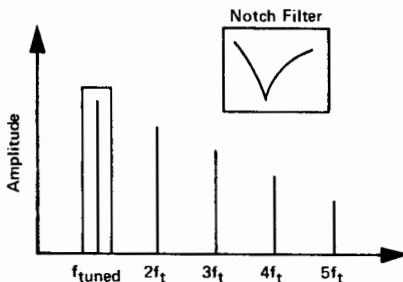

Only signal detected by wave analyzer. For example, the notch of a filter can be accurately measured to its full depth.

### Distortion, Audio Analyzers

Harmonic distortion is one of many types of distortion created in communications equipment, audio and ultrasonic sound sys-

tems. Nonlinear elements in amplifiers cause harmonic related frequencies from a pure tone stimulus to be created at the output. Hence, to a listener, a poor reproduction quality becomes apparent. The total of these frequency components present in a signal, in addition to the fundamental frequency, can be measured quickly and easily with Hewlett-Packard distortion and audio analyzers.

The ratio of these frequency components to the amplitude of the fundamental is the total harmonic distortion (THD) as defined by the following equation (1):

$$THD = \frac{\sqrt{\sum (\text{harmonics})^2}}{\text{fundamental}}$$

The Hewlett-Packard distortion and audio analyzers consist of a narrow band rejection filter and broadband detector. Before the fundamental is rejected, the analyzer first measures the amplitude of the fundamental, all the harmonic components, and noise. Then the rejection filter is employed to remove the fundamental. The ratio of the two measurements is an approximation of equation (1) above and is defined by the following equation (2):

$$THD = \frac{\sqrt{\sum [(\text{harmonics})^2 + (\text{noise})^2]}}{\sqrt{\sum [(\text{fundamental})^2 + (\text{harmonics})^2 + (\text{noise})^2]}}$$

An approximation error of 1/2% can be expected for the THD levels of 10%. However, distortion levels as high as 10% are seldom encountered in most measurement situations. The harmonic content of the stimulus source must not be more than a third of the distortion expected to be caused by the system under test.

The Audio Analyzer performs several basic audio measurements in addition to distortion, making it a general purpose audio test set. The audio analyzer includes the SINAD function for testing mobile radio receiver sensitivity. It contains a low distortion audio oscillator for stimulus response testing in combination with its distortion analyzer. It contains a true rms voltmeter and dc voltmeter for accurate measurement of complex waveform levels. Swept ac level and swept distortion measurements can be made when using the audio analyzer with a suitable X-Y recorder. Signal to noise ratio measurements are performed automatically when using the internal source and rms voltmeter. A reciprocal frequency counter is also included that continuously counts the frequency of the input signal.

These basic capabilities provide a general purpose audio test set that represents high value in three major applications areas: 1) General audio component characterization, 2) radio transceiver audio measurements, 3) HP-IB systems component. The Audio Analyzer provides sophisticated measurement capabilities with significantly reduced operator interaction.

### True Harmonic Distortion Measurements

The Hewlett-Packard desk-top computer controlled automatic spectrum analyzers provides the user a rapid means of measuring true harmonic distortion levels. The fundamental and its harmonic components are rapidly measured one at a time and the distortion is computed by applying equation (1). In production test situations, distortion calculations can be stored on tape for future reference and/or plotted for hard copy needs. Limit testing can also be applied.

### Modulation Analyzers

A modulation analyzer is a precision receiver, designed to detect the entire modulation envelope of a signal under test. It can measure and display the carrier characteristics of RF frequency and power as well as AM, FM and phase modulation characteristics such as % AM, peak deviation, residual modulation, and various ratios associated with the above. Faithful recovery of the actual modulation signal for further analysis such as distortion testing is also accomplished.

Applications for modulation analyzers center mostly in transmitter testing and signal generator calibration. The precision receiver capability allows comprehensive testing of the transmitter. All phases of design, production test, and maintenance of transmitters and various modules and subassemblies are applicable. And since signal generator test instruments serve as "precision transmitters", considerable application will be found in metrology and calibration labs for signal generator calibration.

### Capabilities

The unique measurement capabilities of modulation analyzers are easily shown on system tests with multiple-mode modulations such as simultaneous AM and FM. For example, if both amplitude and frequency modulation are present on a signal, a rather complex modulation spectrum is produced. To demonstrate this, an HP 8640B Signal Generator was 46.5% amplitude modulated with a 5 kHz triangular wave and 45 kHz peak frequency modulated with a 5 kHz sine wave simultaneously. The spectrum analyzer display of the resulting signal is shown.

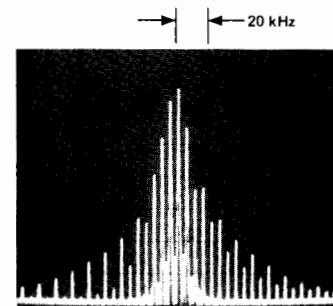

Spectrum Analyzer display of simultaneous AM (46%) and FM (4.5 kHz pk deviation) modulation.

# SIGNAL ANALYZERS

## Wave, distortion, modulation, spectrum and Fourier analyzers (cont'd)

Unequal, complex sidebands result and little data can be deduced. However, since a modulation analyzer faithfully recovers both modulation signals in independent detection systems insensitive to each other, it is easy to separate and read directly the various modulation components involved.



Modulation Analyzer displays of RF signal parameters.

In addition, since the modulation analyzer handles the full complex modulation envelope, it measures and displays peak RF envelope power and average frequency of the entire signal. The readings are all available at the push of a button.

The independent detection systems demodulate the waveforms and present the resulting signal at the output for viewing on an

oscilloscope or for further analysis by a distortion analyzer or audio wave analyzer.

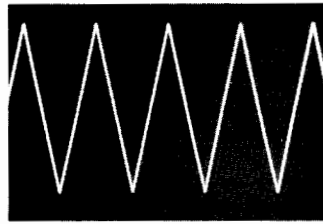

Recovered 5 kHz AM input signal viewed on oscilloscope.

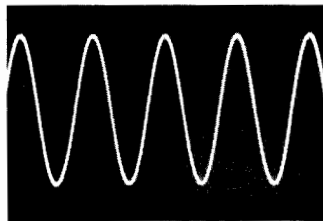

Recovered 5 kHz FM input signal.

Since detection systems are independent and highly insensitive to each other, incidental modulation measurements can be made

with high precision. For example, even with 90% amplitude modulation, the FM demodulator will accurately indicate incidental FM. Such capability is valuable for component design on oscillators, modulators, mixers and so forth. It is very difficult to separate multiple modulation effects on spectrum analyzer displays because both effects are combined.

The HP 8901A Modulation Analyzer contains selectable filters to provide commonly used system characteristics for LP and HP filtering or for FM de-emphasis, etc. Thus measurement of transmitter modulation frequency response doesn't require additional equipment.

Finally the modulation analyzer can serve as a high sensitivity, selective frequency counter. Since the superheterodyne design allows high sensitivity amplification of low level modulated signals, frequency counting of signals as low as -65 dBm is possible with good rejection of other signals (even large interfering ones).

Display and computational conveniences speed typical transmitter measurements and improve confidence in results. For example, ratio keys allow any measurement to be expressed as a % or dB relative to any other measured or key-entered value. Such computations are valuable in mobile FM measurements where hum and noise is expressed relative to an industry standard of 60% of maximum allowable deviation.

### Signal Analyzers Selection Guide Spectrum Analyzers

Frequency Range	Amplitude Calibration Range	Bandwidths		Model Description	Companion Instruments	Page
		Min	Max			
0.02 Hz-25.6 kHz	-120 to +30 dBV	0.02 Hz	363 Hz	3582A Spectrum Analyzer		538
5 Hz-50 kHz	-150 to +30 dBm	1 Hz	300 Hz	3580A Spectrum Analyzer		536
20 Hz-300 kHz	-130 to +10 dBm	10 Hz	10 kHz	8556A Tuning Section Plug-In <sup>1</sup>		526
10 Hz-13 kHz	-140 to +20 dBm	3 Hz	10 kHz	3044A/45A Spectrum Analyzer		542
20 Hz to 40.1 MHz	-137 dB to +30 dBm	3 Hz	30 kHz	3585A Spectrum Analyzer		500
1 kHz-110 MHz	-130 to +10 dBm	10 Hz	300 kHz	8553B Tuning Section Plug-In <sup>1</sup>	8443A Tracking Generator	528
10 kHz-350 MHz	-120 to +20 dBm	1 kHz	3 MHz	8557A Spectrum Analyzer Plug-In <sup>2</sup>	8750A Storage-Normalizer	518
100 kHz-1250 MHz	-122 to +10 dBm	100 Hz	300 kHz	8554B Tuning Section Plug-In <sup>1</sup>	8444A Tracking Generator (500 kHz-1250 MHz)	530
100 kHz-1500 MHz	-115 to +30 dBm	1 kHz	3MHz	8558B Spectrum Analyzer Plug-In <sup>2</sup>	8750A Storage-Normalizer 8444A Opt. 059 Tracking Generator (500 kHz-1500 MHz)	520
100 Hz-1500 MHz	-137 dBm to +30 dBm	10 Hz	3 MHz	8568A Spectrum Analyzer and 8581A Automatic Spectrum Analyzer	8444A Opt. 059 Tracking Generator (500 kHz-1500 MHz)	508 514
10 MHz-21 GHz	-111 dBm to +30 dBm	1 kHz	3 MHz	8559A Spectrum Analyzer	8750A Storage-Normalizer	522
100 Hz-40 GHz	-134 dBm to +30 dBm	10 Hz	3 MHz	8566A Spectrum Analyzer and 8582A Automatic Spectrum Analyzer		511 514
10 MHz-40 GHz	-124 dBm to +30 dBm	100 Hz	3 MHz	8565A Spectrum Analyzer	8750A Storage-Normalizer 8444A Opt. 059 Tracking Generator (10-1500 MHz)	516
10 MHz-40 GHz	-130 to +10 dBm	100 Hz	300 kHz	8555A Tuning Section Plug-In <sup>1</sup>	8444A Opt. 059 Tracking Generator (10 MHz-1500 MHz) 8445B Automatic Preselector (10 MHz-18 GHz)	532
0.01 Hz-10 kHz offset from carrier 500 kHz-18 GHz carrier range	-150 dBc min.	<100 μHz	10 kHz	5390A Frequency Stability Analyzer	59309A Digital Clock	556

NOTE 1: For use in oscilloscope mainframes 140T and 141T with IF section plug-ins 8552A or 8552B (page 524).  
NOTE 2: For use in oscilloscope mainframes 180TR, 181T/TR and 182T.

**Modulation Analyzer (8901A)**

Basic Frequency Range	FM		AM		DM		RF Level Accuracy	Frequency Counter Range	Audio Filters	Page
	Accuracy	Distortion	Accuracy	Distortion	Accuracy	Distortion				
150 kHz To 1300 MHz	1% O.R. ±1 digit for rates 30 Hz To 100 kHz	<0.1% THD	1% O.R. ±1 digit for rates 50 Hz to 50 kHz	<0.3% THD	3% O.R. ±1 digit for rates 200 Hz to 20 kHz	<0.1% THD	±2 dB <650 MHz  ±3 dB ≥650 MHz	150 kHz to 1300 MHz	50 Hz HP 300 Hz HP 3 kHz LP 15 kHz LP >20 kHz LP	551

**Digital Signal Analyzers**

Frequency Range	Amplitude Calibration Range	Resolution Points		Model Description	Functions Available	Page
		Min	Max			
DC-100 kHz (See Note 1)	7 steps from ±0.125 to ±8 V	32	2048	5451C Fourier Analyzer (See Note 3)	Power spectrum Transfer function Coherence Convolution	546
DC-25 kHz	7 Steps From ±0.1 to ±10 V	256	32,000 (See Note 2)	5420A Digital Signal Analyzer  5423A Structural Dynamic Analyzer (See Note 3)	Time Average Linear Spectrum Auto Spectrum Transfer Function Coherence Function Histogram Correlation Impulse Response	544
0.1-25 kHz	7 steps from ±0.125 to ±8 V	256 PS 128 TF	1024 PS 512 TF	5427A Digital Vibration Control System (Analysis Mode)	Power Spectrum (PS) Transfer Function (TF) Transient Capture Shock Response Spectrum	546
0.02 Hz-25.6 kHz	9 steps from 3 mV to 30 V RMS	256	>1.3x10 <sup>6</sup> (See note 2)	3582A Spectrum Analyzer	Voltage Spectrum Phase Spectrum Transfer Function Coherence Function Digital Averaging	538

NOTE 1: Standard range is DC to 50 kHz, expandable with options to 100 kHz.

NOTE 2: Equivalent number of points using Band Selectable Analysis.

NOTE 3: Also includes modal analysis capability.

**Distortion/Audio Analyzers**

Fundamental Frequency Range	Minimum Distortion	Auto Set Level	Auto Nulling	True RMS	AM Detector	Filters	Model No.	Internal Source	HP-IB	Page	
5 Hz to 600 kHz	.03% (-70 dB)		•			•	331A			547	
			•		•	•	333A			547	
			•		•	•	334A				547
			•		•	•	334A Opt 002				547
10 Hz-110 kHz	0.0018% (-95 dB)	•	•	•	•	•	339A	•		548	
20Hz-100kHz	0.01% (-80 dB)	•	•	•	•	•	8903A*	•	•	554	

\*The 8903A also performs Frequency Count, Signal/Noise, SINAD, watts, ad/dc volts measurements.

**Wave Analyzers/Selective Level Meters**

Frequency Range	Selective Bandpass	Dynamic Range		Freq. Readouts	Type of Inputs	Type of Outputs	Modes of Operation	Model Number	Page
		Absolute	Relative						
15 Hz to 50 kHz	3 Hz 10 Hz 30 Hz 100 Hz 300 Hz	0.1 μV-300 V full scale	>85 dB	5-place digital	Banana Jacks	rec: 5 V full scale, with pen lift BFO, Local Oscillator, tuning loudspeaker, and headphone jack	AFC, normal, BFO	3581A/ 3581C	550 578
50 Hz to 32.5 MHz	20 Hz 400 Hz 3100 Hz	-130 to +20 dBm	>80 dB	LED, .1 Hz Resolution	50/75 Ω, BNC 600 Ω Banana Jacks	Tracking Generator Audio/Loud Speaker 1 MHz Ref.	Wideband Selective USB/LSB	3586C (3336C*)	504 370
50 Hz to 32.5 MHz	20 Hz 400 Hz 1740/2000 Hz Optional 3100 Hz WTD	-130 to +20 dBm	>70 dB	LED .1 Hz Resolution	75Ω BNC/WECO 124Ω WECO 135Ω WECO 150Ω Siemens 600Ω WECO/ Siemens	Tracking Generator Audio/Loud Speaker 1 MHz Ref.	Wideband Selective SSB	3586A/B (3336A/B*) (3335A)	596 598 368

\*Tracking Synthesizers.



# SIGNAL ANALYZERS

## 20 Hz to 40 MHz spectrum analyzer

### Model 3585A

- 80 dB dynamic range
- 3 Hz resolution bandwidth
- $\pm 0.4$  dB amplitude accuracy
- Self-calibrating

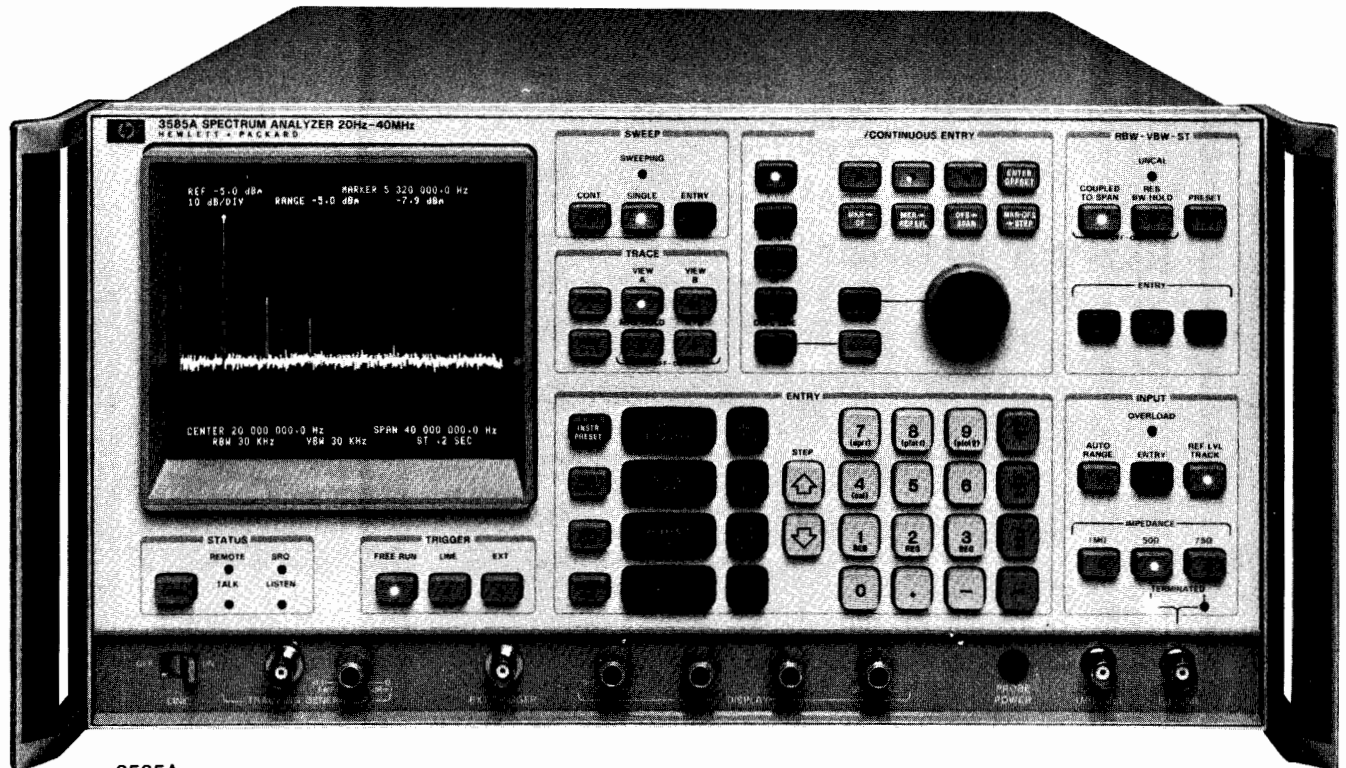

3585A  
(Shown with Opt. 907)



## Description

The HP 3585A Spectrum Analyzer has a fully synthesized local oscillator controlled by a microprocessor. The result of this state-of-the-art contribution offers outstanding performance over its frequency range of 20 Hz to 40.1 MHz. Center frequency and span settings have 0.1 Hz resolution and  $1 \times 10^{-7}$ /mo. stability over its entire operating range. The frequency precision and stability enables the 3 Hz resolution bandwidth filter to be used for close-in analysis even at 40 MHz.

An automatic internal calibration routine, administered by the microprocessor, provides up to  $\pm 0.4$  dB accuracy over most of the measurement range. Improvements in measurement performance of this magnitude cannot be realized by the user unless the basic limitations of the CRT display are bypassed. This has been accomplished by digitizing the detected video signal, which is then stored in memory. Photographic documentation of the display is greatly simplified by displaying all the essential frequency, amplitude and resolution parameters alpha-numerically around the edge of the CRT.

The power of the microprocessor provides a bonus by making this analyzer easier to use. Several of the usually tedious operations, such as centering a signal, raising it to the reference level, etc., are now simplified with dedicated key operated routines working in conjunction with the display marker. Adjustment of resolution and video bandwidth when modifying span is now an automatic function unless individual manual selection is required. In addition, new functions have been added, such as noise power density measurements and off-set capability for both frequency and amplitude.

## Measurement Power & Convenience

The power and convenience of the 3585A's microcomputer-based controls and CRT readout simplify and speed use in so many ways that previously impractical analysis now become routine. Functions such as center frequency and amplitude reference level may be keyboard-set with 0.1 Hz and 0.1 dB precision, varied with an 'analog' knob (actually a rotary pulse-generator), or incrementally key-stepped. The autoranging input attenuator eliminates the error-prone task of adjusting the attenuator to achieve the correct mixer level.

A tunable marker in the 3585A makes basic measurements precise and quick by directly measuring a signal or by speeding the process of magnifying the portion of the spectrum to be analyzed. With the marker set to the signal peak, signal amplitude and frequency (with counter accuracy) are numerically displayed on the CRT. A second marker makes relative measurements instantly available with numerical display of the difference in amplitude and frequency between the two markers. This is useful for modulation, distortion measurements, and bandwidth measurement. For example, in the case of telecommunications applications, the second marker can be set at harmonic or channel spacing from the first so the operator can simply step frequencies to track higher order harmonics or additional channels.

Amplitude and frequency may be offset to normalize values to some reference signal such as a pilot tone or to reflect the relative value of a signal. Other amplitude units, such as dBV or volts, can be chosen. On any occasion all settings can be stored, then later recalled with a short key sequence. As many as three sets of settings may be stored.

Two different traces each of 1001 horizontal points, may be taken, stored in memory, then shown separately or together as desired while comparisons among them may be calculated and displayed digitally on the CRT. A Max Hold key causes the largest amplitude in successive sweeps to be displayed, making it easy to measure residual FM or drift. A built-in tracking generator, with a maximum output of 0 dBm, enables frequency response measurements to be made.

### Automatic Measurements

Not only are all 3585A functions remotely-programmable via the HP Interface Bus (IEEE Standard 488-1975), the instrument also can be commanded to transfer its measurements out via the bus for interpretation and further interaction by a computing controller. The analyzer can be remotely tuned with the precision of the synthesizer, while retaining analog sweep and exceptional spectral purity. The result is a new and higher level of interaction between the user and the measurement system.

### Frequency Accuracy

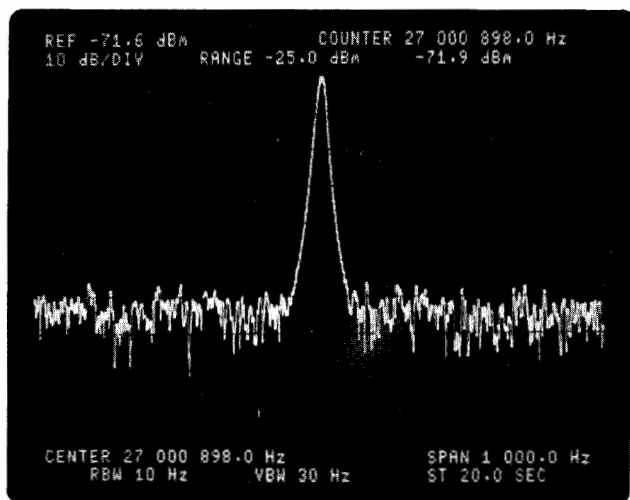

Counter measurements with spectrum analyzer selectivity and sensitivity can be made to  $1 \times 10^{-7}$ /mo. stability while sweeping or manually tuning.

### Dynamic Range

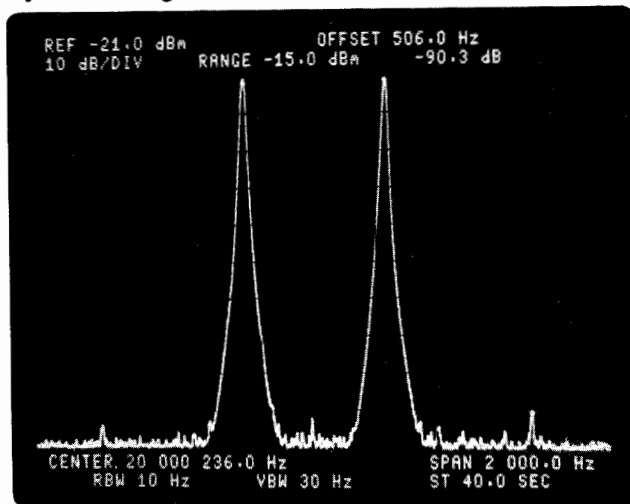

>80 dB spurious free dynamic range with full scale inputs of -25

dBm to +30 dBm in 5 dB steps. Autoranging input provides full dynamic range with no guesswork.

### Internal Calibration

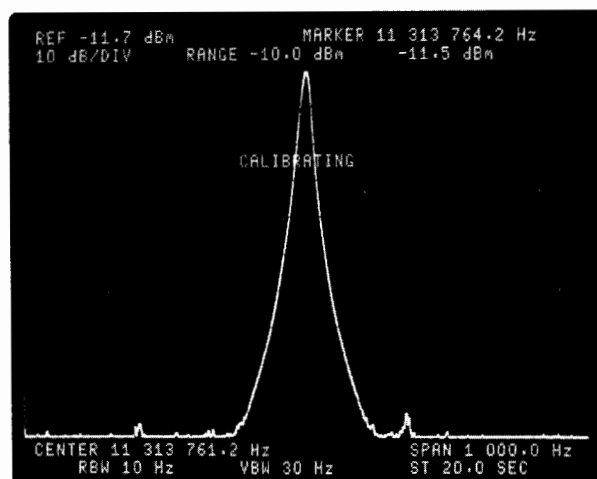

Maximum accuracy is assured at all times by an automatic internal calibration routine which compensates for frequency and amplitude errors in measurements made at the reference level at the center of the screen.

### Swept Response Measurements

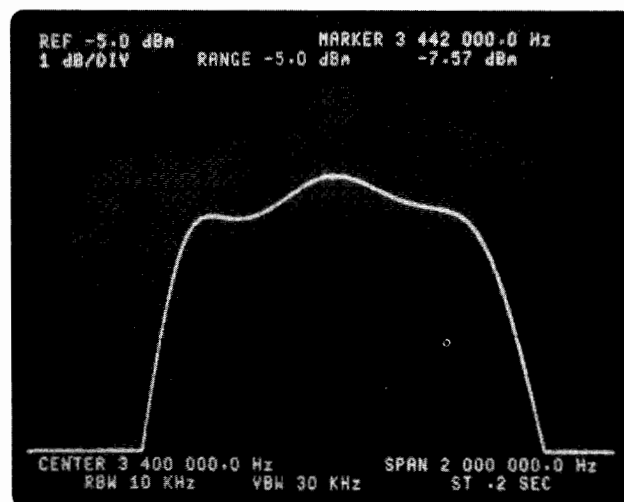

The built-in tracking generator offers superb stability and resolution for crystal filters as well as excellent flatness for wideband devices. The 1 dB/div. amplitude scale is used to expand and resolve small amplitude differences with .01 dB resolution using the marker readout.

# SIGNAL ANALYZERS

## 20 Hz to 40 MHz spectrum analyzer

### Model 3585A (cont.)

#### Marker Aided Measurements

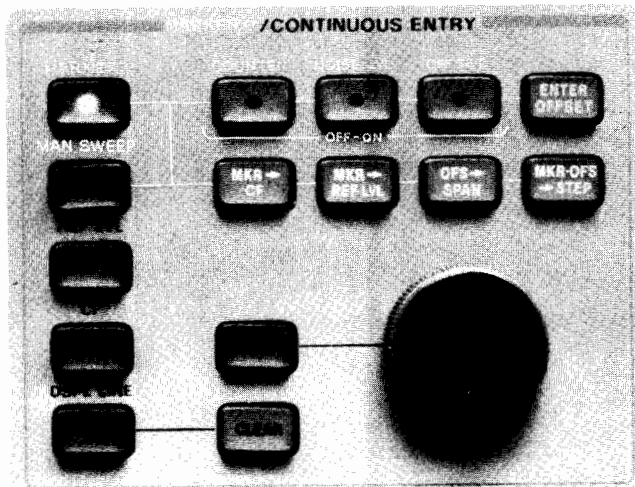

Along with the marker readout capability, there are three additional functions: counter measurements, noise level measurements, and off-set (relative) measurements. The four operating aids just above the knob indicate that the marker or offset value can be directly entered into the center frequency, reference level, frequency span, or center frequency step size. These aids save much time in conventional operations by direct transfer of data to another functional control.

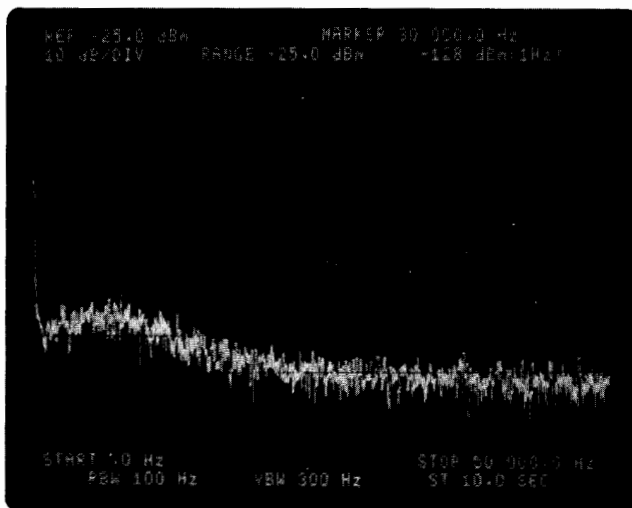

#### Noise Measurement

The noise level key displays RMS noise density normalized to a 1 Hz bandwidth at the marker position. All correction factors are accounted for in the internal measurement routine.

#### Terminal Interaction

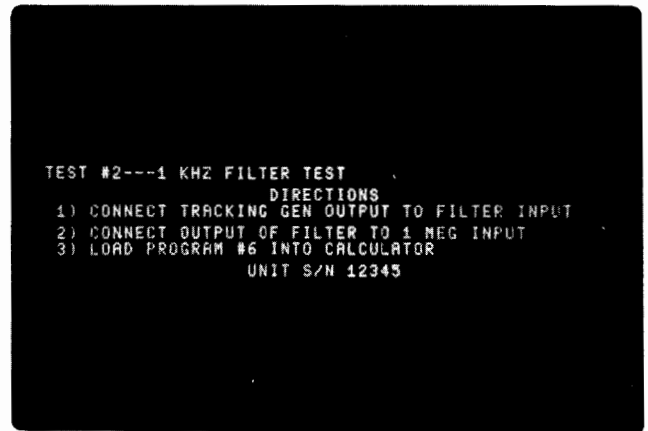

Measurement routines selected from the controller memory via the analyzer keyboard, such as this filter test, can provide instructions to the operator to minimize errors and reduce training time for complex measurements.

#### Specifications

##### Frequency

**Measurement range:** 20 Hz to 40.1 MHz

##### Displayed Range

###### Frequency span:

**Range:** 0 Hz to 40.1 MHz variable with .1 Hz resolution or 10 Hz to 40 MHz in 1, 2, 5 steps

**Accuracy:**  $-0\% + .2\%$  of frequency span setting

##### Center, Start/Stop, and Manual Frequency

**Range:** 0 Hz to 40.1 MHz with .1 Hz resolution

**Accuracy:**  $1 \times 10^{-7}$ /month of frequency

##### Marker

**Readout accuracy:**  $\pm .2\%$  of frequency span  $\pm$  resolution bandwidth

**Counter accuracy:**  $\pm .3$  Hz  $\pm 1 \times 10^{-7}$ /month of counted frequency for a signal 20 dB greater than other signals and noise in the resolution bandwidth setting

##### Resolution

###### Resolution bandwidths

**Range:** 3 dB bandwidths of 3 Hz to 30 kHz in a 1, 3, 10 sequence

**Accuracy:**  $\pm 20\%$  at the 3 dB points

**Selectivity:** 60 dB/3 dB <11:1

##### Amplitude

**Measurement range:**  $-137$  dBm to  $+30$  dBm (50/75 $\Omega$ ) or equivalent level in dBV or volts, 31 nV to 22 V (1 M $\Omega$ )

##### Displayed Range

**Scale:** 10 division CRT vertical axis with Reference Level at the top graticule line

**Calibration:** 10, 5, 2 and 1 dB/division from the Reference Level

**Input range:**  $-25$  dBm to  $+30$  dBm in 5 dB steps

**Reference level (relative to Input Range)**

**Range:**  $-100$  dB to  $+10$  dB

**Accuracy (using 1 or 2 dB/div., at midscreen with sweep rate reduced by 4 or at the manual frequency):**

**50/75 Ω input:**

+10 dB	-50 dB	-70 dB	-90 dB
±.4 dB	±.7 dB	±1.5 dB	

**1 MΩ input - add to above**

20 Hz	10 MHz	40.1 MHz
±.7 dB	±1.5 dB	

**Amplitude linearity (referred to Reference Level)**

0 dB	-20 dB	-50 dB	-80 dB	-95 dB
±.3 dB	±.6 dB	±1.0 dB	±2.0 dB	

**Frequency response (referred to center of span)**

**50/75 Ω input: ±.5 dB**

**1 MΩ input:**

20 Hz	10 MHz	40.1 MHz
±.7 dB	±1.5 dB	

**Marker**

**Amplitude accuracy**

**Midscreen at the reference level:** Use Reference Level accuracy from +30 dBm to -115 dBm, add Amplitude Linearity below -115 dBm.

**Anywhere on screen:** Add Reference Level Accuracy, Amplitude Linearity and Frequency Response.

**Dynamic Range**

**Spurious responses (image, out of band, and harmonic distortion):**

**50/75 Ω input:** <-80 dB referred to a single signal equal to or less than Input Range

**1 MΩ input:** <-80 dB except second harmonic distortion <-70 dB

**Intermodulation distortion:**

**50/75 Ω input:** <-80 dB referred to the larger of two signals each ≥6 dB below Input Range except 2nd order IM from 10 MHz to 40 MHz <-70 dB

**1 MΩ input:** <-70 dB

**Residual responses (no signal at input):** <-120 dBm using -25 dBm range

**Average noise level**

**50/75 Ω input:**

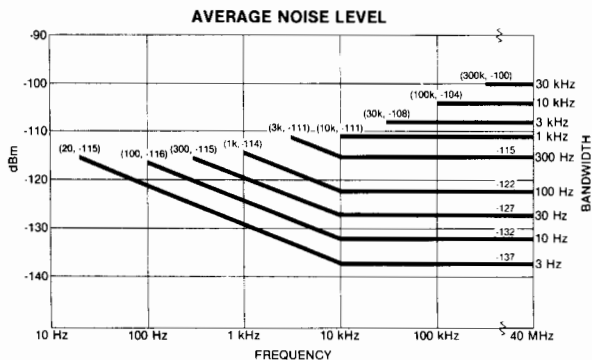

**1 MΩ input:** Below 500 kHz add 12 dB to above

**Sweep**

**Modes:** Continuous, single or manual

**Trigger:** Free Run, Line, or External

**Time:** .2 s full sweep to 200 s/Hz of Frequency Span (swept time excluded auto calibration cycles)

**Display**

**Trace:** Two memories, A and B each 1001 data points horizontally by 1024 data points vertically are displayed on the CRT at a flicker free rate. Memory A updated at the rate of the analyzer sweep time. Memory B updated by transfer from A (Store A→B).

Max Hold retains in Memory A the largest signal level at each horizontal point over successive sweeps, A-B updates Memory A with sweep data minus Memory B data at each corresponding horizontal point.

**Trace detection:** A linear envelope detector is used to obtain video information from the IF signal. Peak signal excursions between horizontal sweep data points are retained and displayed at the left-hand data point. This assures that no signal responses are missed.

**Input**

**Signal inputs:**

**50/75 Ω:** >26 dB return loss, BNC connector

**1 MΩ:** ±3% shunted by <30 pf, BNC connector

**Maximum input level:**

**50/75 Ω:** 13 V peak ac plus dc relay protected against overloads to 42 V peak.

**1 MΩ input:** 42 V peak ac plus dc (derate by factor of two for each octave above 5 MHz).

**External trigger input:** Negative going TTL level or contact closure required to initiate sweep.

**External reference input:** 10MHz (or subharmonic to 1 MHz), 0 dBm minimum level

**Output**

**Tracking generator:**

Level: 0 dBm to -11 dBm with a single turn knob

Frequency accuracy: ± 1 Hz relative to analyzer tuning

Frequency response: ±.7dB

Impedance: 50 Ω; >14 dB return loss

**Probe power:** +15 Vdc, -12.6 Vdc; 150 ma max.

Suitable for powering HP 1120A Active Probe

**External display:**

X, Y: 1 volt full deflection; Z: <0V to >2.4V

Recorder:

X Axis: 10 V full scale

Y Axis: 10 V full scale

Z — penlift output TTL

IF: 350 kHz, -11 dBV to -15 dBV at the reference level

**Video:** 10 V at the reference level

**Frequency reference:** 10.000 MHz ± 1 × 10<sup>-7</sup>/mo., +10 dBm into 50Ω

**General**

**Environmental**

**Temperature:** Operating 0°C to 55°C

**Humidity:** <95% RH except 300 Hz BW <40% RH

**Warm-up time:** 20 minutes at ambient temperature

**Power requirements:** 115 V (+11% -25%), 48-440 Hz

230V (+11% -18%), 48-66 Hz

180 Watts 3A max

**Weight:** 39.9 kg (88 lb.)

**Size:** 22.9 cm (9") H × 42.6 cm (16.75") W × 63.5 cm (25") D

**Ordering Information**

**Opt. 907:** Front Handle Kit

add \$25

**Opt. 908:** Rack Flange Kit

add \$20

**Opt. 909:** Combined Opt. 907 and 908

add \$45

**Opt. 910:** Extra Manual

add \$150

**Model 3585A Signal Analyzer**

**\$19,500**

# SIGNAL ANALYZERS

## 50 Hz to 32.5 MHz Selective Level Meter

### Model 3586C

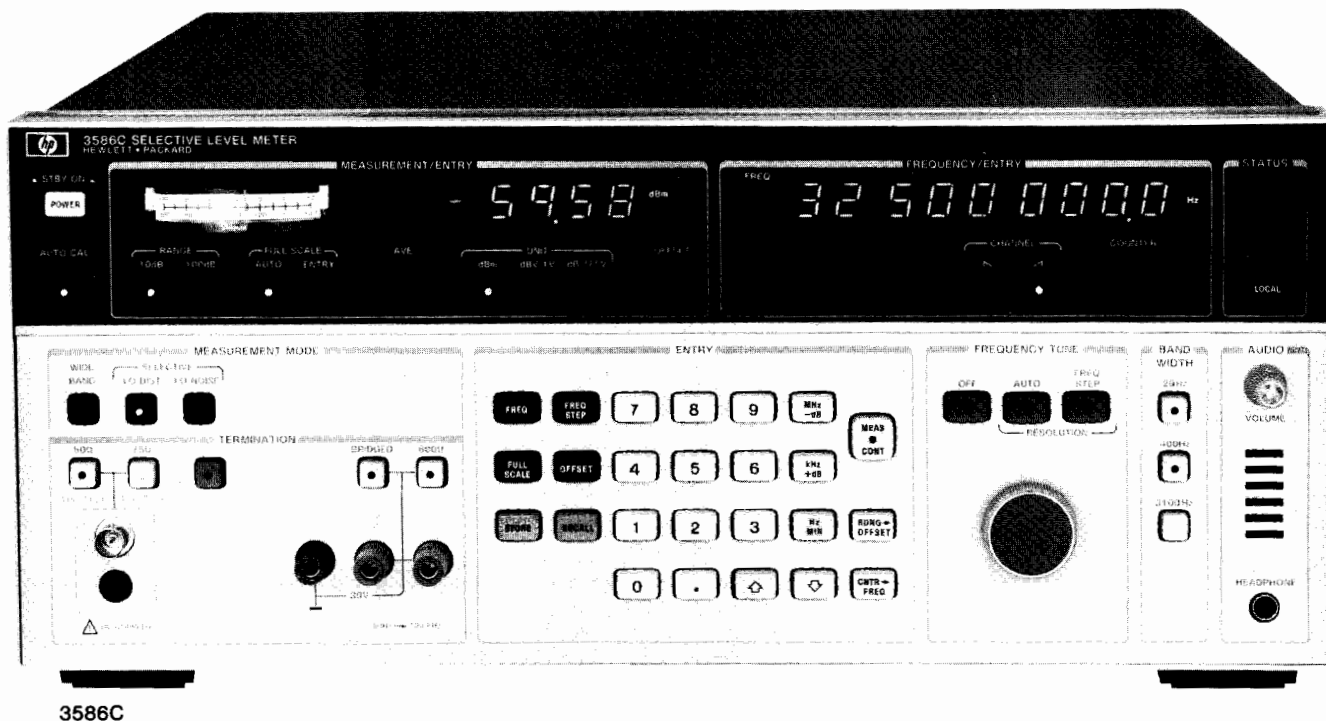

3586C



### Description

The 3586C Selective Level Meter is designed for general purpose wave analysis applications in the design, manufacture, and maintenance of electronic systems.

Microprocessor control and HP-developed fractional-N synthesis provides precise frequency setting and time saving ease-of-use features, and the 3586C is fully HP-IB programmable.

The 3586C Selective Level Meter covers the frequency range from 50 Hz to 32.5 MHz allowing measurement of audio, sonar, and other low frequency systems as well as high frequency communications and sub-systems. Input impedances of 50, 75, or 600  $\Omega$  with 10 k $\Omega$  bridging adds measurement flexibility for a wide variety of applications.

Wideband power measurements can be made up to 32.5 MHz and down to -45 dBm. Measure selectively in LO Distortion or LO noise modes or use USB or LSB for single sideband demodulation of a carrier.

### Measurement Precision

Signal levels are measured with up to  $\pm 0.2$  dB accuracy down to -80 dBm with .01 dB resolution and bandwidth choices of 20, 400, or 3100 Hz. Automatic level calibration eliminates the need for manual calibration operations prior to critical level measurements. Frequency can be set precisely with 0.1 Hz resolution and  $\pm 1 \times 10^{-5}$  stability ( $\pm 2 \times 10^{-7}$  optional). The built-in frequency counter allows you to measure the frequency of a signal greater than -100 dBm within the filter bandwidth chosen and then tune the center of the filter pass-band precisely to that signal with one keystroke.

### Selective Measurements

Make measurements on signals as close as 80 Hz spacing with 50 dB rejection using the 20 Hz filter. Use the extremely selective 3100 Hz filter for telecommunications channel level or noise measurements with 60 dB carrier rejection and 75 dB adjacent channel rejection, or demodulate the upper or lower sideband signal for further processing and listen to it with the speaker output.

### Level Offset

Measurements can be made with respect to an entered offset level or the fundamental signal level, or enter that level as an offset and then measure harmonic levels directly. Relative measurements can be made with respect to any keyboard entered or measured level, saving time-consuming operator calculations.

### Digital or Analog Frequency Control

Frequencies may be entered directly on the keyboard with .1 Hz resolution, and then changed by entering any step size and stepping up or down in frequency or use the analog frequency tune control. The analog frequency tune control will change frequency in automatically chosen steps proportional to the bandwidth chosen, or in the step size entered.

### Nine Storage Registers

Nine different combinations of front panel settings can be stored in the non-volatile storage registers and then recalled at a keystroke—even if the instrument has been turned off. Significant time is saved when repetitive testing is required in manufacturing, development, or metrology environments.

**Tracking Synthesizer**

The 3586C will operate in the frequency tracking mode with either the 3336C Synthesizer (see page 370) for measurements up to 20.9 MHz, or the 3335A synthesizer (see page 368) for full frequency coverage up to 32.5 MHz. The tracking synthesizer will automatically tune to the frequency programmed on the 3586C in the tracking mode, and when their HP-IB interfaces are connected together with a bus cable.

Use the tracking mode to save time in amplitude-only network analysis such as the measurement of crystal filters, and other signal processing networks, or for loop-around measurements in telecommunications systems.

**Fully Programmable**

All necessary functions on the 3586C Selective Level Meter are programmable on the HP-IB using a desktop computer controller such as the HP model 85F, 9825S, 9835A, or 9845B, or a mainframe computer such as the HP-1000. All measurements, and necessary frequency and front panel settings can be interrogated and read out to the bus for print-out or further data processing.

**High Impedance Accessory Probe**

Model 1124A 100 MHz Active Divider Probe provides high voltage, high impedance general purpose probing capability for the 50  $\Omega$  input impedance on the 3586C Selective Level Meter, see page 504 for specifications.

**3586C Specifications**

**Frequency**

**Frequency range:** 50/75  $\Omega$  Unbalanced Input; 50 Hz to 32.5 MHz, 600  $\Omega$  Balanced Input; 50 Hz to 100 kHz

**Frequency resolution:** 0.1 Hz

**Center frequency accuracy:**  $\pm 1 \times 10^{-5}$ /year, ( $\pm 2 \times 10^{-7}$ /year with option 004).

**Counter accuracy:**  $\pm 1.0$  Hz in addition to center frequency accuracy for signals within the 60 dB bandwidth of the IF filter chosen or greater than -100 dBm (largest signal measured).

**Frequency display:** 9 digit LED

**Selectivity**

**3 dB bandwidth,  $\pm 10\%$ :** 20 Hz, 400 Hz, 3100 Hz

**60 dB bandwidth:** 3100 Hz BW,  $\pm 1850$  Hz; 400 Hz BW,  $\pm 1100$  Hz; 20 Hz BW,  $\pm 90$  Hz

**Adjacent channel rejection:** 75 dB minimum at  $\pm 2850$  Hz.

**Passband flatness:**  $\pm 0.3$  dB

**Amplitude**

**Measurement range:** +20 to -130 dBm

**Amplitude resolution:** .01 dBm

**Level accuracy:** 10 dB auto range, low distortion mode, after calibration.

**50/75  $\Omega$  inputs**

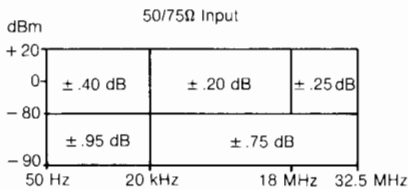

**600  $\Omega$  input**

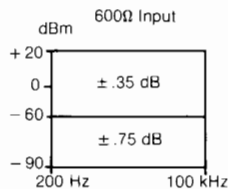

**Level accuracy:** 100 dB Range (after calibration), add correction to 10 dB auto range accuracy for dB below full scale. (Not required when in 10 dB auto-range.)

dB Below Full Scale	Accuracy Correction
0 to -20 dB	$\pm .25$ dB
-20 to -40 dB	$\pm .50$ dB
-40 to -80 dB	$\pm 2.0$ dB

**Dynamic Range**

**Spurious responses:**

**Image rejection (100-132 MHz):** -80 dBc

**IF rejection:** 15625 Hz, -80 dBc; 50 MHz, -60 dBc

**Residual spurious signals:** > 1600 Hz offset, > -80 dBc; 300 Hz to 1600 Hz, > -100 dBm

**Distortion:**

**Harmonic distortion:** -75 dB below full scale, low distortion mode, above 4 kHz.

**Intermodulation distortion:** -70 dB below full scale, 200 Hz to 20 kHz offset; -78 dB below full scale, 20 kHz to 1 MHz offset

**Wideband power accuracy:** after calibration, 100 dB range, average on, -45 to +20 dBm.

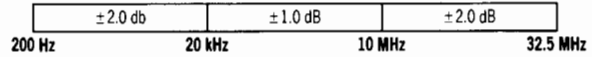

**Noise floor (full scale setting -35 to -120 dBm):**

Frequency	Bandwidth	Noise Level
100 kHz to 32.5 MHz	3100	-114 dBm
	20 Hz, 400 Hz	-120 dBm
10 kHz to 100 kHz	All	-105 dBm

The noise floor for full scale settings of -30 to +25 dBm will be 80 dB below full scale for > 100 kHz, or 60 dB below full scale for < 100 kHz.

**Signal Inputs**

Impedance	Frequency	Mating Connector
50/75 ohms unbalanced	50 Hz to 32.5 MHz	BNC
600 ohms balanced	50 Hz to 100 kHz	Dual Banana Plug 0.75 inch Spacing

**Return loss:** 50/75  $\Omega$ , 30 dB; 600  $\Omega$ , 25 dB

**Balance:** 600  $\Omega$ ; 40 dB

**Demodulated audio output**

**Output level:** 0 dBm into a 600  $\Omega$  load

**Output connector:** 1/4" jack, mates with WECO 347.

**Auxiliary Signal Inputs/Outputs**

**Tracking output:** 0 dBm rear panel tracking output

**Ext. reference input:** 1 MHz to 10 MHz or sub-harmonic input.

**Reference output:** 10 MHz at 0 dBm output (also 10 MHz oven oscillator on instruments with option 004).

**Probe power:** front panel DC output for HP active high impedance accessory probes.

**HP-IB interface:** rear panel interface meeting IEEE 488-1975 for remote operation. Used for tracking synthesizer interface.

**Additional outputs:** audio, phase jitter and meter output.

**Options**

**Option 004: High stability frequency reference:** 10 MHz oven stabilized reference oscillator, improves frequency stability to  $\pm 2 \times 10^{-7}$ /year.

**General**

**Operating Environment**

**Temperature:** 0° to 55°C

**Relative humidity:** 95%, 0° to 40°C

**Altitude:**  $\leq 15,000$  ft.,  $\leq 4600$  metres

**Storage environment temperature:** -40°C to 75°C

**Storage altitude:**  $\leq 50,000$  ft.,  $\leq 15,240$  metres

**Power:** 100/120/220/240 V, +5%, -10%, 48 to 66 Hz, 150 VA

**Weight:** 23 kg. (50 lbs.) net; 30 kg. (65 lbs.) shipping

**Size:** 177 mm H x 425.5 mm W x 466.7 mm D (7" x 16.75" x 18.38")

**3586C Selective Level Meter\***

**\$9100**

**Opt 004:** High Stability Frequency Reference

add \$625

**Opt 907:** Front Panel Handles

add \$40

**Opt 908:** Rack Flange Kit

add \$30

**Opt 909:** Rack Flange & Handle Combination Kit

add \$55

**Accessories**

**1124A:** High Impedance Probe

\$225

\*HP-IB cables not supplied. See page 30.

## SIGNAL ANALYZERS

Spectrum Analyzers, 100 Hz to 40 GHz

Models 8568A &amp; 8566A

- 100 Hz to 15 GHz coverage with counter accuracy
- 10 Hz resolution bandwidth
- Trace markers with amplitude and frequency readout
- 100 Hz to 40 GHz coverage with synthesizer accuracy
- 2 to 22 GHz preselected range
- Comprehensive HP-IB capability

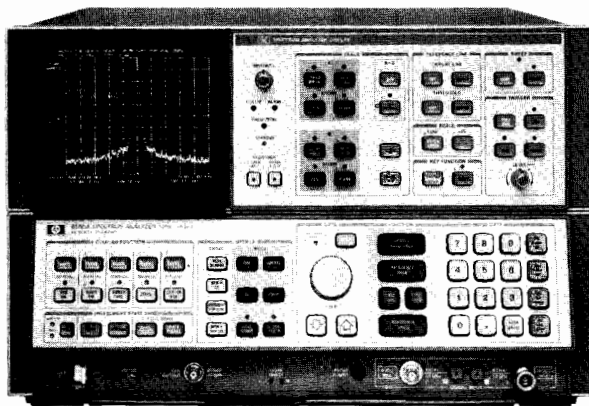

8568A

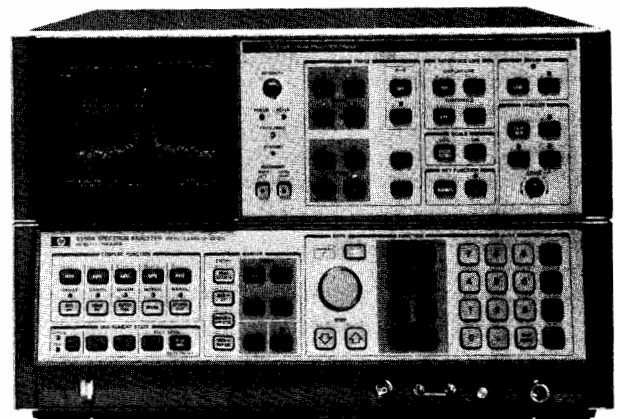

8566A



The 8568A and 8566A are high performance spectrum analyzers for bench and HP-IB system use. The 8568A operates over the 100 Hz to 1500 MHz frequency range, the 8566A operates over a 100 Hz to 22 GHz internal mixing range with preselection from 2 GHz to 22 GHz. External mixers can be used with the 8566A to extend the frequency range to 40 GHz and above. Each analyzer is designed around its own internal bus and controlled by its own microcomputer to yield significant improvements in RF measurement performance, new operational features, and unparalleled flexibility under program control.

The performance specifications for the 8568A and 8566A are described on pages 508 and 511.

#### Performance

Exceptional frequency stability in both the 8568A and 8566A enables the use of a 10 Hz resolution bandwidth over their respective frequency ranges. Superior spectral purity and narrow resolution make it possible to measure clean oscillators directly at RF frequencies. 10 Hz resolution also results in sensitivities to  $-135$  dBm which makes greater than 85 dB spurious-free dynamic range achievable. A frequency reference error of  $1 \times 10^{-9}$ /day together with the analyzers' resolution and sensitivity allow small signals in the presence of large ones to be measured with unequalled accuracy.

#### Usability

All the control settings are conveniently read on the CRT display. The operator changes control settings through the data controls. To activate a function the user pushes the appropriate key; he then has the option of setting the function's value using the knob, step keys or numeric/unit keyboard.

Measurements can be made following conventional "zoom" techniques using the center frequency, frequency span and reference level functions, or with the help of certain measurement aids. A preset button sets all analyzer controls to a convenient starting point; coupled functions, such as resolution bandwidth and sweep time change automatically as frequency span is reduced to maintain a calibrated display.

A tunable marker is available for directly measuring a signal or speeding the process of magnifying the portion of the spectrum to be analyzed. With the marker set to the signal peak, the signal's *amplitude* and *frequency* are displayed on the CRT. A second marker, useful for modulation or distortion measurements, makes relative measurements by displaying the difference in amplitude and frequency between the two markers. Marker information enables the operator to step between evenly spaced portions of the frequency spectrum such as communication channels or signal harmonics; the noise level at the marker can be converted to the RMS noise density normalized to a 1 Hz bandwidth. The marker may also be positioned at the peak of the largest signal on the screen and used to zoom-in on signals *automatically*.

Once the analyzer's controls have been adjusted, all settings can be *saved* in memory and later *recalled* to repeat the measurements. An internal battery maintains the contents of memory in the event of a power failure.

All displayed information resides in a digital memory from which the CRT is refreshed at a flicker-free rate. Display titles may be added. A trace may be viewed real-time or stored; max hold displays the

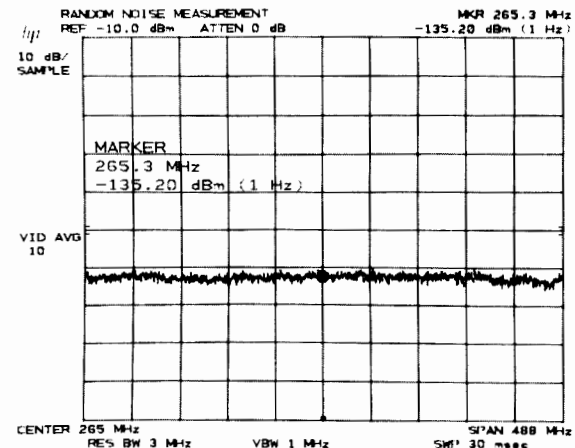
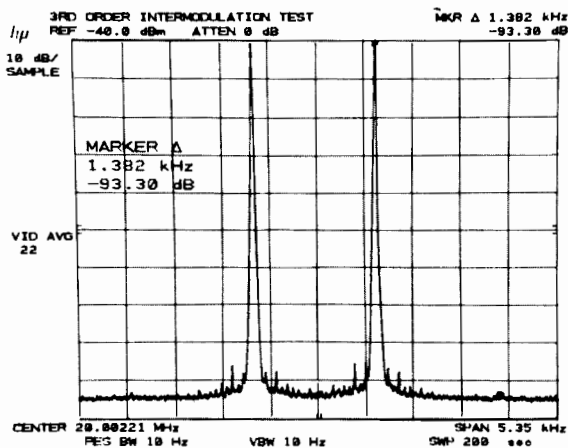
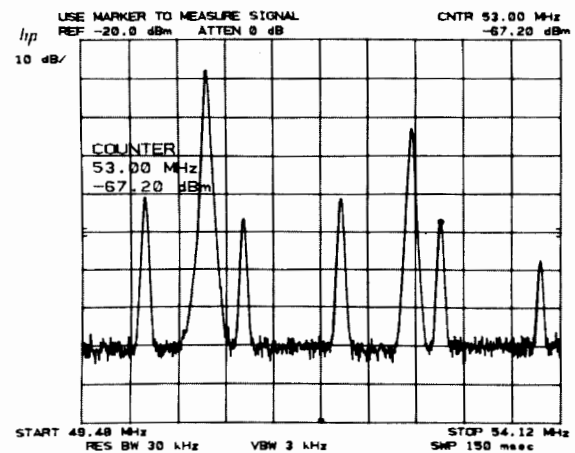
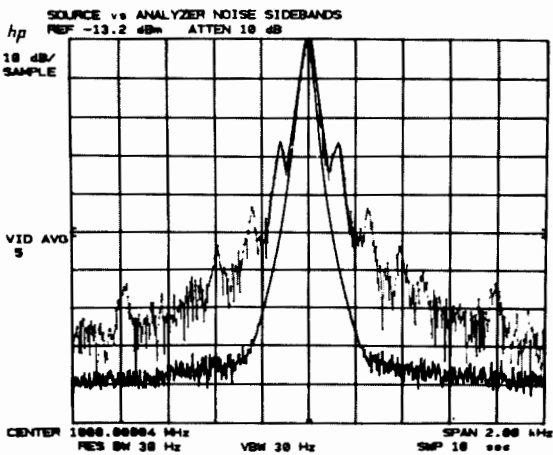
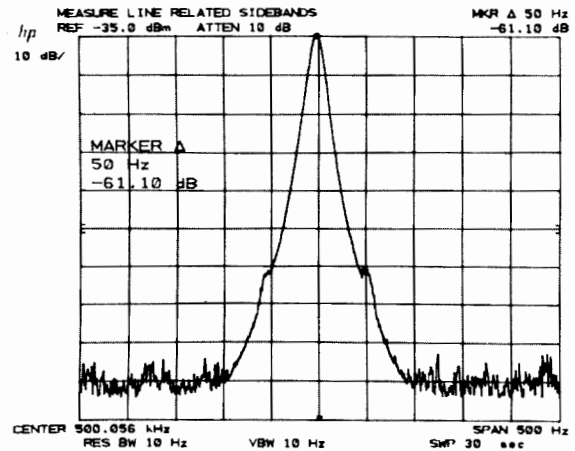
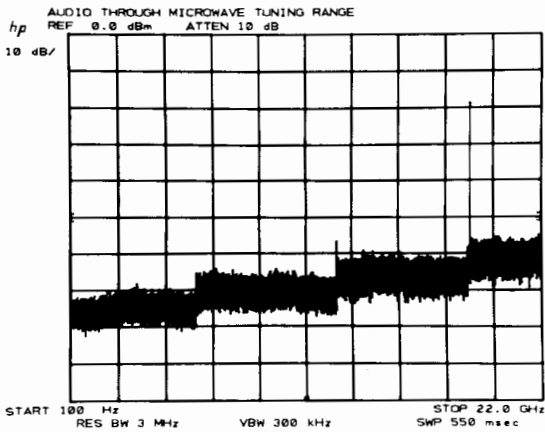

largest amplitude at 1001 points across the CRT over successive sweeps to aid in the measurement of residual FM or drift. Up to three traces may be observed simultaneously and arithmetic between traces or a trace and reference display line is possible for comparison or frequency response normalization.

### Automatic Measurement Capability

The 8568A and 8566A analyzers lend themselves to automatic control via the HP Interface Bus (IEEE Standard 488-1975). The analyzers can be tuned with the precision of a synthesizer while retaining analog sweep and exceptional resolution. The analyzers' control architecture facilitates the remote operation of all function settings and the output of CRT trace information; the display itself is accessible for annotation and graphing purposes.

Friendly analyzer codes and HP-IB commands are used to program the analyzer; for example, CF 20 MZ instructs the analyzer to set center frequency to 20 MHz. Built-in firmware features such as

instrument preset, peak search and automatic zoom further simplify writing software.

The primary advantage of computer control is the execution of complicated or time consuming measurement routines with a minimum of involvement by the operator. This capability is especially useful in production line testing or unattended measurement situations such as spectrum monitoring. An analyzer may be joined by other instruments in a distributed system, or be controlled remotely through a data communications network. External control is desirable for setting the proper analyzer function values, reading data, performing any numerical manipulation required (including error correction), analyzing the results, and providing output data in a convenient format on a printer, plotter, or the analyzer CRT.

This automatic capability is available in two configured systems, the 8581A and 8582A Automatic Spectrum Analyzers. These are specified on pages 514 and 515.



# SIGNAL ANALYZERS

Spectrum Analyzer, 100 Hz to 1500 MHz  
Model 8568A

- 100 Hz to 1.5 GHz frequency range
- 10 Hz resolution bandwidth
- Frequency counter accuracy
- Digital display
- Tunable marker with amplitude and frequency readout
- Store and recall of control settings

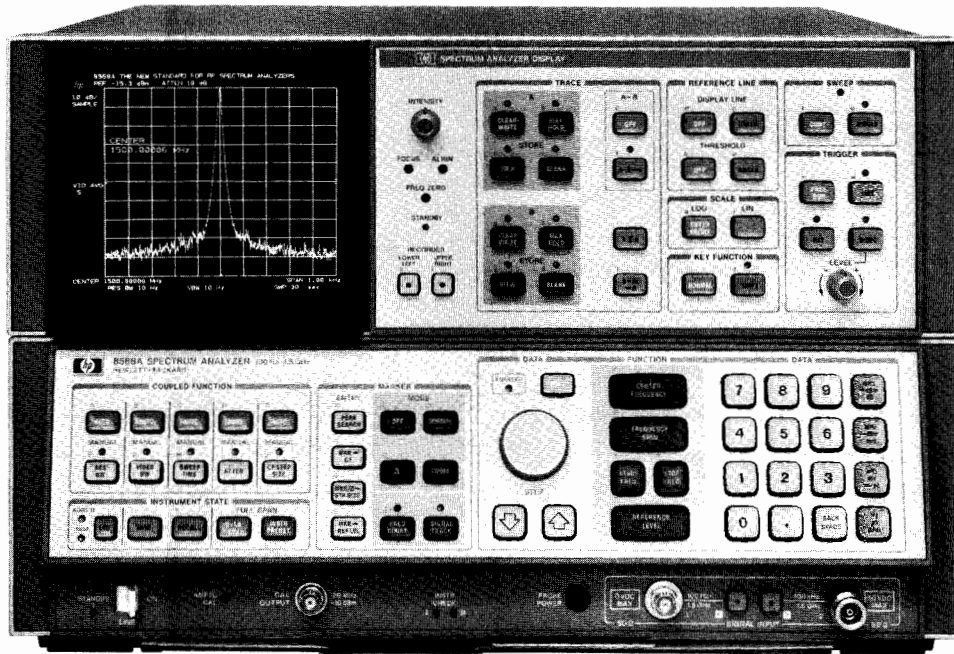

8568A



The 8568A Spectrum Analyzer is a high performance spectrum analyzer for bench and remote operation which covers the 100 Hz to 1.5 GHz frequency range. Frequency stabilized local oscillators and an internal counter bring unequaled measurement precision to RF spectrum analysis. Exceptional frequency stability and local oscillator spectral purity enables the use of a 10 Hz resolution bandwidth to make difficult, close-in sideband measurements on RF signals.

An internal microprocessor opens new horizons of operator convenience features. Digital display, store and recall of control settings, automatic zoom-in and signal track functions are administered by powerful firmware within the 8568A, thus simplifying operation of the analyzer.

All 8568A functions are programmable via HP-IB (IEEE 488-1975). Programming is as straightforward as encoding the steps used in a manual measurement. Friendly programming codes and easily recognizable mnemonics facilitate learning the analyzer language.

## 8568A Specifications

### Frequency

#### Displayed range

**Frequency span:** 100 Hz to 1500 MHz over 10 division CRT horizontal axis. In zero span, the instrument is fixed tuned at the center frequency.

**Full span (0-1500 MHz):** is immediately executed with a 0-1.5 GHz or INSTR PRESET keys.

**Frequency span accuracy:** for spans >1 MHz,  $\pm(2\%$  of the indicated frequency separation between two points +0.5% span); for span  $\leq 1$  MHz,  $\pm(5\%$  of frequency separation +0.5% span).

**Center frequency:** 0 Hz to 1500 MHz. Center frequency step size may be set using the numeric keyboard or MKR/ $\Delta$ →STP SIZE key.

**Readout accuracy:** Span  $\geq 100$  Hz:  $\pm(2\%$  of frequency span + frequency reference error x tune frequency +10 Hz) in AUTO resolution bandwidth after adjusting freq zero at stabilized temperature, and using the error correction function, SHIFT W and SHIFT X.

**Start-Stop frequency:** permissible values must be consistent with those for center frequency and frequency span. SHIFT O sets the analyzer start and stop frequencies equal to the frequencies of the two  $\Delta$  markers.

**Readout accuracy:** center frequency accuracy +  $\frac{1}{2}$  frequency span accuracy.

### Marker

**Normal:** displays the frequency at the horizontal position of the tunable marker.

**Accuracy:** center frequency accuracy + frequency span accuracy between the marker and center frequencies.

PEAK SEARCH positions the marker at the center of the largest signal response present on the display to within  $\pm 10\%$  of resolution bandwidth. MKR → CF sets the analyzer center frequency equal to the marker frequency; MKR/ $\Delta$  → STP SIZE sets the center frequency step equal to the marker frequency.

**Freq count:** displays the frequency signal on whose response the marker is positioned. The marker must be positioned at least 20 dB above the noise or the intersection of the signal with an adjacent signal and more than four divisions up from the bottom of the CRT.

**Accuracy:** for span  $\leq 100$  kHz: frequency reference error x displayed frequency  $\pm 2$  counts. For span > 100 kHz but  $\leq 1$  MHz: freq. ref. error x displayed frequency  $\pm (10 \text{ Hz} + 2 \text{ counts})$ . For span > 1 MHz:  $\pm (10 \text{ kHz} + 1 \text{ count})$ .

**Frequency reference error:** aging rate  $< 1 \times 10^{-9}$ /day; temp stability  $< 7 \times 10^{-9}$ , 0° to 55°C.

**Signal track:** re-tunes the analyzer to place a signal identified by the marker at the center of the CRT and maintain its position. Useful when reducing frequency span to zoom-in on a signal; also keeps a drifting input signal centered.

$\Delta$ : displays the frequency difference between the stationary and tunable markers. Reference frequency need not be displayed.

**Accuracy:** same as frequency span accuracy; in the FREQUENCY COUNT mode, twice the frequency count uncertainty plus drift during the period of the sweep (typically  $< 10$  Hz/minute). MKR/ $\Delta$  → STP SIZE sets the center frequency step size equal to the frequency difference between the markers. SHIFT O sets the

analyzer start stop frequencies equal to the frequencies of the two markers.

**Zoom:** makes it possible to reduce the frequency span about the marker (or signal in the signal track and freq count modes) using the step down key.

**Resolution**

**Resolution bandwidth:** 3 dB bandwidths of 10 Hz to 3 MHz in a 1, 3, 10 sequence. Bandwidth may be selected manually or coupled to frequency span.

**Bandwidth accuracy:** calibrated to:  $\pm 10\%$ , 1 MHz to 3 kHz;  $\pm 20\%$ , 1 kHz to 10 Hz, 3 MHz bandwidths.

**Bandwidth selectivity:** 60 dB/3 dB bandwidth ratio:  $<15:1$ , 3 MHz to 100 kHz;  $<13:1$ , 30 kHz to 10 kHz;  $<11:1$ , 3 kHz to 30 Hz. 60 dB points on 10 Hz bandwidth are separated by  $<100$  Hz.

**Stability**

**Residual FM:**  $<3$  Hz peak-to-peak  $\leq 10$  sec; span  $<100$  kHz, resolution bandwidth  $\leq 30$  Hz, video bandwidth  $\leq 30$  Hz.

**Drift:**  $<10$  Hz/minute of SWEPTIME after 1 hr. warmup at stabilized temperature, for frequency span  $\leq 100$  kHz. Spans  $>100$  kHz but  $\leq 1$  MHz,  $<100$  Hz/minute of SWEPTIME;  $>1$  MHz,  $<300$  kHz/minute of SWEPTIME.

**Spectral purity**

**Noise sidebands:**  $>80$  dB below the peak of a CW signal at frequency offsets  $\geq 30$  x resolution bandwidth setting, for resolution bandwidths  $\leq 1$  kHz.

**Line related sidebands:**  $>85$  dB below the peak of a CW signal.

**Amplitude**

**Measurement range:**  $-135$  dBm to  $+30$  dBm.

**Displayed range**

**Scale:** Over a 10 division CRT vertical axis with the Reference Level at the top graticule line.

**Calibration**

**Log:** 10 dB/div for 90 dB display from Reference Level.

5 dB/div for 50 dB display  
2 dB/div for 20 dB display  
1 dB/div for 10 dB display

expanded from  
reference level

**Linear:**

10% of Reference Level/div when calibrated in voltage.

**Fidelity:**

<b>Log:</b>	<b>Incremental</b>	<b>Cumulative</b>
	$\pm 0.1$ dB/dB over	$\leq \pm 1.0$ dB max over 0 to 80 dB
	0 to 80 dB display	display, 20–30°C.
		$\leq \pm 1.5$ dB max over 0 to 90 dB
		display.

**Linear:**  $\pm 3\%$  of Reference Level.

**Reference level**

**Range**

**Log:**

$+60.0^1$  to  $-139.9$  dBm or equivalent in dBmV, dB $\mu$ V, volts.

**Linear:**

$228.6^1$  volts to 0.22  $\mu$ volts full scale.

**Accuracy:** the sum of the following factors determines the accuracy of the reference level readout. Depending upon the measurement technique followed after calibration, various of these sources of uncertainty may not be applicable.

An internal error correction function calibrates and reduces the uncertainty introduced by analyzer control changes from the error calibration state ( $-7$  dBm reference level, 1 dB/div scale, 10 dB RF attenuation, 1 MHz bandwidth) when SHIFT W is executed just prior to the signal measurement (i.e., at the same temperature) within the 20°–30° range.

**Calibrator uncertainty:**  $\pm 0.2$  dB.

**Frequency response (Flatness) uncertainty:** input #1:  $\pm 1$  dB, 100 Hz to 500 MHz;  $\pm 1.5$  dB 100 Hz to 1500 MHz; input #2:  $\pm 1$  dB, 100 kHz to 1500 MHz.

**Amplitude temperature drift:** at  $-10$  dBm reference level with 10 dB input attenuation and 1 MHz resolution bandwidth,  $\pm 0.05$  dB/°C (eliminated by recalibration).

**Input connector switching uncertainty:**  $\pm 0.5$  dB when calibration and measurement do not use the same RF input.

**Input attenuation switching uncertainty:**  $\pm 1.0$  dB over 10 dB to 70 dB range.

**Resolution bandwidth switching uncertainty:** (referenced to 1 MHz bandwidth)—corrected (uncorrected)

<b>Range</b>	<b>20–30°C</b>	<b>0–55°C</b>
1 MHz to 30 Hz	$\pm 0.1$ dB ( $\pm 0.5$ dB)	( $\pm 2.0$ dB)
10 Hz	$\pm 0.1$ dB ( $\pm 1.0$ dB)	( $\pm 4.0$ dB)
3 MHz	$\pm 0.1$ dB ( $\pm 1.0$ dB)	( $\pm 2.0$ dB)

**Log scale switching uncertainty:**  $\pm 0.1$  dB corrected ( $\pm 0.5$  dB uncorrected).

**IF Gain uncertainty:** corrected (uncorrected). Assuming the internal calibration signal is used to calibrate the reference level at  $-10$  dBm and the input attenuator is fixed at 10 dB, any changes in reference level in the following ranges will contribute IF gain uncertainty:

<b>Range</b>	<b>20–30°C</b>	<b>0–55°C</b>
0 dBm to $-55.9$ dBm	NA <sup>2</sup> ( $\pm 0.6$ dB)	( $\pm 1.0$ dB)
$-56$ dBm to $-129.9$ dBm	$\pm 1.0$ dB <sup>3</sup> ( $\pm 1.0$ dB)	( $\pm 1.5$ dB)

Each 10 dB decrease (or increase) in the amount of input attenuation at the time of calibration and measurement will cause a corresponding 10 dB decrease (or increase) in the absolute reference level settings described above.

**RF Gain uncertainty (due to 2nd LO shift):**  $\pm 0.1$  dB corrected ( $\pm 1.0$  dB uncorrected)

**Error correction accuracy:** (applicable when controls are change from the error calibration state if SHIFT W and SHIFT X are used):  $\pm 0.4$  dB.

**Marker**

**Normal:** displays the amplitude at the vertical position of the tunable marker.

**Accuracy:** equals the sum of calibrator uncertainty, reference level uncertainty, and scale fidelity between the reference level and marker position.

PEAK SEARCH positions the marker at the peak of the largest signal present on the display. MKR  $\rightarrow$  REF LVL set the analyzer reference level equal to the marker amplitude. RMS noise density in a 1 Hz bandwidth is read out using SHIFT M, by sampling the displayed trace and arithmetically correcting for the analyzer envelope detector response, log shaping, and measurement bandwidth.

$\Delta$ : displays the amplitude difference between the stationary and tunable markers. Reference frequency need not be displayed.

**Accuracy:** equals the sum of scale fidelity and frequency between the two markers.

**Reference lines**

**Display line:** movable horizontal line with amplitude readout.

**Threshold:** movable horizontal trace threshold with amplitude readout.

**Accuracy:** equals the sum of calibrator uncertainty, reference level uncertainty, and scale fidelity between the reference level and reference line.

**Dynamic range**

**Spurious responses:** for a total signal power  $\leq -40$  dBm at the input mixer of the analyzer, all image and out-of-band mixing responses, harmonic and intermodulation distortion products are  $>75$  dB below the total signal power for inputs 10 MHz to 1500 MHz;  $>70$  dB below the total signal power for input signals 100 Hz to 10 MHz.

**Video bandwidth:** post detection low pass filter used to average.

**Displayed noise:** bandwidth variable from 1 Hz to 3 MHz in a 1, 3, 10 sequence. Video bandwidth may be selected manually or coupled to resolution bandwidth.

**Digital video averaging:** displays the sweep-to-sweep average of the trace over a specifiable number of sweeps with SHIFT G, video averaging is turned off with SHIFT H.

**Gain compression:**  $<0.5$  dB for signal levels  $\leq -10$  dBm at the input mixer.

**Sweep**

**Trigger**

**Free run:** sweep triggered by internal source.

**Line:** sweep triggered by power line frequency.

<sup>1</sup>Maximum input must not exceed  $+30$  dBm (damage level).

<sup>2</sup>Accounted for under Error Correction Accuracy.

<sup>3</sup>Correction only applies over the 0 dBm to  $-55.9$  dBm range.



# SIGNAL ANALYZERS

## Spectrum Analyzer, 100 Hz to 1500 MHz

Model 8568A (cont'd.)

**Video:** sweep triggered by detected waveform of input signal at an adjustable level; signal must be  $\geq 0.5$  div peak-to-peak.

**External:** sweep triggered by rising edge of signal input to rear panel BNC connector; trigger source must be  $> 2.4$  volt (5 volt max).

### Continuous

Sequential sweeps initiated by the trigger: 20 msec full span to 1500 sec full span in 1, 1.5, 3, 5, 7.5, 10 sequence.

**Accuracy:** sweep time  $\leq 100$  sec,  $\pm 10\%$ ;  $> 100$  sec,  $\pm 20\%$ .

**Zero frequency span:** 1  $\mu$ sec full sweep (10 divisions) to 10 msec full sweep in 1, 2, 5 sequence; 20 msec full sweep to 1500 sec full sweep in 1, 1.5, 2, 3, 5, 7.5, 10 sequence.

**Accuracy:** same as continuous.

Sweep time may be set manually or automatically for the frequency span, resolution bandwidth and video bandwidth selected.

**Single:** single sweep armed on activation and initiated by trigger (sweep  $\geq 20$  msec only).

### Display

**Trace:** A and B are two independent signal response memories each having 1001 horizontal data positions and vertical resolution of 0.1%. Memory contents are displayed on the CRT at a rate independent of the analyzer sweep time. Trace A is displayed brighter than trace B.

**Clear/Write:** clears memory contents when first activated, then writes the analyzer signal response into the memory each sweep and displays memory.

**Max hold:** retains in memory and displays the largest signal level occurring at each horizontal data position over the repetitive sweeps beginning at the time the function is activated.

**View:** stops writing into memory and displays memory without changing its contents.

**Blank:** stops writing into memory and blanks the trace while retaining the last response in memory.

### Arithmetic

**A-B-A:** initially subtracts the stored memory contents of B from the current memory contents of A and writes the difference into A; this process continues as the A memory is updated at the sweep rate. To accomplish A+B-A use SHIFT c.

**A  $\rightleftharpoons$  B:** exchanges A and B display memory contents.

**B-DL-B:** subtracts the amplitude of the display line from the memory contents of B and writes the difference into B.

A third signal response memory, C (also with a 1001 data positions), can be used for signal response storage. It is accessed indirectly by transferring memory contents between B and C.

**B  $\rightarrow$  C:** SHIFT l.

**B  $\leftarrow$  C:** SHIFT i.

**View C:** SHIFT j.

**Blank C:** SHIFT k.

### Annotation

**Title:** allows the user to write characters into a specified area on the CRT by pushing SHIFT E and typing the keys next to the blue front panel characters and data numbers desired. Use BACKSPACE for corrections.

**Blank:** SHIFT o blanks (SHIFT p unblanks) all CRT characters and control setting readouts. SHIFT m blanks (SHIFT n unblanks) the CRT graticule.

### Input

#### RF Inputs

The standard instrument configuration is as follows:

**Input # 1:** 100 Hz to 1500 MHz, 50 $\Omega$ , BNC connector (Fused); dc coupled.

**Reflection coefficient:**  $> 0.20$  (1.5 SWR) to 500 MHz,  $< 0.33$  (2.0 SWR) 500 MHz to 1500 MHz;  $\geq 10$  dB input attenuation.

**Input # 2:** 100 kHz to 1500 MHz, 50 $\Omega$ , Type N connector; ac coupled.

**Reflection coefficient:**  $< 0.20$  (1.5 SWR);  $\geq 10$  dB input attenuation.

**LO emission:** typically  $< -75$  dBm (0 dB RF Atten).

**Isolation:**  $> 90$  dB between inputs.

**Also available:** Input #1, 100 kHz to 1500 MHz, 75 $\Omega$ , BNC connector, ac coupled (Opt 001).

### Maximum input level

**AC:** continuous power, +30 dBm (1 watt); 100 watts, 10  $\mu$ sec pulse into  $\geq 50$  dB attenuation.

**DC:** Input #1, 0 volts; Input #2,  $\pm 50$  volts.

**Input attenuator:** 70 dB range in 10 dB steps. Zero dB attenuation accessible only through numeric/unit keyboard. Attenuation may be selected manually or coupled to reference level to insure a  $-10$  dBm input mixer drive level for full-screen signals; other mixer levels may be specified using SHIFT ' and entering the desired amplitude through the keyboard.

**Accuracy:**  $\pm 0.10$  dB over 10-70 dB range.

### Output

**Calibrator:** 20 MHz  $\pm 20$  MHz x frequency reference error ( $1 \times 10^{-3}$ /Day),  $-10$  dBm  $\pm 0.2$  dB; 50 $\Omega$ .

**Probe power:** +15 V,  $-12.6$  V; 150 mA max.

### Auxiliary (rear panel; nominal values)

**Display:** X, Y and Z outputs for auxiliary CRT displays. X, Y: 1 volt full deflection; Z: 0 to 1 V intensity modulation,  $-1$  V blank. BLANK output (TTL level  $> 2.4$  V for blanking) compatible with most oscilloscopes.

### Recorder

**Horizontal sweep output (x axis):** a voltage proportional to the horizontal sweep; 0 V for left edge to +10 V for right edge.

**Video output (y axis):** detected video output proportional to vertical deflection of CRT trace. Output increases 100 mV/div from 0 to 1 V.

**Penlift output (z axis):** 15 V blanking output during retrace.

**21.4 MHz IF:** a 50 $\Omega$ , 21.4 MHz output related to RF input to the analyzer. Output nominally  $-20$  dBm for a signal at the reference level. Bandwidth controlled by the analyzer's resolution bandwidth setting.

**1st LO:** 2-3.7 GHz,  $> +4$  dBm; 50 $\Omega$  output impedance.

**Frequency reference:** 10.000 MHz, 0 dBm; 50 $\Omega$  output impedance.

### Instrument State Storage

Up to 6 complete sets of user-defined control settings may be stored and recalled by pressing SAVE or RECALL and the desired register number (1 to 6) from the keyboard. Instrument state information is retained in memory approximately 30 days in STANDBY mode or after line power is removed.

### Remote Operation

The standard 8568A operates on the Hewlett-Packard Interface Bus (HP-IB). All analyzer control settings (with the exception of VIDEO TRIGGER LEVEL, FOCUS, ALIGN, INTENSITY, FREQ ZERO and AMPLD CAL) are remotely programmable. Function values, marker frequency/amplitude, and A/B traces may be output; CRT labels and graphics may be input. An HP-IB cable (not supplied) is required for remote operation.

### General

#### Environmental

**Temperature:** operating 0 $^{\circ}$ C to 55 $^{\circ}$ C, storage  $-40^{\circ}$ C to +75 $^{\circ}$ C.

**Humidity:** operating  $< 95\%$  R.H., 0 $^{\circ}$ C to 40 $^{\circ}$ C except as noted.

**EMI:** 8568A conducted and radiated interference is within the requirements of CE03 and RE02 of MIL STD 461A, VDE 0871, and CISPR pub'n 11.

**Power requirements:** 50 to 60 Hz; 100, 120, 220 or 240 volts (+5%, -10%); approximately 450 VA (40 VA in standby). 400 Hz operation is available as Opt 400.

**Weight:** total net, 45 kg (100 lb); Display/IF Section, 21 kg (46 lb); RF Section, 24 kg (54 lb). Shipping net, 72 kg (158 lb); Display/IF Section, 27 kg (60 lb); RF Section, 32 kg (70 lb); Manuals and Accessories, 13 kg (28 lb).

**Size:** 267 H x 425.5 W x 558.8 mm D (10.5" x 16.75" x 22").

### Ordering Information

8568A Spectrum Analyzer	Price
Opt 001: 75 $\Omega$ (BNC), 100 kHz to 1500 MHz RF Input #1	\$29,800
Opt 400: 400 Hz Power Line Frequency Operation	add \$200
Opt 907: Front Handle Kit	add \$400
Opt 908: Rack Flange Kit	add \$80
Opt 909: Rack Flange and Front Handle Kit	add \$40
Opt 910: Extra Manual	add \$120
	add \$250

# SIGNAL ANALYZERS

## Spectrum Analyzer, 100 Hz to 22 GHz

### Model 8566A



- 100 Hz to 22 GHz internal mixing range
- Synthesizer frequency accuracy
- 10 Hz frequency resolution

- Tunable marker with amplitude and frequency readout
- Integrated preselector with automatic peaking feature
- Store and recall of instrument settings

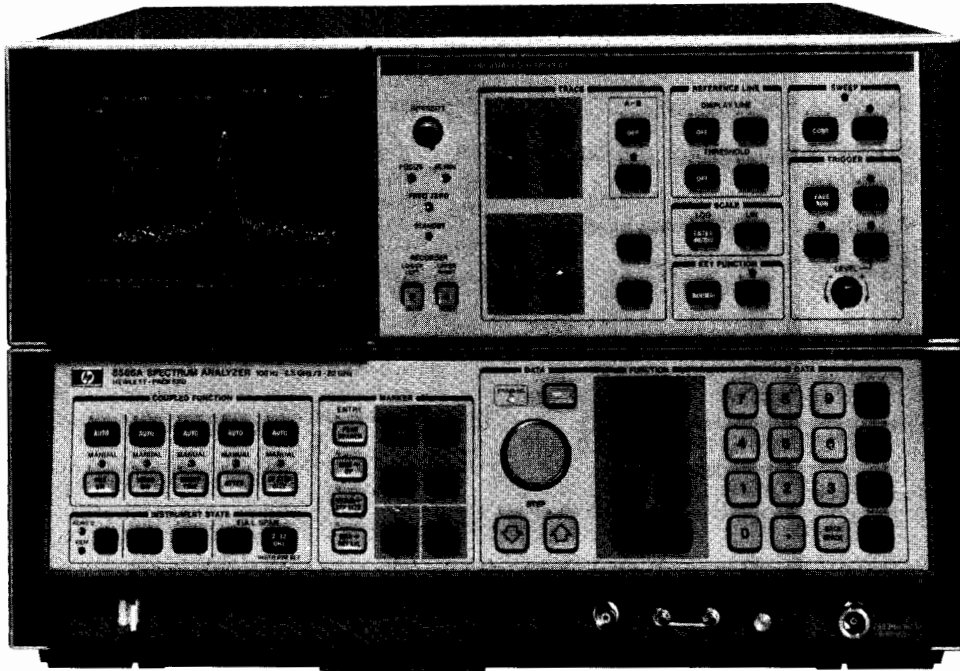

8566A



The 8566A Spectrum Analyzer is a high performance spectrum analyzer for bench and remote operation which operates from 100 Hz to 22 GHz using internal mixing. The frequency range may be extended to 40 GHz with the HP 11517A External Mixer and above 40 GHz with commercially available mixers. A synthesized local oscillator yields counter-like accuracy at microwave and millimeter wave frequencies. 10 Hz resolution bandwidth and superior frequency stability allow difficult measurements such as line-related sideband characterization at 22 GHz.

A unique integrated preselector/mixer provides high sensitivity with preselection from 2 GHz to 22 GHz. For example, in a 10 Hz resolution bandwidth, the sensitivity at 18 GHz is  $< -119$  dBm.

### 8566A Specifications

#### Frequency

**Measurement range:** 100 Hz to 22 GHz with internal mixer, dc coupled input; 12.4 GHz to 40 GHz with HP 11517A External Mixer.

#### Displayed values

**Center Frequency:** 0 Hz to 300 GHz.

**Readout accuracy:** (AUTO resolution bandwidth after adjusting frequency zero at stabilized temperature, and using the error correction function, SHIFT W and SHIFT X) spans  $\leq n \times 5$  MHz:  $\pm(2\%$  of frequency span + frequency reference error  $\times$  center frequency + 10 Hz); spans  $> n \times 5$  MHz:  $\pm(2\%$  of frequency span +  $n \times 100$  kHz + frequency reference error  $\times$  center frequency) where n is the harmonic number, depending on center frequency:

n	Center Frequency (internal mixing)
1	0 Hz to 5.8 GHz
2	5.8 GHz to 12.5 GHz
3	12.5 GHz to 18.6 GHz
4	18.6 GHz to 22 GHz (external mixing)
6	18.6 GHz to 26.5 GHz
8	26.3 GHz to 40.2 GHz

For center frequencies  $> 40.2$  GHz, refer to the Frequency Diagnostic (KSR) display for the value of n.

**Frequency span:** 0 Hz to 300 GHz over 10 division CRT horizontal axis; variable in approximately 1% increments.

**Full span:** 0 to 2.5 GHz and 2 to 22 GHz. 2 to 22 GHz is selected with INSTR PRESET.

**Readout accuracy:** spans  $\leq n \times 5$  MHz,  $\pm 1\%$  of indicated frequency separation; spans  $> n \times 5$  MHz,  $\pm 3\%$  of indicated frequency separation.

**Start/Stop frequency:** SHIFT O sets the analyzer start and stop frequencies equal to the frequencies of the two  $\Delta$  markers.

**Readout accuracy:** Same as center frequency.

**Frequency reference error:**  $< 1 \times 10^{-9}$ /day and  $< 2 \times 10^{-7}$ /year.

#### Resolution

**Resolution bandwidth:** 3 dB bandwidths of 10 Hz to 3 MHz in a 1, 3, 10 sequence. Bandwidth may be selected manually or coupled to frequency span.

**Bandwidth accuracy:** calibrated to:  $\pm 20\%$ , 3 MHz to 10 Hz;  $\pm 10\%$ , 1 MHz to 3 kHz.

**Bandwidth selectivity:** 60 dB/3 dB bandwidth ratio:  $< 15:1$ , 3 MHz to 100 kHz;  $< 13:1$ , 30 kHz to 10 kHz;  $< 11:1$ , 3 kHz to 30 Hz. 60 dB points on 10 Hz bandwidth are separated by  $< 100$  Hz.

#### Stability

**Residual FM (typical):** for fundamental mixing ( $n = 1$ );  $< 50$  kHz peak-to-peak, frequency span  $\geq 5$  MHz;  $< 200$  Hz peak-to-peak, frequency span  $\leq 5$  MHz;  $< 5$  Hz peak-to-peak, frequency span  $< 100$  kHz;  $< 0.2$  Hz peak-to-peak, frequency span  $< 5$  kHz.

**Drift (typical):** after 1 hour warm-up at stabilized temperature. COUPLED FUNCTION not required.

Frequency span	Center frequency drift
$< 100$ kHz	$< 10$ Hz/minute of sweep time
100 kHz to 5 MHz	$< 500$ Hz/minute of sweep time
$\geq 5$ MHz	$< 5$ kHz/minute of sweep time

Because the analyzer is phase locked at the beginning of each sweep, drift occurs only during the time of one sweep.

# SPECTRUM ANALYZERS

## Spectrum Analyzer, 100 Hz to 22 GHz

### Model 8566A (cont'd.)

#### Spectral Purity

**Noise sidebands:** >85 dB below the peak of a 5.8 GHz CW signal at 1 kHz offset; >79 dB for 12.5 GHz signal; >75 dB for 18.6 GHz signal; >73 dB for 22 GHz signal; all for resolution bandwidth  $\leq$  100 Hz.

**Power line related sidebands:** >80 dB below the peak of a 5.8 GHz CW signal, <360 Hz offset.

#### Amplitude

**Measurement range:** -134 dBm to +30 dBm.

#### Display range

**Scale:** over a 10 division CRT vertical axis with the Reference Level at the top graticule line.

#### Calibration:

**Log:** 10 dB/div for 90 dB display from Reference Level.

5 dB/div for 50 dB display

2 dB/div for 20 dB display

1 dB/div for 10 dB display

expanded from  
Reference Level

**Linear:** 10% of Reference Level/div when calibrated in voltage.

#### Fidelity

**Log:**

**Incremental**

$\pm 0.1$  dB/dB over  
0 to 80 dB display

**Cumulative**

<  $\pm 1.0$  dB max over 0 to 80  
dB display, 20-30°C.  
<  $\pm 1.5$  dB max over 0 to 90  
dB display.

**Linear:**  $\pm 3\%$  of Reference Level

#### Reference level

##### Range

**Log:** +30.0 to -99.9 dBm or equivalent in dBmV, dB $\mu$ V, Volts Readout expandable to +60.0<sup>1</sup> volts to -119.9 dBm (-139.9 dBm for <1 kHz resolution bandwidth) using SHIFT I.

**Linear:** 7.07 volts to 2.2  $\mu$ volts full scale. Readout expandable to 223.6<sup>1</sup> volts to 2.2  $\mu$ volts (0.22  $\mu$ volts for <1 kHz resolution bandwidth) using SHIFT I.

**Accuracy:** the sum of the following factors determines the accuracy of the reference level readout. Depending upon the measurement technique followed after calibration with the CAL signal, various of these sources of uncertainty may not be applicable. Specifications are with the preselector tracking optimized with MARKER PRE-SELECTOR PEAK function.

An internal error correction function calibrates and reduces the uncertainty introduced by analyzer control changes from the error calibration state (-7 dBm reference level, and 100 MHz center frequency) when SHIFT W and SHIFT X are executed just prior to the signal measurement (i.e. at the same temperature) within 20-30°C. range.

**Calibration uncertainty:**  $\pm 0.3$  dB.

**Frequency response (flatness) uncertainty:**  $\pm 0.6$  dB, 100 Hz to 2.5 GHz;  $\pm 1.7$  dB, 2.0 GHz to 12.5 GHz;  $\pm 2.2$  dB, 12.5 GHz to 20 GHz;  $\pm 3.0$  dB, 20 GHz to 22 GHz; for 10 dB attenuator setting. Cumulative flatness  $\pm 2.2$  dB, 100 Hz to 20 GHz. COUPLED FUNCTION not required as long as display remains calibrated.

**Absolute amplitude calibration uncertainty:**  $\pm 0.6$  dB. The certainty of setting the frequency response curve absolutely when using the internal CAL signal or any other calibration signal in the 100 Hz to 2.5 GHz band.

**Amplitude temperature drift:** at -10 dBm reference level with 10 dB input attenuation and 1 MHz resolution bandwidth.  $\pm 0.03$  dB/°C (eliminated after recalibration).

#### Scale fidelity

**Log:**

**Incremental**

$\pm 0.1$  dB/dB

**Cumulative**

<  $\pm 1.0$  dB over 0 to 80 dB display  
<  $\pm 1.5$  dB over 0 to 90 dB display

**Linear:**  $\pm 3\%$  of reference level

**Resolution bandwidth switching uncertainty<sup>2</sup>:** referenced to 1 MHz bandwidth, corrected (uncorrected).  $\pm 0.1$  dB ( $\pm 0.5$  dB), 30 Hz to 1 MHz bandwidths.  $\pm 0.1$  dB ( $\pm 1.0$  dB), 10 Hz and 3 MHz bandwidths.

**Log scale switching uncertainty:** Corrected (uncorrected).  $\pm 0.1$  dB ( $\pm 0.5$  dB).

**IF gain uncertainty:** Corrected (uncorrected). Assuming the internal calibration signal is used to calibrate the reference level at -10 dBm and the input attenuator is fixed at 10 dB, any changes

to the reference level function value from -10 dBm will contribute IF gain uncertainty.

#### Range

0 dBm to -55.9 dBm

-55.0 dBm to -129.9 dBm

#### Uncertainty

0 dB ( $\pm 0.6$  dB)

$\pm 1.0$  dB ( $\pm 1.5$  dB)

The range values change with different input attenuator settings. Each 10 dB decrease (or increase, in the amount of input attenuation at the time of calibration and measurement will cause a corresponding 10 dB decrease (increase) in absolute reference level settings described above.

**RF gain uncertainty:** corrected (uncorrected) 0 dB ( $\pm 0.2$  dB). The gain change between preselected and non-preselected bands.

**Error correction:**  $\pm 0.4$  dB

When the error correction function is used (SHIFT W and SHIFT X), amplitude uncertainty is introduced because additional IF gain is used to offset errors in the switching of resolution BW, amplitude scales and RF gain.

#### Dynamic range

**Spurious responses:** (signals generated by the analyzer due to input signals). For signals < -40 dBm all harmonic and intermodulation distortion > 70 dB below input signal.

**Second order harmonic distortion:** for mixer levels  $\leq$  -40 dBm: < -70 dBc, 100 Hz to 50 MHz; < -80 dBc, 50 MHz to 700 MHz; < -70 dBc, 700 MHz to 2.5 GHz. For mixer levels  $\leq$  -10 dBm: < -100 dBc, 2 to 22 GHz.

**Third order intermodulation distortion:** third order intercept (TOI): > +7 dBm, 100 Hz to 5.8 GHz; > +5 dBm, 5.8 to 18.6 GHz; > +5 dBm (typical), 18.6 GHz to 22 GHz; > +50 dBm (typical), 2 to 22 GHz for > 100 MHz signal separation.

**Image responses:** (due to input signals 642.8 MHz above or below the tuned frequency) < -70 dBc, 100 Hz to 18.6 GHz; < -60 dBc, 18.6 GHz to 22 GHz.

**Multiple responses:** (due to the input signal mixing with more than one local oscillator harmonic) < -70 dBc, 100 Hz to 22 GHz.

**Out-of-band responses:** (due to input signals outside the preselector's frequency span) < -60 dBc, 2 to 22 GHz.

**Synthesis related spurious sidebands:** < -90 dBc.

**Residual responses:** (signals displayed by the analyzer independent of input signals) With 0 dB input attenuation and no input signal: < -100 dBm, 100 Hz to 5.8 GHz; < -95 dBm, 5.8 GHz to 12.5 GHz; < -85 dBm, 12.5 GHz to 18.6 GHz; < -80 dBm, 18.6 GHz to 22 GHz.

**Gain compression:** < 1.0 dB, 100 Hz to 22 GHz with  $\leq$  -5 dBm at input mixer.

**Average noise level:** with 0 dB input attenuation and 10 Hz resolution bandwidth. < -95 dBm, 100 Hz to 50 kHz; < -112 dBm, 50 kHz to 1.0 MHz; < -134 dBm, 1.0 MHz to 2.5 GHz; < -132 dBm, 2.0 GHz to 5.8 GHz; < -125 dBm, 5.8 GHz to 12.5 GHz; < -119 dBm, 12.5 GHz to 18.6 GHz; < -114 dBm, 18.6 GHz to 22 GHz.

**Video bandwidth:** post detection low pass filter used to average displayed noise bandwidth variable from 1 Hz to 3 MHz in a 1,3,10 sequence. Video bandwidth may be selected manually or coupled to resolution bandwidth.

**Digital video averaging:** displays the sweep-to-sweep average of the trace over a specifiable number of sweeps with SHIFT G, video averaging is turned off with SHIFT H.

#### Reference Lines

**Display line:** movable horizontal line with amplitude readout.

**Threshold:** movable horizontal trace threshold with amplitude read-out.

**Accuracy:** equals the sum of calibrator uncertainty, and scale fidelity between the reference level and reference line.

#### Marker

The marker is a bright dot placed upon the display trace which is positioned horizontally by the DATA controls. The marker amplitude and frequency are read out continuously.

#### Frequency

**Normal:** displays the frequency at the horizontal position of the tunable marker. PEAK SEARCH positions the marker at the cen-

<sup>1</sup>Maximum input must not exceed +30 dBm (damage level).

<sup>2</sup>Accounted for under Error Correction Accuracy.

<sup>3</sup>Correction only applies over the 0 dBm to -55.9 dBm range.



ter of the largest signal response present on the display to within  $\pm 10\%$  of resolution bandwidth. Following peak search, SHIFT K moves marker to next higher trace maximum. Subsequent SHIFT K entries move marker to sequentially lower maxima. MKR $\rightarrow$ CF sets the analyzer center frequency equal to the marker frequency; MKR/ $\Delta$  $\rightarrow$ STP SIZE sets the center frequency step size equal to the marker frequency.

**Accuracy:** same as center frequency accuracy.

**Signal track:** re-tunes the analyzer to place a signal identified by the marker at the center of the CRT and maintain its position (provided the signal remains on-screen during the period of one sweep). Useful when reducing frequency span to zoom-in on a signal; also keeps a drifting input signal centered.

$\Delta$ : displays the frequency difference between the stationary and tunable markers. Reference frequency may be outside current frequency span accuracy. MKR/ $\Delta$  $\rightarrow$ STP SIZE sets the center frequency difference between the markers. SHIFT O sets the analyzer start and stop frequencies equal to the frequencies of the two markers.

**Accuracy:** same as frequency span accuracy.

**Zoom:** makes it possible to reduce the frequency span about the marker (or signal in the track mode) using the step down key.

#### Amplitude

**Normal:** displays the amplitude at the vertical position of the tunable marker. PEAK SEARCH positions the marker at the peak of the largest signal present on the display.

MKR $\rightarrow$ REF LVL sets the analyzer reference level equal to the marker amplitude. RMS noise density in a 1 Hz bandwidth is read out using SHIFT M, by sampling the displayed trace and arithmetically correcting for the analyzer detector response, log shaping, and measurement bandwidth.

**Accuracy:** same as reference level accuracy plus scale fidelity between the reference level and marker position.

$\Delta$ : displays the amplitude difference between the stationary and tunable marker. Reference frequency may be outside current frequency span.

**Accuracy:** same as frequency response uncertainty and scale fidelity between two markers.

**Preselector peak:** with the marker at the peak of a displayed input signal, preselector peak automatically adjusts preselector tracking for maximum response. SHIFT = resets the preselector tuning to the nominal factory preset condition. If the marker is not activated when preselector peak is used, a peak search will be exercised prior to preselector peaking.

#### Sweep

Trigger, continuous and single is the same as the 8568A, pages 509 and 510.

#### Sweeptime

##### Zero frequency span

**With digital storage:** 20 msec full sweep to 1500 sec full sweep in  $\sim 1\%$  increments.

**Without digital storage:** 1  $\mu$ sec full sweep to 10 msec in 1,2,5 sequence.

##### Marker (sweeps > 20 msec only)

**Normal:** displays time from beginning of sweep to marker position.

$\Delta$ : displays time difference between stationary and tunable marker.

#### Display

The display functions are the same as the 8568A, page 498.

#### Input

**RF Input:** 100 Hz to 22 GHz, precision female type N connector, dc coupled.

**SWR (typical):** 1.2, 100 Hz to 2.5 GHz; 1.5, 2 GHz to 5.8 GHz; 1.9, 5.8 GHz to 22 GHz; with 10 dB input attenuation.

**LO emission (typical):**  $< -80$  dBm when preselected;  $< -90$  dBm when not preselected.

##### Maximum input level

**AC:** +30 dBm (1 watt), continuous power, from 50 ohm source. Mixer protected by diode limiter, 100 Hz to 2.5 GHz.  $< 100$  watts, 10  $\mu$ sec pulse with  $\geq 50$  dB RF attenuation ( $\leq 0$  dBm peak to input mixer).

**DC:**  $< 100$  mA current damage level.

**Input attenuator:** 70 dB steps. Zero dB attenuation accessible only

through numeric/unit keyboard. Attenuation may be selected manually or coupled to reference level to insure a  $-10$  dBm input mixer drive level for full-screen signals; other mixer levels may be specified using SHIFT , and entering the desired amplitude through the keyboard.

**Accuracy:**  $\pm 1.0$  dB over 10–70 dB range.

#### IF Input

##### Maximum input level

**AC:** +10 dBm, continuous power, from 50  $\Omega$  source.

**DC:** 20 volts with rise time of  $< 1$  volt/ $\mu$ sec.

**Sensitivity:**  $-30$  dBm at 321.4 MHz produces full-scale CRT deflection  $\pm 1.0$  dB when KSU has been executed.

#### Output

**Calibrator:** 100 MHz  $\pm$  (frequency reference error).  $-10$  dBm  $\pm 0.3$  dB, 50  $\Omega$  impedance.

##### Auxiliary

Auxiliary outputs are the same as the 8568A, page 27.20.

**21.4 MHz IF (rear panel):** a 50  $\Omega$ , 21.4 MHz output related to the RF input to the analyzer. In log scales, the IF output is logarithmically related to the RF input signal; in linear, the output is linearly related. The output is nominally  $-20$  dBm for a signal at the reference level. Bandwidth is controlled by the analyzer's resolution bandwidth setting; amplitude controlled by the input attenuator, and IF step gain positions.

##### IF Output (front panel)

##### Maximum input level

**AC:** +10 dBm, continuous power, from 50  $\Omega$  source.

**DC:** 20 volts with rise time of  $< 1$  volt/ $\mu$ sec.

**1st LO Output (front panel):** 2.3 to 6.2 GHz,  $> +5$  dBm., 50  $\Omega$  output impedance.

**Maximum input level:** +27 dBm (0.5 watt) total power into 50  $\Omega$  impedance.

**Frequency reference (rear panel):**  $> -5$  dBm, 50  $\Omega$  output impedance

**Sweep plus tune output (rear panel):** 10.000 MHz, 0 dBm; 50  $\Omega$  output impedance.

**10 MHz output (rear panel):**  $> -5$  dBm, 50  $\Omega$  output impedance.

**Sweep plus tune output (rear panel):**  $-1.0$  volt per GHz of tune frequency,  $> 10$  k $\Omega$  load.

**Accuracy:**  $-1$  V/GHz  $\pm 2\% \pm 10$  mV.

#### Instrument State Storage

Up to 6 complete sets of user-defined control settings may be stored and recalled by pressing SAVE or RECALL and the desired register number (1 to 6) from the keyboard. Instrument state information is retained in memory indefinitely in STANDBY and approximately 30 days after line power is terminated.

#### Remote Operation

The standard 8566A operates on the Hewlett-Packard Interface Bus (HP-IB). All analyzer control settings (with the exception of VIDEO TRIGGER LEVEL, FOCUS, ALIGN, INTENSITY, FREQ ZERO and AMPLD CAL) are remotely programmable. Function values, marker frequency/amplitude, and A/B traces may be output; CRT labels and graphics may be input. An HP-IB cable (not supplied) is required for remote operation.

#### General

##### Environmental

**Temperature:** operating  $0^\circ\text{C}$  to  $55^\circ\text{C}$ , storage  $-40^\circ\text{C}$  to  $+75^\circ\text{C}$ .

**Humidity:** operating  $< 95\%$  R.H.,  $0^\circ\text{C}$  to  $40^\circ\text{C}$  except as noted.

**EMI:** Conducted and radiated interference is within the requirements of CE03 and RE02 of MIL STD 461A, VDE 0871, and CISPR pub'n 11.

**Power requirements:** 50 to 60 Hz; 100, 120, 220, or 240 volts ( $+5\%$ ,  $-10\%$ ); approximately 650 VA (40 VA in standby). 400 Hz operation is available as Opt 400.

**Weight:** total net 50 kg (112 lb); Display/IF Section, 21 kg (47 lb); RF Section, 24 kg (53 lb). Shipping, Display/IF Section 31 kg (69 lb); RF Section 39 kg (87 lb).

**Size:** 267 H  $\times$  425.5 W  $\times$  598.5 mm D (10.5"  $\times$  16.75"  $\times$  23.56").

#### 8566A Spectrum Analyzer

**\$49,500**

**Opt 400:** 400 Hz Power Line Frequency Operation add \$400

**Opt 907:** Front Handle Kit add \$80

**Opt 908:** Rack Flange Kit add \$40

**Opt 909:** Rack Flange and Front Handle Kit add \$120

**Opt 910:** Extra Manual add \$250

# SIGNAL ANALYZERS

Automatic Spectrum Analyzers, 100 Hz to 22 GHz

Models 8581A & 8582A

- Interactive front panel under program control
- Friendly programming codes and powerful firmware
- 9825T Desktop Computer
- Ease of operation via HP-IB
- Software PAC minimizes program development time

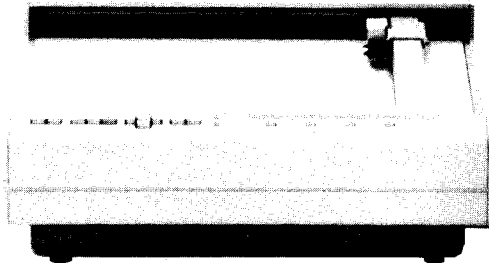
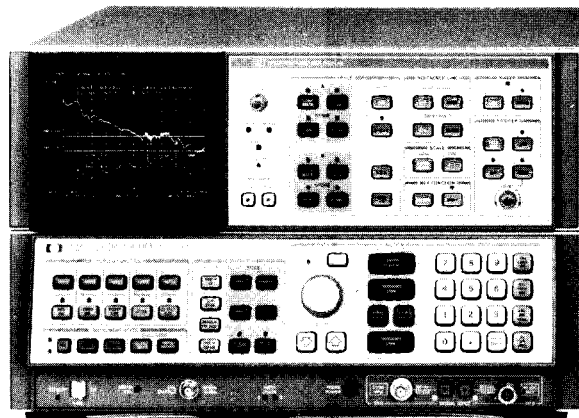

9872B (Recommended)

The 8581A and 8582A Automatic Spectrum Analyzers are systems based on the 8568A and 8566A spectrum analyzers respectively. Each system has the 9825T Desktop Computer with 62 k bytes of memory, the 9866B Printer with stand, a system software PAC, and a system table.

## System Software

The system software provided with each system supplies high level software routines (subprograms) to aid the spectrum analyzer system programmer in developing programs. For the beginning programmers, the software PACs include sample measurement programs which can be run without previous programming experience.

## Sample Measurement Programs

There are four sample programs to illustrate the speed and flexibility of the automatic spectrum analyzers. These programs make carefully controlled measurements of harmonic distortion, spectral content, percent amplitude modulation and noise/impulse bandwidths. The programs use accurate spectrum analyzer measurement techniques, while keeping careful bounds on the complexity of the signal to be measured in order to maintain the program's instructional value. Each measurement program is provided with complete operating instructions, a flow diagram and line-by-line annotation.

Following are illustrations from two of the programs.

The harmonic distortion sample program measures frequency and amplitude of an oscillator and its 2nd and 3rd order harmonics. The program specifically illustrates the automatic measurement of CW signals, automatic optimization of the analyzer's distortion-free dynamic range and the selection of a resolution bandwidth to prevent errors due to signal instability. One typical output follows:

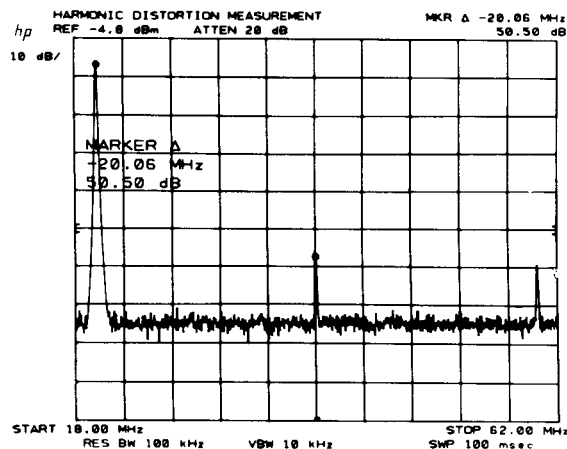

HARMONIC DISTORTION TEST:  
 Signal Frequency: 20.1100 MHz  
 Signal Amplitude: -12.0 dBm  
 2nd Harmonic Distortion: -51.4 dB  
 3rd Harmonic Distortion: -53.5 dB  
 Total 2nd+3rd Harmonic Dist: 0.37 %

The spectrum search sample program scans an operator-specified frequency range (less than one decade) and lists the frequency and amplitude of each signal found. The program specifically

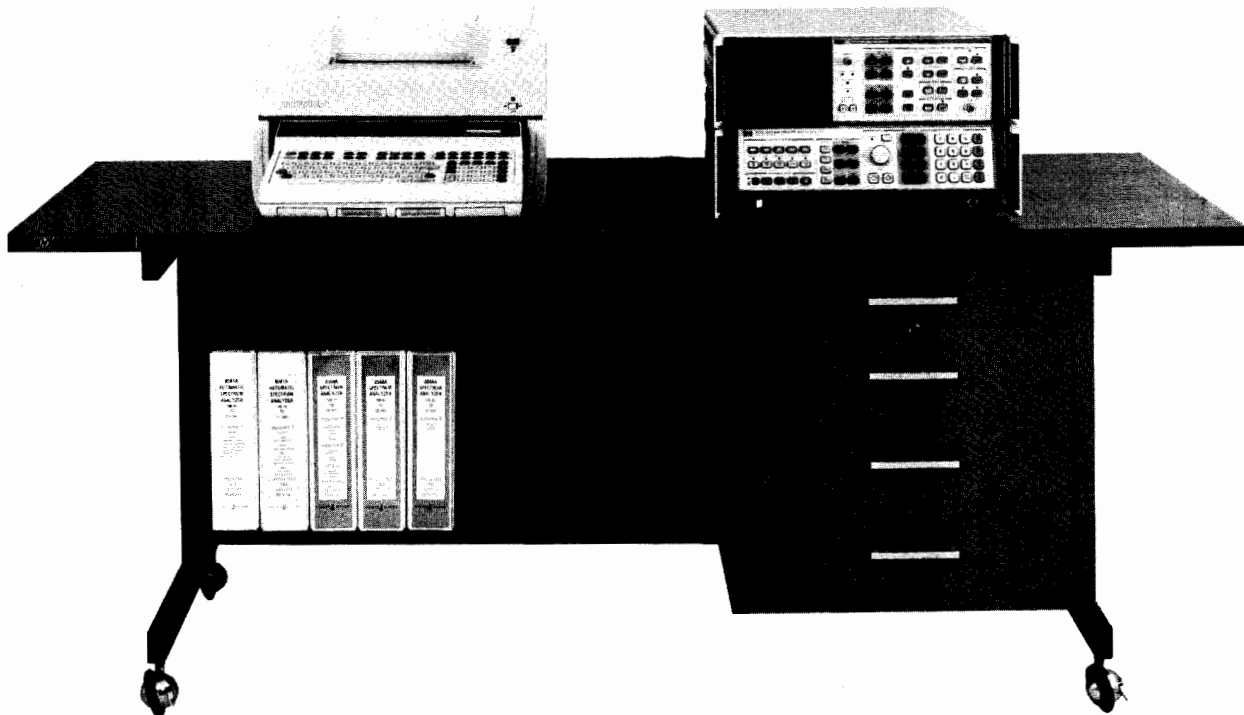

8582A



illustrates the searching process when hunting for signals of unknown amplitude and modulation. The program also sets the analyzer attenuator to prevent analyzer distortion and sets sweep time and detection mode to catch the peak modulation excursions. The following are typical outputs:

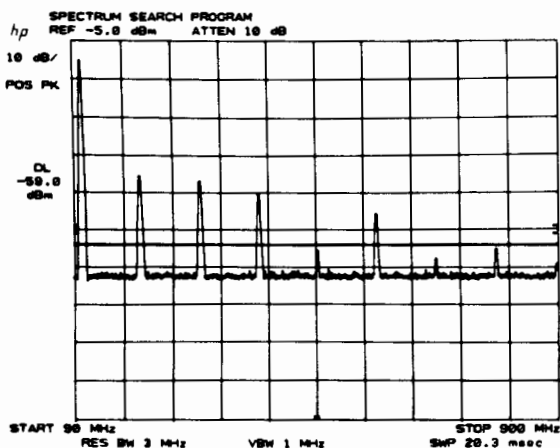

Frequency MHz	Amplitude dBm
102.000000	-10.3
198.000000	-40.5
298.000000	-41.7
399.000000	-45.1
599.000000	-50.7

### Subprogram Library

The system software includes subprogram modules which can be used by the more experienced programmer to extend the capability of the spectrum analyzer in an automatic environment. The sample programs described above illustrate the use of these subprograms.

One of these modules, called \*PEAKS, is a subprogram that returns a list of the frequencies on the analyzer's trace at which there are peak signals as defined by the user.

Another subprogram, \*OPT-RANGE, sets the spectrum analyzer's RF attenuator for the optimum dynamic range based upon the analyzer's current settings, the input signal power and upon either second or third order distortion criteria.

These subprograms are annotated on an operation and line-by-line basis.

Each software PAC includes two 9825 cartridges containing the sample measurement programs, subprograms, and utilities (including CRT plot and system checkout). Also included is a manual with annotated program listings. Complete compatibility requires 8568A or 8566A, 9825S, B or T, 9866B Option 025, and 98034A. For plotting CRT information: order 9872B option 025 and 10631B HP-IB cable.

### Ordering Information

	Price
8581A Automatic Spectrum Analyzer (8568A based system)	\$47,120
8582A Automatic Spectrum Analyzer (8566A based system)	66,820

### System Components

8568A Option 907 Spectrum Analyzer or 8566A Option 907 Spectrum Analyzer  
9825T Desktop Computer with 62k bytes of memory.  
9866B Printer with Option 025, 9825 Interface  
98034A HP-IB Interface Card and HP-IB cable with single connector  
98226A Computer Cradle  
System Table  
85860A Software PAC for 8568A/9825/9866B Opt 025/98034A  
85861A Software PAC for 8566A/9825/9866B Opt 025/98034A  
Factory Assembly and Checkout Prior to Shipment.  
Extra HP-IB cables not included.

### System Options and Software

Opt 002: Delete System Table	Less \$900
Opt 910: Extra Manual Set	\$250
85860A Software PAC for 8568A/9825/9866B/98034A:	\$250
85861A Software PAC for 8566A/9825/9866B/98034A:	\$250



# SIGNAL ANALYZERS

## Spectrum Analyzer, 10 MHz to 40 GHz

### Model 8565A

- 0.01 to 22 GHz coverage with internal mixer
- Internal preselection 1.7 to 22 GHz
- Wide choice of resolution bandwidths
- Simple three knob operation
- Absolute amplitude calibration
- CRT bezel readout displays control settings

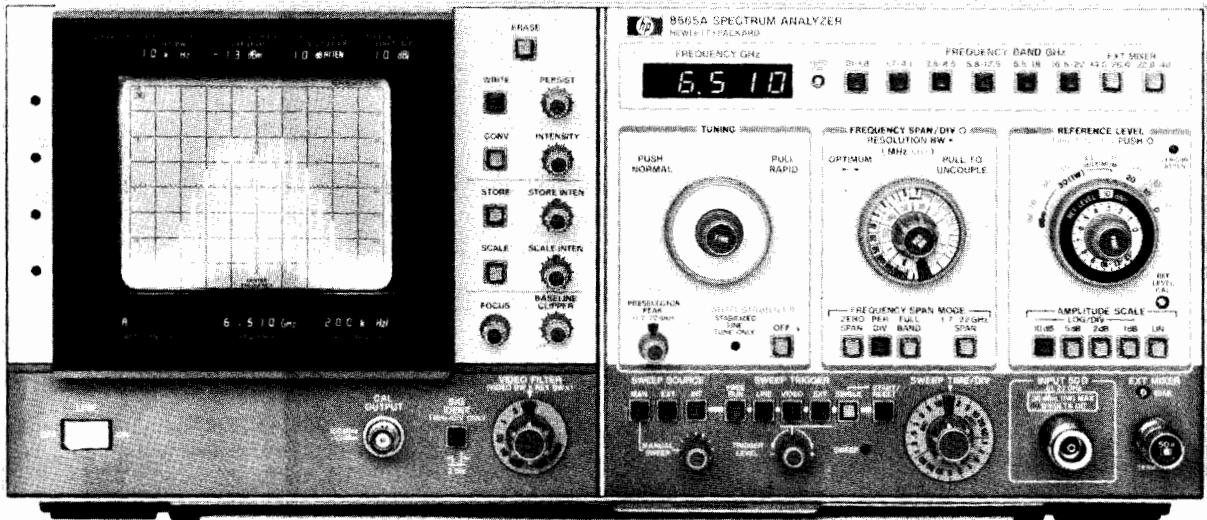

### 8565A Spectrum Analyzer

Covering from 0.01 to 22 GHz with its internal mixer, the 8565A has built-in preselection and brings accuracy plus convenience to microwave spectrum analysis. The wide range, spurious-free display, compact design and ease of use make it well suited for lab, production, or field applications requiring accurate measurement from IF thru microwave frequencies. The 8565A can cover 0.01 to 22 GHz in just two spans for rapid location of signals prior to close-in analysis in one of six bands. Coverage is easily extended up to 40 GHz with the HP 11517A External Mixer.

#### High Resolution

Fully automatic stabilization in narrow spans reduces residual FM and drift. Standard resolution bandwidths range from 1 kHz to 3 MHz. The 1 and 3 MHz bandwidths allow fast sweeps in wide spans and increased dynamic range for pulsed RF; the narrow bandwidths allow measurement of closely spaced signals. Option 100 provides additional 100 Hz and 300 Hz IF bandwidth filters, and residual FM is <100 Hz when stabilized. This 100 Hz resolution is usable up to 8.5 GHz and the 300 Hz resolution bandwidth to 22 GHz. All resolution filters are gaussian-shaped for repeatable measurements, faster non-distorting sweeps and best pulse response.

#### Absolute Amplitude Calibration

Absolute signal levels from -112 dBm to +30 dBm are easily measured because the HP 8565A always displays the value of the reference line with LED's in the CRT bezel and at the reference level control. Changes in RF, IF gain, and preselector loss are automatically included. In addition, flat frequency response insures accuracy for relative as well as absolute power measurements.

#### Wide Dynamic Range

Internal preselection (1.7 to 22 GHz) enables you to measure distortion products as much as 100 dB down. Even for closely spaced signals or measurements below 1.7 GHz, all distortion products are greater than 70 dB down. In either case, maximum dynamic range is assured even for 1 watt signals with the 70 dB input attenuator. An input limiter (0.01 to 1.8 GHz) and the internal preselector (1.7 to 22 GHz) enable the 8565A to withstand RF signals up to +30 dBm for all input attenuator settings.

#### Designed For Convenience

Coupled controls allow you to make most measurements in 3 simple steps. Green color coded keys preset the 8565A for normal operation so a measurement only requires that you tune to a signal, select a desired span, and raise it to the reference level. Automatically select-

ed sweep times insure a calibrated display for all combinations of frequency span, resolution bandwidth and video filtering.

The CRT bezel LED's display all pertinent control settings to give you all the information needed for signal evaluations in one central location. These data are also captured in CRT photos.

### 8444A Option 059 Tracking Generator

Make swept frequency response measurements to  $\pm 1.7$  dB from 10 to 1300 MHz ( $\pm 2.7$  dB up to 1500 MHz) with greater than 90 dB of dynamic range. The output is absolutely calibrated at 0 dBm and continuously variable to  $< -10$  dBm. The frequency of unknown signals as well as the frequency of any point on the frequency response curve can be measured from the external counter output using the low-cost HP 5300/5305B Counter.

### 8750A Storage-Normalizer

The analyzer is made even easier to use with the digital storage of the 8750A because there is no need to re-adjust intensity or persistence as the sweep time changes. With the push of a button, a signal can be frozen on the CRT and then compared directly to the current input signal. Traces can also be compared arithmetically (i.e., normalized) to automatically remove frequency response variations. This is especially useful when used with the HP 8444A Opt. 059 Tracking Generator.

### 8565A Specifications

#### Frequency Specifications

**Frequency range:** 0.01 to 22 GHz with internal mixer, 14.5 to 40 GHz with HP 11517A External Mixer.

**Tuning accuracy (digital frequency readout in any span mode)**

**Internal mixing:** 0.01 to 2.5 GHz  $\pm$  (5 MHz + 20% of Frequency Span/Div.); 2.5 to 22 GHz  $\pm$  (0.2% of center frequency + 20% of Frequency Span/Div.).

**External mixing:** 14.5 to 40 GHz  $\pm$  (0.7% of center frequency + 20% of Frequency Span/Div.).

#### Frequency spans

**1.7 to 22 GHz:** multiband span from 1.7 to 22 GHz in one sweep.

**Full band:** displays spectrum of entire band selected.

**Per division:** eighteen calibrated spans from 1 kHz per div. to 500 MHz per div. in a 1, 2, 5 sequence, plus a full band span, "F".

**Span width accuracy:** the frequency error for any two points on the display for spans from 500 MHz/div to 20 kHz/div (unstabilized) is less than  $\pm 5\%$  of the indicated separation; for stabilized spans 100 kHz/div and less, the error is less than  $\pm 15\%$ .

**Zero span:** analyzer becomes a manually tuned receiver.

**Spectral resolution and stability**

**Resolution bandwidths:** resolution (3 dB) bandwidths from 1 kHz to 3 MHz in 1, 3 sequence. Bandwidth and span width are independently variable or may be coupled for optimum display when control markers are aligned (▶◀).

**Resolution bandwidth accuracy:** 3 dB points:  $< \pm 15\%$ .

**Selectivity (60 dB/3 dB bandwidth ratio):**  $< 15:1$ .

**Stability:** Total residual FM (fundamental mixing 0.01 to 4.1 GHz): stabilized,  $< 200$  Hz p-p in 0.1 s; unstabilized  $< 10$  kHz p-p in 0.1 s.

**Stabilization range:** first LO automatically stabilized for frequency spans 100 kHz/div or less. First LO residual FM typically 30 Hz p-p when stabilized.

**Noise sidebands:**  $> 70$  dB down,  $> 30$  kHz from center of CW signal in a 1 kHz Res. Bandwidth and a 10 Hz (0.01) Video Filter.

**Amplitude Specifications**

**Amplitude range - Internal mixer**

**Measurement range**

**Total power:** +30 dBm (1 watt).

**Damage levels:** (50Ω nominal source impedance.)

**dc:** 0 V with 0 dB input atten,  $\pm 7$  V with  $\geq 10$  dB input atten.

**ac:** 0 V with 0 dB input atten, 10 V peak with  $\geq 10$  dB input atten.

**RF:** (signals above 10 MHz) + 30 dBm for any attenuator setting.

**Gain compression:**  $< 1$  dB for 0 dBm input level with 0 dB attenuation.

**Average noise level:** max. avg. noise level with 1 kHz Res. Bandwidth (0 dB atten and 3 Hz video filter) is in the table below:

Frequency Band (GHz)	First IF in MHz	Harmonic Mode	Noise Level (dBm)	Frequency Response* ( $\pm$ dB MAX)
0.01-1.8	2050	1-	-112	1.2
4.1	321.4	1-	-109	1.7
3.8-8.5	321.4	2-	-103	2.5
5.8-12.9	321.4	3-	-94	2.5
8.5-18	321.4	4+	-87	3.0
10.5-22	321.4	5+	-75	4.5

\*Frequency response includes input attenuator, preselector and mixer frequency response plus mixing mode gain variation (band to band).

**Amplitude range - HP 11517A External Mixer**

**Measurement range:** saturation (gain compression  $< 1$  dB), -15 dBm. Damage level  $> 0$  dBm or 0.1 erg.

**Sensitivity** (Average noise level in a 10 kHz IF bandwidth): 14.5-18 GHz  $< -80$  dBm, 18-26.5 GHz  $< -70$  dBm, 26.5-40 GHz  $< -60$  dBm. Typical sensitivity is 10 dB better for each band.  **$> 40$  GHz:** for signal analysis above 40 GHz with commercially available mixers see Application Note 150-14.

**Reference Level**

**Reference level range** +70 dBm (+30 dBm max. input) to -102 dBm in 10 dB steps and continuous 0 to -12 dB calibrated vernier.

**Reference level accuracy:** the Auto Sweep setting of the sweep time/div control insures a calibrated display within these limits:

**Calibrator output (100 MHz  $\pm$  10 kHz):** -10 dBm  $\pm$  0.3 dB.

**Reference level variation (input attenuator at 0 dB):** 10 dB steps  $< \pm 0.5$  dB (0 to -70 dBm);  $< \pm 1.0$  dB (0 to -90 dBm).

**Vernier (0 to -12 dB) continuous:** maximum error  $< 0.5$  dB.

**Input attenuator:** (at preselector input, 0-70 dB in 10 dB steps).

**Step size variation:**  $< \pm 1.0$  dB, 0.01 to 18 GHz;  $< \pm 1.5$  dB, 0.01 to 22 GHz.

**Maximum cumulative error over the 0 to 70 dB range:**  $< \pm 2.8$  dB, 0.01 to 18 GHz;  $< \pm 4.0$  dB, 0.01 to 22 GHz.

**Frequency response:** see table above.

**Switching between bandwidths:** 3 MHz to 1 kHz,  $\pm 1.0$  dB

**Calibrated display range**

**Log:** (expanded from reference level down): 70 dB @ 10 dB/div, 40 dB @ 5 dB/div, 16 dB @ 2 dB/div and 8 dB @ 1 dB/div.

**Linear:** full scale from  $1.8 \mu V$  (-102 dBm in 50 Ω to 707 volts (+70 dBm) in 10 dB steps and continuous 0 to -12 dB vernier.

**Display accuracy**

**Log:**  $< \pm 0.1$  dB/dB, but  $< \pm 1.5$  dB over full 70 dB display range.

**Linear:**  $< \pm 0.1$  division over full 8 division deflection.

**Residual responses (no signal present at input):** with 0 dB input atten, fundamental mixing (0.01 to 4.1 GHz)  $< -90$  dBm.

**Signal identifier:** available over full tuning range and in all Freq. Span/Div settings for signal identification.

**Signal Input Characteristics**

**Input 50Ω 0.01 to 22 GHz**

**Input connector:** precision Type N female.

**Input impedance**

**Input attenuator at 0 dB:** 50 ohms nominal.

**SWR:**  $< 1.5$ , 0.01 to 1.8 GHz;  $< 2.0$ , 1.7 to 22 GHz (at analyzer tuned frequency).

**Input attenuator at 10 dB or more:** 50 ohms nominal.

**SWR:**  $< 1.3$ , 0.01 to 1.8 GHz;  $< 2.0$ , 1.7 to 22 GHz.

**LO Emission (2.00 to 4.46 GHz):** -50 dBm, 0.01 to 1.8 GHz; -85 dBm, 1.7 to 22 GHz.

**Input protection (for input signals from 0.01 to 22 GHz)**

**0.01 to 1.8 GHz frequency band:** internal diode limiter.

**1.7 to 22 GHz frequency bands:** saturation of YIG filter (pre-selector) occurs at total input signal power levels below input mixer damage.

**External mixer input:** BNC female connector is a port for LO power transfer, bias current and IF return.

**Sweep Specifications**

**Sweep time**

**Auto:** sweep time is automatically controlled by Frequency Span/Div, Resolution Bandwidth and Video Filter controls to maintain an absolute amplitude calibrated display.

**Calibrated sweep times:** 21 internal sweep times from 2 μs/div to 10 s/div in 1, 2, 5 sequence.

**Display Characteristics**

**Cathode Ray Tube (aluminized P31 phosphor, 8 x 10 div internal graticule)**

**Persistence**

**Conventional:** natural persistence of P31 phosphor.

**Write:** continuously adjustable from 0.2 s to full storage.

**Storage time:** continuously adjustable from 1 minute (full brightness) to  $> 30$  minutes (minimum brightness).

**Write speed:** continuously adjustable to vary CRT sensitivity to capture large signal deflections in fast sweeps.

**CRT Bezel Readout:** bezel LEDs display the following measurement data (included in CRT photographs taken with the HP 197B Opt 001, 006 Oscilloscope Camera): Ampl. Scale Factor, Ref. Level, Input Atten., Res. Bandwidth, Sweeptime/Div., Freq., Freq. Span/Div.

**General Specifications**

**Temperature range:** operating 0°C to 55°C, storage -40° to +75°C.

**Humidity range (Operating):**  $< 95\%$  R.H. 0°C to 40°C.

**EMI:** conducted and radiated interference is within the requirements of methods CE03 and RE02 of MIL STD 461A, VDE 0871, CISPR pub'n 11 and FTZ 527/1979.

**Power requirements:** 48-66 Hz, 100, 120, 200 or 240 volts (-10% to +5%) 220 V A max (400 Hz operation available as Opt 400).

**Size:** 188 H x 426 W x 552 mm D (7" x 16.8" x 21.8").

**Weight:** net 29.5 kg (64 lb). Shipping 39 kg (85 lb).

**Standard Options Available**

**Opt 100, 100 and 300 Hz Resolution Bandwidths:** adds 100 Hz and 300 Hz resolution bandwidths with 11:1 shape factor, residual FM  $< 100$  Hz when stabilized and improves sensitivity by 10 dB.

**Opt 200—Calibration in dBμV**

**Opt 400—400 Hz Power Supply**

**Part No. 1540-0654 - Transit Case.** Order Part No. 1490-0913 also for castors.

**Ordering Information**

**8565A Spectrum Analyzer** Price \$19,400

**Opt 100:** 100 Hz and 300 Hz Resolution Bandwidths add \$800

**Opt 200:** Calibration in dBμV add \$100

**Opt 400:** Internal 50 to 400 Hz Power Supply add \$250

**Opt 907:** Front Handle Kit add \$40

**Opt 908:** Rack Flange Kit add \$30

**Opt 909:** Rack Flange and Front Handle Kit add \$65

**Opt 910:** Extra Operating and Service Manual add \$50

**11517A External Mixer** (taper section req'd) \$275

**11518A Taper Section, 12.4 to 18 GHz** \$175

**11519A Taper Section, 18 to 26.5 GHz** \$175

**11520A Taper Section, 26.5 to 40 GHz** \$175

**8444A Opt 059 Tracking Generator, 10 to 1500 MHz** \$4,700

**8750A Storage-Normalizer** \$1,600



# SIGNAL ANALYZERS

## Spectrum Analyzer, 0.01 to 350 MHz

### Models 8557A/182T & 8750A

- Easy to operate
- Signal level displayed directly in dBm
- $\pm 2.25$  dB amplitude accuracy

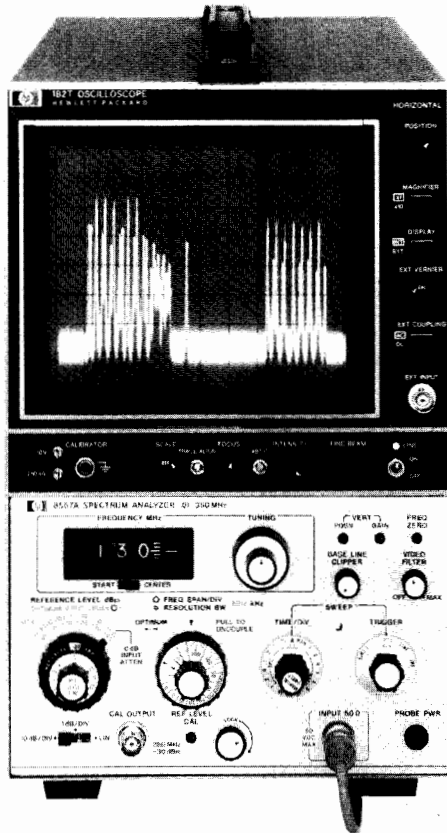

8557A / 182T

### 8557A Spectrum Analyzer

#### Economy Plus Performance

The Model 8557A is a 0.01 to 350 MHz spectrum analyzer which plugs into any model 180-series oscilloscope display. This low cost, easy-to-use analyzer provides high accuracy in both amplitude and frequency measurements.

#### Simple, 3-knob Operation

Most measurements consist of three simple steps. Center the inverted marker under the signal to be measured; its frequency is displayed on the digital readout. Zoom-in on the signal by decreasing the frequency span; bandwidth, sweep time, and video filtering are set automatically. Raise the signal to the top of the CRT; read its amplitude (in dBm) from the reference level control.

#### Absolute Amplitude Calibration

Signal levels can be read directly from the CRT in dBm (dBmV for Option 002) without the use of external standards or calculations. The signal level represented by the top CRT graticule line is always indicated by the reference level control, and vertical scale factors of 10 dB/div, 1 dB/div, or linear can be selected.

#### Optional 75 Ohm Input

Two options are available which allow measurements in 75 ohm systems: Option 001 has 75 ohms impedance and retains the dBm power calibration; Option 002 is also 75 ohms, but the amplitude is calibrated in dBmV for measurements on systems such as CATV.

- Resolution bandwidths 1 kHz to 3 MHz
- Optional 75 $\Omega$  input with dBm or dBmV calibration
- Digital storage-normalizer available

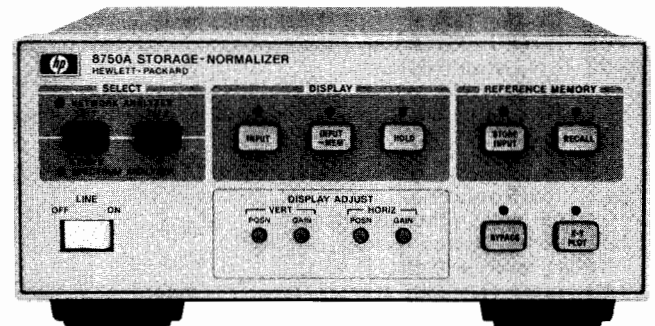

8750A

### 8750A Storage-Normalizer

The 8750A is an accessory which provides digital storage, trace comparison and normalization where data in memory is subtracted from current input and then displayed. In conjunction with the 182T display maniframe and either the 8557A, 8558B, or 8559A, the Storage-Normalizer provides flicker-free display of measured signals. High resolution and slow sweep time measurements are easy to observe because of the 8750A's continuous refresh whose rate is independent of the analyzer's sweep rate. Additionally, two traces can be viewed from memory for CRT photography or detailed signal comparison.

#### Recommended Displays

The 8557A/8558B/8559A Spectrum Analyzers will function with any 180-series display. However, the following are recommended: for low cost, large screen display, the Model 182T is ideal; the Model 181T offers variable persistence and storage; and the Model 180TR offers a rack mount configuration. Each of these displays provides a long persistence P39 phosphor (except variable persistence displays) and four non-buffered rear panel outputs compatible with most X-Y recorders.

### 8557A Specifications

#### Frequency Specifications

**Frequency range:** 10 kHz to 350 MHz.

**Frequency display span:** (on a 10-division CRT horizontal axis): 12 calibrated spans from 20 MHz/div to 5 kHz/div in a 1, 2, 5 sequence. In "F" or full span the analyzer displays the full 10 kHz to 350 MHz. In "0" or zero span, the analyzer is a fixed-tuned receiver.

**Accuracy:** frequency error between any two points on the display is less than  $\pm 10\%$  of the indicated frequency separation.

**Digital frequency readout:** indicates center frequency or start frequency of the frequency display span. In full span, the readout indicates center frequency or start frequency of the frequency display span. In full span, the readout indicates the frequency at the marker with 100 kHz resolution.

**Accuracy:** (after zeroing on the LO feedthrough)  $\pm 3$  MHz + 10% of frequency span per division setting.

#### Stability

**Residual FM:** less than 1 kHz peak-to-peak for time  $\leq 0.1$  s (video filter full clockwise, but not in detent).

**Noise sidebands:** more than 75 dB below CW signal, 50 kHz or more away from signal with a 1kHz resolution bandwidth and full video filtering.

#### Resolution

**Bandwidth ranges:** 3 dB resolution bandwidths of 1kHz to 3 MHz in a 1, 3, 10 sequence. Resolution bandwidth may be coupled to frequency display span at a ratio of two display spans per resolution bandwidth.



**Resolution bandwidth accuracy:** individual resolution bandwidth 3 dB points calibrated to  $\pm 20\%$ , ( $10^\circ - 40^\circ\text{C}$ ).

**Resolution bandwidth selectivity:** 60 dB/3 dB resolution bandwidth ratio  $< 15:1$ .

**Video filter:** post-detection low pass filter used to average displayed noise. Bandwidth variable from approximately 3X Resolution Bandwidth to approximately 0.01X Resolution Bandwidth. In the MAX position provides a noise averaging filter with a bandwidth of approximately 1.5Hz.

## Amplitude Specifications

### Measurement range

**Absolute measurement range:** from  $-117$  dBm to  $+20$  dBm. Reference level settings in 10 dB steps, 0 to  $-12$  dB continuous vernier.

**Log display ranges:** 10 dB/div on a 70 dB display and 1 dB/div on an 8 dB display.

**Linear display:** from 2.2 microvolts ( $-100$  dBm) full-scale to 2.24 volts ( $+20$  dBm) full-scale in 10 dB steps. Full-scale signals in linear translate to approximately full-scale signals in log.

### Dynamic range

**Average noise level:**  $< -107$  dBm with a 10 kHz resolution bandwidth (0 dB input attenuation), 1–350MHz.

**Spurious responses:** for input signal level  $\leq$  Optimum Input Level setting, all image and out of band mixing responses, harmonic and inter-modulation distortion products are more than 70 dB below input signal level, 1 MHz to 350 MHz; 60 dB below, 20 kHz to 1 MHz.

**Spurious responses due to 3rd order intermodulation distortion:** for two input signals 10 dB above Optimum Input Level setting 3rd Order Intermodulation distortion products are  $> 70$  dB below the input signals, 1–350 MHz; 60 dB below, 10 kHz to 1 MHz (signal separation  $\geq 50$  kHz).

**Residual responses: (no signal present at input):**  $< -100$  dBm with 0 dB input attenuation, 0.1–350MHz.

### Amplitude accuracy

**Frequency response (flatness):**  $\pm 0.75$  dB.

**Switching between bandwidths** (at  $10^\circ - 40^\circ\text{C}$ , 90% relative humidity)

**3 MHz to 300 kHz:**  $\pm 0.5$  dB.

**3 MHz to 1 kHz:**  $\pm 1.0$  dB.

**Reference level accuracy** (at fixed center frequency, fixed resolution bandwidth):  $\pm 1.5$  dB (includes input attenuator and IF gain accuracy. May be improved using IF or RF substitution techniques).

**Amplitude log display:**  $\pm 0.1$  dB/dB but no more than  $\pm 1.5$  dB over full 70 dB display range.

### Calibrator

**Amplitude:**  $-30$  dBm  $\pm 1$  dB.

**Frequency:** 250 MHz  $\pm 50$  kHz, crystal controlled.

**Input attenuator:** 50 dB range. Accuracy  $\pm 0.5$  dB per 10 dB step, but not more than  $\pm 1.0$  dB over full 50 dB range.

### Input Specifications

**Input connector:** Type BNC female.

**Input impedance:** 50 $\Omega$  nominal. Typical reflection coefficient  $< 0.27$  (1.74 SWR) for all Optimum Input Level settings except  $-40$  dBm (0 dB Input Attenuation).

### Maximum Input Levels

**AC or peak:** peak or average power  $+20$  dBm (3.16 V ac peak or 0.1 W) incident on analyzer. (MAX input markings on front panel indicate maximum input allowable for  $< 1$  dB gain compression or attenuator overload.)

**DC:**  $\pm 30$  V dc.

### Output Characteristics

**Cal output:**  $-30$  dBm, 250 MHz.

**Probe power:**  $+15$  V,  $-12.6$  V; 150 mA max. Powers 1120A, 1121A, 1123A, or 1124A high impedance probes.

**Note:** oscilloscope display rear panel outputs refer to 180T-series displays and 180-series Option 807 displays only. See below for information on modifying standard displays.

**Vertical output:** (AUX A on oscilloscope display rear panel): 0 to 0.8 V for 8-division deflection on CRT display; 50 $\Omega$  output impedance.

**Pen lift/blinking output:** (AUX B on oscilloscope display rear panel): 0 to 15 V (0 V, pen down). Approximately 10k $\Omega$  impedance when blanked. Compatible with HP 7004B, 7034B, 7005B, and 7035B X-Y RECORDERS.

**21.4 MHz IF output:** a 21.4 MHz output linearly related to the RF input to the analyzer. Bandwidth controlled by analyzer Resolution Bandwidth setting. Amplitude controlled by input attenuator, IF gain vernier, and first six IF step gain positions ( $-10$  through  $-60$  dBm Ref Level with 0 dB input attenuation). Output is approximately  $-10$  dBm for full-scale signals on the CRT. (AUX C on oscilloscope display rear panel, 50 $\Omega$  output impedance.)

**Horizontal output** (AUX D on oscilloscope display rear panel):  $-5.0$  to  $+5.0$  V for 10 div CRT deflection, 5k $\Omega$  output impedance.

## Sweep Characteristics

### Sweep time

**Auto:** sweep time is automatically controlled by Frequency Span, Resolution Bandwidth, and Video Filter.

**Manual:** sweep determined by front panel control; continuously variable across CRT in either direction.

**Calibrated sweep times:** 16 internal sweep times from 0.1 ms/div to 10 sec/div in a 1, 2, 5 sequence. For sweep times of 2 ms/div to 10 sec/div, the analyzer is operable in its normal swept-frequency mode. Faster sweeps are useful for analyzing modulation waveforms when the analyzer is being operated as a fixed-tuned receiver with zero Display Span. Sweep times may be reduced to an effective 10  $\mu\text{sec/div}$  by using the 180-series X10 horizontal magnifier.

**Accuracy:**  $\pm 10\%$ .

### Sweep trigger

**Video:** sweep internally triggered by envelope of RF input signal (signal amplitude of 1.0 division peak-to-peak required on CRT display).

**Line:** sweep triggered by power line frequency.

**Free run:** sweep triggered repetitively by internally generated ramp.

**Single:** sweep triggered by front panel sweep trigger switch (spring return position).

## Display Characteristics

**180 Series compatibility:** the 8557A is compatible with all 180A/180AR, 180C, 180D, 180F, 181A, 181AR, 182A, 184A, and 184B mainframes. It is operable with the 183A, 183B mainframes, but the display is limited to 6 divisions by the 6-division CRT. The 180-series oscilloscope displays are recommended for use with the 8557A Spectrum Analyzer because they provide 4 nonbuffered rear panel auxiliary outputs (for unattenuated vertical, horizontal, and penlift outputs) and P39 medium-persistence CRT phosphor (except with 181T, 181TR which have P31 phosphor and provide variable persistence). See HP Service Notes 180A/AR-10, 180C/D-2, 181A/AR-8 and 182A/C-1 for information needed to modify standard display to provide auxiliary outputs.

### Weight

**Model 8557A:** net, 4.5 kg (10 lb). Shipping 5.4 kg (12 lb).

**Model 182T:** net, 12.3 kg (27 lb). Shipping 15.5 kg (34 lb).

**Model 181T:** net, 10.9 kg (24 lb). Shipping 15.5 kg (34 lb).

**Model 180TR or 181TR:** net, 11.8 kg (26 lb). Shipping 17.2 kg (38 lb).

### Size

**Model 182T** (cabinet/large screen): 338.1 H x 201.6 W x 498.5 mm D (13.3" x 7.9" x 19.6").

**Model 181T** (cabinet/variable persistence): 289 H x 200 W x 530 mm D (11.4" x 7.9" x 21.3").

**Model 180TR or 181TR** (rack/standard and variable persistence): 133 H x 425 W x 543 mm D (5.2" x 16.8" x 21.4").

## Ordering Information

	Price
8557A Spectrum Analyzer	\$4550
Opt 001: 75 ohm input (BNC), dBm calibration	add \$100
Opt 002: 75 ohm input (BNC), dBmV calibration	add \$100
Opt 910: Extra 8557A Manual	add \$17
182T Large Screen Display	\$2275
180TR Rack Mount Display	\$2300
181T Variable Persistence Display	\$3100
181TR Rack Mount 181T Display	\$3200
8750A Storage-Normalizer	\$1750



# SIGNAL ANALYZERS

Spectrum Analyzer, 0.1 to 1500 MHz  
Models 8558B/182T & 8444A Option 059

- Simple, 3-knob operation
- Display of signal levels directly in dBm
- Resolution bandwidths from 1 kHz to 3 MHz

- 0.5 to 1500 MHz tracking generator
- Digital storage-normalizer available
- Input protection

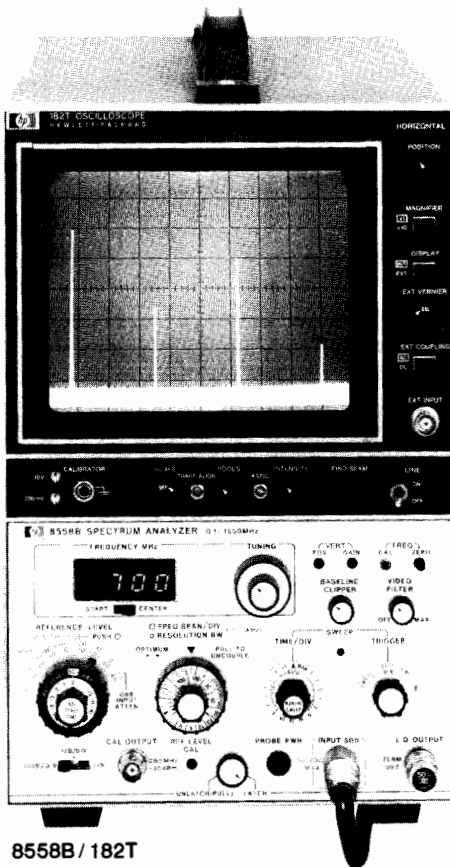

8558B/182T

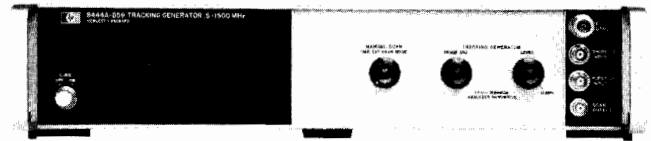

8444A Opt 059 (Compatible with 8558B)

## 8444A Option 059 Tracking Generator (0.5–1500 MHz)

Make swept frequency response measurements to  $\pm 1.5$  dB from 0.5 to 1300 MHz and  $\pm 2.5$  dB to 1500 MHz with greater than 90 dB of dynamic range. The output is absolutely calibrated at 0 dBm and continuously variable to  $-10$  dBm. The frequency of unknown signals, as well as the frequency of any point on the frequency response curve, can be measured using the external counter output and Model 5300/5305B Counter.

## 8750A Storage-Normalizer

The 8750A is an accessory which provides digital storage, trace comparison and swept response normalization. The frequency response variation of a swept measurement system, such as the 8558B and 8444A, can be removed through normalization. In addition, a "real time" signal can be compared with a stored trace or both traces can be viewed from memory for CRT photography or detailed comparison.

## Recommended Displays

The 8557A/8558B/8559A Spectrum Analyzers will function with any 180-series display. However, the following are recommended: for low cost, large screen display, the Model 182T is ideal; the Model 181T offers variable persistence and storage; and the Model 180TR offers a rack mount configuration. Each of these displays provides a long persistence P39 phosphor (except variable persistence displays) and four non-buffered rear panel outputs compatible with most X-Y recorders.

## 8558B Specifications

### Frequency Specifications

**Frequency range:** 100 kHz to 1500 MHz.

**Frequency display span:** (on a 10-division CRT horizontal axis): 14 calibrated spans from 100 MHz/div to 5 kHz/div in a 1, 2, 5 sequence. In "0" (zero span) the analyzer is a fixed-tuned receiver.

**Accuracy:** frequency error between any two points on the display is less than  $\pm 5\%$  of the indicated frequency separation.

**Digital frequency readout:** indicates center frequency or start frequency of the frequency display scan. Two ranges: 0 to greater than 195 MHz with 100 kHz resolution; 195 MHz to 1500 MHz with 1 MHz resolution. ZERO control allows frequency readout to be adjusted for accurate calibration anywhere in the frequency range; CAL control removes frequency hysteresis. Resolution 100 kHz.

**Accuracy:** (after zeroing on the LO feedthrough and operation of the CAL button,  $20^\circ - 40^\circ\text{C}$ ).

**0–195 MHz:**  $\pm 1$  MHz  $\pm 20\%$  of frequency span per division setting ( $\leq 1$  MHz per division).

**195–1500 MHz:**  $\pm 5$  MHz  $\pm 20\%$  of frequency span per division setting.

### Stability

**Residual FM:** less than 1 kHz peak-to-peak for time  $\leq 0.1$  sec.

**Noise sidebands:** more than 65 dB below CW signal, 50 kHz or more away from signal with a 1 kHz resolution bandwidth and full video filter.

### Resolution

**Bandwidth ranges:** 3 dB resolution bandwidths of 1 kHz to 3 MHz in a 1, 3, 10 sequence. Resolution bandwidth may be coupled to frequency span at a ratio of two display spans per resolution bandwidth.

## 8558B Spectrum Analyzer

### Economical, Wide Frequency Coverage

The Model 8558B is a 0.1 to 1500 MHz spectrum analyzer which plugs into any 180-series oscilloscope display. It is fully calibrated in frequency and amplitude, easy to use, and provides an economical means for making measurements in the RF range.

### Simple, 3-knob Operation

Most measurements consist of three simple steps. Tune to the signal to be measured; its frequency is displayed on the LED readout. Zoom-in on the signal by decreasing the frequency span; bandwidth, sweep time, and video filtering are set automatically. Raise the signal to the top of the CRT; read its amplitude (in dBm) from the reference level control.

### Absolute Amplitude Calibration

Signal levels can be read directly from the CRT in dBm (dBmV for Option 002) without the use of external standards or calculations. The signal level represented by the top CRT graticule line is always indicated by the reference level control, and scale factors of 10 dB/div, 1 dB/div, and linear can be selected.

### Optional 75 Ohm Input

Two options are available which allow measurements in 75 ohm systems: Option 001 has 75 ohms impedance and retains the dBm power calibration; Option 002 is also 75 ohms, but the amplitude is calibrated in dBmV for measurements on systems such as CATV.



**Resolution bandwidth accuracy:** Individual resolution bandwidth 3 dB points calibrated to  $\pm 20\%$ , 10-40° C.

**Resolution bandwidth selectivity:** 60 dB/3 dB resolution bandwidth ratio  $< 15:1$ .

**Video filter:** post-detection filter used to average displayed noise. Bandwidth variable from approximately 3X Resolution Bandwidth to approximately 0.01X Resolution Bandwidth. In the MAX position provides a noise averaging filter with a bandwidth of approximately 1.5 Hz.

## Amplitude Specifications

### Measurement range

**Absolute measurement range:** from  $-117$  dBm to  $+30$  dBm. Reference level settings in 10 dB steps, 0 to  $-12$  dB continuous vernier.

**Log display ranges:** 10 dB/div on a 70 dB display, and 1 dB/div on an 8 dB display.

**Linear display:** from 2.2 microvolts ( $-100$  dBm) full scale to 7.1 volts ( $+30$  dBm) full-scale in 10 dB steps. Full-scale signals in linear translate to approximately full-scale signals in log.

### Dynamic range

**Average noise level:**  $< -107$  dBm with a 10 kHz resolution bandwidth (0 dB input attenuation).

**Spurious responses:** for input signal level  $\leq$  Optimum Input Level setting, all image and out-of-band mixing responses, harmonic and intermodulation distortion products are more than 70 dB below input signal level, 5 MHz to 1500 MHz; 60 dB below, 100 kHz to 5 MHz.

**Spurious responses due to 3rd order intermodulation distortion:** for two input signals 10 dB above Optimum Input Level setting 3rd Order Intermodulation distortion products are  $> 70$  dB below the input signals, 5-1500 MHz; 60 dB below, 100 kHz to 5 MHz (signal separation  $\geq 50$  kHz).

**Residual responses:** (no signal present at input):  $< -100$  dBm with 0 dB input attenuation, 1-1500 MHz.

### Amplitude accuracy

**Frequency response (flatness):**  $\pm 1.0$  dB.

**Switching between bandwidths (at 10° -40° C).**

**3 MHz to 300 kHz:**  $\pm 0.5$  dB.

**3 MHz to 1 kHz:**  $\pm 1.0$  dB.

**Reference level accuracy:** (at fixed center frequency, fixed resolution bandwidth):  $\pm 1.5$  dB (includes input attenuator and IF gain accuracy). May be improved using IF or RF substitution techniques.

**Amplitude log display:**  $\pm 0.1$  dB/dB but not more than  $\pm 1.5$  dB over full 70 dB display range.

### Calibrator

**Amplitude:**  $-30$  dBm  $\pm 1.0$  dB.

**Frequency:** 280 MHz  $\pm 30$  kHz, crystal controlled.

**Input attenuator:** 70 dB range. Accuracy  $\pm 0.5$  dB per 10 dB step but not more than  $\pm 1.0$  dB over full 70 dB range.

### Input Specifications

**Input connector:** type N female.

**Input impedance:** 50 $\Omega$  nominal. Typical reflection coefficient  $< 0.20$  (1.5 SWR) for all Optimum Input Level settings except  $-40$  dBm (0 dBm input attenuation).

### Maximum input levels

**Total average power:**  $+30$  dBm (1 watt, 10 Vac Peak) for any input attenuator setting.

**Peak pulse power:**  $+50$  dBm (100 watts, 10  $\mu$ sec pulse width, Duty Cycle = 0.01),  $\geq 10$  dB optimum input setting.

**DC:**  $\pm 50$  V (to 100 Hz).

### Output Characteristics

**LO output:**  $+10$  dBm nominal, 50 ohms; 2.05-3.55 GHz.

**Cal output:**  $-30$  dBm, 280 MHz.

**Probe power:**  $+15$  V,  $-12.6$  V; 150 mA max. Powers 1120A, 1121A, 1123A, or 1124A high impedance probes.

**Note:** the following oscilloscope display rear panel outputs refer to 182T, 180TR, 181T, 181TR displays and older 180-series displays with Option 807 only.

**Vertical output:** (AUX A on oscilloscope display rear panel.) 0 to 0.8 V for 8-division reflection on CRT display; 50 $\Omega$  output impedance.

**Pen lift-blanking output:** (AUX B on oscilloscope display rear panel): 0 to 15 V (0 V, pen down). Approximately 10 k $\Omega$  impedance when blanked. Compatible with HP 7004B, 7034B, 7005B, and 7035B X-Y RECORDERS.

**21.4 MHz IF output:** a 21.4 MHz output linearly related to the RF input to the analyzer. Bandwidth controlled by analyzer Resolution Bandwidth setting. Amplitude controlled by input attenuator, IF gain vernier, and first six IF step gain positions ( $-10$  through  $-60$  dBm Ref Level with 0 dB input attenuation). Output is approximately  $-10$  dBm for full-scale signals on the CRT. (AUX C on oscilloscope display rear panel, 50  $\Omega$  output impedance).

**Horizontal output:** (AUX D on oscilloscope display rear panel):  $-5.0$  to  $+5.0$  V for 10 div CRT deflection, 5k $\Omega$  output impedance.

### Sweep Characteristics

#### Sweep time

**Auto:** sweep time is automatically controlled by Frequency Span, Resolution Bandwidth, and Video Filter.

**Manual:** sweep determined by front panel control, continuously variable across CRT in either direction.

**Calibrated sweep time:** 16 internal sweep times from 0.1 ms/div to 10 sec/div in a 1, 2, 5 sequence. For sweep times of 2 ms/div to 10 sec/div, the analyzer is operable in its normal swept frequency mode. Faster sweeps are useful for analyzing modulation waveforms when the analyzer is being operated as a fixed-tuned receiver with zero Display Span. Sweep times may be reduced to an effective 10  $\mu$ sec/div by using the 180-series X10 horizontal magnifier.

**Accuracy:**  $\pm 10\%$ .

#### Sweep trigger

**Video:** sweep internally triggered by envelope of RF input signal (signal amplitude of 1.0 division peak-to-peak required on CRT display).

**Line:** sweep triggered by power line frequency.

**Free run:** sweep triggered repetitively by internally generated ramp.

**Single:** sweep triggered by front panel sweep trigger switch (spring return position).

### Display Characteristics

**180 Series compatibility:** the 8558B is compatible with all 180A, 180AR, 180C, 180D, 180F, 181A, 181AR, 182A, 184A, and 184B mainframes. It is operable with the 183A, 183B mainframes, but the display is limited to 6 divisions by the 6-division CRT. The 180-series oscilloscope displays are recommended for use with the 8558B Spectrum Analyzer because they provide 4 non-buffered rear panel auxiliary outputs (for unattenuated vertical, horizontal, and penlift outputs) and P39 medium-persistence CRT phosphor (except with 181T, 181TR which have P31 phosphor and provide variable persistence). See HP Service Notes 180A/AR-10, 180C/D-2, 181A/AR-8 and 182A/C-1 for information needed to modify standard displays to provide auxiliary outputs.

#### Weight

**Model 8558B:** net, 5.9 kg (13 lb). Shipping 6.8 kg (15 lb).

**Model 182T:** net, 12.3 kg (27 lb). Shipping 15.5 kg (34 lb).

**Model 181T:** net, 10.9 kg (24 lb). Shipping 15.5 kg (34 lb).

**Model 180TR or 181TR:** net, 11.8 kg (26 lb). Shipping 17.2 kg (38 lb).

#### Size

**Model 182T (cabinet/large screen):** 338.1 H x 201.6 W x 498.5 mm D (13.3" x 7.9" x 19.6").

**Model 181T (cabinet/variable persistence):** 289 H x 200 W x 530 mm D (11.4" x 7.9" x 21.3").

**Model 180TR or 181TR (rack/standard and variable persistence):** 133 H x 425 W x 543 mm D (5.2" x 16.8" x 21.4")

### Ordering Information

	Price
8558B Spectrum Analyzer	\$5700
Opt 001: 75 ohm input (BNC), dBm calibration	add \$100
Opt 002: 75 ohm input (BNC), dBmV calibration	add \$100
Opt 910: Extra 8558B Manual	add \$20
182T Large Screen Display	\$2275
180TR Rack Mount Display	\$2300
181T Variable Persistence Display	\$3100
181TR Rack Mount 181T Display	\$3200
8444A Opt 059 Tracking Generator	\$4450
8750A Storage-Normalizer	\$1750



# SIGNAL ANALYZERS

## Spectrum Analyzer, 0.01 to 21 GHz

### Models 8559A/182T & 8750A

- Simplified operation
- Direct display of signal level in dBm

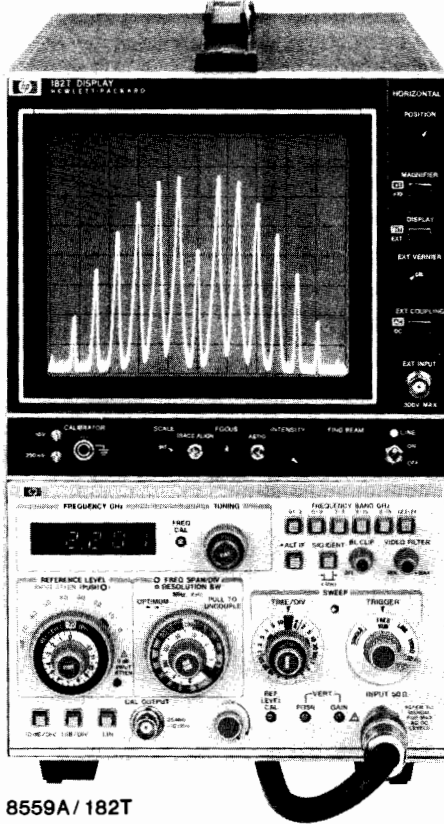

8559A/182T

### 8559A Spectrum Analyzer

#### Economy With Precision

The HP 8559A is a 0.01 to 21 GHz spectrum analyzer plug-in for the HP 180 series displays. It features the performance essential for accurate signal analysis yet is easy to use and portable. This combination with its economical price qualifies the 8559A for a wide variety of applications in R&D, production and service.

#### Simple 3-knob Operation

Most measurements can quickly be made using only 3 controls. Just tune to the signal; the LED readout displays its frequency. Zoom-in on the signal by reducing the span width; the resolution bandwidth, video filter, and sweep time automatically change to the optimum values for a calibrated display. A reference level change brings the peak of the signal to the top of the screen for the most accurate amplitude measurement. Despite automatic operation, measurement flexibility is not lost since the controls can be uncoupled as necessary, for example, you could view a signal demodulated and displayed in the time domain (zero span) using any of the IF bandwidths (1 kHz to 3 MHz).

#### Absolute Amplitude Calibration

Signal levels can be measured accurately and read directly from the CRT in dBm. The signal level represented by the top CRT graticule line is always indicated by the reference level control, and scale factors of 10 dB/div, 1 dB/div, and linear can be selected.

#### 8750A Storage-Normalizer

The 8750A is an accessory which provides digital storage, trace comparison and normalization where data in memory is subtracted from current input and then displayed. In conjunction with the 182T display mainframe and either the 8557A, 8558B or 8559A, the Stor-

- Resolution bandwidths of 1 kHz to 3 MHz
- Digital storage-normalizer available

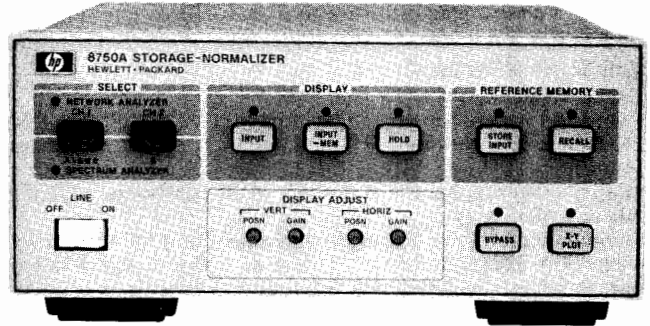

8750A

age-Normalizer provides flicker-free display of measured signals. High resolution and slow sweep time measurements are easy to observe because the 8750A's display is continuously refreshed independent of the analyzer's sweep rate. Additionally, two traces can be viewed from memory for CRT photography or detailed signal comparison.

#### 11870A Low Pass Filter (DC to 2.6 GHz)

For RF applications needing extended coverage to 2.6 GHz, this low pass filter will reject signals above 3 GHz by more than 60 dB for image-free measurements over the entire 10 MHz to 2.6 GHz range.

#### Recommended Displays

The 8557A, 8558B and 8559A Spectrum Analyzers will function with any 180-series display. However, the following are recommended: for low cost, large screen display, the Model 182T is ideal; the Model 181T offers variable persistence and storage; and the Model 180TR offers a rack mount configuration. Each of these displays provides a medium persistence P39 phosphor (except the 181T variable persistence display) and four non-buffered rear panel outputs compatible with most X-Y recorders.

### 8559A Specifications

#### Frequency Specifications

**Frequency range:** 0.01 to 21 GHz.

**Frequency span modes** (on a 10 division CRT horizontal axis): 14 calibrated spans from 200 MHz/div to 10 kHz/div in a 1, 2, 5 sequence. In "F" or full span the analyzer sweeps the entire band selected. In "0" or zero span, the analyzer is a fixed-tuned receiver.

**Accuracy:** frequency error between any two points on the display is less than  $\pm 5\%$  of the indicated frequency separation.

#### Stability

**Residual FM:** <1 kHz p-p in 0.1 s for 100/120 line voltages, <2 kHz p-p for 220/240 line voltages.

**Noise sidebands:** >70 dB below when 30 kHz or more from carrier in a 1 kHz bandwidth with full video filter (not in detent).

#### Resolution

**Bandwidth ranges:** 3 dB resolution bandwidths of 1 kHz to 3 MHz in a 1, 3 sequence. Resolution bandwidth may be coupled to frequency span at a ratio of two display spans per resolution bandwidth.

**Resolution bandwidth accuracy:** individual resolution bandwidth 3 dB points calibrated to  $< \pm 15\%$  (except 3 MHz:  $< \pm 30\%$ ).

**Resolution bandwidth selectivity:** 60 dB/3 dB resolution bandwidth ratio <15:1.

**Video filter:** post detection filter used to average displayed noise. Bandwidth variable from approximately 3X Resolution Bandwidth to approximately 0.01X Resolution Bandwidth. In the MAX position provides a noise averaging filter with a bandwidth of approximately 1.5 Hz.



## Amplitude Specifications

### Absolute amplitude calibration range

**Log calibration range:** from  $-112$  dBm to  $+30$  dBm in 10 dB steps. Reference level vernier, 0 to  $-12$  dB continuously.

**Log display ranges:** 10 dB/div on a 70 dB display, and 1 dB/div on an 8 dB display.

**Linear display:** from 0.56 microvolts ( $-112$  dBm) full scale to 7.1 volts ( $+30$  dBm) full scale. Full scale signals in linear translate to approximately full scale signals in log.

### Dynamic range

**Average noise level:** see table below.

**Spurious responses:** all second harmonic and third order intermodulation distortion products are greater than 70 dB below a  $-40$  dBm input signal(s) and for 0 dB input attenuation.

**Alternate IF:** available over entire tuning range. Nominal first IF at 3.0075 GHz becomes 2.9925 GHz, and adds  $<1.0$  dB of error to reference level unless recalibrated.

**Signal identifier:** provided on all frequency bands and frequency spans for positive signal identification. Available in all spans and usable for spans from 10 MHz to 100 kHz/div.

**Residual responses** (no signal present at input):  $<-90$  dBm with 0 dB input attenuation.

### Amplitude accuracy

**Frequency response** (flatness): see table below

Frequency Range (GHz)	Avg. Noise Level (dBm/1 kHz)	Frequency Response ( $\pm$ dB max.)	Amplitude Accuracy ( $\pm$ dB max.)
0.01-3	-111	1.0	2.3
6.0-9	-108	1.0	2.3
3.0-9	-103	1.5	2.8
9.0-15	-98	1.8	3.1
6.0-15	-93	2.1	3.4
12.1-18	-92	2.3	3.6
18.0-21	-90	3.0	4.3

### Switching between bandwidths

**3 MHz to 300 kHz:**  $\pm 0.5$  dB.

**3 MHz to 1 kHz:**  $\pm 1.0$  dB.

**Reference level variation** (input attenuator at 0 dB): 10 dB steps,  $<\pm 1.0$  dB ( $-10$  to  $-100$  dBm); vernier (0 to  $-12$  dB) continuous,  $<\pm 0.5$  dB.

**Amplitude log display:**  $\pm 0.1$  dB/dB, but not more than  $\pm 1.5$  dB over full 70 dB display range.

### Calibrator

**Amplitude:**  $-10$  dBm  $\pm 0.3$  dB.

**Frequency:** 35 MHz  $\pm 400$  kHz.

### Input Specifications

**Input connector:** type N female.

**Input impedance:** 50  $\Omega$  nominal. Typical reflection coefficient  $<0.34$  (2.0 SWR) for 0 dB input attenuation,  $<0.13$  (1.3 SWR) for 10 dB input attenuation.

**Input attenuator:** 70 dB range. Accuracy  $\pm 1$  dB per 10 dB step but not more than  $\pm 2.4$  dB over 60 dB range.

### Maximum input levels

**Gain compression:** less than 0.5 dB for  $-10$  dBm input level with 0 dB input attenuation.

**Total power:**  $+20$  dBm (100 mW,  $\pm 3.16$ V) with 0 dB input attenuation,  $+30$  dBm (1 W,  $\pm 10$ V) with  $\geq 10$  dB input attenuation.

**Peak pulse power:**  $\pm 50$  dBm (100 W, 10  $\mu$ sec pulse width, 0.01% duty cycle) with  $\geq 30$  dB input attenuation.

**DC ( $<100$  Hz):**  $\pm 7.1$ V.

### Output Characteristics

**Cal output:**  $-10$  dBm, 35 MHz.

**Note:** The following oscilloscope display rear panel outputs refer to 180TR, 181T, 181TR, 182T displays and older 180-series displays with Option 807 only.

**21.4 MHz IF output:** a 21.4 MHz output linearly related to the RF input to the analyzer. Bandwidth controlled by analyzer Resolution Bandwidth setting. Amplitude controlled by input attenuator, IF gain vernier, and first six IF step gain positions ( $-10$  through  $-60$  dBm

Ref Level with 0 dB input attenuation). Output is approximately  $-10$  dBm for full-scale signals on the CRT. (AUX C on oscilloscope display rear panel, 50  $\Omega$  output impedance).

**Vertical output** (AUX A on oscilloscope display rear panel): 0 to 0.8 V for 8-division deflection on CRT display; 50  $\Omega$  output impedance.

**Pen lift-blanking output** (AUX B on oscilloscope display rear panel): 0 to 15 V (0 V, pen down). Approximately 10 k $\Omega$  impedance when blanked. Compatible with HP 7004B, 7034B, and 7005B, and 7035B X-Y.

**Horizontal output** (AUX D on oscilloscope display rear panel):  $-5.0$  to  $+5.0$  V for 10 div CRT deflection, 5 k $\Omega$  output impedance.

## Sweep Characteristics

### Sweep time

**Auto:** sweep time is automatically controlled by Frequency Span, Resolution Bandwidth, and Video Filter.

**Manual:** sweep determined by front panel control, continuously variable across CRT in either direction.

**Calibrated sweep time:** 20 internal sweep times from 2  $\mu$ sec to 10 sec/div in a 1,2,5 sequence (except 2 sec/div). For sweep times of 2 ms/div to 10 sec/div, the analyzer is operable in its normal swept frequency mode. Faster sweeps are useful for analyzing modulation waveforms when the analyzer is being operated as a fixed-tuned receiver with zero span. Sweep times may be reduced to an effective 0.2  $\mu$ sec/div by using the 180 series X10 horizontal magnifier.

**Accuracy:**  $\pm 10\%$ .

### Sweep trigger

**Video:** sweep internally triggered by envelope of RF input signal (signal amplitude of 1.0 division peak-to-peak required on CRT display).

**Line:** sweep triggered by power line frequency.

**Free run:** sweep triggered repetitively by internally generated ramp.

**Single:** sweep triggered by front panel sweep trigger switch (spring return position).

## Display Characteristics

**180 series compatibility:** the 8559A is compatible with all 180A, 180AR, 180C, 180D, 180F, 181A, 181AR, 182A, 184A, and 184B mainframes. It is operable with the 183A, 182B mainframes, but the display is limited to 6 divisions by the 6-division CRT. The 180-series oscilloscope displays are recommended for use with the 8559A Spectrum Analyzer because they provide 4 non-buffered rear panel auxiliary outputs (for unattenuated vertical, horizontal, and penlift outputs) and P39 medium-persistence CRT phosphor (except with 181T, 181TR which have P31 phosphor and provide variable persistence). See HP Service Notes 180A/AR-10, 180C/D-2, 181A/AR-8, and 182A/C-1 for information needed to modify standard displays to provide auxiliary outputs.

### Weight

**Model 8559A:** net, 5.5 kg (12.5 lb). Shipping 9.1 kg (20 lb).

**Model 182T:** net, 12.3 kg (27 lb). Shipping 15.5 kg (34 lb).

**Model 181T:** net, 10.9 kg (24 lb). Shipping 15.5 kg (34 lb).

**Model 180TR or 181TR:** net, 11.8 kg (26 lb). Shipping 17.2 kg (38 lb).

### Size

**Model 182T:** (cabinet/large screen): 338.1 H x 201.6 W x 498.5 mmD (13.3" x 7.9" x 19.6").

**Model 181T:** (cabinet/variable persistence): 289 H x 200 W x 530 mmD (11.4" x 7.9" x 21.3").

**Model 180TR or 181TR** (rack/standard and variable persistence): 133 H x 425 W x 543 mmD (5.2" x 16.8" x 21.4")

## Ordering Information

**8559A Spectrum Analyzer**

**Price**

**Opt 910:** Extra 8559A Manual

\$8600

**182T Large Screen Display**

add \$20

**180TR Rack Mount Display**

\$2275

**181T Variable Persistence Display**

\$2300

**181TR Rack Mount 181T Display**

\$3100

**8750A Storage-Normalizer**

\$3200

**11870A Low Pass Filter**

\$1750

\$ 200



# SIGNAL ANALYZERS

Plug-in spectrum analyzer system, 20 Hz to 40 GHz

Model 141T system

- 20 Hz to 40 GHz with just a tuning section change
- Advantages of fully calibrated solid state system
- Add measurement capability to your system as needed

- Tracking generator expands measurement capability
- Increase dynamic range with tracking preselector
- Storage-normalizer adds digital storage

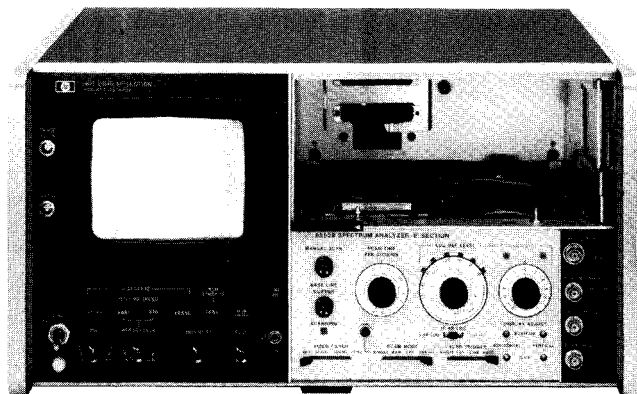

141T, 8552B

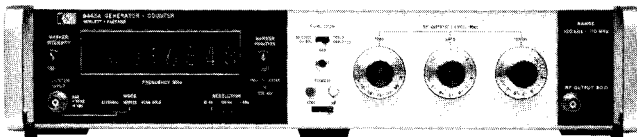

8443A

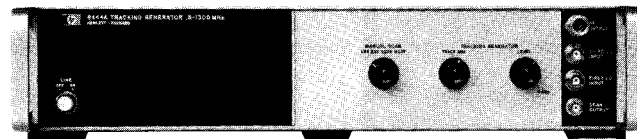

8444A

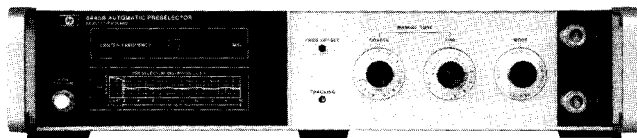

8445B Opt 002, 003

Hewlett-Packard's high performance plug-in spectrum analyzer family makes frequency domain measurements from 20 Hz to 40 GHz. Because of the system's modularity, the user need purchase only analyzer components necessary to meet immediate production or laboratory measurement requirements. Then, as broader frequency capability is required, additional tuning sections or companion instruments can be added.

The models 8553B, 8554B, 8555A, and 8556A are tuning sections which plug into a 141T display mainframe along with an 8552B IF section to form a member of the Hewlett-Packard high performance spectrum analyzer family. Each tuning section covers a frequency range convenient for equipment design or spectrum surveillance: 8556A, 20 Hz to 300 kHz; 8553B, 1 kHz to 110 MHz; 8554B, 100 kHz to 1250 MHz; and 8555A, 10 MHz to 40 GHz. The IF section plug-in which is used with each tuning section, serves to condition the measurement signal for proper display on the CRT. Two IF sections are available, the 8552B high performance model and the 8552A model for economy. The spectrum analyzer specifications included in this catalog assume the use of the 8552B.

The 8443A and 8444A are tracking generators complementing the basic spectrum analyzer function with an RF source locked to the tuning frequency. The 8445B is an automatic preselector which enhances the dynamic range of the 10 MHz to 40 GHz 8555A tuning section analyzer.

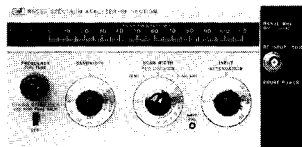

8553B

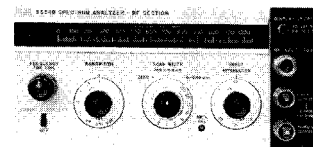

8554B

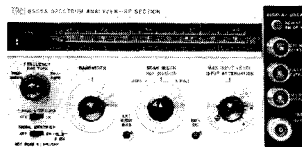

8555A

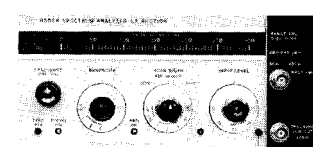

8556A

The 141T based spectrum analyzer features absolute calibration of frequency and amplitude, high resolution and sensitivity, wide dynamic range, and simple to interpret display output.

The following pages cover spectrum analyzer performance with each of the tuning sections and companion tracking generator/preselector.

### Absolute Amplitude Calibration

For ease and speed of measurement, full frequency band amplitude calibration allows direct interpretation of signal power or voltage from the CRT display. A choice of logarithmic or linear scaling calibrates the CRT in dBm or  $\mu\text{V}$  respectively. Front panel settings set the top horizontal graticule on the CRT as the reference power in the logarithmic mode; all other CRT measurements can be made relative to this reference. In linear scaling the CRT is calibrated in voltage per division using front panel settings. The bottom graticule is zero voltage.

When a combination of frequency scan, bandwidth, or video filter settings are chosen such that the display becomes uncalibrated, a warning light indicates the condition.

### High Resolution Frequency Calibration

The frequency measurement capability of the spectrum analyzer is responsive to user need, making spectrum measurements simply and accurately with three frequency scan modes.

First is the FULL scan mode, which displays the entire tuning section frequency band on the 10 cm horizontal CRT graticule. This mode is effective in viewing broadband effects of circuit adjustments and refinements as they are made. In FULL scan a marker on the CRT corresponds in frequency to the position of the pointer on the tuning section frequency scale, so signals can be readily identified.

The second mode, PER DIVISION scan, centers the display about the frequency indicated by the tuning section pointer. In this mode, narrow, calibrated scan per division and automatic frequency stabilization make high resolution measurements for analysis of signal purity, sidebands, and low deviation FM.

In the third mode, ZERO scan, the analyzer becomes a receiver tuned to the frequency indicated on the scale. Modulation in an input signal at the tuned frequency is displayed on the CRT in the time domain. The scan time control provides a calibrated time base.

### High Resolution

The ability to resolve close-in signal sidebands, such as line related modulation, is important in frequency domain analysis. The Hewlett-Packard 141T plug-in spectrum analyzers each have narrow bandwidths for such resolution. Up to 110 MHz, the analyzers offer 10 Hz bandwidths and 18 GHz, 100 Hz bandwidths. The frequency stabilization feature already mentioned ensures high resolution by maintaining a jitter-free display.



### Wide Dynamic Range, Sensitive

Confidence in signal identification is given by the analyzer's ability to measure wide amplitude differentials without distortion products and to measure very low-level signals. The plug-in spectrum analyzers have typically 70 dB of distortion free dynamic range; that is, the capability of measuring 0.03% signal distortion from the CRT display. With the 8445B Preselector the 8555A has a spurious-free range of 100 dB. The CRT displays full dynamic range on a linear, easy to read scale.

Signals at as low a level as  $-142$  dBm (18 nanovolts, 50 ohms) can be detected by the spectrum analyzer with 10 Hz bandwidth. At high frequencies and with 100 Hz bandwidth,  $-125$  dBm signals can be measured.

### A Parallax-free, Storable Display

The 141T spectrum analyzer mainframe and display features a variable persistence CRT which enables response storage for any measurement. With very narrow bandwidth measurements, extremely slow sweeps are necessary to maintain amplitude calibration (allowing band-pass filters time to respond). A recording CRT is necessary to save this response for viewing. Of course, any response can be stored for a display ready to be photographed. Another display mainframe, the 140T, is available with standard persistence.

Interpretation of response levels on the CRT is free from parallax since the graticule is etched on the inside of the display screen adjacent to the phosphor.

### IF Section Adds Convenience Features

The high resolution 8552B or the economic 8552A IF section features video filtering, recorder outputs and an internal calibration signal to make the spectrum analyzer easier to use. Video filtering is a low-pass filter which averages noise amplitude response for easier small signal readings. It also makes wide band noise measurements easier.

Recorder outputs, including pen lift, allow hard copy duplication of the CRT display. Manual scan allows setting up of accessories, such as X-Y recorders, adjusting signals on screen during slow scans and measuring frequencies with a counter.

The internal calibration standard is a very stable  $-30$  dBm, 30 MHz signal for quick front panel calibration.

### Tracking Generators for Each Frequency Band

Either available internally, or as a companion instrument, are leveled signal sources designed to track the swept tuning frequency of the spectrum analyzer. Amplifiers, filters or any circuit which requires an input signal can be characterized to 1300 MHz, with typically wider dynamic range and more precise frequency accuracy than with the spectrum analyzer alone.

The 8556A low frequency tuning section has an internal tracking generator, standard with the instrument. The 8553B and 8554B/8555A use separate generators namely 8443A and 8444A respectively.

### 8750A Storage-Normalizer

You can add digital storage to the 140-series spectrum analyzer with the 8750A (Opt. 001) and an external oscilloscope. Digital storage provides a flicker-free display regardless of the analyzer sweep speed and facilitates trace comparisons of two traces. If a tracking generator is employed, the normalization feature significantly reduces frequency response variations. The 8750A Storage-Normalizer is a versatile accessory which may be used directly with other HP spectrum and network analyzers. (See Page 491).

## General Specifications

### 141T Spectrum Analyzer System

**Input impedance:** 50 $\Omega$  nominal. Reflection coefficient  $<0.30$  (1.85 SWR), input attenuator  $\geq 10$  dB.

**Maximum input level:** peak or average power  $+13$  dBm (1.4 V ac peak),  $\pm 50$  V dc.

**Attenuator:** 0 to 50 dB in 10 dB steps.

**Scan time:** 16 internal scan rates from 0.1 ms/div to 10 sec/div in a 1, 2, 5 sequence, and manual scan (8552B only).

### Scan time accuracy

**0.1 ms/div to 20 ms/div:**  $\pm 10\%$ .

**50 ms/div to 10 s/div:**  $\pm 20\%$ .

### Scan mode

**Int:** analyzer repetitively scanned by internally generated ramp; synchronization selected by scan trigger

**Single:** single scan with front panel reset.

**Ext:** scan determined by 0 to +8 volt external signal.

**Manual:** scan determined by front panel control.

**Scan trigger:** for internal scan mode, select between

**Auto:** scan free-runs.

**Line:** scan synchronized with power line frequency.

**Ext:** scan synchronized with  $>2$  volt (20 volt max.) signal.

**Video:** scan internally synchronized to envelope of RF input.

### Auxiliary outputs:

**Vertical output:** 0 to  $-0.8$  V for full deflection.

**Scan output:**  $-5$  V to  $+5$  V for 10 div CRT deflection.

**Pen lift output:** 0 to 14 V (0 V, pen down).

## Display Characteristics

### 141T, 140T

**Plug-ins:** accepts Models 8552A/B, 8553B, 8554B, 8555A and 8556A and Model 140 series Oscilloscope plug-ins.

### Cathode-ray tube type

**Model 141T:** post-accelerator storage tube, 9000 volt accelerating potential; aluminized P31 phosphor.

**Model 140T:** post-accelerator, 7300 volt potential medium-short persistence (P39) phosphor.

### Cathode-ray tube graticule

**Model 141T:** 8 x 10 division (approx, 7.1 cm x 8.9 cm parallax-free internal graticule).

### Persistence, model 141T only

**Normal:** natural persistence of P31 phosphor (0.1 second).

#### Variable

**Normal writing rate mode:** continuously variable from less than 0.2 second to more than one minute.

**Maximum writing rate mode:** from 0.2 second to 15 seconds.

**Erase:** manual; erasure takes approximately 350 ms.

**Storage time model 141T only:** normal writing rate; more than 2 hours at reduced brightness (typically 4 hours).

**Fast writing speed, model 141T only:** more than 15 minutes.

**Functions used with oscilloscope plug-ins only.** Intensity modulation, calibrator; beam finder.

**EMI:** conducted and radiated interference is within requirements of MIL-I-16910C and MIL-I-6181D and methods CEO3, and REO2 of MIL-STD-461 (except 35 to 40 kHz) when appropriate RF tuning section and 8552A or 8552B are combined in a 140T or 141T Display Section.

**Temperature range:** operating,  $0^{\circ}\text{C}$  to  $+55^{\circ}\text{C}$ ; storage,  $-40^{\circ}\text{C}$  to  $+75^{\circ}\text{C}$ .

**Power requirements:** 100, 120, 220, or 240V  $\pm 5\%$ .  $-10\%$ . 50 to 60 Hz, normally less than 225 watts (includes plug-ins used).

### Weight

**Model 8552A or 8552B IF section:** net, 4.1 kg (9 lb). Shipping 6.4 kg (14 lb).

**Model 140T display section:** net, 18 kg (40 lb). Shipping, 25 kg (54 lb).

**Model 141T display section:** net, 19.2 kg (43 lb). Shipping, 26 kg (57 lb).

**Tuning section:** see following pages.

**Size:** model 140T or 141T with plug-ins: 221 H x 425 W x 416 mm D (8.8" x 16.8" x 16.4").

**Special order:** chassis slides and adapter kit.

### Ordering Information

**140T Normal Persistence Display**

**Opt 908:** Rack Flange Kit

**141T Variable Persistence Display**

**Opt 908:** Rack Flange Kit

**8552A Economy IF Section**

**8552B High Resolution IF Section**

### Price

\$2250

add \$27

\$3050

add \$27

\$3475

\$4325

# SIGNAL ANALYZERS

## 141T Spectrum Analyzer System: 20 Hz to 300 kHz

Model 8556A

- Accurate signal level measurements ( $\pm 0.95$  dB)
- Accurate frequency measurements ( $\pm 3$  Hz)

- High sensitivity ( $-152$  dBV)
- Built-in tracking generator

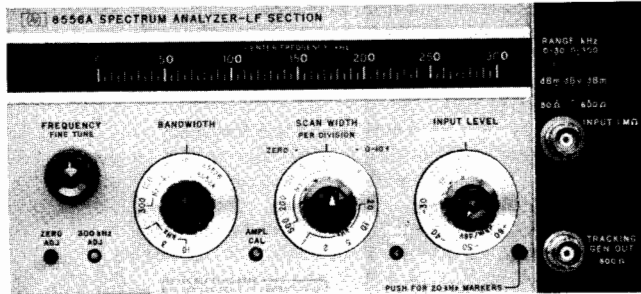

8556A

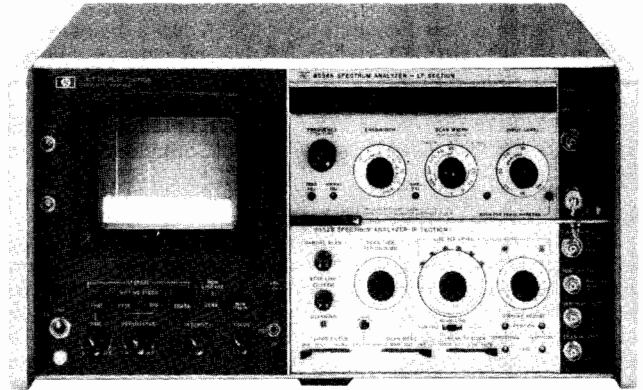

### General Purpose Measurement Flexibility

The 8556A Spectrum Analyzer covers the frequency range from 20 Hz to 300 kHz. It was designed to accommodate the variety of characteristic impedances and amplitude units used in making audio measurements. Balanced or unbalanced inputs are available, and open circuit voltages (dBV or linear) or power (dBm) in several characteristic impedances may be measured. The analyzer is capable of high resolution; frequencies can be measured very accurately. A built-in tracking generator further increases the instrument's utility.

### Frequency Range

The 8556A has two frequency scales, 0–300 kHz for full coverage and 0–30 kHz for better resolution at low frequencies. The analyzer may be swept symmetrically about a tunable center frequency, swept from 0 Hz to a selectable end point, or operated as a fixed tuned receiver. 20 kHz crystal markers (accurate to 0.01%) can be generated on the CRT to make very accurate frequency measurements.

### Absolute Amplitude Calibration

The 8556A is calibrated for dBm in 600 $\Omega$ , dBm in 50 $\Omega$ , dBV, and volts. The very accurate reference level control ( $\pm 0.2$  dB) and vernier ( $\pm 0.25$  dB) allow the IF substitution technique to be used to improve amplitude measurement accuracy.

### Low Distortion

Careful design has decreased analyzer distortion to the extent that a full 70 dB dynamic range is achieved. This allows small signals, such as harmonic or intermodulation distortion, to be measured in the presence of large ones.

### Resolution—Sensitivity

Resolution bandwidths from 10 Hz to 10 kHz are provided on the 8556A. Using the narrow bandwidth, 50 or 60 Hz line related sidebands can be measured. The analyzer's extremely low noise figure together with its narrow bandwidths makes the 8556A very sensitive. Signals as low as  $-152$  dBV (25 nV) can be measured in a 10 Hz bandwidth. The 8556A may be used to measure EMI, such as interference conducted along an ac power line.

### Isolated Input

The isolated input eliminates the possibility of spurious signal pickup which could be caused by line related ground currents flowing in the ground connections between the analyzer and signal source. The input impedance (1 M $\Omega$ ) is high enough so that a scope probe may be used with a minimum of loading. An optional balanced input is available which is transformer coupled for isolation and high common mode rejection. The input impedance is 15 k $\Omega$ , and the analyzer is calibrated for either dBm-135 $\Omega$  or dBm-150 $\Omega$  as well as dBm-600 $\Omega$  and dBm-900 $\Omega$ . Balance (symmetry) is 80 dB at 50 Hz and typically 50 dB at 300 kHz.

### Tracking Generator

A tracking generator is built into the 8556A. If an external counter is connected to the tracking generator, frequencies can be measured to an accuracy of  $\pm 3$  Hz. Swept insertion loss or return loss measurements can be made on a device such as an amplifier or filter. A 140 dB measurement range is possible using the narrowest resolution bandwidth. The tracking generator also provides a convenient signal for compensating an oscilloscope probe used with the 8556A.

### Other Applications

The combination of a tracking generator and spectrum analyzer in this frequency range is valuable in applications such as receiver testing and fault location.

## Specifications—with 8552B IF Section

### Frequency Specifications

**Frequency range:** 20 Hz to 300 kHz. Tuning dial ranges of 0–30 kHz and 0–300 kHz.

**Scan width:** (on a 10-division CRT horizontal axis)

**Per division:** 10 calibrated scan widths from 20 Hz/div to 20 kHz/div in a 1, 2, 5 sequence.

**0–10 f:** 10 calibrated preset scans, from 200 Hz to 200 kHz in a 1, 2, 5 sequence. Analyzer scans from zero frequency to ten times the scan width per division setting.

**Zero:** analyzer is a fixed tuned receiver.

### Frequency accuracy

**Center frequency accuracy:** 0–30 kHz Range:  $\pm 500$  Hz; 0–300 kHz Range:  $\pm 3$  kHz.

**Marker accuracy:** RF markers every 20 kHz accurate to within  $\pm 0.01\%$ . Markers controlled by front panel on/off switch.

**Scan width accuracy:** frequency error between any two points on the display is less than  $\pm 3\%$  of the indicated frequency separation.

### Stability

**Residual FM:** sidebands  $>60$  dB down 50 Hz or more from CW signal, scan time  $\geq 1$  sec/div, 10 Hz bandwidth.

**Noise sidebands:** more than 90 dB below CW signal, 3 kHz away from signal, with a 100 Hz IF bandwidth.

**Frequency drift:** less than 200 Hz/10 min.

### Resolution

**Bandwidth ranges:** IF bandwidths of 10 Hz to 10 kHz are provided in a 1, 3, 10 sequence.

**Bandwidth accuracy:** individual IF bandwidth 3 dB points calibrated to  $\pm 20\%$  (10 kHz bandwidth  $\pm 5\%$ ).

**Bandwidth selectivity:** 60 dB/3 dB IF bandwidth ratios, with IF section:  $<11:1$  for IF bandwidths from 10 Hz to 3 kHz;  $<20:1$  for 10 kHz bandwidth. For 10 Hz bandwidth, 60 dB points are separated by less than 100 Hz.



## Amplitude Specifications

### Absolute amplitude calibration

#### Log calibration modes

dBV	0 dBV = 1 V rms
dBm-600Ω	0 dBm = 1 mW-600Ω
dBm-50Ω	0 dBm = 1 mW-50Ω

Input impedance is 1 MΩ. dBm ranges are referenced with input properly terminated externally.

**Log calibration range:** from -150 dBm/dBV to +10 dBm/dBV.

**Log display range:** 10 dB/div on a 70 dB display, or 2 dB/div on a 16 dB display.

**Linear sensitivity:** from 0.1 μV/div to 1 V/div in a 1, 2, 10 sequence. Linear sensitivity vernier X1 to X0.25 continuously.

### Dynamic range

**INPUT LEVEL control:** -10 to -60 dBm/dBV in 10 dB steps. Accuracy ±0.2dB. Marking indicates maximum input levels for 70 dB spurious-free dynamic range.

**Average noise level:** (specified with a 600Ω or less source impedance and INPUT LEVEL at -60 dBm/dBV)

Mode	1 kHz IF Bandwidth	10 Hz IF Bandwidth
dBm-50Ω	<-122 dBm (180 nV)	<-142 dBm (18 nV)
dBm-600Ω	<-130 dBm (250 nV)	<-150 dBm (25 nV)
dBV	<-132 dBV (250 nV)	<-152 dBV (25 nV)
Linear	<400 nV	<40 nV

**Video filter:** averages displayed noise; bandwidth of 10 kHz, 100 Hz, and 10 Hz. Bandwidth accuracy ±20%.

**Spurious responses:** input signal level ≤ INPUT LEVEL setting; out of band mixing responses, harmonic and intermodulation distortion products are all more than 70 dB below the input signal level 5 kHz to 300 kHz; 60 dB, 20 Hz to 5 kHz. Third order intermodulation products are more than 70 dB below the input signal level, 5 kHz to 300 kHz with signal separation >300 Hz.

**Residual responses (no signal present at input):** With the INPUT LEVEL at -60 dBm/dBV and the input terminated with 600Ω or less, all line related residual responses from 0 to 500 Hz are below -120 dBm/dBV. All other residual responses are below -130 dBm/dBV.

Amplitude accuracy:	Log	Linear
Frequency response	±0.2 dB	±2.3%
Amplitude display	±0.25 dB/dB but not more than ±1.5 dB over 70 dB display range	±2.8% of full 8 div display

**Log reference level control:** provides 90 dB IF gain control in 10 dB steps. Accurate to ±0.2 dB (±2.3%).

**Log reference level vernier:** provides continuous 12dB range. Accurate to ±0.1 dB (±1.2%) in 0, -6, -12 dB positions; otherwise ±0.25 dB (±2.8%).

**Amplitude measurement accuracy:** ±0.95 dB with proper technique.

## General

**Scan time:** 16 internal scan rates from 0.1 ms/div to 10 sec/div in a 1, 2, 5 sequence.

### Scan mode

**Int:** analyzer repetitively scanned internally.

**Ext:** scan determined by 0 to +8 volt external signal.

**Single:** single scan actuated by front panel button.

**Manual:** scan determined by front panel control.

**Input level:** provides 50 dB control of input preamplification and attenuation to prevent input overload. INPUT LEVEL markings of -60 dBm/dBV to -10 dBm/dBV indicate maximum input level for a minimum of 70 dB spurious-free dynamic range. Accuracy ±0.2 dB (2.3%).

**Input impedance:** 1 MΩ shunted by ≈32 pF.

**Maximum input level:** 10 V rms, ±200 V dc. Ground terminals of BNC input connectors are isolated from the analyzer chassis ground to minimize ground loop pickup at low frequencies.

**Maximum voltage, isolated ground to chassis ground:** ±100 V dc.

**Isolated ground to chassis ground impedance:** 100 kΩ shunted by approximately 0.3 μF.

**Gain compression:** for input signal level 20 dB above INPUT LEVEL setting, gain compression is less than 1 dB.

## Tracking Generator Specifications

**Frequency range:** tracks the analyzer tuning, 20 Hz to 300 kHz.

**Amplitude range:** continuously variable from 100 mV rms to greater than 3 V rms into an open circuit.

**Amplitude accuracy:** with TRACKING GEN LEVEL in CAL position and 20 kHz markers off, output level at 100 kHz is 100 mV ±0.3 dB into an open circuit.

**Frequency response:** ±0.25 dB 50 Hz to 300 kHz.

**Output impedance:** 600Ω.

**Residual FM:** <1 Hz peak-to-peak.

**Power requirements:** 100, 120, 200, or 240 V +5%, -10%, 50 to 60 Hz, normally less than 225 watts.

**Weight:** Model 8556A LF section: net, 3.7 kg (8 lb). Shipping, 5.3 kg (12 lb).

**Size:** 102 x H x 226 x W 344 mm D (4" x 8.9" x 13.5").

## Specifications with 8556A Options 001, 002-balanced Input

### Amplitude

#### Log calibration modes-balanced (bridged) input

dBm-135Ω (Option 001)	0 dBm = 1mW-135Ω
dBm-150Ω (Option 002)	0 dBm = 1mW-150Ω
dBm-600Ω	0 dBm = 1mW-600Ω
dBm-900Ω	0 dBm = 1mW-900Ω

Input impedance is typically 15 kΩ. dBm ranges are referenced with input properly terminated externally.

### Input

**Maximum input levels:** normal Mode, ±20 V rms or ±150 V dc for normal mode (symmetrical) signals between input signal connectors; Common Mode, 200 V rms at 60 Hz or ±500 V dc for common mode (asymmetrical) voltages between input signal connectors and GUARD or instrument chassis; Guard, ±100 V dc from GUARD to instrument chassis. (GUARD to chassis impedance is approximately 100 kΩ shunted by 0.3μF.)

**Balance (Symmetry):** 0 -30kHz Range, greater than 80 dB, 50 Hz to 1 kHz; 1 -300 kHz range, greater than 60 dB, 1 kHz to 20 kHz.

## Ordering Information

8556A RF Section

Opt 001: Balanced input

Opt 002: Balanced input

## Price

\$2700

add \$220

add \$220

# SIGNAL ANALYZERS

141T Spectrum Analyzer System: 1 kHz to 110 MHz

Models 8553B & 8443A

- Wide frequency range
- 10 Hz resolution bandwidth
- High sensitivity ( $-140$  dBm)

- Accurate amplitude measurements ( $\pm 1.25$  dB)
- 10 Hz frequency accuracy with tracking generator
- 130 dB swept measurement range

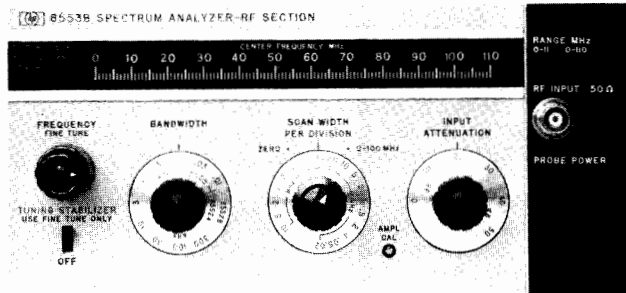

8553B

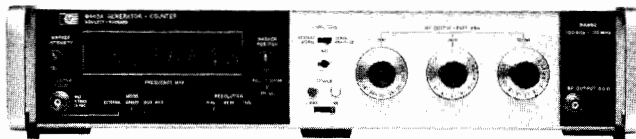

8443A

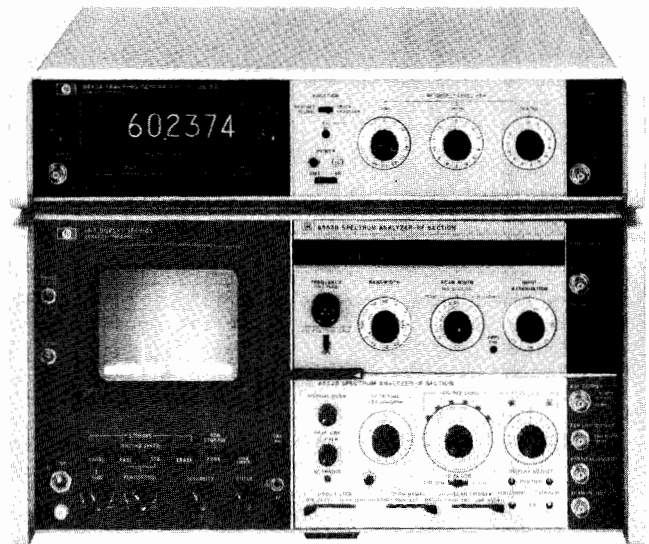

## General Purpose

The 8553B Spectrum Analyzer makes absolute amplitude and frequency measurements over the 1 kHz to 110 MHz range. This frequency span includes audio, video, navigation aids, telemetry, multiplex communication systems basebands, commercial AM, FM, TV, and land mobile communication. The analyzer features high resolution and stability, low distortion, high sensitivity, and a wide dynamic range. A tracking generator is available which improves the frequency measurement accuracy of the analyzer and can be used to make swept measurements.

## Wide Frequency Range

The broad frequency range of 1 kHz to 110 MHz extends from audio through the FM broadcast band. Scan widths from 200 Hz to 100 MHz allow a user to view all or selected parts of the frequency spectrum while the zero scan mode turns the analyzer into a fixed tuned receiver and displays amplitude variations in the time domain. The analyzer has two dial scales, 0-110 MHz for full coverage and 0-11 MHz for better resolution at low frequencies.

## Resolution—Stability

The 8553B has resolution bandwidths that range from 300 kHz to 10 Hz. Wide bandwidths are necessary for making measurements on a wideband spectrum such as FM. The extremely high resolution 10 Hz bandwidth allows measurement of 50 Hz sidebands 60 dB down. Such high resolution is made possible by automatic stabilization through phase lock, which reduces residual FM to a negligible level. Good stability is required to measure oscillator residual FM and drift.

## Absolute Amplitude Calibration

The 8553B Spectrum Analyzer is absolutely calibrated in both dBm and volts from  $-142$  dBm (18 nV) to  $+10$  dBm (0.7 V). This absolute calibration is derived from a built-in calibrator ( $-30$  dBm at 30 MHz) and extremely flat analyzer frequency response ( $\pm 0.5$  dB). A display uncal. light warns if the display becomes uncalibrated. The probe power output supplies power to a high impedance probe which can be used to make bridging measurements on circuits terminated at both ends.

## High Sensitivity

A low analyzer noise figure and narrow bandwidths give the 8553B very high sensitivity. Signal levels as low as  $-140$  dBm can be measured in 10 Hz bandwidth, and a preamplifier is available to further increase sensitivity by 16 dB. Video filtering in 10 kHz, 100 Hz and 10 Hz bandwidths will average the displayed noise. High analyzer sensitivity is required if distortion in an amplifier or oscillator is to be measured as a function of output level. In EMI studies, field strength can be measured with a calibrated antenna.

## 70 dB Dynamic Range

The 8553B has a 70 dB dynamic range when the signal level is properly conditioned at the input mixer. A wide dynamic range is necessary to measure small signals in the presence of large ones, such as harmonic or intermodulation distortion or to monitor signals of widely varying amplitudes, such as in EMC, RFI, and surveillance work.

## 8443A Tracking Generator-Counter

A tracking generator, 8443A, is available which covers the 100 kHz to 110 MHz frequency range of the 8553B. It has a built-in counter, and precision RF attenuators which are useful in making substitution measurements.

## Frequency Accuracy

In conjunction with an 8443A Tracking Generator, the 8553B Spectrum Analyzer can measure frequencies to an accuracy of  $\pm 10$  Hz. When the 8443A is operated in the "track analyzer" mode, the counter will read the frequency at a tunable marker which is generated on the analyzer CRT. The "restore signal" mode is a more convenient way to measure signal frequencies in wide scans because the counter reads the signal frequency automatically without fine tuning. The 8443A Tracking Generator may also be used externally as a 120 MHz direct reading counter.

## Swept Measurements

The 8443A Tracking Generator can be used with the 8553B to make swept insertion loss and return loss measurements over the 100 kHz to 110 MHz frequency range. Because the signal source tracks the analyzer's tuning, up to 130 dB dynamic measurement range is possible (at 10 Hz bandwidth). Excellent system flatness ( $\pm 1.0$  dB) insures the accurate determination of swept response characteristics.



## Specifications—with 8552B IF Section

### Frequency Specifications

**Frequency range:** 1 kHz–110 MHz (0–11 MHz and 0–110 MHz tuning ranges).

**Scan width (on 10-division CRT horizontal axis)**

**Per division:** 18 calibrated scan widths from 20 Hz/div to 10 MHz/div in a 1, 2, 5 sequence.

**Preset:** 0–100 MHz, automatically selects 300 kHz bandwidth IF Filter.

**Zero:** analyzer is fixed tuned receiver with selectable bandwidth.

### Frequency accuracy

**Center frequency accuracy:** the dial indicates the display center frequency within  $\pm 1$  MHz on the 0–110 MHz tuning range;  $\pm 200$  kHz on the 0–11 MHz tuning range with FINE TUNE centered, and temperature range of 20°C to 30°C.

**Scan width accuracy:** scan widths 10 MHz/div to 2 MHz/div and 20 kHz/div to 20 Hz/div: Frequency error between two points on the display is less than  $\pm 3\%$  of the indicated frequency separation between the two points. Scan widths 1 MHz/div to 50 kHz/div: Frequency error between two points on the display is less than  $\pm 10\%$  of the indicated frequency separation.

### Resolution

**Bandwidth:** IF Bandwidths of 10 Hz to 300 kHz are provided in a 1, 3 sequence.

**Bandwidth accuracy:** individual IF bandwidths' 3 dB points calibrated  $\pm 20\%$  (10 kHz bandwidth  $\pm 5\%$ ).

**Bandwidth selectivity:** 60 dB/3 dB IF bandwidth ratios: 10 Hz to 3 kHz bandwidths,  $<11:1$ , 10 kHz to 300 kHz bandwidths,  $<20:1$ ; 60 dB points on 10 Hz bandwidth separated by  $<100$  Hz.

### Stability

**Residual FM stabilized:** sidebands  $>60$  dB down 50 Hz or more from CW signal, scan time  $\geq 1$  sec/div, 10 Hz bandwidth (typically less than 1 Hz peak-to-peak).

**Residual FM unstabilized:**  $<1$  kHz peak-to-peak.

**Noise sidebands:** more than 70 dB below CW signal, 50 kHz or more away from signal, with 1 kHz IF bandwidth.

**Long term drift (after 1-hour warm-up),** stabilized: 500 Hz/10 min; unstabilized: 5 kHz/min, 20 kHz/10 min.

### Amplitude Specifications

#### Absolute amplitude calibration range

**Log:** from  $-130$  to  $+10$  dBm, 10 dB/div on a 70 dB display or 2 dB/div on a 16 dB display.

**Linear:** from  $0.1 \mu\text{V/div}$  to  $100 \text{ mV/div}$  in a 1, 2 sequence on an 8-division display.

#### Dynamic range

**Average noise level:**  $<-110$  dBm with 10 kHz IF bandwidth.

**Video filter:** averages displayed noise; 10 kHz, 100 Hz, and 10 Hz bandwidths.

**Spurious responses:** are below a  $-40$  dBm signal at the input mixer as follows: All image and out-of-band mixing responses, harmonic and intermodulation distortion more than 70 dB down, 2 MHz to 110 MHz; more than 60 dB down, 1 kHz to 2 MHz. Third order intermodulation products more than 70 dB down, 1 kHz to 110 MHz (Signal separation  $>300$  Hz).

**Residual responses (no signal present at input):** with input attenuation at 0 dB:  $<-110$  dBm (200 kHz to 110 MHz);  $<-95$  dBm (20 kHz to 200 kHz).

Amplitude accuracy:	Log	Linear
Frequency response (Flatness: attenuator settings $>10$ dB):		
1 kHz to 110 MHz	$\pm 0.5$ dB	$\pm 5.8\%$
Amplitude Display	$\pm 0.25$ dB/dB	$\pm 2.8\%$ of full 8 div deflection
	but not more than $\pm 1.5$ dB over the full 70 dB display range	

**Calibrator amplitude:**  $-30$  dBm,  $\pm 0.3$  dB

**Calibrator frequency:** 30 MHz,  $\pm 3$  kHz.

**Log reference level control:** provides 70 dB range (60 dB below 200 kHz), in 10 dB steps. Accurate to  $\pm 0.2$  dB ( $\pm 2.3\%$ , Linear Sensitivity).

**Log reference level vernier:** provides continuous 12 dB range. Accurate to  $\pm 0.1$  dB ( $\pm 1.2\%$ ) in 0,  $-6$ , and  $-12$  dB positions; otherwise  $\pm 0.25$  dB ( $\pm 2.8\%$ ).

**Amplitude measurement accuracy:**  $\pm 1.25$  dB with proper technique.

### General

**Input impedance:** 50 $\Omega$  nominal, BNC connector. Reflection coefficient  $<0.13$  (1.3 SWR), input attenuator  $\geq 10$  dB. A special 75 $\Omega$  8553B/8552B is available.

**Maximum input level:** peak or average power  $+13$  dBm (1.4 V ac peak),  $\pm 50$  V dc, 1 dB compression point,  $-10$  dBm.

**Scan time:** 16 internal scan rates from 0.1 ms/div to 10 sec/div in a 1, 2, 5 sequence, or manual scan.

### Scan mode

**Int:** analyzer repetitively scanned internally.

**Ext:** scan determined by 0 to  $+8$ -volt external signal.

**Manual:** scan determined by front panel control.

**Attenuator:** 0 to 50 dB, in 10 dB increments, coupled to Log Reference Level indicator; automatically maintains absolute calibration. Attenuator accuracy  $\pm 0.2$  dB.

**Power requirements:** 100, 120, 220, or 240 V  $+5\%$ ,  $-10\%$ , 50 to 60 Hz, normally less than 225 watts.

**Weight:** Model 8553B RF Section: net, 5.5 kg (12 lb). Shipping, 7.8 kg (17 lb).

**Size:** 102 H x 226 W x 334 mm D (4" x 8.9" x 13.5").

### Tracking Generator-Counter (8443A)

**Frequency range:** 100 kHz to 110 MHz.

**Amplitude range:**  $<-120$  dBm to  $+10$  dBm in 10 and 1 dB steps with a continuous 1.2 dB vernier.

### Amplitude accuracy

**Frequency response (flatness):**  $\pm 0.5$  dB.

**Absolute:** 0 dBm at 30 MHz:  $\pm 0.3$  dB.

**Output impedance:** 50 $\Omega$ , BNC connector, ac coupled, reflection coefficient  $\leq 0.09$  (1.2 SWR) with output  $<0$  dBm.

### Counter

**Display:** 7 digits with 1 digit over-range. Reads to  $\pm 10$  Hz increments.

**Resolution (gate time):** 1 kHz (1 ms), 100 Hz (10 ms), 10 Hz (100 ms).

**Accuracy:**  $\pm 1$  count  $\pm$  time base accuracy.

**Time base aging rate:**  $<3 \times 10^{-9}$ /day (0.3 Hz/day) after warm-up.

**External counter inputs:** 10 kHz to 120 MHz, 50 $\Omega$ ,  $-10$  dBm min.

**Power:** 100, 120, 220, or 240 V  $+5\%$ ,  $-10\%$ , 48 to 440 Hz 75 watts.

**Weight:** Model 8443A: net, 11.04 kg (24.3 lb). Shipping, 14.47 kg (31.9 lb).

**Size:** 88.2 H x 425 W x 467 mm D (3.5" x 16.8" x 18.4").

### Ordering Information

**8553B** RF Section

**8443A** Tracking Generator-Counter

### Price

\$3650

\$5650

# SIGNAL ANALYZERS

141T Spectrum Analyzer System: 100 kHz to 1250 MHz

Models 8554B & 8444A

- High resolution to 100 Hz
- Flat frequency response  $\pm 1$  dB
- High sensitivity to  $-122$  dBm (180 nV)

- Variable persistence display
- Companion tracking generator
- Optional internal limiter

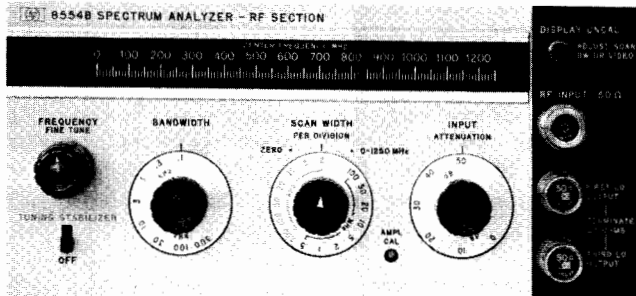

8554B

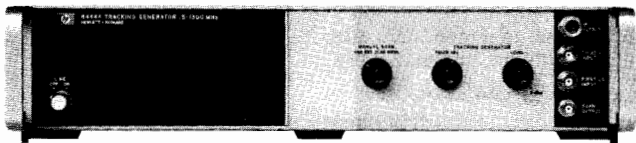

8444A

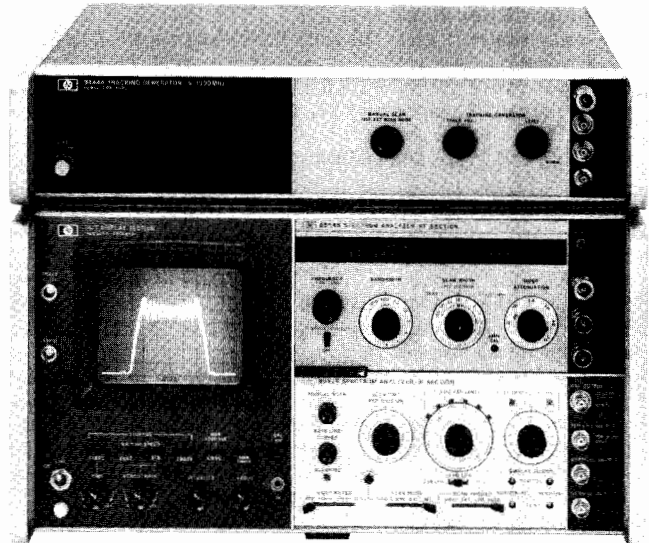

## 8554B Spectrum Analyzer

The 8554B Spectrum Analyzer RF Section covers the frequency range from 100 kHz to 1250 MHz. This broad frequency coverage allows analysis from baseband through UHF navigation bands. Absolute amplitude calibration is maintained over the entire range. Some typical applications include power and frequency measurements on modulation, distortion and spurious outputs, frequency response measurements of filters, amplifiers, modulators and mixers. The analyzer can also be used to make noise measurements such as noise power density over a specified frequency band, carrier-to-noise ratio or swept noise figure measurement of amplifiers. With a calibrated antenna or current probe the analyzer can characterize broadband and narrowband signals encountered in EMI applications.

### Absolute Amplitude Calibration

Absolute amplitude measurements can be made from +10 to  $-122$  dBm with  $\pm 2.8$  dB accuracy. This accuracy can be improved to  $\pm 1.75$  dB using IF substitution. The display is calibrated in log (dBm) to obtain a wide display range and linear (voltage) for measurements requiring maximum resolution. The top graticule line on the CRT is a calibrated reference level which can be changed by the front panel controls from +10 to  $-72$  dBm for IF substitution measurements. Amplitude calibration is dependent upon the proper relationship between sweep width, sweep time, resolution bandwidth and video filtering. An uncal warning light is present to indicate an uncalibrated situation.

### Flat Frequency Response

In broadband use, the wide bandwidths allow fast sweeping of the entire spectrum. The analyzer is extremely flat ( $\pm 1$  dB) over its entire range, allowing direct comparisons of signal amplitudes displayed on the CRT. A 0 to 50 dB input attenuator is provided to prevent overdriving the input mixer.

### Resolution

The low residual FM ( $< 100$  Hz peak-to-peak) of the 8554B makes possible resolution bandwidths as narrow as 100 Hz. This enables resolving closely spaced signals such as 1 kHz and 400 Hz sidebands. Bandwidths range from 100 Hz to 300 kHz in a 1, 3, 10 sequence making it easy to select an optimum bandwidth to scan width ratio.

The resolution bandwidths consist of synchronously tuned "gaussian" shaped filters to enable faster sweeping for any given bandwidth. In addition, these filters have narrow shape factors making it possible to measure closely spaced signals differing greatly in amplitude.

### Sensitivity

The high sensitivity ( $-122$  dBm in 100 Hz bandwidth) and wide spurious-free measurement range ( $> 65$  dB) of the 8554B means accurate measurements can be made on low level signals and signals varying widely in amplitude. For example, modulation as low as 0.2% can be measured. Low level harmonic and intermodulation distortion, spectrum surveillance and EMI are just a few of the measurements possible. A video filter is provided in the IF section to average displayed noise and simplify the measurement of low level signals.

### Automatic Tuning Stabilization

The 8554B Spectrum Analyzer is automatically stabilized in narrow scans. This gives the stability ( $< 100$  Hz peak-to-peak residual FM) needed for high resolution analysis. Stabilization is accomplished by phase locking the LOs (local oscillators) to a crystal reference in scan widths 200 kHz/div and below. No signal recentering or checking for stabilization is required because the signal remains on screen when phase locked.

## 8444A Tracking Generator

The 8444A Tracking Generator is a signal source, which, when connected to the 8554B Spectrum Analyzer, has an output whose frequency is the same as the swept frequency of the analyzer. The tracking generator is used as a signal source to measure the frequency response of a device. It can also be used for precision frequency measurements. An external counter output is provided on the 8444A and the frequency of unknown signals as well as the frequency of any point on a frequency response curve can be measured. The use of the 5300/5305B Counter is suggested for frequency measurements to 1300 MHz.

The tracking generator-spectrum analyzer system can be used as a sweeper to provide test signals for other devices. The sweep widths and sweep rates are controlled from the spectrum analyzer and the output level from the tracking generator.

## 8554B Specifications—with 8552B IF Section

### Frequency Specifications

**Frequency range:** 100 kHz to 1250 MHz.

**Scan width (on 10-division CRT horizontal axis)**

**Per division:** 15 calibrated scan widths from 100 MHz/div to 2 kHz/div in a 1, 2, 5 sequence.

**Preset:** 0-1250 MHz, automatically selects 300 kHz bandwidth IF filter.

**Zero:** analyzer is fixed-tuned receiver.

### Frequency accuracy

**Center frequency accuracy:** The dial indicates the display center frequency within 10 MHz.

**Scan width accuracy:** frequency error between two points on the display is less than 10% of the indicated separation.

### Resolution

**Bandwidth:** IF bandwidths of 0.1 to 300 kHz provided in a 1, 3, 10 sequence.

**Bandwidth accuracy:** individual IF bandwidth 3 dB points calibrated to  $\pm 20\%$  (10 kHz bandwidth  $\pm 5\%$ ).

**Bandwidth selectivity:** 60 dB/3 dB IF bandwidth ratio  $< 20:1$  for IF bandwidths from 10 kHz to 200 kHz. 60 dB/3 dB bandwidth ratio  $< 11:1$  for IF bandwidths 100 Hz to 3 kHz.

### Stability (residual FM)

**Stabilized:**  $< 100$  Hz peak-to-peak.

**Unstabilized:**  $< 10$  kHz peak-to-peak.

**Noise sidebands:** more than 70 dB below CW signal, 30 kHz or more away from signal, with 1 kHz IF bandwidth.

### Amplitude Specifications

#### Absolute amplitude calibration range

**Log:** from  $-122$  to  $+10$  dBm. 10 dB/div on a 70 dB display, or 2 dB/div on a 16 dB display.

**Linear:** from  $0.1 \mu\text{V/div}$  to  $100 \text{ mV/div}$  in a 1, 2 sequence on an 8-division display.

#### Dynamic range

**Average noise level:**  $< -102$  dBm with 10 kHz IF bandwidth.

**Spurious responses:** All image and out-of-band mixing responses, harmonic and intermodulation distortion products are more than 65 dB below a  $-40$  dBm signal at the input mixer.

**Residual responses (no signal present at input):** with input attenuation at 0 dB:  $< -100$  dBm.

#### Amplitude accuracy

	Log	Linear
Frequency response (flatness)		
100 kHz to 1250 MHz	$\pm 1$ dB	$\pm 12\%$
Switching between bandwidths (at 20°C)	$\pm 0.5$ dB	$\pm 5.8\%$
Amplitude display	$\pm 0.25$ dB/dB but not more than $\pm 1.5$ dB over the full 70 dB display range.	2.8% of full 8 div deflection

#### Calibrator output

**Amplitude:**  $-30$  dBm,  $\pm 0.3$  dB.

**Frequency:** 30 MHz,  $\pm 3$  kHz.

**Log reference level control:** provides 70 dB range (60 dB below 200 kHz), in 10 dB steps. Accurate to  $\pm 0.2$  dB ( $\pm 2.3\%$ , Linear Sensitivity).

**Log reference level vernier:** provides continuous 12 dB range. Accurate to  $\pm 0.1$  dB ( $\pm 1.2\%$ ) in 0,  $-6$ , and  $-12$  dB positions; otherwise  $\pm 0.25$  dB ( $\pm 2.8\%$ ).

**Amplitude measurement accuracy:**  $\pm 1.75$  dB with proper technique.

### RF Input Specifications

**Input impedance:** 50 $\Omega$  nominal. Typical reflection coefficient  $< 0.30$  (1.85 SWR), input attenuator  $\geq 10$  dB.

**Maximum input level:** peak or average power  $+13$  dBm (1.4 V ac peak),  $\pm 50$  V dc.

### General

**Scan time:** 16 internal scan rates from 0.1 ms/div to 10 sec/div in a 1, 2, 5 sequence, and manual scan.

#### Scan time accuracy

**0.1 ms/div to 20 ms/div:**  $\pm 10\%$ .

**50 ms/div to 10 s/div:**  $\pm 20\%$ .

#### Weight

**Model 8554B RF section:** net, 4.7 kg (10.3 lb). Shipping 7.8 kg (17 lb).

**Size:** 102 H, 226 W, 344 mm D (4" x 8.9" x 13.5").

## 8444A Specifications

### Specifications for Swept Frequency Response Measurements

**Dynamic range:**  $> 90$  dB from spectrum analyzer 1 dB gain compression point to average noise level (approximately  $-10$  dBm to  $-100$  dBm). Spurious responses not displayed.

**Gain compression:** for  $-10$  dBm signal level at the input mixer, gain compression  $< 1$  dB.

#### Absolute amplitude calibration range:

**Tracking generator** (drive level to test device: 0 to  $-10$  dBm continuously variable. 0 dBm absolutely calibrated to  $\pm 0.5$  dB at 30 MHz.

**Frequency range:** 500 kHz to 1250 MHz.

**Frequency resolution:** 1 kHz.

#### Stability

**Residual FM** (peak-to-peak): stabilized,  $< 200$  Hz; unstabilized,  $< 10$  kHz.

#### Amplitude accuracy

**System frequency response:**  $\pm 1.50$  dB.

**Tracking generator calibration:** 0 dBm at 30 MHz to  $\pm 0.5$  dB.

### Specifications for Precision Frequency Measurements

**Frequency accuracy:** for unknown signals  $\pm 10$  kHz. (Tracking drift typically 50 kHz/10 min after 2-hour warm-up). For points on frequency response curve, counter accuracy  $\pm$  Residual FM (200 Hz).

#### Counter mode of operation

**Manual scan:** scan determined either by front panel control of 8552B IF Section or by external scan signal provided by the 8444A.

**Zero scan:** analyzer is fixed-tuned receiver. Counter reads center frequency to accuracy of tracking drift.

**Counter output level:** typically 0.1 V rms.

### Specifications for Sweep/CW Generator

**Frequency:** controlled by spectrum analyzer. Range 500 kHz to 1250 MHz with 8554B. Scan widths are as enumerated on this page.

**Frequency accuracy:**  $\pm 10$  MHz using spectrum analyzer tuning dial. Can be substantially improved using external counter output.

**Flatness:**  $\pm 0.5$  dB.

#### Spectral purity

**Residual FM** (peak-to-peak): 200 Hz.

**Harmonic distortion:** 25 dB below output level (typical).

**Nonharmonic (spurious) signals:**  $> 35$  dB below output level.

**Long term stability:** drift typically less than 30 kHz/hour when stabilized after 2-hour warm-up.

**Sweep width:** 20 kHz to 1000 MHz.

**Sweep rates:** selected by Scan Time per Division on spectrum analyzer.

### General

**Temperature range:** operation,  $0^\circ\text{C}$  to  $55^\circ\text{C}$ , storage  $-40^\circ\text{C}$  to  $75^\circ\text{C}$ .

**EMI:** conducted and radiated energy is within the requirements of MIL-1-6181D.

**Power:** 115 V and 230 V, 48 to 440 Hz, 12 watts max.

**Weight:** net, 7.1 kg (15.6 lb). Shipping, 9.5 kg (21 lb).

**Size:** 88.2 H, 425 W, 467 mm D (3.5" x 16.8" x 18.4").

### Ordering Information

**8554B RF Section**  
**Opt 003:** Internal Limiter  
**8444A Tracking Generator**

**Price**  
\$5650  
\$170  
\$3950





# SIGNAL ANALYZERS

## 141T Spectrum Analyzer System: 10 MHz to 40 GHz

### Models 8555A, 8444A Option 059 & 8445B

- Absolute amplitude calibration
- High sensitivity to  $-125$  dBm (125 nV)
- Resolve signals to 100 Hz

- Scan up to 8 GHz full screen
- 100 dB distortion free dynamic range with preselector
- Companion tracking generator to 1.5 GHz

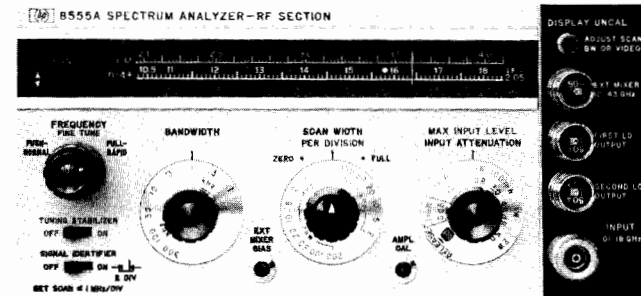

8555A



8444A Opt 059

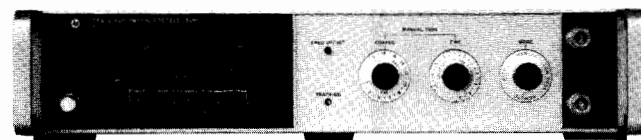

8445B Opt 002, 003

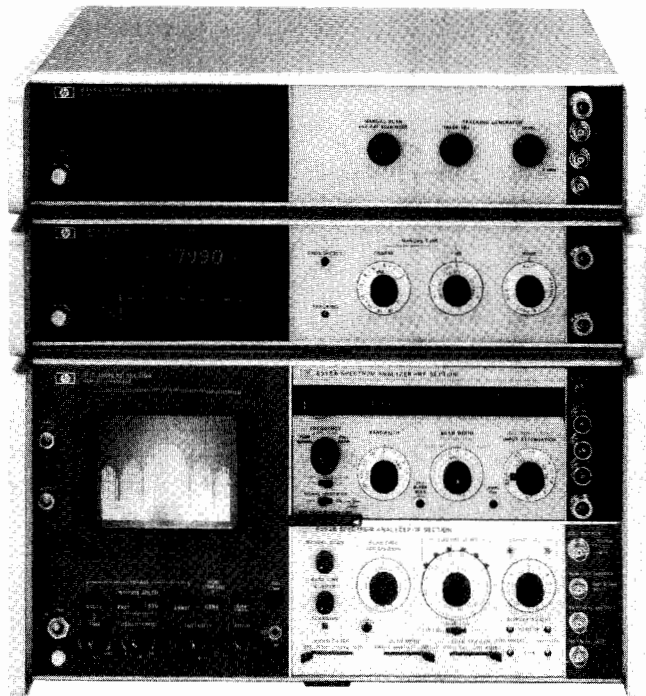

### 8555A Spectrum Analyzer

The 8555A Spectrum Analyzer covers 10 MHz to 18 GHz with fundamental and harmonic mixing. A single external waveguide mixer can provide 12.4 GHz to 40 GHz coverage. This broad frequency range coupled with its high sensitivity and resolution bandwidth allow a variety of power measurements, frequency measurements, modulation, and noise analysis on almost every type of design module: the frequency response of amplifiers, mixers, and modulators, response and alignment of filters, isolators, couplers and limiters. With wide scan widths and calibrated amplitude the 8555A is ideal for spectrum surveillance and RFI/EMC field strength analysis with a calibrated antenna.

#### Absolute Amplitude Calibration

The 8555A offers absolute amplitude calibration from  $+10$  dBm to  $-125$  dBm over the 10 MHz to 18 GHz frequency range. This capability makes possible not only absolute signal power measurements, but also the measurement of the power differential between two signals separated by as much as 18 GHz. The parallax-free CRT graticule can read as a log scale (dBm) or a linear scale (volts) with a frequency response accuracy of  $\pm 1.5$  dB to 6 GHz and  $\pm 2.0$  dB to 18 GHz. The top line of the display is established as the reference level by front panel controls. A light warns of an uncalibrated condition.

#### High Sensitivity

The high sensitivity from  $-125$  dBm (fundamental mixing) to  $-100$  dBm (4th harmonic) in a 100 Hz bandwidth makes it possible to measure large values of attenuation, out of band filter and amplifier response, weak transmitted signals in surveillance work or microvolt signals in EMC applications. A post-detection filter with 10 kHz, 100 Hz and 10 Hz positions averages noise and yields an extremely clean observed trace.

#### High Resolution

Due to low residual FM ( $<100$  Hz peak-to-peak) the 8555A offers outstanding 100 Hz resolution which allows the users to resolve closely spaced signals and low-level sidebands resulting from a 1 kHz modulating signal. The resolution capability makes it possible to analyze spurious low frequency modulation of microwave signals. The high stability of the analyzer results in more accurate measurements of residual FM, long-term drift, phase noise, and spectral purity. Furthermore, the gaussian shape of the IF filters allows fastest sweep for a given resolution bandwidth.

#### Automatic Tuning Stabilization

When scanning over a relatively narrow frequency range, the frequency stability of the analyzer's internal local oscillators becomes important for high resolution and frequency measurements. For this reason the 8555A is equipped with a tuning stabilizer circuit which automatically phase locks the analyzer to a crystal oscillator. Display jitter and signal recentering are virtually eliminated.

#### Added Input Mixer Protection

To prevent an inadvertent 0 dB setting of the input attenuator, a pushbutton lockout is provided on the attenuator knob.

### 8445B Tracking Preselector, 10 MHz to 18 GHz

The 8445B Tracking Preselector is a YIG tuned filter coupled to the 8555A Spectrum Analyzer in order to be tuned exactly to the analyzer's reception frequency. The preselector suppresses harmonic mixing image and multiple responses from 1.8 to 18 GHz. The result is a wide spurious free amplitude measurement range. Clean, full band sweeps are possible in scans of 2, 4, 6 or 8 GHz depending upon the band selected.

Below 1.8 GHz the image and multiple responses are eliminated by a low-pass filter in the preselector.

An optional five digit LED display with 1 MHz resolution allows accurate measurement of either the display frequency at the display marker in full scan mode or the center frequency in per division scan.

### 8444A Option 059 Tracking Generator

The 8444A Option 059 Tracking Generator provides a level, calibrated RF signal which is exactly the tuned frequency of the spectrum analyzer. This enables swept frequency tests such as frequency response and return loss measurements up to 1500 MHz. With an external counter the frequencies of unknown signals on points along a frequency response curve can be made.

### 8555A Specifications—with 8552B IF Section

#### Frequency Specifications

**Frequency range:** 0.01–40 GHz.

#### Tuning range

**With internal mixer:** 0.01–18.0 GHz.

**With external mixer:** 12.4–40 GHz.

#### Harmonic mixing mode

**Signal identification:** not normally required with preselector. Signal identifier provided for positive identification of all responses. Rejection of images and multiple responses with preselector is >70 dB.

#### Scan width

**Full scan:** the width of the scan depends on mixing mode. Scan width =  $n \times 2000$  MHz, where  $n$  is the mixing mode; e.g. for  $n = 2$ , scan width is 4 GHz. Maximum scan width full screen is 8 GHz with coaxial mixer. Preselector necessary to make wide scans usable.

**Per division:** 16 calibrated scan widths from 2 kHz/div to 200 MHz/div in a 2, 5, 10 sequence.

**Zero scan:** analyzer becomes fixed-tuned receiver.

#### Frequency accuracy

**Dial accuracy:**  $n \times (\pm 15 \text{ MHz})$  where  $n$  is the mixing mode.

**Scan accuracy:** frequency error between two points on the display is less than  $\pm 10\%$  of the indicated separation.

**Stability:** residual FM stabilized <100 Hz peak-to-peak (fundamental mixing).

**Noise sidebands:** for fundamental mixing. More than 70 dB below CW signal 30 kHz or more away from signal, with 1 kHz IF bandwidth and 100 Hz video filter.

#### Frequency drift

**Long term drift:** at fixed center frequency after 2-hour warm-up (Typical).

**Stabilized:**  $\pm 3.0$  kHz/10 min.

**Unstabilized:**  $\pm 25$  kHz/10 min.

**Stabilization range:** first LO can be automatically stabilized to internal crystal reference for scan widths of 100 kHz/div or less.

#### Resolution

**Bandwidth range:** selectable 3 dB bandwidths from 100 Hz to 300 kHz in a 1, 3, 10 sequence.

**Bandwidth shape:** approximately gaussian.

**Bandwidth selectivity:** 11:1 to 20:1 (60 dB/3 dB).

**Bandwidth accuracy:** individual IF bandwidth 3 dB points calibrated to  $\pm 20\%$  (10 kHz bandwidth,  $\pm 5\%$ ).

### Amplitude Specifications

#### Measurement range

**Log reference level:** from  $-60$  dBm to  $+10$  dBm.

**Linear sensitivity:** from  $0.1 \mu\text{V/div}$  to  $100 \text{ mV/div}$ .

### Sensitivity and frequency response with internal coaxial mixer

**noise level:** specified for 1 kHz bandwidth.

**Frequency response with 10 dB input attenuator setting:**

Frequency Range (GHz)	Mixing Mode (n)	Average Noise Level (dBm max.)	Frequency Response* (dB max.)
0.01-2.05	1-	-115	$\pm 1.0$
1.50-3.55	1-	-117	$\pm 1.0$
2.07-6.15	2-	-108	$\pm 1.3$
2.60-4.65	1+	-117	$\pm 1.0$
4.11-6.15	1+	-115	$\pm 1.0$
4.13-10.25	3-	-103	$\pm 1.5$
6.17-10.25	2+	-105	$\pm 1.5$
6.19-14.35	4-	-95	$\pm 2.0$
8.23-14.35	3+	-100	$\pm 2.0$
10.29-18.00	4+	-90	$\pm 2.0$

\*Includes mixer frequency response, RF attenuator frequency response, mixing mode gain variation, RF input VSWR.

### Sensitivity and frequency response with 11517A external waveguide mixer and appropriate waveguide tapers

**Average noise level 10 kHz bandwidth (dBm typical):**

Frequency Range (GHz)	Mixing Mode (n)	Average Noise Level (dBm)
12.4-18.0	6-	-90
18.0-26.5	6+	-85
26.5-40.0	10+	-75

**Frequency response:** typically  $\pm 3$  dB over 1 GHz frequency scans.

**Residual responses:** referred to input on fundamental mixing:  $< -90$  dBm.

#### Display range

**Log:** 70 dB, 10 dB/div and 2 dB/div, expanded on a 16 dB display.

**Linear:** from  $0.1 \mu\text{V/div}$  to  $100 \text{ mV/div}$  in a 1, 2, sequence on an 8-division display.

### Spurious responses due to second harmonic distortion with preselector:

Frequency Range	Power Incident on Input Mixer	2nd Harmonic Distortion
0.01-1.85 GHz	-40 dBm	-63 dB
1.85-18.0 GHz	0 dBm	-100 dB

### Spurious responses due to third order intermodulation distortion with preselector

Frequency Range	Signal Separation	Power Incident on Input Mixer	Third Order Intermodulation Distortion
0.01-18.0 GHz	>1 MHz <20 MHz	-30 dBm	-70 dB
0.01-1.85 GHz	>70 MHz	-30 dBm	-70 dB
1.85-18.0 GHz	>70 MHz	0 dBm	-100 dB

**Video filter:** post detection filter used to average displayed noise. Nominal bandwidths: 10 kHz, 100 Hz, and 10 Hz.

**Gain compression:** for internal mixer gain compression  $< 1$  dB for  $-10$  dBm peak or average signal level to input mixer. 11517A External Mixer (12.4-40 GHz) gain compression  $< 1$  dB for  $-15$  dBm peak or average signal level to input mixer.

#### Amplitude accuracy

**IF gain variation with different bandwidth settings:** (at  $20^\circ\text{C}$ .)

**Log:**  $\pm 0.5$  dB.

**Linear:**  $\pm 5.8\%$



# SIGNAL ANALYZERS

## 141T Spectrum Analyzer System: 10 MHz to 40 GHz

Models 8555A, 8444A & 8445B (cont'd)

### Amplitude display

**Log:**  $\pm 0.25$  dB/dB, but not more than  $\pm 1.5$  dB over the full 70 dB display range.

**Linear:**  $\pm 2.8\%$  of full 8-division deflection.

**Log reference level:** accurate to  $\pm 0.2$  dB ( $\pm 2.3\%$  linear sensitivity).

**Log reference level vernier:** accurate to  $\pm 0.1$  dB (1.2%) in 0, -6, and -12 dB positions; otherwise,  $\pm 0.25$  dB ( $\pm 2.8\%$ ).

**Input attenuator range:** 0-50 dB in 10 dB steps, manual safety lock-out for 0 dB position.

**Frequency response:** typically  $\pm 0.6$  dB from 10 MHz to 18 GHz.

**Calibrator output:** amplitude -30 dBm,  $\pm 0.3$  dB. Frequency 30 MHz  $\pm 3$  kHz.

**Absolute calibration accuracy:** overall accuracy is a function of measurement technique. With the appropriate technique, absolute accuracy of  $\pm 1.6$  dB (fundamental mixing) and  $\pm 2.6$  dB (4th harmonic mixing) is achievable.

### Input Characteristics

**Input impedance:** 50 ohms nominal (0.01-18 GHz).

**Reflection coefficient:**  $< 0.130$  (1.30 SWR) for input RF attenuator settings  $\geq 10$  dB.

**Maximum input level:** peak or average power +13 dBm (1.0 V ac rms) incident on mixer (+30 dBm with Opt 002), +33 dBm incident on input attenuator.

**RF input connector:** type N female.

**LO emission:** -10 dBm without preselector, -80 dBm with preselector over recommended operating ranges (10 dB input attenuator setting).

### General

**Scan time:** 16 internal scan rates from 0.1 ms/div to 10 sec/div in a 1, 2, 5 sequence.

**Power requirements:** 100, 120, 220 240 V +5%, -10%, 50-60 Hz, normally less than 225 watts (varies with plug-in units used).

**Weight:** net, 16.8 kg (14.9 lb). Shipping, 8.7 kg (19 lb).

**Size:** 102 H x 226 W x 344 mm D (4" x 8.9" x 13.5").

### Specifications with Option 002;

#### Internal Limiter Installed

All specifications are the same as for the standard unit except the following:

**Frequency range:** 0.1-12.4 GHz, usable over 0.01-18 GHz range.

#### Maximum input level

**Continuous:** 1 W (+30 dBm).

**Pulse:** 75 watts peak, pulse width  $\leq 1$   $\mu$ s, 0.001 duty cycle.

**Reflection coefficient:**  $< 0.33$  (2.0 SWR).

**Frequency response (flatness):**  $< \pm 0.5$  dB degradation in response, 0.1-12.4 GHz.

### 8445B Tracking Preselector

#### Frequency Specifications

**Frequency range:** dc-1.8 GHz low-pass filter. 1.8-18 GHz tracking filter.

**Tracking filter 3 dB bandwidth:** typically 20-45 MHz.

**Tracking filter skirt roll-off:** characteristics of a three-pole filter. (Nominal: 18 dB/octave.)

#### Insertion loss

	Frequency	Insertion Loss (Except Opt. 004)	Insertion Loss (Opt. 004)
Low-Pass Filter	DC-1.8 GHz	$< 2.5$ dB	*
	@2.05 GHz	$> 50$ dB	*
Tracking Filter	1.8-12 GHz	$< 8$ dB	$< 7$ dB
	12-18 GHz	$< 10$ dB	$< 8$ dB

\*Low-Pass Filter deleted with Opt 004.

### Typical preselector minimum insertion loss at 25°C.

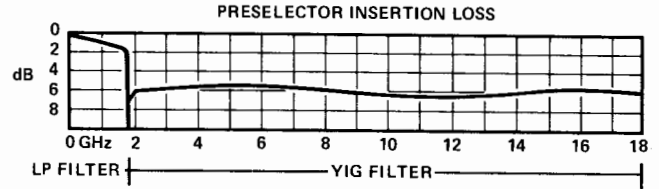

**Out-of-band rejection:** for YIG filter 1 GHz from center of pass-band  $> 70$  dB.

### Digital frequency readout (Option 003):

#### Function:

**Full scan mode:** displays frequency at inverted marker.

**Per division scan.** displays center frequency.

**Manual or remote operation of preselector:** displays tuned frequency of filter.

**Resolution:** 1 MHz.

**Accuracy:** 0.01-1.0 GHz:  $\pm 6$  MHz.

1.0-4.0 GHz:  $\pm 8$  MHz.

4.0-18 GHz:  $\pm 0.2\%$

### Input Specifications

**Input connector:** precision Type N female.

**Input VSWR:** typically  $< 2.0$  (1.8-18 GHz).

**Limiting level:** (maximum input level for  $< 1$  dB signal compression),  $> +5$  dBm.

**Damage level:**  $> +20$  dBm.

### General

**Remote function:** YIG filter frequency can be set by externally supplied voltage.

**Power requirements:** 100, 120, 220, or 240 V +5%, -10%, 48 to 440 Hz, less than 110 watts.

**Weight:** net, 8.8 kg (19.5 lb). Shipping, 11.9 kg (26 lb).

**Size:** 88.2 H x 425 W x 467 mm D (3.5" x 16.8" x 18.4").

### 8444A Opt 059 Tracking Generator

**Frequency range:** 0.5 MHz to 1500 MHz.

**Frequency resolution:** 1 kHz.

**Residual FM (peak-to-peak):** 200 Hz (stabilized).

#### Amplitude range

**Spectrum analyzer display:** from -130 dBm to +10 dBm, 10 dB/div on a 70 dB display or 2 dB/div on a 16 dB display (8552B only).

**Tracking generator (drive level to test device):** 0 to -10 dBm continuously variable.

#### Amplitude accuracy

**System frequency response:**  $\pm 2.7$  dB.

**Tracking generator calibration:** 0 dBm at 30 MHz to  $\pm 0.5$  dB.

**Dynamic range:**  $> 90$  dB.

**Counter output:** typically 0.1 V rms.

### General

**Power:** 115 V and 230 V, 48 to 440 Hz, 12 watts max.

**Weight:** net, 7.1 kg (15.6 lb). Shipping, 9.5 kg (21 lb).

**Size:** 85.2 H x 425 W x 467 mm D (3.5" x 16.8" x 18.4").

### Ordering Information

**8555A Tuning Section**

**Opt 001:** APC-7 connectors

**Opt 002:** Internal limiter

**Opt 005:** Video tape

**8445B Tracking Preselector, dc -18GHz**

**Opt 001:** APC-7 connectors

**Opt 002:** Add manual controls

**Opt 003:** Add digital frequency readout

**Opt 004:** Delete low-pass filter

**Opt 005:** Delete interconnect rigid coax

**8444A Opt 059 Tracking Generator**

**11517A External Mixer (taper section req'd)**

**11518A Taper Section, 12.4 to 18 GHz**

**11519A Taper Section, 18 to 26.5 GHz**

**11520A Taper Section, 26.5 to 40 GHz**

### Price

\$8600

add \$40

add \$210

add \$105

\$3700

add \$155

add \$80

add \$670

less \$425

less \$50

\$4450

\$275

\$175

\$175

\$175

# SIGNAL ANALYZERS

## Spectrum analyzer accessories

Models 8750A, 8447 Series, 11694A, 1121A

535



11694A

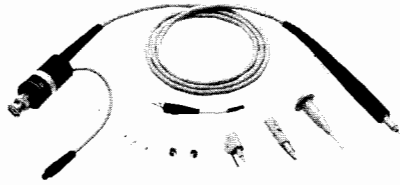

1121A

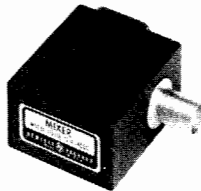

11517A



11693A



11867A

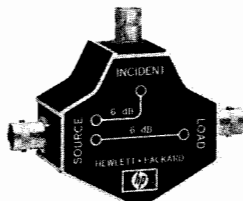

8721A

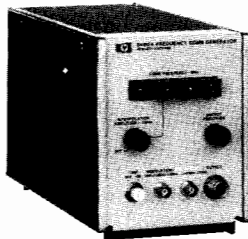

8406A

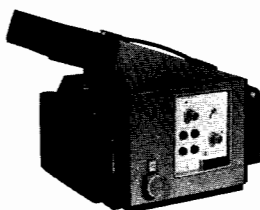

197B



8750A

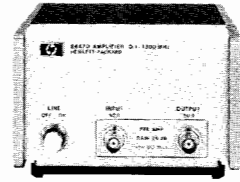

8447 Series

### 8750A Storage-Normalizer

The 8750A is directly compatible with the HP 8557A, 8558B, 8559A, and 8565A Spectrum Analyzers, as well as most HP network analyzers, and requires a conventional low-frequency oscilloscope to be used with the 140 series analyzers. (See page 491).

### 8447 Series Amplifiers (0.1-1300 MHz)

The 8447 Series Amplifiers feature low noise and wide bandwidth. This makes them ideal for improving spectrum analyzer sensitivity and noise figure while providing input isolation. Accurate measurements over a wide frequency range are assured due to the broad frequency coverage, flat frequency response and low distortion of these amplifiers. (See page 37).

### 11694A 75Ω Matching Transformer (3-500 MHz)

Allows measurement in 75-ohm systems while retaining amplitude calibration. VSWR is less than 1.2, and insertion loss is less than 0.75 dB. Note: Also see Options 001 and 002 for 75Ω versions of 8557A and 8558B.

### 1121A Active Probe (0.1-500 MHz)

Provides high impedance (>100 kΩ shunted by <3 pF) input to spectrum analyzer for measurements on sensitive circuits. Probe power is supplied by most HP Spectrum Analyzers and flat response with unity gain assures accurate, convenient measurements. (See page 481).

### 11517A External Mixer

To extend the frequency range of the 8555A, 8565A and 8566A analyzers to 40 GHz (for use with 8566A, order 11517A, Opt E02). Taper sections for 12.4-18 GHz (11518A), 18-26.5 GHz (11519A) or 26.5-40 GHz (11520A) bands are required.

### 11693A Limiter (0.1-12.4 GHz)

The Model 11693A Limiter provides input protection for a variety of instruments in general applications (usable from 0.01 to 18 GHz). For example, the input circuits of spectrum analyzers, samplers, or amplifiers may be protected for inputs up to 75 watts peak or 1 watt average power. Also, signal generators can be protected from application of reverse power.

### 11867A RF Limiter (DC-1800 MHz)

The 11867A is a general purpose diode limiter designed to provide input protection from inadvertent strong signal overloads. Absolute amplitude calibration is maintained with flatness degraded <±0.25 dB and insertion loss <0.75 dB. 10 watts average or 100 watts peak power can be tolerated.

### 8721A Directional Bridge

For making return loss measurements from 100 kHz to 110 MHz. (See page 481 under "11652A: Directional bridge").

### 8406A Frequency Comb Generator

Produces frequency markers at 1, 10, and 100 MHz increments accurate to ±0.01%. External oscillator can be used to generate precision interpolation sidebands. Comb is usable to beyond 5 GHz.

### 197B Oscilloscope Camera

For a permanent record of your measurements. (See page 219 for necessary adapters).

### Ordering Information

	Price
11694A 75Ω Matching Transformer	\$75
11517A External Mixer (Mixer only)	\$275
11518A/11519A/11520A Waveguide Taper Sections	\$175
11693A Limiter	\$235
11867A RF Limiter	\$225
8406A Frequency Comb Generator	\$1100
8750A Storage-Normalizer	\$1750

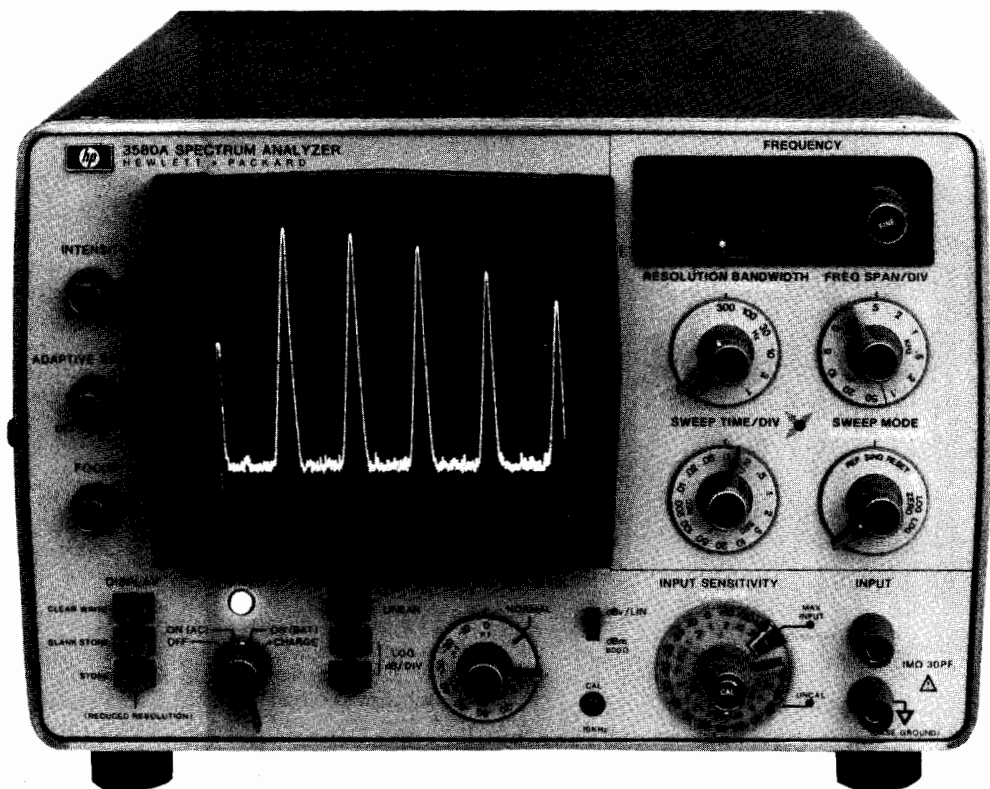

### Description

Hewlett Packard's 3580A Spectrum Analyzer is a low frequency high performance analyzer. Its 1 Hz bandwidth allows the user to examine noise and extraneous signal content close in to a signal of interest.

For low frequency applications where sweep speeds can be slow and time-consuming, a special feature, adaptive sweep, allows the user to set a threshold above which only the spectra of interest are observed. In this mode, the CRT is rapidly swept. When a signal is encountered, the sweep slows down to reproduce full response. A factor of ten speed gain is possible.

Digital storage is another important feature which enhances the display for slowly swept low frequency signals. The analyzed signals are digitized and stored in memory. Trace information is then read from memory at a rate appropriate for obtaining an analog-like display.

### Digital Storage for Spectra Comparison

Digital storage makes it possible to store one or two traces. When two are stored, both may be simultaneously displayed for easy comparison as shown below.

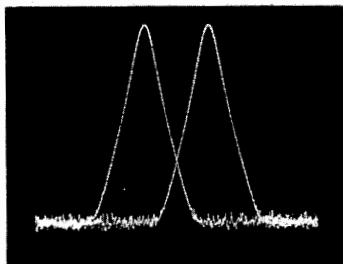

### Adaptive Sweep

A tremendous savings in sweep time can be achieved by using adaptive sweep. In the left trace below, over 80 dB of dynamic range is used to look at low level signals and noise. Two hundred seconds were required to make the sweep. In the right trace, the baseline is raised to give 50 dB of dynamic range. Noise and other responses are not analyzed so the sweep now takes only 14 seconds.

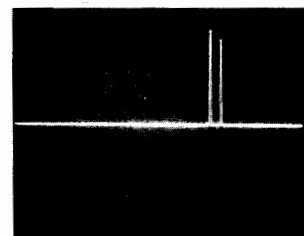
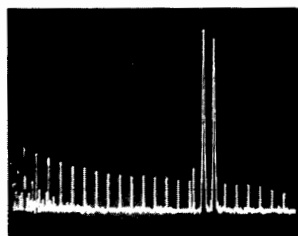

### 1 Hz Bandwidth

When using a 1 Hz bandwidth 60 Hz line related spectra are clearly exposed as shown in the left trace. An analysis of the same signal with a 10 Hz bandwidth will not resolve the line related spectra as shown on the right.

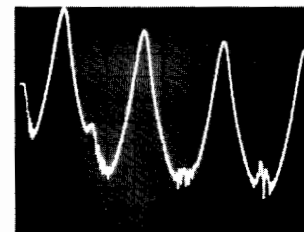
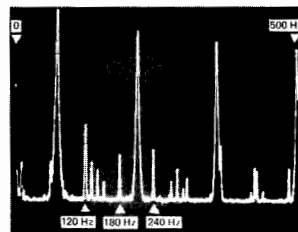

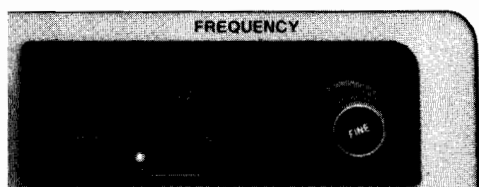

## Digital Frequency Display

This display provides 1 Hz resolution for setting analysis range and for determining tuned frequency. In the automatic sweep modes, the sweep start or center frequency is displayed. In the manual sweep mode, actual tuned frequency is indicated. This mode effectively provides a cursor function for easy and accurate determination of the frequency at any point on the screen.

## Internal Calibration Signal

A 10 kHz pulse derived from a crystal can be used to compensate for internal errors. A 10 kHz calibration potentiometer is provided so the 10 kHz fundamental can be adjusted to fall on the top line of the display. With this feature, operation and calibration can be verified for most of the instrument.

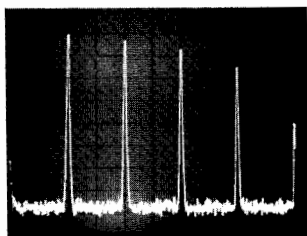

## Specifications

### Frequency Characteristics

**Range:** 5 Hz to 50 kHz.

**Digital Frequency Display:**

**Resolution:** 1 Hz

**Accuracy:**  $\pm 3.5$  Hz, 0 to 55°C.

**Typical stability:**  $\pm 10$  Hz/hr after 1 hour;  $\pm 5$  Hz/°C.

**Bandwidths:**  
(accuracy  $\pm 15\%$ )

1 Hz (25°C $\pm 5^\circ$ C)	3 Hz	10 Hz	30 Hz	100 Hz	300 Hz
10					8

**Out of range blank:** if controls are set so portions of displayed signal lie below 0 Hz or above 50 kHz, the baseline is displayed.

### Amplitude Characteristics

**Overall instrument range:**

Linear: 20 V –100 nV full scale  
Log: +30 dBm or dB V;  
–150 dBm or dB V

<b>Amplitude accuracy:</b>	Log	Linear
Frequency response:		
20 Hz–20 kHz	$\pm .3$ dB	$\pm 3\%$
5 Hz–50 kHz	$\pm .5$ dB	$\pm 5\%$
Switching between bandwidths (25°C):		
3 Hz–300 Hz	$\pm .5$ dB	$\pm 5\%$
1 Hz–300 Hz	$\pm 1$ dB	$\pm 10\%$
Amplitude display	$\pm 2$ dB	$\pm 2\%$
Input attenuator	$\pm .3$ dB	$\pm 3\%$
Amplitude reference level: (IF attenuator)		
Most sensitive range	$\pm 1$ dB	$\pm 10\%$
All other ranges	$\pm 1$ dB	$\pm 3\%$

**Dynamic range:** 80 dB

**IF feedthru:** input level  $>10$  V,  $-60$  dB;  $<10$  V,  $-70$  dB.

**Spurious responses:**  $>80$  dB below input reference level.

**Smoothing:** 3 positions, rolloff is a function of bandwidth.

**Overload indicator:** this LED indicator warns of possible input amplifier overloading. Without this indication it would be possible to introduce spurious responses without knowing it.

### Sweep Characteristics

**Scan width:** 50 Hz to 50 kHz.

**Log sweep:** 20 Hz to 43 kHz  $\pm 20\%$  after 3 sweeps.

**Sweep times:** .1 sec to 2000 sec.

**Rep:** Repetitive sweeps over the specified band.

**Reset:** Resets to the beginning of the sweep—used to adjust start or center frequency.

**Manual:** in combination with the concentric knob, manual sweep fully duplicates the span of the electronic sweep.

**Adaptive sweep:** when in adaptive sweep below the threshold level, scan speed is 20 to 25 times faster. Threshold is adjustable to cover 0–60% of screen. Signals greater than about 6 dB above threshold are detected and swept slowly.

**Sweep error light:** this LED indicates a sweep that is too fast to capture full response. When the light is on, response can be  $>5\%$  lower than it should.

**Zero scan:** to look at the time varying signal at the center or start frequency within the bandwidth selected, the zero scan is used.

### Output Characteristics

**Tracking generator output:** (also known as BFO or tracking oscillator output).

**Range:** 0 to 1 V rms into 600 $\Omega$ .

**Frequency response:**  $\pm 3\%$ , 5 Hz to 50 kHz.

**Impedance:** 600 $\Omega$ .

**Total harmonic and spurious content:** 40 dB below 1 volt signal level.

### X-Y recorder analog outputs

**Vertical:** 0 to +5 V  $\pm 2.5\%$ .

**Horizontal:** 0 to +5 V  $\pm 2.5\%$ .

**Impedance:** 1 k $\Omega$ .

**Pen lift:** contact closure to ground during sweep.

**Size:** 203.2 mm H x 412.8 mm W x 285.8 mm D (8" x 16 1/4" x 1 1/4").

**Weight:** net, 12.25 kg (27 lb); 3580A Opt 001: net, 15.88 kg (35 lb).

**Temperature range:** 0°C to 55°C.

**Power:** 100 V, 120 V, 220 V, or 240 V  $+5\%$   $-10\%$ . 48 to 440 Hz, 35 VA max.

**Opt 001 battery:** 5 hours from full charge. 14 hours to fully recharge. The internal battery is protected from deep discharge by an automatic turn off. Useful life of batteries is over 100 cycles.

### Ordering Information

**Opt 001:** internal rechargeable battery

**Opt 002:** balanced input

**Price**

add \$450

add \$135

**3580A Spectrum Analyzer**

**\$5300**

# SIGNAL ANALYZERS

Dual-Channel, Dynamic Signal Analyzer 0.02 Hz to 25.5 kHz

Model 3582A

- Transfer function magnitude and phase measurements
- Coherence function measurement
- Phase spectrum measurement
- Transient capture and frequency domain analysis
- Internal periodic and random noise source
- Band selectable analysis for 0.02 Hz resolution
- Alphanumeric CRT annotation and marker readout

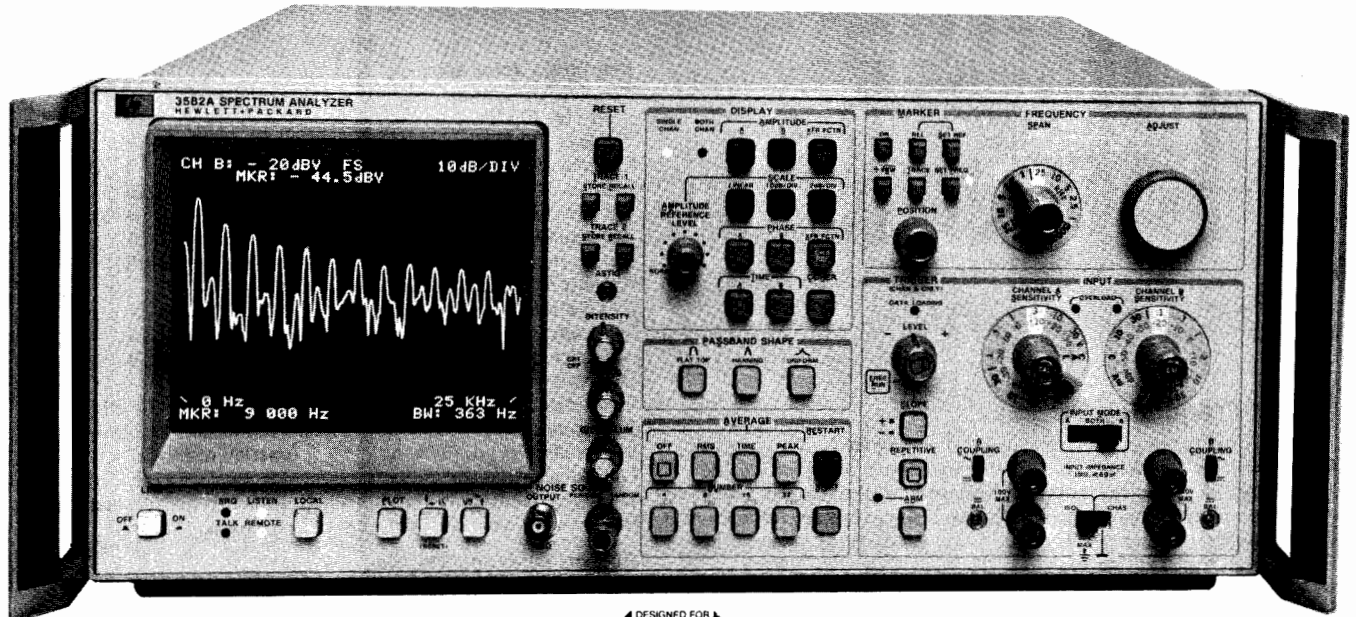

### Description

The 3582A is a powerful dual-channel, real-time spectrum analyzer that solves bench or systems measurement problems in the frequency range of 0.02 Hz to 25.599 kHz. Sophisticated LSI digital filtering combined with microcomputer execution of the Fast Fourier Transform (FFT) provides exceptional measurement capability and performance.

### Exceptional Frequency Resolution

The ability to resolve closely spaced spectral components is often critical in the study of subtle phenomena such as structural transfer functions. Unlike conventional dynamic signal analysis which extends from DC to some maximum frequency, the Model 3582A can "zoom in" to analyze any selected band of frequencies with dramatically improved resolution. The start or center frequency of the 5 Hz to 25 kHz band analysis spans can be adjusted in 1 Hz increments to cover the entire frequency range of the instrument. This provides resolution down to 20 milliHertz across the entire range for spectrum analysis or 40 milliHertz for transfer functions, representing as much as 5000 to 1 improvement over conventional "baseband" analysis.

### Excellent Low Frequency Coverage

Many electrical and physical measurements have significant spectral information in the audio and sub-audio range. With frequency ranges from 25 kHz down to 1 Hz full scale, the Model 3582A is extremely well suited to these types of measurements. The display shown in fig. 1 represents the phase noise of a frequency synthesizer over the range of 0 to 1 Hz with a frequency resolution of 6 milli-Hertz.

### Real Time Measurement Speed

Long measurement times can be a major limitation of swept low frequency spectrum analyzers. In high volume testing or in applications requiring substantial on-line tuning these long measurement times are both expensive and inconvenient. Since the Model 3582A uses an advanced microcomputer to execute the Fast Fourier Transform (FFT), it can perform equivalent measurements as much as one to two orders of magnitude faster than a swept analyzer.

### Wide Amplitude Range

When examining the sensitivity of an analyzer, it is important to consider the full range of potential applications. If the analyzer does not directly cover the range of anticipated signals, external amplifiers or attenuators will be required. These devices can add their own noise and can distort the signal being measured. The Model 3582A offers 150 dB of calibrated measurement range covering +30 dBV (31.6 volts) to -120 dBV (1  $\mu$ volt) and thus minimizes the need for external signal conditioning. Even with input sensitivities down to -120 dBV the input circuit is fully protected against accidental overloads of 100 Volts DC or 120 Volts RMS for short periods.

### Wide Dynamic Range

In many applications the information of interest is contained not in the high amplitude fundamental, but rather in the low amplitude components. For a spectrum analyzer to provide useful information about these low level components in the presence of a large signal, it must offer wide dynamic range. The Model 3582A dynamic range is specified as 70 dB.

### Phase Spectrum Measurement

Most spectrum analyzers can measure only the amplitude spectrum of a signal, yet complete characterization in the frequency domain

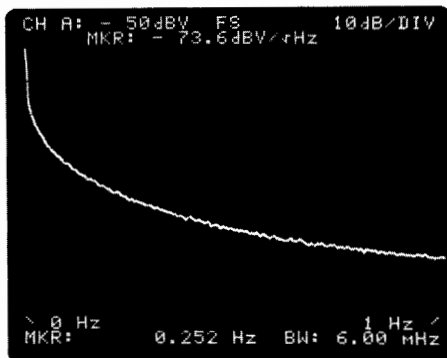

Figure 1: Phase Noise Measurement

also requires phase information. Signals with identical amplitude spectra, but different phase spectra can differ significantly. The advanced digital signal processing techniques incorporated in the Model 3582A provide direct measurement of phase spectra.

### Transient Capture and Analysis

Many signals such as mechanical shocks and electrical transients may occur infrequently and spontaneously and may last only for a brief period of time. Swept spectrum analyzers generally cannot handle these transient signals. By using digital processing techniques, the Model 3582A can capture and analyze transients as short as a few milliseconds. This means that spectrum analysis and transfer function analysis are no longer limited to stable, time invariant signals.

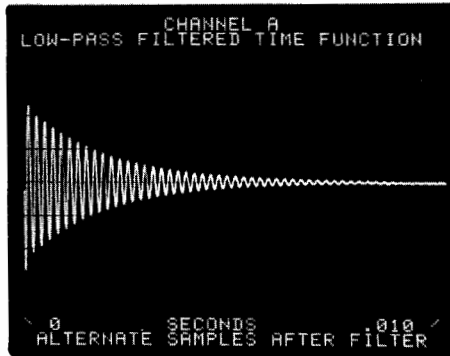

Fig. 2A

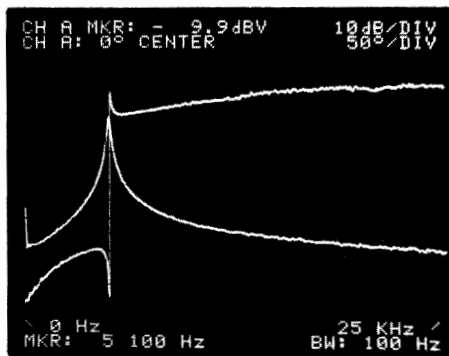

Fig. 2B

Figures 2A & 2B: Capture and analyze transients in both amplitude and phase.

### Transfer Function Measurement With the Internal Noise Source

Many electrical circuits and mechanical systems can be treated as linear networks and can be characterized by the magnitude and phase of their transfer functions.

Most spectrum analyzers can measure only the magnitude portion of the transfer function - and even then only by assuming a flat drive signal. The Model 3582A directly measures the complete transfer function, both magnitude and phase. With dual channels the actual drive signal is measured on Channel A and thus does not have to be totally flat; drive signal variations are taken out in the computation process to give valid results. The major constraint on the input signal is that, unlike a swept source, it must stimulate all frequencies of interest simultaneously. Two sources are provided in the Model 3582A which meet this constraint. They are pseudo-random and random noise. For linear networks, the pseudo-random noise source gives you accurate results in the fastest theoretically possible time. When nonlinearities are a problem, random noise gives the best estimate of the transfer function at the operating point. In addition, both noise sources are bandlimited to concentrate all stimulus energy in the band of frequencies analyzed. This minimizes test time because it improves the signal to noise ratio of the measurements. This also minimizes the disturbance to the network under test, which can be very important in control applications.

With this drive signal functioning as a "tracking generator" substitute, the Model 3582A is a low frequency network analyzer with "real-time" measurement speed. As with spectrum measurements, portions of the transfer function as narrow as 5 Hz can be examined anywhere over the 25 kHz frequency range.

### Coherence Function Measurement

The measurement of a device transfer function assumes that the device under test is linear and that no portion of the output is caused by noise or extraneous signal sources. In active electronic circuits or mechanical structures these conditions can easily be violated - yet such violations are very difficult to identify. The Model 3582A considerably simplifies this problem by providing the direct measurement of the coherence function. This is a frequency domain measure of the fraction of the power in one signal (e.g., the output) caused by the other measured signal (e.g., the input). If this fraction is 1.0, the output at that frequency is caused by the input and the transfer function is valid. If the fraction is near 0.0, the output is caused by something other than the measured input. This cause could be noise, nonlinearities or an unanticipated input, but the result is the same - the transfer function data at that frequency is suspect.

In addition to serving as a valuable check on the validity of transfer functions, the coherence function can be useful when investigating cause/effect relationships particularly in multiple input systems.

### Digital Averaging Capability

Many spectral measurements contain both discrete signals and random noise components. Obtaining proper amplitude readings can be difficult if the random components are really the ones of interest or are of nearly the same amplitude as the discrete signals.

The digital averaging techniques incorporated in the Model 3582A help solve these problems. The RMS averaging mode takes the power average of 4 to 256 successive spectra in order to reduce the uncertainty of the estimate of random spectral components. For measurements where the spectral information is not stable but varies slowly with time, a running exponential form of RMS averaging is provided. By continually reducing the importance of older spectra, this mode prevents old data from completely obscuring new data yet still retains the basic advantages of averaging.

When a synchronizing trigger signal is available, the TIME average can enhance the signal-to-noise ratio by as much as 24 dB. Since it involves the averaging of successive time records before transformation it is also significantly faster than other types of averaging.

### Fully Annotated, Calibrated CRT Display

One of the most important features of the Model 3582A is its ease of use. Operator interaction with the instrument is simplified by the combination of intelligent microcomputer control and the alphanumeric display capability. The basic annotation clearly shows the major measurement parameters.

### Operational Diagnostics

In addition to measurement results, the display is used to provide the operator with useful diagnostics. As the examples show, these tend to not only indicate the problem, but also to suggest an appropriate action.

Fig. 3A

Fig. 3B

Figures 3A & 3B: Operational diagnostics not only show problem but also suggest solution



# SIGNAL ANALYZERS

## Dual-Channel, Real-Time Spectrum Analyzer 0.02 Hz to 25.5 kHz

Model 3582A (cont.)

### Service Diagnostics

By pressing combinations of front panel keys, the instrument will run self-diagnostic routines. These include a test of all the ROM, RAM, front panel, display, recorder output and the digital filters. The test results are displayed on the CRT as either "OK" (correct) or "ER" (error).

### Powerful HP-IB Capability

The Hewlett-Packard Interface Bus (HP-IB) is an interface concept that allows two-way communication among as many as fifteen different devices. Generally, at least one of these devices is a "computing controller" which exercises overall system control. This controller directs and coordinates the activities of the other devices in the system.

All major front panel controls with the exception of the verniers are fully programmable via the HP-IB. The programming codes are simple and are logically derived from the front panel control labels. The states of the various controls occupy only ten 8-bit bytes of data that can be read and written by the HP-IB. This allows you to manually set up a test from the front panel and store it in a compact form.

From the HP-IB it is a simple matter to command the Model 3582A to output results in a usable form. Not only can the various control settings be retrieved, but numeric marker data can be extracted. More importantly, the full display can be read in ASCII format along with complete annotation.

The HP-IB structure is entirely flexible, allowing any of the RAM (random access memory) in the instrument to be read or written into. This means that intermediate computational results such as the cross power spectrum can be read by a computing controller. In applications where speed is critical, the controller can transfer the displayed traces in binary, direct from the RAM. The ability to write into the RAM is also extremely valuable. For example, a perfect time record can be synthesized from a mathematical model and input to the instrument for analysis. More importantly, stored display information such as the vibration signatures of a rotating machine can be input to the instrument for review. Also, the controller can mathematically process the stored data and format the results for display on the CRT. Since the controller can also write its own four lines of alphanumeric text, the results can be properly annotated and calibrated. The operator can even be given brief interpretation instructions—all on the CRT of the instrument.

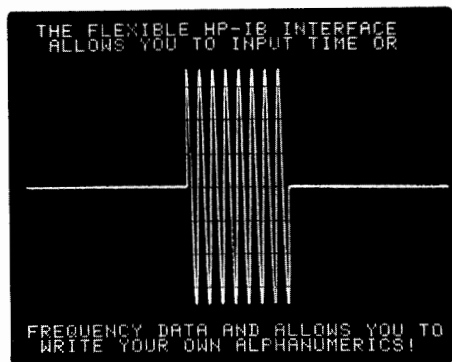

Figure 4:

Special Displays Are Possible Under HP-IB Control

### A Wide Range of Applications Including:

#### • Low frequency electronics

#### Characterize Signal Sources

Spectrum analyzers have typically been of major value in characterizing the harmonic distortion, spurious outputs, level and frequency of signal sources. The model 3582A not only makes these measurements better and more accurately than before, but it also makes them faster. The additional combination of "real-time" measurement speed and the powerful HP-IB capability make automated testing of these parameters very attractive.

#### Phase Noise Measurement

In addition to characterizing low frequency sources, the Model 3582A can help characterize the short term random frequency fluctu-

ations of a precision high frequency source. This is accomplished by mixing the high frequency signal down to DC and measuring the phase noise close-in to the carrier.

#### Filter Measurement

With direct transfer function measurements and the built-in driving source, the Model 3582A is well suited to performing a network analysis of low frequency devices such as filters. Figure 5 shows a five section low pass elliptic filter.

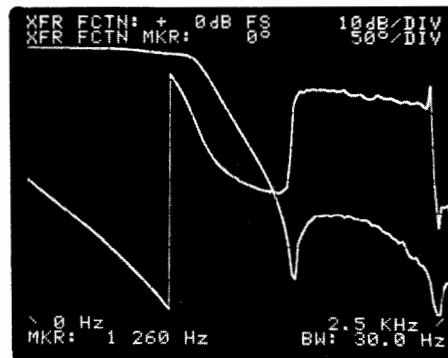

Figure 5:  
Filter Transfer Function

#### • Telecommunications

The frequency range and performance characteristics of the Model 3582A are well matched to the R&D and production needs of telecommunications. Voice frequency components including analog lines can be easily characterized.

Specialized signal sources such as multifrequency tone sources and modems can pose unusual testing problems. Figure 6 shows the frequency spectrum of a modem transmitting a string of asterisks.

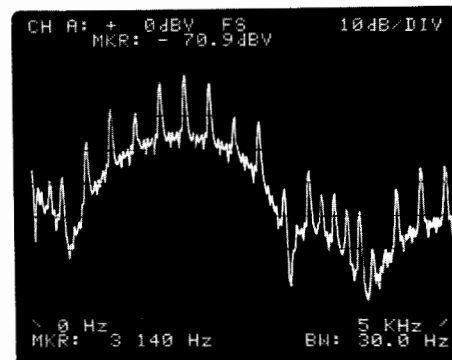

Figure 6:  
Modem Spectrum

#### Audio and Acoustics

#### Tape Recorder Flutter

The Model 3582A has a number of features that make it well suited to the analysis of entertainment products. For example, an audio tape recorder is a moderately complex electromechanical system. Any unwanted mechanical speed variations will show up as discrete modulation sidebands on a recorded tone. With the frequency resolution of the Model 3582A, it is possible to identify the sidebands precisely enough to relate them to actual geometries.

#### Loudspeaker Testing

Loudspeakers provide another interesting application example. By combining the built-in noise source with time averaging, it is possible to obtain valid characterizations even in the presence of ambient noise as shown in figure 7.

It is also possible to use impulse type signals for this measurement. Since the time record collection time is only a few milliseconds, this can minimize the echo problems.

With a slightly different hook-up the electrical impedance of a loudspeaker can even be measured.

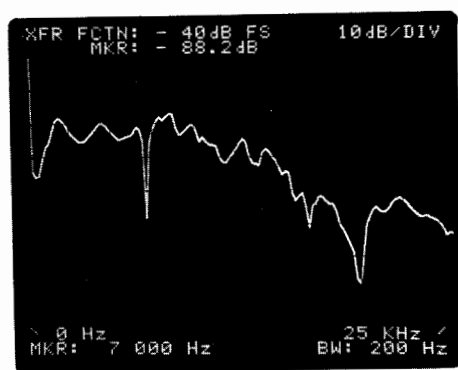

Figure 7:  
Loud Speaker Response

• **Structural analysis**

A broad range of mechanical structures can be adequately described as linear systems and can be characterized by their frequency domain transfer functions. These transfer functions relate applied forces and the resulting motion. This example illustrates the driving point inertance (acceleration/force) transfer function of a small beam.

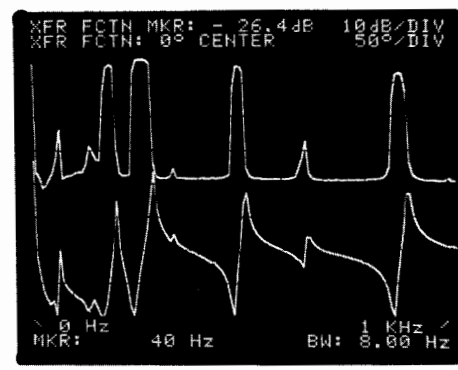

Figure 8:  
Driving Point Inertance

• **Rotating machinery signatures**

Every rotating machine exhibits a unique characteristic vibration pattern determined not only by the basic design and construction of the machine, but also by environmental factors and wear. With the appropriate transducers the Model 3582A can measure and analyze these vibration patterns or "signatures."

**3582A Specifications**

**Frequency**

**Range:** 0.02 Hz to 25.5 kHz with the low frequency limit the result of DC response.

**Spans:** 1 Hz to 25 kHz in a 1-2.5-5-10 sequence. The 1 Hz and 2.5 Hz spans are usable only in the 0-start mode.

**Accuracy:** ±0.003% of display center frequency.

**Resolution:** 0.4% of the frequency span for single channel or 0.8% of the frequency span for dual channels.

**Filter passband shape:**

	Flat Top	Hanning	Uniform
<b>3 dB Bandwidth (single channel)</b>	(1.4 ±0.1% of span)	(0.58 ±0.05% of span)	(0.35 ±0.02% of span)
<b>Shape Factor</b>	2.6 ±0.1	9.1 ±0.2	716 ±20

**Amplitude**

**Display modes:**

**Log:** 10 dB/division or 2 dB/division

**Linear:** Constant voltage/division

**Measurement range:**

**Log:** +30 dBV to -120 dBV noise floor

**Linear:** +30 V to 1μV noise floor

**Dynamic range:** 70 dB

**DC response:** Adjustable to >40 dB below maximum input level

**Accuracy:**

**Accuracy at the Passband Center** ±0.5 dB

**Flat top filter:** +0, -0.1 dB

**Hanning filter:** +0, -1.5 dB

**Uniform filter:** +0, -4.0 dB

**Note:** Overall accuracy is the sum of the accuracy at the passband center plus the selected filter accuracy.

**Resolution:**

**Log:** 0.1 dB

**Linear:** 3 digits

**Phase**

**Display range:** +200 degrees to -200 degrees

**Accuracy:** ±10 degrees

**Resolution:** 1 degree

**Transfer Function**

**Measurement range:**

**Log:** +160 dB full scale to -80 dB full scale

**Linear:** 4 × 10<sup>8</sup> full scale to 4 × 10<sup>-9</sup> full scale

**Phase display range:** +200 degrees to -200 degrees

**Accuracy:**

**Amplitude:** ±0.8 dB

**Phase:** ±5 degrees

**Accuracy: Option 001**

Amplitude	0.4 dB	0.8 dB	
φ	±2°	±5°	
	0.02 Hz	5 kHz	25.5 kHz

**Coherence**

**Measurement range:** 0.0 bottom display line to 1.0 top display line

**Resolution:** 0.01

**Input**

**Impedance:** 10<sup>6</sup> Ω ±5% shunted by <60 pF from input high to low (for less than 75% relative humidity)

**Isolation:** Input low may be floated up to 30V

**Coupling:** Switch selection of AC or DC coupling. The low frequency 3 dB roll off is <1 Hz.

**Common mode rejection:**

**50 Hz:** >60 dB

**60 Hz:** >58 dB

**Crosstalk:** <-140 dB between channels with 1 kΩ source impedance driving one channel and the other terminated in 1 kΩ.

**Output**

**X-Y recorder:**

**Level:** 0V to 5.25 V ±5%

**Impedance:** 1 kΩ

**Pen lift:** contact closure during sweep

**Noise source:**

**Type:** Periodic pseudorandom noise or random noise signal with switch selection. Both are band limited and band translated to match the analysis.

**Level:** From <10 mV to >500 mV RMS into >50 Ω

**Impedance:** <2 Ω

**General**

**Environmental:**

**Temperature:** 0°C to 55°C operating; -40°C to +75°C storage

**Humidity:** <95% R.H. 0°C to 40°C

**Power requirements:** 100, 120, 220, or 240 volts (+5%, -10%); 48-66 Hz; less than 150 VA

**Dimensions**

**Size:** 425.5 W x 552.5 D x 188 mmH (16.75" x 21.75" x 7.4")

**Weight:** 24.5 kg (54 lbs.); shipping weight: 29 kg (63 lbs.)

**Options**

**Opt 001:** High Accuracy Transfer Function Measurement Option

**Price**

add \$500

**3582A Spectrum Analyzer**

**\$10,700**



## SIGNAL ANALYZERS

Automatic spectrum analyzers from 10 Hz to 13 MHz

Models 3044A/3045A

### 3044A

- High accuracy and resolution digital amplitude measurements
- Synthesizer frequency accuracy and stability
- Wide amplitude range of 150 dB
- Narrow band analysis
- Full digital control via HP-IB

### 3045A

- Full automation and low cost
- Speed and precision in measurements
- Data analysis and presentation of results
- Simplicity and flexibility in operation
- HP-IB systems interfacing flexibility
- 9825T Desktop Computer

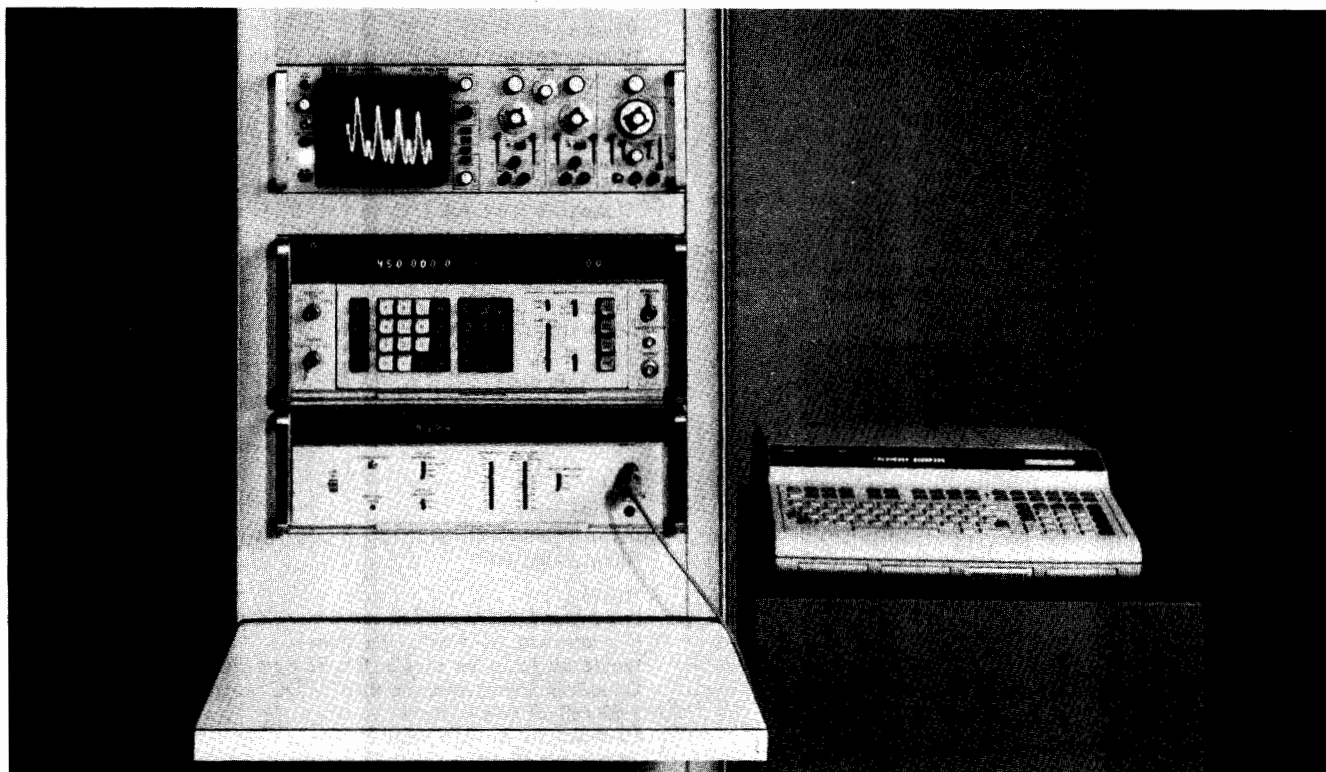

3045 System with Option 204 (HP Model 1201B Oscilloscope)



## Description

### 3044A Spectrum Analyzer

Meeting the demand for precise frequency and amplitude measurements in the 10 Hz to 13 MHz region, the 3044A is a spectrum analyzer with tracking generator. This system uses a synthesizer with leveled output and sweep capability to generate the local oscillator signal for the analyzer and the tracking generator output. This allows fast, extremely accurate "tuning" with the use of frequency up-down keys or keyboard entry of center frequency. The input impedance is front-panel switch selectable to 50 $\Omega$ , 75 $\Omega$ , and 1 M $\Omega$ . The units of the digital display are also front-panel selectable to dBm, dBV and dB relative to a user-entered offset. Digital display of amplitude and frequency gives an unambiguous, high-resolution readout commensurate with the wide dynamic range and high accuracy of this analyzer.

### 3045 Automatic Spectrum Analyzer

While the 3044A is an excellent stand-alone spectrum analyzer, the capabilities are greatly improved with the addition of the 9825T Desktop Computer, which forms the 3045A system.

The 9825T Desktop Computer allows program and data storage on its fast tape cassette. The tape cassette, short calculation times and

buffered input/output speed allow repeated, automated tests which can greatly reduce production and quality-assurance test times. Also the scope of possible measurements greatly increase with the 3045A System. Logarithmic sweeps and limit tests are only two examples. The calculator also allows data manipulation and presentation in units familiar to the system operator in graphic or tabular form.

Because the user may not be familiar with HPL (the language of the 9825T) or even with programming, a compiler is furnished with the 3045A System. The compiler allows the calculator to converse in terms understood by the test engineer, like start and stop frequencies, plot results, and compare with limits. It also accepts and outputs in units of Hz, kHz, MHz, dBm and dBV. The compiler enables the execution of sophisticated tests, like intermodulation distortion measurements, with only a few minutes of initial "programming" time. It can also record the test parameters, which can then be used repeatedly, as in a production environment. The compiler's versatility and ease of use make the full power of the 3045A Spectrum Analyzer readily available to the user.

The 3045A Automatic Spectrum Analyzer system is fully integrated, tested, verified and specified as a system. It is supplied with complete software and documentation.



### Accurate and Repeatable Results

Whether the spectrum analysis environment is the R & D lab, production test or Q.A., the prime requirement is almost always for test results that are both accurate and repeatable, and easily and quickly acquired. The 3044A/3045A systems meet all of these testing requirements. The analyzer with its synthesized source offers drift-free performance with high accuracy. Because the system is fully programmable, a controller such as a Desktop Computer can set analyzer RF and IF gains, bandwidths, sweepwidths, etc.—operations that would be time consuming and error-prone with a manual system. Results are thus very repeatable and a highly trained operator is not required.

### High Resolution and Wide Dynamic Range

The spectrum analyzer systems offer 0.1 Hz tuning resolution and 0.01 dB amplitude resolution. The high resolution display, combined with the analyzer's wide 80 dB dynamic range, allows accurate measurement of signal peaks and spurious responses in one sweep. The analyzer also features a large amplitude range of 150 dB (+10 dBV to -140 dBV), making it suitable for a wide range of applications.

### Presentation of Results

Using the 9825T Desktop Computer, the 3045A system offers a variety of formats for data presentation—from a simple pass/fail indication on the computer's alphanumeric display to more complete presentations on a wide range of HP-IB printers and plotters. An example print out is shown below.

```

Amplifier Test          S/N 12345
Gain Test
  1 KHz ref.           0.12 dBm output    PASSED
*****
Freq. Response Test
  3 dB Corner Freq.   1.1 MHz           PASSED
*****
Linearity Test
  (10dBm ref.)        1.13 dB compression    FAILED
UNIT FAILED---Check adjustment of R22
*****

```

Test results printed on the HP 9871A

## 3044A/3045A Specifications

### Frequency Specifications

**Frequency range:** 10 Hz to 13 MHz.

**Scan width:** any desired scan is possible in 10, 100 or 1000 steps of frequency increments as small as 0.1 Hz and with 0.1 Hz resolution. The 3045A is additionally capable of taking any number of steps with direct calculator control of the sweep.

### Resolution

**Bandwidth:** 3 Hz to 10 kHz in a 1, 3, 10 sequence.

**Bandwidth selectivity:** 60 dB/3 dB bandwidth ratios  $\leq 11:1$ .

### Stability

**Long term:**  $\pm 1 \times 10^{-8}$ /day.

$\pm 1 \times 10^{-7}$ /month.

**Phase noise:** <50 dB below CW signal in a 30 kHz band around signal.

### Amplitude Specifications

**Absolute amplitude calibration range:** -130 dBm to +20 dBm (50 or 75 $\Omega$ ). -140 dBV to +10 dBV.

**Digital amplitude readout:**  $\pm 199.99$  dB with 0.01 dB resolution.

### Dynamic range

**Average noise level:** -127 dBV in 1 kHz resolution bandwidth.

**Smoothing (video filter):** provides smoothing with a bandwidth of  $\frac{1}{10}$ th the resolution bandwidth on all but the 3 Hz and 10 Hz bandwidths.

**Spurious responses:** >70 dB below input range setting.

**Distortion responses:** >80 dB below input signal at input range setting level.

**Power-line related responses:** 70 dB below input range on +10 dBV through -40 dBV ranges; 60 dB on -50 dBV; 50 dB on -60 dBV ranges.

### Amplitude Accuracy

**Frequency response:**  $\pm 0.25$  dB (250 kHz reference).

**Input range:**  $\pm 0.05$  dB/step,  $\pm 0.15$  dB total accumulation.

### Log linearity:

0 to -30 dB  $\pm 0.1$  dB.  
 -30 to -60 dB  $\pm 0.25$  dB.  
 -60 to -80 dB  $\pm 0.75$  dB.

**Stability:** (8 hr., 25°C  $\pm 1$ °C, after 1 hr. warmup)

10 kHz, 3 kHz, 100 Hz, 30 Hz, 10 Hz, BW's

0 dB	-30 dB	-60 dB
$\pm 0.05$ dB		$\pm 0.08$ dB

temp. coefficient

$\pm 0.02$  dB/°C

1 kHz, 30 Hz, 3 Hz BW's

0 dB	-30 dB	-60 dB
$\pm 0.08$ dB		$\pm 0.15$ dB

$\pm 0.04$  dB/°C

### Tracking Generator (3330B output)

**Frequency range:** 0.1 to 13 000 999.9 Hz.

**Frequency resolution:** 0.1 Hz (9 digits).

**Amplitude range:** +13.44 to -86.55 dBm (50 $\Omega$ ).

+11.68 to -88.31 dBm (75 $\Omega$  option).

### Amplitude Accuracy

**Leveled frequency response (10 kHz reference)\***

10 Hz	13 MHz	
$\pm 0.05$ dB		+13.44 dBm
$\pm 0.1$ dB		-16.55 dBm
$\pm 0.2$ dB		-36.55 dBm
$\pm 0.4$ dB		-66.55 dBm
		-86.55 dBm

\*Add 0.5 dB for leveling switch in off position.

**Attenuator (10 kHz reference, 25°C  $\pm 5$ °C):**  $\pm 0.02$  dB/10 dB step of attenuation from maximum output.

**Absolute accuracy:**  $\pm 0.05$  dB at 10 kHz and +13.44 dBm (25°C  $\pm 5$ °C).

**Amplitude stability (24 hr., 25°C  $\pm 1$ °C):**  $\pm 0.01$  dB.

### General

**Input impedance:** 50 $\Omega$ , 75 $\Omega$  >30 dB return loss.

1 M $\Omega$   $\pm 5\%$  shunted by 30 pF.

**Maximum input level:** +20 dBm.

**Programmability:** all controls, except power switches, are programmable using the HP-IB format.

### 3044A/3045A Options

The basic 3044A and 3045A system options are listed below. For more information refer to the 3044A/3045A data sheet.

#### 3044A Options

**110:** Standard 3571A

**Price**

add \$8000

**120:** Standard 50 $\Omega$  3330B w/Isol. HP-IB

add \$8270

**121:** Standard 75 $\Omega$  3330B w/Isol. HP-IB

add \$8270

**122:** 5 V Output

add \$310

#### 3045A Options

**200:** 50 $\Omega$  System

N/C

**201:** 75 $\Omega$  System

N/C

**204:** 1201B Oscilloscope

add \$3,300

### Ordering Information\*

**3045A Automatic Spectrum Analyzer consisting of:** \$27,800  
 3330B Synthesizer; 3571A Spectrum Analyzer; 9825T Desktop Computer, 64 k bytes memory; ROMs, Interface, documentation; 56" Rack.

\*HP-IB cable not supplied. See page 30.



# SIGNAL ANALYZERS

## Digital signal analyzers

Models 5420A and 5423A

- Dual-Channel Transfer Function
- Band Selectable Analysis
- Fully Calibrated Annotated Display

- Powerful Post-Measurement Processing
- Digital Data Storage
- Random Noise Generator

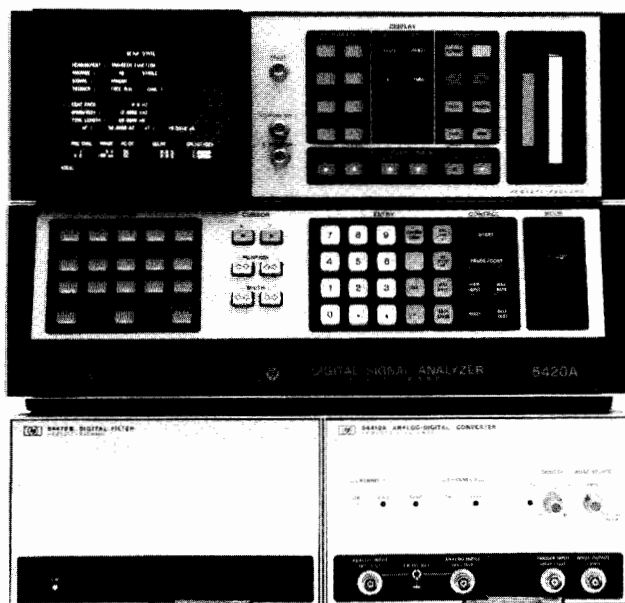

5423A



The 5420A Digital Signal Analyzer and 5423A Structural Dynamics Analyzer are high performance dual-channel instruments capable of a number of both time domain and frequency domain measurements over a 25 kHz range. In addition to broad measurement capability, the 5423A Structural Dynamics Analyzer provides complete facilities for analyzing the vibration characteristics of mechanical devices and displaying the results in the form of an animated mode shape. Both instruments are particularly adapted to solving problems associated with structural vibration and noise, rotating machinery, electro-mechanical control systems, acoustics and a host of similar applications which call for advanced low-frequency analysis.

Among the important standard features are a fully annotated and calibrated dual-trace display, permanent digital storage for measurement results, band selectable analysis, extensive data processing, advanced triggering capability, external sampling capability, calibration in engineering units and a built-in random noise generator. Capable of both stimulus-response and response only analysis, their measurement repertoire includes:

- Transfer Function
- Coherence Function
- Impulse Response
- Auto Spectrum
- Cross Spectrum
- Linear Spectrum
- Time Record
- Amplitude Histogram
- Auto Correlation
- Cross Correlation

Important capabilities such as independent pre and post trigger delay on each input channel, overlap processing, and external sampling insure that each instrument's measurement power can be effectively applied to a wide range of problems.

A built-in "waveform calculator" is useful for processing measured or synthesized data and greatly extends the basic capabilities. Examples of useful computed functions include:

- Data Comparisons
- Resonant Frequency
- % Critical Damping
- Open Loop Gain
- Calibration in %
- Mechanical Impedance
- Total Harmonic Distortion
- Coherent Output Power
- Signal-to-Noise Ratio
- Transmissibility
- Function Synthesis
- Power

### Operation

Operation of a digital signal analyzer has never been easier. A novel "menu" concept replaces the rotary and toggle switches commonly used to control an instrument's operation. The entire current set-up state, including measurement type, bandwidth, input ranges, etc., is displayed on the CRT at the push of a key. Changes to the set-up are made by selection from displayed lists (menus) or by direct numerical input from the control keyboard.

Once set-up, measurements are easily executed and may be paused or continued at will. Results are always fully calibrated and annotated. A self-test feature verifies proper operation.

### Data Display

Both the 5420A and the 5423A feature a fully annotated and calibrated, dual trace, three-format display which provides for ease of data interpretation. Each display trace is totally independent of the other in terms of the data which the user selects for display, the horizontal and vertical ranges over which it is displayed, and the coordinate system chosen. The user may select from up to 13 available coordinate systems, including complex plots such as Nyquist, at the push of a key. Display traces may be viewed one at a time in full format or simultaneously in either an upper/lower or overlaid format.

Dual X and Y axis cursors provide numerical data readout, in either absolute or relative terms, on both axes simultaneously in full format. Any area of the display may be graphically expanded for optimum viewing. Cursors may be either swept or set explicitly, via numerical entry, to desired locations. Harmonic cursors are provided. The X axis cursors may also be used to set the frequency range over which the instrument will operate, thereby concentrating its resolution into the bandwidth of interest.

The display section also contains a digital recorder which provides permanent storage of measurement results on small removable tape cartridges and eliminates the need to repeat time consuming and expensive testing. Stored measurements may be easily recalled for display, plotting, or further processing.

#### SETUP STATE

```
MEASUREMENT : TRANSFER FUNCTION
AVERAGE :      25      . STABLE
SIGNAL :        RANDOM
TRIGGER :      FREE RUN . CHNL 1
```

```
CENT FREQ :     2.0000 KHZ
BANDWIDTH :     800.000 HZ
TIME LENGTH :   320.000 MS
  AF :          3.12500 HZ      AT :          625.000 µS
```

ADC CHNL	RANGE	AC/DC	DELAY	CAL (C1/C2)
1	5 V	AC	0.0 S	33.3333
* 2	10 V	DC	10.0000 S	20.0000

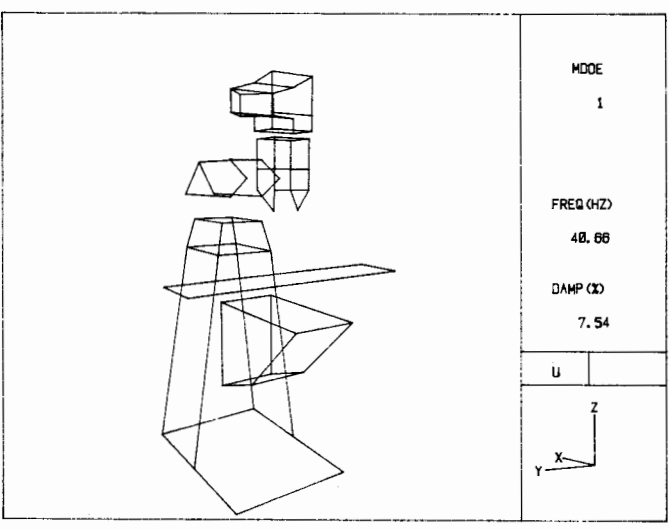
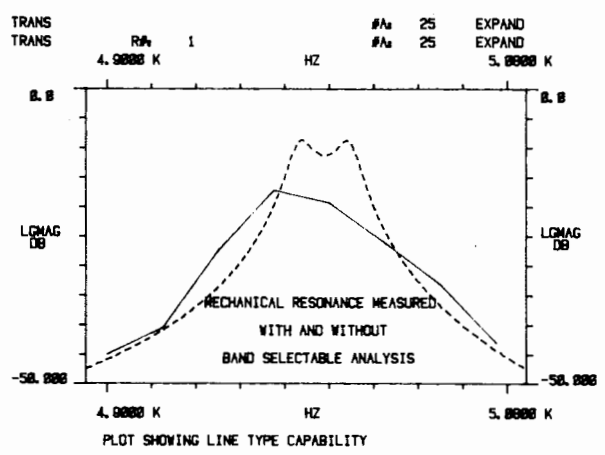
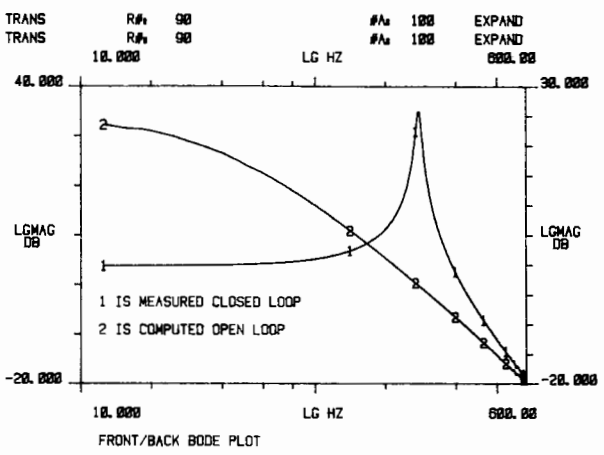
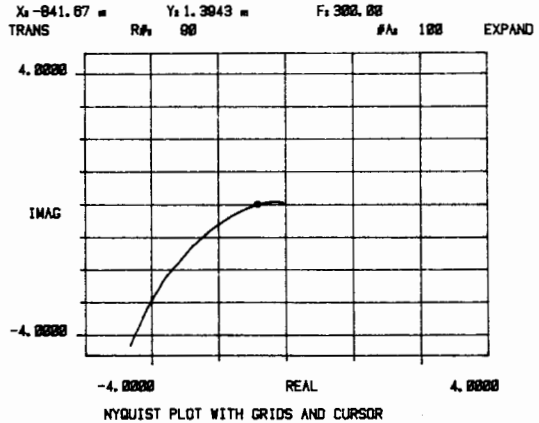
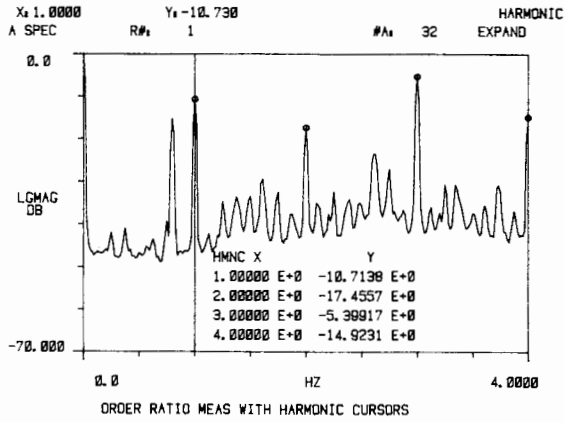

MODE SHAPE

MODE NO. : 1	M. MASS: 10.136 μ	LB-SEC <sup>2</sup> /IN
FREQ (HZ) : 40.000	M. DAMP: 301.538 μ	LB-SEC/IN
DAMP (X) : 7.537	M. STIF: 665.487 μ	LB/IN

DOF#	PT	DIR	AMPLITUDE
1	1	X	-15.4980 μ
2	1	Y	39.8400 μ
3	1	Z	-583.770 μ
4	2	X	10.2221 μ
5	2	Y	26.5220 μ
6	2	Z	-640.350 μ
7	3	X	10.2420 μ
8	3	Y	-0.0004 μ
9	3	Z	-470.791 μ
10	4	X	0.1779 μ

TOTAL DEGREES OF FREEDOM: 348

**Dynamic Analysis**

The 5423A provides, for the first time in a transportable, easy to use, low cost instrument, complete dynamic analysis capability. Frequency response measurements are made at points of interest on the test structure. The 5423A then analyzes the raw data to determine the frequency and damping associated with the structure's natural modes of vibration. In addition, the deflection pattern or mode shape of the structure is calculated for each mode of vibration. Results are available in tabular form or as an animated display with perspective to ease interpretation.

Mode shape display features include the ability to view the structure from any desired direction and distance. Amplitude and speed of animation are easily controlled and the structure can be made to rotate about any desired axis. A split-screen format facilitates compari-

son of different modes of vibration and may also be used to observe the structure in three dimensions with stereo viewers.

**HP-IB\***

Both the 5420A and 5423A include an HP-IB interface to provide for instrument control and data transfer to and from external computing controllers. In addition, both instruments are directly compatible with the HP 9872A, 7245A, and 7221A/17601A Digital Plotters. A separate computing controller, with its attendant cost and programming requirements is not needed. The user merely presses the plot or print key and the instrument will reproduce the desired information in hard copy form on the plotter.

**Ordering Information**

5420A Digital Signal Analyzer	\$28,000
5423A Structural Dynamics Analyzer	\$38,000

\*HP-IB cables not supplied, see page 30 for description and prices

# SIGNAL ANALYZERS

## Digital Fourier Analyzer, Vibration Test Control

Models 5451C, 5427A

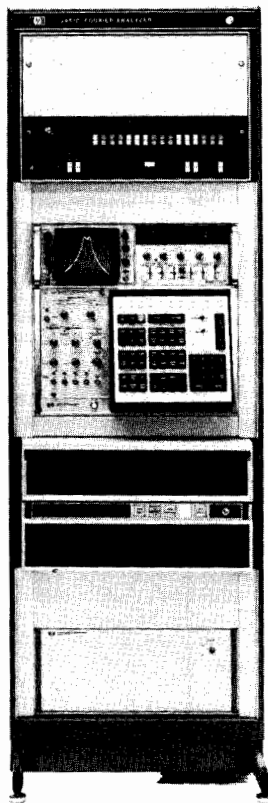
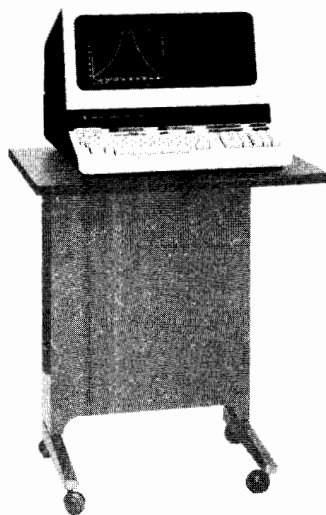

5451C Fourier Analyzer

### 5427A Description

The 5427A provides closed-loop control of environmental and/or developmental random vibration test stimuli. Sine and transient test control may be added optionally and inexpensively.

The basic system consists of: 5478C 2-channel (expandable to 4) analog-to-digital converter for processing feed-back information; 21MX-E series, microcoded digital processor; 1335A Persistence CRT Display; 2640B operator's terminal; 5477A pushbutton control unit, 9885M flexible disc storage unit; cabinet and programs for random control and a set of analysis routines designed for easy operation by laboratory personnel.

### System Operation

Random, sine and transient control follow the same logical operational phases. First, the appropriate disc is loaded and the test program or setup (envelope, alarm and abort limits, test time, calibrations, etc.) is loaded from disc storage in response to search codes or names. If a new program or modifications are desired, a friendly question-and-answer sequence is used. Once a new setup has been generated or changes made, it can be assigned a new name and stored for later use.

After a satisfactory setup is obtained, the operate phase allows control of the actual test via pushbuttons on the central control panel. Removable snap-on overlay panels clearly label buttons for the type of test desired. Choices of on-line displays and a 'save' button allows saving of data for later plotting, including auxiliary PSD measurements during random control.

After the test, results and all saved data are available for review or documentation. The digital plotter or graphic terminal options provide fully labeled, report-quality plots of test results.

### Specification Summary (Random Control)

**Resolution:** 64, 128, 256, & 512 lines (1024 lines optional).

**Loop Time:**  $\leq 0.9$  second with 2500 Hz bandwidth, 256 lines.

**Bandwidth:**  $\Delta f$  to 5000 Hz.

**Dynamic Range:**  $\geq 65$  dB.

**Reference Spectrum:** programmable, 32 breakpoints.

**5427A Base Price**

**\$45,150**

### Model 5427A

- Digital Accuracy and Repeatability
- Pushbutton Operation, Eliminates Programming
- Easily Expanded to Sine and Transient Control

### Model 5451C

- Multi-Channel Operation DC to 50 kHz (100 kHz Optional)
- Keyboard-Controlled Data Acquisition and Analysis
- $> 75$  dB Dynamic Range
- Dedicated Modal and Signature Analysis Packages

### 5451C Description

The 5451C Fourier Analyzer provides digital frequency domain analysis of complex time signals in the frequency range of DC to 50 kHz. It is a fully calibrated, multi-purpose digital system for data acquisition, data storage, and data analysis. The primary analysis functions which are controlled from the system keyboard include: Forward and inverse Fourier transform, auto and cross power spectrum, transfer and coherence function and time or frequency domain averaging.

The ability to measure these functions quickly and accurately and with large dynamic range makes the Fourier Analyzer a powerful tool for stimulus-response measurements, system identification, vibration control, modal analysis, signature analysis, underwater sound, acoustics, communications, and more.

### Band Selectable Fourier Analysis

5451C Band Selectable Fourier Analysis (BSFA) allows the digital analyzer user to perform digital spectrum analysis over a frequency band whose center frequency and bandwidth are independently selectable by the operator. This frees the user from the DC to  $F_{\max}$  restrictions of conventional baseband digital analysis. With BSFA the frequency resolution of a measurement can be increased by a factor of 400:1 without a corresponding increase in the amount of computer data space required. With BSFA, the full dynamic range of the analyzer can be applied to the band of interest without interference from outside frequencies.

### Modal Analysis Option

Hewlett-Packard offers a comprehensive modal analysis system designed to meet the requirements of a wide range of modal testing applications. The Hewlett-Packard Modal System operates on measured transfer function data to determine modal properties. In addition, an animated isometric display of the structure under test is generated to aid the engineer to better understand its dynamic characteristics. This system offers significant time savings over traditional swept sine analog techniques because it operates on transfer function data. The system provides random, pseudo-random, transient, or periodic random excitation for transfer function measurements.

### Signature Analysis

Noise, vibration, and failure problems in rotating machinery are quickly analyzed using Hewlett-Packard's powerful Signature Analysis Package. It combines key rotating machinery measurements into a dedicated user-oriented system that's used for preventive maintenance, production quality control, design analysis, and noise and vibration studies.

Six measurements are pushbutton selectable from the operator's control panel: RPM and TIME Spectral Maps, Power Spectrum Analysis, Composite Power Spectrum, Order Ratio, and Order Tracking. This complete range of measurement and analysis features helps the user quickly gain insight into the overall dynamic characteristics of the device, eliminating time-consuming trial-and-error procedures.

**5451C System Price**

**from \$66,250**

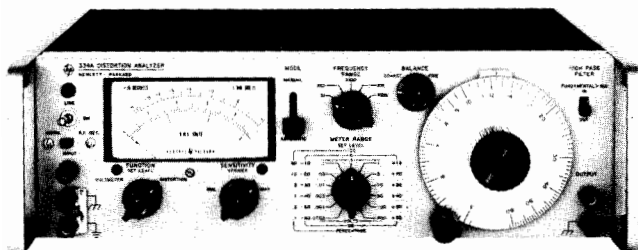

334A

## Description

Hewlett-Packard's models 331A, 333A and 334A Distortion Analyzers measure total distortion down to 0.1% full scale at any frequency between 5 Hz to 600 kHz; harmonics are indicated up to 3 MHz. These instruments measure noise as low as 25 microvolts and measure voltages over a wide range of level and frequency. Refer to table below for available models and features.

Model No.	Auto Nulling	Hi-Pass Filter	Lo-Pass Filter	AM Detector
331A				
333A	X	X		
334A	X	X		X
334A Opt. 002	X		X	X

Option 001, for each model, features VU meter characteristics conforming to FCC requirements.

### Automatic Fundamental Nulling

The automatic mode is used to complete rejection of the fundamental on more sensitive ranges after manually nulling to <10% of the Set Level Reference.

### High-pass Filter

In order to reduce the effect of hum components, a switchable high pass filter is provided which attenuates frequencies below 400 Hz.

### Amplitude Modulation Detector

HP's model 334A Analyzer is provided with an amplitude modulation detector having a frequency range from 550 kHz to 65 MHz. The high impedance dc restoring peak detector measures distortion at carrier levels as low as 1 volt. Input to the detector is located on the rear of the instrument.

### VU Option Available

Option 001 provides an indicating meter having VU ballistic characteristics which meets FCC requirements.

### Model 344A Opt 002

The 334A Opt 002 has a switchable 30 kHz low pass filter to reduce effect of unwanted high frequencies (noise, etc.) when measuring low frequency signals with high accuracy.

## 331A Specifications

**Input level for distortion measurements:** 0.3 V rms for 100% set level or 0.245 V for 0 dB set level (up to 300 V may be attenuated to set level reference).

**Harmonic measurement accuracy (full scale)**  
Fundamental Input Less Than 30 V

Range	±3%	±6%	±12%
100%-0.3%	10 Hz-1 MHz	10 Hz-3 MHz	
0.1%	30 Hz-300 kHz	20 Hz-500 kHz	10 Hz-1.2 MHz

Fundamental Input Greater Than 30 V

Range	±3%	±6%	±12%
100%-0.3%	10 Hz-300 kHz	10 Hz-500 kHz	10 Hz-3 MHz
0.1%	30 Hz-300 kHz	20 Hz-500 kHz	10 Hz-1.2 MHz

**Elimination characteristics:** fundamental rejection >80 dB. Second harmonic accuracy for a fundamental of 5 to 20 Hz; better than +1 dB; 20 Hz to 20 kHz; better than ±0.6 dB; 20 kHz to 100 kHz; better than -1 dB; 100 kHz to 300 kHz; better than -2 dB; 300 kHz to 600 kHz; better than -3 dB.

**Distortion introduced by instrument:** > -70 dB (0.03%) from 5 Hz to 200 kHz. > -64 dB (0.06%) from 200 kHz to 600 kHz. Meter indication is proportional to average value of a sine wave.

**Frequency calibration accuracy:** better than ±5% from 5 Hz to 300 kHz. Better than ±10% from 300 to 600 kHz.

**Input impedance:** distortion mode; 1 MΩ ±5% shunted by <70 pF (10 MΩ shunted by <10 pF with HP 10001A 10:1 divider probe). Voltmeter mode: 1 MΩ ±5% shunted by <35 pF, 1 to 300 V rms; 1 MΩ ±5% shunted by <70 pF, 300 μV to 0.3 V rms.

**DC isolation:** signal ground may be ±400 V dc from external chassis.

**Voltmeter range:** 300 μV to 300 V rms full scale (13 ranges) 10 dB per range. Average responding calibrated in rms.

**Voltmeter accuracy:** (using front panel input terminals)

Range	±2%	±5%
300 μV	30 Hz-300 kHz	20 Hz-500 kHz
1 mV-30 V	10 Hz-1 MHz	5 Hz-3 MHz
100 V-300 V	10 Hz-300 kHz	5 Hz-500 kHz

**Noise measurements:** voltmeter residual noise on the 300 μV range: <25 μV rms, when terminated in 600 (shielded) ohms, <30 μV rms terminated with a shielded 100 kΩ resistor.

**Output:** 0.1 ±0.01 V rms open circuit.

**Output impedance:** 2 kΩ.

**Power supply:** 115 or 230 V ±10%, 48 to 66 Hz, approximately 4 VA.

## 333A Specifications

Same as Model 331A except as indicated below:

**Automatic nulling mode:** set level: at least 0.2 V rms

**Frequency ranges:** X1, manual null tuned to less than 3% set level; total frequency hold-in ±0.5% about true manual null. X10 through X10 k, manual null tuned to less than 10% of set level; total frequency hold-in ±1% about true manual null.

**Automatic null accuracy:** 5 Hz to 100 Hz: meter reading within 0 to +3 dB of manual null. 100 Hz to 600 kHz: meter reading within 0 to +1.5 dB of manual null.

**High-pass filter:** 3 dB point at 400 Hz with 18 dB per octave roll off. 60 Hz rejection: 40 dB.

## 334A Specifications

Same as Model 333A except as indicated below:

**AM detector:** frequency range: from 550 kHz to 65 MHz.

**Maximum input:** 40 V p-p AC or 40 V peak transient.

**Distortion introduced by detector:** carrier frequency: 550 kHz-1.6 MHz: <50 dB (0.3%) for 3-8 V rms carriers modulated 30%. 1.6 MHz-65 MHz: <40 dB (1%) for 3-8 V rms carriers modulated 30%.

Note: Distortion introduced at carrier levels as low as 1 Volt is normally <40 dB (1%) 550 kHz to 65 MHz for carriers modulated 30%.

### General

**Size:** 426 mm W x 126 mm H x 337 mm D (16.75" x 5" x 13.25").

**Weight:** net, 7.98 kg (17.75 lb). Shipping, 10.35 kg (23 lb).

### Ordering Information

331A Distortion Analyzer

333A Distortion Analyzer

334A Distortion Analyzer

Option 001

Option 002 (334A only)

### Price

\$1500

\$1650

\$1750

add \$25

add \$125



# SIGNAL ANALYZERS

## Distortion Measurement Set

### Model 339A

- Ultra low distortion measurements
- Built-in low distortion oscillator
- Automatic
- True RMS detection

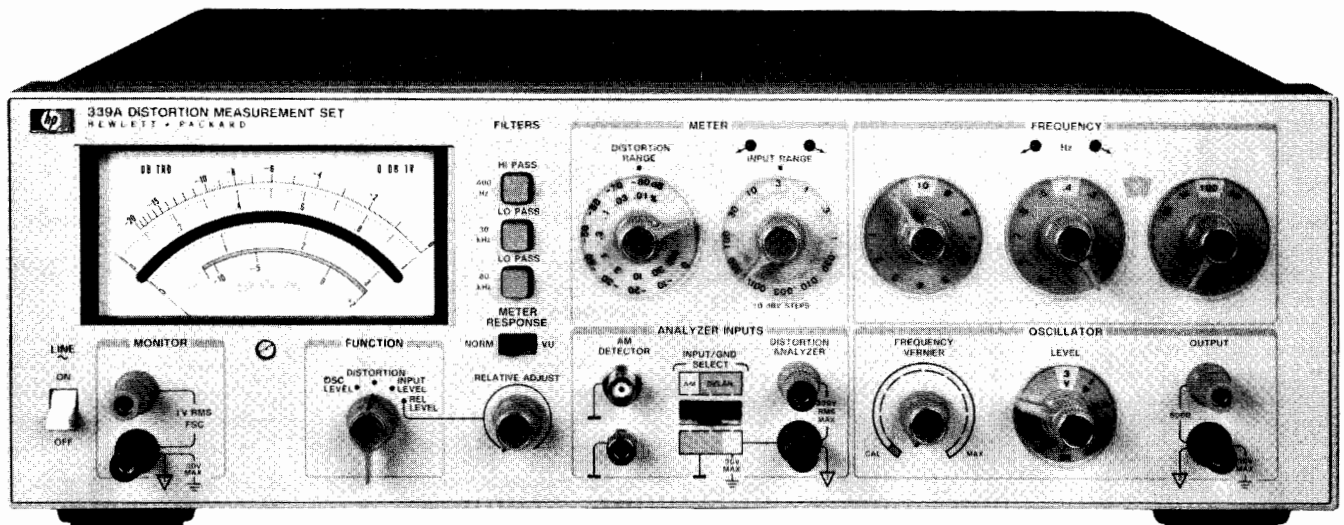

339A

### Description

Hewlett-Packard's new Model 339A Distortion Measurement Set is an ultra low distortion measuring system complete with total harmonic distortion (THD) analyzer, true-rms voltmeter, and sinewave oscillator. This small, lightweight bench measurement set allows you to make THD distortion measurements as low as 0.0018% over a 10 Hz to 110 kHz frequency band including harmonics to 330 kHz.

For fast and easy THD measurements the built-in tracking oscillator in HP's 339A saves test time because you tune one instrument instead of two. Frequency and level measurements are easy to do with HP's 339A's voltmeter, which offers you a 1 mV to 300 V measurement range. The Relative Level mode has been included to further simplify frequency response measurements. Just set a 0 dBm reference at any frequency from 10 Hz to 110 kHz. Gain measurements can be read directly from the easy-to-read meter.

### Operation Simplicity

Automatic frequency tuning and set-level features allow you to make rapid, error free THD measurements. The 339A's built-in tracking oscillator eliminates the need to find the fundamental frequency and tune the analyzer for a null. Just select your oscillator frequency and the rest is automatic. Automatic set-level saves time by automatically setting 0 dB (100%) reference in the distortion measuring mode. Front panel directional indicators light when the input range setting is improper insuring accurate and repeatable measurements. Automatic set-level also greatly simplifies measurements where distortion as a function of level (SINAD<sup>1</sup>, for example) is desired. Without this feature, measurements are very time consuming and tedious.

When an external stimulus is used, analyzer tuning is simplified by directional indicator lights for reaching the fundamental null quickly and easily.

### IHF Standards

The ultra low distortion and true rms measuring capabilities of the

339A will be of significant interest to the manufacturers and sales/service companies offering high performance HI-FI equipment. The 339A conforms to portions of a new standard method of measurement for audio amplifiers (IHF-A-202 1978) published by the Institute of High Fidelity, Inc. Particularly noteworthy is the rms measurement of (THD + N) according to sections 1.17 and 2.9.3.1.

### SINAD<sup>1</sup> Measurements

Receiver sensitivity and selectivity are two of the most important checks for a transistor. Since both of these measurements are generally made by the SINAD<sup>1</sup> method, it is very important to use a distortion analyzer that automatically compensates for input variations and provides an accurate indication of noise. Now, with the 339A's auto set level feature and true-rms detection, a more accurate SINAD measurement is possible.

Auto set level eliminates the need for continually checking the 100% set level reference while the receiver input is reduced during the measurement, thus eliminating several tedious operator adjustments with a considerable savings in test time. Also, the true-rms responding 339A more accurately determines the thermal noise and harmonic components in SINAD since it is not subject to the same reading and calibration errors as an average detector.

### FCC Requirements

The FCC required features for broadcast testing are included in the 339A. They include an AM detector, 30 kHz low pass filter, and switchable VU meter ballistics.

### Other Features

Hum and noise filters, a high level monitor output for further harmonic analysis, and floating input are standard features on the model 339A.

<sup>1</sup>SINAD is a sensitivity measurement computed from the ratio of signal plus noise and distortion to noise and distortion.



## Specifications

### Distortion

**Fundamental frequency range:** 10 Hz to 110 kHz continuous frequency coverage in 4 decade ranges with 2-digit resolution. Distortion analyzer and oscillator are simultaneously tuned.

**Distortion measurement range:** 0.01% full scale to 100% full scale (-80 dB to 0 dB) in 9 ranges.

**Detection and meter indication:** True rms detection for waveforms with crest factor  $\leq 3$ . Meter reads dB and % THD (Total Harmonic Distortion). Meter response can be changed from NORMAL to VU ballistics with a front panel switch.

**Distortion measurement accuracy:**

20 Hz to 20 kHz	$\pm 1$ dB
10 Hz to 50 kHz	+1, -2 dB
50 kHz to 110 kHz	+1.5, -4 dB

**Note:** The above specifications apply for harmonics  $\leq 330$  kHz.

**Fundamental rejection (3 V scale or above):**

10 Hz to 20 kHz:	> 100 dB
20 kHz to 50 kHz:	> 90 dB
50 kHz to 110 kHz:	> 86 dB

**Distortion introduced by instrument (input > 1V rms):**

10 Hz to 20 kHz:	< -95 dB (0.0018%) THD
20 kHz to 30 kHz:	< -90 dB (0.0056%) THD
30 kHz to 50 kHz:	< -85 dB (0.01%) THD
50 kHz to 110 kHz:	< -70 dB (0.032%) THD

**Residual noise** (fundamental frequency settings < 20 kHz, 80 kHz filter 1N, source resistance  $\leq 1$  K $\Omega$  shielded): < -92 dB referenced to 1V.

**Input level for distortion measurements:** 30 mV to 300 V rms (100 mV range minimum).

**Input impedance:** 100 k $\Omega$   $\pm 1\%$  shunted by < 100 pF input High to Low.

**Monitor:** Provides scaled presentation of input signal after fundamental is removed for further analysis using oscilloscope or low frequency spectrum analyzer. Output voltage: 1V rms  $\pm 5\%$  open circuit for full scale meter indication, proportional to meter deflection. Output resistance: 1k $\Omega$   $\pm 5\%$ .

**Auto set level:** No set level adjustment required. Distortion measurements are made directly over 10 dB range selected by input range switch. Two LED annunciators provide a fast visual indication to change input range for valid distortion measurement. Correct range is indicated when both annunciators are extinguished.

**Automatic fine tuning:** Using internal oscillator: No separate analyzer tuning necessary when using internal oscillator as signal source. Oscillator frequency controls simultaneously tune the analyzer. Using external frequency source: Two LED annunciators provide a quick visual indication for the operator to increase or decrease the frequency. When the analyzer is rough tuned to within one least significant digit of the fundamental frequency, the indicator lights are extinguished and the 339A auto-null circuitry takes over to provide a fast, accurate null without tedious operator tuning.

**Input filters (usable on all functions):** Low Pass: 30 kHz-3 dB point at 30 kHz, +2.6 kHz, -3 kHz with 60 dB/decade rolloff. Provides band limiting required by FCC for proof-of-performance broadcast testing. 80 kHz -3 dB point at 80 kHz, +7 kHz, -7.9 kHz with 60 dB/decade rolloff. Normally used with fundamental frequencies < 20 kHz to reduce the effect of higher frequency noise present in the measured signal. High Pass: 400 Hz -3 dB point at 400 Hz, +35 Hz, -40 Hz with 60 dB/decade rolloff. Normally used with fundamental frequencies > 1 kHz to reduce the effect of hum components in the input signal.

**DC isolation:** Input low may be connected to chassis ground or floated to 30 V to reduce the effects of ground loops on the measurement.

### Relative Input Level Mode

Provides a ratio measurement relative to an operator selected refer

ence level with readout directly in dBV or dBm (600 $\Omega$ ). Voltage range, frequency range, accuracy specifications, and monitor are the same as in Voltmeter mode. (Accuracy is relative to 0 dB set level input.)

### Oscillator

**Frequency range:** 10 Hz to 110 kHz in 4 overlapping decade ranges with 2 digit resolution. Frequency vernier provides continuous frequency tuning between 2nd digit switch settings.

**Output level:** Variable from < 1 mV to > 3 V rms into 600 $\Omega$  with 10 dB/step Level control and > 10 dB Vernier adjustment. OSC Level position on function switch allows a quick check of oscillator level without disconnecting leads to device under test. Off position on Oscillator Level control provides fast signal-to-noise measurement capability. Oscillator output terminals remain terminated in 600 $\Omega$ .

**Frequency accuracy:**  $\pm 2\%$  of selected frequency (with Frequency Vernier in Cal position).

Level flatness:	20 Hz to 20 kHz:	$\leq \pm 0.1$ dB
	10 Hz to 110 kHz:	$\leq \pm 0.2$ dB

**Distortion ( $\geq 600\Omega$  Load,  $\leq 3V$  Output):**

10 Hz to 20 kHz:	< -95 dB (0.0018%) THD
20 kHz to 30 kHz:	< -85 dB (0.0056%) THD
30 kHz to 50 kHz:	< -80 dB (0.01%) THD
50 kHz to 110 kHz:	< -70 dB (0.032%) THD

**Output resistance:** 600 $\Omega$   $\pm 5\%$

### Voltmeter

**Voltage range:** 1 mV rms full scale to 300 V rms full scale (-60 dB to +50 dB full scale, meter calibrated in dBV and dBm into 600 $\Omega$ ).

**Detection and meter indication:** True rms detection for waveforms with crest factor  $\leq 3$ . Meter reads true rms volts, dBm into 600 $\Omega$ , and dBV.

**Accuracy (% of range setting):**

**20 Hz to 20 kHz:**  $\pm 2\%$

**10 Hz to 110 kHz:**  $\pm 4\%$

**Frequency range:** 10 Hz to 110 kHz.

**Input impedance:** 100 k $\Omega$   $\pm 1\%$  shunted by < 100 pF between input High to Low.

**Monitor:** Provides scaled presentation of input signal for further analysis using oscilloscope or low frequency spectrum analyzer. Output voltage: 1V rms  $\pm 5\%$  open circuit for full scale meter indication, proportional to meter deflection. Output resistance: 1 k $\Omega$   $\pm 5\%$ .

### AM Detector

**Frequency range:** Carrier frequencies: 550 kHz to 1.6 MHz. Modulation frequencies: 20 Hz to 20 kHz.

**Distortion introduced by AM Detector (with 30 kHz filter switched IN):** Up to 85% Modulation: < -36 dB (1.6%) THD  
85% to 95% Modulation: < -30 dB (3%) THD

**Input level:** Maximum: 60V peak. Modulation signal level: 2V rms minimum; 10V rms maximum.

### Monitor (with Modulated RF Carrier Applied to AM Detector Input).

**Distortion mode:** Provides scaled presentation of demodulated input signal after fundamental is removed.

**Voltmeter and relative input mode:** Provides scaled presentation of demodulated input signal. Output voltage and output resistance are the same as in Distortion mode.

### General

**Power:** 100/120/220/240 V + 5%, -10% 48 Hz to 66 Hz line operation, 200 mA maximum.

**Size:** 146 mm H x 426 mm W x 375 mm D (5.75" x 16.75" x 14.75").

**Weight:** net 8.2 kg (18 lbs). Shipping 11.3 kg (25 lbs).

**339A Distortion Measurement Set**

**\$2100**



# SIGNAL ANALYZERS

15 Hz to 50 kHz wave analyzer

Model 3581A

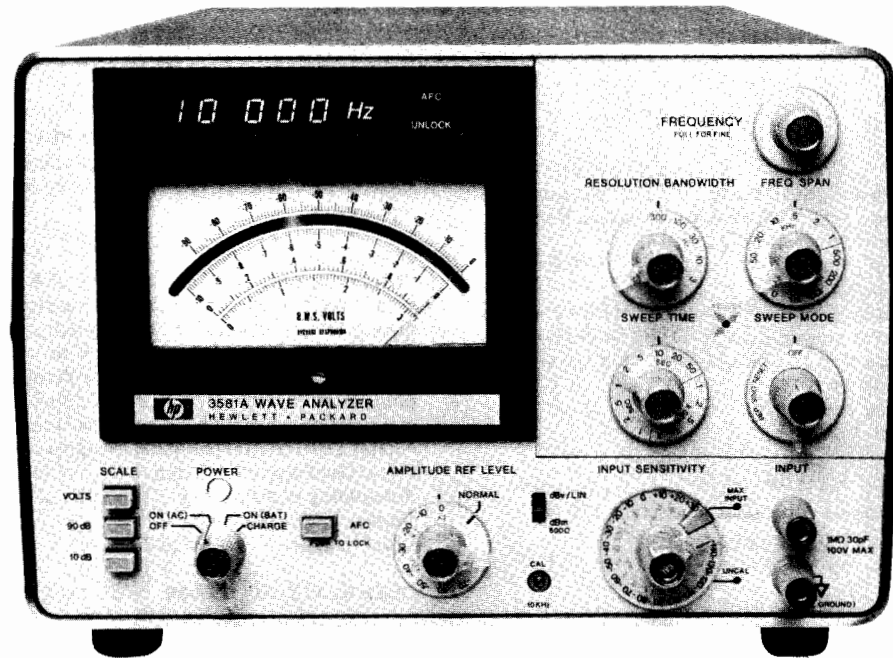

## Description

Hewlett-Packard's 3581A Wave Analyzer resolves and measures the amplitude and frequency of spectral components. This instrument offers accurate amplitude and good frequency resolution in the form of a portable, easy to use measuring tool. Since not all signals originate from a stable frequency source, the 3581A incorporates an AFC circuit which locks to a drifting signal for stable, accurate measurements.

HP's 3581A has other important features that are necessary when making measurements of small voltages from transducers and harmonic signals. Its 30 nV sensitivity becomes important for these measurements. Battery operation can be used to reduce the line related interference common in low level measurements so only the real spectrum is measured.

Digital readout of tuned frequency is located above the analog meter. It has been grouped with the meter for ease of reading. Resolution of the digital readout is 1 Hz for any frequency between 15 Hz and 50 kHz. Readout is updated five times per second so delay between tuning and reading is minimized.

Four meter scales are used to provide a wide range of displays. Two scales are used for linear voltage readings. Two log scales provide either a 90 dB or 10 dB display. In any case, the large meter with its mirror backing can present readings in dBV, dBm or volts. A meter was specifically chosen for amplitude display rather than digital readout because it is easier to peak a meter reading and because it's much easier to get a feel for noise or other amplitude variations by watching the meter. The same voltage used to drive the meter is also available on the rear panel for driving X-Y recorders.

## Specifications\*

### Frequency Characteristics

**Range:** 15 Hz to 50 kHz.

**Display:** 5 digit LED readout.

**Resolution:** 1 Hz.

**Accuracy:**  $\pm 3.5$  Hz., 0 to 50°C.

**Typical stability:**  $\pm 10$  Hz/hr after 1 hour and  $\pm 5$  Hz/°C.

**Automatic frequency control (AFC) hold-in range:**  $\pm 800$  Hz.

### Amplitude Characteristics

#### Instrument range

**Linear:** 30 V to 100 nV full scale.

**Log:** +30 dBm or dBV to -150 dBm or dBV.

#### Amplitude accuracy:

Frequency response,  
15 Hz-50 kHz

#### Log

$\pm 0.4$  dB

#### Linear

$\pm 4\%$

**Dynamic range:**  $> 80$  dB.

**Noise sidebands:** greater than 70 dB below CW signal. 10 bandwidths away from signal.

**Spurious responses:**  $> 80$  dB below input reference level.

### Sweep Characteristics

**Scan width:** 50 Hz to 50 kHz, adjustable in a 1-2-5 sequence from 50 Hz to the full frequency range.

**Sweep error light:** this LED indicates a sweep that is too fast to capture full response. When the light is on, response will be lower than it should be.

**External trigger:** a short to ground stops the normal sweep. Opening the short then enables a sweep.

### Input Characteristics

**Impedance:** 1 M $\Omega$ , 30 pF.

**Maximum input level:** 100 V rms,  $\pm 100$  V dc.

### Output Characteristics

**Tracking generator output:** (also known as BFO or tracking oscillator output).

**Range:** 0 to  $> 1$  V rms into 600  $\Omega$ .

**Frequency response:**  $\pm 3\%$  15 Hz to 50 kHz.

#### X-Y recorder analog outputs

**Vertical:** 0 to +5 V  $\pm 2.5\%$ .

**Horizontal:** 0 to +5 V  $\pm 2.5\%$ .

**Impedance:** 1 k $\Omega$ .

**Pen lift:** contact closure to ground during sweep.

**Restored output:** acts as a narrow band amplifier.

### General

**Power requirements:** 100 V, 120 V, 220 V, or 240 V  $+5\%$  -  $10\%$ , 48 Hz to 440 Hz, 10 VA typical.

**Size:** 412.8 mm H x 203.2 mm W x 285.8 mm D (16 1/4" x 8" x 11 1/4").

**Weight:** 11.5 kg (23 lb). Opt 001: 13.5 kg (30 lb).

### Options

**001:** Internal battery 12 hours from full charge. Internal battery is protected from deep discharge by an automatic turnoff. Useful battery life is over 100 cycles.

**910:** Extra set manuals

**Price**  
add \$450

add \$20

### 3581A Wave Analyzer

**\$3950**

# SIGNAL ANALYZERS

## Modulation Analyzer, 150 kHz to 1300 MHz

Models 8901A, 11715A



- Measures AM and FM to 1% accuracy
- Measures RF frequency
- Measures peak envelope power
- Low internal noise
- Completely automatic
- Optional built-in AM & FM calibrators

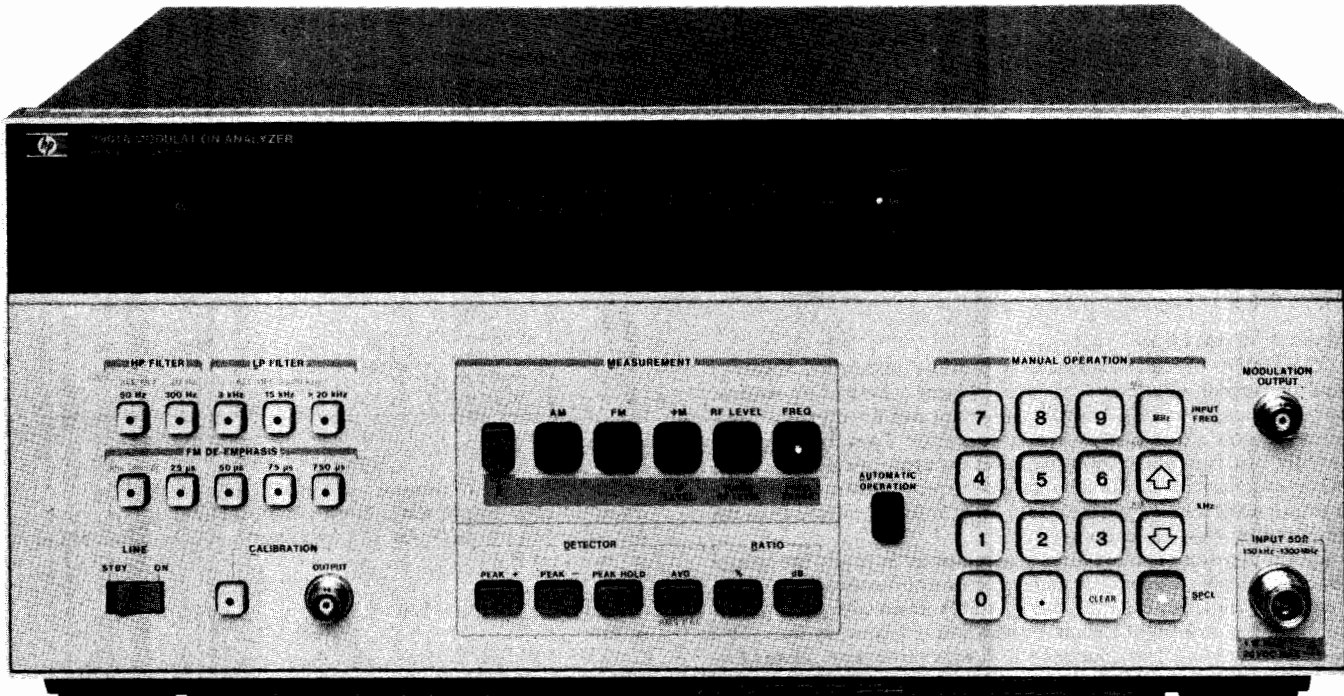

8901A (with Option 010)



### 8901A Modulation Analyzer

The 8901A Modulation Analyzer combines the capabilities of several instruments to give a complete, accurate characterization of modulated signals in the 150 kHz to 1300 MHz frequency range. It very accurately measures modulation and recovers the modulation signal. It determines RF frequency with 10 or 100 Hz resolution. It also measures RF peak power and in many instances eliminates the need for a power meter. The analyzer is ideally suited for characterization of transceivers and for metrology applications in calibrating precision signal generators. The fully automatic 8901A makes all major measurements with the push of a single key or under HP-IB control. Hewlett-Packard Interface Bus (HP-IB) control is a standard feature. Further description and example waveforms of the 8901A are on pages 497 and 498 of this catalog.

### Modulation Measurement Accuracy

Very accurate modulation measurements along with very low internal noise enable the 8901A to characterize even high performance signal sources. Its detection system is configured for wideband recovery of the entire modulation spectrum so that highly precise measurements such as signal-to-noise or distortion can be made on the modulation signal. Modulation depth and deviation accuracy is generally  $\pm 1\%$  of reading. Residual AM noise in a 50 Hz to 3 kHz bandwidth is  $<0.01\%$  while FM noise is  $<8$  Hz for 1300 MHz carrier frequencies, decreasing to  $<1$  Hz below 100 MHz. Since the AM and FM demodulators are independent and highly insensitive to each other, measurements of incidental AM and FM can be made with high precision.

Three detectors are available for depth and deviation measurements: positive peak, negative peak, and an average-responding detector with rms (sinewave) calibration. The average detector is ideal for the determination of residual noise on a signal. A PEAK HOLD

function captures and displays the maximum peak modulation of a signal and is ideal for making transient measurements such as modulation limiting on mobile radios. It can capture even very short transients and hold their peaks indefinitely.

For measuring convenience, two high-pass and three low-pass post-detection filters for filtering the recovered modulation are included. A  $>20$  kHz Bessel filter minimizes overshoot on square wave modulation. This allows accurate measurement of signals which are digitally modulated, such as FSK.

Four de-emphasis networks commonly used in FM systems (25, 50, 75, and 750  $\mu$ s) are provided. When chosen, the de-emphasis networks always affect the demodulated output but the user can select whether or not the de-emphasis network affects the deviation measured and indicated by the display.

A modulation output provides calibrated signal levels relative to the displayed modulation reading. Further measurements (frequency, distortion, frequency response) can be made on this signal with the HP 8903A Audio Analyzer described on page 554.

Option 010 provides two precision modulation standards. One is an amplitude modulated signal whose depth is calibrated to better than 0.1% accuracy. The second standard is a frequency modulated signal with peak deviation calibrated to  $>0.1\%$  accuracy. Because the calibrator can be included in the analyzer, metrology laboratories are not required to purchase a separate standard for AM or FM accuracy calibration. The 11715A AM/FM Test Source is necessary to fully test and calibrate other modulation parameters of the 8901A and is described on the next page.

### Complete Signal Characterization

The 8901A Modulation Analyzer is more than just a high quality modulation meter. It also performs as a frequency counter and RF power meter. Resolution for the 150 kHz to 1300 MHz frequency counter is 10 Hz below 1000 MHz and 100 Hz above 1000 MHz. Sensitivity is  $-25$  dBm (12 mV rms) below 650 MHz and  $-20$  dBm



## Models 8901A, 11715A (cont.)

(22 mV rms) above 650 MHz, with a dynamic range of > 50 dB. The standard instrument's time base stability is  $<1 \times 10^{-6}$ /month or an optional time base is available with  $<1 \times 10^{-9}$ /day stability.

The Modulation Analyzer automatically adjusts the internal level of the signal for optimum measurement. It can also selectively measure signals other than the largest with the approximate frequency entered via the keyboard. This is done with an unprecedented sensitivity of 0.22 mV rms and dynamic range of >90 dB. Input protection from damage is provided for signals up to 25 W with clamping diodes and a relay.

The 8901A uses a diode detection circuit to measure RF input power. This technique measures peak voltage and is calibrated from 1 mW to 1W for sine wave inputs.

Another function, TUNED RF LEVEL, configures the modulation analyzer as a selective RF power meter, allowing relative measurements of only signal levels in the tuned IF filter passband prior to automatic leveling. The 8901A has two selectable IF filters: one at 1.5 MHz with a 3 MHz nominal 3 dB bandwidth; the other at 455 kHz with a 200 kHz nominal 3 dB bandwidth.

### Ease of Operation

The 8901A Modulation Analyzer provides unexcelled accuracy while remaining extremely easy to use. Under control of an internal microprocessor, the 8901A is fully automatic and autoranging. Most measurements require only a single keystroke. There is no need to tune the analyzer, adjust levels, or select the appropriate range. Data processing routines of the microprocessor permit the user to make measurements relative to a measured value or to one entered from the keyboard by using the ratio keys.

Special functions entered using the numerical keys and the special function key give the operator manual control of functions, operation, and service aids. For example, one special function configures the instrument to track input signals without losing frequency lock. This simplifies measurement routines which require data at various frequencies across a band.

## 8901A Specifications

### RF Input

**Frequency range:** 150 kHz to 1300 MHz

#### Operating level:

150 kHz–650 MHz: 12 mVrms to 7 Vrms

650 MHz–1300 MHz: 22 mVrms to 7 Vrms

**Input impedance:** 50Ω nominal

**Tuning:** Manual frequency entry, automatic, or track (frequencies > 10 MHz only).

**Acquisition time (automatic operation):** ~1.5 seconds.

**Maximum safe input level (typical):** ac: 35 Vrms (25 W for source SWR <4); dc: 40V.

### Frequency Modulation

#### Rates:

150 kHz–10 MHz: 20 Hz to 10 kHz

10 MHz–1300 MHz: 20 Hz to 200 kHz

10 MHz–1300 MHz: 20 Hz to 20 kHz with 750 μs filter.

#### Deviations:

150 kHz–10 MHz: 40 kHz peak maximum

10 MHz–1300 MHz: 400 kHz peak maximum

10 MHz–1300 MHz: 40 kHz peak maximum with 750 μs filter.

#### Accuracy<sup>1</sup>:

250 kHz–10 MHz: ±2% of reading ±1 digit, 20 Hz to 10 kHz rates.

10 MHz–1300 MHz: ±1% of reading ±1 digit, 50 Hz to 100 kHz rates; ±5% of reading ±1 digit, 20 Hz to 200 kHz rates.

#### Demodulated output distortion:

400 kHz–10 MHz: <0.1% THD, deviations <10 kHz

10 MHz–1300 MHz: <0.1% THD, rates and deviations <100 kHz

**AM rejection (for 50% AM at 400 Hz and 1 kHz rates)<sup>1</sup>:** <20 Hz peak deviation measured in a 50 Hz to 3 kHz BW.

**Residual FM (50 Hz to 3 kHz BW):** <8 Hz rms @ 1300 MHz, decreasing linearly with frequency to <1 Hz rms for 100 MHz and below.

<sup>1</sup>Peak residuals must be accounted for in peak readings.

<sup>2</sup>For peak measurements only, AM accuracy may be affected by distortion generated by the Modulation Analyzer. In the worst case, this can decrease accuracy by 0.1% of reading for each 0.1% of distortion.

<sup>3</sup>After 30 day warm-up.

### Maximum deviation resolution:

1 Hz, <4 kHz deviation

10 Hz, 4 kHz to 40 kHz deviation

100 Hz, 40 kHz to 400 kHz deviation

Resolution is increased one digit with 750 μs deemphasis and pre-display "on."

**Stereo separation (50 Hz to 15 kHz):** >47dB typical

### Phase Modulation

**Carrier frequency:** 10 MHz to 1300 MHz

**Rates:** 200 Hz to 20 kHz; typically useable from 20 Hz to 100 kHz with degraded performance.

### Deviation and maximum resolution:

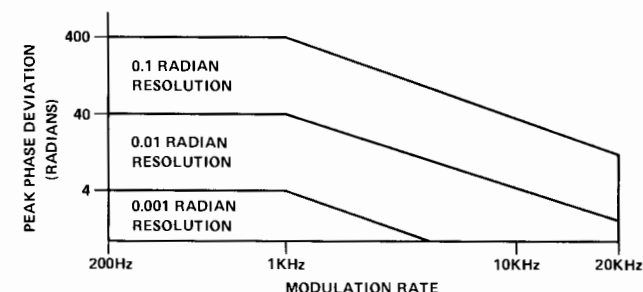

**Accuracy<sup>1</sup>:** ±3% of reading ±1 digit

**Demodulated output distortion:** <0.1% THD

**AM rejection (for 50% AM at 1 kHz rate)<sup>1</sup>:** <0.03 radian peak (50 Hz to 3 kHz BW)

### Amplitude Modulation

#### Rates:

150 kHz–10 MHz: 20 Hz to 10 kHz

10 MHz–1300 MHz: 20 Hz to 100 kHz

**Depth:** to 99%

#### Accuracy<sup>1,2</sup>:

**150 kHz–10 MHz:** ±2% of reading ±1 digit,

50 Hz to 10 kHz rates, >5% depth;

±3% of reading ±1 digit, 20 Hz to 10 kHz rates.

**10 MHz–1300 MHz:** ±1% of reading ±1 digit,

50 Hz to 50 kHz rates, >5% depth;

±3% of reading ±1 digit, 20 Hz to 100 kHz rates.

**Flatness (variation in indicated AM depth for constant depth on input signal):** 10 MHz to 1300 MHz: ±0.3% of reading ±1 digit, 90 Hz to 10 kHz rates, 20 to 80% depth.

**Demodulated output distortion:** <0.3% THD for ≤50% depth; <0.6% THD for ≤95% depth

**FM rejection (at 400 Hz and 1 kHz rates, 50 Hz to 3 kHz BW)<sup>1</sup>:**

250 kHz to 10 MHz: <0.2% AM for <5 kHz peak deviation

10 MHz to 1300 MHz: <0.2% AM for <50 kHz peak deviation

**Residual AM (50 Hz to 3 kHz BW):** <0.01% rms

#### Maximum depth resolution:

0.01% for depths ≤39.99%; 0.1% for depths ≥40%

### Frequency Counter

**Range:** 150 kHz–1300 MHz

**Accuracy:** reference accuracy ±3 digits

#### Internal reference:

**Frequency:** 10 MHz

**Aging rate:** <1 × 10<sup>-6</sup>/month (optional: <1 × 10<sup>-9</sup>/day<sup>3</sup>)

#### Maximum resolution:

10 Hz for frequencies <1 GHz; 100 Hz for frequencies ≥1 GHz

### RF Level (Peak Voltage Responding, RMS Sine Wave Power Calibrated)

**Range:** 1 mW to 1W

**Instrumentation accuracy:** ±2 dB (≤650 MHz); ±3dB (>650 MHz)

**SWR:** <1.5 in a 50Ω system

#### Resolution:

0.1 mW for levels 0.1 to 1W

0.01 mW for levels 0.01 to 0.1W

0.001 mW for levels <0.01W



### Audio Filters

**High pass (3 dB cutoff frequency):** 50 Hz and 300 Hz  
**Low pass (3 dB cutoff frequency except >20 kHz filter):** 3 kHz, 15 kHz, >20 kHz

**De-emphasis filters:** 25  $\mu$ s, 50  $\mu$ s, 75  $\mu$ s, and 750  $\mu$ s.

### Flatness:

50 Hz High Pass: <1% at rates  $\geq$ 200 Hz  
 300 Hz High Pass: <1% at rates  $\geq$ 1 kHz  
 3 kHz Low Pass: <1% at rates  $\leq$ 1 kHz  
 15 kHz Low Pass: <1% at rates  $\leq$ 10 kHz  
 >20 kHz Low Pass: <1% at rates  $\leq$ 10 kHz

### Calibrators (Option 010)

**AM calibrator depth and accuracy:** 33.33% depth, nominal; internally calibrated to an accuracy of  $\pm$ 0.1%

**FM calibrator deviation and accuracy:** 33 kHz peak deviation, nominal; internally calibrated to an accuracy of  $\pm$ 0.1%

### General Characteristics

**Operating temperature range:** 0° to 55°C

**Power requirements:** 100, 120, 220, or 240V ac (+5, -10%); 48-66 Hz; 200 VA max.

**Weight:** net, 20 kg (44 lb); shipping, 25 kg (55 lb)

**Size:** 190 mm H x 425 mm W x 468 mm D (7.5 in. x 16.8 in. x 18.4 in.)

## 11715A AM/FM Test Source

The 11715A AM/FM Test Source provides very flat, wide-bandwidth, and low distortion amplitude or frequency modulated RF signals. Designed primarily for performance tests and adjustments of the 8901A Modulation Analyzer, it will also serve as a high quality modulated test oscillator where its frequency ranges apply.

The major components of the 11715A are a low-noise voltage controlled oscillator (VCO), two digital dividers, and a double balanced mixer. The VCO is the primary signal source, with a typical frequency range of 330 to 470 MHz at the FM OUTPUT. FM is produced by directly coupling the external modulation source to the VCO's tune input, providing very wide bandwidth modulation with low phase shift. This design also ensures very little incidental AM. The digital dividers derive the two lower frequency ranges from the FM modulated VCO output. The AM mode routes the external modulation signal directly to the mixer, which modulates the VCO divide-by-32 signal. This amplitude modulated carrier has very low incidental phase modulation. A separate crystal oscillator and frequency doubler provide a low-residual FM output at 560 MHz.

The 11715A can also be used in conjunction with an 8901A as a calibrated signal source for special applications. In particular, the U.S. commercial FM broadcast band of 88 to 108 MHz is covered by the FM  $\div$  4 OUTPUT of the 11715A. Typical stereo separation of 60 dB with very low distortion can be obtained over the full range of broadcast modulation requirements.

## 11715A Specifications

### FM Outputs

#### Frequency range

**AM FM  $\div$  32 output:** 11 to 13.5 MHz

**FM  $\div$  4 output:** 88 to 108 MHz

**FM output:** 352 to 432 MHz

#### Peak deviation

**11 to 13.5 MHz carrier:** >12.5 kHz

**88 to 108 MHz carrier:** >100 kHz

**352 to 432 MHz carrier:** >400 kHz

#### Distortion

<0.025% THD (<-72 dB) for

Carrier frequency	Peak deviation	Modulation rate
12.5 MHz	12.5 kHz	<10 kHz
100 MHz	100 kHz	<100 kHz
400 MHz	400 kHz	<100 kHz

#### Flatness

**dc to 100 kHz rates:**  $\pm$ 0.1%

**dc to 200 kHz rates:**  $\pm$ 0.25%

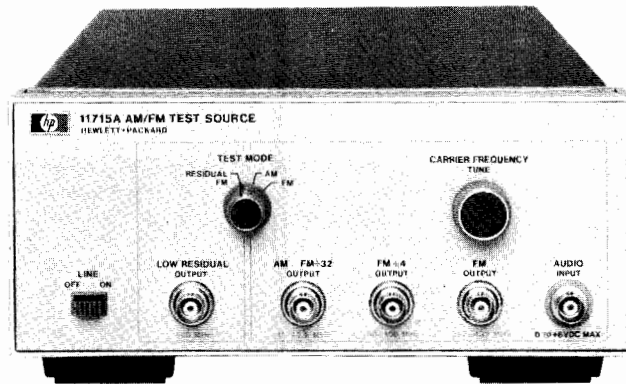

11715A

**Incidental AM (100 MHz carrier, <50 kHz peak deviation, 1 kHz rate, 50 Hz to 3 kHz bandwidth):** <0.08%

**Residual FM (typical, 50 Hz to 15 kHz bandwidth)**

**12.5 MHz:** <1 Hz rms

**100 MHz:** <8 Hz rms

**400 MHz:** <32 Hz rms

**Stereo separation (88 to 108 MHz carrier, 75 kHz peak deviation, 1 kHz rate):** >60 dB typical

### AM Output

**Frequency range (AM FM  $\div$  32 output):** 11 to 13.5 MHz

**Depth:** to 99%

#### Distortion

**50% AM, 20 Hz to 100 kHz rates:** <0.05% THD (<-66 dB)

**95% AM, 20 Hz to 100 kHz rates:** <0.1% THD (<-60 dB)

#### Flatness

**50 Hz to 50 kHz rates:**  $\pm$ 0.1%

**20 Hz to 100 kHz rates:**  $\pm$ 0.25%

**Incidental  $\Delta$ M (12.5 MHz carrier, 50% AM, 1 kHz rate, 50 Hz to 3 kHz bandwidth):** <0.008 radian peak

#### Linearity

**$\leq$ 95% AM:**  $\pm$ 0.1%

**$\leq$ 99% AM:**  $\pm$ 0.2%

**Residual AM (50 Hz to 3 kHz bandwidth):** <0.01% rms

### Low Residual Output

**Residual FM (50 Hz to 3 kHz bandwidth):** <3 Hz rms

**Frequency:** 560 MHz  $\pm$  50 kHz nominal

### General

#### Line voltage

**48 to 440 Hz:** 100 to 120 Vac (+5%, -10%)

**48 to 66 Hz:** 220 to 240 Vac (+5%, -10%)

**Power dissipation:** 40 VA maximum.

**Weight:** net 4.4 kg (9.5 lb); shipping 6.5 kg (14 lb)

**Size:** 102 mm H x 212 mm W x 444 mm D (4.0 x 8.4 x 17.5 in.)

#### Temperature

**Operating:** 0 to 55°C

**Storage:** -55 to 75°C

### Ordering Information

8901A Modulation Analyzer

(Note: HP-1B cable not supplied. See page 30.)

**Option 001:** Rear panel instead of front panel connectors add \$100

**Option 002:**  $1 \times 10^{-9}$ /day internal reference oscillator add \$600

**Option 003:** Rear panel connections for external local oscillator add \$200

**Option 004:** Operation from 48 to 440 Hz power line (100-120V ac only) add \$150

**Option 010:** AM and FM calibrators add \$500

**Option 907:** Front panel handle kit add \$40

**Option 908:** Rack mounting flange kit add \$30

**Option 909:** Front panel handle and rack mounting flange kit add \$65

**Option 910:** Extra operating & service manual add \$25

11715A AM/FM Test Source \$1550

**Option 907:** Front panel handle kit add \$28

**Option 910:** Extra operating & service manual add \$3.50

**Rack mounting kit:** (P/N 5061-0072) add \$30

### Price

\$7800



# SIGNAL ANALYZERS

Audio Analyzer, 20 Hz to 100 kHz

Model 8903A

- Measures distortion, SINAD, signal-to-noise
- Measures true rms volts, dc volts, frequency

- Programmable low distortion source

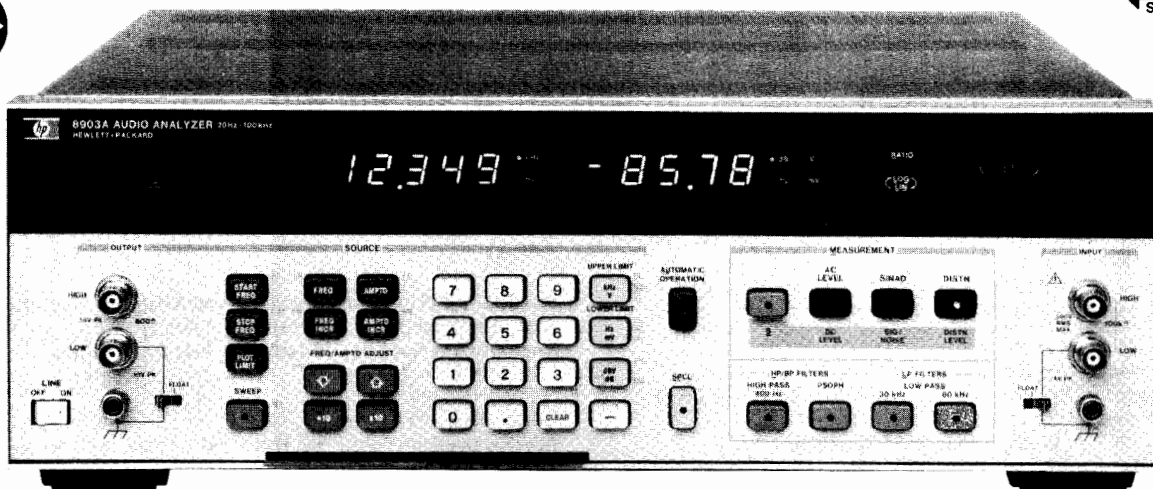

8903A

## 8903A Audio Analyzer

The 8903A Audio Analyzer combines the capabilities of several instruments under microprocessor control to yield accurate and rapid characterizations of audio signals in the range of 20 Hz to 100 kHz. It contains an audio source, measures distortion, SINAD, and signal-to-noise ratio, ac and dc level, and counts frequency completely automatically with either a single front panel keystroke or under HP-IB remote control. This combination reduces the number of instruments and complexity of setup needed in many applications.

The analyzer is ideally suited for performing audio measurements on transceivers. Along with a suitable generator and modulation analyzer, receiver sensitivity and transmitter distortion measurements can be made accurately and rapidly.

With the internal source and measurement functions enhanced by microprocessor control, the 8903A has more measurement capability and less display ambiguity than separate instruments. The Audio Analyzer makes true rms measurements for ac level and distortion, thus assuring more accurate measurements of complex waveforms and noise. The ability to perform swept measurements makes it an extremely versatile stand-alone bench instrument for general audio stimulus/response work. Its programmability over HP-IB is well suited to system applications.

### Transceiver Testing

The Audio Analyzer performs several measurements and contains various features specifically designed for receiver testing. The most common audio measurements are SINAD for FM receivers and signal-to-noise for AM receivers. In the 8903A, these measurements are optimized for measuring the noisy signals encountered in receiver testing. Measurements of SINAD are indicated both by the analog meter and the digital display. The specially marked meter for EIA and CEPT sensitivity and selectivity results in fast, accurate, repeatable measurements. Also, a psophometric filter allows testing to CEPT standards.

By combining the 8903A with the 8901A Modulation Analyzer, you can make all common transmitter tests. The 8903A provides the tone for microphone inputs, measures transmitter audio distortion, and counts squelch tones. Distortion measurements can be made using the 400 Hz high pass filter to reject squelch tones. In rapid frequency count mode, counter measurements can be made at a rate of 8 ms/reading, allowing burst counting of squelch tone frequencies. In rapid programming mode, the source can switch frequencies rapidly enough to generate sub-audio squelch tone sequences. All functions are remotely programmable.

### Audio Testing

The 8903A simplifies general audio testing by combining several traditional audio instruments into one. It is fully automatic and autoranging, so most measurements take only a single keystroke. Microprocessor control of all functions greatly enhances measurement efficiency. For example, distortion can be displayed in either percent or dB. In ac level you can choose between volts, dBV, or watts by entering the load resistance from the keyboard. You can establish a reference and make measurements in percent or dB relative to a measured or entered value. Using the source increment/decrement keys and relative display mode it is easy to determine parameters such as the 3 dB points of filters and amplifiers. With both low-distortion source and analyzer built in, the 8903A makes stimulus-response measurements. Internal processor control over all functions expands this capability to powerful swept characterization. With only a few keystrokes you can measure frequency response and swept distortion characteristics of filters, high quality amplifiers, audio IC's, and other devices. Hard copy results are easily generated with an X-Y recorder connected to the analyzer's rear panel outputs.

### Systems Applications

The Audio Analyzer is a powerful HP-IB system component. Many audio functions frequently required in automatic systems are combined in the 8903A. In many cases it does the work of an audio synthesizer, digital voltmeter, frequency counter, and custom interface with notch filters. All these measurements are available at a single input connector. As a result, interfacing requirements, hardware cost, and software development time are reduced. The 8903A makes a major contribution by automatically measuring distortion under HP-IB control. It also provides a low distortion programmable source. Typical combined distortion of both source and analyzer at 1V is <math><0.003\%</math> between 20 Hz and 20 kHz.

Often systems applications involve measuring low level ac signals. The 8903's most sensitive range features a full scale ac level display of .300 mV with an accuracy of 4% of reading (2% of reading > 50 mV, 20 Hz to 20 kHz). The ac converter is true rms for correct noise measurements and the 3 dB bandwidth is greater than 500 kHz.

Large measurement systems often have troublesome noise problems. The 8903A has 30 kHz and 80 kHz low-pass filters to reject high frequency noise. Also, the 400 Hz high-pass filter rejects line related hum and noise greater than 68 dB.

Two special binary programming modes are available in remote operation. Rapid frequency count mode provides a packed four byte output for fast counting. Also, a rapid source mode is available which allows the internal oscillator hardware to be programmed directly with five bytes.



## 8903A Specifications

### Source

**Frequency range:** 20 Hz to 100 kHz.

**Frequency resolution:** 0.3%

**Frequency accuracy:** 0.3% of setting.

**Output level range:** 0.6 mV to 6V open circuit.

**Output level resolution:** 0.3% or better.

**Output level accuracy (open circuit):** 2% of setting, 60 mV to 6V, 20 Hz to 50 kHz; 3% of setting, 6 mV to 6V, 20 Hz to 100 kHz; 5% of setting, 0.6 mV to 6 mV, 20 Hz to 100 kHz.

**Flatness (1 kHz reference):**  $\pm 0.7\%$ , 20 Hz to 20 kHz;  $\pm 2.5\%$ , 20 Hz to 100 kHz.

**Distortion & noise:** the higher of:  $-80$  dB or  $30 \mu\text{V}$ , 20 Hz to 20 kHz, 80 kHz BW;  $-70$  dB or  $95 \mu\text{V}$ , 20 kHz to 50 kHz, 500 kHz BW;  $-65$  dB or  $169 \mu\text{V}$ , 50 kHz to 100 kHz, 500 kHz BW.

**Impedance:**  $600\Omega \pm 1\%$ .

**Sweep mode:** logarithmic sweep with up to 500 points/decade or 255 points between entered start and stop frequencies, whichever is smaller.

### AC Level

**Full range display:** 300.0V, 30.00V, 3.000V, 0.3000V, 30.00mV, 3.000 mV, 0.3000mV.

**Overrange:** 33% except on 300V range.

**Accuracy:**  $\pm 2\%$  of reading, 30V to 300V, 20 Hz to 1 kHz;  $\pm 2\%$  of reading, 50 mV to 30V, 20 Hz to 20 kHz;  $\pm 4\%$  of reading, 0.3 mV to 30V, 20 Hz to 100 kHz.

**AC Converter:** true-rms responding for signals with crest factor  $\leq 3$  and harmonics up to 80 kHz typical. 3 dB measurement BW:  $> 500$  kHz typical.

### DC Level

**Full range display:** 300.0V, 48.00 V, 16.00V, 4.00V.

**Overrange:** 33% except on 300V range.

**Accuracy:**  $\pm 0.75\%$  of reading, 400 mV to 300V;  $\pm 3$  mV,  $< 400$  mV.

### Distortion

**Fundamental frequency range:** 20 Hz to 100 kHz.

**Display range:** 0.001% to 100%,  $-99.99$  dB to 0 dB.

**Accuracy:**  $\pm 1$  dB, 20 Hz to 20 kHz;  $\pm 2$  dB, 20 kHz to 100 kHz.

**Input voltage range:** 50 mV to 300V.

**Residual noise and distortion:** the higher of: 0.01%,  $-80$  dB, or  $30 \mu\text{V}$ , 20 Hz to 20 kHz, 80 kHz BW; 0.032%,  $-70$  dB, or  $95 \mu\text{V}$ , 20 kHz to 50 kHz, 500 kHz BW; 0.056%,  $-65$  dB, or  $169 \mu\text{V}$ , 50 kHz to 100 kHz, 500 kHz BW.

**Displayed resolution:** 0.0001%,  $< 0.1\%$  distortion; 0.001%, 0.1% to 3% distortion; .01%, 3% to 30% distortion; 0.1%,  $> 30\%$  distortion.

**Detection:** true rms.

### SINAD<sup>1,2</sup>

**Fundamental frequency range:** 20 Hz to 100 kHz.

**Display range:** 0 dB to 99.99 dB.

**Accuracy:**  $\pm 1$  dB, 20 Hz to 20 kHz;  $\pm 2$  dB, 20 kHz to 100 kHz.

**Input voltage range:** 50 mV to 300V.

**Detection:** true rms (average detection selectable by internal jumpers).

**Resolution:** 0.01 dB for SINAD ratios  $> 25$ . For ratios  $< 25$  the display is rounded to the nearest half dB to reduce digit flickering of noise signals. (Full resolution is available by defeating this feature using special function 16.1).

**Analog meter:** active in SINAD only and for SINAD ratios  $< 18$  dB (or 24 dB using special function 7.1).

**Tuning:** notch filter is tuned to analyzer source frequency.

### Signal to noise

**Frequency range:** 20 Hz to 100 kHz.

**Display range:** 0 dB to 99.99 dB.

**Accuracy:**  $\pm 1$  dB.

**Input voltage range:** 50 mV to 300V.

**Residual noise:** the higher of  $-80$  dB or  $30 \mu\text{V}$ , 80 kHz BW;  $-70$  dB or  $95 \mu\text{V}$ , 500 kHz BW.

**Resolution:** same as SINAD.

**Operation:** The analyzer displays the ratio of the input voltages as the internal source is automatically switched on and off.

### Frequency counter

**Range:** 20 Hz to 150 kHz<sup>3</sup>.

**Resolution:** 5 digits<sup>4</sup>.

**Accuracy:**  $0.004\% \pm 1$  digit.

**Input sensitivity:** 50 mV in distortion and SINAD modes, 5.0 mV in ac level and sig/noise modes.

**Counting technique:** reciprocal with 2 MHz timebase.

### Audio Filters

**400 Hz high pass filter:** 3 dB cutoff frequency, 400 Hz  $\pm 40$  Hz; 140 dB/decade rolloff.

**Psophometric filter (CCITT recommendation P53):** deviation from ideal response:  $\pm 0.2$  dB at 800 Hz;  $\pm 1$  dB, 300 kHz to 3 kHz;  $\pm 2$  dB, 50 Hz to 3.5 kHz;  $\pm 3$  dB, 3.5 kHz to 5 kHz.

**30 kHz low pass filter:** 3 dB cutoff frequency, 30 kHz  $\pm 2$  kHz; 60 dB/decade rolloff.

**80 kHz low pass filter:** 3 dB cutoff frequency, 80 kHz  $\pm 4$  kHz; 60 dB/decade rolloff.

### Rear Panel Inputs/Outputs

**Recorder output:** X: 0-10 Vdc (typical) corresponding to log of oscillator frequency.

Y: 0-10 Vdc (typical) corresponding to displayed value and entered plot limits.

**Recorder output resistance:** 1 k $\Omega$  nominal.

**Monitor output:** In ac level mode provides scaled output of measured input signal. In SINAD, distortion, and distortion level modes provides scaled output of input signal with the fundamental removed.

### General

**Input impedance:** 100k $\Omega \pm 1\%$  shunted by  $< 300$  pF with low terminal grounded<sup>5,6</sup>.

**CMRR (@ 60 Hz):** 60 dB for differential input  $< 2\text{V}$ ; 36 dB for differential input  $< 48\text{V}$ ; 30 dB for differential input  $> 48\text{V}$ .

**Remote operation:** HP-IB, all functions except the line switch, low terminal ground switches, and the  $\times 10 \div 10$  increment keys.

**Temperature:** operating, 0° to 55°C; storage,  $-55^\circ\text{C}$  to 75°C.

**Power requirements:** 100, 120, 220, or 240 volts (+5, -10%); 48-440 Hz; 100 VA maximum.

**Weight:** net, 12.3 kg (27 lb); shipping, 16.4 kg (36 lb).

**Size:** 146 H x 425 W x 440 mm D (5.75 x 16.8 x 17.3 in.).

**EMI:** Conducted and radiated interference is within the requirements of methods CE03 and RE02 of MIL STD 461A, VDE 0871, and CISPR publication 11. Conducted and radiated susceptibility meet the requirements of methods CS01, CS02, and RS03 (1 volt/meter) of MIL STD 461A dated 1968.

### Ordering Information

#### 8903A Audio Analyzer

(Note: HP-IB cable not supplied. See page 30.)

	Price
<b>Option 001:</b> Rear panel connections instead of front panel for source output and analyzer input.	add \$50
<b>Option 907:</b> Front panel handle kit	add \$32
<b>Option 908:</b> Rack mount flange kit	add \$25
<b>Option 909:</b> Front panel handle plus rack mount flange kit	add \$55
<b>Option 910:</b> Extra Operating & Service Manual	add \$30

<sup>3</sup>20 Hz to 100 kHz in SINAD and distortion.

<sup>4</sup>Resolution is limited to 0.01 Hz for input frequencies  $< 100$  Hz.

<sup>5</sup>In dc level mode input resistance is  $10\text{k}\Omega \pm 1\%$ .

<sup>6</sup>Input capacitance is  $< 330$  pF for Option 001.

<sup>1</sup>SINAD is a sensitivity measurement computed from the ratio of signal plus noise and distortion to noise and distortion.

<sup>2</sup>Residual noise and distortion same as for distortion mode.



# SIGNAL ANALYZERS

## Frequency Stability Analyzer

Sample of Model 5390A

- Phase noise measurements close to carrier
- Offsets from 0.01 Hz to 10 kHz
- Sensitivity as high as  $-140$  dBc at 1 Hz offset

- Measures sources to 18 GHz
- Automatic Operation

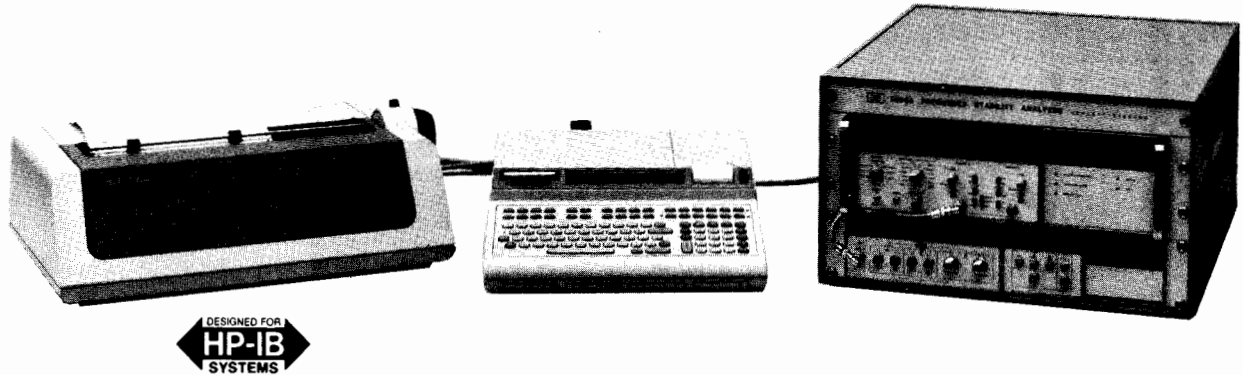

5390A Frequency Stability Analyzer

### General

The 5390A Frequency Stability Analyzer will characterize oscillator stability in either the time domain or the frequency domain. For time domain characterization, the 5390A measures fractional frequency deviation which represents the RMS deviation of the signal from the nominal carrier frequency measured over a given time interval. For characterization in the frequency domain, the 5390A presents results in terms of the spectral density of phase fluctuations. The 5390A specializes in high resolution phase noise measurements close to the carrier where other techniques are difficult to use or are unable to make the measurements at all.

The system can accommodate a wide frequency range of input signals from 500 kHz to 18 GHz. Provision is also made for external mixers for broader frequency coverage or direct input in the range of DC-100 kHz. With this amount of flexibility, almost any oscillator can be measured with the 5390A. All the signal processing capabilities needed to make measurements are built into the system, including down-conversion, low-noise amplification, and bandwidth control.

The 5390A is a complete hardware and software measurement system, fully assembled and tested at the factory. Making measurements only requires connecting the test and reference oscillators and specifying a few measurement parameters. Thereafter, the system runs unattended to the completion of the specified group of measurements. Access to the interactive application programs is provided through specially defined keys on the computing controller's keyboard.

### Measurement Technique

The basic system configuration uses a heterodyne down-conversion technique to produce a measurable signal. Two oscillators, the test oscillator at a carrier frequency  $\nu_0$  and a reference oscillator at a frequency  $\nu_0 \pm \nu_b$ , are connected to a double balanced mixer through one of the sets of inputs on the 10830A Mixer/IF Amplifier. (Usually two identical oscillators, one slightly offset, are used. In this case, the noise measured is twice the contribution of either oscillator. The 5390A's software can compensate for this factor of two to produce the correct result). The resultant difference frequency (or "beat" frequency),  $\nu_b$ , is filtered and amplified by a low noise limiting amplifier and applied to the input of the 5345A Electronic Counter. The 5345A makes frequency measurements of the beat frequency under the control of the 5358A Measurement/Storage Plug-in at measurement intervals also determined by the 5358A. The measurement results are stored locally in the 5358A facilitating the taking of a large number of measurements very rapidly and reducing "dead time" between measurements to less than 17  $\mu$ s.

### Fractional Frequency Deviation Measurements

The 5390A system measures fractional frequency deviation over an exceptionally wide range of averaging times (tau values). Taus as small as 10  $\mu$ s and as large as  $999 \times 10^3$  s can be accommodated by the system. The measurement bandwidth is another parameter critical to the validity of fractional frequency measurements. The 5390A provides the choice of several bandwidths: 100 kHz, 25 kHz, 6.3 kHz, 1.6 kHz, 400 Hz, 100 Hz and 25 Hz. There is also provision for an external filter.

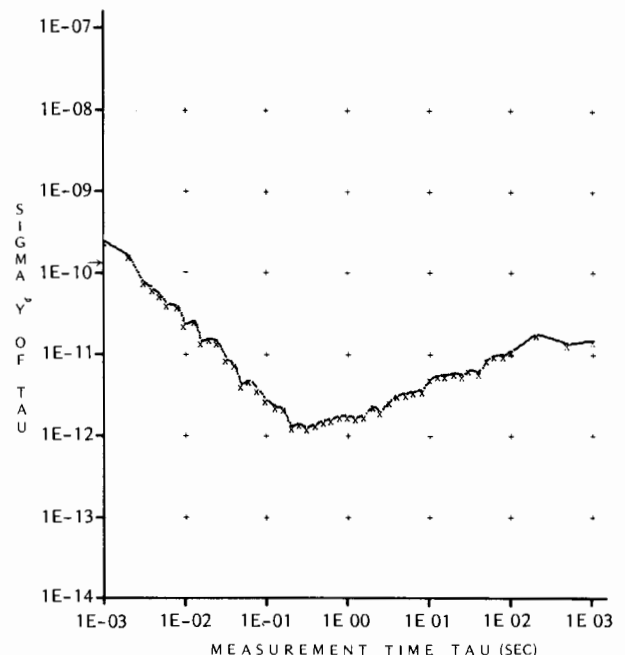

Sample  $\sigma_y(\tau)$  vs  $\tau$  plot generated by 5390A.

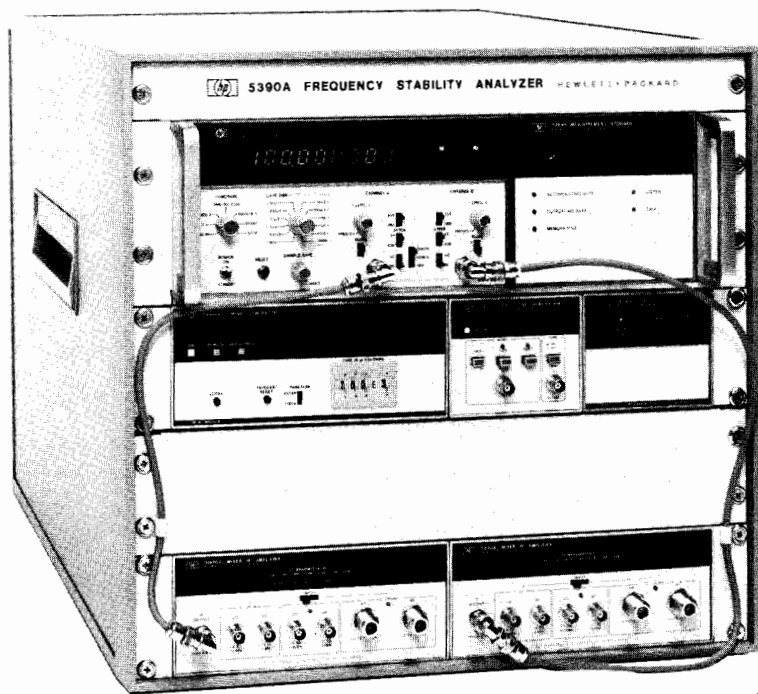

5390 opt 010 instrument cluster (shown with Digital Clock opt 004)

**Phase Spectral Density Measurements**

The measurement of close-in phase noise (spectral density of phase fluctuations) at offset frequencies from the carrier below 10 to 100 Hz has traditionally been difficult or impossible. Now, with the 5390A, it is possible to make these measurements rapidly and easily. The measurement technique is based on an N sample variance computed by the 9825B from frequency measurements made by the 5345A. Phase noise spectral density is then determined from the measured N sample variance. The 5358A Measurement Storage Plug-In controls gate time and dead time between frequency measurements. This makes the 5345A look like a digital filter in the frequency domain whose center frequency and bandwidth are determined by gate time, dead time, and number of measurements in the sample.

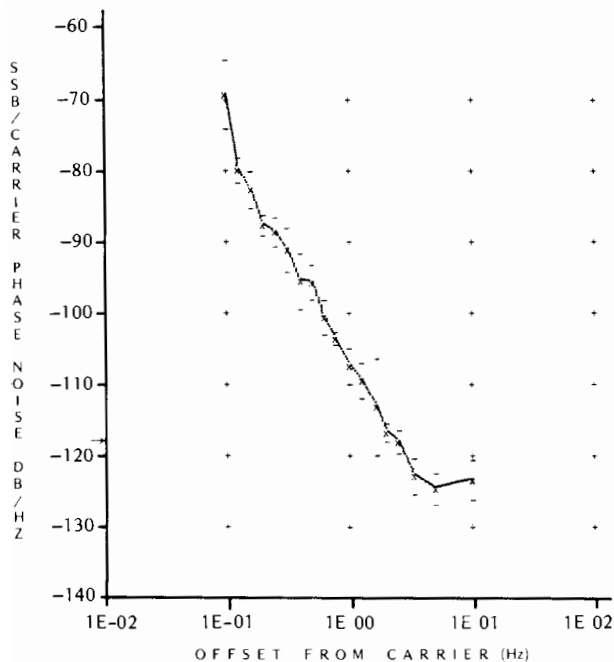

Sample phase noise plot generated by 5390A.

**Option 010 Dual Mixer Time Difference**

Measurements can be made with the 5390A using either the standard single heterodyne configuration or the dual mixer time difference configuration (Option 010). The primary application of the single heterodyne method is where an offsettable reference oscillator is available, whose noise over the range of interest is equal to or better than the test oscillator. The primary application of the Option 010 configuration is for measuring non-offsettable sources.

In the Dual Mixer Time Difference configuration of the system (Option 010) a second 10830A Mixer-IF Amplifier is added. A third difference oscillator is used in this set-up to produce two measureable signals. The test oscillator at a frequency  $\nu_0$  and the reference oscillator at essentially the same frequency are each applied to the 10830A's. The difference oscillator's signal ( $\nu_0 + \nu_b$ ) is split and applied to both 10830A's. The resultant two difference signals ( $\nu_b$ ) are applied to the 5345A's inputs and time interval measurements are made between the two at intervals  $\tau$ .

**Systems Options**

	<b>Price</b>
<b>001</b> Expands 5358A memory in 2K increments. Up to 3 Opt. 001's may be added.	add \$300 each
<b>004</b> Adds 59309A Digital Clock and HP-IB cable.	add \$1085
<b>010</b> Adds second 10830A, 59308A, power splitter, system cabinet, and expands 5358A memory to 6K bytes.	add \$5900
<b>325</b> Deletes 9825B	less \$8200
<b>371</b> Deletes 9871 Printer/Plotter	less \$4100

**Ordering Information**

- 5390A** Basic System includes:  
**5345A** Option 011 Electronic Counter  
**5358A** Measurement Storage Plug-in  
**10830A** Mixer/IF Amplifier  
**10831A** Test Tone Generator  
**9825B** Computing Controller  
 (This includes 32K memory, and all needed ROMs)  
**98034A** HP-IB Interface  
**9871A** Option 001 Printer/Plotter  
 System Cabinet  
 System Software

**5390A Basic System**

**\$27,250**

# TRANSCEIVER TEST EQUIPMENT

Automatic RF test system

Model 8950B

- Designed for AM, FM and 0M transceivers from 2 to 1000 MHz



- Ideal for testing FM mobile, aircraft communication, tactical and citizen's band radios.
- Component stimulus/response testing from dc to 1000 MHz.



### Varied Applications

The HP 8950B Transceiver Test System automatically tests AM and FM communications transceivers over the frequency range of 2 to 1000 MHz. It is ideal for production line testing, R & D evaluation, quality assurance testing, incoming inspection, and user maintenance of many transceivers. The HP 9825B desk top computer controls the stimulus and measurement capabilities of the system via the HP Interface Bus (HP-IB).

### Speed

Using the 8950B system, transceiver testing time can typically be reduced by a factor of 10 or more, resulting in greatly increased productivity. For example, the system performs a typical set of tests on a mobile radio in about 2 minutes, while a manually operated setup would require about 20 minutes.

### Accuracy

Operation of the 8950B under computer control offers better accuracy than a manual system. By automatically applying previously

measured calibration factors, repeatable system errors such as frequency response and insertion loss are virtually eliminated.

### Data Presentation

The 9825B contains a 16 character wide thermal printer adequate for writing software or for short message printouts. For more sophisticated printouts several peripherals are system compatible including the HP 7245A plotter-printer, 9866B thermal printer, and the 9871A character impact printer.

### A Flexible HP-IB System

HP-IB interconnection insures that your 8950B will not become obsolete in the near future: as new and more advanced instrumentation is offered, your system can easily be updated to include added measurement capability. The 8950B employs general purpose, off-the-shelf instruments except for the 8951B System Interface. This means you may already be using nearly identical instruments in your measurements; therefore, test results will be directly comparable and operation and maintenance simplified.



## Varied Applications

The system interface provides access, under program control, to all instruments in the system. This hardware switching combined with the modular instrument driver subroutines provides powerful general purpose automatic stimulus/response testing from DC to 1000 MHz of components, audio and RF amplifiers, modules, and subassemblies.

## 8951B System Interface

The 8951B System interface contains all the signal switching and conditioning needed to route signals to and from the proper instruments and the radio under test. All radio connections are made at a single working panel and no manual switching or cable reconnection is necessary during a typical series of tests.

In addition to switches, the 8951B includes a 100 watt RF attenuator, a high quality FM discriminator, and a diode detector for AM measurements. Three band-reject filters with provision for an external filter are used for distortion and SINAD measurements.

Positive and negative peak detectors provide true FM peak deviation measurement. Extra switching is provided to add spectrum analysis capability to the system.

## 9825B Computer Controller

The flexible and powerful 9825B is an ideal controller for this system. It employs HPL, a high-level programming language which offers power and efficiency for handling equations and controlling instruments, yet is easy to learn and use. The controller and HPL allow easy storage and review of programs and data on a high speed, 250,000 byte tape cartridge.

## System Software

The 8950B is furnished with a tape cartridge containing a comprehensive library of system programs: 1) the *verification program* is a short system self-test to assure the user that the system is operational, 2) the *calibration program* generates calibration factors to correct repeatable errors in the system, 3) the *measurement subroutines* allow complex measurements to be made by writing only a single statement, 4) and the *instrument drivers* facilitate information transfer between the calculator and the instruments.

## Writing Programs

To perform a series of tests on a transceiver, a program must be written which accesses the appropriate measurement and instrument driver subroutines. Additional program statements will provide a printed copy of the results which can include the chosen test limits or a Pass-Fail indication of total test performance. Because of the software flexibility, special tests can easily be written using the instrument drivers provided with the system.

## Typical System Tests

### Receiver

SINAD sensitivity	Hum and noise
Quieting sensitivity	AGC response
Squelch threshold	Modulation acceptance bandwidth
Audio power	Power supply sensitivity
Audio distortion	Current drain
Audio response	DC and AC voltage

### Transmitter

Carrier power	Audio sensitivity
Carrier frequency and stability	Squelch tone frequency
AM depth	Limited spurious measurement
FM deviation	Power supply sensitivity
Audio distortion	Current drain
Audio response	Modulation limiting

### General Purpose Automatic Tests

DC voltage	Resistance
AC voltage	Frequency
Amplifier gain	Flatness

## 8950B System Specifications (Includes Software Calibration)

### General

**System frequency range:** 1–1000 MHz.

**System power range:** 0.5 – 100 watts.

**Calculator controlled power supply voltages:** 0 to 30 V, 50 mV resolution.

**Current drain measurement range:** 50 mA to 10 A.

### Transmitter Tests

**Power measurement range (Antenna port):** 1 mW to 100 watts.

**Power measurement range (AUX RF Input):** 10  $\mu$ W to 1 watt.

**Power measurement accuracy (Antenna port):** expected  $\pm 0.3$  dB  $\pm 7.2\%$ .

**Frequency measurement range:** 0 to 1300 MHz.

### AM measurement

**Frequency range:** 2–400 MHz.

**AM depth range:** 0.5 to 95%.

**AM accuracy (1 kHz rate 10% to 80%):**  $\pm 2\%$  AM DEPTH  $\pm 5\%$  of reading.

**AM rate range (3 dB):** 50 Hz – 25 kHz.

**AM residual distortion (at 30% AM):** (at 400 Hz, 1 kHz, 3 kHz rates):  $\leq 2\%$

### FM measurement (positive and negative peak detection)

**Frequency range:** 4–1000 MHz.

**Peak deviation range:** 300 Hz – 20 kHz.

**System residual:**  $< 10$  Hz in 1 kHz BW.

**FM accuracy (1 kHz rate):**  $\pm 3\% \pm 30$  Hz.

**FM rate range (3 dB):** 50 Hz – 20 kHz.

**FM residual distortion (at  $\geq 3$  kHz peak deviation at 400 Hz, 1 kHz, 3 kHz rates):**  $\leq 1.0\%$ .

### $\emptyset$ M measurement

**Frequency range:** 4 – 1000 MHz.

**Deviation:**  $\Delta\emptyset_{\max} = 20/\text{mod. rate (kHz)}$ .

**$\emptyset$ M rate range:** 50 Hz – 20 kHz.

**$\emptyset$ M accuracy (1 kHz rate):**  $\pm 3\%$ .

**Spurious measurements ( $> 1$  MHz away from carrier):** 0 to  $-40$  dBc.

### Receiver Tests

**Minimum measurable sensitivity (typical):** 0.2  $\mu$ V.

**Output level range (Antenna port, into 50 ohms):**  $-145$  to  $-19$  dBm ( $\sim 0.013$   $\mu$ V to 25 mV).

**Output level accuracy (1 to 1000 MHz, at Antenna port):**  $\pm 1.5$  dB.

**Audio power measurement accuracy:** 0.5%  $\pm$  speaker load tolerance.

**Audio distortion measurement:** At 400, 1000, and 3000 Hz rates.

**Residual distortion:** RF generator distortion  $+0.3\%$ .

### Audio frequency range:

**AM:** 50 Hz to 50 kHz (RF freq  $> 10$  MHz)

**FM:** 50 Hz to 100 kHz.

**Modulation acceptance bandwidth measurement range:** 1 to 100 kHz.

### General Characteristics

**Operating temperature range:** 15° to 35°C.

**Power requirements:** 115 volts  $\pm 10\%$ , 60 Hz.

**Net weight (less calculator):** 186 kg (410 lb).

### Ordering Information

8950B Transceiver Test System (including controller and programs) **Price** \$64,000

### 8950B Options

**002:** Additional Power Supply capability (Substitute 6268B Option 026/J80 and 59501A for 6002A) add \$650

**003:** Reduced frequency (110 MHz) less \$4500

**004:** 230 V, 50 Hz operation N/C

**005:** Delete 9825B Controller and HP-IB interface less \$8100

### PCM/TDM Transmission Techniques

Pulse code modulation (PCM) developed because of a need for greater capacity over local telephone circuits between exchanges. In its basic form, it replaces a system of one pair of wires per subscriber with a system of two pairs of wires for 24 or 30 subscribers.

The basic PCM process converts the analog signal into digital pulses. The 4 kHz voice channel is sampled at an 8 kHz rate, each sample quantized to one of 256 possible levels and then each sample allocated an 8-bit binary code dependent on its quantized level. The result is a two-level (binary) digital stream clocked at 64 kb/s.

Time division multiplexing (TDM) is a means of transmitting several sources of information over one medium by allocating time slots to each source. Primary level multiplexing (usually of 4 kHz voice channels) is achieved, either by sampling each source sequentially prior to quantizing and encoding or by time interleaving the 8-bit encoded samples at the 64 kb/s level. A 24 voice channel assembly will then produce a digital stream at 1544 kb/s comprising 24 × 64 kb/s encoded voice plus 8 kb/s (1 bit per frame) of framing information to allow separation of the individual channels at the receive terminal equipment. Signalling infor-

mation is carried by "bit stealing" the least significant bit of each speech time slot one frame in every six. This is the standard system used in North America. In Europe, 30 voice channels are combined in a digital stream at 2048 kb/s comprising 30 × 64 kb/s encoded voice plus 64 kb/s (8 bits per frame) of framing information and 64 kb/s (8 bits per frame) of signalling information.

Higher level multiplexing is achieved by further interleaving of digital streams, either synchronously or asynchronously using pulse stuffing or pulse justification. There are three standard digital transmission "hierarchies" which have been developed (North American, European, and Japanese) and some of the interfaces have been standardized internationally by the International Telegraph and Telephone Consultative Committee (CCITT). However, to suit various local needs other transmission rates exist locally within national boundaries.

The basic concept of digital transmission is to send data so that it can be regenerated at frequent intervals without producing errors. Transmission impairments are then largely dependent on terminal performance. The binary digital stream generated in the multiplex is not ideal for cable transmission because of its dc content, significant energy spectrum up to high frequencies and pattern-

dependent timing content. Therefore, a line code is usually employed which has zero dc content, energy concentrated at frequencies lower than the bit rate, and regular timing content. The simplest form of line code is alternate mark inversion (AMI) where each data mark or "one" is given a polarity opposite to the preceding mark. This results in a bipolar (pseudo-ternary) signal meeting the first two criteria. A further development of AMI is to insert a specific pattern whenever long runs of zeros occur to maintain the timing content. Various patterns are in use; for example, B6ZS and B3ZS (bipolar with six or three zero substitution) and HDB3 (high density bipolar with a maximum of three consecutive zeros). All are recognizable in that they produce a known sequence of bipolar errors (ie violate the AMI rule) and so can be removed at the receive terminal. These simple line codes are also used on interface connections between digital equipment.

The primary multiplex digital output signal in line code is transmitted over existing audio cable by replacing loading coils with digital regenerators (see Fig. 1). Higher order multiplex signals are transmitted over coaxial cable using more complex line codes or over radio systems using phase shift keying of an IF or RF carrier or over optical fibre using further binary coding.

### PCM/TDM Measurements

Measurements on PCM/TDM equipment can be divided into those on the terminal and those on the transmission link (see Fig. 2).

Traditionally the primary PCM multiplex terminals have been characterised in terms of their voice channel performance by either connecting two terminals back-to-back or looping a single terminal at the digital side. The measurements made have been standard voice channel tests of level, frequency response, noise, crosstalk, intermodulation, etc, plus measurements unique to PCM such as quantizing distortion. The measurement methods have been agreed and standardized by CCITT. While this approach to terminal testing has been adequate for local junction PCM systems, the increasing use of PCM in the trunk network and the introduction of digital TDM switching now makes it necessary to measure the performance of the transmit half of a terminal separately from the receive half. This requires analog-to-digital (A-D) and digital-to-analog (D-A) tests of the voice channel parameters plus checks of digital functions such as frame alignment or synchronization. These types of measurements are also required on digital switching equipment which contains PCM coder/decoders (codecs) to interface with the existing analog environment, for example, a PABX.

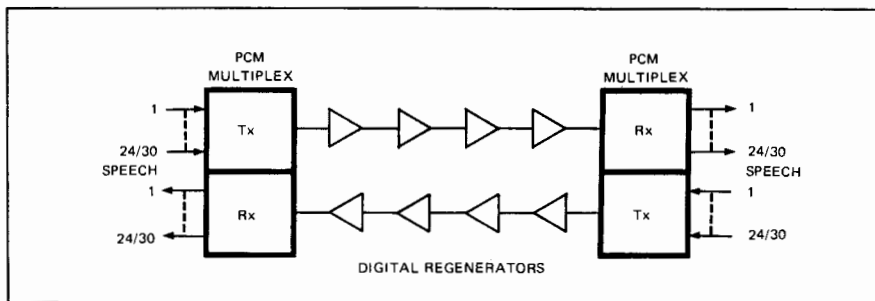

Figure 1. Basic PCM/TDM transmission system

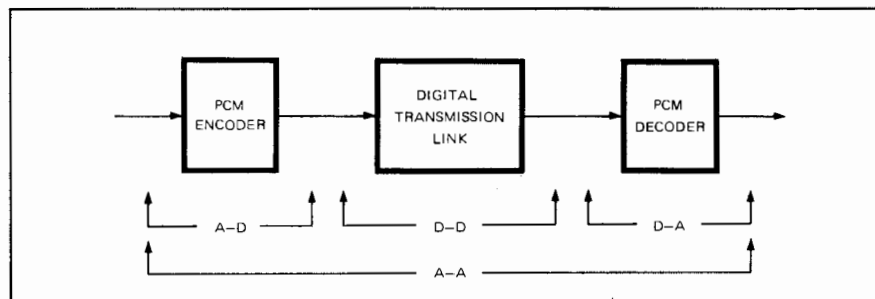

Figure 2. PCM/TDM measurements

Increasing use of single channel PCM codec "chips" in this type of equipment also requires A-D and D-A testing of integrated circuit devices.

Measurements on digital transmission systems (including higher order TDM multiplexes) are aimed at establishing primarily two performance criteria—binary error and timing jitter performance. Both out-of-service and in-service measurements are of interest.

Error performance can be expressed in various ways, for example, bit error ratio (BER), error-free seconds (EFS), or percentage time for which mean error rate exceeds a given threshold. The standard out-of-service technique of measuring error performance is to stimulate the system with a test pattern, usually a pseudo-random binary sequence (PRBS). The PRBS length should be chosen to simulate a normal traffic signal to be carried by the system, and vary sufficiently in pattern content to adequately test pattern-sensitive parts of the equipment, for example, clock recovery circuits. For measurements at 1.5/2.0 Mb/s and 6.3/8.4 Mb/s, a  $2^{15}-1$  PRBS has been standardised by the CCITT; while for higher speed systems,  $2^{15}-1$  and  $2^{23}-1$  PRBS patterns are used. At the transmission system output, the data stream is synchronized with a locally-generated, error-free reference pattern and then a bit-by-bit comparison carried out. Any differences are bit errors and these can be counted and displayed as BER, EFS, total error count etc. In-service measurements of error performance can be performed by monitoring fixed known patterns carried within the traffic signal, for example, the frame alignment signal of the terminal multiplex, or, in the case of line systems, monitoring errors in the line code. However, the latter method is only valid where no binary signal processing occurs between system input and system output.

Jitter performance of a system or subsystem, regenerator, etc, is normally expressed in three ways—input jitter immunity (i.e. how much jitter can be applied before digital errors occur), intrinsic output jitter, and jitter transfer function (or jitter frequency response). Jitter immunity and jitter transfer function are normally measured with the system out of service and applying timing jitter to a test pattern while measuring errors and output jitter. Basic intrinsic output jitter can be measured out-of-service or in-service provided that the jitter meter has some means of recovering a timing reference from the input signal.

### PCM/TDM Test Equipment

HP's range of dedicated PCM/TDM test equipment is generally divided into two types—A models which are compatible with CEPT standards, and B models for checking Bell standard equipment. In some cases, the A models are suitable for both.

For testing primary PCM terminal equipment, the 3779A/B Primary Multiplex Analyzer provides A-A, A-D and D-A measurement capability in an integrated test set. The instrument can be programmed to execute a complete measurement sequence to stored test limits and print out results on an

external printer. Automatic testing of all the voice channels in a multiplex can be carried out via the 3777A Channel Selector controlled by the 3779A/B.

For testing digital transmission equipment, a range of instrumentation is available. The 3780A Pattern Generator/Error Detector provides binary and code error measurements in a single portable instrument for bit rates up to 50 Mb/s (see Fig. 4). Many of the North American digital transmission systems utilise the frame structure of the terminal multiplex for error monitoring and protection switching. In this case, the test equipment must also generate and receive the appropriate frame structure at each hierarchy level. The 3781B Pattern Generator and 3782B Error Detector have been designed specifically for this type of application with interfacing capability at the DS-1, DS-1C, DS-2, and DS-3 levels of the Bell

digital hierarchy (see Fig. 5). This system also has jitter generation, advanced error analysis capability, and full HP-IB control. Error performance measurements on higher speed systems up to 150 Mb/s can be made with the 3762A Data Generator and 3763A Error Detector. The system has specific options for interfacing at the 34 and 139 Mb/s levels of the CEPT digital hierarchy. The 3762A/3763A have also been designed to operate in burst mode for Time Division Multiple Access (TDMA) satellite applications.

For in-service measurements on 2 Mb/s digital transmission systems to CCITT standards, the 3783A 30Ch PCM Alignment Monitor and Error Detector provides error measurements on the frame alignment signal of the primary PCM/TDM multiplex and the HDB3 line code. It also detects and displays any alarm states present in the signal.

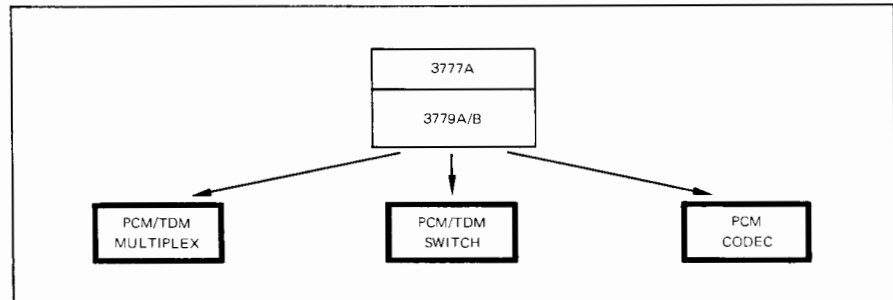

Figure 3. PCM/TDM terminal test equipment

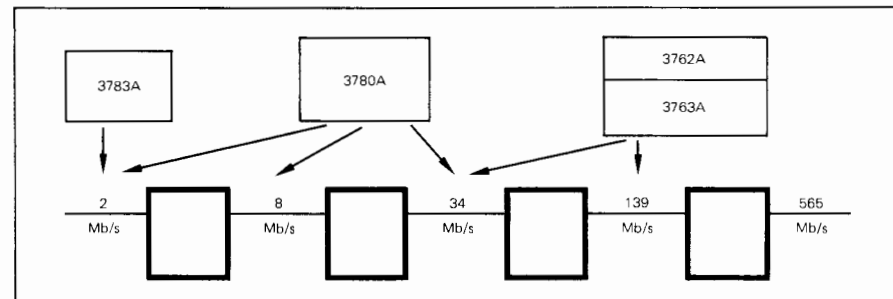

Figure 4. CEPT TDM hierarchy test equipment

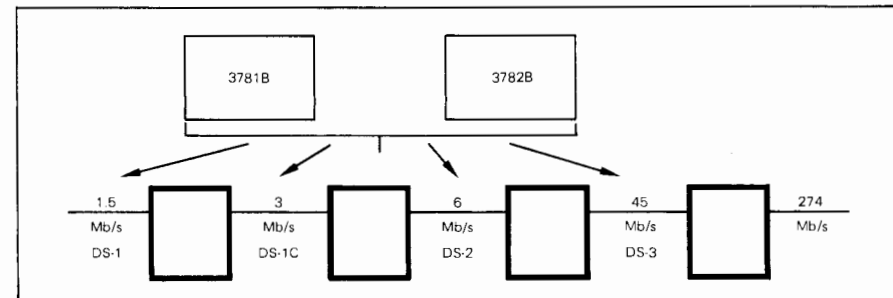
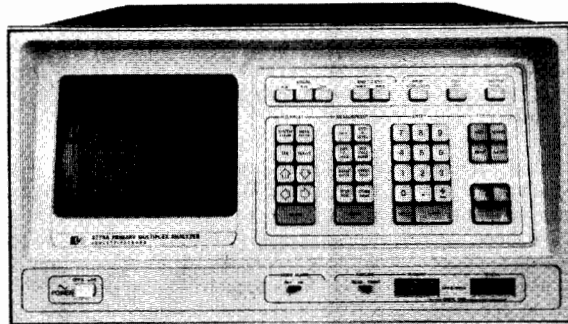

Figure 5. Bell TDM hierarchy test equipment

# TELECOMMUNICATIONS TEST EQUIPMENT

## Primary Multiplex Analyzer Models 3779A and 3779B

- A-A, A-D, and D-A measurements
- Automatic measurement sequencing
- User-level keyboard programming
- Non-volatile program storage
- End-end testing via built-in data modem
- CCITT, CEPT, and Bell compatible



Model 3779A provides voice channel measurements to CEPT recommendations. The digital option is designed to test PCM equipment conforming to CCITT Recommendations G.711 and G.732, ie 30 voice channels/32 time slots encoded using the A-law and time division multiplexed into a 2048 kb/s digital stream. Single channel codecs can also be tested via a TTL interface.

Model 3779B provides voice channel measurements to Bell recommendations. The digital option is designed to test PCM equipment conforming to CCITT Recommendations G.711 and G.733, ie 24 voice channels/24 time slots encoded using the  $\mu$ -law and time division multiplexed into a 1544 kb/s digital stream. Single channel codecs can also be tested via a TTL interface.

### Concept

The 3779A/B Primary Multiplex Analyzer (PMA) is a totally new concept in automated measurements of voice channel equipment including PCM, FDM, TDM terminals, and switching. It has been designed specifically to measure to CCITT, CEPT, and Bell recommendations and makes significant contributions in new measurement hardware and software. Separate tests of analog-digital (A-D) and digital-analog (D-A) performance of PCM terminals can be made in addition to characterizing the analog-analog (A-A) performance of voice channels.

Organized around a microprocessor, the instrument can automatically sequence through a number of measurements to programmed limits, calculate, and display results. Control over the PMA is via a keyboard orientated towards voice channel measurements. Programming requires no special expertise, since all measurement execution software is pre-programmed into the instrument. Operation is therefore at measurement parameter level. If required, the measurement parameters (test levels, frequencies, limits, etc.) may be modified via the keyboard. Once programmed, measurements may be assembled into a sequence which is stored in non-volatile memory for future use. Indication of the status of the instrument, together with measurement parameters/results, are on an alpha-numeric CRT display. Built-in self-test greatly facilitates calibration and fault diagnosis. Security of stored programs is provided via an electronic, keyboard-operated, combination lock.

The PMA itself can control a number of 3777A Channel Selectors to provide multi-channel access for voice and signalling measurements. The PMA can also format results and print them out via a 2631A printer equipped with HP-IB. A built-in modem in the PMA allows one instrument to control another remotely over the voice channel under test, enabling automatic end-end testing of the analog parameters of a voice channel circuit without recourse to external modems and common carrier interfaces.

Full details of the features and measurement capability are given in the 3779A/B Data Sheet.

Table 1. 3779A/B Measurement Capability

Measurements	A-A	A-D	D-A	E-E
Gain	•	•	•	•
High accuracy gain	•			
Gain using peak codes		•		
Digital mW gain			•	
Gain vs frequency	•	•	•	•
Gain vs level using noise (3779A only)	•			•
Gain vs level using tone	•	•	•	•
Gain vs level using peak codes		•		
Gain vs level using sync 2 kHz			•	
Pedestal (coder offset)		•		
Idle channel noise psophometric (3779A only)	•	•	•	•
Idle channel noise C-message (3779B only)	•	•	•	•
Idle channel noise 3 kHz flat	•	•	•	•
Idle channel noise selective	•	•	•	•
Noise-with-tone	•			•
Quantizing distortion using tone			•	•
Quantizing distortion using noise (3779A only)	•			•
Intelligible crosstalk	•	•	•	•
Intermodulation using two tones	•			•
Intermodulation using four tones (3779B only)	•			•
Discrimination against out-of-band inputs	•			•
Spurious out-of-band outputs	•			•
Spurious in-band outputs	•		•	•
Return loss (Tx and Rx)	•			•
Impedance balance (TX and Rx)	•			•
Signal balance	•			•
E & M signalling distortion	•			•
Analog level	•			
Digital level		•		
Remote alarms (3779A only)			•	
Multi-frame alignment (3779A only)			•	
Frame alignment (3779A only)			•	
Local alarms (3779A only)			•	

### Specifications

The standard 3779A/B provides analog-analog and end-end measurement capability. Analog-digital and digital-analog capabilities are optional. The measurements are summarized in Table 1.

#### Options (3779A)

**001:** provides A-D and D-A hardware and software; digital interfaces are bipolar rectangular via 75 $\Omega$  unbalanced BNC connectors, and single channel TTL. **Prices** add \$2285

**002:** same as Opt 001 but with Siemens 1.6 mm connectors. add \$2285

#### Options (3779B)

**001:** provides A-D and D-A hardware and software; digital interfaces are bipolar rectangular via 100 $\Omega$  balanced WECO connectors, and single channel TTL. add \$2285

**002:** provides A-D and D-A hardware and software for  $\mu$ -law codecs, but 2048kb/s clocking. Digital interface TTL only. add \$2240

#### Ordering Information

**3779A** Primary Multiplex Analyzer (CEPT) \$24,465  
**3779B** Primary Multiplex Analyzer (Bell) \$24,465

# TELECOMMUNICATIONS TEST EQUIPMENT

563

## PCM Test Systems

Models 3779A/B, 3777A, 2631A, 9825S, 9835A, 9845S, 1000 System



- 3779A/B multi-measurement capability
- 3779A/B ease of programming and operation

- Extended operation using the HP-IB
- Wide range of system controllers

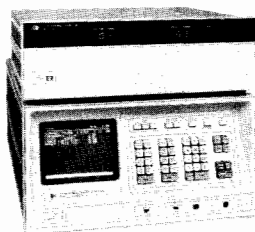

3777A, 3779A/B



2631A



9825S

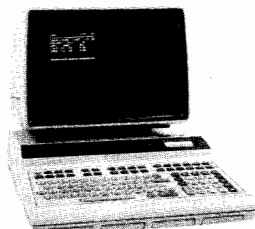

9835A

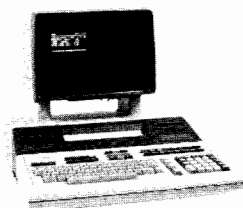

9845S

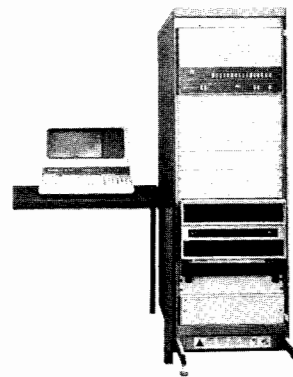

1000 System

### System Configuration

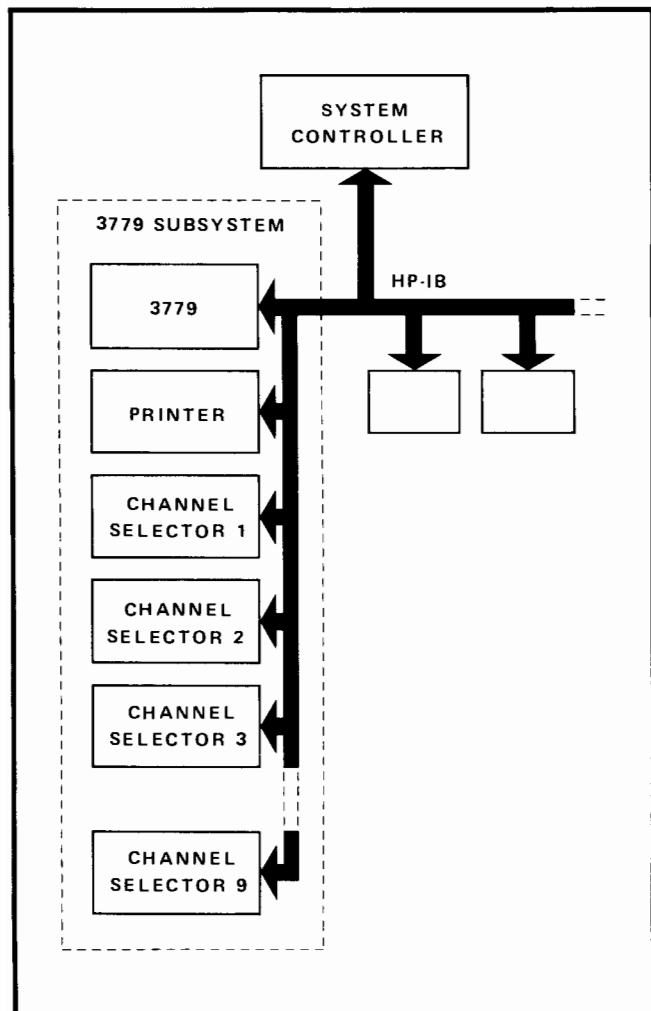

### Applications

The 3779A/B Primary Multiplex Analyzer (PMA) is itself a system controller, containing operating software for a system comprising a printer and up to nine 3777A Channel Selectors. However, versatile as the PMA is, some users may require more. The following examples are just a few of the ways in which the PMA capability can be enhanced by using an external system controller.

- A worst-case channel can be identified, and then analyzed in detail. Statistical analysis of results can also be performed.
- For testing different types of terminal equipment consisting of a wide variety of channel cards, the desired measurement sequences can be constructed in the PMA using the instrument's ease of programmability, then transferred into an external controller and recalled as required.
- In processor-controlled switching applications, the switch controller can instruct the PMA to perform a number of measurements on the matrix path.
- Production test stations using PMA's can be controlled from a centralized computer system.
- A PMA subsystem may form part of a larger automatic test system incorporating, for example, power supplies, DVM's, switches, etc.

### System Components

- 3779A/B Primary Multiplex Analyzer
- 3777A Channel Selector
- 2631A Printer

### Choice of System Controller

- 9825S Desktop Computer with 24 kbytes read/write memory (23 kbytes user read/write memory) and 98201A String-Advanced Programming ROM, 98216A Plotter-General I/O-Extender I/O ROM.
- 9835A Desktop Computer with 65 kbytes read/write memory (49 kbytes user read/write memory) and 98332A I/O ROM.
- 9845S Desktop Computer with 64 kbytes read/write memory (62 kbytes user read/write memory) and CRT, Graphics ROM, 98432A I/O ROM.

The above System Controllers require the 98034A HP-IB Interface Card.

- 1000 Computer System with 59310B HP-IB interface.



# TELECOMMUNICATIONS TEST EQUIPMENT

## HP-IB Controlled Channel Selector; PCM Terminal Test Accessories

Models 3777A, 15512A, 15513A, 15514A, 15515B, 15516A, 15517A

- DC to 110 kHz
- 2-wire/4-wire balanced switching
- Modular construction
- Up to 30 4-wire channels

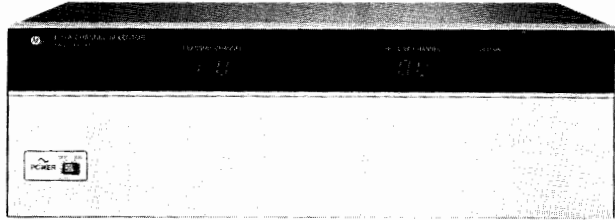

3777A



### 3777A Channel Selector

The 3777A is an HP-IB controlled Channel Selector. It provides test point access for maintenance and production testing of PCM and FDM telecommunications systems.

The instrument contains two identical banks of relays, termed 'Transmit' and 'Receive.' Each bank comprises up to 30 balanced, bi-directional, two-pole changeover switches. The Transmit bank enables switching of a single source to any one of up to 30 outputs. In the Receive bank, any one of up to 30 inputs can be switched to a common output. To provide a quiet termination for telecommunications equipment, all unselected channels are terminated in 600Ω in series with 2.2 μF.

The two switch banks are controlled independently via the HP-IB from the 3779A/B Primary Multiplex Analyzer, a computer or a programmable calculator. For automatic test systems, the 3777A can scan, under external program control, through a number of channels in any desired sequence.

Construction of the 3777A is modular, with the 30 channels in both Transmit and Receive banks arranged in 5 blocks, each block having 6 Transmit and 6 Receive channels. 12 and 24 channel versions with only 2 or 4 blocks are available as options.

Principal applications are in testing telecommunications equipment where the 3777A may be used to switch PCM primary multiplex channels, FDM voice channels or groups, and voice frequency telegraph circuits, for measurements during production, installation, or maintenance. The high quality relays employed in the 3777A also make it suitable for many other general purpose applications requiring an HP-IB controlled channel selector.

#### 3777A Options

	Price
<b>001:</b> 24 channels in transmit and receive banks. WECO 310 connectors used for transmit I/P and receive O/P.	\$295
<b>002:</b> 12 channels in transmit and receive banks. Siemens audio connectors used for transmit I/P and receive O/P.	\$865
<b>003:</b> 12 channels in transmit and receive banks. WECO 310 connectors used for transmit I/P and receive O/P.	\$865

**3777A Channel Selector** **\$4670**

#### 15512A Cable

The 15512A is a 1m length of 600Ω balanced cable with a 3-pin audio connector (Siemens type) at each end.

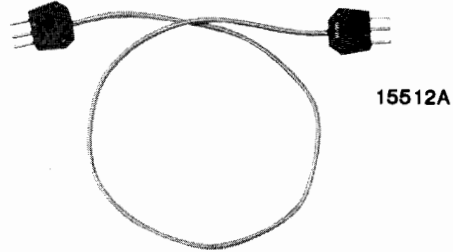

15512A

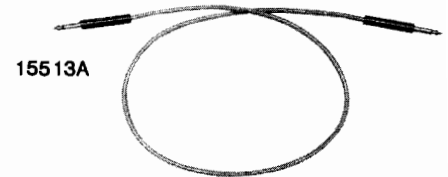

15513A

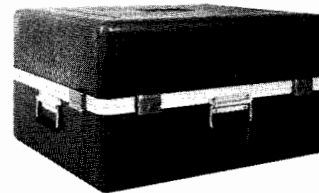

15514A



15515B

15516A/  
15517A

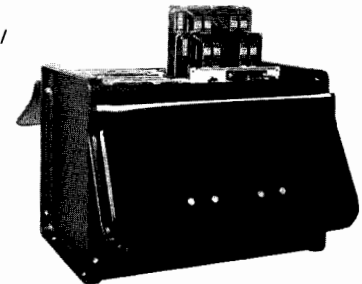

### 15513A Cable

The 15513A is a 1m length of 600Ω balanced cable with a WECO 310 jack plug at each end.

### 15514A Transit Case

The 15514A is a transit case with moulded foam inserts for transporting the 3779 Primary Multiplex Analyzer.

### 15515B Loop Holding Unit

Model 15515B is a loop holding unit which provides 24mA loop holding current sinking. It is supplied with WECO connectors.

### 15516A and 15517A Conversion Kits

The 15516A Conversion Kit allows a 3779A to be converted to a 3779B. The 15517A converts a 3779B to a 3779A. The kits provide all the required hardware and software, and include a rear panel assembly and carrying case.

#### Ordering Information

	Price
<b>15512A</b> Cable	\$75
<b>15513A</b> Cable	\$60
<b>15514A</b> Transit Case	\$775
<b>15515B</b> Loop Holding Unit	\$310
<b>15516A</b> Conversion Kit (3779A to 3779B)	\$7260
<b>15517A</b> Conversion Kit (3779B to 3779A)	\$7260

# TELECOMMUNICATIONS TEST EQUIPMENT

## 30 CH PCM Alignment Monitor and Error Detector

Model 3783A

565



- Provides in-service error monitoring
- Counts frame or code errors
- Low-cost, portable unit
- Optional rechargeable battery

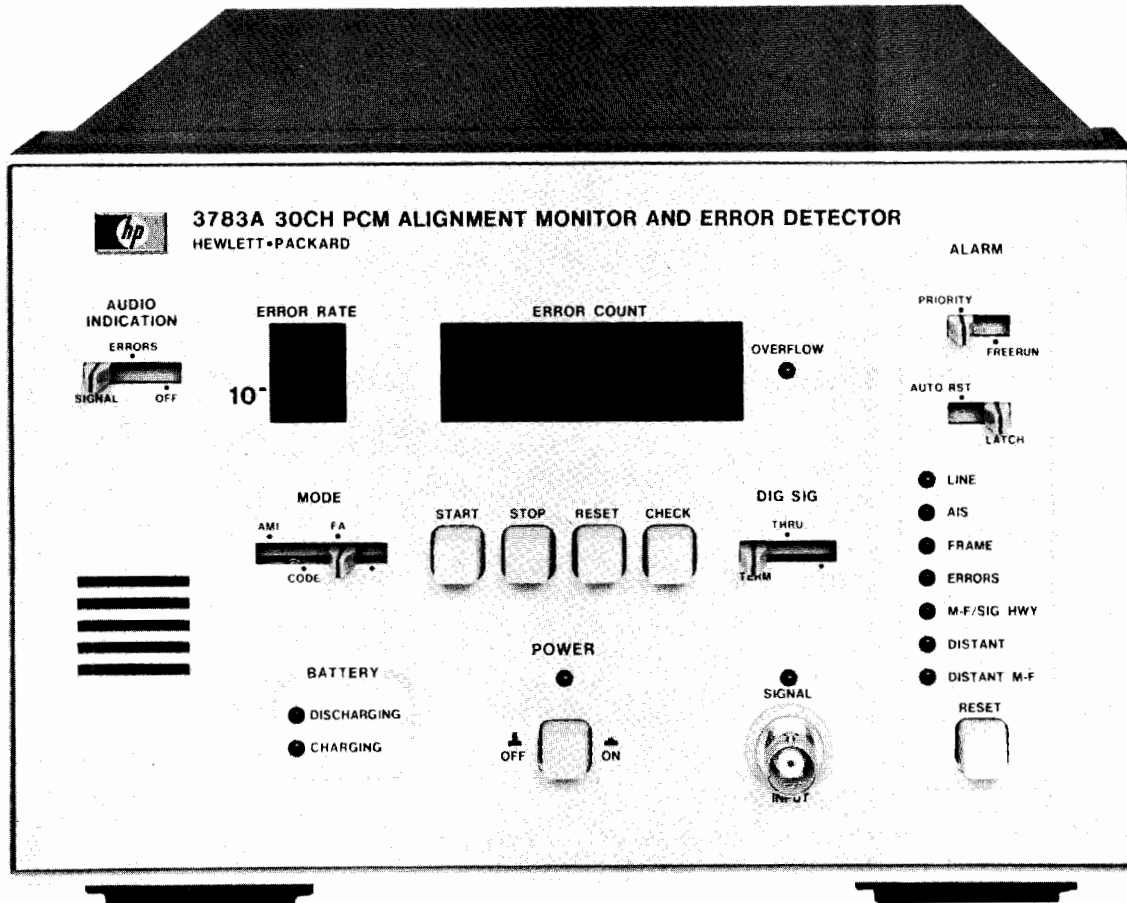

3783A

The 3783A is a low-cost, portable instrument for in-service measurements on 2 Mb/s digital transmission systems conforming to CCITT Recommendation G.732 (European CEPT, 30 channel PCM multiplex standard). The instrument can detect and count:

- Frame alignment signal errors
- Code violation errors
- External input error pulses from a multiplex

Frame alignment signal (FAS) errors are measured by decoding the HDB3 2 Mb/s line signal and recovering the time slot allocated to the framing signal, TS0, from which errors occurring in the FAS can be detected and counted. Display of the measured result can be a binary bit error rate, based on the assumption that the overall signal contains a Poisson distribution of errors, or a FAS error count over a manually selected measurement period. While operating as a FAS error detector, the instrument also detects and displays any system alarm states which are carried in TS0 and TS16, the time slot allocated to signalling. These alarm states can be displayed on a priority or free run basis with a latch/auto-reset facility.

In addition to monitoring FAS errors, the 3783A can check the input line signal for code violation errors according to the AMI or HDB3 encoding rule. The instrument can also count low frequency input pulses such as the error output signal found on some digital transmission equipments.

The 3783A can be attached in terminated mode to the output of an equipment (out-of-service measurement) or in monitor mode to the high impedance monitor point provided on digital transmission equipment (in-service measurement). An optional rechargeable battery pack allows portable field use where normal station ac main supplies are unavailable. An audio indication of signal present or detection of errors can be selected.

### Specifications Summary

**Signal input:** switched digital signal or error count input.

**Clock recovery:** from the digital signal input at 2048 kb/s  $\pm$  100 b/s.

**Signal format:** AMI or HDB3 with frame structure conforming to CCITT Recommendation G.732.

**Impedance:** 75  $\Omega$  unbalanced (120  $\Omega$  balanced, by special request).

**Count input:** maximum 4 kHz binary input.

**Measurements:** code errors, frame alignment errors, and external error count.

**Display:** error rate exponent and 5 digit error count simultaneously.  
**Gating:** automatic for error rate, manual for error count with start/stop/reset control.

**Alarm flags:** line, AIS, frame, errors, multi-frame/signalling high-way, distant, distant multi-frame; priority or free run selection with auto-reset or latch plus overall reset facilities.

**Audio indication:** tone burst for signal or errors present, selectable.

**Alarm outputs:** two TTL outputs; each goes high when alarm state detected.

**Recorder output:** current drive proportional to displayed result.

### General

**Power supply:** 115 V + 10% - 22% or 230 V + 10% - 18%, ac, 48 to 66 Hz.

### Options

001: operation from rechargeable battery pack.

**Price**  
add \$60

**3783A 30 CH PCM Alignment Monitor and Error Detector**

**\$1950**

# TELECOMMUNICATIONS TEST EQUIPMENT

Dedicated 150 Mb/s PCM/TDM Error Detection System:

Models 3762A & 3763A

- Crystal clocks and clock recovery
- Frequency offset facilities
- Burst mode operation
- Binary and interface codes
- Input equalization
- Error detection on PRBS + 2

3762A

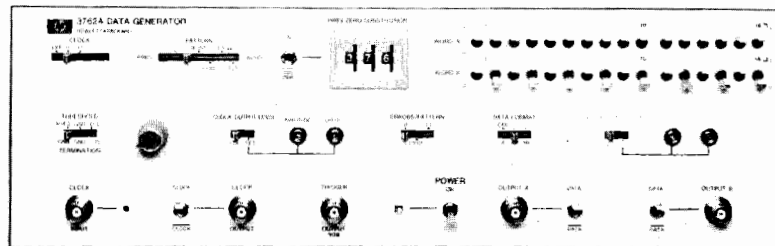

3763A

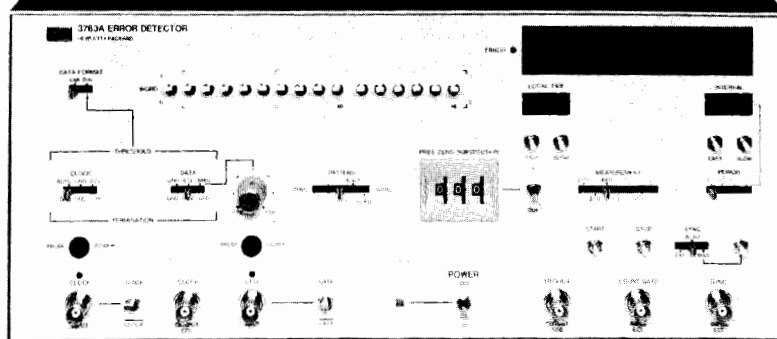

The 3762A Data Generator and 3763A Error Detector comprise a dedicated error rate measurement system for evaluating high-speed digital transmission equipment. Basically, there are two versions of the system available. One features CMI and binary data formats and is specifically intended for use in field commissioning and maintenance of digital radio (terrestrial microwave, and TDMA satellite) systems. The other version, with CMI and ternary (HDB3 and B3ZS) data formats, is designed for digital multiplex and digital cable systems. Although optical fiber systems are still undefined, the 3762A and 3763A have sufficient built-in capability and flexibility to cover applications in this rapidly developing area of telecommunications. Burst gating inputs allow the 3762A/3763A to be used in TDMA applications.

## Specifications Summary

### 3762A Data Generator

**Internal clock:** two crystal clocks in the range 30 to 150 MHz; crystals fitted in standard unit are 139.264 and 141.040 MHz; offset continuously variable up to  $\pm 60$  ppm.

**External clock input:** 1 kHz to 150 MHz; 75 $\Omega$ .

**Patterns:**  $2^{10} - 1$ ,  $2^{15} - 1$ , and  $2^{23} - 1$  PRBS; two 10- or 16-bit programmable words; two 1010...repetitive patterns; two 8-bit words alternated by an external signal; PRBS patterns can be gated off for 1 to 999 clock periods after trigger pulse (zero substitution); error add facilities.

**Data output A:** PRBS or WORD A; DATA or  $\overline{\text{DATA}}$ , in CMI, NRZ or RZ format; 75 $\Omega$ .

**Data output B:** PRBS delayed, or WORD B, in NRZ or RZ format.

### 3763A Error Detector

**Data input:** CMI, NRZ, or RZ formats; 75 $\Omega$  DATA or  $\overline{\text{DATA}}$ ; 12 dB fixed equalization at 70 MHz on CMI inputs with clock recovery.

**External clock:** as 3762A.

**Patterns:** all the patterns of the 3762A, including zero substitution, but excluding alternating words.

**Synchronization:** automatic, manual, or external (ECL).

**Error measurements:** closed loop bit-by-bit comparison at the binary level with an independent, error-free local reference.

**BER:** looks for 10 or 100 errors and takes reciprocal of clock counter; result displayed as  $X.Y \times 10^{-n}$  where  $n = 1$  to 9, with automatic scaling.

**COUNT:** totalizes errors over a selected gating period; internal period can be  $10^6$ ,  $10^8$ ,  $10^{10}$  clock periods or 1 min to 24 h, repetitive or single shot, manual start/stop or external (ECL) control; result displayed as ABCD.

**Measurement gating input:** gates error and clock inputs to error counter, providing a measurement "window"; 50 $\Omega$ ; ECL levels.

**Frequency offset measurement:** measures deviation of received bit rate from nominal rate; result displayed as  $\pm \text{BCD} \times 10^{-6}$ .

**Printer output (rear panel):** 8-4-2-1 BCD, 10-column output of result, plus local time, if required, and flags; TTL print command pulse.

**Recorder output (rear panel):** constant current drive output of BER or COUNT result, with flags.

### Options (3762A/3763A)

**105:** 75 $\Omega$  interfaces changed to 50 $\Omega$ . Frequencies are 60.032 and 30.016 MHz.

**201:** Data output B not delayed; HDB3/B3ZS/AMI; 75 $\Omega$ ;  $\pm 1$  V. Second data input (B) on 3763A; 75 $\Omega$ ; HDB3/B3ZS/AMI; automatic equalization for up to 12 dB cable loss at  $\frac{1}{2}$  bit rate relative to a  $\pm 1$  V signal; clock recovery at installed crystal frequencies. Channel B cannot be used simultaneously with A. Frequencies are 139.264 and 120.000 MHz.

**202:** as for Option 201 except frequencies are 139.264 and 34.368 MHz.

**330:** as for Option 201 except frequencies are 137.088 and 44.736 MHz. In addition, clock and binary data interfaces changed to 50 $\Omega$ .

**801:** front cover.

Prices  
N/C

N/C #5420

N/C #5350

N/C #5370

#52874 543

### Ordering Information

3762A Data Generator

3763A Error Detector

#5340

#5375

# TELECOMMUNICATIONS TEST EQUIPMENT

3780A PCM/TDM Error Measuring Set for Field Use; TDM Accessories

Models 3780A, 15507A, 15508B, 15509A



- Binary and code error detection
- Internal crystal clock and clock recovery
- Clock frequency offset generation and measurement
- Ternary coded and error detection
- PRBS and WORD pattern generation and detection
- Printer and recorder outputs

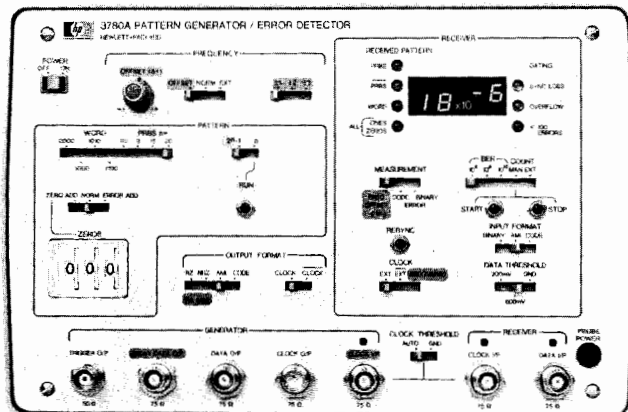
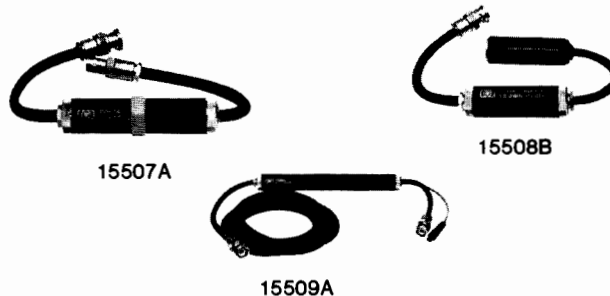

The 3780A Pattern Generator/Error Detector is a comprehensive error measuring set in one portable package. The instrument measures Binary Errors and Code Errors in digital transmission equipment operating at bit rates between 1 kb/s and 50 Mb/s. Frequency offset generation and measurement are also provided at the standard bit rates used in PCM/TDM transmission.

The 3780A has been designed principally for use in field trials, commissioning, and maintenance of digital transmission terminal and link equipment. It is particularly suited for testing digital multiplex, radio, and line systems but will also find application in the development of more advanced systems such as optical fibre transmission and time division switching.

## Specifications

### Measurements

**Binary errors:** closed loop bit-by-bit detection on any pattern produced by generator, excluding added zeros or alternating words.

**Code errors:** violations of coding rule detected on any pattern with AMI, HDB3, or HDB2 coding (optionally AMI, B6ZS, or B3ZS).

**Frequency offset:** measurement of fractional offset of generator clock output from installed crystal rates.

### Options

#### Word/connector options

**001:** all words replaced by a 16-bit front panel programmable word. add \$255

**002:** Siemens 1.6 mm connectors. add \$85

**003:** combination of 001 and 002. add \$315

#### Frequency offset option

**099:** frequency offset capability—measurement only, generation facility deleted. less \$170

#### Frequency/codec options

**Std:** internal clock frequencies of 2048, 8448, and 1536 kHz; HDB3/HDB2 codec.

**100:** internal clock frequencies of 2048, 8448, and 34368 kHz; HDB3/HDB2 codec. add \$255

**101:** internal clock frequencies of 1544, 6312, and 44736 kHz; B6ZS/B3ZS codec. N/C

**102:** internal clock frequencies of 1544, 6312, and 3152 kHz; B6ZS/B3ZS codec. N/C

3780A Pattern Generator/Error Detector \$8340

In some applications, measurements with the 3762A/63A/80A require modified digital interfaces. A range of accessories for these PCM instruments has been designed, therefore, to facilitate connection to the transmissions equipment under test.

## 15507A Isolator

The 15507A Isolator is a passive unit which provides isolation from longitudinal voltages appearing on connections to digital transmission equipment. This is useful when the ground potential of the test equipment is different from that of the transmission equipment.

### Specifications

**Bit Rate:** 1 kb/s to 150 Mb/s.

**Insertion Loss:** < 1.5 dB, from 0.1 to 150 MHz.

**Return Loss:** 20 dB against 75Ω, from 0.5 to 150 MHz.

**Longitudinal Attenuation:** > 40 dB at 50 Hz.

> 35 dB at 100 Hz.

> 20 dB at 1 kHz.

**Connectors:** 75Ω BNC.

**Case Size:** 22 D x 86 mm L (0.88" x 3.38").

## 15508B Converter

The 15508B converter is a 1 to 20 MHz balanced interface providing 75Ω unbalanced/110Ω balanced impedance conversion. It has been designed as a passive converter for use in applications where the interface to the digital equipment requires a balanced bipolar signal.

### Specifications

**Bit Rate:** 1 to 20 Mb/s.

**Frequency Range:** -3dB from 6 kHz to 100 MHz.

**Turns Ratio (75Ω/110Ω):** 1/1.2, nominal.

**Connectors:** 75 unbal—BNC.

110Ω bal—accepts WECO 310 Jack Plug.

**Case Size:** 22 D x 86 mm L (0.88" x 3.38")

## 15509A Amplifier

The 15509A Amplifier provides sufficient gain on a digital signal appearing at a standard digital equipment monitor point to trigger the 3780A or 3763A error detector input. It can be used with the 3780A to monitor, for example, a traffic signal for code violations. Power for the 15509A is supplied from the front panel of the 3780A or 3763A.

### Specifications

**Bit Rate:** 1.5 to 150 Mb/s.

**Gain:** 25 ± 2 dB at 0.1 MHz.

21 ± 2 dB at 45 MHz.

18 ± 2 dB at 75 MHz.

**Input Impedance:** 75Ω, typically; return loss > 20 dB, 1 to 70 MHz, > 15 dB, 70 to 150 MHz.

**Required Load Impedance:** 75Ω.

**Maximum Safe Input:** ac, 3 V peak; dc, ± 20 V.

**Maximum Safe dc Applied to Output:** ± 10 V.

**Power Supply:** + 15 V, 0 V, -12.6 V; consumption 1 VA.

**Case Size:** 19 D x 163 mm L (0.75" x 6.4").

### Ordering Information

15507A Isolator \$250

15508B Converter \$208

15509A Amplifier \$330



# TELECOMMUNICATIONS TEST EQUIPMENT

## Bell Compatible PCM/TDM Error Measuring Set

Models 3781B, 3782B

### 3781B

- DS-1, DS-1C, DS-2, & DS-3 all in one compact system
- Jitter modulation input facility
- Second DS-3 output with 22 bits delay

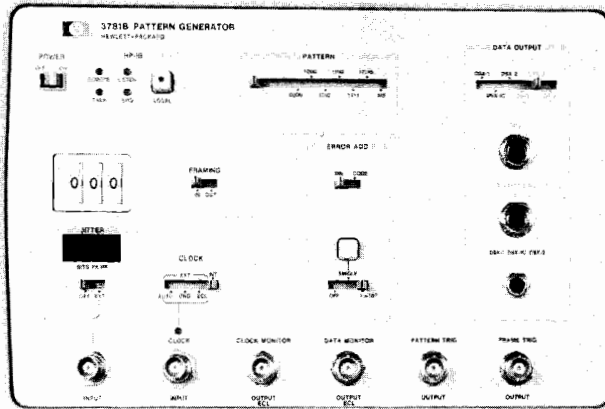

3781B



### 3782B

- Binary, code, and parity error measurements
- Error rate, error count, error secs, and error free secs displayed
- Preselectable error rate threshold for printing of results

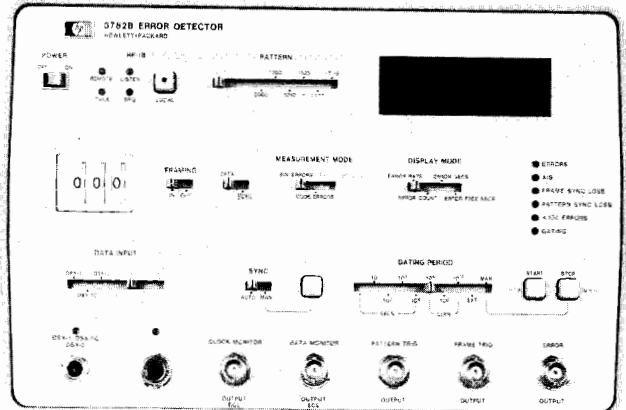

3782B



The 3781B Pattern Generator and 3782B Error Detector form a dedicated error measurement system for testing and evaluating the performance of Bell digital transmission terminal and link equipment, up to and including the DS-3 level in the digital hierarchy. The 3781B/3782B can be used in production testing, field installation, and maintenance of the Bell digital transmission system, including PCM/TDM transmission over cable, radio, satellite, and fibre optic links. The principal application is at the DS-3 level in the Bell digital hierarchy.

In addition to providing a comprehensive measurement capability which includes in-service error measurement, the microprocessor-controlled Pattern Generator and Error Detector are easy-to-use with logical grouping of switches and connectors on the front panels. Both instruments are designed to interface fully with the HP-IB, allowing bus-controlled operation and automatic measurement sequencing.

The 3781B/3782B are designed to Bell standards with automatic selection of the appropriate framing structure, ternary coding, and interface voltage levels at each hierarchical level. At the DS-3 level, a choice of four data formats is available. Alternatively, binary ECL interfaces can be used.

The 3781B Pattern Generator provides a selection of standard  $2^9 - 1$ ,  $2^{15} - 1$ , and  $2^{20} - 1$  bit PRBS and fixed WORD test patterns with a choice of single error or  $1$  in  $10^5$  error simulation on the digital data stream for normal measurements and troubleshooting. A pattern of 17 ones/15 zeros and zero substitution (up to 999 zeros) for PRBS patterns are included to examine phase sensitive circuitry such as clock recovery of regenerators. A jitter modulation input facility is provided for simple oscillator connection, with direct LED display of pk-pk bits of jitter. This can be used to measure the input jitter immunity of digital transmission equipment. In addition, a second DS-3 output channel with 22 bits delay provides adequate simulation of an independent sequence for thorough testing of  $4\phi$  PSK digital radio systems. As an optional extra, four DSX-3 outputs on the rear panel can be included for driving adjacent radio channels.

The 3782B Error Detector detects any binary or code errors generated by the system under test. At the DS-3 level, it can perform in-service or out-of-service measurements of parity errors within the digital transmission system. The 3782B can measure simultaneously error rate, error count, error seconds, and error free seconds over a single gating period. When the DS-3 MON facility is used, in-service measurements (eg parity errors) of live traffic are possible. For ease of use, there is a built-in automatic check for compatibility of switch position combinations. An error code flashes on the display if incompatibility is detected. Hard copies of results can be obtained on a

printer via HP-IB control, either in the "talk-only" or "addressable" modes. In addition, a preselectable error rate threshold and a real time clock allows selection for printing results which exceed a defined threshold (with local time, if required).

### Measurements

In binary error measurements, the 3781B transmits to the system under test a digital test pattern at the selected bit rate with the appropriate framing structure, ternary coding and interface voltage levels. The output is compared bit-by-bit with an internally generated error-free reference pattern. Any differences between the two patterns (ie errors) can be counted and displayed over a suitably chosen gating period in the 3782B.

Code errors are violations of the appropriate coding rule and are detected during decoding into binary data. Parity errors are detected by comparing the parity bits in one frame, at the DS-3 level, with that of the digital sum of the data bits in the previous frame. This latter measurement is particularly useful in monitoring the quality of live traffic using the DS-3 MON input of the 3782B.

Errors can be counted over internally, manually, or externally controlled gating periods and displayed as ERROR RATE, ERROR COUNT, ERROR SECS, or ERROR FREE SECS.

An oscillator can be connected directly to a clock modulation input in the 3781B. The jitter "amplitude" produced is displayed directly in pk-pk bits. The 3782B can be used to measure the effect of jittered data on the transmission system, eg error count against jitter frequencies.

### HP-IB Operation

The 3781B/3782B capabilities can be enhanced by using the HP-IB. A system controller (eg a 9825 desktop computer) may be connected to the 3781B/3782B via the HP-IB to provide remote operation and automatic sequencing of results. The communication distance can be extended using bus extenders and suitable modems.

The HP-IB facility offers several principal features:

- remote control of front panel switches and pushbuttons using programming codes
- control masks which are set to default values on power-on, and can be user-defined with the controller
- the ability to transfer all desired switch positions and masks onto a tape memory and reloaded back onto the instrument at a later time ("learn" mode)
- output of the result data to the printer (eg 5150A Thermal Printer) or tape memory (eg 9875A Cartridge Tape Unit).

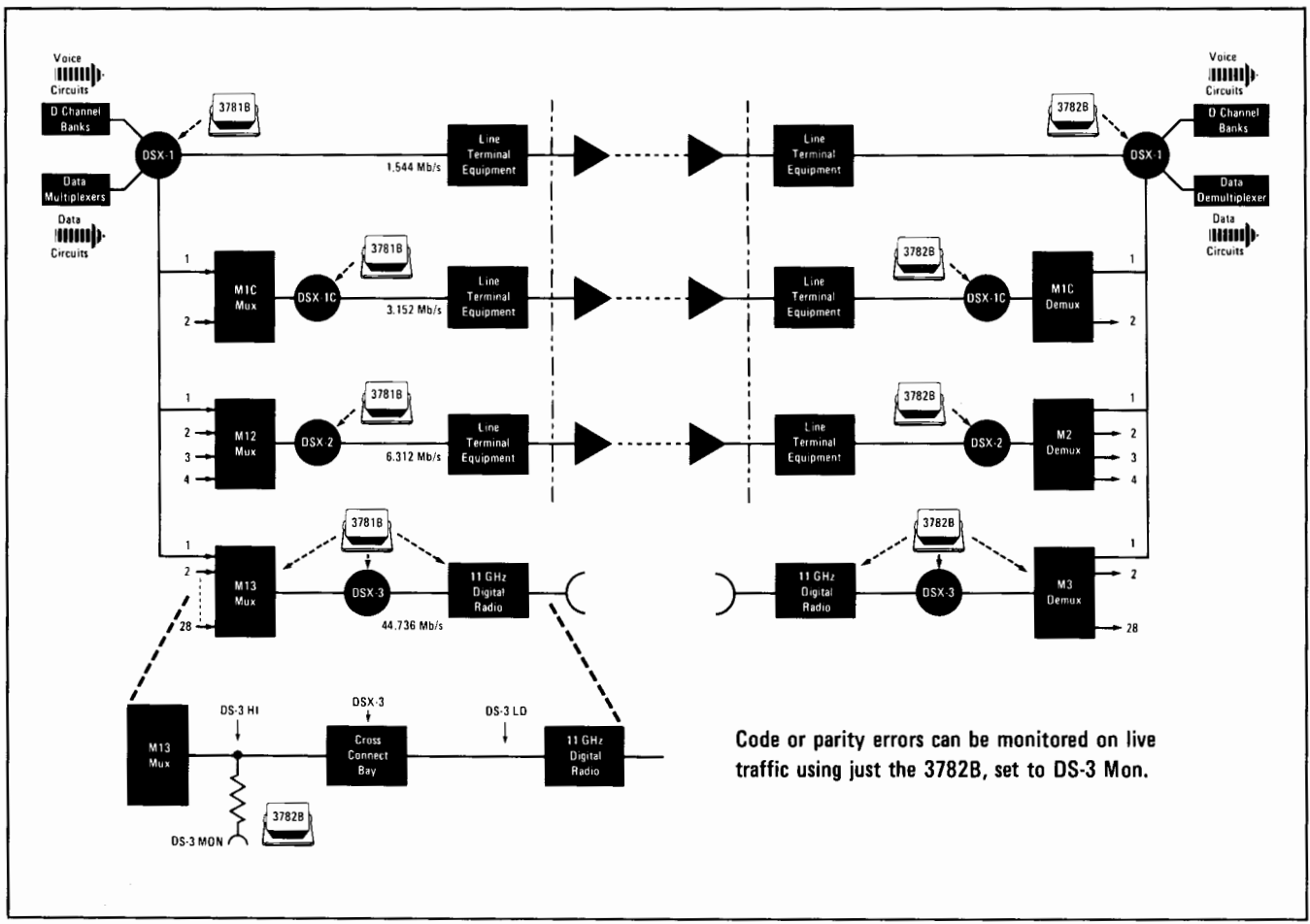

Access points for the 3781B/3782B on the Bell digital system hierarchy

**Specifications Summary**

**3781B Pattern Generator**  
**Data Outputs:** DSX-1, DSX-1C, DSX-2, and DS-3 compatible ternary outputs, and ECL compatible binary outputs.  
**Internal Clock:** four crystal controlled clocks at 1.544 MHz (DS-1), 3.152 MHz (DS-1C), 6.312 MHz (DS-2), and 44.736 MHz (DS-3).  
**External Clock:** 1 kHz to 50 MHz.

**Patterns**  
**PRBS:**  $2^9 - 1$ ,  $2^{15} - 1$ ,  $2^{20} - 1$ .  
**WORD:** 0000, 1000, 1010, 1100, 1111; 17/15 (17 ones/15 zeros);  
**AIS** (alarm indication signal — all ones without framing bits).  
**Zero Substitution (PRBS only):** sequence can be gated off for a number of clock periods, variable over the range 0 to 999 in unit steps. Gating occurs every sequence 6 bits after the PRBS trigger pulse, when viewed at the Data Monitor Output.  
**Framing:** framing and control bits are added to the output pattern according to the bit rate selected (DS-1, DS-1C, DS-2, or DS-3). Framing may be inhibited by a switch.  
**Zero Limit:** when the DS-1 or DS-1C bit rates are selected, the max run length of zeros in the output pattern is limited to 14.  
**Error Add:** binary or code errors are added as an error rate of  $10^{-5}$  or a single error via a pushbutton switch.

**Jitter Modulation:** timing jitter can be added to the clock and data output signals by applying an external modulating source.

**3782B Error Detector**  
**Data Inputs:** DSX-1, DSX-1C, DSX-2, and DS-3 compatible ternary inputs, and ECL compatible binary inputs.  
**Data Monitor Output:** decoded ternary, or binary, input data in binary NRZ format, without framing bits.  
**Recovered Clock:** recovered from ternary data inputs at 1.544 MHz (DS-1), 3.152 MHz (DS-1C), 6.312 MHz (DS-2), and 44.736 MHz (DS-3)  
**Binary Clock Input:** 1 kHz to 50 MHz.

**Patterns**  
**PRBS:**  $2^9 - 1$ ,  $2^{15} - 1$ ,  $2^{20} - 1$ .  
**WORD:** 0000, 1000, 1010, 1100, 1111; 17/15 (17 ones/15 zeros).  
**Zero Substitution:** sequence can be gated off for a number of clock periods, variable over the range 0 to 999 in unit steps. Gating occurs every sequence following the PRBS trigger.  
**Zero Limit:** when the DS-1 or DS-1C bit rates are selected, the max run length of zeros in the reference pattern is limited to 14.  
**Measurements:** binary errors (closed loop bit-by-bit detection at binary level), code errors, and parity errors.  
**Display Modes:** error rate, error count, error seconds, error free seconds, error codes, real-time clock.

Options	Prices
<b>3781B</b>	
<b>001:</b> adds four additional in-phase DSX-3 outputs to rear panel.	add \$450
<b>061:</b> basic rack mount kit.	add \$109
<b>062:</b> rack mount kit allowing Option 001 outputs to be accessed from front panel.	add \$340

<b>3782B</b>	
<b>001:</b> DS-3 Data Input connector changes from WECO type 440A to BNC	N/C
<b>061:</b> basic rack mount kit	add \$109
<b>062:</b> rack mount kit allowing front panel access to Binary/Ternary Input and Real-Time Clock switches, Binary Data and Clock Inputs, and External Gating	add \$250

Ordering Information	
<b>3781B</b> Pattern Generator	\$7340
<b>3782B</b> Error Detector	\$6895

### Data and Voice Testing

There are a wide variety of tests which can be made on a data communications system. Depending on the point in the system at which the tests are made, quite different philosophies and techniques apply. These group conveniently into three areas; data domain, time domain and frequency domain (Fig. 1) Data domain tests are concerned with protocol and flow of data characters within the data communication systems. Time domain includes common digital tests such as bit error rate. Frequency domain tests describe the analog transmission line, for example, loss and noise.

Data communications troubleshooting involves some unique testing problems that are

testing or repair, a new trunk will be patched in with different parameters. This constant change requires more frequent testing.

### Data Domain

A new serial analyzer, the HP 1640B, captures and displays the serial data at the RS-232-C (V.24) interface. Data is displayed in binary form using hexadecimal notation, or in the actual high level code being transmitted, such as ASCII or EBCDIC. In addition, the analyzer makes time interval measurements between events occurring at the interface. The 1640B can trap on invalid character sequences, time interval violations, or data errors, enabling the user to identify problems quickly when troubleshooting a computer communications network.

the modem's ability to overcome them. Modems vary widely in their sensitivity to line impairments. Low speed (less than 300 bps) and adaptively equalized modems are less sensitive than high speed (more than 4800 bps) and nonadaptively equalized modems.

Since data communications systems transmit data and control errors in blocks, these instruments also measure Block Error Rate. Bit Error Rate and Block Error Rate can be used together to examine the statistics of the error mechanism. If the Bit Error Rate and Block Error Rate are both high, the impairment is random and probably due to noise. If the Bit Error Rate is high but the Block Error Rate is low, the impairment is more sporadic. This happens when lines are switched, sync is temporarily lost or impulse noise is too high.

Error rates are qualitative checks of the data communication system which can be made in a few minutes. If the system is bad, diagnostic measurements are provided to help isolate the problem. Dropouts, clock slips, error skew, jitter and total peak distortion indicate some of the problems that can occur on a link. These measurements are made simultaneously with the error rate measurements and can be printed out in automatic, unattended mode if desired.

Catastrophic failures can usually be found with self tests and loop back switches built into the Data Terminal Equipment and Modem. A Transmission Test Set can find catastrophic failures of the transmission line. Logic Analyzers and Data Error Analyzers can find catastrophic failures that are not illuminated by internal self tests.

Degradations of the modem or transmission line are more difficult to find and require more extensive test equipment. The most common degradation is an excessive error rate due to line impairments or a faulty modem.

The transmission line will have a set of steady state impairments (e.g., amplitude distortion, envelope delay distortion, non-linear distortion, and frequency offset which smear the modem's symbols and make them harder to separate in the modem receiver). The line will also have random impairments (e.g., message circuit noise, impulse noise, phase jitter, phase and gain hits which can temporarily push the symbols into the wrong slot, causing a digital error).

### Line Impairments— Requirements Domain

Transmission Line Analyzers and Transmission Impairment Measuring Sets (TIMS) are used to measure the transmission distortion parameters which can cause the modems to have a high error rate. These instruments make frequency domain measurements on the analog telephone line and therefore provide direct information of whether the line meets its specified parameters. These impairments fall into two main types: steady state and transient. In most cases the transmission parameter measurements conform to CCITT or Bell Standards both in the methods used and results obtained.

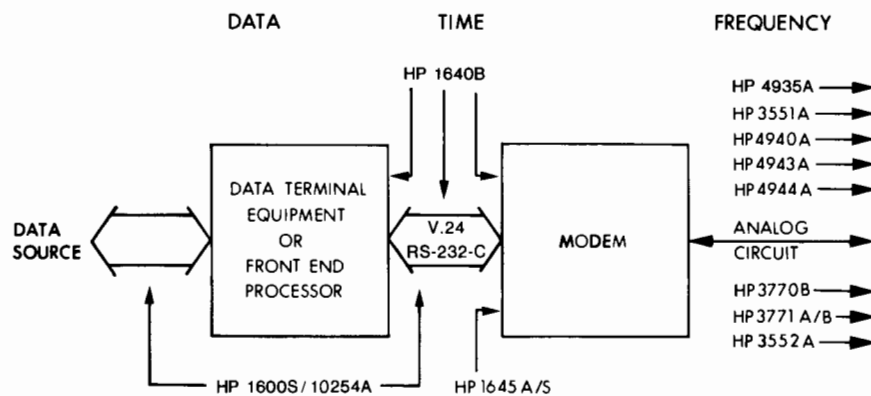

Figure 1. The three domains of data communication instrumentation.

different from the testing done on traditional equipment. The individual tests and parameters are simple because of the low bandwidths (about 3 kHz) and modest signal-to-noise ratios (about 24 dB). The difficulty comes from the complex interrelationships of these simple parameters. For example, how does envelope delay distortion of the line (Figure 2) affect the digital error rate of a modem (Figure 3), and how does that affect the throughput of the computing system? The mathematical relationship between these simple parameters is very difficult to understand for terrestrial data links. Generally, specific limits for each parameter are tarified for different classes of channel service.

Data communication systems require extensive handshaking between machines and across the different domains. Handshake problems are difficult to locate because they are transient and because each machine alone usually will test good. It is very difficult to isolate the handshake problem to one interface.

The geographic size and multitude of subsystems in a telecommunication system make it vulnerable to intermittent and transient impairments as well as degradation and change with time. Intermittent problems are very difficult and time consuming to troubleshoot in any system. The size and complexity of a data communication system aggravates the problems.

Even private leased lines are in a constant state of flux. When a trunk goes down for

The 1640B is also capable of simulating a computer, terminal, or the digital side of a modem by generating specific messages and interface handshake signals, a capability useful not only during network troubleshooting but also for developing and debugging systems software during systems integration and installation phases.

The HP 1600S Logic State Analyzer, when combined with the 10254A Serial-to-parallel Converter, extends HP's 1600S capability to the serial buses within the CPU or terminal. Comparative analysis can be made across I/O interfaces to verify performance of serial formatters for terminals and disc drives. The 1600S/10254A system operates to 10 MHz and displays data in its natural binary format. Its application is intended primarily for synchronous interfaces or asynchronous interfaces where a bit clock is available.

### Digital Measurements— Time Domain

Data Error Analyzers are used to monitor the quality of both the modem and transmission facility. They provide more information about the modem and transmission line than Logic State Analyzers, but no information about the Data Terminal Equipment which they replace.

The overall quality of the link is indicated by its Bit Error Rate. A good link will have an error rate better than  $1 \times 10^{-5}$  errors per bit. This measurement will include the effect of both transmission line impairments and



Typically a leased telephone line is conditioned to suit it to the type of service that it is going to carry. There are three parameters which must be considered if reliable transmission is to be achieved:

- (a) effective channel bandwidth as given by the attenuation and delay distortion.
- (b) net circuit loss.
- (c) noise.

The attenuation and delay distortions impose an upper limit to data transmission speed and reduce the noise margin to errors generated. Noise includes both steady-state background noise and transient noise which includes impulse noise, gain and phase hits and dropouts.

### Measurements

Data transmission at speeds below 2400 bps is usually achieved using asynchronous modems employing frequency shift keyed or FSK modulation. These modems are not as sensitive to line impairments as high speed modems and most maintenance requirements may be satisfied with basic test equipment such as the 3551A/3552A or the 3555A/3556A transmission test sets. Digital test measurements may be made using the 1645S Data Error Analyzer which is designed for asynchronous and synchronous testing.

At transmission rates of 2400 bps and above it is necessary to reduce the bandwidth of the transmitted signal so that it may be carried within the 300 Hz to 3.4 kHz bandwidth of the telephone channel. This is accomplished using synchronous modems which code several data bits in each transmitted symbol. These modems are more sensitive to line impairments than low speed modems and consequently it is desirable to control line quality to more tightly specified limits.

High speed data modems working at 4800 bps and above generally include adjustable filters called equalizers which are used to modify the frequency and phase response of the telephone circuit so that optimum performance may be obtained. Often these equalizers are designed as transversal filters which are automatically adjusted by the modem receiver so that slowly varying line parameters may be compensated for, without requiring frequent operator intervention. Auto-equalized modems are often more sensitive to transient line impairments which can cause the modem to lose synchronization, consequently, for example, a short dropout lasting only a few milliseconds may cause a loss of data for several seconds or even minutes.

The 4940A Transmission Impairment Measuring Set is capable of measuring all of the tariffed parameters in the U.S. The 4943A/4944A measure the parameters needed for circuit routing and installation testing to the standards required by Bell PUB 41009. For measurements to European standards the 3770B measures all of the maintenance parameters laid down in CCITT recommendation M.1060. This includes amplitude and group delay distortion to CCITT rec. 0.81, noise to P.53 and impulse noise to 0.71. The 3771A/B is designed

for making troubleshooting measurements on high speed voice band transmission systems. The 3771A/B measures loss, noise, phase jitter, frequency shift and the transient impairments, phase hits, gain hits, dropouts and three levels of impulse noise. The 3771A makes measurements to CCITT standards, the 3771B to Bell Standards. There is some degree of overlap in the frequency domain measurements. A 3551A or 3552A might be used to make level and noise measurements on a high speed circuit and a 4940A may be required to investigate difficult problems on a low speed asynchronous circuit.

There usually must be an "identical" or equivalent test set at each end of the line e.g. 4940A/4940A or 3770B/3770B and a technician to operate the set in each direction. The 3770B and 4943A/4944A may each be used in master/slave configuration so that the measurement may be controlled, and results obtained, at one end of the link. This simplifies test procedures and often results in more reliable measurements.

Sometimes lines can be looped around at the far end to eliminate the need for an extra technician and test set. This is ideal for half duplex testing of experimental equipment in the laboratory. In the field the loop around results in testing a tandem line of twice the normal length. Some measurements obtained in this way are not valid because the impairment on the two halves of the circuit are likely to cancel for example: frequency shift and phase jitter. Other measurements will show whether the parameters of the circuit have become degraded but the results are comparative, not absolute and cannot be used for tariffing. System fault finding is generally done by performing Bit Error Rate measurements both end to end and in loop around and some modems are capable of gain restoration in analog loopback to avoid the unrealistic 16 dB loss.

Only the Serial Data Analyzer is capable of on-line testing with data traffic. The Data Error Analyzer and Transmission Test Sets generally require that the line be taken out of service and tested at each end with a compatible test set. These test sets require a known stimulus for all measurements except signal level and message circuit noise.

The choice between digital and frequency domain measurements depends on the application. A telephone company, for instance, may not have access or responsibility for the digital side of the modem and frequency do-

main measurements are most suitable. A data communications end user can make go/no go tests most quickly with bit error rate tests and will only need to resort to analog testing where marginal circuit quality is suspected. Since malfunctions know no boundaries, it's important that the test equipment fit the problem.

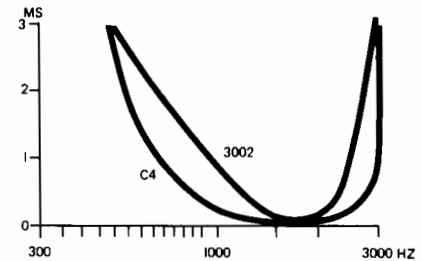

Figure 2. Advanced test sets like the 4940A, 4943A/4944A and 3770B can measure envelope delay distortion.

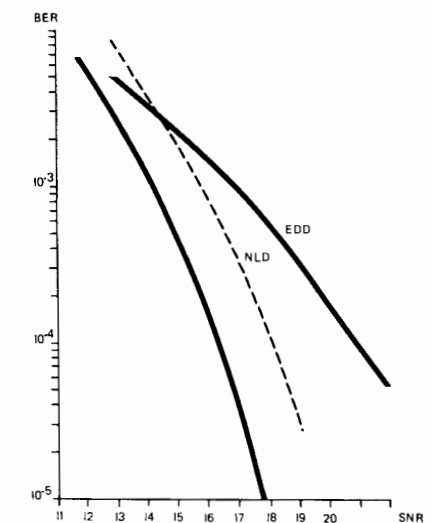

Figure 3. This classical performance characteristic for a modem shows how it is affected by line impairments. Data error analyzers can measure bit-error-rate (BER) in the time domain. Transmission test sets like the 3551A can measure signal-to-noise ratio in the frequency domain. Advanced test sets like the 3770B, 4940A and 4943A/4944A can measure envelope delay distortion (EDD). Further, the 4940A and 4944A can measure non-linear distortion (NLD).

MODEM TYPE	FREQUENCY		TIME	DATA
	US	CCITT		
ASYNCR < 2000 bps	3551A 4935A	3552A		
SYNCR > 2000 bps	4940A 4943A 4944A 3771B	3770B 3771A	1645A 1645S	1640B
DDS				

Figure 4. Where to use the various HP instruments in a data communication system.





# TELECOMMUNICATIONS TEST EQUIPMENT

## Telephone Line Analyzer

Model 3770B

- Delay and Attenuation Distortion measurements
- Compatible with CCITT Recommendation 0.81
- Rugged, portable, and really easy to use
- Makes all the maintenance measurements listed in CCITT Recommendation M.1060
- Optional slaving facilities

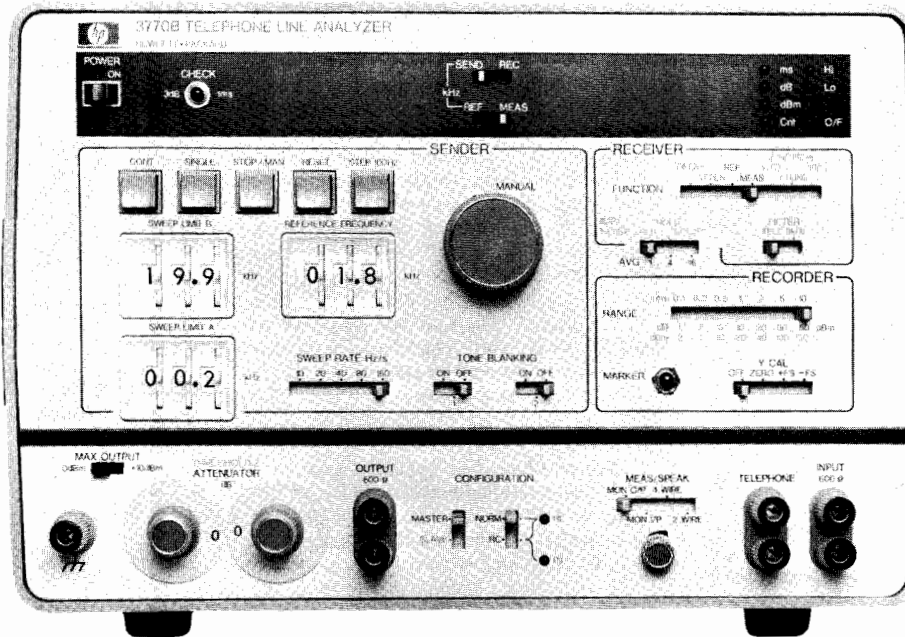

### Description

The 3770B is designed for audio data line characterization to CCITT standards. The 3770B makes, in one combined unit, all of the routine maintenance measurements listed in CCITT Recommendation M.1060 for high speed data lines.

The 3770B measures group delay, attenuation distortion, and absolute level in the frequency range 200 Hz to 20 kHz. It has automatic ranging, zeroing, and synchronization, with simultaneous LED read-out of measurement result and frequency. The sender and receiver are combined in a single, rugged, portable unit.

The 3770B, in addition, measures weighted noise, noise-with-tone and impulse noise. Further, an optional slave facility for group delay and attenuation distortion measurements allows the measurement re-

sults for both directions of transmission on a 4-wire circuit to be displayed at one end of the circuit. Also, the measurements in both directions can be controlled from one end of the circuit, leaving the slave unit unattended.

The 3770B has X-Y recorder outputs to enable a permanent swept record of the measurements to be made. A suitable portable X-Y recorder can be supplied as an option. Pre-printed graph paper showing CCITT limits for group delay and attenuation distortion measurements can also be supplied.

The instrument also has a built-in telephone facility to allow voice communication in a 2- or 4-wire mode over the line or lines under test. An integral loudspeaker allows the operator to monitor either the receiver input or sender output.

### Ordering Information

When ordering a 3770B, select ONE option from the table below (i.e. select the standard instrument OR one option). This completely specifies the measurements selected. Note that group delay, attenuation distortion and absolute level measurement facilities are provided with ALL instruments.

Option	Measurement Facilities				Price
	Noise	Slaving	+10 dbm Output	Tone Blanking	
STD	•				\$9730
001		•			-\$170
002	•	•			+\$435
003	•		•		+\$70
004	•			•	+\$205
005	•		•	•	+\$205
006		•	•		-\$375
007		•		•	N/C
008		•	•	•	N/C
009	•	•	•		+\$435
010	•	•	•	•	+\$595
011	•	•	•	•	+\$595

Opt 005: tone blanking add \$205  
**Range:** two bands in the range 0.2 to 9.9 kHz.

**Range limits:** any multiple of 100 Hz.

**Frequency range blanked (kHz):** Opt # specifies range:

Opt	kHz	Opt	kHz	Opt	kHz	Opt	kHz
117:	0.4 to 0.6	103:	1.9 to 2.2	107:	2.3 to 2.7	111:	3.0 to 3.4
101:	0.5 to 0.7	104:	2.0 to 2.4	108:	2.4 to 2.8	112:	3.2 to 3.6
102:	0.6 to 0.9	105:	2.1 to 2.5	109:	2.6 to 3.0	113:	3.4 to 3.8
115:	0.8 to 1.2	106:	2.2 to 2.6	110:	2.8 to 3.2	114:	3.6 to 4.0
116:	1.4 to 1.8	Other ranges available. Order Opt 100 and specify ranges.					

Opt 012: loop holding for sender output receiver input. add \$185

**Maximum dc loop holding current:** 100 mA.

**Voltage drop at maximum current:** ~12 V.

**Dynamic output impedance:** ~50 kΩ.

**In-lid operating instructions:** English: std; German: N/C

Opt 031: French: Opt 032; Italian: Opt 033; Spanish:

Opt 034.

Opt 040: suitable portable X-Y Recorder in carrying case. add \$1395

Pre-printed graph paper showing CCITT limits

also available; Amplitude Distortion (9280-0403), De-

lay Distortion (9280-0402).

Opt 061: rack mount version. add \$220

Opt 910: additional set of manuals. add \$28

Opt C01: 0.75" banana connectors.

**3770B Telephone Line Analyzer**

**\$9730**

# TELECOMMUNICATIONS TEST EQUIPMENT

Data Line Analyzer  
Models 3771A, 3771B



- CCITT and Bell versions
- Simultaneous measurement of transients

- HP-IB option
- Optional printer output

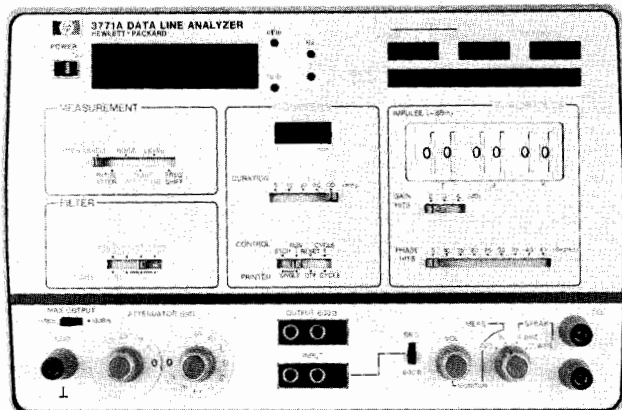

3771A

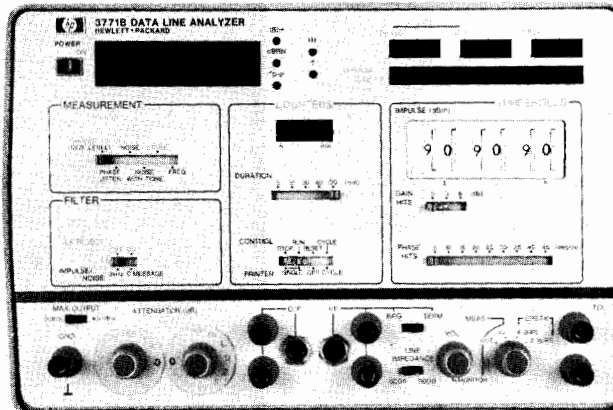

3771B



## Description

The 3771A and 3771B Data Line Analyzers have been designed for making installation and troubleshooting measurements on telephone lines used for carrying high-speed data. Two versions are available—the 3771A is compatible with CCITT standards, the 3771B with Bell Publication 41009 (May 1975).

The 3771A is a companion instrument to the HP 3770B Telephone Line Analyzer. When used with the 3771A, it provides a complete portable easy-to-use CCITT data line testing facility. Routine data line maintenance measurements can be performed using the 3770B, and troubleshooting measurements using the 3771A. The 3771B can be used with the hp 4943A/4A Transmission Impairment Measuring Set for complete data line characterization and testing where Bell measurement standards are required.

The 3771A/B measures two basic types of impairment affecting data lines—steady state and transient.

The steady state parameters measured are:

- Level
- Phase Jitter
- Weighted Noise
- Noise-with-Tone
- Frequency Shift

The transients measured are (all measured simultaneously):

- 3-Level Impulse Noise
- Phase Hits
- Gain Hits
- Dropouts

Transient parameters are normally measured over 15-minute intervals and by measuring all of them simultaneously, the 3771A/B saves considerable operator time. Also, any comparison of results is statistically valid.

The 3771A/B can be used as a stand alone test instrument or as part of an automatic test system. An option allows the 3771A/B to be controlled externally via the Hewlett-Packard Interface Bus (HP-IB). Other optional features available are a printer output for

recording the results of unattended long-term transient measurements, and dc loopholding for sender output and receiver input. In-lid operating instructions are provided for the 3771A/B, in addition to the normal detailed operating booklet. In the 3771A, the in-lid instructions can be supplied in English, French, German, Italian, or Spanish.

### Options (3771A and 3771B)

Options (3771A and 3771B)	Prices
<b>Option 001—+ 10 dBm Output (3771A only)</b> Output Level: maximum sender output level 0 or + 10 dBm, selected by switch.	add \$58
<b>Option 002—Loopholding</b>	add \$140
<b>Option 003—Frequency Shift (3771A only)</b> Range: 0 to 10 Hz. Tone Frequencies: 1020 and 2040 Hz, in harmonic relationship. Technique: compatible with CCITT Recommendation 0.111.	add \$320
<b>Option 004—Printer Output</b> Format: 8421 BCD. Compatibility: hp 5150A, 5055A, 5050B. Information: all transient data at end of each timer interval.	add \$220
<b>Option 005—HP-IB Data Output and Remote Control.</b>	add \$590
<b>Option 006—LF Phase Jitter (3771B only)</b> Provides measurement of low frequency phase jitter components in three ranges: 4 to 20 Hz or 4 to 300 Hz (by internal selection) and 20 to 300 Hz.	add \$350
<b>In-lid Operating Instructions:</b> English—std; German—Option 031; French—Option 032; Italian—Option 033; Spanish—Option 034.	N/C

### Ordering Information

3771A Data Line Analyzer—CCITT	\$7950
3771B Data Line Analyzer—North America	\$7950



# TELECOMMUNICATIONS TEST EQUIPMENT

## Transmission test sets

Models 3551A & 3552A

- Voice grade testing
- Data circuit testing

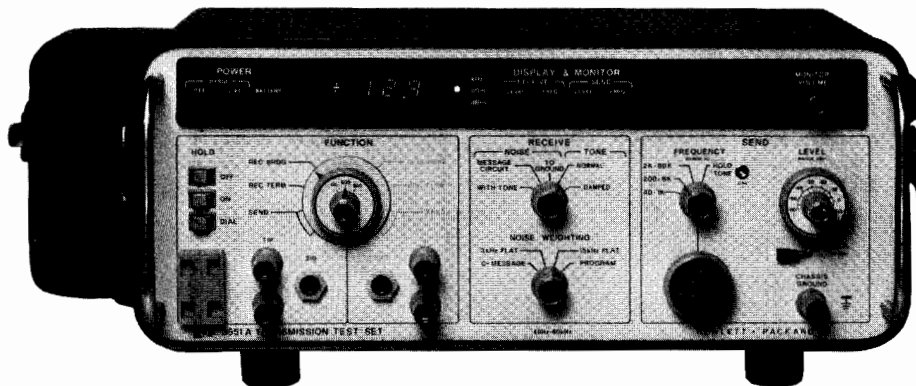

3551A  
(North American)

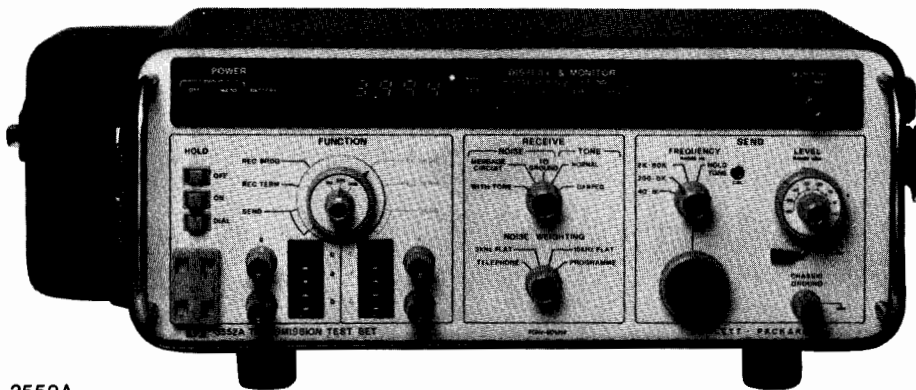

3552A  
(CCITT)

### Description

Hewlett-Packard's 3551A (North American Measurement Standard) and 3552A (CCITT) Transmission Test Sets are rugged, portable and ideally suited for measurements on voice, program and data circuits up to 50 kb/s.

These four-function test sets are capable of measuring tone level, noise level, and frequency, while simultaneously sending tone. Both level and frequency are fully autoranging.

A normal sampling of 10/second in tone level and frequency allows a "direct feel" between an adjustment and the ensuing reading. In addition, a damped sample rate of 2/second is useful when reading noisy signals. The digital LED (Light Emitting Diode) readout displays either the level or frequency of the input or output regardless of terminal function selected.

Appropriate resolution, time constant and sample rate are automatically provided to simplify operation for the user.

These test sets can measure both two-wire and four-wire balanced circuits. Impedances of 135, 600, and 900 ohms can be selected on the 3551A; impedances of 150, 600, and 900 ohms are available on the 3552A. In addition, the receiver may be either terminated or bridged.

The test sets may be powered by either ac line or internal rechargeable batteries and are suited for both inside and outside plant maintenance.

A full wave average detector is used for tone level measurements. Automatic ranging eliminates the need to set attenuators and thus reduces the possibility of errors due to faulty calculations. Direct digi-

tal readout gives a 0.1 dB resolution over the entire 85 dB dynamic range.

For frequency measurements, a four-digit autoranging frequency counter is provided. The readout is calibrated in kHz and features 1 Hz resolution from 40 Hz to 10 kHz and 10 Hz resolution from 10 kHz to 60 kHz. The decimal point is automatically positioned to avoid the possibility of errors due to overflow of the four digits.

Noise measurements are made with a QUASI RMS detector and displayed in dBm on the 3551A and dBm on the 3552A, with 1.0 dB resolution. Display rate is slowed to 2 per second to provide analog feel of slowly changing noise levels. Both test sets have the capability of measuring noise-with-tone, message circuit noise, and noise-to-ground. Four switch selectable weighting networks are provided; C-message, Program, 3 kHz, and 15 kHz Flat in the 3551A; and Telephone (Psophometric), Programme, 3 kHz Flat and 15 kHz Flat in the 3552A. In the noise-with-tone position, a notch is inserted before the selected weighting network.

Send oscillator covers a frequency range of 40 Hz to 60 kHz in three bands; 40 Hz to 1 kHz, 200 Hz to 6 kHz and 2 kHz to 60 kHz. The output level is continuously variable from +10 dBm to -60 dBm.

In addition, a fixed position is provided to be used as the holding tone when making a noise-with-tone measurement.

A convenient set of clip-on dial terminals for connecting a lineman's handset is provided. This allows a line connection to be dialed up and then held in an off-hook (busy) condition while making either receive or send measurements on a two-wire wet line.

## Specifications, Model 3551A & 3552A

### Receiver

#### Level Measurements

**Frequency range:** 40 Hz to 60 kHz.  
**Dynamic range:** +15 dBm to -70 dBm.  
**Resolution:** 0.1 dB.  
**Sample rate:** 10/second normal, 2/second damped.  
**Detector type:** average responding.  
**Accuracy:** at 25°C ± 10°C, temperature coefficient: ± 0.005 dB/°C beyond this range.

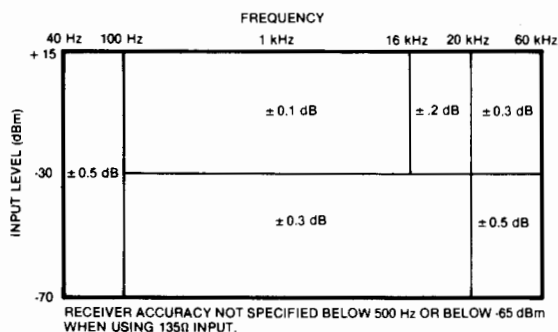

#### Frequency measurements

**Frequency range:** 40 Hz to 60 kHz.  
**Dynamic range:** +15 dBm to -70 dBm.  
**Resolution:** 1 Hz (40 Hz to 10 kHz), 10 Hz (10 kHz to 60 kHz).  
**Sample rate:** 10 second normal, 2/second damped.  
**Accuracy:** ± 1 count.

### Transmitter 3551A & 3552A

**Frequency range:** 40 Hz to 60 kHz.  
**Ranges:** 40 Hz to 1 kHz, 200 Hz to 6 kHz, 2 kHz to 60 kHz, 800 Hz fixed, 3552A. (Other frequencies available.) 1004 Hz fixed, 3551A.  
**Resolution:** 1 Hz (40 Hz to 10 kHz), 10 Hz (10 kHz to 60 kHz).  
**Sample rate:** 10/second.  
**Harmonic distortion:** < -50 dB THD (100 Hz to 4 kHz); < -40 dB THD (40 Hz to 100 Hz and 4 kHz to 20 kHz); < -30 dB THD (20 kHz to 60 kHz); < -55 dB (all harmonics 100 Hz to 4 kHz); < -60 dB THD (1004 Hz fixed).  
**Accuracy:** ± 1 count.  
**Level range:** +10 dBm to -60 dBm (40 Hz to 60 kHz), +6 dBm to -60 dBm. (1004 Hz fixed—3551A; 800 Hz fixed—3552A).  
**Resolution:** 0.1 dB.  
**Sample rate:** 10/second.  
**Accuracy:** at 25°C ± 10°C, temperature coefficient: ± 0.005 dB/°C beyond this range.

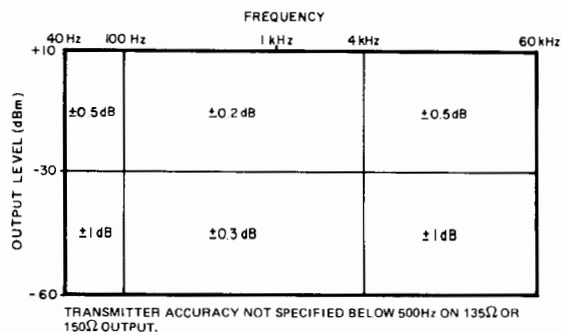

### 3551A Noise Measurements

**Dynamic Range**  
**Message circuit noise:** 0 dBm to +85 dBm.  
**Noise-with-tone:** 10 dBm to +85 dBm.  
**Noise-to-ground:** 40 dBm to +125 dBm.  
**Resolution:** 1 dB.  
**Sample rate:** 2/second.  
**Detector type:** Quasi-RMS responding.

#### Accuracy

**Message circuit noise:** ± 1 dB (+20 dBm to +85 dBm), ± 2 dB (0 dBm to +20 dBm).  
**Noise-with-tone:** ± 1 dB (+20 dBm to +85 dBm), ± 2 dB (+10 dBm to +20 dBm).  
**Noise-to-ground:** ± 1 dB (+60 dBm to +125 dBm), ± 2 dB (+40 dBm to +60 dBm).  
**Weighting filters:** C-message, 3 kHz flat, 15 kHz flat, program.

### 3552A Noise Measurements

**Dynamic Range**  
**Message circuit noise:** -90 dBm to -5 dBm.  
**Noise-with-tone:** -80 dBm to -5 dBm.  
**Noise-to-ground:** -50 dBm to +35 dBm.  
**Resolution:** 1 dB.  
**Sample rate:** 2/second.  
**Detector type:** Quasi-RMS responding.

#### Accuracy

**Message circuit noise:** ± 1 dB (-70 dBm to -5 dBm), ± 2 dB (-90 dBm to -70 dBm).  
**Noise-with-tone:** ± 1 dB (-70 dBm to -5 dBm), ± 2 dB (-80 dBm to -70 dBm).  
**Noise-to-ground:** ± 1 dB (-30 dBm to +35 dBm), ± 2 dB (-50 dBm to -30 dBm).  
**Weighting filters:** Telephone (CCITT Psophometric), 3 kHz flat, 15 kHz flat, Programme.

### General

**Monitor:** built-in speaker, monitors received or transmitted signal.  
**Balanced impedances:** 135Ω, 600Ω, 900Ω (3551A).  
**Balanced impedances:** 150Ω, 600Ω, 900Ω (3552A).  
**Bridging loss:** < 0.2 dB.  
**Return loss:** > 30 dB, 40 Hz to 4 kHz, > 20 dB, 4 kHz to 20 kHz. Except 135 Ω > 30 dB 500 Hz to 4 kHz.  
**Longitudinal balance:** > 60 dB at 6 kHz.  
**Hold circuit:** 20 milliamps constant current. < 0.2 dB holding loss, resistive fuse protection.  
**Input/output protection:** blocks 300 V dc.  
**Maximum longitudinal voltage:** 200 V rms.  
**Battery supply:** > 4 hours continuous operation on internal rechargeable batteries at 25°C. Battery drain is automatically turned off when discharged below proper operating level. Complete recharge in 12 hours.  
**Power requirements:** 100 V, 120 V, 220 V, 240 V ± 10%; 48 Hz to 440 Hz; 4 VA.  
**Temperature range:** 0°C to 55°C, operating; -20°C to +65°C storage.  
**Relative humidity:** 0 to 95% (< 40°C).  
**Size:** 133 mm H × 343 mm W × 254 mm D (5¼" × 13½" × 10").  
**Weight:** net, 6.6 kg (14.5 lb). Shipping, 7.3 kg (16 lb).

#### Options

**C01-3551A, C01-3552A:** 19 inch rack mount, ac power only (no batteries) N/C  
**H10-3551A:** Extends frequency range to 85 kHz add \$355

#### Ordering Information

**3551A** Transmission test set \$2500  
**3552A** Transmission set (CCITT) \$3005



# TELECOMMUNICATIONS TEST EQUIPMENT

## Transmission & noise measuring set

Models 3555B & 3556A

- Voice and carrier testing

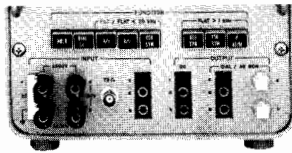

### Description

Hewlett-Packard's 3555B Transmission and Noise Measuring Set is designed especially for telephone plant maintenance. It measures attenuation, distortion, cross-talk coupling and noise. Weighting networks designed to comply with Bell System Technical Reference Publication number 41009, and include C-message, 3 kHz, 15 kHz flat and program.

HP's 3556A performs the same tasks as the 3555B. It also has built-in weighting networks designed to that comply with CCITT requirements, which include telephone (psophometric) 3 kHz flat, and 15 kHz flat, Programme (P53) weighting filters.

Operating instructions printed in the protective cover are available in most languages at no extra charge.

Complementary equipment for the 3555B is HP 236A Telephone Test Oscillator (236A Opt. H10 for the 3556A). When used together, they make a complete transmission test set for accurate, convenient voice and carrier measurements.

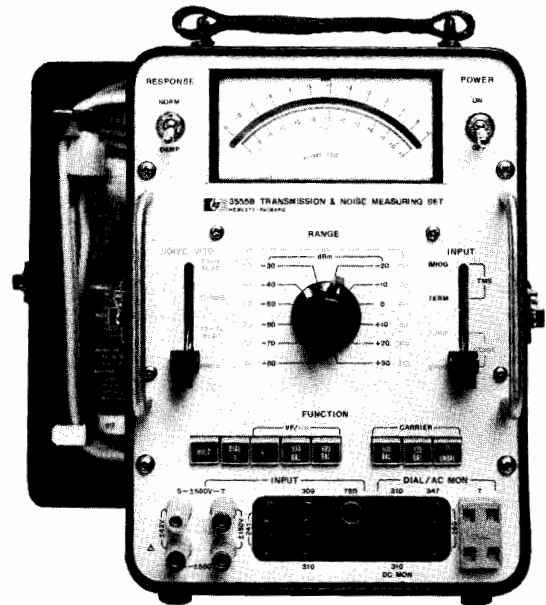

### Specifications

	3555B (North American Standards)	3556A (CCITT Standards)
<b>VOICE FREQUENCY LEVEL MEASUREMENTS: 20 Hz to 20 kHz</b>		
dB/volt range	-91 dBm to +31 dBm	-78 dBm to +32 dBm/0.1 mV to 30 V F.S.
Level accuracy**	±0.5 dB; ±0.2 dB, 40 Hz to 15 kHz, level >60 dBm	100 Hz to 5 kHz: ±0.2 dB; 20 Hz to 20 kHz: ± 0.5 dB
Input	Terminated or bridged 600Ω or 900Ω balanced. Bridging loss: <0.3 dB at 1 kHz. Balance: >80 dB at 60 Hz >70 dB at 6 kHz, >50 dB to 20 kHz. Return loss: 30 dB min (50 Hz to 20 kHz)	Terminated: 600Ω symmetrical. Non-terminated: 10 kΩ symmetrical. Non-terminated error: <0.4 dB at 800 Hz. Symmetry: >80 dB at 50 Hz, >70 dB at 6 kHz, >50 dB to 20 kHz. Return loss: 30 dB min (50 Hz to 20 kHz)
Holding circuit	700Ω dc resistance, 60 mA max. loop line current at 300 Hz. With holding circuit in, above specs apply from 300 Hz to 4 kHz	
<b>NOISE MEASUREMENTS:</b>		
dB/volt range	-1 dBm to +121 dBm	-78 dBm to +32 dBm/0.1 mV to 30 V F.S.
Weighting filters	3 & 15 kHz flat, C-message, and program (Bell system technical reference pub # 41009)	3 & 15 kHz flat, Telephone and Programme (P53, CCITT)
Input	Same as for voice frequency measurements	
<b>CARRIER FREQUENCY LEVEL MEASUREMENTS:</b>		
dB/volt range	-61 dBm to +11 dBm	-48 dBm to +12 dBm/3 mV to 3 V F.S.
Level accuracy	600Ω balanced (symmetrical): 1 kHz to 150 kHz ±0.5 dB; 10 kHz to 100 kHz, ±0.2 dB. 1350Ω balanced (or 150Ω balanced): 1 kHz to 600 kHz, ±0.5 dB; 10 kHz to 300 kHz, ±0.2 dB. 75Ω unbalanced (asymmetrical): 100 Hz to 600 kHz, ±0.2 dB; 30 Hz to 1 MHz, ±0.5 dB; 1 MHz to 3 MHz, ±0.5 dB ±10% of meter reading	
Input	Terminated or bridged 1350Ω† or 600Ω balanced (symmetrical) and 75Ω unbalanced (asymmetrical)	
Return loss	600Ω: 26 dB min., 3 kHz to 150 kHz; 1350Ω†: 26 dB min. 1 kHz to 600 kHz; 75Ω: 30 dB min. to 3 MHz	
Bal/symmetry	>70 dB to 10 kHz, >60 dB to 100 kHz, >40 dB to 600 kHz	
<b>GENERAL:</b>		
Meter	Linear dB scale	Linear dBm scale
External battery	24 V or 48 V office battery, <15 mA	
Internal battery	Single NEDA 202, 45 V "B" battery Option H03 uses rechargeable batteries and similar to 3556A	4 rechargeable batteries (25 V total) or power line from 90 V to 250 V ac, 48 Hz to 440 Hz, <10 VA. Option 001 uses same battery as 3555B
AC	115 or 230 V (specify for 3555B) (switch for 3556A) 48 Hz to 440 Hz, <10 VA	
Dimensions	299 mm H x 197 mm W x 207 mm D (11 3/4" x 7 3/4" x 8 1/4")	
Weight	Net, 6.8 kg (15 lb). Shipping, 7.5 kg (17 lb).	
Jacks	Will accept Western Electric 241, 309, 310, 358, 289 and 347 plugs; 1011B hand-set or 52 type headset	Will accept Siemens 9 REL KL1-6A, 4 mm diameter banana plugs or 3-prong Siemens 9 REL STP-6AC connector
**For levels >1 dBm accuracy spec applies only for freq. above 100 Hz. †1500Ω for 3556A.		

### Ordering Information

HP 236A Telephone Test Oscillator (complementary equipment for 3555B) see page 577

3555B Transmission and Noise Measuring Set  
3556A Psophometer

Price  
\$1600  
\$1840

# TELECOMMUNICATIONS TEST EQUIPMENT

Telephone test oscillators

Model 236A (Bell) Model 236A Opt H10 (CCITT)

577



- Voice and carrier testing



HP 236A

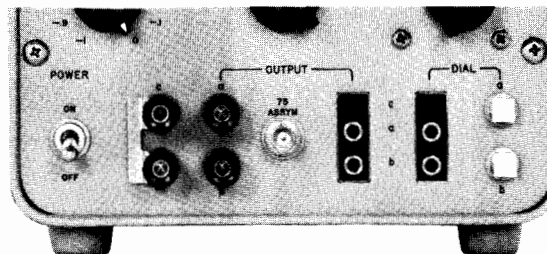

HP 236A Option H10

## General

Hewlett-Packard's Models 236A and 236A Option H10/H20 Telephone Test Oscillators are particularly useful for lineup and maintenance of telephone voice and carrier systems when used with their companion instruments 3555B and 3556A Transmission Noise Meters. The HP236A Opt H10 and HP 3556A are designed to meet CCITT requirements, while the HP 236A and 3555A are designed to meet Bell requirements when used together.

## Ordering Information

<b>HP236A</b> Option H10, CCITT (ac line and dry battery)	add \$235
<b>HP 236A</b> Option H20, CCITT (ac line and rechargeable batteries)	add \$340
<b>HP 236A</b> Telephone Test Oscillator (North American)	\$1150

## Specifications

	236A (Bell)	236A Option H10 (CCITT)
Frequency range	50 Hz to 560 kHz	
Frequency dial accuracy	±3% of setting	
Frequency response		
600Ω output	±0.3 dB from 50 Hz to 20 kHz	
900Ω output	±0.3 dB from 50 Hz to 20 kHz	—
135Ω output	±0.5 dB from 5 kHz to 560 kHz	—
150 and 75Ω outputs	—	±0.5 dB from 5 kHz to 560 kHz
Output level/accuracy	-31 to +10 dBm in 0.1 dBm steps/ ±0.2 dBm from -31 to +10 dBm (1 kHz ref., Opt H10, 800 Hz ref.).	
Noise	At least 65 dB below total output or -90 dBm—whichever noise is greater. 3 kHz bandwidth	
Distortion	At least 40 dB below fundamental output.	
Output circuit	Balanced (symmetrical) and floating. Can be operated up to ±500 V dc above (earth) ground.	
Output impedance	600 and 900Ω ±5% from 50 Hz to 20 kHz 135Ω ±10% from 5 kHz to 560 kHz	600 and 150Ω symmetrical 75Ω asymmetrical
Output balance (output symmetry)	600 and 900Ω outputs: 70 dB at 100 Hz, 55 dB at 3 kHz 135 and 150Ω outputs: 50 dB at 5 kHz, 30 dB at 560 kHz	
Output jacks	Accepts Western Electric 241, 309, and 310 plugs.	Accepts 3-prong Siemens 9 REL, STP 6 AC or 4 mm diameter banana plugs.
	Binding posts accept banana plugs, spade lugs, phone tips or bare wires.	
Dial jacks	Accepts Western Electric 309 and 310 plugs. Clip posts accept Western Electric 1011B lineman's hand-set clips.	Accepts 3-prong Siemens 9 REL, STP 6 AC or 4 mm diameter plugs. Clip posts accept lineman's hand-set clips as alligator clips.
DC holding coil	600 and 900Ω outputs only. 700Ω ±10% dc resistance. 60 mA maximum loop current at 100 Hz.	
Power requirements	Line: 115 or 230 V (switch) ±10% ac, 48 Hz to 440 Hz, <2 VA. Internal battery: single NEDA 202 45 V "B" battery. 236A Option H20: (same as 236A Option H10 except) five 6.25 V rechargeable batteries: 90 V ac-250 V ac, 48 Hz-440 Hz, <10 VA during battery charge.	
Weight	Net. 6.1 kg (13.5 lb). Shipping, 7.7 kg (17 lb)	
Complementary equipment	HP 3555B Transmission and Noise Measuring Set	HP 3556A Psophometer

# TELECOMMUNICATIONS TEST EQUIPMENT

## 15 Hz to 50 kHz selective voltmeter

Model 3581C

- Voice grade testing
- Wideband data circuit testing
- Single frequency interference
- Spectrum analysis

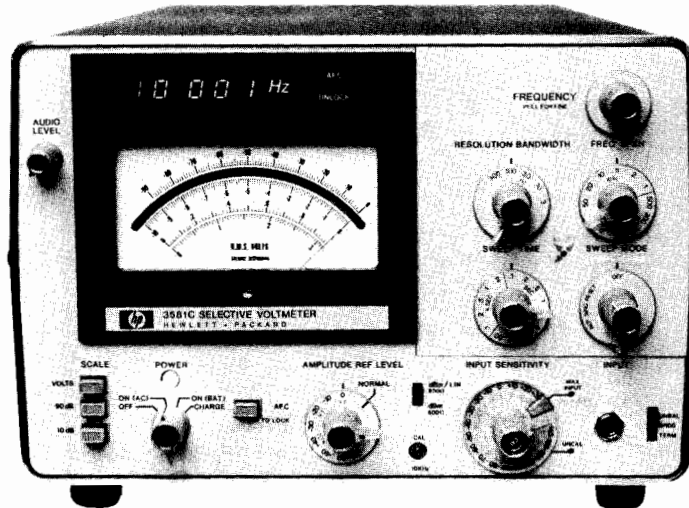

### Description

The 3581C Selective Voltmeter has found wide application in testing special service circuits in both inside and outside plant maintenance. The 3581C is used to do spectrum analysis, measure non-linear distortion (harmonic distortion) and to locate and measure unwanted spurious and induced tones. The unit can be operated from ac line or from optional internal batteries.

### Specifications

**Frequency range:** 15 Hz to 50 kHz.  
**Display:** 5 digit LED readout. Resolution: 1 Hz. Accuracy:  $\pm 3$  Hz.  
**Typical stability:**  $\pm 10$  Hz/hr. after 1 hour.  $\pm 5$  Hz/ $^{\circ}$ C.  
**Automatic frequency control (AFC), hold-in range:**  $\pm 800$  Hz.  
**Pull-in range:**  $> 5$  x bandwidth for 3 Hz to 100 Hz bandwidth;  $> 800$  Hz for 300 Hz bandwidth for full-scale signal.  
**Lock frequency:** center of passband  $\pm 1$  Hz.

### Amplitude

#### Instrument range

**Linear:** 30 V to 100 nV full scale.  
**Log:** +30 dBm or dBV to -150 dBm or dBV.

Amplitude accuracy*	Log	Linear
15 Hz-50 kHz, frequency response	$\pm 0.4$ dB	$\pm 4\%$
Switching between bandwidths	$\pm 0.5$ dB	$\pm 5\%$
Amplitude display	$\pm 2$ dB	$\pm 2\%$
Input attenuator	$\pm 0.3$ dB	$\pm 3\%$
Amplitude reference level, Most sensitive range	$\pm 1$ dB	$\pm 10\%$
All other ranges	$\pm 1$ dB	$\pm 3\%$

**Dynamic range:**  $> 80$  dB.

**Noise sidebands:** greater than 70 dB below CW signal. 10 bandwidths away from signal.

**IF feedthrough:** input level  $> 10$  V: -60 dB; input level  $< 10$  V: -70 dB.

**Spurious responses:**  $> 80$  dB below input reference level.

### Sweep

**Scan width:** 50 Hz to 50 kHz. These scans can be adjusted to cover a group of frequencies within the overall instrument range.

**Sweep error light:** this LED indicates a sweep that is too fast to capture full response.

\*Note: these specifications cover the full temperature frequency and amplitude range, and represent worst case. Accuracy is significantly better for measurements not at the extremes.

**External trigger:** a short to ground stops normal sweep. Opening the short then enables a sweep.

### Input

#### Unbalanced (UNBAL)

**Impedance:** 1 M $\Omega$ /40 pF.

#### Balanced/bridged (BRDG)

**Impedance:** 10 k $\Omega$ .

**Frequency response:** 40 Hz-20 kHz,  $\pm 0.5$  dBm for signals  $< 20$  dBm.

#### Balanced/terminated (TERM)

**Impedance:** 600 $\Omega$ /900 $\Omega$  balanced.

**Frequency response:** same as balanced/bridging.

**Input connector:** accepts WECO 310 plug.

### Output Characteristics

**Tracking generator output** (also known as BFO or tracking oscillator output). Switchable on rear panel to restored output (3581C acts as a narrow band amplifier).

**Range:** 0 to 2 V rms.

**Frequency response:**  $\pm 3\%$  15 Hz to 50 kHz.

**LO output:** 100 mV signal from 1 MHz to 1.5 MHz as input is tuned from 0 to 50 kHz.

**Output connector:** WECO 310, for connection to tracking generator output or restored output. In addition to monitoring restored output with headphones, an internal speaker also provides an audio indication of signal content.

**Restored output:** acts as a narrow band amplifier.

**X-Y recorder analog outputs:** 0 to +5V  $\pm 2.5\%$ .

### General

**Operating temperature range:** 0 $^{\circ}$ C to 55 $^{\circ}$ C.

**Humidity:** 95% relative, maximum at 40 $^{\circ}$ C.

**Power requirements:** 100 V, 120 V, 220 V, 240 V +5% -10%, 10 VA typical, 48 Hz to 440 Hz.

**Size:** 412.8 mm H x 203.2 mm W x 285.8 mm D (16 $\frac{1}{4}$ " x 8" x 11 $\frac{1}{4}$ ").

**Weight:** 11.5 kg (23 lb); Option 001, 13.5 kg (30 lb).

**Accessory available:** 7035B Option 20, X-Y recorder.

**Option 001: Rechargeable battery:** used to make floating measurements; 12 hours to fully charge. Also includes front panel dust cover.

### Ordering Information

3581C Selective Voltmeter

Opt 001: Battery Pack, dust cover

7035B Opt 020: X-Y Recorder

### Price

\$4250

add \$450

add \$2095



- Voice and carrier measurements

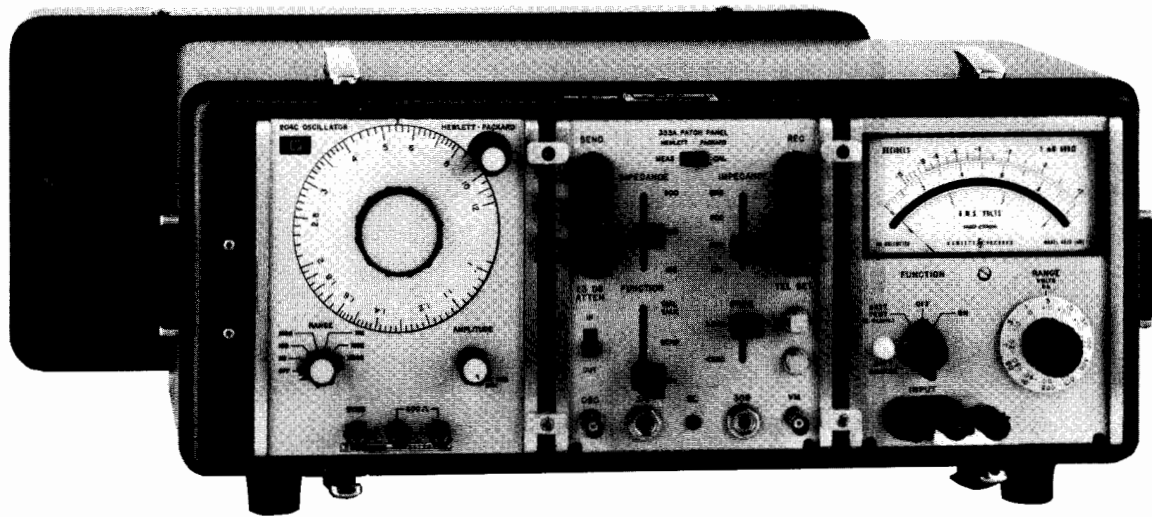

## Description

Hewlett-Packard's Model 3550B Portable Test Set is designed specifically to measure transmission line and system characteristics such as continuity and attenuation distortion. It is particularly useful for lineup and maintenance of multi-channel communication systems. Model 3550B contains a wide range oscillator, a voltmeter, and a patch panel to match both oscillator and voltmeter to 135, 600, and 900 ohm lines. These instruments are mounted in a combining case that is equipped with a splash-proof cover. In addition, the oscillator, voltmeter, and patch panel may be used separately whether they are in or removed from the combining case.

Both the oscillator and voltmeter are transistorized and operate from their internal rechargeable batteries or from the ac line. Batteries provide 40 hours of operation between charges and are recharged automatically during operation from the ac line.

## Specifications

### Oscillator HP 204C Opt H20

(Refer to Page 356)

### Voltmeter, HP 403B Opt 001

(Refer to Page 44)

### Patch Panel, HP 353A

(Specifications apply with oscillator and voltmeter)

#### Input (receiver)

**Frequency range:** 50 Hz to 560 kHz.

**Frequency response:**  
±0.5 dB, 50 Hz to 560 kHz.

**Impedance:** 135Ω, 600Ω, and 900Ω and bridging (10 kΩ center tapped).

**Balance:** better than 70 dB at 60 Hz for 600Ω and 900Ω; better than 60 dB at 1 kHz for 600Ω and 900Ω; better than 40 dB over entire frequency range for 135Ω, 600Ω, and 900Ω.

**Insertion loss:** less than 0.75 dB at 1 kHz.

**Maximum level:** +10 dBm (2.5 V rms at 600 ohms).

#### Output (send)

**Frequency range:** 50 Hz to 560 kHz.

**Frequency response:** ±0.5 dB, 50 Hz to 560 kHz.

**Impedance:** 135Ω, 600Ω, and 900Ω center tapped.

**Balance:** better than 70 dB at 60 Hz for 600Ω and 900Ω; better than 60 dB at 1 kHz for 600Ω and 900Ω; better than 40 dB over entire frequency range for 135Ω, 600Ω, and 900Ω.

**Insertion loss:** less than 0.75 dB at 1 kHz.

**Distortion:** less than 1%, 50 Hz to 560 kHz.

**Maximum level:** +10 dBm (2.5 V rms into 600 ohms).

**Attenuation:** 110 dB in 10 and 1 dB steps.

**Accuracy, 10 dB section:** error is less than ±0.25 dB at any step.

**Accuracy, 100 dB section:** error is less than ±0.5 dB at any step.

**Connectors:** two 3-terminal binding posts for external circuit connection and two BNC female connectors for oscillator and voltmeter connection.

### Patch Panel, Opt H02-353A

(Same as Model 353A except as indicated below)

#### Hold circuit (rec terminals)

**Frequency response:** 300 Hz to 3 kHz ±0.5 dB, 1 kHz reference.

**DC resistance:** 240 ohms nominal.

**Maximum DC current:** 100 mA.

**Maximum DC voltage:** 150 volts.

**Attenuation:** 23 dB ±0.5 dB (1-step slide switch).

#### Hold circuit (send terminals)

**Frequency response:** 300 Hz to 3 kHz ±0.5 dB, 1 kHz reference.

**DC resistance:** 240 ohms nominal.

**Maximum DC current:** 100 mA.

**Maximum DC voltage:** 150 volts.

**Connectors:** special telephone jacks to accept Western Electric No. 309 and 310 plugs. Sleeve jack is connected to sleeve of jacks 309 and 310. Two 3-terminal binding posts for external circuit connection.

Two terminals (Tel Set) connector for Hand Set, two BNC female connectors for oscillator and voltmeter connection.

### Patch Panel, Opt H03-353A

(Same as Model H02-353A except Western Electric 241 connectors replace 3-terminal binding posts)

## General

**Size:** 489 H x 213 W x 337 mm D (19.3" x 8.4" x 13.3") with cover installed.

**Weight:** net, 13.5 kg (30 lb). Shipping, 18 kg (40 lb).

## Ordering Information

	<b>Price</b>
<b>3550B</b> Portable Test Set (with 353A Patch Panel)	\$2100
<b>H02-3550B</b> (with H02-353A substituted for standard 353A)	add \$175
<b>H03-3550B</b> (with H03-353A substituted for standard 353A)	add \$175



# TELECOMMUNICATIONS TEST EQUIPMENT

## Transmission Impairment Measuring Sets (TIMS)

Models 4940A

- Complete analog testing of voice/data channels
- Compatible with North American Standard
- Low frequency phase jitter

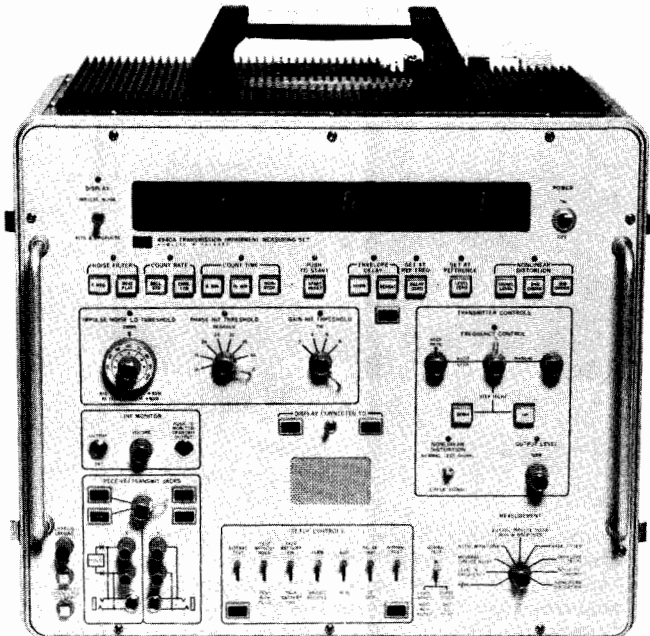

4940A

### TIMS—Transmission Impairment Measuring Set

Most of the important analog parameters can be measured by a combined assortment of analog test sets which measure only a few parameters. However, TIMS are "stand alone" combination test sets that measure 7 to 15 parameters depending on the model and options selected. Thus TIMS can replace a large number of analog test sets. The major advantages of TIMS are that they cost significantly less and are more compact and more portable than a combination of test sets required to do the same measurements.

In addition to its cost savings and portability, TIMS are easy to operate. The switches on the front panel are logically arranged in functional groups. Simple straight-forward operating procedures allow the craftsman or engineer to quickly and easily analyze voice band data channel.

### 4940A TIMS—Complete Analog Testing

The HP 4940A measures all the necessary parameters to completely describe the ability of a voiceband channel to carry medium and high speed data. The 4940A is the ideal tool for analyzing and troubleshooting C and D-1 conditioned lines.

With the HP 4940A it is possible simultaneously to observe all of the transients that cause data errors. By counting phase hits, gain hits, dropouts and three levels of impulse noise at the same time, a more accurate analysis can be made of error causes and channel quality. All of these transients are totalled by TIMS during the selected count time and stored in memory. The pushbutton-selectable count times are 5, 15 minutes and continuous. During the test and at the end of the count time, either the impulse noise totals or the hits and dropout totals may be displayed from memory.

The 4940A TIMS measures the peak-to-peak phase jitter in two separate bands. Bell standard phase jitter is measured in the frequency band of 20 Hz to 300 Hz, and Bell low frequency phase jitter is measured in the frequency band of 4 Hz to 20 Hz. By measuring the peak-to-peak phase jitter in each band, you can identify positively the existence of low frequency phase jitter from standard phase jitter.

### 4940A Specifications

For detailed specifications ask your local HP sales office for a 4940A TIMS data brochure.

#### General

**Power:** 105 to 129 V AC, 60 Hz, 130 watts.

**Dimensions:** 464 H x 470 W x 32.4 mm D (18.3" x 18.5" x 12.8").

**Weight:** net, 18 kg (39 lb). Shipping, 25 kg (54 lb).

#### Options

Options	Price
001: adds P/AR measurement	add \$350
002: adds nonlinear distortion measurement	add \$875
003: adds P/AR and nonlinear distortion measurements	add \$1175
004: adds P/AR, nonlinear distortion and low frequency phase jitter	add \$1950
010: Field carrying case	add \$300
019: 19" Rack Mount Adapter, deletes cover	N/C
023: 23" Rack Mount Adapter, deletes cover	N/C

The nonlinear distortion technique is licensed under Hekimian Laboratories, Inc., USA Patent No. 3862380.

### 4940A Transmission Impairment Measuring Set

**\$10900**

Measures level and frequency, message circuit noise (C-message and 3 kHz flat), noise-with-tone, 3-level impulse noise, phase hits, gain hits, dropouts, phase jitter, envelope delay, noise-to-ground.

### 4940A, 4943A and 4944A Comparison

Measurement	4940A	4943A	4944A
Message Circuit Noise-C-Message	•	•	•
3 kHz Flat	•	•	•
Noise with Tone	•	•	•
Attenuation Distortion	•	•	•
Envelope Delay Distortion	•	•	•
Impulse Noise 1 Level	•	•	•
3 Levels	•	•	•
Phase Hits	•	•	•
Gain Hits	•	•	•
Dropouts	•	•	•
Phase Jitter	•	•	•
Low Frequency Phase Jitter	•	•	•
Non-Linear Distortion	•	•	•
Peak to Average Ratio	•	•	•
Noise to Ground	•	•	•
Signal to Noise Ratio	•	•	•

# TELECOMMUNICATIONS TEST EQUIPMENT

## Transmission impairment measuring set (TIMS)

Models 4943A and 4944A



- Portable for field service tests
- Analog testing of voice/data channels

- Master-slave for remote end-to-end testing
- Automatic self check

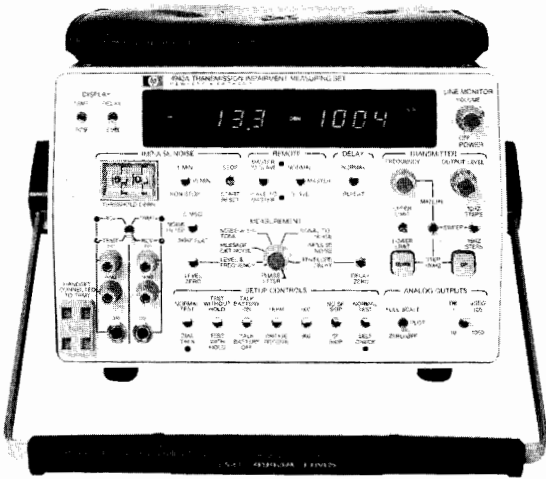

4943A



4944A



### 4943A TIMS

#### Gives You a Permanent Record of Your Measurements

The analog output circuit allows you to display the measured signal on a CRT display or record it on an X-Y recorder or strip chart recorder. Built-in storage and internally generated graticule lines allow you to use non-storage oscilloscopes or uncalibrated CRT display.

MASTER-SLAVE operation allows remote end-to-end testing without adding an external controller. The Slave unit operates unattended, with measurements in both directions controlled and displayed by the Master unit. Adding the HP-IB option provides automatic testing.

#### 4943A Specifications

For detailed specifications ask your local HP Sales Office for a 4943A TIMS Data Brochure.

##### General

**Power:** 100, 120, 220, 240 V AC +5% -10%, 48 to 66 Hz.

**Size:** 196 H x 338 W x 591 W mm D (7.7" x 13.3" x 23.3").

**Weight:** 12.2 kg (27 lb).

##### Options

**010:** HP-IB Interface

**012:** Nonlinear distortion replaces phase jitter

**015:** 18055A Transit Case

**019:** 10491B 19" Rack Mount

**910:** Extra set manuals

##### Price

add \$550

add \$550

add \$350

add \$120

add \$75

#### 4943A Transmission Impairment Measuring Set \$8850

Measures level and frequency, message circuit noise (C-message and 3 KHz Flat), 1 level impulse noise, signal-to-noise ratio, envelope delay, phase jitter. Analog outputs with internal storage and internally generated graticules, two holding coils, MASTER-SLAVE feature, and portable mainframe. Low frequency phase jitter available on special order.

### 4944A TIMS

#### Measures All Parameters for C & D Conditioned Channels

The 4944A TIMS measures all parameters including nonlinear distortion, tariffed for C- and D-conditioned leased data lines. Non-linear distortion is measured using the four tone intermodulation distortion technique. This technique is licensed under Hekimian Laboratories, Inc. USA Patent No. 3862380. The 4944A TIMS computes the 2nd and 3rd order products and automatically corrects the readings for noise.

Applications for the 4944A TIMS include circuit routing, circuit troubleshooting and installation testing. The portable 4944A is designed for both field service use and test center use.

#### 4944A Specifications

For detailed specifications ask your local HP Sales Office for a 4944A TIMS Data Brochure.

##### General

**Power:** 100, 120, 220, 240 V AC, +5% -10%, 48 to 66 Hz.

**Size:** 196 H x 338 W x 591 mm D (7.7" x 13.3" x 23.3").

**Weight:** 12.2 kg (27 lb).

##### Options

**001:** Deletes nonlinear distortion

**010:** HP-IB Interface

**015:** 18055A Transit Case

**019:** 10491B 19" Rack Mount

**910:** Extra set of manuals

##### Price

less \$800

add \$550

add \$350

add \$120

add \$75

#### 4944A Transmission Impairment Measuring Set \$8850

Measures level and frequency, message circuit noise (C-message and 3 KHz Flat), signal-to-noise ratio, 1 level impulse noise, envelope delay, non-linear distortion, two holding coils, MASTER-SLAVE feature, and portable mainframe.

# TELECOMMUNICATIONS TEST EQUIPMENT

## Transmission Impairment measuring sets (TIMS)

### Model 4935A

- Includes normal and wideband data circuits to 110 kHz
- 2000 Hz to 2713 Hz frequencies



4395A

### A Wideband TIMS for Data Line Testing

Newest member of the Hewlett-Packard TIMS family, the 4935A expands TIMS capability to include program and wideband data channels such as DDS\*. It combines the most common impairment measurements—level, frequency, attenuation distortion, background noise, signal to noise ratio, noise with tone, and 3 level impulse noise—into one portable, rugged unit. Noise filters are provided to cover voiceband thru wideband. Noise to ground measurement is included in the standard unit for identifying those tough longitudinal noise problems. For quick benchmark testing on data lines, P/AR is optionally available instead of noise to ground.

Two-wire and four-wire testing are both covered by the 4935A. For dial-up circuits there are two Hold circuits and a dial thru handset connection. The TIMS tradition of minimizing operator errors, which cost test time, is continued with features such as SF Skip (prevents transmission of a 2600 Hz signal frequency). Now the 4935A takes this tradition one step further by providing a variable skip frequency. Independent transmit and receive impedances make the 4935A more flexible in a wider variety of applications such as switch testing.

#### Send To Us

Like its TIMS predecessors, the 4935A is designed to simplify data line testing. Four commonly used frequencies—404 Hz, 1004 Hz, 2804 Hz, and 2713 Hz—are transmitted at the touch of a key; and

any four other frequencies can easily be stored into those same locations. With the digital transmitter you can return to these stored frequencies precisely and instantly without sweeping or cranking the oscillator. Using the microprocessor control, signal to noise ratio and attenuation distortion are displayed directly with no further calculations by the operator. A frequency sweep is easily accomplished in 1, 10, 100, 1k, or 10k Hz steps with the Step Up key for a quick scan of the channel.

#### Design for the Field

The 4935A is well suited for field use. Its touch panel can withstand more actuations than most mechanical switches, and including the rechargeable battery option it still weighs less than 14 pounds.

### 4935A Specifications

For detailed specifications ask your local HP sales office for a 4935A data sheet.

#### Power

100, 120, 220, or 240 V AC +6%, -10%, 45 to 66 Hz

Size: 11.2 x 25.9 x 28.6 cm (4.4 x 10.2 x 11.25 in)

Weight: 4.86 kg (10.8 lbs); 6.25 kg (13.9 lbs) with Option 001

#### Options

**001:** adds rechargeable battery pack

**002:** adds P/AR measurement in place of Noise to Ground

**003:** adds both the battery pack and P/AR

\*Dataphone Digital Service is a trademark of AT&T

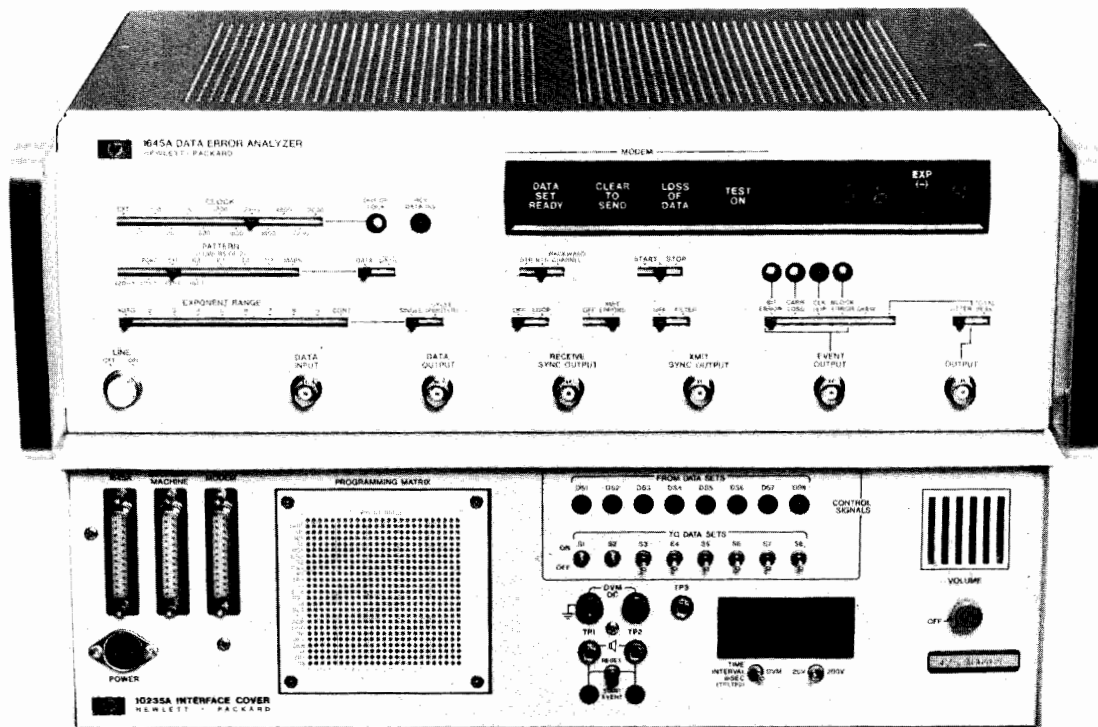

1645S

#### 1645A Description

Hewlett-Packard's Model 1645A Data Error Analyzer quickly isolates data communications link problems through six simultaneous measurements. During tests, the 1645A can be left totally unattended because it automatically maintains synchronization even in the presence of dropouts. And for added convenience, the 1645A can be equipped with a printer for hard-copy, permanent recordings of long tests.

Bit-error and block-error rate tests are autoranged and displayed directly on an LED readout, there is no need to perform any calculation. Additionally, the 1645A measures jitter or total peak distortions, (the sum effect of jitter and bias), counts the number times carrier loss or dropouts occur, measures data-error skew and counts the number of times carrier loss or dropouts occur, measures data-error skew and counts the number of clock slips resulting from phase hits on the link or modem sync problems.

With all these measurements made during the same test interval, you'll know precisely what is causing your problems in modems, data channels, complete communication systems.

#### 10235A Interface Cover

The 10235A Interface Cover is designed for troubleshooting problems on the RS-232C interface bus. The most common problems such as wrong voltages and excessive turnaround times, which most commonly occur during installation, are easily pinpointed with the measurement capability of the interface cover.

Measurements include time interval, voltage measurements, audio monitoring, data set control signal monitoring, and the ability to send control signals to the data sets. This measurement capability can be easily patched through the 25 x 25 pin matrix to every pin of the RS232C interface for complete testing.

The programmable matrix has the 25 pins of the RS-232C interface (modem and business machine) connected to the columns along with most of the RS-232C conductors from the 1645A to the modem. Several important signals, send data, receive data, transmit clock and receive clock, are separated and applied to the matrix rows for manual manipulation by the technician.

The most important row outputs are TP1 and TP2 which are connected to the time interval circuits for measuring the interval between signals occurring on two different leads in the matrix. The interval

timer measures the time while a visual indication of which lead changed state first is supplied by LED's connected to TP1 and TP2. This permits accurate timing measurements of important signals such as turnaround time between Request to Send and Clear to Send responses. Test points 1 and 2 may also be monitored with the built-in loudspeaker. For maximum flexibility the voltmeter can be connected through jumper leads to TP1, TP2, or TP3 of the matrix to any of the 25 input leads. The external inputs also allow external voltage measurements such as telephone line signal levels.

Control information can also be exchanged between the 10235A and the data set by using any of the eight data set control switches. In addition control signals from the data set can be monitored through the matrix on the eight control signal indicators.

#### Interfaces

For versatility in design and troubleshooting, both CCITT V24 (RS-232C) levels and TTL levels are available in the 1645A. TTL levels are through front panel BNC connectors. Interfacing with standard RS-232C systems is through a rear panel 25 pin connector. The system interface, including connector, is contained on one circuit card which is easily replaced for other interfaces. The Model 10388A interface card and cable is for modems conforming to CCITT V35 (W.E. Type 306) high speed modems. The Model 10387A interface is for type 303 wideband modems. Interfacing with modems conforming to MIL-188C standards is available with Model 18062B. A breakout box, Model 10389A for RS-232C systems, is available as a convenient method of opening interconnecting lines. Test points on each side of the switch permits monitoring of signal levels, or with jumper leads offer a convenient method of matching different system installations.

#### 1645S Data Transmission Test Set

For communications companies that need to test both low and high speed systems the 1645S offers a complete data transmission test set. The test set includes a 1645A Data Error Analyzer with RS-232C interface; 10235A Interface Cover; CCITT V 35 and Type 303 interface with cables; Model 10389A RS-232C breakout box with cable; and two accessory pouches. The 1645S includes two diode and two resistor pins for the 10235A matrix. This complete test system offers eight basic data communication measurements plus audio which is capable of detecting malfunctions ranging from crossed wires to intersymbol interference in a wide range of data communications systems.

# TELECOMMUNICATIONS TEST EQUIPMENT

Six simultaneous, automatic data measurements

Models 1645A & 10235A (con't)

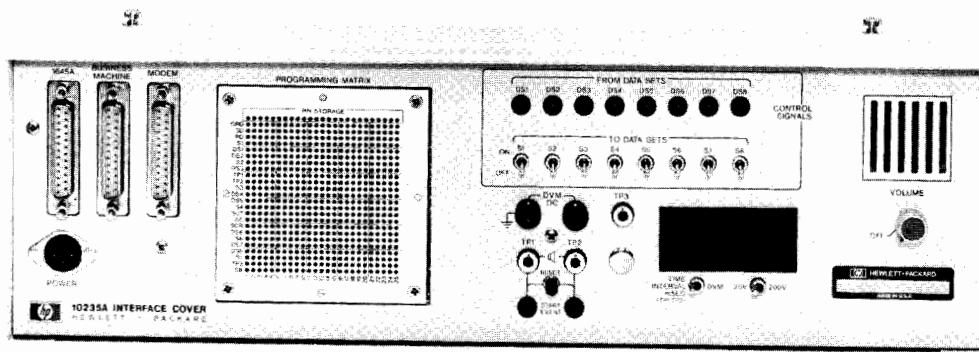

10235A

## 1645A Specifications

### Bit Rate

#### Internal

**Transmitter bits per second:** selectable 75, 150, 200, 300, 600, 1200, 1800, 2400, 3600, 4800, 7200, 9600.

**Crystal frequency:** 5.75 MHz  $\pm 0.03\%$ ,  $< 0.01\%$  jitter.

**Receiver with bit synchronizer:** same as internal transmitter.

**External:** transmitter and receiver, to 5 MHz.

### Data Outputs/Inputs

#### Front panel

**Input:** data input required TTL levels; max input 5.5 V.

**Outputs:** receiver sync, transmitter sync, and event at TTL levels; data output is  $> 2$  V into 50 ohms; jitter/total peak is 1 V p-p for each 10% of p-p distortion from waveform causing distortion.

#### Rear panel

**Inputs:** backward channel data, external transmitter and receiver clock require TTL levels; max input 5.5 V.

**Outputs:** bits lost at TTL levels; internal transmitter clock is  $> 2$  V into 50 ohms.

**Multipin connectors:** 25 pin female connector for interfacing with standard RS-232C communications systems. 36 pin female printer output at TTL levels in BCD 8421 code.

### General

**Power:** 115 or 230 V ac, 48 to 440 Hz, 150 VA max.

**Operating environment:** temperature, 0 to  $+55^{\circ}\text{C}$  ( $+32^{\circ}\text{F}$  to  $+130^{\circ}\text{F}$ ); humidity, to 95% relative humidity at  $+40^{\circ}\text{C}$  ( $+104^{\circ}\text{F}$ ); altitude, to 4600 m (15 000 ft); vibration, vibrated in three planes for 15 min. each with 0.254 mm (0.010 in.) excursion, 10 to 55 Hz.

**Dimensions:** 133 H x 425 W x 286 mm D ( $5\frac{1}{4}''$  x  $16\frac{3}{4}''$  x  $11\frac{1}{4}''$ ).

**Weight:** net, 8.2 kg (18 lb). Shipping, 10.9 kg (24 lb).

**Accessories supplied:** one 3 m (10 ft) RS-232C interconnecting cable to connect the 1645A to the modem, connects to 10235A when used in the 1645S configuration (HP P/N 01645-61605), one 2.3 m (7.5 ft) 3 wire power cord (HP P/N 8120-1378); one Operating and Service Manual.

## 1645A Indicators and Controls

### Indicators

Out of lock; received data inverted; bit error; carrier loss; clock slip; block error; data set ready (DSR); clear to send (CTS); loss of data; test on.

### Selector Switches

Clock; pattern; data/data; exponent range; single/cycle (printer); DTR/RTS/backward channel; start/stop; off/look; off/xmit errors; off/filter; event, bit error, carrier loss, clock slip, block error, skew, jitter/total peak.

## 10235A Specifications

### Time Interval

**Range:** 999 ms full scale.

**Resolution:** 1 ms.

**Accuracy:**  $\pm 2\%$  of measured interval  $\pm 1$  count.

**Start-Stop:** TP1 & TP2 input, LED indicates event start at TP1 or TP2.

**Trigger slope:** positive edge.

**Trigger amplitude:**  $\pm 3$  V.

**Input resistance:** approx. 4 k $\Omega$ .

### DC Digital Voltmeter

**Ranges:** 19.99 V, 199.9 V full scale.

**Accuracy:**  $\pm 1\%$  of reading,  $\pm 1$  count.

**Digital units:**  $3\frac{1}{2}$  digits.

**Input resistance:** 1 M $\Omega$ .

**Overload protection:** to 1000 V.

### General

**Interface connectors:** three 25 pin female connectors for connecting the 10235A to the 1645A, modem, and business machine. Interface conforms to RS-232C standard.

**Power requirements:**  $+15$  V to 25 V and  $-15$  V to  $-25$  V supplied by the 1645A.

**Dimensions:** 132 H x 399 W x 48 mm D ( $5.2''$  x  $15.7''$  x  $1.9''$ ).

**Weight:** net, 1.8 kg (4 lb). Shipping, 3.2 kg (7 lb).

**Accessories supplied:** one 46 cm (18") RS-232C interconnecting cable connects 10235A to 1645A (HP P/N 10235-61606); one accessory pouch, attaches to side of 1645A (HP P/N 1540-0385); one Operating Note.

### Indicator and Control Functions

**Indicators:** eight light emitting diodes (LED) provide logic HI or LO indications for corresponding patch pins in the programming matrix,  $+3$  V lights LED.

**Audio:** built-in loudspeaker and volume control.

**Control switches:** eight switches supply control signals through the program matrix to business machine/modem connectors. ON is  $+5$  V, OFF is  $-5$  V.

### Interfaces

Interface Model	Price
Model 10387A for Type 303 modems (with cable)	\$510
Model 10388A for CCITT V35 (with cable)	\$510
Model 10389A Breakout Box (RS-232C)(with cable)	\$300
Model 18062B MIL-STD-188C Interface	\$240

### Accessories

**Printer interconnecting cable:** Model 10233A cable \$100

connects the 1645A to HP Model 5055A or 5150A printers; 36 pin male connector on one end and 50 pin male connector on the other

**Front panel cover:** protects 1645A front panel during transit and provides convenient carrying handle (HP P/N 5060-8767). This cover is not needed when a 10235A Interface Cover is ordered with a 1645A, or with a 1645S Data Transmission Test Set. \$165

### Ordering Information

<b>1645A Data Error Analyzer</b>	\$3200
<b>Opt 908:</b> includes rack mounting kit	add \$20
<b>Opt 910:</b> additional set of manuals	add \$15.50
<b>10235A Interface Cover</b>	\$1850
<b>1645S Data Communications Test Set*</b>	\$5700
<b>Opt 910:</b> additional set of manuals	add \$25

\*Includes 1645A, 10387A, 10388A 10389A, 10235A, and interconnecting cables.

# TELECOMMUNICATIONS TEST EQUIPMENT

585

Cable maintenance and construction test sets  
Models 4960, 4961, 4910G, 4930A, 4904A, 4905A, 4918A



## CMC Test Sets

For cable maintenance and construction (CMC), Hewlett-Packard offers test sets that will locate any fault that is likely to occur in a cable. In addition, advanced pair identifier systems provide simplified, fast identification of wire pairs. Mostly used by telephone operating companies, this test equipment is also employed in other areas such as a power company, cable TV service, city government, military and electrical contractors.

The easy-reference matrix (below) shows the areas that our test sets are used most effectively. It cross-references the test sets to specific tasks in aerial, buried and underground cables.

## Fault Isolation and Repair

The flowchart (below) shows the sequence of steps necessary to isolate and repair a cable fault. Sometimes, given experience and knowledge of the cable route, it's possible to eliminate a step or combine steps, but the testing sequence must still follow the flowchart. In addition, the trouble situation should be thoroughly analyzed at each step to make sure you're still on the right track and provide additional clues to the trouble.

	Buried Plant							Aerial or Underground Plant							
	Path/Depth	Shield or Conductor to Earth	Short	Cross	Ground	Split	Open	Pair I.D.	Short	Cross	Ground	Split	Open	Pair I.D.	Gas Leak
<b>ULTRASONIC DETECTORS</b>															
4905A															
4918A															
<b>DIRECT READING FAULT LOCATORS</b>															
4910F															
4910G															
4930A			H	H	H				H	H	H				
<b>SHEATH FAULT AND CABLE LOCATORS</b>															
4900A															
4904A															
<b>PAIR IDENTIFIERS</b>															
4960A/B															
4961A/B															

H = Maximum sensitivity to high resistance faults

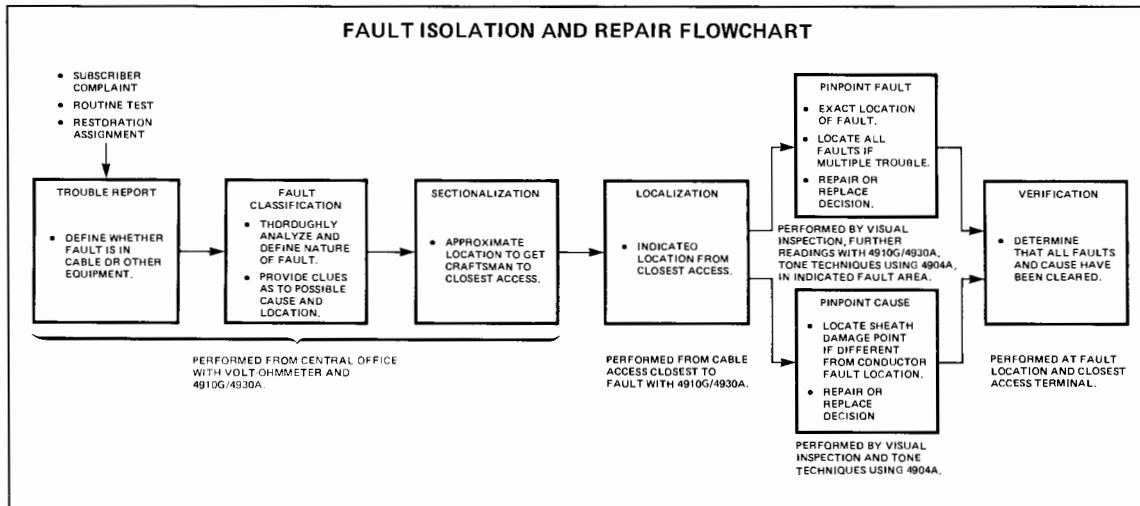



# TELECOMMUNICATIONS TEST EQUIPMENT

Telephone outside plant instruments

Models 4960, 4961, 4910G, 4930A, 4904A, 4905A, 4918A (Industrial Model)

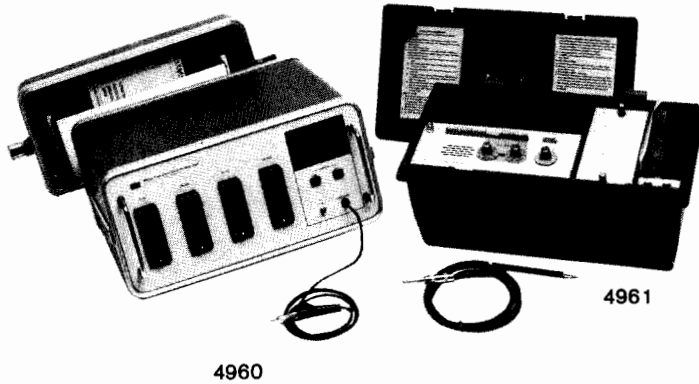

4960

4961

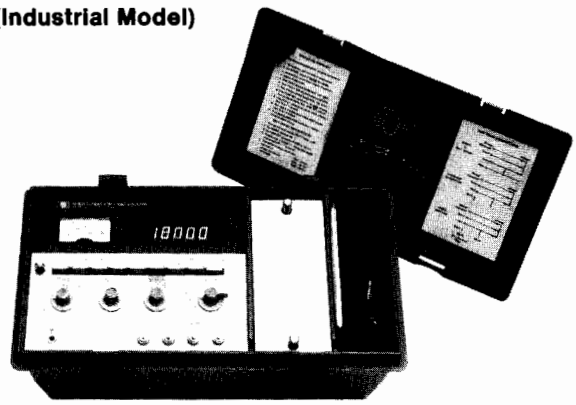

4930A

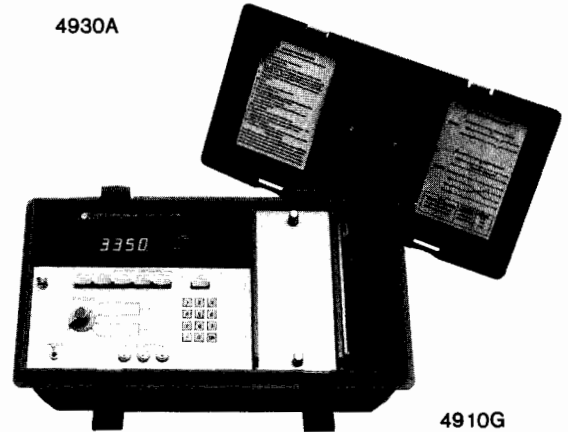

4910G

## 4960/4961 Telephone Pair Identifier System

An increasing need to rearrange telephone cables and pairs as well as a higher labor content associated with such activities has resulted in a need for fast, reliable pair identification equipment. The 4960/4961 System reliably identifies and tests working and nonworking telephone cable pairs in loaded or nonloaded telephone cables up to 40,000 feet in length. The system consists of the 4960 Office Unit and the 4961 Field Unit. The Field Unit is operated by the craftsman in a manhole or other access point. A pushbutton starts the operation of testing, identifying and determining the status of each pair.

There are four operating modes: Self Check, Shoe Check, Scan Mode and Select Mode. Self Check tests the operation of the units. Shoe Check determines if all the pairs in the shoe are making good contact to the mainframe. Scan Mode determines the pair number of a randomly chosen pair within the hundred pair count. Select Mode instructs the Office Unit to apply an audible tone to any selected pair in the count for a specific pair identification. The Select Mode is useful for identifying pairs that do not identify in the Scan Mode and for determining the problem on a faulted pair.

No control pair is required for communication between the Office and Field Units. Other features include bad, busy and reversed pair indications as well as large, lighted digital displays.

There are two models available: "A" and "B." The 4960A/4961A is for use with U.S. independent telephone companies and non-U.S. telephone systems. The 4960B/4961B is for use with the Bell System. Both are similar in operation, but the "A" model has higher command frequencies.

## Direct Distance-to-Fault Locators

Field instruments that provide a direct distance-to-fault reading in feet (or metres) have the benefit of relieving the craftsman of the drudgery of performing manual calculations. Locating faults becomes faster, requires less training and is less error prone than with manual bridge techniques. The 4910G and 4930A provide these automatic readings.

## 4930A Automatic Digital Test Set

The 4930A is an automatic, digital, direct reading test set operating on the Wheatstone Bridge principle. It is designed to locate extremely high resistance shorts, crosses and grounds, such as might occur from minute amounts of moisture in plastic insulated cable (PIC). The 4930A is connected to the cable pairs at an access point and the far-end of the cable is strapped to form a bridge configuration. Two nulling operations are performed and then either the distance to the fault, distance strap to fault or the distance to the far-end is obtained on the autoranging digital display. The 4930A includes pushbutton checks of the fault resistance, the condition of the strap as well as of its 12 V battery. A self check circuit is built into the set. The 4930A is housed in a rugged polycarbonate case. 50 Hz noise rejection and metric options are available.

## 4910G Open and Split Fault Locator

The 4910G is designed to provide direct distance readings to both opens and splits. An open is a discontinuity in one or both of the wires of a cable pair. Opens can be the result of bad splices as well as the result of damage caused by shotgun pellets, squirrels, gophers or shovels. A split is a splicing error in which one side of a pair is inadvertently cross-connected with one side of a second pair while the remaining sides are spliced correctly. The split is the only cable fault that is virtually always man-made. The 4910G operates on a capacitance charge sampling principle which relates the charge placed on a length of wire to its capacitance and hence its length. A built-in microprocessor performs automatically the measurements and calculations necessary to locate opens and splits. The test set averages out the effect of noise on the line by automatically taking several readings on the pair prior to displaying the fault distance on its autoranging digital display. The 4910G is set automatically for standard .083µf/mile exchange cable but can be reset to other types of cable by means of the D Factor control. 50 Hz noise rejection and metric options are available.

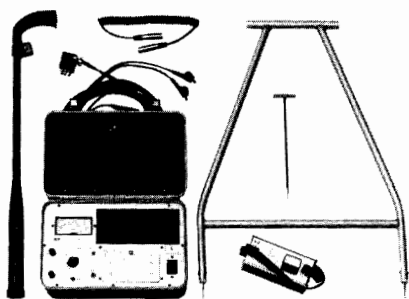

4904A



4905A

#### 4904A Pulsed Tone System

The 4904A is a pulsed tone system that accurately locates path and depth of buried cables and pipes. It also can be used for locating shorts, crosses and grounds in aerial, underground (ducted), and direct buried utilities cable. The sensitive narrow bandwidth receiver rejects ac hum and permits locating high resistance faults. The tone transmitter unit also has a built-in ohmmeter for analyzing faults. The accessory earth contact frame is especially useful for locating high resistance pinhole faults in the cable sheathing. It comes complete with transmitter, receiver, search wand, earth contact frame, cables and ground rod. It is shipped with batteries installed.

#### Ultrasonic Leak Detector

The most common causes of pressure leaks in cable plant are corrosion (particularly in coastal areas), electrolysis, squirrels, boring beetles, abrasion from wind and weather, hunters, and outside workmen. Abrasion (during installation) and corrosion are the most frequent causes of cable sheath trouble in cable installed underground in ducted passages.

To detect leaks in aerial cables, the craftsman merely scans the cable from the ground with the flashlight-size microphone, listening for the characteristic hissing sounds of a leak. By simultaneously observing the level meter, he can "peak in" on the leak and determine its exact location.

#### 4905A Ultrasonic Detector

The 4905A is a lightweight, portable ultrasonic detector which includes an 18020A directional probe, focusing extension, a 6-ft. coil cord and a leather utility case. It has a self-contained speaker, a logging meter, and provision for headphones. It is shipped with batteries installed.

Pole mounted accessories are available for closer scanning of the cable and the Ultrasonic Reflector accessory is a parabolic type dish allowing exact aerial leak locating from ground level.

Leaks in ducted underground systems are located with a unique "Duct Probe" accessory.

#### Industrial Applications

There are many applications for ultrasonic translators other than detecting pressurized gas leaks. Using air as the conducting medium, corona discharge and arcing from electrical equipment such as transformers, insulators, and contactors can be detected. In fixed head magnetic disc memory units, the level of ultrasonic noise created by the head riding on the disc can be monitored, giving advance warning of possible "crashes."

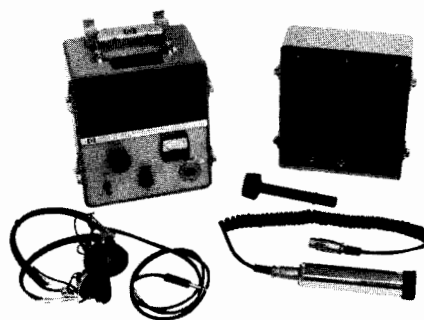

4918A

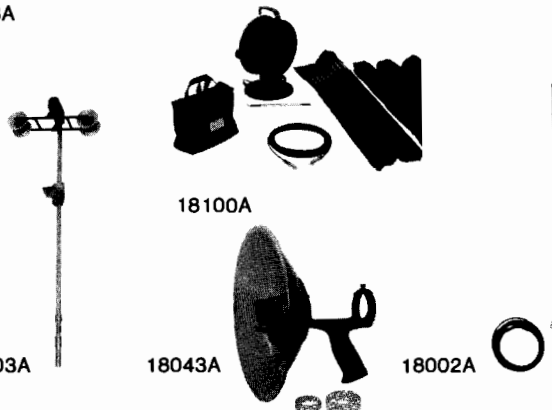

18100A

18003A

18043A

18002A

Some applications require the use of a contact probe to pick up vibration transmitted through a solid medium. In piped steam systems the operation of steam traps, heat exchangers, and valves can be checked. Ultrasonic detection can be used for preventative maintenance on rotating mechanical equipment, and for energy loss control on heating and cooling equipment.

#### 4918A Ultrasonic Translator/Reflector

The 4918A combines near-laboratory performance with field portability. It is a complete system in a rugged aluminum cabinet, listed by Underwriters' Laboratories, Inc., for use in Class 1, Group D, hazardous environments. Using mercury cell batteries, the device will operate from 500 to 700 hours. Accessories can be stored in the removable cabinet cover, which is designed to fit the instrument only when the power switch is off.

This instrument is also available as Model 118 with dc recorder output. However, with this option it is not Underwriter's Laboratories, Inc. listed for use in hazardous environments.

The 4918A comes complete with headset, 18020A general purpose probe, coil cord, and focusing extension. It is shipped with batteries installed.

#### Accessories

**18002 Quick Search Wand/18003A Mobile Reflector:** when used with the Model 4905A, these accessories increase sensitivity by placing the microphone and pre-amplifier close to the cable. The 18003A is ideal for exploring high spans or long sections of cable. Isolation up to 10kV is provided with each unit for protection when exploring near power lines.

**18043A Ultrasonic Reflector:** this unit may be used with all ultrasonic detectors to allow location of leaks by simply scanning the cable with the gun sight mounted in the reflector. It is useful in locations where the cable can't be effectively approached with Model 18002A/18003A.

**18021A Contact Probe:** this contact style probe is designed for detecting conducted ultrasonic energy in lieu of radiated energy. It may be used in lieu of the 18020A general purpose probe supplied with Model 4918A.

**18100A Underground Leak Location System (Duct Probe):** this system, designed for use with the Model 4905A, allows pinpointing leaks in underground (ducted) cable sections. This truly unique system can save considerable money that would otherwise be wasted on hit-and-miss excavation and unnecessary cable replacement.





### FDM/Carrier Systems

FDM/carrier systems are used to transmit large numbers of communications channels simultaneously over a single transmission medium, each channel being allocated a unique part of the frequency spectrum. The transmission media are generally microwave radio networks, which typically carry up to 1800 channels on each RF carrier, and coaxial cable systems, which typically carry up to 3600 channels on each coaxial 'tube'. Higher capacity systems also exist (for example, 60 MHz coaxial cable) which can carry 13,200 channels on each tube.

Each transmission spectrum is complex, containing—in addition to the communications channels—residual carriers, pilot tones, signalling and test tones which may be used to monitor the working of the system while it is actually carrying traffic.

### Measurement Requirements

In the design, manufacture, installation and maintenance of FDM/carrier systems several types of measurement are necessary. Some measurements use general-purpose instruments such as network analyzers, power meters and frequency standards, but the majority of measurements require a dedicated communications selective level meter and a level generator.

HP offers a wide range of instrumentation to satisfy your measurement needs.

### FDM/Carrier System Measurements

Of the many FDM measurements made, the most common are:

- Reference pilots
- Line pilots
- Channel power
- Channel noise
- Group power
- Carrier leak
- Signalling tone
- Test tone
- Supervisory tones
- Inter-supergroup noise
- Spectrum analysis
- Broadband power
- Frequency response
- Gain/loss
- Return loss
- Crosstalk

### Selective Level Meter Requirements

When choosing a selective level meter (SLM), there are several criteria to consider in balancing cost and performance.

1. **Frequency Accuracy:** Ideally, tuning should be accurate and stable, using a synthesized local oscillator. This allows precise tuning to the frequency at which the measurement is to be made and, if required, remote control of the tuning.

Cost savings can be made using a free-running local oscillator, with reduced frequency accuracy and stability. This approach needs manual searching in the region of the signal and peaking the meter on the signal of interest.

2. **Sensitivity:** An SLM as well as being able to measure high level signals accurately needs enough sensitivity to measure, for example, channel noise at a low level test point. In defining measurement range, noise floor is typically the limiting factor and generally -115 dBm in 3.1 kHz is acceptable. Where greater sensitivity is required, external low-noise amplifiers are available.

3. **Measurement Filters:** It is useful to have a selection of filters for measuring pilots and other single-frequency tones, channel power, channel noise and group power. The pilot filter should have sufficient out-of-band rejection to reject adjacent signals, for example, when measuring a channel virtual carrier leak in the presence of a group pilot. If the SLM is synthesizer-tuned and the need for "peaking" is to be avoided, then a flat top is necessary to allow for drift in the station master oscillator and the SLM between calibrations.

The channel filter should ideally have a flat top and a bandwidth equal to the voice-channel (generally 3.1 kHz). At the same time, it should have sufficient out-of-band rejection to reject adjacent channels, residual carriers and pilots, thereby ensuring an *accurate* measurement of *all* signals within the voice-channel. To make accurate noise measurements on all types of signals, a true psophometric or "C"-message weighting filter should be used with an RMS detector. Account should be taken of inverted channels, since weighting filters are asymmetric.

Cost savings can be made using the conventional 1.74 kHz effective noise bandwidth filters. The sacrifice with these is that they give the correct result only if the signals being measured are single tones or white noise. If the channel contains, for instance, VF signalling tones or data then the measurement may be in error.

The group filter is useful both in measuring the power in a group and in speeding up the search for high level users in the multiplex. In the majority of cases it is found that a high level user in one channel of a group has a sufficiently large effect on the group power to enable reliable detection with the group filter. Thus by measuring blocks of 12 channels the search is greatly speeded up.

4. **RMS versus Average Detector:** A true RMS detector always gives the correct result regardless of the composition of the signal being measured, but it is more expensive than an averaging detector. Usually the averaging detector is calibrated to give correct power measurements with sinusoidal signals and it will be in error when signals with a different spectral composition are measured. In order to overcome this, in the case of the nominal 1.74 kHz bandwidth channel filter, this bandwidth is increased to give the correct results when measuring white-noise signals.

5. **Ease of Use:** When making measurements on an FDM signal with a conventional manually-tuned SLM, the frequency of the desired pilot or channel to be measured must first be determined from the line frequency chart, a table containing several hundred frequencies. The SLM is then tuned to that frequency, its input and IF attenuators adjusted and the meter read, probably after fine tuning to peak the signal. The meter reading must be added to the attenuator settings to complete the measurement. The process is a familiar one, but time consuming and prone to error.

An alternative approach, made possible by developments in microprocessors and semiconductor memories, is to store the tables of FDM frequencies in the SLM so that, with the aid of a synthesized local oscillator, measurements may be made, with speed and confidence, directly in terms of the FDM description.

### Manual Testing

The new 3586A & B SLM and its companion Level Generator, the 3336A & B, are specifically designed for FDM system manufacture, installation and maintenance. The units offer state-of-the-art performance in both manual and programmable modes. The SLM local oscillator and the frequency determining circuits of the Generator utilize synthesis techniques that lead to 0.1 Hz



frequency resolution and corresponding frequency stability. The SLM offers absolute amplitude accuracy and flatness of  $\pm 0.2$  dB and Generator leveled output of  $\pm 0.15$  dB. The 3586A/3336A combination is optimized for testing to CCITT standards and the 3586B/3336B to Bell or North American standards.

The accuracy standards of these instruments are enhanced by the resolution of the SLM and the low distortion of the Generator. Filter bandwidths of 20 Hz, 400 Hz, 1.74 kHz, or 3.1 kHz, "C"-message or psophometrically weighted, are available. The 3336A/B Level Generator enjoys a harmonic distortion of  $-60$  dB to 1 MHz and  $-50$  dB to 21 MHz. These characteristics make the 3586A/B and 3336A/B an ideal test set for in-traffic use.

Programmability via HP-IB is standard on both instruments. The 3336A/B Generator can operate either in a stand-alone mode or track the 3586A/B SLM via the HP-IB without the need for an external controller.

The 3745A & B and the 3747A & B Selective Level Measuring Sets and the 3335A Synthesizer/Level Generator provide an optimum solution to the problems of measurements on FDM systems for manufacture, installation and field maintenance. These selective level measuring sets each have a synthesized local oscillator, wide sensitivity range of  $+15$  dBm to  $-120$  dBm (which is adjusted automatically), and absolute measurement accuracy of  $\pm 0.25$  dB in-

cluding typical flatness of 0.1 dB. The measurement filters are specifically designed for FDM systems: a 22 Hz flat-topped pilot filter, a 3.1 kHz channel filter with an optional true psophometric or "C"-message weighted noise filter and a 48 kHz group filter. The detector is a true RMS thermopile detector.

The sensitivity is automatically adjusted and the measurement results displayed on a digital LED display. CCITT and Bell frequency plans are stored in memory thus tuning is effected simply by keying in Channel, Group, Supergroup number, etc.

Several automatic routines are also accessible from the simple keyboard. Examples are scans of pilots, channel power, group power, carrier leak and inter-supergroup noise. These sets can also measure broadband power and, optionally, phase jitter, weighted noise and noise-with-tone.

#### Automatic Testing

Hewlett-Packard manufactures a wide range of HP-IB automatic system components. These make the implementation of automatic system ideas relatively straight forward from both the hardware and software standpoints. HP-IB systems make automatic testing more economically justifiable.

The 3042A Network Analyzer offers automatic stimulus-response testing of level, phase and group delay. It is ideal for use in the design and manufacture of FDM equipment to 13 MHz (2700 channels.)

The 3045A Automatic Spectrum Analyzer is also used primarily in FDM design and

manufacture. The system consists of a precision source and tracking detector under the control of a desk-top computer such as the 9825A. Manufacturers of FDM equipment have found that the 3045A has helped reduce test time on radio equipment by a factor of 10. Equally important is that manufacturers have found that 3045A programming can be handled in-house without needing software specialists.

The 3745A & B and the 3747A & B can be remotely controlled through the HP-IB from a suitable controller such as the 9825A or 9845A Desk-top Computers or the HP 1000 Computer System. This facilitates building a range of measurement systems from, for example, a single-instrument automatic, production test system to a fully automatic, multi-station, remote surveillance system. 3745A & B and 3747A & B SLMS systems are already providing comprehensive automatic measurement capability on FDM networks in many countries throughout the world.

An integral part of both large and small surveillance systems is a means of both connecting test points to the measuring set and connecting test signals to appropriate test inputs. This access switching is provided by the 3754A, 3756A and 3757A Switches which are controlled by a 3755A Switch Controller. For small systems, manual control is available by means of a keyboard on the 3755A and for large systems an HP-IB input is provided.

### Summary of Selective Level Meters

	3586A 3586B	3745A 3745B	3747A 3747B
Frequency Range	50 Hz to 32 MHz	50 Hz to 25 MHz	10 kHz to 90 MHz
Level Range	+20 to $-130$ dBm	+15 to $-120$ dBm	+15 to $-120$ dBm
Detector	RMS	RMS	RMS
Filters	20 Hz 400 Hz 1.74 kHz/2.0 kHz 3.1 kHz* Psophometric or "C"-Message weighted* Notch filters*	22 Hz 3.1 kHz 48 kHz Psophometric or "C"-Message weighted* 2.5 kHz* Notch filters*	22 Hz 3.1 kHz 48 kHz Psophometric or "C"-Message weighted* 2.5 kHz* Notch filters*
Broadband Power	Yes	Yes	Yes
Phase Jitter	Yes*	Yes*	Yes*
Impulse Noise	Yes*	No	No
S/N With Tone	Yes*	Yes*	Yes*
Scanning	Manual†	Automatic	Automatic
Companion Level Generator	3335A (32 MHz) 3336A/B (21 MHz)	3335A	3335A

\*Optional—refer to specifications †Automatic with external controller

# TELECOMMUNICATIONS TEST EQUIPMENT

## 25 MHz and 90 MHz Selective Level Measuring Sets

Models 3745A, 3745B and 3747A, 3747B

- Frequency range 50 Hz to 25 MHz (3745A/B), 10 kHz to 90 MHz (3747A/B)
- Selective filters for pilot, channel and group power measurements
- Autoranging attenuators and automatic tuning to stored frequency plans
- Out-of-limit alarm with hardcopy record on separate printer
- Automatic routines for unattended measurements
- HP-IB compatible

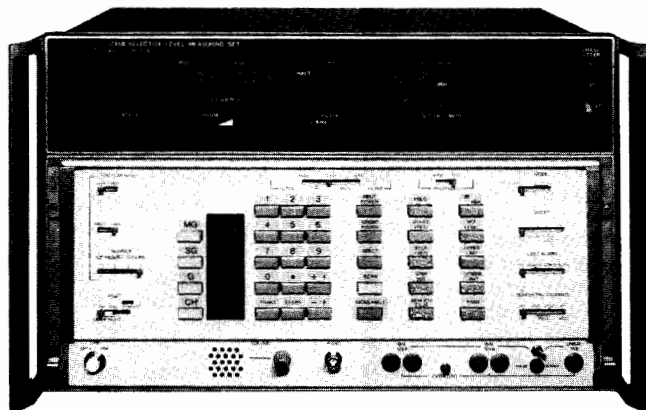

3745B

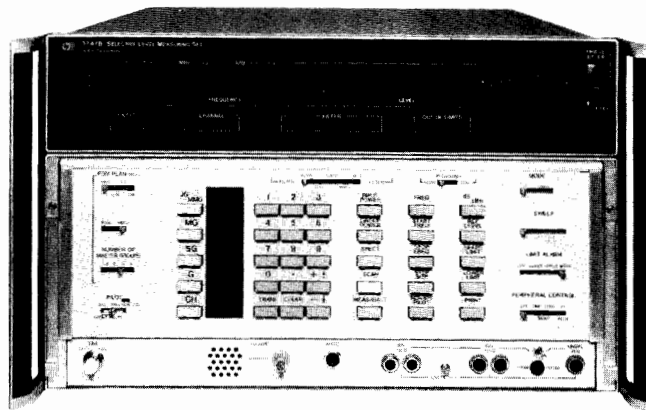

3747B



### Description

The 3745A & B and 3747A & B Selective Level Measuring Sets (SLMS's) are designed to make fast, accurate selective level measurements. A built-in frequency synthesizer gives accurate, stable tuning to the precise frequency at which the measurement is to be made. This simplifies the tuning of the SLMS. The 3745A/B and 3747A/B can be tuned over their frequency ranges (1 kHz to 25 MHz for the 3745A/B (50 Hz to 25 MHz with Opt 050); and 10 kHz to 90 MHz for the 3747A/B) with a resolution of 10 Hz.

The SLMS's measure true rms power between +15 dBm and -120 dBm with 0.1 dB or 0.01 dB resolution. Fully autoranging attenuators and amplifiers simplify operation further by eliminating the need to set attenuators and add meter readings. Measurement results are automatically displayed to the selected resolution, in dBm or dB relative terms, on an LED display. The absolute accuracy of the measurement over wide level and temperature ranges is  $< \pm 0.25$  dB including a flatness variation of typically  $< \pm 0.1$  dB.

Many benefits are derived from the purpose-designed filters contained in the SLMS's. The pilot filter has a flat-top, necessary for automatic tuning, and achieves high out-of-band rejection so that, for example, carrier leak and adjacent pilots can be measured on active systems. The channel filter is a flat-topped 3.1 kHz filter which measures all signals in the voice-channel with high out-of-band rejection—ensuring that pilots, residual carriers, signalling tones, etc., do not interfere with measurements. Optional weighted filters are available to make either true 'C'-message or CCITT psophometrically weighted noise measurements. With these options, phase jitter on a voice-channel can also be measured. A 48 kHz filter for group power measurements is also provided, to facilitate fast location of high level signals on a multiplex.

The SLMS is internally-controlled by a microprocessor which provides several ease-of-use and time-saving features. As well as tuning exactly to an entered frequency, the SLMS can refer to CCITT

(3745A and 3747A) or Bell (3745B and 3747B) multiplex frequency plans in its memory and automatically tune to the correct frequency at any level in the multiplex. Other frequency plans can be installed to special order. This eliminates the need for FDM Plan Charts and Tables. The SLMS's can automatically step through pilots, channels, group powers, carrier leaks, etc., across the baseband of a multiplex—comparing levels with pre-determined alarm limits and providing a print-out of out-of-limit signals on a separate Thermal Printer. 250 pilot measurements can be made in about 2 minutes and 2700 channel powers or carrier leaks can be measured in about 15 minutes. Spectrum analysis measurements of a voice-channel, group, supergroup or even the whole baseband can also be made. Measurements can be made unattended, for example, overnight.

The SLMS's are fully programmable via the Hewlett-Packard Interface Bus (HP-IB) and so can form the basis of a powerful, fully-automatic surveillance system.

### Options

Options	Price
021: phase jitter + psophometric weighted filter.	+\$295
022: phase jitter + C-message weighted filter.	+\$295
023: 800 Hz notched filter.	+\$320
024: 1010 Hz notched filter.	+\$320
025: 2.5 kHz channel filter.	+\$590
040: X-Y recorder/X-Y display driver.	+\$1150
050: 3745A/B extended frequency range.	+\$170
908: rack flange kit.	+\$53
910: extra set manuals.	3745A/B +\$63 3747A/B +\$73

### Ordering Information

3745A/B Selective Level Measuring Set	\$22685
3747A/B Selective Level Measuring Set	\$29020

# TELECOMMUNICATIONS TEST EQUIPMENT

Synthesizer/level generator 200 Hz to 80 MHz

Model 3335A

591

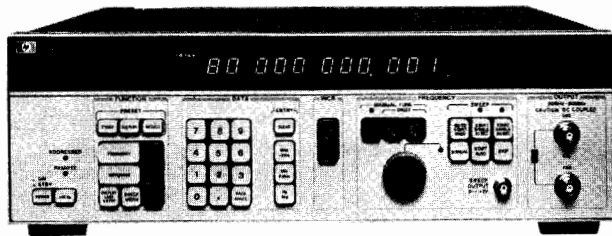

## Description

The 3335A is a 200 Hz-80 MHz Synthesizer/Level Generator with performance characteristics that make it ideally suited for testing low-density carrier, radio baseband and high-density cable carrier systems as well as for R&D and production testing. It features precision level control, high frequency resolution (0.001 Hz from 200 Hz to 80 MHz), optional frequency stability of  $\pm 5 \times 10^{-10}$ /day and high spectral purity. The 3335A is fully HP-IB programmable.

## Precision Amplitude Control

High capacity FDM systems are placing more stringent requirements on testing transmission parameters. One such area where new standards of performance are required is amplitude control. The 3335A incorporates a state-of-the-art attenuator structure resulting in attenuator accuracies of up to  $\pm 0.04$  dB over the 80 MHz frequency range. A true rms leveling loop provides  $\pm 0.15$  dB flatness over the entire frequency range ( $\pm 0.10$  dB from 1 kHz to 25 MHz) and 0.01 dB resolution over a 100 dB amplitude range. The 3335A can be externally leveled.

## Digital Frequency Selection

Frequency is controlled via the front panel or by remote control with up to 0.001 Hz resolution. Frequency can also be changed by incrementing or decrementing the frequency by any arbitrary amount. FDM testing is simplified by stepping from channel to channel with a single keystroke.

## Amplitude Blanking

The 3335A has switch selectable amplitude blanking to prevent disturbing a pilot tone when testing FDM systems. The output is blanked while the synthesizer tunes to the new frequency. This allows response testing of FDM systems while in service.

## Internal Storage For Repetitive Testing

The 3335A's internal microprocessor-controlled memory can store any combination of parameters (frequency, level, etc.) of the instrument in 10 separate memory registers. The contents of these registers can then be recalled for fast and repeatable testing.

## SLMS Tracking Generator

The 3335A operates as a tracking generator with the HP 3745A/B Selective Level Measuring Set (SLMS) and 3586A/B/C Selective Level Meter for automatic or semi-automatic testing of FDM systems. For closed-loop tracking, (3335A and 3745A/B in the same location), the frequency is controlled by the SLMS. The 3745A/B and 3335A can sweep through any selectable frequency spectrum or cycle through the channels of a multiplex system by calling up the FDM frequency plans stored in the SLMS memory. The 3335A and 3745A/B can also operate in an open loop tracking mode separated by the system under test or they can be interfaced via the HP Interface Bus (compatible with IEEE STD 488-1975) to a programmable calculator or computer for a completely automatic test system.

## Options

**Standard:** Equipped with switch-selectable 50 $\Omega$  and 75 $\Omega$  outputs (BNC connectors).

**001:** High-stability frequency reference

**002/004:** Equipped with 75 $\Omega$  unbalanced and 124 $\Omega$  and 135 $\Omega$  balanced connectors per table.

	Option	Fits WECCO Type	Spacing	Accepts WECCO Type
75 $\Omega$	002	477B	N/A	358A
	004	560A		439A/440A
124 $\Omega$	002	477B	16 mm (.625")	372A
	004	560A	12.7 mm (0.5")	443A
135 $\Omega$	002/004	223A	16 mm (.625")	241A

**003:** 75 $\Omega$  unbalanced BNC output and 150 $\Omega$  balanced output using a pair of BNC connectors at 20 mm (0.80 in.) spacings.

## Abbreviated Specifications

(For complete specifications, refer to page 368 and the 3335A data sheet.)

### Frequency range:

**Standard:** 200 Hz-80 MHz;

**Opt. 002/004:** 75 $\Omega$ , 200 Hz-80 MHz; 124 $\Omega$ , 10 kHz-10 MHz; 135/150 $\Omega$ , 10 kHz - 2 MHz.

**Opt. 003:** 75 $\Omega$ , 200 Hz-80 MHz; 150 $\Omega$ , 10 kHz - 2 MHz

**Frequency resolution:** .001 Hz.

**Stability, long term:**  $\pm 1 \times 10^{-8}$ /day;  $\pm 1 \times 10^{-7}$ /month.

**Opt. 001** (high stability frequency reference):

**Aging rate:**  $\pm 5 \times 10^{-10}$ /day;  $\pm 2 \times 10^{-8}$ /month;  $\pm 1 \times 10^{-7}$ /year

**Warmup:** Within  $5 \times 10^{-9}$  of final value 20 minutes after turn-on at 25°C.

### Spectral purity

**Harmonic distortion:** 200 Hz-10 MHz:  $< -45$  dB; 10 MHz-80 MHz:  $< -40$  dB

**Phase noise** (30 kHz band, excluding  $\pm 1$  Hz, centered on the carrier): 9.9 MHz:  $< -63$  dB; 20 MHz:  $< -70$  dB; 40 MHz:  $< -64$  dB; 80 MHz:  $< -58$  dB

**Spurious:** Nonharmonically related signals 75 dB below the carrier or -110 dBm, whichever is greater

### Amplitude range:

**Standard:** 50 $\Omega$ : +13.01 dBm to -86.98 dBm; 75 $\Omega$ : +11.25 dBm to -88.74 dBm.

**Opt. 002/004:** 75/124/135 $\Omega$ : +11.25 dBm to -88.74 dBm

**Opt. 003:** 75/150 $\Omega$ : +11.25 dBm to -88.74 dBm

**Signal balance (124 $\Omega$ , 135 $\Omega$ , 150 $\Omega$  balanced outputs):**  $> 40$  dB

**Resolution:** 0.01 dB

**Absolute level accuracy (max. output at 100 kHz, 20°C to 30°C):**  $\pm 0.05$  dB

**Flatness (relative to 100 kHz, full amplitude):** 50/75 $\Omega$ : 1 kHz - 25 MHz:  $\pm 0.07$  dB; 200 Hz - 80 MHz:  $\pm 0.15$  dB. 124 $\Omega$ : 10 kHz - 10 MHz:  $\pm 0.15$  dB, 10 kHz - 10 MHz  $\pm 0.4$  dB; 135/150 $\Omega$ : 10 kHz - 2 MHz:  $\pm 0.18$  dB

**Attenuator accuracy (relative to 100 kHz, full amplitude)**

Impedance	Amplitude (dBm)	Frequency	
		200 Hz	80 MHz
50 $\Omega$	+13.01 to -6.98		$\pm 0.03$ dB
	-6.99 to -46.98		$\pm 0.07$ dB
	-46.99 to 86.98		$\pm 0.20$ dB
75 $\Omega$	+11.25 to -8.74	$\pm 0.04$ dB	$\pm 0.15$ dB
	-8.75 to -48.74	$\pm 0.09$ dB	$\pm 0.25$ dB
	-48.75 to -88.74	$\pm 0.20$ dB	$\pm 0.50$ dB

NOTE: For 124 $\Omega$ , 135 $\Omega$ , and 150 $\Omega$ , refer to data sheet.

## Options

**001:** Hi-stability reference

**Price**

add \$580

**002:** Connector option (75/124/135 $\Omega$ )

add \$300

**003:** Connector option (75/150 $\Omega$ )

add \$200

**004:** Connector option (75 $\Omega$ , miniature WECCO on 124/135 $\Omega$ )

add \$300

**3335A Synthesizer/Level Generator**

**\$7700**



# TELECOMMUNICATIONS TEST EQUIPMENT

Access/distribution switches and controller (8.5 MHz, 25 MHz, 90 MHz)

Models 3754A, 3755A, 3756A, 3757A

- Select 1 from a possible 10 RF Inputs/Outputs
- Cascade several Switches to allow selection from 1000 Inputs/Outputs
- Mix different Switches for the most cost-effective solution
- Single 3755A can control 111 Switches from a simple keyboard
- Remote input selection using HP-IB
- 75Ω termination of unselected ports



3754A

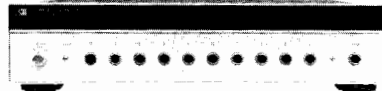

3756A



3757A

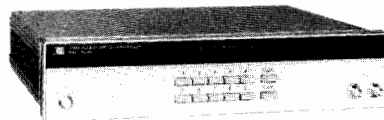

3755A

The 3754A, 3756A and 3757A Switches and the 3755A Controller have been developed to meet the requirements of three main areas.

1. Frequency Division Multiplex (FDM) System surveillance and maintenance—the Controller/Switch combination is used in conjunction with a Selective Level Measuring Set (SLMS), such as the 3745A/B (25 MHz) or 3747A/B (90 MHz), to monitor pilot and traffic levels at various points in the multiplex without manually connecting the SLMS to each point.
2. Production testing—where automatic selection of several RF signals is required.
3. Data logging—where large numbers of RF signals need to be accumulated at one control point.

### 3754A 25 MHz Access Switch

The 3754A 25 MHz Access Switch is an ac-coupled, uni-directional, ten-input switch with a frequency range from 10 kHz to 25 MHz. The 3754A incorporates a virtual-ground amplifier—giving an insertion loss of  $< \pm 0.1$  dB from 50 kHz to 20 MHz and high isolation across the whole frequency range. The isolation between any unselected input and the output is  $> 85$  dB and the isolation between any two inputs is  $> 90$  dB. In addition, pre-set gains of 1, 2 and 3 dB are internally selectable to compensate for losses in cables and equalizers. (The 3754A can be powered from the ac mains or from a dc supply.)

### 3756A 90 MHz Bi-directional Switch

The 3756A 90 MHz Switch is a dc-coupled, bi-directional, ten-way switch with a frequency range from dc to 90 MHz. The 3756A offers isolation of  $> 80$  dB between Channels, and  $> 75$  dB between unselected input and output ports. It has an insertion loss of 1 dB with a flatness of  $\pm 0.2$  dB and  $> 28$  dB return loss. (The 3756A can be powered from the ac mains or from a dc supply.)

### 3757A 8.5 MHz Access Switch

The 3757A 8.5 MHz Access Switch is a low-cost, ac-coupled, uni-directional, ten-input switch with a frequency range of 10 kHz to 8.5 MHz. An option provides expanded frequency range from 200 Hz to 8.5 MHz. The 3757A has an insertion loss  $< 0.1$  dB from 10 kHz to 4 MHz and isolation of  $> 95$  dB between Channels. In addition, pre-set gains of 1, 2 and 3 dB are internally selectable to compensate for losses in cables and equalizers. (The 3757A is powered from a  $\pm 15$  V dc supply.)

### 3755A Switch Controller

The 3755A Switch Controller has a small, easy-to-operate keyboard with a 3-digit LED display to denote the input or output selected. Each Switch (3754A, 3756A or 3757A) is given a 1-digit code, to select the required port. In a large Switch network, involving 3 levels of cascaded Switches, selection from up to 1000 inputs or outputs is possible. This requires a 3-digit code (000 to 999) where each digit represents the input or output of the appropriate Switch at each of the 3 levels.

Because the 3755A is a self-contained unit, separate from the Switches, it is possible to locate the Switches remotely from the Controller. In the case of the 3754A and 3757A, the control signal can be transmitted over the same cable as the RF signal. This eliminates the need for separate control cables and makes inter-connection changes easier. Sending control signals over the RF path has no effect on the RF signal source. (The 3755A is powered from the ac mains.)

The control signals can also be sent along a separate two-wire path. This is necessary for the 3756A or when the continuous dc path between the Switches and Controller is interrupted, for example, by an ac-coupled equalizer inserted to compensate the line-frequency response.

A combination of both methods of control signaling can be employed in the same Switch system. Also, if necessary, high and low frequency Switches can be incorporated into the same system.

### HP-IB Control

The 3755A Switch Controller can be remotely controlled over the Hewlett-Packard Interface Bus (HP-IB) by a desk-top computer. Selection of the RF input/output to be accessed is achieved using a 3-digit code that defines the particular input/output required. Since it is the 3755A which is controlled via the HP-IB, only one bus address is used for up to 111 Switches.

### Ordering Information

3754A 25 MHz Access Switch	
3755A Switch Controller	
3756A 90 MHz Bi-directional Switch	
3757A 8.5 MHz Access Switch	

Price	
\$2395	
\$2140	
\$3145	
\$1005	

# TELECOMMUNICATIONS TEST EQUIPMENT

Access/Distribution Switches and Controller (8.5 MHz, 25 MHz and 90 MHz) (Cont'd)

Models 3754A, 3755A 3756A and 3757A



## Specifications

Parameter	3754A 25 MHz Access Switch	3755A Switch Controller	3756A 90 MHz Bi-directional Switch	3757A 8.5 MHz Access Switch
Frequency Range	10 kHz to 25 MHz	-	dc to 90 MHz	10 kHz to 8.5 MHz 200 Hz to 8.5 MHz (Opt 200)
Insertion Loss	< ±0.1 dB (50 kHz to 20 MHz) < ±0.3 dB (10 kHz to 25 MHz)	<0.1 dB (I/P & O/P on rear) <0.2 dB (I/P & O/P on front)	1 dB ± 0.15 dB, dc to 80 MHz 1 dB ± 0.3 dB, 80 to 90 MHz	0 dB ± 0.1 dB (10 kHz to 4 MHz) 0 dB ± 0.2 dB (10 kHz to 8.5 MHz) 0 dB ± 0.5 dB (200 Hz to 10 kHz — Opt 200)
Pre-set Gain	0 dB 1 dB ± 0.1 dB 2 dB ± 0.1 dB 3 dB ± 0.1 dB (75Ω only)	-	-	1 dB ± 0.03 dB 2 dB ± 0.03 dB 3 dB ± 0.03 dB
Isolation	>85 dB (between I/P & O/P) >90 dB (any two Inputs)	-	>77 dB (between I/P & COMMON) >80 dB (any two unselect- ed Inputs)	>70 dB (any I/P & O/P over 10 kHz to 8.5 MHz) >75 dB (any I/P & O/P over 10 kHz to 4 MHz or 20 Hz to 10 kHz — Opt 200) >95 dB (any two adjacent Inputs 10 kHz to 8 MHz) >105 dB (any two adjacent Inputs 10 kHz to 4 MHz or 200 Hz to 10 kHz — Opt 200)
Return Loss	>30 dB (selected I/P from 60 kHz to 25MHz) >23 dB (unselected I/P from 60 kHz to 25 MHz) >30 dB (output from 60 kHz to 25 MHz)	>30 dB (rear panel from 60 kHz to 25 MHz)	≥24 dB (output, dc to 80 MHz) ≥20 dB (output, 80 to 90 MHz) ≥28 dB (ports 0 to 9, dc to 80 MHz) ≥20 dB (ports 0 to 9, 80 to 90 MHz)	>35 dB (selected I/P from 10 kHz to 8 MHz) >35 dB (unselected I/P from 10 kHz to 8 MHz) >35 dB (output from 10 kHz to 8 MHz)
Overload Level	0 dBm (control over signal path) +10 dBm (control over separate path) +8 dBm (50Ω version only)	-	-	0 dBm
Maximum Ac Input Power	+25 dBm (at each input)	-	+25 dBm (at each input)	+25 dBm (at each input)
Noise Power Ratio (Typical)	>70 dB (-10 dBm over any 8 MHz band)	>70 dB (-10 dBm over any 8 MHz band)	-	>50 dB (-10 dBm Input from 60 kHz to 8 MHz) >58 dB (-10 dBm Input from 60 kHz to 4.1 MHz)
Thermal Noise (in 3.1 kHz bandwidth)	<-115 dBm (from 60 kHz to 300 kHz) <-120 dBm (from 300 kHz to 25 MHz)	-	-	<-119 dBm (60 kHz to 4.1 MHz) <-117 dBm (60 kHz to 8.5 MHz) <-100 dBm (300 Hz to 3.4 kHz — Opt 200)

## General

Power	3754A		3755A		3756A		3757A	
Input Voltages (ac)	100, 120, 220, 240 V		100,120,220,240 V		100,120,220,240 V		-	
Tolerance	±10%		±10%		±10%,-15%		-	
Consumption	<20 VA		<20 VA		<20 VA		-	
Frequency	48 to 66 Hz		48 to 66 Hz		48 to 66 Hz		-	
OR								
Input Voltages (dc)	±15 V		-		+15 V		20 V	
Tolerance	±2%		-		±2%		±0.5 V	
Nominal Current	150 mA (-15 V) 300 mA (+15 V)		-		200 mA		100 mA	
Ripple	<5 mV pk-pk		-		5 mV pk-pk		<5 mV pk-pk	
Weights								
Net	6 kg (13 lb)		5 kg (11 lb)		6 kg (13 lb)		1.7kg (3.75 lb)	
Shipping	11 kg (24 lb)		12 kg (26 lb)		11 kg (24 lb)		4 kg (7.5 lb)	
Size								
Width	425 mm (16.8 in)		425 mm (16.8 in)		425 mm (16.8 in)		483 mm (19 in)	
Height	89 mm (3.5 in)		89 mm (3.5 in)		89 mm (3.5 in)		44 mm (2 in)	
Depth	350 mm (13.9 in)		350 mm (13.9 in)		350 mm (13.9 in)		260 mm (10 in)	
Options	Front	Rear	Front	Rear	Front	Rear	Front	Rear
BNC (75Ω)	STD	010	STD	010	STD	010	STD	-
Siemens Series								
2.5/6 mm (75Ω)	001	011	001	011	001	011	-	-
Siemens Series								
1.6/5.6 mm (75Ω)	002	012	002	012	002	012	-	-
BPO Type IE (75Ω)	003	013	003	013	-	-	-	-
Commercial equivalent of WECO Type 560 A (75Ω)	004	014	004	014	004	014	-	-
Commercial equivalent of WECO Type 477B (75Ω)	005	015	005	015	005	015	005	-
BNC (50Ω)	006	016	006	016	-	-	-	-
Suhner J-Type (75Ω)	-	-	-	-	007	017	-	-

# TELECOMMUNICATIONS TEST EQUIPMENT

## FDM Network Surveillance System Software

Models 37013A, 37014A



### Introduction

Hewlett-Packard offers remote-surveillance systems for use with Frequency Division Multiplex (FDM) networks. There are two basic types of system available, the choice being made according to the size of the FDM network and the network management requirements.

### 37013A System Software

The 37013A FDM Network Surveillance System Software is designed to provide a comprehensive solution to the problems associated with performance monitoring of a complex and widely-spaced FDM network. The 37013A Software, together with the necessary control and measurement hardware, forms a complete automatic measurement system for use in the commissioning, surveillance, fault finding and maintenance of FDM installations.

The system operates under the direct control of a central HP 1000 Computer, which gathers measurement information from up to 16 remote stations simultaneously. A 3745A/B or 3747A/B Selective Level Measuring Set (SLMS) forms the basis of each station.

### Capability of the 37013A

The 37013A Software provides a full range of automatic surveillance measurement sequences, together with the ability to print out, or store for future analysis, all measurement results. Also provided are demand programs used to make measurements under the direct control of an operator. Access to the computer may be gained from any desired location using a suitable terminal connected via modems and a dialled-up or dedicated telephone line.

The ease with which information about the FDM network can be collected and processed enables performance trends and management reports to be assembled with a minimum of effort.

### Trend Analysis

The analysis of long-term trends in the network allows performance degradations to be found, and the necessary maintenance undertaken before any serious problems develop. This can reduce radically the time during which the network is inoperative if major failures have to be first diagnosed and then repaired.

When failures do occur, the ability to localize the fault quickly and accurately is of paramount importance. The 37013A Software can be configured to monitor continuously specific test points throughout the network. If a problem then arises somewhere between stations, a message is output directly onto an operator terminal allowing immediate action to be taken.

### Management Reporting

The extensive data base which is a part of the 37013A Software

forms an ideal base for the preparation of management reports. Information about the network obtained over a long period can be extracted from the data base by the HP 1000 Computer. This data forms a concise and convenient basis for management reporting.

### Measurement Hardware—The Heart of the System

The 37013A FDM Network Surveillance System is based on the 3745A/B and 3747A/B SLMS's. These instruments, with the addition of the HP 1000 Computer, become the heart of a powerful automatic measurement system.

Switching between test points is achieved with the 3754A, 3756A or 3757A Switches controlled by the 3755A Switch Controller. Test signals are generated by the 3335A Synthesizer/Level Generator. All the instruments forming a measurement station are controllable from the HP-IB.

Communication between stations is achieved over full duplex, dedicated telephone lines, with conversion of the parallel HP-IB information to an RS-232C compatible serial data form suitable for transmission through voice channel modems.

### System Software—The Power of the 37013A

The 37013A FDM Network Surveillance System Software consists of system functional tests, a system diagnostic and measurement programs.

The system functional tests are designed to verify, as fully as possible, that the instruments at a station function correctly. The diagnostic routine is intended to aid the user in identifying a fault condition in the system.

Measurements can be made in either of two modes; automatic measurements, or measurements on operator demand at any time.

Automatic measurements are made under the control of the "SFDM" program and consist of a sequence of surveillance-type measurements such as group pilots, virtual carriers, channel powers, etc. Measurements are made without operator intervention, apart from initiation, and sequences may be strung together so that the system proceeds to the next and subsequent sequences automatically.

An operator works interactively with demand measurement programs, entering simple requests on a terminal to initiate spot tests such as single point frequency, input power and FDM scan.

Information about each test point connected to the system is stored in the station data base, which can also be used to store measurement results. The stored results may be used as the basis of network management reports.

HP's distributed operating system DS1000 can be incorporated if required, enabling several distant computers to be interconnected, thereby expanding the monitoring capability.

### Documentation

Full documentation is provided in the form of the 37013A System Library, which includes information on integrating the system hardware, entering details of the FDM network into the data base, running "SFDM" and the demand measurement programs, and using the System Functional Test and Diagnostic programs. The System is supplied on an HP disc cartridge, ready for immediate use on the HP 1000 Computer.

# TELECOMMUNICATIONS TEST EQUIPMENT

FDM Network Surveillance System Software

Models 37013A, 37014A

595



## Support Services

A full training course on the use of the Surveillance System is available from Hewlett-Packard, along with an equipment verification service whereby the computer, the instrumentation and the software are assembled, and correct operation is verified.

All the individual components that make up the Surveillance System are designed and manufactured by Hewlett-Packard and are backed up by HP's worldwide support. 37013A is in use around the world, providing valuable service to FDM network operators.

## Ordering Information

The 37013A FDM Network Surveillance System Software consists of the Disc Cartridge for the HP 1000 Computer, the documentation in the system library, and a diagnostic kit for use with the System Functional Test and Diagnostic programs. The HP 1000 Computer and all other instrumentation must be ordered separately. For further information on the equipment required, and on the capability of the 37013A Software, see the 37013A data sheet or contact your local Hewlett-Packard representative.

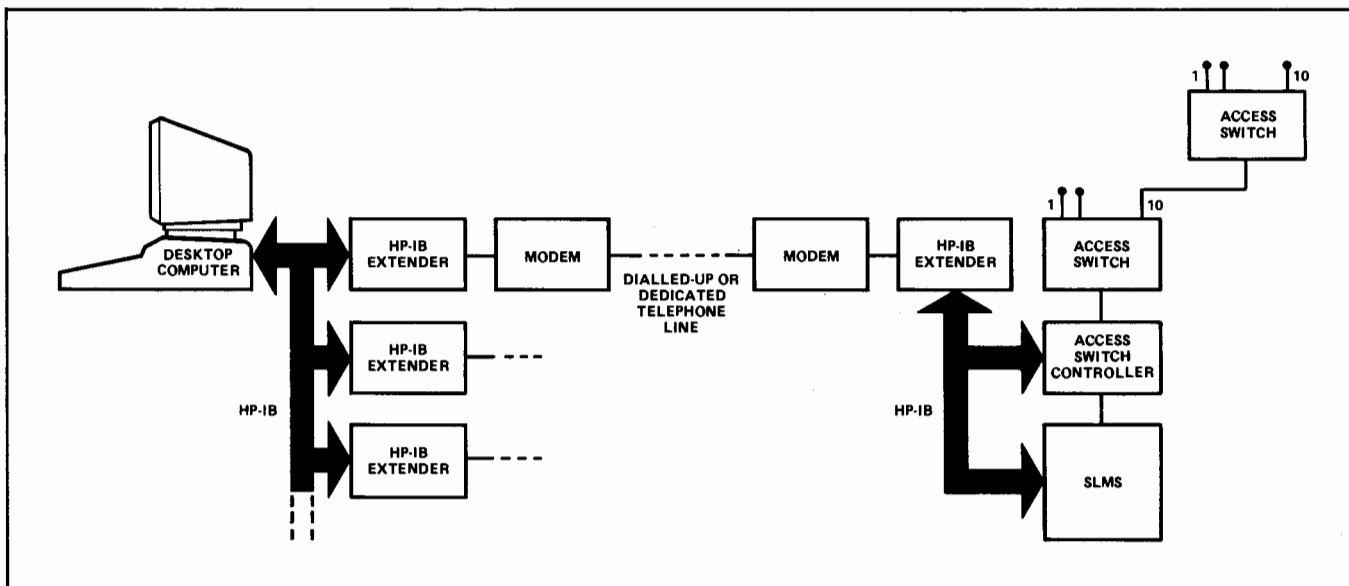

37014A configuration for multiple point-to-point operation

## 37014A System Software

The 37014A FDM Network Surveillance System Software is designed to provide a cost-effective system for monitoring the performance of an FDM network.

### Description

The 37014A Software provides for a number of measurement stations controlled from a 9835A Desktop Computer. Each station is based upon 3745A/B and 3747A/B SLMS's, with the 3754A, 3756A or 3757A Switches used to access test points under the control of the 3755A Switch Controller.

Point-to-point, Multi-drop or Dial-up operation over telephone lines is achieved using the 37201A HP-IB Extender and suitable voice channel modems. All the instruments forming a measurement station are controllable from the HP-IB.

The 37014A Software can control several remote measurement stations one-at-a-time. Up to six such stations can be handled with ease this way. In the absence of controller activity, the semi-automatic capabilities of the 3745A/B and 3747A/B may be utilized in each location.

### System Software—The Versatility of 37014A

The 37014A System Software comprises system functional test programs and measurement programs.

The system functional tests are designed to verify, as fully as possible, that the instruments at a station function correctly.

The measurement programs enable the Desktop Computer to acquire the results of measurements made by an SLMS at any one station in the network. Measurement routines such as group pilot scan group power and channel noise can be assembled in any order into an automatic surveillance sequence. Additionally, interactive demand programs are provided, enabling measurements to be made at any time under the direct control of an operator. Typically, demand measurements may be used to investigate problems found by the automatic routines, or to aid in the commissioning of new links.

The software includes a data base containing details of each test point in the network. This data is used by the system functional tests and the measurement programs, both of which require information on the FDM hierarchy, the test level at each point, and the configuration of each station.

### Documentation and Ordering Information

The 37014A FDM Network Surveillance System Software consists of a 9835A Data Cartridge, a System Library and a diagnostic kit for use with the system functional tests. The 9835A Desktop Computer and all other instrumentation must be ordered separately.

The 37014A System Library includes information on integrating the system hardware, entering details of the FDM network into the data base and running the system functional test and measurement programs.



# TELECOMMUNICATIONS TEST EQUIPMENT

## Selective Level Meter And Synthesizer

Models 3586A/B & 3336A/B

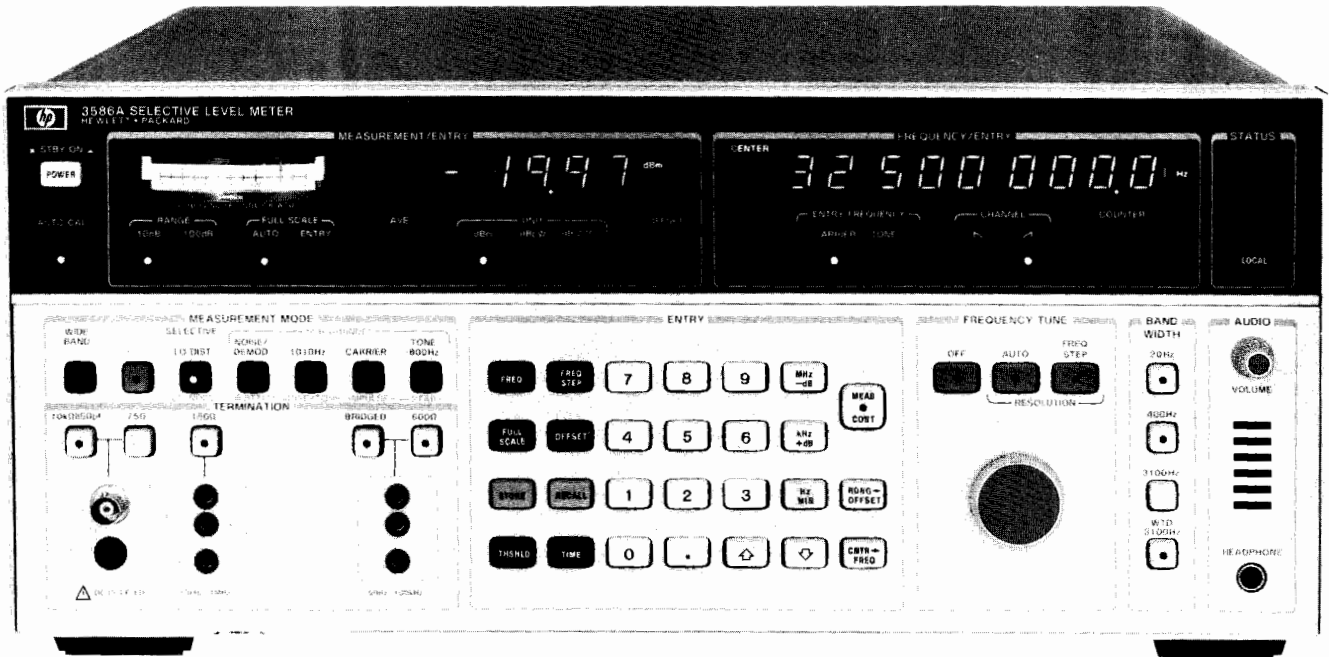

3586A Selective Level Meter (CCITT) (Shown with Opt 003)

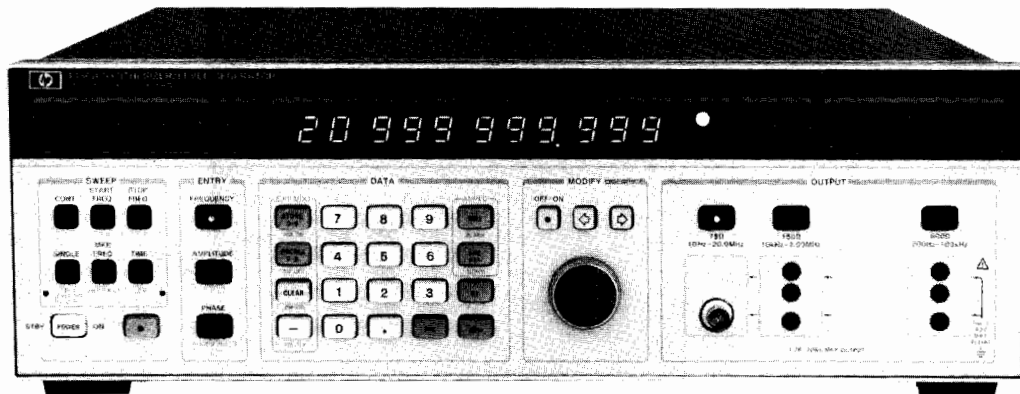

3336A Synthesizer/Level Generator (CCITT)

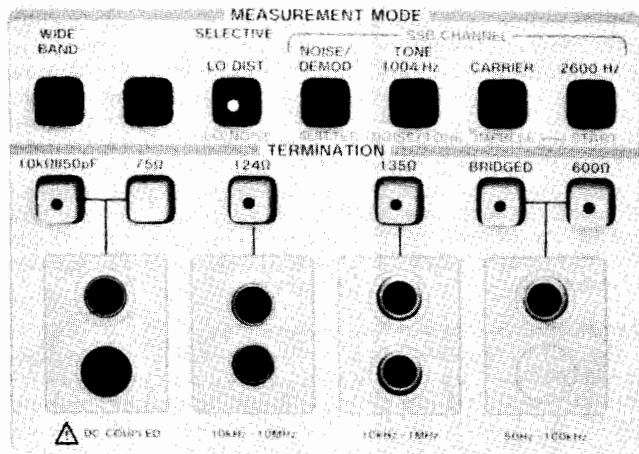

Measurement Mode Section, 3586B Selective Level Meter, North American (BELL) (Shown with Opt 003)



### Description

#### General

Hewlett-Packard's new 3586A/B Selective Level Meters and 3336A/B Tracking Synthesizers offer the high performance necessary to meet the demanding requirements in the design, manufacture, commissioning and maintenance of Frequency Division Multiplex (FDM) systems. The 3586 and 3336 "A" models meet CCITT requirements, and the "B" models meet North American (Bell) standards. Both are fully programmable over the HP Interface Bus. The 3586A & B Selective Level Meter provides a unique combination of features, including wideband power and optional telephone impairment measurement of impulse noise, phase jitter, noise with tone, and signal-to-noise with tone ratio. The 3586A & B's wide frequency coverage to 32.5 MHz allows measurements to be made at both voice channel and carrier frequencies. Microprocessor control adds many ease-of-use features such as amplitude offset measurements of tone and noise level in units of dBmO, dBmCO, or dBpWPO. Convenience features include simultaneous analog and digital level dis-

plays, precise frequency setting with HP's fractional N synthesized local oscillator, accurate frequency counter and tone measurements with automatic channel alignment for 800 Hz (CCITT) or 1004 Hz (Bell) test tone or carrier frequency reference.

**Carrier Frequency and Voice Channel**

The 3586A & B can make both carrier frequency measurements to 32.5 MHz and voice channel measurements from 50 Hz to 100 kHz.

You can measure tone levels, idle channel noise or weighted noise at voice channel, then compare at carrier frequency. Level measurements can be made with  $\pm .2$  dB accuracy up to 18 MHz and down to  $-80$  dBm. The built-in frequency counter can be used to measure frequency within  $\pm 1.0$  Hz and 0.1 Hz resolution. When using the 20 Hz bandwidth to measure pilots accurately, an adjacent carrier leak will be rejected by 50 dB.

**Transmission Impairments (Optional)**

The Transmission Impairments Option 003 permits phase jitter, weighted noise, noise-with-tone, signal-to-noise-with-tone ratio, and single level impulse noise measurements. The 3586A's capability to make these transmission impairment measurements at both FDM voice channel and carrier frequencies is unique.

Standard models include a 1740 Hz psophometric (CCITT) or 2000 Hz C-message (Bell) equivalent noise filter or you can make weighted noise measurements directly with the 3100 Hz channel filter and noise weighting filter provided with the Transmission Impairments Option 003. The channel filter shape factor of  $<1.2$  provides 60 dB carrier and 75 dB adjacent channel rejection and synthesizer accuracy aligns it perfectly—you know you're measuring only that channel.

**Precision Frequency Setting**

Synthesizer accuracy and resolution is made possible with a fractional-N synthesized local oscillator—a unique HP development. 0.1 Hz resolution and  $\pm 1 \times 10^{-5}$ /year stability ( $\pm 2 \times 10^{-7}$ /year optional) means the 3586A/B is tuned exactly where you want it. Or use the counter to measure a frequency precisely, then tune to it with one keystroke. This unique capability eliminates the need for "rocking" the tuning control to peak the signal.

**North American (Bell) and CCITT Requirements**

The 3586A & B Selective Level Meter and 3336 A & B Synthesizer/Level Generator are designed to meet most world-wide connector and impedance requirements for both carrier and voice channel measurements. Special or regional connectors can be provided by option or special request.

**Input Configuration:**

**CCITT Requirements:**

3586A SLM	75 $\Omega$ /10 k $\Omega$ Unbalanced 150 $\Omega$ , 600 $\Omega$ /10 k $\Omega$ Balanced
3336A Synthesizer	75 $\Omega$ Unbalanced 150 $\Omega$ , 600 $\Omega$ Balanced

**North American (Bell) Requirements:**

3586B SLM	75 $\Omega$ /10 k $\Omega$ Unbalanced 124 $\Omega$ , 135 $\Omega$ , 600 $\Omega$ /10 k $\Omega$ Balanced
3336B Synthesizer	75 $\Omega$ Unbalanced 124 $\Omega$ , 135 $\Omega$ , 600 $\Omega$ Balanced

The 3586A SLM uses an 800 or 1010 Hz nominal tone frequency reference for level measurements. A 1010 Hz notch for noise with tone and impulse noise and 1010 Hz for phase jitter measurements is used when the Transmission Impairments Option 003 is included. The 3586B SLM uses 1004 Hz for all tone and impairments measurements.

**Wideband Power Measurement**

RMS wideband power measurements from +20 to  $-45$  dBm can be made from 20 kHz to 10 MHz with  $\pm 1.0$  dB accuracy and from 50 Hz to 32.5 MHz with  $\pm 2.0$  dB accuracy. Use this capability to make baseband power measurements.

**Fully Programmable**

HP-IB control is standard, allowing automatic operation to be controlled by a desktop calculator such as the HP Model 85A, 9825S, 9835A or 9845B, or by a main frame computer, such as the HP 1000. FDM tests such as surveillance can be made from a remote location to reduce maintenance costs and increase troubleshooting efficiency.

**Amplitude Offset**

Make level measurements with respect to TLP or any offset level up to  $\pm 199.99$  dBm. Or make level measurements relative to a measured signal level, such as harmonics relative to a fundamental signal.

**Frequency Tracking**

The frequency of the 3336 A/B companion synthesizer will automatically be set to the frequency of the 3586A/B Selective Level Meter when in the tracking mode and with their HP-IB\* inputs connected together. Make "loop-around" measurements on a telephone circuit or frequency response measurements on signal processing networks.

**High Impedance Accessory Probes**

Models 15580A, 15581B high-impedance probes are available for use with the 3586A/B for bridging measurements. See page 679 for probe specifications.

**3336 A/B Synthesizer/Level Generator**

**Description**

The 3336 A/B Synthesizer/Level Generator is an excellent precision tracking signal source for the 3586A and B Selective Level Meter. When the Selective Level Meter and Synthesizer are in the tracking mode, the frequency of the synthesizer is automatically set to the frequency of the SLM. Frequency coverage is 10 Hz to 20.9 MHz, making the 3336 A and B useful for telephone circuit loop testing on most FDM systems, transfer function and distortion measurements in telecommunications manufacturing.

**Frequency and Amplitude Precision**

The 3336 A/B provides frequency resolution of one microhertz (.000001 Hz) up to 100 kHz and one millihertz (.001 Hz) to 20.9 MHz. Level accuracy is  $\pm .15$  dB at full output over the full frequency range with  $\pm .12$  dB optional. Harmonic levels are more than 60 dB down up to 1 MHz and more than 50 dB down up to 20.9 MHz, performance not previously available in a synthesizer.

**FDM Testing**

The flexible output section allows different connectors to be provided either by option or special request. Frequency entry is accomplished by keyboard or analog control for manual tuning or frequency stepping of any digit.

The Amplitude Blanking feature allows testing of operational FDM systems without disturbing adjacent channels while the frequency is changed. The output is blanked to less than  $-85$  dBm until the next desired frequency is reached.

**General Purpose Features**

The 3336 A/B Synthesizer provides wide band sweep capability—sweep the full frequency range (or as little as two microhertz), log or linear, single or continuous. Single phase lock loop design means the sweep is phase continuous and you can modulate with AM to 50 kHz or PM to 5 kHz. Ten storage registers can be used to keep different test settings available for repetitive test. All necessary functions on the 3336 A/B can be remotely programmed by HP-IB control for automatic testing.

**Designed-in Serviceability**

The 3586 A/B Selective Level Meter and the 3336 A/B Synthesizer/Level Generator have been designed for reliable operation and excellent accessibility with many useful service features.

**Abbreviated Specifications for 3586 A & B**

(See Data Sheet or manual for complete specifications)



# TELECOMMUNICATIONS TEST EQUIPMENT

## Selective level meter/synthesizer

Models 3586A/B and 3336A/B (cont.)

### Frequency

Signal Input	3586A	3586B
75 $\Omega$ Unbalanced	50 Hz to 32.5 MHz	
124 $\Omega$ Balanced		10 kHz to 10 MHz
135 $\Omega$ Balanced		10 kHz to 1 MHz
150 $\Omega$ Balanced	10 kHz to 1 MHz	
600 $\Omega$ Balanced	50 Hz to 100 kHz	

The 124  $\Omega$ , 135  $\Omega$ , 150  $\Omega$  and 600  $\Omega$  inputs are usable over wider frequency ranges, but are not specified in under and overrange operation.

**Frequency resolution:** 0.1 Hz.

**Center frequency accuracy:**  $\pm 1 \times 10^{-5}$ /year, ( $\pm 2 \times 10^{-7}$ /year with option 004).

**Counter accuracy:**  $\pm 1.0$  Hz in addition to center frequency accuracy for signals within the 60 dB bandwidth of the IF filter chosen or greater than -100 dBm (largest signal measured).

**Frequency display:** 9 digit LED.

### Selectivity

**3 dB Bandwidth,  $\pm 10\%$ :**

3586 (CCITT)		3586B (N. American)	
Standard	Option 003	Standard	Option 003
20 Hz	20 Hz	20 Hz	20 Hz
400 Hz	400 Hz	400 Hz	400 Hz
1740 Hz <sup>1</sup>	3100 Hz	2000 Hz <sup>2</sup>	3100 Hz
—	Psophometric Noise Weighting	—	C-Message Noise Weighting

1. Psophometric Equivalent Noise Weighting Filter
2. C-Message Equivalent Noise Weighting Filter

**Adjacent channel rejection:** 75 dB minimum at  $\pm 2850$  Hz., 3100 Hz bw.

**Passband flatness:**  $\pm .3$  dB.

### Amplitude

**Measurement range:** +20 to -130 dBm.

**Amplitude resolution:** .01 dB.

**Level accuracy:** 10 dB autorange, low distortion mode, after calibration.

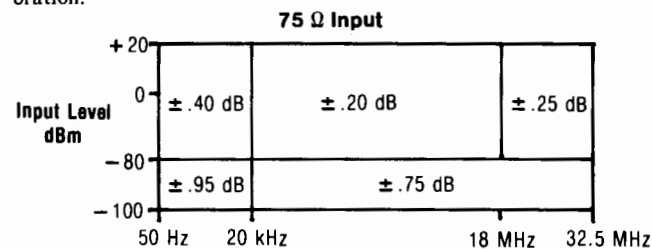

124  $\Omega$  Input (3586B):  $\pm .35$  dB, 60 kHz to 5 MHz;  $\pm .50$  dB, 10 kHz to 50 kHz, and 5 MHz to 10 MHz for +20 to -80 dBm.

135  $\Omega$  / 150  $\Omega$  input (3586A or B):  $\pm .35$  dB 50 kHz to 1 MHz,  $\pm .50$  dB 10 kHz to 50 kHz for +20 to -80 dBm.

600  $\Omega$  input (3586 A/B):  $\pm .35$  dB 200 Hz to 108 kHz for +20 to -80 dBm.

**Level accuracy: 100 dB range (after calibration):** add correction to 10 dB autorange accuracy for dB below full scale. (Not required when in 10 dB autorange).

dB Below Full Scale	Accuracy Correction
0 to -20 dB	$\pm .25$ dB
-20 to -40 dB	$\pm .50$ dB
-40 to -80 dB	$\pm 2.0$ dB

### Dynamic Range

#### Spurious responses:

**Image rejection (100-132 MHz):** -80 dBc.

**IF rejection:** 15625 Hz, -80 dBc; 50 MHz, -60 dBc.

**Residual spurious signals:** > 1600 Hz offset, -80 dBc; 300 Hz to 1600 Hz offset, -75 dBc.

#### Distortion:

**Harmonic distortion:** -70 dB below full scale (> 4 kHz on 75  $\Omega$  and 600  $\Omega$  inputs), low distortion mode.

**Intermodulation distortion:** -70 dB below full scale, 200 Hz to 20 kHz offset; -75 dB below full scale, 20 kHz to 1 MHz offset.

**Wideband power accuracy:** after calibration, 100 dB range, averaging on, -45 to +20 dBm.

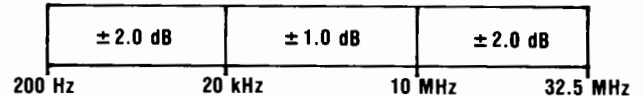

### Noise Floor (Full scale setting -35 to -120 dBm):

Frequency	Bandwidth	Noise Level
100 kHz to 32.5 MHz	3100, 1740, 2000 Hz	-116 dBm
	20 Hz, 400 Hz	-120 dBm
10 kHz to 100 kHz	All	-105 dBm

The noise floor for full scale settings of -30 to +24 dBm will be 80 dB below full scale for > 100 kHz, or 60 dB below full scale for < 100 kHz.

### Signal Inputs

Model	Impedance	Frequency	Mating Connector
3586A	75 ohms unbalanced	50 Hz to 32.5 MHz	BNC
	150 ohms balanced	10 kHz to 1 MHz	Siemens 3-prong
	600 ohms balanced	50 Hz to 108 kHz	9 Rel 6 AC
3586B	75 ohms unbalanced	50 Hz to 32.5 MHz	WECO 439/440A
	124 ohms balanced	10 kHz to 10 MHz	WECO 443A
	135 ohms balanced	10 kHz to 1 MHz	WECO 241A
	600 ohms balanced	50 Hz to 108 kHz	WECO 310

### Connector options:

**Opt 001 (3586A):** 75 ohms mates with Siemens 1.6/5.6 mm coaxial.

**Opt 001 (3586B):** 75 ohms mates with WECO 358A.

124 ohms mates with WECO 372A.

(Contact local sales office for other special connectors.)

**Return loss:** -30 dB (600 ohms -25 dB).

### Balance:

Input	Frequency	Balance
124 $\Omega$	10 kHz to 10 MHz	-36 dB
135 $\Omega$ or 150 $\Omega$	10 kHz to 1 MHz	-36 dB
600 $\Omega$	50 Hz to 108 kHz	-40 dB

### Demodulated Audio Output

Output Level: 0 dBm into a 600  $\Omega$  load, adjustable.

Output Connector: mates with WECO 347A.

### Transmission Impairments Option 003

Adds transmission impairment measurement capability to standard instrument. Measures phase jitter, noise with tone, single level impulse noise and weighted noise at voice channel and carrier frequencies. Compatible with N. American (Bell) or CCITT standards.

### Additional Options

#### 3586A (CCITT)

**Opt 001:** 75  $\Omega$  input connector option. Siemens 1.6/5.6 mm coaxial connector replaces BNC.

**Opt 004:** High Stability Frequency reference 10 MHz oven stabilized reference oscillator improves frequency stability to  $\pm 2 \times 10^{-7}$ /year.

#### 3586B (N. American)

**Opt 001:** 75  $\Omega$  and 124  $\Omega$  input connector option. Changes 75  $\Omega$  input connector to mate with WECO 358A and 124  $\Omega$  input to mate with WECO 372A.

**Opt 002:** Psophometric equivalent noise filter option. Changes 2000 Hz filter (C-message equivalent) to 1740 Hz (Psophometric equivalent). Not available with opt 003.

**Opt 004:** High Stability Frequency reference. Same as Opt 004-3586A

### Auxiliary Signal Inputs/Outputs

**Tracking generator:** 0 dBm rear panel tracking output.

**External reference input:** 1 MHz, 10 MHz or sub-harmonic input.

**Reference output:** 10 MHz, +8 dBm output.



**Probe power:** front panel DC output for HP active high impedance accessory probes.

**HP-IB interface:** rear panel interface meeting IEEE 488-1975 for remote operation. Used for tracking synthesizer interface.

**Additional outputs:** rear panel demodulated audio; phase jitter meter.

**General**

**Operating Environment**

**Temperature:** 0° to 55°C.

**Relative humidity:** 95%, 0° to 40°C.

**Altitude:** ≤15,000 ft; ≤4600 metres.

**Storage environment**

**Temperature:** -40°C to 75°C.

**Altitude:** ≤50,000 ft; ≤15,240 metres.

**Power:** 100/120/220/240 V, +5%, -10% 48 to 66 Hz, 150 VA.

**Weight:** 23 kg (50 lbs) net; 30 kg (65 lbs) shipping.

**Size:** 177 mm H x 425.5 mm W x 466.7 mm D (7" x 16.75" x 18.38")

**3336 A & B Abbreviated Specifications**

(See Data Sheet or manual for complete specifications)

**Frequency**

**Frequency range of signal outputs**

Signal Output	3336A	3336B
75 Ω Unbalanced	10 Hz to 20.999 999 999 MHz	
135 Ω Balanced		10 kHz to 10.999 999 999 MHz
124 Ω Balanced		10 kHz to 2.099 999 999 MHz
150 Ω Balanced	10 kHz to 2.099 999 999 MHz	
600 Ω Balanced	200 Hz to 109.999 999 kHz	

All balanced outputs are usable over wider frequency ranges but are not specified in under and overrange operation.

**Resolution:** 1 μ Hz for frequencies < 100 kHz, 1 μ Hz for frequencies ≥ 100 kHz.

**Accuracy (instruments without option 004):** ± 5 x 10<sup>-6</sup> of programmed frequency.

**Aging rate (instruments without option 004):** ± 5 x 10<sup>-6</sup>/year (20° to 30°C).

**Warm-up time:** 30 minutes.

**Amplitude**

**Range:** 75 and 600 Ω outputs; -72.99 to +7.00 dBm  
124, 135 and 150 Ω outputs; -78.23 to +1.76 dBm.

**Level accuracy, 20° to 30°C:**

**75 Ω output**

dBm	± .15 dB		
+7.00			
-3.00	± .25 dB	± .30 dB	± .35 dB
-13.00	± .30 dB	± .35 dB	± .40 dB
-33.00	± .35 dB	± .40 dB	± .45 dB
-72.99			
	10Hz	10MHz	10MHz 20.9MHz

**75 Ω output with option 005\***

dBm	± .12 dB
+7.00	
-3.00	± .16 dB
-13.00	± .18 dB
-33.00	± .22 dB
-72.99	
	10 Hz

\*high accuracy attenuator

124 Ω output: 60 kHz to 10.9 MHz ± .15 dB -8.23 to 1.76 dBm, ± 0.3 dB -18.23 to -8.24 dBm, ± .35 dB -38.23 to -18.24 dBm ± .4 dB -78.23 to -38.24 dBm.

135 Ω/150 Ω output: 10 kHz to 2.09 MHz, ± .17 dB -8.23 to +1.76 dBm, ± .32 dB -18.23 to -8.24 dBm, ± .37 dB -38.23 to -18.24 dBm, ± .42 dB -78.23 to -38.24 dBm.

600 Ω output: 200 Hz to 109.9 kHz, ± .30 dB -3.00 to +7.00 dBm/ ± .40 dB -13.00 to 2.99 dBm, ± .45 dB -33.00 to -12.99 dBm ± .50 dB -72.99 to -32.99 dBm.

1. Add ± .03 dB for 0° to 65°C operation.

2. Warm-up time is 30 minutes.

**Amplitude blanking:** < -85 dBm output during blanking

**Spectral purity**

**Phase Noise:** < -72 dB, Models 3336A and 3336B, for a 3 kHz band, 2 kHz either side of a 20 MHz carrier.

**Harmonic level:** -35 dB, 10 Hz to 30 Hz; -50 dB, 30 Hz to 50 Hz; -60 dB, 50 Hz to 1 MHz; -55 dB, 1 MHz to 5 MHz; -50 dB, 5 MHz to 20 MHz.

**Spurious:** all non-harmonically related signals will be more than 70 dB below the fundamental or -100 dBm (-115 dBm with option 005 except 150 or 600 Ω), whichever is greater.

**Phase offset**

**Range:** ± 719.9° with respect to arbitrary starting phase or assigned zero phase.

**Resolution:** 0.1°.

**Increment accuracy:** ± 0.2°

**Ambient stability:** ± 1.0 degree of phase per degree C

**Frequency sweep**

**Sweep time:** linear sweep, 0.01 s to 99.99 s, single log sweep, 2 s to 99.99 s, continuous log sweep, 0.1 s to 99.99 s

**Maximum sweep width:** specified frequency range of selected output

**Minimum sweep width:** log sweep, 1 decade; linear sweep, minimum sweepwidth (Hz) = 0.1 (Hz/s) x sweep time(s).

**Phase Continuity:** sweep is phase continuous over full frequency range.

**Sweep flatness:** ± 0.15 dB, fast leveling, 10 kHz to 20 MHz, 0.03 s sweep time; ± 0.15 dB, normal leveling, 50 Hz to 1 MHz, 0.5 s sweep time.

**Amplitude modulation:** modulation depth, 0 to 100%. Modulation frequency range, 50 Hz to 50 kHz.

**Phase modulation:** range, 0 to ± 850°. Linearity, ± 0.5% from best fit straight line. Modulation frequency range, dc to 5 kHz.

**External leveling:** input from an external voltage source to regulate the signal amplitude at a remote point.

**Options**

**Option 001, 3336A/B Synthesizer/Level Generator:**

1.6/5.6 mm 75Ω input, (3336A). 75Ω mates with WECO 358A, (3336B). 124Ω connector mates with WECO 372A, (3336B).

**Option 004, high stability frequency reference:**

**Accuracy:** ± 5 x 10<sup>-8</sup>

**Aging rate:** ± 5 x 10<sup>-8</sup>/week after 72 hours continuous operation ± 1 x 10<sup>-7</sup>/month after 15 days continuous operation.

**Ambient stability:** ± 5 x 10<sup>-7</sup> maximum, 0° to 55°C.

**Option 005, high accuracy attenuator:** Improves level accuracy and spurious level. See main specifications.

**General**

**Operating environment**

**Temperature:** 0° to 55°C.

**Relative humidity:** ≤85%, 0° to 40°C.

**Altitude:** ≤15,000 ft., ≤4600 metres.

**Storage environment**

**Temperature:** -50° to +65°C.

**Altitude:** ≤50,000 ft., ≤15,240 metres.

**Power Requirements:** 100/120/220/240 V, +5%, -10%, 48 to 66 Hz, 60 VA, (100 VA with all options), 10 VA standby.

**Size:** 132.6 high x 425.5 wide x 497.8 deep; 5¼" x 16¾" x 19¼".

**Weight:** Net wt., 10 kg. (22 lbs). Shipping wt., 15.5 kg. (34 lbs).

**Ordering Information**

**3586A Selective Level Meter (CCITT)**

**Price**  
**\$9200**

**Opt 001:** 1.6/5.6 mm 75 Ω Connector

add \$100

**Opt 003:** Transmission Impairments Option

add \$475

**Opt 004:** High Stability Frequency Reference

add \$625

**3586B Selective Level Meter (N. American)**

**\$9200**

**Opt 001:** 75 Ω Connector mates with WECO 358A and 124 Ω Connector mates with WECO 372A

add \$100

**Opt 002:** 1740 Hz Equivalent Noise Bandwidth Filter Replaces 2000 Hz. Not available with opt 003

N/C

**Opt 003:** Transmission Impairments Option

add \$475

**Opt 004:** Same as 3586A

add \$625

**3336A Synthesizer/Level Generator (CCITT)**

**\$4100**

**Opt 001:** 1.6/5.6 mm 75 Ω Connector

add \$100

**Opt 004:** High Stability Frequency Reference

add \$550

**Opt 005:** High Precision Attenuator

add \$550

**3336B Synthesizer/Level Generator (N.American)**

**\$4100**

**Opt 001:** 75 Ω WECO 358A, 124 Ω WECO 372A

add \$100

**Opt 004, 005:** Same as 3336A



# TELECOMMUNICATIONS TEST EQUIPMENT

## SLMS Accessories

15575A-H, 15580A, 15581B, 15582A, 15584A, 15585A, 15587A, 15588A, 15589A



15580A



15581B

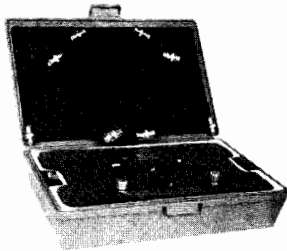

15582A

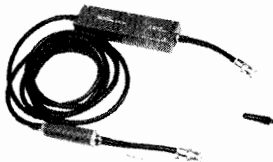

15587A

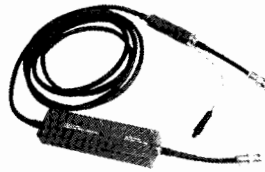

15588A



15575A-H

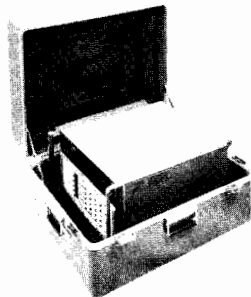

15584A

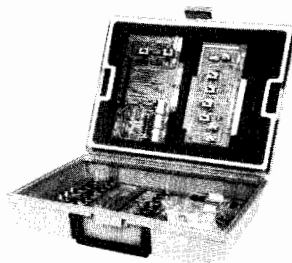

15585A

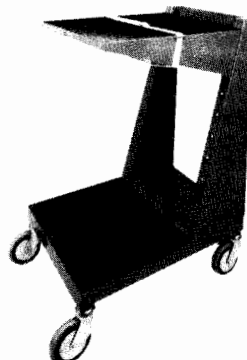

15589A

### Active and Passive Probes

Models 15580A and 15581B High-Impedance Probes are used with the SLMS for bridging measurements. The 15580A is an "active" device having an insertion loss of 0 dB. Model 15581B is a passive probe having an insertion loss of 20 dB. The 15581B can also inject signals from a Level Generator at points where a high impedance source is required. See Data Sheet (5952-3218) for options.

### Specifications

Parameter	15580A	15581B
Frequency Range	20 kHz to 25 MHz	10 kHz to 25 MHz
Insertion Loss	0 dB ± 0.2 dB (50 kHz to 20 MHz)	20 dB ± 0.2 dB (50 kHz to 20 MHz)
Tapping Loss (in 75Ω system)	<0.15 dB (50 kHz to 20 MHz)	<0.25 dB (50 kHz to 20 MHz)
Max Input Power	+10 dBm	+25 dBm
Power Supply	+15 V (25 mA)	—
Price	\$485	\$395

### Low-Noise Amplifiers

Models 15587A and 15588A are 20 dB Low-Noise Amplifiers designed to increase the sensitivity of the SLMS. They are particularly useful for extending the range of the 3745A/B or 3747A/B for low level Group Power and Broadband Power measurements. See Data Sheet (5952-3218) for options.

### Specifications

Parameter	15587A	15588A
Frequency Range	60 kHz to 25 MHz	300 kHz to 90 MHz
Gain	20 dB ± 0.2 dB (300 kHz to 18 MHz) 20 dB ± 1 dB (60 kHz to 25 MHz)	20 dB ± 0.2 dB (4 MHz to 70 MHz) 20 dB ± 1 dB (300 kHz to 90 MHz)
Input Return Loss	>20 dB (300 kHz to 18 MHz)	>20 dB (1 MHz to 70 MHz)
Noise Figure	<5 dB (60 kHz to 12 MHz) <10 dB (12 MHz to 20 MHz)	<7 dB (1 MHz to 90 MHz)
Max Input Power	-10 dBm	-10 dBm
Power Supply	+15 V (45 mA)	+15 V (20 mA)
Price	\$755	\$780

### Return Loss Kit

**\$700**

Model 15582A Return Loss Kit, with a suitable Level Generator, allows the SLMS to make return loss measurements from 10 kHz to 25 MHz. Extended coverage from 100 kHz to 90 MHz is possible with Model 8721A Opt 008 Directional Bridge.

### Cable Equalizers

**\$280 ea**

Models 15575A-H constitute a range of eight Cable Equalizers, designed to equalize the Loss/Frequency characteristics of different lengths of 75 Ohm coaxial cable.

### Transit Case

**\$550**

Model 15584A is a fibre-glass transit case with custom-moulded foam inserts to suit the 3745A/B or 3747A/B SLMS.

### Diagnostic Kit

**\$1465**

Model 15585A consists of several troubleshooting aids which assist in servicing the SLMS.

### Instrument Cart

**\$810**

Model 15589A is suitable for transporting the SLMS and its auxiliary equipment.



In many countries the main communication system consists of a network of FM microwave radio links. Typically, these links can carry up to 1800 FDM telephone channels, using a 70 MHz IF carrier and an RF band in the range 600 MHz to 18 GHz. However, some countries are now installing 140 MHz IF microwave links which can carry up to 2700 FDM telephony channels.

All information signals (speech, television, or data) carried by these links have a common objective—to convey the information with maximum fidelity. Failure to keep distortion in a link within specified limits results in an unacceptably high level of intermodulation noise. This prevents the link from carrying the designated channel capacity and the link operator incurs a severe financial penalty due to loss of revenue-earning channels.

Measurements required on a microwave link are of two distinct types – qualitative and diagnostic. Qualitative measurements, often made using test signals which simulate normal traffic, are intended to assure the operator that the microwave link is performing correctly. Such measurements are normally made from baseband to baseband and

show the overall system performance without giving much diagnostic information if discrepancies are found. Table 1 shows a list of qualitative measurements for both video and FDM traffic together with the capabilities of a new instrument, the 3724A/25A/26A Baseband Analyzer. This instrument provides, in addition to White Noise tests, all the baseband measurements normally required in the design, production, installation, and maintenance of FDM radio systems.

It is often desirable to make qualitative measurements hop-by-hop along a microwave link to ensure that each individual section is set up correctly. In many cases this requires the use of a 70 MHz modem since baseband signals are not available in non-demodulating repeaters. The 3717A 70 MHz Modulator/Demodulator provides this capability and, with its comprehensive range of pre- and de-emphasis options, is a useful companion instrument to the Baseband Analyzer. In addition, since it is fully specified, it may be used as a standby for the link's own modem. If the qualitative tests show that the distortion in a microwave link is too high, then diagnostic measurements are required to discover the source of the problem.

The main contributors to distortion in FM microwave radio links are the modulators, demodulators and carrier circuits at IF such as amplifiers, and carrier circuits at RF such as non-linear amplifiers. The distortion parameters of these circuits can be measured in terms of nonlinearity, amplitude variations and group delay variations. To do this, test equipment must interface with the links at BB, IF and RF. Commissioning microwave link equipment involves minimizing these circuit distortion parameters by adjustment or equalization.

On lower capacity systems, these adjustments are normally enough to reduce intermodulation distortion to an acceptable level. With increased traffic capacity, the tolerances imposed on the circuit parameters become more and more strict and normal commissioning methods often do not produce satisfactory results. Consequently, relating the circuit parameters to the intermodulation noise (measured by a noise-loading test set) becomes increasingly more difficult.

The main source of discrepancy is the result of amplitude modulation to phase modulation (AM/PM) conversion in the transmission carrier path. This AM/PM conversion occurring in non-linear networks introduces additional intermodulation from the signal deviations arising in preceding networks. These 'coupled' responses can be assessed only by differential gain/differential phase (DG/DP) measurements with high-frequency test tones. HP Application Note AN 175-1 'Differential Phase and Gain at Work' covers this subject in considerable detail.

HP microwave link analyzers (MLA's), at 70 MHz IF or dual 70/140 MHz IF, were developed specifically for the purpose of measuring various forms of distortion on terrestrial and satellite microwave radio links. The measurement capabilities of HP link analyzers, as shown in Table 2, were established in close cooperation with the telecommunications industry.

A valuable extension of the MLA measurement capability can be obtained using RF up and down converters. The circuit distortions at RF have identical effects to the IF circuit distortions when the carrier signal is eventually demodulated. Hence, the RF distortions can be analyzed using an MLA, provided a transparent RF-to-IF interface is available. A down converter provides such an interface and allows independent measurements on microwave transmitters. A so-called 'up-converter' in fact provides a transparent BB-to-RF interface, allowing independent measurements on microwave receivers. Both converters used with an MLA provide an RF-to-RF measurement capability.

**Table 1. Qualitative tests to verify radio system performance**

Test	FDM	Video	3724A/25A/26A
1. Insertion Gain	•	•	•
2. Frequency Response	•	•	•
3. Envelope Delay Distortion		•	
4. Spurious Interference Tones	•	•	•
5. Thermal Noise	•	•	•
6. White Noise Loading	•		•
7. Video Waveform Tests		•	
8. Video System Program Channel (Subcarrier) Tests		•	

**Table 2. Diagnostic tests to maintain radio system performance**

Measurement	BB	IF	RF
1. Module Power Levels, Gains and Losses	•	•	•
2. Modem Centre Frequencies		•	•
3. TX and RX Local Oscillator Frequencies			•
4. Transmitter RF Output Frequency			•
5. Spurious Tones	•	•	•
6. FM Mod + Demod Deviation Sensitivity	•	•	•
7. FM Mod + Demod Linearity	•	•	•
8. Return Loss	•	•	•
9. Amplitude Flatness	•	•	•
10. Group Delay		•	•
11. Differential Gain and Phase		•	•



# TELECOMMUNICATIONS TEST EQUIPMENT

## Microwave Link Analyzers and Accessories

Models 3711A/3712A, 3710A/3702B, 3743A, 3744A, 3750A

- Test analog and digital radios
- Isolate and characterize causes of intermodulation distortion in wideband FM microwave radios
- Baseband and IF interfaces
- 70/140 MHz or 70 MHz only IF capability
- Selectable combinations of BB test tones

### 70/140 MHz IF MLA System

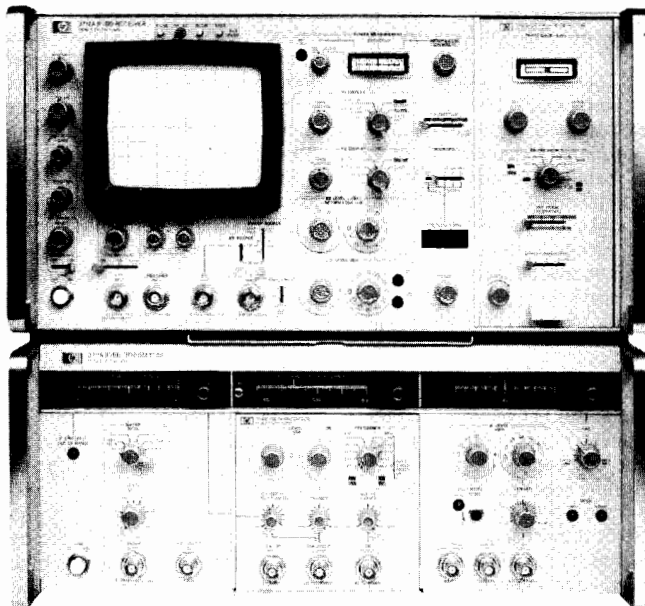

3711A IF/BB Transmitter  
3791B BB Transmitter (Plug-in)  
3712A IF/BB Receiver  
3793B Diff. Phase Detector (Plug-in)

### 70 MHz IF MLA System

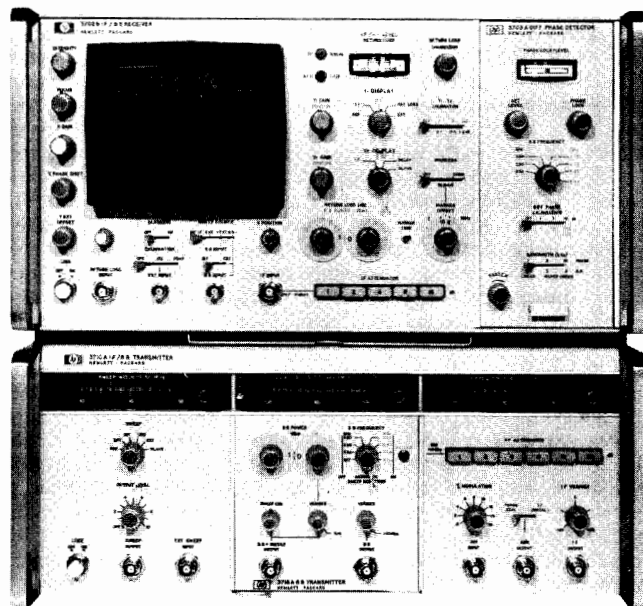

3710A IF/BB Transmitter  
3715A or 3716A BB Transmitter (Plug-in)  
3702B IF/BB Receiver  
3703B or 3705A Group Delay Detector (Plug-in)

Two versions of the Microwave Link Analyzer (MLA) are available: the 70 MHz IF 3710A/3702B System, and the dual 70/140 MHz IF 3711A/3712A System. For microwave radio stations employing both 70 and 140 MHz intermediate frequencies, the dual IF MLA is an economical way of providing a complete range of dedicated measurements at both IF's.

The 3710A/3702B and 3711A/3712A MLA's isolate and characterize causes of intermodulation distortion in wideband microwave radios. They have applications in both analog and digital radio systems. Measurements performed by the MLA's include:

- BB power, gain, and loss
- IF power, gain, and loss
- modulator/demodulator deviation sensitivity
- modulator/demodulator linearity
- modulator/demodulator group delay
- swept IF amplitude response
- swept IF group delay
- swept IF return loss
- BB and IF differential gain (HF linearity)
- BB and IF differential phase (HF group delay)
- BB return loss

When used with the 8620C/86200 Series RF Sweeper system (equipped with the MLA interface option) and the 3730B RF Down Converter, the swept measurements of the basic MLA's can be extended to RF. Pages 606 and 607 give further details about this RF instrumentation (3730B and 8620C).

Apart from the dual 70/140 MHz IF capability, with the full range of measurements available at both frequencies, the 3711A/3712A MLA has many other refinements over earlier systems. These include an improved marker system, an IF input frequency counter, improved input sensitivity at  $-19$  dBm, a slope control, a 16 dB dynamic display range, and X-Y Recorder facilities.

Another major contribution is the provision of an interface for the 8501A Storage-Normalizer. Use of this instrument with the 3711A/3712A MLA provides digital averaging and normalizing facilities. Further, measurement limit masks and adjustment instructions can be displayed on the MLA screen when a desk-top computing controller is used with the Storage-Normalizer.

A series of options are available with the MLA's, including:

- test-tone frequencies
- connectors
- balanced 124  $\Omega$  baseband impedance
- sweep frequencies
- variable phase output of sweep signal

**Options** (3711A/3712A and 3710A/3702B MLA's)

To compile a suitable MLA System for your application, select *one* of the following combinations:

**70/140 MHz IF**— 3711A/3791B/3712A/3793B.

**70 MHz IF with low- and high-frequency test-tones**—  
3710A/3716A/3702B/3705A.

**70 MHz IF with low-frequency test-tones only**—  
3710A/3715A/3702B/3703B.

**Connector Options**

(3711A/3791B/3712A/3710A/3716A/3715A/3702B only)

Option	BNC	Siemens Large	Siemens Small	WECO 477B	WECO 560A
Std	•				
002		•			
003			•		
004				•	
005*					•

\* Available with 3711A/3791B/3712A only.

**Test-tone (BB) Options**

(3791B/3793B/3716A/3715A/3705A/3703B only)

3791B/ 3793B/ 3716A/ 3705A Options	Test-tone Frequencies (MHz except where indicated)													
	83.333 kHz	92.593 kHz	250 kHz	277.778 kHz	& 500 kHz	& 555.556 kHz	2.4	3.50	3.58	4.43	4.50	5.60	8.20	12.39
Std	•													
010		•	•	•	•	•	•	•	•	•	•	•	•	•
011		•	•	•	•	•	•	•	•	•	•	•	•	•
012		•	•	•	•	•	•	•	•	•	•	•	•	•
013	•													
014	•						•							
016	•									•				
018	•								•					
019	•								•					
021*	•								•					
022	•								•					
3715A/ 3703B Options														
Std	•													
009		•												

\* Available with 3791B/3793B only.

**Sweep Frequency Options** (3711A/3710A only)

Option	70 Hz	LINE	Opt			
			70 Hz	50 Hz	100 Hz	18 Hz
Std	•	•				
006	•	•	•			
007	•	•		•		
015	•	•			•	•

**Miscellaneous Options**

**008** (3711A/3710A only) Variable phase sweep output.

**015** (3793B/3705A only) Additional phase detector bandwidths of 90 and 180 Hz—must be used with 18 Hz sweep rate on 3711A or 3710A IF/BB Transmitter.

**020** (3712A only) CRT graticule illumination.

**908** (3711A/3712A/3710A/3702B only) Rack mounting kit.

**910** Extra manuals.

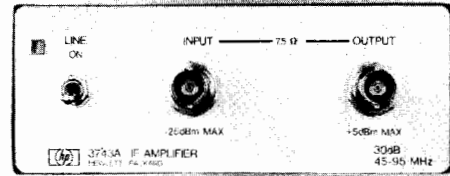

3743A IF Amplifier

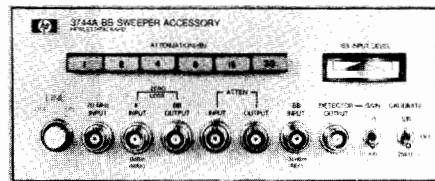

3744A BB Sweeper

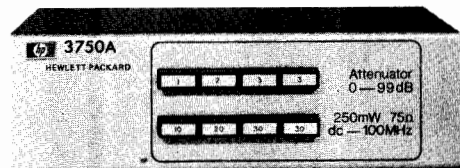

3750A Attenuator

**3743A IF Amplifier**

- Improve MLA IF input sensitivity to  $-40$  dBm.
- Frequency range 45 to 95 MHz.
- Group delay  $<0.3$  ns.
- Amplitude flatness  $<0.2$  dB.
- Return loss  $>26$  dB (75  $\Omega$ ).
- Noise figure  $\leq 8$  dB.

**3744A BB Sweeper**

- Operates with 70 MHz or 140 MHz IF MLA's to provide swept baseband stimulus and amplitude detection.
- Frequency range 100 kHz to 15 MHz.
- Flatness  $<0.1$  dB (from 100 kHz to 8.5 MHz).

**3750A Attenuator**

- Impedance 75  $\Omega$ .
- Attenuation range 0 to 99 dB, in 1 dB steps.
- Frequency range dc to 100 MHz.

**Ordering Information**

	Price
<b>70/140 MHz system</b> (3711A/3791B/3712A/3793B)	\$29,830
<b>70 MHz system with low- and high-frequency test-tones</b> (3710A/3716A/3702B/3705A)	\$23,025
<b>70 MHz system with low-frequency test-tones only</b> (3710A/3715A/3702B/3703B)	\$21,500
<b>3743A IF Amplifier</b>	\$1,255
<b>3744A BB Sweeper</b>	\$2,185
<b>3750A Attenuator</b>	\$535



# TELECOMMUNICATIONS TEST EQUIPMENT

## RF-IF Microwave Link Analyzer Model 3707A

- For testing direct modulation digital radio systems
- RF-IF and RF-RF measurements
- Low cost

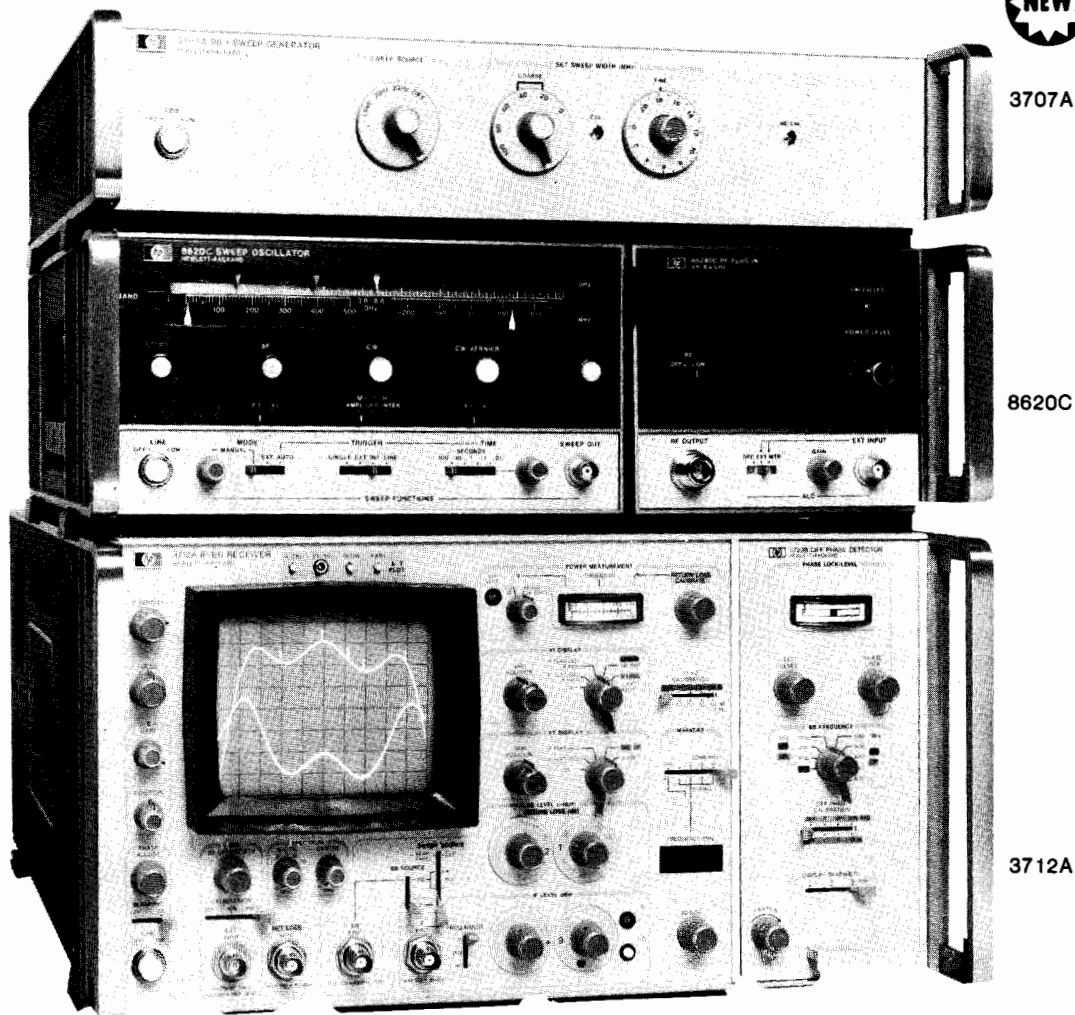

Increasingly popular direct RF modulation systems do not always require the IF transmitter sections of conventional microwave link analyzers. Hence, the 3707A BB + Sweep Generator has been designed to drive an 8620C Sweep Oscillator, giving a swept, frequency-modulated source in the range 0.5 to 18 GHz. This source, in conjunction with a standard 3702B or 3712A IF/BB Receiver, allows measurement of transmission distortions in the radio link.

Although the principal area of application is in digital-radio testing, the instruments are equally useful on analog radios which use direct modulation. A single low-frequency test tone of 250 or 500 kHz (internally selectable) is provided which allows the measurement of linearity or group delay. The 3702B IF/BB Receiver is suitable for use on systems with a 70 MHz receive IF, while the 3712A provides, in addition to 70 MHz, a capability at 140 MHz. A 3730B Down Converter, with appropriate RF plug-in, may be used to help isolate distortions in the RF parts of the link.

The complete system has been designed with low cost and ease of use as primary considerations and so is ideal for routine maintenance as well as installation and production applications.

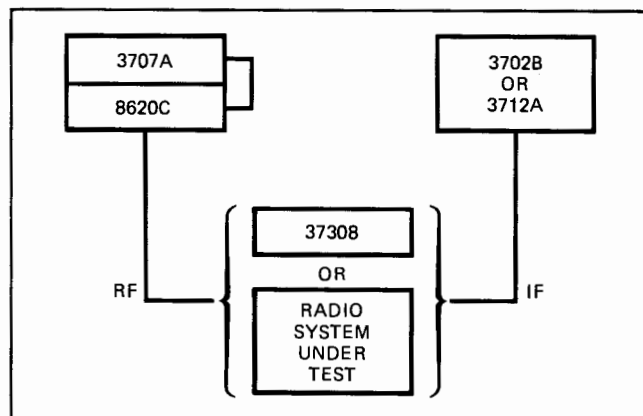

3707A BB + Sweep Generator

\$1950

# TELECOMMUNICATIONS TEST EQUIPMENT

## 70 MHz Modulator/Demodulator

Model 3717A

605



- Up to 5 pre-/de-emphasis networks
- Video and telephony inputs and outputs
- Service channel provided

- Built-in 15 dB open-ended attenuator
- Optional HP-IB control
- Optional balanced BB input and output

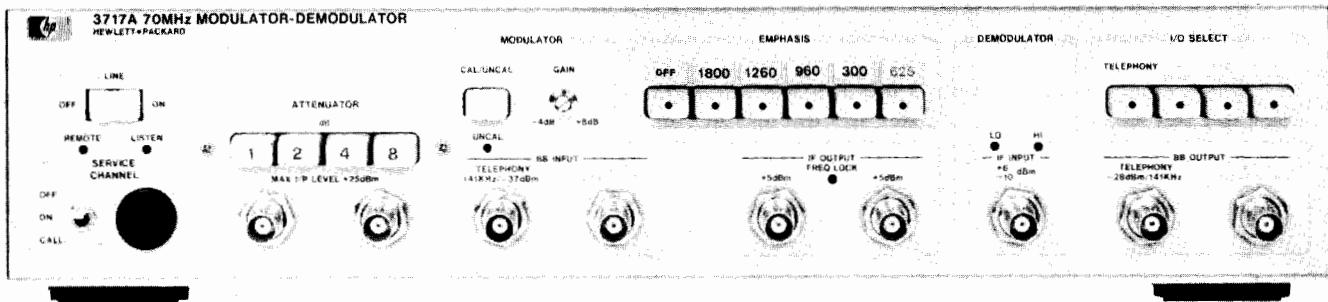

The 3717A 70 MHz Modulator/Demodulator can be used in microwave radio link systems to enable BB qualitative measurements to be made at non-demodulating repeater stations.

Standard measurement practice for the alignment and maintenance of microwave radio links involves two specific categories of tests, i.e. swept response measurements and BB qualitative measurements. Normal practice is to align a microwave radio initially by using swept response techniques such as those provided by an MLA. After these measurements have been completed successfully, qualitative measurements such as white noise loading, TV waveform testing, and BB frequency response are performed at the BB terminals of the microwave radio to verify operational performance.

However, the optimum swept response does not always produce the best possible qualitative figure. When this happens it may be necessary to isolate the faulty section by performing qualitative measurements from BB terminal stations to IF repeater stations, or vice versa. To do this, a high quality wideband test modulator or demodulator is required. The 3717A provides this capability.

### Specifications Summary

#### Back-to-back Performance (Telephony)

##### BB Frequency Response (with or without Emphasis)

50 Hz to 10 MHz:  $\pm 0.2$  dB.

50 Hz to 20 MHz:  $\pm 3$  dB.

##### Noise Loading Performance

At manual loading for all slots, 70 to 7600 kHz (1800 channels with Emphasis):  $\leq 25$  pWOp (57 dB NPR).

Thermal: mod/demod is thermally dominated and will typically tolerate a 6 dB overload with no degradation.

##### Spurious Response

50 Hz to 10 MHz:  $\geq 75$  dBm0.

#### Back-to-back Performance (Video)

##### BB Frequency Response

5 Hz to 10 MHz:  $\pm 0.2$  dB.

Square Wave Tilt (50 Hz):  $< 1.0\%$ .

Diff. Gain (4.43 MHz): 1%.

Diff. Phase (4.43 MHz):  $1^\circ$ .

\*Measured on an HP Microwave Link Analyzer with a test tone of 4.43 MHz.

### Options

Connector options—select any one.

**Std:** BNC

**003:** Siemens small.

**004:** commercial equivalent of WECO 477B balanced input.

Emphasis networks—up to five may be installed and should be specified with every order.

#### CCIR

**011:** 24 channel emphasis.

**012:** 60 channel emphasis.

**013:** 120 channel emphasis.

**014:** 300 channel emphasis.

**015:** 600 channel emphasis.

**016:** 960 channel emphasis.

**017:** 1260 channel emphasis.

**018:** 1800 channel emphasis.

**021:** 525 line emphasis.

**022:** 625 line emphasis.

**023:** 819 line emphasis.

#### Bell

**031:** Bell 600 channel emphasis.

**032:** Bell 900 channel emphasis.

**033:** Bell 1200 channel emphasis.

**034:** Bell 1500 channel emphasis.

**035:** Bell 1800 channel emphasis.

**036:** Bell 2100 channel emphasis.

**037:** Bell 2400 channel emphasis.

#### Miscellaneous

**006:** deletes Modulator section.

**007:** deletes Demodulator section.

**100:** HP-IB.

**136:** Combination of options 003 and 006.

**137:** Combination of options 003 and 007.

**146:** Combination of options 004 and 006.

**147:** Combination of options 004 and 007.

**3717A 70 MHz Modulator/Demodulator**

### Price

N/C

N/C

+\$885

+\$195

+\$195

+\$195

+\$195

+\$195

+\$195

+\$195

N/C

+\$1950

+\$1950

+\$1950

+\$1950

+\$195

+\$195

+\$195

+\$195

+\$195

+\$195

+\$195

+\$195

-\$2115

-\$2335

+\$285

\$2115

\$2335

\$1230

\$1450

**\$9010**

# TELECOMMUNICATIONS TEST EQUIPMENT

## RF Down Converter Model 3730B

- RF to IF frequency conversion
- 1.7 to 14.5 GHz frequency range

- Extends test capability of MLA's to RF
- 70 or 140 MHz IF output

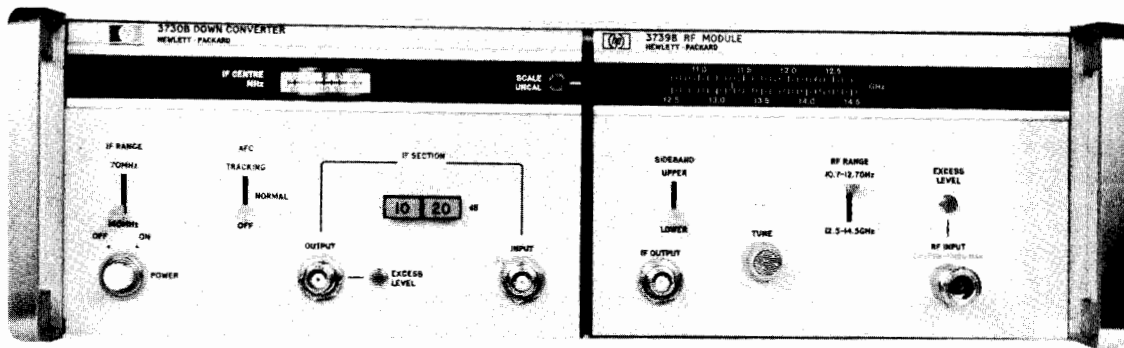

3730B Down Converter mainframe with 3739B RF Module plug-in



The 3730B Down Converter and plug-ins provide RF to IF conversion and RF test capabilities for Microwave Link Analyzers (MLA's). The 1.7 to 14.5 GHz RF range is accommodated by a series of local oscillator plug-ins, allowing easy tuning to the desired operating frequency.

The 3730B has dual IF capability which allows the Down Converter to interface with single 70 MHz IF (eg the 3710A/3702B) or dual 70/140 MHz IF (eg the 3711A/3712A) MLA's, or with wide-band demodulators (eg the 3717A) when white noise loading.

A tracking AFC and recovered sweep facility causes the local oscillator in the 3730B to track the incoming swept RF signal, thus almost eliminating the swept component of the IF signal. Note that because of the effective sweep compression of the IF signal, the residual distortions of both the Down Converter and Microwave Link Analyzer receiver are reduced considerably.

On a microwave radio route containing a number of repeater stations, the local oscillator can be positioned above or below the carrier frequency and this can vary from repeater station to repeater station. This can cause difficulties when comparing MLA responses between stations due to frequency axis inversion of the swept response. Selecting upper or lower sideband operation on the 3730B overcomes this problem.

Lengthy runs of RF cable between the Down Converter and the RF test point can generate ripple responses which can mask the true measurement response. To avoid this problem, it is possible to remove the Down Converter plug-in and mount this directly onto a waveguide test point. The plug-in is then connected to the 3730B mainframe by an umbilical cable. Only IF signals which are less susceptible than RF signals to lengthy runs of interface cable are transmitted along the umbilical cable.

Option 010 of the 3730B incorporates an additional IF section, comprising a 25 dB fixed gain amplifier and a 30 dB stepped attenuator, to ensure that the IF signal level is sufficient to drive most MLA's when operating at RF input levels below -12 dBm. Note that no degradation of the residual performance specifications occurs when this option is fitted.

Various connector types can be fitted on a special basis. Only BNC connectors are offered on the standard product; to interface with equipment fitted with other types of connector, the following adapter cables are recommended:

- 15525A Opt 008: BNC to large Siemens cable.
- 15525A Opt 009: BNC to small Siemens cable.
- 15525A Opt 006: BNC to WECO 477B cable.
- 15525A Opt 007: BNC to WECO 560A cable.

### Specifications

#### 3730B + 3736B/7B/8B/9B

#### Residual Performance:

	50 MHz Sweep Width at 70 MHz centre frequency	100 MHz Sweep Width at 140 MHz centre frequency
Amplitude Response	0.2 dB	0.3 dB
Group Delay	0.2 ns	0.3 ns
Diff Gain (5.6 MHz test tone)	0.3%	0.5%
Diff Phase (5.6 MHz test tone)	0.3°	0.5°

The residual specifications quoted are measured using the FM Sweep Input to reduce the residual contributions of the RF test source, and using storage normalizer techniques to remove MLA receiver contributions.

**Min RF Input Level:** -15 dBm, typically (-40 dBm when Opt 010 is fitted), for correct operation of MLA; however, min input level dependent on input sensitivity of MLA and RF-IF gain conversion of Down Converter (3710A/3702B MLA—min input sensitivity -10 dBm; 3711A/3712A MLA—min input sensitivity -19 dBm).

**Size:** 141 mm H x 425 mm W x 467 mm D (5.5 x 16.75 x 18.38 in.)

**Power Supply:** 100, 120, 220, or 240V ac, +5 -10%; 48 to 66 Hz; consumption 100 VA max, including plug-in.

**Weight:** 11.9 kg (26 lb) net, including plug-in.

**Temperature Range:** 0 to 55°C, operating.

#### Options

**010:** 25 dB fixed gain amplifier, with 30 dB (10 dB step) attenuator.

#### Price

+\$1195

#### Accessories

- 15600A Isolator: 3.7 to 4.2 GHz. \$660
- 15601A Isolator: 5.9 to 6.5 GHz. \$630
- 15602A Isolator: 7.1 to 8.5 GHz. \$560
- 15603A Isolator: 10.7 to 11.7 GHz. \$760
- 15609A Remote Extender Cable: 3 metre umbilical cable. \$420

#### Ordering Information

- 3730B Down Converter \$3785
- 3736B 1.7 to 4.2 GHz \$4610
- 3737B 3.7 to 8.5 GHz \$5960
- 3738B 5.9 to 11.7 GHz \$6620
- 3739B 10.7 to 14.5 GHz \$9425

# TELECOMMUNICATIONS TEST EQUIPMENT

## RF Sweeper MLA Upconverter Simulator

Models 8350A, 8620C, 86200 Series RF Plug-ins



- MLA Upconverter Simulator Options 0.5 to 18.0 GHz
- Use with MLA or as a general purpose sweeper
- Swept and CW RF Source
- Test Digital & Analog Microwave Radio Systems & Components

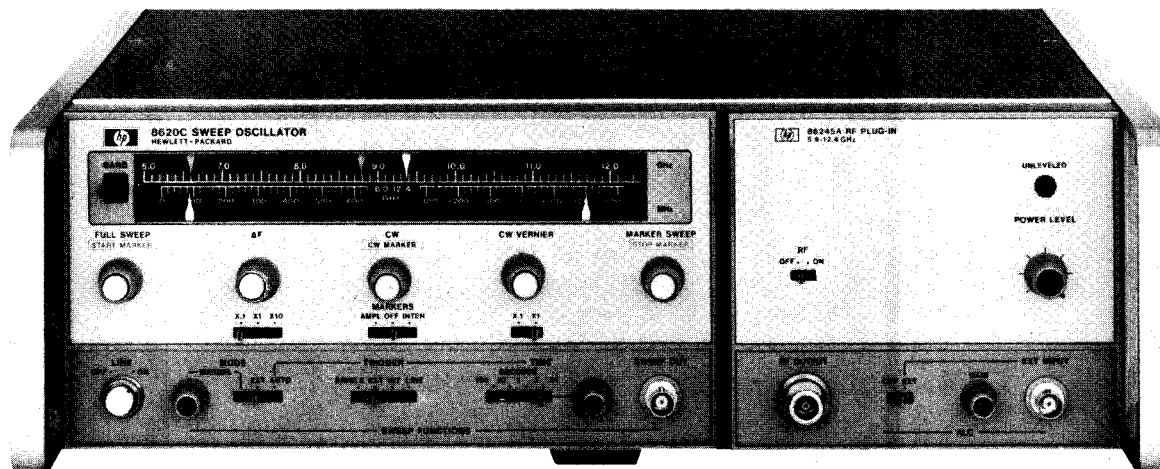

8620C/86245A

### Description

The 8620C Sweep Oscillator and 86200 Series of RF plug-ins provide a high performance, solid state source for Microwave Radio System tests via MLA Upconverter Simulation Options. These permit accurate RF-to-BB, RF-to-IF and RF-to-RF distortion measurements to be made with the 3700 Series MLA Systems. Also the plug-ins can be used as standard sweeper plug-ins, with the only basic difference being modified FM circuitry. The RF-to-RF measurements must be made in conjunction with the 3730A RF Down Converter. This allows group delay, linearity, differential gain and phase measurements to be made on RF devices and components within the Microwave Radio System. The 8350A Sweep Oscillator Mainframe is also compatible with the 86200 series MLA option plug-ins through the use of the 11869A Adapter.

### Specifications

The 8620C/86200 Series MLA Upconverter Simulation Plug-ins are optimized for group delay, linearity, and differential gain and

phase over the specified frequency range. All plug-ins can be used with MLA sweep widths of 100 MHz or less. The following specifications supplement the standard 8620C system specifications (covered on pages 418-423).

<b>Complementary Equipment</b>	<b>Price</b>
<b>8620C Sweeper Mainframe (required)</b>	\$2850
To properly interface the 8620C/86200 Series plug-in to the item under test, the following are recommended for optimal performance:	
<b>8350A Sweeper Mainframe</b>	\$4250
<b>11869A Adapter</b>	\$200
<b>784C Directional Detector (1.7 – 12.4 GHz)</b>	\$1350
<b>Flatness over any 30 MHz: &lt;math&gt;\leq \pm 0.1 \text{ dB}&lt;/math&gt;</b>	
<b>Equivalent Source Match: typically <math>\leq 1.5</math></b>	
<b>11675B Leveling Cable Assembly (1.7 – 12.4 GHz)</b>	\$450
<b>Group Delay: <math>\leq 0.25 \text{ ns p-p}</math> (with 1.25 SWR at each end)</b>	

### MLA Upconverter Simulation Plug-in Specifications (25°C)

Model Number	MLA Option Number	MLA Freq. Range (GHz)	Group Delay (ns) p-p	Linearity (%)	Diff. Gain (%)	Diff. Phase (°)	FM Sens. (MHz/V)	Price W/MLA Option
			@277.7 kHz		@5.6 MHz*			
			Across Any 30 MHz BW					
86222A/B	H80	0.5–2.4	<3	<2.5	<2.5	<3	N/S	\$5450/6350
86235A	008	1.7–4.3	<2	<2.0	<2.0	<2	+20	\$4250
86240C	—	3.6–8.6	<1	<0.5	<0.5	<1	+20	\$5450
86242D	008	5.9–9.0	<1	<0.5	<0.5	<1	+20	\$4000
86245A	008	5.9–12.4	<1	<0.5	<0.5	<1	+20	\$5750
86250D	008	8.0–12.4	<1	<0.5	<0.5	<1	+20	\$4100
86260A	H82	12.0–18.0	<3	<2.5	<2.5	<3	N/S	\$5350

\*Except 86222A/B & 86260A which are tested @ 2.4 MHz.

For applications requiring better distortion specifications, HP also offers plug-in systems which include a leveling cable and directional coupler. These systems are available in the following bands: 1.7–2.4 GHz, 3.6–4.3 GHz, 5.8–6.5 GHz, 7.0–8.6 GHz, 10.7–11.7 GHz, and 12.2–12.7 GHz. The system specifications are as follows:

**Group Delay @ 500 kHz: <math>\leq 0.5 \text{ ns p-p}</math>**

**Linearity @ 500 kHz: <math>\leq 0.25\%</math>**

**Flatness: <math>\leq \pm 0.1 \text{ dB}</math>**

For more information consult your local HP Field Engineer.

The options shown after each plug-in provide the special MLA interface capability. Refer to pages 418 to 423 for details on other RF Sweeper plug-in specifications and options.

# TELECOMMUNICATIONS TEST EQUIPMENT

## Baseband Analyzer

Models 3724A, 3725A, 3726A

- Automatic noise power ratio scan of up to four slot frequencies
- SLMS scan routines with variable violation limits
- Spectrum analysis for spurious signal identification
- BB frequency response—locally or end to end with storage and normalisation
- Broadband power down to  $-70$  dBm
- Easy conversion between level measurement units

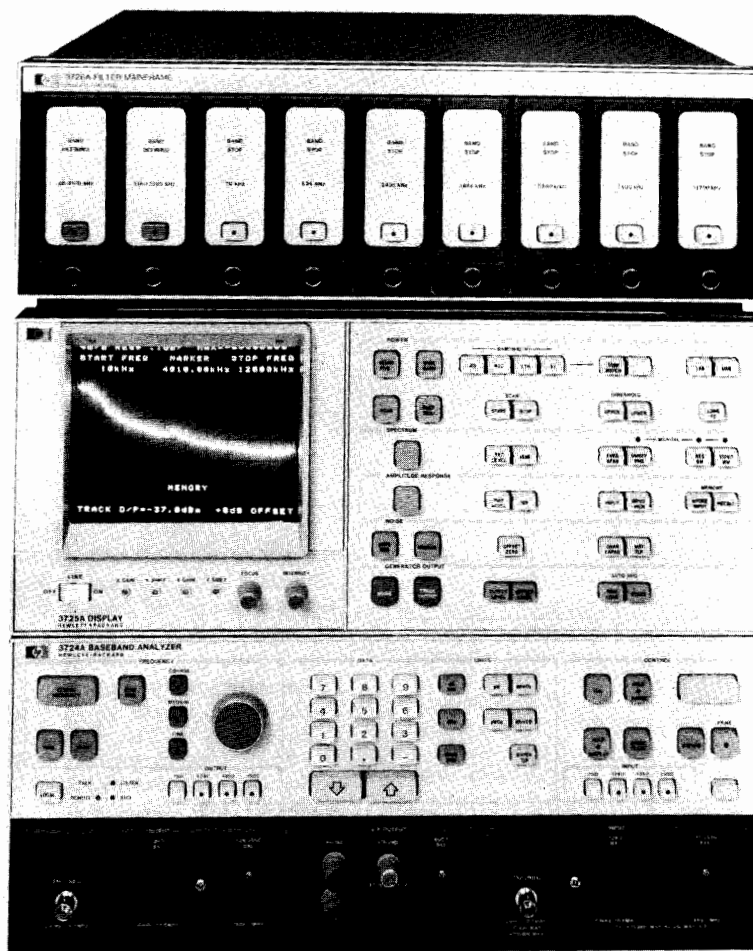

3726A Filter Mainframe with 37264A Band Defining Filter and 37265A Band Stop Filter plug-ins  
3725A Display  
3724A Baseband Analyzer



A new approach to microwave radio maintenance, the 3724A/3725A/3726A Baseband Analyzer provides in a single convenient, transportable package, all the qualitative measurements commonly performed on FDM microwave radio systems.

The full capability of the Baseband Analyzer covers measurements traditionally performed by stand-alone products such as a Selective Level Measuring Set (SLMS), Broadband Power Meter, Spectrum Analyzer, Tracking Generator, and White Noise Measuring Set. For the first time, these instruments have been integrated into a single product offering state-of-the-art features for ease-of-use, high performance, and cost effectiveness.

This measurement capability is enhanced by the ability to make complementary measurements on the same signal. For example, a spurious tone found using the Spectrum Analysis mode may have both its level and frequency accurately measured by changing to the SLMS mode. During the changeover, the tuned frequency is automatically retained.

All measurement results appear on a CRT in both analog and digital form, as appropriate. A hard copy of the information on the screen may be obtained using an X-Y plotter or a printer plotter via the HP-IB. No external controller is required for this function.

For portability, the Baseband Analyzer is manufactured in three separate cabinets. The basic instrument comprises two cabinets—the 3724A Baseband Analyzer and the 3725A Display module. Together they provide all the measurement capability except white noise generation. For white noise loading the third cabinet, the 3726A Filter Mainframe, must be added. The 3726A houses the white noise source, the 37264A Band Defining Filter plug-ins, and the 37265A Band Stop Filter plug-ins. Various bandwidths and frequencies to comply with CCIR, CCITT, Intelsat, and Bell recommendations can be provided as options. For the majority of white noise loading applications band pass filters, as required by conventional white noise receivers, are not required. However, if a noise power ratio performance better than 67 dB is required then 37266A Band Pass Filter plug-ins can be installed, offering a further 10 dB improvement in NPR.



## Measurement Summary

### Level Measurements

Make accurate level and frequency measurements of pilots, carrier leaks, channel power, spurious tones, and other measurements associated with Frequency Division Multiplex (Carrier) systems.

#### Wideband

**Frequency Range:** 50 Hz to 18.6 MHz.

**Power Range:**  $\pm 20$  dBm to  $-76$  dBm.

**Accuracy:**  $< \pm 0.5$  dB.

#### Selective

**Measurement Bandwidths:** 40 Hz; 400 Hz; 1.74 kHz; 3.1 kHz.

**Frequency Range:** 20 Hz to 18.6 MHz.

**Power Range:**  $+20$  dBm to  $< -130$  dBm.

**Accuracy:**  $\leq \pm 0.2$  dB.

**Frequency Measurement:** 0.1 Hz resolution.

#### Features

- Synthesizer Based Tuning—for frequency accuracy and stability.
- Scan Routines—enables sequences of measurements on pilots or channels within a supergroup; also tabulates frequency response when used with a tracking generator.
- Fast High Level User Routine—checks in 80 seconds a radio baseband of 1800 channels for signals above a specified level.

### Spectrum Analysis

Make measurements on system traffic to check occupancy, or on unloaded systems to check for spurious signals.

#### Spectrum Analysis

**Frequency Range:** 20 Hz to 20 MHz.

**Amplitude Range** (2 dB or 10 dB/cm):  $+20$  dBm to  $-130$  dBm.

**Dynamic Range:** 80 dB.

**Frequency Span:** 20 MHz to 5 kHz.

**Sweep Time:** 8 ms/div to 32 s/div.

**Resolution Bandwidth:** 10 kHz to 100 Hz.

**Video Bandwidth:** 5 kHz to 5 Hz.

#### Features

- Automatic or manual coupled controls ensure error free measurements along with flexibility.
- Digitally stored and refreshed CRT display—trace can be digitally stored and at a later time recalled for visual comparisons.
- CRT readout of all control settings.
- X-Y plots via the HP-IB—no external controller is required for this function.

### BB Frequency Response Measurements

There are three methods of making frequency response measurements with the Baseband Analyzer, i.e. using the Power, Spectrum, or BB Response modes in conjunction with the tracking generator output.

#### Tracking Generator

**Frequency Range:** 200 Hz to 18.6 MHz.

**Amplitude Range:**  $+6$  dBm to  $-60$  dBm.

**Flatness:**  $< 0.2$  dB.

**Absolute Accuracy:**  $< \pm 0.4$  dB.

**Harmonics and Spurious:**  $< -40$  dB on output level.

Using the Power and Spectrum modes for BB amplitude response testing offers wide display range coupled with fast response times. However, these modes are limited to local applications. In contrast, the BB Response mode offers:

- No connection needed between sender and receiver (apart from item under test).
- Automatic point-by-point measurements with results presented graphically.
- Trace storage and normalisation.
- Sweep time fast enough to allow adjustments.
- Display scaling of 1 or 0.1 dB per square.

### White Noise Measurements

White noise measurements allow the overall performance of a radio link to be assessed using test signals which simulate normal traffic. The test signal used is white noise, band limited to correspond to the baseband bandwidth of the particular radio under test.

### White Noise Measurements

**Frequency Range:** for measurements on systems with 12 to 2700 channels.

**Noise Power Ratio Range:** 0 to 67 dB.

**Signal to Noise Range:**  $-18.8$  to  $-85$  dBm0p ( $1.3 \times 10^7$  to  $3.16$  pW0p);  $72$  to  $5$  dBm0c ( $1.66 \times 10^7$  to  $4$  pW0c).

A full range of band defining and slot filters is available, consult Data Sheet.

**Noise Power Range:**  $+12$  to  $-60$  dBm.

#### Features

- Simultaneous measurement of broadband and slot power dispenses with repeated reference checking.
- Full range of filters easily changed from front panel.
- Auto mode allows automatic scan of up to four slots even on an end-end measurement.
- V curve and overload plotting made simple by offset key, or fully automate with an external controller.
- Measures all commonly used units, i.e. NPR, dBm0p, and dBm0c.
- Conforms to all relevant CCIR and CCITT Recommendations.

### Options

#### 3724A Baseband Analyzer

Input/Output	Standard	Option 003	Option 004
75 $\Omega$	BNC	Siemens 1.6 mm	WECO 477B
124 $\Omega$	Blank	Blank	WECO 477B
135 $\Omega$ /150 $\Omega$	Siemens 3-pin Bal	Siemens 3-pin Bal	Large 223A
600 $\Omega$ Audio	Siemens 3-pin Bal	Siemens 3-pin Bal	Large 310
Head Phone	0.75" Banana	0.75" Banana	0.75" Banana

#### 3726A Filter Mainframe

**301:** delete noise source (for systems where more than nine filters are required). N.B. Up to three 3726A Filter Mainframes can be controlled by one 3724A Baseband Analyzer.

#### 37264A Band Defining Filter

**311:** 60 to 300 kHz.      **315:** 60 to 4100 kHz.      **318:** 316 to 5600 kHz.  
**312:** 60 to 552 kHz.      **316:** 316 to 4100 kHz.      **319:** 316 to 8160 kHz.  
**313:** 60 to 1296 kHz.      **317:** 60 to 5600 kHz.      **320:** 316 to 12360 kHz.  
**314:** 60 to 2600 kHz.

N.B. All nine plug-in compartments of the 3726A Filter Mainframe must be filled for correct operation. The 37268A Dummy Plug-in should be ordered to fill any empty plug-in compartments.

#### 37265A Band Stop Filter

**311:** 70 kHz.      **314:** 1248 kHz.      **317:** 5340 kHz.  
**312:** 270 kHz.      **315:** 2438 kHz.      **318:** 7600 kHz.  
**313:** 534 kHz.      **316:** 3886 kHz.      **319:** 11700 kHz.

#### 37266A Band Pass Filter

Only required if a noise power ratio performance of better than 67 dB is required. NPR performance of instrument is extended to 77 dB when Band Pass Filter fitted. These filters must be housed in separate 3726A Filter Mainframe.

**311:** 70 kHz.      **314:** 1248 kHz.      **317:** 5340 kHz.  
**312:** 270 kHz.      **315:** 2438 kHz.      **318:** 7600 kHz.  
**313:** 534 kHz.      **316:** 3886 kHz.      **319:** 11700 kHz.

N.B. Consult Baseband Analyzer data sheet for Band Defining, Band Stop, and Band Pass Filters to meet Intelsat and Bell requirements.

#### 37267A Adapter Case (for Marconi filters)

**311:** high or low pass.  
**313:** band pass (including 750  $\Omega$ /75  $\Omega$  transformer).  
**314:** band stop.

#### 37268A Dummy Plug-in

Must be used to fill any empty plug-in compartments on the 3726A Filter Mainframe.

#### 37269A Plug-in With Front Panel Input Connector

To be used in conjunction with 37266A Band Pass Filter.

**003:** Siemens 1.6 mm connector.

**004:** WECO 477B connector.

### Ordering Information

**3724A** Baseband Analyzer

**3725A** Display

**3726A** Filter Mainframe

### Prices

\$21,685

\$12,790

\$2,675



Hewlett-Packard offers a complete line of computational products ranging from inexpensive hand-held calculators and personal computers to multiple-user, multiple-language computer systems. This computational product line is divided into four product groups: personal calculators, desktop computers, technical computer systems and business computer systems. Each product is designed to help a particular type of customer solve particular types of problems.

Programmable and non-programmable calculators are available for both scientific/engineering and business applications.

Desktop computers are designed for technical applications involving computation, graphics, data acquisition and control, where the user may not be a computer professional but needs easy-to-use computer power at his fingertips.

The HP 1000 series consists of technical computers ranging from computers-on-a-board, through computers-in-a-box, up to complete systems including software and peripherals. HP 1000 systems are designed with multiple languages for large computation, instrumentation, operations management and distributed systems applications.

Our business systems range from computers-in-a-desk for small businesses to HP 3000 computer systems, designed specifically for terminal-oriented business data processing with virtual memories, multiprogramming capabilities and multiple languages.

In addition, HP offers a complete line of terminals and peripherals compatible with all our computational products except the personal calculators.

Support of Hewlett-Packard computer customers is extremely important. Hewlett-Packard has defined a full range of customer support products ranging from user training to dedicated on-site support. It is possible for a customer to define specifically his support program by order combination of HP's computer support products.

The following will describe in more detail

the purpose and capabilities of each of the four computational product groups.

#### Personal Calculators

Hewlett-Packard offers a wide range of personal calculators for both technical and financial applications. Each different model has its own set of unique features designed to solve particular problems. Common to all models is the standard excellence by design. The use of RPN logic, Continuous Memory and the unparalleled HP support system are but a few examples of this effort.

Since the introduction of HP's first calculator in 1972, its RPN logic system has achieved universal acceptance as being the most powerful and efficient logic system for solving complex problems. The logical and consistent methodology of RPN, as well as its superior speed in operation, make it unsurpassed in user satisfaction.

In 1975 Hewlett-Packard pioneered Continuous Memory for handheld calculators and today HP's CMOS technology prevails as a standard in the industry. With the CMOS feature, frequently needed calculations and functions can be programmed once and remain intact even when the calculator is turned off. It saves time by eliminating program reloading and makes possible the addition of specialized functions. Added to these features is a support system unequalled in the industry. HP handbooks and owner's literature have long been respected for being clear, thorough, and easy to understand. The same is true of HP's extensive line of software.

Now, in 1980 Hewlett-Packard has introduced a Personal Computer for professionals to be used in the fields of science, engineering, industry or business. This self-contained portable system provides computing power when and where you need it. You can enhance the computer's capability by adding powerful HP peripherals, like the full-width line printer, full-size plotter, or flexible discs. And you can customize it to your needs with HP Application Pacs which offer prepro-

grammed solutions in a wide variety of disciplines.

Excellence is designed into the HP personal computation systems in every aspect—the results are professional instruments which meet professional needs.

#### Desktop Computers

HP desktop computers are designed for scientific/engineering problems that are too complex for personal calculators or that require peripherals or interfacing capabilities for data acquisition or instrumentation control. Desktop computers have full, high-level programming languages, much larger memories than personal calculators, built-in mass storage devices and I/O ports for interfacing to peripherals or other instruments. Some have impressive graphics capabilities for plotting, drawing, graphing and lettering.

With large memories (up to 449K bytes user read/write), powerful language, built-in mass storage, versatile I/O and high-speed processors, desktop computers are powerful problem solvers and true computers. But they are built with a turn-me-on-I'm-ready-to-go simplicity that makes them easy to operate and program, even if you've never been near a computer before. They're specifically designed to provide computer power to professional people whose profession is not computer programming, but who have technical problems to solve.

Many types of software development can be much faster and less expensive on a desktop computer because of operating-system features such as interpretive language; interactive syntax checking, editing and debugging; automatic tracing and automatic variable allocation.

Applications involving the desktop computer's capability to interface with instruments that measure and record electrical, mechanical or physical measurements fall into the area commonly called data acquisition and control. Such applications range from acquiring data from instruments that



convert analog output from transducers into the digital information a computer can handle, to gathering and processing statistical data for quality control or trend determination, to radioimmunoassay and blood gas analysis in the clinical laboratory.

In production test applications, a desktop computer can gather test data showing compliance with published specifications and convert it to a permanent record. In monitoring temperature and humidity in a manufacturing plant, a desktop computer can help plant engineers balance environmental conditions for maximum energy conservation and worker comfort. In the clinical laboratory, a desktop computer system allows the technician to identify and reject bad data to maximize the accuracy of resulting log and logit curves.

Quality control data monitoring can identify the point at which vendor items must be rejected, or testing must be changed from sampling to 100% to assure acceptable products. Using this data, the desktop computer system can generate reports that identify yield rates and causes of failure. These reports allow management to locate problems before they affect product quality.

The desktop computer system designer, who can also be the programmer without needing special computer training, can create systems with a wide range of capability and automation. Transducers are available to convert nearly any measurable parameter, such as temperature, pressure, humidity, velocity, distance, turbidity and pH into digital quantities that can be measured and compared to limits or recorded for permanent files. When physical or electrical parameters must be continuously monitored, analyzed and controlled, the desktop computer system can do this economically, saving many hours of manual testing, analysis and record keeping.

Hewlett-Packard desktop computers offer a spectrum of capabilities for data acquisition and control applications. The 97S is an economical unit affording control using a BCD interface code. The HP85 is Hewlett-Packard's personal computer for professionals and it can also interface to instruments and computer peripherals. The 9815, 9825, System 35 and System 45 can interface with peripherals and other devices using HP-IB (Hewlett-Packard's implementation of IEEE-488), BCD, RS-232-C or bit-parallel. A real-time clock interface providing real-time reference and time-related control activities is also available for the 9825 and Systems 35 and 45. With this range of interfacing capabilities, a large variety of data acquisition and control system designs is possible and now they can be supported with color graphics available on the 9845C.

Desktop computers are used around the world by engineers, scientists, mathematicians, statisticians, technicians and manufacturers for data acquisition, instrument control, production control, mechanical and

environmental testing, quality control, statistical analysis, data reduction, numerical analysis, time series analysis, mathematical modeling, analysis of variance, regression analysis, medical calculation, engineering design, civil engineering, graphic data representation, linear programming, project control, critical path planning and machine-tool control.

### Technical Computers

HP 1000 Computers and Computer Systems are aimed at applications in science, engineering, and manufacturing. Typical uses are modeling, instrument control, graphics, factory automation, and scientific analysis. To fit particular situations with precision, HP 1000s are offered at four levels of speed and power. M-Series are for cost-critical purposes, E-Series have about twice as much speed and power, and F-Series models add more precision and speed with hardware floating-point operations and a range of other performance-accelerating options. The HP 1000 L-Series uses the concept of distributed system architecture to permit I/O processing to occur concurrently with CPU processing to improve overall system throughput for I/O intensive applications. Further to fit individual needs, they are available as circuit boards alone, in boxes, or in a range of complete computer systems. All 1000's are multi-lingual, multi-programming systems capable of supporting multiple terminals. They are user-microprogrammable for further adaptability to special uses. Real-time executive operating systems readily implement efficient programming for scientific and engineering applications. Semiconductor main memory may be as large as 2 M bytes. Application tools now include a modern, friendly data-base management capability (IMAGE/1000 with QUERY), a menu-driven factory data collection system (DATACAP/1000) that can be set up with a minimum of user programming, and GRAPHICS/1000 software to speed production of graphs, charts, and diagrams. Languages include BASIC, FORTRAN and PASCAL. With HP Distributed Systems Network software and hardware, HP 1000s can be interconnected in an almost unlimited variety of network configurations, sharing files, programs and other resources with great ease. HP 1000s may similarly be interconnected with HP 3000 networks. Throughout their history, and throughout that of their generic predecessors, compatibility of instruction sets and operating systems has been preserved, assuring the continuing value of earlier software investments by users and by HP.

### HP Business Computers

Especially well-suited for on-line, interactive, distributed processing applications, HP business computers are offered in three series. The HP 250 is a low-priced computer

with full data-base management capability and other powerful software tools for developing applications. With these, value may be economically added by suppliers who tailor computer solutions for small businesses, and by larger users needing systems that are easy to dedicate to particular functions.

The HP 300 is a compact office computer system, based on Hewlett-Packard's advanced silicon-on-sapphire (SOS) technology, with an integrated display system able to show several different files at once, for rapid interpretation and decision-making. Main memory is expandable to 1 megabyte within the computer's enclosure, and workstations duplicating the functions of the main console may be added. Working languages are BASIC and RPG. It is particularly applicable for larger users and suppliers of computer systems who have existing RPG applications for conversion to more modern equipment, and for computer professionals who can exploit its unusual abilities to add value economically.

The HP 3000 is a family of totally compatible systems, sharing the same multiprogramming executive operating system (MPE), the same languages, and able to run one another's programs interchangeably. Today, this evolving family's fastest and most expandable system is the HP 3000 Series III, with main memory to 2 megabytes, and ability to support as many as 64 terminals, each running or developing separate programs. The SOS-based HP 3000 Series 33 and 30, at less cost, offer much the same ability to handle simultaneously many transaction-processing, time-sharing, program-development, and batch operations in any of five high-level languages, COBOL, RPG, BASIC, FORTRAN, and SPL (the HP systems programming language). Only APL is confined to Series III. All may be interconnected so as to command one another's resources readily, sharing files and programs, with HP Distributed Systems Network DS/3000 hardware and software that also can integrate HP 3000s with HP 1000 networks.

### HP Computer Peripherals

HP is a single source not only for computers, but also for almost all the peripherals used in HP systems. Among these are CRT terminals, all microprocessor-controlled, some with built-in mass storage, some with specialized graphics capabilities, and some with integrated printers. Fast HP character-sequential printers are offered also in printing-terminal and graphics configurations; there is a 450-lpm HP line printer, and a series of quiet thermal printers. Monochrome and color plotters, disc memories ranging to 120 megabyte capacity, magnetic tape, and digitizer equipment all are manufactured by the company. HP peripherals are compatible with HP desktop computers, HP computer systems, and to a considerable degree with equipment of many other makers.



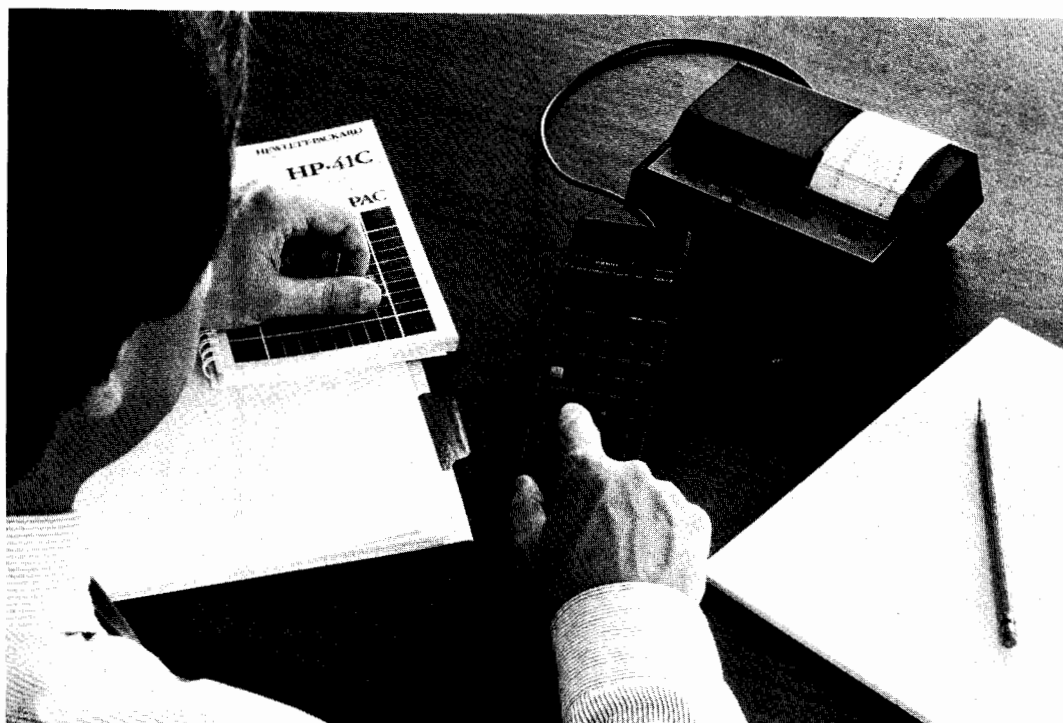

### Why a Professional Calculator?

Hewlett-Packard introduced the world's first scientific pocket calculator in 1972. Since then, HP has introduced numerous personal calculating devices for the professional—each with technologically advanced features, and each with a wide range of capabilities—designed to solve your specific problems.

If your problems involve only addition, subtraction, multiplication and division, almost any well made four-function calculator will do. But when your problems extend beyond basic arithmetic, then you need a *professional* calculator—designed with the needs of a professional in mind.

Today, more than ever, proper selection depends largely on careful analysis of your personal and professional needs, plus those you're likely to face in the future. The following information will help you select the HP calculator for your specific problem-solving needs.

### Scientific Calculators for Technical Professionals

No matter what technical field you're in, Hewlett-Packard has a calculator capable of enhancing your problem-solving ability. HP scientific calculators have the most needed and useful functions preprogrammed into the calculator. So most of your simple problems can be solved at the touch of a key.

And for more specialized or repetitive problem-solving needs, most HP scientific calculators are programmable. From the keystroke programmable HP-33C and HP-34C, to the fully programmable HP-67 and HP-97, to the full performance HP-41C

system, these calculators are loaded with programming features, such as:

- Insert/delete editing
- Conditional tests
- Alpha prompts
- Multiple addressable labels
- Controlled looping
- Indirect addressing

With HP's powerful scientific programmable calculators, you can quickly and easily write programs to solve your unique problems. Or you can use programs already written by Hewlett-Packard that solve problems common to a number of major technical areas, such as electrical engineering, physics, chemistry, statistics and more.

### Financial Calculators for Business Professionals

Making decisions quickly and profitably is more than just desirable these days. With the ever-quickening pace of today's business environment, sound decision-making has become absolutely essential!

Understanding basic business principles—like the time value of money—is only half the battle. Applying these principles to the problems you face is the other half. That's no easy job.

With HP's financial calculators, it isn't necessary to know the mathematical formulas involved, all you do is enter the variables and press the keys. Solving for any unknown is as easy as adding or subtracting. Problems like computing a loan payment or calculating the terms for a wrap-around mortgage, or finding the return on an investment—are push-button easy.

With HP's powerful financial programmable calculators, you can quickly and easily

write programs, or you can use programs already written by Hewlett-Packard that solve common problems.

So, if this type of professional problem-solving answers your needs, see HP's full-line of Business Calculators on the following pages.

### Professional Personal Computation

Bridging the gap between calculator and large computer—Hewlett-Packard added a new dimension to its computational line: the HP-85. It is a powerful BASIC language computer complete with built-in keyboard, CRT display, printer, and tape unit. An impressive graphics system is integrated into the HP-85 BASIC as a standard feature. Four ports allow you to expand the memory, add enhancement modules, and attach peripherals. Application Pacs on tape cartridges and special plug-in ROMs let you customize the system to fit your needs. And with capabilities integrated into a single unit weighing less than 20 pounds—light enough to easily take with you.

When your computational needs expand, the HP-85 can grow with you. You can double its memory or add an exciting array of powerful peripherals to enhance your computing system. You can plug in a full-width line printer and a high resolution plotter, or a floppy disk system.

The HP-85 combines the power of a large-scale computing system with the portability and ease-of-use of a calculator. It goes where you go. At the office or at home, the HP-85 helps you get the job done.

Personal Computation products, featured on pages 613 through 622, can be purchased from authorized dealers in your area.

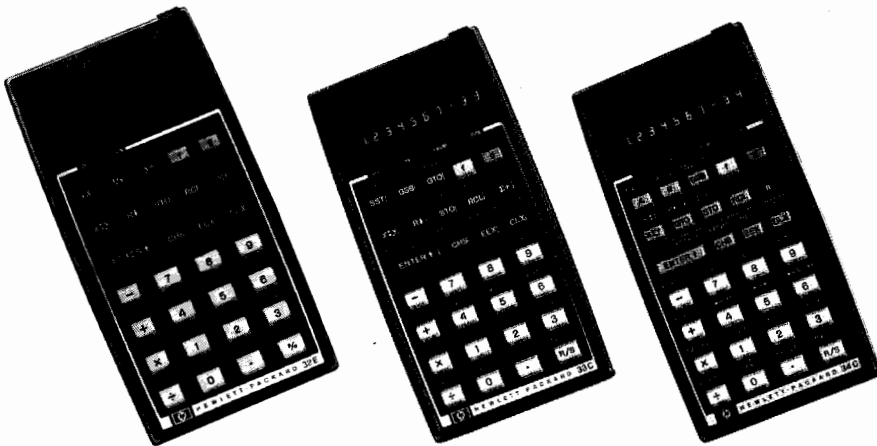

### HP-32E Scientific With Statistics

Designed specifically for the scientist, engineering professional and student who need to solve complex problems involving trigonometry, logarithms, or metric conversions—all at the touch of a key. The HP-32E includes basic statistical functions; such as percent, summations, two-variable means and standard deviations, linear regressions, and correlation. Equipped with 9 user plus 6 statistical storage registers, the HP-32E is powerful, yet easy to use.

The HP-32E comes complete with the following standard accessories: Owner's Handbook, the informative "Solving Problems with Your Hewlett-Packard Calculator," recharger/AC adapter, rechargeable battery pack and soft carrying case.

### HP-32E Specifications

**Mathematical functions:** SIN, COS, TAN, and inverses, DEG, RAD, GRD Modes, R $\rightarrow$ P, DEG $\rightarrow$ RAD, H $\rightarrow$ H.MS, SINH, COSH, TANH, and inverses, log, 10<sup>x</sup>, LN, e<sup>x</sup>, y<sup>x</sup>,  $\sqrt{x}$ , x<sup>2</sup>, 1/x,  $\frac{1}{\square}$ , +, -,  $\times$ ,  $\div$ .

**Statistical functions:** %,  $\Delta\%$ , %T,  $\bar{x}$ , s, r, L.R.,  $\hat{x}$ ,  $\hat{y}$ ,  $\Sigma+$ ,  $\Sigma-$ , (n,  $\Sigma x$ ,  $\Sigma x^2$ ,  $\Sigma y$ ,  $\Sigma y^2$ ,  $\Sigma xy$ ), n!, Q, Q<sup>-1</sup>.

**Clearing options:** CLX, REG,  $\Sigma$ , ALL, PREFIX.

**Memory:** 15 storage registers, four-register stack, last-x register.

**Recharger power requirements:** 90 to 120 Vac or 198 to 242 Vac (50 to 60 Hz).

**Size:** 30 mm (1.2 in)  $\times$  75 mm (3.0 in)  $\times$  140 mm (5.6 in).

### HP-33C Programmable Scientific With Continuous Memory

The HP-33C provides fundamental programming as well as extraordinary problem-solving capabilities.

With 49 lines of program memory, the HP-33C's easy-to-master programming capability helps you perform complicated technical calculations quickly and accurately.

The Continuous Memory feature allows you to retain programs and data even when the calculator is turned off. This not only saves you time, but helps to conserve battery life.

To increase calculator versatility, HP offers these Application Books: Mathematics,

Statistics, Student Engineering, and Survey. They provide easy to understand, step-by-step procedures designed to get you through even the toughest problems.

The HP-33C comes complete with the following standard accessories: Owner's Handbook, the informative "Solving Problems with Your Hewlett-Packard Calculator," recharger/AC adapter, rechargeable battery pack, quick reference card, Standard Applications Book and soft carrying case.

### HP-33C Specifications

**Mathematical functions:** SIN, COS, TAN, and inverses, DEG, RAD, GRD modes, R $\rightarrow$ P, DEG $\rightarrow$ RAD, H $\rightarrow$ H.MS, SINH, COSH, TANH, and inverses, log, 10<sup>x</sup>, LN, e<sup>x</sup>, y<sup>x</sup>,  $\sqrt{x}$ , x<sup>2</sup>, 1/x,  $\frac{1}{\square}$ , +, -,  $\times$ ,  $\div$ , ABS, integer part, fractional part.

**Statistical functions:** %,  $\bar{x}$ , s, r, L.R.,  $\hat{x}$ ,  $\hat{y}$ , summations (n,  $\Sigma x$ ,  $\Sigma x^2$ ,  $\Sigma y$ ,  $\Sigma y^2$ ,  $\Sigma xy$ ).

**Programming features:** SST, BST, GTO, GSB, RTN, R/S, PAUSE, no-operation, three levels of subroutines, eight conditional tests ( $x < 0$ ,  $x > 0$ ,  $x \neq 0$ ,  $x = 0$ ,  $x \leq y$ ,  $x > y$ ,  $x \neq y$ ,  $x = y$ ).

**Clearing options:** CLX, STK, REG, PRGM, PREFIX.

**Memory:** Eight storage registers, last-x register, 49 program lines.

**Recharger power requirements:** 90 to 120 Vac or 198 to 242 Vac (50 to 60 Hz).

**Size:** 30 mm (1.2 in)  $\times$  75 mm (3.0 in)  $\times$  140 mm (5.6 in).

### HP-34C Advanced Programmable Scientific with Continuous Memory

Designed for the scientific students and professionals who need the flexibility and power of advanced programming to handle their repetitive problems, as well as a full set of preprogrammed scientific functions. Two important keyboard functions are: "Solve," which finds real roots for an incredibly wide range of functions; and "Integrate," which computes that area of a function bounded by upper and lower limits. Additionally, the HP-34C has Continuous Memory, which lets you retain programs and data even when the calculator is turned off.

The advanced programming features of the HP-34C include 12 addressable labels, insert/delete editing, and a dynamically con-

trolled memory that varies between 210 program lines and 21 user storage registers.

To increase calculator versatility, you can write your own programs, or use applications books HP has developed: Mathematics, Statistics, Student Engineering and Surveying. These application books are easy to understand with step-by-step procedures through even the toughest problems.

The HP-34C comes complete with the following standard accessories: Owner's Handbook, the informative "Solving Problems with Your Hewlett-Packard Calculator," a recharger/AC adapter, rechargeable battery pack, quick reference card, Standard Applications Book and soft carrying case.

### HP-34C Specifications

**Mathematical functions:** SIN, COS, TAN, and inverses, DEG, RAD, GRD, R $\rightarrow$ P, DEG $\rightarrow$ RAD, H $\rightarrow$ H.MS, 10<sup>x</sup>, LN, e<sup>x</sup>, y<sup>x</sup>,  $\sqrt{x}$ , x<sup>2</sup>, 1/x,  $\frac{1}{\square}$ , +, -,  $\times$ ,  $\div$ , ABS, integer/fraction truncation, round, integrate, and solve.

**Statistical functions:** %,  $\Delta\%$ , %T,  $\bar{x}$ , s, r, L.R.,  $\hat{x}$ ,  $\hat{y}$ , summations (n,  $\Sigma x$ ,  $\Sigma x^2$ ,  $\Sigma y$ ,  $\Sigma y^2$ ,  $\Sigma xy$ ), factorial, gamma function.

**Programming features:** direct line branching, label addressing, two user-definable keys and 12 labels; indirect addressing of labels, data storage, subroutines, and program lines; six levels of subroutines, controlled looping, four flags, eight conditional tests ( $x = 0$ ,  $x \neq 0$ ,  $x < 0$ ,  $x > 0$ ,  $x = y$ ,  $x \neq y$ ,  $y < x$ ,  $y > x$ ); editing operations include singlestep execution, singlestep and backstep inspection of a program, insert/delete editing, positioning the calculator at any step in program memory, and pause.

**Clearing options:** CLX, REG, STATISTICS, PRGM, PREFIX.

**Display:** fixed decimal, scientific, and engineering notation, display mantissa, commas separate thousands.

**Memory:** four-register stack, last-x register, continuous dynamic memory allocation, from 70 program lines and 20 storage registers to 210 program lines and one storage register (the indirect register).

**Recharger power requirements:** 90 to 120 Vac or 198 to 242 Vac (50 to 60 Hz).

**Size:** 30 mm (1.2 in)  $\times$  75 mm (3.0 in)  $\times$  140 mm (5.6 in).

Ordering Information	Price
HP-32E Scientific Calculator with Statistics	\$70
HP-33C Programmable Scientific Calculator with Continuous Memory	\$110
Optional Application Books for HP-33C	\$5
HP-34C Advanced Programmable Scientific Calculator with Continuous Memory	\$150
Optional Application Books for HP-34C	\$8



# COMPUTERS, PERIPHERALS & CALCULATORS

## Personal computation

### Model HP-41C

- Most powerful programmable ever designed by HP
- Alphanumeric capabilities

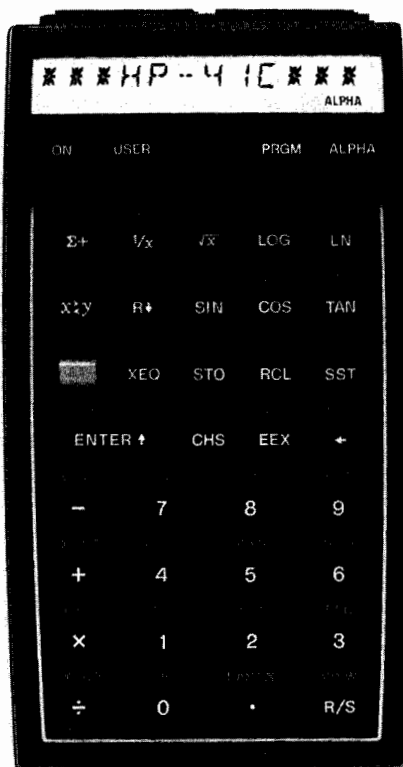

### HP-41C Alphanumeric Full Performance Programmable Calculator With Continuous Memory

The HP-41C incorporates the latest in calculator technology to give you a powerhouse of functions and features that will still slip right into your pocket. The HP-41C is fully-programmable with incredible power that can expand to over 2,000 lines of program memory. Or 319 registers for data storage. Or any mix of storage registers and program memory that you choose.

The HP-41C communicates with more than numbers. You can key in any combination of letters and numbers up to 24 characters wide. Twelve characters can be reviewed at one time. A complete system of status annunciators also help to keep you firmly in control of the HP-41C. You know whether the next key you press will be executed or "remembered" as a programming instruction; whether you're keying in numbers or alphabetic characters. You can tell at a glance the condition of program flags, trigonometric modes, battery life, even whether the shift key has been pressed. And error messages are displayed in plain, understandable English, too. For aural feedback, you can use the HP-41C "beeper." Ten different tones let you signal the end of a program or a data entry point without monitoring the display.

With a few keystrokes, you can actually create a "personalized" custom calculator for special applications. The HP-41C comes with some 58 popular functions ready to help you solve scientific and mathematic problems. And, over 130 separate operations comprise the total function library of the HP-41C. And, you can assign any of these functions or program to any key. To help you use this customizing feature, each HP-41C comes with two keyboard overlays and a set of user labels. You simply mark on the overlay above each key the function you've assigned to it. And whether you've assigned it to your personalized keyboard or not, every operation in the HP-41C's vast function library is always accessible. You merely press the special "execute" key and key the function name into the alphabetic display.

The HP-41C is equipped with Continuous Memory that preserves stored data, program information, flag states, trigonometric modes, and your user-defined "personalized" keyboard assignments and

- Customization with reassignable keyboard
- Each program is autonomous
- Special Application Modules can be plugged in

memory configuration, even though the calculator is turned off. As a result, you need only program frequently used programs once.

You can maintain more and longer programs in the HP-41C than you ever thought possible. Each program is autonomous. Call it up by name, edit it, even clear it without affecting other programs. And each program can have up to 99 local labels for addresses, subroutines, or defining parts of a program. Yet these independent programs are also interactive. Using global labels, you can summon one program or branch to a subroutine (up to six levels) from another program.

With your HP-41C calculator, the following items are standard accessories, included in the price of the calculator: Owner's Handbook and Programming Guide, Quick Reference Guide, Application Book, four size N batteries (ready to be installed), two keyboard overlays, one module/overlay holder, one set of function labels, and a soft carrying case.

### HP-41C Specifications

#### Preprogrammed Functions

**Mathematical:** SIN, COS, TAN, and inverses, DEG, RAD, GRD, R $\rightarrow$ P, Deg $\rightarrow$ Rad, H $\rightarrow$ H.MS, octal/decimal conversions, sign, modulo, INT, FRAC, ABS, rounding, log, 10<sup>x</sup>, LN, e<sup>x</sup>, ln(1+x), (e<sup>x</sup>)+1, y<sup>x</sup>,  $\sqrt{x}$ , x<sup>2</sup>, 1/x,  $\frac{1}{x}$ ,  $\frac{1}{x}$ , +, -,  $\times$ ,  $\div$ .

**Statistical:** %,  $\Delta\%$ ,  $\bar{x}$ , s, summations (n,  $\Sigma x$ ,  $\Sigma x^2$ ,  $\Sigma y$ ,  $\Sigma y^2$ ,  $\Sigma xy$ ), summation corrections, factorials.

**Alpha:** alpha mode on and off, alpha store and recall, alpha shift left, alpha view, append alpha display.

**User-definition:** assign key function, catalog list, copy, user mode selection, keyboard power on/off, continuous power on.

#### Programming Features

**Branching:** direct line branching; 99 numeric labels, unlimited alpha labels, labels; user-definable keys; indirect addressing of labels, data storage and recall, storage register arithmetic, alpha storage and recall, viewing register contents, display formats, looping, audible tone pitch, definition of accumulation registers, flag setting and clearing, flag tests, catalog list; six levels of subroutines; controlled looping; 30 user flags, 26 system flags, four flag test functions in addition to set flag and clear flag; ten conditional tests ( $x=0$ ,  $x\neq 0$ ,  $x<0$ ,  $x>0$ ,  $x\leq 0$ ,  $x=y$ ,  $x\neq y$ ,  $x<y$ ,  $x>y$ ,  $x\leq y$ ) two of which may be used with alpha strings ( $x=y$ ,  $x\neq y$ ).

**Editing:** singlestep execution, singlestep and backstep inspection of a program, delete program memory lines, position the calculator at any line in program memory, pause to review intermediate results, correction key to delete keystroke while entering data or alpha characters, change size of data storage register allocation, catalog positioning.

**General:** label program, alpha prompt, aural prompt, pack program memory, stop, end, programmable OFF, go to end of program memory and prepare calculator for new program.

#### General

**Clearing options:** clear display, clear x, clear all storage registers, clear alpha register, clear specific program, clear program flag, clear stack, clear statistics registers, clear prefix, clear keystroke (correction key).

**Display:** fixed decimal, scientific, and engineering notation.

**Memory:** last-x register, four-register stack, display. Continuous.

**Memory allocation:** The HP-41C comes standard with 63 registers (441 bytes), initially configured with 17 of these registers allocated to data storage registers and the remainder (46) to program memory. User can change the memory allocation to make room for more programs or to change the number of data storage registers. Memory can be expanded up to five times with plug-in Memory Modules. Standard memory of 63 registers (441 bytes) gives user from 200 to 400 lines of program memory; maximum memory (with four additional memory modules) of 319 registers (2,233 bytes) gives user from 1000 to 2000 lines of program memory.

**Power requirements:** four Size N batteries, not rechargeable.

**Size:** 33 mm (1.3 in)  $\times$  79 mm (3.1 in)  $\times$  144 mm (5.7 in).

**HP-41C Alphanumeric Full Performance Programmable Calculator With Continuous Memory** **\$295**



- The standard for professionals



Standing alone, the HP-41C is a powerful programmable problem-solving calculator. But by adding optional plug-in peripherals and modules, you can expand the capabilities of the HP-41C to keep pace with your growing computational requirements. It can become a printing calculator, can save hundreds of programs on magnetic cards, or can even become a "specialized problem-solving machine."

Four input/output (I/O) ports are provided on the top of the HP-41C for interfacing with these devices. Each quick-connect peripheral and module is self-contained, with its own set of functions that is added to the calculator's existing function library. And each is fully portable.

### HP 82106A Memory Module

These handy memory modules can actually quintuple the HP-41C calculator's memory. Each module contains an additional 64 registers that can be allocated as program memory or storage registers, or any combination. You can add four memory modules to your HP-41C system, providing you with a whopping 319 registers. (That's 2000 lines of program memory.) Like the calculator itself, the memory modules have Continuous Memory.

### HP 82104A Card Reader

The HP-41C is so easy to program—and the resulting programs so powerful and versatile—that you'll undoubtedly be inspired to write specialized programs for later use. When your programming output exceeds the sizeable capacity of the Continuous Memory in the HP-41C—or the even larger capacity with optional memory modules—you can permanently store your programs on magnetic cards using the HP 82104A Card Reader.

The HP-41C allows you to specify a single program you wish to record from its Continuous Memory onto a magnetic card. A program or group of registers need not be limited in length to the capacity of a single card (32 registers), it can be segmented among as many cards as necessary. You don't have to figure out whether more than one card is required for reading and writing the HP-41C does that for you automatically, then *tells* you by displaying a message.

Adding over 30 more functions to your calculating system, the "extra smart" HP 82104A Card Reader will even record any key assignments that are made to run the recorded programs. If you wish, you can ensure "program security"—a secured program can only be executed, *not* viewed or altered. And, the HP-41C has been specifically designed to accept a program or data on a magnetic card recorded on an HP-67 or HP-97, thus enabling you to utilize the vast number of specialized programs available from HP-67/97 User's Library.

### HP 82143A Printer

For a permanent record of calculation results, or for assistance in checking or editing long programs, you can connect an HP 82143A Printer to your HP-41C. Powered by its own set of batteries, it prints alphanumeric characters quietly and efficiently.

The printer can also be set to provide you automatically with valu-

able diagnostic information when creating or running a program. And when executing a program or series of manual keystrokes, the printer can provide a record of the numbers keyed in, functions performed, and answers calculated. The printer gives you numbers, upper and lower case letters, double-size characters, special characters, character plotting, and an intensity control for optimum contrast and readability. It even allows you to define your own "special" characters.

### HP 82153A Optical Wand

The HP 82153A Optical Wand permits you to load programs and data into the HP-41C quickly and easily. When plugged into one of the HP-41C ports, the Wand actually reads bar codes from a printed page, translating these codes into HP-41C program and data information as they are loaded into the calculator.

Drawing its power from the calculator, the Wand can load long programs into the HP-41C in a matter of seconds. And because HP-41C Solutions Books and User's Library programs are available with printed bar codes along with their step-by-step keystroke listings, the Wand makes it fast and easy to load a wide variety of software.

### HP-41C Application Pacs

Whether you're an engineer or technician, student or scientist, business person or professional, you'll find an Application Pac to solve the most common and the toughest problems in your area of interest.

Every Application Pac comes with a comprehensive manual, as well as a keyboard overlay. You simply plug in a module, put the keyboard overlay in place, and you're in business putting the combined problem-solving power of the HP-41C calculator and the module's functions and programs to work for you immediately. Choose from:

- Aviation
- Clinical Lab and Nuclear Medicine
- Circuit Analysis
- Financial Decisions
- Mathematics
- Games
- Home Management
- Real Estate
- Securities
- Statistics
- Stress Analysis—Mechanical Engineers
- Structural Analysis—Civil Engineers
- Surveying
- Machine Design
- Navigation
- Thermal and Transport Science

### Ordering Information

	Price
HP 82106A Memory Module	\$45
HP 82104A Card Reader	\$215
HP 82143A Printer	\$385
HP 82153A Wand	\$125
HP-41C Application Pacs	\$45 to \$75
HP-41C Solutions Books	\$12.50

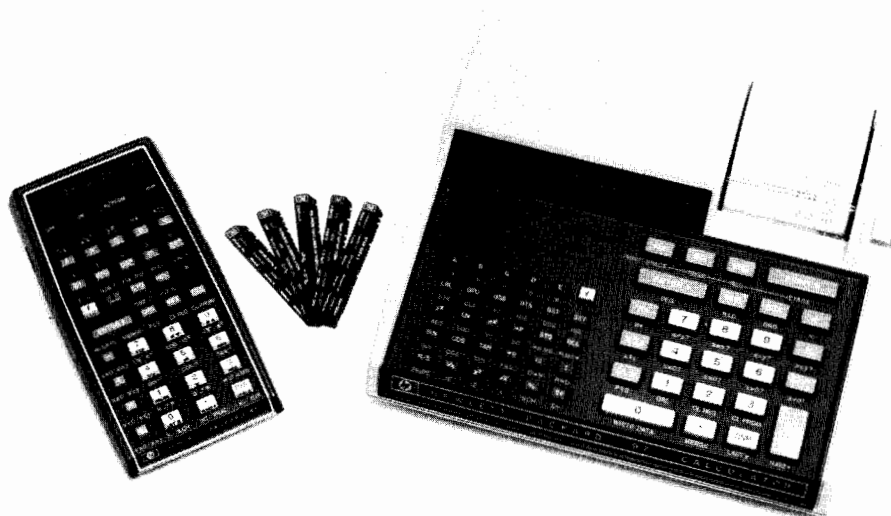

### HP-67 Handheld Fully Programmable and HP-97 Desktop Fully Programmable Printing

The HP-67 Handheld Fully Programmable calculator offers exceptional power to handle your lengthy and repetitive problems. For those who prefer a desktop version, the HP-97 Desktop Fully Programmable Printing calculator has all the capabilities of the HP-67, plus the convenience of a built-in printer—all battery operable.

Keystroke programming with the HP-67/97 is push-button easy. An editing feature, to easily correct and modify your programs, enhances both calculators. All commonly used mathematical, trigonometric and statistical functions are included. The HP-67/97 has 224 program lines, plus 26 storage registers.

These calculators come complete with: a detailed Owner's Handbook; quick reference card (HP-67 only); Standard Pac complete with 40 magnetic cards, card holder, and manual; rechargeable battery pack; recharger/AC adapter; programming pad; soft carrying case; and 2 rolls of thermal paper (HP-97 only).

Both calculators are supported by an array of HP designed Application Pacs,

- Business Decisions Pac
- Civil Engineering Pac
- Clinical Lab & Nuclear Medicine Pac
- Stat Pac I
- ME Pac I
- EE Pac I
- Games Pac
- Math Pac I
- Navigation Pac
- Surveying Pac I

Another important customer service is the HP's User's Library—which offers a broad range of programs written by the user, for the user and administered by Hewlett-Packard.

### HP-67 and HP-97 Specifications

**Mathematical functions:** sin, cos, tan,  $\sin^{-1}$ ,  $\cos^{-1}$ ,  $\tan^{-1}$ , three trigonometric modes (degrees, radians, grads), rectangular/polar coordinate conversions, degree/radian conversions, hours-minutes-seconds addition and conversion to decimal hours, integer/fraction truncation, absolute value, rounding, log,  $10^x$ , LN,  $e^x$ ,  $y^x$ ,  $\sqrt{x}$ ,  $x^2$ ,  $1/x$ ,  $\uparrow$ ,  $\downarrow$ ,  $\pm$ ,  $\times$ ,  $\div$ .

**Statistical functions:** percent, percent change, mean and standard deviations, summations ( $n$ ,  $\Sigma x$ ,  $\Sigma x^2$ ,  $\Sigma y$ ,  $\Sigma y^2$ ,  $\Sigma xy$ ), factorials.

### Programming Features

**Card reader:** record/load all data registers; load selected data registers; record/load entire program memory; merge program subsections; angular mode, flag settings, and display status are recorded with program recording and reset with program loading; user is prompted for proper operation when loading; card reader operations can be initiated manually or under program control (except program recording).

**Branching:** direct line branching; label addressing, 10 user-definable keys or 20 labels; indirect addressing of labels and data storage; three levels of subroutines, controlled looping, four flags, eight conditional tests ( $x=0$ ,  $x \neq 0$ ,  $x < 0$ ,  $x > 0$ ,  $x=y$ ,  $x \neq y$ ,  $x < y$ ,  $x > y$ ).

**Editing:** singlestep execution, singlestep and backstep inspection of a program, insert/delete editing, position the calculator at any step in program memory, pause to review intermediate results, key in data, or load magnetic cards.

### HP-97 Printing Features

Quiet, thermal printer lets you record and level your calculations. Print mode switch selects three printing modes. In addition, you can print and label the contents of the stack registers, the primary data storage registers, program memory, and the display.

### General

**Clearing options:** clear x, clear registers, clear program.

**Display:** fixed decimal, scientific, and engineering notation.

**Memory:** 224 program lines, 26 storage registers, four-register stack, last-x register.

**HP-67 power requirements:** 86 to 127 Vac or 172 to 254 Vac, 50 to 60 Hz, or 3.75 Vdc nickel cadmium rechargeable battery pack.

**HP-97 power requirements:** 90 to 127 Vac or 200 to 254 Vac, 50 to 60 Hz, or 5.0 Vdc nickel cadmium rechargeable battery pack.

**HP-67 size:** 18 to 34 mm (0.7 to 1.4 in)  $\times$  81 mm (3.2 in)  $\times$  152 mm (6 in).

**HP-97 size:** 64 mm (2.5 in)  $\times$  229 mm (9 in)  $\times$  203 mm (8 in).

### Ordering Information

	<b>Price</b>
HP-67 Handheld Fully Programmable Calculator	\$375
HP-97 Desktop Fully Programmable Printing Calculator	\$750
HP-67/97 Application Pacs	\$35
HP-67/97 Solution Books	\$10



## HP-37E Business

The HP-37E is the basic financial calculator for most business and financial problems. Designed to assist real estate agents, retailers, managers, financial analysts, and business students in solving financial problems quickly and easily.

In addition to built-in price and percent functions and advanced statistical functions the HP-37E features the basic time and money functions;  $n$  (number of compounding periods),  $i$  (interest rate), PV (present value), PMT (payment), and FV (future value). With the HP-37E you can also calculate amortization schedules, yields with a balloon, present and future value, as well as several other business problems.

To expand the HP-37E's problem-solving capability, HP has developed a number of specific applications books that address these areas: Real Estate; Real Estate II (Income Property Analysis); Investment Analysis and Statistics; Lending, Savings, and Leasing; and Marketing and Forecasting.

The HP-37E comes complete with a detailed Owner's Handbook, the informative, "Your HP Financial Calculator: An Introduction to Financial Concepts and Problem-Solving," recharger/AC adapter, rechargeable battery pack, soft carrying case, and your choice of one of the optional applications books (free).

## HP-37E Specifications

**Financial functions:**  $n$ ,  $i$ , PV, PMT, FV, amortization (accumulated interest, payment to principal, remaining balance), BEGIN-END switch for ordinary or annuity due problems.

**Mathematical functions:**  $+$ ,  $-$ ,  $\times$ ,  $\div$ ,  $1/x$ ,  $\sqrt{x}$ ,  $y^x$ , LN,  $e^x$ .

**Statistical functions:** percent,  $\Delta\%$ ,  $\%T$ , price,  $\bar{x}$ ,  $s$ ,  $r$ , L.R.,  $\hat{x}$ ,  $\hat{y}$ ,  $\Sigma+$ ,  $\Sigma-$ ,  $(n, \Sigma x, \Sigma x^2, \Sigma y, \Sigma y^2, \Sigma xy)$ , factorials.

**Clearing options:** CLX, FINANCE, ALL.

**Memory:** seven storage registers, five financial registers, four-register stack.

**Recharger power requirements:** 90 to 120 Vac or 198 to 242 Vac (50 to 60 Hz).

**Size:** 30 mm (1.2 in)  $\times$  75 mm (3.0 in)  $\times$  140 mm (5.6 in).

## HP-38C Advanced Financial Programmable With Continuous Memory

The HP-38C is Hewlett-Packard's most powerful financial calculator. It combines a wide array of financial functions plus the ability to remember all the keystrokes in a calculation and then repeat them with the touch of a key. Featuring 20 data storage registers and 99 program lines, the HP-38C has Continuous Memory which allows you to retain data and programs even when the calculator is turned off.

The HP-38C is designed to solve tough financial problems for professional real estate agents, financial analysts, accountants, bankers and business students. This calculator has the advanced financial capability of discounted cash flow using either NPV or IRR as well as basic time and money functions ( $n$ ,  $i$ , PV, PMT and FV).

Additionally, the HP-38C extends its problem-solving with an easy-to-master programming capability that lets you solve repetitive financial and investment analysis problems quickly and easily.

With the HP-38C you can create your own programs or choose from the following Applications Books: Real Estate; Real Estate II (Income Property Analysis); Investment Analysis and Statistics; Lending, Savings and Leasing; Marketing and Forecasting; and Personal Finance.

The HP-38C comes complete with: A detailed Owner's Handbook, the informative "Your HP Financial Calculator: An Introduction to Financial Concepts and Problem-Solving," recharger/AC adapter, rechargeable battery, quick reference card, soft carrying case, and your choice of one of the optional applications books (free).

## HP-38C Specifications

**Financial functions:**  $n$ ,  $i$ , PV, PMT, FV, amortization (accumulated interest, payment to principal, remaining balance), simple interest, NPV, IRR, automatic entry for grouped or individual cash flows, BEGIN-END switch for ordinary or annuity due problems.

**Mathematical functions:**  $+$ ,  $-$ ,  $\times$ ,  $\div$ ,  $1/x$ ,  $\sqrt{x}$ ,  $y^x$ , LN,  $e^x$ , round, integer/fraction truncation.

**Statistical functions:**  $\%$ ,  $\Delta\%$ ,  $\%T$ ,  $\bar{x}$ ,  $s$ ,  $r$ , L.R.,  $\hat{x}$ ,  $\hat{y}$ , summations ( $n, \Sigma x, \Sigma x^2, \Sigma y, \Sigma y^2, \Sigma xy$ ), factorials.

**Calendar functions:** 2000-year calendar; finds number of days between two dates, date with day of week, future or past date, all with 360- or 365-day calendar basis.

**Programming features:** SST, BST, BTO, GTO, R/S, pause, two conditional tests ( $x=0$ ,  $x \geq y$ ).

**Clearing options:** CLX, FINANCE, STATISTICS, PREFIX, PRGM, ALL.

**Memory:** five financial registers, four-register stack, last-x register. Dynamic memory allocation between storage registers and program memory.

**Recharger power requirements:** 90 to 120 Vac or 198 to 242 Vac (50 to 60 Hz).

**Size:** 30 mm (1.2 in)  $\times$  75 mm (3.0 in)  $\times$  140 mm (5.6 in).

## Ordering Information

	Price
HP-37E Business Calculator	\$ 75
HP-38C Advanced Financial Programmable Calculator with Continuous Memory	\$150
Optional Applications Books	\$ 5



# COMPUTERS, PERIPHERALS & CALCULATORS

## Personal Computation

### Calculator Accessories

- Increase the versatility of your calculator.
- Customize your HP calculator to your applications.



### Solution Books

As your problem-solving capabilities grow, HP helps you grow. You may find that the programs you require already exist in Solution Books. HP-67/97 and HP 41C Solution Books contain programs written to solve a wide variety of problems.

#### HP-41C Solution Books

##### Business

- Business Statistics/Marketing/Sales
- Home Construction Estimating
- Lending, Savings, and Leasing
- Real Estate
- Small Business

##### Engineering

- Antennas
- Chemical Engineering
- Civil Engineering
- Control Systems
- Electrical Engineering
- Fluid Dynamics and Hydraulics
- Heating, Ventilating, and Air Conditioning
- Mechanical Engineering
- Solar Engineering
- Surveying

##### Computation

- Geometry
- High-Level Math
- Test Statistics

##### Other

- Cardiac/Pulmonary
- Chemistry
- Games
- Optometry I (General)
- Optometry II (Contact Lens)
- Physics

### HP-67/97 Solutions Books

##### Business

- Home Construction
- Home Management
- Marketing/Sales
- Options/Technical Stock Analysis
- Real Estate Investment
- Portfolio Management
- Bonds and Notes
- Small Business
- Taxes

##### Computation

- Geometry
- High-Level Math
- Test Statistics

##### Optional Accessories

In keeping with the growing number of HP personal calculator owners, Hewlett-Packard provides a full line of personal calculator accessories.

- DC Adapter/Recharger
- Reserve Power Pack
- Security Cradle/Cable
- Hard Leather Case
- Battery Pack
- Recharger/AC Adapter
- Soft Case

##### Engineering

- Antennas
- Beams and Columns
- E.E. (lab)
- Industrial Engineering
- Thermal and Transport Sciences

##### Other

- Chemistry
- Energy
- Games

- Owner's Handbook
- Thermal Printing Paper
- Program Pad
- Blank Program Cards
- Overlay Kit
- Module Holders

# COMPUTERS, PERIPHERALS & CALCULATORS

Personal Computation

Comparison Chart

619



Operating Features	Programmable					
	Business		Advanced			Scientific
	HP-37E	HP-38C	HP-67/97	HP-41C	HP-34C	HP-33C HP-32E
RPN logic system	●	●	●	●	●	●
Automatic 4-memory stack	●	●	●	●	●	●
Error recovery (Last x)	—	●	●	●	●	●
Stack manipulation	●	●	●	●	●	●
Maximum number of storage registers	7	20	26	319	21	8 15
Continuous Memory	—	●	—	●	—	●
Maximum number of digits displayed	10	10	10	10	10	10 10
Number of digits used in computation	10	10	10	13	10	10 10
Rechargeable batteries/AC recharger	●	●	—	—	—	●
Long-life disposable batteries	—	—	—	●	—	—
Software Support						
Application Pacs (with modules)	—	—	—	●	—	—
Application Pacs (with mag cards)	—	—	—	●	—	—
Solutions Books	—	—	—	●	—	—
Users' Library programs	—	—	—	●	—	—
Applications books	●	●	—	●	●	—
Accessory Support						
Memory modules	—	—	—	●	—	—
Reserve power pack	●	●	●	—	●	●
Security cradle/cable	—	—	●	—	—	—
Multipurpose Rechargeable Battery Pack	—	—	—	●	—	—
One-year limited warranty	●	●	—	●	—	●
Display separates 1,000's	●	●	—	●	—	●
Diagnostic self-check	●	●	M	—	●	—
Error codes/messages	●	●	—	●	—	●
Reassignable keyboard	—	—	—	●	—	—
Alpha mode/display	—	—	—	●	—	—
Alpha prompts	—	—	—	●	—	—
Status annunciators	—	—	—	●	—	—
Automatic power off	—	—	—	●	—	—
Catalog of functions, programs and peripheral functions	—	—	—	●	—	—
Audible tones	—	—	—	●	—	—
Programming Features						
Maximum number of program lines	—	99	224	2000	210	49
Memory allocation	—	●	—	●	—	—
Redefinable keyboard	—	—	—	●	—	—
Alpha program labels	—	—	—	●	—	—
Single character program labels	—	—	10	56	2	—
Numeric program labels	—	—	10	99	10	—
Program review (single step, back step)	—	●	●	●	●	—
Insert/delete editing	—	—	●	●	●	—
Unconditional branching	—	●	●	●	●	—
Levels of subroutines	—	—	3	6	6	3
Conditional tests	—	2	8	10	8	8
Flags	—	—	4	56	4	—
Pause	—	●	●	●	●	—
Controlled Looping	—	—	●	●	●	—
Indirect control of:						
Data storage and recall	—	—	●	●	●	—
Alpha storage and recall	—	—	—	●	—	—
Storage register arithmetic	—	—	●	●	●	—
Branching, looping, and display	—	—	●	●	●	—
Flags	—	—	—	●	—	—
Integer/fraction truncation	—	●	●	●	●	—
Alpha string manipulation	—	—	—	●	—	—
Input/Output Devices						
"Smart" card reader	—	—	●	P	—	—
Program card compatibility	—	—	C	C	—	—
Records private programs	—	—	—	P	—	—
Whisper-quiet printer	—	—	97	P	—	—
Battery operable	—	—	97	P	—	—

Operating Features	Programmable					
	Business		Advanced			Scientific
	HP-37E	HP-38C	HP-67/97	HP-41C	HP-34C	HP-33C HP-32E
Manual/trace/normal modes	—	—	—	P	—	—
Alpha and special characters	—	—	—	P	—	—
Plotting capability	—	—	—	P	—	—
Optical wand (bar code reader)	—	—	—	P	—	—
General Features						
+ , - , X, + , y <sup>x</sup> , √x, 1/x, CHS	●	●	●	●	●	●
Ln x, e <sup>x</sup>	●	—	●	●	●	●
Log x, 10 <sup>x</sup>	—	—	●	—	—	—
x <sup>2</sup>	—	—	●	●	●	●
π	—	—	●	●	●	●
Absolute value	—	—	●	●	●	●
Storage register arithmetic	●	●	●	●	●	●
Business Features						
Maximum number of financial registers	8	5	5	—	—	—
Solves for:						
Number of periods (n), Compound interest	—	—	—	—	—	—
(i), Present value (PV), payment (PMT), Future value (FV)	●	●	M	MR	A	A
Simple interest	—	●	M	A	—	—
Accumulated interest/remaining balance (amortization)	●	●	M	MR	●	A
Net present value (NPV) and internal rate of return (IRR)	—	●	M	MR	A	—
Price	●	—	—	—	—	—
Beginning of period/End of period selection	●	●	M	MR	A	—
Calendar functions	—	●	M	MR	—	—
Scientific Features						
Solve (rootfinder)	—	—	M	MR	●	—
Integrate (numerical integration)	—	—	M	MR	●	—
Metric conversions	—	—	M	MR	—	●
Trigonometric functions						
Modes (degrees, radians, grads)	—	—	●	●	●	●
Sin, Sin <sup>-1</sup> , Cos, Cos <sup>-1</sup> , Tan, Tan <sup>-1</sup>	—	—	●	●	●	●
Hyperbolics and inverses	—	—	M	R	A	A
Rectangular coordinates → Polar coordinates	—	—	●	●	●	●
Decimal angle → angle in degrees (hrs)/min/sec	—	—	●	●	●	●
Degrees → radians	—	—	●	●	●	●
Fixed and scientific notation	●	●	●	●	●	●
Engineering notation	—	—	●	●	●	●
Automatic overflow/underflow into scientific	●	●	●	●	●	●
Decimal-octal conversion	—	—	—	●	—	—
Statistical Features						
Percent	●	●	●	●	●	●
Percent change	●	●	●	●	●	●
Percent of total	●	●	●	—	—	●
Mean/standard deviation (1 or 2 variable)	●	●	●	●	●	●
Summation (Σx, Σx <sup>2</sup> , Σy, Σy <sup>2</sup> , Σxy, n)	●	●	●	M	●	●
Linear regression/estimate	●	●	M	MR	●	●
Correlation coefficient	●	●	M	MR	●	●
Normal distribution	—	A	M	MR	A	●
Factorial function	—	—	●	●	●	●
Gamma function	—	—	M	M	●	—

Symbols

- M Available on prerecorded magnetic program cards.
- R Available with ROM (read only memory) Application Pac.
- P Available with peripheral
- C 67/97 → 67/97, 87/97 → 41C, 41C → 41C.
- A Available program in application book.
- Built-in function.
- Not available.





# COMPUTERS, PERIPHERALS & CALCULATORS

## Personal computers

### Model HP-85A

- BASIC language programming
- Integrated graphics
- Display, keyboard, printer, tape drive built in
- Customization possible with Application Pacs
- Double memory size with plug-in RAM module



### HP-85A

The HP-85A is a powerful BASIC language computer complete with keyboard, CRT display, printer, and tape drive—all built into one unit. An impressive graphics system is integrated into the HP-85 as a standard feature. Four ports allow you to expand the memory, add enhancement modules, and attach peripherals. Application Pacs on tape cartridges let you customize the system to fit your needs. The complete unit weighs 20 pounds—light enough to carry.

#### BASIC Language

You don't have to be a computer programmer to use the new HP-85. The key to the HP-85's simplicity and power is the BASIC programming language. English-like commands are straightforward and easy to remember and you can apply it to engineering, business, mathematics—any discipline. Then when you take it home, it can do the family budget, tutor the children, or entertain with a variety of games.

And the HP-85 BASIC not only meets the standard for minimal BASIC set down by the American National Standards Institute, it actually exceeds this standard.

#### Graphics is Standard

The HP-85 has a dazzling array of graphics capabilities that add up to an advanced graphics system. Simplicity is maintained by integrating these capabilities into the BASIC language. The HP-85 even lets you interact from the keyboard in graphics mode. And once the display is just the way you want it, you can print it out with a single command.

#### Built-In Keyboard, Display, Printer, and Tape Drive

All of the components of the HP-85 are built into one unit. The computer, keyboard, display, tape drive, and printer are also completely *integrated*. This means they are designed to operate together as a system. And at 20 pounds, the HP-85 can easily be moved or carried. An optional carrying case makes it even more convenient.

Display editing is convenient, easy, and powerful. The display shows 16 lines at a time and display memory holds up to 64 lines. Roll up and roll down keys let you see the lines you need from display memory. Using the display editing keys you can move the cursor anywhere on the bright, clear display. Once positioned, editing keys let you make desired changes.

The thermal printer is fast and quiet. At two lines per second, the built-in printer gives you a quick copy of the display, outputs from

your programs, and copies of your graphics. A single command copies whatever is in the display to the printer. And the new bidirectional thermal printer design provides excellent print quality with adjustable intensity.

Magnetic tape cartridges supply the HP-85 with high quality digital storage. The high-density tape cartridges are used for temporary or archival storage of data and programs. High search speed and data access rates coupled with automatic tape directories give the HP-85 superior storage capabilities. Each magnetic tape cartridge can hold up to 217 K bytes in up to 42 separate files. You can find out exactly what is on any tape with the catalog command. It tells you the name, type, and length of every file on the tape.

#### HP-85 Application Pacs

Preprogrammed solutions to special problems help you customize your HP-85 to fit your needs. The Application Pacs come on prerecorded magnetic tape cartridges and are available in a variety of disciplines. Each pac consists of a prerecorded tape cartridge and a handbook that provides details about the programs on the tape and instructions for their use.

#### HP 82903A 16K Memory Module

This module plugs into one of the HP-85 ports and adds 16K bytes of computer memory. The HP-85 will accept only one memory module. If your application includes programs like network analysis, data base management, or large graphics and plotting routines, you may need the memory module.

#### HP-85A Specifications

**Memory:** 16K bytes (10% overhead), expandable to 32K bytes with 16K RAM module.

**CRT:** 5" diagonal (adjustable intensity).

**Thermal Printer:** 32 character width, 2 lines per second, bidirectional printing.

**Magnetic Tape Cartridge:** 217K byte capacity, 42 separate files, search speed 60 ips, read/write speed 10 ips.

**Power requirements:** 90-127 Vac (115 Vac line), 200-254 Vac (230 Vac line), switchable at rear panel. Frequency: 50-60 Hz.

**Size:** 15.9 cm (6.25 in) × 41.9 cm (16.5 in) × 45.2 cm (17.8 in).

#### Ordering Information

**HP-85A Personal Computer;** includes 16K bytes read/write memory (10% overhead), built-in graphics, keyboard, tape drive unit, display, and thermal printer

**HP 82903A 16K Memory Module**

**Price**

\$3250

\$395

# COMPUTERS, PERIPHERALS, & CALCULATORS

621

Personal Computation

HP-85A Peripherals & Interfaces



## System Expansion Capability

The HP-85A is designed as an open-ended expansion oriented system. The application of Enhancement ROMS and Interface Cards provides advanced I/O capability usually found in larger systems. HP-IB and RS-232 allow the system to employ many powerful peripherals.

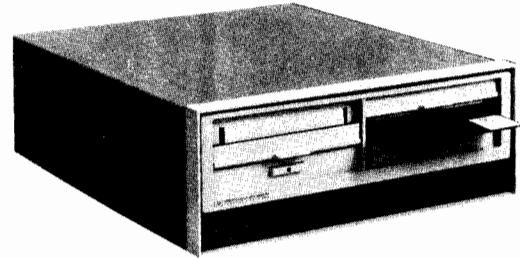

## 9895A Flexible Disc Drive

Supplies up to 2.36 million bytes of mass storage capacity on 8 inch discs with additional capacity available through an optional dual-drive slave unit without controller.

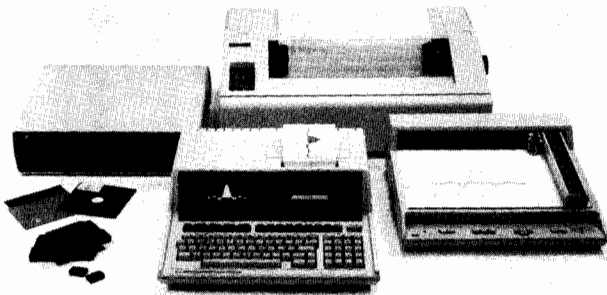

Shown above is the HP-85A with the 7225A Graphics Plotter, 2631B Impact printer, 82901M flexible Disc Drive, and the 82936A ROM Drawer with ROMS—only a few of the powerful Hewlett-Packard Peripherals that expand the capability of the HP-85A.

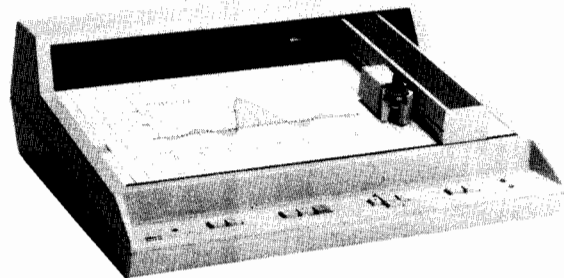

## 7225A Graphics Plotter

Produces high-quality plots on any size charts up to 210 x 297 mm (8.3 x 11.7 in.). Exceptional line quality with addressable moves as small as 0.32 mm (0.0013 in.). A 17601A Opt. 085 Personality Module (plugs into the 7225A) is required for interfacing with the HP-85. The Plotter/Printer ROM (00085-15002) completes the interface with an integrated plotting package.

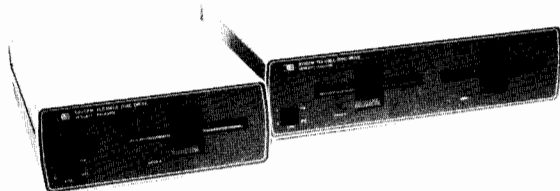

## 82900 Series and 9895A Disc Drives

These disc drives read a double-sided double density format on HP qualified flexible discs.

### 82901M Flexible Disc Drive\*

Supplies approximately 540k bytes of on-line storage. This disc drive consists of one master controller with two drives. You can add one 82901S or one 82902S for a maximum of four drives.

### 82902M Flexible Disc Drive\*

Supplies approximately 270k bytes of on-line storage. This disc drive consists of one master controller and one drive. You can add one 82901S or one 82902S.

### 82901S Flexible Disc Drive

Supplies an additional 540K bytes of on-line storage. Must be connected to an 82901M or 82902M.

### 82902S Flexible Disc Drive

Supplies an additional 270K bytes of on-line storage. Must be connected to an 82901M or 82902M.

\* The HP-IB Interface module (82937A) and the Mass Storage ROM (00085-15001) combine to integrate the disc into the system and add 30 operations that enable complete control and utilization of the 82900 Series disc drives as well as other Mass Storage devices.

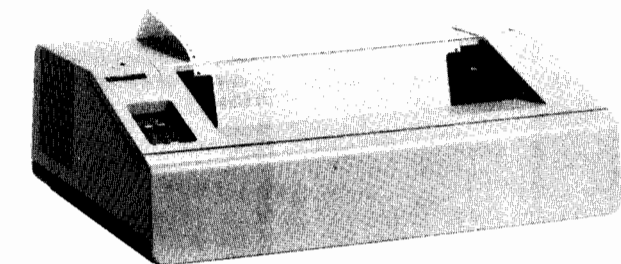

## 2631B Impact Printer

A full-size, high-speed, bidirectional, dot-matrix, impact printer. Prints 180 characters per second on inexpensive computer paper or multipart forms. Has eight print sizes and forms tractor. The Plotter/Printer ROM (00085-15002) integrates the printer into the system.

## Ordering Information

	Price
82901M Flexible Disc Drive	\$2500
82902M Flexible Disc Drive	\$1500
82901S Flexible Disc Drive	\$2200
82902S Flexible Disc Drive	\$1300
9895A Dual drive with controller	\$6500
9895A Option 010 Single drive with controller	\$4750
9895A Option 011 Single drive without controller	\$3750
9895A Option 012 Dual drive slave without controller	\$5500
7225A Graphics Plotter	\$2050
2631B Impact Printer	\$3650



• Shown above is the 82936A ROM drawer with ROMs.

### 82936A ROM Drawer

The ROM drawer plugs into an HP-85 port. The drawer has slots for six ROMs.

### Mass Storage ROM (00085-15001)

Adds 30 operations that enable complete control and utilization of HP 82900 Series and 9895A Flexible Disc Drives.

### Plotter/Printer ROM (00085-15002)

Enables you to interface your HP-85 with Hewlett-Packard's high-resolution graphics plotters and full-width line printers.

### I/O ROM (00085-15003)

The I/O ROM provides BASIC language extensions for general I/O capability for a variety of interfaces and devices.

### Matrix ROM (00085-15004)

The Matrix ROM provides a powerful set of statements and functions for working with both matrix (two dimensional arrays) and vectors (one dimensional arrays).

### 82937A HP-IB Interface Card

The 82937A interface implements the IEEE 488-1978 Standard Digital Interface for Programmable Instrumentation and is required for interfacing all peripherals. It may communicate to as many as 14 HP-IB compatible instruments per interface.

### 82939A Serial Interface Card

The bit serial interface provides RS-232C compatible I/O for communication with devices such as printers and terminals.

**Option 001**—Serial interface module with male connector for the HP-85.

**Option 002**—Serial interface module with current loop cable for the HP-85.

### 82940A GPIO Interface Card

This interface provides 16-bit general purpose input/output operation for connection to TTL-type signal levels.

### 82941A BCD Interface Card

This interface provides the hardware necessary for connection to devices having BCD (binary coded decimal) outputs.

### HP-85F Interfacing System

Includes: HP-85A, 82936A ROM Drawer, I/O ROM (00085-15003), and 82937A HP-IB Interface.

### HP-85F Interfacing System Option 001

Includes: HP-85A, 82936A ROM Drawer, I/O ROM (00085-15003), and 82939A Serial Interface.

### HP-85F Interfacing System Option 002

Includes: HP-85A, 82936A ROM Drawer, I/O ROM (00085-15003), and 82939A Option 001 Serial Interface.

### HP-85F Interfacing System Option 003

Includes: HP-85A, 82936A ROM Drawer, I/O ROM (00085-15003), and 82939A Option 002 Serial Interface.

### HP-85F Interfacing System Option 004

Includes: HP-85A, 82936A ROM Drawer, I/O ROM (00085-15003), and 82940A GPIO Interface.

### HP-85F Interfacing System Option 005

Includes: HP-85A, 82936A ROM Drawer, I/O ROM (00085-15003), and 82941 BCD Interface.

### Ordering Information

	Price
82936A ROM Drawer	\$45
Mass Storage ROM (00085-15001)	\$145
Plotter/Printer ROM (00085-15002)	\$145
I/O ROM (00085-15003)	\$295
Matrix ROM (00085-15004)	\$145
82937A HP-IB Interface Card	\$395
82939A Serial Interface Card	\$395
82939A Serial Interface Card Option 001	\$395
82939A Serial Interface Card Option 002	\$395
82940A GPIO Interface Card	\$495
82941A BCD Interface Card	\$495
HP-85F Interfacing System	\$3985
HP-85F Interfacing System Option 001	\$3985
HP-85F Interfacing System Option 002	\$3985
HP-85F Interfacing System Option 003	\$3985
HP-85F Interfacing System Option 004	\$4085
HP-85F Interfacing System Option 005	\$4085

# COMPUTERS, PERIPHERALS & CALCULATORS

623

## Desktop Computers

Models 97S, 9815S, 9825B, 9825T



9825B/T



97S

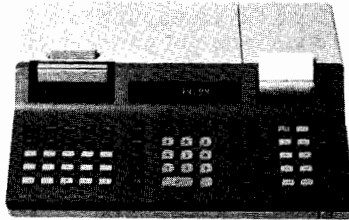

9815S

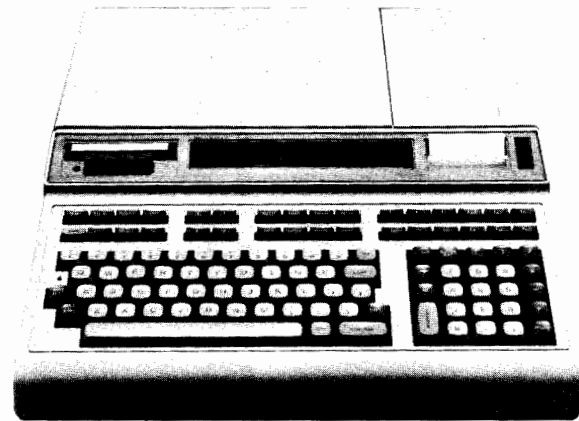

9825B/T

The 9825B or 9825T Desktop Computer offers many features previously found only on minicomputers. It is particularly suited to controller applications and is a powerful stand-alone device. The 9825T includes a larger memory than the 9825B.

### Packaged System

Both the 9825B and the 9825T provide a compact computing system with built-in peripherals. The 9825B includes 23K bytes of read/write memory and internally integrated ROMs (read-only memories) for Strings, Advanced Programming, Plotters, General I/O and Extended I/O. The 9825T has 62K bytes of read/write memory, all the built-in ROMs of the 9825B plus a built-in Systems Programming ROM.

A 32-character LED display and a built-in 16-character thermal printer provide alphanumeric readout including both capital and lower case letters. The high-speed bidirectional data cartridge holds 250K bytes and has an average access time of 6 seconds to any place on the tape. File verification is automatic on recording.

Twelve Special Function keys on the keyboard, combined with the shift key, can handle 24 different operations. They can serve as immediate execute keys, as call keys for subroutines, and as typing aids.

### Powerful Programming

The 9825 is programmed in HPL, a high-level, formula-oriented language. HPL provides for subroutine nesting and flags and allows 26 simple variables and 26 multidimensional array variables, limited only by the size of the 9825's memory. Fixed- and floating-point formats can be set from the keyboard. Syntax checking is simple: a flashing cursor in the display identifies error locations.

The 9825 offers several contributions that make it a powerful and flexible programmable computer. Live keyboard lets the user examine and change program variables, perform complex calculations, call subroutines, and record or list programs while the 9825 is performing other operations. The internal calculation range is  $\pm 10^{511}$  to  $\pm 10^{-511}$ . The tape cassette can be used to record and load the entire memory automatically.

### I/O Performance

Three I/O slots accept standard interface cards offering 16-bit parallel, BCD, serial, or HP-IB communication with instruments and peripherals. Code conversion logic is available to interpret a variety of machine codes. High-speed I/O handles data input speeds up to 400K 16-bit words/second. This is all accessible through formatted and binary read/write instructions in the HPL language.

With two-level priority interrupt, available in the Extended I/O ROM, the 9825 will act as a controller for several instruments or peripherals requiring attention at unpredictable rates or times. Stand-alone controlling is enhanced with auto restart and interface status testing.

### Ordering Information

	Price
97S I/O Calculator	\$1375
97SD Five 97S I/O Calculators	\$6530
9815S Desktop Computer	\$3800
9825B Desktop Computer	\$7700
9825T Desktop Computer	\$8200

### 97S

Flexible and simple interfacing is a design feature that makes the 97S a cost-effective solution for low-cost BCD data acquisition applications. In addition to the features of the 97A Scientific Programmable Calculator, the 97S allows a reading of up to 10 BCD digits to be input to the calculator at about 1 reading per second. Comparisons of input data with standards or other computations can then be easily performed. Magnetic cards provide data or program storage and an internal thermal printer provides hard copy output.

Instruments interfaced to the 97S include electronic balances, gaging and measurement systems, spectrophotometers, gamma counters, and chemical analyzers. A manual with all technical data and examples is included. A data sheet and supplement describing the interfacing with examples is available.

### 9815S

The 9815S offers economical solutions to dedicated data acquisition and computation problems. The integration of peripherals into a small package, plus price/performance flexibility, provide attractive solutions for OEMs.

Single keystrokes provide math and transcendental functions. For repetitive problem solving, simply program the keystrokes into the computer memory. The 9815S offers 3800 program steps. Ten data registers are always available and program steps can be assigned as additional data registers. The efficient RPN programming language has enhanced features such as FOR-NEXT loops, symbolic and calculated branching and nesting of subroutines. Fifteen keys can be defined to provide special functions by simply pressing a key.

The tape drive allows up to 96K bytes of program or data storage and a numeric display and 16-character alphanumeric printer are included. With the Auto-start feature, simply inserting a tape cartridge and turning on the machine will load the first program and run it, prompting the user for interaction. Operation of a system thus requires minimal operator training.

Two I/O channels allow use in data acquisition and control applications. The 98133A BCD interface allows 9-digit input at up to 2000 readings per second as well as an 8-bit output. The 98134A is a general purpose bidirectional 8-bit parallel interface providing transfer rates of up to 800 bytes/sec. The 98135A provides HP-IB compatibility. Up to 14 peripherals and instruments can be interconnected to one HP-IB interface. RS232C compatible serial I/O as well as current-loop receive-only capability is available with the 98136A. Peripherals are interfaced using standard interfaces. In addition to printers and digitizers, a paper tape punch, a four-color plotter and a low-cost plotter are available.

Software packages for Statistics and Financial Analysis and Electrical Engineering are also available.



# COMPUTERS, PERIPHERALS & CALCULATORS

## Desktop Computers

### Series 9800 System 35



Series 9800 System 35A



### Series 9800 System 35

System 35 is a powerful, integrated desktop computer that is ideal for many scientific, manufacturing and engineering applications involving computation, data acquisition, instrument control, production/process control, engineering design, automation and statistical/numerical analysis. It offers a large user-available memory (64K bytes expandable to 256K bytes), a built-in tape cartridge drive (217K bytes/tape), an optional CRT display, a built-in 16 column thermal line printer (optional) and an impressive array of interfacing and I/O capabilities.

System 35 has the power you'd expect from a mini-computer, yet it retains the friendliness of an HP Desktop computer in both system design and programming language.

#### Languages

##### BASIC

System 35's HP Enhanced BASIC is easy to learn and use, yet it is much more powerful than the standard ANSI BASIC. It offers many of the convenient features of FORTRAN and APL including subprograms, multi-dimensional numeric arrays, string arrays, and multi-character identifiers. An option provides System 35 with several structured BASIC statements. These include looping constructs such as REPEAT...UNTIL, WHILE...END WHILE, LOOP EXIT IF...END LOOP; decision constructs such as IF...THEN...ELSE and SELECT (CASE) statements; and two documentation aids, INDENT and XREF.

**Assembly.** The system 35 can also be programmed in Assembly Language by experienced programmers. For certain specialized computational and I/O operations, Assembly programming can increase program execution speeds by a factor of 100 or more. For more general applications, Assembly Language may be of little benefit. Assembly Language capability is available as a set of optional System 35 Read-Only Memories (ROMs).

- Complete I/O capability
- User R/W memory from 64K to 256K bytes
- HP Enhanced BASIC
- Assembly Language and Structured Programming options
- Optional CRT
- Built-in thermal line printer (optional) and tape cartridge drive
- Interactive keyboard
- Data Comm capability
- Wide range of peripherals



Series 9800 System 35B



#### CRT

The optional 12 in. (diag.), monochromatic CRT (available on the 9835A) can display 20 lines of alphanumeric program or data at a time. Each line can contain up to 80 characters. If a CRT is not needed, the 9835B has a 32-character single-line LED display.

#### Data Communication

An optional High-Speed Asynchronous Data Comm package is configured to allow the System 35 to connect to a large host computer via a hard wired or modem link. It provides for emulation of an alphanumeric or graphics terminal that uses ASCII characters. Also, a new RJE Bisync software/firmware package permits the System 35 to communicate with any host computer that supports or emulates an IBM 2780 or 3780 terminal.

#### I/O

The optional I/O ROM (98332A) provides buffered I/O, DMA, fast read/write, 15 levels of priority interrupt and built-in I/O drivers. A time-out feature avoids deadlocks.

Ready made, plug-in HP Interface Cards are available to simplify system hook-up. They are the HP-IB (IEEE 488-1978), Bit Parallel, Bit Serial and BCD Cards. The System 35 has three I/O ports to accept these cards. I/O expanders can provide six more I/O slots each to interface to even more instruments and peripherals.

A complete line of peripherals is available: printers, plotters, paper tape punches and readers, card readers, digitizer, cartridge tape drives and flexible disc drives.

#### Ordering Information

**9835A** Desktop Computer, includes 65 536 total bytes read/write memory of which 49 962 are available to the user, alphanumeric CRT, ASCII character set and built-in tape cartridge drive.

**9835B** Desktop Computer, includes 65 536 total bytes read/write memory of which 56 854 are available to the user, 32-character LED single-line display, ASCII character set and built-in tape cartridge drive.

**9835A** Desktop Computer  
**9835B** Desktop Computer

**Price**  
\$10,400  
\$8,700



## Series 9800 System 45

System 45 is HP's most powerful desktop computer. It is ideally suited for applications such as engineering design, statistical/numerical analysis, mathematical modeling, data acquisition/control, business management and manufacturing. It offers a totally integrated system featuring a CRT display, built-in page-width thermal line printer (optional), tape cartridge drives, interactive keyboard and dual processors for increased throughput.

System 45 provides two models from which to choose — the 9845B (or T) and the 9845C. The 9845B/T offers 56K to 449K bytes of user memory, a monochromatic CRT with full graphics capability, language-expanding read only memories, thermal printer and HP Enhanced BASIC language.

The new 9845C offers all the benefits of the 9845B/T *plus* a full color graphics CRT package that provides up to 4 913 different colors, high speed vector writing and an interactive light pen.

### CRT

System 45's CRT, whether it is monochromatic or color, is an integral part of the desktop computer's chassis. It features both alphanumeric and graphics modes. The alphanumeric mode's 24 line by 80 character display lets you view data, list programs and display keyboard inputs, messages and system commands. The graphics mode allows high speed interactive plotting within a 560 by 455 dot matrix.

The 9845B/T's monochromatic CRT is a flicker-free, raster scan device with a refresh rate of 60 times per second. High speed listing, upper and lower case characters, inverse video, blinking and underlining are also features of this CRT.

The 9845C features a high resolution, tri-color shadow mask tube; software-assisted color convergence tuning and a high speed vector generator. Adding color graphics to the CRT display makes your data work harder. It helps you spot the important facts faster and with greater comprehension. For interactive design applications, the 9845C light pen offers a fast, easy way to pick, move and construct objects directly on the CRT screen.

### HP Enhanced BASIC

System 45's Enhanced BASIC language is easy to use and much more powerful than typical BASIC languages. System 45 can run standard ANSI BASIC programs and also offers many of the powerful features of FORTRAN and APL. It provides for unified mass storage operations — that is, no matter which storage device you choose, you use the same set of statements to address the media, whether it is an HP Flexible Disc Drive, Cartridge Disc Drive or the System 45's built-in 217K byte tape cartridge.

System 45 can also be programmed in Assembly Language by experienced programmers. For certain computation-intensive or I/O

- HP Enhanced BASIC with optional Assembly Language
- Graphics capability (optional)
- New color CRT package (9845C only)
- Two built-in tape cartridge drives (one standard, one optional)
- Overlapped processing
- Typewriter-like keyboard
- User available r/w memory expandable from 56K to 449K bytes
- Interfacing capability
- New Data Base Management and Data Comm capability
- Built-in thermal printer (optional)
- Optional character sets in Franch, German, Spanish, Swedish/Finnish and Katakana (Japanese)
- Wide range of external peripherals (digitizer, plotters, etc.)

routines, Assembly Language can increase program execution speeds by as much as a factor of 100 or more. For most general applications, however, Assembly Language may be of little benefit.

### Built-in Thermal Printer

The optional built-in thermal line printer prints up to 80 characters per line at up to 480 lines per minute and plots at about 25.4 mm/s (1 in./s). The printer provides high quality printing with standard ASCII upper and lower case characters. CRT screen graphics can be transferred directly to the printer for fast, precise hard-copy output.

### Interfacing Capability

Should your application require peripheral/instrument control, the System 45 has a wide range of interfacing capabilities. It features 15 levels of programmable priority interrupt, DMA, buffered I/O and overlapped processing. Interface types include BCD, Bit Parallel, Bit Serial (RS-232-C), HP-IB (IEEE 488-1978), Real Time Clock, Incremental Plotter and Disc Interface. A complete line of peripherals is also available: printers, plotters, paper tape punches and readers, card readers, a digitizer, cartridge tape drives and flexible disc drives.

### Additional Capabilities

System 45 also offers a new technical Data Base Management software/firmware package that allows you to define, build, maintain, access, restructure and back-up a data base that can be tailored to your unique needs.

This DBM package is designed after the IMAGE system used on the HP 3000 computer. It also includes QUERY/45, the primary data base manipulation tool for both the programmer and non-programmer, which reduces the programming task by providing general and highly interactive data base access routines.

System 45 also offers a new High Speed Asynchronous Data Communications package that is configured to allow the desktop computer to connect to a host computer via a hardwired or modem link. It allows emulation of alphanumeric or graphics terminals that use ASCII characters. A new RJE Bisync package permits the System 45 to communicate with any host that supports an IBM 2780 or 3780 terminal.

### Ordering Information

When ordering the System 45, be sure to specify either the 9845B, 9845T or 9845C.

**9845C Desktop Computer**, includes 186 840 bytes read/write memory, color graphics CRT package, light pen, two 217K byte tape cartridge drives and a built-in thermal line printer. **\$39,500**

**9845T Desktop Computer** includes 187 146 bytes read/write memory, CRT with graphics package, two 217K byte tape cartridge drives and a built-in thermal line printer) **\$23,500**

**9845B Desktop Computer** includes 56 266 bytes read/write memory, 24 line CRT display and one 217K byte tape cartridge drive. **\$14,000**

### Price



# COMPUTERS, PERIPHERALS & CALCULATORS

Dedicated real-time computer systems

HP 1000 Systems

- Computation
- Operations management
- Instrumentation
- Automatic test systems



With the HP 1000 family of real-time computers, tailoring a computer solution to your application is a simple matter of choice. You begin by selecting the computer power you need from four series of HP 1000 computers. Then you choose from four levels of packaging—from component-level board computers all the way up to a totally-integrated computer system. Then you can further fine-tune your HP 1000 to your intended task by choosing from an array of specific hardware and software products designed to help you get results over a wide range of specific applications.

Compatibility of design throughout the HP 1000 family is the fundamental element that enables you to harness the specific level of power you need to a specific application. It also gives you a clear growth path. Once you've matched the proper combination of HP 1000 products to your initial needs, you remain free to choose an impressive number of options to keep pace with your growth. Or, if your needs change or shift, you can smoothly reconfigure your HP 1000 to handle new applications. This compatibility extends through:

- HP 1000 computers. Because the L,M,E, and F-series computers use the same basic instruction set, you can change models with minimal effect on software, peripherals and operator training.
- HP 1000 systems. You can upgrade from the smallest memory-based system to the largest disc-based system at any time you choose, at once or in gradual increments.
- HP 1000 software. HP's Real-Time Executive (RTE) operating systems are upward-compatible—your programming investment is

protected because application programs written for one RTE system will execute on the others with minimal modification.

- HP 1000 applications-oriented software. To wield more computer power, you can superimpose HP 1000 applications software products on your system to move even closer to a computer solution for your specific application.

### HP 1000 L-Series Microcomputers: Lower cost, and increased flexibility, for OEM's and end users alike

The HP 1000 L-Series is a recent, low-cost addition to the Hewlett-Packard family of technical real-time computers. It is a new concept in LSI-based computer products because it puts two kinds of advanced processors to work in one computer. Both processors are the result of HP's CMOS/SOS (Silicon On Sapphire) Large Scale Integration manufacturing process.

One SOS circuit is the L-Series central processor. The other SOS processor is used on each L-Series interface board. Placing a small but powerful processor on every I/O board creates a new "Distributed Intelligence" architecture with vastly improved I/O efficiency and flexibility. While priced like an LSI microcomputer, the L-Series provides a significant improvement in price/performance for this category of computers.

L-Series products are available in board, box and system configurations. For maximum packaging flexibility, OEM's can choose from card cages and both general-purpose and specialized I/O boards to put the L-Series to work in their products.



## HP 1000 Computer Systems

The HP 1000 system family consists of both memory-based systems and disc-based systems for powerful computation and measurement/control applications.

The Model 10 uses the low-cost L-Series LSI computers. Models 20 and 40 utilize an E-series computer while the odd-numbered systems (Models 25 and 45) feature the F-series computer with hardware Floating Point Processor and Scientific Instruction Set which speed calculations.

HP 1000 systems feature a Real-Time Executive (RTE) operating system and are programmable in FORTRAN, PASCAL, BASIC, Assembly Language, and Micro-assembly Language.

### Computation

Model 45 combines the fast F-series computer with powerful RTE-IVB software to provide processing speed and power unique for this price range. The system can process data arrays as large as 2.048 M bytes directly in physical memory, without time-consuming disc swaps. GRAPHICS/1000 software formats output in plots and pictures that are easier to interpret. The Model 45 also includes a Vector Instruction Set which significantly reduces the time required for matrix and vector computations.

### Instrumentation

HP 1000 systems are also designed for control and interaction with HP-IB instruments. Up to 14 HP-IB devices connect to the system via a single interface card, so that the system can control multiple test or measurement stations. For small analog input needs, the 91000A plug-in card adds a capacity of 16 single-ended or 8 differential  $\pm 10$  V fs analog inputs.

### Operations Management

Two optional software packages, DATACAP/1000 and IMAGE/1000, aid operations management. DATACAP/1000 is designed for automatic factory data capture from multiple terminals

(e.g., test records, order entry, or inventory control). IMAGE/1000, data base management software, simplifies building and maintaining a large data base.

### Distributed Systems Network

An important feature of HP real-time systems is their ability to be linked together to form a large multi-system network. DS/1000 software/firmware interfaces multiple HP 1000 systems to each other or to a larger HP 3000 system. RJE/1000 provides direct communication between HP 1000 systems and most IBM 360/370 installations.

### Five Models to Choose From

**Model 10** includes an L-series computer with 64 k bytes of memory, RTE-L software, a system console with CRT display, and a 12 M byte disc.

**Model 20** includes an E-series computer with 64 k bytes of memory, RTE-M software, a system console with CRT display, and your choice of desk or upright cabinet configuration.

**Model 25** is physically identical to the Model 20 but includes 64 k bytes of high-performance memory and an F-series processor.

**Model 40** includes an E-series computer with 128 k bytes of memory, RTE-IVB software, system console with CRT and a 19.6 M byte disc.

**Model 45** features the fast F-series computer with 128 k bytes of high performance memory, RTE-IVB and GRAPHICS/1000 software, Vector Instruction Set, system console with graphics display terminal, and a 19.6 M byte disc.

### Ordering Information

	Price
HP 1000/10 Computer System	\$22,500
HP 1000/20 Computer System	\$22,000
HP 1000/25 Computer System	\$28,500
HP 1000/40 Computer System	\$38,000
HP 1000/45 Computer System	\$46,000

## HP 1000 System Compatibility Summary

	MODEL 10	MODEL 20		MODEL 25		MODEL 40		MODEL 45	
	2146B	2174A	2174B	2175A	2175B	2176C	2176D	2177C	2177D
Base system computer type	L-Series	E-Series		F-Series		E-Series		F-Series	
Type of memory	Std performance	Std performance		High performance		Std performance		High performance	
Memory cycle time	680 ns	595 ns		350 ns		595 ns		350 ns	
Operating system	RTE-L	RTE-M		RTE-M		RTE-IVB		RTE-IVB	
System console	2621A	2645A		2645A		2645A		2648A	
Memory: Base (bytes) Maximum	64 k 512 k	64 k 2048 k	64 k 1280 k	64 k 1280 k	64 k 1280 k	128 k 2048 k	128 k 1280 k	128 k 2048 k	128 k 1280 k
Standard system disc	7910 (12 Mb)	None		None		7906 (19.6 Mb)		7906 (19.6 Mb)	
Optional alternate system discs	7906 19.6 Mb	None		None		7920 (50 Mb) or 7925 (120 Mb)	7920 (50 Mb) 7925 (120 Mb)	7920 (50 Mb) 7925 (120 Mb)	7920 (50 Mb) 7925 (120 Mb)
Flexible disc available?	Yes	Yes	Yes	Yes	Yes	Yes	Yes	Yes	Yes
RJE/1000 available?	No	No	No	No	No	Yes	Yes	Yes	Yes
DS/1000 available?	Yes	Yes	Yes	Yes	Yes	Yes	Yes	Yes	Yes
IMAGE/1000 available?	Yes	No	No	No	No	Yes	Yes	Yes	Yes
91000A/2313A Analog-digital Subsystem available?	No	Yes	Yes	Yes	Yes	Yes	Yes	Yes	Yes
2240A Meas. & Control Processor available?	Yes	Yes	Yes	Yes	Yes	Yes	Yes	Yes	Yes
92840A GRAPHICS/1000 available?	No	Yes	Yes	Yes	Yes	Yes	Yes	Incl.	Incl.
12790A Multipoint interface available?	No	Yes	Yes	Yes	Yes	Yes	Yes	Yes	Yes
12979B Dual-Port I/O Extender available?	No	Yes	No	Yes	No	Yes	No	Yes	No
12990B Memory Extender available?	No	Yes	No	Yes	No	Yes	No	Yes	No
Datacap/1000 available?	No	No	No	No	No	Yes	Yes	Yes	Yes
ATS/1000 Integration Services?	No	No	No	No	No	Yes	Yes	Yes	Yes





# COMPUTERS, PERIPHERALS & CALCULATORS

## HP 1000 L-Series, M-Series, E-Series and F-Series Computers

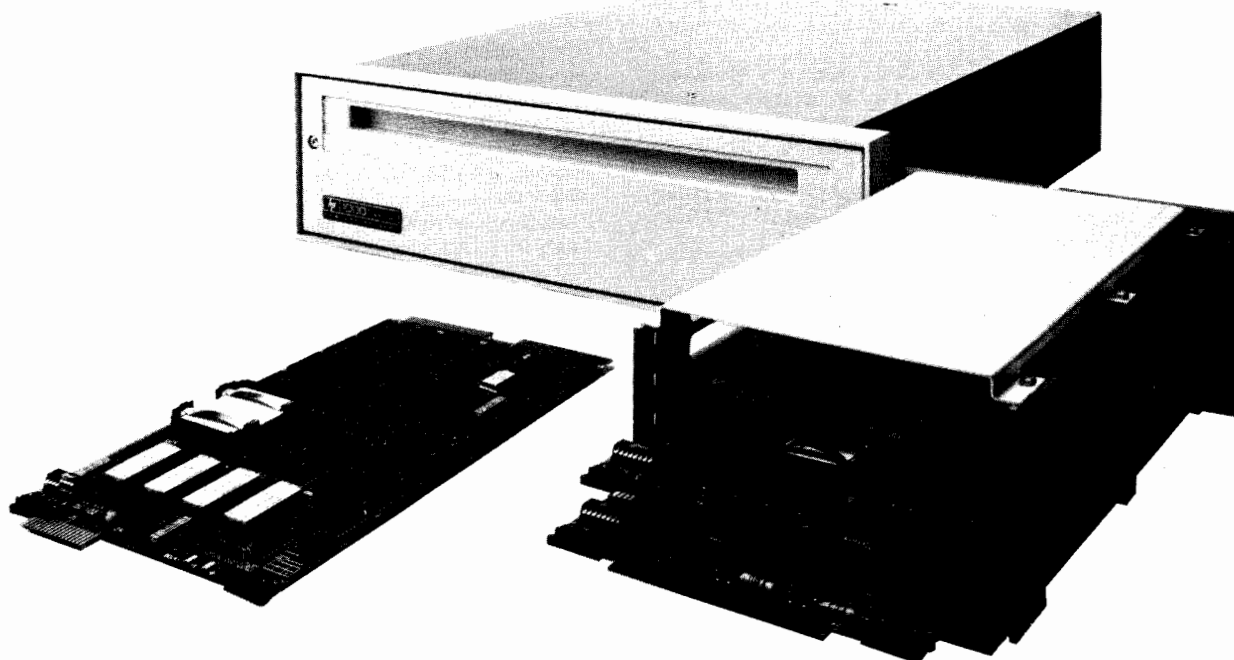

HP 1000 L-Series computer products are available in packaged or component form

### HP 1000 L-Series

The low-cost L-Series, designed for I/O-intensive applications and ease of integration into a wide range of OEM and end user products or systems, includes the 2103LK board computer and 2103L rack-mountable computer. Memory capacity is 64K bytes and I/O capacity is 8 channels. Standard features include memory protect, a time base generator, self-test, integer arithmetic, automatic parity generation and checking and virtual control panel. DMA bandwidth is a very fast 2.8M bytes/second.

### HP 1000 M-Series

The economical M-Series, designed for cost-critical applications, includes the 2108M and 2112M computers. Memory capacity ranges from 64K to 2M bytes, and I/O capability is 9 to 14 channels, expandable to 46 channels. Standard features include memory parity, extended arithmetic, and floating point instructions. A board-computer version, the 2108MK, is available for OEM and high-volume applications. The 2108MK processor board is a capable 24-bit microprocessor with 211 instructions and 325-ns cycle time.

### HP 1000 E-Series

The E-Series computer is nearly twice as powerful as the M-Series, and provides variable microcycle timing, microprogrammable block I/O, a microprocessor port, asynchronous memory, and much larger control store address space. E-Series computers are available in two models, HP 2109E and 2113E, with a choice of maximum mainframe memory capacities from 640k to 1280k bytes and 9 or 14 I/O channels, expandable to 46 channels. (Also available as a board computer, the HP 2109EK.)

### HP 1000 F-Series

For users who need speed, precision and larger memory capacity, HP offers two F-Series computers, 2111F and 2117F. Both feature a hardware Floating Point Processor that speeds calculations (2.5 to 6 times faster than E-Series) and a Scientific Instruction Set for rapid execution of trigonometric and logarithmic functions (compute sine in less than 48  $\mu$ s). A Fast FORTRAN Processor, also standard in F-Series computers, provides firmware microcode for more than a dozen instructions—e.g., array address calculations, parameter passing, and other routines—that run 2 to 20 times faster than conventional software execution speed. F-Series computers feature high-performance 350-ns memory and are fully user-microprogrammable.

### Alternate Memory Systems

For configuration flexibility, the standard memory in any HP 1000 computer may be deleted at the time of the order, and you can select an alternative memory system of equal or greater size. High-performance 350-ns memory is available as an option for the E-Series.

Fault-control memory, optionally available for most HP 1000 computers, detects and corrects single-bit errors and detects all double-bit errors, thereby improving memory MTBF three times or more.

For compatibility and prices of alternative memory packages, consult your HP field engineer.

### Ordering Information

	Price*
2103LK L-Series Board Computer w/64Kb memory	\$2,250
2103L L-Series Computer w/64Kb memory	\$4,450
2108MK M-Series Board Computer w/64Kb memory	\$3,400
2108M M-Series Computer w/64Kb memory	\$6,950
2112M M-Series Computer w/128Kb memory	\$9,700
2109EK E-Series Board Computer w/64Kb memory	\$3,900
2109E E-Series Computer w/64Kb memory	\$8,700
2113E E-Series Computer w/128Kb memory	\$11,000
2111F F-Series Computer w/64Kb high-perf. memory	\$11,750
2117F F-Series Computer w/128Kb high-perf. memory	\$16,000
12030A L-Series Board Computer 10-slot card cage	\$425
12032A L-Series Board Computer 5-slot card cage	\$225
12035A L-Series Board Computer power module	\$1,375
12539C Time Base Generator	\$350
12897B Dual Channel Port Controller	\$750
12791A Firmware Expansion Module	\$575
12944B Power Fail Recovery System	\$800
12991B Power Fail Recovery System	\$900
12977B M-Series Fast FORTRAN Processor	\$950
12979B I/O Extender	\$5,250
12990B Memory Extender	\$4,500
13047A User Control Store	\$700
13197A Writable Control Store	\$2,000
13306A E-Series Fast FORTRAN Processor	\$650

\*Quantity discounts are available.

A complete list of computer accessories is available from your HP Sales Office.

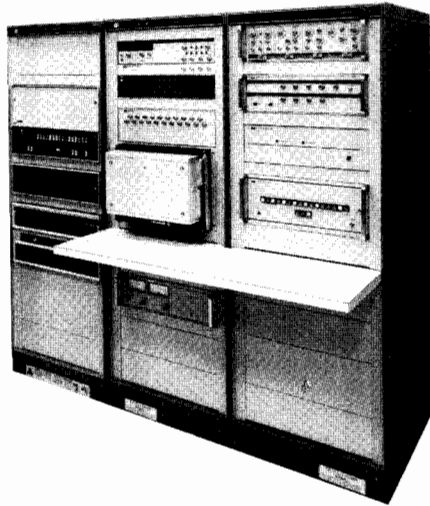

**Consolidation, installation,  
and configuration/testing for automatic test systems**

## Switches for Automatic Test

HP-IB switch products used in HP automatic test systems are available individually for HP 1000 system users who manufacture their systems in-house or those who have complex switching requirements in their HP 1000-based automated test setups. These switches provide a commercially-available solution to connecting the system to the unit-under-test (UUT). Three types of switching units are available, all controlled by a single 9411A Switch Controller that provides micro-processor control of multiple switch mainframes.

- **9411A Switch Controller** \$3,300  
The 9411A is for use on HP 1000 Computer Systems and is controlled via the HP-IB. It provides control logic and relay power for the switch mainframes. Performs comprehensive self-test and fault isolation of all signal relays in the 9412A and 9414A switching units.
- **9412A Modular Switch** \$10,000 to \$35,000  
Provides high-density, multi-function switching of signals up to 10 MHz. A built-in 1768-pin (34 x 52) matrix interface panel improves signal performance and eliminates "spider web" cabling. The 9412A accommodates five types of switchcards in any combination up to a total of 25 cards.
- **9413A VHF Switch** \$2000 to \$7000  
Provides modular, flexible high-frequency switching of pulse and video signals up to 500 MHz. The 9413A accommodates up to 12 coaxial switch modules.
- **9414A Matrix Switch** \$5000 to \$35,000  
Provides maximum flexibility in switching signals up to 10 MHz. Designed for high-density, high-performance switching, the 9414A allows any UUT pin to be switched to any instrument in the system. The 16-input matrix can be configured in 30-pin increments (UUT pins) up to 120 pins. A distribution bus allows several instruments to share four of the 16 matrix inputs, thus minimizing switching requirements.

## ATS/1000 Integration Services

Previously, when building an automatic test system, users had only two choices: purchase an already-assembled "turn-key" system or purchase computer and instruments separately and assemble them on your own. As a result of our experience with more than 1000 HP automatic test system installations worldwide, HP offers two categories of system-building assistance, called ATS/1000 Integration Services.

An automatic test system can be purchased at various levels of completion, depending on how much help the user desires. At the lowest level, Racking and Cabling Service, HP consolidates the equipment, designs cabinet layout and power distribution, then installs the equipment in cabinets. The user assumes responsibility for software configuration and testing.

With the highest level of service, Configuration/System Test, the user receives a fully-installed, fully-integrated system, ready to solve problems. HP consolidates the equipment, installs it in cabinets, configures the operating software, and checks out the system on-site.

Integration service prices vary depending on the complexity and size of the system. A typical system that contains \$100,000 of instrumentation would require \$20,000 to \$30,000 of integration services to be fully configured and tested.

## Ordering Information

93283A ATS Racking and Cabling Service  
93284A ATS Configuration/System Test Service

HP 9411A  
Switch  
Controller

HP 9413A  
VHF  
Switch

HP 9412A  
Modular  
Switch

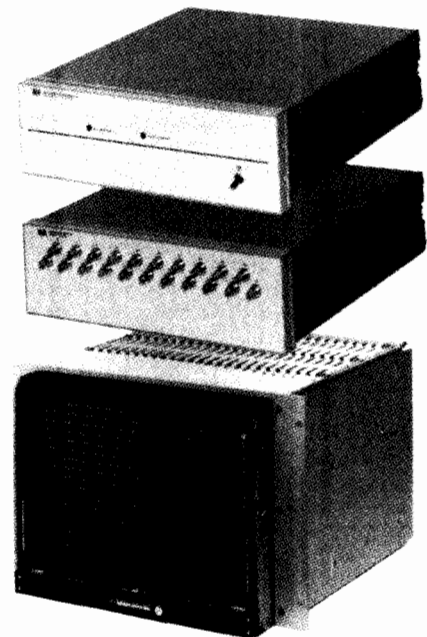



# COMPUTERS, PERIPHERALS & CALCULATORS

## Measurement and Control Computer Interface

Model 2240A and System 9030

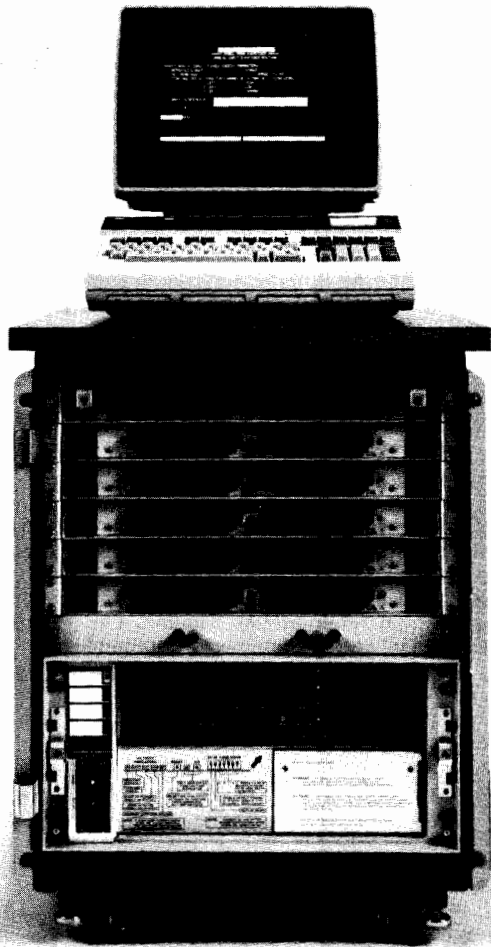

System 9030

### System 9030

The HP 2240 can be installed in a roll-around cabinet with plug connectors for portable use. Adding a controller (HP 9825, 9835, or 9845) and available exercising software, the preconfigured combination is called the HP System 9030. Contact your local HP office for information about specific ordering constraints.

### 2240/2241A Measurement and Control Processor

The microprocessor-based HP 2240A Measurement and Control Processor provides 128 channels of both analog and digital input/output signals, with interrupt handling for complete measurement and control capability in one unit. The HP 2241A Extender adds up to 128 channels to extend the capability to a total of 256 I/O points. The 2240A executes computer-independent, real-time tasks delegated from the controller. A powerful command set, tailored for measurement and control applications, is built into the 2240A to simplify and reduce programming. Programming can be done in BASIC, FORTRAN, HP Assembly or HPL languages via the HP-IB.

The 2240A can be used with a HP 9825, 9830A, or 9845A Desktop Computer or with the HP 1000 Computer System. Multiple 2240A test stands can be added via the HP-IB as part of a distributed measurement and control network. You can remote the 2240A up to 1000 meters over a single twisted pair of wires, or delegate tasks over phone lines with the HP 59403A HP-IB/Common Carrier Interface and industry standard modems.

The 2240A option 001, Extended Throughput ROM, increases the speed of continuous data acquisition severalfold by providing additional commands, larger buffer size, and binary data transmission instead of ASCII data transmission.

A variety of measurement and control function cards is available for the 2240A/2241A:

- **22900A Analog Input Card** \$1,600  
32 single-ended or 16 differential channels,  $\pm 10$  V, 12 bits including sign, 20 kHz sample/scan rate. Auto correction for gain and offset temperature drift.
- **22901A Analog Output Card** \$900  
4 channels, 0 to 10 V or  $-10$  V to  $+10$  V output, 10 bits with dual level storage. Auto readback from first level, 4-lead remote sense (Kelvin) connections.
- **22901B Analog Output Card** \$1,200  
4 channels, 4 to 20 mA current output, 0 to 10 V, or  $-10$  V to  $+10$  V output, 12 bits resolution with dual level storage. Four-lead remote sense (Kelvin) connections.
- **22902A Digital Input Card** \$310  
32 channels, TTL or CMOS levels.
- **22903A Common Interrupt Card** \$450  
16 channels, TTL or CMOS levels, individual channel enable and transition direction, interrupt test.
- **22904A Digital Output Card** \$480  
32 channels, TTL or CMOS, open-collector output, dual level storage, auto readback, level or pulse outputs.
- **22905A Counter/Stepper Motor Card** \$800  
4 channels for event counting, frequency or period measurement, or stepper drive output. Internal self-test clock, TTL compatible.

### 22920A Signal Conditioning Tray

The HP 22920A Signal Conditioning Tray provides maximum isolation for the 2240A Measurement and Control Processor from high voltage inputs and electrical noise. Each 22920A holds one signal conditioning card, with provision for field wiring (14-22 AWG) connection to 56 screw terminal connectors. Signal conditioning cards available for the 22920A are:

- **22912A Relay Output Card** \$290  
16 channels, 2 amperes, 125 VAC/DC, 60 VA rating, Form-C (SPDT) hermetically sealed relays.
- **22913A Isolated Digital Input Card** \$430  
16 channels, 5 to 120 VDC and 16 to 230 VAC with selectable response times and overload fuses.
- **22914A General Purpose Breadboard Card** \$130  
16 channels for analog/digital, input/output signal conditioning. Pad layouts for user-installed signal conditioning components such as amplifiers, relays, filters, fuses, resistors and voltage regulators.
- **22915A Low Level Analog Input Card** \$1,250  
16 differential channels, amplifier-per-channel, jumper selectable gains  $\pm 20$  mV,  $\pm 50$  mV,  $\pm 100$  mV,  $\pm 500$  mV,  $\pm 10$  V. Pads for filters, current loop and open thermocouple detection resistors.

### Ordering Information

	<b>Price</b>
<b>2240A</b> Measurement and Control Processor	\$2,750
<b>2240A-001</b> Extended Throughput ROM	\$250
<b>2240A Opt 501</b> Cabinets & Assembly	\$3,000
<b>09835-10200</b> 9835/9845 Software	\$500
<b>09825-10200</b> 9825 Software	\$500
<b>2241A</b> Extender	\$1,500
<b>22920A</b> Signal Conditioning Tray	\$165
<b>2313B</b> Analog I/O Subsystem	\$6,200



HP3000

#### HP 3000 Business Computer

The HP 3000s are a totally compatible family of business computer systems for distributed data processing. All models share the same multiprogramming executive operating system (MPE) featuring virtual memory, the same high-level languages, and are able to run one another's programs interchangeably. Full-function general-purpose capabilities include simultaneous transaction-processing, data communication, on-line program development, and batch operations in COBOL, RPG, BASIC, FORTRAN, and SPL (the HP system programming language). Fastest and capable of greatest expansion is the HP 3000 Series III, with main memory to 2 megabytes, and ability to support as many as 64 terminals, each running or developing separate programs. The SOS (Silicon-on-Sapphire)-based HP 3000 Series 30 and 33 offer much the same capability at a less cost. The HP 3000s provide a complete data base management and inquiry facility, IMAGE/QUERY, as well as a data entry/forms generation system, V/3000. In addition, all may be interconnected to allow one to command another's resources sharing files and programs, with HP Distributed Systems Network, DS/3000, hardware and software that can also integrate HP 3000s with HP 1000 networks.

HP3000 Series III	from \$107,000
HP 3000 Series 33	from \$60,000
HP 3000 Series 30	from \$51,000



HP300

#### HP 300 Business Computer

The HP300 is a full capability, low cost computer system designed for dedicated online business applications. It can address the overall requirements of a smaller organization as well as the specialized needs of a department in a large organization. In either case, the HP 300 can be tailored to optimize each dedicated application environment.

The basic unit includes the Information Display System, built-in disc storage for over 12 million characters, a flexible disc drive for one million character flexible discs, and 256 thousand characters of error correcting solid-state memory.

The HP 300's Fundamental Operating Software includes the Amigo/300 Operating System, the HELP online reference manual and utilities (Sort/Merge, HP 300 Data Utility, Menu Facility, Forms/300, Typist — a text editor, System Build, Diagnostic/Utility Package, and Image/300 Data Base Management including the Data Base Inquiry Facility). Optional languages include Business Basic/300, System Language/300, and RPG II/300 (which includes Conversion Utility).

The HP 300 has been designed to accommodate growth in a modular, step-by-step manner. Expansion potential allows up to 1 megabyte of error-correcting main memory, over 490 megabytes of on-line disc storage, 16 application terminals, 2 printers, 2 HP 300 Workstations, and data communications.

HP 300 (12 Mb disc)	\$ 36,500
---------------------	-----------



HP250

#### HP 250 Business Computer

The HP 250 is designed to meet the business management needs of small companies and departments of larger ones. User convenience and human engineering combine with excellent computing power to allow simplified operation—even for the first-time user. It achieves big-system performance at small-system prices.

Available on the HP 250 through Hewlett-Packard software supplies are HP-developed applications packages for finance (FIN/250), manufacturing (MFG/250) and order management (OM/250). These flexible, easy-to-operate packages can help small or large businesses gain better monetary control of their operations, improve customer service and reduce clerical costs.

The standard system contains 32K bytes of user memory, 128K bytes of system memory, a 1.2-megabyte flexible disc drive, and a 12.1 Mbyte fixed disc.

The HP 250 is able to support up to 5 additional terminals—called REMOTE/250's—each with the same capabilities that exist at the main console. For distributed applications, it can communicate with larger computers either asynchronously or synchronously. A software package called LK 3000 links the HP 250 as an interactive terminal to the HP 3000; and another called RJE/250 allows the HP 250 to function in an IBM 2780/3780 terminal emulator mode.

HP 250 (1 flexible-disc and 12Mb flexible disc)	\$23,000
---	----------



# COMPUTERS, PERIPHERALS & CALCULATORS

## Interactive Display Terminals

Models 2621A, 2621P



2621A



2621P

## Interactive Display Terminals Introduction

Hewlett-Packard offers a broad range of general purpose computer terminals. The Hewlett-Packard Family is composed of the 2647 and 2648 graphics display terminals, the 2640 series alphanumeric display terminals and the new 2620 family of interactive display terminals.

Hewlett-Packard's terminals are widely used in manufacturing, financial, governmental and service related industries for a variety of applications such as:

- Data Entry
- Inquiry Response
- Editing Text
- Program Development
- Data Storage
- Time Sharing
- Graphics
- Data Logging

If the standard Hewlett-Packard terminals do not exactly fit your applications, the 2649 series microprogrammable terminals and 13290B development terminal may be just the answer. These terminals are ideally suited for OEM applications.

Hewlett-Packard computer terminals are also offered in several international versions.

Hewlett-Packard terminals have been engineered for high reliability and fast repair when needed. Many built-in self-test capabilities provide the user with a quick GO/No-GO indication to isolate defective modules so that they can be quickly and easily replaced.

### 2621 A/P Interactive Display Terminal

The 2621A and 2621P terminals emphasize simplicity, reliability, and quality in products designed for interactive applications. The 2621P with an integral thermal printer combines the convenience of local hard copy with the speed of a video terminal.

**High resolution display:** The 2621 displays 1,920 characters in a 24 line by 80 column format on a 6 by 8.5 inch high-resolution display. The 9 x 15 dot character cell allows precise formation of complex symbols with wide line and character separation. These features combine to produce a bright, easy to read display for improved operator satisfaction.

**Memory:** In order to provide a backwards look at interactive dialogue, the 2621 contains two full pages (48 lines) of continuous scrolling memory. The contents of memory are viewed with roll up and roll down keys.

**Hard copy:** In addition to the features of the 2621A, the 2621P Interactive Terminal contains an integral hard-copy unit. Upper/Lower case letters and underline are printed on thermal paper at 120 characters-per-second with a typical throughput rate of 60 cps. This self-contained unit is ideal for the occasional walk-away copy. Automatic data logging causes data being sent to the display to be copied to the integral printer also. This provides flexible remote control of the printer.

**Ease of use:** The familiar typewriter-style keyboard of the 2621 presents a friendly interface designed to minimize training time. Eight screen-labeled control keys provide quick access to editing, configuration, self-test, printer control, and other functions. Rapid numeric entry is assisted by an embedded numeric pad. The 8 screen-labeled keys also double as special function keys which can be used to call computer-resident routines. Traditional mechanical switches selecting baud rate, parity, and various communication parameters are replaced by soft configuration using non-volatile memory which can be displayed and changed easily from the keyboard.

**Editing:** The HP 2621 terminal is equipped with editing functions designed to work in interactive, character-mode applications without any need for system software modifications. Because the 2621 keeps track of data sent by the computer, versus data entered from the keyboard, the operator can use local character insert and delete to edit replies to computer-generated questions. In Cine Mode, each line of data entered from the keyboard is buffered until the return key is pressed. During normal character mode operation, the operator can use Modify Mode to edit and then transmit a selected line from the terminal's 48 line memory.



## 2626 Display Station:

The 2626A is a high performance terminal using silicon on sapphire components to provide unique display capabilities and data communications flexibility. The 2626 display memory can be divided into four independent workspaces, and the display screen into separate windows to examine and manipulate the contents of the workspace. Dual data communications ports may be linked to workspaces to display data from two different computers. An optional integral printer provides copies of forms and up to 132 column reports on 8½ inch wide paper.

### Multiple Workspaces:

Display memory may be divided into a maximum of four individual workspaces. Each workspace may be independently viewed, controlled and configured including attachment to a data comm port. (For example memory lock, auto line feed, etc., may be set in a particular workspace.) Data may be transferred from one workspace to another to the integral printer or to an external device. This capability amounts to four virtual terminals which may be changed from application to application or system to system.

The number of lines in a workspace may vary; however, the total number of lines in all workspaces must be less than or equal to the total amount of memory available. The total amount of memory available is 9520 displayed characters independent of control codes for display enhancements, field definitions, and edits. The line length for all workspaces may be set from 80 to 160 characters so that 132 column reports as well as double width pages may be handled. Viewing is via horizontal scrolling.

### Multiple Windows:

The display screen can be divided into up to four windows. The windows are attached to workspaces to view and manipulate the contents. To view the entire contents of a workspace, data may be scrolled horizontally and vertically or the size of a window may be changed from the keyboard. The screen may be divided into up to four horizontal segments and two vertical segments with a total maximum of four.

The screen displays 1920 characters in a 24 line by 80 column format with two additional lines used for the labeling of function/soft-keys, or as a system error/status window.

The 2626 display provides high quality resolution using a 7 x 11 dot matrix in a 9 x 15 character cell with full interstitial dots, a technique providing the best display quality yet in a terminal from Hewlett-Packard.

### Dual Data Communication Ports:

Two communications ports allow simultaneous communications with two computers or with a computer and external RS232 serial printer. Data may be communicated to the computer using block, line, line modify, or character modes. The line modify mode allows a

user to take advantage of the editing capabilities of the terminal while using character mode applications on the computer.

Data communications flexibility is complete. The HP 2626A provides point-to-point and asynchronous or synchronous multipoint capabilities, full and half duplex operation, flexible handshaking, and expandable buffers. RS232C interfacing or 20mA current loop is available. Data communications set-up is made easy by a series of configuration menus which present only the options required for a particular capability. Default values provide for the most common choices.

### Form Copy Integral Printer:

An optional printer makes dot copies of information in workspaces, windows, or as displayed on the screen. It duplicates the line drawing, math, and large characters as well as the characters associated with the language options. Inverse video fields are copied by outlining with a box. In addition a compressed print mode may be used to copy lines of up to 132 columns on the 8½ inch wide paper. Longer line lengths are printed by wrapping the characters. An "expanded print" mode prints double sized characters. A report mode formats data into pages of 60 lines and the metric mode into 64 line pages.

### Interactive Forms Design:

Function keys provide access to a sketch forms capability for drawing horizontal and vertical lines with single, double line, and bold definitions. Data Frame and Margin Frame keys are also provided. Fields may be defined as protected, unprotected, or transmit only and are accessed through a Define Field function. The edit function assigns character edits for alphanumeric, alpha, and numeric data. The display enhancements include inverse video, underline, and blinking in any of eight possible combinations. A Security Video enhancement allows passwords to be entered but not displayed. These capabilities are all accessed via function keys. No special codes to learn and memorize. A capability guaranteed to shorten the development time for forms.

### Screen Labeled User Keys:

Eight soft keys can be labeled on the screen using two lines of eight characters each. This capability offers a new level of operator/application program interfacing by allowing the program to re-define and re-label the keys as required to increase ease of use. In addition the Return and Enter keys are programmable. The Return key could tab for example, or the Enter key could change workspaces revealing a hidden form. Also the Tab key can be set to transmit spaces to the computer.

### Programmable Audio Feedback:

Audio cues to alert operators to conditions or status within an application program may be provided using the programmable tone which has fifteen pitches with sixteen durations and two volume levels.



## 2620 Series Specifications

### General

**Screen size:** 2621/2626, 150 mm (6 inches) x 215 mm (8.5 inches)

**Screen capacity:** 2621/2626, 24 lines x 80 columns (1,920 characters); 2626, 25th and 26th line for labeling of function/softkeys or as message status lines.

**Character generation:** 2621, 7 x 9 2626, 7 x 11 enhanced dot matrix with interstitial dots; 9 x 15 dot character cell; non-interlaced raster scan.

**Character size:** 2621/2626, 2.4 mm (0.094 inches) x 3.5 mm (0.138 inches)

**Character set:** 2621/2626, upper/lower case, displayable control codes. Finnish/Swedish, Danish/Norwegian, French, German, Spanish and U.K. characters; 2626, optional math symbols, and large characters.

**Display enhancements:** 2621/2626, underline; 2626, inverse video, blink, security.

**Refresh rate:** 2621/2626, 60 Hz (50 Hz optional)

**Tube phosphor:** 2621/2626, P4

**Implosion protection:** 2621/2626, tension band

**Memory:** 2621, 4096 bytes (two full pages). 256 bytes, configuration memory (battery powered); 2626, 80 characters by 119 lines including a default data comm buffer. (Buffer expandable to 2K bytes. Reduces memory to 80 characters by 107 lines.) 128 bytes, non-volatile configuration memory (battery powered).

**Keyboard:** 2621/2626, full ASCII code keyboard; eight screen labeled keys; cursor controls; numeric key pad; auto repeat; N-key rollover; detached with 1.2 M (4 foot) cable. Optional Finnish/Swedish, Danish/Norwegian, French, German, Spanish and U.K. characters.

**Data rate:** 2621/2626, 110, 134.5 (2626 only), 150, 200, 300, 600, 1200, 1800, 2000 (2626 only), 2400, 3600 (2621 only), 4800, 9600 baud and external. Operation with control codes, escape sequences or integral printer may require CPU supplied delays or handshakes. Typical printer throughput is 60 cps. Full 24 x 80 line character screen copies in 18 seconds.

**Asynchronous interface:** 2621: EIA standard RS232C (fully compatible with Bell 103A and 212 modems) CCITT V.24

**Transmission modes:** 2621, full duplex, asynchronous.

**Operating modes:** 2621, on-line; off-line; character, line.

**Parity:** 2621, selectable; even, odd, zero, one.

**2626:**

**Port 1 Asynchronous/Synchronous Interface (50 pin):** EIA standard RS232C; fully compatible with Bell 103A, 202C/D/S/T modems. Choice of main channel or reverse channel in half duplex. CCITT V.24 hardware handshaking available. Accessories provide current loop, (13266A); asynchronous or synchronous multipoint, (13267A first terminal, and 13268A daisy chain terminal).

#### Transmission Modes:

Full or half-duplex asynchronous, synchronous

#### Port 2 Asynchronous Interface (25 pin):

EIA standard RS232C; fully compatible with Bell 103A modems, 202C/D/S/T modems. Choice of main channel or reverse channel in half duplex. CCITT V.24, hardware handshaking for control of external printer.

#### Transmission Modes:

Full or half duplex, asynchronous, synchronous

#### Operating Modes (Both Ports):

On-line; off-line; character, line modify, line and block

#### Parity:

Selectable; even, odd, none, zero, one

### Product Safety

2621/2626: U.L. requirements for: EDP equipment, office appliances, teaching equipment. CSA labels are applied to equipment shipped to the U.S. and Canada.

### Ordering Information

	PRICE
<b>2621A Interactive Display Terminal</b>	\$1495
<b>Opt 001:</b> Swedish/Finnish	\$100
<b>Opt 002:</b> Norwegian/Danish	\$100
<b>Opt 003:</b> French	\$100
<b>Opt 004:</b> German	\$100
<b>Opt 005:</b> United Kingdom	\$100
<b>Opt 006:</b> Spanish	\$100
<b>2621P Interactive Terminal With Printer</b>	\$2650
<b>Opt 001:</b> Swedish/Finnish	\$100
<b>Opt 002:</b> Norwegian/Danish	\$100
<b>Opt 003:</b> French	\$100
<b>Opt 004:</b> German	\$100
<b>Opt 005:</b> United Kingdom	\$100
<b>Opt 006:</b> Spanish	\$100
<b>2626A Display Station:</b>	\$3950
<b>Opt 001:</b> Finnish/Swedish*	\$250
<b>Opt 002:</b> Danish/Norwegian*	\$250
<b>Opt 003:</b> French*	\$250
<b>Opt 004:</b> German*	\$250
<b>Opt 005:</b> United Kingdom*	\$250
<b>Opt 006:</b> Spanish*	\$250
<b>Opt 013:</b> 240V, 50 Hz operation	N/C
<b>Opt 014:</b> 100V, 60 Hz operation	N/C
<b>Opt 015:</b> 220V, 50 Hz operation	N/C
<b>Opt 016:</b> 100V, 50 Hz operation	N/C
<b>Opt 050:</b> Integral forms copy thermal printer, 120 characters-per-second using 8½ inch wide paper.	\$1150
<b>Opt 201:</b> Math and Large Character sets. (Standard with any language option)	\$250

\*Deletes U.S. keyboard and includes match and large character sets.

### Accessories 2621/2626

Cables for Port 1 (50 Pin):

<b>13222C</b> RS232 cable—female, 2 m	\$50
<b>13222M</b> European modem cable—male, 5 m	\$75
<b>13222N</b> U.S. modem cable—male, 5 m	\$75
<b>13222W</b> HP 300 System Cable	\$70
<b>13222Y</b> RS232 EMP protect cable—male, 5 m	\$50
Cables for Port 2 RS232 Connector (25 Pin):	
<b>13242G</b> RS232 cable—male/male, 5 m	\$65
<b>13242H</b> RS232 cable—male/female, 5 m	\$65
<b>13242M</b> European modem cable—male, 5 m	\$75
<b>13242N</b> U.S. modem cable—male, 5 m	\$75
<b>13242Y</b> RS232 EMP protect cable—male/male, 5 m	\$70
<b>13265A</b> 300 baud modem	\$375
<b>13266A</b> Current loop interface	\$185
<b>13267A</b> Asynchronous multipoint interface for 1st terminal	\$375
— <b>001</b> Synchronous capability	
<b>13268A</b> Asynchronous multipoint daisy-chain interface pod	\$375
— <b>001</b> Synchronous capability	
<b>13232R</b> Multipoint extension cable—female/male, 100'	\$75
<b>92160A</b> Blue thermal paper, 8½" x 100' 24 rolls)	\$100
<b>92160B</b> Black thermal paper, 8½" x 100' (24 rolls)	\$115
<b>1420-0259</b> 4.2V mercuric battery	\$9.50

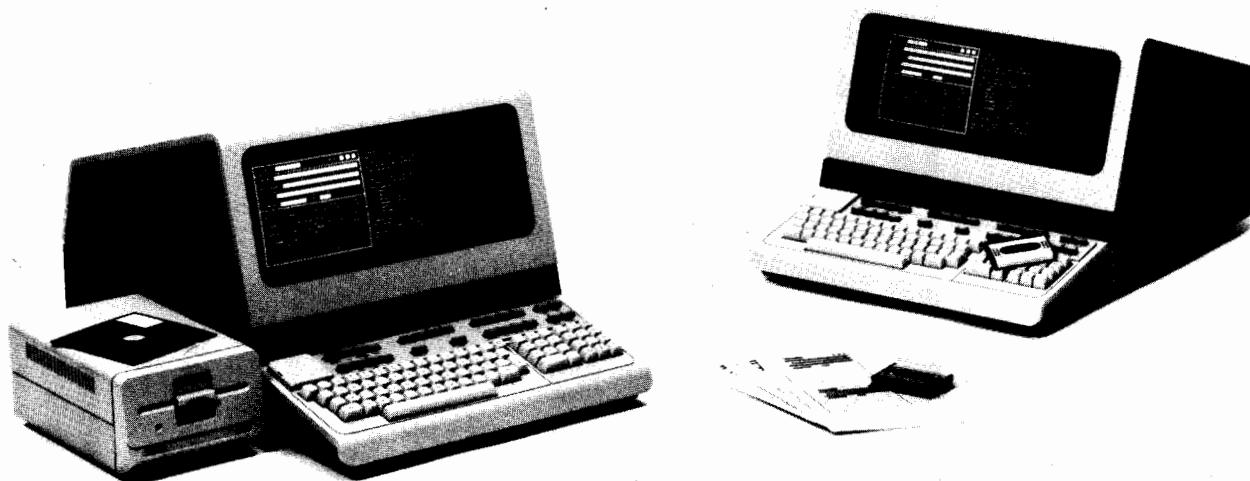

## 2642A Display Station

The 2642A is a sophisticated and flexible terminal providing substantial offline capabilities. The 2642A retains most of the features of the 2645A: high resolution display; user-defined soft keys; flexible data communication; modular architecture and hard copy interface. In addition the 2642A adds five other major features to the Hewlett-Packard 264X Alphanumeric Product Family: Flexible Mini Disc Drive Support; Forms Design Mode; Text Preparation Mode; Screen Labeled Softkeys/Command Channel and Shared Peripheral Interfaces.

### Minifloppy:

The Flexible Mini Disc Drive and file system of the 2642A offers a flexible yet easy to use mass storage device. The system supports up to two 5¼" double sided-double density disc drives. Each 5¼" volume can store up to 270K bytes of information. Files can have up to 10 character alphanumeric names while volume names may contain up to 6 characters. Named volumes and files significantly simplify data storage and retrieval.

### Text Preparation Mode:

The text preparation mode provides a number of special editing functions for use during the local editing of text. The capabilities of the 2642A's text preparation mode are centered around the concept of word wrap; i.e. the ability to recognize words and to wrap a word at the end of a line.

Text preparation feature includes:

- search/replace; search/replace of up to an 80-character string.

- paragraph adjust; aligns paragraph between defined left and right boundary
- delete; word, sentence or paragraph deletion in a single key stroke
- copy paragraph; copies paragraph to specified location in display memory

### Forms Design Mode:

The Forms Design Mode simplifies forms design. Screen labeled function keys assist in the laying out of unprotected and transmit only fields, specifying field checks and enhancements and in drawing lines. Using the Forms Design Mode, forms can be quickly and easily designed.

### Screen Labeled Softkeys/Command Channel:

The 2642A utilizes 8 softkeys with eight character screen labels. In addition, english-like commands are used to control the data flow between various terminal devices. The screen labeled softkey simplifies the usage of the 8 programmable softkeys. Labels can be assigned so that they indicate exactly the function of each key stroke. The english-like commands of the command channel removes uncertainty in controlling data paths and more storage devices.

### Shared Peripheral Interface:

The 2642A supports the standard RS232 interface, 8 bit parallel interface and in addition the HP shared peripheral interface. The shared peripheral interface allows multiple 2642A or 2647A terminals to share hardcopy output devices. The cost of hardcopy per terminal is reduced substantially increasing the cost effectiveness of each hardcopy device.



# COMPUTERS, PERIPHERALS & CALCULATORS

## Interactive display terminals

Models 2645A, 2640B, 2649A



2645A

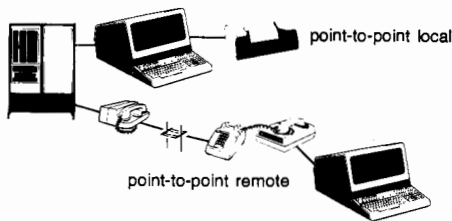

Single Terminal Communications (RS232C or current loop)

### 2645A Alphanumeric Display Station

The 2645A is a high performance alphanumeric display station that can operate at speeds up to 9600 baud in a fully interactive character-by-character mode or in a variable length block mode. Features such as a high resolution display, forms mode, full editing capability, fully integrated mass storage, user-defined soft keys, flexible choice of data communications, modular architecture, microprocessor control and hard copy interface make the 2645A the perfect solution for many computer applications.

#### High resolution display

The 2645A displays 1,920 characters in a 24 line by 80 column format on a 5 inch by 10 inch display. The characters are formed by a 7 × 9 dot matrix generated within a 9 × 15 dot character cell. The 9 × 15 cell allows large characters to be represented accurately. The high resolution is further enhanced by half dot shifting for precise character definition.

#### Forms mode and full editing capabilities

The 2645A transmits character-by-character as an interactive terminal or is capable of operating on a block of data at a time. Local editing allows the terminal user to verify and modify data before transmission to the computer. Standard features include character or line insert and delete, cursor sensing/positioning, numeric/alpha field checking, protected fields, transmit-only fields, tabulation, movable margins, character wraparound, automatic data logging, and

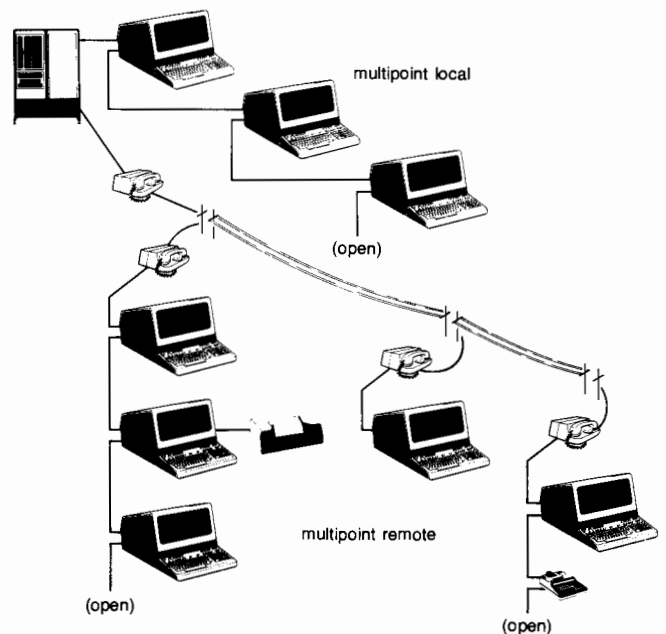

Multiple Terminal Communications (asynchronous or synchronous multipart)

positional display lock. Page select and scrolling can be used with up to 11 kilobytes of display memory for off-screen storage. Optional math, line drawing and user-defined character sets enhance display presentation.

#### Mass storage – fully integrated

Many operations which are normally performed on-line can be performed off-line with the 2645A. Optional dual cartridge tape units are available for easy batching of information. Up to 110K bytes of information can be stored on each cartridge tape. This stand-alone capability can significantly reduce user time and conserve on both computer and communications resources.

#### User-defined function keys:

Each of the 8 special function keys can be easily used to issue a user-defined string of up to 80 characters or several control sequences stored in the 2645A. This feature allows the keyboard to adapt to specialized applications, and can considerably simplify use of the keyboard and result in greater efficiency—each soft key performs the operations of several key sequences. For example, the soft keys could issue frequently used programming sequences, search for files, aid forms construction for data entry, dynamically configure the terminal, or issue instructions to the operator/computer/or both.

#### Choice of communications capability:

The standard 2645A operates at up to 9600 baud with handshake and offers asynchronous point-to-point data communications using an RS232C interface. Optional capabilities include: both asynchronous and synchronous polling for multipoint communications which allow multiple terminals to share communications resources; 20mA DC current loop; split input/output speed; and custom baud rates.

#### Modular architecture, microprocessor controlled:

Microprocessor implementation and modular architecture produce a terminal with a wide range of capabilities. As needs grow, such features as integrated tape units, alternate communications protocols, additional display memory, printer interfaces and display enhancements can be easily added to the terminal.

#### Hard-copy interface:

A wide variety of hard-copy devices can be accommodated via an optional RS232C serial interface, HP video output interface, or HP printer compatible parallel interface. Commands to print data can be initiated either locally from the terminal keyboard or remotely from a computer.

# COMPUTERS, PERIPHERALS & CALCULATORS

Interactive display terminal family

Models 2647A, 2648A

637



2647A

## 2647A Intelligent Graphics Terminal

The 2647 is the intelligent solution to a host of applications that require both an on-line capability and local programmability. The 2647A is user programmable in BASIC, and offers a number of user driven application programs that generate slides and charts. The 2647A features a raster scan display and a full interactive alphanumeric capability.

### BASIC language programmability:

The 2647A can be used with a host CPU that is executing canned programs or as a local programmable graphics work station. The BASIC language used with the 2647A provides an extensive facility for solving a wide variety of business, engineering and scientific applications. An impressive array of commands, statements, functions and graphics make the 2647A a complete problem solving tool.

### High level graphics commands:

The graphics features of the 2647A may be controlled by high level English-like commands. These commands control the 2647A graphics functions in either on-line or off-line environments. This high level control extends to; graphic set up functions, axes and labeling, plotting and interactive graphic functions. The result is that the user has effective control over the terminal graphics features.

### Multiple Automatic Plotting:

The 2647A offers sophisticated local graphing capability while requiring little or no programming knowledge of the user. Menu driven, the 2647A can plot columnar data in multiple formats chosen by the user. Pie charts, bar charts and X-Y Cartesian and logarithmic graphs can all be created without any host CPU graphics software. Different types of shading patterns are available for highlighting the various charts. Data may be submitted to the 2647A from one of three sources; host computer, tape cartridge or display memory. One simply fills in the blanks on a menu form which appears on the terminal screen. Once the data parameters are defined, the data can then be plotted with a single keystroke. This powerful feature makes graphs friendly, easy to create, and system software independent.



2647A

### Graphics memory image output:

In addition to handling vector information for graphics pictures, the 2647A can input and output binary image data to and from graphics memory. The 2647A can output this image data to the dual cartridge tapes which are provided standard or to any compatible hardcopy device or host computer. This provides a very convenient facility to create pictures locally and store them. The stored pictures can be read back, edited, and then stored on cartridge tape again, sent to a hardcopy device, or transmitted to a host computer. The dual mini-cartridges can give you up to 110 kilobytes of mass storage and a pocket full of pictures.

### Simple user interface:

Data paths between terminal facilities and peripherals are controlled by English-like commands. The user is guided by a friendly command line that utilizes soft keys and screen labels to control terminal activities. Once the user specifies an operation to be performed, the terminal presents on the screen the logical alternatives to complete the intended operation. This easy to use interface controls data flow between such terminal facilities as the screen, tape cartridges, printers, plotters, tablets, and other peripherals. Eight user definable soft keys are provided.

### Shared hardcopy and peripheral devices:

Multiple 2647A terminals may share the same compatible hardcopy devices such as plotters and printers. Each 2647A may transmit to a compatible plotter the necessary vector information to obtain high quality plots. When one user completes plotter operations any other user on the same line may initiate subsequent plots on the same device.

Sharing also applies to devices that accept raster formatted information where the contents of graphics memory are output directly to the hardcopy device. For alphanumeric output, the 2647A can also share compatible printers. Whatever your requirements, graphs or alphanumerics, the 2647A can make HP hardcopy devices more cost effective.



# COMPUTERS, PERIPHERALS & CALCULATORS

Interactive display terminal family

Models 2647A, 2648A con't.



2647A



2648A

The 2647A contains all of the above features in addition to the capabilities of Hewlett-Packard's first graphics terminal, the 2648A.

## 2648A Graphics Terminal

The 2648A is a low cost graphics terminal that offers high performance graphics capabilities normally found only in large computer systems.

### Raster scan technology

The 2648A can be used in high, ambient light environments because raster scan provides a bright, easy-to-read display. This bright display also helps to minimize eye fatigue during extended sessions at the terminal.

With refreshed raster scan technology, the ability to modify selected portions of a picture is a natural feature. Portions of the picture can be modified without completely erasing and redrawing the entire display. This minimizes system software overhead, user wait-time, and communication costs.

### Independent graphics and alphanumeric display memories:

The Graphics and Alphanumeric display each have their own independent random access memory (RAM). The alphanumeric display memory can typically contain up to 75 lines, each containing 80 characters. The independent graphics memory, consisting of sixteen 16K bit RAM's provides resolution of 720 by 360 displayable points. Because these two separate memories are independent, computer transactions do not have to obscure the graphics picture. Either the graphics or alphanumeric memory display can be suppressed without

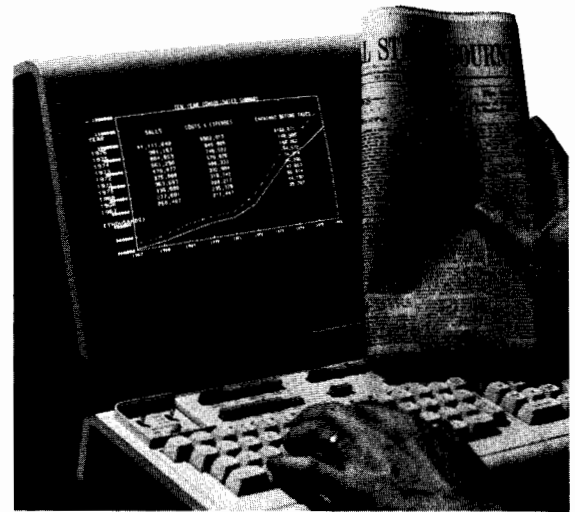

2648A

disturbing the other. This improves the readability of the display. The graphics and alphanumeric displays each have their own separate cursor control keypad.

### Rubber band line:

Trial graphics can be performed with or without computer support using the Rubber Band Line. This provides quick, user initiated picture generation or modification. This feature allows the user to draw a line segment between a predetermined position and the graphics cursor. As the graphics cursor moves to a desired position, the line segment automatically stretches with directional changes of the cursor. After the graphics cursor reaches its final position, a fixed line segment can be drawn.

### Hardware zoom and pan:

The graphics display can be magnified incrementally from one to sixteen times (16X). This feature allows the user to make full use of the 720 by 360 dot resolution. This allows investigation and/or modification of dense display areas such as parallel lines separated by only a single dot spacing. Panning can then be used to view any area of the magnified display not in the viewing window. The complete display can be panned through without affecting the graphics display memory.

### Graphics text composition:

Characters entered into the graphics display memory can be varied in shape, size, and orientation. This feature allows the user to select an incremental character size, orientation (90-degree multiples), and slant (italic). In addition, it lets the user left/right justify or center graphics text automatically. This feature helps the user label axes and makes it easy to add note or comments to a graph after it is displayed.

### Full alphanumeric capability:

The 2648A has the same alphanumeric capability as the 2645A terminal. Data entry, text editing, program preparation and interactive computer sessions are all made easy.

Features such as character wraparound make text editing and program preparation a snap. Optionally store the final text on tape cartridge for later transmission to a computer.

Protected fields, numeric and alpha checking, forms and block mode make data entry a friendly experience. When the 2648A isn't being used as a powerful graphics workstation, it's a productive alphanumeric workstation.



2649A



13290B

### 2649A Microprogrammable Terminal/Controller

The Hewlett-Packard Model 2649A Microprogrammable Terminal/Controller represents an innovative approach to satisfying the need for an intelligent terminal or controller with a set of capabilities which can be tailored to meet the requirements of a particular application. By combining applications specific hardware and firmware with the wide selection of standard hardware and firmware which is available with the 2649A, the OEM or sophisticated end user can develop a reliable, cost-effective solution to business, industrial and research problems spanning the applications spectrum.

#### Complete System in a Single Package:

The 2649A combines a processor, memory, I/O and peripherals in a single, attractive package. This means that the 2649A is ideal for use in applications where space is a limiting factor or where the aesthetics of the package are of concern.

#### Modular architecture:

Modular architecture allows the OEM or end user to optimize both hardware and firmware configurations to match each specific application. Thus, unnecessary hardware and firmware is avoided with a resulting cost savings. Modular architecture also means greater flexibility so that as the application grows, the capability of the terminal or controller may be enhanced by adding more memory, peripherals or firmware.

#### Graphics capability:

The optional graphics capability of the 2649A adds a new dimension to the solution of application problems. This unique capability allows large quantities of data to be displayed in graphical form for easy interpretation and manipulation by the user. The overhead imposed by the addition of the graphics capability is minimized by the use of a hardware vector generator and a separate graphics memory.

#### Choice of interface and memory options:

Interfacing is made easier because there is a wide selection of general purpose interfaces including the shared peripheral interface, and data communications interfaces to choose from. A variety of memory options, including RAM, ROM and PROM modules, are available to meet program and data storage requirements in a highly efficient manner. Memory options may be configured to support up to 120 kilobytes of combined RAM, ROM and PROM.

#### Simplified hardware/firmware development:

Development of hardware and firmware is simplified by the extensive development tools which are available. The HP 13290B Development Terminal for example, provides the user with source program generation, resident assembly, program execution and debug capabilities. The comprehensive documentation package and training course which are offered provide the knowledge necessary to adapt the 2649A to meet various application requirements.

### 2649I Intelligent Alphanumeric Terminal

The 2649I is an intelligent alphanumeric terminal that offers the OEM an alternative to Microprogramming. The 2649I is programmable in BASIC to meet the unique requirements of an OEM's application. It can be the intelligent solution to a broad range of applications requiring the combination of a high level program, microprocessor, CRT display and keyboard.

#### Programmability:

The 2649I can be used with a host CPU executing application programs or as a local programmable work station. An impressive array of commands, statements, and functions make the 2649I a powerful tool for solving business, engineering, and scientific applications.

The BASIC language offered in the 2649I is an enhanced version of BASIC and provides many special functions and statements.

These special functions and statements and up to 25K bytes of workspace will aid in the development of application programs and provide increased efficiency.

#### High Resolution Display:

The 2649I displays 1920 characters in a 24 line by 80 column format. A bright display (a high resolution 9 x 15 dot matrix character cell) helps to minimize eye fatigue during extended sessions at the terminal.

Display enhancements are a standard feature of the 2649I and offer up to sixteen possible combinations of blinking, underline, half bright and standard inverse video. Three additional character sets are also offered with display enhancements. A line drawing set is provided to aid in the creation of data entry forms. An optional large character set is provided that will allow you to display characters which can be read at a distance and finally an optional mathematics symbol set contains Greek characters and other commonly used math symbols for technical applications.

# COMPUTERS, PERIPHERALS & CALCULATORS

## Interactive display terminals

Model 2649I (cont.)



2649I

### Full Editing and Forms Mode:

The 2649I transmits character-by-character as an interactive terminal or is capable of operating on a block of data at a time. Local editing allows the terminal user to verify and modify data before transmission to the computer. Standard features include character insert and delete, cursor sensing/positioning, numeric/alpha field checking, protected fields, tabulations, movable margins, character wraparound, automatic data logging, and positional display lock. Page select and scrolling can be used with up to 96 full lines of data.

### Simple User Interface:

Data paths between terminal facilities and peripherals are controlled by English-like commands. A friendly command line utilizes function keys and screen labels to control terminal activities. Once an operation is specified the terminal presents on the screen the logical alternatives to complete the intended operation. This easy to use interface controls data flow between such terminal facilities as the screen, cartridge tapes, printers, or other peripherals.

Eight definable soft keys and a programmable return key are available for simplifying many application tasks. These soft keys are ideal for repetitive tasks such as logging on to the CPU and accessing application programs. They can also search for files, aid in forms construction for data entry, issue instructions to the computer and can be loaded programmatically.

The 2649I offers complete modularity and allows complete freedom to optimize both hardware and software to match each specific application. Two interface slots to the 2649I dual data buses are provided for those who may wish to add additional features.

### Integral Mass Storage:

The 2649I cartridge tapes provide an extensive stand alone capability. This capability can significantly reduce user time, conserve CPU resources, and allows the terminal to keep on working when the computer is not available. The cartridge tapes are useful for storing data, forms and program text and each tape can store up to 110,000 bytes each.

### Shared Peripherals:

The 2649I supports the shared peripheral interface. This interface allows you to connect multiple terminals to the same printer or a single terminal can share several compatible printers. The cost savings and convenience of the shared peripheral interface are obvious. In

addition to the shared peripheral interface the 2649I also supports both serial and parallel interfaces which can be used with Hewlett-Packard's dot matrix printers or other devices.

### Choice of Data Communications Capability:

The standard 2649I operates up to 9600 baud with handshake and offers asynchronous point-to-point data communications using an RS232C interface. Optional capabilities include: a 20mA DC current loop or both asynchronous and synchronous polling for multipoint communications which allow multiple terminals to share communication resources.

### 2640 Series Enhancements and Accessories

**13231A Display Enhancement:** With the 13231A individual characters or fields of characters can be displayed in any of the sixteen possible combinations of blinking, underline, half-bright or standard inverse video. The 13231A also provides the capacity for adding up to three 128-character sets. A line drawing set, math symbol set and large character set are currently available.

**13245A Character Set Generation Kit:** The high resolution display and  $9 \times 15$  dot character cell are available for special character set design with the 13245A. An included manual documents the steps necessary to design individual characters, assign the desired ASCII code equivalent, and generate the information to purchase Programmable Read Only Memories (PROM) which store the user-defined character sets.

**13238A Duplex Register:** The 13238A provides a parallel output interface which supports the 9871 character-serial impact printer.

**13250B Serial Printer Interface:** The versatile 13250B supports a wide variety of RS232C serial interface compatible printers at speeds up to 9600 bits per second.

**13254A Video Output Interface:** The 13254A provides the capability of generating video output which can be used by compatible television monitors and video hardcopy to duplicate whatever is being displayed by one of the 2640 Series family of display terminals.

**13296A Shared Peripheral Interface:** The 13296A allows connection of up to 15 compatible peripheral devices to 2647A. The cable is included.

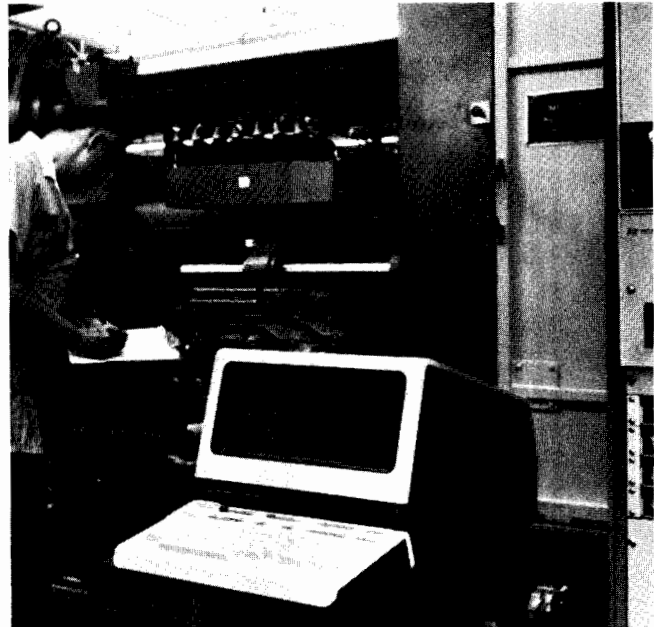

## 2640 Series Specifications

### General

**Screen size:** 127 mm (5") × 254 mm (10").

**Screen capacity:** 24 lines × 80 columns (1,920 characters).

**Character Generation:** 7 × 9 enhanced dot matrix; 9 × 15 dot character cell; non-interlaced raster scan.

**Character size:** 2.46 mm (0.097") × 3.175 mm (0.125").

**Character set:** 128 character Roman set with 2640B, 2645A, 2647A, 2648A; 128 character Cyrillic and 64 character Roman sets with 2640C; 128 character APL set with 2641A; 128 character Danish/Norwegian set with 2645N; 128 character Roman/Arabic set with 2645R; 128 character Swedish/Finnish set with 2645S.

**Cursor:** blinking-underline (alphanumeric), crosshair (graphics).

**Display modes:** white on black; black on white (inverse video); half-bright, underline, blinking (opt); std on (2641A).

**Refresh rate:** 60 Hz (50 Hz optional).

**Tube phosphor:** P4.

**Implosion protection:** bonded implosion panel.

**Keyboard:** detachable. Full ASCII/APL keyboard for 2641A. Full ASCII code keyboard; 2640B 20 control/editing keys, 2645 8 user-defined soft keys and 16 additional control/editing keys; ten-key numeric pad; cursor pad; full graphics cursor control pad 2647A, 2648A; multi-speed auto-repeat, n-key roll-over; 1.22 m (4 ft) cable.

**Cartridge tape:** two mechanisms, 10 ips read/write speed, 60 ips search rewind speed, 800 bpi recording, max 110k bytes of storage per MiniCartridge. Optionally available for 2641A, 2645A, 2648A, and 2649A; standard on the 2647A terminal.

### Data Communications

**Data rate:** 2641A: 110, 150, 300, 1200, 2400, 4800, 9600 baud

2645A N, S

2647A

2648A

2649A

2645K, R: 110, 150, 300, 1200, 2400, 4800 baud

2640B, C: 110, 150, 300, 1200, 2400 baud

Baud rate is external-switch selectable (110 selects two stop bits). Operation above 1200 baud may require nulls or handshake protocol to insure data integrity. Basic language control in the 2647A requires handshaking protocol to a host CPU.

Std. asynchronous communications: EIA RS232C; compatible with Bell 103A, 202C/D/S/T and 212A modems.

**Transmission modes:** full or half duplex, asynchronous.

**Optional communications interfaces:** current loop, split speed,

custom baud rates. Asynchronous and synchronous multipoint (2645A/N/S, 2647A, 2648A, 2649A).

**Operating modes:** on-line/off-line; character, line, block.

**Parity:** switch selectable (even/odd/none).

### Environmental

#### Ambient temperature

**Non-operating:** -40° to 75°C (-40° to 167°F); -10° to 60°C (-15° to 140°F) with tape.

**Operating:** 0° to 55°C (32° to 131°F); 5° to 40°C (41° to 104°F) with tape.

**Humidity (non-condensing):** 5 to 95% (20 to 80% with tape).

#### Altitude:

**Non-operating:** sea level to 7620 metres (25,000 ft).

**Operating:** sea level to 4572 metres (15,000 ft).

**Vibration and shock:** (type tested to qualify for normal shipping and handling in original shipping container.)

**Vibration:** 0.25 mm (0.010") pp, 10 to 55 Hz, 3 axes.

**Shock:** 30 g, 11 ms, 1/2 sine.

### Physical Specifications

**Display monitor weight:** 19.6 kg (43 lb.).

**Keyboard weight:** 3.2 kg (7 lb.).

**Display monitor dimensions:** 342 mm H × 444 mm W × 457 mm D (13.5" × 17.5" × 18"), 648 mm D (25.5") including keyboard.

**Keyboard dimensions:** 90 mm H × 444 mm W × 216 mm D (3.5" × 17.5" × 8.5").

### Power Requirements

**Input voltage:** 115 (+10%, -23%) at 60 Hz +0.2%.

230 (+10%, -23%) at 60 Hz +0.2%

**Power Consumption:** 85 W to 150 W max.

### Ordering Information

**2642A** Display Station

**2645A** Display Station

with cartridge tapes

**2647A** Intelligent Graphics Terminal

**2648A** Graphics Terminal

with cartridge tapes

**2649A** Microprogrammable Terminal

**2949I** Intelligent Alphanumeric Terminal

**13290B** Development Terminal

### Price

\$3500

\$5100

\$8950

\$5950

\$7550

\$2150

\$7750

\$6950



# COMPUTERS, PERIPHERALS & CALCULATORS

## Synchronous Modems

Models 37210T, 37220T

### 37210T

- 4800 bits/s synchronous operation
- Operates over leased, dial-up and multidrop circuits
- 2400 bits/s fallback speed



37210T

### 37220T

- 9600 bits/s synchronous operation
- Built-in diagnostic test
- Fallback rate 4800 bits/s



37220T

### 37210T 4800 bits/s Modem

The 37210T is an automatically equalized 4800 bits/s synchronous modem. It is microprocessor controlled and is designed for point-to-point and multidrop operation over four-wire leased lines or, when fitted with the appropriate option (Opt 002 or 003) for operation over two-wire dial-up circuits. The modem is designed as a stand alone unit and a rack mounting kit is available.

The modem uses automatic equalization to compensate for a wide range of group delay and attenuation distortions. At the start of transmission, the equalizer is set up by a special training sequence, after which it adapts automatically to compensate for any variations in circuit quality. The equalizer will withstand dropouts lasting up to one second without retraining and will, if necessary, retrain using the normal data signal.

The normal operating speed is 4800 bits/s and the modulation technique used is 8-phase Differentially Phase Shift Keyed (DPSK); for poorer quality circuits a fallback speed of 2400 bit/s using 4-phase DPSK is available. This may be selected via the modem interface or by using a front panel switch. The modulation scheme is compatible with the requirements of CCITT V.27 bis.

The modem includes digital and analog loopback controls and a test pattern generator. All of these may be controlled from the front panel of the modem or remotely via Option 005 (Remote Command). These functions may be used to perform a modem self check and an end-to-end performance check on the system. As a further aid to system diagnosis the principal modem interface signals are displayed on LED monitors.

### 37220T 9600 bits/s Modem

The 37220T 9600 bits/s Modem is an auto equalized synchronous modem designed for transmission of data over 4-wire point-to-point leased telephone circuits.

LSI circuits are employed to give cost effective and trouble free performance, and the modem will operate over unconditioned circuits, although higher quality circuits may also be used. It is built as a stand alone unit, and a rack mount kit is available.

The modem includes local and remote loopback tests which may be used with the built in pattern generator/error indicator to allow a modem self test to be carried out, and also to enable performance checks on transmission quality to be carried out from one end of the link. As a further aid to ensuring system integrity LED monitors are

provided on each of the principal interface leads.

The modulation scheme used is 4-level pulse amplitude modulation transmitted as a vestigial sideband on a 2853 Hz carrier. At the fallback rate of 4800 bit/s the scheme is altered to a 2-level VSB. This gives enhanced immunity to the effect of noise and allows the modem to operate over degraded quality circuits.

An automatic adaptive equalizer is used to compensate for the amplitude and delay distortion of the telephone circuit. At the start of transmission the equalizer taps are set up by a special training sequence, thereafter it adjusts itself automatically to compensate for variations in line parameters. Short line breaks or severe disturbances lasting up to two seconds do not require the modem to be retrained; however, under some circumstances retraining may be required (for example if the circuit is rerouted). In these circumstances it will be initiated automatically. Retraining may also be initiated manually with a front panel control.

The digital interface to the modem complies with EIA standard RS232C and is compatible with the requirements of CCITT recommendations V.24 and V.28.

### Options

Options	Prices
<b>37210T</b>	
<b>001:</b> PTT 4-wire Isolation Module—not required in USA	add \$270
<b>002:</b> PTT Dial Line Isolation—not required in USA	add \$140
<b>003:</b> Auto Answer DAA—used in USA/Canada	add \$510
<b>004:</b> Secondary Channel	add \$460
<b>005:</b> Remote Command	add \$400
<b>006:</b> Dial Back-up (0 dB)—limited approval	add \$340
<b>007:</b> Dial Back-up (4 dB)—limited approval	add \$340
<b>908:</b> Rack Mount Kit	add \$28

### 37220T

<b>001:</b> PTT 4-wire Isolation Module—not required in USA	add \$270
<b>908:</b> Rack Mount Kit	add \$28

Note: not all options are approved or required for use in every country. Check with local regulations before ordering.

### Ordering Information

<b>37210T</b> 4800 bits/s Modem	\$4350
<b>37220T</b> 9600 bits/s Modem	\$6150



- 2.4, 4.8, 9.6 and 19.2 kb/s: four data rates cover a wide range of applications
- Range: up to 22 miles at 2.4 kb/s
- Operates in point-to-point and multi-drop modes

- Automatic equalization: optimises performance and simplifies installation
- Built-in diagnostics: simplifies installation, maintenance and testing
- Smaller and less expensive than conventional modems

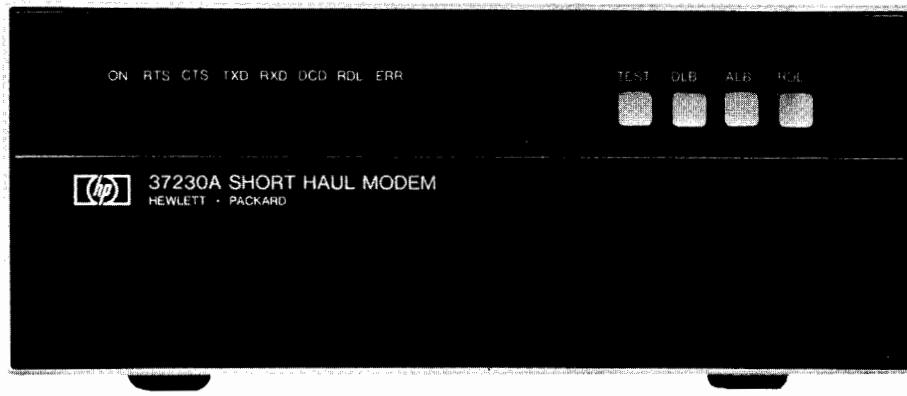

37230A

The 37230A Short Haul Modem provides synchronous transmission of data at rates of 2.4, 4.8, 9.6, and 19.2 kb/s. The unit is designed for half-duplex, full-duplex, and multi-drop operation over local circuits. It offers features similar to those of a conventional modem, but at lower cost. The 37230A is an economic alternative where transmission within a limited area is required.

The modem can be used over unloaded metallic circuits which are either installed privately or leased from the telephone company. The modem operates half-duplex on 2-wire circuits, and half-duplex, full-duplex, and multi-drop on 4-wire circuits. Suitable circuits can normally be obtained from the telephone company but may be restricted to within one end office (exchange) area. The 37230A complies with BSTR Pub 43401 and is also designed to meet the technical requirements of other authorities including many European PTT's.

An automatic equaliser in the modem receiver compensates for variable characteristics of the telephone circuit, optimising the performance throughout the specified range. This removes the need to perform any adjustments on the modem and simplifies the installation procedure. In multi-drop systems the central modem automatically readjusts its equaliser to compensate for whichever of the remote sites is transmitting.

The 37230A includes diagnostic test features similar to those found on conventional leased line modems. These include local and remote digital loopback, local analog loopback, and a test pattern generator/error detector. These facilities can be used for testing and fault-finding without the need for any other test equipment.

### Range

The operating range of the 37230A depends on several factors including data rate, transmit signal level, and cable type used for the circuit. Typical operating ranges are shown in Table 1.

Table 1 Operating Range (max output level)

Data Rate	19 AWG 0.9mm	22 AWG 0.6mm	24 AWG 0.5mm	26 AWG 0.4mm
2.4 kb/s	22 miles	15 miles	12 miles	10 miles
4.8 kb/s	18 miles	12 miles	10 miles	8 miles
9.6 kb/s	13 miles	9 miles	7 miles	6 miles
19.2 kb/s	9 miles	6.5 miles	5 miles	4 miles

Note: test conditions: maximum send level; 140Ω terminating impedance; polythene insulated twisted pair cable simulator.

To meet the requirements of BSTR Pub 43401, the output level from the modem must be reduced for data rates above 2.4 kb/s. The required reduction in send level causes a corresponding reduction in range.

### Remote Control of Loopback

Option 001 of the Short Haul Modem allows the diagnostic loopback facilities to be controlled via the DTE interface connector.

### Specifications Summary

**Operating Mode:** synchronous, 2-wire (half-duplex) and 4-wire (full-duplex, half-duplex, and multi-drop)

**Data Rates:** (nominal) 2.4, 4.8, 9.6, 19.2 kb/s.

**Digital Interface:** EIA RS232C/CCITT V.24 V.28 compatible.

### Transmitter

**Line Coding:** delay modulation (Miller code) plus scrambler.

**RTS/CTS Delay (nominal)**

**Constant Carrier:** 0 ms.

**Switched Carrier:** ≤25 ms at 2.4 kb/s

≤15 ms at 4.8 kb/s

≤10 ms at 9.6 kb/s

≤8 ms at 19.2 kb/s

**Output Impedance:** (nominal) 140Ω or 600Ω by internal strap selection. The transmitter also has a high impedance non-transmit mode for multi-drop operation.

**Output Spectrum:** dependent on data rate. The output level may be strapped so that the line signal conforms to BSTR Pub 43401.

### Receiver

**Input Impedance:** (nominal) 140Ω, 600Ω, or high (≥10kΩ) by internal strap selection.

### Line Signal Detector

**Dropout Level:** -46 ± 3 dBm (measured with 1 kHz tone).

**Pull-in Level:** 6 ± 2 dB above dropout level.

**Dimensions:** 102 mm (4.0 in) high  
213 mm (8.4 in) wide  
285 mm (11.2 in) deep

### Options

**001:** Remote Control of Loopback

**301:** Rack Mount Kit

**302:** Dual Rack Mount Kit

### Prices

add \$140

add \$30

add \$50

**37230A Short Haul Modem**

**\$1020**



# COMPUTERS, PERIPHERALS & CALCULATORS

## Data Capture Terminals

Models 3075A, 3076A, 3077A

- Modular-choice of displays, keyboards, readers, printer and electrical interfaces
- User-definable keys/prompting lights for ease of use



### The Terminal Family

The HP3075A/3076A/3077A family of data capture terminals fulfills a wide range of data collection requirements in industry; in applications ranging from stock control to time reporting.

The HP3075A desktop terminal and HP3076A wall mounted terminal (with cradle) are both workstations equipped with user-definable special function keys and prompting lights. These can be individually defined for specific tasks.

The user-definable keys and lights are labelled with their specific function. This enables people with little or no experience of using computer terminals to operate these terminals with no special training.

The terminals' modular construction and wide range of options enables them to be built in over 300 different configurations. Thus each terminal can be configured to suit the required application.

"Primarily designed for use in manufacturing environments" does not mean they are restricted to the shop floor. They are also perfectly adaptable for applications in finance, order processing or any department with a data processing requirement.

The HP3077A is a time reporting terminal equipped with a large time display and a Type V Badge Reader (or optionally either a Multifunction Reader or a Magnetic Stripe Reader.) It can be used, for example, to register personnel arrival and departure or to control access to restricted areas (using a relay built into the wall mounting cradle).

### Data Communications

The 307X terminals can be connected to HP systems and almost any other computer on the market today. This is owing to their RS232C compatible communications interface with a choice from three of the most popular communications modes available:

- **Factory data link:** the computer and terminals (including HP 264X series) may be connected anywhere along a Data Link. The computer and 264X terminals are connected using an HP 3074A Data Link Adapter. Advantages: cost-effectiveness, high noise immunity, link length up to 8km (5 miles), up to 127 terminals (depending on the computer) and the capability of plugging/unplugging terminals from the link without disturbing system operations.
- **Multipoint:** multiple terminals (including HP 264X series) can be daisy-chained to a single computer interface either hardwired or via half or full duplex modems. Advantage: lower installation costs to remote sites.
- **Point-to-point:** hardwired or via full duplex modems. Data transmission in character mode. Advantage: a direct replacement for a teletype-like device.

- Choice of data communications-factory data link, multipoint or point-to-point
- Simple, low cost installation

### 3075A, 3076A Specifications

The 3076A is a wall mounted version of the 3075A and is supplied with the HP 92904A Wall Mounting Cradle as standard. Other specifications for the 3075A and 3076A are identical.

**Standard keyboard:** numeric keypad; control keys, 10 user-definable special function keys plus 17 user-definable prompting lights.

**Alphanumeric keyboard (option 004):** same as standard numeric keyboard except the 10 special function keys are replaced by 26 alphabetic/special function keys and one shift key.

**Standard display:** 15 position numeric display with protected field and blinking capability.

**Alphanumeric display (option 005):** 24 position display, 64 upper-case ASCII character set (040<sub>8</sub> to 137<sub>8</sub>) plus protected field and blinking capability.

**CRT display (option 006):** two independent screens of information can be stored; 8 lines of 16 large characters (64 ASCII set, 040<sub>8</sub> to 137<sub>8</sub>) and 16 lines of 32 standard characters (91 ASCII set, 040<sub>8</sub> to 172<sub>8</sub>). Only one screen can be displayed at one time.

**Multifunction reader (option 007):** reads type III punched plastic badges, 80 column punched cards, optical mark forms and turn-around documents. Reads in Hollerith (max. 128 char. per column) or Image (max. 4096 combinations per column) modes.

**Type V badge reader (option 008):** reads type V punched plastic badges in Numeric and Image (1024 combinations per column) modes. Reads badges entered either face up.

**Strip printer (option 009):** 5 x 7 dot matrix thermal printer. 20 characters per line, left justified. Speed 40 lines per minute. 64 upper case ASCII set (040<sub>8</sub> to 137<sub>8</sub>).

**Bar code reader (option 010):** a low cost reader for black and white bar code labels using codes Industrial 2 out of 5, Matrix 2 out of 5 or so called Code 39.

**HP-IB controller (option 011):** up to 14 devices compatible with the IEEE 488 interface may be connected to the terminal.

**Magnetic stripe reader (option 012):** reads documents/badges encoded with up to 37 numeric characters on track #2 to ISO standard 3554 (as used by the ABA for credit cards). Also reads badges/cards encoded with up to 100 numeric/alphanumeric characters using IBM wide track (3630) format.

**Serial interface (option 013):** allows one device compatible with EIA RS232C or CCITT V 24/28 specifications to be connected to the terminal.

**Terminal control:** via escape sequences of any length, compatible with 264X asynchronous multipoint terminals.

### 3077A Specifications

Standard terminal includes Type V Badge Reader (specs. as for 3075A). A Multifunction Reader (option 001) or Magnetic Stripe Reader (option 002) may be fitted instead. An Alphanumeric Display (option 005) may also be fitted (Specs. as for 3075A).

**Clock display:** four 7-segment LED's indicate time in hours and minutes. Selectable 12 or 24 hour clock.

**Read operation:** time stored with contents of each badge.

### HP 92904A Wall Mounting Cradle Specifications

**Function:** holds one 3076A or 3077A terminal on a wall or pedestal. Also routes electrical power and data cables to the terminal. Supplied as standard with the terminal.

### HP 3074A Data Link Adapter Specifications

**Function:** interfaces RS232C/CCITT V24 electrical levels to Data Link electrical levels and vice-versa. Used between computer/terminal (except 3075A, 3076A, 3077A) on the Data Link.

### Ordering Information

	Price
<b>3075A Desktop Data Capture Terminal</b>	from \$2488 to \$5323
<b>3076A Wall-Mounted Data Capture Terminal</b>	from \$2945 to \$5780
<b>3077A Wall-Mounted Time Reporting Terminal</b>	from \$2945 to \$3990
<b>92904A Wall Mounting Cradle</b>	\$ 479
<b>3074A Data Link Adapter</b>	\$ 551

# COMPUTERS, PERIPHERALS & CALCULATORS

Optical mark reader for data collection and entry

Model 7260A

645



- Immediate off-line data preparation at source
- Reads marks made by ordinary pencil
- Reads standard punched cards

- Off-line operation with terminals
- Easy local/remote connection to computer via RS232C/CCITTV24 interface.

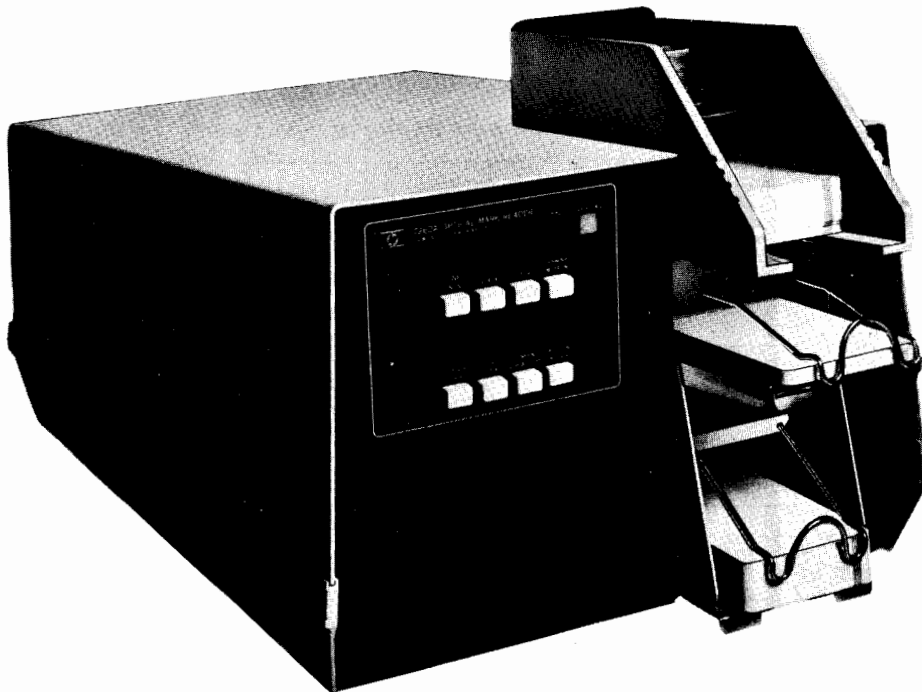

7260A

A typical mark sense form

PRODUCTION		PRODUCTION CARD				QUALITY CONTROL	
Operator No.	Card No.	Quantity Produced	USE ONLY IN TYPE SOFT PENCIL	Controller No.	Quantity Punched if all punched, mark		
0	0	0		0	0	0	
1	0	0		0	0	0	
2	0	0		0	0	0	
3	0	0		0	0	0	
4	0	0		0	0	0	
5	0	0		0	0	0	
6	0	0		0	0	0	
7	0	0		0	0	0	
8	0	0		0	0	0	
9	0	0		0	0	0	

The 7260A Optical Mark Reader saves data preparation time and prevents errors by using one functional card for both source document and data entry. The data may be marked with an ordinary soft lead pencil, eliminating the need for special marking pencils or keypunch operations. Also, errors can easily be erased. Each form may contain any combination of pencil marks/prepunched holes/preprinted marks.

The 7260A can be operated remotely from the computer via an RS232C/CCITTV24 interface and modems. This enables it to be sited exactly where it is needed, e.g. production line, quality control, warehouse. All source documents can then be conveniently batched for transmission to the computer at one time. A Select Hopper (option 002) is available which allows card selection under program control.

### Specifications

**Code capacity:** recognizes 128 characters Hollerith code.

**Translation:** to bit-serial 7-level ASCII, selectable parity.

**Operational modes:** demand and continuous feed.

**Parity:** generates and transmits selectable parity.

**Data rates:** 110, 150, 300, 600, 1050, 1200, 2400 baud, selectable.

**Tab cards dimensions:** standard tab card size 82.6 x 187.3 mm (3.3 x 7.4") up to 82.6 x 282.6 mm (3.3 x 11.1")

**Hopper capacity:** 450 cards input, 450 cards output.

**Interface:** RS-232C and CCITT V24

**Interface Connectors:** 2 Cinch/Cannon DBM-25S-rear panel.

**Invalid Code:** transmits a selectable character when data outside 128 character set is marked.

**Mute and Line-Local Operation:** allows operation with local terminal, and allows muting of terminal Printer.

**Mnemonic Control:** allows 3 letter mnemonics to control Reader when control codes would interfere with system operation.

**Image:** transmits Binary card image as two typing characters with selectable parity, activated by control codes from computer.

**Size:** 305 mm H x 368 mm W x 610 mm D (12 x 14.5 x 24")

**Weight:** net, 24.6 kg (54 lb). Shipping, 33.2 kg (73 lb).

**Environment (exclusive of tab cards):**

**Storage temperature:** -40°C to +75°C

**Exposure power on:** -20°C to +65°C

**Meets specifications:** 0°C to +55°C

**Humidity:** 5%-95% at 25°C to 40°C.

**Vibration:** 10-55 Hz, 0.25mm (0.01") peak-to-peak excursions.

**Environment (tab cards):** from 20% to 75% RH at 23°C.

**AC Power:** (see Option 005 for 220/240 V ac operation) 100 or 120 V. ac, +5%-10%, switch selected 47.5 Hz, 66 Hz; 300 VA.

**Fuses:** line 4ASB, transformer 2ASB.

**U.L. approval:** U.L. approved and meets IEC specs.

### Options

**002:** Select Hopper

**003:** Encoder

**004:** Bell

**005:** 220/240V ac +5% -10% (line fuse 2ASB, Transformer 1ASB.)

**006:** 50 Hz operation

**007:** Wider input hopper (+0.5 mm/0.2 inch) for use with forms of nominal standard burst from continuous line printer stationery.

**045:** Operation with 9825/45 Desktop Computers

**300:** Operating manual for 3000 series II system

**7260A Optical Mark Reader**

### Price

add \$440

add \$551

add \$60

NC

NC

add \$220

add \$22

add \$10

**\$6936**

# COMPUTERS, PERIPHERALS & CALCULATORS

## Technical Computer Peripherals Interfacing Summary

Interface ports are included in each Hewlett-Packard technical computer to provide plug-to-plug compatibility with a wide variety of HP peripherals, as shown in the following table:

HP Technical Computer Interfacing Summary

Peripherals		Technical Computers						
	Reference Page No.	85A	9815S	9825	System 35	System 45	1000	
							M-, E-, F-Series	L-Series
9111A Graphics Tablet	648	•	•	•		•	•	
9874A Digitizer	648		•	•	•	•	•	•
9885M/S Flexible Disc Drive	647			•	•	•	•	
9895A Flexible Disc Drive	647	•		•	•	•	•	•
82901M/S Flexible Disc Drive	620	•						
82902M/S Flexible Disc Drive	620	•						
7906H Hard Disc Drive	662				•			•
7906M/S Hard Disc Drive	662				•	•	•	
7910H/R Hard Disc Drive	664				†			•
7920H/M/S Hard Disc Drive	662				•	‡	•	
7925H/M/S Hard Disc Drive	662				•	‡	•	
7970B Tape Drive	652						•	
7970E Tape Drive	652				•	•	•	•
9875A Cartridge Tape Unit	649		•	•	•	•		
9878A I/O Expander	649			•	•	•		
12050A Fibre Optic HP-IB Link	31		•		•	•	•	•
7221B/S Plotter	654						•	
7225A Graphics Plotter	656	•	•	•	•	•	•	
9872B/S Four-color Plotter	655	•	•	•	•	•	•	•
2608A Dot Matrix Line Printer	650		•	•	•	•	•	
2631A Dot Matrix Impact Printer	651	•	•	•	•	•	•	•
2631G Graphics Printer	651	•	*		•	•	•	
7245B Printer/Plotter	658		*	•	•	•	•	•
7310A Thermal Graphics Printer	659		•	•	•	•	•	
9866B Thermal Printer	649		•	•	•	•		
9871A Character Impact Printer	649		•	•	•	•	•	
9876A Thermal Graphics Printer	649	•	*	•	•	•	•	
9884A Tape Punch	649		•	•	•	•	•	•
1350S Graphics Display System	234		*	•	•		•	
2621A/P CRT Terminal	632		•	•			•	•
2626A/P Terminal	633						•	
2635B Hard Copy Terminal	651		•	•			•	•
2640B CRT Terminal	636		*	*			•	
2645A CRT Terminal	636		*	*			•	•
2647A CRT Graphics Terminal	638		*	*			•	•
2648A CRT Graphics Terminal	639		*	*			•	•
2649B/C/G OEM Terminal	636						•	
3076A Data Capture Terminal	644		*	*			•	•
3077A Data Capture Terminal	644		*	*			•	•

\* Depends on application; not all functions may be implementable.

† 7910H only.

‡ 7920M/S and 7925M/S only.

# COMPUTERS, PERIPHERALS, & CALCULATORS

Technical Computer Peripherals

Models 9885 M/S, 9895A

647

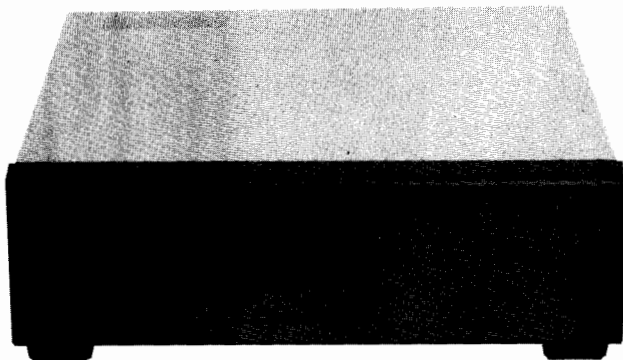

9885M/S

## 9885M/S

Low cost, high speed, large storage capacity, reliability and ease of operation in data management are features offered by the 9885 Flexible Disc Drive. The 9885 provides a means of transferring data and programs to and from the HP 9825B/T, and Systems 35 and 45 Desktop Computers. Mass storage on the 9885 provides random access to approximately 500,000 bytes of data per removable disc.

This reliable and easy-to-use flexible disc drive comes in two versions: the 9885M (master) and the 9885S (slave). The 9885M contains a built-in controller to handle data storage for the master and up to three additional drives. Up to three slaves can connect to one master. This expandability provides a means of ensuring easy "backup" of critical information or providing random access to nearly two million bytes of data. The 9885S has no controller and must be connected to the 9885M.

Average transfer rate between computer and disc drive is 23K byte/s. Double-density read/write on the flexible disc further enhances access rate and increases total storage capacity. Average access time on the disc is 267 ms. The 9885 is also self-contained and incorporates a self-test feature.

The 9885 system software is contained in read-only memory. The system requires about 1000 bytes of read/write memory for data buffer, bootstrap area, pointers and status words. All statements are programmable. The file-by-name system has a directory that maintains user files and available space.

### Features

- High-speed data transfer
- Double-density read/write
- Write-verify for greater reliability
- High-level system software
- Self-contained package
- Approximately 500,000 bytes of total user-available space per disc
- Low-cost, removable disc
- Multiple flexible disc drive configuration
- Data recovery routines

### Ordering Information

	Price
9885M Flexible Disc Drive Master	\$3250
9885M and Opt. 025 (for operation with 9825B/T)	\$3900
9885M and Opt. 035* (for operation with 9835A/B)	\$3750
9885M and Opt. 045* (for operation with 9845A/B/C/S/T)	\$3750
9885S Flexible Disc Drive Slave	\$2500

\*Mass Memory ROM not included.

## 9895A

The Hewlett-Packard 9895A Flexible Disc Memory provides up to 2.36 million bytes of mass storage capacity. Each of the two drives in

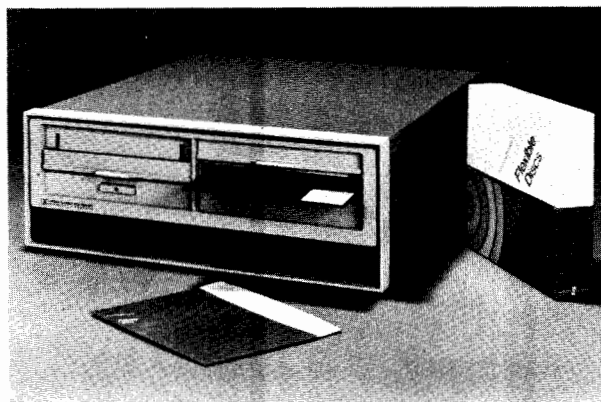

9895A



the 9895 reads and writes double-sided, double-density format on HP qualified flexible discs. The 9895 can store up to 590,000 bytes of data per disc side for a total of 1.18 million bytes of storage per disc.

Featuring the HP-IB\*\* interface, the 9895 is compatible with the HP System 35 and 45\*, 9825T and HP 85 Desktop Computers and the HP Series 1000 Minicomputers.

The 9895's built-in controller can recognize if the flexible disc has been recorded on one or two sides. This capability enables the 9895 to read single-sided discs written by the HP 9885M or HP 9885S Flexible Disc Memories. The controller of the 9895 also allows it to exchange data with other systems which use the IBM 3740 single-sided, single-density format provided additional software exists on the host computer. (Note: Since tolerance on IBM compatible media are not fully specified by vendors and do vary, HP cannot guarantee that IBM 3740 media can be read by the 9895 in every case.)

The 9895 can provide up to 4.72 million bytes storage capacity through an optional dual-drive slave unit (without controller). This option is one of several available designed to give the user price-performance flexibility. An optional single drive slave offers an extra 1.18 million bytes storage, and the dual-drive slave provides an additional 2.36 million bytes. The 9895 can also be ordered with one drive installed for 1.18 million bytes capacity. These options can be easily upgraded to 9895 full capability at a later date if the user so desires.

HP provides the user a convenient source of approved, quality media through extensive testing, selection and control. These HP qualified flexible discs bring out the most reliable performance in the 9895 disc drive.

\*\*Hewlett-Packard Interface Bus: Not just IEEE-488, but the hardware, documentation and support that delivers the shortest path to a computer system.

\*The 9835A/B and 9845B require a dedicated HP-IB channel (98034A) for mass storage devices.

### Features

- Double-sided/double-density
- HP-IB Compatible
- Handles up to four drives
- Reads 9885 Single-sided discs
- Optional slave storage
- Single drive option

### Ordering Information

	Price
9895A Dual drive with controller	\$6000
9895A Opt. 010 Single drive with controller	\$4500
9895A Opt. 011 Single drive without controller	\$3500
9895A Opt. 012 Dual drive slave without controller	\$5000

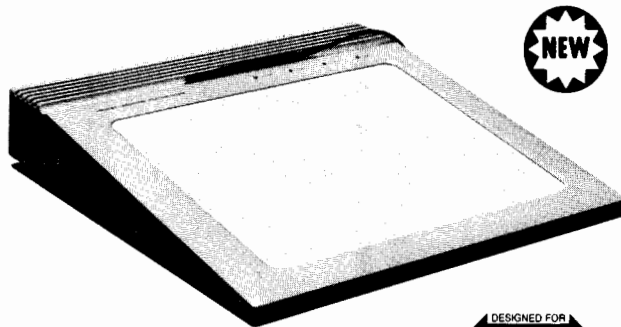

9111A

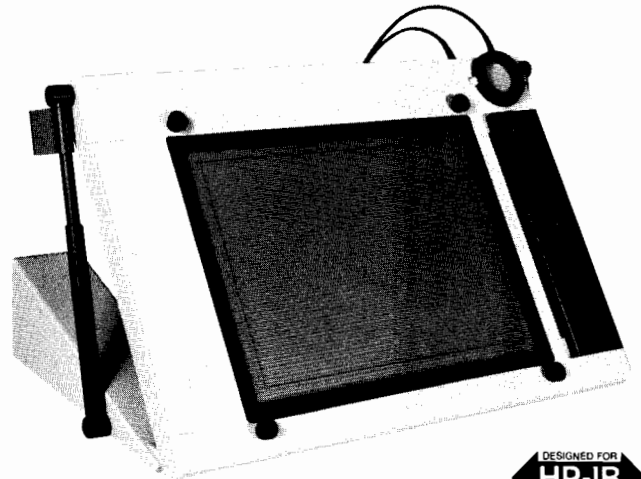

9874A



### 9111A Graphics Tablet

Hewlett-Packard's 9111 is a graphics tablet which can open up new fields of user interaction in graphics and menu applications.

The 9111 can be used as a cursor mover in interactive graphics. Single point or continuous digitizing modes may be used to enter raw graphics data into a host computer. The binary cursor transfer combined with the single point digitizing mode are a perfect combination for cursor moving and "picking" in interactive graphics.

A programmable cursor position update rate of up to 60 updates per second allows matching the cursor update to your display refresh rate. A binary cursor transfer is provided for maximizing the data transfer rate, allowing inputting the cursor location without having to translate from ASCII characters to internal integer representation. This is in addition to the standard HP-IB character string which is easy to use with high level languages.

The 9111's 16 softkeys provide a "hardware" menu, with interpretation built into the graphics tablet. This eliminates cumbersome analysis of position for small menu operations to enter data or control the program. The user selects a key by positioning the stylus in one of the 16 softkey boxes and pressing down to activate the digitizing switch. The softkeys may be turned off to expand the digitizing area.

Quality and durability are apparent from the 9111's platen and stylus. The hard ceramic material will not easily scratch or pit.

The artwork defining the softkeys and border is fired into the ceramic, and will not wear off. The stylus is slim and lightweight with good tactile feedback on the switch position. Interchangeable inked and non-inked refills are available.

A four-octave beeper, with programmable frequency, duration and loudness, is provided for an audio response channel. The frequency is specified in terms of an even-tempered musical scale, for better human engineering of audio prompts. Duration is programmable directly in milliseconds (up to 32,767) and six amplitude levels (including off) are available.

Two built-in self-tests are provided to ensure the user that the machine is operating properly. The electronics self-test is performed whenever the instrument is turned on and may also be initiated under program control. A more extensive interactive self-test is also available, either by switch selection from the rear panel or by command from the host computer.

Through the standard HP-IB interface (HP's implementation of IEEE-1978), the 9111 is compatible with a wide variety of computers and terminals from HP. The 9111's repertoire of 25 HP-GL commands provides the user with precise control of all its functions.

9111A Graphics Tablet

\$1950

### 9874A Digitizer

The 9874 Digitizer provides a convenient method of entering graphic information into computers using the HP-IB (IEEE Standard 488-1978) interface including any HP Series 9800 Desktop Computer, the HP 1000 Minicomputer and the 2647A Intelligent Graphics Terminal.

Used in numerous applications — strip chart analysis, mapping and resource management, medical research and treatment, and destructive and non-destructive test analysis — the 9874's advanced features make it easy to control an entire application right from the digitizer.

Features include an adjustable glass platen that enables digitizing exact images without distortion from a wide variety of projectable media such as X-rays, movies and 35mm slides.

A unique vacuum cursor adheres to any area of the platen. It is lighted, and has an open-circle target, 0.250mm in diameter, giving pinpoint precision to accurately position and move.

In addition, the 9874 has microprocessor intelligence. It also has a control pad with digitizer control, Special Function and numeric entry keys, and a self-test feature. Points may be digitized one at a time or continuously (based on the time or distance increments) by simply pressing the appropriate key. An axis align key automatically aligns the x and y axes of the digitizer with those of the document, matching the digitizer coordinate system to the document being used.

Forty different instructions, available on the 9874, simplify programming and increase communication efficiency. Additional ROMs are available for HP desktop computers to simplify and expand the language capability. Although not required, these language ROMs are helpful when programming the desktop computers.

#### Features

- Adjustable glass platen
- Automatic alignment of the coordinate system
- Free-moving cursor
- Stylus
- Absolute coordinate system
- Cursor Vacuum System
- Rear projection of graphic images
- Self-test
- Relocatable origin
- Microprocessor intelligence
- Axis extension capability for large documents
- Special function keys
- Auto-sampling by time or distance increments

9874A Digitizer

\$7200

# COMPUTERS, PERIPHERALS & CALCULATORS

649

## Technical Computer Peripheral

Models 9866B, 9871A, 9875A, 9876A, 9878A, 9884A, 11310A

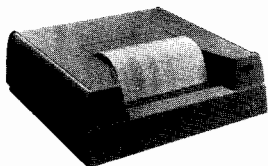

### 9866B

**9866B Thermal Printer** — a general purpose, 80-column printer that produces single-copy, page-width, fully formatted, alphanumeric text, tables or simple plots at 240 lines per minute. The standard ASCII character set is in a 5 x 7 dot matrix format.

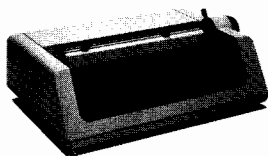

### 9871A

**9871A Impact Printer** — can be used with Series 9800 Computers and 2640 terminals. Bidirectional vertical and horizontal motion provides plotting capabilities. Six interchangeable 96-character print discs and a 98021A optional form-feed mechanism are available.

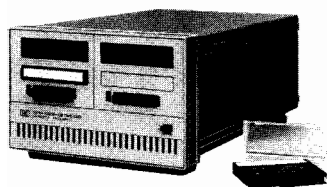

### 9875A

**9875A Cartridge Tape Unit** — The 9875A is a peripheral mass storage device that provides data interchange among the HP Series 9800 Desktop Computers or other HP-IB (IEEE 488-1978) compatible devices. The 9875 is available as either a single or double tape drive unit, and each cartridge has a 225K byte capacity, providing large mass storage for less than the cost of a disc drive.

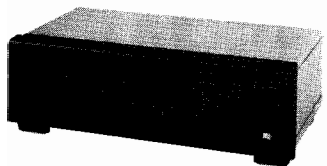

### 9878A

**9878A I/O Expander** — interfaced with the Hewlett-Packard 9825B/T and Systems 35 and 45 Desktop Computers, provides six additional I/O ports and will accommodate all the 9825 and Systems 35 and 45 interface cards.

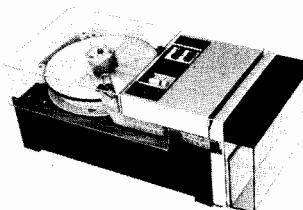

### 9884A

**9884A Tape Punch** — provides a fast and reliable method of direct transferring output onto punched tape at 75 characters per second. Other features include automatic cut-out, automatic rewinding, a tape lifter and an additional tearer.

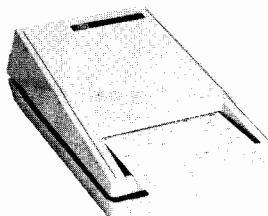

### 11310A

**11310A Card Reader** — reads 35 columns of hand-fed cards, marked or punched, in less than two seconds. Ideal for data entry applications. This low cost card reader is small and quiet enough for OEMs customers' use in most business environments.

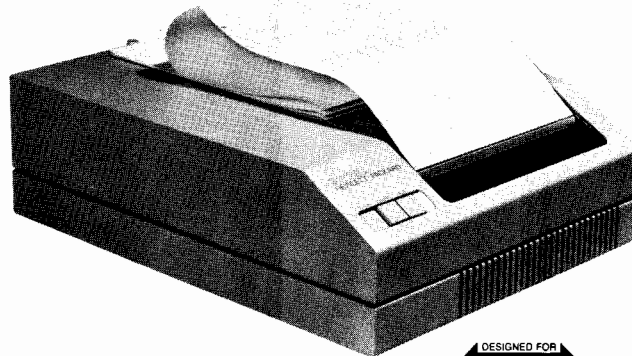

9876A



The 9876A Thermal Graphics Printer is a fast, quiet line printer offering graphics capability as well as alphanumeric printing. Its speed of up to 480 lines per minute makes it ideal for producing high-speed listings, working reports or quick plots and graphics. The 9876 is quiet enough for lab or office, and reliable enough to run unattended.

The raster graphics field contains 560 dots across an 18.5 cm field. The standard ASCII character set is in a 5 x 7 dot matrix format with additional dots available for ascenders and descenders, underlines and overlines. The additional dots (in a 7 x 12 matrix) can be used to define any special characters you may need for unique applications. Underlines, overlines and characters 50% taller than normal let you highlight elements of the output to make it more legible. Seven international character sets — French, German, Katakana, British, Spanish, Danish/Norwegian and Swedish/Finnish — reside in the printer and can be accessed by software.

The 9876 thermal paper comes in fanfolded, perforated, standard size packages of 330 sheets, either 8.5 x 11 in. (216 x 279 mm) English size or 210 x 297 mm (8.27 x 11.69 in.) metric size. The paper is available for printing either in blue for utility use or in black for higher contrast and fade resistance.

Built-in self-test features assure proper operation or help pinpoint problems quickly to maintain the 9876's reliable performance.

Available with HP-IB (IEEE-488), 8-bit parallel or RS-232-C interfaces, the 9876 is compatible with a wide variety of computers and terminals from Hewlett-Packard and other manufacturers.

The 9876 is also available as a caseless version (11479).

### Features

- Fast printing and graphics
- Quiet operation
- Easy-to-read hardcopy output
- Character generation flexibility
- Nine software selectable character sets
- Form control functions
- English and metric perforated, fanfolded paper
- 30 dot/cm (77 dot/in.) graphics resolution

### Ordering Information

9866B Thermal Line printer
9871A Impact Printer
9875A Cartridge Tape Unit
9876A Thermal Graphics Printer
9878A I/O Expander
9884A Tape Punch
11310A Card Reader

### Price

\$4800
\$4100
\$2750
\$3950
\$1500
\$3080
\$ 505



# COMPUTERS, PERIPHERALS & CALCULATORS

## Line Printer

Model 2608A

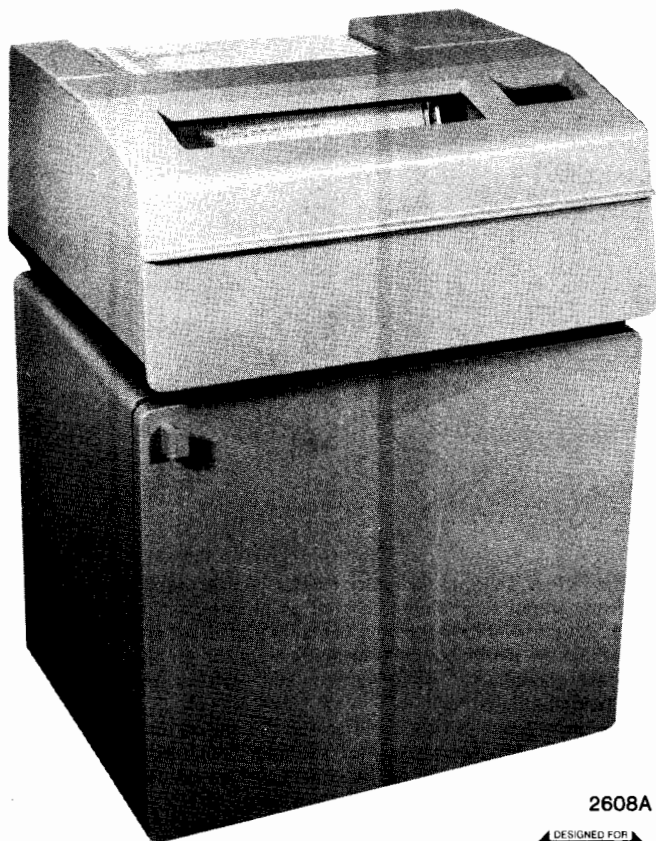

2608A



Performance is the watchword for the HP 2608A line printer. It is a low cost, highly reliable, medium speed printer which has been designed for use in most computer applications. With quality dot matrix printing, the HP 2608A will print at speeds up to 400 lines per minute. Special user features include multiple character sets, 16 channel vertical format control, graphics capability and double sized characters. The 2608A is rugged enough for EDP applications yet quiet enough to approach usage in the office environment.

**High Reliability:** The HP 2608A printing mechanism has few moving parts, operates virtually without friction, and requires minimum maintenance. The basis of the printing mechanism is a hammer and coil set for each of 132 print positions. With this hammer and coil arrangement, dots can be placed in any of 924 dot positions on the print line.

In addition, the printer is microprocessor controlled for flexibility, increased functional capability, and added reliability. Microprocessor control also provides an internal self test capability.

**High Throughput:** The HP 2608A will print in upper case ASCII characters at a speed of 400 lines per minute. The print speed in conjunction with the 14 inch per second slew rate results in high throughput.

**Quality Print Capability:** The dot matrix character cell provides clear character formation and is especially well suited for the printing of multipart forms. Each dot is formed with equal force; thus, impact variations, which cause embossing, smearing, and light or partially formed letters, do not occur.

Up to six-part forms may be used with the HP 2608A. To maintain print quality when changing pack thickness, the platen-to-hammer gap can be easily adjusted by the operator. (All multi-part forms should be tested for satisfactory feeding, registration and print quality.)

**Printing Versatility:** The HP 2608A can be programmatically controlled to print double size characters (5 x 7 matrix is increased 10 x 14). When double size characters are printed, line spacing becomes either three or four lines per inch instead of six or eight lines per inch, and characters occupy two print columns instead of one.

The HP 2608A can support up to 12 different character sets with any two being used interchangeably in the same line.

Forms control is provided through a 16-channel electronic vertical format control unit which may be operated with either the standard 11-inch channel assignments or with programmatically assigned channel definitions. An optional 12-inch form VFC is available.

**User Convenience Features:** Special attention has been given to make the HP 2608A a quiet printer. Acoustical materials have been used in both the printer and attached stand to reduce audible noise to 72 dBA. The stand also provides an out-of-the-way paper location.

An extended life, easy-to-install cartridge ribbon will print an average of 30-million characters. When a ribbon change is required, it is a quick, clean task.

A self test routine tests the HP 2608A to verify its operational status. This self test function may either be initiated with the control panel switch or, depending on the system configuration, performed under program control. If a self test failure occurs, the printer has been designed to provide a binary display which will identify the specific portion of the self test routine which has failed.

*(NOTE: Not all 2608A features are supported on all HP systems. Please refer to systems configuration/peripheral support documentation for information concerning HP 2608A support.)*

Model 2608A Line Printer

\$9,900

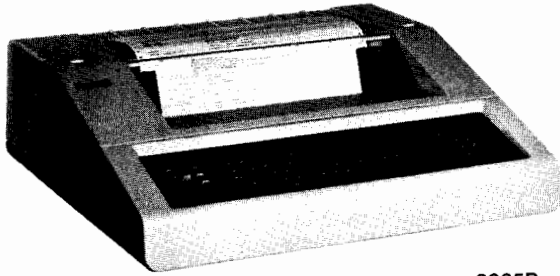

2635B

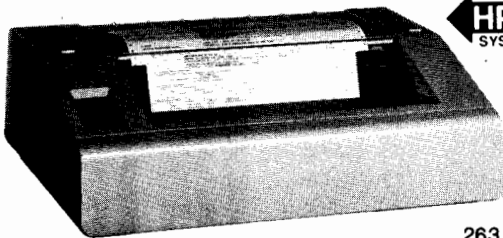

2631B/2631G



## HP 2631B Printer from \$3,600

The 2631B printer is a smart bidirectional dot matrix serial printer. Due to its microprocessor based control it has the capability to optimize throughput, and offers a wide range of print features to handle various printing requirements. The 2631B utilizes a 7 x 9 wide matrix print head for crisp, clear character formation, and is capable of handling forms of various widths and lengths.

**Optimized Throughput:** The 2631B suppresses leading and trailing blanks, performs a high speed slew over ten or more imbedded blanks, and looks ahead at each print line to determine the fastest direction for printing. All of these capabilities combine to optimize throughput.

**Multiple Print Modes:** Eight different print modes are user selectable. Normal (10 cpi), compressed (16.7 cpi), and expanded (5.0 cpi) are switch selectable from the front panel. The five remaining modes, from 4.16 to 12.5 cpi, are program selectable via escape sequences. Compressed print allows 132 columns on 8½ inch wide paper, while the other modes are useful for headings, titles, and bold print.

**Print Features:** The 2631B offers many print features that contribute to overall throughput and printing versatility. These features include left and right margins, horizontal and vertical tabs, programmable page length, eight print modes, and twelve vertical line spacings.

**Character Sets:** The standard character set is a full 128 USASCII set. The 7 x 9 dot matrix cell uses a half dot shift technique to print at optimum speed. An optional high density character set is available which prints a full 7 x 9 dot matrix cell, at 90 cps, with resulting higher quality print. National language character sets are available in both standard and high density character cells.

**Long Life Print Head:** The durable print head used in the 2631B is conservatively rated at 100 million characters.

**Easy Loading Ribbon Cartridge:** The print ribbon is contained in a unique plastic cartridge that is easily removed and installed without touching the ribbon itself. The 60 yards of ribbon form a mobius loop which allows printing on both sides of the ribbon, extending its life to 15 million characters.

**Self Test:** Each member of the 2630 family has a built-in self test which allows the user to verify proper operation with the touch of a

button. Additional built-in diagnostics are accessible for more complete testing and diagnostic purposes.

**Variety of Interfaces:** The 2631B has a variety of interfaces available for configuration on HP systems. These include RS-232C with full duplex modem control, ENQ/ACK, X-on/X-off, and printer busy protocols; 8-bit TTL interface for the HP 264X series of terminals, IEEE 488-1975 (HP-IB); and a parallel differential interface.

## HP 2635B Printing Terminal from \$3,950

The 2635B combines the printing features and capabilities of the 2631B with a typewriter style keyboard for use in a variety of applications as a hardcopy printing terminal.

**Configuration Keys:** To facilitate use of the printing features available, the 2635B has a set of 12 configuration keys which allow the user to set parameters with only a few simple keystrokes.

**Print Features:** The 2635B utilizes the same print features which are available in the 2631B. These include left and right margins, horizontal and vertical tabs, programmable page length, eight print modes, and twelve vertical line spacings. The 2635B output can be easily customized to handle different print requirements.

**Interfacing:** The 2635B interfaces to asynchronous ports via an RS-232C interface. ENQ/ACK, X-on/X-off, and printer busy protocols are all available on the interface as standard protocols.

## HP 2631G Graphics Printer from \$4,550

The 2631G combines the capabilities of a high performance alphanumeric character printer with the ability to print raster data format graphics.

**Graphics Printing:** The 2631G offers 72 dot per inch vertical and horizontal resolution graphics printing, ideal for medium resolution graphics such as business, general scientific, and engineering data. As the hardcopy output device for the HP 2647A and HP 2648A Graphics Terminals, the 2631G prints a 10 by 5 inch copy of the CRT memory in 65 seconds.

**Alphanumeric Printing:** In alphanumeric printing, the 2631G shares many of the print capabilities of the 2631B. It is a smart bidirectional 180 cps serial printer with a 7 x 9 dot matrix cell, four print modes, seven line spacings, and optional high density USASCII print.

**Interfacing:** The 2631G has an HP-IB (IEEE 488-1975) interface, which is compatible with the HP 2647A and HP 2648A Graphics Terminals, the HP 9845B, and the HP 9835B Desktop Computers.



# COMPUTERS, PERIPHERALS & CALCULATORS

## Tape Drives 7970 series



DESIGNED FOR  
**HP-IB**  
SYSTEMS

Hewlett-Packard offers a wide variety of digital magnetic tape units in its 7970 Series, plus a number of fully interfaced, cabinet mounted magnetic tape subsystems.

### 7970 Magnetic Tape Units

Hewlett-Packard Series 7970 Digital Magnetic Tape Units offer a compact and reliable solution to your tape system needs. Units are available in a 9-track configuration utilizing either NRZI or phase encoded electronics. All Series 7970 Tape Units have been designed to provide interchangeability of data with other ANSI compatible equipment.

Reel motors provide direct drive, eliminating troublesome belts and pulleys. Tape tensioning is performed by photo-resistive controlled tension arms that eliminate the need for vacuum system components. Head assemblies consist of read stack, write stack and full width erase head. All major transport assemblies are easily accessible for servicing and/or replacement when required.

### Specifications, 7970 Series

	7970B	7970E
<b>Recording Format</b>	NRZI	PE
<b>Recording Density</b>	800 BPI	1600 BPI
<b>Number of Tracks</b>	9	9
<b>Data Transfer Rate</b>	36K Hz Max	75K Hz Max
<b>Tape Speed:</b>	45 ips max.	

**Reel diameter:** up to 10.5 in. (26.7 cm)

**Tape:** computer grade

**Width:** 0.5 in.

**Thickness:** 1.5 mils

**Tape tension:** 8.5 oz. nominal

**Tape format:** ANSI compatible

**Rewind speed:** 160 ips

**Start/Stop Travel:** Read-After-Write: 0.187 in. ± 0.020 in.

**Power requirements:** 115 or 230 (±10%) Vac; 50 to 60 Hz (±10%) single phase. 400 VA maximum (on high line).

### Operating Environment (Hardware)

**Ambient temperature:** 0 to +55°C (+32 to +134°F)

**Relative humidity:** 20% to 80% noncondensing

**Altitude:** 10,000 ft. (3,048 metres)

### Physical characteristics (without cabinet)

**Size:** 610 H x 483 W x 400 mm D (24" x 19" x 15.75") depth from mounting surface, 305 mm (12").

**Weight:** 63.5 kg (140 lb) maximum

### Ordering Information

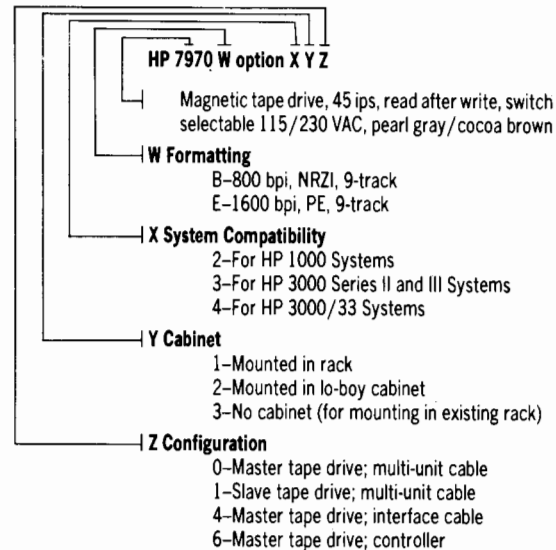

### Available Subsystem Combinations

Z	2YZ			3YZ			4YZ		
	For HP 1000			For HP 3000 II & III			For HP 3000/33*		
Y	1	2	3	1	2	3	1	2	3
0		B E	B E	B E	B E				
1		E	E	E	E			E	
4				B E	B E				
6		B E	B E					E	

B — Subsystem available on 7970B (NRZI) drive

E — Subsystem available on 7970E (PE) drive

### \*HP 3000/33 (HP-IB drives)

An HP-IB controlled HP 7070E (PE) is available for compatibility with this system. The HP 7970B (NRZI) is not available with an HP-IB controller. The HP-IB controller is contained within the HP 7970E tape drive; thus, only the typical HP-IB cable is necessary for hardware interfacing. Up to three more HP 7970E slave tape drives may be operated from the HP-IB controller.

### Cabinets

A variety of cabinets are available depending upon computer system configuration. For HP 1000 systems, the mag tape subsystem is available with the lo-boy cabinet or with no cabinet (for mounting in a rack with other equipment). On HP 3000 Computer Systems, either the lo-boy cabinet or the HP 3000 Series III compatible rack type cabinet may be ordered. The lo-boy cabinet is standard on all HP-IB interfaced tape drives (for HP 3000/33).

7970B 800 BPI Tape Drive	Price
7970E 1600 BPI Tape Drive	\$7,350
	\$9,500

**Price**  
\$7,350  
\$9,500

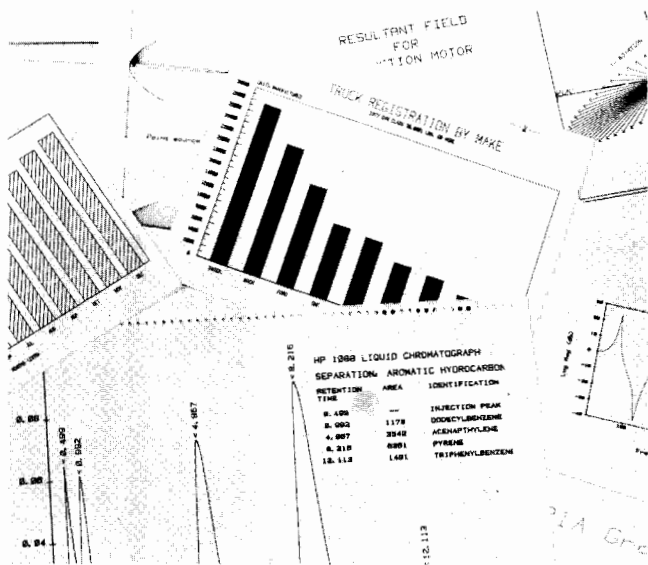

The increasing variety of Hewlett-Packard plotters, plotter/printers, and graphics printers give disciplines, such as engineering, business, finance, and medicine a wide choice of graphic presentations. Because of this choice, data for each discipline can be interpreted with the type of graphics and text that will best produce clarity and professionalism. Depending on the HP plotting device, data relationships can be clarified with 4-color graphs; combined text and plots; 16½ foot long axis plots; or 7-color overhead transparencies. HP printing peripherals can simplify data with formatted text; selection of character sets; user-designed forms; and many other effective, highly illustrative methods of presentation.

### HP-GL Simplifies Graphics Programming

Most HP graphics plotters and plotter/printers accept the Hewlett-Packard Graphics Language (HP-GL). This powerful, but simple-to-use, plotter command set is comprised of 2-letter mnemonics with extensive parameters, designed specifically to draw, enhance, rotate,

label, and color-highlight presentations. Depending on the plotting peripheral, HP-GL provides the user with up to 55 straightforward commands to produce basic and sophisticated graphics.

### User-Oriented Subroutines Minimize Plotting Effort

HP also offers a set of high-level graphics subroutines for the 7221B/S compacted binary language plotters. Called HP-PLOT/21, this software package contains 73 user-accessible subroutines to develop simple or complex graphics with minimum user effort and maximum efficiency in the use of computer time. HP-PLOT/21 is designed to produce graphics with the HP 3000 Series III, 30, and 33 computers; GE Mark III commercial timesharing services; and DEC PDP-11 computers with RT-11 operating systems (File 11 format). With available documentation, users can often adapt HP-PLOT/21 to other systems.

### Printer Commands Provide Sophisticated Text

Simplified printer control commands produce a range of sophisticated text formats with the HP 7240A, 7245B, and 7310A. Depending on the graphics device, there are also commands to highlight text with boldface, reverse characters, and underlining.

### Interface Selection Makes Graphics More Accessible

HP graphics plotters, plotter/printers, and graphics printer are designed to add graphics capabilities to the widest possible range of controllers designed by HP and other companies. Depending on the peripheral, these interfaces are available: Hewlett-Packard Interface Bus (HP-IB) which conforms to ANSI/IEEE 488-1978; EIA RS-232-C (CCITT V.24), RS-423-A; General I/O (16-bit parallel); and 8, 12, 16-bit parallel.

### HP Provides Supplies and Accessories

Hewlett-Packard plotters, plotter/printers, and graphics printers are supported by HP quality controlled paper, pens and other supplies. (see page 660). For a complete listing of HP graphics supplies, request the Computer Supplies Catalog (part no. 5953-2450) from the local HP Sales and Service Office.

### Chart Simplifies Peripheral Selection

The major features of a variety of HP hard-copy graphics devices, including the new 7240A and 7245B plotter/printers and 7310A graphics printer, are available below for comparison.

Features in Common	Special Features	Interface	Model #	Page #
Automatic 4-color plotting; high resolution vector graphics; 6 separate models; "S" models with paper advance, cut, and stack for unattended operation; 280 x 432 mm (11 x 17 in.) paper	HP-GL commands; buffer memory	RS-232-C (CCITT V.24)	7220A/S	654
	Compacted binary language for efficient data transmission at low baud rates; buffer memory	RS-232-C (CCITT V.24)	7221B/S	654
	HP-GL commands	HP-IB (ANSI/IEEE 488)	9872B/S	655
Low-cost, high-resolution vector plotting; 5 user-changeable Personality Modules with I/O interface, interface language, and, in some cases, character sets; fast manual pen changes. 216 x 280 mm (8 1/2 x 11 in.) paper		HP-IB (ANSI/IEEE 488); RS-232-C (CCITT V.24) (2 versions); 8, 12, 16-bit parallel; G I/O	7225A	656
Thermal plotting and printing on one page; high-resolution moves; new sharp contrast output; unattended operation; 5 m (16 1/2 ft) long-axis bidirectional plotting; HP-GL commands		RS-232-C (CCITT V.24)	7240A	658
		HP-IB (ANSI/IEEE 488)	7245B	658
High-speed desktop thermal raster graphics dot matrix, text, and forms printing; large selection of character sets, including proportional spacing; automatic paper advance, cut, and stack. Standard (HP-IB) interface or choice of three optional interfaces		HP-IB (ANSI/IEEE 488) or optional RS-232-C (CCITT V.24) RS-423-A, 8-bit duplex	7310A	659



## Four-color vector plotters

Models 7220A/S, 7221B/S, 9872B/S

- Programmable 4-color presentations
- Choice of 6 plotter designs
- Simplified programming of complex charts
- Available programmable paper advance with cutter

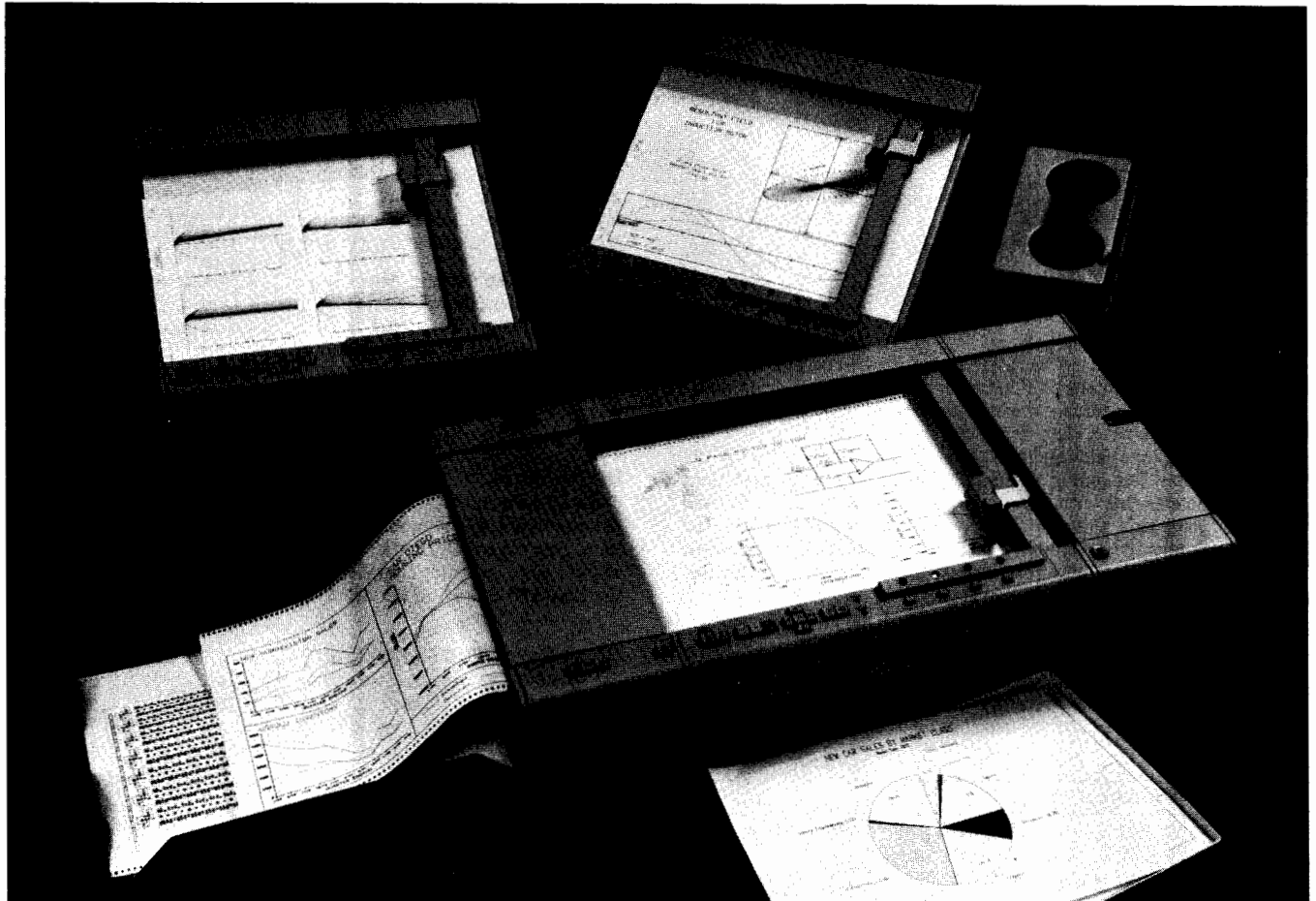

Hewlett-Packard offers six powerful plotters that can produce publication quality four-color graphics on all page sizes up to ISO A3 or 280 x 432 mm (11 x 17 in.). With a single program command, or by pushbutton selection, a pen of another color can be specified to draw the next character or line. The pen stable on the front panel stores and caps pens automatically, keeping them fresh and ready for use. A special damping mechanism lowers pens gently, but quickly, onto the chart, preserving the fineness of the tip.

Some of the important plotting features of these units are: Limits set by pushbutton, or under program control, to produce plot sizes up to 280 x 432 mm (11 x 17 in.); 36 programmable pen speeds to plot on many media, including clear film to make vivid 7-color transparencies; and programmable choice of character sets to produce documentation in many languages.

Publication quality graphics are achieved through microprocessor control that has an addressable resolution (step size) of 0.025 mm (0.001 in.) and plotting accuracy of  $\pm 0.2\% \pm 0.2$  mm. Proper operation of the units can be verified by a user-actuated Confidence Test that checks the basic electronics and mechanics and draws a test pattern.

The models with an "S" model number suffix are also equipped with a programmable paper advance and self-sharpening cutter. These "S" models store a 280 mm x 61 mm or 11 in. x 200-foot roll of paper which is advanced and cut, if required, under program or pushbutton control.

Six versatile 4-color vector plotters are presently available. Each plotter has the same basic plotting features, providing quality graphics for controllers with different I/O interfaces.

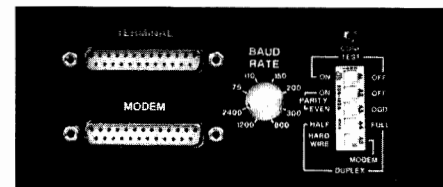

The rear panel interface sections of the 7220A/S and 7221B/S are the same. Mounted on these sections are user-oriented switches that select one of eight baud rates, from 75 to 2400 baud; activate a Confidence Test that affirms the operation of the plotter and draws a diagnostic pattern; plus other switches that select odd, even, or off parity mode; half or full duplex; and hardwired or modem configuration.

### The 7220A/S and 7221B/S Explained

The 7220A/S and 7221B/S are designed with an EIA RS-232-C (CCITT V.24) asynchronous serial ASCII interface, so they can be connected through a modem, or hardwired, to desktop computers, ter-



minals, computer systems, and microprocessor-based systems. The plotters have a user-selectable baud rate from 75 to 2400 and over 900 bytes of buffer memory.

The 7220A/S are programmable with an extensive set of easy-to-use Hewlett-Packard Graphics Language (HP-GL) commands. This command set, designed specifically for graphics production, provides over 50 logical two-letter commands to produce a wide range of professional graphics.

The 7221B/S are programmable with a data-efficient compacted binary language, designed to be particularly effective at low baud rates, such as used on standard telephone lines. In addition, 7221B/S users have available a library of 73 high-level FORTRAN IV subroutines that simplify the development of publication quality graphs and plots. Called HP-PLOT/21, this library has versions for use on the HP 3000 Series, III, 30 and 33 computers and commercial timesharing services with the GE Mark III, or DEC PDP-11 computers with an RT-11 operating system. With available documentation, users can often adapt HP-PLOT/21 to many other systems.

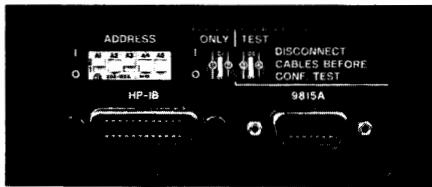

The rear panel interface sections of the 9872B/S are the same. These sections offer user-oriented switches to set up to 31 unique addresses for controller interfacing; a listen-only mode to interface with microprocessor controlled instrumentation or data storage devices; and activate a Confidence Test that affirms the operation of the plotter and draws a diagnostic pattern. The HP-IB connector provides interfacing for an HP-IB (IEEE 488-1978) compatible controller; and the 9815A connector for the HP 9815A desktop computer.

### The 9872B/S Explained

The 9872B/S have the Hewlett-Packard Interface Bus (HP-IB) that conforms to ANSI/IEEE 488-1978. With this interface, the 9872B/S can be controlled by HP terminals, desktop computers, computer systems, microprocessor-based instruments, and non-HP systems that communicate through the IEEE 488 interface. Like the 7220A/S, the 9872B/S are programmed with HP-GL commands. In addition, the 9872B/S are supported by higher level graphics language commands available in HP desktop computer firmware and computer system software.

### Four-Color Plotter Specifications

**Plotting sizes:** Paper up to ISO A3 or 280 x 432 mm (11 x 17 in.).

**Mechanical limits:** 285 x 400 mm (11.2 x 15.8 in.).

**Plotting accuracy:** ±0.2% of deflection ±0.2 mm (0.008 in.), including linearity and repeatability (based on plotter being "zeroed" to exact lower left)

**Repeatability:** Given pen, 0.10 mm (0.004 in.). Pen-to-pen, 0.20 mm (0.008 in.)

**Addressable resolution (step size):** 0.025 mm (0.001 in.)

**Vector length:** Any length within plotter's mechanical limits with specified accuracy.

**Plotting speed:** Programmed vector, 360 mm/s (14 in./s) in either axis or 509 mm/s (20 in./s) at 45°. Vectors can be programmed for 36 speeds from 10 mm/s (0.4 in./s) to 360 mm/s (14 in./s) in 10 mm/s (0.4 in./s) increments.

**Power requirements:** Source, 100, 120, 220, 240V -10% +5% (switch selectable). Frequency, 48-66 Hz. Maximum consumption: 100V/2.3A, 120V/2.1A, 220V/1.2A, 240V/1.1A, 180W

**Size:** "A" or "B" model—189 H x 497 W x 455 mm D (7.5 x 19.5 x 18 in.) "S" models—210 H x 858 W x 455 mm D (8.3 x 33.8 x 18 in.)

**Weight:** "A" or "B" model—18.2 kg (40 lb) "S" model—29.5 kg (65 lb)

### Four-Color Plotter Equipment Supplied

	<b>HP Part No.</b>
Accessory Kit	09872-60070
Disposable pens, four 4-color packs	5060-6810
1 Digitizing Sight	09872-60066
Operating and Programming Manual	
7220A/S	07220-90002
7221B/S	07221-90014
9872B/S	09872-90008
Pocket Guide	09872-90009
Dust Cover	
"A" and "B" Models	9222-0564
"S" Model	9222-0681
Power Cord (appropriate cord supplied)	
Male-to-Male Interface Cable (7220/7221)	07221-60157
Graph Paper, 11 x 17 in., 10 sheets	9270-1004
Graph Paper, 280 x 420 mm, 10 sheets	9270-1024
1 Roll Paper, English ("S" Models)	9280-0493
Paper Tray Assembly ("S" Models)	17072-60023

### Accessories and Supplies

See page 660 for a selection of supplies; page 655 for supplies catalog ordering information.

### Options for 7220A/S or 7221B/S

Option no.	Description	Price
001	2048-byte additional buffer memory	add \$225

### Options for 9872B/S

Option no.	Description	Price
015	For use with 9815A (includes interface cable with ROM)	\$600
025	For use with 9825A (HP-IB interface cable not supplied)	N/C
031	For use with 9831A (HP-IB interface cable not supplied)	N/C
035	For use with System 35 (HP-IB interface cable not supplied)	N/C
045	For use with System 45 (HP-IB interface cable not supplied)	N/C
085	For use with HP-85 (HP-IB interface cable not supplied)	N/C

### Ordering Information

	<b>Price</b>
7220A, 7221B, or 9872B Four-Color Vector Plotters	each \$5300
7220S, 7221S, or 9872S Four-Color Vector Plotters	each \$7000

OEM discounts available



# COMPUTERS, PERIPHERALS & CALCULATORS

## Low-cost plotter with plug-in interfaces

Model 7225A

- 5 user plug-in I/O interfaces
- Compact design with rugged construction
- Cost-effective graphics
- Superior line quality and repeatability

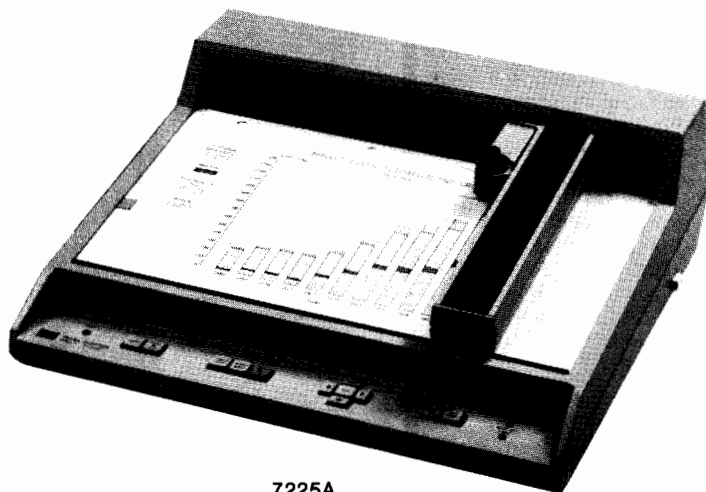

7225A



The 7225A is a compact and cost-effective plotter that produces professional graphics on ISO A4 or 216 × 280 mm (8½ × 11 in.) paper.

The design principles that govern the production of the 7225A are high performance without high price; low cost of ownership through modular construction; and flexibility through user-changeable Personality Modules.

All interface capabilities for the 7225A reside in the plug-in Personality Module; so, with a simple change of Module, the user can configure the unit to provide graphics for a wide variety of desktop computers, computer systems, and microprocessor-based systems.

### Motors Designed as Durable Modules

The 7225A contains two stepper motors. Combining rugged simplicity with state-of-the-art technology, the motor modules are designed without pulleys, cables, gears, or slidewires to avoid the need for scheduled maintenance or adjustments. The motors also accept an addressable microstep of 0.032 mm (0.0013 in.) which increases both plotting accuracy and appearance.

Besides ruggedness and microstep size, the motors are designed to control accuracy to ±0.25 mm (0.01 in.), including linearity and repeatability. Because of these and other design features, the 7225A continues to produce quality graphic representations, even under long-term heavy use.

### Features Provide Ease of Use

The 7225A has a number of sophisticated features that simplify operation. For example, the user-oriented front panel contains push-buttons that provide manual control of plotting limits; pen raising and lowering; pen movement in four orthogonal directions and at any chosen 45° angle; plus lamps that automatically signal error and out-of-limits conditions. A back-panel pushbutton activates the Confidence Test that verifies the basic mainframe and Personality Module performance.

Because the 7225A depends on the Personality Module for its capabilities, a mainframe can be configured to simplify the programming of sophisticated graphics by a high-level of compatibility between the power of the controller and the responsiveness of the plotter with the appropriate Personality Module.

### Plug-in Modules Provide Interfaces

- General I/O (16-bit parallel)
- HP-IB
- 8, 12, 16-bit parallel
- RS-232-C (CCITT V.24) (2 versions)

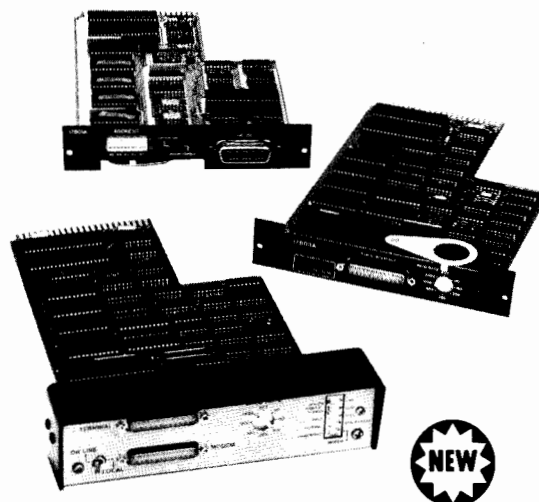

At the present time five Personality Modules are available: General I/O (8-bit parallel), Hewlett-Packard Interface Bus (HP-IB) which conforms to ANSI/IEEE Standard 488-1978, two versions of the RS-232-C (CCITT V.24), and 8, 12, 16-bit parallel. When purchasing a 7225A, one of these modules must be ordered.

### General I/O (16-bit Parallel) — 17600A

Adapts the 7225A to HP desktop computers, such as the 9815A/S, 9820A, 9821A, 9825A/S, 9830A/B and 9831A. The 17600A decodes computer-originated commands; sends pen positioning and status data to the 7225A; and includes the Module in the Confidence Test. The capability of the 7225A with the 17600A Module is enhanced by the desktop computer in the configuration.

### HP-IB (ANSI/IEEE Standard 488-1978) — 17601A

Adapts the 7225A to HP and other desktop computers, computer systems, intelligent terminals, and microprocessor-based systems with interfaces that conform to the ANSI/IEEE Standard 488-1978. The 17601A accepts the full Hewlett-Packard Graphics Language (HP-GL) instruction set that includes commands to specify five built-in character sets, seven dashed line fonts, user-defined symbols, point digitizing, and user-specified integer scaling. The panel of the 17601A includes a plotter address switch and a Listen Only-Addressable switch to make the 7225A useful in computer-based configurations. The Listen Only mode allows a group of plotters to accept commands from a single controller. Testing of the basic electronics in the 17601A is also done by the Confidence Test.



### 8, 12, 16-bit Parallel — 17602A

Adapts the 7225A to computer systems and microprocessor-based systems with an applicable interface. Position data can be 4 or 8-bit words in BCD or Binary. This Personality Module is particularly useful with plotter controllers, such as those in the OEM market, because all control panel pushbutton logic is available at the back panel connector. The 17602A controls absolute and relative coordinate moves; raises and lowers the pen; and includes the Module in the Confidence Test.

### RS-232-C (CCITT V.24) Compatible — 17603A

Adapts the 7225A to be hardwired to in-house computer systems and desktop computers with RS-232-C (CCITT V.24) capabilities. The 17603A provides switch selection of seven baud rates: 110, 150, 200, 300, 600, 1200, and 2400. In addition, there is a switch position to allow baud rate selection by the controller. A second switch is used to select odd, even, or no parity. The 17603A accepts Hewlett-Packard Graphics Language (HP-GL) instructions and a software "handshake" procedure, made even more efficient by a standard buffer of 630 usable bytes. A hardwired handshake is included in the connector, providing hardware plotter control from a wide range of OEM controllers. The Module is included in the Confidence Test.

### RS-232-C (CCITT V.24) with Eavesdrop — 17604A

Adapts the 7225A to RS-232-C interface systems configured with a modem. The 17604A also provides an "eavesdrop" feature, so a 7225A on the communications line between a terminal and a computer, or modem, can react to instructions from either controller. The 17604A is designed with seven switch-selectable baud rates (110, 150, 200, 300, 600, 1200, and 2400), plus a switch position to allow baud rate selection by the controller. A second switch is used to select odd, even, or no parity. The 17604A accepts the Hewlett-Packard Graphics Language (HP-GL) and provides firmware to make arcs and circles with a single command. In addition, the 17604A is configured with a built-in software "handshake" procedure that includes 630 usable bytes of buffer, plus a hardwired handshake integrated into the rear connector. This dual handshake capability, plus eavesdrop, greatly increase the I/O power and versatility of the 7225A. The Module is included in the Confidence Test.

### 7225A Specifications

**Plotting sizes** – Paper: Up to ISO A4 or 216 x 280 mm (8½ x 11 in.). Plotting area: 203 x 285 mm (8.1 x 11.2 in.)

**Plotting accuracy:** ±0.25 mm (0.01 in.), including linearity and repeatability, based on plotter being "zeroed" to exact lower left (0,0)

**Repeatability:** 0.1 mm (0.004 in.) from any given point.

**Addressable resolution (step size):** 0.032 mm (0.0013 in.)

**Vector length:** Any length within plotter's mechanical limits

**Plotting speeds:** Vectors: 250 mm/s (10 in./s) in either axis or 350 mm/s (14 in./s) at 45°. Characters: Up to three 2.5 mm (0.1 in.) characters/s

**Power requirements:** Source: 100, 120, 220, 240 V – 10% +5% (selected internally). Frequency: 48–66 Hz. Consumption: 70 W maximum

**Size:** 140 high x 413 wide x 379 mm deep (5.5 x 16.3 x 14.9 in.)

**Weight:** Net: 8 kg (17.6 lb). Shipping: 11.4 kg (25 lb)

### Accessories and Supplies

See page 660 for selection of supplies; page 653 for supplies catalog ordering information.

### 7225A Options

The 7225A mainframe order requires the specification of one power option (001-004), one Personality Module, and the applicable operating and programming manual for the Personality Module.

Option no.	Description	Price
001	100 Vac power	N/C
002	120 Vac power	N/C
003	220 Vac power	N/C
004	240 Vac power	N/C
006	Paper/pen supplies kit: fifteen 50-sheet pads ISO A4 blank paper, two each black and red 5-pen packages, one each blue and green 5-pen package, and stand-alone pen holder	\$95.00
007	Same as 006, except paper is 216 x 280 mm (8½ x 11 in.)	95.00
010	Vinyl carry case (not for shipping use)	220.00

### 17600A Personality Module Options

The following options are for operating and programming manuals and interface cables for HP desktop computers.

Option no.	Description	Price
001	Cable for 9815A/S	\$250.00
002	Cable with plotter ROM for 9820A and 9821A	350.00
003	Cable for 9825A/S	350.00
004	Cable for 9830A	250.00
015	Manual for 7225A with 9815, using 9815 option 002 (2 I/O channels) or 98122A field kit.	N/C
020	Manual for 7225A with 9820A, using plotter ROM 11220A supplied with 17600A option 002.	N/C
021	Manual for 7225A with 9821A, using plotter ROM 11220A supplied with 17600A option 002.	N/C
025	Manual for 7225A with 9825A/S, using 98212A or 98214A ROM.	N/C
030	Manual for 7225A with 9830A/B, using 11271B or 11271F ROM.	N/C

### 17601A Personality Module Options

The 98034A cable should be available to connect the 7225A/17601A (HP-IB) plotter to an HP desktop computer.

Option no.	Description	Price
001	Manual for 7225A with HP desktop computers, intelligent terminals, and computers not listed below.	N/C
025	Manual for 7225A with 9825A using 98215A or 98216A ROM	N/C
035	Manual for 7225A with 9835A	N/C
045	Manual for 7225A with 9845A/B	N/C
085	Manual for 7225A with 85	N/C

### 17602A Personality Module Options

General operating and programming manual furnished with the Personality Module.

Option no.	Description	Price
001	Male I/O connector	\$30.00

### 17603A Personality Module Options

General operating and programming manual furnished with the Personality Module.

### 17604A Personality Module Options

General operating and programming manual furnished with the Personality Module.

### Ordering Information

	Price
7225A Graphics plotter mainframe	\$2200.00
17600A Personality Module	150.00
17601A Personality Module	750.00
17602A Personality Module	200.00
17603A Personality Module	750.00
17604A Personality Module	900.00

OEM discounts available.



# COMPUTERS, PERIPHERALS & CALCULATORS

## Versatile thermal plotter/printers

Models 7240A, 7245B

- Quality graphics and printing on the same page
- New high-contrast output
- 5m (16.4 ft) long-axis plots
- HP-IB or RS-232-C (CCITT V.24) interface



7240A

7245B

The HP 7240A and 7245B thermal plotter/printers are compact desktop units that produce high quality graphics and fast clean text on the same page. Designed for quiet in-office use or rugged laboratory conditions, these plotter/printers are ideal peripherals to produce professional documentation for engineering, scientific, financial, and business use. Either unit can draw plots with one axis up to 5 metres (16.4 feet) long; produce unattended graphics and text; and draw circles and arcs with a single command. Both units have the sophisticated HP thin-film print head and soft-platen writing surface that produce page after page of sharp, high-contrast text and graphics documentation on black or blue-trace thermal paper.

The 7240A and 7245B accept over 55 Hewlett-Packard Graphics Language (HP-GL) plotter commands, plus over 41 printer commands to simplify the generation of complex graphics and formatted text. The plotter commands produce both basic and enhanced graphics, so even the new user can start to draw vector plots with labels, pie charts, and bar graphs. Print commands can format the text; set up tables; and print a selection of character sets, including a number of special characters, to produce documentation in many languages. With all these capabilities, users can generate formatted pages with text and graphics to provide professional quality documents, without cutting and pasting.

The design of the 7240A and 7245B also provides an excellent selection of front and rear panel pushbuttons, switches, and indicator lights that further simplify operation. For example, pushbuttons can be used to set scaling points and left margin; move paper; turn on and off the print head; and add control characters and escape sequences to program listings for faster debugging. Switches can be used to set the number of lines per inch for text, paper length, and scaling mode. Indicator lights alert the user to error conditions, and paper and plotting limits. Both units have a user-activated Confidence Test that check both the electronic and mechanical operation.

### The 7240A Differences Explained

The 7240A is designed with an EIA RS-232-C (CCITT V.24) asynchronous serial ASCII interface. Baud rate is user-selectable from 75 through 2400 and there is a 1200-character input buffer. This model is ideal for use with a modem for remote computer systems or in a hardwired configuration with an in-house computer system or with a RS-232-C (CCITT V.24) desktop computer.

### The 7245B Differences Explained

The 7245B is designed with a Hewlett-Packard Interface Bus (HP-IB) that conforms to ANSI/IEEE Standard 488-1978. This model is

a highly useful peripheral for computer, desktop computer, and microprocessor-based systems with HP-IB or other interfaces that are compatible with the ANSI/IEEE 488 specification. With this interface, the 7245B has a selection of up to 30 unique addresses and a Listen-only switch to allow a group of 7245B units to accept commands individually, or as a group, from a single controller. In addition to the plotting and printing features available on the 7240A, the 7245B has a raster graphics image printing capability that can be used with HP graphics terminals and a 132-column condensed character set.

### Specifications

**Plotting/printing sizes (maximum):** 188 mm x 5 m (7.4 in. x 16.4 ft) with full paper return; 188 mm x 61 m (7.4 in. x 200 ft) without full paper return

**Perforated Page sizes:** English—216 x 279 mm (8.5 x 11 in.); metric—210 x 298.5 mm (8.3 x 11.75 in.)

**Addressable dynamic range:**  $\pm 1 \times 10^{\pm 99}$  scaled units

**Plotting accuracy:**  $\pm 0.2\%$  of deflection  $\pm 0.35$  mm ( $\pm 0.014$  in.). Includes linearity and repeatability

**Repeatability:** 0.25 mm (0.01 in.) from any given point

**Motor resolution:** 0.016 mm (0.0006 in.)

**Maximum plotting speed:** Pen-off velocity—513 mm/s (20.2 in./s)—in either axis and 725 mm/s (28.6 in./s) at 45° angle. Pen-on velocity—256 mm/s (10.1 in./s) in either axis and 363 mm/s (14.3 in./s) at 45° angle. Selectable from 10 to 480 mm/s (0.39 to 18.9 in./s)

**Print head positioning:** Arrow pushbuttons—6.1 mm/s (0.24 in./s). Arrow and Fast pushbuttons—95.5 mm/s (3.76 in./s)

**Power requirements:** 100V, 120V, 220V, 240V  $-10\%$   $+5\%$  300W maximum

**Environmental range:** Temperature—0 to 55°C. Relative humidity—5 to 95% (below 40°C)

**Dimensions:** 201 mm (7.9 in.) H x 442 mm (17.4 in.) W x 483 mm (19 in.) D. Net weight—19.1 kg (42 lb)

### Accessories and Supplies

See page 660 for a selection of supplies; page 653 for supplies catalog information.

### Ordering Information

7240A Thermal Plotter/Printer

7245B Plotter/Printer

OEM discounts available.

### Price

\$5200.00

\$200.00

# COMPUTERS, PERIPHERALS & CALCULATORS

## High-speed desktop graphics printer

Model 7310A

659



- High resolution text and graphics
- Choice of 3 interfaces or standard HP-IB

- Versatile text formatting and forms printing
- Variety of standard and optional character sets

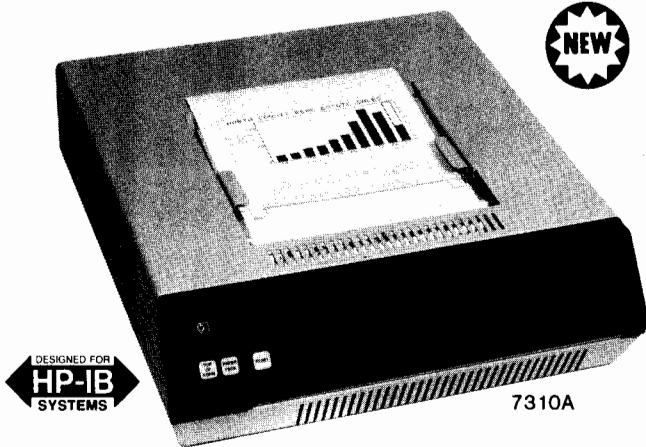

7310A

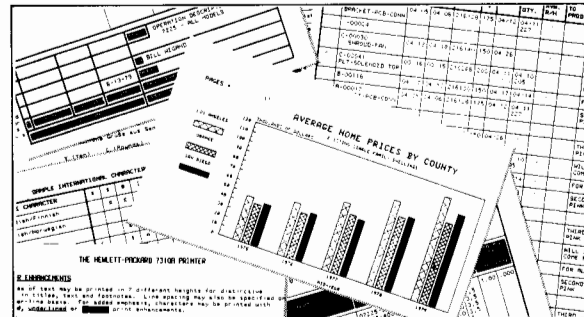

The 7310A is a high-speed desktop raster graphics printer designed to provide thermal raster graphics, forms, and text printing when configured with a wide variety of HP terminals, desktop computers, computer systems, and many non-HP systems. The 7310A can produce complex user-designed forms; print text with fixed or proportionally spaced type and user-programmed format; and highlight documentation with boldface or reverse printing (light on dark) and underlining. In addition, 7310A offers two USASCII character sets, plus language characters to produce documentation for many countries. Optional character sets include mathematics, APL programming symbols, and line drawing symbols to design and print forms. Pages from the 7310A can be cut to size automatically, or under program control, and stacked on top of the unit.

### Fast, Versatile Printing Provides Professional Text

In text mode, dot matrix characters are printed at speeds up to 500 lines per minute. Under program control, all margins can be specified; tabulations set; and text printed with fixed or proportionally spaced characters and a variety of character enhancements. Character sets supplied with the unit are USASCII with fixed or proportional spacing and HP Roman Extensions with 25 language symbol sets and one HP 9825 symbol set. Optional sets for line drawing (forms), mathematics, APL symbols, or Katakana may be specified at time of purchase.

### CRT Images Copied Dot-for-Dot

In graphics mode, the 7310A produces high-resolution hard copies of images "dumped" from HP graphics terminals or desktop computers. These images can be printed at speeds up to 31.25 mm/s (1.23 in./s) with horizontal and vertical resolution of 40 dots/cm (100 dots/in.). Twenty-five raster commands can control the positioning of the image on the page.

### Interfaces Provide System Versatility

The 7310A comes with the Hewlett-Packard Interface Bus (HP-IB) interface that conforms to the IEEE/ANSI standard 488-1978. However, the standard (HP-IB) interface can be replaced with one of these three optional interfaces: RS-232-C (CCITT V.24), RS-423-A, or General Purpose I/O (8-bit duplex). This interface option capability allows the unit to be tailor made for the specific configuration needs of most users.

### Specifications

**Paper roll size:** Metric—210 mm x 75 m; English—8.5 in. x 250 ft  
**Page length:** Switch selectable—297 mm or 11 in.; Programmable 55 to 512 mm (2.2 to 20.2 in.)

**Graphics speed:** 4.55 to 31.25 mm/s (0.18 to 1.23 in./s), depending on dot density

**Printing speed:** 200 to 500 lines/minute, depending on number of characters/line, character set, and printing enhancements

**Graphics resolution:** 40 dots/cm (100 dots/in.) horizontally and vertically

**Character size:** Default—7 x 9 matrix in a 9 x 15 cell; 2.3 mm (0.09 in.) high characters. Programmable—1.15 to 4.6 mm (0.5 to 0.18 in.)

**Line Length:** Fixed characters—80; Proportional—15 to 20% more characters

**Formatting:** 80 available tab positions; all margins programmable

**Power requirements:** Source—100, 120, 220, 240V +5%, -10%, specified by option; Frequency—46 to 88 Hz; Consumption—100 V/4.9 A, 120V/4.2 A, 220 V/2.4 A, 240 V/2.2 A, 250 W (855 Btu/hr) max, 130 W (444 Btu/hr) max in idle state

### Options

Character sets (USASCII and Roman Extensions are standard). Options 001 through 006 and 025 provide USASCII as the secondary character set.

Option no.	Description	Price
001	Swedish/Finnish	N/C
002	Norwegian/Danish	N/C
003	French	N/C
004	German	N/C
005	British	N/C
006	Spanish	N/C
008	JASCII (primary), Katakana added (do not order with 009)	\$150.00
009	APL character set added (do not order with 008)	150.00
010	HP 2640-series math symbols added	150.00
011	HP 2640-series line drawing symbols added	150.00
025	HP 9825 symbols	N/C
<b>Line Voltage</b> (120V standard)		
014	100V, 48-66 Hz	N/C
015	220V, 48-66 Hz	N/C
016	240V, 48-66 Hz	N/C
<b>Interfaces</b> (HP-IB standard)		
050	RS-232-C (CCITT V.24)	\$ 50.00
051	RS-423-A	50.00
052	General I/O (8-bit parallel)	N/C
240	13232J printer cable & 13238A duplex register module for HP 2640-series terminals (installation not included)	155.00

### Extended Use

020	Metric paper (instead of English)	N/C
035	Graphics binary tape for 9835A only	N/C

### Accessories and Supplies

See page 660 for a selection of supplies; page 653 for supplies catalog information.

### Ordering information

**7310A** Graphics printer  
 OEM discounts available.

**Price**  
 \$5250.00





# COMPUTERS, PERIPHERALS & CALCULATORS

## Overhead transparency kit & general supplies

Model 17055A & plotting/print supplies

- Transparencies with 7 vivid colors
- Normal & broad stroke transparency pens
- Superior results with HP-controlled supplies
- Fast shipment of most supplies

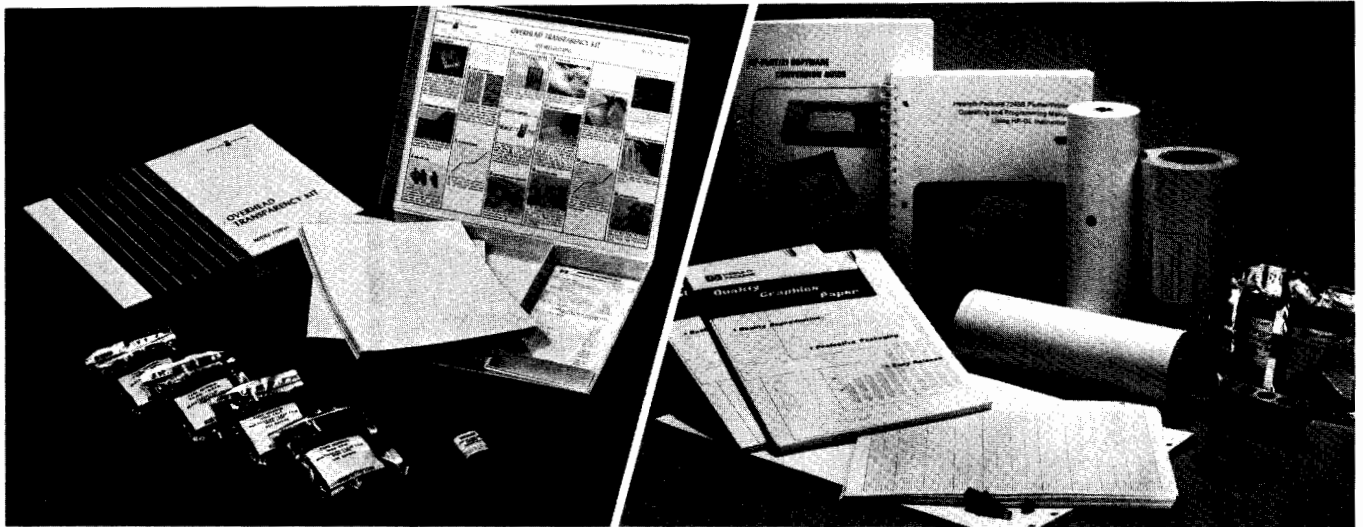

17055A

### Overhead transparency kit

The HP Overhead Transparency Kit contains all the supplies necessary to prepare up to 200 transparencies 216 x 267 mm (8½ x 10½ in.) on the HP graphics plotters 7220, 7221, 9872 and 7225A with 17601A, 17603A or 17604A Personality Module. With this Kit, graphics can be made at a price significantly lower than usually paid to outside vendors.

The Kit contains 16 pens in two pen widths: regular (approximately 0.025 mm) and broad (approximately 0.7 mm). The colors in each width are black, red, green, blue, violet, orange, and brown. The ink formula was created specifically to adhere firmly to the plastic film surface; dry to a hard finish in minutes at temperatures of 20°C and above; and maintain vivid hues when projected.

The 200 transparent sheets of plastic film are packaged in lots of 100 with protective paper between each sheet. The protective paper can be used to shield the charting surface of the film from scratches and body oil deposits. This is done by simply leaving the paper on top of the film until it is held firmly by the plotter's electrostatic hold-down mechanism.

Overhead transparencies can be drawn with the same programs used to prepare graphics on chart paper. The finished transparency can have clean color lines, filled-in blocks of color, or both. However it is drawn, the completed transparency is virtually smearproof, providing professional graphics for use after use.

The contents of the Overhead Transparency Kit are packaged in a clean-line, durable box that can be stored vertically or flat. Each box includes step-by-step instructions, plus part numbers for reordering separate items as needed.

### Supplies Provided

Description	Part no.
4-pen package: Black, red, blue, green; regular tip	5060-6818
4-pen package: Black, orange, brown, violet; regular tip	5060-6834
4-pen package: Black, red, blue, green; broad tip	5060-6819
4-pen package: Black, orange, brown, violet; broad tip	5060-6835
Solvent: 29.6 ml (1 fl oz)	5060-6828
Transparency film: Two 100-sheet packages of transparency film (order in packages of 100)	9270-0639

### Ordering information

Ordering information	Price
17055A Overhead transparency kit	\$100.00

### Plotting and printing supplies available

Hewlett-Packard offers a large selection of supplies and accessories for HP plotters, plotter/printers and graphics printers. All supplies and accessories meet demanding HP specifications. Ordering supplies from HP provides other advantages, including a single source for all needs; superior hard copies from HP peripherals; and world-wide HP

Sales and Service Offices to accept orders, so shipments can be made quickly. The supplies shown below are only a sampling of the variety available. For a complete listing of peripheral supplies, request the HP Computer Supplies Catalog (part number 5953-2450) from the local HP Sales and Service office.

### Paper-writing pens (7220, 7221, 7225, 9872)

Description	Price
5-pen pack: Red (5060-6784), blue (5060-6785), green (5060-6786), and black (5060-6787); 4-pen pack with 1 pen of each color (5060-6810), 1 pack	\$6.50

### Paper sheets (7220A, 7221A/B, 9872A/B and, if 8½ x 11 in., 7225A)

Description	Price
280 x 420 mm (11 x 16½ in.), heavyweight paper English standard grid (9270-1004) or Metric standard grid (9270-1024) or English gridless (9280-0180) 100 sheets	\$10.00
216 x 280 mm (8½ x 11 in.), heavyweight paper English standard grid (9270-1006), 100 sheets	7.00
Metric standard grid (9270-1023), 100 sheets	7.00
English gridless (9280-0475) or Metric gridless (9280-0476), 50-sheet pad	3.00

### Paper roll (7220S, 7221S, 9872S)

Description	Price
61 m (200 ft) continuous gridless paper. 11-inch wide roll (9280-0493); 297 mm (11.7 in.) wide (9280-0494). 1 roll	\$14.00

### Thermal paper roll (7240A, 7245A/B)

Description	Price
61 m (200 ft) roll perforated every 278 mm (11 in.) 216 mm (8½ in.) wide. Black trace (9270-0605); blue trace (9270-0699). 2-roll box	\$22.00
Same as above, except no perforations. Black trace (9270-0609), blue trace (9270-0959). 2-roll box	22.00
61 m (200 ft) roll perforated every 298.5 m (11.8 in.) 210 mm (8.27 in.) wide. Black trace (9270-0607), blue trace (9270-0700). 2-roll box	22.00

### Thermal paper roll (7310A)

Description	Price
75 m (247 ft) roll. 216 mm (8.5 in.) wide. Black trace (9270-0682), blue trace (9270-0683) or 210 mm (8.3 in.) wide. Black trace (9270-0680), blue trace (9270-0681), 210 mm black (9270-0680) or blue (9270-0681).	

Description	Price
6-roll box blue	\$66.00
black	78.00

Quantity discounts are available.

# COMPUTERS, PERIPHERALS & CALCULATORS

Certified disc media products

Models 12940A, 13356A, 13394A



- 100% Tested
- Greater Dependability
- Full Warranty



13394A

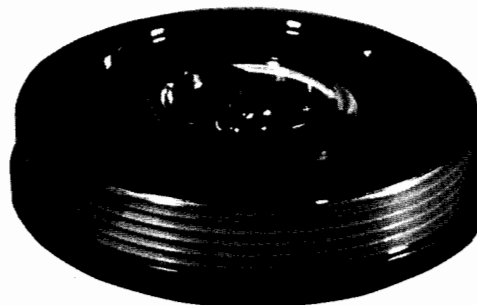

13356A

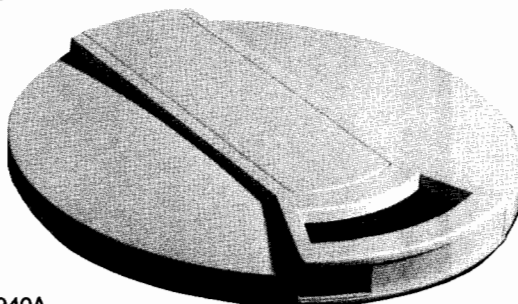

12940A

A certified Hewlett-Packard cartridge or pack is provided with each family disc drive. Each HP disc media product is uniquely selected and individually tested to meet our rigid requirements for total disc drive performance.

## Features

- 100 percent testing and certification of each disc pack and cartridge.
- Dynamic mechanical testing dramatically increases reliability through detection of surface imperfections or imbalances.
- Exhaustive worst-case data transfer testing to ensure optimum error rate and interchangeability.
- Maximum security through greater media dependability.
- Full warranty protection for HP disc drives when using HP media products.

## Disc inspection and testing

Although the technology for producing magnetically coated discs is well established, a significant quantity prove to be unacceptable to meet HP's stringent reliability requirements. Critical dimensions, cleanliness, and oxide coating irregularities are closely monitored resulting in out-of-tolerance components being rejected.

## Dynamic mechanical testing

Each disc is tested dynamically to insure head flyability over its entire surface. This means each disc surface must be both flat and smooth within very small tolerances, since the head typically "flies" at less than 50 microinches above the surface.

## Iterative data transfer testing

If a disc meets the mechanical requirements, it is tested for data transfer capability under "worst case" conditions. Each disc is subjected to the worst written data patterns and track following information it could ever expect to see under normal operating conditions. Data is then read back with the head offset to simulate mis-aligned heads. All data is then shifted one bit and again read with offset. This is done iteratively, after which defective tracks are flagged and catalogued.

## Media statement

HP seeks to provide the best possible total disc performance through extensive testing, selection, and control over all the critical

components that make up an HP disc product. Because of the unique interdependence of total disc performance and the head/media interface, disc drive specifications and reliability can only be assured when using HP media products.

Undesirable alteration of the media surface environment can result from improper cleaning. The cleaning of HP media products using a non-approved process is, therefore, *not* recommended.

Any damage sustained to the heads or media, or any consequential damage resulting from the use of non-HP media or improperly cleaned media is excluded from warranty or service contract coverage but will be repaired subject to HP's standard time and material charges. Use of non-HP media, however, does not affect the warranty and service contract coverage of other components of the drive not associated with the head/media interface.

## Availability

New disc media products are available through Computer Supplies Operation. Consult the Computer Supplies Catalog for further information. Refurbished disc media products are available through Computer Support Division. Consult the nearest Hewlett-Packard Sales Office.

## Specifications

### Environmental

#### Temperature

Operating: 4.5° to 55°C (40° to 130°F)

Non-Operating: -40° to 75°C (-40° to 167°F)

#### Relative Humidity

Operating: 8% to 80%

Non-Operating: 8% to 80%

#### Dimensions

##### 12940A - Disc Cartridge for 7906

Diameter: 38.1 cm (15.0 in.)

Height: 3.6 cm (1.4 in.)

##### 13356A - Disc Pack for 7925 (Includes protective cover set)

##### 13394A - Disc Pack for 7920 (Includes protective cover set)

Diameter: 37.9 cm (14.9 in.)

Height: 11.2 cm (4.4 in.)

#### Ordering Information

12940A Disc Cartridge for 7906

13356A Disc Pack for 7925

13394A Disc Pack for 7920

#### Price

\$180

\$850

\$525



# COMPUTERS, PERIPHERALS & CALCULATORS

## M/S/H series disc drives

Models 7906, 7920, 7925

- Performance
- Reliability
- Serviceability



7906

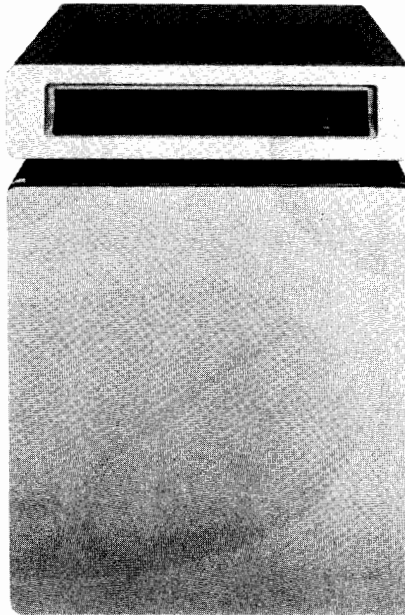

7920

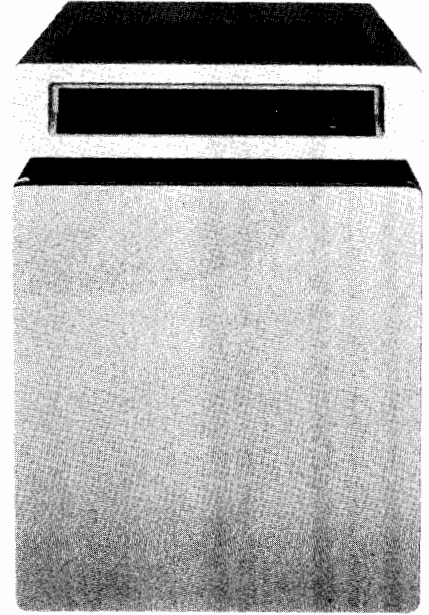

7925

Hewlett-Packard offers a complete line of disc drives for mass storage applications. Product offerings include the 7906 (20 Mbytes), 7920 (50 Mbytes) and 7925 (120 Mbytes). Configuration flexibility allows the user to build systems from 20-960 Mbytes of mass storage providing the most cost effective problem solutions available on the market.

Two different controller options are offered depending on the application requirements. The highly versatile Multi-Access Controller is capable of supporting up to eight 7906, 7920, and/or 7925 disc drives. For single spindle applications, a wise choice for any user is the Integrated Controller Disc (ICD) which retains all the performance characteristics of its predecessor, the MAC controller, at a substantially reduced price in single drive configurations. All disc drives are compatible with a wide variety of Hewlett-Packard computing systems to provide users with a single HP solution.

Each Hewlett-Packard disc drive is backed by manufacturing expertise gained from producing over 20,000 disc drives for minicomputer and desktop calculating systems. Each disc drive is subjected to exhaustive testing before it leaves the factory floor. Critical components and printed circuit assemblies are baked in ovens for at least 48 hours—the equivalent of 500 operational hours—to identify and correct early failures. Fully assembled disc drives are then operated continuously for at least two days under the control of special diagnostic software.

### Multi-Access Controller (MAC)

The MAC design emphasizes total system flexibility through the "multi-spindle" concept: Any number from one to eight MAC drives may be accessed through a single controller, resulting in unparalleled freedom of system design. This flexibility allows the user to tailor the most economic storage system to his current needs and budget, while providing the option for future expansion as mass storage requirements increase.

The MAC disc drives utilize fast-access, track follower servo-feed-back head positioning to provide exceptional performance over a wide

temperature range. Each drive has self-contained fault indicators to aid in isolating and identifying malfunctions that may occur within the system. This feature, together with HP's proven reliability, results in a minimum of expensive down-time. Each master drive (7906M, 7906MR, 7920M, and 7925M) includes enclosure, controller, cabling, and disc pack or cartridge. Each slave drive (7906S, 7906SR, 7920S, and 7925S) includes enclosure, cabling, and disc pack or cartridge.

### Integrated controller disc (ICD)

The integrated controller disc drive family incorporates a new, less expensive, intelligent HP-IB disc controller within the physical confines of each ICD drive. The ICD controller contributes to greater reliability, increased serviceability and reduced cost for single disc drive users while providing all the performance features of the MAC family disc drives.

The integrated controller design reduces the number of system interconnections and components, which, in turn, reduces the probability of failure in the controller. Sophisticated self-test diagnostics in the ICD controller firmware provide an integrity check of the controller subsystems and a comprehensive servicing aid to assist troubleshooting. Self-test uses a feature called "loop-back" which sends a message into the I/O structure of the HP-IB interface chip (built into the controller) and retrieves it to examine the I/O before giving approval for data transfer. Self test is initiated automatically at power on, manually, or under software control.

In addition to providing the end user with up-to-date status of essential disc drive functions, total system up-time is dramatically increased by significantly reducing the repair times in the event of component failure. Self-test results are displayed as various LED patterns on the back panel of the ICD drives or passed to the host system for display. Because the new two-board controller is an integral part of the drive, repairs are easier.

Each ICD drive, (7906H, 7906HR, 7920H, and 7925H) includes enclosure, integrated HP-IB controller, cabling, and disc pack or cartridge.

**Features**

	MAC	ICD
• High performance disc drives with 25 ms average seek time (5 ms, track-to-track)	X	X
• Self-contained fault indicators for improved serviceability	X	X
• Removable media (disc-to-disc backup capability)	X	X
• Data base protection	X	X
• Cylinder or surface mode operation	X	X
• Automatic track sparing and switching	X	X
• Programmable recovery of marginal data	X	X
• Error detection	X	X
• Error correction	X	X
• Configuration flexibility from 20-960 Mbytes of formatted mass storage	X	X
• HP-IB interface capability (Amigo Protocol) (Opt)	(Opt)	X
• Self-test capability		X
• CPU directed loop back to check hardware interface		X
• Media interchangeability	X	X
• Power fail protect	X	X
• Multi-CPU access (HP 1000 M/E/F)	X	X

**7906 Cartridge Type Disc Drive**

**19.6 Mbytes formatted capacity:** The 7906 disc drive features 9.8 Mbytes of removable and 9.8 Mbytes of fixed media to provide single drive users with a convenient backup capability. The cartridge type media is exceptionally easy to store, use, and/or transport. An advanced temperature compensation circuit in each disc drive provides start-up times of less than 60 seconds and allows accurate transfer of data between the fixed and removable surfaces under diverse temperature conditions.

**7920 Pack Type Disc Drive**

**50 Mbytes formatted capacity:** The 7920 disc drive is the fastest of its kind in the market with an average seek time of 25 ms and an average access time of 33.1 ms. Each media pack is removable and fully interchangeable among drives to facilitate storage and transportation of data files.

**7925 Disc Drive**

**120 Mbytes formatted capacity:** Each 7925 pack type drive provides 120 Mbytes of formatted storage capacity, which means a total of 960 Mbytes (0.960 gigabytes) would be available using eight 7925 drives on a single Multi-Access Controller.

**Configuration**

**MAC**—The maximum configuration for MAC Family disc drives is eight 7906, 7920, and/or 7925 drives per controller. All cabling between Master and Slave drives is included.

**ICD**—The maximum number of ICD drives on any one HP-IB channel is two. A 2 m HP-IB cable is included with each shipment.

**RFI Emissions/Safety**

Meets or exceeds EMC/RFI emissions standards such as VDE 0871 and C.I.S.P.R. Consult the appropriate HP systems configuration guide for details.

Products have appropriate UL/CSA approvals. VDE certification pending.

**Specifications**

**Seek Time (All Models)**

**Track-to track:** 5 ms  
**Average random:** 25 ms  
**Full stroke (typical):** 45 ms

**Rotation**

**Speed:** 7906/7920 - 3,600 rpm  
7925 - 2,700 rpm  
**Average rotational delay:** 7906/7920 - 8.33 ms  
7925 - 11.1 ms

**Capacity (Maximum Per Drive) - Formatted**

**7906:** 19,660,800 bytes  
**7920:** 50,073,600 bytes  
**7925:** 120,176,640 bytes

**Environmental**

**Temperature:** 10° to 40°C (50° to 104°F) operating  
**Relative humidity:** 8% to 80%  
**Altitude:** Sea level to 4 572 m (15,000 ft) operating, -304.8 m (-1,000 ft) to 15 240 m (50,000 ft) non-operating  
**Tilt:** 7920/7925 - Up to ± 10 degrees about either horizontal axis  
7906 - Up to ± 20 degrees about either horizontal axis

**Transfer Rates (Burst Only)**

**79XXM:** 937.5 Kbytes/sec  
**79XXM-Opt 102:** 0-1 Mbytes/sec  
**79XXH:** 881-937.5 Kbytes/sec

**Ordering Information**

**79XXM** Master Drive (includes Multi-Access Controller)  
**79XXS** Slave Drive (Add-on disc drive with 79XXM)  
**79XXH** Integrated Controller Disc (ICD) drive  
**7906XR** Rack Mountable unit

**Price**  
see table

Drive	Controller included?	Max Power @ 120V, 60Hz	Media	Available Options	Base Price
7906M	Yes	740W/8.0A	12940A	015,102	\$15,000
7906MR	Yes	720W/7.8A	12940A	015,020,102	\$14,000
7906H	Yes	520W/5.5A	12940A	015	\$13,000
7906HR	Yes	490W/5.4A	12940A	015,020	\$12,000
7906S	No	520W/5.7A	12940A	015	\$11,000
7906SR	No	500W/5.5A	12940A	015,020	\$10,000
7920M	Yes	700W/7.4A	13394A	015,102	\$18,000
7920S	No	480W/5.1A	13394A	001,015	\$14,000
7920H	Yes	560W/5.6A	13394A	015	\$16,000
7925M	Yes	630W/6.7A	13356A	015,102	\$21,000
7925S	No	410W/4.4A	13356A	001,015,250	\$17,000
7925H	Yes	410W/4.5A	13356A	015	\$19,000

Options:  
001 Changes cable lengths. (Substitutes 5.5 m (18 ft.) Multi-Unit and 7.6 m (25 ft.) data cables for standard lengths)  
015 230V/50Hz operation  
020 Substitutes 30 inch rack slide kit  
102 Adds HP-IB adapter kit  
250 Adds controller upgrade service required to support the first 7925S added to our existing MAC subsystem (may include the use and/or exchange of refurbished printed circuit assemblies)



# COMPUTERS, PERIPHERALS & CALCULATORS

## Fixed disc drives

Model 7910

- Low Cost
- Reliability
- Serviceability

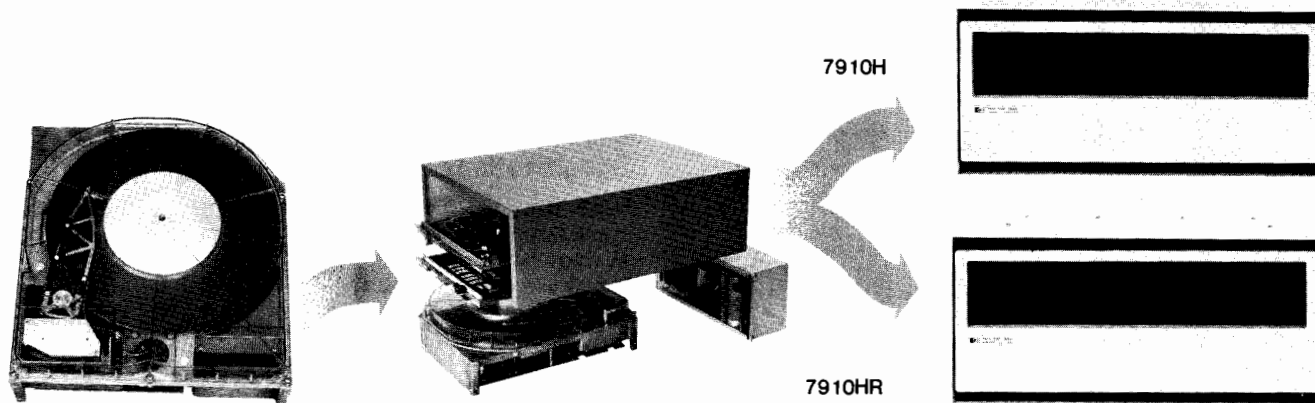

The 7910 disc drive is an ideal solution for applications requiring modest storage capacities and demanding lower cost.

Design features of the drive are totally unique from previous HP disc drives. The 7910 is the first Hewlett-Packard disc drive to feature both "Winchester" technology and fixed media. The mechanical simplicity afforded by this design is responsible for significant contributions to reliability and lower cost. The result is a low overall cost of ownership.

The 7910 provides 12 megabytes of formatted storage in a compact, lightweight package. The single disc platter in the 7910 is fixed within a sealed module providing operating independence from ambient conditions. The drive's servoing technique eliminates the need for field head alignment, and a comprehensive self-test diagnostic program contained in controller firmware improves serviceability. These features, combined with the drive's medium performance, make the 7910 ideal for a wide variety of applications.

The HP 7910 is especially suitable for small business systems operating in office environments, technical systems operating under harsh ambient conditions (laboratory or factory floor applications), or general purpose low cost systems requiring mass storage at a favorable price.

### Winchester Technology

The head and media system in the 7910 employs "Winchester" technology. The Winchester head assembly is characterized by its low mass and light loading, exerting almost no "weight" on the read/write head as it "flies" over the surface of the disc media. Because Winchester disc media also has a thin film of lubricant deposited on its surfaces, limited head/media contact can occur during drive operation without damaging heads or media. Head crashes are virtually eliminated, significantly enhancing reliability.

### Features

- Winchester head/media technology
- Mechanical simplicity offered by fixed media and a rotary actuator
- Embedded servo code
- Self-contained HP-IB controller capable of buffered and unbuffered data transfers
- Comprehensive internal self-test diagnostics
- Modular design for serviceability
- Environmental tolerance
- Lower entry level price and cost of ownership

### RFI Emissions/Safety

Meets or exceeds EMC/RFI emission standards such as VDE 0871 and C.I.S.P.R. Consult the appropriate HP system configuration guide for details.

Products have appropriate UL/CSA approvals. VDE certification pending.

### Specifications

#### Capacity

**Formatted:** 12.09 MB

**Tracks per surface (2 surfaces)\*:** 735 + 3 spares

**Sectors per track:** 32

**Bytes per sector:** 256

\*Up to 10 additional tracks per surface may be spared at the factory's option, and are not included in capacity figures.

#### Seek time

**Average track-to-track:** 11 ms

**Average random:** 70 ms

**Average full stroke (748 tracks):** 100 ms

#### Rotation

**Speed:** 3,000 rpm

**Average rotational delay (latency):** 10 ms

#### Data transfer rates

**Unbuffered burst:** 526.5 kB/sec

**Unbuffered average:** 409.6 kB/sec

**Buffered:** System dependent

#### Temperature

**Operating:** 0° to 45°C (32° to 113°F)

**Non-operating:** -40°C to 65°C (-40° to 149°F)

**Maximum rate of change:** 10°C/hr (18°F/hr)

**Maximum operating wet-bulb:** 26°C (79°F)

#### Relative humidity

**Operating:** 8% to 80%

**Non-operating:** 8% to 80%

#### Altitude

**Maximum operating:** 4 572 m (15,000 ft)

**Maximum non-operating:** 15 240 m (50,000 ft)

#### Power requirements

100/120/220/240 Vac, +5% -10%, switch-selectable on rear panel, 47.5 to 66 Hz, single phase.

#### Ordering information

**7910H** Disc Drive (desk-top)

**7910HR** Disc Drive (rack-mount)

**Option 015** (230V/50 Hz operation)

#### Price

\$8,350

\$7,950

NC

The 7910H/HR drives are fully configured mass storage systems, ready for operation after simply being "plugged-in" to the host system. An HP-IB controller, power supply, cabling and packaging are standard in both models.

# COMPUTERS, PERIPHERALS & CALCULATORS

Multiprogrammer: versatile I/O expander & converter

Model 6940B

665



Use the MULTIPROGRAMMER to get exactly what you want when building your own Automatic System.

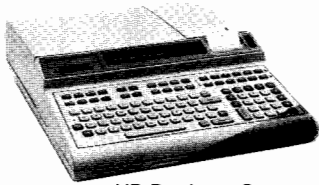

HP Desktop Computer

First, Select your HP Controller and Interface Kit ... Use either a Desktop or Minicomputer ...

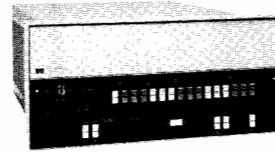

HP Minicomputer

or use the 59500A HP-IB Interface Kit

DESIGNED FOR HP-IB SYSTEMS

with the 98032A Option 040 16-Bit Interface Kit

or use the 59500A HP-IB Interface Kit

DESIGNED FOR HP-IB SYSTEMS

with the 14550A 16-Bit Interface Kit For HP Computers

Then select from a wide range of these MULTIPROGRAMMER CARDS for the MAINFRAMES ...

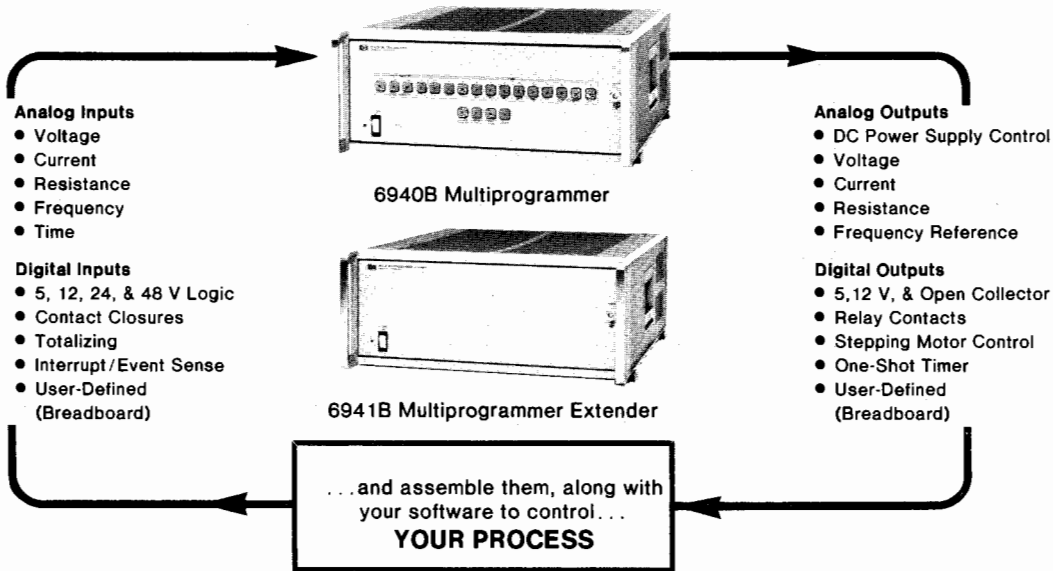

## Introduction

The Multiprogrammer is the vital link between a Hewlett-Packard Desktop Computer or Minicomputer and your test or process. The Multiprogrammer provides the interface between the controller and the physical world. Thousands of Multiprogrammers are in use now as part of user defined and assembled systems for production testing and control, data acquisition, process monitoring, life testing, quality control, and component evaluation.

The Multiprogrammer Family gives you the choice of two mainframes: The 6940B or the 6942A. The 6940B is the lower cost solution and can give the more advanced programmer maximum I/O speed. The 6942A is the latest addition to the family and offers simplified programming and some new, powerful I/O cards. The next eight pages will give you more details to help you decide which of these two mainframes is the right one for your application.

6942A. The brochures include detailed specifications, applications, programming, interfacing, and ordering information. Ask your HP Field Engineer for publication 5952-4025 (for the 6940B) or 5952-4034 (for the 6942A), or use the card at the rear of this catalog.

## Complete Technical Data

If you would like additional information on Multiprogrammer products we have a free, 60-page brochure on the 6940B and one on the

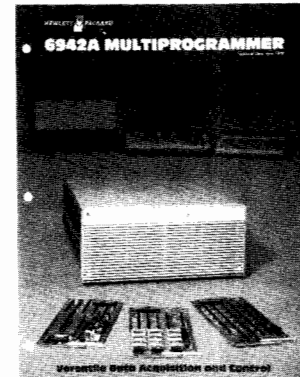
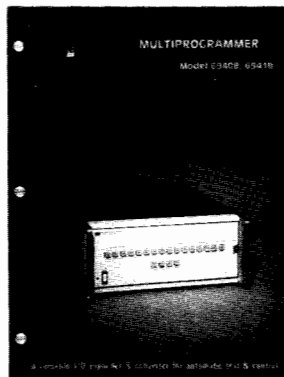



# COMPUTERS, PERIPHERALS & CALCULATORS





## Multiprogrammer: versatile I/O expander

Model 6940B

- Stimulus
- Measurement

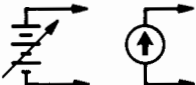
- Control
- Data acquisition

### Multiprogrammer I/O Card Function

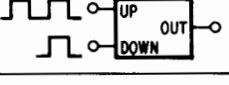
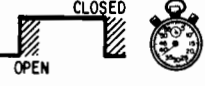
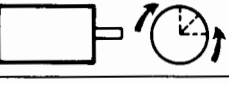
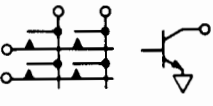
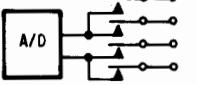
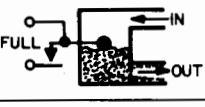
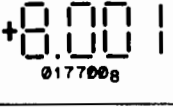
	Functions	Applications	Cards Used
<b>STIMULUS</b>	 <p>Programmable DC Voltage and Current</p>	The output voltage (up to 100V) and current (up to 1000A) of thirty-seven different HP power supplies can be programmed to provide bias in automatic test systems or control of electromechanical process equipment.	Resistance Output 69501A-69513A
	 <p>Digital-to Analog Conversion</p>	Twelve bit voltage and current DAC's for strip chart, x-y, and analog tape recordings as well as control of analog programmable instruments and process control devices with 0-5 volt or 4-20 mA inputs.	Quad DAC, 69322A; Voltage DAC 69321B; Current DAC, 69370A; Regulator 69351B
	 <p>Time and Frequency Reference</p>	One-shot timing pulses, programmable from 1 $\mu$ s to 40 days, and crystal-controlled pulse trains in fixed frequencies of 1, 10, 100, 1 K, 10 K, and 100 kHz serve as time base references for control, measurement, and data acquisition.	Timer, 69600B; Frequency Ref. 69601B.
<b>MEASUREMENT</b>	 <p>Voltage, Current and Resistance Measurements</p>	Measure voltages in the presence of 100 V of common mode noise. Connecting a resistor across the input permits current measurements for 4-20 mA current loops used in process control. Combine voltage monitor and current DAC cards for resistance measurements.	High Speed A/D, 69422A; Low Level A/D, 69423A; Current DAC, 69370A; Regulator 69351B
	 <p>Frequency Measurements</p>	The pulse counter card accumulates counts over a precise time interval when a programmable timer card is connected to the enable line of the counter. The program divides the count by the time interval to measure the frequencies from 200 kHz to 0.001 Hz.	Pulse Counter, 69435A, Timer, 69600B.
	 <p>Pulse Counting Preset Up/Down</p>	Counter may be preset to any value within count range of 0 to 4095. The program can examine the counter without disturbing the counting process (read-on-the-fly).	Pulse Counter, 69435A.
	 <p>Time Interval Measurement</p>	Elapsed time between two events can be measured in the range of 10 $\mu$ s to 1 hour by counting a known frequency over the unknown interval. The program divides the accumulated count by the known frequency to determine the interval.	Pulse Counter, 69435A; Frequency Reference, 69601B.
<b>CONTROL</b>	 <p>Stepping Motor Control</p>	One output word to card produces from 1 to 2047 square-wave pulses at either of two outputs (CW or CCW) to control motor translators. Output pulses are also used for pulse train update of supervisory control stations.	Stepping Motor Control, 69335A.
	 <p>Digital Output and Switching</p>	Twelve bits of data in TTL, open collector, or SPST relay-contact form provide digital control of instruments, indicators, and solid-state AC relays.	TTL, 69331A; Open Collector, 69332A; Relay Out, 69330A; Relay Out/Readback, 69434A.
<b>ACQUISITION</b>	 <p>Scanning and Input Multiplexing</p>	The High Speed Scanner Card acts as an input multiplexer for the High Speed A/D. Single-ended or differential voltages can be read at rates of up to 20,000 channels per second.	High Speed Scanner Card 69336A.
	 <p>Event Sensing</p>	It is often necessary for a system to respond quickly to alarm conditions, operator intervention or other requests for immediate service. This service request is made via a program interrupt generated by either an event sense or a process interrupt card.	Event Sense, 69434A; Process Interrupt, 69436A.
	 <p>Digital Input</p>	Digital input cards accept 12 bits of data from digital measuring instruments, push buttons, switches, relays, and other digital devices in the form of logic levels or contact closures. Digital data sources with more than 12 bits of data use several digital input cards.	Digital Input, 69431A; Isolated Digital Input, 69430A.

New Multiprogrammer plug-in cards are being developed. Ask your HP Field Sales Engineer for the latest technical data describing all Multiprogrammer products.



### Desktop Computer-Based Multiprogrammers

Unless your automatic system requires the high-speed execution of a computer, there's a good chance you can take advantage of the economy, flexibility, and ease-of-programming offered by a desktop computer-based Multiprogrammer. The heart of the Multiprogrammer approach to real-time system design is the HP Desktop Computing Controller.

**9825 HPL language computing controller:** a powerful programmable calculator that features a high-level language particularly suited to test and control applications. Designed principally for engineering, research, and statistics use, it has many features previously found only in minicomputers.

**9835 BASIC language computing controller:** features a powerful version of the BASIC programming language plus assembly language and up to 246K bytes of user read-write memory. The CRT display greatly simplified program entry and editing.

**9845 BASIC language computing controller:** provides the same capabilities of the 9835 plus graphics. All three controllers may be interfaced with the 6940B via 16-bit duplex or HP-IB.

A basic system includes an HP desktop computing controller, a 6940B Multiprogrammer, from one to fifteen plug-in I/O cards, and the interfacing accessories of your choice. Model 6941B Extender mainframes and additional I/O cards can be used to further expand the system.

### HP-IB Interfacing Accessories

For HP-IB systems, a 59500A Multiprogrammer Interface unit is required, together with the HP-IB interface card associated with your computing controller (98034A card for 9825A controllers).

### HP-IB Multiprogrammer Cabling

**Computing controller-to-59500A interface unit:** One HP-IB cable is supplied with the controller interface card. Additional 10833, B or C cables can be ordered separately in 1, 2, or 4 metre lengths.

**59500A-to-6940B:** Standard 18-inch (0.46 m) chaining cable Model 14541A, supplied with 59500A.

**6940B-to-6941B:** Standard 18-inch (0.46 m) chaining cable Model 14541A, purchased separately. Lengths up to 100 ft (30 m) are available on special order.

**Plug-in card-to-users device:** 14555A connector provided with most Multiprogrammer plug-in cards for user to fabricate own cable.

### 16-Bit Duplex Interface

The Multiprogrammer may also be interfaced directly to a 9825, 9835 or 9845 computing controller using the 98032A option 040 for the 9825, or 98032A option 340. The 98032A option 040/340/440 comes with the interface card, a book, and a cable ready to connect to the 6940B mainframe.

### Documentation Package

A complete documentation package is supplied with each purchase, including a User's Guide for the selected desktop computer, a Multiprogrammer User's Guide, and Operating and Service Manuals for the various Multiprogrammer mainframes, plug-in cards, and accessories.

### Minicomputer-Based Multiprogrammers

Hewlett-Packard computers are interfaced to most Multiprogrammers with HP Interface Kit 14550B. The kit contains the HP computer-to-6940B cable, verification and driver software, and plug-in cards and cable.

### 14550B Interface Kit for HP Minicomputers

This kit provides all the equipment necessary to install, verify, and operate a Multiprogrammer with HP 1000 series computers.

### Condensed Specifications

#### 6940B/6941B Common Specifications

**Input/output card positions:** Maximum of 15 plug-in input or output cards per mainframe. Hinged front panel provides access.

**Mainframe data connectors:** Two 50-contact, ribbon connectors.

**Data transfer rate:** up to 20,000 words/second.

**Maximum data resolution:** 12 bits per plug-in card.

**Accessories furnished:** Data Input Plug, PC Board Extender Card.

**Cooling:** Natural convection.

**Temperature:** 0°C to 55°C operating, -40°C to +75°C storage.

**Size:** 172.2 H x 425.4 W x 539.8 mm D (6.78" x 16.75" x 21.25").

**Power:** 100/120/220/240 V ac selectable, 48-440 Hz, 230 watts.

#### 6940B Specifications

**Front panel controls:** Power ON/OFF switch and indicator lamp, REMOTE/LOCAL switch for selecting computer or manual control, 19 switches for manual data entry and control.

**Weight:** net, 15.9 kg (35 lb). Shipping, 19.5 kg (43 lb).

**Price**  
**\$1700**

#### 6941B Specifications

**Front panel controls:** Power ON/OFF switch and indicator lamp.

**Weight:** net, 15.2 kg (33.5 lb). Shipping, 18.3 kg (40.3 lb).

**\$1500**

### Programmable Plug-In Cards

#### Output Cards

<b>69500A-69506A Resistance Output Cards:</b>	\$350-\$400
<b>69510A-69513A Resistance Output Cards:</b>	\$400
<b>69321B Voltage D/A Converter Card:</b>	\$400
<b>69322A Quad D/A Voltage Converter Card:</b>	\$600
<b>69330A Relay Output Card:</b>	\$330
<b>69433A Relay Output/Readback Card:</b>	\$300
<b>69331A Digital Output Card:</b>	\$210
<b>69332A Open Collector Output Card:</b>	\$130
<b>69335A Stepping Motor Control Card:</b>	\$200
<b>69600B Programmable Timer Card:</b>	\$300
<b>69380A Breadboard Output Card:</b>	\$125
<b>69601B Frequency Reference Card:</b>	\$250

#### Input Cards

<b>69336A High Speed Scanner Card:</b>	\$400
<b>69422A High Speed A/D Converter Card:</b>	\$700
<b>69423A Low Level A/D Converter Card:</b>	\$700
<b>69431A Digital Input Card:</b>	\$210
<b>69430A Isolated Digital Input Card:</b>	\$250
<b>69434A Event Sense Card:</b>	\$400
<b>69435A Pulse Counter Card:</b>	\$200
<b>69436A Process Interrupt Card:</b>	\$400
<b>69480A Breadboard Input Card:</b>	\$125

#### 59500A Interface Unit Specifications

**\$900**

Converts the serial ASCII alphanumerics of the HP-IB to the 16-bit parallel format required by the 6940B/6941B Multiprogrammer. The 59500A design is optimized for ease of programming the 6940B/6941B.

**Front panel controls:** Power ON/OFF switch and indicator. LED's indicate mode and gate/flag status between HP-IB and the Multiprogrammer for system check-out and maintenance.

**Cooling:** Natural convection.

**Temperature:** 0°C to 55°C operating; -40°C to +75°C storage.

**Size:** 82.6 H x 425.4 W x 463.6 mm D (3.25" x 16.75" x 18.25").

**Weight:** 5.4 kg (12 lb).

**Power:** 100/120/220/240 V ac (selectable) 48-440 Hz, 15 W.



# COMPUTERS, PERIPHERALS & CALCULATORS

## Multiprogrammer: versatile data acquisition and control

Model 6942A

- Action-Oriented Instructions
- Isolated Analog Inputs and Outputs
- Built-in Self Test

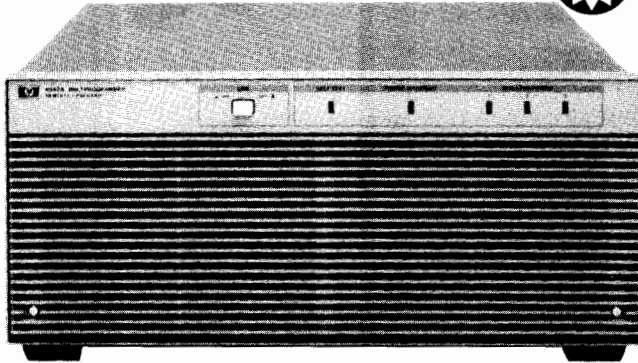

6942A



- Overlapped Input and Output
- Internal or External Pacing
- Easy to Configure

### The Multiprogrammer Performs Operations in Parallel

With this one instrument you can control several processes at once. And, while you are controlling the processes, the Multiprogrammer can also be watching for interrupt conditions. The internal microprocessor manages all the parallel operations and monitors the alarm lines; when the operations have completed or if an alarm condition occurs, the Multiprogrammer interrupts the controller.

### How does the 6942A Connect With Your Controller?

The 6942A Multiprogrammer interfaces with your controller (desktop or minicomputer) using the HP-IB, Hewlett-Packard's implementation of IEEE Standard 488 and the identical ANSI Standard MC1.1. Data and status readback make use of the extended bus addressing features of the HP-IB.

### Documentation Package

The complete documentation package supplied with each mainframe includes a User's Guide, with programming examples for all the desktop computer controllers, a utility program tape, operating and service manuals, and a binder to hold all this material.

### Programming Flexibility

Mnemonic, action-oriented instructions make the 6942A Multiprogrammer simple to learn and use. For instance, the output instruction "OP" works with all output cards. When you send an instruction, the internal microprocessor checks which type of card you are addressing and automatically converts the data to the proper format for that card. You select the units with which you want to program each card. Whether you want to use volts, millivolts, amps, degrees, feet, or any other units, the Multiprogrammer does the converting for you.

### Mainframe Memory Unburdens The Controller

The mainframe memory of the 6942A will accept up to 76 instructions from the controller at one time. This leaves your controller free for other processing activities while the Multiprogrammer works on the I/O operations. This mainframe memory may also be used to collect up to 1440 data readings and hold them until the controller is free to take them. For even more data storage, 4K Memory Cards, 69790A, may be used to store 4096 16-bit words of input or output data.

### Real Time Clock

Built-in real-time clock gives you time-of-day readings and pacing of measurements. The clock detects which power line frequency you are using, 50 Hz, or 60 Hz, and automatically synchronizes itself to this frequency. The range of the clock is 65,534 days, with resolution to a tenth of a second.

### Accessories

**14700A extender kit:** This kit contains the transmission boards which go into the master mainframe (6942A) and the last extender mainframe in the chain.

**14701A intermediate extender kit:** When more than two mainframes are in a chain, the card in this kit must be used in each intermediate extender mainframe.

**14702A chaining cable:** This is the cable which chains together the master and extender mainframes. One cable is required for each extender mainframe.

**14703A card edge connector:** Extra connectors for the I/O cards may be ordered in addition to the one supplied with each I/O card.

### Which is the Right Multiprogrammer For You?

The 6942A is the right choice when you require the easiest to program solution and can sacrifice programming speed to achieve this. While the 6942A is far from slow, it cannot match the 20,000 words per second throughput rate of the 6940B. In applications where only bursts of high speed are required, the Memory card, 69790A may be used with the 6942A to obtain high speeds (up to 33,000 words per second) for limited amounts of data (up to 4096 readings).

The 6940B offers maximum continuous throughput especially important in certain real-time control applications. For the less complex application, the 6940B also offers the lower hardware cost. Either way, there is no wrong choice when you choose a Multiprogrammer as your interface.

### 6942A/6943A Specifications

**Plug-in I/O card positions:** maximum of 16 plug-in output or input cards per mainframe. Removable rear cover provides access to card slots.

**Computer interface (6942A only):** the Multiprogrammer is connected to a controller via the Hewlett-Packard Interface Bus (HP-IB), Hewlett-Packard's implementation of IEEE Std. 488.

**Real time clock (6942A only):** the built-in real time clock is automatically synchronized with the 50/60 Hz ac power line frequency. The clock is read and set with data in the form of days, hours, minutes and seconds with a resolution of 0.1 seconds.

**Extender interface kits (6943A only):** each 6943A Extender requires one 14700A or 14701A Interface Kit and one 14702A Chaining Cable for operation with the 6942A.

**Maximum number of mainframes per chain:** up to seven 6943A Multiprogrammer Extenders may be placed in a chain with one 6942A Multiprogrammer.

**Maximum chain length:** a chain of mainframes can be up to 152 meters (500 feet) long. This maximum length is the sum of the lengths of all 14702A Chaining Cables used in one chain.

**Power supplies:** all power supplies for up to 16 I/O cards are built-in including three  $\pm 18$  V supplies isolated from each other and from the ground.

**Cooling:** built-in forced air cooling draws air in through the front panel and exhausts air through the ventilated rear cover.

**Front panel indicators:** five light emitting diodes on the front panel indicate power supply and self-test status.

**Operating temperature range:** 0°C to 55°C.

**Power:** 100/120/220/240 Vac (selectable), +5%, -10%, 47 to 63 Hz, 600 VA.

**Dimensions:** 177.0 mm high x 425.5 wide x 597.0 mm deep, (6.96 in. high x 16.250 in. wide x 23.500 in. deep).

**Weight (without I/O cards):** net, 20 kg. (45 lbs); shipping, 27 kg. (60 lbs).

**Accessories furnished:** PC board Extender Card (HP Part No. 5060-2792).

## 6942A I/O Card Functions

	Functions	Applications	Cards Used	
S T I M U L U S		Programmable DC Voltage and Current	The output voltage (up to 250V) and current (up to 1000A) of forty different HP power supplies can be programmed to provide bias in automatic test systems or control of electromechanical process equipment.	Resistance Output, 69700A-69706A.
		Digital-to-Analog Conversion	Twelve-bit voltage DAC's provide outputs for strip chart, x-y, and analog tape recorders as well as control of analog programmable instruments and stimulus of units under test. Control process equipment with 4-20mA outputs.	Voltage DAC, 69720, Current DAC, 69721A.
		Analog Waveform Synthesis	The Memory card can continually supply pre-loaded data to the D/A card at rates of up to 100kHz. Special waveforms may be loaded into the Memory card from the computer and used as stimuli for test and processes.	Memory card, 69790A; Voltage DAC, 69720A; or Current DAC, 69721A.
M E A S U R E M E N T		Voltage, Current, and Resistance Measurements	A/D converters may be used to measure voltages from $\pm 50\mu\text{V}$ to $\pm 100\text{V}$ in the presence of 250V of common-mode noise. Connecting a resistor across the input permits current measurements for 4-20mA current loops used in process control. Combine the A/D with the current DAC for resistance measurements.	High Speed ADC, 69751A.
		Frequency Measurements	The Pulse Counter card accumulates counts over a precise time interval when a Timer card is connected to the enable line of the Counter. The program divides the count by the time interval to measure frequencies from 1 MHz to less than 0.001Hz.	Counter, 69775A; Timer, 69736A.
		Pulse Counting Preset and UP/Down	The Counter may be preset to any value within the count range of 0 to 65,535 and can cause an interrupt when it rolls over. The Counter may be enabled and disabled by pulses or levels. The computer may read the count without disturbing the counting process.	Counter, 69775A.
		Offline Analog Acquisition	Differential or single-ended signals may be digitized at rates up to 33KHz by the A/D, and stored on the Memory card. Each Memory card can store up to 4096 Readings. The digitizing process can take place independent of other Multiprogrammer activity.	High Speed ADC, 69751A; Memory card, 69790A.
		Time Interval Measurement	Elapsed time between two events can be measured in the range of $10\mu\text{s}$ to 65,000 days. The Counter card counts a known frequency over the unknown interval. This count is divided by the known frequency to determine the interval. For resolution of .1 sec, the built-in real time clock alone may be used. This real time clock provides time-of-day readings.	Counter, 69775A; Timer/Pacer, 69736A.
C O N T R O L		Digital Output and Switching	Sixteen-bits of data in TTL, open collector, or SPST relay-contact form provide digital control of instruments, indicators, and solid-state AC relays.	Digital Output, 69731A; Relay Output, 69730A
		Digital Input	Digital Input cards accept 16-bits of data from digital measuring instruments, push-buttons, switches, relays, and other digital devices in the form of logic levels or contact closures. Digital data sources with more than 16-bits of data use several digital input cards.	Digital Input, 69771A; Isolated Digital Input, 69770A.
		Stepping Motor Control	The Stepping Motor card can produce from 1 to 32767 pulses at either of two outputs (CW or CCW) to control motor translators. Output pulses are also used for pulse-train update of supervisory control stations. The pulse rate (motor speed) is also programmable.	Pulse Train/Stepping Motor, 69735A.
		Time and Frequency Reference	Crystal controlled timing pulses, programmable from $1\mu\text{s}$ to 18 hours, may be used as a time-base reference for control, measurement, and data acquisition. Period, duty cycle, and number of pulses are all programmable.	Timer, 69736A or Pulse Train 69735A.
A L A R M		Level Detecting	When signals cross preset levels, the Digital Input card can trigger the interrupt card to interrupt the computer. The alarm trigger levels can be programmed with the D/A or fixed with resistors.	Digital Input 69771A; Interrupt card, 69776A.
		Event Sensing	A digital word may be used to trigger quick computer response with the interrupt card. The computer responds to the interrupt with a software routine. The interrupt may also cause immediate local response by triggering a preloaded output card.	Interrupt card, 69776A



# COMPUTERS, PERIPHERALS & CALCULATORS

## Multiprogrammer: versatile data acquisition & control Model 6942A (cont.)

### 6942A Applications

Product Testing	
<p><b>Electronic Subassembly Testing</b></p> <p>The digital and analog inputs and outputs of the Multiprogrammer are connected through fixtures to printed circuits modules, cables, and other assemblies such as D/A and A/D converters, filters, and oscillators for incoming inspection, production, calibration, and troubleshooting. During the test, 69701A Resistance Output cards control the outputs of DC Power Supplies that bias the subassembly. Adjustment of critical circuits is performed by a 69735A Stepping Motor control card that operates a motor translator and flexible shaft as an automatic screwdriver. Multiconductor cables are tested for continuity with 69731A Digital Output and 69771A Digital Input cards.</p>	
<p><b>Electromechanical Component Testing</b></p> <p>A wide variety of tests on relays and solenoids are performed with Multiprogrammers, including operational test in which the 69731A Digital Output card applies power to the coil, and 69771A Digital Input cards check for proper contact action. Hysteresis in the relay is often measured by generating a staircase function from a programmable power supply under the control of a 69701A Resistance Output card. Time delays are measured with the 69775A Counter card 69736A Timer/Pacer card. Contact and coil resistance at various current levels are measured by using a 69721A Current DAC or Constant Current DC Power Supply and the 69751A High Speed A/D card. Production tests of other electromechanical devices such as process control valves, flowmeters, tachometers, gauges, switches, and detectors are performed with Multiprogrammer-based automatic systems.</p>	
Research and Development	
<p><b>Environmental Testing</b></p> <p>Multiprogrammer I/O cards are not only capable of operating analog and digital instruments under environmental test and measuring their performance, but are also well suited to control environmental chamber parameters such as temperature, pressure and humidity during the test cycle. In other types of environmental testing such as operation of shake tables for small structures, and control of hydraulic rams for large structures and vehicles, 69720A Voltage DAC cards are programmed to synthesize the waveforms that simulate actual transportation and shock conditions. Designers can alter parameters during the lab test to analyze the effect of severe stresses and abusive treatment.</p>	
Monitoring and Control	
<p><b>Data Acquisition and Signal Distribution</b></p> <p>Data acquisition systems employ the 69751A High Speed ADC card for measurement and the 69790A Memory card for storage of up to 4096 of the measurements. Digital signals may be stored directly on the 69790A Memory card or the 69771A Digital Input card may be used when local storage is not required. Optical isolators on the 69770A Isolated Digital Input card may be used for monitoring 115 or 230 V ac signals. Control signals up to 100 V dc or ac rms are distributed directly to the process with 69730A Relay Output cards, while the 69731A Digital Output cards control solid-state ac or dc relays for controlling voltages above 100 volts. The Multiprogrammer mainframe can be separated by up to 500 feet (150 meters), so that proper location of mainframes used for scanning and distribution significantly reduce cabling costs to sensors and indicators.</p>	

#### Ordering Information

6942A Multiprogrammer	\$3700
Option 910 Extra Manual	\$30
Option 908 Rack Mount Kit	\$30
6943A Multiprogrammer Extender	\$2400
Option 908 Rack Mount Kit	\$30
14700A Extender Kit	\$450
14701A Intermediate Extender Kit	\$300
14702A Chaining Cable	\$250
14703A Card Edge Connector	\$40

#### Programmable Plug-In Cards

69700A-69706A Resistance Output cards	\$550
69720A D/A Voltage Converter card	\$700

#### Price

69721A D/A Current Converter card	\$800
69730A Relay Output card	\$550
69731A Digital Output card	\$400
69735A Pulse Train output/Stepping Motor Control card	\$450
69736A Timer/Pacer card	\$450
69751A A/D Converter card	\$950
69770A Isolated Digital Input Card	\$650
69771A Digital Input/Analog comparator card	\$550
69775A Counter/Totalizer card	\$625
69776A Interrupt card	\$500
69790A Memory card	\$1100
69793A Breadboard card	\$100



### Laser Measurement

The Hewlett-Packard 5526A Laser Measurement System utilizes a precisely-known wavelength of light to provide a portable, easily used dimensional measurement tool for such parameters as length, angle, straightness, squareness and flatness.

The 5526A Laser Measurement System is used in a wide variety of applications where very accurate physical measurements are required, such as characterizing the positioning accuracy and geometry of machine tools and measuring machines.

A wide variety of output devices are available to record the measurement data including digital printers and X-Y recorders. The measurement data can be transferred directly from the Laser Measurement System to an HP desktop computer and immediately processed by prewritten metrology programs. The reduced data is then presented in either printed format or plotted to provide report-quality graphs of the measurements.

### Quartz Crystal Technology

Hewlett-Packard laboratories have developed quartz crystals which respond to temperature or pressure with amazing linearity, stability, accuracy, and sensitivity. Quartz crystals resonate in electronic oscillator circuitry at a very precise frequency. Hewlett-Packard has discovered a way to produce quartz crystals whose resonant frequencies vary extremely linearly with temperature or pressure. For example, the resonant frequency of a 2804A temperature sensing crystal varies 1000 Hz (nominal) per °C. These resonant frequencies are conditioned by electronic circuitry to produce exceptionally high resolution temperature or pressure measurements.

### Digital Thermometer

HP's 2804A Quartz Thermometer provides extremely precise, reliable measurements with standard resolution of 0.0001°C over the range -80 to +250°C. The excellent sensing characteristics of the quartz thermometer are enhanced by the advantages of

*direct digital readout* (no bridge balancing, or reference-to-resistance or voltage-temperature tables or curves), immunity to noise and cable resistance effects, and no requirement for external equipment such as a reference junction. Temperature can be measured up to 1.37 km (4500 feet) from the 2804A with optional amplifiers.

### Quartz Pressure Gauge

The Hewlett Packard 2811B Quartz Pressure Gauge can detect pressure changes as small as 0.01 psi in 10,000 psia. Precision pressure measuring capability and rugged construction make the HP 2811B Quartz Pressure Gauge (Probe and Signal Processor) ideal for applications requiring surface readout such as oil well logging, oceanographic research, and studies of subterranean hydrodynamics. The 2820A Pressure Recording System connects directly to the Quartz Pressure Probe. With it, pressure test data is displayed, printed and stored on magnetic tape and a strip chart.

# PHYSICAL & OPTICAL MEASUREMENTS

## Laser system for dimensional measurements

Model 5526A

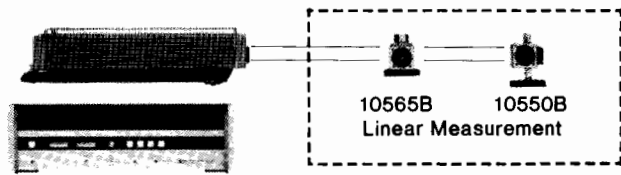

### General Capabilities

The 5526A Laser Measurement System is a major advance in machine tool calibration and economical dimensional metrology. A choice of optics allows the measurement of length, angle, flatness, straightness, squareness and parallelism. In addition, measurements can be automatically printed and/or plotted.

The system is a highly accurate displacement measuring tool with a resolution of one millionth of an inch (0.01  $\mu\text{m}$ ) for linear measurements and 0.1 arc-second for angular measurements. Fully automatic tuning, instant warm-up and remote interferometric measurement techniques assure drift-free accuracy from the moment of switch-on.

### Specifications

**Laser:** Helium-Neon type. Fully automatic tuning. Instant warm-up.  
**Resolution:** normal and smooth modes.

**Normal:** 0.1  $\mu\text{m}$ . English: 0.000 01 inch. Angular: 1 arc-second.

**X10:** 0.01  $\mu\text{m}$ . English: 0.000 001 inch. Angular: 0.1 arc-sec.

**Maximum allowable signal loss:** 95% (-13 dB).

**Maximum measuring velocity:** 18.3 m/min. (720 inch/min.)

**Atmospheric and material compensation:** manual input from tables. 5510A Automatic Compensator optional.

### Linear Measurement

#### Accuracy:

**Metric:**  $\pm 0.5$  parts per million  $\pm 2$  count in last digit.

**English:**  $\pm 0.5$  parts per million  $\pm 1$  count in last digit.

**Maximum measuring range:** up to 60 m (200 ft) depending on conditions.

### Angular/Flatness Measurement

**Accuracy:**  $\pm 0.1$  arc-second ( $\pm 1$  count in last digit) up to 100 arc-seconds.  $\pm 1$  arc-seconds ( $\pm 1$  count in last digit) up to 1000 arc-seconds.  $\pm 4$  arc-seconds per degree ( $\pm 1$  count in last digit) up to  $\pm 10$  degrees using correction table.

### Short-Range Straightness Measurement

#### Accuracy

**Metric:**  $\pm 0.4$  micrometre/metre  $\pm 2$  counts in last digit.

**Inch:**  $\pm 5$  microinches/foot  $\pm 1$  count in last digit.

**Resolution:** same as above.

**Lateral range:**  $\pm 2.5$  mm ( $\pm 0.1$  inch)

**Axial range:** 3 m (10 feet)

### Long-Range Straightness Measurement

**Accuracy:** same as Short-Range version.

**Resolution:** one-tenth that of the Short-Range version.

**Axial Range:** 30 m (100 ft)

### Automatic Compensation

- For air temperature within range 20-30°C (68-85°F) 1.3 ppm  $\pm 2$  counts (English 1.3 ppm  $\pm 1$  count.)
- For air temperature within range 13-40°C (55-105°F) 1.5 ppm  $\pm 2$  counts (English: 1.5 ppm  $\pm 1$  count.)

### Ordering Information

5500C Laser Head	\$7140
5505A Laser Display	\$5300
5510A Automatic Compensator	\$5280
10550B Retroreflector	\$1150
10558A Beam Bender	\$1160
10559A Reflector Mount	\$645
10563A Material Temperature Sensor	\$425
10565B Remote Interferometer	\$3460
10579A Straightness Adaptor	\$1555
10690A Short-Range Straightness Interferometer	\$3070
10691A Long-Range Straightness Interferometer	\$3070

## Laser transducer for "build-in" applications

Model 5501A

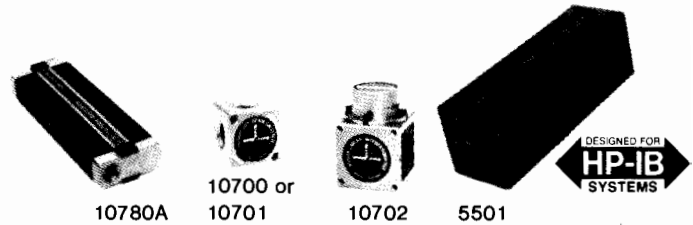

### Systems description

The 5501A Laser Transducer is a smaller interferometer intended as a built-in position sensor for servo control of linear motion of systems such as X-Y stages, machine tools and measuring machines. Using a single laser source, up to 4 axes of motion may be monitored simultaneously. This feature, plus numerous other design innovations, significantly lowers the cost of laser interferometer feedback. A range of output devices offers the choice of feedback control or digital display. Although the Laser Transducer is designed for original equipment manufacturers (OEM), simple installation techniques make it attractive for retrofit by end-users as well.

### Specifications

**Resolution:** 0.16  $\mu\text{m}$  (6 microinches) or 0.08  $\mu\text{m}$  (3 microinches) using Plane Mirror Interferometer. Resolution Extension can increase measurement resolution up to a factor of 10.

**Accuracy:**  $\pm 0.5$  parts per million.

**Range:** up to 60 metres (200 feet) depending upon conditions (sum of axes for multi-axis configurations).

**Number of axes:** up to 4 depending on system configuration and environmental conditions. Maximum allowable measurement velocity: 18.3 meters/min (720 inches/min.)

### Accessories

A wide variety of Interferometers, Retroreflectors, Beam Splitters, and Beam Benders allow application of the 5501A Laser Transducer to the most complex measurement problems.

**Linear interferometer:** most economical and widely used for linear displacement measurements.

**Plane mirror interferometer:** used for precision measurement and control of X-Y stage motion.

**Single beam interferometer:** extremely small linear measurement interferometer for applications where size and weight are critical.

**Beam splitters and benders:** optional components to divide and direct the laser beam to the individual measurement axes.

### Electronic Outputs

A range of output formats are available for the 5501A Laser Transducer which provide compatibility with a wide variety of measurement applications.

**Computer interface electronics:** interface the 5501A Laser Transducer to virtually any digital processor or controller. This universal binary interface is ideal for position control systems with the most demanding response requirements.

**Calculator interface electronics:** based on Hewlett-Packard Desktop Computer and the Hewlett-Packard-Interface Bus provide completely integrated measurement packages. Designed for acquiring, reducing and displaying measurement data, this interface allows simple application of the 5501A Laser Transducer to a wide variety of measurement oriented machines.

**English/metric pulse output electronics:** provides a universal interface to almost all numerical controls for machine tools. Designed primarily to facilitate installation of the 5501A Laser Transducer on machine tools by Original Equipment Manufacturers, this interface provides inch or metric value pulses over a wide range of resolutions.

### Ordering Information

5501A Laser Transducer	\$5850
10780A Receiver	\$465
10700A 33% Beam Splitter	\$360
10702A Linear Interferometer	\$1425
10703A Retroreflector	\$565
10707A Beam Bender	\$270



- $\pm 0.04^{\circ}\text{C}$  Absolute Accuracy
- $0.0001^{\circ}\text{C}$  or  $0.001^{\circ}\text{F}$  Resolution
- $-80^{\circ}$  to  $+250^{\circ}\text{C}$  Range
- Display of Absolute or Differential Temperature
- Flexible HP-IB System Interface
- Variable Resolution Analog Output
- Easy Ice Point or Triple Point Adjustment



The 2804A Quartz Thermometer allows you to easily measure temperature with exceptionally high accuracy and resolution. Absolute accuracy is  $\pm 40$  millidegrees Celsius over the range of  $-50^{\circ}\text{C}$  to  $150^{\circ}\text{C}$ , NBS traceable to IPTS-68. The useable resolution of  $0.0001^{\circ}\text{C}$  allows you to measure temperature changes that could not be detected by other digital thermometers.

The 2804A can be used with one or two temperature sensing probes. The temperature of either probe, or their difference, can be measured and displayed under pushbutton control. Display resolution is selectable from  $0.01$  to  $0.0001^{\circ}\text{C}$  ( $0.1$  to  $0.001^{\circ}\text{F}$ ) by pushbuttons. An internal switch allows you to easily select measurement in the Celsius or Fahrenheit temperature scale.

Temperature is measured and displayed automatically with the microprocessor and electronics provided in the 2804A package. There is no need to balance a bridge, perform calculations using resistance- or voltage-temperature tables or curves, or to use calibration correction tables. The only adjustment necessary to remove effects of thermal history on the sensor is a simple ice point or triple point calibration adjustment using the front panel thumbwheel switches.

#### How It Works

The 2804A temperature sensor is a quartz crystal whose precise angle of cut gives a stable and repeatable relationship between resonant frequency and temperature. Each quartz sensor is individually calibrated at the factory over the full temperature range. The calibration data for each sensor is processed and stored in a calibration module which is supplied with the probe.

In operation, a microprocessor in the thermometer performs the complex control and calculation operations to accurately measure temperature from the quartz sensor frequency and probe calibration information in the calibration module. The microprocessor also performs self-checks to detect fault conditions. If a problem occurs that would give an improper measurement, an error message is displayed to indicate the source of the problem.

#### System Oriented Design

The HP-IB option offers you a simple, yet flexible, way to connect the Quartz Thermometer to either an HP computing controller or printer. Temperature data can easily be sent to a calculator or computer for processing and recording. All front panel controls can be operated automatically by commands sent on the bus.

The optional analog output converts any three consecutive digits to a voltage between 0 and +10 volts to drive a chart recorder. Front panel controls allow easy adjustment of pen zero and full scale as well as normal or offset (center-zero) operation. Any three digits can be

selected for conversion allowing you to change the full scale value on the recorder.

### 2804A Specifications

#### Performance

**Range:**  $-80$  to  $250^{\circ}\text{C}$ .

**Absolute Accuracy:** 2804A with 18110A, 18111A, 18112A or 18117A Quartz Probe —

$\pm 0.04^{\circ}\text{C}$  from  $-50$  to  $150^{\circ}\text{C}$

$\pm 0.075^{\circ}\text{C}$  from  $-80$  to  $250^{\circ}\text{C}$

NBS traceable to IPTS-68

**Resolution:** Three levels can be selected —

Level of selection	Resolution		Nominal time between readings in seconds	
	$^{\circ}\text{C}$	$^{\circ}\text{F}$	T1 or T2	T1 - T2
Low	0.01	0.1	0.1	0.2
Medium	0.001	0.01	1	2
High	0.0001	0.001	10	20

#### General

**Display:** 7 digit LED with polarity, decimal, and degree C or F annunciator.

**Probes:** a variety of probes are available for use with the 2804A. Refer to the data sheet for specifications and sheath configurations.

#### Power Required

100, 120, 220, or 240 VAC, +5%–10%, 48 to 66 Hz, <30 VA.

#### Options

**006:** Analog Output

**010:** HP-IB Interface

#### Price

\$475

\$400

#### Accessories and Probes

**18107A** External Oscillator \$200

**18108A** Line Amplifier \$200

**18109A** Diagnostic Kit \$480

**18110A** Laboratory Probe and cal module, 25 mm (1") \$1050

**18111A** Laboratory Probe and cal module, 230 mm (9.1") \$1050

**18112A** Laboratory Probe and cal module, 460 mm (18.1") \$1100

**18115A** Heavy Duty Probe and cal module, 30 mm (1.2") \$1100

**18116A** Heavy Duty Probe and cal module, 100 mm (3.9") \$1100

**18117A** Heavy Duty Probe and cal module, 180 mm (7.1") \$1100

**2804A Quartz Thermometer**

**\$2900**



# PHYSICAL & OPTICAL MEASUREMENTS

## Quartz pressure gauge

Model 2811B

- 0.01 psi resolution (69 Pa)
- 0.025% Full Scale Accuracy
- Direct Surface Readout
- Simple Operation
- Long Term Stability
- 200-11000 PSIA Range

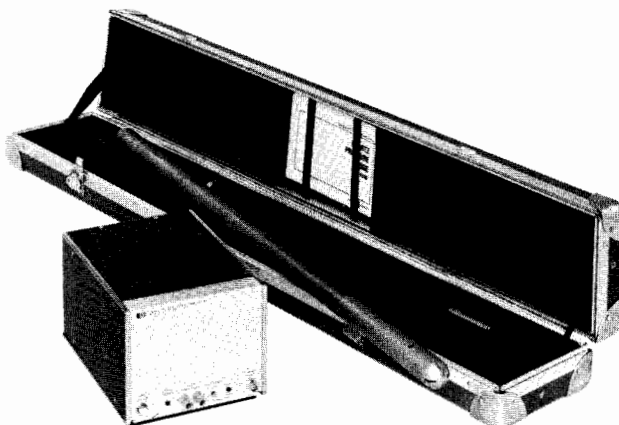

2811B Quartz Pressure Gauge

### 0.01 psi Resolution at 11,000 psi (69 PA @ 69 MPa)

The HP 2811B Quartz Pressure Gauge measures wellbore pressure with a resolution of 0.01 psi over a dynamic range in excess of 11,000 psi. This capability makes it possible to measure pressure changes that cannot be detected with conventional gauges using bourdon tube transducers.

This ability to detect and record small pressure changes allows sophisticated test techniques to be used economically. For example, since the super-sensitive HP Quartz Pressure Gauge can detect small pressure transients at observation wells, pulse tests can be conducted with extremely short pulse cycle times at the stimulus well. Because the shut-in time is reduced, the permeability and formation thickness between wells can be determined at a substantially lower cost.

With the 2811B, pressure transients can be observed and recorded on the surface while the test is in progress. When the surface readout indicates the test is completed, the gauge can be retrieved immediately. Pressure data can be read directly without intermediate scaling or other calculations, when used with the 2820A Pressure Recording System.

The 2811B Quartz Pressure Gauge was specifically designed for pressure measurement in oil and gas wells and it is used by many oil companies and well service companies. However, its high resolution pressure measuring capability and rugged construction also make it ideally suited for oceanographic research and subterranean hydrodynamic studies.

### Description

The 2811B consists of a 2813B Quartz Pressure Probe and a 2816A Pressure Signal Processor. A frequency signal proportional to pressure is transmitted from the bottom-hole pressure probe to the signal processor on the surface. It travels through a single-conductor, armored electric line. The processor conditions the pressure-related signal to drive a separate electronic frequency counter for direct readout. An HP Desktop Computer may be used to calculate bottom hole pressure from the probe frequency and temperature. If a preset counter is used wellbore pressure will be displayed in psi. No scaling or intermediate calculations are necessary.

For field use, the 2820A Pressure Recording System is available. It provides a convenient method of obtaining direct visual display and a permanent record of pressure data. Test pressure data is recorded on a strip chart recorder, digital printer, and magnetic tape. All instruments are shock mounted in a rugged field case to withstand rough handling.

### System Specifications

**Sensitivity:** 105 Hz/psi nominal (105 Hz/6.9 kPa) output of signal processor.

**Probe operating pressure range:** 0-12,000 psi (0-82.7 MPa).

**Probe operating temperature range:** 32° to 302°F (0 to 150°C).

**Signal processor operating temperature range:** 32° to 131°F (0° to 55°C).

**Calibrated pressure range:** 200-11,000 psia (1.4-75.8 MPa).

**Resolution:** 0.01 psi (69 Pa) when sampling for a 1-second period.

**Repeatability:** ±0.4 psi (±2.76 kPa) over entire range.

**Accuracy (at thermal equilibrium) if operating temperature is known**

**within 1.8°F (1°C):** ±0.5 psi or ±0.025% of reading (±3.45 kPa or ±0.025% of reading).

**within 18°F (10°C):** ±1 psi or ±0.1% of reading (±6.89 kPa or ±0.1% of reading).

**within 36°F (20°C):** ±5 psi or ±0.25% of reading (±34.5 kPa or ±0.25% of reading).

### Dimensions and weights

**2813B Probe:** 1.4" (36.5 mm) OD by 39.4" (1000 mm) long.

**Weight:** 11 lb (5.0 kg).

**2816A Signal Processor:** 154 mm H x 197 mm W x 279 mm D (6.1" x 7.8" x 11")

### 2811B Quartz Pressure Gauge

**Price**  
**\$19,200**

Includes HP 2813B Quartz Pressure Probe and carrying case, calibration tables, manual and HP 2816A Pressure Signal Processor.

### 2813B Quartz Pressure Probe

**\$17,750**

### 2816A Pressure Signal Processor

**\$1,450**

# PHYSICAL & OPTICAL MEASUREMENTS

## Pressure Recording System

Model 2820A

675



- Surface readout and recording for the 2813B Quartz Pressure Probe
- Failsafe operation protects test data
- Autorestart after power interrupt minimizes data loss

- No set-up calculations or interpolation
- Connects directly to wireline from pressure probe
- Flexible system can be expanded



2820A  
System

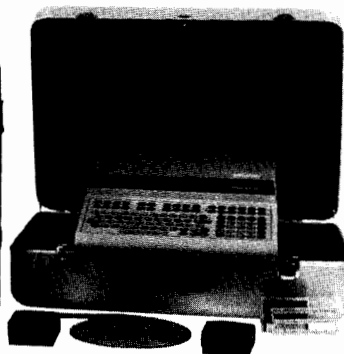
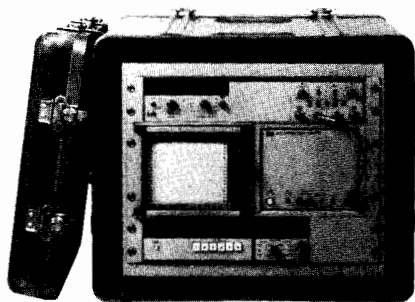

### Description

The HP 2820A Pressure Recording System provides surface readout and recording for the 2813B Quartz Pressure Probe. Pressure test data (time, bottom hole pressure, and temperature) is automatically displayed, printed, and recorded on magnetic tape and a strip chart while the test is in progress. The system is simple to set up and operate. Many built-in checks are provided to protect against accidental operator entries and other conditions that would cause an error and halt operation. The user can add other HP-IB compatible instruments and peripherals to the 2820A system to display and plot the pressure test data for extensive analysis after the test.

### Easy to Use

The 2820A Pressure Recording System is easy to set up and operate, even by an operator that has no experience in programming. Programs are run by simply pressing function keys on the computer and making entries that are requested by its program. The operator is guided by the computer display and printed messages.

While setting up for a test, the operator can print out a detailed list of instructions to help check system wiring, switch settings and function keys to run the programs.

### Auto Restart After Power Interrupt

In case of a power interruption, the quantity of lost test data is minimized with the automatic restart capability of the 2820A. The system automatically restarts and resumes logging pressure data without an operator when power returns. This feature is enabled by pressing the START TEST function key. A backup battery inside the real time clock insures continuous operation.

### Failsafe Operation Minimizes Errors

The 2820A Pressure Recording System has several "failsafe" features that bypass many operating conditions that would halt operation due to non-data errors. For example, the program checks all operator entries for validity and rejects any entry that would cause an error. The program even protects against pressing function keys out of sequence by ignoring the invalid function key.

The computer is programmed to automatically skip logging program instructions to print data (or record it on magnetic tape) if the printer runs out of paper (or the tape files are full). Recovery is also automatic when the error condition is cleared.

### Flexible System Can Be Expanded

The 2820A Pressure Recording System is a standard system that can be expanded easily to meet individual needs. For example, the time and effort required to analyze pressure test data is reduced dramatically when field tape data is automatically plotted or displayed on HP-IB compatible plotting and display instruments added by the user.

### 2820A Operating Characteristics

**Data display:** real or elapsed time, pressure, temperature, logging time remaining on magnetic tape.

**Printed data:** real or elapsed time, pressure, temperature.

**Tape recorded data:** real time, pressure, temperature.

**Real time:** current month, day, hours, minutes and seconds.

**Elapsed time:** days, hours, minutes, seconds since START TEST key was pressed.

### Display and Chart Recorder Update Time Interval

Pressure Resolution	Nominal Display and Chart Recorder Update Time	
	Min	Max
0.01 Psi	1 Sec	2 Sec
0.001 Psi	1 Sec	10 Sec

### Printing and Magnetic Tape Recording Time Interval Selected By User

Pressure Resolution	Nominal Printing and Magnetic Recording Time (Print Interval)		
	Min	Max	Increment
0.01 Psi	2 Sec	99999 Sec	1 Sec
0.001 Psi	10 Sec	99990 Sec	10 Sec

**Data recording capacity:** each field tape stores 24 hours (nominal) of test data with 10 second Print Interval.

**Temperature input:** keyboard entry by operator or calculated from a continuous frequency input to counter.

### 2820A System Operating Modes

(Factory settings are in italics) Pressure data in *psi* or *kg/cm<sup>2</sup>*. Temperature data in degrees *Fahrenheit* or *Celsius*. Temperature input from *9825 keyboard* or frequency counter. Test data printed on *9825 printer* or *9866B printer* after test. Maximum resolution of *0.01 psi* (0.001 *kg/cm<sup>2</sup>*) or 0.001 *psi* (0.0001 *kg/cm<sup>2</sup>*). Strip chart recorder *on* or *off*.

### 2820A System Operating Variables

(Changed during test by keyboard entry)

**Print interval:** pressure data is printed every 2 to 99999 s (or 10 to 99990 s).

**P:T ratio:** 1 to 99 lines of time and pressure data are printed before each line of temperature data.

**Well temperature:** 32 to 302°F (0 to 150°C).

**Chart scale:** full scale on the strip chart recorder can be set between 1 *psi* and 10,000 *psi*.

**Instruments:** program flags are to enable/disable the record instructions for DAC/chart recorder, printer, and magnetic tape.

### 2820A Pressure Recording System

**\$20,850**

Includes instruments in shock isolated fiberglass transit case and 9825 computer in padded aluminum case.



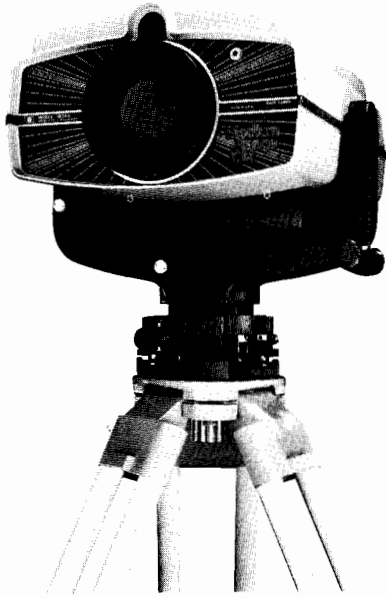

HP 3808A Medium Range Distance Meter

Hewlett-Packard, long recognized as the leading supplier of electronic measuring and computing instruments for the engineer, has developed a similar position in electronic distance/angle measurement and computation instrumentation for the surveyor. These instruments are briefly described on this page.

#### HP 3808A Medium Range Distance Meter

The HP 3808A Distance Meter is a medium range, one-push button, slope distance instrument with a range of 10 km (6.25 miles) to two triple prism retro-reflector assemblies.

The HP 3808A is designed for surveyors to use in applications such as land, construction, and control surveys; as well as precise traversing, photo control, structural monitoring, and land slip studies. In addition, its versatility will allow its use in many other applications, such as precision control of industrial fabrication operations, and other areas where the measurement of distance is critical. The HP 3808A features digital input and output capability allowing simple control and recording of distance meter results. When properly interfaced, the distance meter can be controlled remotely by simple calculators or complex computers. This feature enables automatic distance monitoring to be achieved.

Measured distance may be displayed in either metres or feet (switch selectable). A "tracking" mode permits continuous updating of distances or return signal strengths. Target acquisition is facilitated by an audio aiming feature.

A number of special accessories and options are available for the HP 3808A to enhance its performance in surveying, monitoring, and industrial control applications.

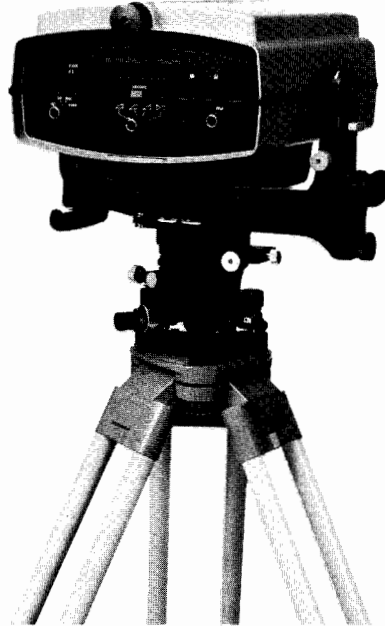

HP 3810A Total Station

#### HP 3810A Total Station

The HP 3810A Total Station is a short range, automatic, direct reading, electro-optical distance and angle measuring instrument utilizing an infrared light source. The range of the HP 3810A is 1.6 km (1 mile) with the measured distance displayed in metres or feet and angles displayed in degrees or grads. The key to the Total Station's power is a built-in microcomputer and a vertical angle sensing device. The instrument has the ability to measure the slope distance, zenith angle, correct for curvature and refraction, and automatically compute and display the horizontal distance. Four parameters are selectable for display: zenith angle, slope distance, horizontal distance, and vertical distance. The communicative display indicates the quality of the measurement, on target indication, and notifies the operator of a low battery. Horizontal angle measurements are made with the 20 second or 50<sup>cc</sup> least count horizontal angle base with estimation to 5 seconds or 10<sup>cc</sup> on the micrometer scale. The HP 3810A also features a built-in atmospheric correction to 1 part per million, a snap-in battery, and a "tracking" mode for rapid point setting to one-tenth of a foot with updated measurements every three seconds. Precise measurements to one-thousandth of a foot can be made in approximately six seconds.

#### HP 3820A Electronic Total Station

The HP 3820A Electronic Total Station is a medium range, automatic, direct reading, electro-optical distance and angle measuring device utilizing a laser diode light source. Solid state electronics gives the HP 3820A its high accuracy plus a range of 5 km (3+ miles) which means long shots can be made without intermediate set ups. The operator, by merely pressing a button, can electroni-

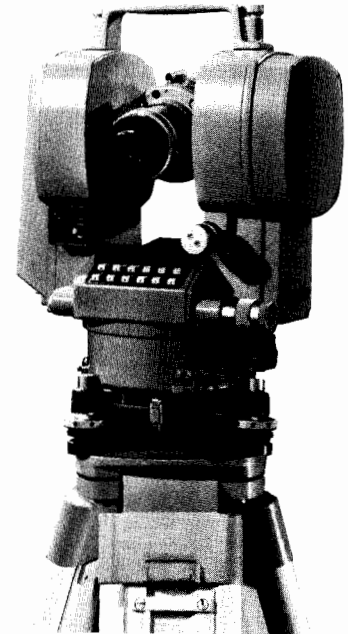

HP 3820A Electronic Total Station

cally display both horizontal and zenith angles to one second. Both horizontal and zenith angles are automatically dual-axis compensated for instrument mislevel—an HP exclusive. The instrument also displays relative direction—that is—the clockwise angle from the previous direction to the current direction. In addition to angle measuring capability, the HP 3820A has the ability to measure slope distance, zenith angle, and automatically compute and display horizontal distance. Vertical distance and slope distance can also be displayed at the touch of a button. The HP 3820A features a built-in atmospheric correction to one part per million plus a snap-in battery pod that fits into the instrument's left standard for a lightweight, compact, easy to use field instrument. A built-in output plug allows the operator to electronically transfer any of its measured components to an external Data Collector or calculator.

#### Versatility and Simplicity

Hewlett-Packard's versatile Distance Meters and Total Stations are suited for such applications as layout, location, boundary, hydrographic, topographic, control, and mine surveys. A short demonstration is all that is necessary for operator training on these instruments.

#### Surveying Calculators

The Civil Engineering Division also markets Hewlett-Packard's line of desk-top programmable calculators and peripherals filling the surveyor's requirements for distance/angle measurements and computation instrumentation. Application and programming specialists have developed libraries of surveying programs for these systems.

For detailed specifications and prices on these instruments and optional accessories, contact the Civil Engineering Division, P.O. Box 301, Loveland, Colorado 80537.

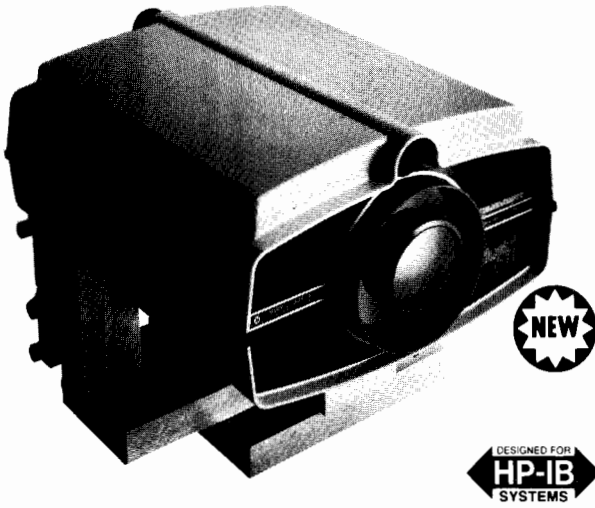

- provides non-contact distance measurement—updating 9 times per second
- determines the elapsed time between distance measurements—providing velocity and acceleration data
- supplies status information on the measurement system—enabling user to monitor system conditions

### Measurements Without Contact

The HP 3850A Industrial Distance Meter is designed to provide accurate distance measurement to a reflecting target mounted on various objects. The non-contact measurement, which is performed rapidly and accurately, eliminates or reduces mechanical downtime that often plagues industrial measurement applications. When the HP 3850A is coupled with an external controller, raw distance data can be combined with time information to determine position, velocity, and acceleration providing a powerful feedback control system.

### Proven Technology

The HP 3850A uses an invisible infrared beam transmitted to a retro-prism that reflects the beam back to the instrument. By modulating the beam and comparing the phase relationship between the returned energy and an internal reference, the HP 3850A accurately determines the distance between the instrument and target.

### Two Modes of Operation

#### Transducer Mode

The Transducer Mode, activated only through a controller, operates in one of three selectable resolutions. Once the controller selects the desired resolution, the Industrial Distance Meter outputs raw distance data corresponding to the position of the target and the elapsed time between measurements. By scaling and combining the data from all three resolutions, positioning repeatability of 1 mm (.04 in.) with a maximum range of 8 km (26 240 ft.) can be obtained. The output rate is rapid enough to allow accurate velocity and acceleration computations.

#### Instrument Mode

In the Instrument Mode, the Industrial Distance Meter uses an internal microprocessor to automatically combine data from the three resolutions and converts this data to a distance. An optional controller may be used to monitor the computed distance as well as the control panel functions. In this mode, distance measurement of up to 8 km (26 240 ft.) is available in as little as nine seconds.

HP 3850A Industrial Measurement System Block Diagram

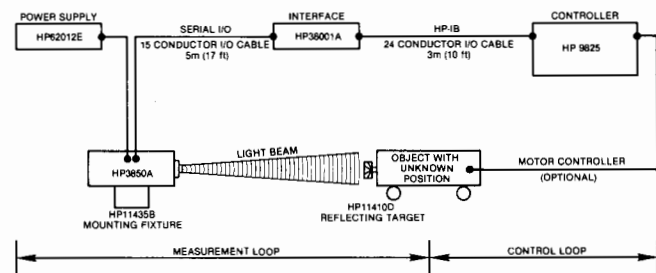

### 3850A Industrial Distance Meter Specifications

<b>Positional Accuracy (rms):</b>	$\pm(5 \text{ mm} + 1 \text{ mm/km})$ or $\pm(0.20 \text{ in} + 0.06 \text{ in/mi})$	
<b>Range:</b> With minimal heat shimmer	0.5 m–2.0 km (1.6 ft–6560 ft) to a single prism (HP 11410D) 0.5 m–8.0 km (1.6 ft–26 240 ft) to two triple prisms (HP 11411D)	
<b>Positional Repeatability (rms):</b> Average of 6 outputs at a distance less than 100 metres at a constant temperature ( $23^\circ\text{C} \pm 1^\circ\text{C}$ ) within a 24 hour interval	<b>Transducer Mode</b> High: $\pm 1 \text{ mm} (\pm 0.04 \text{ in})$	<b>Instrument Mode</b> not applicable
<b>Resolution:</b>	High: 1 mm (0.04 in) Medium: 40 mm (1.60 in) Low: 4 m (160.0 in)	Single: 1 mm (0.04 in) Repeat: 10 mm (0.4 in)
<b>Velocity Accuracy (rms):</b> Computed from successive readings	High: $\pm 0.050 \text{ m/s} (\pm 0.167 \text{ ft/sec})$	not applicable
<b>Velocity Range:</b>	High: 0–40 m/s (0–133 ft/sec) Medium: 0–1600 m/s (0–5333 ft/sec)	not applicable
<b>Data Output Rate:</b>	9 outputs/sec	1 output/9 sec (min.)



# MEASUREMENT ACCESSORIES

## AC/DC meter calibrator Model 6920B

- Calibrate/test DC ammeters up to 5 amps
- Calibrate/test average-reading AC ammeters up to 5 amps

- Calibrate/test DC voltmeters up to 1000 volts
- Calibrate/test average-reading AC voltmeters up to 1000 volts



### Description

Model 6920B is a versatile ac/dc meter calibrator, capable of both constant-voltage and constant-current output. Its absolute accuracy makes it suitable for laboratory or production testing of panel meters, multimeters, and other meters having accuracy on the order of 1.0% or higher. This calibrator has been designed for convenience, and combines in one instrument all the outputs needed to test the most commonly used meters.

#### Output Switch

The output switch has two ON positions. The ON TEST position has a momentary contact and output is obtained only while the switch is held ON. This is convenient when several full scale readings are being checked successively and the meter and calibrator are being switched through their ranges. The ON HOLD position is used when continuous output is desired.

#### AC Output Waveshape

When the function switch is set on AC, the output wave-shape is sinusoidal (to a first approximation) and has the same frequency as the input line power applied to the instrument (except when an external ac reference is used). The feedback loop, which controls and regulates this ac, is actually monitoring the average value of the ac output although the front panel controls are calibrated in terms of rms. Thus, this calibrator is suitable for use with average-reading ac voltmeters scaled in rms. In addition, the calibrator can be used with true-rms meters, provided allowance is made for the total output distortion. This distortion is approximately equal to the line input waveshape distortion (or distortion of the external ac reference) plus 3%.

### Specifications

#### Output Voltage Ranges

- 0.01-1 V: current capability 0-5 A.
- 0.1-10 V: current capability 0-1 A.
- 1-100 V: current capability 0-100 mA.
- 10-1000 V: current capability 0-10 mA.

Above output voltage ranges and maximum current capabilities for each range apply for either dc or ac operation.

#### Output Current Ranges (5 A maximum output)

- 1-100  $\mu$ A: voltage capability 0-500 V (uncalibrated in AC).
- 0.01-1 mA: voltage capability 0-500 V.
- 0.1-10 mA: voltage capability 0-500 V.
- 1-100 mA: voltage capability 0-50 V.
- 0.01-1A: voltage capability 0-5 V.

0.1-10A: (5 A max. output) voltage capability 0-0.5 V.

Above output current ranges and maximum voltage capabilities for each range apply for either dc, 50 Hz or 60 Hz operations.

**Output accuracy:** DC—0.2% of set value plus 1 digit. AC—0.4% of set value plus 1 digit (when used with average-reading meters). Above accuracy applicable over a temperature range from 15°C to 35°C, over full input voltage range, and after 1-hour warmup.

### Controls

**Function switch:** 3-positions: OFF, AC, and DC. In the OFF position the ac power input is disconnected from the unit. In the AC position the meter calibrator produces an ac output, and in the DC position the calibrator produces a dc output.

**Range switch:** 10 positions, one for each voltage and current range.

**Calibrated output control:** digital potentiometer readout control (3 significant digits) determines exact value of output.

**Output switch:** switch described at left.

**Output terminals:** two front panel terminals are provided; these are the output terminals for both ac and dc operation. In voltage ranges, the negative terminal is grounded.

**Ripple:** in dc operation the output ripple is typically less than 1.0% rms/5% p-p of the output range switch setting.

**Input:** 115 V ac  $\pm$  10%, single-phase, 58-62 Hz, 0.7 A, 65 W max. (See Options 005 and 028 for 50 Hz and 230 V ac operation).

**Operating temperature range:** 0°C-50°C; convection cooled.

**Size:** 172 H x 198 W x 279 mm D (6 $\frac{7}{8}$ " x 7 $\frac{13}{16}$ " x 11").

**Weight:** net, 6.8 kg (15 lb). Shipping 7.71 kg (17 lb).

#### Options

- 005: 50 Hz output regulation realignment
- 028: 230 V ac  $\pm$  10%, single phase input

**Price**  
N/C  
N/C

#### Accessories

- 5060-8762 Rack kit for mounting one or two 6920B's in a 19" rack \$70
- 5060-8760 Filler panel to block unused half of rack adapter \$21

**6920B Meter calibrator**

**\$1200**

# CABINETS & MEASUREMENT ACCESSORIES

679

Instrument accessories

Models 11473A-11476A, 15104A, 15115A & 15116A

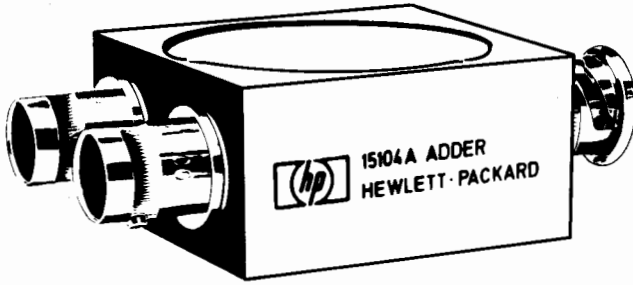

### 15104A Pulse Adder/Splitter

50 ohm delta network decouples two loads for stimulation from common source, or combines two pulse forms.

**Step Response:** 150 ps

**Reflection:**  $\leq 10\%$  with 160 ps step (bandwidth dc to 2 GHz).

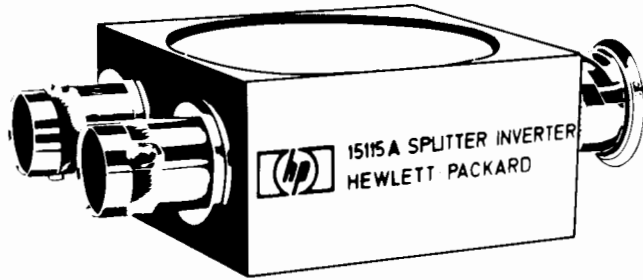

### 15115A Pulse Splitter/Inverter

50 ohm delta network splits a single input pulse in two output pulses; inverted (via transformer) and non-inverted (direct).

	Inverted	Non-inverted
<b>Step Response:</b>	400 ps	200 ps
<b>Reflection</b> (160 ps step)	$\leq 10\%$	$\leq 10\%$
<b>Drop</b> (300 ns pulse width)	$\leq 5\%$	$\leq 3\%$

Delay between inverted and non-inverted output: 1 ns

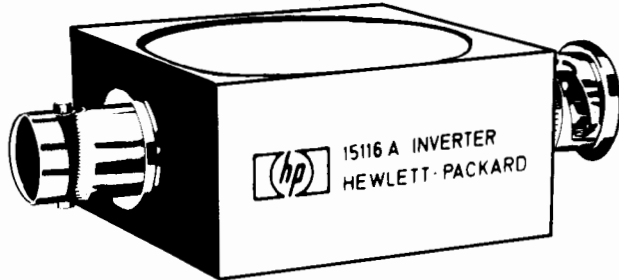

### 15116A Pulse Inverter

Transformer coupling, common ground, converts incoming pulse to opposite polarity.

**Step Response:** 400 ps

**Reflection** (200 ps step):  $\leq 10\%$

**Drop** (300 ns pulse width):  $\leq 5\%$

### Ordering Instructions

15104A Pulse Adder/Splitter

15116A Pulse Inverter

15115A Pulse Splitter/Inverter

### Price

\$75

\$140

\$140

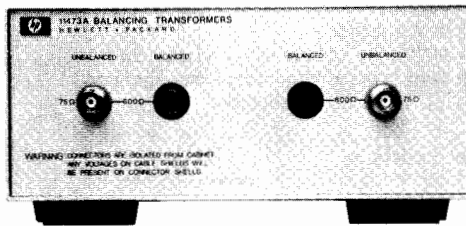

11473A

### 11473A-11476A Description

Balancing transformers provide a balanced output from a single ended input, or a single-ended output from a balanced input. Impedances available are 75 ohms unbalanced to 124 $\Omega$ , 135 $\Omega$ , 150 $\Omega$ , and 600 $\Omega$  balanced. Frequency response is  $\pm 0.5$  dB.

(Each module contains two transformers with the following specifications)

Model No.		11473A	11473B	11474A	11475A	11476A
Impedance*	Unbal	75 $\Omega$	75 $\Omega$	75 $\Omega$	75 $\Omega$	75 $\Omega$
	Bal	600 $\Omega$	600 $\Omega$	135 $\Omega$	150 $\Omega$	124 $\Omega$
Mating connectors	Unbal	BNC	BNC	BNC	BNC	BNC
	Bal	WECO 310	Siemens 9 REL; STP-6AC	WECO 241	Siemens 9 REL; STP-6AC	WECO 408A
Frequency range:		20 Hz—50 kHz	20 Hz—50 kHz	2 kHz—2 MHz	2 kHz—2 MHz	5 kHz—5 MHz
Frequency response:		$\pm 0.5$ dB	$\pm 0.5$ dB	$\pm 0.5$ dB	$\pm 0.5$ dB	$\pm 0.5$ dB
Insertion loss:		<0.75 dB at 1 kHz	<0.75 dB at 1 kHz	<0.25 dB at 50 kHz	<0.25 dB at 50 kHz	<0.25 dB at 50 kHz
Longitudinal balance:		>40 dB	>40 dB	>40 dB	>40 dB	>35 dB
Max input power:		+13 dBm	+13 dBm	+27 dBm	+27 dBm	+27 dBm
Price:		\$400	\$400	\$400	\$375	\$400

\*50 $\Omega$  unbalanced to balanced transformer available on special basis. Above specifications apply.

# MEASUREMENT ACCESSORIES

## Cables

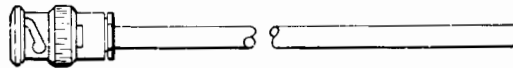

10501A: 110 cm (44 in)

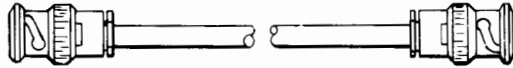

10502A L=20 cm (9 in)  
10503A L=120 cm (48 in)  
10519A L=180 cm (72 in)

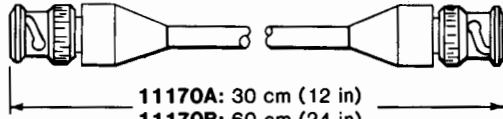

11170A: 30 cm (12 in)  
11170B: 60 cm (24 in)  
11170C: 120 cm (48 in)

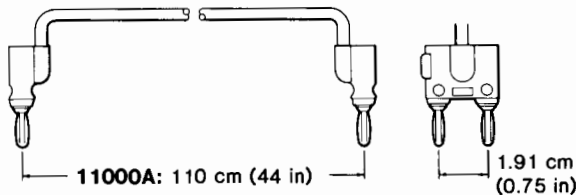

11000A: 110 cm (44 in)

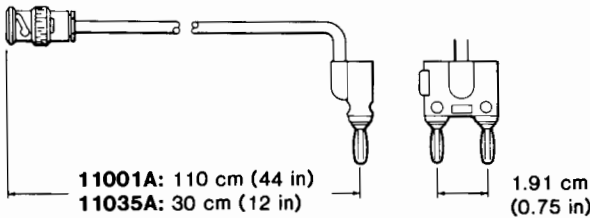

11001A: 110 cm (44 in)  
11035A: 30 cm (12 in)

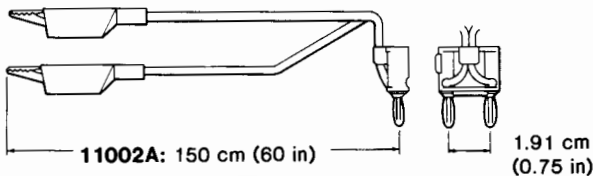

11002A: 150 cm (60 in)

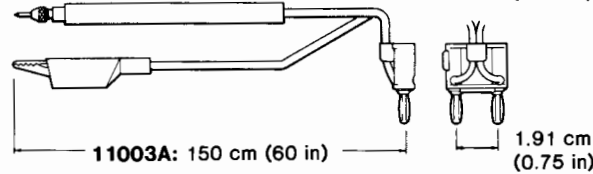

11003A: 150 cm (60 in)

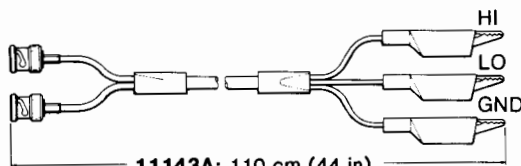

11143A: 110 cm (44 in)

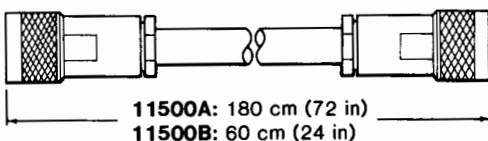

11500A: 180 cm (72 in)  
11500B: 60 cm (24 in)

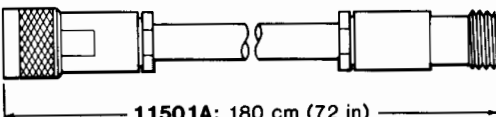

11501A: 180 cm (72 in)

### Cable Assemblies

Price

#### 10501A Cable Assembly

111.76 cm (44 in.) of 50-ohm coaxial cable terminated on one end only with UG-88C/U BNC (m) connector.

\$10

#### 10502A Cable Assembly

22.86 cm (9 in.) of 50-ohm coaxial cable terminated on both ends with UG-88C/U BNC (m) connectors.

\$15

#### 10503A Cable Assembly

121.96 cm (48 in.) of 50-ohm coaxial cable terminated on both ends with UG-88C/U BNC (m) connectors.

\$15

#### 10519A Cable Assembly

182.88 cm (72 in.) of 50-ohm coaxial cable terminated on both ends with UG-88C/U BNC (m) connectors.

\$30

#### 11170A Cable Assembly

30 cm (12 in.) of 50-ohm coaxial cable terminated on both ends with BNC (m) connectors.

\$17

#### 11170B Cable Assembly

61 cm (24 in.) of 50-ohm coaxial cable terminated on both ends with BNC (m) connectors.

\$17

#### 11170C Cable Assembly

122 cm (48 in.) of 50-ohm coaxial cable terminated on both ends with BNC (m) connectors.

\$20

#### 11000A Cable Assembly

112 cm (44 in.) of 50-ohm coaxial cable terminated on both ends with a dual banana plug, for (3/4 in.) binding posts.

\$17

#### 11001A Cable Assembly

112 cm (44 in.) of 50-ohm coaxial cable terminated on one end with a dual banana plug and on the other end with a UG-88C/U BNC (m) connector.

\$17

#### 11035A Cable Assembly

30 cm (12 in.) of 50-ohm coaxial cable terminated on one end with a dual banana plug and on the other end with a UG-88C/U BNC (m) connector.

\$17

#### 11002A Test Leads

152 cm (60 in.) test leads alligator clips to dual banana plug.

\$15

#### 11003A Test Leads

152 cm (60 in.) test leads, probe and alligator clip to dual banana plug.

\$12

#### 11143A Cable Assembly

112 cm (44 in.) test leads, dual BNC to alligator clips.

\$60

#### 11500A Cable Assembly

183 cm (72 in.) of 50-ohm coaxial cable terminated on both ends with UG-21D/U Type N (m) connectors.

\$65

#### 11500B Cable Assembly

Identical with 11500A except 61 cm (24 in.) long.

\$60

#### 11501A Cable Assembly

183 cm (72 in.) of 50-ohm coaxial cable terminated with UG-21D/U Type N (m) and UG-23D Type N (f) connectors.

\$70



1250-0077  
1250-1534  
1250-1477

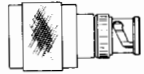

1250-0082  
1250-1533  
1250-1473

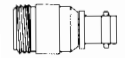

1250-1474  
1250-1536

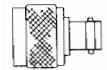

1250-0780  
1250-1535  
1250-1476

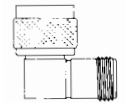

1250-0176

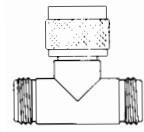

1250-0559

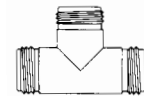

1250-0846



1250-0777  
1250-1529  
1250-1472

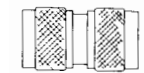

1250-0778  
1250-1528  
1250-1475

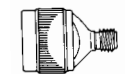

1250-1250



1250-1158



1250-1159



1250-0831



1250-1236



1250-0832

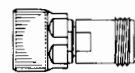

11524A



11525A



11533A

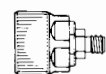

11534A



1250-0076  
1250-1286



1250-0080  
1250-1287



1250-0216  
1250-1288

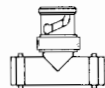

1250-0781



1250-1263

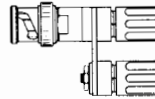

1250-1264

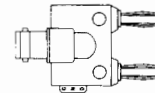

1251-2277

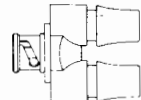

10110B

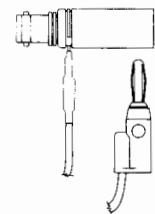

10111A

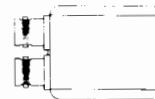

10113A

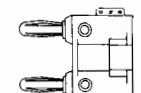

1251-2816

## Adapters Type N, Standard 50Ω

Part Number	Price
1250-0077 N (f) to BNC (m)	\$8.00
1250-0082 N (m) to BNC (m)	\$15.00
1250-0176 N (m) to N (f) right angle	\$33.00
1250-0559 N tee, (m) (f) (f)	\$21.00
1250-0777 N (f) to N (f)	\$9.75
1250-0778 N (m) to N (m)	\$9.50
1250-0780 N (m) to BNC (f)	\$9.75
1250-0846 N tee (f) (f) (f)	\$13.00
1250-1250 N (m) to SMA (f)	\$70.00

## Adapters Type N, Precision<sup>1</sup> 50Ω

Part Number	Price
1250-1472 N (f) to N (f)	\$19.00
1250-1473 N (m) to BNC (m)	\$21.00
1250-1474 N (f) to BNC (f)	\$15.50
1250-1475 N (m) to N (m)	\$28.00
1250-1476 N (m) to BNC (f)	\$22.50
1250-1477 N (f) to BNC (m)	\$19.00

## Adapters Type N, Standard 75Ω<sup>2</sup>

Part Number	Price
1250-1528 N (m) to N (m)	\$32.00
1250-1529 N (f) to N (f)	\$26.00
1250-1533 N (m) to BNC (m)	\$25.00
1250-1534 N (f) to BNC (m)	\$21.00
1250-1535 N (m) to BNC (f)	\$23.50
1250-1536 N (f) to BNC (f)	\$17.50

## Adapters SMA

Part Number	Price
1250-1158 SMA (f) to SMA (f)	\$12.00
1250-1159 SMA (m) to SMA (m)	\$14.50

## Adapters SMB, SMC

Part Number	Price
1250-0831 SMC (m) to BNC (m)	\$20.00
1250-0832 SMC (f) to BNC (f)	\$22.00
1250-1236 SMB (f) to BNC (f)	\$22.50

## Adapters APC-7®

Part Number	Price
11524A APC-7 to N (f)	\$110
11525A APC-7 to N (m)	\$120
11533A APC-7 to SMA (m)	\$160
11534A APC-7 to SMA (f)	\$160

## Adapter Banana Plug

Part Number	Price
1251-2816 Dual Banana plug	\$4.00

## Adapters BNC, Standard 50Ω

Part Number	Price
1250-0076 Right angle BNC (UG-306/D)	\$7.25
1250-0080 BNC (f) to BNC (f) (UG-914/U)	\$5.50
1250-0216 BNC (m) to BNC (m)	\$6.25
1250-0781 BNC Tee (m) (f) (f)	\$8.25
1250-1263 BNC (m) to single banana plug	\$10.00
1250-1264 BNC (m) to dual banana plug	\$21.50
1251-2277 BNC (f) to dual banana plug	\$9.50
10110B BNC (m) to dual banana plug	\$35.00
10111A BNC (f) to shielded banana plug	\$20.00
10113A Dual BNC (f) to triple banana plug	\$25.00

## Adapters BNC, Standard 75Ω<sup>3</sup>

Part Number	Price
1250-1286 Right Angle BNC	\$14.50
1250-1287 BNC (f) to BNC (f)	\$9.00
1250-1288 BNC (m) to BNC (m)	\$9.00

<sup>1</sup> "Precision": typically ≥36 dB return Loss to 1.3 GHz.

<sup>2</sup> Type N outer conductor; center pin sized for 75Ω characteristic.

<sup>3</sup> BNC outer conductor; center pin sized for 75Ω characteristic.

\* A registered trademark of the Bunker Ramo Corporation

# CABINETS: TRANSIT, OPERATING & COMBINING CASES

## Cabinet Identification

### SYSTEM I

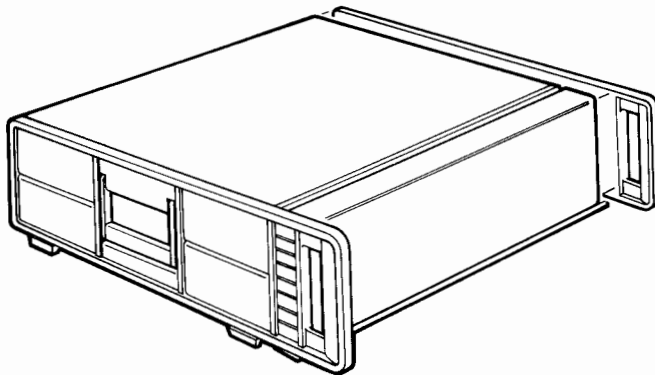

The two disassembly drawings below are for identification only. They illustrate differences between SYSTEM I and SYSTEM II cabinets (instruments come assembled from the factory).

### SYSTEM II

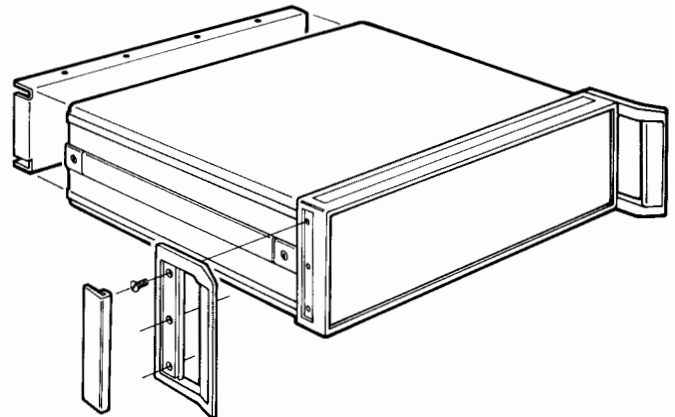

#### SYSTEM I

SYSTEM I is Hewlett Packard's first generation modular enclosure system. It offers a coordination of instrument appearance and many user conveniences which had never been offered.

#### SYSTEM II

SYSTEM II, introduced in the early 1970's superseded SYSTEM I and is now the standard package in which most Hewlett Packard instruments are being introduced. SYSTEM II is designed to address the new problems of today's electronics and to provide still more user convenience.

Compatibility of the two systems has been carefully considered. Cabinet and panel colors are coordinated and either system will stack upon the other.

#### SYSTEM DIFFERENCES

The notable difference in the two systems is that SYSTEM I has cast aluminum side frames while SYSTEM II has cast aluminum front and rear frames. The SYSTEM I side frames are secured together by sheet metal panels, while the SYSTEM II front and rear frames are secured by cast aluminum struts then enclosed in sheet metal.

Another distinguishable feature is in the front handles on the full module cabinets. SYSTEM I front handles extend straight forward, have rounded corners and are an integral part of the side frames. SYSTEM II front handles flair outwards slightly, have square corners and are separable from the cabinet.

#### PROPER ORDERING

These differences in design necessitate separate lines of accessories. When ordering, it is most important to identify your cabinet system.

For specific reasons (like disc memories, as an example) Hewlett Packard also manufactures enclosures different from either SYSTEM I or SYSTEM II. If your H.P. device enclosure is far different from those pictured here, please see the accessories listed with that device shown elsewhere in this catalog.

#### SUB-MODULE CABINETS

Hewlett Packard also uses cabinets of smaller width than the full module size. SYSTEM I design called for sub-modules to be  $\frac{1}{3}$  or  $\frac{1}{2}$  of the full module dimension. SYSTEM II, designed for miniaturized circuits, uses sub-modules of  $\frac{1}{4}$  or  $\frac{1}{2}$  of full module size. You can identify your cabinet system using the same basic concepts as outlined in "System Differences" above. It is important to do so for the accessories in each system are different and not interchangeable.

#### RACK MOUNTING

SYSTEM I and SYSTEM II products can be mounted vertically in the same rack cabinet, or stacked on one another. However, the rack mounting hardware is not interchangeable, nor can SYSTEM I and SYSTEM II sub-modules be combined in the same horizontal rack space.

SYSTEM II module size and rack mounting hole spacing meet the specifications described in EIA Standard RS-310-C for Racks, Panels and Associated Equipment.

### SYSTEM I

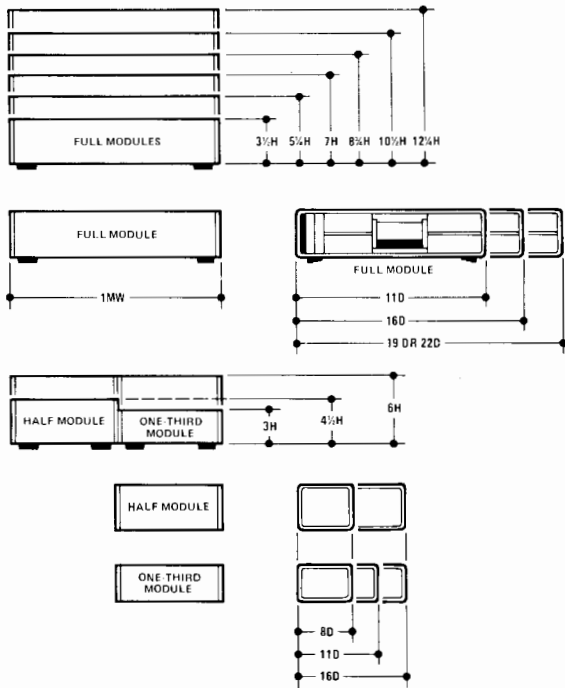

### SYSTEM II

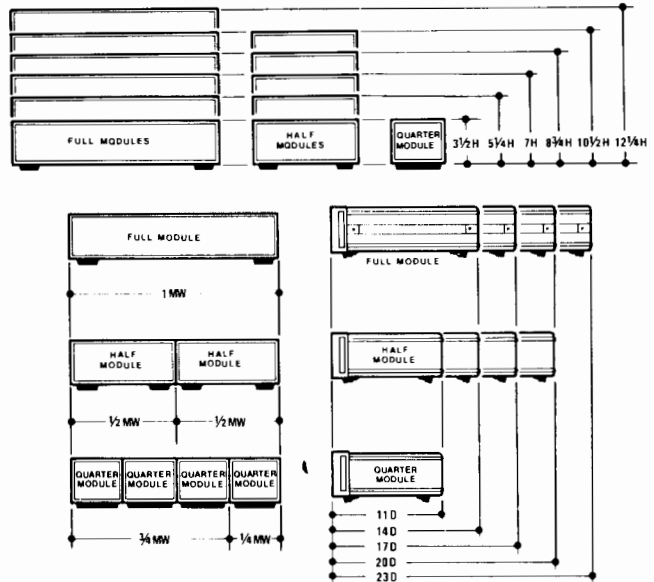

Summary of Nominal and Actual Sizes for SYSTEM I Modules				
Nominal Instrument Height <sup>1</sup>		Actual Height <sup>1</sup>		
mm	inches	mm	inches	
76	3	77.0	3.031	
89	3½	85.7	3.375	
114	4½	115.9	4.562	
133	5¼	127.8	5.031	
152	6	154.7	6.093	
178	7	172.3	6.781	
222	8¾	216.7	8.531	
267	10½	261.1	10.281	
311	12¼	306.6	12.031	
Nominal Instrument Width <sup>2</sup>		Actual Width <sup>2</sup>		
		mm	inches	
½ MW <sup>3</sup>		130.2	5.125	
½ MW		197.6	7.781	
1 MW <sup>4</sup>		425.5	16.750	
Nominal Instrument Depth <sup>4</sup>		Actual Depth		
mm	inches	mm	inches	
203	8	203.2	8.000	
279	11	279.4	11.000	
279	11	285.6	11.250 <sup>5</sup>	
406	16	406.4	16.000	
406	16	415.9	16.375 <sup>5</sup>	
483	19	492.1	19.375	
559	22	568.3	22.375	

Summary of Nominal and Actual Sizes and EIA Specifications for SYSTEM II Modules				
Nominal Instrument Height <sup>1</sup>		EIA "U" Equivalent <sup>2</sup>	Actual Front Frame Height	
mm	inches		mm	inches
89	3½	2U	88.1	3.469
133	5¼	3U	132.6	5.219
178	7	4U	177.0	6.969
222	8¾	5U	221.5	8.719
267	10½	6U	265.9	10.469
311	12¼	7U	310.4	12.219
Nominal Instrument Width			Actual Front Frame Width	
			mm	inches
¼ MW <sup>3</sup>			105.7	4.160
½ MW			212.3	8.360
¾ MW <sup>4</sup>			318.9	12.550
1 MW <sup>5</sup>			425.5	16.750
Nominal Instrument Depth <sup>4</sup>			Actual Instrument Depth	
mm	inches		mm	inches
279	11		269	10.6
356	14		345	13.6
432	17		422	16.6
508	20		498	19.6
584	23		574	22.6

<sup>1</sup>This is the nominal height only and does not include feet. Add 0.5" for cabinet height with feet.  
<sup>2</sup>Combining Cases or Rack Adapter Frames are required if a SYSTEM I cabinet, which is less than a full module width (1 MW) is to be rack mounted. See SYSTEM I accessories.  
<sup>3</sup>MW = Module Width of 425.5 mm (16.750 inch) as standard.  
<sup>4</sup>Adding SYSTEM I rack flanges extends the 1 MW dimension to the width necessary for mounting in a standard 482.6 mm (19.000 inch) rack.  
<sup>5</sup>Depth dimension includes basic instrument only; does not include protrusions such as controls, front handles, etc.  
<sup>6</sup>Full Module cabinet size

<sup>1</sup>This is the nominal front frame height only and does not include feet.  
<sup>2</sup>U = Panel Height increment. Actual panel height is equal to 44.45 x U - 0.8 mm (1.750 x U - .031 inch). See EIA RS-310-C or IEC 297-1975.  
<sup>3</sup>MW = Module Width to fit a standard 482.6 mm (19.0 inch) rack.  
<sup>4</sup>HP Products are not available in SYSTEM II cabinets ¾ MW, but this is a useful dimension to indicate front panel widths to fill.  
<sup>5</sup>Adding SYSTEM II rack flanges extends the 1 MW dimension to the width necessary for mounting in a standard 482.6 mm (19.0 inch) rack.  
<sup>6</sup>Depth dimension includes basic instrument only; does not include protrusions such as controls, front handles, etc.



# CABINETS: TRANSIT, OPERATING & COMBINING CASES

## SYSTEM II—General Accessories<sup>1</sup>

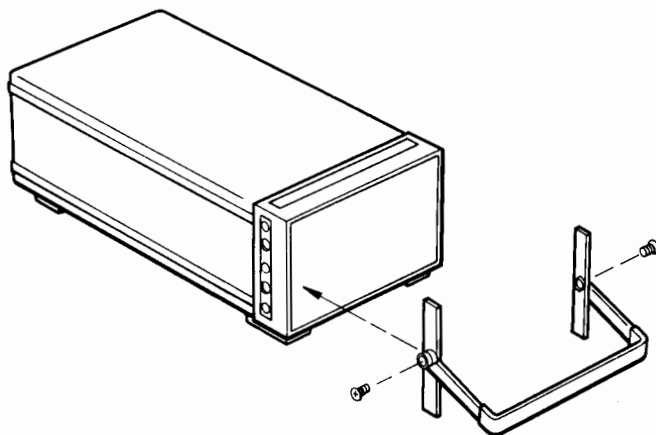

**Bail Handle Kit**

Bail Handle Kit				
½ MW (Half Module) Only	Convenient carrying handle for lightweight cabinets this high:	3½ H	5061-2001	\$25.00
		5¼ H	5061-2002	32.00
		7 H	5061-2003	39.00

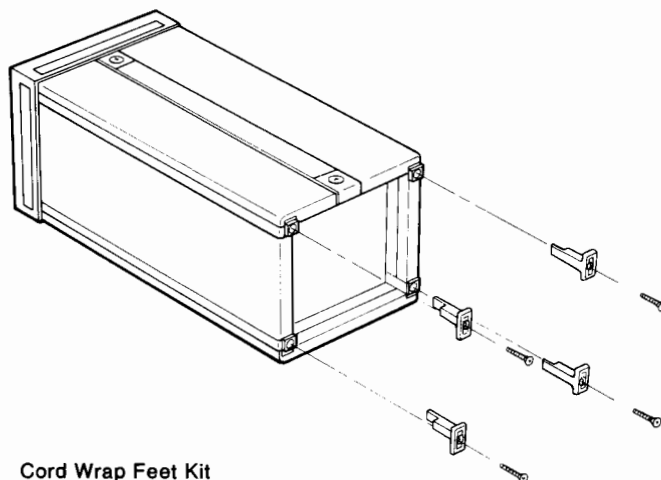

**Cord Wrap Feet Kit**

Cord Wrap Feet Kit			
Recommended for products only ¼ MW and ½ MW weighing less than 11 kg (24 lbs.)	Kit of four flanged posts which power cords or signal cables may be wrapped for transport/storage. It provides flanged cord wrap posts as a convenient way to keep power cords and signal cables with an instrument (not designed for heavy duty support; use kit 5061-2009 for such applications.)	5061-0095	\$15.50

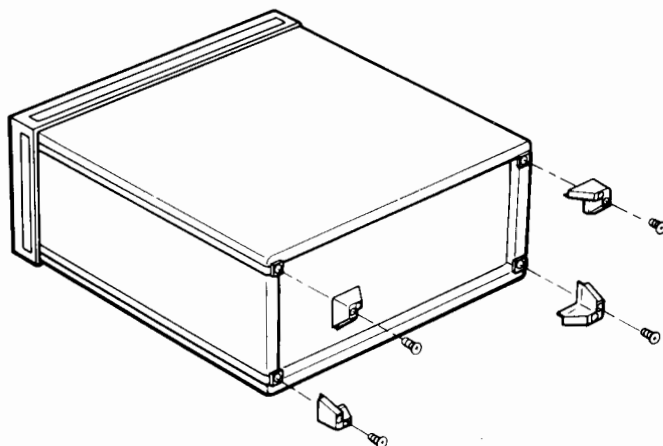

**Rear Panel Stand-Off Kit**

Rear Panel Stand-Off Kit			
For all cabinets—except does not normally fit cabinets which are ¼ MW by 3½ H.	Kit of four special feet which provide 25.4 mm (1 in.) stand-off protection to rear panel. Used when instrument is operated in vertical position, or when it is transported/stored on its rear panel.	5061-2009	\$10.00

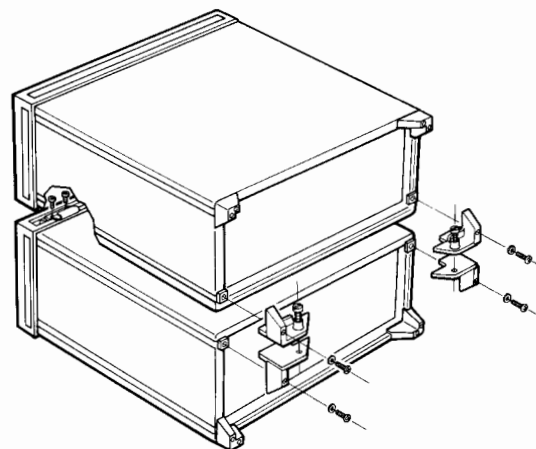

**Rear Panel Lock Foot Kit**

Full Module Cabinet Lock Foot Kit			
Combines Full Modules vertically. Used in combination with Rear Panel Standoff (5061-2009) only. Kit consists of right and left foot pairs, front lock links and fasteners—order 5061-2009 separately.		5061-0099	\$40.00

<sup>1</sup>All kits are supplied with appropriate mounting screws.

# CABINETS: TRANSIT, OPERATING & COMBINING CASES

SYSTEM II—General Accessories<sup>1</sup>

685

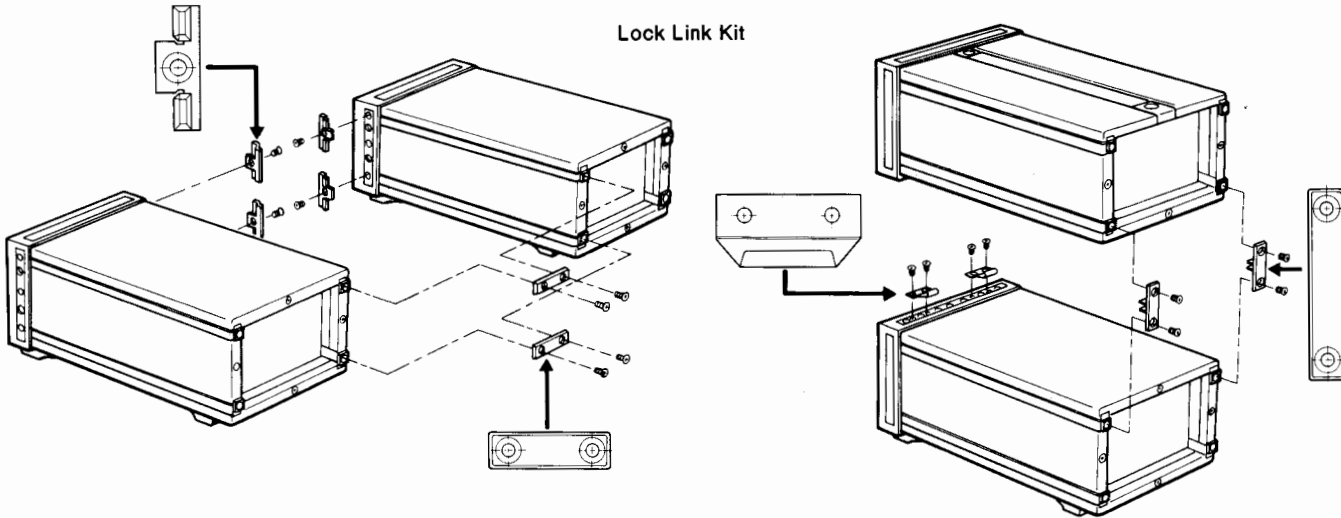

Lock Link Kit

Lock Link Kit			
For use with all subModule cabinets, provided they are of equal depth. <sup>2</sup>	Kit consists of lock hardware and screws for joining instrument cabinets in several different configurations. Enough horizontal links (12 front, 6 rear) for three side-by-side joints (up to 4 instruments), and enough vertical links (4 front, 4 rear) to form two over under joints (up to 3 instruments). <sup>2</sup>	5061-0094	\$42.00

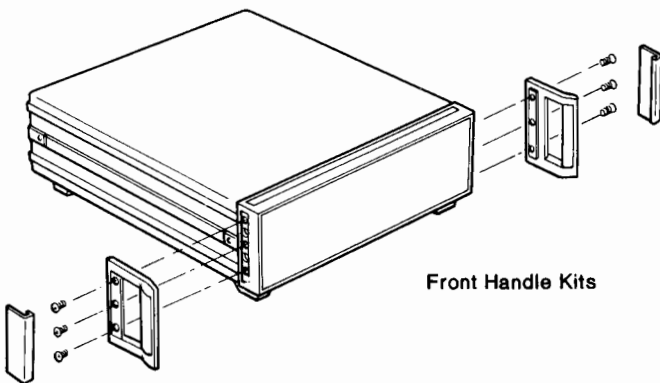

Front Handle Kits

Front Handle Kit				
For use with all cabinets—but principle use if on 1 MW (Full Module) cabinets, or on sub-Module cabinets locked together to form width of 1 MW.	Kit includes two front handles to fit on each side of front panel frames, for cabinets this high:	3½ H	5061-0088	\$28.00
		5¼ H	5061-0089	32.00
		7 H	5061-0090	40.00
		8¾ H	5061-0091	72.50
		10½ H	5061-0092	80.00
		12¼ H	5061-0093	85.00
Will be shipped with instrument, if ordered as Option 907 at same time. Otherwise available separately per Part Numbers listed at right.				

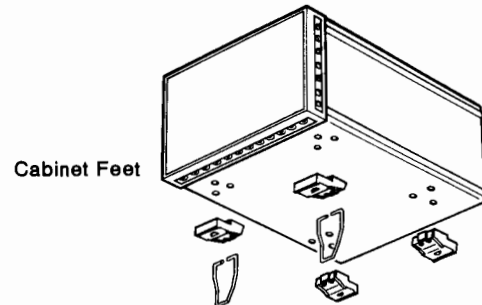

Cabinet Feet

Full and Half Module Cabinet Feet		
Standard foot (1): fits bottom of 1 MW and ½ MW cabinets (requires 2 front, 2 rear).	5040-7201	\$2.00 ea.
Tilt stand (1): fits onto standard foot and is used in pairs (front or rear).	1460-1345	\$2.00 ea.
Non-skid foot (1): used (in pairs) in lieu of standard rear or front foot, to minimize bench-top creeping instrument. (Some lighter-weight products are supplied with this type foot on rear.)	5040-7222	\$3.00 ea.

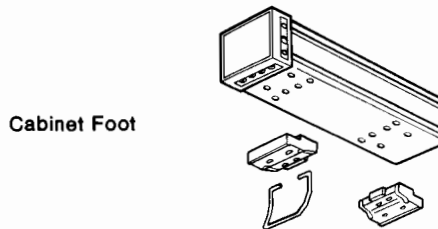

Cabinet Foot

Quarter Module Cabinet Foot		
Standard foot (1): fits bottom of ¼ MW cabinet (requires 1 in front, 1 in rear).	5040-7205	\$3.00 ea.
Tilt stand (1): fits onto ¼ MW standard foot (only 1 used, for front or rear).	1460-1369	\$2.50 ea.

<sup>1</sup>All kits are supplied with appropriate mounting screws.

<sup>2</sup>Locking cabinets together horizontally in a configuration wider than 1 MW (Full-Module) is not recommended.



# CABINETS: TRANSIT, OPERATING & COMBINING CASES

## SYSTEM II—Rack Mounting Accessories<sup>1</sup>

For full Module Cabinets

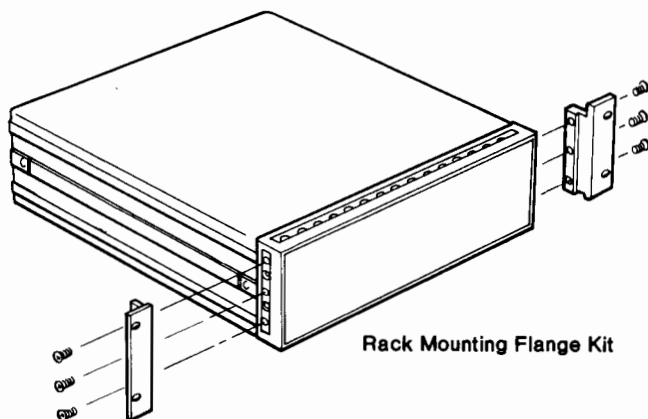

Rack Mounting Flange Kit

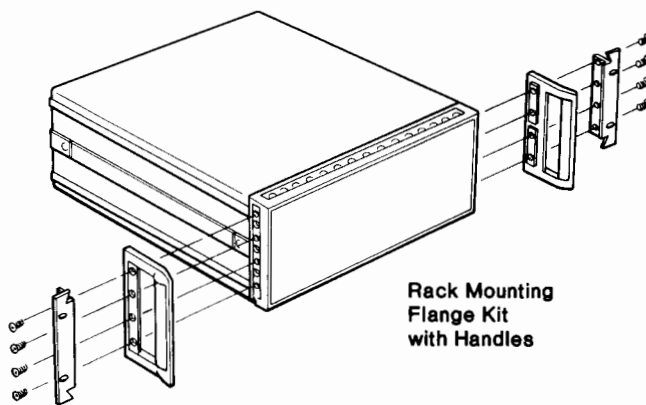

Rack Mounting Flange Kit with Handles

Rack Mounting Flange Kit				
Will be shipped with instrument, if ordered as Option 908 at same time. Otherwise available separately per Part Numbers listed at right.  <b>Note:</b> 5061-0074 has 1.75" hole spacing and is the standard flange. 5061-0076 has 3.00" hole spacing and is a special flange.	Kit includes two rack flanges to fit on each side of front panel	3½ H	5061-0074	\$20.00
		3½ H	5061-0076	30.00
		5¼ H	5061-0077	25.00
		7 H	5061-0078	30.00
		8¾ H	5061-0079	35.00
		10½ H	5061-0080	40.00
		12¼ H	5061-0081	45.00

Rack Mounting Flange Kits with Handles				
Combination kit. Will be shipped with instrument, if ordered as Option 909 at same time. Otherwise available separately as Part Numbers listed at right. <b>Note:</b> 5061-0075 has 1.75" hole spacing and is the standard flange. 5061-0082 has 3.00" hole spacing and is a special flange.	Kit includes two rack flange/front handle combinations to fit one each side of front panel frame, for cabinets this high:	3½ H	5061-0075	\$ 41.00
		3½ H	5061-0082	57.50
		5¼ H	5061-0083	55.00
		7 H	5061-0084	65.00
		8¾ H	5061-0085	97.50
		10½ H	5061-0086	120.00
		12¼ H	5061-0087	130.00

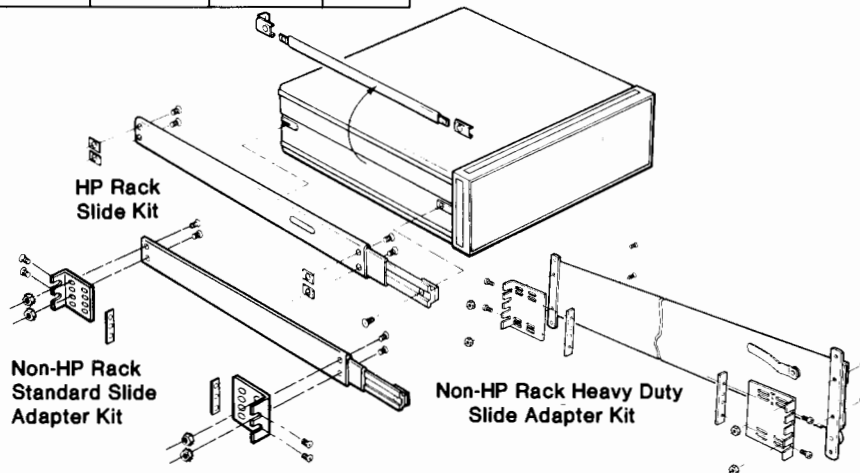

Standard slides fit full module cabinets for installation in HP rack enclosures. Adapter brackets for non-HP rack enclosures are also available.				
Standard slide kit for HP rack enclosures	Kit includes two standard slides for installing instrument weighing no more than 38.6 kg (85 lb.) into HP rack enclosures. Fit side handle recess on S-II cabinets this deep:	14D & 17D 20D & 23D	1494-0018 1494-0017	\$45.00 45.00
Standard tilt kit for HP rack enclosures	Same as standard slide above, plus permits tilting instruments up or down 90° Fit: side handle recess on S-11 cabinets this deep:	14D & 17D 20D & 23D	1494-0025 1494-0026	\$95.00 95.00
Slide adapter bracket kit for standard slides	Includes brackets for adapting the standard slides above for use in most non-HP rack system enclosures of adequate depth.		1494-0023	\$20.00
Heavy duty slide kit for HP rack enclosures.	Includes two heavy-duty slides for installing instrument weighing no more than 79.6 kg (175 lb.) into HP rack enclosures. Fit side handle recess on S-II cabinets this deep:	20D & 23D	1494-0016	\$115.00
Slide adapter bracket kit for heavy duty slides	Includes brackets for adapting the heavy-duty slide above for use in most non-HP rack system enclosures of adequate depth.		1494-0042	\$40.00

# System II—Rack Mounting Accessories<sup>1</sup>



## For Sub Module Cabinets

Rack flange kit<sup>1</sup> May be used whenever S-II cabinets ¼ MW and/or ½ MW are combined to a full width of 1 MW (Full Module) See 1 MW Page 686

Rack flanges & front handle combination kit<sup>2</sup> May be used whenever S-II cabinets ¼ MW and/or ½ MW are combined to a full width of 1 MW (Full Module) See 1 MW Page 686

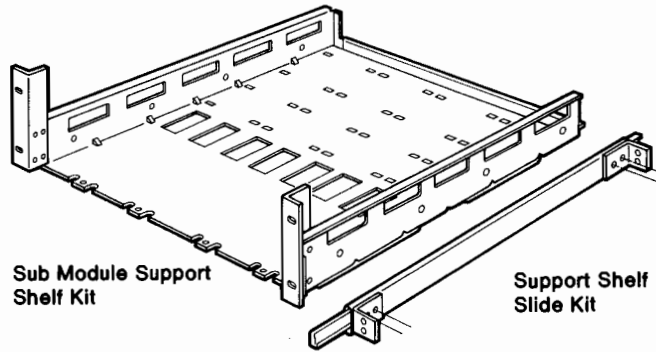
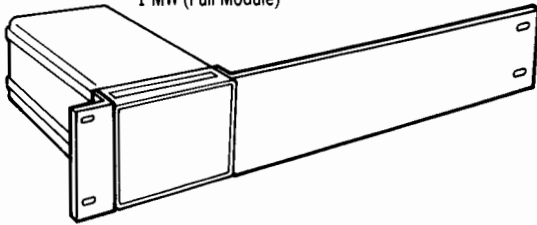

Sub Module Support Shelf Kit

Support Shelf Slide Kit

### Rack Mounting Adapter Kit<sup>2</sup>

Kit includes one rack flange and one extension adapter ¾ MW. For mounting one S-II cabinet ¼ MW, having a height 3½ H.	3½ H	5061-0073	\$57.50
--	------	-----------	---------

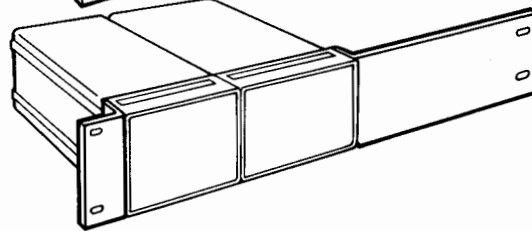
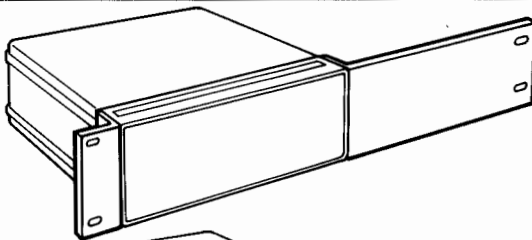

### Rack Mounting Adapter Kit<sup>2</sup>

Kits include one rack flange and one extension adapter ½ MW. For mounting one S-II cabinet ½ MW or two cabinets ¼ MW, having these heights:	3½ H	5061-0072	\$50.00
	5¼ H	5061-0057	45.00
	7 H	5061-0060	55.00
	10½ H	5061-0066	65.00

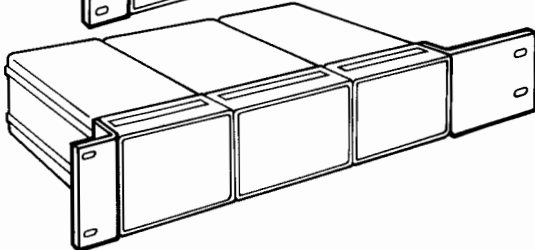
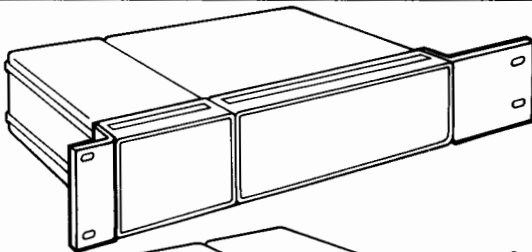

### Rack Mounting Adapter Kit<sup>2</sup>

Kits include one rack flange and one extension adapter ¼ MW. For mounting one S-II cabinet ½ MW together with one cabinet ¼ MW, or for mounting three cabinets ¼ MW together, having these heights:	3½ H	5061-0071 <sup>3</sup>	\$42.00
	5¼ H	5061-0058 <sup>3</sup>	41.00
	7 H	5061-0061 <sup>3</sup>	50.00
	10½ H	5061-0067 <sup>3</sup>	65.00

### Support Shelves and Slide Kits

Support Shelf for mounting one or more S-II cabinets which are ½ MW or ¼ MW, and up to 20 D. Cabinet depths need not be equal, but heights must match support shelf height, except where top filler panels are used. Maximum shelf projection behind front mounting panel is 534 mm (21 in.). Maximum combined instrument weight is 22.7 kg (50 lb.)	3½ H	5061-0096	\$190.00
	5¼ H	5061-0097	210.00
	7 H	5061-0098	230.00
Slide Kit includes two slides for slide-mounting any of the above three support shelves in HP rack enclosures. Shelf can easily be removed from rack.		1494-0041	125.00

Top Filler Panel

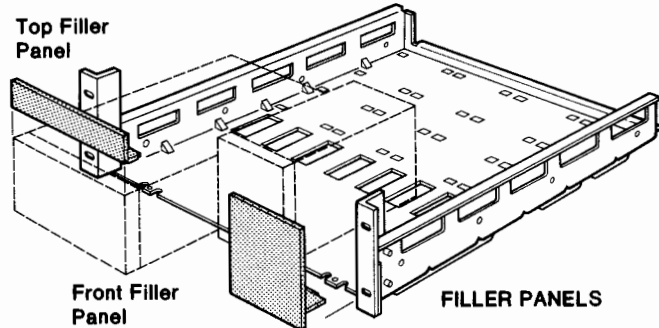

Front Filler Panel

FILLER PANELS

### Support Shelf Filler Panels

For 3½ H support shelf partially filled with S-II instruments, and having the following front panel space to fill:	¼ MW to fill	5061-2021	\$35.00
	½ MW to fill	5061-2022	37.00
	¾ MW to fill	5061-2023	42.00
For 5¼ H support shelf, and having the following front panel space to fill:	¼ MW to fill	5061-2024	\$36.00
	½ MW to fill	5061-2025	38.00
	¾ MW to fill	5061-2026	46.00
For 7 H support shelf, and having the following front panel space to fill:	¼ MW to fill	5061-2066	\$39.00
	½ MW to fill	5061-2027	40.00
For ¼ MW and having the following vertical space to fill:	1¾ H	5061-2035	\$37.00
	3½ H	5061-2036	37.00
For ½ MW and having the following vertical space to fill:	1¾ H	5061-2037	\$38.00
	3½ H	5061-2038	39.00

**Note:** Mounting hole patterns conform to EIA Standard RS-310-C for Racks, Panels, and Associated Equipment and the equivalent IEC standard

<sup>1</sup>All kits are supplied with appropriate mounting screws.

<sup>2</sup>Cabinet lock-together kit (5061-0094) is also required whenever two, three or four sub-modules (¼ MW and/or ½ MW) are to be joined in a configuration using Rack mounting adapters or Rack flanges. Also, sub-modules must be of equal depth.

<sup>3</sup>Requires two kits if one cabinet ½ MW is to be center-mounted.

**Notice:** SYSTEM II accessories will not fit SYSTEM I Cabinets. See Page 682.

# CABINETS; TRANSIT, OPERATING & COMBINING CASES

Rugged protection for instruments

Modular instrument transit cases

Typical cushion  
full size (425.5 mm) module

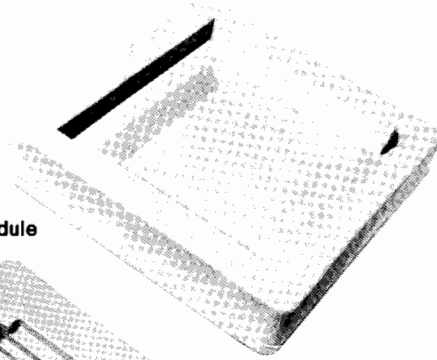
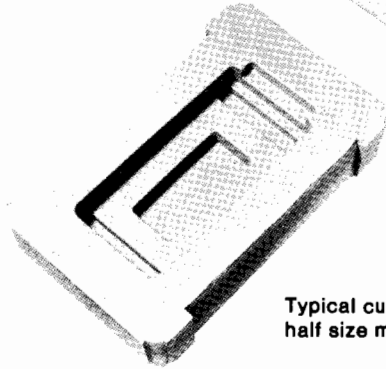

Typical cushion  
half size module (197.8 mm wide)

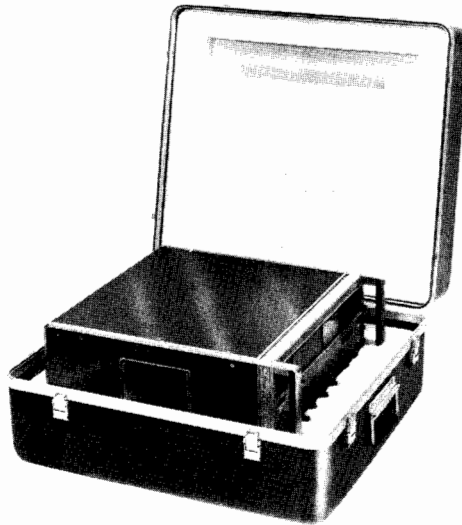

Typical System I transit case

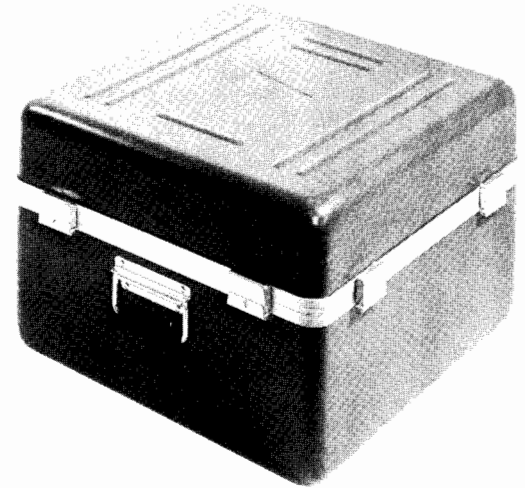

V = Valise Style

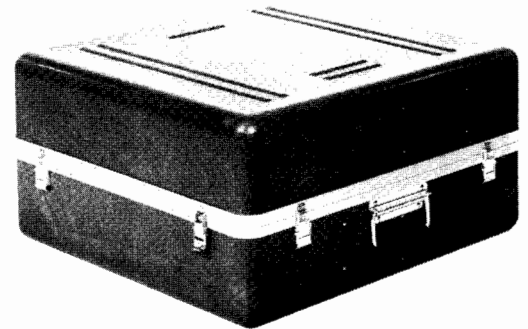

S = Split Style

## Transit Case Styles

The HP transit cases are rugged protective outer shells for use when instruments must be frequently transported and used away from laboratory conditions. They are molded of strong fiberglass-reinforced plastic. All are sealed tightly with O-ring gaskets and clamping latches. They are rainproof under the test conditions of MIL-STD-108. Carrying handles are conveniently placed, fold flat when not in use.

Transit cases are typically provided with foam cushions, custom formed to fit the standard HP modular cabinets. This arrangement provides maximum protection against damage from handling, dropping, or crushing. A selection of case sizes is available to accommodate nearly any instrument and combination of accessories.

## Transit Cases - System I

Instrument Size (inches)			Instrument Size (mm)			Case Size* (inches) Not including hardware			Case size (mm) Not including hardware			Style	Shipping Weight		HP Part Number	Price
H	W	D	H	W	D	L	W	D	L	W	D		Lbs.	kg		
*3½	16¾	13¼	88.1	425.5	336.6	20½	17½	9	520.7	444.5	228.6	V	15	68	9211-1288	\$270
5¼	16¾	13¼	132.6	425.5	336.6	20½	17½	10¼	520.7	444.5	273.1	V	16	73	9211-1289	\$280
7	16¾	13¼	177.0	425.5	336.6	20½	17½	12½	520.7	444.5	317.5	V	17	77	9211-1290	\$280
8¾	16¾	13¼	221.5	425.5	336.6	20½	17½	14¼	520.7	444.5	362.0	S	18	82	9211-1291	\$300
3½	16¾	18¾	88.1	425.5	466.7	23	21	9	584.2	533.4	228.6	V	18	82	9211-1292	\$290
5¼	16¾	18¾	132.6	425.5	466.7	23	21	10¼	584.2	533.4	273.1	V	19	86	9211-0839	\$300
7	16¾	18¾	177.0	425.5	466.7	23	21	12½	584.2	533.4	317.5	V	20	91	9211-1293	\$310
8¾	16¾	18¾	221.5	425.5	466.7	23	21	14¼	584.2	533.4	362.0	V	21	95	9211-1294	\$310
10½	16¾	18¾	265.9	425.5	466.7	23	21	16	584.2	533.4	406.4	S	22	100	9211-1295	\$320
12¼	16¾	18¾	310.4	425.5	466.7	23	21	17¾	584.2	533.4	450.9	S	22	100	9211-1313	\$330
5¼	16¾	21¾	132.6	425.5	542.9	25½	23½	10¼	647.7	596.9	273.1	V	24	110	9211-1296	\$320
7	16¾	21¾	177.0	425.5	542.9	25½	23½	12½	647.7	596.9	317.5	V	24	110	9211-1735	\$330
12¼	16¾	24¾	310.4	425.5	542.9	24	19	29¾	609.6	482.6	755.7	S	32	150	9211-1297	\$380
6½	5¼	8	165.1	130.2	203.2	14¼	9	11¼	362.0	228.6	285.8	V	8	36	9211-1317	\$240
6½	5¼	11	165.1	130.2	279.4	16¼	10¼	11¼	428.6	263.5	285.8	V	11	50	9211-1318	\$245
6½	7¾	8	165.1	196.9	203.2	16¼	10¼	11¼	428.6	263.5	285.8	V	11	50	9211-1316	\$245
6½	7¾	11	165.1	196.9	279.4	16¼	10¼	11¼	428.6	263.5	285.8	V	11	50	9211-1315	\$245
6½	7¾	16	165.1	196.9	406.4	20½	12½	11¼	520.7	317.5	285.8	V	15	68	9211-1734	\$270
6½	10½	11	165.1	266.7	279.4	16½	14½	8½	419.1	368.3	215.9	V	12	55	9211-1895	\$250

**Full-Module Width Instruments**

**Transit Cases-System II:**

Appropriate Front Handle Kit (HP Part Number 5061-0088 to -0093) must be installed on instruments for adequate protection.

**Dimensions in inches and mm**

Instrument size						Case size* (not including hardware)						Style	HP Part Number	Price			
in	H	mm	in	W	mm	in	D	mm	in	L	mm				in	W	mm
3½	88.1	16½	425.5	13¾	349.3	23	584.2	21	533.4	8¾	222.3	V	9211-2642	\$310			
5¼	132.6	16¾	425.5	13¾	349.3	23	584.2	21	533.4	10½	266.7	V	9211-2643	\$320			
7	177.0	16¾	425.5	13¾	349.3	23	584.2	21	533.4	12¼	311.2	V	9211-2644	\$330			
8¾	221.5	16¾	425.5	13¾	349.3	23	584.2	21	533.4	14	355.6	V	9211-2645	\$350			
10½	265.9	16¾	425.5	13¾	349.3	23	584.2	21	533.4	15¾	400.1	S	9211-2646	\$360			
12¼	310.4	16¾	425.5	13¾	349.3	23	584.2	21	533.4	17½	444.5	S	9211-2647	\$380			
3½	88.1	16¾	425.5	16¾	425.5	24½	622.3	24½	622.3	8¾	222.3	V	9211-2648	\$330			
5¼	132.6	16¾	425.5	16¾	425.5	24½	622.3	24½	622.3	10½	266.7	V	9211-2649	\$350			
7	177.0	16¾	425.5	16¾	425.5	24½	622.3	24½	622.3	12¼	311.2	V	9211-2650	\$380			
8¾	221.5	16¾	425.5	16¾	425.5	24½	622.3	24½	622.3	14	355.6	S	9211-2651	\$380			
10½	265.9	16¾	425.5	16¾	425.5	24½	622.3	24½	622.3	15¾	400.1	S	9211-2652	\$400			
12¼	310.4	16¾	425.5	16¾	425.5	28	711.2	24	609.6	17½	444.5	S	9211-2653	\$430			
3½	88.1	16¾	425.5	19¾	501.7	28	711.2	24	609.6	8¾	222.3	V	9211-2654	\$350			
5¼	132.6	16¾	425.5	19¾	501.7	28	711.2	24	609.6	10½	266.7	V	9211-2655	\$380			
7	177.0	16¾	425.5	19¾	501.7	28	711.2	24	609.6	12¼	311.2	V	9211-2656	\$390			
8¾	221.5	16¾	425.5	19¾	501.7	28	711.2	24	609.6	14	355.6	S	9211-2657	\$400			
10½	265.9	16¾	425.5	19¾	501.7	28	711.2	24	609.6	15¾	400.1	S	9211-2658	\$420			
12¼	310.4	16¾	425.5	19¾	501.7	28	711.2	24	609.6	17½	444.5	S	9211-2659	\$430			
3½	88.1	16¾	425.5	22¾	577.9	30½	774.7	24½	622.3	8¾	222.3	V	9211-2660	\$380			
5¼	132.6	16¾	425.5	22¾	577.9	30½	774.7	24½	622.3	10½	266.7	V	9211-2661	\$390			
7	177.0	16¾	425.5	22¾	577.9	30½	774.7	24½	622.3	12¼	311.2	S	9211-2662	\$410			
8¾	221.5	16¾	425.5	22¾	577.9	30½	774.7	26¼	666.8	14	355.6	S	9211-2663	\$440			
10½	265.9	16¾	425.5	22¾	577.9	30½	774.7	26¼	666.8	15¾	400.1	S	9211-2664	\$450			
12¼	310.4	16¾	425.5	22¾	577.9	30½	774.7	26¼	666.8	17½	444.5	S	9211-2665	\$470			

\*For overpack size to hold case add 1¼", 31.8 mm, to L & W and 1¼", 6.4 mm to D.

**Half-and Quarter-module Width Instruments**

**Transit Cases-System II:**

**Dimensions in inches and mm**

Instrument size						Case size* (not including hardware)						Style	HP Part Number	Price			
in	H	mm	in	W	mm	in	D	mm	in	L	mm				in	W	mm
3½	88.1	8¾	204.2	10¾	273.1	14¾	377.8	13¾	349.3	7½	190.5	v	9211-2666	\$250			
5¼	132.6	8¾	204.2	10¾	273.1	14¾	377.8	13¾	349.3	9¾	235.0	v	9211-2667	\$250			
7	177.0	8¾	204.2	10¾	273.1	14¾	377.8	13¾	349.3	11	279.4	v	9211-2668	\$250			
8¾	221.5	8¾	204.2	10¾	273.1	14¾	377.8	13¾	349.3	12¾	323.9	v	9211-2669	\$260			
10½	265.9	8¾	204.2	10¾	273.1	14¾	377.8	13¾	349.3	14½	368.3	v	9211-2670	\$260			
3½	88.1	8¾	204.2	13¾	349.3	20	508.0	13¾	342.9	7½	190.5	v	9211-2671	\$260			
5¼	132.6	8¾	204.2	13¾	349.3	20	508.0	13¾	342.9	9¾	235.0	v	9211-2672	\$260			
7	177.0	8¾	204.2	13¾	349.3	20	508.0	13¾	342.9	9¾	235.0	v	9211-2673	\$260			
8¾	221.5	8¾	204.2	13¾	349.3	20	508.0	13¾	342.9	12¾	323.9	v	9211-2674	\$270			
10½	265.9	8¾	204.2	13¾	349.3	20	508.0	13¾	342.9	14½	368.3	v	9211-2675	\$280			
3½	88.1	8¾	204.2	16¾	425.5	20	508.0	13¾	342.9	7½	190.5	v	9211-2676	\$260			
5¼	132.6	8¾	204.2	16¾	425.5	20	508.0	13¾	342.9	9¾	235.0	v	9211-2677	\$260			
7	177.0	8¾	204.2	16¾	425.5	20	508.0	13¾	342.9	11	279.4	v	9211-2678	\$270			
8¾	221.5	8¾	204.2	16¾	425.5	20	508.0	13¾	342.9	12¾	323.9	v	9211-2679	\$270			
10½	265.9	8¾	204.2	16¾	425.5	20	508.0	13¾	342.9	14½	368.3	v	9211-2680	\$280			
3½	88.1	8¾	204.2	19¾	501.7	24¼	616.0	13	330.2	7½	190.5	v	9211-2681	\$260			
5¼	132.6	8¾	204.2	19¾	501.7	24¼	616.0	13	330.2	9¾	235.0	v	9211-2682	\$270			
7	177.0	8¾	204.2	19¾	501.7	24¼	616.0	13	330.2	11	279.4	v	9211-2683	\$280			
8¾	221.5	8¾	204.2	19¾	501.7	24¼	616.0	13	330.2	12¾	323.9	v	9211-2684	\$300			
10½	265.9	8¾	204.2	19¾	501.7	24¼	616.0	13	330.2	14½	368.3	v	9211-2685	\$310			
3½	88.1	4¾	104.8	10¾	273.1	14	355.6	10	254.0	6½	165.1	v	9211-2686	\$240			
5¼	132.6	4¾	104.8	10¾	273.1	14	355.6	10	254.0	8¼	209.6	v	9211-2687	\$245			
7	177.0	4¾	104.8	10¾	273.1	14	355.6	10	254.0	10	254.0	v	9211-2688	\$250			
3½	88.1	4¾	104.8	13¾	349.3	16¾	428.6	10½	266.7	6½	165.1	v	9211-2689	\$245			
5¼	132.6	4¾	104.8	13¾	349.3	16¾	428.6	10½	266.7	8¼	209.6	v	9211-2690	\$250			
7	177.0	4¾	104.8	13¾	349.3	16¾	428.6	10½	266.7	10	254.0	v	9211-2691	\$250			
3½	88.1	4¾	104.8	16¾	425.5	20¼	514.4	11¾	298.5	6½	165.1	v	9211-2692	\$250			
5¼	132.6	4¾	104.8	16¾	425.5	20¼	514.4	11¾	298.5	8¼	209.6	v	9211-2693	\$250			
7	177.0	4¾	104.8	16¾	425.5	20¼	514.4	11¾	298.5	10	254.0	v	9211-2694	\$260			

\*For overpack size to hold case add 1¼", 31.8 mm, to L & W and ¼", 6.4 mm to D.

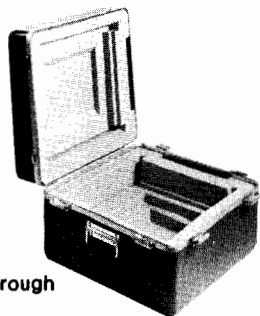

Cases for other size instruments or special applications are available through HP Service Center

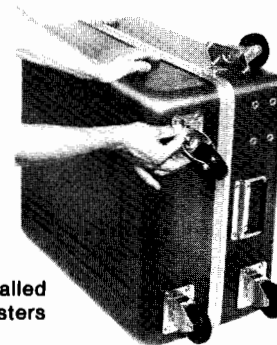

Caster kit 1490-0913 can be field installed to provide (4) 3½" diameter swivel casters mounted with quarter turn fasteners

# CABINETS; TRANSIT, OPERATING & COMBINING CASES

Operating Cases: rugged protection for instruments

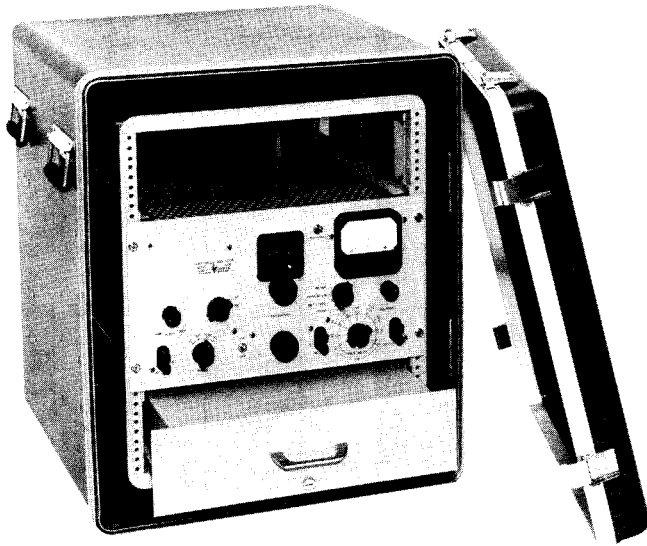

Operating Case with instrument and drawer.

HP cases are rugged protective outer shells for use when instruments must be frequently transported and used away from laboratory conditions. They are molded of strong fiberglass and have conveniently placed carrying handles that fold flat when not in use. All are sealed tightly with O-ring gaskets and clamping latches and are rain-proof under the test conditions of MIL-STD-108.

Operating cases are equipped internally with shock-mounted frames that accept any standard 19-inch rack-mounting instruments up to the maximum height of the frames. This arrangement offers the convenience of operation without removing the instrument from its carrying case. At the same time, environmental protection is afforded.

More than one instrument may be combined in a single operating case for convenience in setting up and operating. Patch-cable interconnections may then be left in place within the case, so that when the unit has been transported to its place of use the covers are removed and the instruments inside are ready to put into use with a minimum of delay.

Drawers are available in three different heights so that small accessories, tools, etc., can be kept inside the case with the instruments. Fitted foam cushions can be made up to accommodate nearly any shape articles.

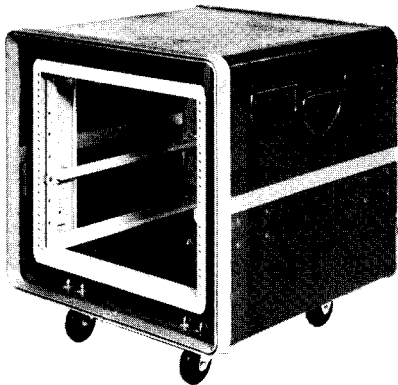

A caster kit is available to fit the operating case allowing it to become a mobile rack. Once the kit is installed, the casters themselves may be attached or removed in seconds. With casters removed, the attaching hardware adds nothing to the overall dimensions of the case.

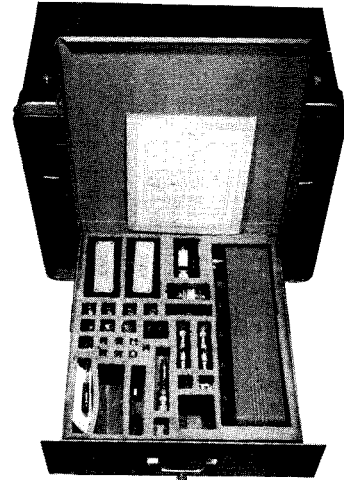

Fitted foam drawer cushions to accommodate various HP accessory combinations are available.

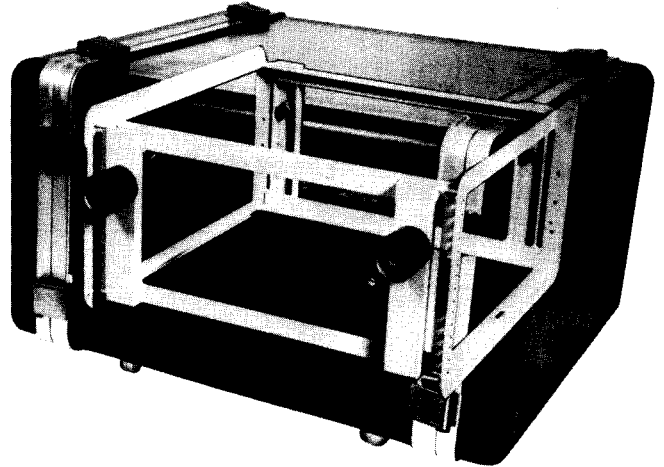

Equipped with elastomeric shock mounts, these enclosures provide outstanding shock and vibration attenuation. A set of standard shock mounts can be provided for any equipment weight and fragility.

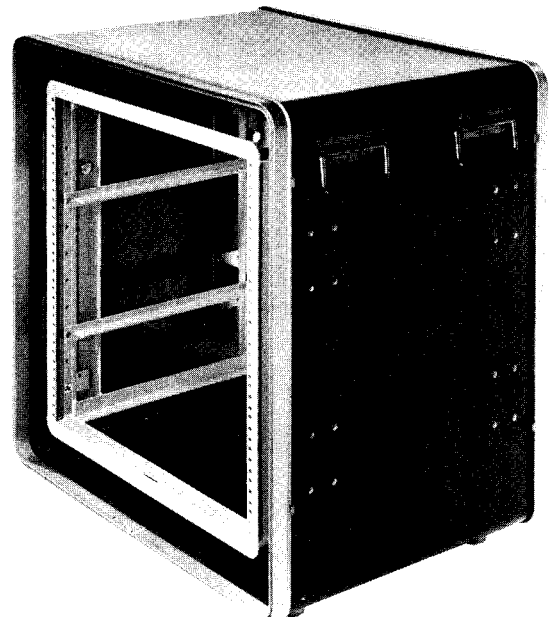

Operating Case showing T-Bars installed.

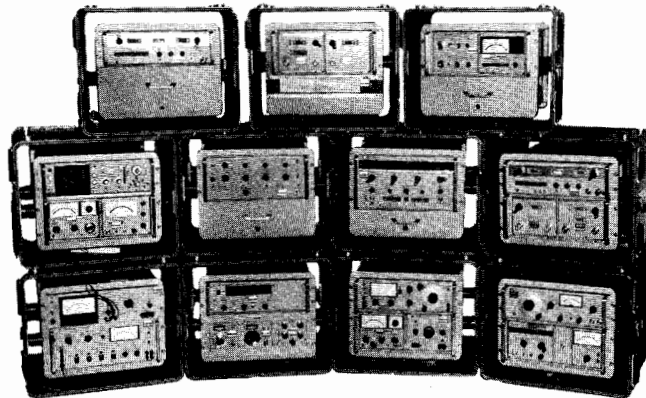

Nominal rack ht. in	ISO	Instrument Weight				Case Size (inches)			Case Size (mm)			Weight				HP Part Number	Price
		Maximum lb	Maximum kg	Minimum lb	Minimum kg	Not including hardware			Not including hardware			Case		Shipping			
						W	H	D	W	H	D	lb	kg	lb	kg		
5¼	3U	75	34.0	20	9.1	24.0	10.8	28.5	609.6	274.3	723.9	40	18.1	50	28.7	9211-1302	\$975
8¾	5U	75	34.0	20	9.1	24.0	15.2	27.0	609.6	381.0	685.8	46	20.9	56	25.4	9211-1303	\$1,050
10½	6U	130	59.0	30	13.6	24.0	17.0	28.5	609.6	431.8	723.9	53	24.0	64	29.0	9211-2635	\$1,200
12¼	7U	100	45.4	25	11.3	24.0	18.9	28.5	609.6	480.1	723.9	55	24.9	65	29.5	9211-1163	\$1,250
14	8U	130	59.0	30	13.6	24.0	20.6	28.5	609.6	523.2	723.9	57	25.9	70	37.8	9211-1241	\$1,300
15¾	9U	130	59.0	30	13.6	24.0	22.4	28.5	609.6	569.0	723.9	60	27.2	75	34.0	9211-1242	\$1,400
17½	10U	130	59.0	30	13.6	24.0	24.1	28.5	609.6	612.1	723.9	64	29.0	80	36.3	9211-1243	\$1,400
19¼	11U	130	59.0	30	13.6	24.0	25.9	28.5	609.6	657.9	723.9	69	31.3	85	38.6	9211-1244	\$1,450
21	13U	250	113.4	50	22.7	24.0	28.1	28.5	609.6	711.2	723.9	75	34.0	90	40.8	9211-1245	\$1,500
22¾	14U	250	113.4	50	22.7	24.0	29.75	28.5	609.6	749.3	723.9	77	34.9	95	43.1	9211-2636	\$1,550
24½	15U	250	113.4	50	22.7	24.0	31.0	28.5	609.6	787.4	723.9	80	36.3	100	45.4	9211-1911	\$1,600
26¼	16U	250	113.4	50	22.7	24.0	33.1	28.5	609.6	782.3	723.9	83	37.6	105	47.6	9211-2637	\$1,600
28	17U	250	113.4	50	22.7	24.0	35.1	28.5	609.6	876.3	723.9	87	39.5	110	49.9	9211-2638	\$1,650
29¾	18U	250	113.4	50	22.7	24.0	36.4	28.5	609.6	924.6	723.9	90	40.8	115	52.2	9211-2639	\$1,700
31½	19U	250	113.4	50	22.7	24.0	37.6	28.5	609.6	965.2	723.9	94	42.6	120	54.4	9211-2640	\$1,700
33¼	20U	250	113.4	50	22.7	24.0	39.9	28.5	609.6	995.7	723.9	97	44.0	125	56.7	9211-1713	\$1,750
47¼	21U	320	145.2	70	31.8	24.0	53.9	28.5	609.6	1369.1	723.9	140	63.5	175	79.4	9211-2641	\$2,800

### Standard & Special Order Features

Inner rack frame with provision for infinitely adjustable T-bar instrument support brackets. Supplied

Inner rack frame with RETMA hole pattern drilled in rear rails. Supplied

Mating feet for stacking one case on top of another. Special color other than tan. Please specify. Supplied

Modified inner rack frame depth. Standard depth 20" from front panel mounting surface to rear surface of frame. This option includes an appropriate change in the overall depth of the enclosure. Please specify desired inner frame depth. Maximum 23", minimum 12". N/C

Chassis trak C-300 instrument slide pair to mount on either side of inner frame using RETMA hole pattern drilled in front and rear rails. \$60

Special shock mounts for unusual instrument weights. Please specify weights. \$10

Increased front cover depth. Maximum depth 6". Please specify. \$40

Increased rear cover depth. Maximum depth 6". Please specify. \$40

Latches recessed into the surface of the case. \$75

Handles recessed into the surface of the case. \$20

Hermetically sealed case tested by the hot water method. \$35

MIL-C-4150 certification with the exception of design and preproduction testing. Case will have increased wall thickness, hardware anodized to military \$70

specification, and will be hermetically tested using the hot water method.

Addition of an automatic pressure relief valve. \$20

Addition of a manual pressure relief valve. \$10

Addition of four permanently mounted, 3½" diameter swivel casters. \$40

Addition of four removable, 3½" diameter swivel casters. Also available in kit form P/N 1490-0913. \$55

Addition of two aluminum hat-section skids to the case bottom. \$30

Addition of lift rings to either side of the case. \$15

### Accessories

**9211-1164** 3½ H (88.1 mm) Drawer with ball bearing slides. \$270

**9211-1165** 5¼ H (132.6 mm) Drawer with ball bearing slides. \$320

**9211-1166** 7 H (177 mm) Drawer with ball bearing slides. \$300

**0950-0122** AC power receptacle strip with four outlets mounted on bottom rear of inner rack frame. Power cord 1 m (3.3') long, NEMA connectors. \$26

**9211-1173** Pair T-Bar instrument support brackets. \$25

**1490-0913** Caster kit, four removable 3½" (88.9 mm) swivel casters. \$130

On special order, complete transportable field instrument groups can be assembled to suit individual requirements. On request, cases can be fabricated that meet the environmental requirements of Military Specifications.



# CABINETS: TRANSIT, OPERATING & COMBINING CASES

## SYSTEM I—Rack Hardware and Accessories

1051A

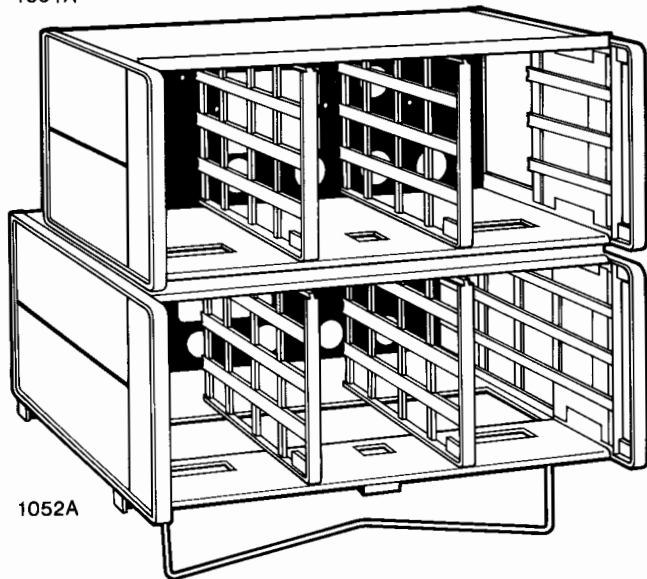

1052A

### Combining Cases, 1051A, 1052A

Models 1051A and 1052A combining cases conveniently rack or bench mount combinations of small modular Hewlett-Packard SYSTEM-I instruments. In addition, these cases can be stacked on each other or on any full module instrument. Both cases accept 1/8 or 1/2 instrument modules, 130mm or 198 mm wide (5 1/8 or 7 7/8 inches). The basic difference is that the 1052A is 130 mm (5 1/8") deeper, and will accept modules up to 416mm deep (16 3/8"). The extra depth provides more space in the rear for wiring. The 1051A accepts instruments up to 286mm deep (11 1/4"). Each case is furnished with two dividers.

#### 1051A, 1052A Specifications

Size	Price
1051A: 178 H x 482.6 W x 337 mm D (7"x19"x13 1/4").	\$390.00
1052A: 178 H x 482.6 W x 467 mm D (7"x19"x18 3/8").	415.00
<b>Weight</b>	
1051A: net, 4.5 kg (10 lb); shipping, 6.7 kg (15 lb)	
1052A: net, 5.4 kg (12 lb); shipping, 8.1 kg (18 lb)	
<b>Opt 908: Rack Mount Kit</b>	22.50
<b>Opt 910: Extra Manual</b>	1.00

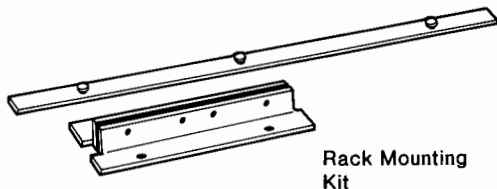

### Rack Mounting Kits, 5060-8739 to 5060-8744

With these kits all Hewlett-Packard products in full rack-width cabinets of the integral side frame-handle style (see 1051A, 1052A, Combining Cases above) can be easily prepared for rack mounting. Each kit contains two flanges, a filler strip, and mounting screws.

#### Rack Mounting Kit Ordering Information

Part Number	Nominal Cabinet Height		Price
	Millimetres	Inches	
5060-8739	88.1	3 1/2	\$25.00
5060-8740	132.6	5 1/4	22.00
5060-8741*	177	7	22.50
5060-8742	221.5	8 3/4	27.00
5060-8743	265.9	10 1/2	31.00
5060-8744	310.4	12 1/4	32.00

\* Also used to rack mount Combining Kits 1051A & 1052A shown above.

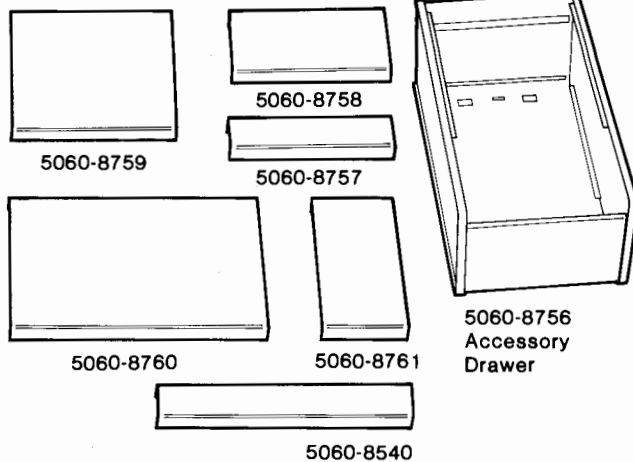

### Filler Panels, 5060-8757 to 5060-8761

Filler panels can be used to close off any leftover space after instruments are mounted in combining cases or adapter frames. Panels are made in a variety of widths and heights. Available widths are 1/8, 1/4, and 1/2 modules; heights are 1/4, 1/2 and the full 155 mm (6 3/8").

#### Specifications, Filler Panels

Part No.	Module Case Height x Width	Dimensions		Price
		Millimetres	Inches	
5060-8540	1/4 x 1/2	38 x 198	1 1/2 x 7 7/8	\$23.50
5060-8757	1/4 x 1/2	38 x 130	1 1/2 x 5 1/8	26.00
5060-8758	1/2 x 1/2	77 x 130	3 1/2 x 5 1/8	14.00
5060-8759	full x 1/2	155 x 130	6 3/8 x 5 1/8	22.50
5060-8760	full x 1/2	155 x 198	6 3/8 x 7 7/8	21.50
5060-8761	full x 1/8	155 x 63	6 3/8 x 2 3/16	27.00

Price  
\$95.00

#### Accessory Drawer, 5060-8756

The accessory drawer can be used in place of a 1/8 width filler panel to finish off unused space in the HP 1051A and 1052A Combining Cases. Size: 77 H x 130.2 W x 279.4 D (3 1/8" x 5 1/8" x 11")

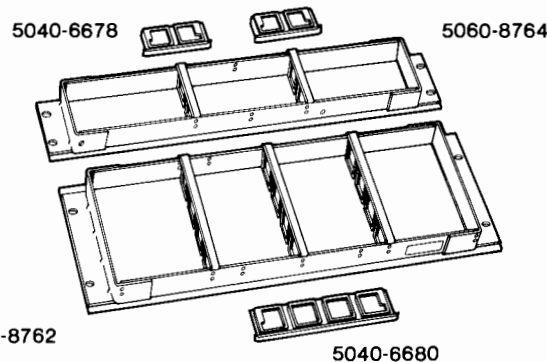

5060-8762

5040-6680

### Rack Adapter Frames, 5060-8762, 5060-8764

These Frames can be used to hold combinations of 1/8 and 1/2 module-width HP instruments. Each frame is furnished with mounting hardware and dividers. Two models are available for different instrument heights. Adapter frames are for permanent or semipermanent rack mounting. Where quick removal and reinstallation of instruments is desirable, the 1015A and 10152A should be used.

Note: Instruments in full rack-width cabinets can be rack mounted with kits described above; they do not require rack adapter frames.

Part Number	For Frame	Price
5060-8762: equivalent to EIA 4U (7" H), accepts instrument heights of 38, 77, or 155 mm (1 1/2", 3 1/8", or 6 3/8")	5060-8764	\$72.50
5060-8764: accepts only instrument heights of 38 or 77 mm (1 1/2" or 3 1/8") EIA 2U narrow	5060-8762	\$110.00

#### Extra Divider Panels

Part Number	For Frame	Price
5040-6678	5060-8764	\$10.00
5040-6680	5060-8762	5.75

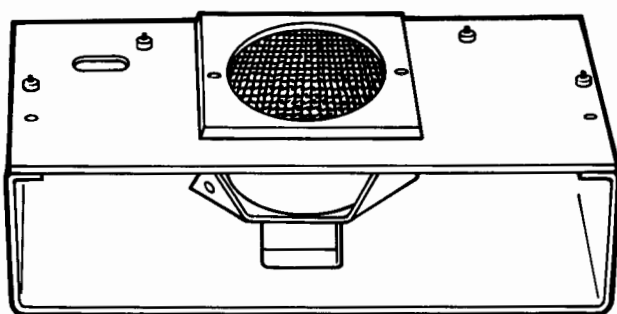

### Cooling Kits, 5060-0789 and 5060-0796

These cooling kits are designed to be easily installed in the 1052A Combining Case. They can be installed in the 1051A, at the factory upon special request, but installation in the shorter case limits the depth of instruments the case can accept, and makes it impossible to use the accessory drawer.

	Price
<b>5060-0789:</b> 115 V, 50 to 60 Hz	<b>\$460.00</b>
<b>5060-0796:</b> 230 V, 50 to 60 Hz	<b>450.00</b>

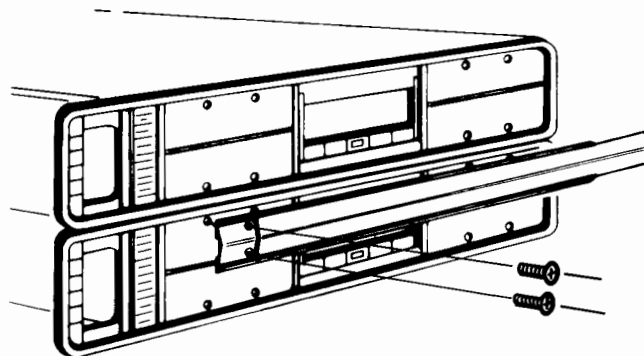

### Joining Bracket Kits, 5060-8541 to 5060-8545

These kits join HP SYSTEM I instruments of the same width and length into easily handled single stacks. Each kit consists of two brackets, mounting hardware and trim. They are available to fit the three most common instrument depths:

	Price
<b>5060-8541:</b> 279 mm (11") EIA panel depth	<b>\$110.00</b>
<b>5060-8543:</b> 406 mm (16") EIA panel depth	<b>87.50</b>
<b>5060-8545:</b> 480 mm (19") EIA panel depth	<b>160.00</b>

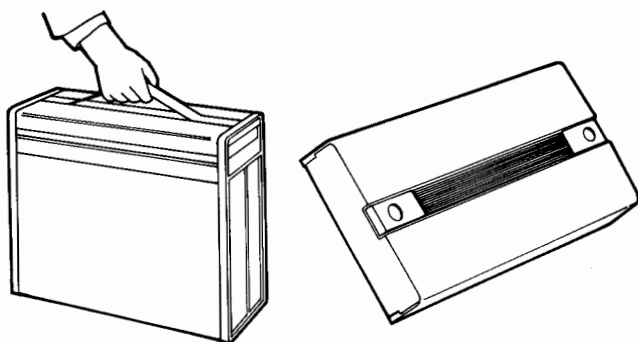

### Control Panel Covers, 5060-8766 to 5060-8771

A series of control panel covers equipped with carrying handles are available for full rack width instruments. These covers protect instrument front panels and make rack mounted instruments tamper-proof.

One of these covers, the 5060-8768, fits both the 1051A and the 1052A Combining Case (page 692). Other covers are available to fit the six modular enclosures with front panel heights ranging from 88.1 to 310.4 mm (3½ to 12¼"). Cover locks securely to front handles.

	Price
<b>5060-8766:</b> 88.1 mm (3½") EIA panel height	<b>\$200.00</b>
<b>5060-8767:</b> 132.6 mm (5¼") EIA panel height	<b>170.00</b>
<b>5060-8768:</b> 177 mm (7") EIA panel height	<b>195.00</b>
<b>5060-8769:</b> 221.5 mm (8¾") EIA panel height	<b>220.00</b>
<b>5060-8770:</b> 265.9 mm (10½") EIA panel height	<b>220.00</b>
<b>5060-8771:</b> 310.4 mm (12¼") EIA panel height	<b>300.00</b>

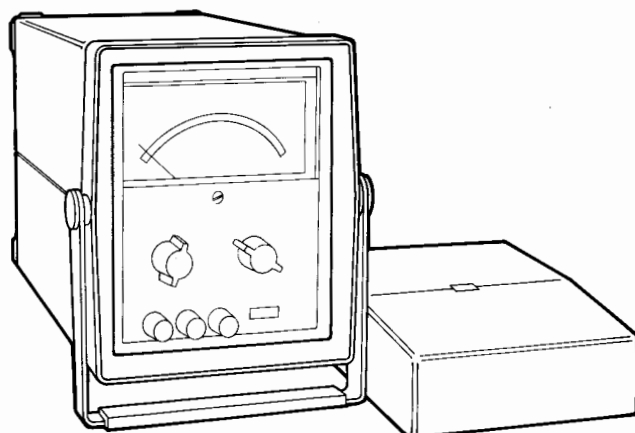

### Module Instrument Cases, 11075A, 11076A

Rugged, high impact plastic instrument cases for HP ½ module instruments. Instruments can be operated, stored or carried in this splashproof case. Storage compartment for power cord in rear of case is accessible through a removable hatch. Front lid contains adequate storage space for cables, test leads, etc. The dual purpose tilt stand also serves as a carrying case handle. 11075A is 203 mm D (8"); 11076A is 279 mm (11") D.

	Price
<b>11075A:</b> Module Instrument Case	<b>\$145.00</b>
<b>11076A:</b> Module Instrument Case	<b>135.00</b>

#### RACK MOUNTING

SYSTEM I and SYSTEM II products can be mounted vertically in the same rack cabinet, or stacked on one another. However, the rack mounting hardware is not interchangeable, nor can SYSTEM I and SYSTEM II sub-modules be combined in the same horizontal rack space.

SYSTEM II module size and rack mounting hole spacing meet the specifications described in EIA Standard RS-310-C for Racks, Panels, and Associated Equipment.

# SOLID STATE COMPONENTS

## Optoelectronics

Hewlett-Packard Optoelectronic Components offer exceptional performance in consumer, industrial, military and OEM equipment. With sophisticated semiconductor processing equipment and the industry's most extensive hybrid thin-film microcircuit manufacturing facilities, Hewlett-Packard applies newly developed technologies to component manufacturing. This results in high performance solid state numeric and alphanumeric readouts, display systems, plus LED lamps, fiber optics, emitter/detector systems, PIN photodiodes and optocouplers.

### Fiber Optics

Fiber optics has emerged as a practical, cost-effective technology for data communications. Pulses of light travel down hair-thin fibers replacing electrical signals transmitted over copper wire. The light signals are impervious to electrical or magnetic interference and therefore generate no electrical or magnetic noise. This makes them ideal for linking computers or control devices and their peripherals in different environments such as those found in factories, aircraft, hospitals and large power plants.

Elements of the HP System include modular optical transmitters and receivers, single fiber optical connectors, and compatible optical fiber cables.

Currently, Hewlett-Packard's fiber optic system is fully specified and guaranteed for transmitting any pattern of digital information, from dc to 10 Mbaud, up to 1000 metres.

### Emitters/Detectors

As the growing trend continues for microprocessor systems capable of high-resolution-mechanical to electronic-interfaces, Hewlett-Packard addresses an unfulfilled need with the high resolution optical reflective sensor. This sensor is the only such device on the market designed to scan color bar codes, and will find application in optical inspection, facsimile sensing, pattern recognition, edge sensing and tachometry.

Utilizing this device, Hewlett-Packard has produced its first Digital Bar Code Wand which can scan black-and-white bar codes and convert the codes to microprocessor-recognizable digital output. The Wand can be manufactured in custom colors with desired logos.

In addition to the complete emitter/detector system described in the optical scanner above, Hewlett-Packard also offers the designer the choice of discrete emitter and detector components. High radiant intensity emitters near-IR in both floodlight and spotlight configurations are ideally suited for use in optical transducers and encoders, smoke detectors, and fiber optic drivers.

### PIN Photodiodes

Hewlett-Packard PIN photodiodes are excellent light detectors with an exceptionally fast response of  $10\text{ns}$ , wide spectral response from near infrared to ultra-violet, and wide range linearity (constant efficiency over 6 decades of amplitude). With dark current as low as  $250\text{ pA}$  at  $10\text{ V}$ , these detectors are es-

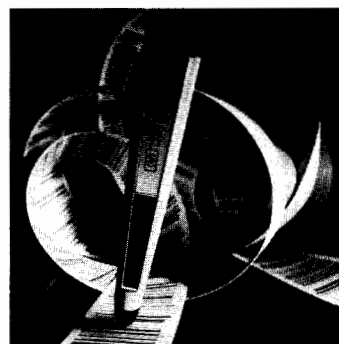

Digital Bar Code Wand

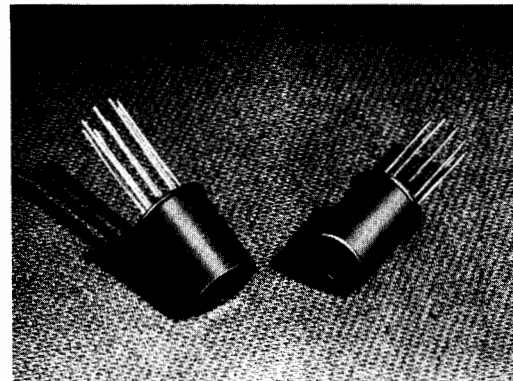

High Resolution Optical Sensor

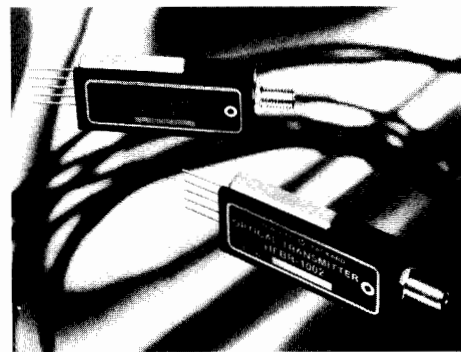

1 km Digital Fiber Optic Transmitter

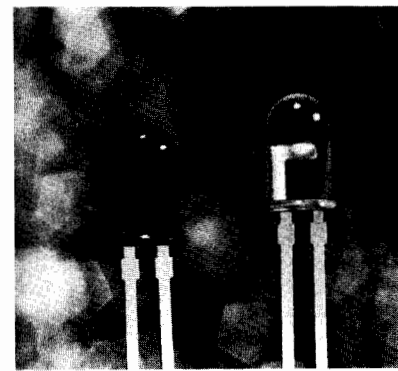

5-V and 12-V Resistor Lamps

pecially well-suited for operation at low light levels. The device construction allows high speed operation at reverse voltages of 5 volts. Some applications include fiber optic receivers, laser scanners, range finders, and medical diagnostic equipment. High reliability test programs are also available.

### Solid State Displays

Hewlett-Packard has expanded its selection of both alphanumeric and seven-segment numeric displays to satisfy an even broader base of applications:

Hewlett-Packard's completely supported alphanumeric display systems allow freedom from costly display maintenance, require

very low operating power, and minimize the interaction normally required for alphanumeric displays. The display systems are TTL compatible, require a single 5 V supply, and easily interface to a keyboard or microprocessor. They are ideally suited for word processing equipment, instrumentation, desktop calculators, and automatic banking terminal applications.

Hewlett-Packard's yellow alphanumeric display is the answer to applications that require small size and prohibit the use of red displays. Both red and yellow alphanumeric displays feature four  $5 \times 7$  dot matrix characters and on-board shift registers for data storage. They are contained in 16-pin DIPs which are end-stackable for unlimited possibilities in alphanumeric display formatting.

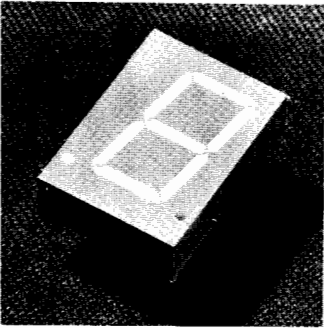

20.32 mm (0.8") LED display

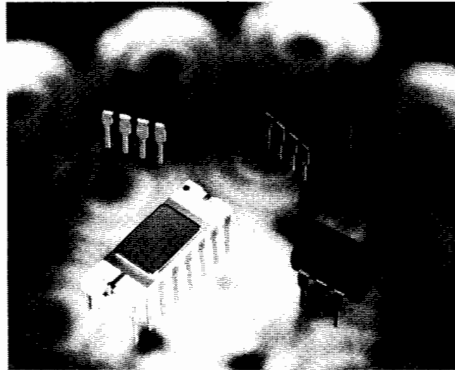

Full-Range Optocoupler Line

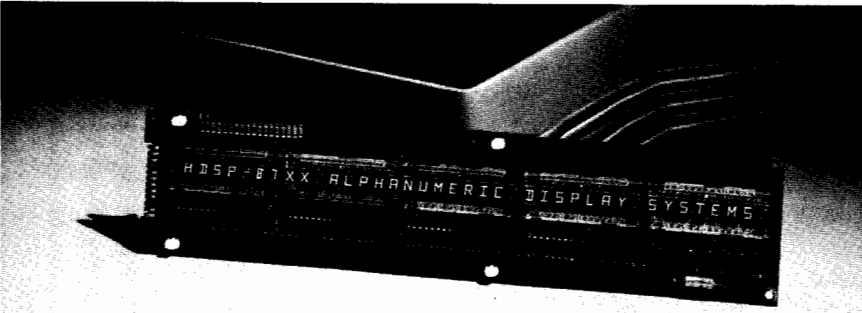

18-Segment Alphanumeric Display System

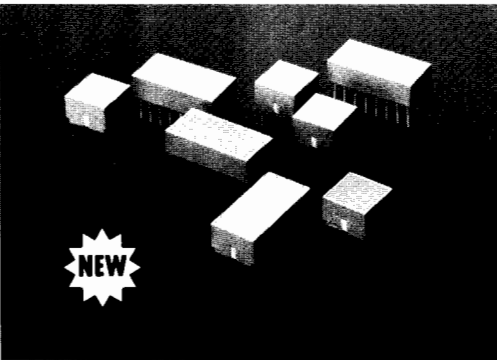

Light Bar Modules

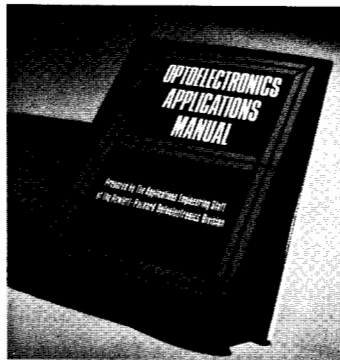

HPBK-1000

Available in four- and eight-character end-stackable modules are Hewlett-Packard's 18-segment solid state LED alphanumeric displays. Magnification of the LED by an integral lens results in a character size of 3.8mm (0.15 in.) making these displays ideal for use in computer peripheral products, automotive instrument panels, calculators and systems requiring low power consumption.

Low cost numeric displays, packaged single or clustered, are available in character heights from 0.11" to 0.8". Low power small character displays have been designed for portable instrumentation and calculator applications. Other seven-segment display units are available in red, yellow, and green colors for use in instrumentation, point of sale terminals, and TV indicator applications. High power, sunlight viewable, large character displays are readily adapted to outdoor terminals, gas pumps and agricultural instrumentation. For these displays, Hewlett-Packard has successfully integrated a gray package design with untinted segments. This

results in excellent bright ambient contrast enhancement.

Integrated numeric and hexadecimal displays (with on-board IC's), available in plastic and hermetic packages, solve the designer's decoding/driving problem. These displays have been designed for low cost and ease of application in a wide range of environments.

### Solid State Lamps

Light Emitting Diode Light Bar Modules are Hewlett-Packard's answer to the problem of how to effectively backlight legends. The Light Bar's large, uniformly illuminated surface provides a bright light source available in either high efficiency red, yellow, or green. The universal pin-out arrangement allows connecting in parallel, series, or series/parallel configurations. Hewlett-Packard's Light Bar Modules come in four sizes, are available in single, twin, and quad arrangements, are X-Y stackable, and flush mounting is easy and convenient.

Besides the new Light Bar Modules, Hewlett-Packard LED lamps are available in a wide variety of plastic and hermetic packages to satisfy almost any application. Many styles can be mounted on a front panel using clips and all are suitable for P.C. board mounting. Hewlett-Packard military screened hermetic lamps are very popular in applications demanding hi-reliability.

Products with wide or narrow viewing angles, and a range of brightnesses, are available in red, high efficiency red, yellow and green. Package styles include the traditional T-1-3/4, T-1, and TO-18 packages, as well as our own subminiature (stackable on 2.54mm [0.100 in.] centers), rectangular, and panel mountable hermetic packages.

### Optocouplers

Hewlett-Packard's family of optocouplers provide economical, high performance solutions to problems caused by ground loops and induced common mode noise for both analog and digital applications in commercial, industrial, and military products.

Hewlett-Packard's original approach toward integrated output detectors provides performance not found in conventional phototransistor output optocouplers. With 3000 VDC isolation, the types of optocouplers available include high speed devices capable of 10M bits and high gain devices which are specified at 400% CTR at input currents as low as 0.5mA. In addition, highly linear optocouplers are useful in analog applications, and a Hewlett-Packard integrated input optically coupled line receiver can be connected directly to twisted pair wires without additional circuitry. Most of these devices are available in dual versions, as well as in hermetic DIP packages. For military users, Hewlett-Packard's established hi-rel capability facilitates economical, hi-rel purchases.

HP's new AC/DC to logic interface optocoupler contains an input IC for threshold detection processing electrical signals *before* they are passed onto the LED's. This reduces a user's external component count for sensing an AC or DC power signal and coupling it into a microprocessor unit.

### Write for More Information

Hewlett-Packard Optoelectronic capabilities are described in data sheets and application notes and bulletins. All literature, prices, product availability and information can be obtained from any Hewlett-Packard Sales Office or franchised distributor.

### Optoelectronic Designer's Catalog:

This contains detailed, up-to-date information on our complete optoelectronic product line. Included in the 496 pages are application notes, product photographs, specifications, operating characteristics and performance graphs. This catalog is free.

### Optoelectronics Applications Manual:

This manual serves as an engineering guide for the application of and designing with LED products. Each of the generalized LED product types are covered, with additional chapters on contrast enhancement, photometry, radiometry, reliability and mechanical considerations of LED devices, photodiodes, and LED theory. This book may be purchased from a Hewlett-Packard Components Distributor or from the McGraw-Hill Book Company.

Hewlett-Packard RF and Microwave components, utilized in consumer, industrial, military and other OEM equipment, assure optimum system performance. Advanced processing techniques are employed to produce highly sophisticated Silicon and Gallium Arsenide devices. The product line consists of silicon bipolar and GaAs field effect transistors; Schottky, PIN, Step Recovery Diodes; and Integrated Products.

### Transistors

HP silicon bipolar and GaAs field effect transistors fill most requirements for multi-stage amplifiers from the VHF region through 18 GHz. Devices are available for the low noise input, the high gain intermediate and the power output stages.

**Silicon Bipolar Transistors:** Device-to-device uniformity and superior performance are combined in the HXTR series of microwave devices which have been individually designed for low noise (HXTR-6000 series), high gain (HXTR-2000 series), low distortion linear power (HXTR-5000 series); or oscillator performance (HXTR-4101). In addition, new low cost, big pad general purpose chips (HXTR-3001/3002) are available. With guaranteed performance specifications from 1.5 GHz to 4 GHz, these devices are well suited for high reliability space, military, and industrial applications at frequencies up to 6 GHz. Examples of products in this series of devices include the low noise HXTR-6104, which typically offers 1.4 dB NF with 14 dB associated gain at 1.5 GHz, and the HXTR-5102 linear power transistor, featuring 27.5 dBm typical  $P_{1dB}$  linear power with 7 dB associated gain at 4 GHz. All devices in this family are available in package or chip form.

**GaAs Field Effect Transistors:** HP offers a wide range of GaAs FETs to meet your application needs for low noise, high gain, and linear power from 1 GHz to 20 GHz. This family of GaAs FET's includes both chip and packaged devices for use in communications, satellite, radar and military systems. All devices are available with high reliability testing. Examples of products include the low noise HFET-2201 with 2.4 dB typical noise figure at 10 GHz; the dynamic range HFET-5001 with 100 mW typical output power at 8 GHz; and the general purpose HFET-1001 chip which is suitable for low noise, high gain or medium power application.

Hewlett-Packard silicon bipolar and GaAs field effect transistors are supplied in chip form, or in various stripline packages. Complete data sheet characterization and excellent processing uniformity make it possible to design your circuit by calculation instead of by trial-and-error.

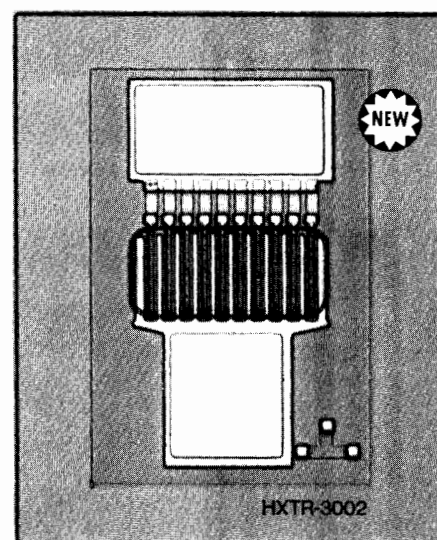
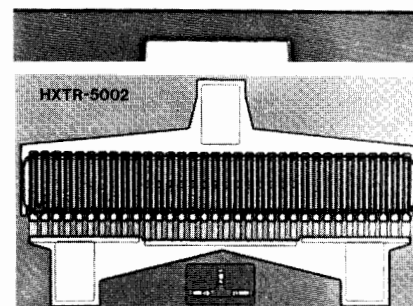
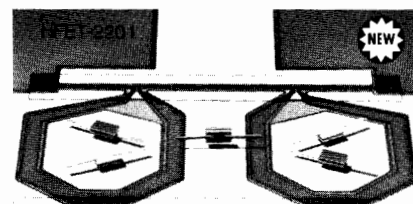
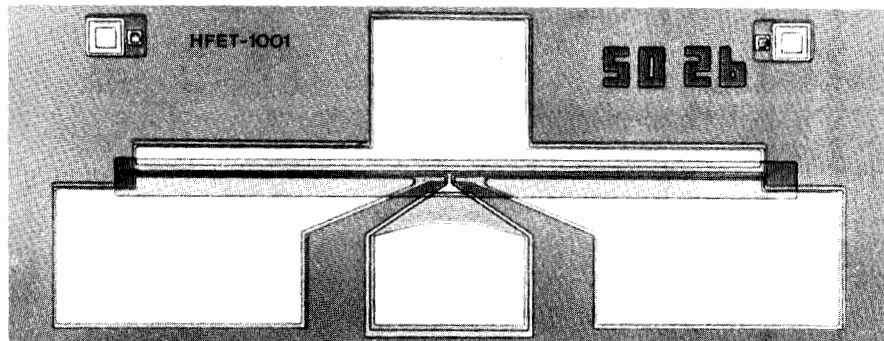

### GaAs Field Effect Transistors

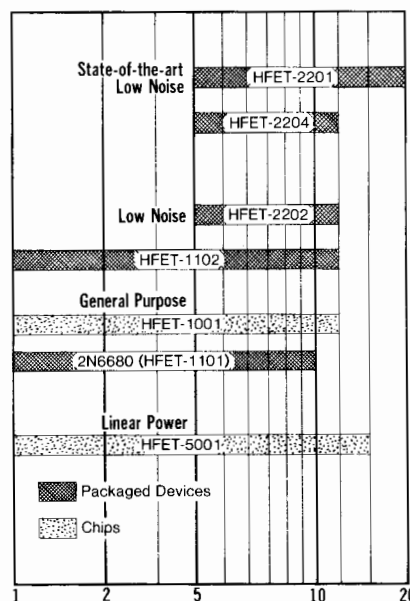

### Diodes

**Schottky Barrier Diodes:** Schottky diodes combine extremely high rectification efficiency with pico-second switching speeds, low series resistance, and low noise characteristics. This combination makes the Schottky an excellent mixer/detector diode.

At HF, VHF, and UHF frequencies, HP delivers glass-packaged devices in million piece quantities at economical prices. These same diodes have many digital circuit applications such as clipping and clamping where switching speed is important. The most popular of the glass packaged diodes are available in JAN qualified types.

At microwave frequencies, their low noise and repeatable RF impedance lead to outstanding performance either as mixers or detectors. A new series of zero bias Schottky detector diodes offers improved detection efficiency without the DC bias requirements of conventional detector diodes. Package configurations for mixer/detector diodes include beam-leaded devices as well as conventional microstrip, ceramic and axial-leaded packages.

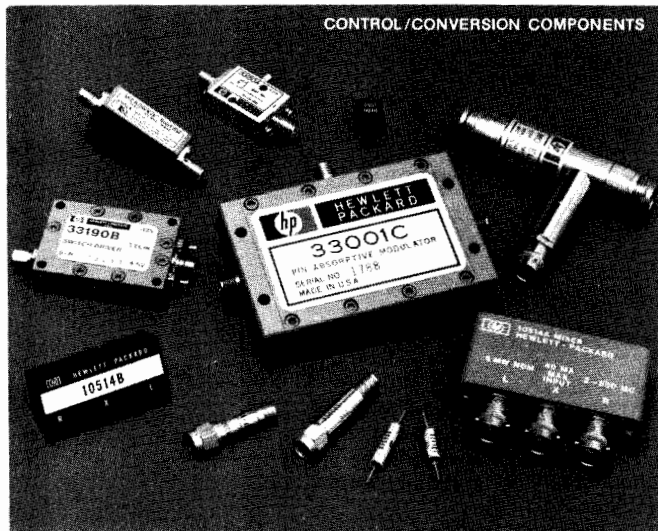
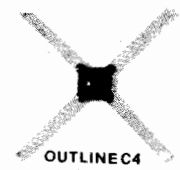
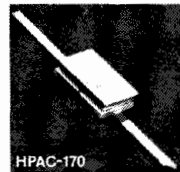
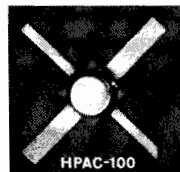
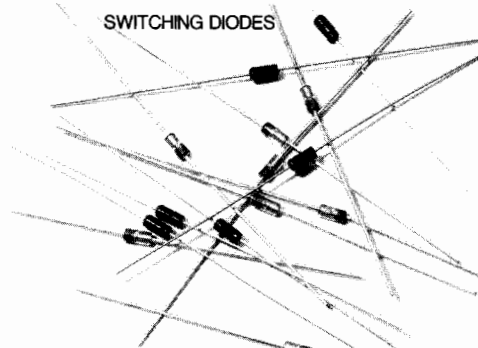
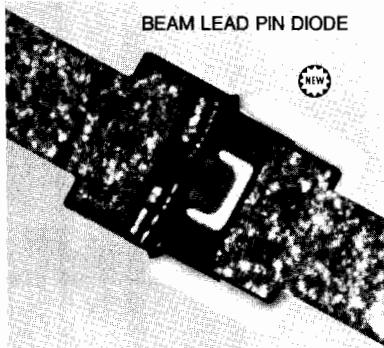

**PIN Diodes:** PIN Diodes function as variable resistors at microwave frequencies. By controlling the DC bias, the RF resistance of a PIN diode can be varied from  $1\Omega$  to about  $10k\Omega$ . This property of the PIN diode makes it extremely useful as a switch, attenuator, modulator, phase shifter, limiter or AGC element at all frequencies, from 1 MHz to 18 GHz and above. Package configurations include beamleaded devices as well as conventional microstrip, ceramic and axial-leaded packages.

**Step Recovery Diodes:** SRD's are intended for use as comb generators and harmonic frequency multipliers. When used as a comb generator, the abrupt termination of the diode's reverse recovery current generates voltage pulses up to tens of volts with pulse

widths as narrow as 100ps giving useful power at frequencies in excess of 20 GHz. By optimizing the circuit around any specific harmonic, high efficiency multiplication can be accomplished.

**Diodes For Hybrid Integrated Circuits:** Hybrid Integrated Circuits are used to achieve circuits with light weight, small size, operation to high frequencies, repeatable characteristics and lower end product costs. HP offers a wide range of PIN, Schottky and SRD single diodes in beam lead, chip and LID configurations as well as Schottky beam lead quad diodes.

### Integrated Products

Hewlett-Packard manufactures a broad line of components for the control, conversion, and generation of RF and microwave

signals. This line of integrated products (combinations of chip and beam lead diodes with hybrid thin film circuit technology) includes SPST switches, absorptive modulators, attenuators, limiters, comb generators, double-balanced mixers, and mixer/detectors.

The HMXR-5001 is a double balanced mixer which provides excellent broadband performance and reliability. This rugged mixer has low conversion loss and high isolation across the full 2-12.4 GHz RF/LO band, while retaining a wideband IF of 0.01-1.0 GHz. For the HF-UHF range, both double balanced and low cost single balanced mixers are available.

Recently the Microwave Semiconductor Division has developed a line of X-band, narrow band GaAs FET amplifiers. These low noise, front end amplifiers have exhibited state-of-the-art performance. These units, which offer greater reliability and lower costs compared to devices such as paramps, utilize HP's half micron and one micron GaAs FETs.

### High Reliability Testing

Many Hewlett-Packard components are space qualified. The reliability of these devices is established by one of the finest high reliability testing facilities in the microwave component industry. Hewlett-Packard's High Reliability Test Group maintains military approved JAN and JANTX parts in stock and can recommend HP standard screening programs, patterned after MIL-S-19500, for any HP component. Those who wish to design their own screening specifications can consult with and obtain quotations from Hewlett-Packard's staff of dedicated field sales engineers.

### Write for More Information

Hewlett-Packard RF and microwave component capabilities are described in individual data sheets and application bulletins.

**Diode and Transistor Designer's Catalog:** This catalog contains detailed, up-to-date specifications on our complete product line. It is divided into the following major sections: Silicon Bipolar Transistors, Gallium Arsenide Field Effect Transistors, Schottky Barrier and High Conductance Diodes, PIN Diodes, Step Recovery Diodes, Devices for Hybrid Integrated Circuits and High Reliability Devices.

**Microwave Integrated Products Catalog:** This 80 page designer's catalog contains complete specifications of our broad line of components for the control, conversion, generation and amplification of RF and microwave signals. Special testing, screening and electrical or mechanical modifications are also included.

## Gas Chromatographs

### HP5880A

The 5880A is more than a gas chromatograph; it's a complete GC system. By choosing the appropriate components, you can design the instrument you need. When those needs change, the 5880A can be upgraded in your own lab. You can begin with a single column, single detector unit with an isothermal oven and upgrade to a programmed oven, four-detector GC with dual channel integration and computation, a cartridge tape unit, and BASIC programming.

**Versatility**—Build a complement of up to 4 individual detectors, and up to 4 individual sample inlets, tailored to your analytical needs. A wide range of accessories can also be added for special needs.

**Automation**—All 5880A's have Run Time, Clock Time, and Keystroke Programming. Complete automation is achieved with the addition of automatic valves and an automatic sampler.

**Data Handling**—Peak integration, pre-programmed chromatographic calculations and BASIC Programming are optional. Store programs, instrument setpoints and other data on your Cartridge Tape Unit and recall them as needed.

**Communications**—Options are available that allow your 5880A to output an analog detector signal for further processing by a plotter or data system; to accept an analog signal from another GC and process it as if it came from a 5880A detector; and to output a digital signal for use by an HP 3350 Series Lab Automation System.

**Reproducibility**—Extraordinary retention time reproducibility is the result of a new oven design coupled with sophisticated electronic and software control. Impressive peak area reproducibility is due to a superior integrator and injection system.

### HP 5840A

The HP 5840A is a complete analytical GC system which produces a comprehensive chromatogram and report including peak retention times, areas, and calculated amounts. A wide range of detectors, valves, and accessories provide solutions to almost any GC problem. An optional capillary inlet system facilitates high-resolution work. Magnetic-card storage of complete analytical methods makes setup of routine procedures easier.

### HP 5700 Series

The HP 5710 dual column and 5730 dual column, multi-detector gas chromatographs are low cost, reliable answers to your analysis needs. Options include specific detectors, dual input/output electrometer, electronic baseline compensation, and a glass capillary inlet system.

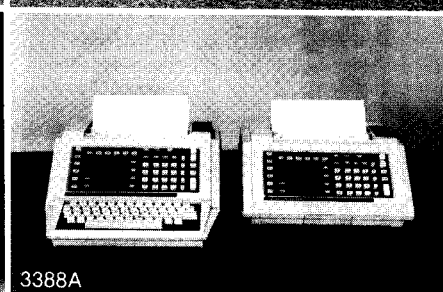
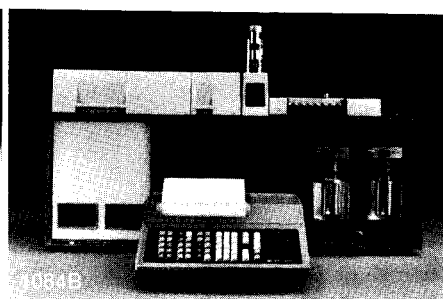
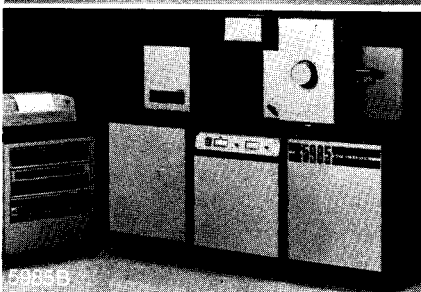
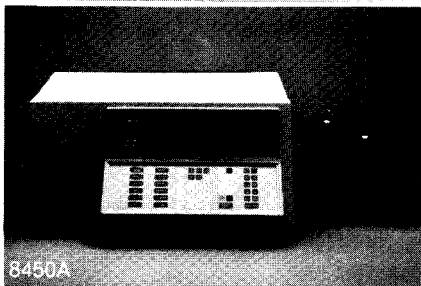
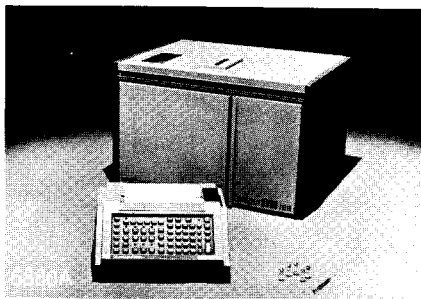

## UV/VIS Spectrophotometer

### HP8450A

This powerful, computer-controlled UV/VIS instrument measures and displays in seconds: multiple components, a full spectrum, list of analysis conditions and concentrations.

The HP 8450A has an innovative reversed-optics design which disperses the light that has passed through a sample simultaneously across two parallel arrays of light-sensitive diode detectors—one array measuring visible, the other ultraviolet light. Resulting spectra are shown instantly on the instrument's built-in video display.

The HP 8450A offers high precision, high productivity and versatility in single and multicomponent sample analyses with easy keystroke programming of operating parameters and measurement of virtually any sample with only minimum preparation.

Because of its high sensitivity, speed, and ability to monitor several component concentrations simultaneously, the HP 8450A is particularly well suited for kinetics work. From the keyboard, which is sealed to prevent damage from chemical spills, the spectrophotometer can be programmed to alter many operating parameters at specified times during an analysis.

Internal diagnostics shorten down time and lower service costs. Peripherals offered for the HP 8450A include plotters, printers/plotters, and a cartridge tape drive for external data storage.

## GC/Mass Spectrometer Systems

All HP systems are of advanced design and include innovations such as hyperbolic quadrupole mass filters, the theoretically ideal design which provides improved peak shapes and higher sensitivity, compared to roundrod filters.

### HP 5992 Series

Compact HP 5992A or B Series Systems offer excellent performance at an economical price. Features include an HP 9825A Desktop Computer Controller with HP 9866B Printer, easy-to-use software with AUTOTUNE (automatic tuning, and a wide range of accessories including the Purge/Trap unit for measuring organics in water. HP 5992B Systems include automatic, rather than manual, valving for control of effluent and calibration compound to the ion source, plus provision for CO<sub>2</sub> sub-ambient cooling. Mass range to 800; 1 ng scanning sensitivity.



### HP 5995A

This versatile benchtop GC/MS has all the features of the HP 5992 plus direct insertion probe, turbomolecular pump, independent temperature control for transfer line, source, and analyzer.

It uses the same controller and printer as the HP 5992B with an expandable, flexible disc system. Software programs (including AUTOTUNE) control the gas chromatograph, scan the mass spectrometer, monitor up to six ions in the selected ion monitoring mode, plot and tabulate normalized spectra, search libraries, and perform self-diagnostics. FID and split/splitless capillary are options.

### HP 5993 Series

This middle-priced system combines the compact GC/MS of the HP 5992B with a powerful data system very similar to that provided with the HP 5985B. A full line of computer accessories including 9-track magnetic tape are available. The HP 5993A Systems have manual valving; the B-Series has automatic valving. Mass range is 10 to 800 amu.

### HP 5986A

The HP 5986A has dual CI/EI source and other GC/MS features of the HP 5985B. It is controlled by the HP 9825A Desktop Computer operating with the expandable, flexible disc system available on the HP 5992. Its 800 amu mass range can be increased to 1000 and a powerful data system can be added by upgrading to the HP 5985B Hardware/Software Operating System.

### HP 5985B

Top-of-the-line research system provides the ideal answer for collecting, storing, and processing the vast amount of data produced from GC/MS measurements. It includes CI/EI dual source, mass range to 1000 amu, and direct insertion probe operation. The microprocessor-controlled dual column HP 5840 GC can operate independent from the MS for use as a standalone GC with integrator, time and run programming and methods analysis. The data system in the 5985B includes 10 million words of disc storage, a program for automatic sampler control, Probability Based Library Search, and simultaneous data acquisition/reduction operation. Options include negative ion detection, LC/MS interface, and turbomolecular pumps.

## Liquid Chromatographs

### HP 1084B

The HP 1084B is designed to meet the exacting requirements of research and analytical method development.

Key product features keep the needs of researchers in mind. The variable volume injector handles sample sizes between 10 and 200 $\mu$ l and the 60-bottle automatic sampler uses either 2-ml vials or where only small quantities are available--microvials. Solvent flow and composition are programmable.

Refractive index, fixed (254nm) and variable (190-600nm) wavelength detectors are available. The variable wavelength detector can be programmed to change wavelengths automatically either during or between runs. The 1084B can also change separation parameters, calibration factors and calculation procedures between runs, enabling greater ease of method development.

The microprocessor controls and monitors all subsystems according to the analyst's instructions. The 1084B injects the sample at full column pressure without interrupting solvent flow, controls solvent composition, generates flow gradients, and collects, computes, and reports chromatographic data—all automatically.

The new HP 79825A Fraction Collector enables collection of up to six (optionally 11) peak fractions from the 1084B. Fraction collection is controlled from the keyboard and can be initiated during a run either manually or automatically.

### HP 1081B

The HP 1081B is a new compact, isocratic liquid chromatograph which is simple to use and offers the precise control of parameters needed to operate efficiently for repetitive quantitative analysis.

Only six keys on the 1081B are needed to access, set, and check all the microprocessor-controlled functions, including operation of the optional 60-vial automatic sampling system.

The flow system uses a single-head diaphragm pump with closed-loop processor control. Actual and set flow rates, along with all other functions, can be monitored on a three digit numeric display. The 1081B operates efficiently with both integrator and data systems. It is the first LC to offer total two-way data communications with a laboratory automation system; up to ten 1081B's can be connected in series and controlled by a single laboratory automation system (RS232C interface).

## Laboratory Automation Systems

HP 3350 Series Laboratory Automation Systems can increase your sample throughput, provide easy-to-use, yet sophisticated data reduction, perform record keeping tasks and automate your analytical procedures. The 3350 Series provides ascending levels of laboratory automation. As a result, it gives you the freedom to configure an affordable system to meet your present needs and provides the flexibility to grow easily and economically to meet future requirements.

System growth occurs in two areas. Software capability can grow from the "turnkey" chromatographic package to include liquid sampler control, simulated distillation and LAB BASIC.

LAB BASIC offers you the flexibility to tailor data handling and report generation to meet your specific requirements without sacrificing any of the security and friendliness of the "turnkey" operation. Hardware can grow to include additional instruments, system terminals and expandable data storage on tape cartridges or disc.

The top-of-the-line 3354 Lab Automation System with a 20M byte disc offers reintegration of raw data, control of sampling devices, simulated distillation and LAB BASIC II. In addition to capability of 45 instrument interfaces, the system can have 15 terminals and four industry standard nine-track mag tapes.

## Reporting Integrator

The HP 3388A Reporting Integrator provides the chromatographer with extensive analytical capabilities for data handling. The dual channel option allows for simultaneous operation of two instruments, each with its own printer/plotter. Standard calculation procedures include area %, external standard, normalization, and internal standard.

Other features of the 3388A include BASIC programming, alphanumeric and functional keyboards, multiple reference peaks, automatic recalibration, multiple internal standards, time-selectable area slices, and retention time labeling to 1/1000 of a minute.

HP Automatic Sampler control and cartridge tape unit are available as options.



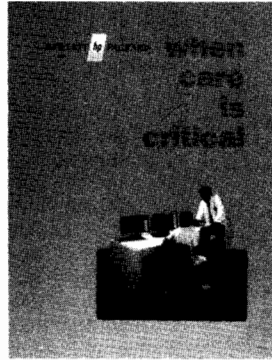

### Patient Monitoring and Resuscitation

- Stand-alone monitors.
- Modular instruments.
- ECG telemetry.
- Arrhythmia detection, storage and recall.
- Patient Data Management.
- Mobile Resuscitation System with battery/ac operating defibrillator.

*Request Brochure #5953-1391*

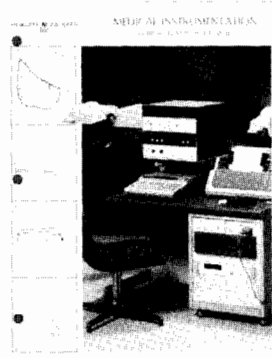
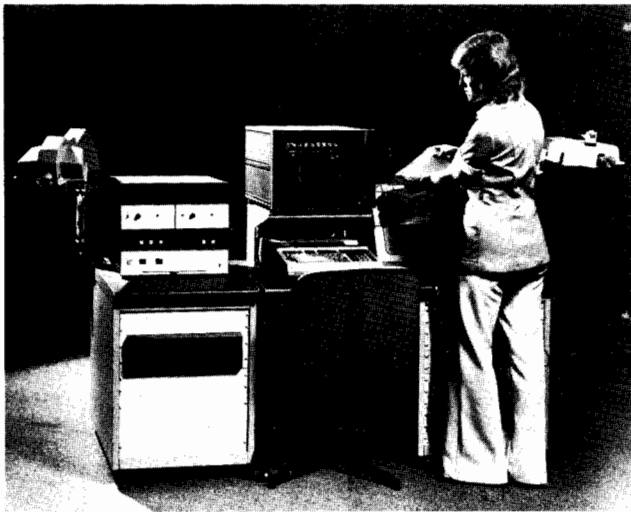

### Pulmonary Instrumentation

- Pulmonary Calculator System.
- Measurements for spirometry, lung volumes and distribution, diffusion.
- Modular pulmonary function testing instruments.
- Ear Oximeter
- Respiratory Recording Systems.

*Request Catalog #5952-5257*



### Perinatal Instrumentation

- Fetal/maternal monitoring equipment includes bedside fetal monitors and central stations.
- Telemetry for birthing centers.
- Calculator based system for on-line acquisition and evaluation of fetal monitoring data.
- Neonatal monitoring uses heart rate, respiration, temperature, ambient oxygen measuring instruments, and a Cardiorespirograph.

*Request: Telemetry for Obstetrics Brochure #5953-1149*

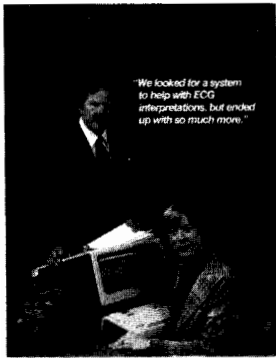
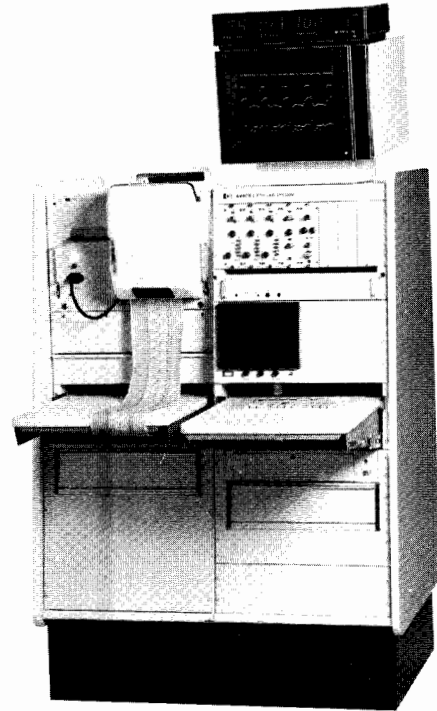
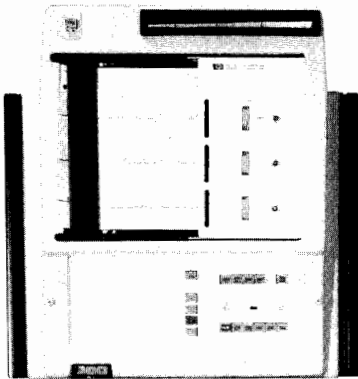

"We looked for a system to help with ECG interpretations, but ended up with so much more."

### Cardiology Instrumentation

- ECG Management Systems for computer-aided, interpretation of ECGs.
- Single and 3 channel electrocardiographs.
- ECG Stress Testing Systems.
- ECG/Heart Sound/Pulse Recording Systems.
- ECG computer terminals for phone transmission or tape recording of ECG data. *Request Brochure #5953-4915.*

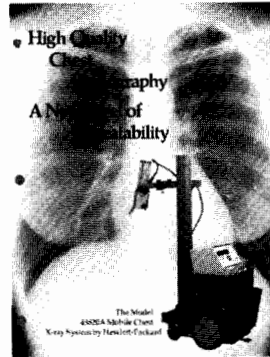

High Quality  
Radiography  
A New Era of  
Stability

The Model  
43820A Mobile Chest  
X-ray System by Hewlett-Packard

### Radiology

- Several unique x-ray machines for use in the medical community.
- Model 43820A (shown at left): high performance photo-timed mobile system designed for ICU use.
- For specimen radiography, Model 43805P shielded cabinet x-ray system with automatic exposure control.
- Model 43897P for practical laboratory training of radiological technologists.

*Request publications #5953-1230 and #5953-6781*



CARDIAC CATHETERIZATION SYSTEMS

### Cardiovascular Instrumentation

- Multi-channel thermal or optical recording systems for clinical or research use.
- Complete choice of transducers, meter, and numerical displays.
- More than 12 plug-in signal conditioners.
- Computerized catheterization data analysis system automates on-line data collection and analysis. *Request Brochure #5952-5394.*

HEWLETT  
PACKARD

CRITICAL  
CARE  
SUPPLIES



### Medical Instrumentation Supplies

Wide choice for use with HP and other medical electronics instruments. *Request any of the following catalogs:*

- *Critical Care Supplies #5935-4802 (Pictured)*
- *Cardiology Supplies #5953-4801*
- *Labor and Delivery Supplies #5953-4800*
- *Multi-Channel Recording Supplies #5953-4803*
- *Pulmonary Diagnostic Supplies #5953-4804*

# X-RAY SYSTEMS

## Scientific and Industrial X-ray Systems



### Faxitron® Cabinet Systems

Radiography, the art and science of making pictures with X-rays, has an important place in modern technology. It is one of the major nondestructive test methods available to industry, provides an indispensable tool in scientific investigations and is a valuable aid to law enforcement agencies. Hewlett-Packard makes a major contribution to these activities with X-ray equipment that offers a "better way" through advanced technology and design. This equipment makes radiographs easier and safer to take.

### Industrial Inspection

Industrial quality control and inspection procedures, especially in the field of electronics, benefit from nondestructive testing by radiography. The advantages of a testing method which does not harm the test objects are obvious. Radiography, therefore, offers benefits in design engineering, incoming inspection, production quality control, product reliability and failure analysis. X-rays are used to detect misregistration or plate-thru problems in multi-layer P.C. boards; porosity, poor substrate bonding and wiring or lead location in transistors and integrated circuits; voids and other encapsulation problems in potted components; and solder balls or other defects in sealed relays.

Die casting is another industry that benefits from the nondestructive aspects and abil-

ity to "see inside" provided by radiography. Porosity, gas voids, tramp metal inclusion and other common defects can be easily detected and the cause determined. Expensive machining time can be avoided for castings found to be defective through X-ray inspection. The integrity of welds, alignment of connectors, inspection for proper assembly and mechanical defects are further examples of tests which radiography performs for industry. The benefits of X-ray testing are reduced production costs, better quality assurance and product safety. The results are increased profits.

### Law Enforcement Applications

Radiography aids many law enforcement groups. Crime labs use X-rays to visualize certain types of latent fingerprints, for powder and lead splatter patterns in ballistics and for questioned-document examination. Medical examiners use X-rays for cause-of-death investigations and identification of remains. X-rays aid in examining parcels or mail to identify dangerous devices and to verify bomb circuitry.

These are among the many applications served by HP Faxitron® Cabinet X-ray Systems. They offer a unique combination of high quality radiographic capability, simplicity of operation and convenience of use which is expanding the capabilities of scientific and industrial concerns throughout the world.

### Scientific Applications

Oceanography, geology, marine biology, paleontology, pathology, botany, forestry and agricultural research are a few examples of scientific disciplines that use X-rays. Applications range from the study of the interior anatomy of fossils to determining the viability of seeds.

### Pulsed Radiation Sources

Hewlett-Packard has pioneered in the design and manufacture of cold-cathode, flash X-ray tubes and systems. Cold-cathode tubes, based on the field emission principle, are combined with a pulse generator and appropriate control units. The systems produce nanosecond bursts of X-rays and electrons. Output voltage and energy are provided by Marx-surge type energy storage modules charged in parallel and discharged in series through a pressurized spark gap switch mechanism.

A number of channels can often be operated from common controls enabling a series of stop motion radiographs at desired intervals.

Other capabilities include slow and fast cine-systems providing a limited train of motion picture-like radiographs at rates from 1 to 1000 frames/sec. These systems are custom designed from standard units.

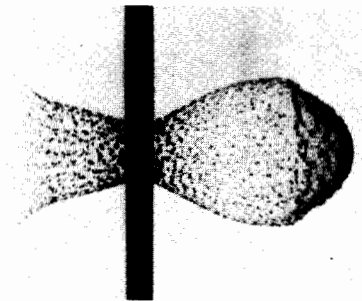

HP pulse radiation systems yield a reproducible 5,000-10,000 ampere electron beam in air at energies at 300-2300 keV and pulse widths of 3-50 nanoseconds. Current densities of 12,500 amperes per cm<sup>2</sup> and dose rates up to 10<sup>15</sup> Rads/second can be obtained.

Their reproducibility, high dose-rate output, ease of operation and instrumentation and small space requirement make them ideal for radiation chemistry or pulsed radiolysis studies as well as radiation effects studies, radiation biology and laser pumping.

For specific information and consultation regarding HP X-ray systems, contact Hewlett-Packard, 1700 S. Baker Street, McMinnville, Oregon 97128, telephone: (503) 472-5101.



Designed to help you obtain maximum use from your HP equipment



Hewlett-Packard Application Notes are a compilation of applications research and experience which have been written in collaboration with HP engineers and our customers. Some are tutorial, while others describe specific "how to" procedures. Listed below are the application notes that are currently available from your local sales office. Or, you may write directly to Application Notes, Hewlett-Packard, 1820 Embarcadero Road, Palo Alto, California 94303, U.S.A.

- |        |  |       |   |        |  |
|--------|--|-------|---|--------|--|
| 52-1   | Fundamentals Of Time And Frequency Standards   | 89    | Magnetic Tape Recording Handbook  | 140-6  | Measurement Of Machine Tool Vibration  |
| 52-2   | Timekeeping And Frequency Calibration  | 90B   | DC Power Supply Handbook  | 140-7  | Nuclear Power Plant Diagnostics Using Fourier Analysis Techniques                                |
| 57     | Noise Figure Primer  | 91    | How Vector Measurements Expand Design Capabilities—1 To 1,000 MHz                     | 142    | EMI Measurement Procedure  |
| 63E    | Modern EMI Measurement   | 95-1  | S-Parameter Techniques For Faster, More Accurate Network Design                       | 150    | Spectrum Analysis... Spectrum Analyzer Basics  |
| 63E-1  | Quasi-Peak Measurements Using A Spectrum Analyzer  | 114   | A2A Video Transmission System Alignment   | 150B   | Spectrum Analysis... Using The 8557A And 8558B Spectrum Analyzers                                |
| 64-1   | Fundamentals Of RF And Microwave Power Measurement   | 115   | Principles Of Cathode-Ray Tubes, Phosphors, And High-Speed Oscillography              | 150-1  | Spectrum Analysis... AM And FM   |
| 64-2   | Extended Applications Of Automatic Power Meters.   | 117-1 | Microwave Network Analyzer Applications   | 150-2  | Spectrum Analysis... Pulsed RF   |
| 77-1   | Transistor Parameter Measurements  | 117-2 | Stripline Component Measurements With The 8410A Network Analyzer                      | 150-3  | Spectrum Analysis... Tracking Generators   |
| 77-3   | Complex Impedance Measurements   | 121-1 | Network Analysis With The HP 8407A 0.1-110 MHz  | 150-4  | Spectrum Analysis... Noise Measurements  |
| 77-4   | Swept-Frequency Group Delay Measurements   | 121-2 | Swept Impedance With The 8407A Network Analyzer 0.1-110 MHz                           | 150-5  | Spectrum Analysis... CRT Photography And X-Y Recording Techniques                                |
| HP-80  | Financial Pocket Calculator  | 123   | Floating Measurements And Guarding  | 150-7  | Spectrum Analysis... Signal Enhancement  |
| 80-001 | Direct Reduction Loan Amortization Calculations  | 124   | True RMS Measurements   | 150-8  | Spectrum Analysis... Accuracy Improvement  |
| 80-002 | Annuity Due Calculations For Savings Funds   | 128   | Applications Of A DC Constant Current Source  | 150-9  | Spectrum Analysis... Noise Figure Measurement  |
| 80-003 | Annuity Due Calculations For Savings Plans When Compounding Periods Differ From Payment Periods    | 134   | Audio Frequency Measurements With The 8556A-8552B Spectrum Analyzer                   | 150-10 | Spectrum Analysis... Field Strength  |
| 80-004 | Annual Percentage Rate For Loans With A Balloon Payment  | 136   | Understanding And Operating The 8555A Spectrum Analyzer & 8445B Automatic Preselector | 150-11 | Spectrum Analysis... Distortion Measurements   |
| 80-005 | Price And Yield Calculations For Mortgages Traded At A Discount/Premium                            | 140   | Fourier Analyzer Training Manual  | 150-12 | Spectrum Analysis... Using The HP 11517A External Mixer To 40 GHz                                |
| 80-006 | Annuity Due And Present Value  | 140-3 | Dynamic Testing Of Mechanical Systems Using Impulse Testing Techniques                | 150-13 | Stimulus-Response Measurements Using The HP 8565A Spectrum Analyzer from 2 to 18 GHz             |
| 80-007 | Calculating Logs, Anti-Logs, And Roots Of Numbers  | 140-4 | Digital Auto-Power Spectrum Measurements  | 150-14 | Spectrum Analysis Using External Waveguide Mixers Above 40 GHz                                   |
| 80-008 | Yield And Periodic Payment Amount Calculations For Leases With A Balloon Payment Or Residual Value |       |   | 152    | Probing In Perspective   |
| 80-009 | Internal Rate Of Return (IRR) For Uneven Cash Flows  |       |   | 154    | S-Parameter Design   |
| 80-010 | Linear Regression Calculations   |       |   | 155-1  | Active Device Measurements With The HP 8755 Frequency Response Test Set                          |
| 86     | Using The Vector Impedance Meters  |       |   | 155-2  | 100 dB Dynamic Range Measurements Using The HP 8577 Frequency Response Test Set                  |
|        |  |       |   | 156-2  | Calibration Of A Surface Plate   |
|        |  |       |   | 156-4  | Calibration Of A Machine Tool  |
|        |  |       |   | 156-5  | Measurement Of Straightness Of Travel  |
|        |  |       |   | 157    | Low Frequency Gain Phase Measurements  |
|        |  |       |   | 161-1  | Hewlett-Packard Series 9800: The Name And Number That Saves Time And Money                       |
|        |  |       |   | 161-7  | Low-Cost Calculator System Saves Time, Improves Accuracy For Radiation Therapists and Physicists |
|        |  |       |   | 161-10 | HP 9830 System Tackles Administrative Data Processing Tasks at Leominster High School            |
|        |  |       |   | 162-1  | Time Interval Averaging  |
|        |  |       |   | 163-1  | Techniques of Digital Troubleshooting  |
|        |  |       |   | 164-2  | Calculator Control Of The 8660A/C Synthesized Signal Generator                                   |
|        |  |       |   | 164-3  | New Techniques For Analyzing Phase Lock Loops  |

# APPLICATION NOTES

Designed to help you obtain maximum use from your HP equipment

- |                |   |               |   |               |   |
|----------------|---|---------------|---|---------------|---|
| <b>164-4</b>   | Digital Phase Modulation (PSK) And Wideband FM  | <b>174-5</b>  | Determining Probability Densities (Histograms) With The 5345A Electronic Counter                                      | <b>176-25</b> | Ensuring Reproducible Mass Spectral Patterns With Automatically Tuned GC/MS Systems   |
| <b>166</b>     | Large Screen Display Applications And Interfacing   | <b>174-6</b>  | Measuring The Stability Of A Frequency Source   | <b>176-26</b> | Identification Of Drugs In Body Fluids Using GC/MS  |
| <b>166-2</b>   | 1304A Large Screen Display Applications And Interfacing   | <b>174-7</b>  | Measuring Fractional Frequency Standard Deviation (SIGMA) Versus Averaging Time (TAU)                                 | <b>176-27</b> | Precision, Accuracy And Sensitivity Determination Of SIM Analysis Using An Automated GC/MS Injection And Data Reduction System, BATCH SIM |
| <b>167-4</b>   | Engineering In The Data Domain Calls For A New King Of Digital Instrument                         | <b>174-8</b>  | Measuring FM Peak-to-Peak Deviation   | <b>176-28</b> | Probability Based Search System (PBS)   |
| <b>167-5</b>   | Troubleshooting In The Data Domain Is Simplified By Logic Analyzers                               | <b>174-9</b>  | Making Automatic Phase Measurements With The 5345A Electronic Counter   | <b>176-29</b> | LC/MS Analysis of Bromocryptine   |
| <b>167-6</b>   | Mapping, A Dynamic Display Of Digital System Operation  | <b>174-10</b> | Measuring Electrical Length Delay of Cables   | <b>176-30</b> | Quantitation of Dalmane by NCI  |
| <b>167-7</b>   | Supplementary Data From Map Displays Without Changing Probes                                      | <b>174-11</b> | Measuring Warm-Up Characteristics And Aging Rates Of Oscillators  | <b>181-1</b>  | Measuring Linearity Of VCO's From 10Hz To 23 GHz  |
| <b>167-9</b>   | Functional Analysis Of The Motorola M6800 Microprocessor System                                   | <b>174-12</b> | Measuring Frequency Sweep Linearity Of Sweep Generators   | <b>181-2</b>  | Data Acquisition With The 5300B Measuring System  |
| <b>167-11</b>  | Functional Analysis Of INTEL 8008 Microprocessor System   | <b>174-13</b> | Measuring The Tuning Step Transient Response Of VCO's To 18 GHz   | <b>183</b>    | High Frequency Swept Measurements   |
| <b>167-12</b>  | Functional Analysis: Fairchild F8 Microprocessor Systems  | <b>175-1</b>  | Differential Phase And Gain At Work   | <b>185</b>    | Waveform Parameter Measurements Using The Microprocessor Controlled Oscilloscope (1722)   |
| <b>167-12A</b> | Functional Analysis: MOSTEK F8 Microprocessor Systems   | <b>176-5</b>  | A Comparison Of Magnetic Sector And Dodecapole Spectra Column Technology In GC/MS                                     | <b>185-2</b>  | Transmission Line Matching And Length Measurements Using Dual-Delayed Sweep   |
| <b>167-13</b>  | The Role Of Logic State Analyzers In Microprocessor Based Designs                                 | <b>176-6</b>  | Doubly-Charged Ions   | <b>185-3</b>  | Percent Amplitude Modulation Measurements In The Time Domain  |
| <b>167-14</b>  | Functional Analysis Of 8080 Microprocessor Systems  | <b>176-7</b>  | Explosives: Analysis Using Dual Chemical/Electron Ionization GC/MS  | <b>185-4</b>  | Elimination of Computation of Analog Measurements By Using The Direct Reading Oscilloscope 1722   |
| <b>167-15</b>  | Functional Analysis Of INTEL 4004 Microprocessor Systems  | <b>176-8</b>  | Methane: Its Usefulness As Both Carrier And Reactant Gas In Chemical Ionization GC/MS                                 | <b>187-2</b>  | Configuration Of A 2-18 GHz Synthesized Frequency Source Using The 8620C Sweep Oscillator   |
| <b>167-16</b>  | Functional Analysis Of INTEL 4040 Microprocessor Systems  | <b>176-10</b> | Femtomole Analysis Of A Biogenic Amine By GC/MS   | <b>187-3</b>  | Three HP-IB Configurations For Making Microwave Scalar Measurements   |
| <b>167-17</b>  | Functional Analysis Of National IMP Microprocessor Systems  | <b>176-11</b> | Picogram Detection Of Tetrachlorodibenzodioxin  | <b>187-4</b>  | Configuration Of A Two-Tone Sweeping Generator  |
| <b>167-18</b>  | Functional Analysis Of National Semiconductor SC/MP Microprocessor System                         | <b>176-12</b> | Reactant Gas Selection In Chemical Ionization Mass Spectrometry Part I (See 176-18)                                   | <b>187-5</b>  | Calculator Control Of The 8620C Sweep Oscillator Using The HP-IB  |
| <b>167-19</b>  | Systematic "Turn-On" Of Microprocessor Systems Using Logic State Analyzers                        | <b>176-13</b> | Picogram Detection Of An Anticonvulsant By Chemical Ionization GC/MS  | <b>187-6</b>  | The Frequency Performance Of The 8620C Sweep Oscillator Under Remote Programming  |
| <b>170-1</b>   | HP 8640A/B Signal Generator Output Level Accuracy   | <b>176-14</b> | Analysis Of Pollutants In Urban Air By GC/MS  | <b>188</b>    | Thermocouple Measurements With The 3050B  |
| <b>170-2</b>   | The 8640A/B Third Order Intermodulation Product Characteristics                                   | <b>176-15</b> | Analysis Of Derivatized Amino Acids By Chemical Ionization GC/MS  | <b>191-1</b>  | Automatic Zero Calibration Of The 5359A Time Synthesizer At A Designated Remote Location  |
| <b>171-1</b>   | Crystal Testing With The 8640A/B And 8405   | <b>176-16</b> | Effect Of A Membrane Separator On GC/MS Peak Shape And Retention Characteristics                                      | <b>191-2</b>  | Determining Digital Circuit Timing Tolerance To Optimize Adjustment Or Design   |
| <b>171-2</b>   | Extending The 8640B Frequency Down To DC  | <b>176-17</b> | Reactant Gas Selection In Chemical Ionization Mass Spectrometry: Part II. (See 176-13)                                | <b>191-3</b>  | Precision Time Interval Measurements In Radar Applications  |
| <b>173</b>     | Recent Advances In Pulsed RF And Microwave Frequency Measurements                                 | <b>176-18</b> | Use Of A Mixed Reagent Gas For Chemical Ionization GC/MS  | <b>191-4</b>  | Using The 5370A Universal Time Interval Counter To Characterize Pulse Width, Repetition Rate And Jitter                                   |
| <b>173-1</b>   | Dynamic Measurement Of Microwave Voltage Controlled Oscillators With The 5345A Electronic Counter | <b>176-19</b> | Automatic Data Reduction And Analysis Using Batch Processor GC/MS   | <b>191-5</b>  | Measurement of Propagation Delays Using the 5370A Time Interval Counter and 5363B Time Interval Probes                                    |
| <b>174-0</b>   | Index To The AN-174 Application Note Series   | <b>176-21</b> | Analysis Of Chloropesticides And PCB's In Cheese By Glass Capillary GC/MS Using The Selected Ion Monitoring Technique | <b>191-6</b>  | Precise Cable Length and Matching Measurements Using the 5370A Universal Time Interval Counter and 5363B Time Interval Probes             |
| <b>174-1</b>   | Measuring The Transfer Characteristic Of A Voltage Controlled Oscillator                          | <b>176-22</b> | Capillary Column GC/MS Analysis Of Essential Oils   |               |   |
| <b>174-2</b>   | Measuring Differential Nonlinearity Of A Voltage Controlled Oscillator                            | <b>176-23</b> | GC/MS Analysis Of Volatile Organic In Water   |               |   |
| <b>174-3</b>   | Measuring Integral Nonlinearity Of A Voltage Controlled Oscillator                                | <b>176-24</b> |   |               |   |
| <b>174-4</b>   | Measuring Dual VCO Tracking Error   |               |   |               |   |

192	Using A Narrow Band Analyzer For Characterizing Audio Products	212-1	Building An Inventory Control Data Base	229-1	HP-Plot/2l Software Conversion Guide
195	Pulse Generator Techniques In CMOS Applications	212-2	Building An Order Processing Data Base	230-1	Automated Data Reduction For Gel Permeation Chromatography
196	Automatic Measurements Using HP 436A Power Meter	213-1	Dropouts (Loss Of Signal In Tape Recording)	230-2	Using A Laboratory Automation System To Facilitate Industrial Hygiene Monitoring
196-1	Automated Measurements Using the 432C Power Meter	213-2	Crosstalk (Tape Recording)	230-3	Plotting Chromatograms with the 18675B Four-Pen Plotter
197-1	Laser Interferometers For Position Feedback	213-3	Interchannel Time Displacement Error. (Tape Recording)	230-4	The Parameters of GPC-Automated Molecular Weight Distribution by the 3354 Lab Automation System
197-2	Laser And Optics of HP 5501A Laser Transducer	214-1	Recording With Input Noise Present	230-5	Correlated ASTM Distillation Distribution Based on Simulated Distillation (ASTM D-2887) Data
198	Event-Related Triggering... A Clear Solution For Digital Signals	214-2	X-Y Recorder Dynamic Response	232-1	HPLC Of Pharmaceutical Products Analgesic Tables
199	Small Screen Displays—Medical Diagnostic System Applications And Interfacing	214-3	X-Y Recorder Input Connection Configuration And Input Noise	232-2	HPLC Method Development On The HP 1084A
200	New Fundamentals of The Electronic Counters	214-4	High Sensitivity X-Y Recorder Has Few Restrictions	232-3	Theophylline Assay By High Performance Liquid Chromatography
200-1	Fundamentals Of Microwave Frequency Counters	215-1	A More Rugged, Cleaner Writing Oscillographic Ink Recorder	232-4	HPLC Analysis Of Food Additives I: Preservatives
200-2	Fundamentals Of Quartz Oscillators	216	A Guide To The Use Of The HP 3570A/3571A Analyzers	232-5	HPLC Analysis Of Food Additives II: Antioxidants
200-3	Time Interval Measurement Using An Electronic Counter	218-1	Applications And Performance Of The 8671A/8672A Microwave Synthesizers	232-6	HPLC Of Pharmaceutical Products: Vitamins
200-4	Understanding Frequency Counter Specifications	218-2	Obtaining Millihertz Resolution From The 8671A And 8672A	232-9	Hydrocarbon Group Type Analysis of Gasoline by High Performance Liquid Chromatography
201-1	Routine QA Measurements Of Precision Resistors	218-3	A 1 MHz-18 GHz Signal Generator With 1,2, Or 3 Hz Resolution	232-10	Molecular Weight Determinations by Gel Permeation Chromatography
201-2	Measuring Differential Non-Linearity Of A Voltage Controlled Oscillator	218-4	Synthesized Signals From 18 to 37.2 GHz Using the 8672A	232-11	Reproducibility of the Model 1081B Liquid Chromatograph for Gel Permeation Chromatography
201-4	Performance Evaluation Of HP-IB Using RTE Operating Systems	219	HP 8595A R.F. Network Analyzer Basic Measurements	232-13	Analysis of Some Lipids in Biological Material
201-5	The HP-IB Link: Control Of Distributed HP-IB Devices	220	Operating the HP 8565A Spectrum Analyzer	232-14	Analysis of Carbohydrates in Food by HPLC
201-6	Computer Interconnections: A Choice Of Ways To Link HP 1000 System To HP 9825AS Desktop	221	Semi-Automatic Measurements Using The 8410B Microwave Network Analyzer And The 9825A Desktop Computer	232-15	Crude Oil Characterization Using Gel Permeation Chromatography
201-7	High-Performance Software For The HP 3455A/3495A Subsystem	222	A Designer's Guide To Signature Analysis	232-16	Errors in Average Molecular Weights in Gel Permeation Chromatography Due to Improper Baseline Correction
201-8	HP 1000/HP-IB: The Use Of Device Subroutines with HP 1000 Computers	222-1	Implementing Signature Analysis For Production Testing With The 3060A Board Test System	232-17	Analysis of Fatty Acid Derivatives by HLPC
202-1	Optical Mark Readers Substantially Increase Productivity	222-2	Application Articles on Signature Analysis	233-1	Functional Analysis Of Signetics 2650 Microprocessor Systems Using the 1610A
202-2	Optical Mark Readers Provide Low Cost Data Entry Into An HP 3000 Computer System	223	Oscilloscope Measurements In Digital Systems	233-2	Functional Analysis Of TMS 9900 Microprocessor Systems Using The 1610A
202-3	Distributed HP Optical Mark Readers Provide Easy Remote Data Collection	224-2	Signal Conditioning: HP 22914A Breadboard Card	233-3	Functional Analysis Of ZILOG Z80 Microprocessor Systems Using The 1610A
204-1	Automatic Accelerometer Calibration	225	Measuring Phase Spectral Density Of Synthesized Signal Sources Exhibiting $f^0$ And $f^{-1}$ Noise Characteristics With The 5390A Frequency Stability Analyzer	233-4	Functional Analysis Of 8080 Microprocessor Systems Using The 1610A
204-2	Energy Conservation In A Restaurant	225-1	Measurement Considerations When Using The 5390A Option 010	233-5	Functional Analysis Of Motorola M6800 Microprocessors Systems Using the 1610A
205-1	Low Frequency Amplitude Considerations Of The 3042A System	227	Word Generator Techniques In Multi-Channel Applications	235	An Introduction To Balanced Circuits And Impedance Matching
205-2	Sonar Transducer Calibration Measurement and Computation with the HP 3042A Automatic Network Analyzer System	228-3	Determination Of Benzene And Toluene In Gasoline	236-1	A "Make" or "Buy" Analysis For Power Supplies
206-1	Measuring Wide-Band Noise With The HP-3045A Automatic Spectrum Analyzer	228-4	Applications And Operation Of The Nitrogen-Phosphorus Detector	236-2	Two Power Supply Redundancy Schemes
207	Understanding And Using Phase Noise In The Frequency Domain	228-5	Optimizing Analysis Using Splitless Injection On Capillary Columns	236-3	Measure Switcher Efficiency without a Wattmeter
210-1	Modeling And Simulation For Digital Testing	228-6	Automated Determination Of Benzene Adsorbed On Charcoal Tubes		
210-4	Designing Digital Circuits For Testability (DTS-70)	228-7	Determination Of Boiling Range Of Petroleum Fractions		
		228-10	Hydrocarbon Group Type Analysis Of Gasoline By High Performance Liquid Chromatography		



# APPLICATION NOTES

Designed to help you obtain maximum benefit from your HP equipment

238	Measurement of Semiconductor Characteristics with the HP 4140A pA Meter/DC Voltage Source	281-1	Microprogramming—A Way To Get Higher Performance From HP 1000 Computers	401-5	5328A Counter/HP 1000 Computer: Programming Guide
240-1	Feedback Control System Measurements	281-2	Microprogramming—HP 1000 M-Series To E-Series Microprogram Conversion	401-6	3438A Digital Multimeter/HP 1000 Computer: Programming Guide
240-2	Improving The Accuracy Of Structural Response Measurements	281-3	Microprogramming—Using The HP 1000 E-Series Microprogrammable Processor Port	401-7	3455A Digital Multimeter/HP 1000 Computer: Programming Guide
245-1	Signal Averaging With The HP 3582A Spectrum Analyzer	282-1	6940B Multiprogrammer System Throughput Analysis	401-8	59309A Digital Clock/HP 1000 Computer: Programming Guide
245-2	Measuring The Coherence Function With The HP 3582A Spectrum Analyzer	283-1	HP 8662A RF Synthesized Signal Generator Performance, Familiarization and Applications	401-9	6002A Power Supply/HP 1000 Computer: Programming Guide
245-3	Third Octave Analysis With The HP 3582A Spectrum Analyzer	283-2	External Frequency Doubling Of The 8662A Synthesized Signal Generator	401-10	3437A Digital Voltmeter/HP 1000 Computer: Programming Guide
245-4	Accessing the 3582A Memory With HP-IB	284	Guide to Quartz Thermometry Measurement Accuracy	401-11	3495A Scanner/HP 1000 Computer: Programming Guide
245-5	Log Sweep with HP 3582A Spectrum Analyzer	285	Successful Buried Cable Fault Locating	401-12	3582A Spectrum Analyzer/HP 1000 Computer: Programming Guide
246	Using The HP 3585A Spectrum Analyzer With The HP 9825A Computing Controller	286-1	Applications And Operations Of The 8901A Modulation Analyzer	401-13	3325A Function Generator/HP 1000 Computer: Programming Guide
246-1	Optimizing the Dynamic Range of HP 3585A Spectrum Analyzer	287-1	Waveform Analysis Using The 5328A Universal Frequency Counter	401-14	4262A Digital LCR Meter/HP 1000 Computer: Programming Guide
250-1	HP-IB Power Supply Interface Guide	287-2	Frequency Profile Using An HP 5345A Electronic Frequency Counter And An HP 5359A Time Synthesizer	401-15	8672A Synthesized Signal Generator/HP 1000 Computer: Programming Guide
250-2	Battery Charging/Discharging Understanding Hewlett-Packard's Model 1615A Logic Analyzer	287-3	Frequency Profile Using An HP 5370A Universal Time Interval Counter And An HP 5359A Time Synthesizer	401-16	436A Microwave Power Meter/HP 1000 Computer: Programming Guide
260-1	Eliminating Time Base Errors From Oscilloscope Measurements	287-3	Model 5328A Beginner's Guide/Programming Note	401-17	8620A Sweep Oscillator/HP 1000 Computer: Programming Guide
262	Thermal Measurements of Electronic Components Using the HP Temperature Probe	288-1	A Stimulus For Automatic Test Thermocouple Measurement With The HP 3467A	401-18	59306A Relay Actuator/HP 1000 Computer: Programming Guide
263	An Example Of Automatic Measurement Of Conducted EMI With The HP 8568A Spectrum Analyzer	289	User's Guide To The 5355/56 Automatic Frequency Converter	401-19	8660C Synthesized Signal Generator
270-1	Automated Noise Sideband Measurements Using the HP 8568A Spectrum Analyzer	290	Minicomputer Analysis Techniques Using Logic Analyzers	401-20	9871A Character Impact Printer
270-2	Adding Soft Copy Graphics to 9825A-based Systems Using the Model 1350A Graphics Translator	291-1	Functional Analysis Of Microprocessor Systems With The 1611A - Opt. 001 General Purpose Module	401-21	6942A Multiprogrammer II
271-1	Precise Time Interval Measurements Using The Crystal Controlled Time Base Model 1743A Oscilloscope	292	Semi-automatic Network Analyzer System For 4-1300 MHz Measurements	402-1	HP 1000 Application Briefs
272	Symptomatic Troubleshooting Of Computer Networks With HP 1640A	293	Data Pattern Stimulus for Manual and Automatic Bench Use	402-2	ACCEL/1000 Program Acceleration—Speeding Up N/C Program Compilation
275	Using The HP 1640A Serial Data Analyzer With The EPI-COM, Inc. Model 200 CS047 Epitape Recorder	294	Emulation of Microprocessor-based Systems with HP 64000 Logic Development System	403	HP 2608 Medium Speed Dot Matrix Printer Special Forms Printing Guide
275-1	Using The HP 1640A Serial Data Analyzer With The Spectron Corp. T-511 Recorder	296	Interfacing HP Model 1336S Display to High Resolution Imaging Systems	404-3	Using the 25 kHz Power from the HP1000 L-Series Power Module to Meet Unique Power Supply Needs
275-2	Making Complex Measurements With The HP Model 1602A Logic State Analyzer	298-1	Low Noise Division of 10 MHz Oscillators	405	Use of the IPS-7000 Printer with HP Data Capture Terminals
280-1	Monitoring the IEEE-488 Bus With The 1602A Logic State Analyzer	299	Factory Data Collection: A Quality Assurance Early Warning System	406	HP 3000/Data Capture Terminals—Programming Application Brief
280-2	The 1602A Logic State Analyzer As An Automatic Test Instrument	301	Factory Data Collection: An Example Of How To Implement An HP 1000-Based Labor And Job Status Reporting System	712	8800 Medical Systems—Heart Sound Measurement
280-3	Making Measurements On Wide Buses With HP's Model 1602A Logic State Analyzers	400-1	HP 1000/HP-IB Programming Procedures	718	Patient Safety
		400-2	59307 VHF Switch/HP 1000 Computer: Programming Guide	721	ECG Application Note for Nurses
		401-1	5345A Counter/HP 1000 Computer: Programming Guide	725-1	Esophageal Motility
		401-2	5342A Microwave Counter/HP 1000 Computer: Programming Guide	732	Recording Phonocardiography And External Pulse Wave Recording
		401-3		733	Physicians Guide To The HP Cath Lab Computer System
		401-4		738	Architectural Guidelines—Patient Monitoring Systems
				739	Guide To Physiological Pressure Monitoring
				742	A Compendium On Automated Arrhythmia Detection

- 743** Electrosurgery Interference—Minimize Its Effects On ECG Monitors
- 744** Fluid Column ECG Electrodes
- 746** Proper Cleaning of HP Cables
- 747** Defibrillator Energy Dosage
- 748** Monitoring Instrumentation: Isolated Inputs, Electrosurgery Filtering, Burns Protection
- 749** X-Ray Film And Intensifying Screen Combinations
- 750** X-Ray Film Processing And Troubleshooting
- 751** Performance Verification
- 752** Demonstration And Installation Log—Model 43820A
- 753** Resuscitation Cart Planning Guide
- 755** Resuscitation Basics
- 759** A Technician's Guide To Stress Testing
- 760** HIS Bundle And Epicardial Electrograms—Clinical Applications
- 762** A Guide to Hemodynamic Monitoring Using the Swan Ganz® Catheter
- 922** Application Of PIN Diodes
- 923** Hot Carrier Diode Video Detectors
- 928** Ku-Band Step Recovery Multipliers
- 929** Fast-Switching PIN Diodes
- 932** Selection And Use Of Microwave Diode Switches And Limiters
- 934** 5082-7300 Series Solid-State Display Installation Techniques
- 936** High Performance PIN Attenuator For Low-Cost AGC Applications
- 937** Monolithic Seven Segment LED Display Installation Techniques
- 939** High Speed Optically Coupled Isolators
- 941** 5082-7700 Series Seven-Segment LED Display Applications
- 942** Schottky Diodes For High Volume Low Cost Applications
- 944-1** Microwave Transistor Bias Considerations
- 945** Photometry Of Red LEDs
- 946** 5082-7030 Series Monolithic Seven-Segment Displays
- 947** Digital Data Transmission Using Optically Coupled Isolators
- 948** Performance Of The 5082-4350/51/60 Isolators In Short To Moderate Length Digital Data Transmission Systems
- 951-1** Applications For Low Input Current, High Gain Optically Coupled Isolators
- 951-2** Linear Applications Of Optically Coupled Isolators
- 956-1** The Criterion For The Tangential Sensitivity Measurement
- 956-3** Flicker Noise In Schottky Diodes
- 956-4** Schottky Diode Voltage Doubler
- 956-5** Dynamic Range Extension Of Schottky Detectors
- 956-6** Temperature Dependence Of Schottky Detector Voltage Sensitivity
- 957-1** Broadbanding The Shunt Pin Diode SPDT Switch
- 957-2** Reducing The Insertion Loss Of A Shunt Pin Diode
- 957-3** Rectification Effects In Pin Attenuators
- 963** Impedance Matching Techniques For Mixers And Detectors
- 964** Contrast Enhancement Techniques
- 966** Applications Of The HP HDSP-2000 Alphanumeric Display
- 967** A Low Noise 4 GHz Amplifier Using The HXTR-6101 Silicon Bipolar Transistor
- 969** An Optimum Zero Bias Schottky Detector Diode
- 970** A 6 GHz Amplifier Using The HFET-1101 GaAs FET
- 971** The Beam Lead Mesa Pin in Shunt Applications
- 972** Two Telecommunications Power Amplifiers for 2 and 4 GHz Using the HXTR 5102 Silicon Bipolar Power Transistor
- 1000** Digital Data Transmission With The HP Fiber Optical System
- 1001** Interfacing The HDSP-2000 To Microprocessor Systems
- 1002** Consideration Of CTR Variations In Optically Coupled Isolator Circuit Designs
- 1003** Interfacing 18 Segment Displays to Microprocessors
- 1005** Operational Considerations for LED Lamps and Display Devices
- AB 1** Construction and Performance of High Efficiency Red, Yellow, And Green LED Materials
- AB 3** Soldering Hewlett-Packard Silver Plated Lead Frame LED Devices
- AB 4** Detection And Indication Of Segmented Failures In 7-Segment LED Displays
- AB 5** Current Source For Diode Testing
- AB 6** Pin Diode RF Resistance Measurement
- AB 7** Mixer Distortion Measurements
- AB 9** Derivation, Definition And Application Of Noise Measure
- AB 10** Transistor Noise Measurements
- AB 13** Transistor Speed Up Using Schottky Diodes
- AB 14** Waveform Clipping With Schottky Diodes
- AB 15** Waveform Clamping With Schottky Diodes
- AB 16** Waveform Sampling With Schottky Diodes
- AB 17** Noise Parameters And Noise Circles For The HXTR-6101, -6102, -6104 And -6105 Low Noise Transistors
- AB 18** The Performance Of The HXTR-6101 At Submilliampere Bias Levels
- AB 19** Noise And Power Parameters For The HFET-1101
- AB 24** Selecting a Design Medium for the HFET-2201 GaAs Field Effect Transistor
- AB 54** Mechanical Handling Of Sub-Miniature LED Lamps And Arrays
- AB 55** Low Cost Interface For A 32-Character HDSP-2000 Alphanumeric Display
- AB 56** Interface Timing and Display Length Expansion Information for HDSP-2000 Coded Data Controller
- AB 57** Flux Budget Considerations for Fiber Optic Link Design
- GC 1-73** Analysis Of Polychlorinated Biphenyls
- GC 2-73** Operating Conditions For Optimum Performance Of The 5711A Flame Ionization Detector
- GC 3-73** Heroin Assay Using Gas Chromatography
- GC 4-73** Automatic Flame Photometric Analysis Without Solvent Flame-out
- GC 6-74** Determination Of Acetaldehyde, Ethyl Acetate And Fusel Oils In Alcoholic Beverages
- GC 7-74** The Determination Of Chromium By Gas Chromatography Using A Flame Photometric Detector
- GC 9-74** Classification Of Anaerobic Bacteria By Gas Chromatography
- GC 1-75** The Gas Chromatographic Determination Of Vinyl Chloride Monomer
- GC 2-75** Analysis Of Essential Oils By Gas Chromatography
- GC 3-75** The Automatic Determination Of FO CO, CH<sup>4</sup>, And Total Hydrocarbons
- GC 4-75** Automated Analysis Of Essential Oils
- GC 5-75** The Rapid Determination Of H<sub>2</sub>S, COS And SO<sub>2</sub> By Gas Chromatography
- GC 3-76** The Analysis Of Gas In Transformer Oils By Gas Chromatograph
- GC 4-76** Splitless Injection On Open Tubular Columns
- GC 6-76** Trace Organic Constituents In Water
- GC 7-76** Quantitative Analysis Using A "Purged Splitless" Injection Technique
- GC 8-76** The Gas Chromatographic Determination Of Residual Acrylonitrile Monomer
- GC 9-76** Analysis Of Ammonia Plant Gases
- GC 2-77** Therapeutic Drug Monitoring Performance Data For The Variable Volume Injection System
- IN-1** Quantitative Analysis With HP 1084A
- IN-3** 3050B Turbine Measurements Monitoring And Controlling The pH Of Industrial Chemical Waste





### Training Alternatives

With Hewlett-Packard's extensive product line and worldwide customer mix there are two main avenues for technical customer training. These are live training sessions and video tapes. Live training sessions fall into three subcategories: applications, service and tutorial. Application seminars aimed at increasing your utilization of general purpose test instrumentation are often available at no charge. On the other hand, seminars on the operation of dedicated systems are more specific in nature and generally have a fee for tuition. Service seminars are available on a supply-and-demand basis and also have a tuition fee. For detailed information on all HP seminars, contact your Hewlett-Packard field engineer or call the Hewlett-Packard office nearest you—see pages 715-720.

### HP Video Tapes

#### A Better Way to Learn

Part of the "extra value" which comes with each Hewlett-Packard product is our continuing commitment to provide Hewlett-Packard customers with useful training information in the areas of applications and service. In the past, this information has often been in the form of classroom seminars, either at your nearby Hewlett-Packard sales office or at one of our training facilities in California.

Now our capability is expanding by offering you both service and applications training via video tape. Video tape training is exceptionally convenient and readily available for your own use at any time or any place, including within your own facilities.

**Effective:** Hewlett-Packard has found that video tape is a highly effective training medium. Video tapes can convey more information in less time, and with higher retention, than even the best live instruction. Hewlett-

Packard programs are professionally produced and are based on measurable instructional objectives. They consider what the student already knows, emphasize what he needs to know, and omit what he does not need to know. Many video tapes utilize split-screen techniques, allowing students to watch a procedure on one part of the screen while observing its effect on another part. Most Hewlett-Packard video tapes are 100% visualized, as opposed to conventional, partially visualized video taped "lectures."

**Flexible:** With video tapes, you can tailor your training program to suit the many needs of your organization. You may select training programs for individuals with different backgrounds and specific needs, present effective programs to audiences of just one or hundreds, and offer a library of technical programs your staff members can easily consult on their own . . . for new information or for refresher purposes.

**Faster:** It has been our experience that Hewlett-Packard video programs compress learning time by a factor of up to 6-to-1. A video tape library also reduces the time needed to organize and schedule your training. You can schedule highly professional presentations anytime and anywhere, without arranging for outside instructors or juggling the detailed logistics that are often required for live training sessions. More effective training in one-sixth the time!

**Convenient:** Video tape programs come on small, easy-to-file magnetic tape cassettes. Inexpensive playback equipment is easily operated by unskilled personnel. Programs may be viewed on small portable monitors or on full-screen TV sets. Video tapes can be quickly searched for specific information using "fast forward" or "fast rewind," and many recorders can stop on a single frame for more detailed study.

**Time-tested:** All the video tapes offered in the Hewlett-Packard Videotape Catalog

were developed to serve Hewlett-Packard's needs for a practical, low cost source of up-to-date training in a wide variety of subjects. Now, after having been tested in Hewlett-Packard training activities throughout the world, many of these video programs are available to help meet your training objectives.

### Understanding Microprocessors

90301RD

This videotape training module, developed to train HP technicians, provides a practical introduction to microprocessor systems.

Microprocessors are now found in the most familiar places: automobiles, kitchen appliances, toys, home entertainment devices, as well as in modern electronic instruments. Soon all electronic technicians must be able to troubleshoot and repair this type of equipment.

Understanding Microprocessors consists of 5 videocassette lessons in color, a textbook/experiment book, and a study guide. Each lesson concludes with a self-scoring quiz. The HP 5036A Microprocessor Lab is recommended for performing assigned experiments. The lessons are directed to technicians who already are able to troubleshoot and repair equipment using digital circuitry. After completing this module, technicians should be well prepared for more advanced microprocessor troubleshooting modules. The more advanced modules presently are offered as live tutorial training courses (see photo above). They are being produced in video format for future release.

### What is a Microprocessor?

90302RD

Lesson 1

17 Mins.

This first lesson reviews the history of computers and microprocessor systems and provides an overview of the microprocessor video series. Microprocessor systems are graphically demonstrated along with the elements of microprocessor systems. Lesson 1 con-

cludes with a summary and a short self-scoring quiz.

### Analog vs Digital Systems

**90303RD Lesson 2 40 Mins.**

The differences between analog and digital systems are never more apparent than when studying microprocessor systems. This program clearly describes these differences and goes on to explain the three-state bus concept, talkers and listeners, and bus troubleshooting techniques.

### Introduction to Programming

**90304RD Lesson 3 19 Mins.**

This brief review of programming defines a few terms, describes what a program is, why programs are necessary, and how to develop them. The concepts of low and high level programs and a review precede the self-scoring quiz.

### Processor Registers and Instruction Set

**90305RD Lesson 4 30 Mins.**

This lesson describes the many registers contained on the microprocessor chip, including their uses in the operational sequence: fetch, execute and increment. The instruction set is described briefly to enable the viewer to follow the succeeding lessons.

### Simple Assembly Programming

**90306RD Lesson 5 33 Mins.**

Using the knowledge of the instruction set, the viewer is led through simple examples of assembly language programs. Translating the assembly language into machine language is shown, as well as how the program is stored in memory and executed by the processor. A program review precedes the self-scoring quiz.

### Digital Troubleshooting 90420D

Developed to train HP's own technicians, this course is especially useful in showing how to approach real problems in real equipment.

- Practical demonstrations
- Proven teaching techniques
- Flexibility of use for classroom or individual study
- Latest in digital troubleshooting tools
- Most recent logic symbology
- Useful troubleshooting tips

Digital troubleshooting was made for technicians. It is an appropriate transition from transistors to digital electronics. It also can be used as a refresher course. Equivalent in coverage to a college term of 13 weeks, the course is presented in color on 14 videocassettes having a total running time of 5 hours and 31 minutes. The lab demonstrations shown in video are from the workbook included with the series. Also included is a 180 page text and a study guide.

There is ample use of reinforcement in the presentation and in the self-scoring quizzes at the end of most of the modules.

### Digital Troubleshooting Videotapes

#### Introduction to Digital Electronics/

**90421D Lesson 1 12 Mins.**

Digital products and techniques are becoming more popular and widely used. This lesson looks at some of the areas where digital techniques are used—areas such as computers, communications, telemetry, test equip-

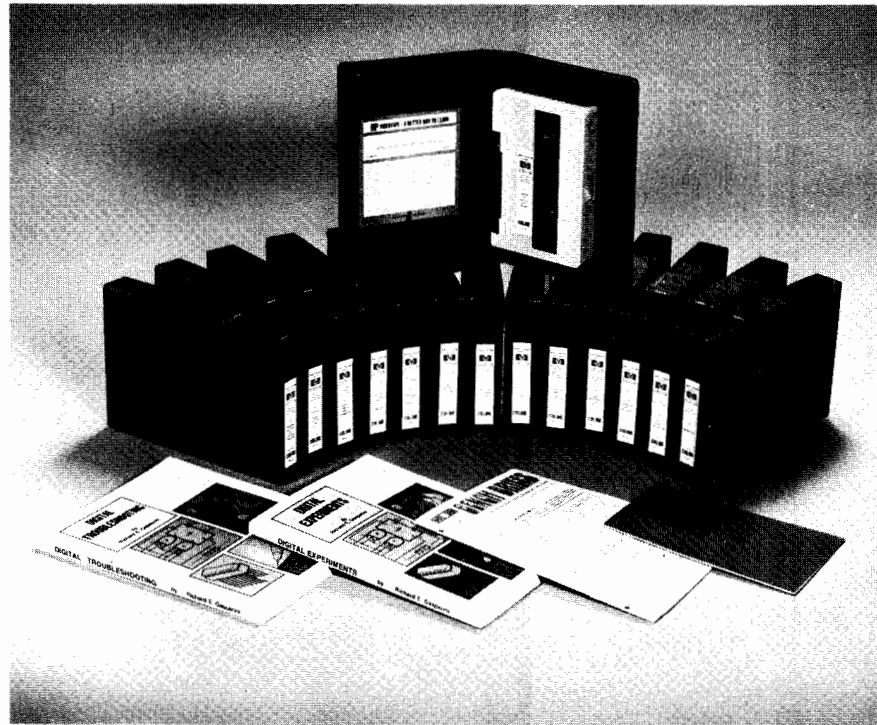

ment, industrial control, and consumer electronics. It also points out how the integrated circuit (IC) has caused a virtual explosion in the use of digital techniques. Widely used terms and concepts such as binary, digital, analog, gates, and memory are explained. The lesson concludes with a comparison of digital and analog techniques, a summary, and a short, self-scoring quiz.

### Binary Nature of Digital Circuits

**90422D Lesson 2 18 Mins.**

Digital circuits operate using the binary or two-digit number system. Binary digits (bits) are introduced in this lesson covering the operation of the pure binary and Binary Coded Decimal (BCD) systems. Mechanical or transistor switches can be used to control the two logic levels used to represent binary data. Either positive or negative logic systems can be used to represent binary numbers, and they can be transmitted in either serial or parallel fashion. This lesson concludes with a summary and a short, self-scoring quiz.

### Basics of Transistors and IC's

**90423D Lesson 3 18 Mins.**

Integrated Circuits have revolutionized digital electronics. An IC contains many transistorized circuits deposited on a tiny silicon chip. These transistorized circuits switch between two voltage levels that represent binary 1's and 0's. Because of their importance, this lesson reviews the basics of transistors and diodes. PN junction diodes are covered first, then PNP and NPN junction transistors are reviewed. The lesson then discusses how transistors can be operated as either saturated or non-saturated switches. Metal Oxide Semiconductor (MOS) transistor switches are also covered. Packaging and classification of Integrated Circuits are the final topic in this lesson followed by a summary and a short, self-scoring quiz.

### Logic Gates and Symbols

**9042D Lesson 4 25 Mins.**

Logic gates and flip-flops are the two main digital building blocks. This program covers six basic logic gates and their symbols. The logic circuits covered are the AND, NAND, OR, NOR, Exclusive OR, and Inverter. After the operation of each logic element is explained using logic symbols, the operation of a circuit is demonstrated. Next, troubleshooting of gate circuits is covered, then the use of logic troubleshooting tools is demonstrated. The lesson ends with a summary and a short, self scoring quiz.

Note: The logic symbols included in this series are based on ANSI Y32.14/IEEE 91-183. This industry standard document supersedes MIL-STD-806 B/C and is approved for use by the U.S. Department of Defense.

### Introduction to Digital IC Families

**90425D Lesson 5 29 Mins.**

This is the first of two lessons dealing with digital IC families. In this section DCTL, RTL, and DTL are covered.

This videotape begins with a review of logic gates consisting of the circuit diagram, truth table, logic diagram, and Boolean expression. Several schematics from an actual instrument are explained. Equivalent gates, shown on these schematics, are discussed according to function. This is followed by a discussion of the history of gate design as it applies to the digital troubleshooter, so that bad troubleshooting practices can be avoided. The lesson concludes with a short, self-scoring test.

### Modern Digital IC Families

**90426D Lesson 6 27 Mins.**

This is the second of two lessons dealing with digital IC families. In this section TTL, HTL, ECL and CMOS are covered.

This videotape begins with a review of the principles introduced in Lesson 5, then explains how the five subfamilies of TTL work (Standard TTL, Low Power TTL, High

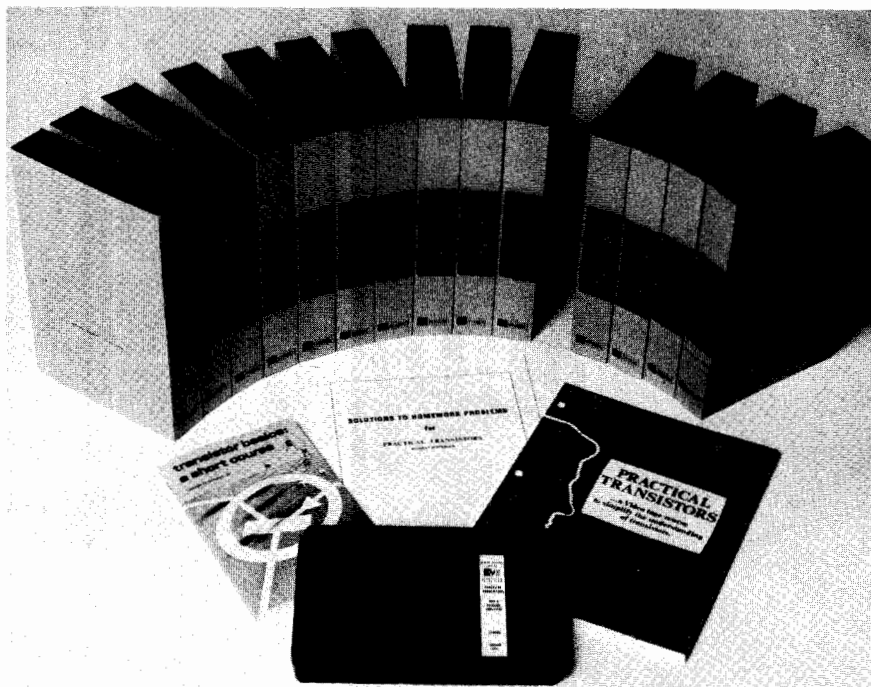

Speed TTL, Schottky TTL, and Lower Power Schottky TTL. Also explained are open-collector TTL and three-state logic. Similar discussion occurs about HTL, ECL, and CMOS families. The lesson concludes with troubleshooting as applied only to families.

**Simple Troubleshooting Techniques**  
90427D Lesson 7 18 Mins.

Experienced service technicians use a number of simple troubleshooting tools and techniques to help reduce repair time and eliminate the need for electrical measurement, when servicing integrated circuit assemblies.

This program focuses attention on logical approach to troubleshooting, highlighting simple techniques of isolating and replacing defective components on integrated circuit assemblies.

**Troubleshooting Digital IC's**  
90428D Lesson 8 27 Mins.

Fundamental differences between analog and digital circuits make traditional troubleshooting tools inefficient. Products designed especially for testing digital circuits include: The Logic Clip, Logic Probe, Logic Pulser, Current Tracer, and Logic Comparator. This program takes a close look at these IC Troubleshooters. Also covered are the types of failures found in digital integrated circuits and how to troubleshoot them.

**Flip-flops**  
90429D Lesson 9 31 Mins.

Flip-flops are one of the main building blocks of digital circuits. This program covers both the NAND and NOR RS, closed RS, D, T, and JK flip-flops. The theory of operation of each flip-flop is covered using ANSI Y32.14/IEEE 91-1973 logic symbology. Then, the flip-flop is demonstrated and its operation summarized. Clocked logic, edge and level triggering, direct set and reset inputs,

and troubleshooting flip-flops are also covered.

**Counters and Shift Registers**  
90430D Lesson 10 30 Mins.

Counters and Shift Registers are the two most popular uses of flip-flops. This program covers binary and decade counters, both ripple and synchronous types. Also covered are up and down counters, presettable counters, frequency dividers, circular shift registers and strobed displays. The operation of each circuit is first explained using logic symbols, then demonstrated. Troubleshooting is the final topic in this program. The lesson ends with a short, self-scoring quiz.

**Combinational Logic Circuits**  
90431D Lesson 11 30 Mins.

The basic building blocks of combinational logic circuits are gates. In this videotape we see how gates are combined to form line drivers, three-state drivers, one-shot multivibrators, multiplexers, adders, and code converters.

After an overview of the operation of these devices, they're shown in actual use in a production line device.

The program concludes with a section on troubleshooting, which deals with typical problems which may arise in combinational logic circuits.

**Display Technologies**  
90432D Lesson 12 30 Mins.

A large variety of display technologies is used with digital circuits. This program looks at the types and configurations of displays, then discusses typical troubleshooting problems specific to them. Some of the types covered are neons, gaseous discharge tubes, and light emitting diodes (both segmented and dot matrix forms). Included is a discussion on planar tubes, incandescent displays, and liquid crystals.

In the troubleshooting section typical faults the technicians might encounter are discussed. Each of these faults is demonstrated and solutions are suggested.

**IC Manufacturing**  
90433D Lesson 13 11 Mins.

A basic knowledge of IC manufacturing should prove helpful to anyone involved in servicing digital equipment.

Manufacturing IC's involves a photographic process, and a series of masks is used to control the areas where impurities are allowed to diffuse forming semiconductors. This program shows the steps in the manufacture of IC's, starting with an actual wafer and following it through to a completed IC package.

**Memories**  
90434D Lesson 14 25 Mins.

Due to the many unique demands of today's users of computers and calculating devices, many different configurations for different types of memory are required. This lesson considers six types of memory-punched paper tape, punched cards, magnetic (reel-to-reel and cartridge), magnetic disc (hard and floppy), ferrite core, and semiconductor.

This lesson defines and describes the use of sequential access and Random Access Memory (RAM), volatile and nonvolatile memory, Read/Write Memory, Read-Only Memory (ROM) and Programmable Read-Only Memory (PROM). Tips on handling the various types of memory conclude the program.

**Practical Transistors 90100D**

The widely used Practical Transistor Series is a definitive, monochrome, 15-tape excursion into the exceedingly important (and mysterious) world of transistors. As outlined below, each highly informative program in the wide-ranging series is primarily concerned with examining the many practical aspects of transistors rather than just dwelling on theory and math. The end result, after viewing this popular series, will be a deeper working understanding of transistors which will make maintenance and troubleshooting problems far easier and more efficient. The series is therefore highly recommended for electronics students, service personnel and engineers.

A supplementary textbook by transistor authority George Stanley Jr. (who also hosts the series), plus a complete set of homework problems and answers, is included with the nearly nine hours of video taped material.\*

**Transistors vs. Tubes**  
90030D330 Lesson 1 30 Mins.

The first program in the 15-part series introduces author George C. Stanley Jr., who defines the objectives of the course, describes the text upon which the course is based and explains the use of the homework problems. The rest of the program then reviews and builds upon the student's prior knowledge to make comparisons between vacuum tubes and transistors.



### Temperature Effects

**90030D316 Lesson 2 41 Mins.**

Part 2 develops the various common techniques of biasing transistors, and emphasizes the effects of heat on transistor circuits with demonstrations.

### Current/Voltage Drive

**90030D317 Lesson 3 41 Mins.**

Part 3 is concerned with the comparison between voltage drive and current drive in transistor circuits. During this program, several concepts are developed which become important building blocks for the rest of the course.

### Answers by Inspection

**90030D318 Lesson 4 43 Mins.**

Part 4 develops the first of several valuable timesaving rule-of-thumb formulas: a simplified expression for voltage gain. Demonstrations serve to illustrate the usefulness and effectiveness of this formula.

### Answers by Inspection

**90030D319 Lesson 5 40 Mins.**

Part 5 develops additional rule-of-thumb formulas for the calculation of voltage gain with feedback, input impedance, output impedance, and distortion in common emitter circuits.

### Answers by Inspection

**90030D331 Lesson 6 37 Mins.**

Part 6 concentrates on the emitter follower circuit and develops expressions for its voltage gain, and input and output impedance.

### Multistage Amplifiers

**90030D322 Lesson 7 44 Mins.**

Part 7 is devoted to applying the knowledge gained in Parts 4, 5, and 6 to an analysis of a three-stage transistor amplifier. Demonstrations on an actual circuit illustrate the accuracy of the approximations involved.

### Troubleshooting

**90030D323 Lesson 8 43 Mins.**

The information obtained in preceding programs is further clarified in Part 8, which covers troubleshooting on both single-stage and multi-stage transistor circuits. Class problems are presented and solved using actual circuits.

### Feedback Amplifiers

**90030D324 Lesson 9 27 Mins.**

Part 9 first reviews single-stage and multi-stage circuits with feedback. Valuable troubleshooting tips for feedback circuits are then illustrated with demonstrations.

### Why a Transistor Amplifies

**90030D325 Lesson 10 27 Mins.**

Part 10 illustrates how and why transistors amplify electrical signals. Discussion of the roles of majority and minority carriers leads to an intriguing example of the effect of nuclear radiation on transistor performance.

### Troubleshooting

**90030D326 Lesson 11 33 Mins.**

Part 11 is devoted to more practical applications of what has been learned so far. Demonstrations of troubleshooting are given on an actual multistage transistor amplifier to illustrate common failure patterns.

### Fets and Unijunctions

**90030D327 Lesson 12 34 Mins.**

Part 12 provides explanations of the operation of both junction and MOS field-effect transistors. Troubleshooting tips and the ef-

fects of nuclear radiation on these devices are given. The program concludes with the operation of the Unijunction transistor.

### Breakdown Diodes

**90030D328 Lesson 13 37 Mins.**

Part 13 compares Zener and avalanche diodes in terms of their temperature coefficient of voltage. This leads to a discussion of the use of various kinds of diodes for temperature compensation networks.

### SCR's and Tunnel Diodes

**90030D329 Lesson 14 28 Mins.**

Part 14 covers the operation and the uses for silicon controlled rectifiers and tunnel diodes. Special video effects help to explain the complexities of tunnel diode operation. Comparisons are then drawn to other semiconductor devices.

### PIN, SRD, and HC Diodes

**90030D332 Lesson 15 28 Mins.**

Part 15 explains step recovery diodes, hot carrier diodes, and PIN diodes, and outlines their typical applications. The series concludes with a short presentation on how the many special video effects were created for the various tapes in the series.

### How to Use an Oscilloscope Series

**90741D 1 hr, 16 Mins.**

The oscilloscope is one of the most versatile and widely used electronic test instruments. However, for best results it must be used properly. The purpose of this 3 videotape series, in color, is to train electronic technicians in the basic techniques of waveform measurement, using an oscilloscope. The HP1740A general purpose scope and the HP1741A storage scope are used in this series. However, the information presented will also help you operate other scopes.

### Front Panel Controls

**90742D Part I 27 Mins.**

This videotape will show you how to:

- measure the peak-to-peak ac voltage, time period, frequency and dc component (if any) of a waveform;
- measure low level signals such as power supply ripple;
- trigger or synchronize the scope to obtain a stable display on the CRT; and
- avoid errors in control settings that could lead to measurement inaccuracies.

### Front Panel Controls (cont.)

**90743D Part II 24 Mins.**

This program completes the coverage of the front panel controls of a general purpose oscilloscope. In Part I, only single channel operation was covered. This program covers dual channel operation. You will see how to operate a scope in the dual trace, A + B, A - B, and A versus B modes. Also covered are selectable and composite triggering, trigger view mode, bandwidth limit and delayed sweep operation.

### Oscilloscope Measurements

**90744D Part III 25 Mins.**

This program completes the series. It shows you how to check your scope and probe to make sure they are operating properly. You'll see that one probe cannot be used for all measurements, so the three types of commonly available voltage probes are covered. Then you will see how to make some typical oscilloscope voltage and time measurements.

Finally, storage scopes are covered. You will see how they can help you solve the problem of viewing low rep-rate signals and one-shot events. The program ends with a short summary.

### How to Solder

**90751D 35 Mins.**

This program is especially useful for training new hires who will work in electronic manufacturing and servicing—including those persons who believe they already know how to solder and unsolder properly.

Part I (16 minutes) covers:

- What is soldering Flux
- Wetting Soldering Irons
- Solder Tinning

Part 2 (19 minutes) shows:

- How to clean parts to be soldered
- The four basic soldering steps
- How to recognize a good solder connection
- How to unsolder, using the vacuum bulb, the solder-sucker, and the desoldering wick.

The program ends with a summary and a self-scoring quiz.

### Ordering Information

To order video programs, books, the HP 5035T Logic Lab or the 5036A Microprocessor Lab, please contact your local Hewlett-Packard sales office, addresses are listed on pages 715-720.

### HP Product Number

Price

**90301RD** Understanding Microprocessors (5 videocassettes, plus a textbook/experiment book, and study guide). \$1,700.\*

Lab experiments are used to reinforce learning. They require access to a microprocessor lab such as the HP 5036A.

**90420D** Digital Troubleshooting (14 videocassettes, plus a textbook, lab workbook, and study guide) \$3,600\*

Lab experiments are used to reinforce learning. They require access to a digital experimenter's kit such as the HP 5035T Logic Lab.

**90100D** Practical Transistors (15 monochrome videocassettes plus a textbook, workbook problem sets) \$1,687.50\*

**90741D** How to Use an Oscilloscope Series \$750.00

**90751D** How to Solder \$395.00

**22958B** RTE Fortran Independent Study Course (6 videocassettes (color) and workbook). Access to an HP 1000 with an RTE IVB operating system is required. \$1000

Local taxes, shipping and handling will be added to all orders.

Midterm examinations, final examination, examination solutions and certificates of completion are supplied with the purchase of 90100D and 90420D, but are shipped separately. See your local HP field engineer for details.

Video programs are supplied in NTSC Standard only.

Available formats are ¾" U Matic, ½" VHS and ½" Beta I.

Domestic U.S. Prices only.

\*Not eligible for quantity discount.



## POST-SALE SUPPORT SERVICE

Warranty, certification, parts, publications

When you purchase a Hewlett-Packard product, you also receive the assurance that it will continue to perform to its published specifications today, tomorrow, and for a reasonable number of years in the future.

We firmly believe that our obligation to you as a customer goes beyond delivery of your new HP product. This philosophy is implemented in two ways: (1) by designing and building excellent products with good serviceability, and (2) by backing those products with customer support programs which quickly respond to all your needs.

HP customer support service programs provide responsive support services from HP and distributor organizations in countries throughout the world. (Their support capabilities are specified in the sales/support office listing inside the back cover of this catalog.) These programs are one of the major reasons for Hewlett-Packard's reputation of integrity and responsibility.

### Warranty

As an expression of confidence that our products will continue to meet the high standards of reliability and performance that our customers expect, Hewlett-Packard products carry the following warranty:

*Hewlett-Packard (HP) products are warranted against defects in materials and workmanship. The warranty period for each product will be provided on request at the time of sale, and is specified in documentation supplied with the product. During the warranty period, HP will, at its option, either repair or replace products which prove to be defective.*

*Warranties requiring return-to-HP are not limited to the country of purchase. Parts and labor are provided during the warranty period when the customer returns the product to any office designated by HP for repair of the product.*

*Installation services provided during warranty and on-site warranty services are available only in HP Service Travel Areas, and only in the country of initial purchase, unless buyer pays HP international prices. On-site warranty service for those products requiring installation services is provided only at the initial installation point.*

*If the buyer transports his product from the initial country of purchase without paying HP international prices, then any remaining warranty covers parts and labor only. The customer can return the product to any office designated by HP for repair of the product. In this case, the customer can obtain on-site warranty service if the location is one where HP can normally provide on-site service for the product by paying HP established travel charges and, if required for the product, purchasing all necessary installation services from HP.*

*Buyer shall prepay shipping charges for products returned to HP for warranty service; and HP shall pay for return of the products to buyer. However, buyer shall pay all shipping charges, duties and taxes for products returned to HP from another country.*

### Limitation of warranty

*The foregoing warranty shall not apply to defects resulting from:*

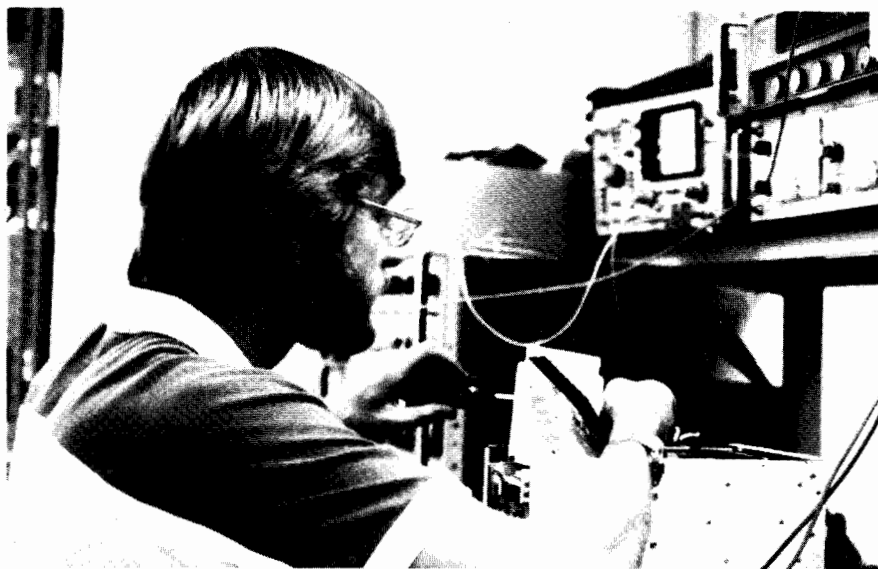

1. *Improper or inadequate maintenance by buyer;*
2. *Buyer-supplied software or interfacing;*
3. *Unauthorized modification or misuse;*
4. *Operation outside of the environmental specifications for the product; or*
5. *Improper site preparation or maintenance.*

*No other warranty is express or implied. HP specifically disclaims the implied warranties of merchantability and fitness for a particular purpose.*

### Exclusive remedies

*The remedies provided herein are buyer's sole and exclusive remedies. HP shall not be liable for any direct, indirect, special, incidental, or consequential damages, whether based on contract, tort or any other legal theory.*

### Certification

Hewlett-Packard testing and quality assurance programs are documented in a Certificate of Conformance which is available upon request at the time of purchase. This certificate states:

*Products, materials, parts and services furnished on this order have been provided in accordance with all applicable Hewlett-Packard specifications. Actual inspection and test data pertaining to this order is on file and available for examination.*

*Hewlett-Packard's calibration measurements are traceable to the National Bureau of Standards to the extent allowed by the Bureau's calibration facilities.*

*The Hewlett-Packard Quality Program satisfies the requirements of MIL-Q-9858A, MIL-I-45208A and MIL-C-45662A.*

### Replacement Parts and Supplies

Replacement parts play a key role in Hewlett-Packard's customer support services program. Hewlett-Packard's strategically located parts centers supply parts to both HP field operations and our customers. HP's field operations maintains extensive parts inventories at repair centers and local service responsible offices to assure prompt repair of your product.

The reliability and product life of HP products can be enhanced by the use of quality operating supplies. Hewlett-Packard provides a complete selection of high quality supplies for electronic instruments, medical products, and computer systems. Separate catalogs describing the supplies offered for each product line are available from your local HP office.

When ordering replacement parts or supplies from your local office, please specify the correct HP part number and description obtained from product documentation, a parts price list, or the appropriate supplies catalog. If you do not know the part number, please include the product model number, serial number, and a complete description of the item, its function and location within the product. These orders are generally shipped from HP parts centers on the next working day. Replacement parts are not available for the handheld calculator line.

### Service Publications

The *Operating* and *Service Manual* supplied with each Hewlett-Packard test and measuring product contains maintenance, calibration, diagnostic and repair procedures, with troubleshooting charts and circuit diagrams. All replaceable parts are listed. Extra manuals are available from your nearby Hewlett-Packard field office. Most operating and service manuals, manual updates, and *Service Notes* are now available on COSATI standard, positive microfiche.

New or special calibration procedures, instrument modifications, and special repair procedures are described in detail in Hewlett-Packard *Service Notes*. This series of publications serves as a convenient means of updating operating and service manuals.

*Bench Briefs*, a periodic newsletter, has service tips, new modifications, and other suggestions to help repair and maintenance personnel get maximum performance from Hewlett-Packard instruments. It describes new *Service Notes* and other company publications as they become available. To become a regular subscriber, ask your local HP office to place your name on the mailing list.

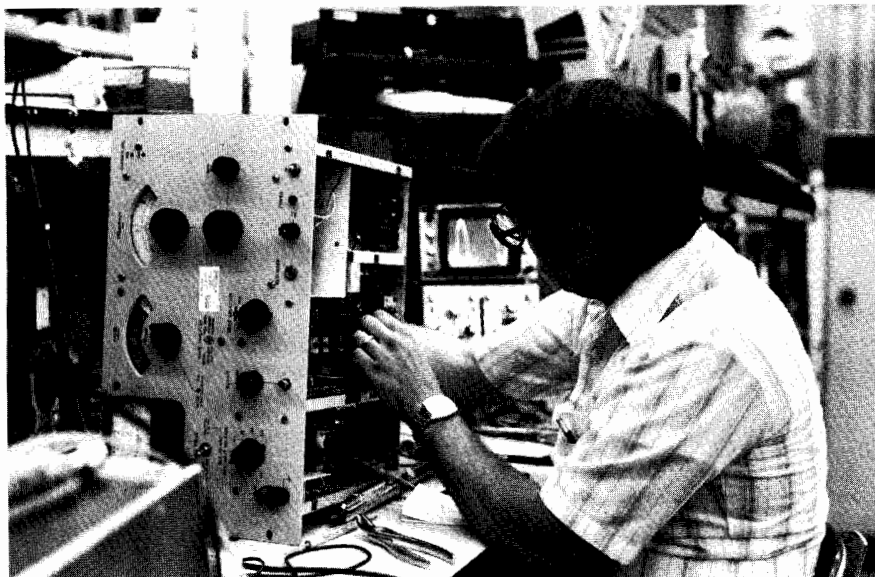

### Service Responsible Offices

Providing complete support services when and where you need them is one of Hewlett-Packard's primary goals. Throughout the world, Hewlett-Packard has established HP Service Responsible Offices (SROs) to meet the support requirements of all HP customers.

Hewlett-Packard's worldwide support is further enhanced by the use of privately-owned companies operating as distributors for the sale and support of selected products. You should contact these companies directly or through your nearest HP SRO for information on available services.

Since it is impractical for offices to support products not marketed within their assigned territory, all products within a given product category are not supported by every HP office. The office list in the back of this catalog identifies the product lines supported by each office. For more specific information about office capability, contact your nearest HP Sales/Support office.

### Travel for on-site services

Each Hewlett-Packard Service Responsible Office is surrounded by defined travel zones which are used to quote both response times and travel charges for specified on-site services. Hewlett-Packard routinely provides its on-site support services within defined travel areas of each country where the products are sold. In many instances these travel areas encompass the entire country. However, there are instances which prohibit routine travel such as geographical obstacles, underdeveloped roads, or unsuitable public transportation. In such cases these areas will be excluded from routine travel. Your HP SRO will be able to provide information regarding excluded travel areas, as well as response times and charges for on-site service.

### Customer Support Services Agreement

Hewlett-Packard offers a wide range of service programs for products and systems under a Customer Support Services Agreement (CSSA). This ongoing agreement features a known cost billed on a periodic basis. Products and service programs can be added to the agreement as required. On-site services can be provided at multiple locations within a country under a single CSSA.

### Electronic Instruments/Measurement Systems

Hewlett-Packard offers a variety of service programs for instruments and measurement systems. HP instrument repair centers located around the world support HP instrument products under several CSSA programs. A Calibration Agreement assures ongoing instrument performance checks at either HP or customer recommended intervals. A Repair Agreement provides an insurance policy for instrument failures resulting from normal use. Both these services can be obtained under a Full Service Agreement.

HP also offers a number of on-site support services under CSSA for HP measurement systems products. These programs provide a choice among optional levels of response, hours of coverage, critical instrument sparing, installation and training.

### Analytical Instrumentation

Analytical on-site Product Maintenance Service includes comprehensive repairs (all parts except certain expendables and consumables), labor and travel. Routine customer maintenance training can be provided at customer request and, as an option, installation for instruments where it is not normally provided. Normal on-site response to a service request is 1 day.

### Computer Products/Systems

A wide variety of hardware and software support programs are available for computer systems, desktop computers, terminals and related peripherals. Sufficient flexibility exists to allow you to tailor a comprehensive program for your site at a reasonable cost. Complete details are available from your Sales Representative. Ask him for a copy of HP's *Computer Systems Support Services Data Book*.

### Medical products systems

Specialized service plans are available for medical products and systems under the CSSA. In addition to an agreement covering on-site repairs, HP offers options for Safety Assurance Checks, Performance Assurance Checks, or both.

### Per-call Service

Per-call service can meet your need for repairs, installation, site planning, site surveys, calibrations, preventive maintenance, safety and performance checks, overhauls and technical assistance. These services are available at your site, or at HP Repair Centers located around the world.

For many Hewlett-Packard products, the labor and parts costs for repair of failures resulting from normal use have been combined into a convenient Standard Repair Charge which can be quoted prior to the repair. If a Standard Repair Charge has not been established, per-call services are performed on a time and material basis.

### Maintenance and Customer Training

Maintenance training is available on both a formal and informal basis for specific HP products. Product Service Seminars, covering theory of operation, service techniques, and component level repair are provided for some electronic instruments. Scheduled training courses for selected computer products cover theory of operation, and assembly level troubleshooting in a classroom and lab environment. Depending upon availability, HP personnel can provide maintenance training at your facility on a time and material basis.

For more efficient utilization of HP products, systems and software, HP offers a wide variety of customer training courses at HP Customer Training Centers located around the world. Experienced Systems Engineers teach courses ranging from general introductions to advanced training on specific products or applications. Contact your local HP office for a training schedule which lists course descriptions, training locations and dates.



# ORDERING INFORMATION

Shipping, prices, and terms of sale

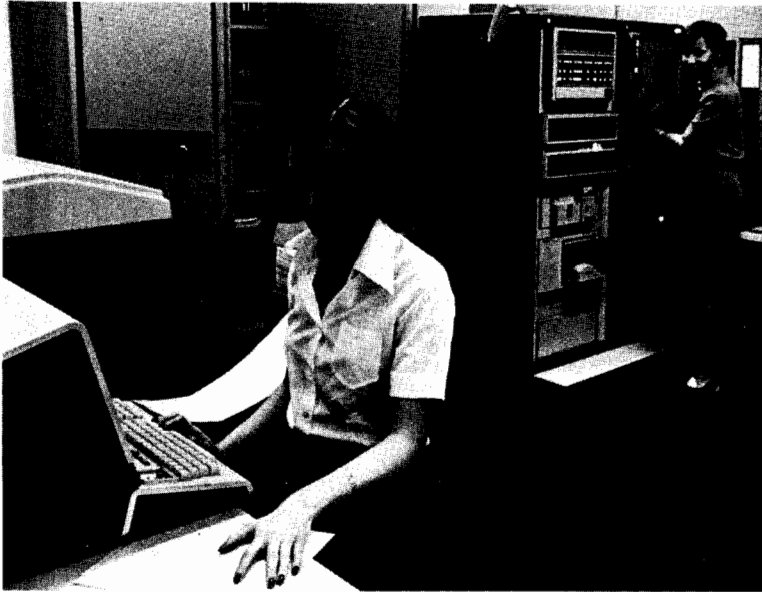

## Communicating With HP

Hewlett-Packard is committed to providing convenient local support and the best possible attention to customer needs on a worldwide basis. There are more than 172 sales offices and representatives, many of which provide service, located in 65 countries; A listing of these offices appears on pages 715-720.

Your entry point to the resources of Hewlett-Packard is through the local HP office nearest you. Our sales representatives and order support specialists there are well-equipped to provide you with pre-sale assistance in product selection, as well as related business information such as current product availability and price delivered to your location.

Many HP sales offices are tied into a sophisticated intra-company communications system. This not only means prompt transmission of orders to any of the 30 HP product responsible divisions—it also speeds the flow of regular messages among HP sales offices and factories. The objective, of course, is to provide the fastest possible response to your product interests.

## Placing Your Order

Hewlett-Packard people at the sales office nearest you will be pleased to provide assistance in selecting the HP equipment most appropriate to your needs, and to help you prepare your order.

The information in this catalog will, in many cases, be sufficient for you to decide to buy a particular HP product. In those instances, a telephone call to the nearest HP office will provide you with (1) information on product availability, and (2) the product's price.

HP wants to be sure the product delivered to you is exactly the one you want. Therefore,

when placing your order, please specify the product's catalog (model, accessory, or part) number, as well as the product's name. Be as complete as possible in specifying exactly what you'd like, including standard options.

In the event you want special features or capabilities such as different color or a non-standard power line voltage, ask your HP sales representative about availability and cost of these "specials" first—and then, to prevent misunderstandings, include special instructions and specification details with your order.

## Shipping Methods

**Inside the USA:** Shipments to destinations in the USA are made directly from factories or local warehouses. Unless specifically requested otherwise, express or truck transportation is used, whichever is less expensive and most serviceable to you. Small items are sent parcel post or UPS. If fast delivery is needed, we gladly ship by air freight, air express, or air parcel post, when specified on your order, at prevailing rates. In many parts of the USA, a consolidated air freight service provides the speed of air transport at surface rates. Ask your HP sales representative for details.

**Outside the USA:** Shipments to destinations outside the USA are made from the appropriate Hewlett-Packard facility by either surface or air, as requested. Sea shipments usually require commercial export packaging at a nominal extra charge.

## Budgetary Prices

Price information which may be supplied with this catalog provides you with helpful budgetary guidance.

Prices appearing in this catalog, unless otherwise specified, are F.O.B. U.S.A. factory or shipping point and apply only to domestic U.S.A. customers for use in the U.S.A.

Please call your nearby Hewlett-Packard sales office to determine a product's delivered price outside of the U.S.A.

Prices furnished with this catalog are net prices prevailing at the time of printing. Hewlett-Packard reserves the right to change prices, and those prices prevailing at the time an order is received will apply.

## Quotations and Pro Forma Invoices

Destination prices and other details you may need to know before ordering can be quickly obtained via telephone. Just call your nearest HP office.

If you are an international customer requiring formal paperwork such as pro forma invoices or quotations, please contact the Hewlett-Packard office or representative serving your area. Exportation or importation assistance is also available.

## Terms of Sale

**Inside the USA:** Terms are net 30 days from invoice date. Unless credit with Hewlett-Packard has already been established, shipments will be made COD or on receipt of cash in advance.

Leasing and extended financial terms are available. However, the associated costs are not included in any product prices furnished with this catalog. Your nearby HP office will be pleased to discuss your requirements, and work with you in setting up an appropriate program.

**Outside the USA:** Terms for orders from customers outside the United States of America which are placed with the Hewlett-Packard Company, are irrevocable letters of credit or cash in advance—unless other terms have been previously arranged. Terms for orders placed with authorized Hewlett-Packard international subsidiaries or representatives/distributors are mutually determined.

## U.S. Government Sales

Some products in this catalog are covered on GSA federal supply schedule multi-award contracts.

## Product Changes

Although product information and illustrations in this catalog were current at the time it was approved for printing, Hewlett-Packard, in a continuing effort to offer excellent products at a fair value, reserves the right to change specifications, designs, and models without notice.

NOTES: 1. Minimum order in USA \$20, except where cash is received with order on over-the-counter or direct mail sales.  
2. Not all HP-IB instruments are furnished with interconnecting cables; see page 30 for description.



## Product Line Sales/Support Key

Key	Product Line
A	Analytical
CM	Components
C	Computer Systems
CP	Computer Systems Primary Service Responsible Office (SRO)
CS	Computer Systems Secondary SRO
E	Electronic Instruments & Measurement Systems
M	Medical Products
MP	Medical Products Primary SRO
MS	Medical Products Secondary SRO
P	Consumer Calculators
.	Sales only for specific product line
..	Support only for specific product line

**IMPORTANT:** These symbols designate general product line capability. They do not insure sales or support availability for all products within a line, at all locations. Contact your local sales office for information regarding locations where HP support is available for specific products.

HP distributors are printed in italics.

## ANGOLA

*Telebra*  
*Empresa Tecnica de Equipamentos*  
*Electricos, S.A.R.L.*  
*R. Barbosa Rodrigues, 41.-I. DT.*  
*Caixa Postal 6487*  
**LUANDA**  
*Tel: 35515,35516*  
*A\*,E,M,P*

## ARGENTINA

Hewlett-Packard Argentina S.A.  
 Avda Santa Fe 2035  
 Martinez 1640 **BUENOS AIRES**  
 Tel: 798-6086, 792-1293  
 Cable: HEWPACARG  
 A,E,CP,P

*Bioltron S.A.C.I.y.M*  
*Avenida Paseo Colon 221*  
*9 Piso*  
*1399 BUENOS AIRES*  
*Tel: 30-4846, 30-1851, 30-8384,*  
*34-9356, 34-0460, 34-4551*  
*Telex: (33)17595 BIONAR*  
*Cable: BIOTRON Argentina*  
*M*

*Fate S.A. Electronica*  
*Bartolomeu Mitre 833*  
*1036 BUENOS AIRES*  
*Tel: 74-41011, 74-49277,*  
*74-43459*  
*Telex: 18137, 22754*  
*P*

## AUSTRALIA

**Australia Capital Territory**  
 Hewlett-Packard Australia Pty.Ltd.  
 121 Wollongong Street  
**FYSHWICK, A.C.T.** 2609  
 Tel: 804-244  
 Telex: 62650  
 Cable: HEWPARD Canberra  
 A\*,CM,CS,E,MS,P

**New South Wales**  
 Hewlett-Packard Australia Pty.Ltd.  
 17-23 Talavera Road  
**NORTH RYDE, N.S.W.** 2113  
 P.O. Box 308  
 Tel: 887-1611  
 Telex: 21561  
 Cable: HEWPARD Sydney  
 A,CM,CP,E,MS,P

## Queensland

Hewlett-Packard Australia Pty.Ltd.  
 5th Floor  
 Teachers Union Building  
 495-499 Boundary Street  
**SPRING HILL, Queensland** 4000  
 Tel: 229-1544  
 Telex: 42133  
 Cable: HEWPARD Brisbane  
 A,CM,CS,E,MS,P

## South Australia

Hewlett-Packard Australia Pty.Ltd.  
 153 Greenhill Road  
**PARKSIDE, S.A.** 5063  
 Tel: 272-5911  
 Telex: 82536  
 Cable: HEWPARD Adelaide  
 A\*,CM,CS,E,MS,P

## Victoria

Hewlett-Packard Australia Pty.Ltd.  
 31-41 Joseph Street  
**BLACKBURN, Victoria** 3130  
 Tel: 89-6351  
 Telex: 31-024  
 Cable: HEWPARD Melbourne  
 A,CM,CP,E,MS,P

## Western Australia

Hewlett-Packard Australia Pty.Ltd.  
 141 Stirling Highway  
**NEDLANDS, W.A.** 6009  
 Tel: 386-5455  
 Telex: 93859  
 Cable: HEWPARD Perth  
 A,CM,CS,E,MS,P

## AUSTRIA

Hewlett-Packard Ges.m.b.h.  
 Veraufsbuero Graz  
 Grottenhofstrasse 94  
**A-8052 GRAZ**  
 Tel: 21-5-66  
 Telex: 32375  
 CM,C\*,E\*  
 Hewlett-Packard Ges.m.b.h.  
 Wehlstrasse 29  
 P.O. Box 7  
**A-1205 VIENNA**  
 Tel: (222) 35-16-210  
 Telex: 135823/135066  
 A,CM,CP,E,MS,P

## BAHRAIN

*Green Salon*  
*P.O. Box 557*  
**BAHRAIN**  
*Tel: 5503*  
*Telex: 88419*  
*P*

## Wael Pharmacy

*P.O. Box 648*  
**BAHRAIN**  
*Tel: 54886, 56123*  
*Telex: 8550 WAEL GJ*  
*M*

## BANGLADESH

*The General Electric Co. of*  
*Bangladesh Ltd.*  
*Magnet House 72*  
*Dilkusha Commercial Area*  
**MOTIJHELL, Dacca 2**  
*Tel: 252415, 252419*  
*Telex: 734*  
*Cable: GECDAC Dacca*  
*A,E,M*

## BELGIUM

Hewlett-Packard Belgium S.A./N.V.  
 Boulevard de la Woluwe 100  
 Woluwedal  
**B-1200 BRUSSELS**  
 Tel: (02) 762-32-00  
 Telex: 23-494 B  
 A,CM,CP,E,MP,P

## BRAZIL

Hewlett-Packard do Brasil I.e.C.  
 Ltda.  
 Alameda Rio Negro, 750  
**ALPHAVILLE** 06400 Barueri SP  
 Tel: 421-1311  
 Telex: 011 23602 HPBR-BR  
 Cable: HEWPACK Sao Paulo  
 A,CM,CP,E,MS  
 Hewlett-Packard do Brasil I.e.C.  
 Ltda.  
 Rua Padre Chagas, 32  
**90000-PORTO ALEGRE-RS**  
 Tel: 22-2998, 22-5621  
 Cable: HEWPACK Porto Alegre  
 A\*,CM,E,MS,P\*

Hewlett-Packard do Brasil I.e.C.  
 Ltda.  
 Avenida Epitacio Pessoa, 4664  
**20000 RIO DE JANEIRO-RJ**  
 Tel: 286-0237  
 Telex: 021-21905 HPBR-BR  
 Cable: HEWPACK Rio de Janeiro  
 A,CM,E,MS,P\*

## BURUNDI

*Typomeca S.P.R.L.*  
*B.P. 553*  
**BUJUMBURA**  
*Tel: 2659*  
*P*

## CANADA

**Alberta**  
 Hewlett-Packard (Canada) Ltd.  
 210, 7220 Fisher Street S.W.  
**CALGARY, Alberta** T2H 2H8  
 Tel: (403) 253-2713  
 Telex: 610-821-6141  
 A,CM,CP,E\*,MS,P\*

Hewlett-Packard (Canada) Ltd.  
 11620A-168th Street  
**EDMONTON, Alberta** T5M 3T9  
 Tel: (403) 452-3670  
 Telex: 610-831-2431  
 A,CM,CP,E,MS,P\*

## British Columbia

Hewlett-Packard (Canada) Ltd.  
 10691 Shellbridge Way  
**RICHMOND, British Columbia** V6X 2W7  
 Tel: (604) 270-2277  
 Telex: 610-922-5059  
 A,CM,CP,E\*,MS,P\*

## Manitoba

Hewlett-Packard (Canada) Ltd.  
 380-550 Century Street  
 Saint James  
**WINNIPEG, Manitoba** R3H 0L8  
 Tel: (204) 786-6701  
 Telex: 610-671-3531  
 A,CM,CS,E,MS,P\*

## Nova Scotia

Hewlett-Packard (Canada) Ltd.  
 P.O. Box 931  
 900 Windmill Road  
**DARTMOUTH, Nova Scotia** B2Y 3Z6  
 Tel: (902) 469-7820  
 Telex: 610-271-4482  
 CM,CP,E\*,MS,P\*

## Ontario

Hewlett-Packard (Canada) Ltd.  
 552 Newbold Street  
**LONDON, Ontario** N6E 2S5  
 Tel: (519) 686-9181  
 Telex: 610-352-1201  
 A,CM,CS,E\*,MS,P\*

Hewlett-Packard (Canada) Ltd.  
 6877 Goreway Drive  
**MISSISSAUGA, Ontario** L4V 1M8  
 Tel: (416) 678-9430  
 Telex: 610-492-4246  
 A,CM,CP,E,MP,P

Hewlett-Packard (Canada) Ltd.  
 1020 Morrison Drive  
**OTTAWA, Ontario** K2H 8K7  
 Tel: (613) 820-6483  
 Telex: 610-563-1636  
 A,CM,CP,E\*,MS,P\*

## Quebec

Hewlett-Packard (Canada) Ltd.  
 275 Hymus Boulevard  
**POINTE-CLAIRE, Quebec** H9R 1G7  
 Tel: (514) 697-4232  
 Telex: 610-422-3022  
 A,CM,CP,E,MP,P\*

## CHILE

*Jorge Calcagni y Cia. Ltda.*  
*Arluro Burtle 065*  
*Casilla 16475*  
**Correo 9, SANTIAGO**  
*Tel: 220222*  
*Telex: JCALCAGNI*  
*A,E,M,P*

*Olympia (Chile) Ltd.*  
*Rodrico de Araya 1045*  
*Casilla 256-V*  
**SANTIAGO 21**  
*Tel: 25-50-44*  
*Telex: 40-565*  
*P*

## COLOMBIA

*Instrumentacion*  
*H. A. Langebaek & Kier S.A.*  
*Carrera 7 No. 48-75*  
**BOGOTA 2, DE**  
*Aparlado Aereo 6287*  
**BOGOTA 1 D.E.**  
*Tel: 269-8877*  
*Telex: 44400*  
*Cable: AARIS Bogota*  
*A,E,M,P*

*Instrumentacion*  
*H.A. Langebaek & Kier S.A.*  
*Edif. Camaco, Local 105*  
*Carrera 63 No. 49-A-31*  
*Aparlado 54098*  
**MEDELLIN**  
*Tel: 304475*  
*A,E,M,P*

## COSTA RICA

*Cientifica Costarricense S.A.*  
*Avenida 2, Calle 5*  
*San Pedro de Montes de Oca*  
*Apartado 10159*  
**SAN JOSE**  
*Tel: 24-38-20, 24-08-19*  
*Telex: 2367 GALGUR CR*  
*Cable: GALGUR*  
*A,E,M,P*

## CYPRUS

*Kryponics*  
*19 Gregorios Xenopoulos Street*  
*P.O. Box 1152*  
**NICOSIA**  
*Tel: 45628, 45629*  
*Telex: 3018*  
*E,M,P*

## CZECHOSLOVAKIA

*Vyvojova a Provozni Zakladna*  
*Vyzkumnych Ustavu v Bechovicich*  
*CSSR-25097 BECHOVICE U PRAHY*  
*Tel: 89-9341*  
*Telex: 12133*  
*P\**

*Hewlett-Packard*  
*Obchodni Zastupitelstvi v CSSR*  
*Pisemny styk*  
*Post. schranka 27*  
**CS 118 01 PRAHA 011**  
*Tel: 66-296*  
*Telex: 121353 1HC*  
*A\*,C\*,E\*,M\*,P\**

## DENMARK

Hewlett-Packard A/S  
 Datavej 52  
**DK-3460 BIRKEROD**  
 Tel: (02) 81-66-40  
 Telex: 37409 hpas dk  
 A,CM,CP,E,MS,P

Hewlett-Packard A/S  
 Navervej 1  
**DK-8600 SILKEBORG**  
 Tel: (06) 82-71-66  
 Telex: 37409 hpas dk  
 CM,CS,E

## ECUADOR

*CYEDE Cia. Ltda.*  
*P.O. Box 6423 CCI*  
*Avenida Eloy Alfaro 1749*  
**QUITO**  
*Tel: 450-975, 243-052*  
*Telex: 2548 CYEDE ED*  
*Cable: CYEDE-Quito*  
*A,E,P*

## Hospitalar S.A.

*Casilla 3590*  
**Robles 625**  
**QUITO**  
*Tel: 454-250, 545-122*  
*Cable: HOSPITALAR-Quito*  
*M*

## EGYPT

*Samitro*  
*Sami Amin Trading Office*  
*18 Abdel Aziz Gawish*  
**ABDINE-CAIRO**  
*Tel: 24-932*  
*P*

*International Engineering Associates*  
*24 Hussein Hegazi Street*  
*Kasr-el-Aini*  
**CAIRO**  
*Tel: 23-829*  
*Telex: 93830*  
*E,M*





# SALES & SUPPORT OFFICES

Arranged alphabetically by country

## EL SALVADOR

*IPESA*  
*Boulevard de los Heroes*  
*Edificio Sarah 1148*  
**SAN SALVADOR**  
Tel: 252787  
A\*,C,E,M,P

## ETHIOPIA

*Abdella Abdulmalik*  
*P.O. Box 2635*  
**ADDIS ABABA**  
Tel: 11-93-40  
A,E,M

## FINLAND

Hewlett-Packard Oy  
Revontulentie 7  
SF-02100 **ESPOO** 10  
Tel: (90) 455-0211  
Telex: 121563 hewpa sf  
A,CM,CP,E,MS,P

## FRANCE

Hewlett-Packard France  
Le Ligoures  
Bureau de Vente de  
Aix-en-Provence  
Place Romee de Villeneuve  
F-13090 **AIX-EN-PROVENCE**  
Tel: (42) 59-41-02  
Telex: 410770F  
A,CM,CS,E,MS,P\*

Hewlett-Packard France  
Bureau de Vente de Lyon  
Chemin des Mouilles  
Boite Postale No. 162  
F-69130 **ECULLY** Cedex  
Tel: (78) 33-81-25  
Telex: 310617F  
A,CM,CP,E,MP

Hewlett-Packard France  
Immeuble France Evry  
Tour Lorraine  
Boulevard de France  
F-91035 **EVRY** Cedex  
Tel: (60) 77-96-60  
Telex: 692315F  
CM,E

Hewlett-Packard France  
Batiment Ampere  
Rue de la Commune de Paris  
Boite Postale 300  
F-95153 **LE BLANC MESNIL**  
Tel: (01) 865-44-52  
Telex: 211032F  
CM,CP,E,MS

Hewlett-Packard France  
Avenue du President JF Kennedy  
F-33700 **MERIGNAC**  
Tel: (56) 34-00-84  
Telex: 550105F  
CM,CP,E,MS

Hewlett-Packard France  
32 Rue Lothaire  
F-57000 **METZ**  
Tel: (87) 65-53-50  
CM,CS

Hewlett-Packard France  
Avenue des Tropiques  
Zone d'activites de Courtabouef  
Boite Postale 6  
F-91401 **ORSAY** Cedex  
Tel: (1) 907-78-25  
Telex: 600048F  
A,CM,CP,E,MP,P

Hewlett-Packard France  
15 Boulevard De L'Amiral Bruix  
F-75016 **PARIS**  
Tel: (01) 502-12-20  
Telex: 613663F  
CM,CP,MS,P

Hewlett-Packard France  
2 Allee de la Bourgonette  
F-35100 **RENNES**  
Tel: (99) 51-42-44  
Telex: 740912F  
CM,CS,E,MS,P\*

Hewlett-Packard France  
4 Rue Thomas Mann  
F-67033 **STRASSBOURG** Cedex  
Tel: (88) 28-56-46  
Telex: 890141F  
CM,CS,E,MS,P\*

Hewlett-Packard France  
20 Chemin de la Cepiere  
31081 **TOULOUSE** Cedex  
Tel: (61) 40-11-12  
Telex: 531639F  
A,CM,CS,E,P\*

Hewlett-Packard France  
Bureau de Vente de Lille  
Immeuble Pericentre  
Rue Van Gogh  
F-59650 **VILLENEUVE D'ASQ**  
Tel: (20) 91-41-25  
Telex: 160124F  
CM,CS,E,MS,P\*

## GERMAN FEDERAL REPUBLIC

Hewlett-Packard GmbH  
Technisches Buro Berlin  
Keithstrasse 2-4  
D-1000 **BERLIN** 30  
Tel: (030) 24-90-86  
Telex: 018 3405 hpbldn d  
CM,CS,E,P

Hewlett-Packard GmbH  
Technisches Buro Boblingen  
Herrenberger Strasse 110  
D-7030 **BOBLINGEN**  
Tel: (07031) 667-1  
Telex: 07265739 bbn  
A,CM,CP,E,MP,P

Hewlett-Packard GmbH  
Technisches Buro Dusseldorf  
Emanuel-Leutze-Strasse 1  
D-4000 **DUSSELDORF**  
Tel: (0211) 5971-1  
Telex: 085/86 533 hpdd d  
A,CM,CP,E,MS,P

Hewlett-Packard GmbH  
Vertriebszentrale Frankfurt  
Berner Strasse 117  
Postfach 560 140  
D-6000 **FRANKFURT** 56  
Tel: (0611) 50-04-1  
Telex: (841) 04 13249 hpffm d  
A,CM,CP,E,MP,P

Hewlett-Packard GmbH  
Technisches Buro Hamburg  
Kapstadttring 5  
D-2000 **HAMBURG** 60  
Tel: (040) 63804-1  
Telex: 021 63 032 hphh d  
A,CM,CP,E,MS,P

Hewlett-Packard GmbH  
Technisches Buro Hannover  
Am Grossmarkt 6  
D-3000 **HANNOVER** 91  
Tel: (0511) 46-60-01  
Telex: 092 3259  
A,CM,CS,E,MS,P

Hewlett-Packard GmbH  
Technisches Buro Nurnberg  
Neumeyerstrasse 90  
D-8500 **NURNBERG**  
Tel: (0911) 56-30-83  
Telex: 0623 860  
CM,CS,E,MS,P

Hewlett-Packard GmbH  
Technisches Buro Munchen  
Eschenstrasse 5  
D-8021 **TAUFKIRCHEN**  
Tel: (089) 6117-1  
Telex: 0524985  
A,CM,CP,E,MS,P

## GREAT BRITAIN

Hewlett-Packard Ltd.  
Trafalgar House  
Navigation Road  
**ALTRINCHAM**  
Cheshire WA14 1NU  
Tel: (061) 928-6422  
Telex: 668068  
A,CM,CP,E\*,MS

Hewlett-Packard Ltd.  
Lorrilleaux Bolton Premises  
Morely Road, Staplehill  
**BRISTOL** BS16 4QT  
Tel: (0272) 570743  
CM,CS,MS

Hewlett-Packard Ltd.  
14 Wesley Street  
**CASTLEFORD**  
Yorkshire WF10 1AE  
Tel: (0977) 550016  
Telex: 5557355  
CM,CP

Hewlett-Packard Ltd.  
9 Savoy Street  
**LONDON WC2R 0BA**  
Tel: 013797700  
CM,CP

Hewlett-Packard Ltd.  
Fourier House  
257-263 High Street  
**LONDON COLNEY**, St. Albans  
Herts., AL21HA  
Tel: (0727) 24400  
Telex: 1-8952716  
CM,CP,E,MS

Hewlett-Packard Ltd  
Tradax House, St. Mary's Walk  
**MAIDENHEAD**  
Berkshire, SL6 1ST  
Tel: (0628) 39151  
CM,CP

Hewlett-Packard Ltd.  
308/314 Kings Road  
**READING**, Berkshire  
Tel: 61022  
Telex: 84-80-68  
A,CM,E\*,MS

Hewlett-Packard Ltd.  
Quadrangle  
106-118 Station Road  
**REDHILL**, Surrey RH1 1PS  
Tel: (0737) 68655  
A,CM,CP,E,MS,P

Hewlett-Packard Ltd.  
Westminster House  
190 Stratford Road  
**SHIRLEY, SOLIHULL**  
West Midlands B90-3BJ  
Tel: (021) 7458800  
Telex: 339105  
CM,CP,MS

Hewlett-Packard Ltd.  
King Street Lane  
**WINNERSH**, Wokingham  
Berkshire RG11 5AR  
Tel: (0734) 784774  
Telex: HEWPIE WINNERSH 847178  
A,CM,E,MP,P

## GREECE

*Kostas Karaymnis*  
*8 Omirou Street*  
**ATHENS 133**  
Tel: 32-30-303, 32-37-371  
Telex: 21 59 62 RKAR GR  
E,M,P

*"Plaiso"*  
*G. Gerados*  
*24 Slournara Street*  
**ATHENS**  
Tel: 36-11-160  
Telex: 21 9492  
P

## GUAM

*Guam Medical Supply, Inc.*  
*Jay Ese Bldg., Room 210*  
*P.O. Box 8947*  
**TAMUNING 96911**  
Tel: 6464513  
Cable: EARMED Guam  
M,P

## GUATEMALA

*IPESA*  
*Avenida Reforma 3-48*  
*Zona 9*  
**GUATEMALA CITY**  
Tel: 316627, 314786, 664715  
Telex: 4192 Teltro Gu  
A,C,E,M,P

## HONG KONG

Hewlett-Packard Hong Kong, Ltd.  
Room 105, Austin Center  
1st Floor  
21 Austin Avenue  
TST P.O. Box 98524  
**KOWLOON**, Hong Kong  
Tel: 3-721143/8  
Telex: 36678 HEWPA HX  
Cable: PASIALTO Hong Kong  
E,CP,P

Hewlett-Packard Hong Kong, Ltd.  
11th Floor, Four Seas Building  
212 Nathan Road  
P.O. Box 795  
**KOWLOON**, Hong Kong  
Tel: 3697446  
Telex: 36678 HEWPA HX  
Cable: HEWPACK Hong Kong  
E,CP,P

*Schmidt & Co. (Hong Kong) Ltd.*  
*Wing On Centre, 28th Floor*  
*Connaught Road, C.*  
**HONG KONG**  
Tel: 5-455644  
Telex: 74766 SCHMX HX  
A,M

## ICELAND

*Elding Trading Company Inc.*  
*Hafnarholvi-Tryggvagolu*  
*P.O. Box 895*  
**IS-REYKJAVIK**  
Tel: 1-58-20, 1-63-03  
M

## INDIA

*Blue Star Ltd.*  
*Bhavdeep*  
*Stadium Road*  
**AHMEDABAD 380 014**  
Tel: 42932  
Telex: 012-234  
Cable: BLUEFROST  
E

*Blue Star Ltd.*  
*11 Magarath Road*  
**BANGALORE 560 025**  
Tel: 55668  
Telex: 0845-430  
Cable: BLUESTAR  
A,CM,C,E

*Blue Star Ltd.*  
*Band Box House*  
*Prabhadevi*  
**BOMBAY 400 025**  
Tel: 45-73-01  
Telex: 011-3751  
Cable: BLUESTAR  
A,M

*Blue Star Ltd.*  
*Sahas*  
*414/2 Vir Savarkar Marg*  
*Prabhadevi*  
**BOMBAY 400 025**  
Tel: 46 65 55  
Telex: 011-4093  
Cable: FROSTBLUE  
A,CM,C,E,M

*Blue Star Ltd.*  
*7 Hare Street*  
**CALCUTTA 700 001**  
Tel: 12-01-31  
Telex: 021-7655  
Cable: BLUESTAR  
A,M

*Blue Star Ltd.*  
*Meenakshi Mandiram*  
*XXXXV/1379-2 Mahatma Gandhi*  
*Road*  
**COCHIN 682-016**  
Tel: 32069  
Telex: 085-514  
Cable: BLUESTAR  
A\*

*Blue Star Ltd.*  
*133 Kodambakkam High Road*  
**MADRAS 600 034**  
Tel: 82057  
Telex: 041-379  
Cable: BLUESTAR  
A,M

*Blue Star Ltd.*  
*Bhandari House, 7th/8th Floors*  
*91 Nehru Place*  
**NEW DELHI 110 024**  
Tel: 682547, 682970  
Telex: 031-2463  
Cable: BLUESTAR  
A,CM,C,E,M

*Blue Star Ltd.*  
*1-1-117/1 Sarojini Devi Road*  
**SECUNDERABAD 500 033**  
Tel: 70126  
Telex: 0155-459  
Cable: BLUESTAR  
A,E

*Blue Star Ltd.*  
*T.C. 7/603 Poornima*  
*Maruthankuzhi*  
**TRIVANDRUM 695 013**  
Tel: 65799  
Telex: 0884-259  
Cable: BLUESTAR  
E

# SALES & SUPPORT OFFICES

Arranged alphabetically by country

717



## INDONESIA

**BERCA Indonesia P.T.**  
P.O.Box 496/Jk1.  
Jl. Abdul Muis 62  
**JAKARTA**  
Tel: 373009  
Telex: 46748 BERSAL IA  
Cable: BERSAL  
A,E,M,P  
**BERCA Indonesia P.T.**  
J.L. Jimento 23  
**SURABAYA**  
Tel: 42027  
Telex: 31146 BERSAL S.D.  
Cable: BERCACON  
A\*,E,M,P

## IRAQ

Hewlett-Packard Trading S.A.  
Mansoor City 9B/3/7  
**BAGHDAD**  
Tel: 5514973  
Telex: 2455 HEPAIRAQ 1k  
CP

## IRELAND

Hewlett-Packard Ltd.  
Kestrel House  
Clanwilliam Place  
Lower Mount Street  
**DUBLIN 2, Eire**  
Tel: 680424, 680426  
Telex: 30439  
A,E,P\*  
Hewlett-Packard Ltd.  
2C Avonberg Ind. Est.  
Long Mile Road  
**DUBLIN 12, Eire**  
Tel: 514322, 514224  
Telex: 30439  
A\*,CP,E,MS,P\*  
*Cardiac Services Ltd.*  
Kilmore Road  
Artane  
**DUBLIN 5, Eire**  
Tel: (01) 315820  
M

## ISRAEL

*Electronics & Engineering Div.*  
*Motorola Israel Ltd.*  
16 Kremenetski Street  
P.O. Box 25016  
**TEL-AVIV**  
Tel: 338973  
Telex: 33569  
Cable: BASTEL Tel-Aviv  
A,CM,C,E,M,P

## ITALY

Hewlett-Packard Italiana S.p.A.  
Via Martin Luther King, 38/III  
I-40132 **BOLOGNA**  
Tel: (051) 402394  
Telex: 511630  
CM,CS,E,MS  
Hewlett-Packard Italiana S.p.A.  
Via G. Di Vittorio 9  
I-20063 **CERNUSCO SUL NAVLIGLIO**  
Tel: (2) 903691  
Telex: 334632  
A,CM,CP,E,MP,P  
Hewlett-Packard Italiana S.p.A.  
Via Nuova san Rocco A  
Capadimonte, 62A  
I-80135 **NAPOLI**  
Tel: (081) 7413544  
A,CM,CS,E

Hewlett-Packard Italiana S.p.A.  
Via Turazza 14  
I-35100 **PADOVA**  
Tel: (49) 664888  
Telex: 430315  
A,CM,CS,E,MS  
Hewlett-Packard Italiana S.p.A.  
Via G. Armellini 10  
I-00143 **ROMA**  
Tel: (06) 546961  
Telex: 610514  
A,CM,CS,E,MS,P\*  
Hewlett-Packard Italiana S.p.A.  
Corso Giovanni Lanza 94  
I-10133 **TORINO**  
Tel: (011) 682245, 659308  
Telex: 221079  
CM,CS,E

## JAPAN

Yokogawa-Hewlett-Packard Ltd.  
Inoue Building  
1348-3, Asahi-cho  
**ATSUGI, Kanagawa 243**  
Tel: (0462) 24-0451  
CM,C\*,E  
Yokogawa-Hewlett-Packard Ltd.  
Kumagaya Ashai Building  
4 Tsuchikuba, 3-chome  
**KUMAGAYA, Saitama 360**  
Tel: (0485) 24-6563  
CM,CS,E  
Yokogawa-Hewlett-Packard Ltd.  
Mito Mitsui Building  
4-73, San-no-maru, 1-chome  
**MITO, Ibaragi 310**  
Tel: (0292) 25-7470  
CM,CS,E  
Yokogawa-Hewlett-Packard Ltd.  
Sunitomo Seimei Bldg.  
11-2 Shimo-sasajima-cho  
Nakamura-ku  
**NAGOYA, Aichi 450**  
Tel: (052) 581-1850  
CM,CS,E,MS  
Yokogawa-Hewlett-Packard Ltd.  
Chuo Bldg., 4TH FLOOR  
54-20 Nishinakajima, 5-chome  
**YODOGAWA-ku, Osaka-shi**  
**OSAKA, 532**  
Tel: (06) 304-6021  
Telex: 523-3624 YHPOSA  
A,CM,CP,E,MP,P\*

Yokogawa-Hewlett-Packard Ltd.  
29-21 Takaido-Higashi 3-chome  
Suginami-ku **TOKYO 168**  
Tel: (03) 331-6111  
Telex: 232-2024 YHPTOK  
Cable: YUHPMARKET TOK23 724  
A,CM,CP,E,MP,P\*  
Yokogawa-Hewlett-Packard Ltd.  
Tanigawa Building  
2-24-1 Tsuruya-cho  
Kanagawa-ku  
**YOKOHAMA, Kanagawa 221**  
Tel: (045) 312-1252  
Telex: 382-3204 YHP YOK  
CM,CS,E

## JORDAN

*Mouasher Cousins Company*  
P.O. Box 1387  
**AMMAN**  
Tel: 21456, 24907, 39907  
Telex: 21456 SABCO JO  
E,M,P

## KENYA

*International Aeradio (E.A.) Ltd.*  
P.O. Box 95221  
**MOMBASA**  
**M**  
*ADCOM Ltd., Inc.*  
*City House, Wabera Street*  
P.O. Box 30635  
**NAIROBI**  
Tel: 331955  
Telex: 22639  
A\*,E,M  
*International Aeradio (E.A.) Ltd*  
P.O. Box 19012  
*Nairobi Airport*  
**NAIROBI**  
Tel: 336055, 336056  
Telex: 22201, 22301  
M

## KOREA

*Samsung Electronics*  
C.P.O. 2775  
**SEOUL**  
Tel: 8334311, 8330002, 8330006  
Telex: SAMSAN 27364  
A,C,E,M,P

## KUWAIT

*Al-Khalidya Trading & Contracting*  
P.O. Box 830 Safat  
**KUWAIT**  
Tel: 42-4910, 41-1726  
Telex: 2481 Areeg kt  
A,E,M  
*Photo & Cine Equipment*  
P.O. Box 270 Safat  
**KUWAIT**  
Tel: 42-2846, 42-3801  
Telex: 2247 Matin  
P

## LUXEMBOURG

Hewlett-Packard Belgium S.A./N.V.  
Boulevard de la Woluwe 100  
Woluwedal  
**B-1200 BRUSSELS**  
Belgium  
Tel: 762/32/00  
Telex: 23-494 paloben bru  
A,CP,E,MP,P

## MALAYSIA

Hewlett-Packard Sales (Malaysia)  
Sdn. Bhd.  
Suite 2.21/2.22  
Bangunan Angkasa Raya  
Jalan Ampang  
**KUALA LUMPUR**  
Tel: 483544  
Telex: MA31011  
A,CP,E,MP,P\*  
*Protel Engineering*  
P.O. Box 1917  
Lot 319, Satok Road  
Kuching, **SARAWAK**  
Tel: 53544  
Telex: MA 70904 PROMAL  
Cable: PROTELENG  
A,E,M

## MEXICO

Hewlett-Packard Mexicana, S.A. de  
C.V.  
Av. Periferico Sur No. 6501  
Tepepan, Xochimilco  
**MEXICO CITY 23, D.F.**  
Tel: (905) 676-4600  
Telex: 017-74-507  
A,CP,E,MS,P

Hewlett-Packard Mexicana, S.A. de  
C.V.  
Rio Volga #600 Colonia del Valle  
**MONTERREY, N.L.**  
Tel: 78-42-93, 78-42-40, 78-42-41  
Telex: 038-410  
CS

## MOROCCO

*Dolbeau*  
81 rue Karatchi  
**CASABLANCA**  
Tel: 3041-82, 3068-38  
Telex: 23051, 22822  
E  
*Gerep*  
2 rue d'Agadir  
Boite Postale 156  
**CASABLANCA**  
Tel: 272093, 272095  
Telex: 23 739  
P

## MOZAMBIQUE

*A.N. Goncalves Ltd.*  
162, 1° Apt. 14 Av. D. Luis  
Caixa Postal 107  
**MAPUTO**  
Tel: 27091, 27114  
Telex: 6-203 NEGON Mo  
Cable: NEGON  
A,E,M,P

## NETHERLANDS

Hewlett-Packard Nederland B.V.  
Van Heuven Goedhartlaan 121  
**NL1181KK AMSTELVEEN**  
Tel: (20) 47-20-21  
Telex: 13 216  
A,CM,CP,E,MP,P  
Hewlett-Packard Nederland B.V.  
Bongerd 2  
**NL2906 VK CAPELLE A/D IJssel**  
Tel: (10) 51-64-44  
Telex: 21261 hepac nl  
A,CM,CP

## NEW ZEALAND

Hewlett-Packard (N.Z.) Ltd.  
169 Manukau Road  
P.O. Box 26-189  
Epsom, **AUCKLAND**  
Tel: 68-7159  
Cable: HEWPACK Auckland  
CM,CS,E,P\*  
*Northrop Instruments & Systems Ltd.*  
Eden House, 44 Khyber Pass Road  
P.O. Box 9682  
Newmarket, **AUCKLAND**  
Tel: 794-091  
A,M  
*Northrop Instruments & Systems Ltd.*  
Terrace House, 4 Oxford Terrace  
P.O. Box 8388  
**CHRISTCHURCH**  
Tel: 64-165  
A,M  
Hewlett-Packard (N.Z.) Ltd.  
4-12 Cruickshank Street  
P.O. Box 9443  
Kilbirnie, **WELLINGTON 3**  
Tel: 877-199  
Cable: HEWPACK Wellington  
CM,CP,E,P

*Northrop Instruments & Systems Ltd.*  
Sturdee House  
85-87 Ghuznee Street  
P.O. Box 2406  
**WELLINGTON**  
Tel: 850-091  
Telex: NZ 31296  
A,M

## NIGERIA

*The Electronics Instrumentations Ltd.*  
N6B/770 Oyo Road  
Oluseun House  
P.M.B. 5402  
**IBADAN**  
Tel: 461577  
Telex: 31231 TEIL NG  
A,E,M,P  
*The Electronics Instrumentations Ltd.*  
144 Agege Motor Road, Mushin  
P.O. Box 6645  
Mushin, **LAGOS**  
A,E,M,P

## NORTHERN IRELAND

*Cardiac Services Company*  
95A Finaghy Road South  
**BELFAST BT 10 OBY**  
Tel: (0232) 625-566  
Telex: 747626  
M

## NORWAY

Hewlett-Packard Norge A/S  
Nygaardsgaten 114  
P.O. Box 4210  
N-5013 Nygaardsgaten, **BERGEN**  
Tel: (05) 21-97-33  
Telex: 16621 hpnas n  
CM,CS,E  
Hewlett-Packard Norge A/S  
Oestendalen 18  
P.O. Box 34  
N-1345 **OESTERAAS**  
Tel: (02) 17-11-80  
Telex: 16621 hpnas n  
A\*,CM,CP,E,MS,P

## OMAN

*Khimi Ramdas*  
P.O. Box 19  
**MUSCAT**  
Tel: 72-22-17, 72-22-25  
Telex: 3289 BROKER MB MUSCAT  
P

## PAKISTAN

*Mushko & Company Ltd.*  
10, Bazar Road  
Sector G-6/4  
**ISLAMABAD**  
Tel: 28624  
Cable: FEMUS Rawalpindi  
A,E,M,P  
*Mushko & Company Ltd.*  
Oosman Chambers  
Abdullah Haroon Road  
**KARACHI 0302**  
Tel: 511027, 512927  
Telex: 2894 MUSHKO PK  
Cable: COOPERATOR Karachi  
A,E,M,P\*



# SALES & SUPPORT OFFICES

Arranged alphabetically by country

## PANAMA

Electronico Balboa, S.A.  
Apartado 4929  
Panama 5  
Calle Samuel Lewis  
Edificio "Alfa" No. 2  
**CIUDAD DE PANAMA**  
Tel: 64-2700  
Telex: 3480380  
Cable: ELECTRON Panama  
A,E,M,P

Foto Internacional, S.A.  
P.O. Box 2068  
Free Zone of Colon  
**COLON 3**  
Tel: 45-2333  
Telex: 3485126  
Cable: IMPORT COLON/Panama  
P

## PERU

Compania Electro Medica S.A.  
Los Flamencos 145, San Isidro  
Casilla 1030  
**LIMA 1**  
Tel: 41-4325  
Telex: Pub. Booth 25424 SISIDRO  
Cable: ELMED Lima  
A,E,M,P

## PHILIPPINES

The Online Advanced Systems  
Corporation  
Rico House, Amorsolo Cor. Herrera  
Street  
Legaspi Village, Makati  
P.O. Box 1510  
Metro **MANILA**  
Tel: 85-35-81, 85-34-91, 85-32-21  
Telex: 3274 ONLINE  
A,C,E,M

Electronic Specialists and  
Proponents Inc.  
690-B Epifanio de los Santos  
Avenue  
Cubao, **QUEZON CITY**  
P.O. Box 2649 Manila  
Tel: 98-96-81, 98-96-82, 98-96-83  
Telex: 742-40287  
Cable: ESPINC MANILA  
P

## POLAND

Buro Informacji Technicznej  
Hewlett-Packard  
Ul Slawki 2, 6P  
**PL00-950 WARSZAWA**  
Tel: 39-59-62, 39-67-43  
Telex: 81 24 53  
A,C\*,E\*,M\*,P\*

## PORTUGAL

Telectra-Empresa Tecnica de  
Equipamentos Electronicos S.a.r.l.  
Rua Rodrigo da Fonseca 103  
P.O. Box 2531  
**P-LISBON 1**  
Tel: (19) 68-60-72  
Telex: 12598  
A,C,E,P  
Mundinter  
Intercambio Mundial de Comercio  
S.a.r.l.  
P.O. Box 2761  
Avenida Antonio Augusto de Aguiar  
138  
**P-LISBON**  
Tel: (19) 53-21-31, 53-21-37  
Telex: 16691 munter p  
M

## PUERTO RICO

Hewlett-Packard Puerto Rico  
Calle 272  
#203 Urb. Country Club  
**RIO PIEDRAS**, Puerto Rico 00924  
Tel: (809) 762-7255  
Telex: 345 0514  
A,CP

## QATAR

Business Communications Quatar  
P.O. Box 3656  
**DOHA**  
Tel: 5851  
Telex: 4454  
P  
Nasser Trading & Contracting  
P.O. Box 1563  
**DOHA**  
Tel: 22170  
Telex: 4439 NASSER  
M

## RHODESIA

Field Technical Sales  
45 Kelvin Road North  
P.O. Box 3548  
**SALISBURY**  
Tel: 705231  
Telex: RH 4122  
A,E,M,P

## ROMANIA

Hewlett-Packard Reprezentanta  
Boulevard Nicolae Balcescu 16  
**BUCURESTI**  
Tel: 130725  
Telex: 10440  
C\*,E\*

## SAUDI ARABIA

Modern Electronic Establishment  
P.O. Box 193  
**AL-KHOBAR**  
Tel: 44-678, 44-813  
Telex: 670136  
Cable: ELECTA AL-KHOBAR  
C,E,M,P

Modern Electronic Establishment  
P.O. Box 1228, Baghdadiah Street  
**JEDDAH**  
Tel: 27-798  
Telex: 401035  
Cable: ELECTA JEDDAH  
C,E,M,P

Modern Electronic Establishment  
P.O. Box 2728  
**RIYADH**  
Tel: 62-596, 66-232  
Telex: 202049  
C,E,M,P

## SCOTLAND

Hewlett-Packard Ltd.  
Royal Bank Buildings  
Swan Street  
**BRECHIN**, Angus, Scotland  
Tel: 3101, 3102  
CM,CS  
Hewlett-Packard Ltd.  
**SOUTH QUEENSFERRY**  
West Lothian, EH30 9TG  
GB-Scotland  
Tel: (031) 3311000  
Telex: 72682  
CM,CP,E,MS

## SINGAPORE

Hewlett-Packard Singapore (Pte.)  
Ltd.  
6th Floor, Inchcape House  
450-452 Alexandra Road  
**SINGAPORE 0511**  
P. O. Box 58 Alexandra Post Office  
Singapore 9115  
Tel: 631788  
Telex: HPSGSO RS 32409  
Cable: HEWPACK, Singapore  
A,CP,E,MS,P

## SOUTH AFRICA

Hewlett-Packard South Africa (Pty.)  
Ltd.  
Pine Park Center  
Forest Drive, Pinelands  
**CAPE PROVINCE**, 7405  
P.O. Box 120  
Howard Place  
**CAPE PROVINCE 7450**  
Tel: 53-7955, 53-7956, 53-7957,  
53-7958, 53-7959  
Telex: 57-0006  
A,CM,CS,E,MS,P  
Hewlett-Packard South Africa (Pty.)  
Ltd.  
P.O. Box 37066  
Overport  
**DURBAN 4067**  
Tel: 28-4178, 28-4179, 28-4110  
CM,CS  
Hewlett-Packard South Africa (Pty.)  
Ltd.  
Hewlett-Packard Centre  
Daphne Street  
Private Bag Wendywood  
**SANDTON 2144**  
Tel: 802-5111  
Telex: 84782  
Cable: HEWPACK Johannesburg  
A,CM,CP,E,MS,P

## SPAIN

Hewlett-Packard Espanola S.A.  
c/Entenza 312  
**E-BARCELONA 29**  
Tel: (3) 322-24-51, 321-73-54  
Telex: 52603 hpbe e  
A,CM,CP,E,MS,P  
Hewlett-Packard Espanola S.A.  
c/San Vicente s/n  
Edificio Albia II, 7°B  
**E-BILBAO 1**  
Tel: 423-82-06, 423-83-06  
A,CM,E,MS

Hewlett-Packard Espanola S.A.  
Calle Jerez 3  
**E-MADRID 16**  
Tel: (1) 458-2600  
Telex: 23515 hpe  
A,CM,E,MP,P

Hewlett-Packard Espanola S.A.  
Colonia Mirasierra  
Edificio Juban  
c/o Costa Brava 13  
**E-MADRID 34**  
Tel: (1) 734-8061, 734-1162  
CM,CP

Hewlett-Packard Espanola S.A.  
Av Ramon y Cajal 1  
Edificio Sevilla 1, Planta 9  
**E-SEVILLA 5**  
Tel: (954) 64-44-54, 64-44-58  
A,CM,CS,MS,P  
Hewlett-Packard Espanola S.A.  
C/Ramon Gordillo 1 (Entlo.)  
**E-VALENCIA 10**  
Tel: (96) 361-1354  
CM,CS,P

## SRI LANKA

Metropolitan Agencies Ltd.  
209/9 Union Place  
**COLOMBO 2**  
Tel: 35947  
Telex: 1377METROLTD CE  
Cable: METROLTD  
A,E,M,P

## SUDAN

Radison Trade  
P.O. Box 921  
**KHARTOUM**  
Tel: 44048  
Telex: 375  
A,E,M

## SURINAM

Surtel Radio Holland N.V.  
Grote Holstr. 3-5  
P.O. Box 155  
**PARAMARIBO**  
Tel: 72118, 77880  
Cable: Surtel  
E,M

## SWEDEN

Hewlett-Packard Sverige AB  
Enighetsvagen 3  
S-16120 **BROMMA**  
Tel: (08) 730-0550  
Telex: (854) 10721 MESSAGES  
Cable: MEASUREMENTS  
A,CM,CP,E,MS,P

Hewlett-Packard Sverige AB  
Sunnanvagen 14K  
**S-22226 LUND**  
Tel: (46) 13-69-79  
CM,CS

Hewlett-Packard Sverige AB  
Vastra Vintergatan 9  
S-70344 **OREBRO**  
Tel: (019) 14-07-20  
CM,CS

Hewlett-Packard Sverige AB  
Frotallsgatan 30  
S-42132 **VASTRA-FROLUNDA**  
Tel: (031) 49-09-50  
Telex: 85410721  
CM,CS,E,P

## SWITZERLAND

Hewlett-Packard (Schweiz) AG  
Clarastrasse 12  
CH-4058 **BASEL**  
Tel: (061) 33-59-20  
A,CM

Hewlett-Packard (Schweiz) AG  
Bahnhofstrasse 44  
3018 **BERN**  
Tel: (031) 56-24-22  
CM

Hewlett-Packard (Schweiz) AG  
47 Avenue Blanc  
CH-1202 **GENEVA**  
Tel: (022) 32-30-05, 32-48-00  
CM,CP

Hewlett-Packard (Schweiz) AG  
29 Chemin Chateau Bloc  
CH-1219 **LE LIGNON**-Geneva  
Tel: (022) 96-03-22  
Telex: 27333 hpag ch  
Cable: HEWPACKAG Geneva  
A,CM,E,MS,P

Hewlett-Packard (Schweiz) AG  
Zurcherstrasse 20  
P.O. Box 307  
CH-8952 **SCHLIEREN**-Zurich  
Tel: (01) 730-5240, 730-1821  
Telex: 53933 hpag ch  
Cable: HPAG CH  
A,CM,CP,E,MS,P

## SYRIA

General Electronic Inc.  
Nuri Basha-Ahnaf Ebn Kays Street  
P.O. Box 5781  
**DAMASCUS**  
Tel: 33-24-87  
Telex: 11215 ITIKAL  
Cable: ELECTROBOR DAMASCUS  
E

Sawah & Co.  
Place Azme  
Boite Postale 2308

**DAMASCUS**  
Tel: 16-367, 19-697, 14-268  
Telex: 11304 SATACO SY  
Cable: SAWAH, DAMASCUS  
M

Suleiman Hilal El Miawi  
P.O. Box 2528  
Mamoun Bitar Street, 56-58  
**DAMASCUS**  
Tel: 11-46-63  
Telex: 11270  
Cable: HILAL DAMASCUS  
M

## TAIWAN

Hewlett-Packard Far East Ltd.  
Kaohsiung Branch  
68-2, Chung Cheng 3rd Road  
Shin Shin, Chu  
**KAOSHIUNG**  
Tel: 241-2318, 261-3253  
CS,E,MS,P

Hewlett-Packard Far East Ltd.  
Taiwan Branch  
Bank Tower, 5th Floor  
205 Tun Hwa North Road  
**TAIPEI**  
Tel: 751-0404  
Cable: HEWPACK Taipei  
A\*,CP,E,MS,P  
San Kwang Instruments Co., Ltd.  
20 Yung Sui Road  
**TAIPEI**

Tel: 361-5446, 361-5447,  
361-5448, 361-5449  
Telex: 22894 SANKWANG  
Cable: SANKWANG Taipei  
A

## TANZANIA

International Aeradio (E.A.) Ltd.  
P.O. Box 861  
**DAR ES SALAAM**  
Tel: 21251  
Telex: 41030  
M

## THAILAND

UNIMESA Co. Ltd.  
Elcom Research Building  
2538 Sukhumvit Ave.  
Bangchak, **BANGKOK**  
Tel: 393-2387, 393-0338  
Telex: TH81160, 82938, 81038  
Cable: UNIMESA Bangkok  
A,E,M

Bangkok Business Equipment Ltd.  
5/5-6 Dejo Road  
**BANGKOK**  
Tel: (022) 96-03-22  
Telex: 234-8670, 234-8671,  
234-8672, 234-8673  
Cable: BUSIQUIPT Bangkok  
P

## TRINIDAD & TOBAGO

CARTEL  
Caribbean Telecoms Ltd.  
P.O. Box 732  
50/A Jerningham Avenue  
**PORT-OF-SPAIN**  
Tel: 62 4214, 62 4213  
A,E,M,P

# SALES & SUPPORT OFFICES

Arranged alphabetically by country



## TUNISIA

Tunisie Electronique  
31 Avenue de la Liberte

**TUNIS**  
Tel: 280-144  
E,P

## Corema

1 Ier. Av. de Carthage

**TUNIS**  
Tel: 253-821  
Telex: 12319 CABAM TN  
M

## TURKEY

Teknim Company Ltd.

Riza Sah Pehlivi

Caddesi No. 7

Kavaklidere, ANKARA

Tel: 275800

Telex: 42155

E

## UNITED ARAB EMIRATES

Emilac Ltd.

P.O. Box 2711

ABU DHABI

Tel: 331370, 331371

E,M,P

Emilac Ltd.

P.O. Box 1641

SHARJAH

Tel: 354121, 354123

Telex: 68136

E,M,P

## UNITED KINGDOM

see: GREAT BRITAIN

NORTHERN IRELAND

SCOTLAND

## UNITED STATES OF AMERICA

### Alabama

Hewlett-Packard Co.  
700 Century Park South  
Suite 128

BIRMINGHAM, AL 35226

Tel: (205) 822-6802

CM,CS,MP

Hewlett-Packard Co.

P.O. Box 4207

8290 Whitesburg Drive, S.E.

HUNTSVILLE, AL 35802

Tel: (205) 881-4591

CM,CP,E,M\*

### Alaska

Hewlett-Packard Co.

1577 "C" Street, Suite 252

ANCHORAGE, AK 99510

Tel: (206) 454-3971

CM,CS\*\*

### Arizona

Hewlett-Packard Co.

2336 East Magnolia Street

PHOENIX, AZ 85034

Tel: (602) 273-8000

A,CM,CP,E,MS

Hewlett-Packard Co.

2424 East Aragon Road

TUCSON, AZ 85706

Tel: (602) 889-4661

CM,CS,E,MS\*\*

### Arkansas

Hewlett-Packard Co.

P.O. Box 5646

Brady Station

LITTLE ROCK, AR 72215

Tel: (501) 376-1844

CM,MS

### California

Hewlett-Packard Co.

7621 Canoga Avenue

CANOGA PARK, CA 91304

Tel: (213) 702-8300

A,CM,CP,E,P

Hewlett-Packard Co.

1579 W. Shaw Avenue

FRESNO, CA 93771

Tel: (209) 224-0582

CM,MS

Hewlett-Packard Co.

1430 East Orangethorpe

FULLERTON, CA 92631

Tel: (714) 870-1000

CM,CP,E,MP

Hewlett-Packard Co.

5400 W. Rosecrans Boulevard

LOS ANGELES, CA 90260

Tel: (213) 970-7500

CM,CP,MP

Hewlett-Packard Co.

3939 Lankersham Blvd.

NORTH HOLLYWOOD, CA 91604

Tel: (213) 877-1282

regional headquarters

Hewlett-Packard Co.

3200 Hillview Avenue

PALO ALTO, CA 94304

Tel: (415) 857-8000

CM,CP,E

Hewlett-Packard Co.

646 W. North Market Boulevard

SACRAMENTO, CA 95834

Tel: (916) 929-7222

A\*,CM,CS,E,MS

Hewlett-Packard Co.

9606 Aero Drive

P.O. Box 23333

SAN DIEGO, CA 92123

Tel: (714) 279-3200

CM,CP,E,MP

Hewlett-Packard Co.

363 Brookhollow Drive

SANTA ANA, CA 92705

Tel: (714) 641-0977

A,CM,C\*,E

Hewlett-Packard Co.

3003 Scott Boulevard

SANTA CLARA, CA 95050

Tel: (408) 988-7000

A,CM,CP,E,MP

Hewlett-Packard Co.

454 Carlton Court

SO. SAN FRANCISCO, CA 94080

Tel: (415) 877-0772

CM,CP

### Colorado

Hewlett-Packard Co.

5600 DTC Parkway

ENGLEWOOD, CO 80110

Tel: (303) 771-3455

A,CM,CP,E,MS

### Connecticut

Hewlett-Packard Co.

47 Barnes Industrial Road South

P.O. Box 5007

WALLINGFORD, CT 06492

Tel: (203) 265-7801

A,CM,CP,E,MS

### Florida

Hewlett-Packard Co.

P.O. Box 24210

2727 N.W. 62nd Street

FORT LAUDERDALE, FL 33309

Tel: (305) 973-2600

CM,CP,E,MP

Hewlett-Packard Co.

4080 Woodcock Drive, #132

Brownell Building

JACKSONVILLE, FL 32207

Tel: (904) 398-0663

CM,C\*,E\*,MS\*\*

Hewlett-Packard Co.

P.O. Box 13910

6177 Lake Ellenor Drive

ORLANDO, FL 32809

Tel: (305) 859-2900

A,CM,CP,E,MS

Hewlett-Packard Co.

P.O. Box 12826

Suite 5, Building 1

Office Park North

PENSACOLA, FL 32575

Tel: (904) 476-8422

A,CM,MS

Hewlett-Packard Co.

110 South Hoover, Suite 120

TAMPA, FL 33609

Tel: (813) 872-0900

A\*,CM,CS,E\*,M\*

### Georgia

Hewlett-Packard Co.

P.O. Box 105005

450 Interstate N. Parkway

ATLANTA, GA 30339

Tel: (404) 955-1500

Telex: 810-766-4890

A,CM,CP,E,MP

Hewlett-Packard Co.

Executive Park Suite 306

P.O. Box 816

AUGUSTA, GA 30903

Tel: (404) 736-0592

CM,MS

Hewlett-Packard Co.

P.O. Box 2103

1172 N. Davis Drive

WARNER ROBINS, GA 31098

Tel: (912) 922-0449

CM,E

### Hawaii

Hewlett-Packard Co.

2875 South King Street

HONOLULU, HI 96826

Tel: (808) 955-4455

A,CM,CS,E,MS

### Idaho

Hewlett-Packard Co.

11311 Chinden Boulevard

BOISE, ID 83707

Tel: (208) 376-6000

CM,CS,M\*

### Illinois

Hewlett-Packard Co.

211 Prospect Road

BLOOMINGTON, IL 61701

Tel: (309) 663-0383

CM,CS,MS\*\*

Hewlett-Packard Co.

1100 31st Street

DOWNERS GROVE, IL 60515

Tel: (312) 960-5760

CM,CP

Hewlett-Packard Co.

5201 Tollview Drive

ROLLING MEADOWS, IL 60008

Tel: (312) 255-9800

A,CM,CP,E,MP

### Indiana

Hewlett-Packard Co.

P.O. Box 50807

7301 No. Shadeland Avenue

INDIANAPOLIS, IN 46250

Tel: (317) 842-1000

A,CM,CS,E,MS

### Iowa

Hewlett-Packard Co.

5815 S.W. 5th Street

DES MOINES, IA 50315

Tel: (515) 243-5876

CM,MS\*\*

Hewlett-Packard Co.

2415 Heinz Road

IOWA CITY, IA 52240

Tel: (319) 351-1020

CM,CS,E\*,MS

### Kansas

Hewlett-Packard Co.

514 South Westview

DERBY, KA 67037

Tel: (316) 265-5200

CM,CS

### Kentucky

Hewlett-Packard Co.

10170 Linn Station Rd., Suite 525

Alkinson Square

LOUISVILLE, KY 40223

Tel: (502) 426-0100

A,CM,CS,MS

### Louisiana

Hewlett-Packard Co.

P.O. Box 1449

3229 Williams Boulevard

KENNER, LA 70062

Tel: (504) 443-6201

A,CM,CS,E,MS

### Maryland

Hewlett-Packard Co.

7121 Standard Drive

HANOVER, MD 21076

Tel: (301) 796-7700

A,CM,CP,E,MS

Hewlett-Packard Co.

2 Choke Cherry Road

ROCKVILLE, MD 20850

Tel: (301) 948-6370

A,CM,CP,E,MP

### Massachusetts

Hewlett-Packard Co.

32 Hartwell Avenue

LEXINGTON, MA 02173

Tel: (617) 861-8960

A,CM,CP,E,MP

### Michigan

Hewlett-Packard Co.

23855 Research Drive

FARMINGTON HILLS, MI 48024

Tel: (313) 476-6400

A,CM,CP,E,MP

Hewlett-Packard Co.

4326 Cascade Road S.E.

GRAND RAPIDS, MI 49506

Tel: (616) 957-1970

CM,CS,MS

### Minnesota

Hewlett-Packard Co.

2025 W. Larpenteur Ave.

ST. PAUL, MN 55113

Tel: (612) 644-1100

A,CM,CP,E,MP

### Mississippi

Hewlett-Packard Co.

322 N. Mart Plaza

JACKSON, MS 39206

Tel: (601) 982-9363

CM,MS

### Missouri

Hewlett-Packard Co.



# SALES & SUPPORT OFFICES

Arranged alphabetically by country

## North Carolina

Hewlett-Packard Co.  
5605 Roanne Way  
**GREENSBORO, NC 27409**  
Tel: (919) 852-1800  
A,CM,CP,E,MS

## Ohio

Hewlett-Packard Co.  
9920 Carver Road  
**CINCINNATI, OH 45242**  
Tel: (513) 891-9870  
CM,CP,MS

Hewlett-Packard Co.  
16500 Sprague Road  
**CLEVELAND, OH 44130**  
Tel: (216) 243-7300  
Telex: 810-423-9430  
A,CM,CP,E,MS

Hewlett-Packard Co.  
962 Crupper Ave.  
**COLUMBUS, OH 43229**  
Tel: (614) 432-1041  
CM,CP,E\*

Hewlett-Packard Co.  
330 Progress Rd.  
**DAYTON, OH 45449**  
Tel: (513) 859-8202  
A,CM,CP,E\*,MS

## Oklahoma

Hewlett-Packard Co.  
P.O. Box 32008  
6301 N. Meridan Avenue  
**OKLAHOMA CITY, OK 73122**  
Tel: (405) 721-0200  
A\*,CM,CP,E\*,MS

Hewlett-Packard Co.  
Suite 121  
9920 E. 42nd Street  
**TULSA, OK 74145**  
Tel: (918) 665-3300  
A\*\*,CM,CS,M\*

## Oregon

Hewlett-Packard Co.  
9255 Pioneer Court  
**WILSONVILLE, OR 97070**  
Tel: (503) 682-8000  
A,CM,CP,E\*,MS

## Pennsylvania

Hewlett-Packard Co.  
Crystal Brook Professional Building  
Route 35  
**EATONTOWN, PA 07724**  
Tel: (201) 542-1384  
A\*,CM,C\*,E\*,P\*

Hewlett-Packard Co.  
1021 8th Avenue  
King of Prussia Industrial Park  
**KING OF PRUSSIA, PA 19406**  
Tel: (215) 265-7000  
Telex: 510-660-2670  
A,CM,CP,E,MP

Hewlett-Packard Co.  
111 Zeta Drive  
**PITTSBURGH, PA 15238**  
Tel: (412) 782-0400  
A,CM,CP,E,MP

## South Carolina

Hewlett-Packard Co.  
P.O. Box 6442  
6941-1 N. Trenholm Road  
**COLUMBIA, SC 29260**  
Tel: (803) 782-6493  
CM,CS,E,MS

## Tennessee

Hewlett-Packard Co.  
8906 Kingston Pike  
**KNOXVILLE, TN 37919**  
Tel: (615) 691-2371  
A\*,CM,MS

Hewlett-Packard Co.  
3070 Directors Row  
Directors Square  
**MEMPHIS, TN 38131**  
Tel: (901) 346-8370  
A,CM,CS,MS

Hewlett-Packard Co.  
Suite 103  
478 Craighead Street  
**NASHVILLE, TN 37204**  
Tel: (615) 383-9130  
CM,MS\*\*

## Texas

Hewlett-Packard Co.  
Suite 310W  
7800 Shoal creek Blvd.  
**AUSTIN, TX 78757**  
Tel: (512) 459-3143  
CM,E

Hewlett-Packard Co.  
Suite C110  
4171 North Mesa  
**EL PASO, TX 79902**  
Tel: (915) 533-3555  
CM,CS,E\*,MS\*\*

Hewlett-Packard Co.  
5020 Mark IV Parkway  
**FORT WORTH, TX 76106**  
Tel: (817) 625-6361  
CM,C\*

Hewlett-Packard Co.  
10535 Harwin Street  
**HOUSTON, TX 77036**  
Tel: (713) 776-6400  
A,CM,CP,E,MP

Hewlett-Packard Co.  
P.O. Box 1270  
930 E. Campbell Rd.  
**RICHARDSON, TX 75081**  
Tel: (214) 231-6101  
A,CM,CP,E,MP

Hewlett-Packard Co.  
205 Billy Mitchell Road  
**SAN ANTONIO, TX 78226**  
Tel: (512) 434-8241  
CM,CS,E,MS

## Utah

Hewlett-Packard Co.  
3550 W. 2100 South Street  
**SALT LAKE CITY, UT 84119**  
Tel: (801) 974-1700  
A,CM,CP,E,MS

## Virginia

Hewlett-Packard Co.  
P.O. Box 9669  
2914 Hungary Spring Road  
**RICHMOND, VA 23228**  
Tel: (804) 285-3431  
A,CM,CP,E,MS

Hewlett-Packard Co.  
3110 Peters Creek Road, N.W.  
**ROANOKE, VA 24015**  
Tel: (703) 922-7000  
CM,CS,E\*\*

Hewlett-Packard Co.  
5700 Thurston Avenue  
**VIRGINIA BEACH, VA 23455**  
Tel: (804) 460-2471  
CM,CS,MS

## Washington

Hewlett-Packard Co.  
Bellefield Office Park  
1203 114th Ave. S.E.  
**BELLEVUE, WA 98004**  
Tel: (206) 454-3971  
A,CM,CP,E,MP

Hewlett-Packard Co.  
Suite A-1  
708 North Argonne Road  
**SPOKANE, WA 99206**  
Tel: (509) 535-0864  
CM,CS

## West Virginia

Hewlett-Packard Co.  
4604 MacCorkle Ave., S.E.  
**CHARLESTON, WV 25304**  
Tel: (304) 925-0492  
A,CM,MS

## Wisconsin

Hewlett-Packard Co.  
150 S. Sunny Slope Road  
**BROOKFIELD, WI 53005**  
Tel: (414) 784-8800  
A,CM,CS,E\*,MP

## URUGUAY

*Pablo Ferrando S.A.C. e.l.*  
*Avenida Italia 2877*  
*Casilla de Correo 370*  
**MONTEVIDEO**  
Tel: 40-3102  
Telex: 901 Public Booth Para Pablo  
*Ferrando 919520*  
Cable: RADIUM Montevideo  
A,E,M

*Guillermo Kraft del Uruguay S.A.*  
*Avda. Libertador Brig. Gral.*  
*Lavalleja 2083*  
**MONTEVIDEO**  
Tel: 23 45 88, 23 48 08, 20 88 30  
P

## VENEZUELA

Hewlett-Packard de Venezuela C.A.  
P. O. Box 50933  
3a Transversal Los Ruices Norte  
Edificio Segre 2Y3  
**CARACAS 1071**  
Tel: 239-4133  
Telex: 25146 HEWPACK  
Cable: HEWPACK Caracas  
A,CP,E,MS,P

## YUGOSLAVIA

*Iskra Commerce, n. sol. o.*  
*Zastopstvo Hewlett-Packard*  
*Obilicev Venac 26*  
**YU 11000 BEOGRAD**  
Tel: 636955  
Telex: 11530  
C\*,E\*,M\*,P\*

*Iskra Commerce, n. sol. o.*  
*Zastopstvo Hewlett-Packard*  
*Miklosiceva 38/VII*  
**YU-61000 LJUBLJANA**  
Tel: 321674, 315870  
Telex: 31300  
C\*,E\*,M\*,P\*

## ZAMBIA

*R.J. Tilbury (Zambia) Ltd.*  
*P.O. Box 2792*  
**LUSAKA**  
Tel: 81243  
A,E,M,P

## FOR COUNTRIES AND AREAS NOT LISTED:

### CANADA

#### Ontario

Hewlett-Packard (Canada) Ltd.  
6877 Goreway Drive  
**MISSISSAUGA, Ontario L4V 1M8**  
Tel: (416) 678-9430  
Telex: 610-492-4246

### EASTERN USA

#### New Jersey

Hewlett-Packard Co.  
W120 Century Road  
**PARAMUS, NJ 07652**  
Tel: (201) 265-5000

### MIDWESTERN USA

#### Illinois

Hewlett-Packard Co.  
5201 Tollview Drive  
**ROLLING MEADOWS, IL 60008**  
Tel: (312) 255-9800

### SOUTHERN USA

#### Georgia

Hewlett-Packard Co.  
P.O. Box 105005  
450 Interstate N. Parkway  
**ATLANTA, GA 30339**  
Tel: (404) 955-1500  
Telex: 810-766-4890

### WESTERN USA

#### California

Hewlett-Packard Co.  
3939 Lankersham Blvd.  
**NORTH HOLLYWOOD, CA 91604**  
Tel: (213) 877-1282

## EAST EUROPEAN AREAS

### AUSTRIA

Hewlett-Packard Ges.m.b.h.  
Wehlstrasse 29  
P.O. Box 7  
A-1205 VIENNA, Austria  
Tel: (222) 35-16-20  
Telex: 135823/135066

## EUROPEAN AREAS

### SWITZERLAND

Hewlett-Packard S.A.  
7 Rue du Bois-du-Lan  
CH-1217 MEYRIN 2, Switzerland  
Tel: (022) 98-96-51  
Telex: 27835 hpse  
Cable: HEWPACKSA Geneve

## MEDITERRANEAN AND MIDDLE EAST AREAS

### GREECE

Hewlett-Packard S.A.  
Mediterranean & Middle East  
Operations  
35 Kolokotroni St.  
Platia Kefallariou  
GR-Kifissia, ATHENS, Greece  
Tel: 808-0359, 808-0429  
Telex: 21-6588  
Cable: HEWPACKSA Athens

### OTHER AREAS

Hewlett-Packard Co.  
ICON Headquarters  
3495 Deer Creek Road  
**PALO ALTO, CA 94304**  
U.S.A.  
Tel: (415) 857-2824  
TWX: 910-373-1267  
Telex: 034-8300; 034-8493  
Cable: HEWPACK



**HEWLETT  
PACKARD**

